

ELECTRONIC & RADIO ENGINEER

Incorporating **WIRELESS ENGINEER**

In this issue

Total Differential Feedback

Foster-Seeley Discriminator

Coaxial Transmission Lines

Push-Pull Amplifier Design

**Three shillings
and sixpence**

FEBRUARY 1958 Vol 35 *new series* No 2

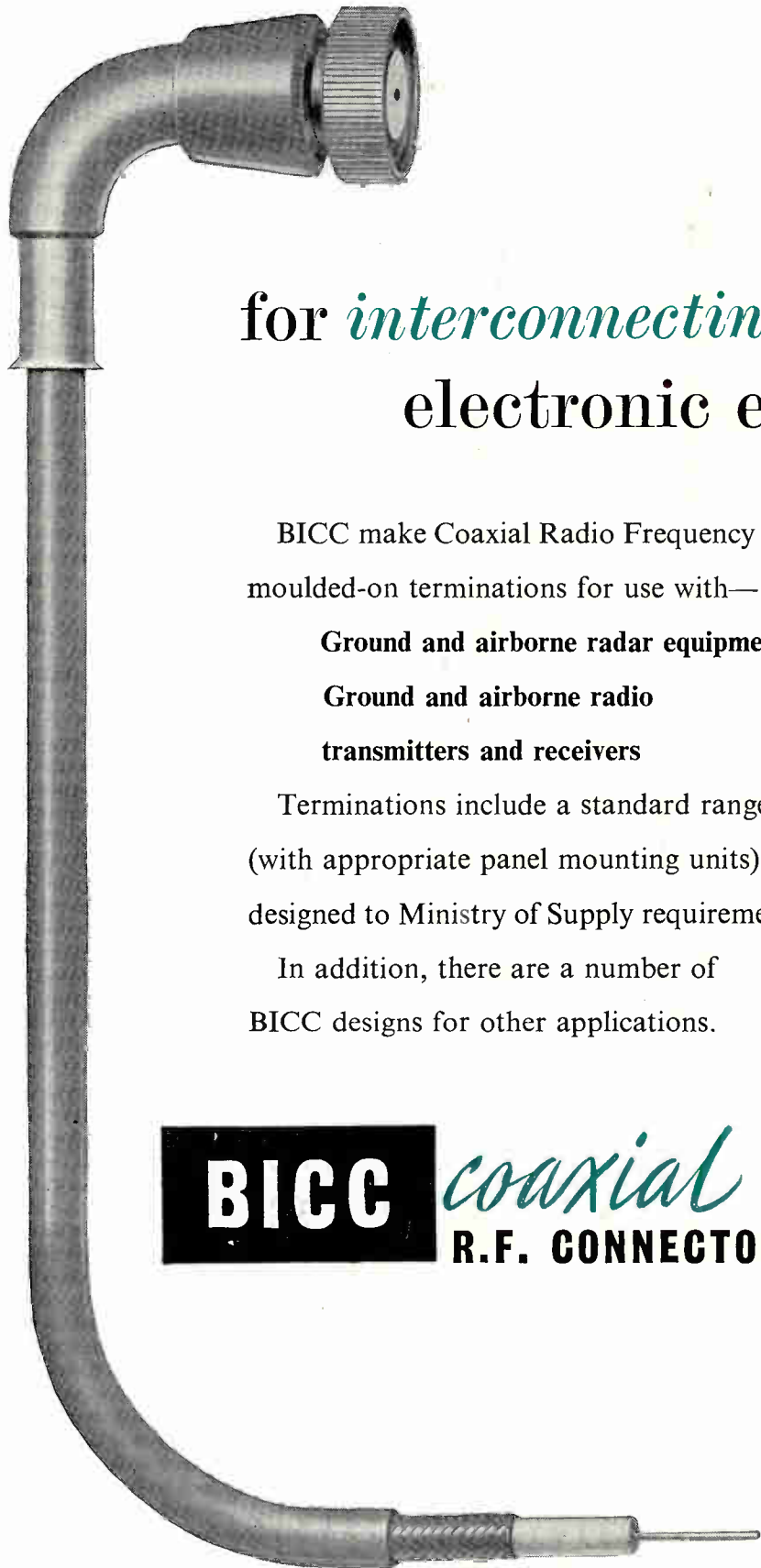

for *interconnecting*
electronic equipment

BICC make Coaxial Radio Frequency Connectors with moulded-on terminations for use with—

Ground and airborne radar equipment

Ground and airborne radio

transmitters and receivers

Terminations include a standard range (with appropriate panel mounting units) designed to Ministry of Supply requirements.

In addition, there are a number of BICC designs for other applications.

BICC *coaxial*
R.F. CONNECTORS

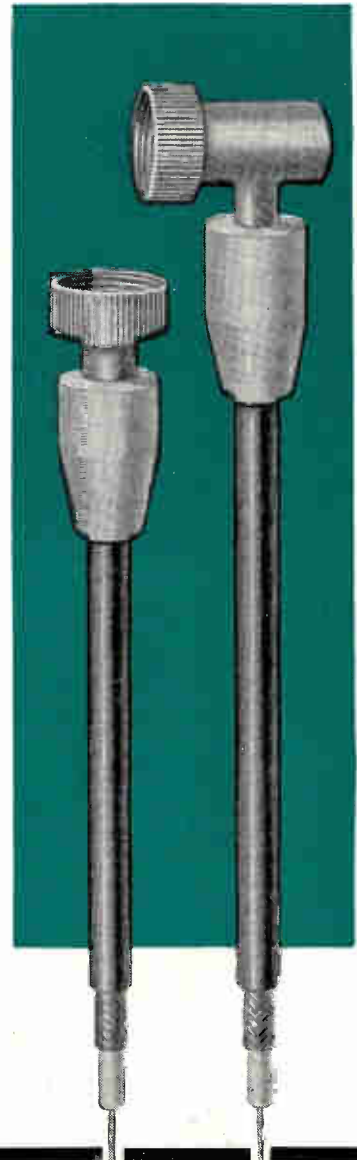

BRITISH INSULATED CALLENDER'S CABLES LIMITED,
21 Bloomsbury Street, London, W.C.1

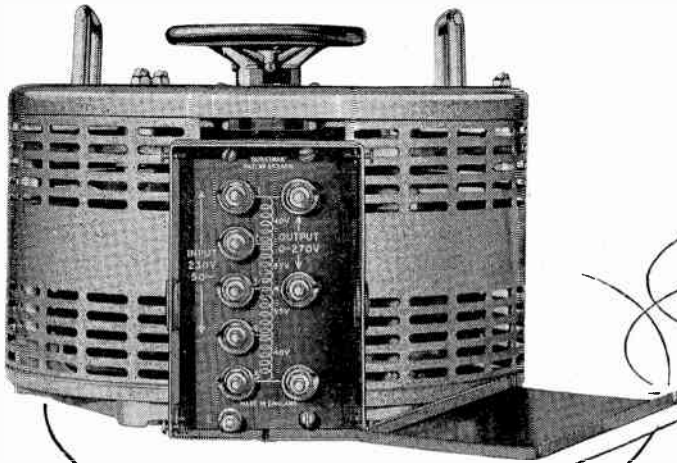

Smooth voltage control -with 'VARIAC'

'VARIAC' (Regd. Trademark) is the *original*, continuously adjustable auto-transformer—the only one having 'DURATRAK' (Regd. U.K. Patent No. 693,406)—and it provides unrivalled smoothness of a-c voltage control for any electrical, electronic, radar or communications equipment. 'DURATRAK' is a track plated with precious metal alloy which ensures very long life, absolute reliability, much increased overload capacity, and high resistance to accidental short-circuits. Compared with the losses of resistive controls 'VARIACS' often save their initial cost within a year.

With the 'VARIAC', voltages from zero to 17% above line are obtained by a 320° rotation of the shaft and an accurately calibrated direct-reading dial is provided. 'VARIACS' are very competitively priced, and are available in many sizes from 170 VA up to 25 kilowatts including 3 gang assemblies for 3-phase working—there are many patterns for use on frequencies up to several thousand cycles/second.

Write for a well illustrated catalogue 424—U.K., and a handy pocket-sized reference Price List VSP—57/16, which give full information about the entire 'VARIAC' range.

Technical Information on the New 4 KVA 'VARIAC' type V-30-HM

(illustrated above)



The 'VARIAC' type V-30-HM effectively meets the insistent demand for a 'VARIAC' of a rating between series 100 (2.0 kVA) and series 50 (7.0 kVA). It features the latest 'rolled' core of ultra-low-loss type and 'DURATRAK' (U.K. Patent No. 693,406), a Rhodium-covered, silver-plated track surface which eliminates the possibility of deterioration due to oxidation, and greatly reduces contact resistance.

INPUT VOLTAGE: 230 (tap at 115). (Voltages above 230, but not exceeding 270, across entire winding).

OUTPUT: 0-270V, on 230V, using 'overvoltage' feature. (Alternatively, 0-Line Voltage).

OUTPUT CURRENT: 15A (rated); 17.5A (maximum).

DIMENSIONS: Only 11 in. x 11 in. x 8 in. (shielded type); depth behind panels (open type), only 6½ in. Weight: 48 lb.

NET PRICES: V-30-H (open style) £41.16.0, Net. V-30-HM (shielded). £42.12.6, Net.

GANGED MODELS: available at very short notice. A 3-gang, 3-phase assembly, arranged in "Star" (for example), for use on 415/3/50, will handle 12.5 kVA, and will cost £130.7.0. Net, delivered. (2-Brush, i.e.: dual-output model also available).

ONLY 'VARIAC' HAS 'DURATRAK'



Claude Lyons Ltd.



76 OLDHALL STREET · LIVERPOOL 3 · LANCS Telephone: Central 4641/2
VALLEY WORKS · HODDESDON · HERTS Telephone: HODdesdon 3007/8/9

CL19

VIBRATION EQUIPMENT

GOODMANS VG.108 VIBRATION GENERATOR—designed and produced entirely by British Enterprise—the first such equipment available from British sources with peak thrust capabilities over one ton. The VG.108 is suitable for vibration testing complete assemblies of moderate mass to current test specifications, with reserves, in thrust and frequency characteristics, adequate to cope with future extensions of test techniques. Random and environmental waveforms can be applied to the VG.108

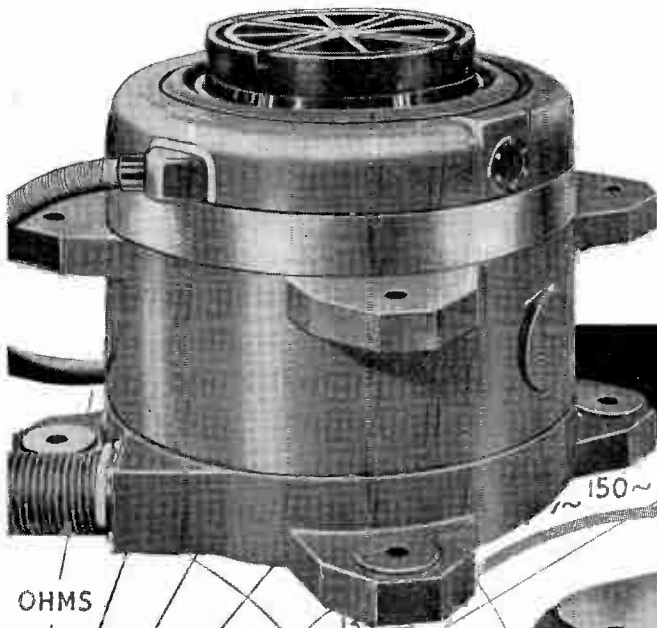

MODEL VG. 108

Peak thrust up to 3,000 lb.
Frequency range ... up to 1 kc/s

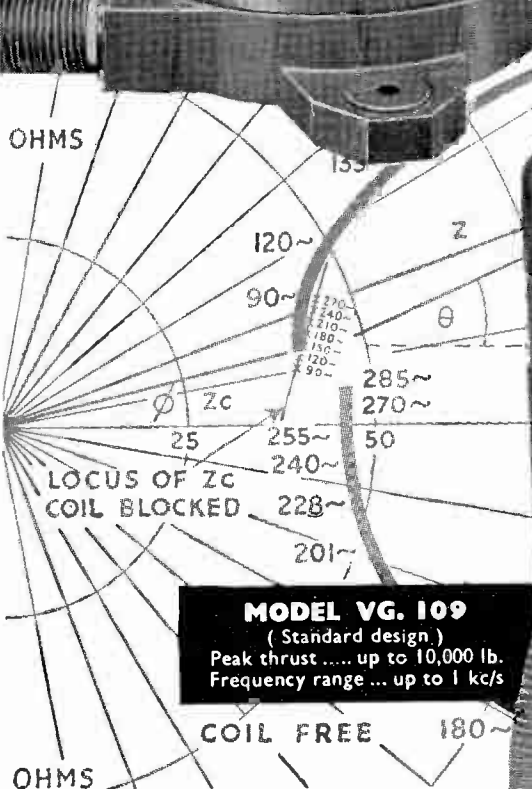

MODEL VG. 109

(Standard design)

Peak thrust up to 10,000 lb.
Frequency range ... up to 1 kc/s

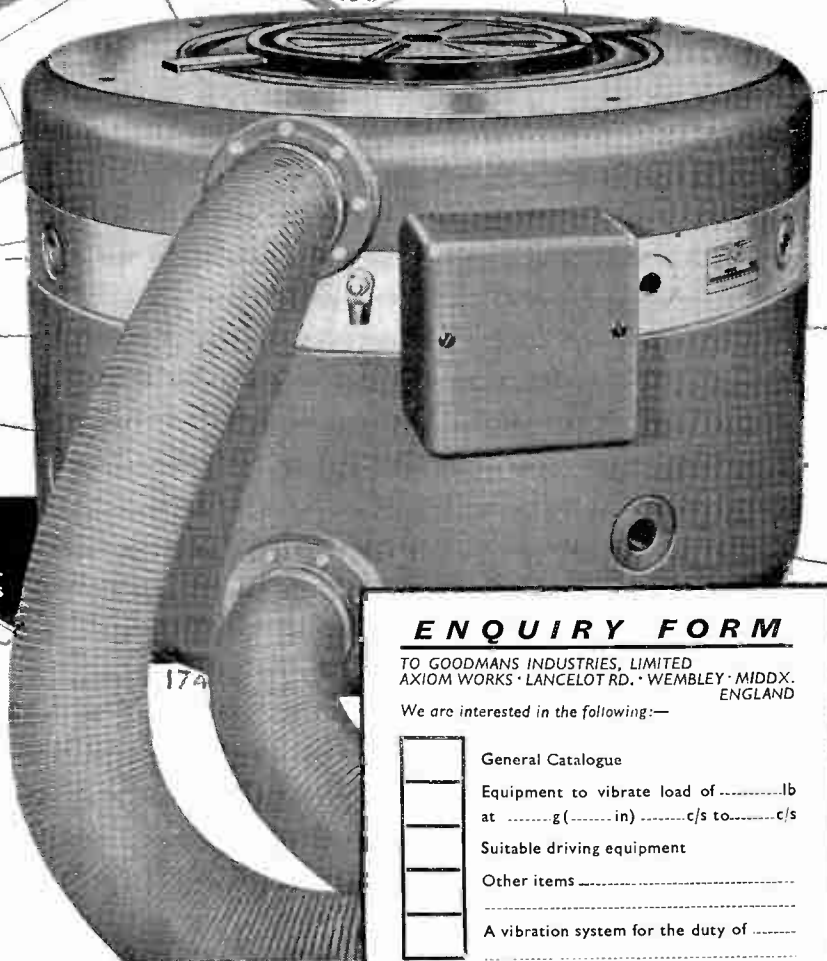

The only European Vibration Generator suitable for work on large complete units, GOODMANS VG.109 provides peak thrusts of 8,000 lb. up to 500 c/s. As with the VG.108, this Generator is suitable for use with random or environmental waveforms. For special purpose applications, this model may be suitably modified.

Consult our Technical Advice Bureau if you have any problem concerning vibration.

GOODMANS

Vibration Generators

GOODMANS INDUSTRIES, LIMITED

AXIOM WORKS · WEMBLEY · MIDDX · ENGLAND
Telephone: WEMBLEY 1200 (8 lines)

GD.19

2

ENQUIRY FORM

TO GOODMANS INDUSTRIES, LIMITED
AXIOM WORKS · LANCELOT RD. · WEMBLEY · MIDDX. ENGLAND

We are interested in the following:—

<input type="checkbox"/>	General Catalogue
<input type="checkbox"/>	Equipment to vibrate load oflb atg (.....in)c/s to.....c/s
<input type="checkbox"/>	Suitable driving equipment
<input type="checkbox"/>	Other items
<input type="checkbox"/>	A vibration system for the duty of

Name

Company

Address

Please mark details required.

R/19

Electronic & Radio Engineer, February 1958

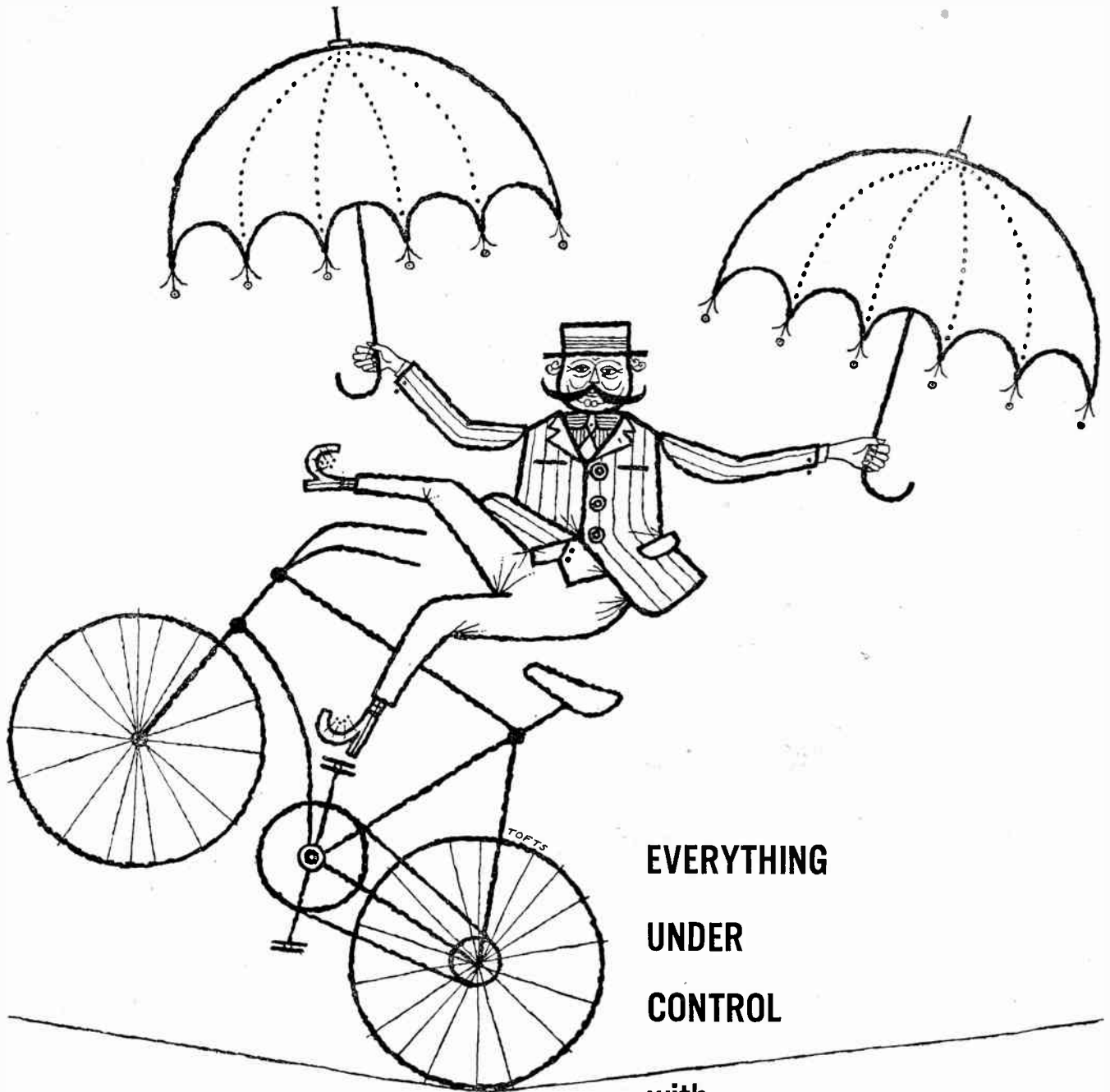

**EVERYTHING
UNDER
CONTROL**

with

Servomex

A.C. Voltage Stabilisers

which could help YOUR electrical measuring gear to work at its best... the cost, at 5d. to 1/- per watt is trifling... may we send details? a scribbled name and address on this page will suffice.

P.S.—87% of our orders are repeats.

*A.C.7 ·
0-30 amps, Range minus 20%
to plus 10%, 12 volts per second.*

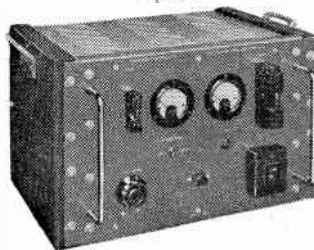

*A.C.2 MkIIB ·
0-9 amps, Range minus 17.5% to
plus 8.75%, 15 volts per second
(A.C.2 MkIIA is identical except
there are no meters).*

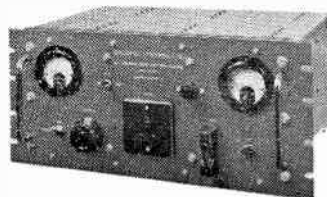

Servomex Controls Limited, Crowborough Hill, Jarvis Brook, Sussex.
Crowborough 1247.

SERVOMEX

**The first
of the**



range of

SILICON JUNCTION DIODES



For High Temperature Operation
with extremely high ratios of
forward to reverse resistance.

SX641 SX642 SX643 SX644

These diodes utilise a recently
developed glass—pure copper
seal which has made possible
the production of devices
with really outstanding
thermal properties.

**LOWER VOLTAGE TYPES
SX641 SX642**

*Suitable for use as Second
Detectors at frequencies
of up to 10 Mc/s and for the
majority of other low power
circuit functions including
Magnetic Amplifiers.*

**HIGHER VOLTAGE TYPES
SX643 SX644**

*Suitable for use as H.T. rectifiers in telecommunication
type power supplies, and for Blocking and Gating functions.*
Typical ratings for capacitive input circuits at ambient
temperatures of less than 75°C are given below:—

Circuit Arrangement	Number of Diodes	Max. Rectified Current (mA)	R.M.S. Input Voltage (V)		D.C. Output Voltage (V)	
			SX643	SX644	SX643	SX644
Half-wave	1	100	64	106	90	150
Bi-phase	2	200	64-0-64	106-0-106	90	150
Bridge	4	200	128	212	180	300

For further information, write to the G.E.C. Valve and Electronic Department

THE GENERAL ELECTRIC CO. LTD., MAGNET HOUSE, KINGSWAY, LONDON, W.C.2.

SALTER

"TRUARC"

Regd. Trade Mark

RETAINERS

Every Designer of
Engineering products
needs this NEW
Catalogue

P.T.O.

Engineering Data and Specifications

The logical advance in

Retaining

Save material-

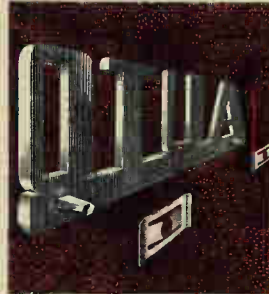

OLD WAY



THE SALTER WAY

W FIXES ON STUDS

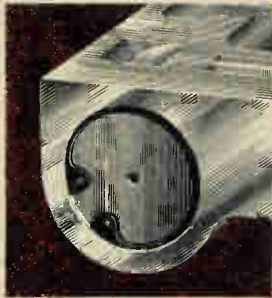

OLD WAY



THE SALTER WAY

CIRCLIP FITTED IN GROOVE

reduce assembly time-

-Cut Costs-

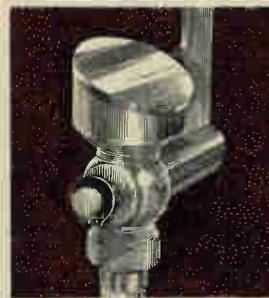

OLD WAY

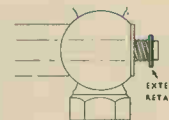

THE SALTER WAY

EXTERNAL RETAINER

When it's a question of assembling components in any engineering field, Salter Retainers are the answer. They replace nuts and bolts, screws, cotter pins, and eliminate expensive threading and machining

operations. A large standard range is at your immediate disposal, and we should welcome the opportunity to assist in developing special retainers to solve your problems.

NEATER — MORE POSITIVE — PERMANENT RETAINING

SALTER

“TRUARC”
Regd. Trade Mark

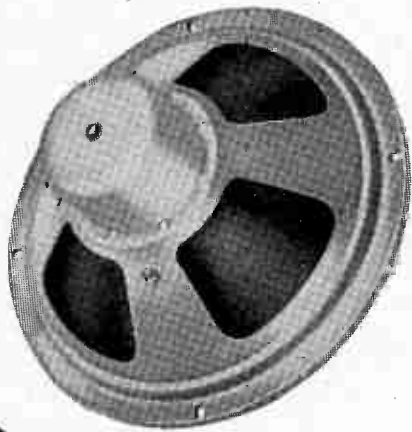

The development and manufacture of Loudspeakers for all purposes has been our business for over 30 years. Whatever the application, we are proud to have assisted in equipping many millions of radio and television receivers throughout the world with Loudspeakers which, in design and performance, have set a standard of their own.

Loudspeakers
for all purposes

ROLA
CELESTION

Rola Celestion Ltd.

FERRY WORKS · THAMES DITTON · SURREY · ENGLAND
Telephone: EMBerbrook 3402/6 Cables: VOICECOIL, THAMES DITTON, ENGLAND

NEW... COMPACT...



series 320 relay

This relay is of compact design and extremely small for the duty it performs, the contact arrangement is three pole double throw and connections to contact and coil are conveniently brought out at one end of the relay. Contacts and terminations are housed in a high grade Bakelite moulding and the design of the moulding gives increased creepage path and excellent insulation. Guards are fitted to avoid flashover between contacts.

Maximum Working Voltage: 440 volts A.C.
50 cycles.

V.A. Rating: 5 V.A.

Contacts rated up to 10 amperes at 250 volts
A.C. or 30 volts D.C.

Series 325 Relay. The only difference is that this is a D.C. Relay and the maximum working voltage is 250 volts D.C.

Wattage: 2 watts.

Contacts rated up to 10 amperes at 250 volts
A.C. or 30 volts D.C.



Magnetic Devices

A.I.D. AND A.R.B. APPROVED LTD.

MAGNETIC DEVICES LIMITED, EXNING ROAD, NEWMARKET, SUFFOLK
Telephone: Newmarket 3181/2/3
Grams: Magnetic Newmarket

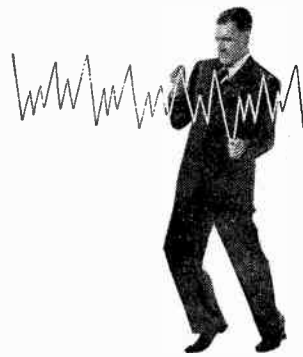

A Mains Voltage Fluctuation problem

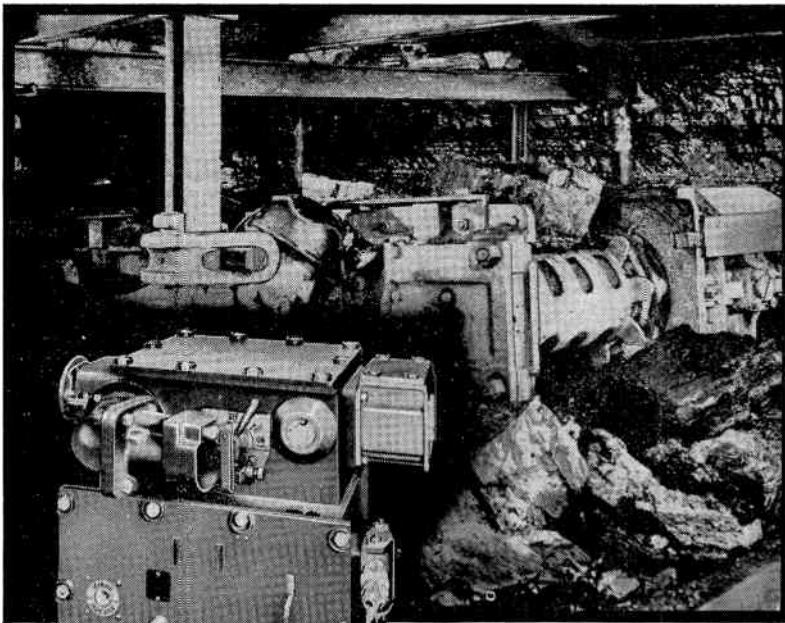

at the Coal Face

The gate-end is the nerve centre for the control of equipment at the coal face. There stands the gate-end box in which is the vital contactor. This contactor *must* "pull-in" irrespective of the low supply voltages that result from poor regulation.

How can reliable operation be assured with these inherent voltage fluctuations?

An armoured conveyor and transfer point (Photograph reproduced by permission of Richard Sutcliffe Limited) and inset, a Baldwin & Francis Ltd. Gate End Box through which power to the conveyors is fed.

... straightened out by **Advance**

In the Baldwin & Francis Limited Gate End Box which is to the N.C.B. Specification P/3/1950, incorporating the Intrinsically Safe Remote Control Circuit, N.C.B. Specification P/130/1955, a d.c. operated contactor is used, the supply to which is via an 'Advance' Constant Voltage Transformer. As a result adequate stabilised voltage is always available ensuring consistent performance over a large range of voltage fluctuation — an important characteristic which 'Advance' C.V.T.s ensured — and have ensured for many years past.

'Advance' Constant Voltage Transformers provide a.c. voltage stabilisation of $\pm 1\%$ for input variations of up to $\pm 15\%$ at maximum load. For power requirements from 4 to 6,000 watts, they are automatic and contain no moving parts.

Technical details and description leaflet 28R gladly sent on request.

Export enquiries welcomed.



CONSTANT VOLTAGE TRANSFORMERS

ADVANCE COMPONENTS LIMITED

ROEBUCK ROAD • HAINAULT • ILFORD • ESSEX • Telephone: HAINault 4444

GD15

22 contacts

“Wedgelock” rivets

And fully type approved*

Recommended for top performance in electronic and communications equipment, the Plessey G.A.2 switch provides dependable long-life action—even under arduous service conditions.

Of advanced design and construction, which permits 22 contacts per wafer and achieves unique compactness and lightness, this switch incorporates the highly successful “Wedgelock”

riveted contact clips. Positive location in all switching positions is assured, the contacts remaining permanently rigid, withstanding even excessive tangential pressure.

Smooth rotary movement results from minimum horizontal and vertical movement of the rotor blades which are rigidly held by strong S.R.B.P. rotors.

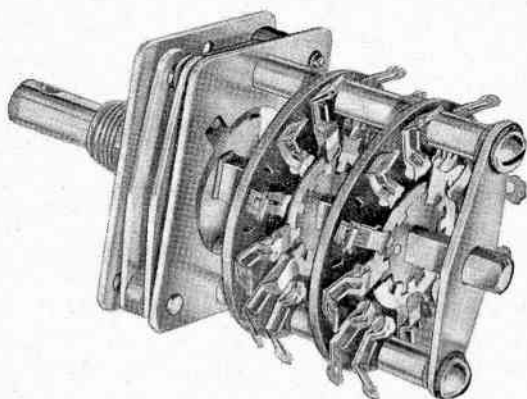

SPECIFICATION

Initial Contact Resistance (Maximum)	5 milliohms
Insulation Resistance (all contacts to spindle)	500 MΩ @ 500V. D.C.
Contact Current	5 amps RMS continuous
Contact Rating	150 mA @ 250V. RMS non-reactive load 250 mA @ 110V. RMS

The **Plessey** G.A.2 switch

* Type Approval Certificate No. 1116 H.2. Grade 1. RCS 15

- Up to 22 fully insulated contacts per wafer (double-wiping, self-cleaning type)
- 30° Index (12 positive switching positions)
- Providing for unusual contact arrangements
- Roller Click Index mechanism, if required, for special applications

Design Engineers who have not yet received a copy of the new, comprehensive Plessey Switches Catalogue are invited to send for Publication No. 922.

COMPONENTS GROUP · SWITCH UNIT · THE PLESSEY COMPANY LIMITED · NEW LANE · HAVANT · HANTS · Telephone: HAVANT 1311

Overseas Sales Organisation: PLESSEY INTERNATIONAL LIMITED · ILFORD · ESSEX · Telephone: Ilford 3040

CO2

SOLARTRON HOME AND EXPORT PRICE LIST

Effective from 1st January, 1958

DESCRIPTION	TYPE	PRICE ex works, unpacked
Gyro Response Test Console	JY. 747	Price on application
Servotest Console	JY. 672	Price on application
Ignition Delay Meter	ECS. 1	£220
Laboratory Amplifier	AWS. 51A	£130
Wide-Band Power Amplifier	AWS. 53	£175
Pulse Generator	OPS. 100C	£130
L.F. Decade Oscillator	OS. 103.2	£640
Transfer Function Analyser	OS. 103.2/ VP. 253.2	£1,300
Regulated Power Supply	SRS. 151A	£115
Twin Regulated Power Supply	SRS. 152	£190
Single Regulated Power Supply	SRS. 152A	£100
Solartron Vari-Pack	SRS.153.2	£50
Power Supply Sub-Unit	SRS. 156	£35*
Wide-Band Attenuator, 600 Ohm	AT. 201	£25
Calibrating Unit	AT. 203	£175
Resolved Components Indicator	VP. 250	£475
Feedback Voltmeter	VF. 252	£175
Resolved Components Indicator	VP. 253.2	£660
High Frequency Amplifier	CA. 411	£70
Square Wave Generator	GO. 511	£95
Standing Wave Ratio Indicator	CA. 512	£190
Solarscope	CD. 513.2	£220
Power Supply Sub-Unit	AS. 516	£35*
Power Supply Sub-Unit	AS. 517	£35*
Oscilloscope	CD. 518	£225
Direct Reading T.M.S.	BM. 519	£220
Solarscope	CD. 523S2	£265
T.F.A. Carrier Convertor	JX. 541	£300
Wide Range Oscillator	CO. 546	£135
Synchrotest	JM. 555	£375
Solarscope	AD. 557	£275
Wide-Band Attenuator, 75 Ohm	CR. 561	£30
Klystron Power Supply	AS. 562	£175
Servo Test Set	JX. 563	£450
2-Phase L.F. Oscillator	BO. 567	£195
Oscilloscope	CD. 568	£210
Mechanical Reference Generator	JX. 603	£375
800 c/s Selective Amplifier	BA. 604	£450
Oscilloscope Probe	CX. 606	£5
Sub-Sonic Power Amplifier	JX. 612	£255
Power Supply Sub-Unit	AS. 616	£180*
Power Supply Sub-Unit	AS. 619	£60*
Computer Amplifier	AA. 621.2	£50
Computer Amplifier	AA. 622.2	£60
Carrier Convertor	JX. 641	£300
Measuring Solarscope	CD. 643	£490
Double-Beam Solarscope	CD. 711	£320
Oscilloscope	CD. 715	£460
Oscilloscope Trolley	MX. 719	£25
Crossed-Fields Multiplier	TA. 721	£295†
Heater Supply Unit	TS. 722.2	£24
Ventilation Unit	TX. 724	£3
Computer Servo Multiplier	TJ. 725	—
Linear Computing Unit	TR. 729.2	£75†
T.F.A. Reference Resolver	JX. 746	£295
Power Supply Sub-Unit	AS. 754	£60*
Regulated Power Supply	AS. 755	£115*
100V. Reference Supply	AS. 756.2	£325
Linear Computing Unit Racking	TX. 790.2	£30
Amplifier Racking	TX. 791.2	£30
Computer Control Panel	TC. 792	£60
Computer Supply Distribution Unit	TS. 793	£90
Resistance Unit	TR. 794.2	£20
Solarscope	CD. 814	£115

The prices on this list are net, ex works, unpacked. 2½% discount for cash within 10 days.

* Quantity Discounts Applicable.

† Provisional Price.

This cancels all previous price lists

THE SOLARTRON ELECTRONIC GROUP LTD

THAMES DITTON · SURREY · Tel: EMBerbrook 5522

Hermetic Sealing

**STEATITE & PORCELAIN
NICKEL METALLISING**

Quality Approved (Joint Service R.C.S.C.)

WILL MEET THE MOST EXACTING REQUIREMENTS



**METALLISED
BUSHES**

Perfect Terminations

—made readily without special precautions by semi-skilled labour, employing simple hand soldering methods, R.F. Heating, Hot Plate, Tunnel Oven or similar mass production methods

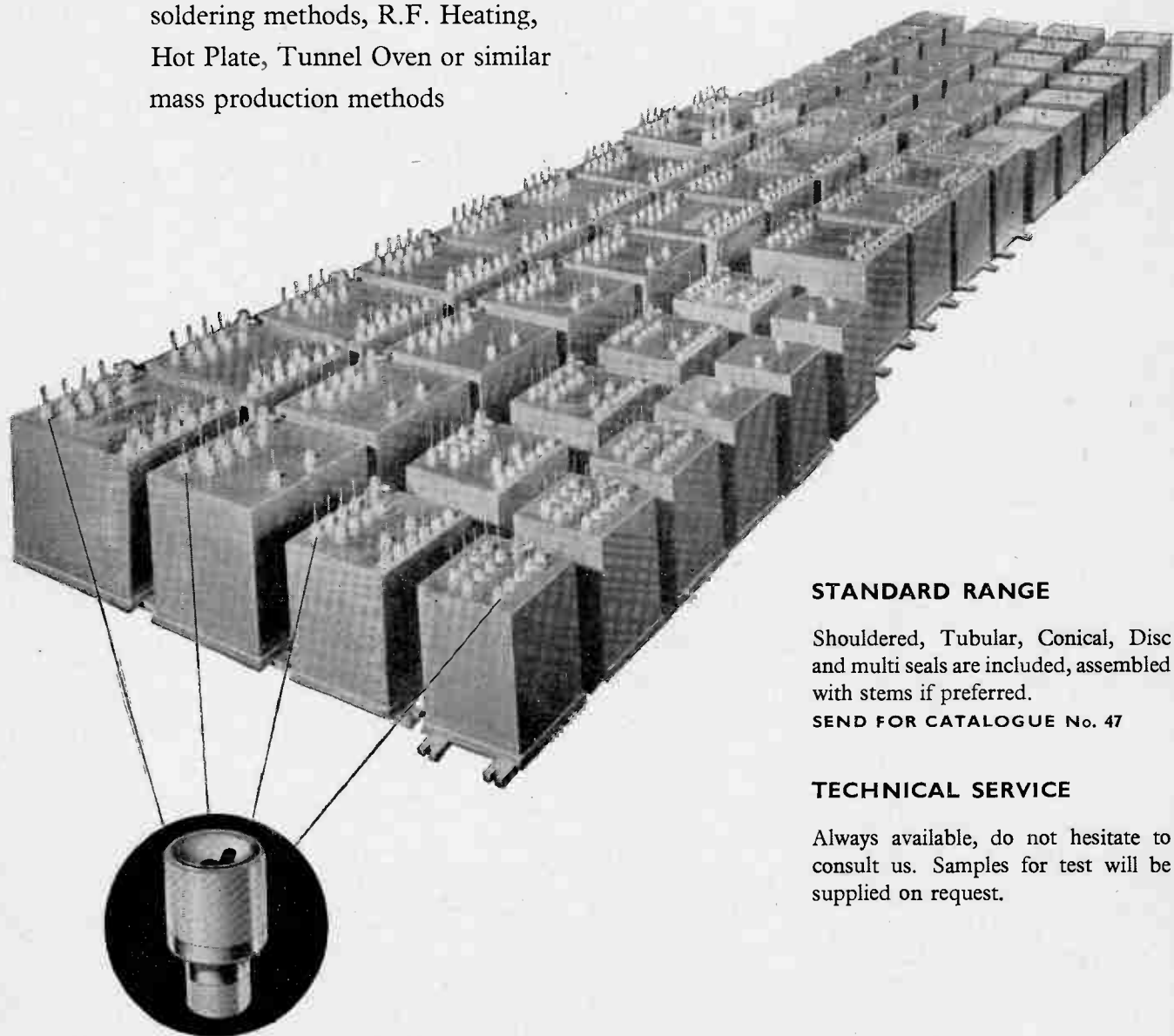

STANDARD RANGE

Shouldered, Tubular, Conical, Disc and multi seals are included, assembled with stems if preferred.

SEND FOR CATALOGUE No. 47

TECHNICAL SERVICE

Always available, do not hesitate to consult us. Samples for test will be supplied on request.

STEATITE & PORCELAIN PRODUCTS LTD.

STOURPORT ON SEVERN, WORCS. Telephone: Stourport 2271. Telegrams: Steatoin, Stourport

SP100

Putting 5 and 5 together

These In-Line Connectors are specially suitable for plug-in unit construction or small rack mounting equipment.

Well proven plug and socket contacts are used and exceptional freedom in dimensional tolerances of fixings etc. has been provided for.

5 and 7 Way versions are available and the Connectors can either be mounted direct to the panel where clearance is provided for contacts or mounted on stand-off pillars.

Location is provided by guide pins which are polarised to prevent incorrect insertion.

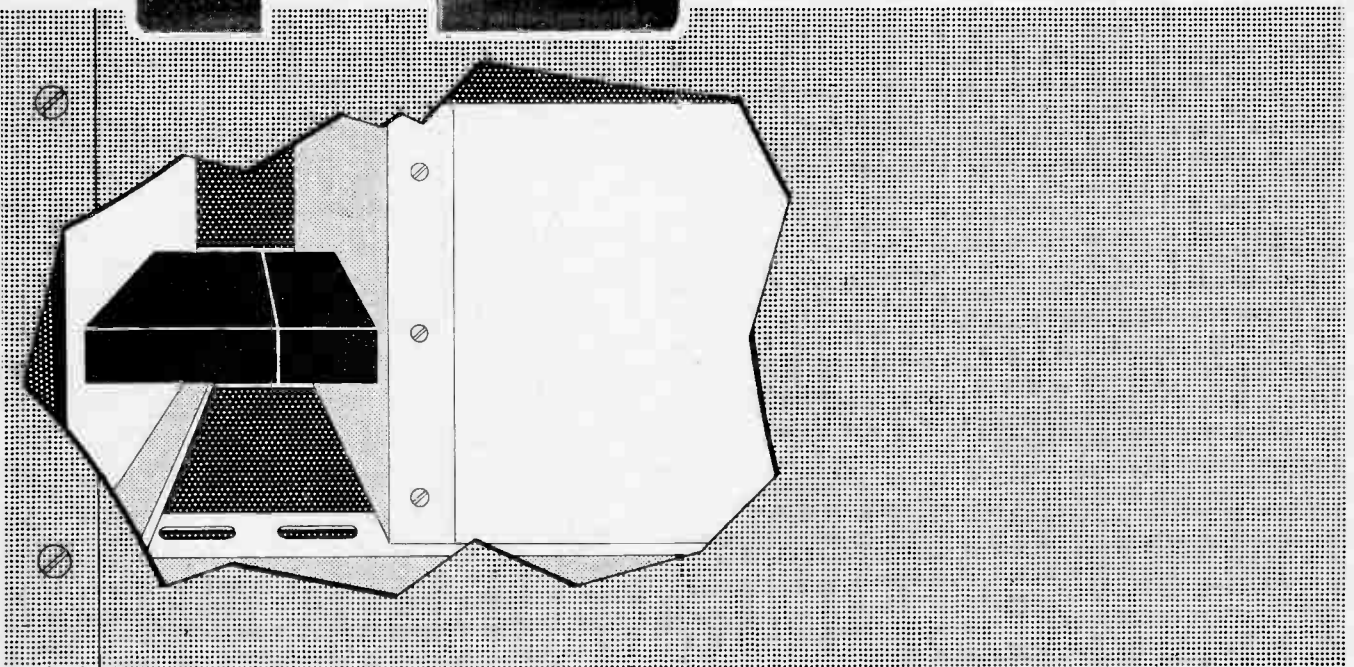
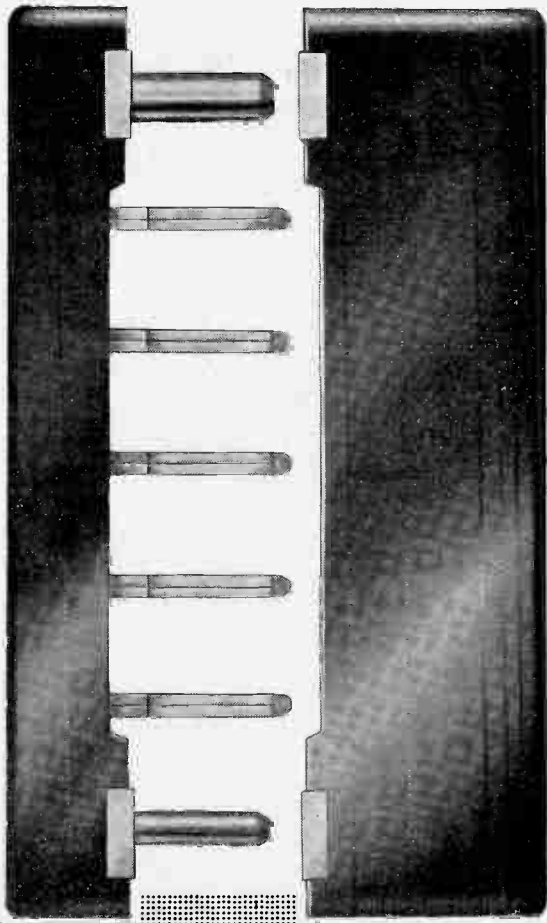

A.I.D. & A.R.B. - APPROVED
POWER CONTROLS
LIMITED

EXNING ROAD, NEWMARKET, SUFFOLK

Telephone: Newmarket 3181/2/3.

Telegrams: Powercon Newmarket.



NOW available from stock!



Anyone can use them!

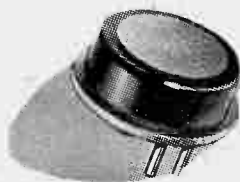

GOLTOP

POWER TRANSISTORS

20!

Type V 15/10P

each retail.

TYPE V 15/10P, one of the regular range of Goltop germanium-alloyed p-n-p junction transistors, is suitable for a number of power applications of which the following is typical.

LOW FREQUENCY OSCILLATOR

This oscillator, employing a V 15/10P transistor, is suitable for the generation of power in the sonic or ultrasonic range. The output is about 1 watt, the output impedance being 30 ohms. (With adjustment of load and the provision of suitable cooling arrangements, the output may be up to 6 watts.) The waveform is dependent on the DC conditions, which may be adjusted by means of the 50-ohm potentiometer. The collector winding resistance should be less than 0.25 ohm. Power output may be increased by adjusting the amount of feedback to the base. At large power outputs the transistor may be driven from the bottomed to the cut-off condition, which reduces the power dissipation in the transistor: this condition is useful where distortion is unimportant.

Obtainable direct from the manufacturer. Trade enquiries invited. Full technical data on application.

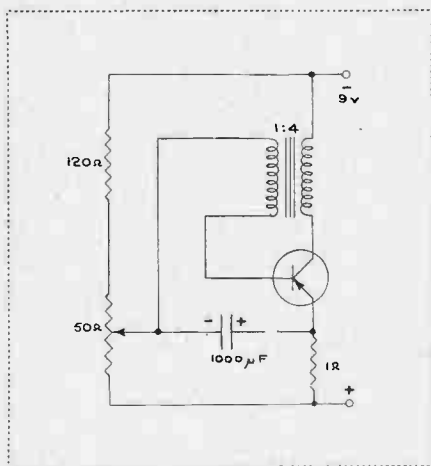

British Design, Materials and Craftsmanship

Newmarket Transistor Co. Ltd.

Exning Road, Newmarket

Telephone Newmarket 3381

C11

Curves of Total Loss against B max
for various frequencies

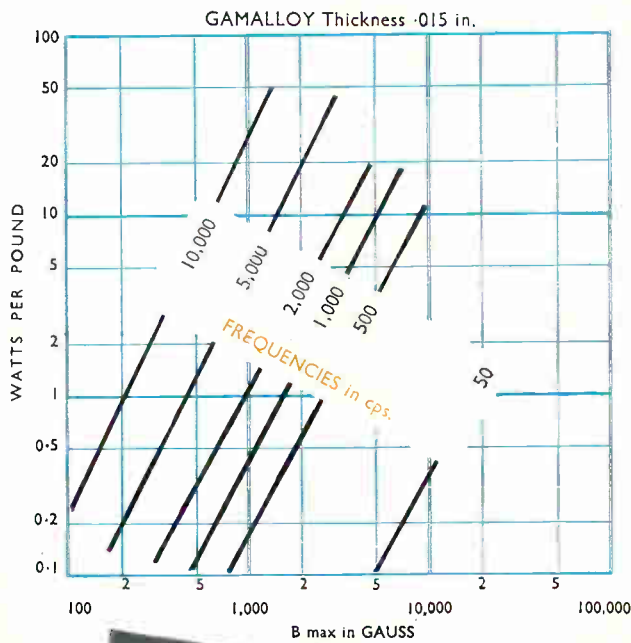

GAMALLOY: nickel-iron core material

'GAMALLOY 48' is the newest nickel-iron core material to be added to the wide range of R.T.B. magnetic materials. As the inset curves indicate, GAMALLOY has low total losses throughout the audio frequency range and, moreover, its permeability at flux densities up to 14,000 gauss is very good. In every way GAMALLOY is an ideal core material for use in small transformers and chokes required in the telecommunications and electronics industry.

GAMALLOY is manufactured as hot-rolled sheets in widths up to 17 inches, and in two standard thicknesses—.015" and .005".

Full technical data can be found in our new catalogue.

RICHARD THOMAS & BALDWIN LTD.

LAMINATION WORKS : COOKLEY WORKS, BRIERLEY HILL, STAFFS.
MIDLAND SECTION OFFICE : WILDEN, STOURPORT-ON-SEVERN, WORCS.
HEAD OFFICE : 47 PARK STREET, LONDON, W.1



"MAKE IT BIGGER AND HEAVIER SO IT WON'T BREAK"

The idea that size means strength was exploded in the Unbrako laboratories years ago. Unbrako designs, Unbrako steels, Unbrako craftsmanship have freed designers from the large and cumbersome fastener, enabling him to use fewer and smaller screws without sacrifice of strength. But Unbrako screws not only save in weight that way, they make practicable weight-saving designs hitherto only dreamed of. Smaller and stronger screws—Unbrako screws—can mean smaller and stronger joints. There's no guesswork about this, we have plenty of examples that we can't go into here, but may we send one of our technicians to talk to you about screws?



UNBRAKO SCREWS COST LESS THAN TROUBLE

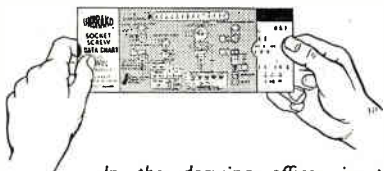

FREE
DATA CHART

In the drawing office, in the toolroom or on production — you'll save valuable time and avoid costly guess-work with this free data chart, it cuts out all physical measurements or calculation.



THE UNBRAKO SOCKET SCREW COMPANY LIMITED · COVENTRY

Calculating loads and stresses is increasingly important in modern screw design. Machines operate at higher speeds under heavier loads, materials are subjected to greater stresses. Screws are required to do more and better work.

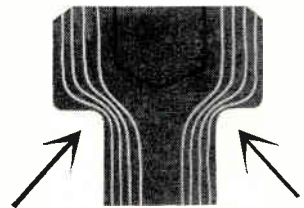

Failure due to repeated stresses on a bolt are located at the point of higher stress concentration. These points are usually the head to shank junction or the threaded section.

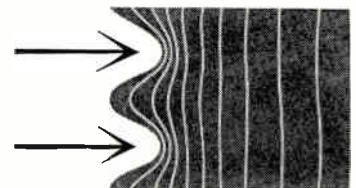

With Unbrako, fillets are used at these critical sections to reduce stress concentration and increase fatigue strength, fillets under the head and at the root radius of the thread, carefully controlled for maximum strength.

TRANSISTOR OCI6

Dissipation

14 watts at 45°C*

INDUSTRIAL APPLICATIONS

This high output germanium junction P.N.P. power transistor is being used to great advantage in the following applications:

Class A and B audio

Amplification

Aircraft Passenger Address

Systems

D.C. Convertors

Power Amplifiers for Servo Motors

Power for Relay Operation.

FEATURES

Peak current 3 amps.

Maximum mean current 1.5 amps with good current linearity.

Maximum continuous junction temperature 75°C. Up to 90°C for intermittent operation (total duration 200 hours max.).

A pair of OCI6's operating in Class B push-pull will provide an output in excess of 10 watts into loudspeakers with 12 volts "H.T."

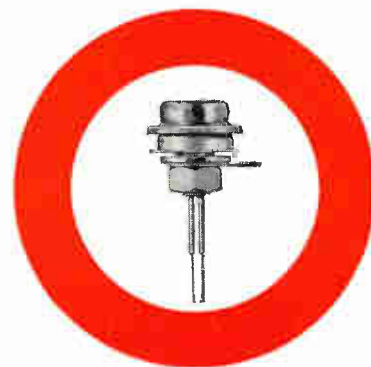

Half actual size

DATA

Characteristics (measured at 25°C ambient)

Collector reverse leakage current, grounded base < 100μA

Current amplification

at I_c = 30mA 40
 at I_c = 300mA 35
 at I_c = 2A 22
 at I_c = 3A 16



POWER DISSIPATION

14 watts dissipation at an ambient temperature of 45°C can be allowed when the OCI6 is bolted to a large but practical heat sink. The accompanying table shows allowable dissipations with different heat sinks. In all cases the transistor is mounted directly on to a plate with a thin tin-plated lead washer. When electrical insulating mica washers are used, the dissipation is somewhat reduced. Full data is available.

AMBIENT TEMP. (TO GIVE 75°C JUNCTION TEMP.)	DISSIPATION WITH INFINITE HEAT SINK, e.g. WATER COOLED	DISSIPATION WITH LARGE METAL PLATE 1°C PER W THERMAL RESISTANCE	DISSIPATION WITH 1 sq. ft. METAL PLATE 2°C PER W THERMAL RESISTANCE	DISSIPATION WITH SMALL METAL PLATE (4 in. x 7 in.) 5.5°C PER W THERMAL RESISTANCE
25°C	45W†	24W	16W	7.6W
35°C	36W†	19W	13W	6.1W
45°C	27W†	14W	9.7W	4.6W
55°C	18W	9.5W	6.5W	3.0W



MULLARD LIMITED
 MULLARD HOUSE
 TORRINGTON PLACE
 LONDON W.C.1

Mullard

COMMUNICATIONS AND
 INDUSTRIAL VALVE DEPARTMENT

† Continuous dissipation values in excess of 24W are at present prohibited by the voltage and current ratings given in the full data.

In a single application, Araldite epoxy resins combine such diverse functions as bonding, impregnating, insulating and providing surface finishes of remarkable protective value.

This rotating magnet generator, made by Ericsson Telephones Limited for telecommunication equipment, has a greater output than other generators of the same drive torque. It incorporates heavy-gauge iron sheet laminations bolted between diecast alloy end cheeks, and the coil is separately wound on to a moulded bobbin which, when assembled, forms an integral part of the lamination structure. Dimensional accuracy between the end cheeks must be combined with a relatively large dimensional tolerance on the thickness of the laminations, and Araldite Surface Coating Resins have proved indispensable for impregnating the coil, locking the laminations, and imparting an excellent surface finish to equipment which also conforms to tropical specifications.

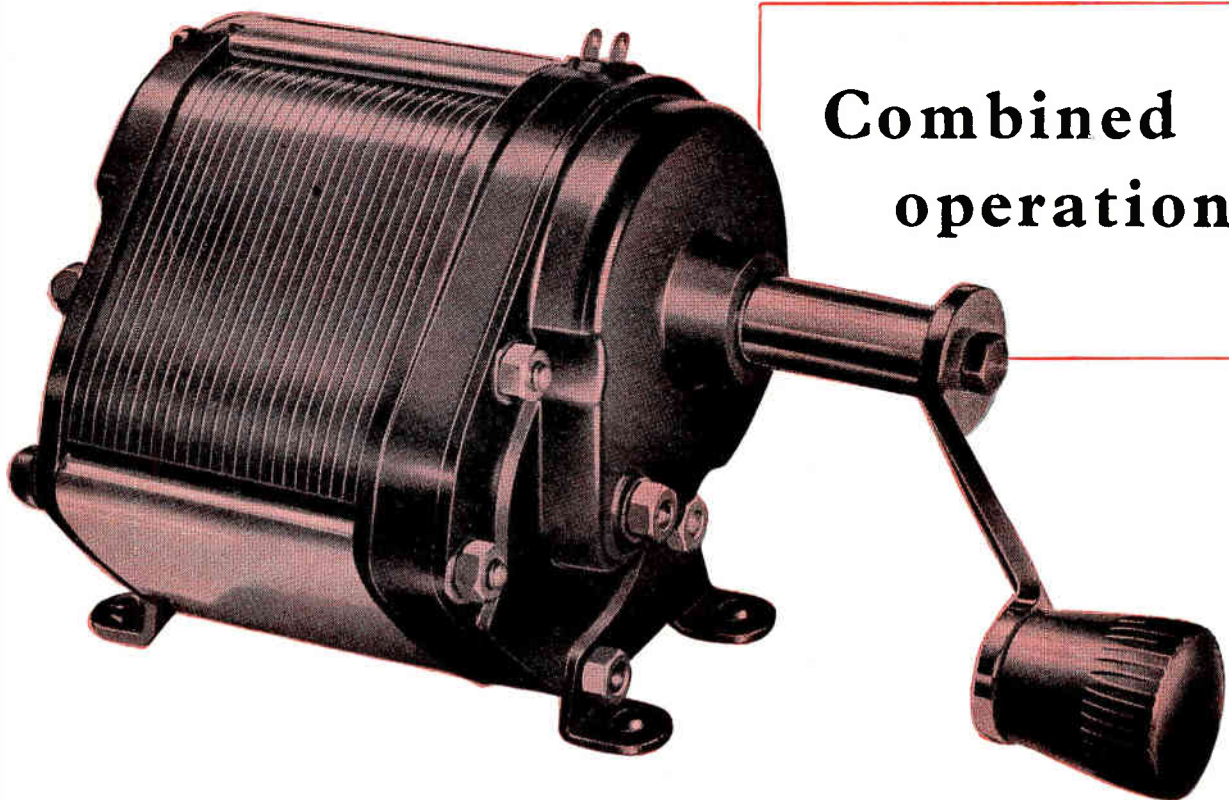

Combined operations

Araldite epoxy resins are used

- ★ for bonding metals, porcelain, glass, etc.
- ★ for casting high grade solid electrical insulation
- ★ for impregnating, potting or sealing electrical windings and components
- ★ for producing glass fibre laminates
- ★ for making patterns, models, jigs and tools
- ★ as fillers for sheet metal work
- ★ as protective coatings for metal, wood and ceramic surfaces

Araldite

epoxy resins

Araldite is a registered trade name

Aero Research Limited

A Ciba Company. Duxford, Cambridge. Telephone: Sawston 2121

AP 321

Electronic & Radio Engineer, February 1958

Advance in miniature



Plessey are not just marching in step with the present day trend of increased miniaturisation, but are keeping quite a few paces ahead with advanced techniques and products that contribute to more compact and increasingly efficient electronic and associated equipment.

The Plessey range of sub-miniature Co-axial Plugs and Sockets are excellent examples of the Company's development and manufacturing ability, being eminently suitable for use in transistorised electronic equipment, mobile transmitters, etc. They are specifically designed for matched impedance coupling of H.F. co-axial cables.

Operating Frequencies up to 29,000 megacycles per sec.
Temperature Range; -55°C to 75°C
Working Voltage; 600 volts R.M.S.
Impedance; 50, 70 and 93 ohm lines can be accommodated.

Design engineers with problems in miniature are invited to apply for samples and further details which will gladly be sent in response to requests.

AIRCRAFT & AUTOMOTIVE GROUP · WIRING & CONNECTOR DIVISION
THE PLESSEY COMPANY LIMITED · CHENEY MANOR · SWINDON · WILTS

Overseas Sales Organisation: PLESSEY INTERNATIONAL LIMITED · ILFORD · ESSEX · TELEPHONE: ILFORD 3040

Plessey

PW3

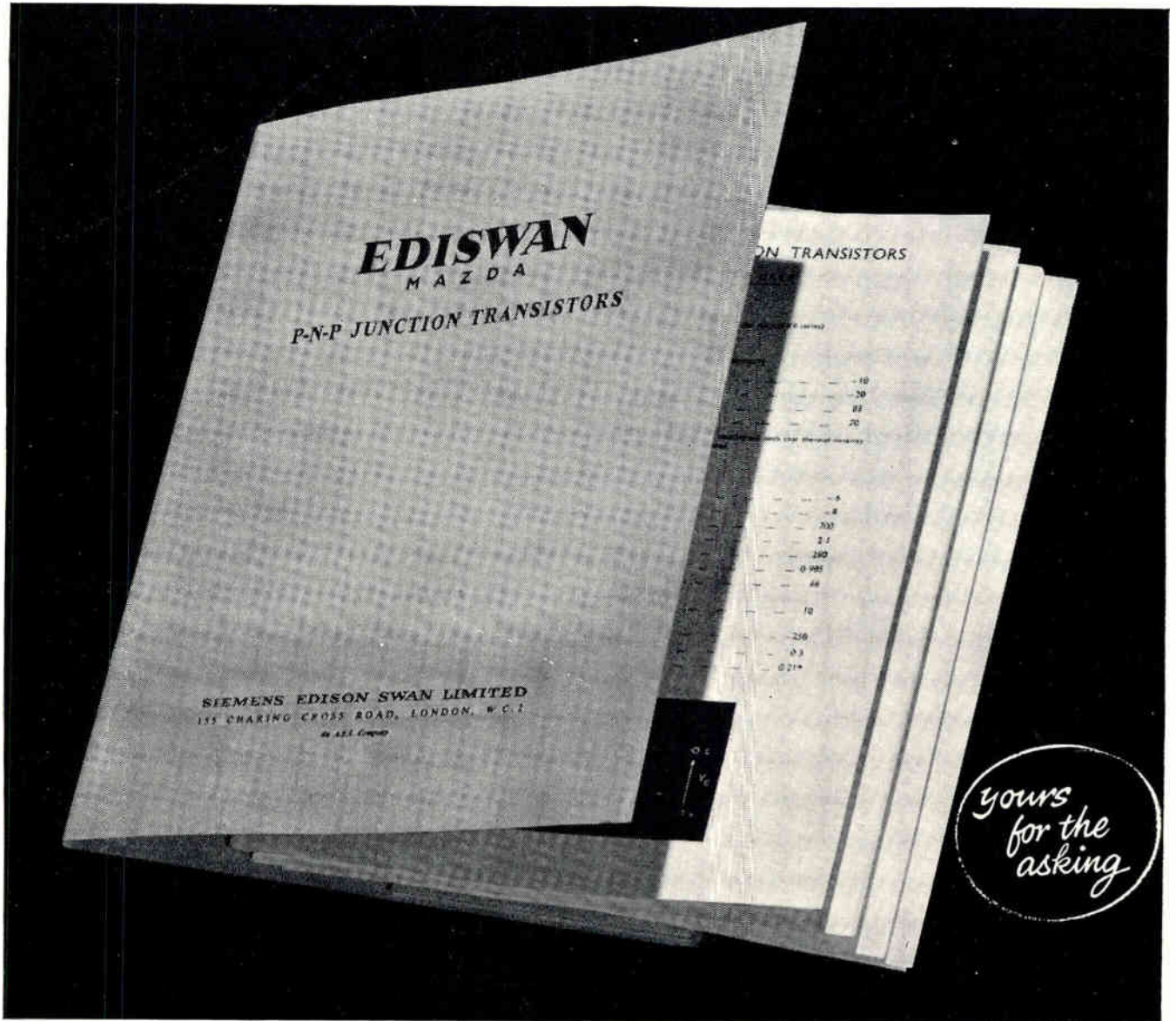

EDISWAN transistors

MAZDA

If you are manufacturing or designing electronic equipment you will find this folio of data sheets helpful as a source of reference. It gives you comprehensive information and characteristic curves covering the whole range of EDISWAN Mazda transistors.

Simply ask for the P-N-P Transistor Folio on your business notepaper.

at highly competitive prices

SIEMENS EDISON SWAN LIMITED

155 CHARING CROSS ROAD, LONDON, W.C.2. AND BRANCHES.

TELEPHONE: GERRARD 8660. AN A.E.I. COMPANY.

TELEGRAMS: SIESWAN WESTCENT, LONDON.

CRC 15/4

FERRANTI SILICON RECTIFIERS

are used in
ELLIOTT
MAGNETIC AMPLIFIERS

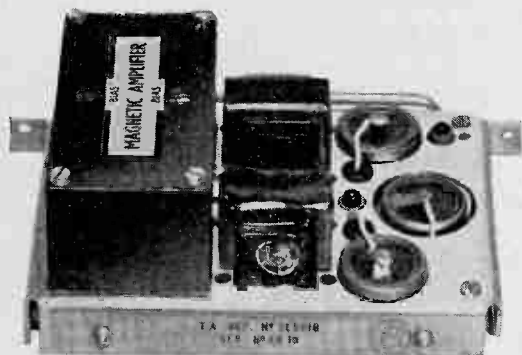
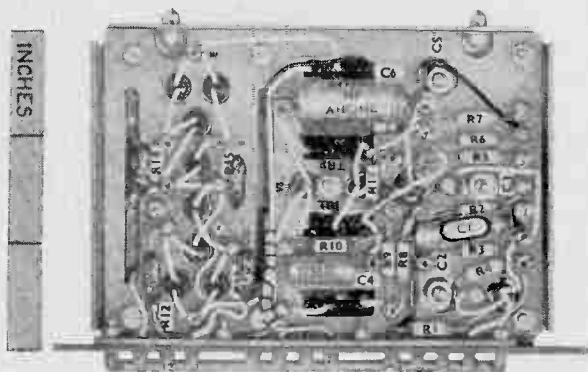
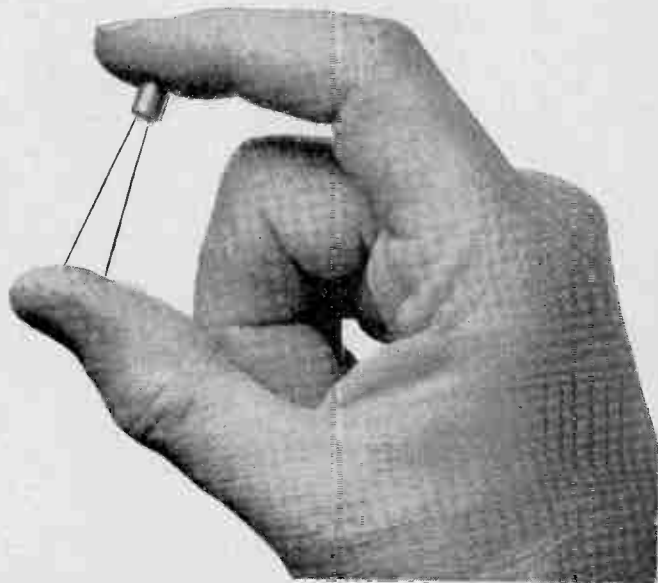

A wide range of applications

Ferranti Silicon Rectifiers are used in Magnetic Amplifiers made by Elliott Bros. (London) Ltd. They were chosen not only for their efficient operation, but also for their complete reliability, robust construction, small size and lightness in weight. Ferranti Silicon Rectifiers have many applications in the aircraft, electronic, electrical and general engineering industries including aero engine controls, aircraft power supplies, radar systems, guided missiles, computers, indicating and recording instruments, process control and telephone equipment.

- ★ LOW REVERSE CURRENT
- ★ HIGH FORWARD SLOPE
- ★ HIGH TEMPERATURE OPERATION
- ★ SMALL PHYSICAL DIMENSIONS
- ★ HIGH MECHANICAL STRENGTH
- ★ APPROVED TO GOVERNMENT SPECIFICATIONS

FERRANTI LTD · GEM MILL · CHADDERTON · OLDHAM · LANCs

London Office: KERN HOUSE, 36 KINGSWAY, W.C.2.



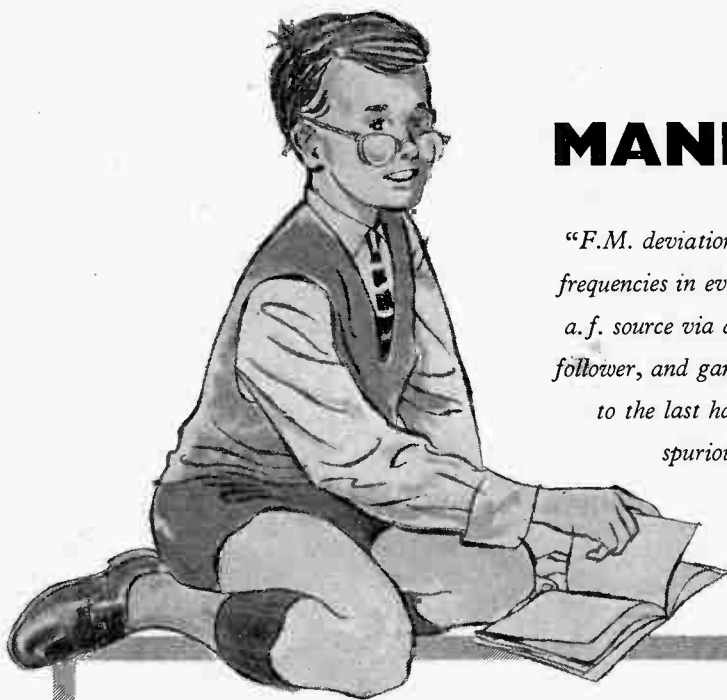

MANIFESTLY . . .

"F.M. deviation is maintained sensibly constant at all carrier frequencies in every band by feeding the reactor valve from the a.f. source via a continuously variable potentiometer, cathode follower, and ganged attenuating system, while A.M. is applied to the last harmonic multiplier in order to overcome the spurious f.m. often encountered when modulating an r.f. oscillator directly."

It's to be expected that a lad familiar with the exploits of Dan Dare, nuclear fission and analogue computers would be knowledgeable about a relatively simple instrument like the Marconi Signal Generator Type TF 995A/2—but are *you* as well-informed? Do *you* know that it has a frequency range of 1.5 to 220 Mc/s, and an output range of 200 mV to 0.1 μ V? That it has a built-in crystal calibrator and direct-reading incremental frequency control? That it is F.M. or A.M.—or both, simultaneously? Such basic facts about what is a standard unit of telecommunication test equipment should be known to every electronic engineer. If you don't know them, don't be too shy to admit it—write for leaflet V111 which describes this Signal Generator in detail.

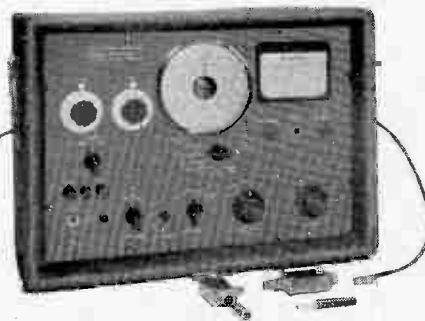

FM/AM SIGNAL GENERATOR
Type TF 995A/2

1.5 to 220 Mc/s; crystal check facilities from 13.5 Mc/s upwards. Output: 0.1 μ V to 100 mV at 52 and 75 ohms, and up to 200 mV at 75 ohms. Internal 1000-c/s modulation: a.m., variable up to 50% depth; f.m., variable up to 25 and 75 kc/s deviation on all r.f. ranges, also greater max. deviations—up to 600 kc/s on the highest range. External modulation; f.m., up to 15 kc/s modulation frequency; a.m., up to 10 kc/s.

MARCONI
INSTRUMENTS

AM & FM SIGNAL GENERATORS · AUDIO & VIDEO OSCILLATORS
FREQUENCY METERS · VOLTMETERS · POWER METERS
DISTORTION METERS · FIELD STRENGTH METERS
TRANSMISSION MONITORS · DEVIATION METERS
OSCILLOSCOPES, SPECTRUM & RESPONSE ANALYSERS
Q METERS & BRIDGES

MARCONI INSTRUMENTS LTD · ST. ALBANS · HERTFORDSHIRE · TELEPHONE: ST. ALBANS 56161

London and the South: Marconi House, Strand, London, W.C.2. Tel: COVent Garden 1234

Midlands: Marconi House, 24 The Parade, Leamington Spa. Tel: 1408

North: 30 Albion Street, Kingston-upon-Hull. Tel: Hull Central 16347

WORLD-WIDE REPRESENTATION

TC 111

No Grass Grows Here!

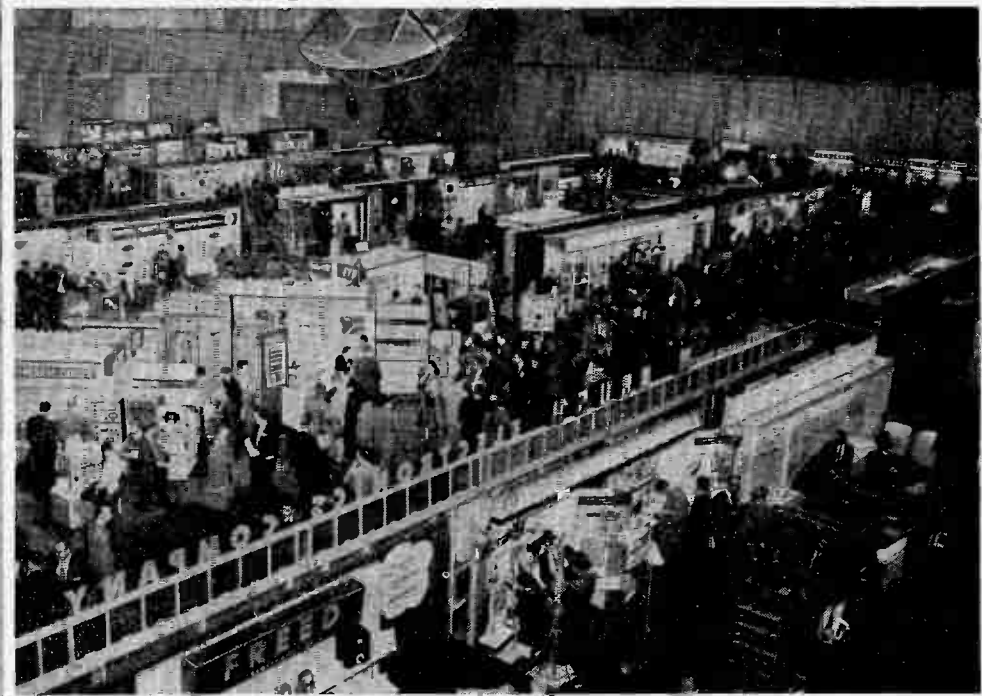

The 1958 IRE Convention and Show will be the source of new ideas for more than 50,000 radio engineers. Be sure you are there.

MARCH 24-27

THE IRE NATIONAL CONVENTION

Waldorf-Astoria Hotel
and The Radio Engineering Show
Coliseum
New York City

REGISTRATION: IRE Members **\$1.00**
Non-members **\$3.00**

PRODUCTION

INSTRUMENTS
AND COMPONENTS

COMPONENT
PARTS

SYSTEMS



THE INSTITUTE OF RADIO ENGINEERS 1 East 79th Street, New York 21, N. Y.

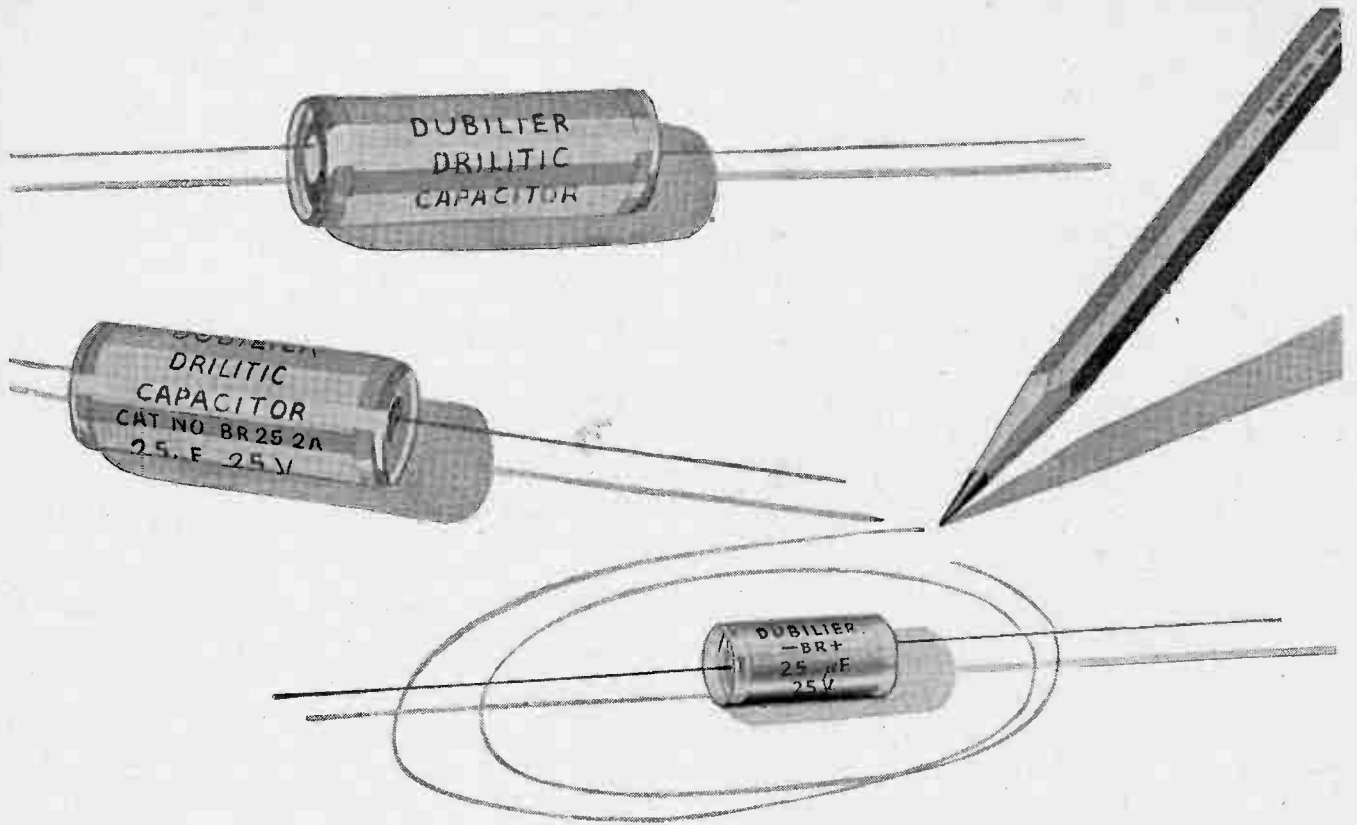

we're reducing...

the size of our electrolytic capacitors. The new type BR miniature electrolytic capacitor retains all the characteristics of this well-known range with the added advantage of reduced size.

In modern equipment where every square inch of space is vital, these new capacitors will meet the physical requirements without any degradation of the electrical specification.

Capacitance (μF)	D.C. Wkg. Voltage	Dia. (in.) including sleeve	Length (in.)
25	12	$\frac{7}{16}$	$\frac{3}{4}$
50	12	$\frac{7}{16}$	$1\frac{1}{16}$
10	25	$\frac{7}{16}$	$\frac{3}{4}$
25	25	$\frac{7}{16}$	$\frac{3}{4}$
5	50	$\frac{7}{16}$	$\frac{3}{4}$
10	50	$\frac{7}{16}$	$\frac{3}{4}$
4	100	$\frac{7}{16}$	$\frac{3}{4}$
8	100	$\frac{7}{16}$	$1\frac{1}{16}$
2	150	$\frac{7}{16}$	$\frac{3}{4}$
4	150	$\frac{7}{16}$	$\frac{3}{4}$

We shall be pleased to supply full information upon request.

DUBILIER

DUBILIER CONDENSER CO. (1925) LTD • DUCON WORKS • VICTORIA ROAD • NORTH ACTON • LONDON W.3
 Telephone : ACOrn 2241

Telegrams : Hivolcon Wesphone London
 DNI75B

ELECTRONIC & RADIO ENGINEER

incorporating *WIRELESS ENGINEER*

HUGH S. POCOCK M.I.E.E. *Managing Editor*
W. T. COCKING M.I.E.E. *Editor*
Professor G. W. O. HOWE D.Sc., LL.D., M.I.E.E., *Technical Consultant*
Hon. M. Brit. I.R.E.

Editorial Advisory Board

H. E. M. BARLOW B.Sc. (Eng.), Ph.D. (Science), M.I.E.E., M.I.Mech.E. (*Pender Professor of Electrical Engineering, University College, London*);
E. B. MOULLIN M.A., Sc.D., M.I.E.E. (*Professor of Electrical Engineering, University of Cambridge*); A. H. MUMFORD O.B.E., B.Sc. (Eng.), M.I.E.E.
(*G.P.O. Engineering Department*); A. R. A. RENDALL O.B.E., Ph.D., B.Sc., M.I.E.E. (*British Broadcasting Corporation*); R. L. SMITH-ROSE C.B.E.,
D.Sc., Ph.D., M.I.E.E. (*Department of Scientific and Industrial Research*).

C O N T E N T S VOLUME 35 NUMBER 2 FEBRUARY 1958

Automatic Testing	39	Editorial
Total Differential Feedback	40	by J. C. H. Davis
Foster-Seeley Discriminator	44	by C. G. Mayo, M.A., B.Sc., and J. W. Head, M.A.
The Fringe of the Field	52	by Quantum
New Types of D.C. Amplifier, Part 2	56	by D. J. R. Martin, B.Sc.
Coaxial Transmission Lines	63	by S. Mahapatra
Mathematical Tools	67	by Computer
Transistor Cut-Off Frequency	69	by W. L. Stephenson, B.Sc.
Push-Pull Amplifier Design	72	by R. G. Christian
Correspondence	74	
New Books	76	
Standard-Frequency Transmissions	77	
New Products	78	
Abstracts and References	A17-A32	

Established 1923
Published on the fifth of each month

ANNUAL SUBSCRIPTION
(including Annual Index to Abstracts and References)
Home and Overseas £2 9s od Canada and U.S.A. \$7.50
Second-class mail privileges authorized
at New York, N.Y.

Published by

ILIFFE & SONS LTD. DORSET HOUSE STAMFORD STREET LONDON S.E.1
Telephone · Waterloo 3333 Telegrams · Wirenger, Sedist, London

Branch Offices

COVENTRY 8-10 Corporation Street—Telephone · Coventry 5210 · BIRMINGHAM · King Edward House, New Street, 2—Telephone · Midland 7191
MANCHESTER · 260 Deansgate, 3—Telephone · Blackfriars 4412 and Deansgate 3595 · GLASGOW · 26b Renfield Street, C.2—Telephone · Central 1265

MULLARD HIGH EFFICIENCY POT CORES

have these outstanding features

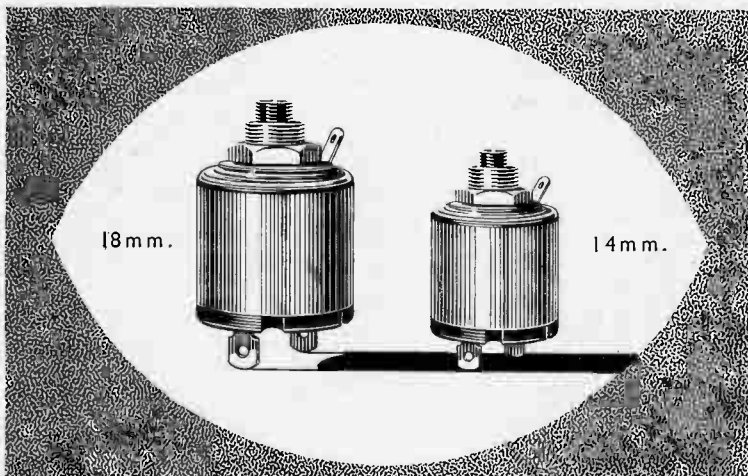

- * Pot core design facilitating rapid assembly
- * Small size
- * High value inductance
- * Low losses resulting in high Q values
- * Very fine setting accuracies
- * Operative over a wide frequency range
- * Controlled temperature coefficient

Wherever high quality pot cores are required, there will be a Mullard type available to meet the specification, furthermore, they can be supplied wound to customers individual requirements.

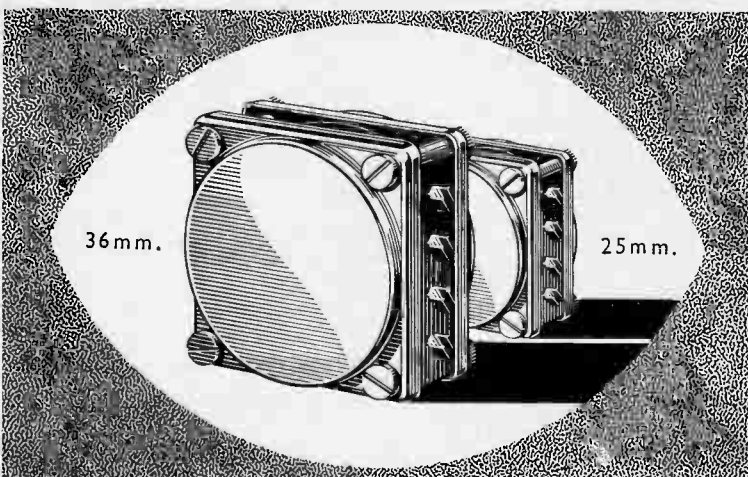

Write now for full details of the comprehensive range currently available.

Mullard



'Ticonal' permanent magnets
Magnadur ceramic magnets
Ferroxcube magnetic cores

MULLARD LTD., COMPONENT DIVISION, MULLARD HOUSE, TORRINGTON PLACE, W.C.1

MC 255A

ELECTRONIC & RADIO ENGINEER

VOLUME 35 NUMBER 2

FEBRUARY 1958 *incorporating WIRELESS ENGINEER*

Automatic Testing

IN our complex civilization, the repair and maintenance of our complicated devices is a serious problem. In electrical and electronic apparatus, particularly, it is the diagnosis of the cause of the trouble which occupies so much time and effort.

In some cases, it is possible to apply automatic testing methods which not only indicate a fault at once but give a fairly precise indication of its nature and place. Such methods have been used for the automatic inspection of radio equipment as it comes off the production line. They are now being applied by the British Post Office for the testing of telephone circuits in automatic telephone networks.

In London, there are 2 million automatic telephones and 35 million calls a week and it is plain that routine testing and fault-finding is quite a problem.

One difficulty encountered is that a call between two exchanges may use any one of a large number of combinations of sections of line and pieces of exchange equipment. Thus, when a fault is reported, it is impracticable to repeat the particular combination of lines and exchange equipment with which the fault was observed. A piece of test equipment has recently been introduced which makes calls from the faulty number to special numbers at 100 or more exchanges. If these are received, the call is automatically answered and a 1,000-c/s tone returned to the calling number.

Another device assists engineers who are installing new telephones at subscribers' premises. When the instrument is ready for use, the engineer dials a special number which connects the subscriber's line to test equipment at the exchange. A complete series of tests is accomplished in about 15 seconds and, if any test fails, the engineer is informed verbally by means of a magnetic recording on a drum at the exchange. Transistors are used in the amplifiers associated with the recording, since the required circuitry is compact and a ready source of supply voltage is available in the form of the exchange battery.

A third equipment tests the insulation resistance of telephone lines at the rate of about 600 lines per hour. (Several tests are carried out on each line.) It thus becomes practicable to test lines sufficiently often to observe the gradual deterioration of a line and repair it before it develops a definite fault.

These are automatic methods which perhaps as yet can hardly be called automation. Their purpose is to speed up testing and to relieve engineers of much routine work. The time has not yet come when a piece of electronic apparatus will announce through its loudspeaker 'Please replace R₃₉'. That is now possible, but it may never come, for we suspect that the automatic testing equipment would be so complex that it would have a higher probability of faults than the equipment it was designed to test!

In test apparatus, as in everything else, it is necessary to exercise a fine discrimination and to guard against the tendency to over-elaboration.

Total Differential Feedback

A DEVICE FOR SQUARING THE EFFECTIVE POSSIBLE FEEDBACK IN A FEEDBACK AMPLIFIER

By J. C. H. Davis*

In feedback amplifiers, such as those used as line amplifiers in frequency division multi-channel systems, which may, for example, have a bandwidth of six octaves and require more than 25 dB of feedback in order to suppress intermodulation products, there is a definite maximum amount of feedback which can be applied for given valve characteristics¹. This limit is set primarily by the slopes and interelectrode capacitances of the valves used, which determine the maximum possible interstage impedances. Particularly in multi-stage amplifiers the limit may appear as loop instability

resulting in oscillations far outside the transmission band.

The principle of total differential feedback may overcome this limitation. The term is used to describe circuits in which the difference between the input signal to one amplifying path and the total signal feedback by its associated loop is applied to the input of another amplifying path, as shown in Fig. 1. The two output signals are combined in such a way that the transmission gain of the complete amplifier is substantially that of either path with the other path dead, while the gain stability, harmonic margins and signal-to-noise ratios produced other than at the grid of the first stage are improved². If each amplifying path has A dB of feedback applied to it, the effective feedback on the complete amplifier is practically that expected from a single path with $2A$ dB of feedback applied. This is achieved without the additional stability penalty resulting from this amount of feedback in a single loop and also has the advantage that, if one path goes dead, the other path maintains the transmission with A dB of feedback.

Fig. 1. Two methods of applying total differential feedback

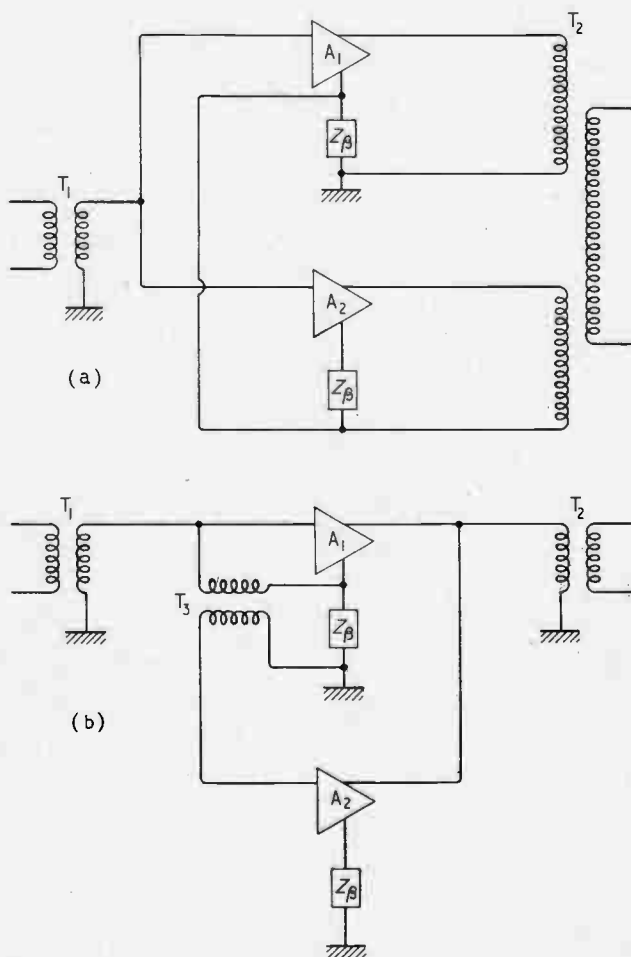

The Theory of Single-Stage Amplifying Paths

Fig. 2 shows the simplified circuit diagram of a single-stage feedback amplifier; i_x represents a current source of distortion products in the valve of slope g_1 .

The total current in Z_2

$$I = i_1 + i_x = (e_{in}/Z_1) [1 - 1/(1 + g_1 Z_1)] + i_x/(1 + g_1 Z_1)$$

This may also be written

$$I = (e_{in}/Z_1) [g_1 Z_1/(1 + g_1 Z_1)] + i_x/(1 + g_1 Z_1) \quad (1)$$

This shows the normal stabilization of gain and reduction of noise due to the feedback $g_1 Z_1$.

The voltage between grid and cathode

$$\begin{aligned} &= e_{in} - e_1 \\ &= e_{in} - IZ_1 \\ &= e_{in}/(1 + g_1 Z_1) - i_x Z_1/(1 + g_1 Z_1) \end{aligned} \quad (2)$$

using Equ. (1).

Let this voltage difference be applied to an amplifying path whose effective slope is I/Z_1 and the resulting output current be added to I .

The combined output current = e_{in}/Z_1 exactly.

This depends on the effective slope of the second amplifying path being exactly $1/Z_1$. In practice, a sufficiently close approximation can be achieved.

Figs. 3(a) and 3(b) show two methods of connecting the second path, corresponding to Figs. 1 (a) and 1 (b).

*British Telecommunications Research Ltd., Taplow Court, Taplow, Bucks.

In Fig. 3(a) a three-winding output transformer is required where the ratio of the turns on windings A and B will normally be 1:1. Similarly, the transformer at the input in Fig. 3(b) will normally have a turns ratio 1:1. When this is so, $Z_1 = Z_3$. The turns ratio of windings A and C in Fig. 3(a) are shown as 1:1 for convenience in analysis.

The current in Z_2 due to i_2 ; i.e., ki_2 in Fig. 3 (a) and i_2 in Fig. 3 (b)

$$= \frac{k(e_{in} - e_1)}{Z_3} \cdot \frac{g_2 Z_3}{1 + g_2 Z_3}$$

$$= \frac{k}{Z_3} \cdot \frac{e_{in} - i_x Z_1}{1 + g_1 Z_1} \cdot \frac{g_2 Z_3}{1 + g_2 Z_3} \quad \dots \quad (3)$$

using Equ. (2). Here g_2 is the slope of the second valve and k the turns ratio of the transformer as shown. The addition of equations (1) and (3) gives the total output current.

$$= \frac{e_{in} g_1 Z_1 (1 + g_2 Z_3) + k g_2 Z_1}{Z_1 (1 + g_1 Z_1) (1 + g_2 Z_3)} + \frac{i_x}{1 + g_1 Z_1}$$

$$\left(1 - \frac{k Z_1}{Z_3} \frac{g_2 Z_3}{1 + g_2 Z_3} \right)$$

$$= \frac{e_{in}}{Z_1} \left[1 - \frac{1}{(1 + g_1 Z_1) (1 + g_2 Z_3)} \right]$$

$$+ \frac{i_x}{(1 + g_1 Z_1) (1 + g_2 Z_3)} \text{ when } \frac{k Z_1}{Z_3} = 1 \quad (4)$$

Comparison of Equis. (1) and (4) shows that both the gain stabilization and the harmonic suppression have been increased by a factor $(1 + g_2 Z_3)$. This has been done without, in simple theory, affecting the feedback loop of the first path.

If g_1 or g_2 is zero; i.e., if either path fails, the output current

$$= \frac{e_{in}}{Z_1} \left(1 - \frac{1}{1 + gZ} \right) + \frac{i_x}{1 + gZ}$$

The extra feedback is removed but the amplifier continues to operate with substantially the same gain as before.

Fig. 3. Two single-stage negative-feedback amplifiers connected as in Fig. 1 to take advantage of total differential feedback

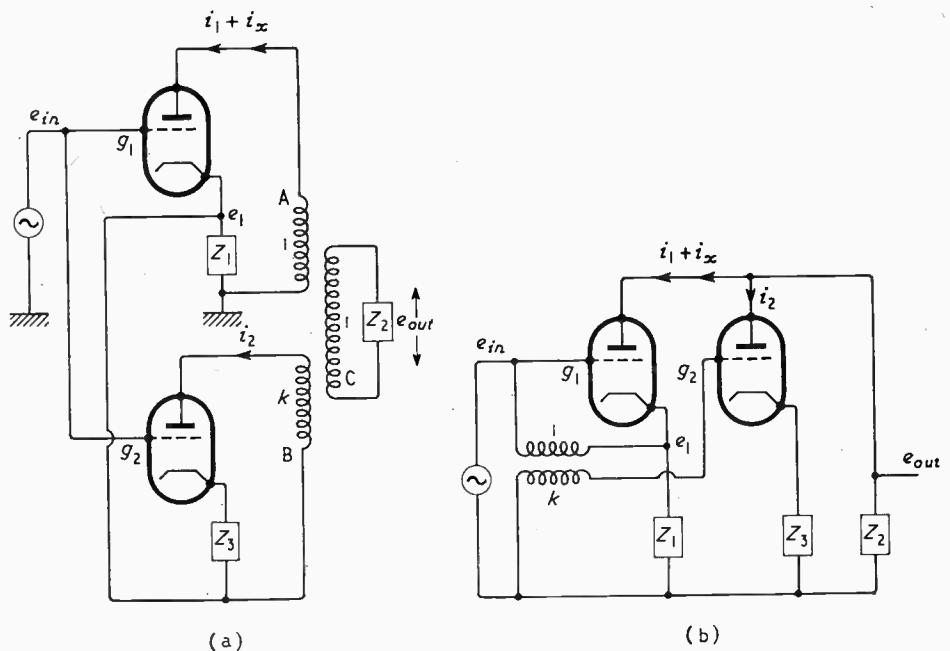
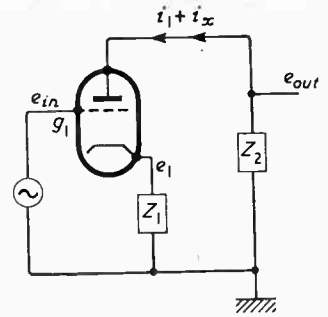

Fig. 2. A normal single-stage amplifier with feedback applied



While noise in the first path is suppressed, noise in the second path is added. However, the voltage fed to the second path $= e_{in} - e_1 = e_{in}/g_1 Z_1$ approx., so that this path works at a much lower level than the first and produces correspondingly negligible noise and harmonics.

The amount of effective feedback added from the second path depends on how closely $1 - (kZ_1/Z_3) g_2 Z_3 / (1 + g_2 Z_3)$ approximates to zero. If $kZ_1/Z_3 = 1$ and the second path has 20 dB of feedback, $g_2 Z_3 = 10$ and $1 - (kZ_1/Z_3) g_2 Z_3 / (1 + g_2 Z_3) = 1/11$. If the feedback is very large, the amount of effective feedback which can be added to the first path depends on the accuracy of kZ_1/Z_3 . For the limit of added feedback to be 20 dB, $kZ_1/Z_3 = 10/11$; i.e., $kZ_1/Z_3 = 1 \pm 9\%$. As this assumes a large amount of feedback in the second path, the accuracy will have to be greater than this when the feedback in the second path approaches 20 dB, but it can be seen that the required accuracy is not very high; e.g., if the feedback in the second path is 20 dB and $kZ_1/Z_3 = 1 \pm 4\%$ the effective feedback added to the first path is 17 dB.

In principle, it should be possible to add a third path to increase the apparent feedback on the second path and thus on the first. This could be extended indefinitely, but the limit of usefulness is set by the accuracy of the expression $kZ_1/Z_3 = 1$ which controls the maximum amount of feedback which can be added to the first path from all subsequent paths.

It is of interest to see what the effect of a catastrophic

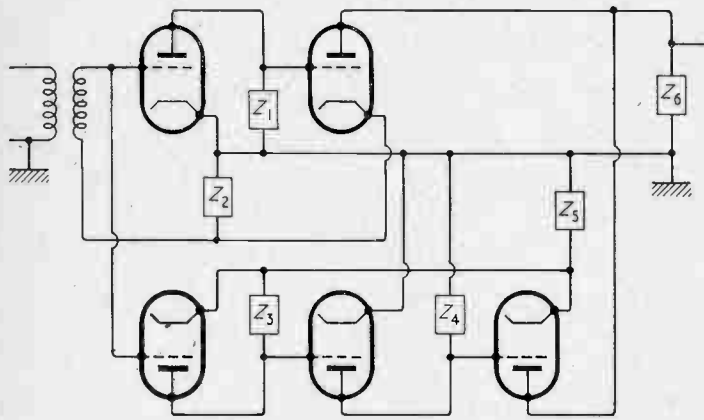

Fig. 4. A circuit using a two-stage amplifier in one path and a three-stage amplifier in the other to minimize difficulties in building wideband transformers

failure of one path would be in a 1500-mile route where the C.C.I.T.T. requirements are hardest to meet. The total feedback on a repeater is unlikely to be much more than 40 dB. Therefore, on failure of one path, the repeater would lose a maximum of 20 dB of effective feedback. There would be a small gain change, some of which might be absorbed by the regulation system, but the main effect would be on noise and harmonics, which would increase by 20 dB. This is an increase of 10 times in voltage and 100 times in power. The fault is, therefore, equivalent to the addition of 10 or 100 amplifiers to the system if the harmonics or noise add as voltages or power respectively. In a system planned to contain over 250 amplifiers in each direction of transmission, as in a 4-Mc/s system, or 500 in each direction, as in a 12-Mc/s system, the system should remain within the specification even in a fault condition.

Multi-Stage Paths and Other Configurations

The same principles apply to multi-stage as to single paths, but the anode load on the first stage of the first path, Z_1 in Fig. 4, must be decoupled to the cathode so that the local feedback does not affect the signal fed to the second path. This is not necessary in the second path unless a third is added.

Circuits based on Fig. 1 (a) have the disadvantage of requiring a transformer, T_2 , which has three windings, one of which is isolated from earth. The design of the output transformer of a wideband line amplifier is already a very difficult problem when it has two windings which both have one side earthed. When an extra winding is added and this is isolated from earth the difficulties become forbidding. The configuration in Fig. 1 (b) overcomes this difficulty but T_3 now presents an impedance to the input which may have a serious effect on the transmission unless the input impedance is kept low, reducing the maximum possible transmission gain. Fig. 4 shows one way of minimizing these difficulties. The fact that the two paths have different numbers of stages and thus, almost certainly, different loop characteristics is immaterial. Only the gains and phases of the transmissions through the two paths affect the characteristics of the complete amplifier.

Fig. 5 shows how the second path through V_3 can be

used to compensate for the distortion in only part of the first path, namely V_2 . Here g_1 , Z_1 , Z_2 , perform the same function as Z_1 in Fig. 3 (a) in providing a difference between the signal at the grid of V_2 and the feedback voltage which is applied to V_3 . The condition for cancellation is

$$g_1 Z_1 Z_2 / Z_3 = 1$$

There seems no reason to doubt that transistors could replace valves in any of the circuits mentioned, though an amplifier using them was not built.

A Practical Amplifier

The amplifier shown in Fig. 6, using two stages in each of the transmission paths, was built to test the theory without the detailed loop design required for three-stages. This made it necessary to use a three-winding output transformer, but the bandwidth aimed at in this test was not comparable with that often used on coaxial cable systems and no trouble was taken to produce the best design.

It can be shown that, in simple theory, the condition of the loop of one amplifying path should not affect the stability margin of the loop of the other amplifying path. This was supported by practical evidence. When the feedback ratio in the loop of each amplifying path was measured, it was found that there was no change when the other path was made inactive.

The transmission gain of the complete amplifier was between 19dB and 20dB from 15 kc/s to 150 kc/s as shown in Fig. 7. With one path dead the gain dropped by 2dB. This was a consequence of the effective feedback of the complete amplifier dropping from 20dB to 10dB. With larger amounts of feedback this would become less marked. The irregularities below 15 kc/s and above 150 kc/s were due to imperfections of the transformer T_1 which should be an ideal transformer having no phase shift in the transmission band and with 0dB voltage gain. These irregularities could be reduced considerably by careful design and some compensation could also be applied.

The second and third harmonic margins for the complete amplifier and for each transmission path alone are shown in Table 1. The fundamental output level was kept within 0.5dB of that at 60 kc/s for second

Fig. 5. A circuit showing how V_3 and Z_2 can be connected to compensate for distortion in V_2 only

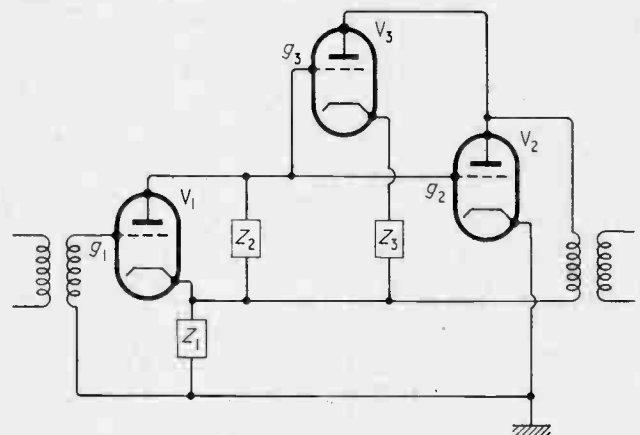

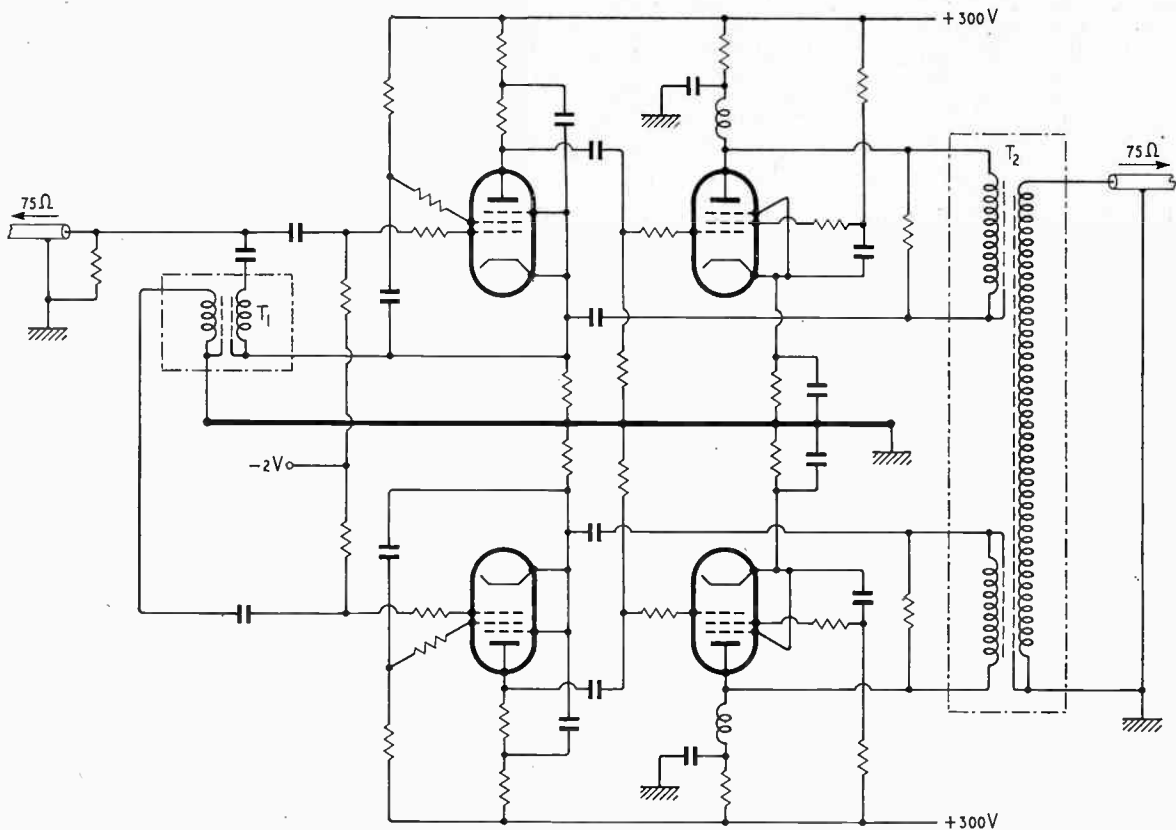

Fig. 6. A practical amplifier using total differential feedback

and third harmonic readings so that the apparent improvements in margins between one path dead and the complete amplifier were approximately 16 dB and 18 dB. This was greater than expected from the increased feedback alone as the added path contributed 2dB to the transmission gain without adding appreciably to harmonics. This was equivalent to an additional improvement of 4dB and 6dB in the second and third harmonic margins.

It was the input impedance which provided the most serious objection to the use of an unterminated transformer as T_1 . The experimental amplifier was fed from a terminated 75-ohm source which swamped the variations in impedance but wasted possible transmission gain. When the first transmission path was dead, the input impedance, with the 75-ohm termination removed, was that of the transformer whereas, when the first path was active, the feedback increased the impedance greatly. Circuits based on Fig. 1 (a) avoid this, but when two stages are used the second path is potentially a multivibrator.

Conclusions

The device works substantially as simple theory predicts, but the circuit used must be chosen so that the input and output impedances do not interfere with preceding or succeeding circuits. If a circuit based on that in Fig. 1 (a) is used, an output transformer must normally be used which is difficult to make in wideband applications. A circuit based on Fig. 1 (b) demands either a low impedance source or the toleration of a variation of gain with frequency of an irregular shape

when one of the amplifying paths fails. There may be a limited number of circuits such as in Fig. 4 where the penalties are small.

With the above disadvantages the device has the following advantages.

(1) Even when an amplifier has been designed with the maximum feedback consistent with stability, the apparent feedback ratio may be squared without

TABLE 1
Harmonic Margins Produced by the Amplifier in Fig. 6

Fundamental Frequency (kc/s)	Transmission Path	Second Harmonic		Third Harmonic	
		Fundamental Output Level (dBm)	Harmonic Margin (dB)	Fundamental Output Level (dBm)	Harmonic Margin (dB)
60	Complete Amp.	-1	57½	+5	69
	First path	-1	41½	+5	50½
	Second path	-1	41½	+5	50½
120	Complete Amp.	-1	59	+5	69½
	First path	-1	42½	+5	52½
	Second path	-1	42½	+5	52½
240	Complete Amp.	-1½	57½	+4½	61½
	First path	-1½	43	+4½	55½
	Second path	-1½	43	+4½	55
480	Complete Amp.	-1	38		
	First path	-1	40		
	Second path	-1	34½		

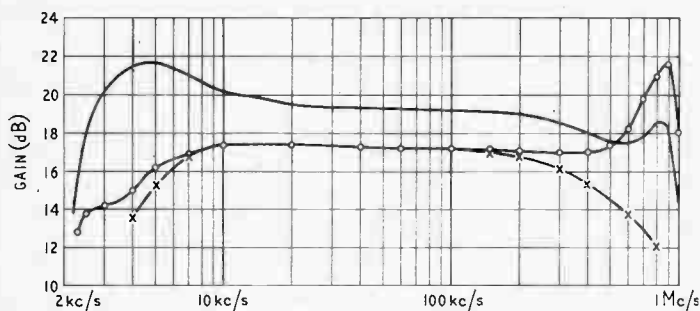

Fig. 7. Transmission gain of the amplifier in Fig. 6; — complete amplifier as in Fig. 6; o o o o as in Fig. 6, but with first amplifying path inactive; x-x-x-x as in Fig. 6, but with second amplifying path inactive

affecting the stability substantially. This feedback has the normal beneficial effects on gain stability, harmonics and noise produced in the amplifier.

(2) If one part of the complete amplifier is faulty the other part continues working with a slightly changed gain and reduced harmonic margin.

Acknowledgements

The author wishes to thank British Telecommunications Research Limited, for permission to publish this article and Mr. H. O. Friedheim for his advice and help.

REFERENCES

- ¹ Bode. "Network Analysis and Feedback Amplifier Design" (1st Edition), p. 485.
- ² Patent No. 732, 630, "Improvements in or Relating to Negative Feedback Amplifiers". Western Electric Co. Inc.

Foster-Seeley Discriminator

By C. G. Mayo, M.A., B.Sc., M.I.E.E.,* and J. W. Head, M.A.*

SUMMARY. The Foster-Seeley discriminator is essentially a parallel-tuned circuit and an impedance inverter by means of which the frequency variation is converted into amplitude variation in a linear manner. A series-tuned circuit could also in theory achieve this conversion, but impossibly-high values of inductance would be required.

The analysis has been carried out by means of elementary matrices (having not more than four rows and columns) and straightforward if somewhat tedious mathematics, the detail of which is relegated to the Appendices. This procedure enables us to understand the essential behaviour of the discriminator rather than merely to obtain numerical results, and has enabled the authors to devise an improved version of the discriminator which will be described in due course. Normalized units have been used to simplify the general discussion, but the derivation of the relevant parameters for a particular assembly is briefly discussed.

With the circuit arrangements here discussed, sensitivity of about 1.4 audio signal volts per i.f. milliampere can be obtained, with less than 0.1% second-harmonic distortion at 100% modulation, and n th-harmonic distortion less than $(0.1/2^{n-1})$ per cent, with current British f.m. practice. Errors of the same order can be caused by mistuning by, say, 50 kc/s. Errors due to misalignment of tuning capacitance (due to temperature variations, etc.) are negligible if the tuning capacitance never differs from its intended value by more than 1%.

A particular arrangement of the Foster-Seeley discriminator circuit is shown in Fig. 1, and the object of this paper is to analyse it, with the help of mathematical methods where necessary, so that a creative understanding of the factors which significantly affect performance is gained; this is more important than the derivation of actual quantitative results. This type of analysis is greatly simplified by the use of suitable normalized units; the performance of one particular assembly will be briefly discussed so as to explain the relation between the normalized units and those customarily used.

A craftsman, such as a french-polisher, when at work often spends about nine-tenths of his time in preparation

and only about one-tenth on doing the actual job. There is a similar craftsmanship of mathematics, and normalization is part of it when our main object is creative understanding. The full power of mathematics is developed in calculations of this type. It is not so much that very complicated or advanced mathematics is required, but rather that the skilful and repeated application of reasonably elementary principles enables us not merely to understand one particular case (in this case, the performance of one particular discriminator) but the general pattern associated with many different cases. When mathematics is used for the derivation of particular numerical results, it may considerably reduce—perhaps halve—the time taken to obtain those results. When mathematics is used for the type of calculation developed

* Research Department, B.B.C. Engineering Division.

here, it can make all the difference between creative understanding and complete lack of understanding. The derivation of particular results is relatively easy once we have obtained this creative understanding, that is to say, once we have seen the problem as a whole and in detail, with nothing essential left out and nothing accidental left in. If possible, any particular problem should be related to other problems previously solved.

Our first steps may seem to take us further from a solution, just as the french-polisher's early preparatory activities may seem useless to the uninitiated. This is because we are apt to confuse the unfamiliar with the difficult.

In mechanics, normalization consists in replacing familiar quantities by what used to be called 'specific' quantities, e.g., pressure by stress (pressure per unit area), displacement by strain, etc. These normalized quantities, though less familiar, are more significant. Normalization does require an initial effort of memory for learning new quantities and symbols but, in the long run, it makes the work very much easier, just as new jigs or tools initially appear to hold up production, but in the long run lead to vastly increased production.

In Section 1 we shall show how the essential features of the discriminator can be expressed by means of the simplified circuit of Fig. 2. A reasonable justification of this simplification is given in the main text; a more mathematical justification is given in Appendix 3. Matrix methods are used where needed; in the main text only matrices having two rows and columns are involved but, in Appendix 3, matrices having four rows and columns appear. Although matrices in general need the attention of a mathematician, these specially simple types can be manipulated by means of techniques which an engineer can learn very quickly¹. They are not at present very familiar to engineers, but they so greatly increase our powers of understanding and appreciating the significant phenomena associated with a system like the discriminator under discussion that the effort of learning to handle matrices is well worth making. In Section 2, the solution for the simplified coupled circuit of Fig. 2 is obtained; normalized units are used to simplify the algebra. The performance of a particular assembly is briefly discussed in Section 4, where the conversion from normalized units to the usual practical units and vice versa is explained. The behaviour of the discriminator output voltage as a function of frequency is discussed fully in Section 3; some of the mathematical detail is relegated to Appendix 2.

1. Derivation of Simplified Coupled Circuit

A particular arrangement of the Foster-Seeley discriminator circuit is shown in Fig. 1. Here L_1 is the

primary coil, supplied from the anode of a pentode valve and tuned by C_1 . L_2 is closely coupled to L_1 and the secondary sections L_3 and L_4 are closely coupled to each other. The diode D_3 and the associated capacitance C_3 and load r_3 are supposed respectively to be similar to the diode D_4 and its associated capacitance C_4 and load r_4 . L_3 and L_4 are supposed equal and equally coupled to L_1 . The action of the diodes causes the output V_o to be

$$V_o = |V_2 + V_3| - |V_2 + V_4| \quad \dots \quad (1)$$

where the vertical lines indicate numerical values.

We could solve the circuit of Fig. 1 as it stands, but this would introduce unhelpful complexity. The justification for the simplifying assumptions we now make is contained in Appendix 3; a reasonable but less strict explanation of these assumptions follows.

Consider first the close-coupled coils L_1 and L_2 as a slight deviation from an ideal transformer, so that the coupling coefficient is $k_{12} = 1 - \mu$ where μ is of order 0.05. On the other hand, the coupling coefficients k_{13}

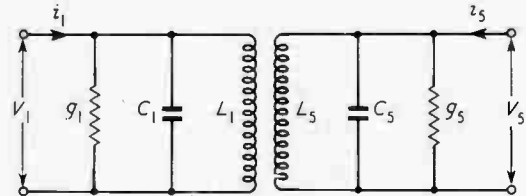
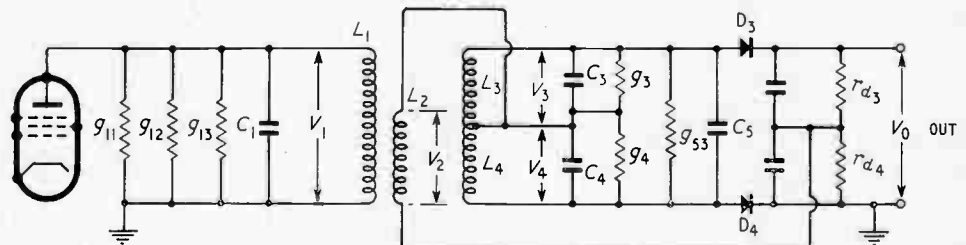

Fig. 2. A simplified form of the discriminator circuit showing essential features of its performance

and k_{14} between L_1 and the secondary coils L_3 and L_4 will be small, say of order 0.05. We allow for the imperfect coupling by supposing that the circuit consists of the coil L_1 together with an ideal transformer whose turns ratio is nearly the square root of L_1/L_2 and an unwanted equivalent series (leakage) inductance in the circuit of L_2 whose value is $(1 - k_{12}^2)L_2$ which is nearly $2\mu L_2$. The effective value of V_2 reaching the diodes is reduced by the product of the effective series impedance due to the leakage inductance and the effective load current into the diode circuit; it thus becomes $(1 - b)V_2$, where $b = 2\mu\omega L_2/r_2$, $\omega/(2\pi)$ being the frequency and r_2 the total load on L_2 . As in practice the leakage reactance $2\mu\omega L_2$ is of the order 10 ohms while r_2 is of order 50 k Ω , b is of very minor importance, so we can regard L_1 and L_2 as forming an ideal transformer of ratio $\rho_1 = (L_2/L_1)^{1/2}$. In (1) we can therefore replace V_2 by $\rho_1 V_1$, and the equivalent load of the diode circuit on L_1 is ρ_1^2 times the actual load of the diode circuit on L_2 . This is explained in Appendix 1.

If we similarly consider the equal coils L_3 and L_4 , they

Fig. 1. A particular arrangement of the Foster-Seeley discriminator circuit



can be effectively replaced by a single coil L_5 having inductance equal to L_1 and an ideal push-pull transformer of ratio $\pm \rho_2 : 1$ where $\rho_2 = (L_3/L_1)^{1/2}$, with the same precautions as to proper assignment of the diode circuit loading, Equ. (1) now becomes

$$V_o = |\rho_1 V_1 + \rho_2 V_5| - |\rho_1 V_1 - \rho_2 V_5| \quad \dots \quad (2)$$

The essentials of the circuit are contained in Fig. 2 but we have to determine the appropriate values for the equivalent losses g_1 and g_5 shown across L_1 and L_5 respectively, and for the corresponding equivalent capacitances C_1 and C_5 . The conductance g_1 includes

- (a) the equivalent source conductance g_{11}
- (b) coil losses g_{12} in L_1 and L_2 (Fig. 1) adjusted to take account of the transformer of ratio ρ_1
- (c) conductance g_{13} deliberately added across L_1 or L_2 , adjusted to take account of the transformer of ratio ρ_1 if necessary
- (d) referred diode circuit load g_{14}

For (d) the usual convention is that if the diode load resistance is r_d k Ω , the equivalent diode load is taken as $2/r_d$ mmho under peak rectifying conditions. In Fig. 1 the load on L_2 is thus the equivalent load due to both diodes in parallel or $4/r_d$ mmho, r_d being of the order 100 k Ω . Allowing for the transformer of ratio ρ_1 , g_{14} becomes $4/r_d \rho^2$. As all these conductances are in parallel, we finally have

$$g_1 = g_{11} + g_{12} + g_{13} + g_{14}$$

(The computation of the equivalent total load g_1 from the separate parts is considered mathematically in Appendix 3 in a somewhat more general case.)

Similarly

$$g_5 = g_{52} + g_{53} + g_{54}$$

where g_{52} is the contribution from coil losses in L_3 and L_4 (Fig. 1) to the total loss across L_5 (Fig. 2) adjusted to take account of the transformer of ratio ρ_2 , g_{53} is conductance deliberately added across L_3 and L_4 in Fig. 1, and adjusted to take account of the transformer of ratio ρ_2 and g_{54} is the referred diode circuit load $\rho^2 r_d$. There is no source conductance affecting L_5 . The capacitances C_1 and C_5 can be regarded as made up of stray capacitances and tuning capacitances deliberately added, but since the tuning capacitances can be adjusted, we can regard C_1 and C_5 simply as variable capacitances in parallel with L_1 and L_5 in Fig. 2 and we need not examine how they are made up. We shall see later what effective values of C_1 and C_5 are required for tuning.

2. Solution for the Simplified Circuit of Fig. 2.

Normalization

At frequency $\omega_0/(2\pi)$, the reactance of L_1 in Fig. 2 is $j\omega_0 L_1$ ohms. At frequency $\omega/(2\pi)$ the impedance of L_1 is $j\omega L_1$ ohms or $j\omega_0(1 + \xi)L_1$ ohms, where ξ is the fractional frequency deviation $(\omega - \omega_0)/\omega_0$. With an i.f. or mean frequency of 10.7 Mc/s and a maximum frequency deviation of 75 kc/s, the maximum numerical value of ξ is 0.007. It is convenient to replace ξ by sx , where s is merely an abbreviation for 0.007 and x varies between -1 and $+1$. Thus we finally obtain that the impedance of L_1 or L_5 at frequency $\omega/(2\pi)$, alternatively written $\omega_0(1 + sx)/(2\pi)$, is

$$j\omega_0(1 + sx)L_1 \text{ ohms.}$$

We now normalize the unit of impedance so that this

quantity shall be numerically equal to unity when $\omega = \omega_0$ and $x = 0$, that is to say, we take as our reactive unit an impedance of $\omega_0 L_1$ ohms rather than an inductance of a henry or a capacitance of a farad. The impedance of L_1 or L_5 thus becomes p in the normalized units where

$$p = j(1 + sx) \quad \dots \quad \dots \quad \dots \quad (3)$$

In the same units the quantities g_1 and g_5 become equivalent loss factors, the reciprocals of the corresponding equivalent Q -factors; the quantity we called g_{13} is likewise the reciprocal of the Q of coil 1 in these normalized units. The coupling coefficient k between L_1 and L_5 will be of order 0.05, like the quantities g_1 and g_5 . With this notation, we have at frequency $\omega/(2\pi)$

$$\left. \begin{aligned} V_1 &= \rho i_1 + p k i_5 \\ V_5 &= p k i_1 + \rho i_5 \end{aligned} \right\} \dots \dots \dots (4)$$

where i_1, i_5 are the currents flowing in Fig. 2 on the assumption that the elements g_1, C_1, g_5 and C_5 are absent. In matrix notation this can be written

$$\begin{bmatrix} V_1 \\ V_5 \end{bmatrix} = p \begin{bmatrix} 1 & k \\ k & 1 \end{bmatrix} \begin{bmatrix} i_1 \\ i_5 \end{bmatrix} \quad \dots \quad \dots \quad \dots \quad (5)$$

Equation (4) can be solved for i_1 and i_5 in terms of V_1 and V_5 , and the result expressed in matrix notation in the form

$$\begin{bmatrix} i_1 \\ i_5 \end{bmatrix} = \frac{1}{p(1 - k^2)} \begin{bmatrix} 1 & -k \\ -k & 1 \end{bmatrix} \begin{bmatrix} V_1 \\ V_5 \end{bmatrix}$$

As k is of order 0.05, we can neglect k^2 compared with unity so that

$$\begin{bmatrix} i_1 \\ i_5 \end{bmatrix} = \frac{1}{p} \begin{bmatrix} 1 & -k \\ -k & 1 \end{bmatrix} \begin{bmatrix} V_1 \\ V_5 \end{bmatrix} \quad \dots \quad \dots \quad \dots \quad (6)$$

Now the capacitance C_1 carries a current $pC_1 V_1$ and this current increases i_1 only. The equivalent loss g_1 also carries a current $g_1 V_1$ which likewise increases i_1 only. Similarly for C_5 and g_5 , so that, allowing for the elements C_1, C_5, g_1 and g_5 the relation between current and voltage is

$$\begin{bmatrix} i_1 \\ i_5 \end{bmatrix} = \begin{bmatrix} 1/p + pC_1 + g_1 & -k/p \\ -k/p & 1/p + pC_5 + g_5 \end{bmatrix} \begin{bmatrix} V_1 \\ V_5 \end{bmatrix} \quad (7)$$

for the actual circuit of Fig. 2, in which i_5 must be equated to zero since no further elements are connected to L_2 .

For tuning we take $C_1 = C_5 = 1$ (in normalized units). In effect, the primary is tuned with the secondary short-circuited and the secondary is tuned with the primary short-circuited and, at the mean frequency ($p = j$), we have

$$\begin{bmatrix} i_1 \\ i_5 \end{bmatrix} = \begin{bmatrix} g_1 & kj \\ kj & g_5 \end{bmatrix} \begin{bmatrix} V_1 \\ V_5 \end{bmatrix} \quad \dots \quad \dots \quad \dots \quad (8)$$

If g_1 and g_5 are small compared to k , Equ. (8) indicates that the primary current depends only upon the secondary voltage and vice versa, so that the circuit is behaving as a quarter-wave impedance inverter or Boucherot circuit. As will be seen later, short-circuiting either winding makes the other winding have maximum impedance. This inversion property is the key to understanding the whole arrangement.

Equations (6) and (8), and much of the treatment which now follows, can be regarded as a method of analysing coupled-coil circuits in general (apart from the present application to the discriminator) which presents

at a glance the essential and important features of such circuits. The normalization procedure takes adequate care of the detail associated with a particular application. Indeed, we could have started with (6) and only considered the normalization with concrete design details.

From (7) with $i_5 = 0$ we have, by 'inverting' the matrix, that is, finding V_1 and V_5 in terms of i_1 and i_5 ,

$$\left. \begin{aligned} V_1 &= [p + 1/p + g_5] \cdot (i_1/\Delta) \\ V_5 &= (-k/p) \cdot (i_1/\Delta) \end{aligned} \right\} \dots \dots (9)$$

where

$$\Delta = \{p + (1/p) + g_1\} \{p + (1/p) + g_5\} - (k^2/p^2) \quad (10)$$

But from (3)

$$p + (1/p) = 2j_s x (1 + \frac{1}{2} s x) / (1 + s x) \approx 2j_s x (1 - \frac{1}{2} s x) \dots \dots (11)$$

so that if we take $p + (1/p)$ as $2j_s x$, there is an error of $\frac{1}{2}s$ or 0.35% at 100% modulation ($x = 1$).

For the present we shall neglect this error, and the error of the same order of magnitude involved in replacing p^2 by -1 in the last term of (10). In Appendix 2, the effect of this approximation, which is only significant for second-harmonic distortion, is examined more fully.

Now in (9) all the quantities involved are of the same order of magnitude. We therefore write

$$g_1 = 2s\alpha, \quad g_5 = 2s\beta, \quad k = 2s\lambda \quad \dots \dots (12)$$

where, as before, $s = 0.007$; the variables α , β and λ will then lie between 1 and 10 in practice, and with such variables it is much easier to see the significance of results obtained than is the case with the original variables g_1 , g_5 and k . Eqs. (9) and (10) now reduce to

$$\left. \begin{aligned} V_1/i_1 &= \frac{\beta + jx}{2s\{(\alpha + jx)(\beta + jx) + \lambda^2\}} \\ V_5/i_1 &= \frac{j\lambda}{2s\{(\alpha + jx)(\beta + jx) + \lambda^2\}} \end{aligned} \right\} \dots \dots (13)$$

and (13) is easier to understand with the aid of the following verbal definitions which in effect recapitulate (11) and (12): α and β are the equivalent loss factors of primary and secondary divided by $2s$ (i.e., 0.014), that is, measured relative to maximum fractional frequency deviation. λ is the coupling coefficient between L_1 and L_5 (Fig. 2) measured likewise relative to maximum fractional frequency deviation. x has the maximum numerical value unity at 100% modulation. In practice λ is of order 3, according to the coupling, and α and β are also of order 3, according to the loading.

From (13), we could plot $|V_1/i_1|$ and $|V_5/i_1|$ against x . In effect we regard the input current i_1 as delivered through a high impedance. The curve of $|V_5/i_1|$ against x can be made either concave upwards (with two maxima) or concave downwards (with one maximum) or very flat-topped by suitable choice of α , β and λ . The curve of $|V_1/i_1|$ against x only differs from that for $|V_5/i_1|$ because of the factor $(\beta + jx)$ in the numerator of V_1 in (13). If $|V_5/i_1|$ is nearly flat-topped, V_1/i_5 is nearly linear in x ; this important fact is not obvious from the curves.

Since in (13) we have used $\omega_0 L_1$ as our unit of impedance, V_1/i_1 and V_5/i_1 must both be multiplied by $\omega_0 L_1$ if they are to be expressed in volts/ampere on the assumption that ω_0 is in radians/sec, and L_1 is in henrys. V_1/i_1 and V_5/i_1 will, however, be in V/mA if L_1 is in mH

and $\omega_0/2\pi$ in Mc/s. For the particular assembly discussed below (Section 5) the sensitivity thus turns out to be about 1.4 V/mA.

Now from (10) we have $\Delta = 4s^2 \Delta_0$, where

$$\Delta_0 = (\alpha + jx)(\beta + jx) + \lambda^2 \dots \dots (14)$$

The discriminator output voltage V_o is therefore found by substitution in (2) to be

$$V_o = \frac{i_1}{2s|\Delta_0|} \{ |\rho_1(\beta + jx) + j\rho_2\lambda| - |\rho_1(\beta + jx) - j\rho_2\lambda| \} \dots \dots (15)$$

where, as in (2), vertical bars denote numerical values.

3. Behaviour of the Discriminator Output Voltage

To understand the significance of (15), we need to expand the numerator and denominator in powers of x ; here we shall consider powers of x up to and including x^5 in the numerator and x^4 in the denominator. The result, derived more fully in Appendix 2, is

$$V_o = \frac{i_1 \rho_2 \lambda}{s K^{\frac{1}{2}} N} \cdot \frac{x - (\beta^2 x^3 / 2K^2) + [\beta^2 x^5 (3\beta^2 - 4\sigma^2 \lambda^2) / 8K^4]}{1 + [(\alpha^2 + \beta^2 - 2\lambda^2) x^2 / 2N^2] + [(\alpha + \beta)^2 \{4\lambda^2 - (\alpha - \beta)^2\} x^4 / 8N^4]} \dots \dots (16)$$

where

$$\sigma = \rho_2 / \rho_1; \quad K = \beta^2 + \lambda^2 \sigma^2 \quad \text{and} \quad N = \alpha\beta + \lambda^2 \quad (17)$$

Now in the special case when $\alpha = \beta = \lambda = 3$, the x^2 term in the denominator of (16) is absent, and the x^4 term reduces to $1/(2 \times 18^2)$, so that there is only 0.15% of fourth-power deviation from constancy in this denominator. The curve showing $|\Delta_0|$ as a function of x could be made still flatter by keeping α , β and λ equal and increasing their common value; the discriminator would thus be made broader at the expense of output. The influence of $|\Delta_0|$ on (16) can be considered as if $|\Delta_0|$ were the response curve of a preceding section of the i.f. amplifier; $|\Delta_0|$ behaves like such a response. We can think of $|\Delta_0|$ as constant, and suppose that i_1 contains the nonlinearity of $|\Delta_0|$ as if it came from a preceding stage.

If for the time being we neglect the variations in $|\Delta_0|$, we notice in (13) that V_1 varies linearly with x while V_5 is constant, and in (16) the leading term of the numerator is proportional to x . If V_1 itself were being detected by a diode, a change in the sign of the modulation x would not be detected; it is the addition and subtraction of the V_5 -term in phase with the x -term that allows the output voltage V_o in (16) to be linear in x to a high degree of accuracy. The β -term in V_1 at first sight would seem to endanger the precision, but V_5 only has to be about 50% greater than V_1 in order to achieve satisfactory precision (as will be shown in Appendix 2).

If we now consider (16) as a whole, instead of considering the behaviour of the numerator and the denominator separately as hitherto, it is clear that the sensitivity of the discriminator is controlled by the coefficient of x when V_o/i_1 is derived from (16). Allowing for our normalization, the sensitivity is

$$\frac{\rho_2 \lambda}{s K^{\frac{1}{2}} N} \cdot \omega_0 L_1 \quad \text{V/mA at 100% modulation}$$

L_1 being in mH. For the particular values of α , β , λ and σ

given in (22), this gives a sensitivity of 1.4 V/mA assuming $\rho_2 = 1/\sqrt{5} \approx 0.45$.

There will be no third-harmonic distortion if the ratio of the coefficient of x^3 to that of x in the numerator equals the ratio of the coefficient of x^2 to the constant term in the denominator. If this is arranged, there will only be fifth-harmonic distortion; the relevant coefficient of x^5 (2^5-1 times the fifth-harmonic distortion) will then be the difference between the ratio of the coefficient of x^5 in the numerator to that of x , and the ratio of the coefficient of x^4 in the denominator to the constant term. It is not profitable to derive general formulae for third- and fifth-harmonic distortion from (16) because we have somewhat over-simplified the problem by assuming that the capacitances C_1 and C_2 could be made to have exactly the values unity we desired; in fact these capacitances may vary relative to one another in a manner which can change with time and is not under our control. We shall see later that errors from this cause are minimized by making $\beta = \lambda$. Our object is not primarily to determine the distortion terms in the general case but to find rough ranges of values of the parameters α , β , λ , σ (which are under our control) so that the discriminator performance shall be thoroughly satisfactory. But, first, it is desirable to consider more closely what has been achieved hitherto.

We wish to derive an output proportional to a frequency deviation which is a small fraction of the mean frequency. If we try to use a pure inductance L_a mH for this purpose, the voltage per milliampere would be $j\omega L_a$ at frequency $\omega/(2\pi)$ which in the notation of (3) is $j\omega_0 L_a(1 + xs)$, and since $s = 0.007$, the output thus obtained is not sufficiently sensitive to the variations in x in which we are interested. If now a tuning capacitance is connected in series with L_a , the output becomes

$$V = (R_1 + j2sx)\omega_0 L_a$$

where R_1 represents the effective series losses of the circuit. This expression is, as required, linear in x , but L_a would have to be very large to obtain adequate sensitivity, and self-capacitance of the windings makes it impracticable to have L_a large. If we try a parallel tuned circuit, high impedances are easily obtained, but the output voltage is of the form

$$V = A/(\beta + jx)$$

so that x is not linearly related to V ; this makes precise discrimination difficult. In (13), however, V_1 had a numerator $(\beta + jx)$ and a nearly constant denominator, and we were thus able to obtain from (16) an output almost linear in x . This numerator of (13), which has the same form as applies to a series tuned circuit, arises because the circuit of Fig. 2 is in essence an inverter; the $(\beta + jx)$ is in fact the secondary admittance inverted by the circuit to give the primary impedance.

In order that the distortion terms in the numerator of (16) may be reasonably small, we need to make K relatively large; it is sufficient to have $\lambda\sigma/\beta$ greater than say 1.5. But this requires high values of L_3 and L_4 in Fig. 1, which are inconvenient because the high coupling between L_3 and L_4 will then involve high winding capacitance. As we have allowed for the effective presence in the circuit of Fig. 1 of an ideal transformer of ratio ρ_1 , we can choose L_1 to have the value most appropriate to

the anode and stray-capacitances. This means that $\omega_0 L_1$ should be of order 1000 ohms, and C_1 , including all strays and anode capacitance, should be of order 20 pF. Similarly, the highest appropriate value of $\omega_0 L_3$ and $\omega_0 L_4$ will be of order 200 ohms. Hence ρ_2 should be of order $1/\sqrt{5}$, and to make $\rho_2\lambda/(\rho_1\beta) = 1.5$ then requires ρ_1 to be about $1/1.5\sqrt{5}$, say $1/3.5$, β and λ being approximately equal to minimize errors due to drift or initial misalignment of tuning capacitance as explained immediately below.

We have now determined the sensitivity of the discriminator, and the third- and fifth-harmonic distortion terms, and analysed the essential behaviour of the discriminator and the reasons for its effectiveness, but hitherto we have made two assumptions which are oversimplifications; we assumed that C_1 and C_5 could be made equal to unity in normalized units, and we assumed that $[p + (1/p)]$ could be replaced by $2j\sigma x$ in (11). Now since in (15), V_0 is clearly zero when x is zero, and $(\beta + jx)$ is in essence secondary admittance inverted, we can regard zero d.c. output as an accurate indication of secondary tuning. If the receiver is fitted with some kind of tuning indicator, it may be assumed that in use the secondary tuning is accurate. The accuracy of the primary tuning will then depend on the accuracy of the initial alignment and any subsequent change of capacitances due to temperature, etc. We propose to allow for all such errors by assuming an effective 1% error at most in primary tuning. This means that the term p representing primary tuning capacitance in (7) must be replaced by $p(1 + \epsilon)$ where $|\epsilon| < 0.01$. Equations (9) are unaffected except in so far as the value of Δ_0 given by (14) is altered: Δ_0 becomes Δ' where

$$\Delta' = (\alpha + jx + j\epsilon)(\beta + jx) + \lambda^2$$

and $\epsilon = e/2s$ in the fractional capacitance tuning error measured relative to the fractional frequency deviation, so that $|\epsilon| < 0.7$. We then find that

$$\begin{aligned} |\Delta'|^2 &= (\alpha\beta + \lambda^2 - \epsilon x - x^2) + \{(\alpha + \beta)x + \epsilon\beta\}^2 \\ &= \{(\alpha\beta + \lambda^2)^2 + \epsilon^2\beta^2\} + 2\epsilon(\beta^2 - \lambda^2)x \\ &\quad + (\alpha^2 + \beta^2 + \epsilon^2 - 2\lambda^2)x^2 + 2\epsilon x^3 + x^4 \end{aligned} \quad (18)$$

so that if we make $\beta = \lambda$, there will be no second-harmonic distortion due to capacitance mistuning. In the special case $\alpha = \beta = \lambda = 3$, which we considered before to appreciate the orders of magnitude of the various distortion terms involved, the x^2 term due to the presence of ϵ in the expansion of $|\Delta'|$ is $\epsilon^2/648$, giving third-harmonic distortion of $\epsilon^2/(648 \times 2^3-1)$, while the fourth-harmonic distortion is $2\epsilon/(648 \times 2^4-1)$; these are both very small even with the maximum value of ϵ . We conclude that the discriminator can tolerate errors of up to 1% on alignment of primary capacitance without more than 0.1% resultant distortion, that is to say, if the final output is expressed as

$$V_0 = Ax(1 + Bx + Cx^2 + Dx^2 + Ex^4) \quad (19)$$

the capacitance errors do not change B , C , D and E by more than 0.001 at most from the values associated with (16).

This also implies that mistuning by an amount not large compared with 75 kc/s will produce little distortion. If the receiver were mistuned by 75 α kc/s, we should have to replace x by $x + \alpha$ in (19), and therefore V_0

would become V'_o where

$$\begin{aligned}
 V'_o = & (A\alpha + B\alpha^2 + C\alpha^3 + D\alpha^4 + E\alpha^5) \\
 & + x(A + 2B\alpha + 3C\alpha^2 + 4D\alpha^3 + 5E\alpha^4) \\
 & + x^2(B + 3C\alpha + 6D\alpha^2 + 10E\alpha^3) \\
 & + x^3(C + 4D\alpha + 10E\alpha^2) \\
 & + x^4(D + 5E\alpha) + E\alpha^5 \dots \dots (20)
 \end{aligned}$$

and clearly if α is sufficiently small (that is, the mistuning is sufficiently small compared with 75 kc/s) the coefficients of the various powers of x in (20) will differ little from those in (19).

When $p + (1/p)$ was taken as $2jsx$, the strict truth was

$$p + 1/p = 2jsx \left[1 - \frac{1}{2}s + \frac{\frac{1}{2}s^2x^2}{1 + sx} \right]$$

and as s is 0.007, we are perfectly justified in neglecting the last term, as in (11). This will introduce additional terms involving s into Δ in (10) as well as into the expression for V_1 in (9). Hence (13) and (16) will also contain additional s -terms. The expansion of V_o in powers of x can be carried out in the manner indicated in Appendix 2, but the presence of the additional s -terms complicates the procedure. Only the contribution of the s -terms to second-harmonic distortion, however, need be calculated, because for higher-order distortions the contribution of the s -terms is clearly small compared with the distortions already discussed in relation to (16) and (18), owing to the small value of s . When the s -terms are taken into account, the relative value of the coefficient of x^2 in the expansion of V_o to that of x is, as explained in Appendix 2,

$$s \left[\frac{\lambda^2 - \alpha\beta}{\lambda^2 + \alpha\beta} + \frac{1}{2} \frac{\lambda^2\rho_2^2 - \beta^2\rho_1^2}{\lambda^2\rho_2^2 + \beta^2\rho_1^2} \right] \dots \dots (21)$$

so that if $\alpha = \beta = \lambda = 3$, $\rho_2 = 1.5\rho_1$, the relative x^2 term in the expansion of V_o is 0.00135, and the second-harmonic distortion is half this or 0.07%; clearly from (21) values of α , β , λ , ρ_1 and ρ_2 can easily be found such that this type of distortion is less than say 0.2%.

4. The Performance of a Particular Assembly

We have seen that by proper choice of the parameters λ , ρ_1 , ρ_2 , α and β (which were defined in the last section, and which are under our control) and by due regard to Equations (16) and (21), we can control the distortion terms associated with powers of x (the parameter representing modulation) up to x^5 . By making λ and β equal, we can minimize the effect of tuning-capacitance misalignment. For the particular set of values

$$\alpha = 3; \beta = \lambda = 3.79; \rho_2/\rho_1 = 1.5 \dots \dots (22)$$

the second-harmonic distortion percentage is found from (21) to be 0.108, there is no third harmonic, the fourth-harmonic distortion percentage (for maximum tuning-capacitance misalignment of 1%) is about 0.02% and the fifth-harmonic distortion is about -0.005%. To make up an assembly having parameter-values as near (22) as practicable, the coils are first wound so spaced as to get λ within 10% of the required value 3.79, which means from (12) that the coupling coefficient k is within 10% of $0.014 \times 3.79 = 0.053$. The secondary split coil should have as high an inductance as is possible so that the self-capacitance is not too large; this means that the impedance at 10.7 Mc/s must be of order 1000 ohms. The

tuning capacitance must exceed this self-capacitance by an amount which can be added with reasonable accuracy. There is no difficulty about ensuring that ρ_1/ρ_2 is of the right order. To obtain values of α , β of the required order, the conductance g_1 must be about 0.042 in our normalized units and the conductance g_5 about 0.053; these values must be divided by the impedance of the primary at 10.7 Mc/s to express them in mhos. It will then be found that the required conductances are several times those provided by the coil losses and diode loads, so that shunt resistances across the primary and secondary must be added. A discrepancy of the order of 10% can be tolerated in any of the parameters (22) as performance does not depend critically on these parameters; the equality of β and λ is somewhat more critical than the values of any of the parameters. The errors for the parameter values (22) due to mistuning or to misalignment of tuning capacitance are of the same order as in the case already discussed when α , β and λ were all equal to 3.

APPENDIX 1

Intuitive Derivation of the Equivalent Load of the Diode Circuit

The coils L_1 and L_2 in Fig. 1, which have coupling $1 - \mu$, must therefore have mutual inductance $M = (1 - \mu) \sqrt{L_1 L_2}$. For these coils alone, the A -matrix relating input voltage V_1 and current I_1 to output voltage V_2 and current I_2 is given by

$$\begin{bmatrix} V_1 \\ I_1 \end{bmatrix} = \begin{bmatrix} L_1/M & p(L_1 L_2 - M^2)/M \\ 1/(pM) & L_2/M \end{bmatrix} \begin{bmatrix} V_2 \\ I_2 \end{bmatrix}$$

Now $L_1 L_2 - M^2 = \mu L_1 L_2$; if $\rho_1 = L_1/M = \sqrt{L_1/L_2(1 - \mu)}$ so that $\rho_1 \approx (L_1/L_2)^{1/2}$, we have

$$\begin{aligned}
 \begin{bmatrix} V_1 \\ I_1 \end{bmatrix} &= \begin{bmatrix} L_1/M & 0 \\ 0 & M/L_1 \end{bmatrix} \begin{bmatrix} M/L_1 & 0 \\ 0 & L_1/M \end{bmatrix} \begin{bmatrix} L_1/M & p\mu L_1 L_2/M \\ 1/(pM) & L_2/M \end{bmatrix} \begin{bmatrix} V_2 \\ I_2 \end{bmatrix} \\
 &= \begin{bmatrix} \rho_1 & 0 \\ 0 & 1/\rho_1 \end{bmatrix} \begin{bmatrix} 1 & p\mu L_2 \\ 1/pL_2(1 - \mu) & 1/(1 - \mu) \end{bmatrix} \begin{bmatrix} V_2 \\ I_2 \end{bmatrix} \\
 &= \begin{bmatrix} \rho_1 & 0 \\ 0 & 1/\rho_1 \end{bmatrix} \begin{bmatrix} 1 & 0 \\ 1/pL_2(1 - \mu) & 1 \end{bmatrix} \begin{bmatrix} 1 & p\mu L_2 \\ 0 & 1 \end{bmatrix} \begin{bmatrix} V_2 \\ I_2 \end{bmatrix} \\
 &= \begin{bmatrix} \rho_1 & 0 \\ 1/p\rho_1 L_2(1 - \mu) & 1/\rho_1 \end{bmatrix} \begin{bmatrix} 1 & p\mu L_2 \\ 0 & 1 \end{bmatrix} \begin{bmatrix} V_2 \\ I_2 \end{bmatrix} \\
 &= \begin{bmatrix} 1 & 0 \\ 1/pL_1 & 1 \end{bmatrix} \begin{bmatrix} \rho_1 & 0 \\ 0 & 1/\rho_1 \end{bmatrix} \begin{bmatrix} 1 & p\mu L_2 \\ 0 & 1 \end{bmatrix} \begin{bmatrix} V_2 \\ I_2 \end{bmatrix}
 \end{aligned}$$

The third of these equations shows that the coils L_1 and L_2 are equivalent to the network of Fig. 3, while the last shows that they are also equivalent to the circuit of Fig. 4.

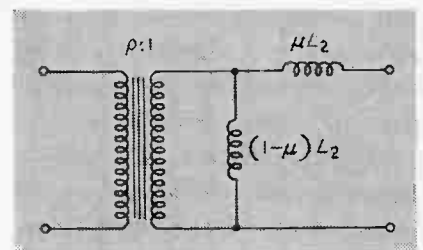

Figs. 3 and 4. Networks equivalent to the coils L_1 and L_2 of Fig. 1

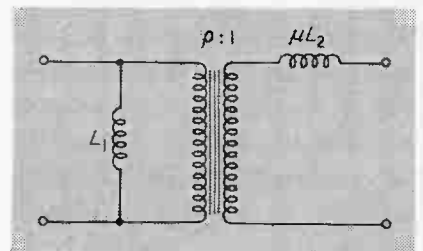

APPENDIX 2

Expansion of V_0 in Powers of x

For the numerator, the expression requiring expansion is

$$\{\rho^2_1\beta^2 + (\rho_1x + \rho_2\lambda)^2\}^{1/2} - \{\rho^2_1\beta^2 + (\rho_1x - \rho_2\lambda)^2\}^{1/2}$$

or

$$A^{1/2}\{(1 + Bx + Cx^2)^{1/2} - (1 - Bx + Cx^2)^{1/2}\}$$

where

$$A = \rho^2_1\beta^2 + \rho^2_2\lambda^2 \quad B = 2\rho_1\rho_2\lambda/A \quad C = \rho^2_1/A$$

and this reduces, neglecting powers of x above the fifth, to

$$\begin{aligned} & A^{1/2}(1 + Cx^2)^{1/2} \left\{ \frac{Bx}{1 + Cx^2} + \frac{1}{8} \frac{B^2x^3}{(1 + Cx^2)^3} + \frac{7}{128} \frac{B^5x^5}{(1 + Cx^2)^5} \right\} \\ &= A^{1/2}Bx \left\{ \left[1 - \frac{1}{2}Cx^2 + \frac{3}{8}C^2x^4 \right] + \left[\frac{1}{8}B^2x^2 - \frac{5}{16}B^2Cx^4 \right] \right. \\ & \quad \left. + \frac{7}{128}B^4x^4 \right\} \\ &= A^{1/2}Bx \left\{ 1 - \frac{\rho^4_1\beta^2}{2A^2}x^2 + \frac{\rho^6_1\beta^2x^4}{8A^4} (3\rho^2_1\beta^2 - 4\rho^2_2\lambda^2) \right\} \end{aligned}$$

For the denominator, we have

$$\begin{aligned} |\Delta_0| &= \{(\alpha\beta + \lambda^2 - x^2)^2 + (\alpha + \beta)^2x^2\}^{1/2} \\ &= \{(\alpha\beta + \lambda^2)^2 + (\alpha^2 + \beta^2 - 2\lambda^2)x^2 + x^4\}^{1/2} \\ &= (\alpha\beta + \lambda^2) \left\{ 1 + \frac{\alpha^2 + \beta^2 - 2\lambda^2}{2(\alpha\beta + \lambda^2)^2}x^2 + \frac{x^4}{2(\alpha\beta + \lambda^2)^2} \right. \\ & \quad \left. - \frac{1}{8} \frac{(\alpha^2 + \beta^2 - 2\lambda^2)^2}{(\alpha\beta + \lambda^2)^4}x^4 - \dots \right\} \\ &= (\alpha\beta + \lambda^2) \left\{ 1 + \frac{\alpha^2 + \beta^2 - 2\lambda^2}{2(\alpha\beta + \lambda^2)^2}x^2 \right. \\ & \quad \left. + \frac{(\alpha + \beta)^2\{4\lambda^2 - (\alpha - \beta)^2\}}{8(\alpha\beta + \lambda^2)^4}x^4 + \dots \right\} \end{aligned}$$

If we now take account of s -terms but consider only second-harmonic distortion, that is to say, the x and x^2 terms in the numerator of V_0 and the numerical and x term in the denominator, we have, instead of (15),

$$\begin{aligned} \text{Numerator} &= |\rho_1\beta_1 + j\rho_1x(1 - \frac{1}{2}sx) + j\rho_2\lambda(1 - sx)| \\ & \quad - |\rho_1\beta + j\rho_1x(1 - \frac{1}{2}sx) - j\rho_2\lambda(1 - sx)| \\ &= \sqrt{\{\rho^2_1\beta^2 + [\rho_2\lambda + (\rho_1 - \lambda\rho_2)x - \frac{1}{2}s\rho_1x^2]^2\}} \\ & \quad - \sqrt{\{\rho^2_1\beta^2 + [\rho_2\lambda - (\rho_1 + \lambda\rho_2)x + \frac{1}{2}s\rho_1x^2]^2\}} \\ &= A^{1/2} \left\{ 1 + \frac{2\rho_2\lambda x}{A} (\rho_1 - \lambda\rho_2) + \frac{x^2}{A} (\rho^2_1 - 3\lambda\rho_1\rho_2) \right\}^{1/2} \\ & \quad - A^{1/2} \left\{ 1 - \frac{2\rho_2\lambda x}{A} (\rho_1 + \lambda\rho_2) + \frac{x^2}{A} (\rho^2_1 + 3\lambda\rho_1\rho_2) \right\}^{1/2} \end{aligned}$$

neglecting s^2 . Expanding this as far as the x^2 term only, it reduces to

$$A^{1/2}\{Bx - (3\lambda\rho_1\rho_2x^2/A) + (2\lambda^3\rho_1\rho_2s^2x^2/A^2)\}$$

where A and B have the same meaning as before in this Appendix. The denominator $|\Delta|$ is given by (10); we have

$$\Delta = 4s^2\{jx(1 - \frac{1}{2}sx) + \alpha\} \{jx(1 - \frac{1}{2}sx) + \beta\} + \lambda^2(1 - 2sx)$$

so that

$$|\Delta| = 4s^2\{(\alpha\beta + \lambda^2) - 2s\lambda^2x + \dots\}^2 + x^2\{1 - \frac{1}{2}sx\}^2(\alpha + \beta)^2\}^{1/2}$$

and therefore the sole contribution of $|\Delta|$ to second-harmonic distortion is a term $+ 2s\lambda^2/(\alpha\beta + \lambda^2)$ since all other terms in $|\Delta|$ involve at least x^2 , and the total x^2 -term relative to the x -term in the expansion of V_0 is

$$s \left[\frac{2\lambda^2}{\alpha\beta + \lambda^2} - \frac{3}{2} + \frac{\lambda^2\rho^2_2}{\rho^2_1\beta^2 + \rho^2_2\lambda^2} \right] = s \left[\frac{\lambda^2 - \alpha\beta}{\lambda^2 + \alpha\beta} + \frac{1}{2} \frac{\lambda^2\rho^2_2 - \beta^2\rho^2_1}{\lambda^2\rho^2_2 + \beta^2\rho^2_1} \right]$$

APPENDIX 3

Justification of Simplifying Assumptions in Main Text

The significant essentials of the Foster-Seeley discriminator circuit are contained in Fig. 1, in which the coils L_1 and L_2 are closely coupled, and the coils L_3 and L_4 are also closely coupled. It is convenient to call the coupling coefficient between coils 1 and 2, $1 - \mu_{12}$, where μ_{12} is small (of order 0.05), and the coupling coefficient

between 3 and 4 $1 - \mu_{34}$, where μ_{34} is similarly small. The remaining coupling coefficients are small (of order 0.05), and we shall denote the coupling coefficient between coil k and coil j by λ_{kj} except in the cases of close coupling already specified. We can then expect to find

$$\left. \begin{aligned} |\lambda_{1k} - \lambda_{2k}| &< \mu_{12}\lambda_k \quad (k = 3, 4) \\ |\lambda_{j3} - \lambda_{j4}| &< \mu_{34}\lambda_j \quad (j = 1, 2) \end{aligned} \right\} \dots \dots \dots (3.1)$$

where λ_k is the average of λ_{1k} and λ_{2k} and λ_j is the average of λ_{j3} and λ_{j4} .

The reason for the inequalities (3.1) is that the high coupling coefficient between coils 1 and 2 can only be obtained if these coils are close together, and therefore at approximately the same distance from coil 3 and from coil 4; similarly, the coils 3 and 4 must be close together and therefore at approximately the same distance from coils 1 and 2. The inequalities (3.1) signify that there can only be slight asymmetry.

Matrix methods are used throughout this Appendix. We first derive the impedance matrix expressing the voltages V_k across the coils in terms of the currents I_k in them as if the other elements of Fig. 3 were absent, and obtain, with the normalized units of the main text,

$$\begin{bmatrix} V_1 \\ V_2 \\ V_3 \\ V_4 \end{bmatrix} = p \begin{bmatrix} 1 - \mu_{12} & 1 - \mu_{12} & \lambda_{13} & \lambda_{14} \\ \lambda_{13} & \lambda_{23} & 1 & 1 - \mu_{34} \\ \lambda_{23} & \lambda_{24} & 1 & 1 - \mu_{34} \\ \lambda_{14} & \lambda_{24} & 1 - \mu_{34} & 1 \end{bmatrix} \begin{bmatrix} I_1 \\ I_2 \\ I_3 \\ I_4 \end{bmatrix} \quad (3.2)$$

Now, in view of (3.1) it is clear that the second row of the square matrix in (3.2) is very similar to the first, and the fourth row is very similar to the third. It follows that $|V_1 - V_2|$ is small compared to V_1 and V_2 , and $|V_3 - V_4|$ is small compared to V_3 and V_4 , and similarly with the I s. We therefore introduce new voltage variables

$$\left. \begin{aligned} v_1 &= \frac{1}{2}(V_1 - V_2); \quad v_2 = \frac{1}{2}(V_1 + V_2); \\ v_3 &= \frac{1}{2}(V_3 + V_4); \quad v_4 = \frac{1}{2}(V_3 - V_4) \end{aligned} \right\} \dots \dots (3.3)$$

and new current variables

$$i_1 = (I_1 - I_2); \quad i_2 = I_1 + I_2; \quad i_3 = I_3 + I_4; \quad i_4 = I_3 - I_4 \quad (3.4)$$

so that

$$\left. \begin{aligned} v_2 &\approx V_1 \text{ or } V_2; \quad v_3 \approx V_3 \text{ or } V_4; \quad v_1 \text{ and } v_4 \text{ are small} \\ i_2 &\approx 2I_1 \text{ or } 2I_2; \quad i_3 \approx 2I_3 \text{ or } 2I_4; \quad i_1 \text{ and } i_4 \text{ are small} \end{aligned} \right\} (3.5)$$

Our matrix equation (3.2) now becomes

$$\begin{bmatrix} v_1 \\ v_2 \\ v_3 \\ v_4 \end{bmatrix} = p \begin{bmatrix} \frac{1}{2}\mu_{12} & 0 & \sigma' & \sigma'' \\ 0 & 1 - \frac{1}{2}\mu_{12} & \rho & \sigma \\ \sigma' & \rho & 1 - \frac{1}{2}\mu_{34} & 0 \\ \sigma'' & \sigma & 0 & \frac{1}{2}\mu_{34} \end{bmatrix} \begin{bmatrix} i_1 \\ i_2 \\ i_3 \\ i_4 \end{bmatrix} \quad (3.6)$$

where

$$\left. \begin{aligned} \rho &= \frac{1}{4}(\lambda_{13} + \lambda_{14} + \lambda_{23} + \lambda_{24}); \quad \sigma = \frac{1}{4}(\lambda_{13} - \lambda_{14} + \lambda_{23} - \lambda_{24}) \\ \sigma' &= \frac{1}{4}(\lambda_{13} + \lambda_{14} - \lambda_{23} - \lambda_{24}); \quad \sigma'' = \frac{1}{4}(\lambda_{13} - \lambda_{14} - \lambda_{23} + \lambda_{24}) \end{aligned} \right\} (3.7)$$

It follows from Equ. (3.1) that σ , σ' and σ'' (which may be positive or negative) are all of order $\frac{1}{2}\rho(\mu_{12} + \mu_{34})$ at most; in other words, if we regard μ_{12} , μ_{34} and ρ as small quantities of the first order, say 0.05 or so, then σ , σ' and σ'' are of the second order.

We now require to invert the matrix (3.6) so that the quantities i_1 , i_2 , i_3 and i_4 are expressed in terms of the quantities v_1 , v_2 , v_3 and v_4 .

To do this, we make use of a special result applicable to matrices having any number of rows and columns, where the principal-diagonal terms are at least an order of magnitude greater than the remainder. For the four-row and four-column matrices with which we are here concerned, this result is perhaps best expressed in the form

$$\begin{bmatrix} 1 & a & b & c \\ d & 1 & e & f \\ g & h & 1 & k \\ l & m & n & 1 \end{bmatrix} \begin{bmatrix} 1 & a & -b & -c \\ -d & 1 & -e & -f \\ -g & -h & 1 & -k \\ -l & -m & -n & 1 \end{bmatrix} = I \quad (3.8)$$

where I is the unit matrix, having its four principal-diagonal elements unity and the remaining elements zero; this result is true provided that we can neglect all products of a , b , c , etc. To apply this result we rewrite (3.6) in the form

$$\begin{bmatrix} v_1 \\ v_2 \\ v_3 \\ v_4 \end{bmatrix} = p \begin{bmatrix} 1 & 0 & \sigma'/(1 - \frac{1}{2}\mu_{34}) & 2\sigma''/\frac{1}{2}\mu_{34} \\ 0 & 1 & \rho/(1 - \frac{1}{2}\mu_{34}) & 2\sigma/\frac{1}{2}\mu_{34} \\ 2\sigma'/\mu_{12} & \rho/(1 - \frac{1}{2}\mu_{12}) & 1 & 0 \\ 2\sigma''/\mu_{12} & \sigma/(1 - \frac{1}{2}\mu_{12}) & 0 & 1 \end{bmatrix} \times \begin{bmatrix} \frac{1}{2}\mu_{12}i_1 \\ (1 - \frac{1}{2}\mu_{12})i_2 \\ (1 - \frac{1}{2}\mu_{34})i_3 \\ \frac{1}{2}\mu_{34}i_4 \end{bmatrix} \quad (3.9)$$

It will be convenient to define

$$q_1 = \frac{1}{2}\mu_{12} \quad q_2 = 1 - \frac{1}{2}\mu_{12} \quad q_3 = 1 - \frac{1}{2}\mu_{34} \quad q_4 = \frac{1}{2}\mu_{34} \quad (3.10)$$

simply in order to save space; q_1 and q_4 are then small quantities of the first order while q_2 and q_3 are nearly unity. Inverting (3.9) by means of (3.8) and expressing the result in terms of q not μ we have

$$\begin{bmatrix} q_1 i_1 \\ q_2 i_2 \\ q_3 i_3 \\ q_4 i_4 \end{bmatrix} = \frac{1}{p} \begin{bmatrix} 0 & 0 & -\sigma'/q_3 & -\sigma''/q_4 \\ 0 & 1 & -\rho/q_3 & -\sigma/q_4 \\ -\sigma'/q_1 & -\rho/q_2 & 1 & 0 \\ -\sigma''/q_1 & -\sigma/q_2 & 0 & 1 \end{bmatrix} \begin{bmatrix} v_1 \\ v_2 \\ v_3 \\ v_4 \end{bmatrix} \quad (3.11)$$

or

$$\begin{bmatrix} i_1 \\ i_2 \\ i_3 \\ i_4 \end{bmatrix} = \frac{1}{p} \begin{bmatrix} 1/q_1 & 0 & -\sigma'/q_1 q_3 & -\sigma''/q_1 q_4 \\ 0 & 1/q_2 & -\rho/q_2 q_3 & -\sigma/q_2 q_4 \\ -\sigma'/q_1 q_3 & -\rho/q_2 q_3 & 1/q_3 & 0 \\ -\sigma''/q_1 q_4 & -\sigma/q_2 q_4 & 0 & 1/q_4 \end{bmatrix} \begin{bmatrix} v_1 \\ v_2 \\ v_3 \\ v_4 \end{bmatrix} \quad (3.12)$$

and if the values of i_1 , etc., derived from (3.12) are substituted back into (3.6), the error is at worst of the second order.

Now consider the capacitances alone. We assume that these are effectively as in Fig. 1. C_1 may be made up partly of stray primary capacitance and partly of tuning capacitance deliberately added; there is no need to distinguish between these two parts as long as C_1 has the correct total value. C_2, C_3 and C_4 are all stray capacitances; the secondary tuning capacitance C is placed across the whole secondary. Mutual capacitances between the coils are here neglected; they can if necessary be allowed for by some adjustment in the effective values of the coupling coefficients or replacing some of the zeros in the matrix (3.13) below by small quantities, but the procedure would be unaltered. For our present purpose of general understanding, these capacitances are merely an irrelevant complication. The matrix expressing currents in terms of voltages for the capacitances alone, in terms of the original variables, is

$$\begin{bmatrix} I_1 \\ I_2 \\ I_3 \\ I_4 \end{bmatrix} = \begin{bmatrix} pC_1 & 0 & 0 & 0 \\ 0 & pC_2 & 0 & 0 \\ 0 & 0 & p(C_3 + C) & pC \\ 0 & 0 & pC & p(C_4 + C) \end{bmatrix} \begin{bmatrix} V_1 \\ V_2 \\ V_3 \\ V_4 \end{bmatrix} \quad (3.13)$$

In terms of the variables i and v (3.13) becomes

$$\begin{bmatrix} i_1 \\ i_2 \\ i_3 \\ i_4 \end{bmatrix} = \begin{bmatrix} p(C_1 + C_2) & p(C_1 - C_2) & 0 & 0 \\ p(C_1 - C_2) & p(C_1 + C_2) & 0 & 0 \\ 0 & 0 & p(4C + C_3 + C_4) & p(C_3 - C_4) \\ 0 & 0 & p(C_3 - C_4) & p(C_3 + C_4) \end{bmatrix} \begin{bmatrix} v_1 \\ v_2 \\ v_3 \\ v_4 \end{bmatrix} \quad (3.14)$$

To obtain the currents in terms of the voltages for coils and capacitances only, it is merely necessary to add the matrices on the right-hand sides of (3.12) and (3.13), but we need to consider how to allow for the coil losses and the diode loads before we can decide on the correct values of C_1 and C , which are under our control. The coil losses give rise to a matrix analogous to that in (3.14) in which pC_1 is replaced by G_1 , the total loss across the primary, including resistance deliberately added, and pC_2 by G_2 , pC_3 by G_3 and pC_4 by G_4 . pC must be replaced by G_s , the resistance deliberately added across the secondary. This matrix must be added to those of (3.14) and (3.12) to give currents in terms of voltages for the combined system of coils, capacitances and losses, but we have still the diodes to take into account. Let us therefore consider the diode loads alone. With our original variables, the relations expressing current in terms of voltage could be written

$$\left. \begin{aligned} I_1 &= 0 \\ I_2 &= d_3(V_2 + V_3) + d_4(V_2 - V_4) \\ I_3 &= d_2(V_2 + V_3); \quad I_4 = -d_4(V_2 - V_4) \end{aligned} \right\} \dots \dots (3.15)$$

These, rearranged in terms of our new variables, become

$$\begin{bmatrix} i_1 \\ i_2 \\ i_3 \\ i_4 \end{bmatrix} = \begin{bmatrix} (d_3 + d_4) & -(d_3 + d_4) & -(d_3 - d_4) & -(d_3 + d_4) \\ -(d_3 + d_4) & (d_3 + d_4) & (d_3 - d_4) & (d_3 + d_4) \\ -(d_3 - d_4) & (d_3 - d_4) & (d_3 + d_4) & (d_3 - d_4) \\ -(d_3 + d_4) & (d_3 + d_4) & (d_3 - d_4) & (d_3 + d_4) \end{bmatrix} \begin{bmatrix} v_1 \\ v_2 \\ v_3 \\ v_4 \end{bmatrix} \quad (3.16)$$

As the various types of element we have hitherto considered separately are in parallel, the admittance matrix for the whole system is obtained by adding the admittance matrices already obtained for the various parts. We thus obtain for the whole system of Fig. 1

$$[i] = [Y][v] \quad \dots \dots \dots (3.17)$$

where $[i]$, $[v]$ are the column matrices with elements i_1, i_2, i_3, i_4 and

v_1, v_2, v_3, v_4 respectively, as in (2.16), and $[Y]$ is a square matrix with four rows and columns having elements $y_{ij}(i, j = 1, 2, 3, 4)$ defined as follows:

$$\begin{aligned} y_{11} &= \frac{1}{p q_1} + p(C_1 + C_2) + (G_1 + g_2) + (d_3 + d_4) \\ y_{12} = y_{21} &= p(C_1 - C_2) + (G_1 - g_2) - (d_3 + d_4) \\ y_{13} = y_{31} &= \frac{\sigma'}{p q_1 q_3} - (d_3 - d_4) \\ y_{14} = y_{41} &= -\frac{\sigma''}{p q_1 q_4} - (d_3 + d_4) \\ y_{22} &= \frac{1}{p q_2} + p(C_1 + C_2) + (G_1 + g_2) + (d_3 + d_4) \\ y_{23} = y_{32} &= -\frac{\rho}{p q_2 q_3} + (d_3 - d_4) \\ y_{24} = y_{42} &= -\frac{\sigma}{p q_2 q_4} + (d_3 + d_4) \\ y_{33} &= \frac{1}{p q_3} + p\{4C + C_3 + C_4\} + \{4G_s + g_3 + g_4\} + (d_3 + d_4) \\ y_{34} = y_{43} &= p(C_3 - C_4) + (g_3 - g_4) + (d_3 - d_4) \\ y_{44} &= \frac{1}{p q_4} + p(C_3 + C_4) + (g_3 + g_4) + (d_3 + d_4) \end{aligned} \quad (3.18)$$

Now when the discriminator is in operation, since only L_1 has an external current supply, we have

$$I_2 = 0 \text{ (i.e., } i_1 = i_2) \quad i_3 = i_4 = 0 \quad \dots \dots \dots (3.19)$$

and (3.17) can be written in full

$$\left. \begin{aligned} i_1 &= y_{11}v_1 + y_{12}v_2 + y_{13}v_3 + y_{14}v_4 \\ i_2 &= y_{12}v_1 + y_{22}v_2 + y_{23}v_3 + y_{24}v_4 \\ i_3 &= y_{13}v_1 + y_{23}v_2 + y_{33}v_3 + y_{34}v_4 \\ i_4 &= y_{14}v_1 + y_{24}v_2 + y_{34}v_3 + y_{44}v_4 \end{aligned} \right\} \dots \dots \dots (3.20)$$

Subtract the second of (3.20) from the first, and then use the last of (3.20) to eliminate v_4 . The left-hand side is zero from (3.19) so that

$$\begin{aligned} 0 &= \left\{ y_{11} - y_{12} - \frac{y_{14}(y_{14} - y_{24})}{y_{44}} \right\} v_1 + \left\{ y_{12} - y_{22} - \frac{y_{24}(y_{14} - y_{24})}{y_{44}} \right\} v_2 \\ &+ \left\{ y_{13} - y_{23} - \frac{y_{34}(y_{14} - y_{24})}{y_{44}} \right\} v_3 \quad \dots \dots \dots (3.21) \end{aligned}$$

Now in (3.18), before any allowance is made for tuning, y_{11} and y_{44} are of order -1 , $y_{12}, y_{23}, y_{14}, y_{33}$ are of order zero, and y_{13}, y_{23}, y_{24} and y_{34} are of order 1. Hence v_1 from (3.21) is of the first order of small quantities compared to v_2 and v_3 , for the coefficient of v_1 in (3.21) contains y_{11} in the numerator, whereas the other coefficients are at most of order zero. It then follows by substitution in the last of (3.20) (with i_4 zero) that v_4 is of the second order compared with v_2 and v_3 , since y_{44} is of order -1 . We may therefore omit v_4 and the last of (3.20) from now on.

Now multiply the first of (3.20) by y_{12}/y_{11} , and subtract from the second, and multiply the first of (3.20) by y_{13}/y_{11} and subtract from the third. (3.20) become, in view of (3.19),

$$\begin{aligned} \left[1 - \frac{y_{12}}{y_{11}} \right] i_1 &= \left[y_{22} - \frac{y_{12}^2}{y_{11}} \right] v_2 + \left[y_{23} - \frac{y_{12}y_{13}}{y_{11}} \right] v_3 \\ - \frac{y_{13}}{y_{11}} i_1 &= \left[y_{23} - \frac{y_{12}y_{13}}{y_{11}} \right] v_2 + \left[y_{33} - \frac{y_{13}^2}{y_{11}} \right] v_3 \quad \dots \dots (3.22) \end{aligned}$$

Now (3.22) are of the same form as (7) in the main text, for y_{13}/y_{11} is of the second order so that the left-hand side of the second of (3.22) is effectively zero and i_5 is zero in (7). Thus the imperfections of coupling considered in this Appendix can be allowed for by replacing the circuit of Fig. 1 by that of Fig. 2, the coupling k/p being replaced by $y_{23} - (y_{12}y_{13}/y_{11})$. The tuning conditions become that the imaginary parts of

$$y_{22} - (y_{12}^2/y_{11}) \text{ and } y_{33} - (y_{13}^2/y_{11}) \quad \dots \dots \dots (3.23)$$

must be zero respectively for the primary and secondary tuning. The term y_{13}^2/y_{11} is of the third order—completely negligible.

REFERENCE

¹ See 'Basic Mathematics for Radio Engineers', by F. M. Colebrook and J. W. Head, Iliffe & Sons, London, revised edition 1957. [See also p. 67 of this issue. Ed.]

THE LAMB SHIFT-1: The Electron and its Self-Energy

What we believe as hard facts about the electron are that it has a charge e of -4.8×10^{-10} absolute e.s.u., and a mass m which has the value $m_0 = 9.1 \times 10^{-28}$ gm when it is at rest or moving slowly, increasing to $m_0(1 - v^2/c^2)^{-\frac{1}{2}}$ when its velocity v is appreciable compared with c , the velocity of light. The energy equivalent of its rest-mass, m_0c^2 , is about 8×10^{-7} ergs, or say 0.5 MeV.

As often happens with vital statistics, the length measurements associated with it are less precise, in the sense that we are not quite sure what is really being measured. If it is a little round particle, then classical theory assigns it a radius $r_c = e^2/m_0c^2 = 2.82 \times 10^{-13}$ cm. If it acts as a wave, as diffraction experiments suggest, then its 'Compton wavelength' is $\lambda_c = h/m_0c$, (where h is 6.5×10^{-27} units), which gives 2.4×10^{-10} cm. For most purposes of modern theory, people do not worry very much about its dimensions. You will see why in a minute.

But the really uncertain quantity about the electron is its *self-energy*. This may be defined as the energy which the electron itself contributes to the field in which it is situated. According to classical theory, the electrostatic energy of the whole of the field surrounding a sphere of charge e and radius r is $0.6 e^2/r$. If this is equated to the mass-energy m_0c^2 , then r works out to be $0.6r_c$.

Unfortunately, whatever properties may be ascribed to the electron at the beginning or end of the process, the operations of wave-mechanics are performed on wave-functions which are, like other mathematical functions, expressed in terms of the space co-ordinates of *points*. It is true that the uncertainty principle forbids the *determination* of the position of a point with ideal mathematical accuracy, but it does not vitiate arguments that stop short of the act of measurement. The electron, it appears, is being treated as if it were a point-charge. If this be so, then $0.6e^2/r$ is infinitely great, and if this classical self-energy is equated to mc^2 , then it follows that m (the self-mass) must be infinitely great as well.

Now, the ideas of infinitely great self-energy and an infinite electron mass seem very strange; but, when you come to think of it, not so very stranger than that of a mathematical point. We can regard the two extremes as complementary unobservables, which the mathematicians of 'infinite-resource-and-sagacity' can control with equal impartiality. After all, the whole art in their projective geometry consists of hurling the problem to infinity and fetching it back again solved; and so long as they remember to renormalize the mass at the end of the sum it is perfectly reasonable to use similar tactics in mathematical physics. But it seems really that, as with potential energy in more familiar problems, the absolute value of the self-energy of an electron in any situation is almost uninteresting even if it can be determined; the important

quantity is the *change* in self-energy that accompanies a *change* in situation. This, if it is to mean anything at all, must necessarily be finite.

The real point at issue is whether or not differences in self-energy contribute appreciably to the total energy difference between the levels available to a bound electron in the Coulomb field surrounding the nucleus of an atom. In the early Bohr-Sommerfeld theory, only the Coulomb-field potential energy and the kinetic energy of the circulating electron (with due regard to relativity effects) were counted. The Dirac theory of 1928 attributed a good deal more to the electron in the way of spin, magnetic moment, and relativistic behaviour; and it gave a quite complete calculation of the levels of the one-electron system of the hydrogen atom. The accuracy was so high that any clearly observed disagreement of the order of a few parts in a million would have been taken up for investigation and *possible* discrepancies have indeed been discussed all the time. The Dirac theory did not take the effect of self-energy into account; it was suspected from about 1938 that there might be at least two processes, which were quite unforeseen by the theory, leading to differences in self-energy for different energy levels and, in particular, causing the symmetrical wave-function (or 'S') levels in the hydrogen atom to be a little higher than they were thought to be.

It was very difficult indeed to establish this by optical spectroscopy. The difference, expressed in wave-numbers, is only about 0.033 cm^{-1} ; this is of about the same order as the Doppler broadening of spectral lines, and even when that is reduced by using a low-temperature source it would require a resolving power (or spectroscopic Q) of about a quarter of a million to detect such a shift and measure it. This has been done, but the first really *conclusive* measurements were made as late as 1948 by Kuhn and Series.

A wave-number of 0.033 cm^{-1} corresponds to a frequency of about 1,000 Mc/s and a radio wavelength of 30 cm, or so—which is right within the radio-frequency spectroscopy range. And in 1947, using radio techniques, the now famous 'Lamb Shift' was observed by W. E. Lamb and R. C. Retherford. It will take the whole of the March 'Fringe' to try to explain this work. The present article deals only with the shift itself, and the reasons advanced for it.

The Dirac Electron and the Vacuum

The expression for the kinetic energy of an electron obtained by Dirac admitted of both positive and negative values. Using the exclusion principle, he suggested that the negative values were states already filled with *positive* electrons; and that a vacuum is not just emptiness, but stored with an infinite number of positive electrons.

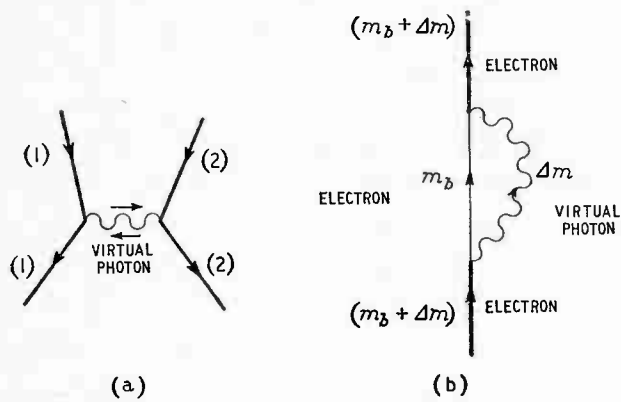

Fig. 1. (a) Short-range repulsion between electrons 1 and 2, pictured as the emission and absorption of virtual photon, or photons
 (b) Change in the self-energy of an electron when in a fluctuating field, during the interval between the emission of a virtual photon and its subsequent re-absorption. Here $(m_b + \Delta m)$ is what is ordinarily measured as the mass; and m_b , called the 'bare' mass, is what remains after Δm has been parked temporarily as a virtual photon

One consequence of this picture, which has only more recently been suggested, is that the presence of an ordinary electron induces polarization of the infinite vacuum, similar to that to be expected in a dielectric, but far more extensive. Again, the possibility of infinite self-energy appears, though this time without involving any r . In the hydrogen atom, there is a polarization effect due to the proton charge also. But the overall result of polarization is only about 3% of the total Lamb Shift.

Interaction with Radiation

Matters become even more difficult to visualize when the electromagnetic field in the neighbourhood of an electron is itself regarded as being composed of quanta which are subject to statistical fluctuations. Even if the field is nominally zero, this simply means that it fluctuates about a zero value; and an electron in such a situation is provoked, if it is in an excited state, to emit radiation itself. If it is not in an excited state, so that the energy for real radiation is lacking, it has to make do with virtual radiation! The Coulomb-law repulsion between two electrons when they are very close together can be pictured (if that is a fair term) as a chain of operations in which the field of each stimulates the other to emit radiation, which is in turn absorbed by the original 'each'. The radiation is, however, only virtual—the so-called 'virtual photon'. One property of the virtual photon will not surprise you. It may carry infinite energy. Things seem to have reached a stage at which it would be refreshing to find something that doesn't.

The same kind of thing happens when we consider a single electron in a fluctuating radiation field. Provoked to emit a virtual photon, it duly obliges; having no partner to trade with, it re-absorbs the thing itself [Fig. 1 (b)]. This diagram is hard to interpret literally, for it looks as though the virtual photon has to wait about for the more leisurely moving electron. It really means simply that part of the self-energy of the electron is temporarily loaned to the surrounding vacuum, to be recalled later. If ΔE is the energy of the photon, and Δt the time for which it is out, then $\Delta E \times \Delta t = h/2\pi$. If

ΔE is large, than Δt must be very small. But, if Δt is very small, so must be the distance represented in Fig. 1 (b). This kind of thing, then, may well be relevant to very short-range actions, incredible though it looks when drawn in a diagram.

But a temporary change of energy ΔE means also a temporary change of mass Δm ; so for the duration Δt the mass of the electron is altered. If it is not subjected in the meantime to any external force, then the temporary change of Δm does not matter. If, however, it is in an accelerating electromagnetic field, or is in a bound state in the field due to an atomic nucleus, then things can happen to the electron during the interval while the Δm is out and about; the total energy of the reunited system will then differ from that which would have resulted if there had been no virtual photon process.

If the law of conservation of energy holds for Fig. 1 (b), then

$$m = m_b + \Delta m.$$

Here m is the ordinary finite observed electron mass; Δm probably infinite and certainly unobservable; m_b , called the 'bare mass' has to be probably infinite, certainly unobservable, slightly different from Δm , and negative in sign. Becoming acclimatized to this world "of infinite jest, of most excellent fancy", one can accept the items term by term. It is rather harder to understand the equation, though, since violations of the law of conservation of energy would seem to be permissible in this set-up.

Perhaps all that I have really made intelligible in the course of these last two sections is that both the polarization of the vacuum, and the interaction between the electron and radiation, modify the self-energy of the electron; that because of this the energy levels within, say, the hydrogen atom are not quite what they are made

Fig. 2. Sommerfeld orbits of the hydrogen atom, for $n = 1, 2,$ and 3 . Taken from his "Atomic Structure and Spectral Lines", 1923 edition. The eccentricity of the $2p$ ellipse is $\sqrt{3}/2$; that of the $3p$ ellipse $\sqrt{5}/3$, and of the $3d$ ellipse $\sqrt{8}/3$. The only transitions allowed in this rudimentary scheme are shown by vertical lines. Since the greatest energy separation is that between $2s$ and $2p$, the lines 1 and 3 are fairly close together, and the main $H\alpha$ doublet separation is between this pair and 2

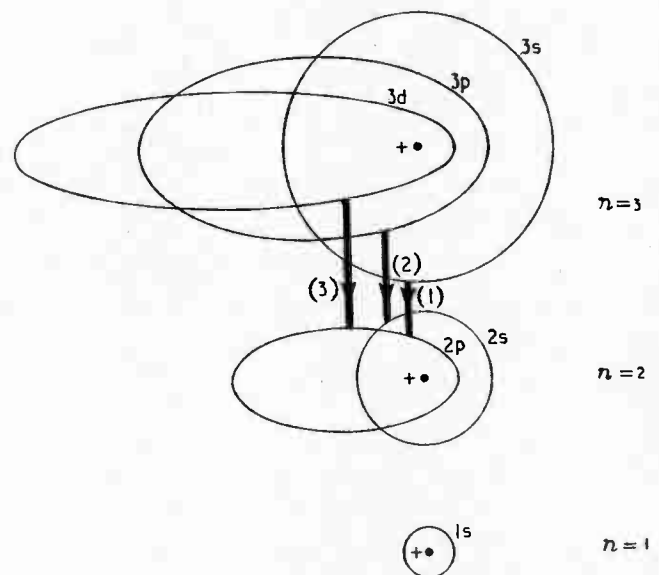

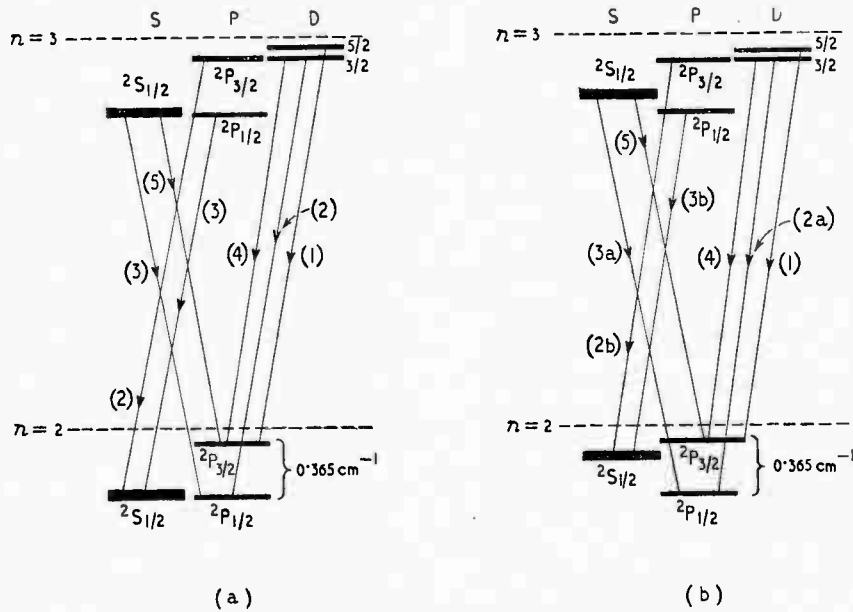

Fig. 3. The $n = 2$ and $n = 3$ levels of hydrogen (a) according to the Dirac theory, and (b) including the self-energy effect. The separations are not drawn to scale. In (a) there are five distinct components only to the H_{α} line, as both sets of ${}^2S_{3/2}$ and ${}^2P_{3/2}$ levels are degenerate. In (b) the ${}^2S_{3/2}$ and ${}^2P_{3/2}$ levels are separated by 0.033 cm^{-1} , and there is a smaller separation between the ${}^3S_{3/2}$ and ${}^3P_{3/2}$ levels. The H_{α} line has seven components, the additional two coming from the splitting of 2 into 2a and 2b, and of 3 into 3a and 3b. The "H $_{\alpha}$ doublet" separation that figured so prominently in Sommerfeld's discussion is that between the ${}^2P_{3/2}$ and ${}^2P_{1/2}$ levels. The arrowed lines on each diagram indicate the transitions giving rise to radiation.

out to be; and that a rather fanciful-seeming mechanism has been advanced to explain this. The reason why the whole thing is important is that it may eventually lead to a better understanding of the operation of short-range forces between particles; the Lamb Shift can be regarded as the first clear experimental justification for this approach. Actually, the mechanism affects the magnetic moment of the electron as well; and this anomalous magnetic moment fits into the picture. But that is another story, to be dealt with next month.

The next stage in the discussion is to identify the hydrogen-atom levels that are concerned in the originally observed 0.033 cm^{-1} Lamb Shift. This is most easily done by stepping back to the ideas and terms of more than thirty years ago.

Energy Levels in the Hydrogen Atom

In the earliest Bohr theory of the hydrogen atom, the electron could circulate round the proton in any one of a series of non-radiating circular orbits, such that the angular momentum equalled $n h/2\pi$, where $n = 1, 2, 3 \dots$ is an integer now called the principal quantum number for the orbit. The total energy E_n in the n th orbit, the sum of the kinetic energy of rotation and the Coulomb-

field potential energy, worked out to $E_n = -\frac{2\pi^2me^4}{n^2h^2}$ ergs,

the negative sign indicating that E_n is taken as zero when n is infinitely great. The radius of each orbit, and the velocity of the electron are calculated from the ordinary

TABLE I

Quantum number n	Orbit radius	Velocity expressed as fraction v/c of velocity of light	Total energy E_n in electron-volts
1	$a_1 = 0.53 \times 10^{-8} \text{ cm}$	1/137	-13.53 eV
2	$4a_1 = 2.12 \times 10^{-8} \text{ cm}$	1/(2 × 137)	-3.38 eV
3	$9a_1 = 4.77 \times 10^{-8} \text{ cm}$	1/(3 × 137)	-1.50 eV
n	n^2a_1	1/($n \times 137$)	$-E_1/n^2 \text{ eV}$

formulae for circular motion, and specimen figures shown in Table 1.

The figure 1/137 in the third column is, I believe, the origin of the expression "a smashing little number". It is the value of the fine-structure constant $2\pi e^2/hc$, which seems to turn up in many important calculations.

The lowest state is $n = 1$; from any higher state, originally excited by absorbing the appropriate energy

TABLE 2

Principal quantum number n	Azimuthal quantum number l	Symbol	Energy difference due to relativity effect
2	0	2s (circle)	} 0.365 cm^{-1}
2	1	2p	
3	0	3s (circle)	} 0.0036 cm^{-1}
3	1	3p	
3	2	3d	

difference, return to a lower state happens with the emission of the energy difference ΔE as a quantum of radiation of frequency ν given by $\Delta E = h\nu$; the wavelength $\lambda = c/\nu$, or the wave-number $1/\lambda$ can be used to denote this. The series of emissions which end up with the electron on $n = 2$ give lines in the visible spectrum, the Balmer series for which the wave-numbers are given successively by inserting $n = 3, 4, 5 \dots$ in the formula

$$\frac{1}{\lambda} = \frac{2\pi^2me^4}{ch^3} \left(\frac{1}{2^2} - \frac{1}{n^2} \right).$$

The first of these, the red H_{α} line, for which $n = 3$, has wave-number $15,237 \text{ cm}^{-1}$, wavelength $6.563 \times 10^{-5} \text{ cm}$, and quantum energy 1.88 eV.

But the Balmer series lines are really pairs of lines very close together (doublets) with a separation between the lines of 0.365 cm^{-1} , suggesting that the $n = 2$ level really consists of two which differ slightly in energy. The members of the doublets themselves can be further resolved, due to multiplicity of the higher levels also. The Sommerfeld explanation of this is that there are n

different types of possible orbit for each principal quantum number, specified by an azimuthal quantum number l , which can have the values $0, 1, 2 \dots$ up to $(n - 1)$. For $l = 0$, the orbit is still a circle; $l = 1, l = 2$, etc., denotes ellipses of progressively greater eccentricity (Fig. 2). The code letters s, p, d, f are used for $l = 0, l = 1, l = 2, l = 3$ respectively. While the total energy for all orbits of the same n should be the same in the absence of relativity effects, the variation of mass with velocity operates differently on ellipses of different eccentricity, as calculated in Table 2. This old-fashioned approach is just as good as more recent theory for the purpose of classifying energy levels; and the symbols are still in use, though they do not nowadays stand for Kepler ellipses but for wave-equations called orbitals.

It looks as if there should be six independent ways of generating the H_{α} line; in fact, there are *here* only three, because l can only change by ± 1 ; other transitions are forbidden. As Fig. 3 illustrates, there are really more levels than in Fig. 2, and *seven* possible ways in all!

Further quantum numbers, the inner quantum number j , and a magnetic quantum number m , were introduced by Sommerfeld to deal with the complex spectra observed when the source was in a magnetic field. The modern theory, although it does not regard the energy levels or states as orbits in which a little round particle circulates, still preserves this notation. Nowadays, j is the vector resultant of the orbital and spin angular momenta, compounded in a definite way; and m , which can only have the value $+\frac{1}{2}$ or $-\frac{1}{2}$, represents the electron spin. Energy levels are repre-

sented by code symbols which give the principal quantum number; the letter for the orbital angular momentum, usually as a capital; a subscript which gives the value of j ; and a superscript representing the maximum multiplicity of the term. Thus, $2^2S_{\frac{1}{2}}$ means $n = 2, l = 0, j = \frac{1}{2}$, and that the term is a doublet; similarly, $2^2P_{\frac{1}{2}}$ means $n = 2, l = 1, j = \frac{1}{2}$, and a doublet.

The full multiplicity of a level is only revealed as a rule in the presence of a strong electric or magnetic field; in the ordinary way, two or more levels may coalesce, when they are said to be *degenerate*.

Fig. 3 shows the pattern of the lower energy levels of the hydrogen atom, from which components of the H_{α} line could arise. According to the Dirac theory of the electron, the $2^2S_{\frac{1}{2}}$ and $2^2P_{\frac{1}{2}}$ should be degenerate—that is, coincident—and there should be only five components. If, however, the self-energy effects operate to raise the $2^2S_{\frac{1}{2}}$ level, there should be seven components. Since the theory can predict the probability of each transition, it also enables the intensity of each component to be forecast; and (though this is one of the most difficult things of all to verify experimentally) there should be differences in intensity as well as in wavelength and number present. (All S levels are affected; $2^2S_{\frac{1}{2}}$ considerably more than $3^2S_{\frac{1}{2}}$.)

This article has really done little more than state the problem. If self-energy effects operate, then the $2^2S_{\frac{1}{2}}$ and $2^2P_{\frac{1}{2}}$ levels are distinct, the former lying about 0.033 cm^{-1} above the latter. The direct attack on this very significant little difference, made with all the resources of radio-frequency technique by Lamb and Retherford, will be described next time.

THE TWISTOR—A NEW MAGNETIC MEMORY DEVICE

A new memory device has emerged from exploratory work by A. H. Boeck at Bell Telephone Laboratories. This device, which has been named the 'Twistor', is expected to make possible memory systems which are simpler to fabricate and more economical to manufacture than existing units.

The new device gets its name from a characteristic of wire made of magnetic material. Torsion applied to such a wire shifts the preferred direction of magnetization from a longitudinal to a helical path. The helical path has both longitudinal and circular components, and the coincidence of a circular and longitudinal magnetic field can thus be used to insert information into the wire.

In practice, the circular magnetic field is provided by a current pulse through the magnetic wire, and the longitudinal field by a current pulse through a copper wire coiled round the magnetic wire. Storing a binary digit requires two coincident current pulses. Readout is accomplished by passing a large current through the copper-wire coil in the reverse direction, a readout signal being taken from the magnetic wire. Because the lines of magnetic flux along the helical path encircle the magnetic conductor many times, an appreciable output signal is obtained.

Investigations are now under way to determine optimum size and composition for the magnetic wires. It appears that a conductor plated with magnetic material may have some advantages. Diameters as small as one-thousandth of an inch appear to be feasible. At least 10 bits per inch may then be stored without adverse interaction.

In conventional magnetic-core memory devices, conductors must be threaded through the cores to make up a suitable matrix. When a ferrite sheet is employed, either a threading or a plating operation

is necessary to locate the conductors suitably. However, with the 'Twistor', the ferrite material is completely eliminated and no threading or plating is necessary. Speed of operation and output of the 'Twistor' are comparable to ferrite memory systems.

It is thought that the drive circuits for a 'Twistor' array can be readily transistorized. Thus, a memory system using the 'Twistor' concept will retain all the advantages of ferrite core or sheet systems, and will be much simpler and more economical to fabricate.

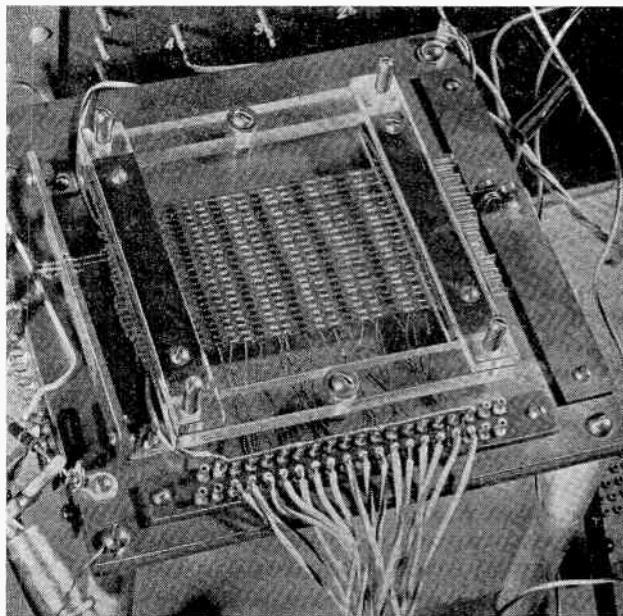

An experimental magnetic memory array which has been set up at Bell Telephone Laboratories to evaluate the 'Twistor' device. In this experimental set-up, the longitudinal magnetic field for the magnetic wires is provided by small solenoids wound around glass tubes. Such an arrangement facilitates the testing of various magnetic wires

THE REFLEX-MONITOR SYSTEM

By D. J. R. Martin, B.Sc., A.Inst.P.*

SUMMARY. The cascade-balance principle, described in Part 1, is now revised and embodied in a direct-coupled amplifier of the type using overall drift-correction. Contrary to normal practice, the correcting amplifier, or monitor, is not inherently drift-free but is itself direct-coupled and is a replica of the first stage of the main amplifier; it corrects alternately its own drift and the drift of the main amplifier. The residual effects of supply-voltage and temperature fluctuations are balanced between the two amplifiers, which are effectively in cascade during the overall-correction phase.

Whereas the simple cascade-balance system is best suited to amplifiers with a single-ended input, this later development automatically provides for a differential input, with a very high rejection factor against in-phase components. Apart from certain incidental advantages the performance capabilities are similar, an overall zero-stability of $100 \mu\text{V}$ being readily obtained without recourse to stabilized heater-supplies.†

It will be recalled that the straightforward cascade-balance system, described in Part 1, essentially comprises a two-stage direct-coupled amplifier in which drift correction is applied to the first stage only. The drift in that stage is thereby reduced to a level which is comparable in its effect, but opposite in sense, to that of the second stage, and balancing becomes possible. The method of drift correction employed—the Owen-Prinz method—necessitates the duplication of the first stage if bandwidth is to be preserved; the complete amplifier therefore contains three individual amplifying stages which must be identical if the full benefits of the system are to be obtained.

Against the major advantages of high stability and wide frequency response, the possible drawbacks to the system seem to be as follows:

- (1) it involves moving parts;
- (2) the primary balance is a double one, somewhat complicating initial installation;
- (3) the first and second stages must be similar in design, possibly restricting the scope of the system;

- (4) the output may contain a small square-wave component (up to $50 \mu\text{V}$) at the switching frequency, as the result of a residual unbalance between the input stages;
- (5) if a differential input is required the switching tends to become cumbersome.

The first of these is generally accepted as being unavoidable where maximum stability is required. The others have been eliminated by applying the basic cascade-balance principle to an entirely new form of drift-corrected amplifier, which it is the purpose of this article to describe.

The Reflex-Monitor System

The simple cascade-balance amplifier is illustrated in Fig. 1, which is reproduced from Fig. 2 of Part 1. A, B and C are the three identical stages of gain μ . A and B serve as the first amplifying stage alternately, with a sufficient overlap to ensure continuity of the signal channel. While out of service, each of these stages is drift-corrected by the Owen-Prinz method, which reduces the drift by a factor $(\mu + 1)$. Referred to the input of the amplifier, the residual drift in the first stage is comparable to the drift introduced by the second stage, and components attributable to common disturbances may be balanced.

The essential difference in the new system (illustrated in Fig. 2) is that the twin input stages are not operated on a time-shared basis. Instead, one stage (A) is permanently allocated to the signal channel, which is now never diverted. The other (B) serves as a monitor, and alternates between two conditions: in the first of these, which may be termed the 'self-correcting' condition, the stage is isolated from the rest of the amplifier and its drift checked and corrected by the Owen-Prinz capacitor-storage method; in the other, the 'monitoring' condition,

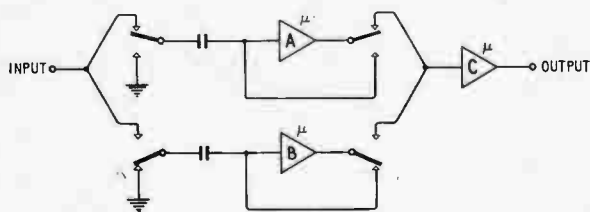

Fig. 1. The cascade-balance system

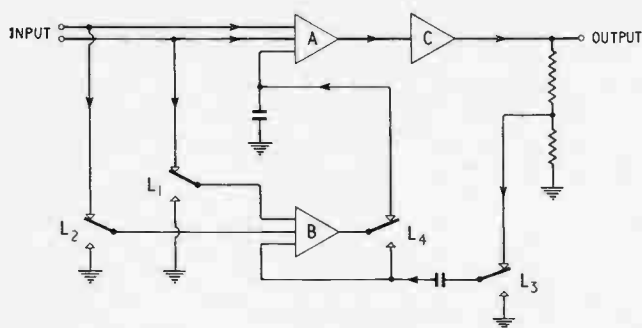

Fig. 2. *The reflex-monitor system*

it is used to check and correct the drift in the main amplifier, again with the use of a storage capacitor.

During the monitoring condition, the main amplifier and the monitor stage are connected in cascade as far as drift considerations are concerned; the cascade-balance principle applies, not between successive stages in the amplifier, as in the original system, but between the entire main amplifier and the monitor stage. In the main amplifier it is the first stage only which is important from considerations of drift, and it is this stage only which need be identical to the monitor stage. Whatever form the rest of the amplifier may take, the additional drift introduced by it will be small by comparison and easily taken up in the balancing adjustment.

It will be seen that since bandwidth is not a prior consideration in the monitor stage there is no need for further duplication of this part, even though the Owen-Prinz method is applied to it. The switching is accordingly simplified, and the double balance of the original system is eliminated; there is also no question of a spurious square-wave output resulting from mismatched zero levels.

The correct sense relationships of the system require that the input signal as applied to the monitor stage shall be reversed in polarity with respect to that applied to the main amplifier. To achieve this without destroying the essential similarity of the input stages, a differential input is necessary in each stage; by simple transposition of the input connections, the necessary phase-reversal is effected. The entire amplifier is then differential by nature, though either input terminal may, of course, be earthed to suit single-sided input signals.

As shown in Fig. 2, each input stage has yet a third input terminal. In the case of the monitor stage, the storage capacitor for self-correction by the Owen-Prinz method is connected to this terminal; during the monitoring phase, a small fraction of the amplifier output is also applied here in such a sense and so adjusted that when the amplifier is operating correctly without introducing any drift the signal input to the monitor stage is exactly cancelled. The third input terminal of the main input stage is used for the injection of the correcting potential from the monitor.

The Individual Stages

Requirements

As in the case of the simple cascade-balance system, the design of the similar stages has to fulfil certain

conditions. The present requirements are as follows:

- (1) the design must include three independent input terminals; two of these must provide equal and opposite sensitivities, forming a normal differential pair, while the third must provide similar (though not necessarily equal) sensitivity with a phase reversal to the output terminal of the stage;
- (2) the stage gain should be high (preferably well over 100);
- (3) the output-voltage swing must embrace earth potential; this requires potentiometer coupling from the anode circuit and the use of a negative supply;
- (4) the current drawn by the third input terminal should be low (not greater than about 10^{-9} A), as a correcting potential is applied at this point on a capacitor.

It will be noted that size of possible output-voltage swing is not a consideration in this case, as the design is not required to serve in the output-stage position. The remainder of the amplifier, in fact, will normally be of conventional single-sided direct-coupled form; it will most satisfactorily consist of a single stage.

The Basic Five-Triode Stage

The basic circuit which has been developed to meet the requirements of the triple-input stages is shown in Fig. 3; input terminals 1 and 2 are used for the input signal, and terminal 3 for drift-correction and sample voltages.

The circuit is essentially that of a cascode amplifier with the lower triode triplicated. Its operation may be analysed by first considering the cathodes of V_1 and V_2 to be earthed. In this condition V_2 and V_3 are each shunted by the anode impedance of the other; since, however, the lower valve in a cascode pair works into a low impedance (the cathode impedance of the upper valve) the mutual shunting effect of V_2 and V_3 is negligible, and the normal cascode gain is realized from the grid of each. The gain from the grid of V_1 is potentially much higher, but may be made to correspond to the cascode gain by making R_1 equal to the anode impedance of V_3 . If, now, the cathode coupling between V_1 and V_2 is restored, the signals on their respective grids are transmitted with very little distinction, partly through V_1 to the grid of V_4 and partly by cascode action through V_2 . At the same time the value of R_1

Fig. 3. *Basic five-triode stage*

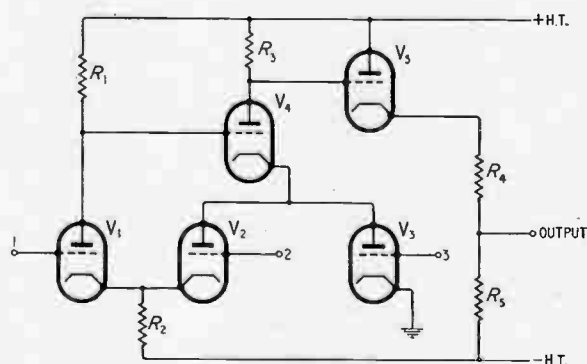

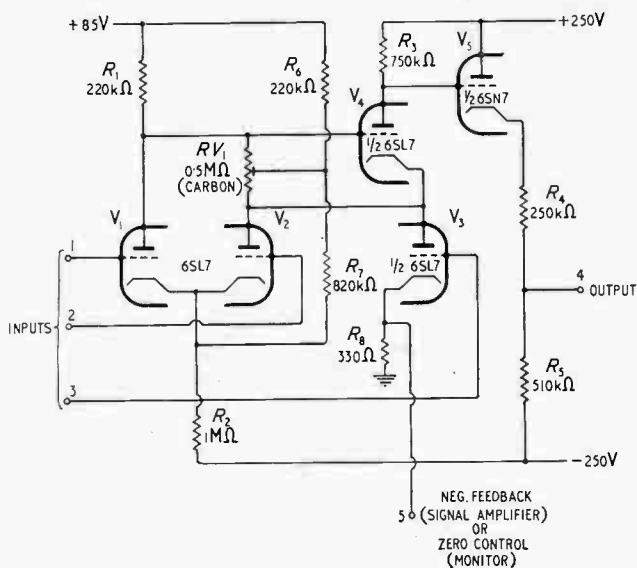

Fig. 4. Five-triode stage in practical form. All resistors are high-stability, 5% tolerance

becomes far less critical; in fact, a satisfactory match of the gains from the grids of V_1 and V_2 may be obtained even if R_1 is omitted, in which case the grid of V_4 is supplied from a steady potential and the action is cascode throughout. Omission of R_1 does, however, halve the stage gain and its presence provides a simple means of obtaining extremely high rejection factors against in-phase components.

The Five-Triode Stage in Practical Form

In practice, control of rejection factor by direct variation of R_1 is unsatisfactory as it disturbs the standing potentials in the circuit. Moreover, with the low value of R_1 that is normally required, the resulting potential drop would be inadequate for the proper operation of V_4 .

These disadvantages have been overcome in the final practical form of the circuit, shown in Fig. 4. R_1 itself is given a fixed value, equal to the average anode resistance encountered in V_3 . An intermediate h.t. supply is provided for V_1 , of such voltage that a satisfactory standing potential results at the grid of V_4 . Resistors R_6 and R_7 are introduced, R_6 being made equal to R_1 and the value of R_7 so chosen that the potential at the junction of R_6 and R_7 is approximately equal to the anode potentials of V_1 and V_2 ; this point is connected to the slider of potentiometer RV_1 , between the anodes of V_1 and V_2 . When the slider of RV_1 is at one extreme of its travel, R_6 shunts R_1 and thus reduces the gain of V_1 ; at the other, R_6 shunts V_3 and thus increases the gain of V_4 for signals applied to its grid. A wide range of control is thus obtained without seriously disturbing the standing potentials in the circuit.

A further addition to the basic circuit is resistor R_8 , which has been inserted in the cathode return of V_3 . This resistor is small enough in value not to interfere with the operation of the stage by itself, but provides a means of injecting zero-control and negative-feedback voltages into the stage.

The Second Stage

The circuit which has been adopted for the remainder of the main amplifier is shown in Fig. 5 and comprises a

single pentode stage with a cathode-follower output. The design need not be rigidly followed; for instance, the pentode may be operated at a much lower anode current and a further cathode-follower interposed, in the manner of the cascade-balance amplifier described in Part 1.

Gain and Zero Controls and Associated Circuits

The method of overall drift-correction used involves a comparison between the input signal and a certain fraction, or 'sample', of the output signal. This sample must bear a constant relation to the input signal when the amplifier is operating correctly without introducing drift. It follows that any form of gain control used must not upset this relationship; in other words, if the gain is variable the sample cannot be a fixed fraction of the output signal but must vary with respect to it in an inverse manner to the gain. This condition is simply met by using a negative-feedback control of gain and deriving the sample voltage from the feedback circuit.

The method is shown in Fig. 6, where RV_2 is the gain control. The minimum gain is determined by the size of the feedback resistor, R_{13} , which is chosen to set this value at about 700; the maximum is the full gain of the amplifier, about 20,000.

At low gain settings (i.e., for high degrees of feedback) the voltage at the slider of RV_2 is substantially independent of the setting of RV_2 , for this is the point from which the feedback factor is invariable. The sample voltage may therefore be derived from this point, using a similar divider chain to that supplying the feedback voltage to the first stage. In Fig. 6, R_{14} and R_{15} form such a chain, corresponding to the feedback path formed by R_{13} and R_8 (Fig. 4). Potentiometer RV_3 has been included to provide differential adjustment, allowing for slight variations in component values and possible mismatch between the monitor and main input stages.

If the full range of the gain control is to be used, this method of deriving the sample voltage must be amended, as a closer analysis shows a discrepancy which becomes more serious as the gain setting is increased. This discrepancy is a constant fraction of the output signal, equal to $1/\mu$ where μ is the full gain of the amplifier referred to the correction grid. It may be exactly cancelled for all settings of the gain control by augmenting the sample voltage by the same constant fraction $1/\mu$ of the output voltage. An additional resistor for this purpose is shown in Fig. 6 as R_{16} ; the value given is correct for the amplifier exactly as described, but may need revision if the design is varied in any way.

Reference back to Fig. 4 will show that a certain part of the main signal channel is inevitably excluded from the feedback loop, for the gain is stabilized with respect to the correction input, corresponding to the point in the monitor stage to which the sample voltage is applied. In practice, the overall gain of the signal channel will not vary by more than 1% provided that h.t. variations to the input stages are confined within about 4%. Heater-voltage changes and changes in emission of the valves have negligible effect on gain, since the drift-correction processes tend to stabilize the anode currents of the valves and thus effectively the slopes. (It should be understood that the drift correction, unlike the negative feedback, includes the entire amplifier within its scope.)

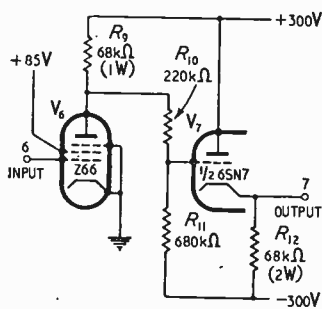

Fig. 5. Circuit of second stage. All resistors are 10% tolerance

Zero Control

In the simple cascade-balance system the output zero-level is controlled in the second stage. In the present system the second stage is included in the correction loop; a control in that position would be insufficiently sensitive, and could not prevent overloading of the second stage due to unsuitable zero-levels in the first.

The zero control must therefore operate in either the signal input stage or the monitor stage, or else in both together by differential action. There is very little to choose between these possibilities; but the monitor stage offers a very convenient point for zero control, corresponding to the feedback point in the main amplifier. As shown in Fig. 6, therefore, the cathode resistor of V_3 in the monitor stage has been shunted by a 10,000-ohm potentiometer, RV_4 , the slider of which passes a bleed current from the positive h.t. supply; a small d.c. is injected into the stage, depending on the setting of the control. To balance the stages at about the central position of this control, a bleed current of about half the magnitude is passed through the corresponding cathode resistor in the main amplifier.

The Automatic Switching and Associated Circuits

The choice of frequency for the automatic switching operation is governed by the same considerations as given in Part 1, and a frequency of 5 c/s is again adopted.

The total switching capacity required is the same as in the first system described, but all the contact actions are now associated with one stage, and the question of overlap does not arise. The contacts may therefore all be carried on a single relay. The contact sets total four in number and are all of the break-before-make change-over type; in Figs. 2 and 7 they have been identified by reference numbers corresponding to those of the associated terminals of the monitor stage.

Sequence of contact actions within the group is again important; the exact requirements in this respect are as follows:

- (1) no contact must make in either condition (i.e., self-correct or monitor) while any contact remains closed in the other condition;
- (2) contact L_4 must be the last to make and the first to break in the self-correcting condition;
- (3) contact L_4 must also be the last to make and the first to break in the monitoring condition.

Contacts L_1 , L_2 and L_3 should be made to operate as near simultaneously as can be judged. In the detailed circuit diagram of the switching circuit, given in Fig. 7, the storage capacitor C_2 is shown permanently connected

to the sample circuit, which is consequently short-circuited during the self-correcting phase; this avoids open-circuiting the correction grid in the change-over process.

The circuit of the multivibrator used for driving the relay is given in Fig. 8.

Facilities for Static Tests and Adjustment

It is helpful during the preliminary checks of the amplifier, and also in any subsequent servicing which may be necessary, if the automatic switching operations may be suspended while particular parts and aspects of the system are examined. The arrangements made for this facility are included in Fig. 7.

Switch S_1 , which is double-pole, prevents the relay from being energized, by short-circuiting its coil; in addition, it provides a leak path to C_1 , causing that capacitor to charge and stay charged to the output potential of the monitor stage in the self-correcting condition. It thus passes on a correction voltage derived entirely from the monitor in its self-correcting condition, without reference to the signal and sample voltages. The cascade-balance action is not thereby affected; but the overall correction feature is suspended, with the result that the effects of any residual unbalance are magnified a hundred times or so. The final adjustments may be made with the amplifier in this condition, and a most accurate estimate of the overall stability may also be obtained.

The effect of manually closing the relay while S_1 is operated may now be noted: the monitor stage adopts the monitoring condition, but the 1-megohm leak R_{19} is still in circuit; any a.c. component of the signal appearing at the output of the monitor stage, such as might result from an incorrect sample-voltage setting, would be observed on an oscilloscope applied to the test terminal. The relay should not be held closed for more than a second or so, since in this condition there is no means of maintaining the proper correcting potential on C_2 . Switch S_2 removes this limitation by establishing a d.c. path through the 1-megohm resistors R_{19} and R_{20} to the output terminal of the monitor stage; when this switch is operated with S_1 the relay may be held closed indefinitely

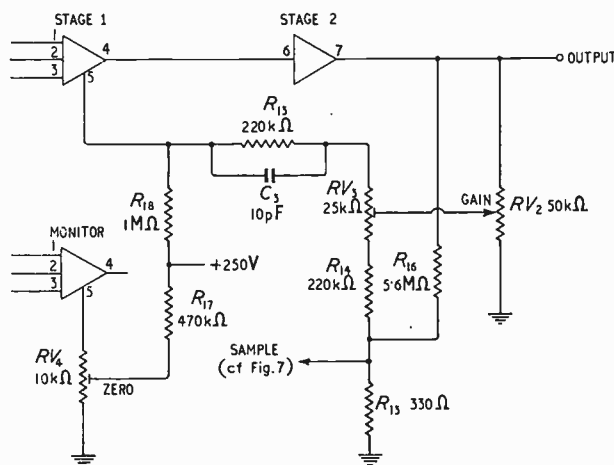

Fig. 6. Inter-stage circuit showing gain control. Resistors R_{13} , R_{14} and R_{15} are high-stability, 5% tolerance, and all potentiometers are wire-wound

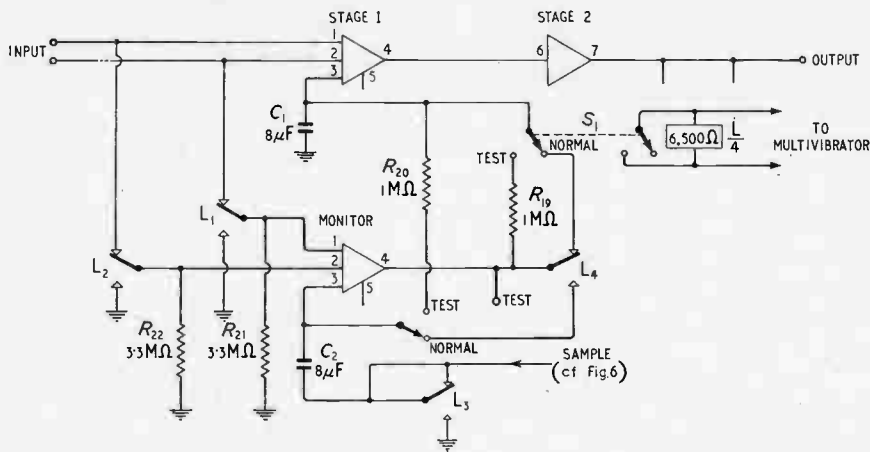

Fig. 7. Inter-stage circuit showing switching arrangements. C_1 and C_2 are $8\text{-}\mu\text{F}$ paper; the relay L is type 3000, 4-pole change-over with platinum contacts and a $6500\text{-}\Omega$ coil; S_1 and S_2 are respectively d.p.c.o. and s.p.c.o. toggle switches

while the behaviour of the monitor stage with a.c. signals is examined.

Figs. 6 and 7 are complementary and between them show in full the inter-stage connections.

Power Supplies

The total power-supply requirements of the amplifier as described in this article are as follows:

- heater supplies
- +300 volts d.c. at 14 mA (stage 2 and multivibrator)
- 300 volts d.c. at 11 mA (stage 2 and multivibrator)
- +250 volts d.c. at 2 mA (input stages and zero control)
- 250 volts d.c. at $1\frac{1}{2}$ mA (input stages)
- +85 volts d.c. at $1\frac{1}{2}$ mA (input stages and stage 2)

For the heater supplies, raw a.c. will normally be suitable and no stabilization is necessary. But, if wide supply-voltage changes are to be tolerated, the balancing technique described in a previous article* must be used. In Part 1 this principle was extended to a three-stage balance but, in the present system, the requirement reduces to a single net balance between the main-input and monitor stages. Control of each stage for supply-

voltage sensitivity is effected through V_3 and V_4 in conjunction, these valves being paired in one envelope (if a double-triode with a tapped heater were used, V_3 alone could serve as the control).

Fig. 9 shows the balancing circuit in the form used. As in the cascade-balance amplifier, certain valves are run with reduced heater-voltage to minimize grid current; the remaining heaters are supplied separately at their rated voltages.

The 300-volt supplies are not subject to any critical requirements of stability or smoothing, but output capacitors of $100\ \mu\text{F}$ are recommended to minimize common-impedance coupling between the multivibrator and signal circuits.

The 250-volt and 85-volt supplies must satisfy certain stringent requirements of filtering as a precaution against rapid mains-voltage fluctuations, which might otherwise defeat the relatively slow drift-correction processes. Steps must also be taken to avoid or counteract the small but significant changes in amplifier gain which can result from wide variations in these supply-voltages. Means have been developed for achieving these ends without resorting to stabilization, but these will not be discussed as it will probably be considered that stabilization is more straightforward, even if more costly. The 85-volt supply is readily obtained using a single neon tube, such as an 85A1; it should be bypassed by a large capacitor. The stabilization of the 250-volt supplies should be effective in reducing sudden small changes by a factor of at least 200, the criterion being that the voltage should not change at a faster rate than about $50\ \text{mV/second}$ or instantaneously by more than $10\ \text{mV}$. Slow variations need only be reduced by a factor of about 5.

General

Constructional Notes

Apart from the h.t. and 6.3-volt supplies, the circuit of a final design may be built up from Figs. 4 to 9. In the practical layout of such an amplifier, care should be taken to position the input circuits as far as possible from the multivibrator valve, which may need to be screened. Usual precautions against hum pick-up in the input stages are necessary.

Adjustment of the relay contacts should be carried out before these are wired into the circuit; the contact

* See Part 1, reference 7.

Fig. 8. Multivibrator for driving relay

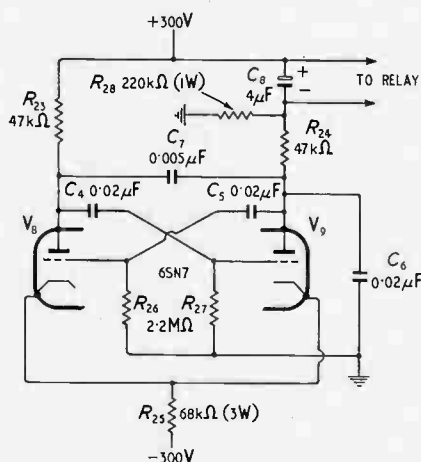

sequences may then be checked electrically. It should be noted that in Fig. 7 the contacts are shown in the energized condition of the relay.

Tests and Adjustments

If resistors R_{29} and R_{30} have been made adjustable, they should be set with the heaters only switched on. The correct adjustments give voltage nulls between the ends of potentiometer RV_5 and its slider, which should be centrally set.

When the h.t. supplies are first applied to the complete amplifier switch S_1 should be in the test position, so that the relay remains unenergized and capacitor C_1 is allowed to adopt the same steady potential as C_2 ; switch S_2 should be in the normal position. In this condition the amplifier functions normally with d.c. and a.c. signals and the gain and zero controls are operative; as already explained, the cascade-balance principle is effective but the overall drift-correction process is suspended. Potentiometer RV_1 in the input stage should be adjusted for zero transmission of a common-mode a.c. signal applied to the input terminals. Switch S_2 should then be operated and the relay held closed while the signal at the test terminal is observed on an oscilloscope; with the common-mode a.c. signal still applied to the input terminals, potentiometer RV_1 in the monitor stage should likewise be adjusted for zero transmission. A differential signal should then be applied to the input terminals and potentiometer RV_3 adjusted for a null in the signal observed on the oscilloscope at the test terminal, with the relay still closed. This adjustment should hold for all settings of the gain control: any variation indicates that the value of R_{16} requires modification to suit the particular amplifier. During these tests, care should be taken that the amplifier is not overloaded, or misleading results will be obtained.

It remains to balance the amplifier for the effects of mains-voltage changes: for this, the relay is released and S_2 returned to normal; potentiometer RV_5 is then adjusted so that changes of $\pm 10\%$ in mains voltage, simulated by means of a variable transformer, have least effect on the d.c. output indication.

Switch S_1 should now be returned to normal, allowing the overall drift-correction process to function. The immediate result will be a reduction of any zero-offset by a factor of a hundred or so, while the transmission of the amplifier to a.c. and d.c. signals will not be affected. If the d.c. output level should wander in the presence of a large a.c. signal it may be taken that the sample-voltage adjustment (of potentiometer RV_3) is incorrect.

Various fault conditions can give rise to spurious output signals at switching frequency. A 'blunt' sawtooth waveform, or 'wobble', devoid of high-frequency components, may be caused by interference from the multivibrator through the h.t. supplies or by a microphonic valve responding to mechanical vibration from the relay. A 'sharp' sawtooth may be due to a leaky storage capacitor or excessive grid-current in V_3 in either input stage, or abnormally large and rapid changes in mains voltage may be occurring. Sharp 'spikes' in the output indicate direct pick-up from the multivibrator if they persist with S_1 in the test position; otherwise, a momentary parasitic oscillation is probably occurring during the change-over operation of the monitor; such an effect may usually be cured by arranging

Fig. 9. Heater-supply arrangements for input valves. R_{29} and R_{30} are wire-wound $\frac{1}{2}$ A and can be of the adjustable type; RV_5 is wire-wound and a Gardners type L.470 will serve for the mains transformer TR

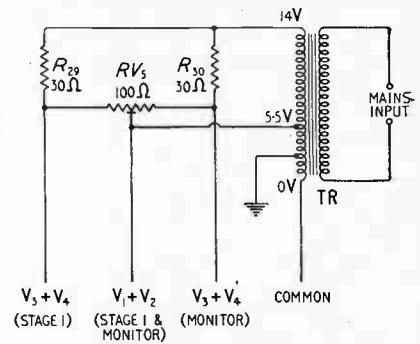

one of contacts L_1 and L_2 to make in the monitoring condition slightly in advance of the other. Wider peaks signify that the inevitable transients in the monitor stage are reaching the signal channel through a common-impedance coupling. A square-wave output at switching frequency may result from too high a source resistance or excessive grid current in the monitor stage.

Performance

The following characteristics of the reflex-monitor amplifier described are maintained against slow variations in heater-supply voltage of 10%, step changes of 0.5%, and all normal temperature and long-term effects.

- Gain: approximately 700 to 20,000 (continuously variable)
- Zero-stability: better than 100 μ V referred to the input
- Effective input resistance: greater than 1 megohm
- Rejection factor against common-mode signals: not less than 10,000
- *Maximum undistorted output-voltage swing: -30 to +70 volts (unloaded)
- *Stability of gain: 1%
- *Frequency response: level within $\pm 1\%$ from 0 c/s to 25 kc/s (with low source-impedance)
- *Output resistance: about 40 ohms
 - * at a gain setting of 1,000

For rated performance the following recommendations should be observed.

- Maximum signal-source resistance: 100,000 ohms
- Maximum source-to-earth resistance: 1 megohm
- Maximum common-mode input voltage: 5 volts (d.c. or peak a.c.)
- Warming-up time (with switch S_1 in test position): 10 minutes

Possible Improvements in Performance

The quoted figure for zero-stability formed part of a preconceived specification upon which the typical design was based, and should not be regarded as the best obtainable from the system. Provided that a reduced source impedance is used, a direct improvement in stability may be obtained by raising the gain of the input stages; if necessary, these stages may be replaced by suitably designed two-stage sections, due consideration being given to the sensing requirements.

To give useful effect to an enhanced stability of mean zero-level, the residual variations at switching frequency would probably need comparable reduction. Short of actual fault conditions, the causes of these variations are twofold: first, the potential on the storage capacitors tends to alter between corresponding correcting opera-

tions; secondly, supply voltages may change too rapidly for the correction processes to give adequate reduction. Each of these conditions will introduce a spurious voltage of sawtooth waveform into the output of the amplifier. Their effects may together be reduced to any desired extent by suitably increasing the switching frequency. Otherwise they may be treated separately, as will be briefly suggested.

Change of potential on the storage capacitors is caused mainly by grid current and leakage in the valves; it may be lessened by using larger capacitances or electrometer-type valves. With certain types of capacitor internal leakage may contribute to the effect; this could be minimized by introducing a series bias to relieve each capacitor of most of its standing potential.

The effects of rapid mains-voltage fluctuations felt through the l.t. supplies could be reduced by employing a simple voltage stabilizer; this need only be a simple constant-voltage transformer with a stabilization ratio of 10 : 1 or less, and frequency coefficient of voltage would be inconsequential. Otherwise the basic five-triode circuit of the input stages could be extended by the addition of yet a sixth triode. This would be cathode-coupled to V_3 in the same way that V_1 is coupled to V_2 and its anode would be connected to the anode of V_1 . It would then be possible to balance each stage inherently for the effects of heater-voltage changes, and the time delay associated with the cascade-balance feature would be avoided.

Radio-Frequency Interference

During the later stages of the tests on the amplifiers described in these articles a marked deterioration in the zero stability and noise level was noticed between certain hours of the day. This trouble was traced to interference from the B.B.C. and I.T.A. television transmitters situated a few miles away; the r.f. signals were being picked up in the amplifier circuits and signal sources and in some manner were being partially detected. The zero variations noticed were caused by the varying d.c. components which are present in the modulation envelopes of television signals and which set the mean brightness levels in the received pictures; the prominent frame-frequency components caused a 50-c/s hum of varying waveform and amplitude.

If such interference is suspected, the simplest check is to connect a pair of headphones across the output terminals of the amplifier: the vision signal would be heard as a rough hum, but the accompanying sound signal would probably give a surer indication.

Similar trouble has been experienced from the regional medium-wave transmitter. In this case the predominant symptom was an unusually high level of high-frequency noise in the amplifier output; this was resolved as a modulated carrier and again could be identified by listening.

The best precaution against such interference is the complete screening of the amplifier and the insertion of filters in all external leads. It has not been found possible to effect a cure with bypass capacitors.

Conclusion

The reflex-monitor system is recommended for applications requiring high stability with a differential

input. Its main advantages over the conventional parallel-balance amplifier are:

- (1) the avoidance of stabilized heater-supplies
- (2) an improvement in long-term zero-stability of at least 100 times
- (3) superior amplifier characteristics resulting from the application of negative feedback.

If a differential input-circuit is not required the simpler cascade-balance system described in Part I might be considered as an alternative; the performance capabilities are similar, but the reflex-monitor system avoids certain disadvantages.

Acknowledgement

The author wishes to thank the Director and Council of the British Scientific Instrument Research Association for permission to publish these articles.

CLEANING SEMICONDUCTOR COMPONENTS

A highly-effective continuous water washing system for removing surface contamination from semiconductor components has been adapted from valve-manufacturing techniques by Bell Telephone Laboratories. All water-soluble materials which remain after etching are removed and the effectiveness of the washing procedure is monitored.

When used on transistors, the new system has resulted in significant improvements in breakdown voltage, sharpness of voltage-current characteristics, saturation current, and emitter reverse impedance.

Distilled water, replaced about once a week, is continuously re-circulated through the cleaning system at about two litres per minute. It first passes through a small de-ionising column which reduces its conductivity to about 0.1 micromho per cm as measured in a conductivity cell. The de-ionized water then rises through a vertical standpipe in which the parts being cleaned are suspended on a stainless steel frame. After flowing over the upper edge of the standpipe, the water passes through a second conductivity cell and thence to a sump for re-circulation.

Carbon dioxide from the air is used as a measuring tool. CO_2 is picked up by the water in the washing chamber in sufficient quantity to increase its conductivity from 0.1 micromho per cm in the first cell to 0.15 micromho per cm in the second. Parts are washed until these two readings are obtained from the cells. The thoroughness of washing is readily specified by the conductivity of the effluent and this makes possible a one-hundred per cent inspection of the product.

Inserting transistors into the semiconductor washing system developed at Bell Telephone Laboratories

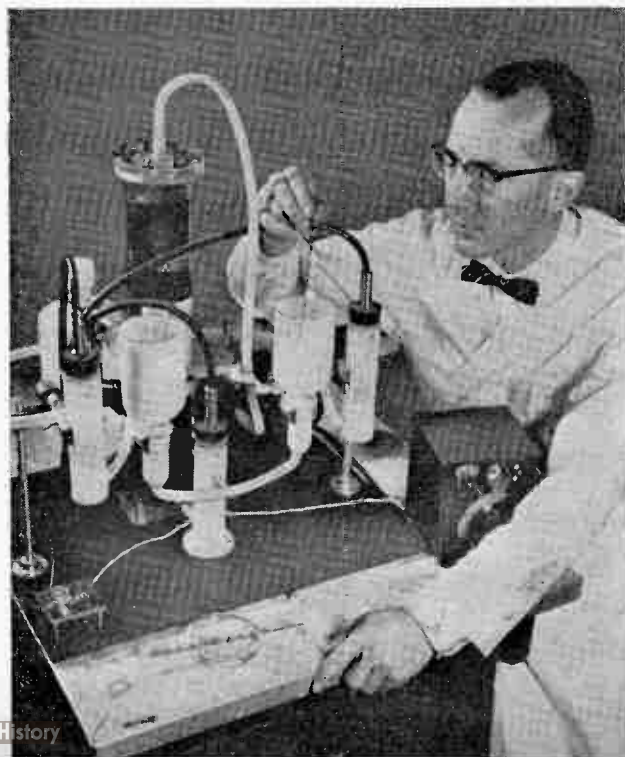

Coaxial Transmission Lines

EFFECT OF ELLIPTICAL INNER CONDUCTOR ON HIGH-FREQUENCY CHARACTERISTICS

By S. Mahapatra*

SUMMARY. Approximate calculations are made for the distributed constants (R, L, G, C) of a coaxial transmission line with the inner conductor of elliptical cross-section. The method of conformal transformation is used to find the capacitance on the assumption that the focal distance of the ellipse from the centre is small compared to the radius of the outer cylinder. The resistance of the inner conductor is computed from the electrostatic charge distribution. The minimum attenuation condition for a given eccentricity of the ellipse is specified.

The problem of the performance of a coaxial line with an elliptical inner conductor arose out of the design of the dee-stem transmission line of the cyclotron at the Institute of Nuclear Physics, Calcutta. The peculiar geometry of the dee-chamber and the link connecting the manifold restricts the space in the vertical axis. Unless the dees are made demountable, which is not a convenient solution, assembly considerations lead to the construction of dee-stem transmission lines with very narrow inner conductors. A circular coaxial line with a ratio of the radii of the outer to the inner conductor exceeding five is not desirable because of the high attenuation involved. To satisfy the optimum condition in the circular case, the diameter of the outer conductors within the manifold may be decreased, but this considerably diminishes the Q-value of the line and is not a convenient solution. The alternative is to use an oval or elliptical inner conductor and the present article describes work on these lines. The theoretical calculations show that whenever space is restricted along one axis so that, for a circular coaxial, we cannot help making the outer-to-inner diameter ratio greater than five, it is always possible to construct a transmission line with elliptical conductors of proper dimension so as to have less attenuation.

In this connection, we may refer to the case of the 225-cm cyclotron at the Nobel Institute, Stockholm, where the dee-neck was made oval¹¹. As the dissipation in the acceleration-chamber and the link-part was extremely high, the elliptical cross-section of the neck was found more suitable to keep the dissipation within reasonable limits¹². This is quite in agreement with the conclusions derived in this paper. We have shown that the ratio of resistance of an elliptical conductor to that of a circular one with diameter equal to the minor axis of the ellipse sharply decreases with increase in major axis. Hence, where the dissipation is inordinately high, and the space is restricted along one axis, the dissipation in this part may be reduced by more than 50% by using an elliptical conductor.

In the case of coaxial lines with good conductors the

assumption of TEM wave is quite justified^{1, 2} and this assumption has been employed to determine the distributed constants of a line with an elliptical inner conductor. In the propagation of a TEM wave in a transmission line, the transverse electric field configuration is identical with the static field distribution³. The conformal transformation^{4, 5, 6} is therefore employed to find the distributed capacitance C per unit length of the line with the assumption that the radius of the outer shield is much greater than the focal distance of the cross-sectional ellipse of the inner conductor from the centre. The characteristic impedance Z_0 , and the distributed inductance L per unit length of the line are then readily obtained from the well-known relations for low-loss lines,

$$Z_0 = \sqrt{L/C} \text{ ohms} \quad \dots \quad (1)$$

$$v_p = 1/\sqrt{LC} \text{ metres/sec.} \quad \dots \quad (2)$$

where v_p is the phase velocity and is equal to 3×10^8 metres per second in vacuum (or air).

Fig. 1. Cross-section of coaxial line with elliptical inner conductor. The dashed curve gives the confocal ellipse having a semi-major axis equal to the inner radius of the circular shield

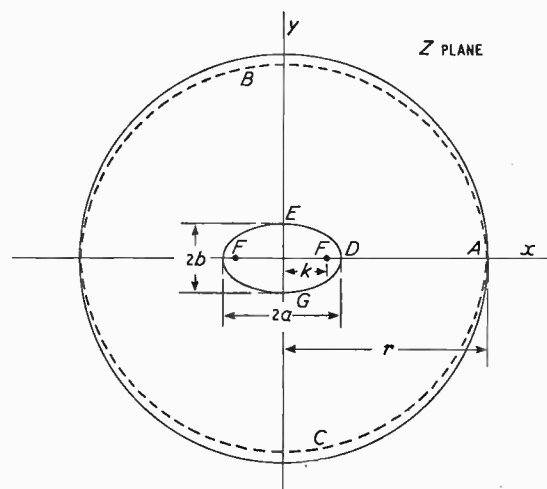

* Institute of Nuclear Physics, Calcutta, India.

To calculate the resistance and attenuation of the line, the distribution of current density must be known⁷. At high frequencies, skin effect predominates; consequently current density becomes a surface phenomenon rather than a volume phenomenon. Calculations being restricted to the case where both the radius of curvature and the thickness of the conductors are very great with respect to the depth of penetration, we are led to the conclusions: (1) that the current distribution must tend to that which produces no internal magnetic field, (2) that the magnetic-field lines in the space between the conductors coincide with the electric equipotential lines and the magnetic equipotential lines with the electric field lines^{8,9}. Consequently, the distribution of the current density on the surface of the conductors corresponds precisely to the distribution of electrostatic charge density. The latter is readily obtained from the knowledge of conformal transformation.

Characteristic Impedance

The transformation

$$w = u + jv = A \log_e \left(\frac{z}{k} + \sqrt{\left(\frac{z}{k}\right)^2 - 1} \right) \quad \dots \quad (3)$$

$$z = x + jy$$

gives a set of confocal ellipses for $u = \text{constant}$ as, on eliminating v , we get

$$\frac{x^2}{k^2 \cosh^2 u/A} + \frac{y^2}{k^2 \sinh^2 u/A} = 1 \quad \dots \quad (4)$$

If $u = \text{constant}$ gives equipotential lines, then corresponding to the ellipse in the z -plane of semi-major axis a and semi-minor axis b (Fig. 1) we get

$$\left. \begin{aligned} a &= k \cosh u/A \\ b &= k \sinh u/A \\ \text{and } k &= \sqrt{a^2 - b^2} \end{aligned} \right\} \quad \dots \quad (5)$$

It also follows from Equ. (3) that if $(z/k)^2 \gg 1$, the transformation becomes very nearly equal to the form $w = A \log_e z$, which transforms $u = \text{constant}$ to circles in the z -plane. So for the cylindrical shield of inner radius r , if $(r/k)^2 \gg 1$, the ellipse will almost completely coalesce into the circular cylinder.

For simplicity, and with no loss of generality, we may put $A = 1$ and get the capacitance per unit length of the line as

$$C = \frac{\oint \epsilon \, dv}{u_{ABC} - u_{DEG}} = \frac{2\pi\epsilon}{\cosh^{-1} r/k - \cosh^{-1} a/k} \quad \text{farads/metre} \quad (6)$$

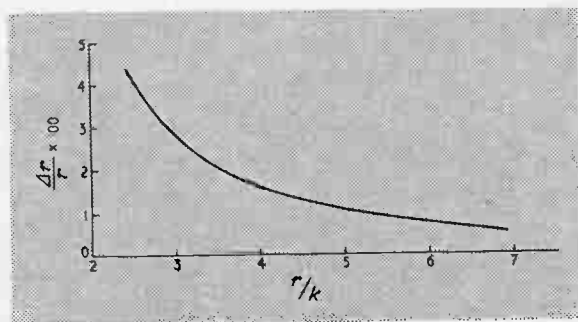

Fig. 2. The fractional percentage $\Delta r/r \times 100$ versus r/k

where the closed integral is performed over the $u = \text{constant}$ curve and ϵ designates the permittivity of the medium. It follows that if we assume + Q charge per unit length of the inner conductor then the constant term A will be $-Q/2\pi\epsilon$ so that the transformation of Equ. (3) may now be written as

$$w = -(Q/2\pi\epsilon) \log_e [z/k + \sqrt{(z/k)^2 - 1}] \quad (7)$$

Equation (6), however, gives a slightly lower value as we have equalized the radius r with the semi-major axis of the ellipse and a closer approximation will be obtained by subtracting a value Δr from r . The fractional variation $\Delta r/r$ has been plotted in Fig. 2 for different values of r/k .

If the relative permittivity of the dielectric medium be ϵ_r , the capacitance per unit length is then given by the formula

$$C = 55.6 \cdot \frac{\epsilon_r}{\log_e \frac{r + \sqrt{r^2 - k^2}}{a + b}} \text{ pF/metre} \quad \dots \quad (8)$$

k being equal to $\sqrt{a^2 - b^2}$

The inductance per unit length and the characteristic impedance from the previous discussion are then given by

$$L = 0.2 \log_e \frac{r + \sqrt{r^2 - k^2}}{a + b} \mu\text{H/metre} \quad \dots \quad (9)$$

$$Z_0 = \frac{60}{\sqrt{\epsilon_r}} \log_e \frac{r + \sqrt{r^2 - k^2}}{a + b} \text{ ohms} \quad \dots \quad (10)$$

Equation (10), however, gives a slightly high value for the same reason that we get a slightly low value of capacitance by Equ. (8). It is seen that for r/k greater than three, the error is very small, thus for $r/k = 4$, the error is about 1%, and for $r/k = 5$, it is only about 0.5%. A plot of characteristic impedance Z_0 versus r/k is given in Fig. 3, with $b/a = 0.5$ and air as the dielectric medium. The continuous line shows the value given by Equ. (10), while the dotted curve gives the value after correction for r .

Calculation of Resistance

It is assumed that the radius of curvature and the thickness of the conductors are much greater (by at least eight times) than the depth of penetration⁹, so that the complex Bessel function calculation may be avoided and the simple knowledge of surface resistivity will enable us to calculate the effective resistance almost precisely.

The surface-charge density on the elliptical conductor is

$$q = -\epsilon \left. \frac{dw}{dz} \right| \quad \dots \quad (11)$$

where $\left. \frac{dw}{dz} \right|$ is taken on the surface of the conductor.

Hence from Equ. (7), putting x and y in the parametric form $a \cos \phi$ and $b \sin \phi$ respectively, we get

$$q = \frac{Q}{2\pi} \cdot \frac{1}{(a^2 \sin^2 \phi + b^2 \cos^2 \phi)^{\frac{1}{2}}} \quad \dots \quad (12)$$

If we represent the r.m.s. surface-current density by i_0 and the r.m.s. high-frequency current by I we may

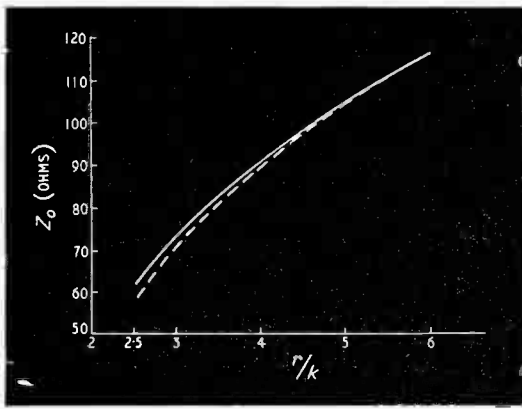

Fig. 3. Characteristic impedance (Z_0) versus r/k as calculated from Equ. (10), for $b/a = 0.5$. The dashed curve gives the value after correction for r

put, following the discussion at the beginning of the article,

$$i_0 = \frac{I}{2\pi} \cdot \frac{1}{(a^2 \sin^2 \phi + b^2 \cos^2 \phi)^{\frac{1}{2}}} \quad \dots \quad (13)$$

So the power loss in an elementary strip of unit length and width equal to $(a^2 \sin^2 \phi + b^2 \cos^2 \phi)^{\frac{1}{2}} d\phi$ is given by,

$$dW = \frac{I^2 R_1}{4 \pi^2} \cdot \frac{d\phi}{(a^2 \sin^2 \phi + b^2 \cos^2 \phi)^{\frac{1}{2}}} \quad \dots \quad (14)$$

where R_1 is the surface resistivity and is given by

$$R_1 = \sqrt{\frac{\pi f \mu}{\sigma}} \quad \dots \quad (15)$$

f = frequency (cycles/second)

μ = permeability of the conductor (henrys/metre).

σ = conductivity of the conductor (mhos/metre).

Hence total loss per unit length of the inner conductor is,

$$W = \frac{I^2 R_1}{4 \pi^2} \int_0^{2\pi} \frac{d\phi}{(a^2 \sin^2 \phi + b^2 \cos^2 \phi)^{\frac{1}{2}}} \\ = (I^2 R_1 / \pi^2 a) F(e, \pi/2) \quad \dots \quad (16)$$

where $F(e, \pi/2) = \int_0^{\pi/2} \frac{d\phi}{\sqrt{1 - e^2 \sin^2 \phi}}$

stands for the elliptic integral of the first kind, and e is the eccentricity of the ellipse, being equal to $\sqrt{1 - (b/a)^2}$.

So the effective resistance R_{el} of the elliptic conductor per unit length is given by

$$R_{el} = \frac{W}{I^2} = \frac{R_1}{\pi^2 a} \cdot F(e, \pi/2) \text{ ohms/metre} \quad (17)$$

$F(e, \pi/2)$ has been plotted¹⁰ for different values of b/a (Fig. 4).

It is of interest to compare the resistance R_{cir} of a circular cylinder with equal cross-sectional area. For equal area, the circle will have a radius equal to $a(1 - e^2)^{\frac{1}{2}}$. So the ratio of the resistance per unit length of elliptic and circular cylinder is given by,

$$\frac{R_{el}}{R_{cir}} = \frac{2}{\pi} \cdot (1 - e^2)^{\frac{1}{2}} \cdot F\left(e, \frac{\pi}{2}\right) \quad \dots \quad (18)$$

This has been plotted against b/a (Fig. 5). It is seen that the ratio decreases with lesser value of b/a (i.e., greater

value of e) despite the increasing non-uniformity of current density. This is because, for the same cross-sectional area, with greater values of e , the ellipse has got a larger perimeter which factor does more than balance the increase in resistance due to non-uniform current density. This is a good illustration showing the high frequency characteristics as a surface phenomenon rather than a volume phenomenon. However, for equal perimeter the ratio

$$\frac{R_{el}}{R_{cir}} = \frac{4}{\pi^2} \cdot F(e, \pi/2) \cdot E(e, \pi/2) \quad \dots \quad (19)$$

[where $E(e, \pi/2) = \int_0^{\pi/2} \sqrt{1 - e^2 \sin^2 \phi} \cdot d\phi$ stands for

the elliptic integral of the second kind] increases with increase in e ; i.e., decrease in b/a (Fig. 6).

For all practical purposes, the following simpler formula will give very nearly correct value of resistance up to the value of $e = 0.866$ (i.e., $b/a = 0.5$),

$$R_{el} = \frac{R_1}{2\pi a} \left[\left(1 - \frac{e^2}{2}\right)^{-\frac{1}{2}} + \frac{3}{64} \cdot \frac{e^4}{1 - e^2} \right] \quad \dots \quad (20)$$

Thus, for $b/a = 0.5$, the value given by Equ. (20) is only about 0.2% less than the actual value. This formula may be extended to $e = 0.94$ (i.e., $b/a \approx 0.34$) where the value given by equation (20) is approximately 3% higher than the actual one.

The resistance per unit length of the transmission line is, therefore,

$$R = (R_1/\pi^2 a) F(e, \pi/2) + R_2/2\pi r \text{ ohms/metre} \quad (21)$$

where R_1 and R_2 are the surface resistivities of the materials of the inner and outer conductors respectively. If the permeability of conductors be taken equal to that of the space we get, σ_1 and σ_2 being the respective conductivity of the centre and outer conductor,

$$R = \sqrt{\frac{f}{10^7}} \left[\frac{2 \times F(e, \pi/2)}{\pi a \sqrt{\sigma_1}} + \frac{1}{r \sqrt{\sigma_2}} \right] \text{ ohms/metre} \quad (22)$$

For values of $e \leq 0.94$, we can utilize Equ. (20) and write,

$$R = \sqrt{\frac{f}{10^7}} \left[\frac{1}{a \sqrt{\sigma_1}} \left\{ \sqrt{1 + (b/a)^2} + \frac{3}{64} \left(\frac{a}{b} - \frac{b}{a} \right)^2 \right\} + \frac{1}{r \sqrt{\sigma_2}} \right] \text{ ohms/metre} \quad (23)$$

Fig. 4. $F(e, \pi/2)$ versus b/a . This also gives the relative value of resistance of elliptical conductor for different values of b/a , when the semi-major axis a is kept constant. The broken line gives the relative resistance (right-hand scale) when the minor axis is kept constant

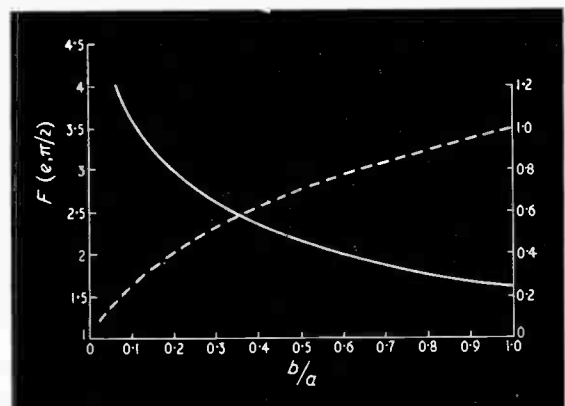

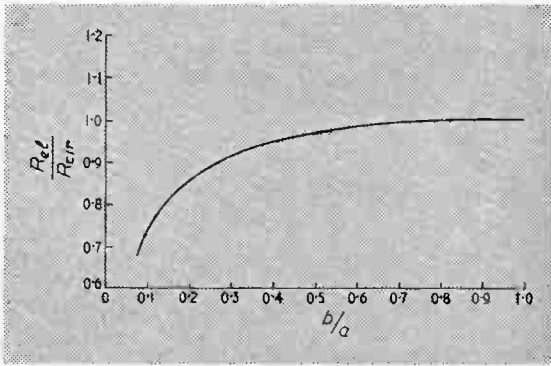

Fig. 5. The ratio of resistance per unit length of the elliptical conductor to that of the circular one, of equal cross-sectional area, against b/a

Attenuation Constant α

At high frequency, the attenuation constant α is given by,

$$\alpha = R/2 Z_0 + G Z_0/2 \text{ nepers/metre} \quad \dots (24)$$

where G is the shunt conductance per unit length and is,

$$G = 2 \pi f C \tan \delta = 3.49 \times 10^{-10} \frac{f \epsilon_r \tan \delta}{\log_e (r + \sqrt{r^2 - k^2}) / (a + b)} \text{ mhos/metre} \quad (25)$$

δ being the loss angle of the dielectric medium.

So, from Equations (22) and (10) we get,

$$\alpha = \frac{\sqrt{\frac{f \epsilon_r}{10^7} \left[\frac{2 \times F(e, \pi/2)}{\pi a \sqrt{\sigma_1}} + \frac{1}{r \sqrt{\sigma_2}} \right]}}{120 \log_e \frac{r + \sqrt{r^2 - k^2}}{a + b}} + 1.05 \times 10^{-8} \sqrt{\epsilon_r} f \tan \delta \text{ nepers/metre} \quad (26)$$

With negligible dielectric loss and $1 \geq b/a \geq 0.34$, substituting m, n and ρ for $b/a, \sigma_1/\sigma_2$ and r/a respectively we have, using Equ. (23),

$$\alpha = \frac{\sqrt{\frac{f \epsilon_r}{10^7 \sigma_1} \cdot \frac{1}{r} \left[\rho \left\{ \sqrt{\frac{2}{1+m^2}} + \frac{3}{64} \left(\frac{1-m^2}{m} \right)^2 \right\} + \sqrt{n} \right]}}{\left(120 \log_e \frac{\rho + \sqrt{\rho^2 - (1-m^2)}}{1+m} \right)} \text{ nepers/metre} \quad \dots (27)$$

To get the condition for minimum attenuation for a given value of r and m , we differentiate Equ. (27) with respect to ρ and the minimum condition is satisfied by the equality

$$\log_e \frac{\rho + \sqrt{\rho^2 - (1-m^2)}}{1+m} = \frac{1}{\sqrt{\rho^2 - (1-m^2)}} \left[\rho + \frac{\sqrt{n}}{\sqrt{2/(1+m^2) + 3/64[(1-m^2)/m]^2}} \right]$$

For the conductors with same material, Table 1 gives the optimum value of $\rho = r/a$ and the corresponding attenuation normalized with respect to the circular coaxial.

The attenuation constant α is plotted in Fig. 7 against ρ for three values of b/a , viz., 0.9, 0.7 and 0.5. The dashed curve corresponding to the circular case ($b/a = 1$), is given for reference.

TABLE 1

$m = b/a$	$\rho = r/a$	Normalized α
1.0	3.59	1.000
0.9	3.45	1.004
0.8	3.31	1.009
0.7	3.16	1.015
0.6	3.02	1.025
0.5	2.86	1.042

It follows from a study of the Fig. 7 that the ratio r/a becomes more critical with greater eccentricity of the ellipse, which is not unexpected. Since an elliptical cylinder has a smaller h.f. resistance than a circular cylinder of equal cross-sectional area, it follows that making both the conductors elliptical or oval, where the cross-sectional area is restricted, specially from one axis, may lead to better performance so far as the attenuation is concerned.

Q of an Elliptical Line

A cyclotron engineer is usually interested in obtaining a high Q -value for the line. The Q -value of a circular coaxial line having radii of the outer and inner conductors r_1 and r_2 respectively, is given by⁷,

$$Q = (2r_1/d) [(\log_e r_2/r_1)/(1 + r_1/r_2)]$$

where d is the depth of penetration, and, in the case of an elliptical inner conductor of semi-major axis a and semi-minor axis b , with outer conductor of radius r_2

$$Q = \frac{2a}{d} \left(\log_e \frac{r_2 + \sqrt{r_2^2 - (a^2 - b^2)}}{a+b} \right) / \left((2/\pi)F(e, \pi/2) + a/r_2 \right)$$

It follows that with restriction in one axis, the elliptical inner conductor transmission line will provide higher Q -values. This occurs specially where the circular coaxial would have to be made with a diameter ratio greater than five, when the Q -value obtainable by such lines may be more than 20% greater than that achieved with circular lines. In such cases, it seems worth while to construct an elliptical conductor. Other cases are conceivable involving similar restrictions where such solutions may be of benefit.

Fig. 6. The ratio of resistance per unit length of the elliptical conductor to that of the circular one, having equal perimeter, versus b/a

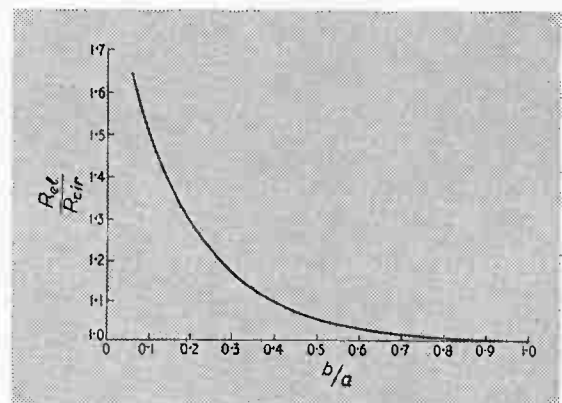

Acknowledgement

The author has pleasure in expressing his deep gratitude to Dr. B. D. Nag Chaudhuri, Director, Institute of Nuclear Physics, Calcutta, for his encouragement in the work.

REFERENCES

- ¹ O. Heaviside, "Electromagnetic Theory", Vol. 1, Dover Publications.
- ² W. Jackson, "High Frequency Transmission Lines", Methuen & Co.
- ³ S. A. Schelkunoff, "Electromagnetic Waves", D. Van Nostrand Co.
- ⁴ R. V. Churchill, "Introduction to Complex Variables and Applications", McGraw-Hill Book Company.
- ⁵ S. Frankel, "Characteristic Impedance of Parallel Wires in Rectangular Troughs", *Proc. Inst. Radio Engrs*, 1942, Vol. 30, p. 182-90.
- ⁶ G. M. Anderson, "The Calculation of the Capacitance of Coaxial Cylinders of Rectangular Cross-Section", *Trans. Amer. Inst. elect. Engrs*, 1950, Vol. 69, p. 728-31.
- ⁷ H. A. Wheeler, "Formulas for the Skin Effect", *Proc. Inst. Radio Engrs*, 1942, Vol. 30, p. 412-24.
- ⁸ F. Kirschstein, "Über den günstigsten Querschnitt des symmetrischen Breitbandkabels", 1936, *E.N.T.*, Band 13, p. 283-95.
- ⁹ E. B. Moullin, "Principles of Electromagnetism", Oxford University Press.
- ¹⁰ E. Jahnke & F. Emde, "Tables of Functions", Dover Publications.
- ¹¹ H. Atterling, "Design of Acceleration-Chamber and Dees for the 225 cm. Cyclotron at the Nobel Institute for Physics, Stockholm", *Ark. Fys*, 1951, Band 2, p. 559-570.
- ¹² G. Lindström, Private communication.

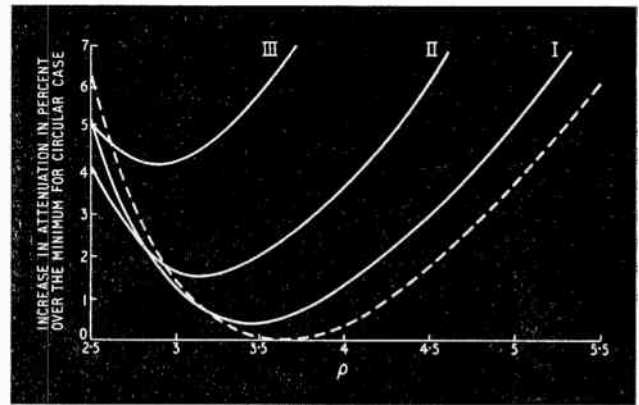

Fig. 7. The increase in attenuation in per cent over the minimum of the circular case versus $\rho (=r/a)$ for three values of b/a : 0.9 (curve I), 0.7 (curve II), 0.5 (curve III). The dashed curve corresponds to the circular case ($b/a = 1$)

MATHEMATICAL TOOLS

By Computer

Matrices. 1-General Principles

In circuit work we are familiar with the idea that a two-terminal network has an 'impedance' which is usually a complex number. The concept of 'impedance' enables us to determine immediately, under steady-state conditions, the current resulting from the application of a given sine-wave voltage to the network. By means of operational calculus, we can obtain the current when an arbitrary voltage is applied, and we can take full account of transient terms. Without the impedance concept, we should be obliged to solve many two-terminal network problems by means of differential equations in the classical manner, and the physical significance of the results obtained would be much more difficult to appreciate. If, however, we consider a network having more than two terminals, it is no longer possible to sum up the properties of this network by means of a single number, even if this number may be complex. We require several such numbers. We can describe such a network by means of a number of its attributes; for example, input and output admittances, open-circuit and short-circuit impedances, transfer constants, etc. There is a wide choice of possible descriptive parameters of this kind available, and those well skilled in the art are able to use these with some facility and perhaps even to have some mental picture

of the whole whose parts are represented by these parameters. What is really needed, however, is a specification of the network performance by means of the smallest possible number of parameters, each of which has a value determined by the essential behaviour of the network, which remains unchanged if a particular form of this network is replaced by an equivalent circuit. The important facts about a network or any other physical entity are those associated with what it does; the question 'What is this network?' is usually irrelevant. If we can not only specify network performance by a group of parameters associated with what the network does, but also can apply to these groups of parameters, regarded as single entities, algebraic manipulations analogous to those associated with impedances in two-terminal network theory, an enormous simplification of network theory becomes possible, much as two-terminal network theory is simplified by the impedance concept. Matrices are groups of essential parameters of the type under discussion, and there is a machinery for their algebraic manipulation. Although this machinery is unfamiliar and apparently difficult to the uninitiated, the matrices associated with four-terminal networks are of a particularly simple kind, and the technique for handling

these matrices can be learnt by an engineer in a few hours.

The mathematical machinery of the complex number enabled electricians to think of an a.c. voltage, current or impedance as a single quantity, even though this quantity had real and imaginary parts and the algebra required had the special law that j^2 must be replaced by -1 in addition to the normal laws of 'real' algebra. At first this machinery, being unfamiliar, appeared to complicate the subject, but in the end it was recognized that the difficulty lay in the subject and not in the machinery. Once the machinery of complex-number theory was understood, the subject of two-terminal network theory became easier to understand; essentially the subject was reduced to the repeated application of a generalized form of Ohm's Law.

The situation is similar with regard to four-terminal network theory and matrices. The essential behaviour of such a network containing linear elements can be expressed by means of four quantities arranged in two rows. Suppose that V_1 and I_1 are the input voltage and current (or rather the p -world counterparts of these quantities with which we have become familiar in recent articles on operational calculus), and that V_2 and I_2 are the corresponding output current and voltage, with the sign convention of Fig. 1. In these articles we shall always use that sign convention. It is the most suitable convention for passive networks where no external voltage is applied at the output. V_2 is then the voltage developed at the output terminals as a result of the application of V_1 , and V_2/I_2 is the impedance of the external circuit connected to the output terminals. With active networks it is more usual to choose I_2 flowing in the opposite direction, and V_2 is an externally applied voltage, so that V_2/I_2 is then the output impedance. It will therefore be necessary to consider carefully



Fig. 1. The two-terminal-pair network has a matrix which is defined in terms of the input and output voltages and currents

the sign appropriate to the output current of active networks with the sign convention of Fig. 1. This at first seems confusing, but the confusion decreases rapidly with practice. Failure to have a consistent sign convention leads to far worse confusion, because the signs of half the elements of the matrices to be described will then be in doubt. With the sign convention of Fig. 1, there are two linear relations between the four quantities V_1 , I_1 , V_2 and I_2 . These relations can be written in the form

$$V_1 = a_{11} V_2 + a_{12} I_2 \quad \dots \quad \dots \quad \dots \quad (1)$$

$$I_1 = a_{21} V_2 + a_{22} I_2 \quad \dots \quad \dots \quad \dots \quad (2)$$

where

$$a_{11} = V_1/V_2 \Big|_{I_2=0} = \text{reciprocal of open-circuit voltage attenuation factor}$$

$$a_{12} = V_1/I_2 \Big|_{V_2=0} = \text{forward short-circuit transfer impedance}$$

$$a_{21} = I_1/V_2 \Big|_{I_2=0} = \text{backward open-circuit transfer admittance}$$

$$a_{22} = I_1/I_2 \Big|_{V_2=0} = \text{reciprocal of short-circuit current attenuation factor.}$$

Alternative ways of writing the linear relations (1) and (2) will be considered in a later article. For the present, we are only concerned with the fact that the expression

$$A = \begin{pmatrix} a_{11} & a_{12} \\ a_{21} & a_{22} \end{pmatrix} \quad \dots \quad \dots \quad \dots \quad \dots \quad (3)$$

obtained by orderly arrangement of the coefficients of (1) and (2), can be regarded as a single entity representing the essential properties of the network, in spite of the fact that four complex numbers are required to define A . Matrix algebra enables us to handle the "A-matrix" A as a single entity. Any information thus obtained could, in fact, be obtained by means of equations (1) and (2). The process, however, is not only greatly simplified by means of matrix algebra, but also its physical meaning and significance become clearer. Matrices enable us to express the behaviour of a complicated network in terms of that of its component parts.

The quantities a_{11} , a_{12} , a_{21} and a_{22} are called the elements of the A -matrix (3). They are unique, that is to say, they are determined entirely by the performance of the network, and remain unchanged if the network is replaced by any of the many possible equivalent-circuit representations of it.

By considering a few special cases, we shall be able to see the significance of these elements. Consider, for example, the equations (1) and (2) for an ideal transformer of ratio $\lambda : 1$. They are

$$\left. \begin{aligned} V_1 &= \lambda V_2 & \dots & \dots & \dots & \dots \\ I_1 &= (1/\lambda) I_2 & \dots & \dots & \dots & \dots \end{aligned} \right\} \quad (4)$$

Hence the A -matrix (3) becomes

$$A_T = \begin{pmatrix} \lambda & 0 \\ 0 & 1/\lambda \end{pmatrix} \quad \dots \quad \dots \quad \dots \quad \dots \quad (5)$$

so that a_{12} and a_{21} are both zero. We shall see later that if the network happens to have a single series element, the impedance of that element is a_{12} , while if the network happens to have a single shunt element, the admittance of the shunt element is a_{21} . The physical significance of the network is best understood in terms of a_{12} , a_{21} , and two other numbers $(a_{11}/a_{22})^{1/2}$ and $(a_{11} a_{22} - a_{12} a_{21})$ which we now consider.

If a network is symmetrical, that is to say, it remains the same if it is reversed so that input and output are exchanged, then it will be found that a_{11} and a_{22} are equal, whether a_{12} and a_{21} are zero or not. When a_{12} and a_{21} are zero, the ratio $(a_{11}/a_{22})^{1/2}$ is seen, by comparing (3) and (5), to be the transformer ratio, which is unity in the symmetrical case. In the general case, the quantity $(a_{11}/a_{22})^{1/2}$ indicates a certain resemblance between the behaviour of the actual network and the behaviour of the analogous ideal transformer having ratio $(a_{11}/a_{22})^{1/2}$.

The remaining physically significant quantity associated with (3) is its 'determinant' $|A|$ defined by

$$|A| = a_{11} a_{22} - a_{12} a_{21} \quad \dots \quad \dots \quad \dots \quad (6)$$

This quantity, as will be shown in a later article, is always unity if the network is passive and obeys the law of reciprocity. As many practical passive networks obey this law, (3) for these networks contains only three effective independent parameters.

For purposes of thought and general understanding (though not necessarily for numerical calculation) we can therefore advantageously regard the behaviour of the four-terminal network as essentially determined by the following four quantities:

- (i) the series impedance quantity a_{12}
- (ii) the shunt admittance quantity a_{21}
- (iii) the ratio $(a_{11}/a_{22})^{1/2}$ of the analogous ideal transformer
- (iv) the determinant $|A|$ given by (6), which is unity for a passive reciprocal network.

Now consider the matrix

$$\begin{pmatrix} 0 & jZ_0 \\ j/Z_0 & 0 \end{pmatrix} \dots \dots \dots \quad (7)$$

which is associated with an impedance inverter. The equations analogous to (1) and (2) are

$$V_1 = j\lambda I_2; I_1 = jV_2/\lambda \quad \dots \dots \dots \quad (8a)$$

so that, if either of V_1 or I_2 is zero, the other is also zero, and if either of I_1 or V_2 is zero, the other is also zero. (8a) can be combined in the form

$$\frac{V_1}{I_1} \cdot \frac{V_2}{I_2} = \lambda^2 \quad \dots \dots \dots \quad (8b)$$

which shows that λ is the geometric mean of the input impedance V_1/I_1 and the output impedance V_2/I_2 .

In practice, the matrix (7) is somewhat idealized but, if a network has an A -matrix whose elements differ by small quantities from those of (7) at a particular frequency, we can expect it to behave somewhat similarly to an impedance inverter at or near that frequency.

Thus we have seen that a network having two terminal pairs should be considered as a single entity; although it cannot be represented by a single number, it can be represented by a single A -matrix, whose four elements are, or are closely related to, quantities having a clear physical significance in relation to the behaviour of the network. With practice, the essential significance of many such A -matrices can be recognized immediately. In later articles we shall first give the rules of matrix algebra and then apply them. Initially, these rules may appear somewhat arbitrary, but they make it possible to analyse the behaviour of a complicated structure in terms of the behaviour of its component parts, and lead to a confident understanding of difficult circuits (such as coupled circuits) which is almost impossible without matrices.

Transistor Cut-Off Frequency

VARIATION WITH COLLECTOR VOLTAGE

By W. L. Stephenson, B.Sc.*

SUMMARY. *The variation of cut-off frequency with collector voltage is calculated from known physical relationships for the transistor. This leads to an expression for the Early feedback factor μ in terms of cut-off frequency and collector voltage, thereby providing a method of measurement of this factor. Other factors which can in theory be determined from these cut-off frequency measurements are the base resistivity and the effect of the field in the base at high current densities.*

It is well known that the cut-off frequency of a transistor varies with the applied collector voltage. This is primarily due to the varying width of the depletion layer at the collector causing changes in the effective base width, which is also related to the Early feedback factor μ .

Starting from well-known physical formulae, expressions for the relationships between cut-off frequency, collector voltage and μ can be derived, thus giving an indirect method of measuring μ . Since the expressions are also affected by the base resistivity it should be possible to determine this by the same method.

For convenience of measurement the cut-off frequency used in this article is not the true α cut-off frequency $f_{c\alpha}$ but the frequency f_1 at which the earthed-emitter current amplification factor $|\alpha'| = 1$. The arguments, however, are equally valid for $f_{c\alpha}$.

Assumptions

Certain fundamental, physical relationships are assumed and these will be described in detail.

The variation of α with frequency at low current densities is given by¹

$$\alpha = \operatorname{sech} \sqrt{j\omega \frac{W^2}{D}} \quad \dots \dots \dots \quad (1)$$

* Mullard Research Laboratories

where W is the effective base width
 D is the diffusion constant for minority carriers
in the base.

Putting $\sqrt{\frac{\omega W^2}{2D}} = A$ this can be written as

$$\alpha = \frac{1}{\cosh A \cos A + j \sinh A \sin A}$$

Since $\alpha' = \frac{\alpha}{1 - \alpha}$

we have $|\alpha'| = \frac{1}{\cosh A - \cos A}$
 $= 1$ when $A = 0.9986 \approx 1$

$\therefore |z| = 1$ at a frequency given by

$$\omega_1 = \frac{2D}{W^2} \dots \dots \dots (2)$$

This compares with the well-known formula

$$\omega_{c\alpha} = \frac{2.43D}{W^2}, \text{ giving } f_{c\alpha} = 1.22 f_1$$

At normal currents, the diffusion constant is increased

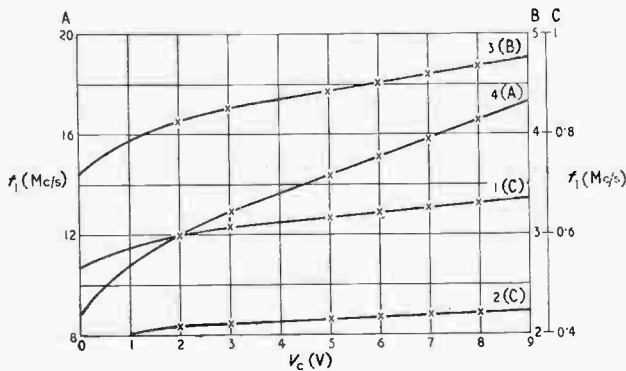

Fig. 1. Variation of f_1 with V_c for four transistors. The curves are drawn to different scales and the letters indicate which one is applicable. The curves show calculated results; measured points are indicated by \times

by a factor n on its low current value. This factor lies between the values 1 and 2 and depends on the current density at the emitter.

Equation (2) may therefore be rewritten:

$$f_1 = \frac{nD_0}{\pi W^2} \cdot 10^{-6} \dots \dots \dots (3)$$

where f_1 is measured in Mc/s.

The relationship between the width of the collector depletion layer and the voltage across the collector junction is given by²

$$W_d = N \sqrt{\rho V_c} \dots \dots \dots (4)$$

where ρ is the resistivity of the base material in Ω -cm and N depends on the type of base material used.

If the resistivity on the base side of the collector junction is considerably higher than that on the collector side (which is normally the case), the depletion layer is almost entirely contained in the base so that

$$W = W_0 - W_d \dots \dots \dots (5)$$

where W_0 is the distance between the junctions.

Variation of f_1 with V_c

On the basis of these two assumptions a relationship between f_1 and V_c can be derived.

From (3)

$$\frac{df_1}{dV_c} = -\frac{2nD_0 \times 10^{-6}}{\pi W^3} \cdot \frac{dW}{dV_c} \dots \dots (6)$$

$$= -2 \cdot 10^3 \sqrt{\frac{\pi}{nD_0}} f_1^{3/2} \frac{dW}{dV_c} \dots \dots (7)$$

From (4) and (5)

$$\frac{dW}{dV_c} = -\frac{dW_d}{dV_c} = -\frac{N}{2} \sqrt{\frac{\rho}{V_c}} \dots \dots (8)$$

and from (7) and (8)

$$\frac{df_1}{dV_c} = N \times 10^3 \sqrt{\frac{\pi \rho}{nD_0}} \cdot f_1^{3/2} V_c^{-1/2} \dots \dots (9)$$

$$\therefore \int f_1^{3/2} df_1 = \lambda \int V_c^{-1/2} dV_c$$

$$\text{where } \lambda = N \times 10^3 \sqrt{\frac{\pi \rho}{nD_0}} \dots \dots (10)$$

$$\therefore 2 f_1^{-1/2} = -2 \lambda V_c^{1/2} + \text{a constant}$$

so that

$$f_1^{-1/2} - f_0^{-1/2} = \lambda (V_0^{1/2} - V_c^{1/2}) \dots \dots (11)$$

where f_0 and V_0 are any corresponding values of frequency and voltage.

A similar formula with $V_0 = 0$ was derived by Ebers and Miller³.

The value of λ may conveniently be determined in practice by measuring at two voltages, the difference of whose square roots is an integer. Such voltages are 1, 4 and 9 volts, so that

$$\lambda = (f_1^{-1/2})_1 - (f_1^{-1/2})_4 = (f_1^{-1/2})_4 - (f_1^{-1/2})_9$$

where the suffix indicates the value of collector voltage.

Once λ is known the value of f_1 at all intermediate points may be calculated using equation (11). Measured and calculated results agreed within $\pm 1\%$, and the form of the curve can be seen in Fig. 1.

Variation of μ with V_c

By definition⁴ the Early feedback factor μ is given by

$$\mu = -\frac{kT}{q} \cdot \frac{1}{W} \cdot \frac{dW}{dV_c} \dots \dots \dots (12)$$

where the negative sign is that of the collector voltage and from equation (6)

$$\begin{aligned} \frac{df_1}{dV_c} &= -\frac{2nD_0}{\pi W^2} 10^{-6} \cdot \frac{1}{W} \cdot \frac{dW}{dV_c} \\ &= -2f_1 \cdot \frac{1}{W} \cdot \frac{dW}{dV_c} \dots \dots \dots (13) \end{aligned}$$

\therefore From equations (12) and (13)

$$\mu = \frac{kT}{q} \cdot \frac{1}{2f_1} \cdot \frac{df_1}{dV_c} \dots \dots \dots (14)$$

Since this equation has been derived without any assumptions about the base resistivity or the collector depletion layer, but only that $f_1 \propto 1/W^2$ it does not necessarily apply only to alloy transistors. Also, since f_1

is directly proportional to $f_{c\alpha}$, equation (14) is equally true with f_1 replaced by $f_{c\alpha}$.

In the case of alloy transistors, equation (9) applies, and equation (14) may be rewritten as

$$\mu = \frac{kT}{q} \cdot \frac{\lambda}{2} \cdot \sqrt{\frac{f_1}{V_c}} \quad \dots \quad (15)$$

μ may therefore be measured in two ways: (a) by measuring f_1 and df_1/dV_c at some particular voltage and applying equation (14); (b) by measuring λ as outlined in section (3) and applying equation (15). This is only true for alloy transistors.

The measurements of μ by this method agree to about 20% with the voltage feedback ratio in earthed-base circuits (h_{12}) measured at low currents.

The variation of λ with voltage and current is given in Fig. 2.

The Coefficient λ

In equation (10) this was defined by

$$\lambda = N \times 10^3 \sqrt{\frac{\pi \rho}{n D_0}}$$

ρ and D_0 are independent of current, so that any

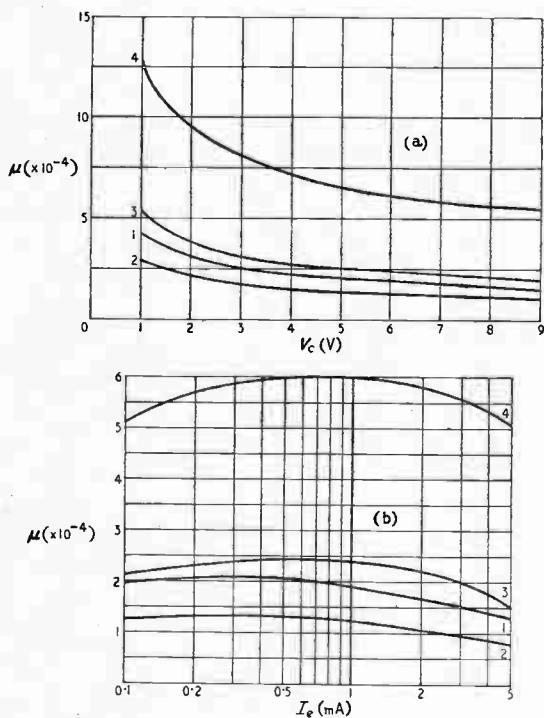

Fig. 2. Variation of feedback factor μ with V_c at $I_e = 1$ mA (a), and with I_e at $V_c = 6$ V (b)

variation of λ with current is due to changes in n , which is a measure of the field present in the base region due to a high concentration of minority carriers.

In theory $n = 1$ at low current levels and $n = 2$ at high current levels so that ρ may be determined from the value of λ measured at different current levels.

In practice, however, the low-current values of f_1 are affected by the emitter depletion-layer capacitance and, at high current, the value of f_1 falls as the hole flow lines

move away from the centre of the emitter and the effective base-width increases.

This makes the determination of ρ by this method

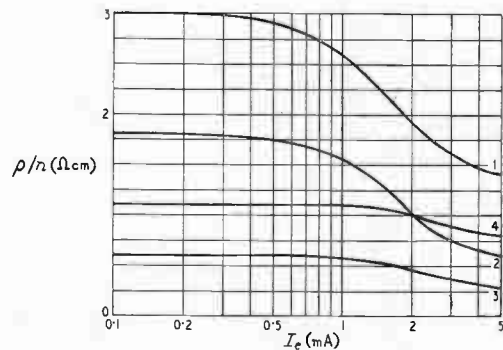

Fig. 3. Change of ρ/n with I_e for four transistors

somewhat inaccurate. The variation of ρ/n calculated from the formula

$$\frac{\rho}{n} = \frac{D_0 \lambda^2}{\pi N^2} \times 10^{-6}$$

$= 1.14 \times 10^3 \lambda^2$ for germanium p-n-p transistors is given in Fig. 3.

Conclusions

The form of the variation of cut-off frequency with collector voltage for alloy transistors has been determined theoretically and has shown good agreement with practical measurements.

The theory also shows that the Early feedback factor may be determined from the change of cut-off frequency with collector voltage, and this is not necessarily limited to alloy transistors.

In theory, the measurement of the cut-off frequency variation can also be used to determine the resistivity of the base materials but, due to other effects, this does not give very accurate results in practice.

Acknowledgements

The author wishes to thank the Director of Mullard Research Laboratories and the Directors of Mullard Limited for permission to publish this paper.

REFERENCES

- ¹ R. L. Pritchard, "Frequency Variation of Current Amplification Factor for Junction Transistors", *Proc. Inst. Radio Engrs*, 1952, Vol. 40, p. 1476.
- ² W. Shockley, "The Theory of p-n Junctions in Semiconductors and p-n Junction Transistors", *Bell Syst. Tech. J.*, 1949, Vol. 28, p. 450.
- ³ J. J. Ebers and S. L. Miller, "Design of Alloyed Junction Germanium Transistors for High Speed Switching", *Bell Syst. Tech. J.*, 1955, Vol. 34, p. 701.
- ⁴ J. M. Early, "Effects of Space Charge Layer Widening in Junction Transistors", *Proc. Inst. Radio Engrs*, 1952, Vol. 40, p. 1401.

CORRECTIONS

In the article "Input Resistance of L.F. Aerials" in the May 1955 issue of *Wireless Engineer* (pp. 131-138) an error occurred in equation (9). In the right-hand expression, the first term in square brackets should be

$$\frac{h}{\rho^2(\rho^2 + h^2)^{\frac{1}{2}}}$$

The Cossor transmitter/receiver illustrated on p. 408 of our November 1957 issue was incorrectly described as a motor-cycle radio telephone. It is, in fact, a 6-lb f.m. walkie-talkie.

Push-Pull Amplifier Design

By R. G. Christian, Graduate I.E.E., Grad. Brit. I.R.E.*

SUMMARY. A method of designing class AB push-pull amplifiers which eliminates the need to plot composite characteristics is discussed, and some examples are given which compare favourably with practical results.

The design of push-pull amplifiers by means of composite characteristics suffers from the severe disadvantage that in plotting these characteristics the supply voltage and grid bias must be chosen first for each set of curves. In the design of an amplifier, several sets of curves may have to be plotted in order to obtain the best operating conditions. This is a tedious and time-consuming procedure which is only necessary if it is

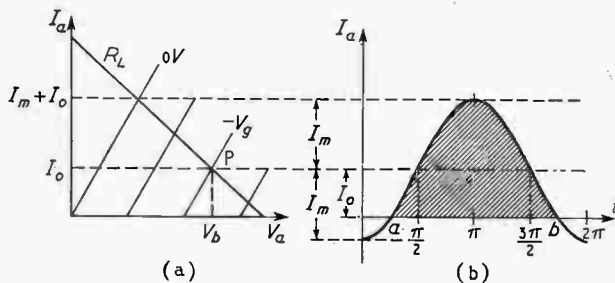

Fig. 1. (a) Ideal $I_a - V_a$ curves; (b) anode-current variation over one cycle

desired to compute the harmonic distortion present. Langford-Smith¹ describes an approximate method for triodes and pentodes using only one set of anode-current-anode-voltage curves which would appear to suffer from the disadvantage that it gives optimistic results. The method to be described here is suitable for triodes and pentodes and the results obtained err on the pessimistic side. The author considers this to be an advantage since, if the design is within the specification by calculation, it will certainly be so in practice.

Design Method

Ideal triode characteristics are shown in Fig. 1 (a) in which the operating point is P and the no-signal anode current per valve is I_0 . The anode load is R_L which is a quarter of the anode-to-anode load and is assumed to be a straight line passing through the point P . This point corresponds to an anode supply voltage V_b and a fixed grid bias $-V_g$ as for a single-ended stage. The graph of anode current against time for a sinusoidal grid input voltage is shown in Fig. 1 (b) and is drawn as a negative cosine wave for ease of calculation. The shaded area represents current flow in the valve, which

is non-conducting over the remaining portion of the cycle. The average value of anode current for two valves is shown in the appendix to be

$$I_{ave} = 2/\pi [I_0 (\pi - a) + I_m \sin a] \quad \dots \quad (1)$$

$$\text{where } a = \cos^{-1} (I_0/I_m) \quad \dots \quad (2)$$

The peak current I_m is readily obtainable from the load-line graph and is used to compute the output power in the load which is

$$P_o = I_m^2 R_L/2 \quad \dots \quad (3)$$

The d.c. power input to the stage at maximum power output is

$$P_i = V_b \cdot I_{ave} \quad \dots \quad (4)$$

giving an anode efficiency of

$$\eta = P_o/P_i \quad \dots \quad (5)$$

and an anode dissipation per valve of

$$P_a = \frac{1}{2} (P_i - P_o) \quad \dots \quad (6)$$

The analysis assumes fixed bias operation but it could be applied to circuits using cathode bias in which case the result would be even more pessimistic. This is due to the increase in bias which occurs as the mean anode current rises from I_0 to I_{ave} resulting in greater power output and smaller average current.

Examples

Two examples are given, one for a pair of pentodes, the second for a pair of triodes, each pair operating in class AB push-pull with fixed bias.

(1) PENTODE. Fig. 2 shows anode characteristics for an EL37 pentode and a load line is drawn to represent

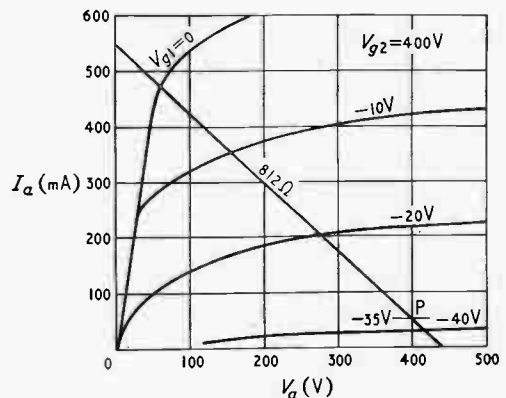

Fig. 2. $I_a - V_a$ curves for EL37 pentode

* Electrical Engineering Department, Liverpool College of Technology.

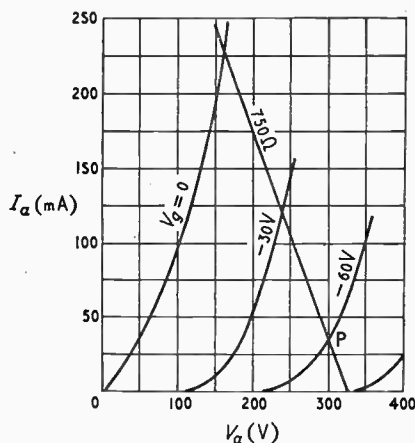

Fig. 3. $I_a - V_a$ curves for 2A3 triode

operation with an h.t. supply of 400 V, a grid bias of -35 V and an anode-to-anode load of 3250Ω . The load per valve is 812Ω and the no-signal anode current per valve I_0 is 50 mA. From the graph $I_m = 410$ mA giving $\cos a = 50/410 = 0.121$, whence $a = 1.24$ radians and $\sin a = 0.94$. The average anode current with maximum signal is

$$I_{ave} = \frac{2}{\pi} [50 (\pi - 1.24) + (410 \times 0.94)] = 306 \text{ mA}$$

and the power output is $P_0 = 410^2 \times 812 / 2 \times 10^6 = 68 \text{ W}$.

(2) TRIODE. Anode characteristics for a 2A3 triode are plotted in Fig. 3 on which a load line is drawn for an anode-to-anode load of 3000Ω , an h.t. supply of 300 V and a grid bias of -62 V. The load per anode is 750Ω and the no-signal current per valve is 40 mA. From the graph, $I_m = 225 - 40 = 185$ mA giving $a = 1.35$ radians, $\sin a = 0.977$, $\pi - a = 1.79$ radians.

TABLE 1

	EL37 Pentode		2A3 Triode	
	Design value	Makers' figure	Design value	Makers' figure
Supply voltage (V)	400	400	300	300
Grid bias (V)	-35	-35	-62	-62
Anode-to-anode load (Ω)	3250	3250	3000	3000
Anode current, no-signal (mA)	100	100	80	80
Anode current, max. signal (mA)	306	276	151	147
Power output (W)	68	69	13	15
Peak-to-peak grid input (V)	70	70	124	124

The average anode current with maximum signal for two valves is therefore

$$I_{ave} = \frac{2}{\pi} [(40 \times 1.79) + (185 \times 0.977)] = 151 \text{ mA}$$

and the power output is $P_0 = (185^2 \times 750) / 2 \times 10^6 = 13 \text{ W}$. The results obtained above are compared with those obtained from the data sheets issued by the valve manufacturers in Table 1.

Conclusions

The results using this method are in fairly good agreement with the makers' figures although they tend

to be somewhat pessimistic in that lower values of power output and higher values of average anode current are obtained. This is probably due to the fact that the method assumes linear characteristics and a linear load line for each valve, which is not so in practice. The errors are not large and, moreover, they are on the right side. If the harmonic distortion is required, it will be necessary to plot the composite characteristics, in which case this method should suffice as a starting point to determine suitable values of anode and grid voltages. If the distortion is to be measured in an actual circuit rather than estimated beforehand, then the design should be possible without further curve-plotting. Furthermore, in this era of heavy negative feedback, harmonic distortion is of less importance.

REFERENCE

¹ F. Langford Smith, "Radio Designer's Handbook", 1953, pp. 577-580, pp. 583-584. (Iliffe & Sons).

APPENDIX

The anode-current curve is chosen to be a negative cosine curve added to a direct current I_0 , giving the equation for anode current as $I_a = I_0 - I_m \cos \theta$

The shaded area under the curve is

$$\int_a^b I_a \cdot d\theta = \int_a^b (I_0 - I_m \cos \theta) d\theta$$

$$= \left[I_0 \theta - I_m \sin \theta \right]_a^b = I_0 (b - a) - I_m (\sin b - \sin a)$$

Now $a + b = 2\pi$ or $a = 2\pi - b$

$$\sin a = \sin (2\pi - b) = -\sin b$$

$$b - a = 2\pi - a - a = 2 (\pi - a)$$

$$\cos a = I_0 / I_m$$

$$\therefore \text{area} = 2 I_0 (\pi - a) + 2 I_m \sin a$$

and the average current for two valves is

$$I_{ave} = \frac{2}{\pi} [I_0 (\pi - a) + I_m \sin a] \quad \dots \quad (1)$$

$$\text{where } a = \cos^{-1} (I_0 / I_m) \quad \dots \quad (2)$$

TALKING BOOKS FOR THE BLIND

The organizers of the Nuffield Talking Books Library for the Blind, the function of which is to distribute gramophone equipment and gramophone records of readings of books, have asked for assistance from radio engineers. Blind persons frequently have difficulty in operating the equipment, although this is very simple. The organization would like voluntary helpers to give assistance to users and also to carry out simple maintenance. There are Talking Books centres throughout the country, but those offering help are asked in the first instance to write to D. Finlay Maxwell, Esq., J. Gladstone & Co., Ltd., Galashiels, Scotland.

I.E.E. CONVENTION ON RADIO AIDS TO AERONAUTICAL AND MARINE NAVIGATION

The Committee of the Radio and Telecommunication Section of the Institution are arranging a Convention on Radio Aids to Aeronautical and Marine Navigation to be held at the Institution on the 27th and 28th March 1958. The following subjects will be covered: Ground, Air and Shipborne Radar; Harbour and Airfield Approach Aids; Hyperbolic and Distance-Bearing Navigation Aids; Doppler and Inertia Navigation.

The Convention is open to members and non-members and the registration fee and other fees payable will be announced in due course.

Correspondence

Letters to the Editor on technical subjects are always welcome. In publishing such communications the Editors do not necessarily endorse any technical or general statements which they may contain.

The Use of Power Series in Network Responses

SIR,—The article by "Computer" in the December 1957 issue on the subject of Power Series Solutions to transient problems will have aroused interest in this method, and I am therefore prompted to draw attention to some extensions to it which have the virtue of neatness—almost elegance—from the mathematical point of view. Unfortunately they are not quite so attractive when applied to numerical and empirical problems.

If the input waveform to a network is zero until time $t = 0$, and if the input and output waveforms are expressed in power-series form, then the unit-step response of the network can be calculated in the same form from the coefficients of the input and output series. The transfer function is readily obtained from the new coefficients by the use of Heaviside's Series Expansion Theorem.

$$\text{Let the input waveform be } E(t) = \sum_{n=1}^{\infty} a_n t^n \quad \dots \quad (1)$$

$$\text{Let the output waveform be } F(t) = \sum_{n=2}^{\infty} b_n t^n \quad \dots \quad (2)$$

$$\text{Let the unit-step response of the network be } \phi(t) = \sum_{m=1}^{\infty} c_m t^m \quad \dots \quad (3)$$

Now in reference 1 the following relationship is derived:

$$F(t) = \sum_{n=1}^{\infty} \sum_{m=1}^{\infty} a_n c_m \frac{n! m!}{(n+m)!} t^{m+n} \quad \dots \quad (4)$$

$$= \frac{1}{2} a_1 c_1 t^2 + \left(\frac{1}{3} a_1 c_2 + \frac{1}{3} a_2 c_1 \right) t^3 + \left(\frac{1}{4} a_1 c_3 + \frac{1}{6} a_2 c_2 + \frac{1}{4} a_3 c_1 \right) t^4$$

$$+ \left(\frac{1}{5} a_1 c_4 + \frac{1}{10} a_2 c_3 + \frac{1}{10} a_3 c_2 + \frac{1}{5} a_4 c_1 \right) t^5$$

$$+ \left(\frac{1}{6} a_1 c_5 + \frac{1}{15} a_2 c_4 + \frac{1}{20} a_3 c_3 + \frac{1}{15} a_4 c_2 + \frac{1}{6} a_5 c_1 \right) t^6$$

$$+ \left(\frac{1}{7} a_1 c_6 + \frac{1}{21} a_2 c_5 + \frac{1}{35} a_3 c_4 + \frac{1}{35} a_4 c_3 + \frac{1}{21} a_5 c_2 + \frac{1}{7} a_6 c_1 \right) t^7$$

$$+ \text{etc.} \quad \dots \quad (5)$$

(Remaining terms are derived thus: for any power n the first and last terms have denominator n , and the denominator of any other term is the sum of the corresponding denominator and the one before it in the previous row).

Thus we have, from Equ. (2),

$$b_2 = \frac{1}{2} a_1 c_1, \quad b_3 = \frac{1}{3} a_1 c_2 + \frac{1}{3} a_2 c_1 \quad \text{and so on.}$$

It is therefore easy to determine the coefficients of the unit-step response of the network, thus:

$$c_1 = 2b_2/a_1$$

$$c_2 = \frac{b_3 - \frac{2}{3} a_2 b_2}{\frac{1}{3} a_1} = \frac{3a_1 b_3 - 2a_2 b_2}{a_1^2}$$

$$c_3 = \frac{4}{a_1} \left(b_4 - \frac{1}{6} a_2 c_2 - \frac{1}{6} a_3 c_1 \right)$$

$$= \frac{4}{a_1^3} \left[a_1^2 b_4 - \frac{a_1 a_2}{2} b_3 + \left(\frac{1}{3} a_2^2 - \frac{1}{2} a_1 a_3 \right) b_2 \right] \dots \quad (6)$$

and so on, by a simple and not-too-laborious process. Thus $\phi(t)$ is readily calculated.

The transfer function, $T(p)$, of the network can now be obtained in series form by the use of Heaviside's Series Expansion^{2,4,5}; thus:

$$\text{If } T(p) = \sum_{n=1}^{\infty} \frac{d_n}{p^{n-1}} \quad \dots \quad (7)$$

and if this series is convergent (e.g., if $|p^{n-1}| > d_n$), then

$$\phi(t) = \sum_{n=1}^{\infty} \frac{d_n t^{n-1}}{(n-1)!} \quad \dots \quad (8)$$

Now since $\phi(t)$ has been determined above, Equ. (3), then clearly $d_n = (n-1)! c_{n-1}$, and the corresponding transfer function is

$$T(p) = \sum_{n=1}^{\infty} \frac{(n-1)! c_{n-1}}{p^{n-1}} \quad \dots \quad (9)$$

which may be more simply written as

$$T(p) = \sum_{n=1}^{\infty} \frac{n! c_n}{p^n} \quad \dots \quad (10)$$

since it is assumed that $c_0 = 0$.

Observations on the Use of this Method

In practice, where power series are fitted empirically to observed functions, the series (1) and (2) cannot be infinite, and will have to be restricted to a relatively small number of terms which adequately describe the function over a limited range of t . If r terms are taken, then the waveform can be exactly fitted at r points (apart from $t = 0$). But it should be observed that, in the process of reference 1, if $E(t)$ and $\phi(t)$ are represented by r terms each, then according to Equ. (5), $F(t)$ will contain non-zero terms up to t^{2r} . Therefore, in operating the reverse process [i.e., in determining $\phi(t)$, given $E(t)$ and $F(t)$] it is necessary to take terms up to t^r in $E(t)$ but up to t^{2r} in $F(t)$ if a correct series of r terms for $\phi(t)$ is to be obtained. Good results have been obtained when this has been done, but errors become large if only r terms are taken in $F(t)$.

When we come to consider the use of Equ. (10) to represent the transfer function, we encounter further practical difficulty. Since the waveforms are fitted to the power series over only a limited range of time, and the steady-state response is not represented, then it is clear that the power series in $1/p$ cannot be expected to be correct for low values of p . If we restrict consideration to the transfer function $T(\omega)$ (obtained on putting $p = j\omega$), clearly we would not expect this to apply at frequencies below the reciprocal of the highest time fitted in the power-series in t . This would probably mean that $T(\omega)$ would apply only above the cut-off frequency in the case of a low-pass filter.

The relationship between $\phi(t)$ and $T(\omega)$, if carefully fitted by empirical power series, is reliable in respect of the ultimate slope of the network loss response. For instance, an m -derived resistance-terminated single-section Zobel filter has an ultimate cut-off slope of 6 dB per octave, and this is indicated by its transient response having a linear term in t , corresponding to a dominant term in $1/\omega$ in the transfer function at high frequencies; but a similar constant- k filter has a transient response without linear or square term³, so that the dominant term in $T(\omega)$ is $1/\omega^3$, correctly indicating an ultimate slope of 18 dB/octave.

Electrical Engineering Department,
University of Birmingham.
6th December 1957.

D. G. TUCKER

REFERENCES

- ¹ D. G. Tucker, "A Note on Duhamel's Integral . . .", *Phil. Mag.*, 1948, Vol. 39, p. 203.
- ² H. S. Carslaw and J. C. Jaeger, "Operational Methods in Applied Mathematics", Oxford, 1949, p. ix and p. 271.
- ³ D. G. Tucker, "Transient Response of Filters", *Wireless Engineer*, 1946, Vol. 23, p. 34.
- ⁴ E. J. Berg, "Heaviside's Operational Calculus", New York, 1936.
- ⁵ H. J. Josephs, "Heaviside's Electric Circuit Theory", Methuen, London, 1946.

Son et Lumière

SIR,—In your October issue¹ "Quantum" has shown the difference between the Doppler effect in acoustics and optics, using the Galilean and Lorentz transformations respectively. This is quite a natural procedure since, in the optical case, the Lorentz transformation *must* be used while, in the acoustic case, the Galilean transformation *may* be used without introducing practically measurable errors. Thus, quite unintentionally, an impression could have been created that the difference is in some way connected with the fact that two different transformations have been used. This is obviously not the case, since there is nothing that forbids the use of the Lorentz transformation in the acoustic case. Hence it may seem advisable to state explicitly that the difference between the two cases is due to the sole fact that in the optical case we deal with two frames of reference, while in the acoustic case we have three such frames.

This is a trivial statement, saying simply that an ether does not exist while air (or any other sound-propagating medium) does. Its importance lies in its form which emphasizes the fact that both cases, while being identical from the point of view of mathematical treatment (both being represented by the wave equation and yielding an exact solution with the aid of the Lorentz transformation) differ in the physical models which represent them—namely the existence of an additional frame of reference in the acoustic case. "Quantum's" paper is a well-timed contribution to the clarification of an almost controversial subject, in view of some recent reports on the application of the Doppler effect^{2,3,4}.

Ministry of Defence,
Tel Aviv, Israel.

10th December 1957.

EFRAIM WEISSBERG

REFERENCES

- ¹ Quantum "Fringe of the Field; Son et Lumière", *Electronic and Radio Engineer*, October 1957, Vol. 34, No. 10.
- ² I. Takahashi, et al., "Doppler Shift of the Received Frequency from the Standard Station Reflected by the Ionosphere", *Proc. Inst. Radio Engrs*, October 1957, Vol. 45, p. 1408.
- ³ Brown et al., "Radio Observations of the Russian Earth Satellite", *Proc. Inst. Radio Engrs*, Nov. 1957, Vol. 45, p. 1552.
- ⁴ A. M. Peterson, "Radio and Radar Tracking of the Russian Earth Satellite", *Proc. Inst. Radio Engrs*, Nov. 1957, Vol. 45, p. 1553.

SIR,—Although I did not put it in quite the same way as Mr. Weissberg, the purpose of the article was to emphasize the error of using the Galilean transformation with its single frame of reference in dealing with the optical case where there are two frames. The point would have been obscured for many readers if I had harped on unmeasurably small inexactness when the Galilean transformation is used for the acoustic case. For, accepting Newtonian mechanics for acoustics, the *argument* is exact; but if we try this on with optics, the argument is wrong whether or not the error in the result is detectable.

To the mathematician, a procedure must be general or it is valueless. The physicist as a rule works in Newtonian terms as long as he has (or thinks he has) a Galilean reference frame, and generalizes only when it is forced on him. I agree with what your correspondent has said so clearly, of course. But I would take the line that the existence of the third frame of reference renders the other two redundant for all practical purposes.

Taking the formal analogy between the two cases as being complete, if we use the Lorentz transformation in acoustics, then the c is the velocity of sound. We should have to do this if clocks could only be synchronized by sound-signals. In fact, in doing this we discard any information that light-signals may afford us, and are effectively choosing to work blindfolded. There is nothing that forbids us to do this at any time if we want to. It would be worth while to inconvenience ourselves in this way only if acoustic measurements could be made more precisely than their optical counterparts.

6th January 1958.

QUANTUM

Uncorrelated Grid Noise

SIR,—Although I am rather late in reading your November issue, I cannot pass by Mr. Harris's further contribution on grid noise, since we are now getting down to fundamentals.

Mr. Harris rejects my treatment in terms of individual electron pulses. But, in the middle of the second column of his letter, he states "the combination of δi_1 and δi_2 occurs in the conductor and not in the valve spaces", δi_1 and δi_2 being the contributions to the grid current from the cathode-grid and grid-anode spaces. I would go further, and say that provided the external circuit is linear the

two are not combined in any irrevocable sense: one finds their difference in the circuit but, if in a hypothetical case they differed in frequency, one could still separate them again. In the same way, either of these currents consists simply of the sum of its component parts (i.e., of electron transits) and one can find the response of a linear system to the whole by summing its responses to the individual parts. This is the basis of Moullin's treatment of shot noise by Fourier analysis of the individual pulses¹, and is also the basis of the treatment by Campbell's theorem². One must *not* assume a Fourier-series or integral representation of a random process extending over time, because (as Mr. Harris says) the phases of the components are randomly distributed; and therefore the phases cannot be known until the phenomenon under analysis is completed; i.e., one cannot predict the Fourier series from general knowledge of the characteristics of the process. What one can predict is the power spectrum (or mean-square values of frequency components) because this excludes phase and refers only to long-term averages, not to particular instances.

No one ignores the effect of pulse spacing: both the treatments cited above^{1,2}, and also the derivation of the power spectrum via the autocorrelation function and the Wiener-Khinchine transformation, postulate that successive electron transits are uncorrelated; i.e., they state specifically that the effect of pulse spacing on the power spectrum is *nil*. Even the Schottky-North theory of space-charge smoothing does not postulate correlation between electron transits which do not overlap in time. It is a matter of mathematical convenience only whether one treats the phenomenon in terms of individual pulses or (in a narrow-band circuit) in terms of a nominal centre frequency which is phase-modulated by the noise. But it must be remembered that the signal applied to the narrow-band circuit is much wider, and will therefore include phase-modulation at such a rate that the narrow circuit cannot follow it. It is not sufficient to consider the response of the circuit to the unmodulated sinusoid.

I believe that the failure to distinguish between the nature of the response of the grid circuit to random noise and to a continuous sinusoid is due in practice to the use of a detecting system of much narrower bandwidth than that of the grid circuit.

No one questions the correlation between currents in the first and second spaces so long as one means correlation between *the currents due to the same group of electrons as they pass successively through the two spaces*. What one must avoid suggesting is that there is some collective Fourier series (known in phase as well as amplitude) which is associated with large numbers of electrons and which *extends in time* with coherence over a number of successive electron transits. This obviously affects the treatment of reflected electrons as well. (Surely the distinction between reflected electrons and secondaries is that only the reflected electrons have sufficient energy to return against the field through the grid to the cathode region?)

My reason for questioning the introduction of $(\omega T)^3$ is that I think one should see how the second-order model fits the physical facts before bringing in a third-order term. A current δi induces grid-current δi_g which causes a grid voltage δv_g and this in turn causes a new component of cathode current $\delta i' = g_m \delta v_g$. But, in the absence of phasing effects between δi and δv_g , the peak of $\delta i'$ would leave the cathode as the group of electrons causing δi passes through the grid, so that $\delta i'$ would lag behind δi by a time of approximately T_1 . This means that δv_g must be further advanced relative to δi if $\delta i'$ is to compensate δi ; and since the requisite amount is a fixed time, it will appear as an increasing phase advance with increasing frequency. This will explain the results of Houlding and Glennie, and I do not see that it requires the introduction of the term in $(\omega T)^3$.

Electrical Engineering Dept.,
University of Birmingham.
24th December 1957.

D. A. BELL

REFERENCES

- ¹ E. B. Moullin, "Spontaneous Fluctuations of Voltage" (Oxford University Press, 1938), pp. 52-56.
- ² N. R. Campbell and V. J. Francis, *J. Instn. elect. Engrs*, 1946, Vol. 93, Part III p. 45.

Comparison of Four Television Standards

SIR,—Dr. N. W. Lewis has informed me that there is an error in my article entitled: "A Comparison of Four Television Standards", which appeared in your November 1957 issue (Vol. 34).

The error in question relates to Fig. 4 (p. 419) for which the responses of vestigial-sideband systems were calculated by means of subtraction from unit-step responses of the same responses delayed

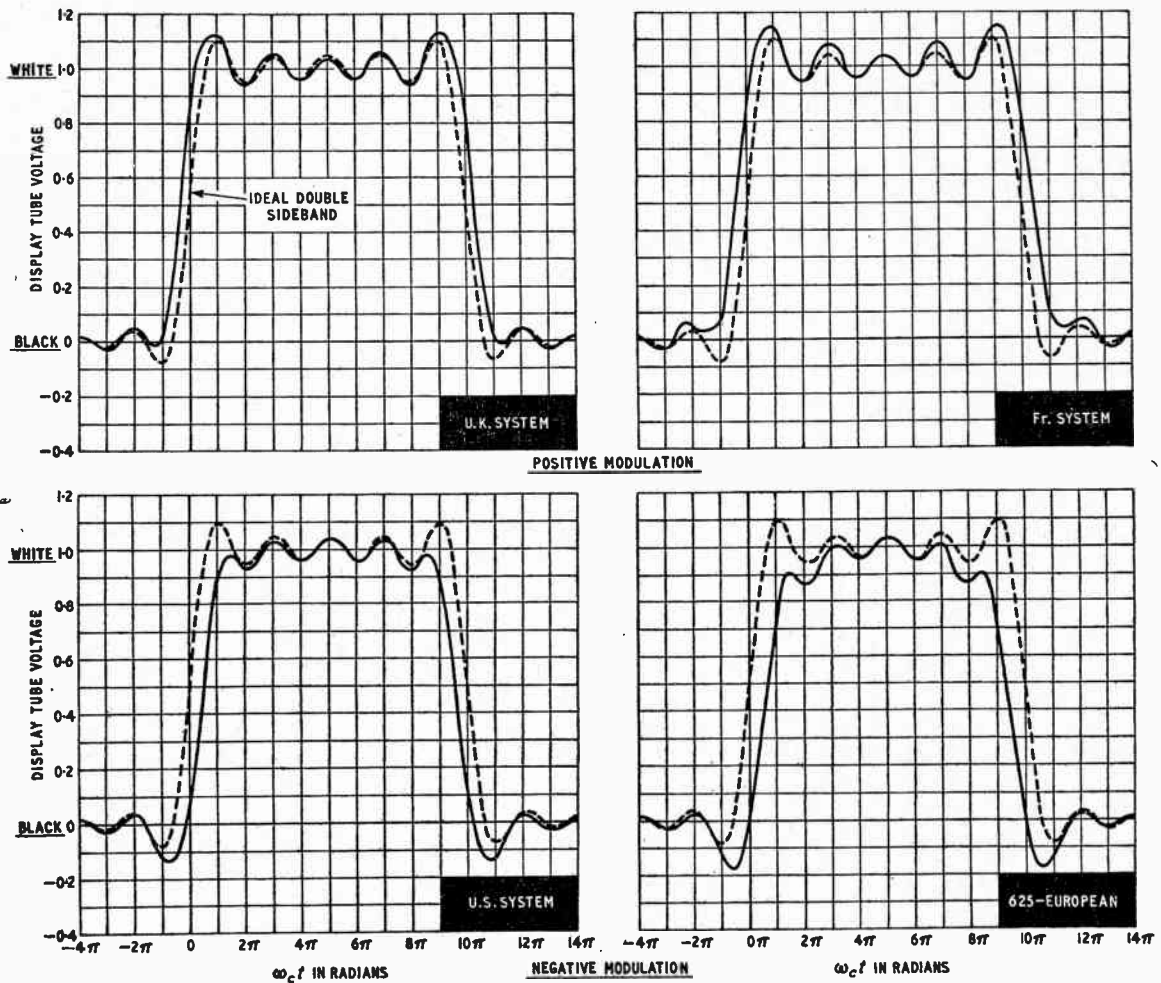

Fig. 4. Normalized rectangular pulse responses (demodulated outputs). The demodulated normalized display tube video voltage is given by

$$E'(t) = \frac{2}{r} \left\{ -\frac{1}{2}a + \sqrt{\left[\frac{1}{2}a + \frac{r}{2\pi} \left\{ \text{Si } \omega_c t - \text{Si } \omega_c (t - 10\pi/\omega_c) \right\} \right]^2} + \frac{r^2}{4\pi^2} \left[\frac{\sin t \Delta\omega}{t \Delta\omega} - \frac{\sin \Delta\omega (t - 10\pi/\omega_c)}{\Delta\omega (t - 10\pi/\omega_c)} + \text{Ci } \omega_c t - \text{Ci } \omega_c (t - 10\pi/\omega_c) - \text{Ci } t \Delta\omega + \text{Ci } \Delta\omega (t - 10\pi/\omega_c) \right]^2 \right\}$$

by a time equivalent to ten picture elements for each system. Such a method may only be used for linear transmission networks and is not applicable to vestigial-sideband systems.

I am grateful to Dr. Lewis for pointing out this error and must add that the fault is mine and not Mr. J. W. Head's to whom the calculations required for Fig. 4 were ascribed.

I give herewith a correct Fig. 4 and would add that the conclusions which I came to are not altered by the above error because they were not based upon this particular figure.

Research Department,
British Broadcasting Corporation,
Tadworth, Surrey.
8th January 1958.

R. D. A. MAURICE

reference books of this kind, there are nine chapters on particular devices, such as multivibrators, variable delay circuits, trigger circuits, clippers, limiters, and clamps. There are also chapters on waveform and network analysis.

Basic Physics

By ALEXANDER EFRON, E.E., Ph.D. Pp. 692. John F. Rider Publisher Inc., 116 West 14th Street, New York 11, N.Y., U.S.A. Price \$7.60.

Elementary physics textbook, comprising two 'volumes' bound together. The first of these gives an introduction to the subject, and the second goes into more detail.

F.B.I. Register of British Manufacturers 1958

Published for the Federation of British Industries by Kelly's Directories Ltd. and Iliffe & Sons Ltd. Pp. 1138. Iliffe & Sons Ltd., Dorset House, Stamford Street, London, S.E.1. Price 42s. post free.

Foreword by the President of the F.B.I., Sir Hugh Beaver, K.B.E.; Details of the Organization, Aims and Activities of the F.B.I. at home and overseas; French, German and Spanish sections; Products and Services: Classified Buyers' Guide; Language Glossaries; Addresses: Alphabetical Directory; Trade Associations; Brands and Trade Names; Trade Marks.

Closed Circuit TV System Planning

By MORRIS A. MAYERS and RODNEY D. CHIFF, P.E. Pp. 250. John F. Rider Publisher Inc., 116 West 14th Street, New York 11, N.Y., U.S.A. Price \$10.00. A user handbook.

New Books

Lewis's Medical, Scientific and Technical Lending Library Catalogue

Pp. 1178 + xii. Revised to December 1956. H. K. Lewis & Co. Ltd., P.O.Box 66, 136 Gower Street, London, W.C.1. Price 42s. (to library subscribers, 25s.). Author and subject indexes.

Electronic Designers' Handbook

By R. W. LANDEE, D. C. DAVIS and A. P. ALBRECHT. Pp. 1029. McGraw-Hill Publishing Co. Ltd., 95 Farringdon Street, London, E.C.4. Price £6 8s.

In addition to the type of general information to be expected in

EXHIBITIONS

- March 4-6.** **Television Society**, Royal Hotel, Woburn Place, London, W.C.1.
- March 24-27.** **Physical Society**, Royal Horticultural Society's Halls, London, S.W.1.
- March 24-29.** **International Instrument Show**, Caxton Hall, Westminster, London, S.W.1.
- March 25-29.** **Electrical Engineers' Exhibition (A.S.E.E.)**, Earls Court, London, S.W.5.
- April 14-17.** **Radio & Electronic Component Manufacturers' Federation**, Grosvenor House and Park Lane House, Park Lane, London, W.1.
- April 16-25.** **Instruments, Electronics and Automation Show**, Olympia, London, W.14.
- April 18-21.** **London Audio Fair**, Waldorf Hotel, London, W.C.2.
(including Sunday 20th)
- Aug. 27-Sept. 6.** **National Radio Show**, Earls Court, London, S.W.5.
- Sept. 1-7.** **Farnborough Air Show**, S.B.A.C., Farnborough, Hants.
- Nov. 28-Dec. 4.** **Electronic Computer Exhibition**, Olympia, London, W.14.

MEETINGS

I.E.E.

6th February. "High Polymers", 49th Kelvin Lecture by H. W. Melville, K.C.B., D.Sc., F.R.S.

18th February. "Magnetic Tape for Data Recording", by C. D. Mee, Ph.D. (To be read by J. F. Doust.)

19th February. "The Relation between Picture Size, Viewing Distance and Picture Quality, with Special Reference to Colour Television and Spot-Wobble Techniques", by L. C. Jesty, B.Sc.

24th February. "Stereophonic Recording on Gramophone Discs", by H. A. M. Clark, B.Sc.(Eng.)

4th March. "Some Impressions of Technical and Industrial Training in the United States", discussion to be opened by K. R. Sturley, Ph.D., B.Sc., at 6 o'clock.

These meetings will be held at the Institution of Electrical Engineers, Savoy Place, Victoria Embankment, London, W.C.2, commencing at 5.30 except where otherwise stated.

Brit. I.R.E.

5th February. "Radio Investigations during the I.G.Y.", by W. J. G. Beynon, Ph.D., D.Sc.

26th February. "DECTRA: A Long Range Navigational Aid", by C. Powell.

These meetings will be held at 6.30 at the London School of Hygiene and Tropical Medicine, Keppel Street, Gower Street, London, W.C.1.

The Television Society

7th February. "The Effects of Noise in Television Transmission", by T. Kilvington, B.Sc.

20th February. "Test Equipment for Colour Television Receivers", by F. H. Cohen and D. C. Kidd.

These meetings will be held at 7 o'clock at the Cinematograph Exhibitors' Association, 164 Shaftesbury Avenue, London, W.C.2.

The Radar Association

12th February. "The Early Days of Radar", by Sir Robert Watson-Watt, at 7.30 at the Anatomy Theatre, University College, Gower Street, London, W.C.1.

R.S.G.B.

14th February. "The Television Interference Problem", by G. A. Bird, to be held at 6.30 at the Institution of Electrical Engineers, Savoy Place, Victoria Embankment, London, W.C.2.

B.S.R.A.

21st February. "Reducing Distortion in F.M. Reception", by Dr. G. J. Phillips, to be held at 7.15 at the Royal Society of Arts, John Adam Street, Adelphi, London, W.C.2.

Women's Engineering Society

26th February. "Three Case Studies in Automation", by G. Denton, to be held at 6.45 at Central Electricity Headquarters, Winsley Street, London, W.1.

NEW YEAR HONOURS

Among the recipients of awards in the Queen's New Year Honours List are:

William R. J. Cook, C.B., deputy director, Atomic Weapons Research Establishment, Aldermaston, who receives a knighthood.

Dr. Harry W. Melville, secretary, Department of Scientific and Industrial Research, who is appointed a Knight Commander of the Order of the Bath.

J. E. S. Cooper, C.M.G., assistant director, Government Communications Headquarters, who becomes a C.B.

Major-General W. R. C. Penney, C.B., C.B.E., D.S.O., M.C., lately director, London Communications Security Agency, who is promoted Knight Commander of the British Empire.

E. H. Ball, managing director, British Thomson-Houston;

V. A. M. Hunt, director, Civil Aviation Control and Navigation Directorate, Ministry of Transport and Civil Aviation;

J. A. Mason, M.M., manager and director, Automatic Telephone and Electric and a director of British Telecommunications Research;

C. Metcalfe, managing director, E.M.I. Electronics;

M. J. L. Pulling, O.B.E., controller, Television Service Engineering, B.B.C., who are appointed C.B.E.s.

W. J. Challens, senior superintendent, Atomic Weapons Research Establishment, Aldermaston;

Lt.-Col. E. N. Elford, T.D., manager radar division, Marconi's Wireless Telegraph Co.;

R. G. Fall, senior signals officer, Civil Aviation Telecommunications Directorate, Ministry of Transport and Civil Aviation;

R. A. McMahon, secretary, British Electrical and Allied Industries Research Association;

H. K. Robin, chief engineer, Communications Department, Foreign Office;

E. G. Rowe, chief valve engineer, Standard Telephones & Cables, and

Wing-Cdr. E. M. Smith, M.B.E., chief executive officer, Foreign Office, Government Communications Headquarters, who become O.B.E.s.

STANDARD-FREQUENCY TRANSMISSIONS

(Communication from the National Physical Laboratory)

Deviations from nominal frequency* for December 1957

Date 1957 December	MSF 60 kc/s 2030 G.M.T. parts in 10 ⁹	Droitwich 200 kc/s parts in 10 ⁸
1	-3	0
2	-3	0
3	-3	+1
4	-3	0
5	-3	0
6	-3	0
7	-3	0
8	-3	-1
9	-3	-1
10	-3	+1
11	-3	0
12	-3	+1
13	-3	+1
14	-3	+2
15	-3	+3
16	-3	+3
17	-3	+3
18	-2	+3
19	-2	+3
20	-2	+2
21	-2	+2
22	-2	+3
23	-2	+2
24	-2	+3
25	-2	N.M.
26	-2	N.M.
27	-2	+3
28	-2	+3
29	-2	+4
30	-2	+4
31	-2	+4

* Nominal frequency is defined to be that frequency corresponding to a value of 9 192 631 830 c/s for the N.P.L. caesium resonator. N.M. = Not Measured.

New Products

Miniature Connector

A 15-way miniature high-voltage connector has been developed which is claimed to be safe and inexpensive.

The method of connecting a cable is said to permit closer pin spacing and to require less skilled operation than orthodox methods.

Plug-pins and socket-inserts are fully shrouded in resilient polythene mouldings, which eliminate the need for gaskets and

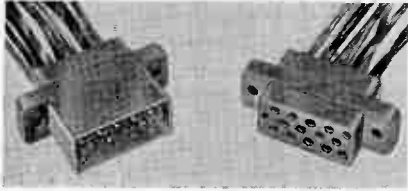

provide the necessary insert anchorage and a considerable degree of protection against vibration.

Plugs and sockets may be used either as fixed or free units. Mating of the units is achieved without the use of coupling nuts or jacking mechanisms.

Multi-stranded cable up to a maximum o.d. of 0.075 in. and maximum conductor o.d. of 0.034 in. may be used.

The connectors have a working voltage of 1 kV and a current rating of 2½ amps per contact and are suitable for operation in temperatures up to 80°C. The unit occupies a total space of 0.75 sq. in.

The Plessey Co. Ltd., Ilford, Essex.

Thermal Relays

Thermal relays of unusual design are available in this country from Mercia Enterprises. These are known as G-V relays, and the principle is illustrated in the drawing. A and B are identical metal members. Differential expansion of these causes the contact C to make. The arm A is heated when current flows through the coil wrapped round it, causing the contact to operate after a certain time which, in different designs, ranges from about 2 sec. to 3 min. Changes in ambient temperature affect A and C equally, and the delay time remains substantially constant. E is a diaphragm through which protrudes the adjusting arm D, moved by the adjusting screw G. This construction enables the device to be hermetically sealed.



In addition to effecting thermal delays, the same type of mechanism can be used for sensing the magnitude of a current passed through the coil and, can therefore, be

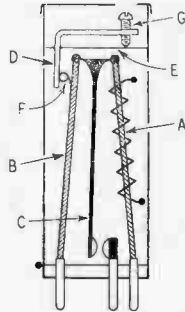

utilized for overload protection and voltage stabilization. The makers' specification states that the operating point will not change by more than ±5% over an ambient temperature range of -70° to +100°C, and that the differential between contact operation and contact return currents is less than 1%.

A folder containing detailed information is available from the suppliers.
Mercia Enterprises Ltd., Godiva House, Allesley Old Road, Coventry.

20-Mc/s Sweep Generator

Marconi Instruments Ltd. have introduced a new 20-Mc/s sweep generator, Type TF1099. This is a video-frequency sweep generator which, in conjunction with a



suitable oscilloscope, is said to enable response measurements to be made to better than 0.01 dB.

The sweep starts at a frequency of less than 100 kc/s and extends to an upper frequency that is continuously variable up to 20 Mc/s; the lower frequency limit is locked to the start of the sweep in order to ensure a steady display on the c.r.o. The level of the frequency-swept signal is variable from 0.3 to 3 volts peak-to-peak, and the selected output level is held constant to within ±0.1 dB. A 250-V time-base waveform, synchronized to the sweep frequency, is provided for connection to the X-plates of a cathode-ray oscilloscope, and a series of

marker pips at 1-Mc/s intervals is available for superimposing on the display to facilitate accurate frequency identification.

The TF1099 includes special circuits for precision differential measurement. For the differential method, the overall gain of the apparatus under test is reduced to unity by means of an external attenuator, and the outputs of the sweep generator and of the apparatus are both sampled; the two signals are then combined and the amplified difference voltage is displayed on the c.r.o.
Marconi Instruments Ltd., St. Albans, Herts.

Switches

Measuring less than 1½ in. by 1½ in. by 1½ in., these new 3- and 4-pole lever switches are rated at 10 A; both types are one-hole mounting.

The 3-pole types are said to be of special interest to electrical engineers on account of the sliding-action contact mechanism, which

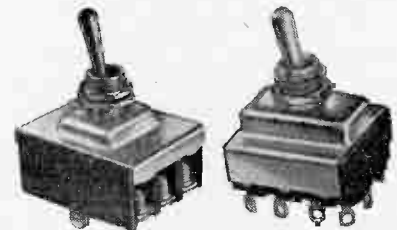

ensures simultaneous breaking of all three contacts, an essential feature when switching 3-phase motors.

N.S.F. Ltd., 31-32 Alfred Place, London, W.C.1.

Electronic Recorder

The recorder illustrated was developed for the atomic-energy industries but is now generally available. Three types of input amplifier are produced. Of these, one is intended for operation from low-impedance sources, such as thermocouples, and gives a minimum instrument range of 1 mV; the second is for a.c. signals from low or medium-impedance sources; the third is for d.c. inputs from high-impedance sources (up to 10 MΩ) and gives a minimum range of 30 mV. Other points from the makers' specification are given below.

Mains supply: 210-250 V, 40-60 c/s.

Pen speed: 2 or 20 sec. full scale.

Chart speed: 1, 2 or 3 in. per minute or 1, 2 or 3 in. per hour.

Accuracy: ±0.3% f.s.d.

George Kent Ltd., Luton, Beds.

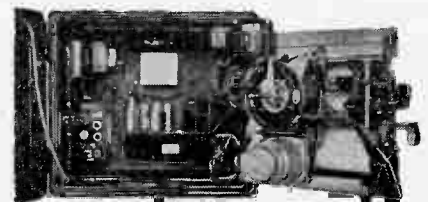

Abstracts and References

COMPILED BY THE RADIO RESEARCH ORGANIZATION OF THE DEPARTMENT OF SCIENTIFIC AND INDUSTRIAL RESEARCH AND PUBLISHED BY ARRANGEMENT WITH THAT DEPARTMENT

The abstracts are classified in accordance with the Universal Decimal Classification. They are arranged within broad subject sections in the order of the U.D.C. numbers, except that notices of book reviews are placed at the ends of the sections. U.D.C. numbers marked with a dagger (†) must be regarded as provisional. The abbreviations of journal titles conform generally with the style of the World List of Scientific Periodicals. An Author and Subject Index to the abstracts is published annually; it includes a selected list of journals abstracted, the abbreviations of their titles and their publishers' addresses. Copies of articles or journals referred to are not available from Electronic & Radio Engineer. Application must be made to the individual publisher concerned.

	Page A		Page A
Acoustics and Audio Frequencies	17	Other Applications of Radio and Electronics	28
Aerials and Transmission Lines	18	Propagation of Waves	28
Automatic Computers	18	Reception	29
Circuits and Circuit Elements	19	Stations and Communication Systems	29
General Physics	20	Subsidiary Apparatus	30
Geophysical and Extraterrestrial Phenomena	21	Television and Phototelegraphy	30
Location and Aids to Navigation	23	Transmission	30
Materials and Subsidiary Techniques	23	Valves and Thermionics	31
Measurements and Test Gear	27	Miscellaneous	32

ACOUSTICS AND AUDIO FREQUENCIES

534.1.087: 621.395.616 **332**
The Condenser Microphone as a Displacement Detector Calibrator.—W. Koidan. (*J. acoust. Soc. Amer.*, July 1957, Vol. 29, No. 7, pp. 813-816.) The absolute calibration of a variable-capacitance-type displacement detector was performed by using the diaphragm of a condenser microphone as a reference moving surface. Measured values of the detector response are plotted from 10 c/s to 40 kc/s. See also 3011 of 1954.

534.2-8-16 **333**
Ultrasonic Attenuation in Metals at Low Temperatures in the Normal and in the Superconducting State.—G. Kurtze. (*Naturwissenschaften*, July 1957, Vol. 44, No. 13, pp. 368-370.) Report of measurements on Cu, Pb and Sn single crystals for longitudinal and transverse waves.

534.2-8-16: 538.221 **334**
Change of Ultrasonic Absorption in Ferrites by an External Magnetic Field.—G. Uhlig. (*Nachr. Tech.*, May 1957, Vol. 7, No. 5, p. 221.) Preliminary note on experiments with a ferrite rod. A strong axial magnetic field produces up to 100% reduction in the ultrasonic absorption of the rod at 3 Mc/s.

534.213-8 **335**
Dispersion Effects in Ultrasonic Waveguides and their Importance in the Measurement of Attenuation.—M. Redwood. (*Proc. phys. Soc.*, 1st Aug. 1957, Vol. 70, No. 452B, pp. 721-737.) The possible sources of error are investigated which arise from the use of the pulse technique in determining absorption at 10-100 Mc/s in low-loss solid materials. Estimated errors of attenuation measurements are tabulated and compared with the intrinsic absorption in fused silica and single-crystal Ge. See also 366 of 1957 (Redwood & Lamb).

534.23: 621.396.677.3 **336**
Theory of Time-Averaged-Product Arrays.—A. Berman & C. S. Clay. (*J. acoust. Soc. Amer.*, July 1957, Vol. 29, No. 7, pp. 805-812.) Mathematical analysis in polynomial form of the directional characteristics of linear additive arrays. It is shown that the same directional characteristics may be obtained from multiplicative arrays having a small number of detectors as with an additive array with many elements. See also 983 of 1956 (Fernandez Huerta).

534.232: 534.64 **337**
Self-Reciprocity Transducer Calibration in a Solid Medium.—R. M. White. (*J. acoust. Soc. Amer.*, July 1957, Vol. 29, No. 7, pp. 834-836.) The application of the self-reciprocity technique to the calibration of a reversible compressional-wave transducer is described.

534.25/26-14: 534.213.4 **338**
Acoustic Refraction and Scattering with Compliant Elements.—W. J. Toulis. (*J. acoust. Soc. Amer.*, Sept. 1957, Vol. 29, No. 9, pp. 1021-1033.) Various techniques of using mechanical structures, such as compliant tubes, for effectively increasing the compressibility of water are described; the results of measurements are analysed.

534.75 **339**
Localization of High-Frequency Tones.—W. D. Feddersen, T. T. Sandel, D. C. Teas & L. A. Jeffress. (*J. acoust. Soc. Amer.*, Sept. 1957, Vol. 29, No. 9, pp. 988-991.) Continuation of earlier work (649 of 1956).

534.76: 534.78 **340**
Mechanism of Binaural Fusion in the Hearing of Speech.—B. M. Sayers & E. C. Cherry. (*J. acoust. Soc. Amer.*, Sept. 1957, Vol. 29, No. 9, pp. 973-987.) The mechanism is discussed as a form of statistical operation based upon the brain's execution of running cross-correlation of the two ear signals.

534.846 **341**
Acoustics of Large Orchestral Studios and Concert Halls.—K. L. Rao: T. Somerville & C. L. S. Gilford. (*Proc. Instn. elect. Engrs.*, Part B, Nov. 1957, Vol. 104, No. 18, p. 597.) Comment on 2017 of 1957 and authors' reply.

621.395.625.6: 534.862.3 **342**
Improved Light Valve for the Photographic Recording of Vibrations.—G. Menon Sreekantath. (*J. acoust. Soc. Amer.*, Sept. 1957, Vol. 29, No. 9, pp. 1034-1035.) A beam of light is modulated by passing through two similar coarse gratings one of which vibrates, and the modulations are recorded on a moving photographic film. The process may be applied to sound recording.

- 621.315.212 343
Multiple Screening of Flexible Coaxial Cables.—L. Krügel. (*Telefunken Ztg*, Sept. 1957, Vol. 30, No. 117, pp. 207–214. English summary, pp. 218–219.) The screening effect of double layers of braiding with and without intermediate magnetic shields is investigated; results are given in graphical form. See also 2334 of 1957.
- 621.315.212.095.3 : 621.372.2 344
An Iteration Method for Computing Electromagnetic Fields.—A. Redhardt. (*Arch. elekt. Übertragung*, June 1957, Vol. 11, No. 6, pp. 227–230.) The conditions at a discontinuity inside a coaxial line are analysed and the resulting field is computed.
- 621.372.2 345
Initial Value Problems and Time-Periodic Solutions for a Nonlinear Wave Equation.—F. A. Ficken & B. A. Fleishman. (*Commun. pure appl. Math.*, Aug. 1957, Vol. 10, No. 3, pp. 331–356.) A discussion of an equation governing the displacement of a taut string, with restraining forces, and applicable to the voltage on a uniform transmission line with certain nonlinear characteristics.
- 621.372.2 346
Return Loss: Part 2.—T. Roddam. (*Wireless World*, Dec. 1957, Vol. 63, No. 12, pp. 583–588.) The relation between loss and circuit response characteristics is discussed with particular reference to distortion in a television picture. Methods of measuring return loss are described. Part 1: 16 of January.
- 621.372.22.09 347
Theory of Nonuniform Lines.—R. Code Lupi. (*Alta Frequenza*, Aug. 1957, Vol. 26, No. 4, pp. 226–282.) Mathematical functions are derived for use in determining the input impedances and voltages along the line and at its terminals. Examples of analyses for multiple reflections are given.
- 621.372.51 : 621.396.674 348
A 200-Watt Balun Coupler for Centre-Fed Antennas.—J. M. Shulman. (*QST*, June 1957, Vol. 41, No. 6, pp. 26–28.) Commercial-type wide-band balun coils are used to provide either 75Ω/75Ω or 75Ω/300Ω unbalance/balance transformation.
- 621.372.51.029.6 : 621.317.335.3 349
The Dielectric Disk used as Transformation Quadripole for the Magnification of the Node Displacement on Measuring Lines.—L. Breitenhuber. (*Arch. elekt. Übertragung*, June 1957, Vol. 11, No. 6, pp. 223–226.) The maximum attainable node displacement is derived as a function of the thickness and the dielectric constant of the disk. The maximum is obtained when the disk shifts the phase by 45°; in this case and for very high dielectric constants the magnification of the node displacement is directly proportional to the dielectric constant.
- 621.372.8 350
Characteristics of some Ferrous and Nonferrous Waveguides at 27 Gc/s.—J. Allison, F. A. Benson & M. S. Seaman. (*Proc. Instn elect. Engrs*, Part B, Nov. 1957, Vol. 104, No. 18, pp. 599–602.)
- 621.372.8.001.2 351
An Application of Sturm-Liouville Theory to a Class of Two-Part Boundary-Value Problems.—S. N. Karp. (*Proc. Camb. phil. Soc.*, April 1957, Vol. 53, Part 2, pp. 368–381.) “A simple solution of a general problem involving a bifurcated waveguide is presented. The purpose of the work is to explain a new and simple method of solving such problems and to exhibit an organic connexion between Sturm-Liouville theory and the theory of two-part boundary-value problems.”
- 621.372.8.002.1 352
Waveguide Design for Die-Casting.—P. Humphreys. (*Electronic Radio Engr*, Dec. 1957, Vol. 34, No. 12, pp. 441–447.) “This article explains how components which have been designed in normal rectangular waveguide may be easily modified on a theoretical basis to make them suitable for die-casting manufacturing methods. The theory is applicable to cases where the waveguide can be manufactured by splitting it along the length of the central E-plane and the unit is therefore cast in two halves.”
- 621.372.822 353
Theory of the Helical Waveguide of Rectangular Cross-Section.—R. A. Waldron. (*J. Brit. Instn Radio Engrs*, Oct. 1957, Vol. 17, No. 10, pp. 577–592.) A mathematical treatment of the properties of a helical waveguide, regarded as an equivalent circular waveguide in which points differing in azimuth by 2π radians are not equivalent.
- 621.372.832.6 354
A New Form of Hybrid Junction for Microwave Frequencies.—L. Young: P. D. Lomer & J. W. Crompton. (*Proc. Instn elect. Engrs*, Part B, Nov. 1957, Vol. 104, No. 18, p. 586.) Comment on 2339 of 1957 and authors' reply.
- 621.372.832.8 355
A Broad-Band Microwave Circulator.—E. A. Ohm. (*Bell. Lab. Rec.*, Aug. 1957, Vol. 35, No. 8, pp. 293–297.) A device for routing microwave energy over a variety of waveguide transmission paths is described. By surrounding the ferrite insert with material of high dielectric constant the rotation/frequency characteristic is flattened and a wide-band device is obtained.
- 621.372.852.22 356
Wide-Band Isolator at 4 kMc/s.—S. Kawazu, K. Matsumaru & H. Ishii. (*Rep. elect. Commun. Lab., Japan*, March 1957, Vol. 5, No. 3, pp. 15–17.) The isolator which incorporates a magnetized ferrite insert covered by dielectric material has forward and reverse losses of 1.5 and 20 dB respectively over a 530-Mc/s band.
- 621.396.677 : 621.372.092 : 621.318.134 357
A New Technique in Ferrite Phase Shifting for Beam Scanning of Microwave Antennas.—Reggia & Spencer. (See 387.)
- 621.396.677 : 621.396.11 358
Aerial/Propagation Mismatch.—R. J. Hitchcock. (*Wireless World*, Dec. 1957, Vol. 63, No. 12, pp. 599–602.) Many point-to-point h.f. circuits in operation are inefficient because aerial systems are not matched to the predominant modes of propagation. Recent investigations show that on medium- and long-distance circuits low angles of arrival predominate both by day and night. Appropriate improvements to aerials and sites are discussed.
- 621.396.677.3 359
The Effect of the Mutual Impedance due to the Neighbouring Elements on the Driving-Point Impedances of a Linear Array.—R. Parthasarathy. (*J. Instn Telecommun. Engrs, India*, June 1957, Vol. 3, No. 3, pp. 242–247.) The driving point impedance of a four-element array is independent of the beam direction, provided the element spacing is not closer than $\lambda/4$.
- 621.396.677.3 360
The New Aerial Installation of the Vatican Short-Wave Broadcasting Service at Santa Maria di Galeria.—W. Berndt. (*Telefunken Ztg*, Sept. 1957, Vol. 30, No. 117, pp. 174–184. English summary, p. 217.) Facilities are provided for changing the angles of main radiation in both the horizontal and vertical planes.
- 621.396.677.3 : 534.23 361
Theory of Time-Averaged-Product Arrays.—Berman & Clay. (See 336.)
- 621.396.677.5 362
The 'Quad' Aerial.—F. B. Singleton. (*Wireless World*, Dec. 1957, Vol. 63, No. 12, pp. 607–608.) The advantages of these aerials for indoor use on bands I and II are outlined.
- 621.396.677.833.1 363
An Experimental Wide-Band Parabolic Aerial for the 2 000-Mc/s Band.—N. Ganapathy & P. E. G. T. Hopkins. (*Marconi Rev.*, 4th Quarter 1957, Vol. 20, No. 127, pp. 134–152.) A 10-ft-diameter horn-fed paraboloid, for multichannel links, combining high gain with good impedance match over a wide band is described; performance data are quoted.

AUTOMATIC COMPUTERS

- 681.142 364
Odd Binary Asynchronous Counters.—J. F. Robertson. (*Trans. Inst. Radio Engrs*, March 1956, Vol. EC-5, No. 1, pp. 12–15. Abstract, *Proc. Inst. Radio Engrs*, June 1956, Vol. 44, No. 6, Part 1, p. 832.)
- 681.142 365
A One-Microsecond Adder using One-Megacycle Circuitry.—A. Weinberger & J. L. Smith. (*Trans. Inst. Radio Engrs*, June 1956, Vol. EC-5, No. 2, pp. 65–73. Abstract, *Proc. Inst. Radio Engrs*, Aug. 1956, Vol. 44, No. 8, p. 1083.)

- 681.142 366
High-Speed Computer stores 2-5 Megabits.—W. N. Papien. (*Electronics*, 1st Oct. 1957, Vol. 30, No. 10, pp. 162-167.) Design and performance details of the Lincoln TX-2 computer are given.
- 681.142 367
An Iterative Analogue Computer for Use with Resistance Network Analogues.—I. C. Hutcheon. (*Brit. J. appl. Phys.*, Sept. 1957, Vol. 8, No. 9, pp. 370-373.)
- 681.142 368
Circuitry and Characteristics of a Repeating Electronic Analogue Computer.—W. Dhen. (*Elektrotech. Z., Edn A*, 11th July 1957, Vol. 78, No. 14, pp. 490-494.) Description of a computer for solving engineering problems. A hyperbolic-field tube [2924 of 1956 (Schmidt)] is used as multiplier.
- 681.142 369
The Error Effect of the Operation Amplifier in Analogue Computers.—A. Kley. (*Telefunken Ztg*, June 1957, Vol. 30, No. 116, pp. 136-141. English summary, p. 153.) The various errors and their sources are discussed and some methods of automatic correction are described.
- 681.142 370
A Multiplier based on the Two-Parabola Method.—W. Schneider. (*Telefunken Ztg*, June 1957, Vol. 30, No. 116, pp. 141-145. English summary, p. 153.) The method of operation is described and the accuracy obtainable is shown by some examples of calculations.
- 681.142: 538.244 371
The Utilization of Domain Wall Viscosity in Data-Handling Devices.—V. L. Newhouse. (*Proc. Inst. Radio Engrs*, Nov. 1957, Vol. 45, No. 11, pp. 1484-1492.)
- 681.142: 621.314.7: 621.375.4 372
Transistors in Current-Analogue Computing.—B. P. Kerfoot. (*Trans. Inst. Radio Engrs*, June 1956, Vol. EC-5, No. 2, pp. 86-93.) A comparison of variable-current and variable-voltage analogue computing techniques shows that transistors are particularly suitable for the former. Low-power low-frequency transistors in direct-coupled amplifiers which may be used in computers are described.
- 681.142: 621.318.57 373
Electric Correlators.—K. Steinbuch & H. Endres. (*Nachrichtentech. Z.*, June 1957, Vol. 10, No. 6, pp. 277-287.) Typical applications of electric correlating devices are discussed, and the operation of various types of these is described. Details are given of a static-type translator using transistors and crystal diodes as nonlinear switching elements.
- 681.142: 621.374.33 374
A Time-Division Multiplier.—M. L. Lilamand. (*Trans. Inst. Radio Engrs*, March 1956, Vol. EC-5, No. 1, pp. 26-34. Abstract, *Proc. Inst. Radio Engrs*, June 1956, Vol. 44, No. 6, Part 1, p. 832.)
- 681.142: 621.385.5 375
Analogue Multipliers and Squarers using a Multigrad Modulator.—R. L. Sydnor, T. R. O'Meara & J. Strathman. (*Trans. Inst. Radio Engrs*, June 1956, Vol. EC-5, No. 2, pp. 82-85. Abstract, *Proc. Inst. Radio Engrs*, Aug. 1956, Vol. 44, No. 8, p. 1084.)
- 681.142: 621.395.625.3 376
A Small Coincident-Current Magnetic Memory.—W. J. Bartik & T. H. Bonn. (*Trans. Inst. Radio Engrs*, June 1956, Vol. EC-5, No. 2, pp. 73-78. Abstract, *Proc. Inst. Radio Engrs*, Aug. 1956, Vol. 44, No. 8, p. 1083.)
- 621.3.049.75 377
The Role of Printed Wiring in High Fidelity.—N. H. Crowhurst. (*Audio*, May 1957, Vol. 41, No. 5, pp. 17-20 . . 78.) The advantages of printed-wiring techniques are summarized.
- 621.314.22 378
A Design Method for Wide-Band Balanced and Screened Transformers in the Range 0.1-200 Mc/s.—M. M. Maddox & J. D. Storer. (*Electronic Engng*, Nov. 1957, Vol. 29, No. 357, pp. 524-531.) Leakages and winding capacitances are accurately and independently controlled, and a high degree of winding balance is attained with an insertion loss of about 0.5 dB.
- 621.314.22 379
Simplified Pulse Transformer Design.—J. H. Smith. (*Electronic Engng*, Nov. 1957, Vol. 29, No. 357, pp. 551-555.) An outline of design techniques for low- and high-power pulse transformers.
- 621.316.726: 621.396.62 380
The Frequency-Lock A.F.C. Circuit.—R. Leek. (*Proc. Inst. elect. Engrs*, Part B, Nov. 1957, Vol. 104, No. 18, pp. 587-597.) Noise-free operation of the system is analysed and its performance at low signal/noise ratios is considered. A theory of the system operation under the latter conditions is developed from an examination of the tracking errors resulting from noise and changes in signal frequency. Practical results obtained are in agreement with this theory.
- 621.318.57 381
A Novel Electronic Transmitter-Receive Switch.—A. Sabaroff. (*QST*, June 1957, Vol. 41, No. 6, pp. 24-25 . . 162.) A Type 6AH6 valve, capable of withstanding 250 V between grid and cathode, isolates the receiver from the transmitter tank circuit.
- 621.318.57: 621.314.7 382
Stabilization of Current-Operated Transistor Switching Circuits.—N. W. Morgalla. (*A.T.E. J.*, July 1957, Vol. 13, No. 3, pp. 192-200.) A method is given for calculating the parameters of simple compensating circuits.
- 621.318.57: 621.314.7: 621.395.3 383
The Transistor as a Speech-Path Switch.—R. C. N. Mundy. (*A.T.E. J.*, July 1957, Vol. 13, No. 3, pp. 227-235.) The suitability of transistors is discussed and some methods of using them for this purpose in telephone systems are described.
- 621.318.57.01: 681.142 384
Complexity in Electronic Switching Circuits.—D. E. Muller. (*Trans. Inst. Radio Engrs*, March 1956, Vol. EC-5, No. 1, pp. 15-17. Abstract, *Proc. Inst. Radio Engrs*, June 1956, Vol. 44, No. 6, Part 1, p. 832.)
- 621.37.049: [537.3+538.6 385
Future Circuit Aspects of Solid-State Phenomena.—E. W. Herold. (*Proc. Inst. Radio Engrs*, Nov. 1957, Vol. 45, No. 11, pp. 1463-1474.) Several phenomena such as superconductivity, molecular amplification, magnetic effects in semiconductors, and the nonlinear capacitance of *p-n* junctions, are discussed from the point of view of the circuit designer. New devices will, to an increasing extent, be based on controlled inhomogeneity.
- 621.372: 538.565.5 386
The Influence of Electromagnetically Coupled Systems.—W. Dahlke. (*Arch. elekt. Übertragung*, June 1957, Vol. 11, No. 6, pp. 231-238.) Compound systems consisting of a primary electromagnetically coupled to a secondary system are considered. The equations obtained are applied to examples of magnetic coupling and a conducting diode.
- 621.372.092: 621.318.134: 621.396.677 387
A New Technique in Ferrite Phase Shifting for Beam Scanning of Microwave Antennas.—F. Reggia & E. G. Spencer. (*Proc. Inst. Radio Engrs*, Nov. 1957, Vol. 45, No. 11, pp. 1510-1517.) In the device described a longitudinal magnetic field is applied to a ferrite rod in a rectangular waveguide excited in the TE₁₀ mode. Phase shifts of over 250°/in. and variations in transmitted power of less than ±0.2 dB have been obtained with a field of 60 oersteds. See also 44 of 1957 (Scharfman).
- 621.372.412.011.2 388
Computation of Crystal Admittance.—W. J. Lucas & P. B. Barber. (*Electronic Radio Engr*, Dec. 1957, Vol. 34, No. 12, pp. 454-458.) The results of a digital-computer program designed to calculate the admittance of a coaxial crystal for various values of video resistance, spreading resistance and barrier capacitance over the range 2-18 kMc/s are given. Comparisons with available measurements are made.
- 621.372.413 389
Method of Obtaining Pressure- and Temperature-Insensitive Microwave Cavity Resonators.—C. M. Crain & C. E. Williams. (*Rev. sci. Instrum.*, Aug. 1957, Vol. 28, No. 8, pp. 620-623.) Methods using invar walls with steel or brass end plates for TE₀₁₁ cavities are unsatisfactory due to hysteresis effects. Improved techniques

are described for fixed-frequency resonators which have temperature coefficients less than ± 0.2 in 10^6 per °C. The pressure coefficient is less than 0.003 in 10^6 per millibar.

621.372.413 : 621.318.134 **390**

Retardation Effects Caused by Ferrite Sample Size on the Frequency Shift of a Resonant Cavity.—J. E. Tompkins & E. G. Spencer. (*J. appl. Phys.*, Sept. 1957, Vol. 28, No. 9, pp. 969–974.) Expressions are derived, using perturbation theory, for the frequency shift of a circularly polarized resonant microwave cavity due to insertion of a small ferrite sample.

621.372.51 **391**

Simplified Design of Impedance-Matching Networks.—G. Grammer. (*QST*, March–May 1957, Vol. 41, Nos. 3–5, pp. 38–42, 32–35 & 29–34.) A step-by-step method of impedance transformation is described. The formation of Π and T networks from the basic L section and some complex matching networks for particular applications are discussed.

621.372.543.2 **392**

Super Selectivity with Crystals.—R. F. Burns. (*Radio TV News*, July 1957, Vol. 58, No. 1, pp. 52–53 . . 132.) Constructional details of a lattice-type i.f. filter with two crystals; the response curve is symmetrical.

621.372.56.029.6 : 621.372.8 **393**

A Frequency-Independent Microwave Attenuator with Largely Constant Phase Shift.—R. Steinhart. (*Nachrichtentech. Z.*, June 1957, Vol. 10, No. 6, pp. 294–297.) A waveguide attenuator of the rotary-vane type is described and calibration and error curves are given. Close agreement of measured attenuation with theoretical values was obtained in attenuators for the range 3 300–4 200 Mc/s.

621.372.57 **394**

The Transactor.—A. W. Keen. (*Electronic Radio Engr.*, Dec. 1957, Vol. 34, No. 12, pp. 459–461.) The two-terminal constant-current and constant-voltage generators used in equivalent circuits of active networks are replaced by transmission-type active elements called transactors. The relations between variants of this element are established.

621.372.6 : 621.3.018.1 **395**

Theory of Two-Phase Networks.—G. Wunsch. (*NachrTech.*, May 1957, Vol. 7, No. 5, pp. 200–205.) Phase-splitting networks as used in s.s.b. modulation systems are discussed and calculations by approximation methods are described.

621.373.4.029.4 : 621.396.963.5 **396**

Phase-Shift Oscillator Indicates Radar Range.—R. C. Barritt. (*Electronics*, 1st Oct. 1957, Vol. 30, No. 10, pp. 160–161.) Firing range information is conveyed by a variable a.f. note.

621.373.4.029.64 **397**

High-Order Harmonics for X Band Oscillator Stabilization.—M. C. Thompson & J. V. Cateora. (*Rev. sci. Instrum.*, Aug. 1957, Vol. 28, No. 8, p. 656.) A simplified

phase-locking stabilization technique for microwave oscillators. Harmonic orders up to about 300 are used.

621.373.421 **398**

The Simultaneous Generation of Two Oscillations in One Oscillator and the Stability of the Difference Frequency.—W. Feist. (*Nachrichtentech. Z.*, May 1957, Vol. 10, No. 5, pp. 215–222.) The operating conditions are determined which are required for the simultaneous generation of two different frequencies in a valve feedback oscillator [see also 80 of 1952 (Herzog)]. Experimental results are discussed.

621.373.43 **399**

'Grid-Diode' Sawtooth Generator.—T. A. Mendes. (*Wireless World*, Dec. 1957, Vol. 63, No. 12, pp. 603–606.) Description of a simple timebase circuit with wide frequency range.

621.373.5 : 537.311.33 : 538.632 **400**

Experimental and Theoretical Investigation of Semiconductor Hall-Effect Generators.—Strutt & Sun. (See 492.)

621.373.52 **401**

Silicon Transistor Crystal Oscillators have High Temperature Stability.—E. G. Homer. (*Electronics*, 1st Oct. 1957, Vol. 30, No. 10, pp. 218–222.) Outline of circuit design considerations and discussion of experimental results.

621.374.32 **402**

Difference Counters.—A. F. Fischmann. (*Electronic Engng.*, Nov. 1957, Vol. 29, No. 357, pp. 546–550.) Two examples are given with maximum counting rates (a) 2×10^5 pulses/s and (b) 10^7 pulses/s. The design of a decimal difference counter is outlined.

621.375.2.024 **403**

Direct-Coupled Amplifiers.—D. J. R. Martin. (*Electronic Radio Engr.*, Dec. 1957, Vol. 34, No. 12, pp. 438–441.) "A method is described of artificially matching valves to obtain improved mutual compensation for the effects of normal heater-supply voltage changes. Adjustment is easier than selecting naturally matched pairs of valves, and considerably better balance is obtained."

621.375.221.029.62 **404**

A 70-Mc/s I.F. Amplifier for Wide-Band Microwave Links.—L. J. Herbst & G. R. Shoubridge. (*A.T.E. J.*, July 1957, Vol. 13, No. 3, pp. 184–191.)

621.375.4 **405**

Direct-Coupled Amplifiers with Junction Transistors.—S. Giustini. (*Alta Frequenza*, Aug. 1957, Vol. 26, No. 4, pp. 196–225.) A balanced d.c. amplifier circuit is analysed and the theory of its operation is developed on the basis of the work by Ebers & Moll (884 of 1955). The problem of balancing the circuit with ideal and with commercial-type transistors is considered and practical design formulae are derived.

621.375.9 : 538.569.4 **406**

Masers and Reactance Amplifiers—Basic Power Relations.—B. Salzberg. (*Proc. Inst. Radio Engrs.*, Nov. 1957, Vol. 45, No. 11, pp. 1544–1545.) An alternative

derivation, based on circuit theory, of the expressions of Manley & Rowe (2988 of 1956). The power relations involve only the source and load frequencies and are independent of the specific characteristics of the nonlinear device.

621.375.9 : 538.569.4 **407**
: 621.317.3.029.64

Maser Noise Measurement.—Helmer. (See 547.)

621.375.9.029.63/64 : 538.221 **408**

New Ferrite Microwave Amplifier.—(*Bell Lab. Rec.*, Aug. 1957, Vol. 35, No. 8, pp. 316–317.) An experimental solid-state amplifier using a ferrite material as the active element is described. The device is suitable as an amplifier of very weak microwave signals. See also 3076 of 1957 (Suhl).

621.375.9.029.64 : 538.569.4 **409**

The Reaction Field and its Use in Some Solid-State Amplifiers.—P. W. Anderson. (*J. appl. Phys.*, Sept. 1957, Vol. 28, No. 9, pp. 1049–1053.) The theory of the maser is presented in terms of the radiation 'reaction' field produced in a cavity or waveguide by the presence of the electromagnetic moment of the sample being investigated. Two amplifiers are discussed which use the reaction field in different ways from the usual solid-state maser.

621.376.32 : 621.314.63 **410**

The PN Junction on a Variable-Reactance Device for F.M. Production.—D. C. Brown & F. Henderson. (*Electronic Engng.*, Nov. 1957, Vol. 29, No. 357, pp. 556–557.) A transistor modulator for a 10-Mc/s carrier frequency is described which gives good f.m. with negligible a.m. 0.15-V change in modulating signal produces a deviation of 100 kc/s.

GENERAL PHYSICS

537.226.2 **411**

The Influence of a Strong Magnetic Field on the Dielectric Constant of a Diamagnetic Fluid.—A. D. Buckingham. (*Proc. phys. Soc.*, 1st Aug. 1957, Vol. 70, No. 452B, pp. 753–760.)

537.226.2 **412**

Formulae for Dielectric Constant of Mixtures.—J. A. Reynolds & J. M. Hough. (*Proc. phys. Soc.*, 1st Aug. 1957, Vol. 70, No. 452B, pp. 769–775.) 15 formulae are tabulated with references and shown to be special cases of a general fundamental formula. An exception is the Lichtenecker type of formula, possibly owing to incorrect assumptions.

537.311 **413**

The Second-Order Effect of Free Electrons on Lattice Conduction.—I. C. Pyle. (*Proc. Camb. phil. Soc.*, April 1957, Vol. 53, Part 2, pp. 508–513.) "Second-order perturbation theory, in conjunction with the usual treatment of electron-phonon

- interaction, allows us to calculate the correction to the first-order result for the scattering of phonons by electrons. It is shown that the second-order term is much smaller, and therefore negligible. This justifies the use of the first-order theory in the treatment of the interaction in metals and semiconductors." See also 2017 of 1956 (Ziman).
- 537.311.1 **414**
A Method of Calculation of Electrical Conductivity.—H. Nakano. (*Progr. theor. Phys.*, Feb. 1957, Vol. 17, No. 2, pp. 145–161.) Using relaxation theory a general solution is obtained for the electric current density; irreversibility is then introduced so that practical cases may be considered. A perturbation approximation gives the same result as that based on the Bloch theory.
- 537.312.62 **415**
A Note on the Energy-Gap Model of Superconductivity.—M. J. Buckingham. (*Nuovo Cim.*, 1st June 1957, Vol. 5, No. 6, pp. 1763–1765. In English.)
- 537.312.62 **416**
Gauge Invariance and the Energy-Gap Model of Superconductivity.—J. Bardeen. (*Nuovo Cim.*, 1st June 1957, Vol. 5, No. 6, pp. 1766–1768. In English.) See also 415 above.
- 537.321 **417**
On the Elementary Theory of Thermoelectric Phenomena.—R. Stratton. (*Brit. J. appl. Phys.*, Aug. 1957, Vol. 8, No. 8, pp. 315–321.) All the relations between the thermoelectric parameters are deduced from physical properties rather than by means of mathematical transformations. The sources of the heat and e.m.f. developed are indicated.
- 537.525 : 538.56 **418**
The Plasma Resonator.—A. Dattner. (*Ericsson Tech.*, 1957, Vol. 13, No. 2, pp. 309–350.) The interaction between an ionized gas column and an electromagnetic wave in a waveguide is studied at $\lambda = 6$ cm. Effects examined include the influence of the discharge current, gas collisions, decay times of electron density, and modulation of the r.f. power.
- 537.525 : 621.387.032.435.4 **419**
New Effects of an Auxiliary Electrode on a Discharge at Low Pressure.—Thong Saw Pak. (*J. Electronics Control*, Nov. 1957, Vol. 3, No. 5, pp. 471–480.) An auxiliary electrode close to the cathode provides a means of sensitive control of the discharge. Optimum operational conditions were found for a range of discharge parameters. Low-frequency noise may be suppressed by an electrode of wire gauze.
- 537.533.8 **420**
Theory of Secondary Emission.—R. G. Lye & A. J. Dekker. (*Phys. Rev.*, 15th Aug. 1957, Vol. 107, No. 4, pp. 977–981.) The elementary theory of secondary electron emission has been generalized and modified to incorporate results of recent measurements of the range/energy relation and the dissipation of energy by slow electrons in solids. These modifications give considerably improved agreement between the theoretical and experimental 'universal' reduced yield curves.
- 538.1 **421**
'Satellite-Electron' Theory of Ferromagnetism, Antiferromagnetism and Related Phenomena.—L. Singh. (*Naturwissenschaften*, Aug. 1957, Vol. 44, No. 15, pp. 417–418. In English.) A theory based on classical concepts is developed to show the electronic nature of ferromagnetism. Magnetic properties of transition-metal oxides are briefly discussed.
- 538.11 : 538.124 **422**
A Note on the Ground State of Antiferromagnetism.—H. Taketa & T. Nakamura. (*J. phys. Soc. Japan*, Sept. 1956, Vol. 11, No. 9, pp. 919–923.) Kasteleijn's method (2199 of 1952) of obtaining the lowest energy state is generalized for the cases of two- and three-dimensional lattices.
- 538.3 : 52 **423**
On the Reflection and Refraction of Magneto-hydrodynamic Waves.—S. Prakash & J. N. Tandon. (*Proc. nat. Inst. Sci. India*, Part A, 26th July 1957, Vol. 23, No. 4, pp. 264–273.)
- 538.566 : 535.42 **424**
Asymptotic Formulas for Diffraction by Parabolic Surfaces.—H. Hochstadt. (*Commun. pure appl. Math.*, Aug. 1957, Vol. 10, No. 3, pp. 311–329.) Asymptotic solutions to the wave equation are found at a boundary consisting of a paraboloid of revolution or a parabolic cylinder. The results are applied to the reflection, at such surfaces, of incoming plane waves or divergent waves from a point or line on the axis of the surface.
- 538.569.4 **425**
Double Modulation System for Narrowing Electron Resonance Absorption Lines.—R. R. Unterberger, J. L. Garcia de Quevedo & A. E. Stoddard. (*Rev. sci. Instrum.*, Aug. 1957, Vol. 28, No. 8, pp. 616–619.) A method for observing electron-resonance absorption on an oscilloscope screen by modulating both the magnetic field and the klystron frequency. The apparent line width can be reduced by a factor of 17 relative to the true line width.
- 538.569.4 **426**
Microwave Studies of the Internal Motion and the Structure of Methyl Amine.—T. Nishikawa. (*J. phys. Soc. Japan*, June 1957, Vol. 12, No. 6, pp. 668–680.)
- 538.569.4 **427**
Potential Barrier and Molecular Structure of Methyl Mercaptan from its Microwave Spectra.—T. Kojima & T. Nishikawa. (*J. phys. Soc. Japan*, June 1957, Vol. 12, No. 6, pp. 680–686.)
- 538.569.4 **428**
Microwave Spectrum of BrCN and Dependence of Quadrupole Coupling Constant on the Vibrational State.—T. Oka & H. Hirakawa. (*J. phys. Soc. Japan*, July 1957, Vol. 12, No. 7, pp. 820–823.)
- 538.569.4 : 621.375.9 **429**
Proposal for a Nuclear Quadrupole Maser.—R. Braunstein. (*Phys. Rev.*, 15th Aug. 1957, Vol. 107, No. 4, pp. 1195–1196.) It is suggested that certain substances exhibiting pure quadrupole transitions have the requisite properties for maser operation. The differences between masers based on these substances and on paramagnetic solids are discussed.
- 538.569.4 : 621.375.9.029.6 **430**
Fluctuations in Amplification of Quanta with Application to Maser Amplifiers.—K. Shimoda, H. Takahasi & C. H. Townes. (*J. phys. Soc. Japan*, June 1957, Vol. 12, No. 6, pp. 686–700.) Expressions for the probability distribution of quanta, for the average values and for the fractional fluctuation are developed and applied to maser-type amplifiers.
- 538.569.4 : 621.375.9.029.64 **431**
The Reaction Field and its Use in Some Solid-State Amplifiers.—Anderson. (See 409.)
- 538.615 **432**
Radio-Frequency Zeeman Effect in O₂.—J. M. Hendrie & P. Kusch. (*Phys. Rev.*, 1st Aug. 1957, Vol. 107, No. 3, pp. 716–723.) By the molecular-beam magnetic-resonance method the ratio of the g -value of the rotational magnetic moment to that of the electron-spin moment is found to be $(6.08 \pm 0.74) \times 10^{-8}$; the ratio of the g -value of the unpaired-electron spin moments in O₂ to that of the free-electron spin moment is $1 - (190 \pm 13) \times 10^{-6}$.
- 539.16.08 : 621.372.413 **433**
The Cloud Chamber.—(*Electronic Radio Engr.*, Dec. 1957, Vol. 34, No. 12, pp. 447–450.) The theory and application of the Wilson cloud chamber are outlined, and its modification by Gabor & Hampton (*Nature, Lond.*, 12th Oct. 1957, Vol. 180, No. 4589, pp. 746–749) is briefly described.

**GEOPHYSICAL AND
EXTRATERRESTRIAL PHENOMENA**

- 523.16 : 523.4 **434**
Sources of Radio Noise on the Planet Jupiter.—C. H. Barrow, T. D. Carr & A. G. Smith. (*Nature, Lond.*, 24th Aug. 1957, Vol. 180, No. 4582, p. 381.) Daily records made from 31st December 1956 to 8th March 1957 at Gainesville, Florida, at 18 Mc/s suggest that there are two localized sources on Jupiter and that Jupiter is surrounded by an ionosphere of electron density 10^8 cm⁻³, i.e. comparable with that of the earth's ionosphere. See 2710 of 1956 (Shain).
- 523.16 : 523.64 **435**
Radio Emission from the Comet 1956 h.—H. G. Müller, W. Priester & G. Fischer. (*Naturwissenschaften*, July 1957, Vol. 44, No. 14, pp. 392–393.) Report of observations carried out at the radio observatory Stockert.

- 523.16 : 551.510.535 436
A Consideration of Radio-Star Scintillations as Caused by Interstellar Particles Entering the Ionosphere: Part 3—The Kind, Number and Apparent Radiant of the Incoming Particles.—G. A. Harrower. (*Canad. J. Phys.*, July 1957, Vol. 35, No. 7, pp. 792–798.) Discussion of results given earlier (106 of January) indicates that the interstellar particles must be hydrogen atoms.
- 523.7 437
The Proportion of Umbra in Large Sunspots, 1878–1954.—A. W. F. Edwards. (*Observatory*, April 1957, Vol. 77, No. 897, pp. 69–70.) The ratio of umbral area to whole-spot area is evaluated and shown to vary significantly with the position of the sunspot in the solar cycle.
- 523.7 : 621.396.822.029.66 438
Detection of Submillimetre Solar Radiation.—H. A. Gebbie. (*Phys. Rev.*, 15th Aug. 1957, Vol. 107, No. 4, pp. 1194–1195.) Preliminary results are presented which indicate regions of transmission in the wavelength range 1 mm–300 μ .
- 523.72 : 621.396.822 439
Short Time Transients in Solar Noise.—T. de Groot. (*Nature, Lond.*, 24th Aug. 1957, Vol. 180, No. 4582, p. 382.) Histograms have been made from observations at Dwingeloo, Holland, at 400 Mc/s. Reber's theory (see 1637 of 1955) that there is a linear relation between wavelength and duration of 'pips' is not confirmed at this frequency.
- 523.746 440
A Review of Recent Investigations into Sunspot Cycles.—N. A. Huttly. (*Marconi Rev.*, 4th Quarter 1957, Vol. 20, No. 127, pp. 117–129.) Summaries of, and comments on, selected published papers and C.C.I.R. documents relating to predictions of solar activity for use in ionospheric work.
- 523.75 441
Occultation of a Radio Source by the Solar Corona.—O. B. Slec. (*Observatory*, Dec. 1956, Vol. 76, No. 895, pp. 228–231.) Measurements of radio-noise flux from Taurus-A, when its angular separation from the sun is very small, suggest that partial wide-angle scattering has occurred due to electron density irregularities in the solar corona.
- 523.75 442
A Solar Flare on 1956 November 7.—P. A. Wayman. (*Observatory*, Feb. 1957, Vol. 77, No. 896, pp. 24–26.) Visual and radio observations during the flare are presented. Anomalies in the radio observations are accounted for by small regions of the flare remaining enhanced for several hours after the main effect had subsided.
- 523.78 443
Centimetre-Wave Observations of the Solar Eclipse of 1954 June 30.—J. S. Hey & V. A. Hughes. (*Observatory*, Dec. 1956, Vol. 76, No. 895, pp. 226–228.) Radiation measurements at 10.5 cm λ disclose an ellipticity in the brightness distribution of the sun's disk with the greatest extent in the equatorial plane.
- 550.3 : 519.24 444
Proper and Improper Use of Statistics in Geophysics.—B. Kinsman. (*Tellus*, Aug. 1957, Vol. 9, No. 3, pp. 408–418.) A discussion of some of the peculiarities of the geophysical sciences together with their implications for statistical methods, particularly for the correlation coefficient, is given. The discussion is illustrated by an analysis of a recently published paper. In conclusion some advice on the use of correlations is offered.
- 550.384 445
Hydromagnetics and the Earth's Inner Core.—G. H. A. Cole. (*Observatory*, Feb. 1957, Vol. 77, No. 896, pp. 17–19.) It is suggested that the terrestrial magnetic field is produced in an inner liquid core permeated by a magnetic field of $\approx 10^6$ G. Secondary motions, partly hydromagnetic, occur in an outer surrounding liquid region and the field emerging from the complete core is the small field measured at the earth's surface.
- 550.385.1 : 523.7 446
Method of Magnetic-Storm Forecasting from the Activities of Flares Accompanied by the Solar Radio Noise Outbursts.—K. Sinno. (*J. Radio Res. Labs, Japan*, July 1957, Vol. 4, No. 17, pp. 267–276.) A statistical examination has been made of the occurrence of magnetic storms, solar flares and radio noise outbursts on 200 Mc/s. The correlations discovered are applied to the problem of forecasting magnetic storms during the I.G.Y.
- 550.389.2 : 551.510.535 (54) 447
Ionospheric Studies in India during the International Geophysical Year.—K. R. Ramanathan. (*J. Instn Telecommun. Engrs, India*, June 1957, Vol. 3, No. 3, pp. 193–197.)
- 550.389.2 : 621.396.11 448
Propagation and the International Geophysical Year.—G. W. Slack. (*R.S.G.B. Bull.*, July 1957, Vol. 33, No. 1, pp. 8–11.) Summary of phenomena which affect h.f. and v.h.f. propagation. Some methods of observation are suggested to the radio amateur.
- 550.389.2 : 629.19 449
Artificial Satellites of the Earth.—(*Wireless World*, Dec. 1957, Vol. 63, No. 12, pp. 574–578.) Extracts are given from *Radio, Mosk.* published before the launching of the U.S.S.R. satellites [see e.g. 3860 of 1957 (Vakhnin)] and results of observations made at various stations in the U.K. are summarized.
- 550.389.2 : 629.19 : 681.142 450
Tracking the Man-Made Satellite.—M. Gunther. (*Radio TV News*, July 1957, Vol. 58, No. 1, pp. 31–33.) An outline of the preparations for launching and observing the U.S. satellite, including the use of an electronic computer for calculating the orbit from observational data.
- 551.501.8 : 621.396.11 451
The Use of Surface Weather Observations to Predict the Total
- Atmospheric Bending of Radio Rays at Small Elevation Angles.**—Bean & Cahoon. (See 578.)
- 551.508.7 452
The Detection and Measurement of Water Droplets.—H. F. Liddell & N. W. Wooten. (*Quart. J. R. met. Soc.*, April 1957, Vol. 83, No. 356, pp. 263–266.) A method of obtaining a permanent record of drop size is described; it can be used for droplets of less than 1 μ diameter.
- 551.510.5 453
The Threefold Structure of the Atmosphere and the Characteristics of the Tropopause.—F. Defant & H. Taba. (*Tellus*, Aug. 1957, Vol. 9, No. 3, pp. 259–274.) The atmosphere in the northern hemisphere is divisible into three regions, north of the polar-front jet, south of the subtropical jet and the region between the jets. Each region has a typical vertical temperature structure in the stratosphere and troposphere and a characteristic tropopause height.
- 551.510.535 454
The Effect of the Equatorial Electrojet on the Ionospheric E_s and F₂ Layers.—N. J. Skinner & R. W. Wright. (*Proc. phys. Soc.*, 1st Sept. 1957, Vol. 70, No. 453B, pp. 833–839.) The occurrence of low values of fE_s at Ibadan is correlated with variations in the horizontal and vertical components of the earth's field, and with F₂-layer parameters. An immediate relation is indicated between the electrojet, the production of equatorial E_s, and vertical drifts in the F₂ layer.
- 551.510.535 455
Dynamical Structure of the Ionospheric F₂ Layer.—T. Shimazaki. (*J. Radio Res. Labs, Japan*, July 1957, Vol. 4, No. 17, pp. 309–332.) Formulae giving diffusion velocity and its divergence are derived for the electron-ion gas in the ionosphere, on the assumption of a linear temperature gradient. The change in electron density distribution is then calculated, using these formulae, for different models of the ionosphere. Comparisons of the calculated and observed changes in the F₂ layer show that Bradbury's rather than Chapman's theory is more appropriate.
- 551.510.535 (52) 456
On the Occurrence of the F_{1.5} Layer in Japan: Part 1.—I. Kasuya. (*J. Radio Res. Labs, Japan*, July 1957, Vol. 4, No. 17, pp. 291–300.) A statistical analysis based on vertical incidence soundings over a sunspot cycle shows annual seasonal and diurnal variations. Good correlation is demonstrated between frequency of occurrence and sunspot number.
- 551.524.7 + 551.571.7 457
Some Further Observations from Aircraft of Frost Point and Temperature up to 50 000 ft.—N. C. Helliwell, J. K. Mackenzie & M. J. Kerley. (*Quart. J. R. met. Soc.*, April 1957, Vol. 83, No. 356, pp. 257–262.) Measurements at various altitudes taken in 46 flights over Southern England in 1955 are tabulated. Good general agreement is obtained with 1954 measurements.

551.578.13 : 551.501.81 458

Variation with Height of Rainfall below the Melting Level.—W. G. Harper. (*Quart. J. R. met. Soc.*, July 1957, Vol. 83, No. 357, pp. 368–371.) 3-cm radar measurements in warm-front conditions suggest that there is uniformity of drop size distribution and rate of rainfall with height once meeting is complete and terminal velocity has been attained.

551.59 459

On a Special Aspect of the Condensation Process and its Importance in the Treatment of Cloud Particle Growth.—C. Rooth. (*Tellus*, Aug. 1957, Vol. 9, No. 3, pp. 372–377.) The distribution of water vapour around a droplet depends upon the ratio of droplet size to a factor determined by the equilibrium rate of exchange of molecules between the water surface and the water vapour.

551.59 460

Electric Charge Separation in Sub-freezing Cumuli.—S. Twomey. (*Tellus*, Aug. 1957, Vol. 9, No. 3, pp. 384–393.) A theory of the electrification of thunderclouds on charge separation occurring when supercooled droplets impinge on ice particles. The theory can explain observed charge separations without assuming the presence of large hailstones.

551.594.21 461

The Measurement of World-Wide Thunderstorm Activity at a Single Locality.—G. A. Isted. (*Marconi Rev.*, 4th Quarter 1957, Vol. 20, No. 127, pp. 130–132.) Counts of atmospheric impulses received in England in the 0.3–12 kc/s band are found to be similar to records of integrated noise in California in the band 25–130 c/s [see 2070 of 1956 (Holzer & Deal)]. It is inferred that world-wide thunderstorm activity was recorded in both experiments.

551.594.221 462

Preliminary Discharge Processes in Lightning Flashes to Ground.—N. D. Clarence & D. J. Malan. (*Quart. J. R. met. Soc.*, April 1957, Vol. 83, No. 356, pp. 161–172.) The first return stroke is usually preceded by three successive and distinct discharge processes lasting several hundred milliseconds. The characteristics of the field changes in these preliminary stages are analysed in terms of the distance of the source. Probable mechanisms are discussed.

551.594.6 463

The Accuracy of the Determination of Reflection Heights and Distances of Atmospheric on the basis of their Waveform.—G. Skeib. (*Z. Met.*, May/June 1957, Vol. 11, Nos. 5/6, pp. 129–135.) The errors in calculating reflection height H and distance D of atmospheric are investigated as a function of the ratio H/D and of the reflection modes. A recorded waveform is analysed and results are tabulated. See also 1762 of 1957 and 122 of 1956 (Horner & Clarke).

551.594.6 : 621.396.029.4 464

Diurnal Variation in the Occurrence of 'Dawn Chorus'.—J. H. Pope. (*Nature, Lond.*, 31st Aug. 1957, Vol. 180, No. 4583,

p. 433.) A histogram of observations made at frequencies between 1 and 10 kc/s on 116 days between January and July 1956 at College, Alaska, shows a maximum at 1400 local time which appears to be related to geomagnetic latitude.

LOCATION AND AIDS TO NAVIGATION

621.396.9 : 621.396.11.029.55 465

Direct-Vision-Type Direction Finder for High Frequency.—K. Miya, T. Sasaki, M. Ishikawa & S. Matsushita. (*Rep. Ionosphere Res. Japan*, March 1957, Vol. 11, No. 1, pp. 1–10.) The bearing of an h.f. signal is indicated directly on a c.r. tube by a bright radial line at the corresponding angle. A sensitivity 40 dB higher than that of conventional equipment is achieved by deriving the c.r.-tube deflection voltages from the changes in the rectified output of a receiver when different aerial combinations are connected to its input in sequence. The high sensitivity permits directional observations on weak scattered signals. Circuit diagrams are given and sources of error are discussed.

621.396.962.33 466

Two Doppler Navigators.—(*Brit. Commun. Electronics*, Sept. 1957, Vol. 4, No. 9, pp. 551–553.) Brief details of airborne equipments for use by military and commercial aircraft.

621.396.962.33 467

Radar Drift Measurement using Doppler Techniques.—P. L. Stride. (*Brit. Commun. Electronics*, Sept. 1957, Vol. 4, No. 9, pp. 554–557.) A drift indicator is described which includes all the control and display circuits necessary to adapt a conventional search radar to measure drifts. Some results of recent trials are discussed.

621.396.963.5 : 621.373.4.029.4 468

Phase-Shift Oscillator Indicates Radar Range.—Barritt. (See 397.)

621.396.969.33 469

Errors in Radar Navigation.—T. Stuland. (*J. Inst. Nav.*, Oct 1957, Vol. 10, No. 4, pp. 390–396.) The possible maximum errors are considered which may be contributory factors to collisions between ships. Alteration in course may not, by itself, be sufficient and should be combined with speed reduction so that there is more time in which information is obtained.

MATERIALS AND SUBSIDIARY TECHNIQUES

533.583 : 621.385.032.14 470

The Oxidation of Evaporated Barium Films (Getters).—R. N. Bloomer. (*Brit. J. appl. Phys.*, Aug. 1957, Vol. 8, No. 8,

pp. 321–329.) Mott's theory of oxidation (see e.g. 439 of 1948) is applied to measurements of the main quantities important to the gettering process. The formation of the first monolayer of oxide film is explained. Below a critical temperature of 40°C a protective oxide film grows to a thickness of about 50 Å only, while above 40°C Ba films are oxidized right through. See also 2140 of 1957.

533.583 : 621.385.032.14 471

Barium Getters and Carbon Monoxide.—R. N. Bloomer. (*Brit. J. appl. Phys.*, Sept. 1957, Vol. 8, No. 9, pp. 352–355.) An experimental study of the absorption of CO by evaporated Ba films indicates that the CO is dissociated at the surface of the Ba film, forming an oxide layer containing free carbon. The critical temperature above which the oxide layer ceases to be protective is 80°C.

535.215 : 537.533 472

Photoelectric Emission from Barium Oxide.—H. R. Philipp. (*Phys. Rev.*, 1st Aug. 1957, Vol. 107, No. 3, pp. 687–693.) Photoelectric emission measurements were made on sprayed coatings of BaO in several states of thermionic activity and at different temperatures. The spectral distribution of the photoelectric yield shows a rise at a quantum energy of 3.8 eV ascribed to exciton-induced emission, and another rise at 5 eV attributed to electrons ejected from the filled band. Analysis of the energy distribution of emitted electrons shows that different emission mechanisms are operative at low and high incident quantum energies.

535.37 : 546.472.21 473

The Measurement of the Optical Properties of Zinc Sulphide.—C. K. Coogan. (*Proc. phys. Soc.*, 1st Sept. 1957, Vol. 70, No. 453B, pp. 845–861.) A comprehensive description of apparatus and technique, and a discussion of results. A comparison is made with other work on the optical properties of ZnS. A band at about 330 m μ is found in the absorption spectrum, particularly at liquid air temperatures, together with a corresponding region of anomalous dispersion.

535.37 : 546.472.21 474

Models of Different Types of Traps in Zinc Sulphide Phosphors. Thermal and Optical Liberation of Trapped Electrons.—D. Curie. (*J. Phys. Radium*, April 1957, Vol. 18, No. 4, pp. 214–222.) Models for shallow and deep traps are considered and activation energies are calculated. 40 references.

535.376 : 546.472.21 475

Mechanism of Electroluminescence of Zinc Sulphide.—R. Goffaux. (*J. Phys. Radium*, Jan. 1957, Vol. 18, No. 1, pp. 1–4.)

537.226/.227 : [546.431.824-31 476

+ 546.42.824-31

Solid-State Reaction between Barium Titanate and Strontium Titanate.—S. Nomura. (*J. phys. Soc. Japan*, Sept. 1956, Vol. 11, No. 9, pp. 924–929.) The reaction is induced by sintering. Measurements were made of the variations, with sintering con-

ditions, of the permittivity/temperature characteristics and of the crystal structure of 1:1 mixtures.

537.226/227: 546.431.824-31 477

Some Aspects of Wedge-Shaped Domains in BaTiO₃ Crystal.—T. Nakamura, W. Kinase & Y. Kato. (*J. phys. Soc. Japan*, July 1957, Vol. 12, No. 7, pp. 836-837.) At 20°C wedge-shaped domains were observed which were presumed to have formed during the transition from cubic to tetragonal structure in cooling through the 120°C Curie point. On cooling below 5°C a marked nonreversible change in the pattern occurred.

537.226: 537.52 478

Dipoles and Electric Breakdown.—J. A. Kok & M. M. G. Corbey. (*Appl. sci. Res.*, 1957, Vol. B6, No. 6, pp. 449-455.) The breakdown of dielectric material may be caused by induced as well as permanent dipoles gathering at a place of maximum stress to form a bridge.

537.227 479

Laboratories Announce New Ferroelectric.—(*Bell Lab. Rec.*, July 1957, Vol. 35, No. 7, p. 271.) Some of the properties of triglycine sulphate are described. These properties make it a promising material for switching circuits and storage devices.

537.228.1 480

Coupling Coefficient and the Electromechanical Efficiency of Piezoelectric Materials.—Y. Le Corre. (*J. Phys. Radium*, Jan. 1957, Vol. 18, No. 1, pp. 51-58.) A mathematical analysis is given defining the electromechanical coupling coefficients and efficiencies of unidimensional and orthorhombic crystals. A hollow cylindrical piezoelectric detector is also considered.

537.311.33 481

Vasileff's Calculation of Electronic Self-Energy in Semiconductors.—E. N. Adams. (*Phys. Rev.*, 1st Aug. 1957, Vol. 107, No. 3, p. 671.) Vasileff's theory (2178 of 1957) fails for semiconductors of the usual type because of the predominance of processes involving virtual phonons of large wave number.

537.311.33 482

The Mass Action Laws for the Reactions between Free Carriers and Impurities in Semiconductors considering the Electron Spin.—F. W. G. Rose. (*Proc. phys. Soc.*, 1st Aug. 1957, Vol. 70, No. 452B, pp. 801-803.) A general rule is quoted which does not require a knowledge of the partition function. The reaction between free electrons and group-V donors in Si or Ge is treated to illustrate the use of the general rule.

537.311.33 483

Low-High Conductivity Junctions in Semiconductors.—L. W. Davies. (*Proc. phys. Soc.*, 1st Sept. 1957, Vol. 70, No. 453B, pp. 885-889.) A theoretical study including the effect of diffusion of charge carriers near the junction. A quantitative description of the 'accumulation' of minority charge carriers at low-high junctions in filaments is given.

537.311.33 484

Semiconductor Lifetime as a Function of Recombination State Density.—D. H. Clarke. (*J. Electronics Control*, Oct. 1957, Vol. 3, No. 4, pp. 375-386.) "The analysis of the Shockley-Read model is extended to describe the transient behaviour. The results are compared with those already given by Fan [1797 of 1954] and by Rittner, and it is concluded that the latter cease to be valid at high recombination state densities. The relation between steady-state and transient measurements of photoconductivity is examined, and some numerical examples are presented."

537.311.33 485

Cooling of Hot Electrons by Acoustic Scattering in Degenerate Semiconductors.—R. F. Greene. (*J. Electronics Control*, Oct. 1957, Vol. 3, No. 4, pp. 387-390.) "Shockley's calculation of the energy loss rate of hot electrons by acoustic scattering in semiconductors is extended to include the case of degenerate electron statistics. A simple formula is given for the loss rate in terms of the acoustic mean free time, valid for any degree of degeneracy. A relaxation time for the electron energy is expressed in terms of the acoustic mean free time showing the effect of degeneracy."

537.311.33 486

Quasi-electric and Quasi-magnetic Fields in Nonuniform Semiconductors.—H. Kroemer. (*RCA Rev.*, Sept. 1957, Vol. 18, No. 3, pp. 332-342.) In a non-uniform semiconductor, e.g. one with non-uniform elastic strains, or a semiconductor alloy of varying composition, the width of the energy gap varies throughout the material. This produces gradients of the band edges which differ for the conduction and valence bands, and act as 'quasi-electric' fields which are not the same for holes and electrons. Examples are given to show how transistor performance can be improved by the incorporation of such fields. A description is also given of how 'quasi-magnetic' fields arise when an inhomogeneity causes a shift of the location within the Brillouin zone of the energy minimum of the band.

537.311.33: [537.32+536.21] 487

Thermoelectric and Thermal Properties of Semiconductors.—A. Joffe. (*J. Phys. Radium*, April 1957, Vol. 18, No. 4, pp. 209-213.) Discussion with reference to the application of semiconductor thermocouples for power supply.

537.311.33: 537.32 488

A Simple Derivation of the Thermoelectric Voltage in a Nondegenerate Semiconductor.—F. W. G. Rose, E. Billig & J. E. Parrott. (*J. Electronics Control*, Nov. 1957, Vol. 3, No. 5, pp. 481-486.) Only concepts such as Fermi levels, field current, diffusion current, etc., are used in the derivation.

537.311.33: 537.533 489

Thermionic and Semiconducting Properties of [Ag]-Cs₂O, Ag, Cs.—J. E. Davey. (*J. appl. Phys.*, Sept. 1957, Vol. 28, No. 9, pp. 1031-1034.) A description of measurements on [Ag]-Cs₂O as a

thermionic emitter. Results are given for work function, conductivity, and activation energy over a wide range of temperatures.

537.311.33: 538.632 490

Determination of the Impurity Concentrations in a Semiconductor from Hall Coefficient Measurements.—P. A. Lee. (*Brit. J. appl. Phys.*, Aug. 1957, Vol. 8, No. 8, pp. 340-343.) Impurity concentrations are found from an equation relating carrier concentration to temperature and acceptor and donor concentrations. The experimental method is applied to p-type Si.

537.311.33: 538.632 491

The Relationship between the Hall Coefficient and the Resistivity of Semiconductors, taking Various Scattering Mechanisms of the Charge Carriers into Account.—T. Fukuroi & C. Yamanoichi. (*Sci. Rep. Res. Inst. Tohoku Univ., Ser. A*, Aug. 1957, Vol. 9, No. 4, pp. 267-272.) In addition to lattice and ionized-impurity scattering, neutral-impurity and dislocation scattering become appreciable at low temperatures. The relation between Hall coefficient and resistivity is calculated for five cases in which two of these four mechanisms are combined. The method is similar to that used by Jones (1357 of 1951) for combined lattice and ionized-impurity scattering.

537.311.33: 538.632: 621.373.5 492

Experimental and Theoretical Investigation of Semiconductor Hall-Effect Generators.—M. J. O. Strutt & S. F. Sun. (*Arch. elekt. Übertragung*, June 1957, Vol. 11, No. 6, pp. 261-265.) D.c. amplification was obtained using an experimental feedback circuit incorporating a Hall element of InSb at room temperature. An oscillator circuit covering the range 13-330 c/s with an output of about 12 mW is described. Results of measurements agree with theory; the effect of temperature on oscillator performance is discussed.

537.311.33: 539.23 493

Frequency Dependence of the A.C. Resistance of Thin Semiconducting Films.—M. Lax & R. Sachs. (*Phys. Rev.*, 1st Aug. 1957, Vol. 107, No. 3, pp. 650-655.) A modification of Howe's theory (see *Wireless Engr.*, Nov. 1940, Vol. 17, No. 206, pp. 471-477) is put forward in which the assumption of constant capacitance per unit length is dropped. The theoretical results agree with the experiments of Broudy & Levinstein (2696 of 1954); the agreement of the Howe theory with earlier experiments is shown to be partially fortuitous.

537.311.33: [546.28+546.289] 494

Anisotropic Diffusion Lengths in Germanium and Silicon Crystals containing Parallel Arrays of Edge Dislocations.—R. L. Bell & C. A. Hogarth. (*J. Electronics Control*, Nov. 1957, Vol. 3, No. 5, pp. 455-470.) Techniques are described for introducing parallel arrays of edge dislocations into Ge and Si by plastic bending. Ge crystals with similar dislocations but with a higher mean minority-carrier lifetime than those subjected to plastic bending, may be grown by pulling from the melt, using a suitably orientated dislocated

seed crystal. The diffusion length is greater when measured along the dislocations than across them. A model suggests that the anisotropies observed will be more marked for crystals in which the dislocations are highly polygonized.

537.311.33 : 546.28 **495**

The Effect of Heat Treatment on the Bulk Lifetime of Excess Charge Carriers in Silicon.—L. M. Nijland & L. J. van der Pauw. (*J. Electronics Control*, Oct. 1957, Vol. 3, No. 4, pp. 391–395.) Bulk lifetime in both *p*- and *n*-type crystals made by the floating zone technique, and in *n*-type crystals made by the Czochralski technique, are increased by annealing at 300°C to 700°C. Annealing at >700°C decreased lifetimes for *p*- and *n*-type crystals made by either method.

537.311.33 : 546.28 **496**

Radiochemical Analysis of Silicon.—J. A. James & D. M. Richards. (*J. Electronics Control*, Nov. 1957, Vol. 3, No. 5, pp. 500–506.) “Results of radioactivation analyses for some 12 elements are given for silicon from two sources. The results of segregation coefficient measurements using radiochemical methods are quoted for P, Fe, Co, W, and Au.”

537.311.33 : 546.28 : 535.343 **497**

Infrared Absorption of Oxygen in Silicon.—H. J. Hrostowski & R. H. Kaiser. (*Phys. Rev.*, 15th Aug. 1957, Vol. 107, No. 4, pp. 966–972.) Three infrared absorption bands have been correlated with the oxygen concentration of Si. Results obtained are explained by a model in which interstitial oxygen is bonded to two adjacent Si atoms in a nonlinear Si-O-Si unit.

537.311.33 : 546.28 : 538.63 **498**

Galvanomagnetic Effects in *p*-Type Silicon.—D. Long. (*Phys. Rev.*, 1st Aug. 1957, Vol. 107, No. 3, pp. 672–677.) Measurements are reported of the dependence, on temperature and field strength, of the resistance and Hall effect, for several samples of *p*-type Si. The results are discussed with reference to the usual valence-band model to show that there is some inconsistency.

537.311.33 : 546.289 **499**

Recombination in Plastically Deformed Germanium.—G. K. Wertheim & G. L. Pearson. (*Phys. Rev.*, 1st Aug. 1957, Vol. 107, No. 3, pp. 694–698.) “Lifetimes in plastically deformed *n*- and *p*-type Ge have been measured as a function of the amount of deformation and as a function of temperature. The results indicate that the dislocations have an electron capture radius of 3.4×10^{-8} cm. The lifetime in high-purity crystals containing 10^3 to 10^4 dislocations per cm^2 may consequently be limited by recombination at dislocations.”

537.311.33 : 546.289 **500**

Recombination Centres and Fast States on Unstable Germanium Surfaces.—S. Wang & G. Wallis. (*Phys. Rev.*, 15th Aug. 1957, Vol. 107, No. 4, pp. 947–953.) The results of measurements of surface conductance, photoconductance,

dark field effect and field effect under illumination are presented for freshly etched samples of *n*- and *p*-type Ge exposed to the Brattain-Bardeen ambient cycle. Analysis shows that the recombination centres and ‘fast’ centres are identical.

537.311.33 : 546.289 **501**

Modulation of Light Reflected from Germanium by Injected Current Carriers.—I. Filiński. (*Phys. Rev.*, 15th Aug. 1957, Vol. 107, No. 4, p. 1193.) Preliminary experimental results are reported of the modulation of reflected light from the surfaces of single-crystal diodes, which arises when alternating voltages are applied to them.

537.311.33 : 546.289 **502**

Contribution of Current Carriers in the Reflection of Light from Semiconductors.—L. Sosnowski. (*Phys. Rev.*, 15th Aug. 1957, Vol. 107, No. 4, pp. 1193–1194.) An interpretation is given of the electro-optical phenomena reported by Filiński (501 above).

537.311.33 : 546.289 **503**

On the Absorption by Free Carriers in Semiconductors.—B. Donovan & N. H. March. (*Proc. phys. Soc.*, 1st Sept. 1957, Vol. 70, No. 453B, pp. 883–885.) The range of validity is assessed of some theoretical treatments of the properties of free carriers in alternating fields [see e.g. 2110 of 1956 (Fan et al.)], by examining infrared absorption in *n*-type Ge.

537.311.33 : 546.289 **504**

Field Dependence of Mobility in *p*-Type Germanium.—K. S. Mendelson & R. Bray. (*Proc. phys. Soc.*, 1st Sept. 1957, Vol. 70, No. 453B, pp. 899–900.) A short description of results obtained on *p*-type Ge at 78°K and 195°K, using samples with carrier content between 3×10^{13} and $4 \times 10^{15} \text{ cm}^{-3}$. A graph of conductivity as a function of electric field is shown.

537.311.33 : 546.289 **505**

Effect of Edge Dislocations on the Alloying of Indium to Germanium.—J. I. Pankove. (*J. appl. Phys.*, Sept. 1957, Vol. 28, No. 9, pp. 1054–1057.) Observations of the effects of crystal imperfections on the alloying process show that edge dislocations and other crystal disturbances enhance the dissolution of Ge in In. An interpretation of this and other effects is given.

537.311.33 : 546.289 **506**

Spiral Etch-Pits in Germanium.—R. G. Rhodes, K. O. Batsford & D. J. Dane-Thomas. (*J. Electronics Control*, Oct. 1957, Vol. 3, No. 4, pp. 403–408.) Discussion illustrated with photographs of spiral ‘terraced’ pits produced by etching the {111} or {100} crystal surfaces with iodine solution. The density is 10^6 – 10^8 cm^{-2} ; association with impurities is suggested.

537.311.33 : 546.289 **507**

On the Carrier Recombination through Nickel Impurities in Germanium.—J. Okada. (*J. phys. Soc. Japan*, June 1957, Vol. 12, No. 6, p. 741.)

The increase of the photo-conductivity to a saturation value as the temperature decreases may be explained by assuming that Ni introduces two acceptor levels and recombination takes place through multiple levels of constant capture cross-section.

537.311.33 : 546.289 **508**

Some Experiments on the Surface Field Effects in Germanium Single Crystals.—M. Kikuchi. (*J. phys. Soc. Japan*, July 1957, Vol. 12, No. 7, pp. 756–762.) Measurements of the field effect on surface conductance and on surface recombination velocity show that the difference between the Fermi level and the middle of the energy gap at the surface drifts to a negative value when the surface is kept in room air after CP4 etching. The drift is accompanied by a gradual growth of an oxide layer on the surface.

537.311.33 : 546.289 **509**

A Simpler Method for Removing Copper from Germanium.—M. Kikuchi & S. Izima. (*J. phys. Soc. Japan*, July 1957, Vol. 12, No. 7, p. 824.) A simple treatment involving immersion in concentrated nitric acid followed by heating in A is described, which removes about 45% of the Cu atoms originally present with a density of about $4\text{--}7 \times 10^{-14} \text{ cm}^{-2}$.

537.311.33 : 546.289 : 538.63 **510**

Galvanomagnetic Effects in Germanium.—G. C. Della Pergola & D. Sette. (*Nuovo Cim.*, 1st June 1957, Vol. 5, No. 6, pp. 1670–1678.) Results of measurements on *n*- and *p*-type single-crystal Ge of magnetoresistance and Hall effect (see also 3444 of 1956) as a function of magnetic induction are compared with results derived theoretically from a knowledge of the valence band structure. This comparison is wholly satisfactory only for *n*-type material.

537.311.33 : 546.289 : 548.73 **511**

Fine Structures of X-Ray Absorption Spectra of Crystalline and Amorphous Germanium.—T. Shiraiwa, T. Ishimura & M. Sawada. (*J. phys. Soc. Japan*, July 1957, Vol. 12, No. 7, pp. 788–792.) A comparison of the spectra suggests that amorphous Ge has a structure similar to the diamond lattice of the crystalline Ge but with a larger spacing.

537.311.33 : 546.48.86 **512**

Electrical Properties of Cd-Sb.—T. Miyauchi & H. Kimura. (*J. phys. Soc. Japan*, Sept. 1956, Vol. 11, No. 9, pp. 1013–1014.) From conductivity and Hall coefficient measurements it is found that hole mobility at room temperature is $1100 \pm 200 \text{ cm}^2/\text{V} \cdot \text{sec}$ and the width of the forbidden energy gap is $0.3 \pm 0.05 \text{ eV}$.

537.311.33 : 546.561-31 **513**

Linear and Quadratic Zeeman Effects and Diamagnetism of the Exciton in Cuprous Oxide Crystals.—E. F. Gross & B. P. Zakhartchenia. (*J. Phys. Radium*, Jan. 1957, Vol. 18, No. 1, pp. 68–71.) Cu_2O films 100μ thick were studied at a temperature of 1.3°K in a magnetic field of 30 000 oersteds by means of a spectrograph of 1.5 \AA/mm dispersion.

- 537.311.33 : 546.682.19 : 538.63 **514**
The Transverse Magnetoresistance Effect in Indium Arsenide.—C. H. Champness & R. P. Chasmar. (*J. Electronics Control*, Nov. 1957, Vol. 3, No. 5, pp. 494-499.) "Measurements were made on samples of various shapes. For a long thin sample the magnitude of the effect is considerably smaller than expected for acoustic lattice scattering. It is suggested that this result may be explained by the presence of some impurity scattering. In approximately square samples the magnitude of the magnetoresistive changes are large being 100% or more at room temperature in a field of 10^4 G."
- 537.311.33 : [546.682.86 + 546.681.86 **515**
Nuclear Magnetic Resonance in Semiconductors : Part 2 — Quadrupole Broadening of Nuclear Magnetic Resonance Lines by Elastic Axial Deformation.—R. G. Shulman, B. J. Wyluda & P. W. Anderson. (*Phys. Rev.*, 15th Aug. 1957, Vol. 107, No. 4, pp. 953-958.) By applying stresses to samples of InSb and GaSb having a high degree of crystalline perfection, it has been possible to destroy the crystalline symmetry reversibly, thereby producing quadrupole broadening of the nuclear-magnetic-resonance lines. Strains of less than 10^{-4} have been detected and the resulting field gradients measured. Part 1: 1107 of 1956 (Shulman et al.).
- 537.311.33 : 546.682.86 **516**
Electrical Properties of P-Type Indium Antimonide.—T. Fukuroi & C. Yamanoichi. (*Sci. Rep. Res. Inst. Tohoku Univ., Ser. A*, Aug. 1957, Vol. 9, No. 4, pp. 262-266.) Report of measurements of resistance, Hall coefficient and magnetoresistance, on polycrystalline specimens, in the temperature range 289° - 1.4° K.
- 537.311.33 : 546.682.86 **517**
Absorption and Dispersion of Indium Antimonide.—T. S. Moss, S. D. Smith & T. D. F. Hawkins. (*Proc. phys. Soc.*, 1st Aug. 1957, Vol. 70, No. 452B, pp. 776-784.)
- 537.311.33 : 546.682.86 : 535.343 **518**
Infrared Resonant Absorption from Bound Landau Levels in InSb.—W. S. Boyle & A. D. Brailsford. (*Phys. Rev.*, 1st Aug. 1957, Vol. 107, No. 3, pp. 903-904.) Measurements of light transmission as a function of magnetic field, on thin *n*-type samples show a field-dependent resonance absorption which is ascribed primarily to Landau levels bound to donor impurities.
- 537.311.33 : 546.682.86 : 538.63 **519**
Oscillatory Galvanomagnetic Effects in *n*-type Indium Antimonide.—Y. Kanai & W. Sasaki. (*J. phys. Soc. Japan*, Sept. 1956, Vol. 11, No. 9, pp. 1017-1018.) Measurements were made of magnetoresistance and Hall coefficient in the temperature range 1.3 - 300° K. At 1.3° K an oscillatory dependence on magnetic field strength was observed. See also 477 of 1956 (Kanai).
- 537.311.33 : 546.873.241 **520**
Electrical Properties of Bi_2Te_3 .—S. Shigetomi & S. Mori. (*J. phys. Soc. Japan*, Sept. 1956, Vol. 11, No. 9, pp. 915-919.) The conductivity, Hall coefficient and thermoelectric power have been measured in the temperature range 100 - 750° K. The conductivity is *p* type at room temperature. Hole mobility varies with temperature as $1.2 \times 10^8 T^{-2.3}$, and the gap width is 0.21 eV at 0° K.
- 537.311.33 : 546.873.241 : 537.322.1 **521**
Performance of Composite Peltier Junctions of Bi_2Te_3 .—T. S. Shilliday. (*J. appl. Phys.*, Sept. 1957, Vol. 28, No. 9, pp. 1035-1042.) An experimental Peltier-type refrigerator using *p*- and *n*-type Bi_2Te_3 as thermoelements of annular shape is described. Under no-load conditions a maximum temperature difference of 49° C was obtained. The experimental results agree with the theoretical predictions. See also 3224 of 1956 (Stil'bans et al.).
- 537.311.33 : 548.73 **522**
The Crystalline Perfection of some Semiconductor Single Crystals.—R. L. Bell. (*J. Electronics Control*, Nov. 1957, Vol. 3, No. 5, pp. 487-493.) "Single crystals of Ge, Si, InSb and HgTe were examined by the Guinier-Tennevin X-ray technique. The degree of perfection as shown by the width of the focused Laue image was compared with the dislocation density as revealed by etch-pits."
- 537.311.33.096 **523**
Graphical Analysis of the Temperature Dependence of the Electronic Population in Semiconductors.—G. Brouwer. (*Philips Res. Rep.*, Oct. 1957, Vol. 12, No. 5, pp. 415-422.) "The distribution of electrons and holes in semiconductors and its variation with temperature may be derived by means of a graphical approximation presented in this paper. The method is based directly on the electronic reaction equations in the equilibrium."
- 537.32 : 546.562.31 **524**
Thermoelectric Effects Shown by some Oxides. Investigation of Cupric Oxide.—G. Péri, M. Perrot & J. Robert. (*J. Phys. Radium*, April 1957, Vol. 18, No. 4, pp. 282-283.) See 3111 of 1956 (Perrot et al.).
- 538.22 **525**
Theory of the Magnetic Properties of Ferrous and Cobaltous Oxides: Parts 1 & 2.—J. Kanamori. (*Prog. theor. Phys.*, Feb. 1957, Vol. 17, No. 2, pp. 177-222.)
- 538.22 : 538.569.4 **526**
High-Field Antiferromagnetic Resonance in MnF_2 using Pulsed Fields and Millimetre Wavelengths.—S. Foner. (*Phys. Rev.*, 1st Aug. 1957, Vol. 107, No. 3, pp. 683-685.) Measurements from 4.2° K up to the Néel temperature (68° K) are reported; they agree with the molecular-field approximation of antiferromagnetic-resonance theory.
- 538.22 : 538.569.4 : 539.15 **527**
Observation of Nuclear Magnetic Resonance in Antiferromagnetic $\text{Mn}(\text{F}^{19})_2$.—V. Jaccarino & R. G. Shulman. (*Phys. Rev.*, 15th Aug. 1957, Vol. 107, No. 4, pp. 1196-1197.) Magnetic resonances have been observed at frequencies in the range 152 - 168 Mc/s, in external magnetic fields between 300 and 3000 oersteds and at temperatures between 1.3° and 20.4° K.
- 538.22 : 546.3-1'711'681'26 **528**
Spontaneous Magnetization in Mn-Ga-C Alloys.—H. P. Myers. (*Canad. J. Phys.*, July 1957, Vol. 35, No. 7, pp. 819-822.) In the alloy systems Mn-Al-C, Mn-Zn-C, Mn-Sn-C and Mn-In-C, there is a distinctive face-centred cubic ternary phase which has pronounced spontaneous magnetization. A similar phase has been found in the Mn-Ga-C system. See also 3924 of 1957 (Brockhouse & Myers).
- 538.221 **529**
Magnetic Influence on the Recrystallized Grain Texture of a Ferromagnetic Alloy.—B. Sawyer & R. Smoluchowski. (*J. appl. Phys.*, Sept. 1957, Vol. 28, No. 9, pp. 1069-1070.) A note on the effect of a magnetic field on the texture of an Fe-Co alloy in the form of rolled sheet.
- 538.221 **530**
Temperature Dependence of Anisotropy Energy of Ferromagnetics.—T. Kasuya. (*J. phys. Soc. Japan*, Sept. 1956, Vol. 11, No. 9, pp. 944-947.) Calculations are made using the spin-wave method. The anisotropy constant is shown to depend on $(M/M_0)^{16}$ where M_0 and M are, respectively, magnetizations at absolute zero and at the finite temperature considered.
- 538.221 : 538.24 : 538.652 **531**
Magnetization, Magnetostriction and Relaxation Phenomena during Isothermal Magnetic Annealing at High Temperatures in Ni-Co Alloys.—H. Masumoto, H. Saito & M. Takahashi. (*Sci. Rep. Res. Inst. Tohoku Univ., Ser. A*, Aug. 1957, Vol. 9, No. 4, pp. 293-308.) The magnetization and magnetostriction as a function of time were investigated at constant temperature after the application of a magnetic field to thermally demagnetized Ni-Co alloys. In a temperature range between about 300° C and the Curie point a relaxation effect was observed which is attributed to displacements of impurities or lattice defects due to the magnetostriction at high temperatures.
- 538.221 : 621.318.1 **532**
The Unusual Magnetic Properties of Quenched Alcomax III.—M. McCaig. (*Proc. phys. Soc.*, 1st Sept. 1957, Vol. 70, No. 453B, pp. 823-826.) Quenching of alcomax III from a high temperature results in an unusual soft magnetic material. The permeability is almost constant up to flux densities of 5000 G, and the ratio of resonance to saturation intensity is less than 0.1 .
- 538.221 : 621.318.122 **533**
Processes occurring during the Heat Treatment of Alcomax.—A. G. Clegg & M. McCaig. (*Proc. phys. Soc.*, 1st Sept. 1957, Vol. 70, No. 453B, pp. 817-822.) The dependence of saturation intensity and coercivity on temperature, from room temperature to 900° C, is shown. Maxima in the coercivity curves are associated with subsidiary Curie points.
- 538.221 : 621.318.124 **534**
Rotational Model of Flux Reversal in Square-Loop Ferrites.—E. M. Gyorgy. (*J. appl. Phys.*, Sept. 1957, Vol. 28, No. 9, pp. 1011-1015.) A discussion of the mech.

anism of magnetic flux reversal using fields much higher than those encountered in quasi-static processes. Detailed results for the switching coefficients are given.

538.221 : 621.318.134 **535**
The K_1 - and True g -values of Polycrystalline Ferrites.—J. Snieder. (*Appl. sci. Res.*, 1957, Vol. B6, No. 6, pp. 471-473.) Measurements are reported which give a true g -value of 2.11 and a K_1 -value at room temperature of $-5.8 \times 10^3 \text{ J/m}^3$ for Ni-Zn ferrites with 50% NiO.

538.221 : 621.318.134 **536**
Magnetic Annealing Effect in Iron-Nickel Ferrites.—Y. Aiyama, H. Sekizawa & S. Iida. (*J. phys. Soc. Japan*, June 1957, Vol. 12, No. 6, p. 742.)

538.221 : 621.318.134 **537**
Structural Study of Iron Selenides FeSex: Part 1—Ordered Arrangement of Defects of Fe Atoms.—A. Okazaki & K. Hirakawa. (*J. phys. Soc. Japan*, Sept. 1956, Vol. 11, No. 9, pp. 930-936.)

538.221 : 621.318.134 **538**
Ferrimagnetic Resonance in Gadolinium Iron Garnet.—B. A. Calhoun, J. Overmeyer & W. V. Smith. (*Phys. Rev.*, 15th Aug. 1957, Vol. 107, No. 4, pp. 993-994.) The apparent g -factor and line width have their maximum values at the compensation point (13°C), which implies that the g -factors of the Gd^{3+} and Fe^{3+} ions are equal.

538.221 : 621.318.134 **539**
Antiferromagnetism of Zn Ferrite.—M. Tachiki & K. Yosida. (*Prog. theor. Phys.*, Feb. 1957, Vol. 17, No. 2, pp. 223-240.) Magnetic dipole-dipole spin interaction probably causes the main anisotropy energy below the Néel temperature. Above this temperature calculations are made for susceptibility and specific heat taking account of short-range order.

538.222 : 538.569.4 **540**
Paramagnetic Resonance of Nickel Fluosilicate under High Hydrostatic Pressure.—W. M. Walsh, Jr. & N. Bloembergen. (*Phys. Rev.*, 1st Aug. 1957, Vol. 107, No. 3, pp. 904-905.)

621.315.616.9 **541**
Dielectric Strength of Polyethylene at 3 300 Mc/s.—H. Farber & J. W. E. Griemsmann. (*J. appl. Phys.*, Sept. 1957, Vol. 28, No. 9, pp. 1002-1005.) The dielectric strength at 3 300 Mc/s was measured to be 16.8, 13.1 and 6.0 kV/10⁻³in. at 26°, 57° and 95°C, respectively. The values are the same as those obtained for a d.c. field. The specially designed electrode system is described.

621.315.616.95 : 621.317.335.3.029.64 **542**
 : 538.569.3
Temperature Dependence of Dielectric Loss of Shellac in Microwave Region.—S. S. Srivastava, D. D. Puri & P. C. Mehendru. (*Proc. nat. Inst. Sci. India*, Part A, 26th July 1957, Vol. 23, No. 4, pp. 289-292.) A description of measurements on three grades of purified shellac in the 3-cm region at temperatures between 20°C and

50°C, using a standing wave technique. $\tan \delta$ increased rapidly with temperature in all cases.

621.318.2.002.2 **543**
Manufacture of Anisotropic Lead Ferrite Permanent Magnets Without the Use of a Magnetic Field during Moulding.—F. Pawlek & K. Reichel. (*Naturwissenschaften*, July 1957, Vol. 44, No. 14, p. 390.) Comparative demagnetization curves of oxide magnets are shown; the Pb-ferrite magnet moulded without magnetic field has higher resonance than one of Ba ferrite.

MEASUREMENTS AND TEST GEAR

529.7 **544**
Relation between the Proper Time of a Terrestrial Clock and Schwarzschild's Astronomical Time to an Approximation of 10^{-12} .—O. Costa de Beauregard. (*J. Phys. Radium*, Jan. 1957, Vol. 18, No. 1, pp. 17-21.) An evaluation of the corrections necessary to a perfect terrestrial clock with reference to a perfect clock at rest at an infinite distance from the sun.

621.3.018.41 (083.74) + 529.786] **545**
 : 538.569.4
Frequency Shift in Ammonia Absorption due to Foreign Gases.—K. Matsuura, Y. Sugiura & G. M. Hatoyama. (*J. phys. Soc. Japan*, July 1957, Vol. 12, No. 7, p. 835.) See also 3949 of 1957.

621.317.3 : 621.314.6 **546**
Measurement of the Mean Rectified Value by Vacuum Diodes and Barrier-Layer Rectifiers.—E. Czeija. (*Arch. tech. Messen*, June 1957, No. 257, pp. 137-140.) The inherent errors in basic rectifier circuits and the suitability of the circuits for d.c. calibration are discussed.

621.317.3.029.64 : 621.375.9 **547**
 : 538.569.4
Maser Noise Measurement.—J. C. Helmer. (*Phys. Rev.*, 1st Aug. 1957, Vol. 107, No. 3, pp. 902-903.) Measurements on an ammonia-beam maser amplifier at 24 000 Mc/s confirm the theoretically low noise figure of such a device.

621.317.33 : 621.372.412 **548**
The Accuracy of a Method of Measuring the Series Capacitance and Inductance of Crystal Resonators.—H. Rühl. (*Nachrichtentech. Z.*, June 1957, Vol. 10, No. 6, pp. 297-302.) The accuracy obtainable with Herzog's method (*T.F.T.*, Sept. 1941, Vol. 30, No. 9, pp. 260-263. Abstract 2031 of 1942) has been investigated. A modification of this method is outlined leading to a simple formula for the series capacitance.

621.317.331 : 537.311.33 **549**
Semiconductor Specific-Resistance Meter by means of A.C. Method.—A. Sato & S. Kanai. (*Rep. elect. Commun. Lab., Japan*, March 1957, Vol. 5, No. 3, pp. 18-21.) Details of a transistor circuit are given.

621.317.332 : 621.314.7 **550**
Measurements of the Impedance Parameters of Junction Transistors.—E. E. Ward. (*Brit. J. appl. Phys.*, Aug. 1957, Vol. 8, No. 8, pp. 329-331.) Practical details are given of equipment for null measurements of earthed-base impedance parameters and α^1 , defined as $\alpha/(1-\alpha)$. Measurements with collector open-circuit are included and typical results at frequencies up to 30 kc/s are shown.

621.317.335.3 : 621.372.51.029.6 **551**
The Dielectric Disk used as Transformation Quadripole for the Magnification of the Node Displacement on Measuring Lines.—Breitenhuber. (See 349.)

621.317.34 : 621.396.65 **552**
Measurement of Transmission Distortion in F.M. Radio-Link Equipment.—H. Hartbaum. (*Arch. elekt. Übertragung*, June 1957, Vol. 11, No. 6, pp. 239-252.) In the method described static and dynamic nonlinearities are determined separately. Equipment operating on this principle can be used for testing the individual elements of radio links as well as the complete system.

621.317.361 **553**
Automatic Frequency Measurement Techniques.—A. J. Green. (*Brit. Commun. Electronics*, June 1957, Vol. 4, No. 6, pp. 342-345.) The equipment described has an upper counting limit of over 30 Mc/s; a commercial-type 100-kc/s frequency standard and the 200-kc/s transmission from Droitwich are used as reference.

621.317.4.083 : 538.221 **554**
The Shape of Specimens for Measurements on Ferromagnetic Materials.—P. K. Hermann. (*Arch. tech. Messen*, May-July 1957, Nos. 256-258, pp. 105-106, 129-132 & 155-158.)

621.317.7 : 621.397.62 **555**
Transistorized TV Pattern Generator.—F. Rozner. (*Brit. Commun. Electronics*, June 1957, Vol. 4, No. 6, pp. 346-349.) The generator described is battery operated and incorporates both $p-n-p$ and $n-p-n$ transistors. The mains are used only to provide frequency locking.

621.317.7 : 621.397.62 : 535.623 **556**
Choosing a Colour-Bar Generator.—A. R. Stamiti. (*Radio TV News*, July 1957, Vol. 58, No. 1, pp. 62-63..139.) Comparison of American signal generators for aligning colour-television receivers. Performance features and prices of fourteen types are given in tabular form.

621.317.7.087.9 : 621.396.822 **557**
Probability Computer for Noise Measurement.—A. W. Sullivan & J. D. Wells. (*Electronics*, 1st Oct. 1957, Vol. 30, No. 10, pp. 208-209.) The equipment described is designed for the investigation of

the amplitude distribution of atmospheric noise and its effect on radio communication systems. A constant-amplitude pulse is produced each time a reference level is exceeded by the noise input.

621.317.715 558
Sensitive D.C. Null Detector.—F. Oakes & E. W. Lawson. (*Wireless World*, Dec. 1957, Vol. 63, No. 12, pp. 597–598.) Constructional details are given of a galvanometer of 50 μ A full-scale deflection incorporating transistors.

621.317.723 559
An Electrometer Amplifier with Two Dynamic Condensers.—R. J. Ritsma. (*Appl. sci. Res.*, 1957, Vol. B6, No. 6, pp. 429–445.) Capacitive modulators for converting d.c. charge into an a.f. signal are reviewed. A type using two capacitors vibrating in opposite phase is described which eliminates the converted a.f. noise. An experimental model was used to measure a charge of 125 e in 13 sec.

621.317.755: 621.373.431 560
A Wide-Range Oscilloscope Time-base.—A. H. Koster. (*R.S.G.B. Bull.*, June 1957, Vol. 32, No. 12, pp. 546–547.)

621.317.757.029.55 561
A 3 to 30 Mc/s Spectrum Analyser.—J. R. Hayward. (*Brit. Commun. Electronics*, Sept. 1957, Vol. 4, No. 9, p. 541.) A panoramic display on the c.r. tube screen of the instrument covers a frequency band up to 30 kc/s wide and an amplitude range of 60 dB; facilities for direct calibration are provided.

621.317.77 562
Simple Measurement of Phase Difference.—G. de Visme. (*Wireless World*, Dec. 1957, Vol. 63, No. 12, pp. 581–582.) One of the two sinusoids is reversed in phase and added to the other and the resultant amplitude is adjusted to minimum. Details of a practical circuit with valve voltmeter indication are given.

621.317.794: 621.316.825 563
Two Portable Thermistor Radiometers.—W. H. Ward. (*J. sci. Instrum.*, Aug. 1957, Vol. 34, No. 8, pp. 317–321.) A description of the construction and calibration of two radiometers for the measurement of the hemispherical short-wave radiation and the total radiative flux through a plane, respectively.

621.317.799: 538.569.4: 539.152.1 564
Low-Field Nuclear-Magnetic-Spectrometer.—R. W. Mitchell & M. Eisner. (*Rev. sci. Instrum.*, Aug. 1957, Vol. 28, No. 8, pp. 624–628.) A description of a spectrometer for fields below 50 G for use in studies of nuclear magnetic resonance. A resolution of 10–20 μ G is obtained over a 30-cm³ sample. Some results on the relaxation time for ethanol-water mixtures are also given.

621.317.799: 621.314.7 565
Test Equipment for Transistor Production.—A. B. Jacobsen & C. G. Tinsley. (*Electronics*, 1st Oct. 1957, Vol. 30, No. 10, pp. 148–151.)

OTHER APPLICATIONS OF RADIO AND ELECTRONICS

539.172.4: 621.317.7: 621-52 566
The Control and Instrumentation of a Nuclear Reactor.—A. B. Gillespie. (*Proc. Instn. elect. Engrs*, Part B, Nov. 1957, Vol. 104, No. 18, pp. 602–604.) Discussion on 3838 of 1956.

621-52: 621.398: 681.17 567
The Digitizer—a High-Accuracy Scale for Automatic Data Processing.—D. S. Evans. (*Brit. Commun. Electronics*, June 1957, Vol. 4, No. 6, pp. 334–339.) The use of finely subdivided coded scales for the accurate conversion of mechanical motion to digital or numerical form in data transmission systems is described. Development and applications of such encoding equipment are reviewed, in particular, of devices which use a 1 000-division scale on a metal disk as a commutator, or on glass for optical scanning [see e.g. 2975 of 1956 (Jones)].

621.384.6.029.6 568
Theory of the Rebatron—a Relativistic Electron Bunching Accelerator for Use in Megavolt Electronics.—P. D. Coleman. (*J. appl. Phys.*, Sept. 1957, Vol. 28, No. 9, pp. 927–935.) A theoretical discussion of the production of highly bunched electron beams having an energy of 1–3 MeV, and the application of the technique in the generation of sub-mm waves (100–3 000 kMc/s). Calculations indicate that the emergent beam has an appreciable harmonic content up to the 1 000th harmonic, with a velocity spread of 0.07%. Pulsed beam powers of about 100 kW should be obtainable using a 3 kMc/s rebatron.

621.384.6.029.64 569
Design and Evaluation of an S-Band Rebatron.—I. Kaufman & P. D. Coleman. (*J. appl. Phys.*, Sept. 1957, Vol. 28, No. 9, pp. 936–944.) Details of the practical design of a rebatron (see 568 above) for producing a high-power, bunched, megavolt electron beam. The properties of the beam are examined experimentally, and the validity of the method is examined by measurements of the ratio of the 26th beam harmonic current amplitudes under two different sets of conditions.

621.384.6.029.65 570
The Harmodotron—a Megavolt Electronics Millimetre Wave Generator.—M. D. Sirkis & P. D. Coleman. (*J. appl. Phys.*, Sept. 1957, Vol. 28, No. 9, pp. 944–950.) A description of a method of producing high powers at sub-mm λ by electronic excitation, at a single frequency, of a high-order TM mode in a cylindrical cavity. Typical experimental measurements at 8.3 mm are described.

621.384.62 571
An Experimental Proton Linear Accelerator using a Helical Waveguide.—D. R. Chick, D. P. R. Petrie, D. G. Keith-Walker & H. Longley. (*Nature, Lond.*, 31st Aug. 1957, Vol. 180, No. 4583, p. 432.) An

experimental section of the accelerator proposed by Chick & Petrie (1694 of 1952) has been constructed. Accelerations up to 4.3 MeV were obtained.

621.385.833: 537.533 572
Photoemission-Type Electron Microscope.—E. L. Huguenin. (*Ann. Phys., Paris*, March/April 1957, Vol. 2, Nos. 3/4, pp. 214–266.) Detailed description of the design and operation of the instrument which is based on electron emission from a metallic surface under ultraviolet irradiation. A magnification of 200 is obtained. Micrograms of specimens of Ag, Cu, Zn and Au etched by ion bombardment are shown.

621.398 573
F.M.-F.M. Telemetry.—E. S. Cassedy, Jr. (*Electronic Radio Engr.*, Dec. 1957, Vol. 34, No. 12, pp. 465–467.) Analysis of the frequency spectrum of a double frequency-modulated wave.

PROPAGATION OF WAVES

621.396.11 574
Theory of Scattering from a Nearly Transparent Anomaly.—V. W. Bolie. (*Appl. sci. Res.*, 1957, Vol. B6, No. 6, pp. 422–428.) An approximate equation for the propagation of e.m. energy in a nearly transparent medium is applied to the case in which the medium contains a dielectric inhomogeneity in the form of an isolated Gaussian-shaped perturbation in the refractive index. Equations for the scattering are illustrated graphically. The energy extracted from the incident wave due to the anomaly is shown by a graph of the total scattering cross-section as a function of perturbation size.

621.396.11 575
Propagation of a Pulse across a Coast Line.—J. R. Wait. (*Proc. Inst. Radio Engrs*, Nov. 1957, Vol. 45, No. 11, pp. 1550–1551.) A generalization of earlier results (*J. Res. nat. Bur. Stand.*, July 1956, Vol. 57, No. 1, pp. 1–15) applied to various transient waveforms.

621.396.11: 523.5 576
V.H.F. Meteor Scatter Propagation.—W. F. Bain. (*QST*, April 1957, Vol. 41, No. 4, pp. 20–24 . . 144.) Basic principles are described with relevant information on direction of transmission, aerial height and directivity, and occurrence of meteor showers for obtaining optimum communication conditions.

621.396.11: 550.389.2 577
Propagation and the International Geophysical Year.—Slack. (See 448).

621.396.11: 551.501.8 578
The Use of Surface Weather Observations to Predict the Total Atmospheric Bending of Radio Rays at Small Elevation Angles.—B. R. Bean & B. A.

Cahoon. (*Proc. Inst. Radio Engrs*, Nov. 1957, Vol. 45, No. 11, pp. 1545-1546.) Useful accuracy even for elevation angles as small as 10 milliradians is obtained. The method is extended to zero elevation by substituting profiles with strong ground-based refractive layers for the ducting profile.

621.396.11: 551.51 579

Scattering of Electromagnetic Waves by an Acoustic Disturbance in the Atmosphere.—A. Tønning. (*Appl. sci. Res.*, 1957, Vol. B6, No. 6, pp. 401-421.) It is shown theoretically that the density variations associated with an acoustic wave affect the propagation of an e.m. wave. Under the assumption that the acoustic waves are spherical, the scattered field at large distances is given in terms of definite integrals. The limiting case of plane acoustic waves is discussed. Two numerical examples show the greater efficiency of scattering from plain waves compared with spherical waves.

621.396.11: 551.510.52/.53 580

On the Scattering of Radio Waves in the Troposphere, Stratosphere and Ionosphere.—K. Takahasi. (*J. Radio Res. Labs, Japan*, July 1957, Vol. 4, No. 17, pp. 333-340.) The scattering is assumed to be due to partial reflexion caused by random isotropic fluctuations in refractive index. A few comparisons are made between the theoretical and experimental results.

621.396.11: 551.510.52 581

Notes on Phase Incoherence in Tropospheric Propagation and its Effects on Scattered Field.—M. Hirai. (*J. Radio Res. Labs, Japan*, July 1957, Vol. 4, No. 17, pp. 255-266.)

621.396.11: 551.594.5 582

Reflection of Short and Ultra-short Waves from the Aurora.—G. Lange-Hesse. (*Arch. elekt. Übertragung*, June & July 1957, Vol. 11, Nos. 6 & 7, pp. 253-261 & 283-288.) A review article on observations of h.f. and v.h.f. reflections from the aurora, covering the state of research at the beginning of the I.G.Y. 92 references.

621.396.11: 621.396.677 583

Aerial/Propagation Mismatch.—Hitchcock. (See 358.)

621.396.11.01 584

Terms and Symbols in the Field of Wave Propagation.—(*Nachrichtentech. Z.*, May 1957, Vol. 10, No. 5, pp. 255-256.) Terms and symbols proposed by the special committee on wave propagation of the German Telecommunications Association (*Nachrichtentechnische Gesellschaft*) are tabulated with their definitions.

621.396.11.029.51/.53 585

The E.B.U. Project of Measurements for the Study of Sky-Wave Propagation in the Long- and Medium-Wave Bands.—H. Ehlers & R. Dobiasch. (*Rundfunktech. Mitt.*, June 1957, Vol. 1, No. 3, pp. 110-120.) Details are given of the organization for the project and of the methods used, and some experiments and field-strength tests are described.

621.396.11.029.62/.63 586

Some Comparative Tests of Propagation Conditions in Bands II and IV.—W. Knöpfel. (*Nachrichtentech. Z.*, May 1957, Vol. 10, No. 5, pp. 233-235.) Comparative measurements show that attenuation in band IV due to local causes and diffraction is greater than that obtained for band II. To ensure equally good coverage a closer spacing of transmitters of higher power appears necessary.

621.396.11.029.62 587

Experimental Investigations of the Mechanism of Long-Distance Propagation in the Metre Wavelength Range.—L. Klinker. (*NachrTech.*, May 1957, Vol. 7, No. 5, pp. 210-215.) The results of one year's observations at Kühlungsborn are summarized (see also 2586 of 1957). The fading rate does not change appreciably over distances ranging from 50 to 400 km, and does not appear to depend on the mean turbulence velocity; however, a close correlation with the vertical drift component of tropospheric inhomogeneities was found. Partial reflections at layer inhomogeneities appears to be the predominant, if not exclusive, mechanism for propagation at $m\lambda$ for distances up to about 500 km.

RECEPTION

621.376.332 588

F.M. Discriminator Bandwidth.—G. J. Phillips. (*Wireless World*, Dec. 1957, Vol. 63, No. 12, pp. 571-574.) A significant reduction of co-channel interference by means of a wide-band discriminator is only obtained when the ratio of wanted to unwanted carriers is less than 6 dB. For normal conditions of broadcast reception a narrow-band discriminator and an a.m. suppression ratio of 35 dB are generally satisfactory. Other forms of interference are not improved by the use of a wide-band discriminator.

621.396.621: 621.372.632 589

A Low-Noise Converter for Four Metres.—G. M. C. Stone. (*R.S.G.B. Bull.*, June 1957, Vol. 32, No. 12, pp. 541-543.) Full constructional details are given.

621.396.621: 621.373.4 590

A Stable Oscillator for Two-Metre Receivers.—W. H. Allen. (*R.S.G.B. Bull.*, June 1957, Vol. 32, No. 12, pp. 544-545.)

621.396.8: 621.396.712 591

The Fixing and Measurement of the Limits of Coverage of A.M. Broadcast Transmitters.—P. Thiessen. (*Rundfunktech. Mitt.*, June 1957, Vol. 1, No. 3, pp. 102-109.) It is proposed that the limit of the near fading zone should be determined on the basis of the statistical distribution of field strengths. The distribution of fluctuating field-strength amplitudes and phase displacements over two propagation paths is examined, and the relation between subjective assessments of quality, signal/noise ratio and field-strength fluctuations is discussed. See also 592 below.

621.396.8: 621.396.712.029.53 592

Statistical Investigation of the Quality of Reception of A.M. Sound Broadcasts.—F. von Rautenfeld & P. Thiessen. (*Rundfunktech. Mitt.*, June 1957, Vol. 1, No. 3, pp. 90-101.) Results of a series of subjective and objective tests are statistically evaluated to assess the quality of reception in West Germany of the 100-kW transmitter at Langenberg as affected by the 100-kW transmitter at Hamburg, distant 315 km and operating at the same frequency 971 kc/s, with or without reduced radiation towards Langenberg.

STATIONS AND COMMUNICATION SYSTEMS

621.396.1 593

Wavelengths as an International and Technical Problem.—W. Nestel. (*Telefunken Ztg*, Sept. 1957, Vol. 30, No. 117, pp. 161-173. English summary, pp. 216-217.) The characteristics of the various modes of wave propagation in the entire r.f. spectrum are summarized and their significance in the past and future planning of international frequency allocations is discussed.

621.396.41: 621.376.3: 621.396.82 594

The Equalization of Base-Band Noise in Multichannel F.M. Radio Systems.—C. A. Parry. (*Proc. Inst. Radio Engrs*, Nov. 1957, Vol. 45, No. 11, pp. 1527-1534.) Pre- and de-emphasis noise-equalizing networks with a maximum attenuation slope of 6 dB/octave are discussed. Second-order distortion is assumed to be predominant. An improvement of signal/noise ratio of 3-6 dB is obtained in the top channel when the mean power of the multichannel signal is adjusted to be unaffected by the networks.

621.396.43.029.62/.63: 621.396.5 595

The Planning of Radio Link Networks for Metre and Decimetre Wavelengths.—H. Paul. (*Nachrichtentech. Z.*, Vol. 10, No. 5, pp. 223-233.) Planning aids in the form of slide rules or similar devices are described; they are based on the relevant C.C.I.F. recommendations.

621.396.65: 621.317.34 596

Measurement of Transmission Distortion in F.M. Radio-Link Equipment.—Hartbaum. (See 552.)

621.396.65.029.63 597

A Decimetre-Wavelength Radio-Link Network providing High-Quality Program Channels using Pulse Phase Modulation.—(*Telefunken Ztg*, June 1957, Vol. 30, No. 116, pp. 85-118.)

Part 3—Modulation Equipment.—H. Oberbeck (pp. 85-99, English summary, p. 150).

Part 4—The Radio Equipment.—E. Willwacher (pp. 100-111, English summary, pp. 150-151).

Part 5—Equipment for Unattended Operation.—K. Hoffmann (pp. 111-118, English summary, p. 151).

Part 1: 3534 of 1956 (Brühl). Part 2: 3283 of 1956 (Schüttlöffel).

SUBSIDIARY APPARATUS

- 621.311.6 **598**
Choke or Capacitor Input?—(*Wireless World*, Dec. 1957, Vol. 63, No. 12, pp. 589-591.) Basic differences of operation and application of the two systems of power supplies are explained.
- 621.311.62 : 621.314.7 **599**
Design of Transistor Regulated Power Supplies.—R. D. Middlebrook. (*Proc. Inst. Radio Engrs*, Nov. 1957, Vol. 45, No. 11, pp. 1502-1509.) Two applications of the circuit are described, one giving 0.5 A at 18-22 V and the other 1 A at 5-25 V. Output resistance is about 0.01 Ω and ripple on full load is less than 5 mV.
- 621.314.63 : [546.28+546.289] **600**
Germanium and Silicon Power Rectifiers.—T. H. Kinman, G. A. Carrick, R. G. Hibberd & A. J. Blundell. (*Proc. Instn elect. Engrs*, Part A, Aug. 1957, Vol. 104, No. 16, pp. 327-330.) Further discussion on 2885 of 1956.

TELEVISION AND PHOTOTELEGRAPHY

- 621.397.26 **601**
Spectrum of Frequency-Shift Radio Photo-transmissions.—A. D. Watt. (*Trans. Inst. Radio Engrs*, Oct. 1956, Vol. CS-4, No. 3, pp. 27-40. Abstract, *Proc. Inst. Radio Engrs*, Jan. 1957, Vol. 45, No. 1, p. 112.)
- 621.397.61 : 621.396.664 **602**
Transistors boost Video for TV Studio Monitors.—L. N. Merson. (*Electronics*, 1st Oct. 1957, Vol. 30, No. 10, p. 205.) Brief description of a compact transistor pre-amplifier unit.
- 621.397.611.2 **603**
Typical Transmission Characteristics of the Image Orthicon Television Camera Tube.—R. Theile & F. Pilz. (*Rundfunktech. Mitt.*, June 1957, Vol. 1, No. 3, pp. 77-85.) The performance and limitations of image orthicons are discussed (see also 2926 of 1957). Instructions for optimum methods of operation are tabulated; some compromise is unavoidable and some faults can be reduced only by suitable lighting and arrangement of the scene.
- 621.397.62 : 525.623 : 621.317.7 **604**
Choosing a Colour-Bar Generator.—Stamiti. (See 556.)
- 621.397.62 : 621.317.7 **605**
Transistorized TV Pattern Generator.—Rozner. (See 555.)
- 621.397.62 : 621.373.52 **606**
A Transistorized Horizontal-Deflection System.—H. C. Goodrich. (*RCA Rev.*, Sept. 1957, Vol. 18, No. 3, pp. 293-307.) A horizontal-deflection system using only transistors is described consisting of an oscillator, driver, output stage with c.h.t.

supply, and phase detector. Audio-type power transistors operated beyond the manufacturer's ratings are used in the output stage, and the results indicate the desirable characteristics for an output transistor designed for this application.

- 621.397.62 : 621.375.4 **607**
Transistor Receiver Video Amplifiers.—M. C. Kidd. (*RCA Rev.*, Sept. 1957, Vol. 18, No. 3, pp. 308-321.) General design problems are discussed and a practical two-stage amplifier is described which uses drift-type transistors.
- 621.397.621.2 **608**
Improvements in Television Receivers: Part 4—Line Synchronization with Automatic Phase Control.—A. Boekhorst, B. G. Dammers, H. Heyligers & A. G. W. Uijtens. (*Electronic Applic. Bull.*, 1956/1957, Vol. 17, No. 4, pp. 129-149.) An analysis of principles and practical requirements. New types of line timebase oscillator and phase discriminator, and a locking circuit are described. Parts 2 & 3: 3674 of 1957.
- 621.397.7 **609**
The B.B.C. Riverside Television Studios: some Aspects of Technical Planning and Equipment.—H. C. Nickels & D. M. B. Grubb. (*B.B.C. Engng Div. Monographs*, Oct. 1957, No. 14, pp. 5-31.)
- 621.397.74 : 621.317.34 **610**
Waveform Testing Methods for Television Links.—A. R. A. Rendall. (*Electronic Radio Engr*, Dec. 1957, Vol. 34, No. 12, pp. 451-453.) A system of testing by means of three standard waveforms has been evolved. Acceptance limits are fixed in relation to subjective picture quality.
- 621.397.743 **611**
Television Coverage in the German Democratic Republic using a New Unified Frequency Plan.—U. Kühn. (*NachrTech.*, May 1957, Vol. 7, No. 5, pp. 215-220.) The allocation of channels according to C.C.I.R. recommendations is discussed.
- 621.397.743 **612**
The Local Television Cable Network in West Berlin.—R. Hoffmann. (*Nachrichtentech. Z.*, May 1957, Vol. 10, No. 5, pp. 209-214.) The design and the various facilities available are described.
- 621.397.743 : 535.623 **613**
Transmission of Colour over Nationwide Television Networks.—F. A. Cowan. (*J. Soc. Mot. Pict. Telev. Engrs*, May 1957, Vol. 66, No. 5, pp. 278-283.) Coaxial and radio relay systems in the U.S.A. are described and their operation is discussed.
- 621.397.8 **614**
Minimizing the Effects of Ambient Light on Image Reproduction.—G. L. Beers. (*J. Soc. Mot. Pict. Telev. Engrs*, June 1957, Vol. 66, No. 6, pp. 347-354.) Discussion, pp. 353-354.) In the method described an oscillating honeycomb screen placed in front of the picture tube prevents light from sources outside a predetermined viewing angle from degrading the image.

TRANSMISSION

- 621.396.61/62 : 621.316.726 **615**
'Autosync' Frequency Control.—R. J. Moser. (*QST*, June 1957, Vol. 41, No. 6, pp. 11-16.) Outputs taken from the mixer and b.f.o. of a commercial receiver are mixed and the resulting frequency is used to control an s.s.b. transmitter, which is thus automatically kept in tune with the receiver.
- 621.396.61 : 621.396.664 **616**
Central Supervisory Equipment for Broadcast Transmitters.—H. Müller. (*Telefunken Ztg*, Sept. 1957, Vol. 30, No. 117, pp. 196-200. English summary, p. 218.) A monitoring installation is described for supervising and modulating up to 10 medium- and short-wave transmitters from one control centre.
- 621.396.61 : 621.396.82 **617**
Reduction of Adjacent-Channel Interference from On-Off Keyed Carriers.—A. D. Watt, R. M. Coon & V. J. Zurick. (*Trans. Inst. Radio Engrs*, Oct. 1956, Vol. CS-4, No. 3, pp. 41-58.)
- 621.396.61.005 **618**
High-Power Broadcast Transmitters for Medium Waves.—A. Ruhrmann. (*Telefunken Ztg*, Sept. 1957, Vol. 30, No. 117, pp. 185-195. English summary, pp. 217-218.) Novel features of recently installed transmitters are described.
- 621.396.61.029.63 : 621.397.8 **619**
 : 621.396.11.083
A 12-kW Pulse Transmitter for Propagation Tests in Band IV.—P. Mallach. (*Rundfunktech. Mitt.*, June 1957, Vol. 1, No. 3, pp. 86-89.) According to the type of directional aerial used, the transmitter described has an effective radiated power of up to 700 kW with 0.03-0.1- μ s pulse length at a repetition frequency of 15-625 kc/s. Various applications of the equipment and planned refinements are discussed with examples of results so far achieved.
- 621.396.61.07 **620**
Power Supply, Control and Protective Equipment [for high-power transmitters].—P. G. Zehnel. (*Telefunken Ztg*, Sept. 1957, Vol. 30, No. 117, pp. 201-206. English summary, p. 218.) Details of recent installations, including remote-control equipment, are given. See also 1588 of 1957 (Burkhardtmaier).
- 621.396.712 : 621.398 **621**
The Remote and Automatic Control of Semi-attended Broadcasting Transmitters.—R. T. B. Wynn & F. A. Peachey. (*Proc. Instn elect. Engrs*, Part B, Nov. 1957, Vol. 104, No. 18, pp. 529-539.) Discussion, pp. 549-552.) Techniques developed by the B.B.C. for controlling semi-attended transmitting stations are described. The performance of the stations is analysed and the economics of the system discussed. Considerable financial saving in operating costs is achieved without sacrifice of broadcasting continuity.

621.396.712 : 621.398

The Design of High- and Low-Power Medium-Frequency Broadcasting Transmitters for Automatic and Semi-attended Operation.—W. J. Morcom & D. F. Bowers. (*Proc. Instn elect. Engrs*, Part B, Nov. 1957, Vol. 104, No. 18, pp. 540-549. Discussion, pp. 549-552.) Two m.f. transmitters are described having power outputs of 660 W and 100 kW respectively. Three of the low-power units are used in parallel to provide a 2-kW fully automatic transmitter. Two high-power units can be used as a semi-attended 200-kW transmitter. See also 621 above.

622

621.314.7

Transistor Circuits and Applications.—A. G. Milnes. (*Proc. Instn elect. Engrs*, Part B, Nov. 1957, Vol. 104, No. 18, pp. 565-580. Discussion, pp. 581-585.) A review paper which deals with junction transistors; new concepts and trends in design are discussed. The applications described include low-level and power amplifiers, square-wave and sinusoidal oscillators, power regulators, and computing and switching circuits, but special types such as tetrodes, *p-n-p-n* and unipolar devices are not considered. 112 references.

627

621.314.7.012.8

The Equivalent Circuit of the Drift Transistor.—J. Almond & R. J. McIntyre. (*RCA Rev.*, Sept. 1957, Vol. 18, No. 3, pp. 361-384.) The quadripole admittances of a drift transistor, as given by Krömer (3389 of 1954), are examined as functions of frequency and used to derive Π -type equivalent circuits for common-base and common-emitter configurations. The frequency variations of the admittance elements used in these circuits are compared with those of the admittance functions they represent, and are shown to give good approximations up to frequencies of the order of the α -cut-off frequency of the intrinsic transistor. The differences in the behaviour of the phase of α for diffusion- and drift-type transistors in grounded-base connection is discussed qualitatively.

635

VALVES AND THERMIONICS

537.533

Simplified Methods in the Statistical Mechanics of Stationary Electron Beams.—B. Meltzer. (*J. Electronics Control*, Oct. 1957, Vol. 3, No. 4, pp. 355-366.) A mathematical analysis of the effects produced in an electron beam by statistical variations in the initial velocities either of thermionic or secondary emission electrons. Axial symmetry is assumed, but the statistical distribution of initial energies is not limited only to the Maxwellian type. Current density, electron temperature and focusing are discussed, and comparisons are made with experimental results for a television camera tube.

623

621.314.63 : 537.311.33

On the Impact Ionization in the Space-Charge Region of *p-n* Junctions.—F. W. G. Rose. (*J. Electronics Control*, Oct. 1957, Vol. 3, No. 4, pp. 396-400.) The Townsend equation for impact ionization in semiconductors is shown to be invalid at low voltages in the space charge region of *p-n* junctions. 'Soft' breakdown must precede Townsend breakdown, although its effect on the characteristic will be masked by surface effects.

624

621.314.63 : 546.289

Thermal Turnover in Germanium *p-n* Junctions.—A. W. Matz. (*Proc. Instn elect. Engrs*, Part B, Nov. 1957, Vol. 104, No. 18, pp. 555-564.) Static reverse characteristics are analysed, taking into account an avalanche multiplication factor. Examination of the condition for thermal stability relates the onset of thermal runaway to a thermal turnover phenomenon. The existence of a thermal negative resistance region is predicted and verified experimentally, a semi-quantitative analysis of the results shows reasonable agreement with theory.

625

621.314.7

The Role of Transistors in Electronics.—R. B. Hurley. (*J. Soc. Mot. Pict. Telev. Engrs*, June 1957, Vol. 66, No. 6, pp. 330-332. Discussion, p. 332.) The advantages of transistors over valves and other devices are summarized.

626

621.314.7

D.C. Stabilization of Junction Transistors.—L. B. Johnson & P. Vermes. (*Mullard tech. Commun.*, April 1957, Vol. 3, No. 23, pp. 67-96. *Electronic Applic. Bull.*, 1956/1957, Vol. 17, No. 4, pp. 151-177.) The need for stabilization of d.c. operating conditions against temperature variations is pointed out. Detailed consideration is given to the most useful methods of achieving such stability. The effects of production spreads in transistor parameters on the design of stabilizing circuitry are discussed.

628

621.314.7

Theory of a Wide-Gap Emitter for Transistors.—H. Kroemer. (*Proc. Inst. Radio Engrs*, Nov. 1957, Vol. 45, No. 11, pp. 1535-1537.) The injection deficit $(1-\gamma)$, where γ is the emitter efficiency, can be increased by several orders of magnitude if the emitter has a higher band gap than the base region.

629

621.314.7 : 621.317.332

Measurements of the Impedance Parameters of Junction Transistors.—Ward. (See 550.)

630

621.314.7 : 621.317.799

Test Equipment for Transistor Production.—A. B. Jacobsen & C. G. Tinsley. (*Electronics*, 1st Oct. 1957, Vol. 30, No. 10, pp. 148-151.)

631

621.314.7 : 621.375.4 : 681.142

Transistors in Current - Analogue Computing.—Kerfoot. (See 372.)

632

621.314.7 : 621.385.4

High-Frequency Semiconductor Spacistor Tetrodes.—H. Statz, R. A. Pucel & C. Lanza. (*Proc. Inst. Radio Engrs*, Nov. 1957, Vol. 45, No. 11, pp. 1475-1483.) Electrons are injected into the space-charge region of a reversed-biased *p-n* junction from an emitter contact on its surface. This input current is modulated by the voltage applied to an adjacent reverse-biased contact. Carrier transit in the space-charge region is rapid and practically unaffected by lifetime considerations. The input and output impedances of experimental units are as high as 30 M Ω . See also 1947 of 1957 (Statz & Pucel).

633

621.314.7 : 621.396.822

Shot Noise in Transistors.—G. H. Hanson & A. van der Ziel. (*Proc. Inst. Radio Engrs*, Nov. 1957, Vol. 45, No. 11, pp. 1538-1542.) Experimental results over a frequency range which greatly exceeds the transistor cut-off frequency in some cases, are interpreted in terms of a recent theory by van der Ziel (600 of 1956). Reasonable agreement is obtained.

634

621.383.2 : 546.34

Use of Lithium in Photoemissive Cathodes.—A. H. Sommer. (*Rev. sci. Instrum.*, Aug. 1957, Vol. 28, No. 8, pp. 655-656.) A discussion of measurements of peak sensitivity and long-wavelength threshold and an interpretation of earlier results.

636

621.383.27

On the Mechanism of the Production of Dark-Current Pulses in Photomultipliers.—Z. Náray & P. Varga. (*Brit. J. appl. Phys.*, Sept. 1957, Vol. 8, No. 9, pp. 377-379.) The predominant component of the dark current is produced by different mechanisms in the negative and positive regions of the shield characteristic. In the former case electrons are emitted from the envelope, and in the latter case electrons from the inner electrodes produce scintillations on the envelope, giving rise to photon feedback.

637

621.383.5

Theoretical Interpretation of Hamaker-Beezhold Ballistic Effect in Barrier-Layer Photocells.—G. Blet. (*J. Phys. Radium*, Jan. 1957, Vol. 18, No. 1, pp. 5-8.) The theory of statistical exchanges between traps and electrons is developed to explain the build-up and decay effects observed under different conditions of illumination. See 312 of 1957 (Blet & Ritti).

638

621.385.029.6

International Congress on Microwave Valves.—(*Le Vide*, Jan./Feb. 1957, Vol. 12, No. 67, pp. 1-146.) A further selection of papers, as follows, presented at the Congress. See also 1267 of 1957.

639

(a) Some Technological Aspects of U.H.F. Triode Design.—E. G. Dorgelo (pp. 3-8, in French & English).

(b) Some Problems on Disk-Sealed Planar Triodes.—H. Nishio, T. Nemoto & H. Murakami (pp. 9-22, in French & English).

(c) Construction and Circuit of a 4 000-Mc/s Triode with L Cathode.—K. Rodenhuis (pp. 23-31, in French & English).

(d) The Space Charge Distribution in a Magnetron under Static Conditions.—J. Verweel (pp. 32-42, in French & English).

(e) Power and Gain Limitations of Helix-Type Travelling-Wave Tubes.—C. W. Barnes (pp. 43-48, in French & English).

(f) Helix Type Travelling-Wave Valve for 24 Gc/s.—T. Miwa, J. Koyama, M. Mishima & I. Yanaoka (pp. 49-52, in French & English).

(g) Low Noise Travelling-Wave Valve: ECL1138.—M. Higuchi, K. Kawazura & J. Koyama (pp. 53-58, in French & English).

(h) Magnetless Magnetron.—A. Versnel (pp. 59-63, in French & English).

(i) A New Electron Lens System providing Convergent-Divergent Action.—T. Seki, Y. Nikaido & K. Simada (pp. 64-73, in French & English).

(j) The Design of an Electron Gun for a Strip Beam Device.—A. B. Cutting & I. Fraser (pp. 74-82, in French & English).

(k) Transmit-Receive Switch Tubes.—M. L. W. Roberts (pp. 83-92, in French & English).

(l) Plug-In T.R. Tubes for use in S-Band Duplexers.—T. L. Dutt (pp. 93-108, in French & English).

(m) High-Power Duplexers.—L. Milosevic (pp. 109-116).

(n) Investigation of Pressures and their Evolution in Gas-Filled Valves.—J. Boissière & C. Romiguère (pp. 117-121).

(o) Power Measurements on Millimetre-Wave Valves.—H. Weill (pp. 122-127).

(p) Electron Deflection System of Travelling-Wave Cathode-Ray Tube.—H. Maeda & K. Miyaji (pp. 128-140, in French & English).

(q) High-Melting-Point Seals.—R. Benichou (pp. 141-146).

621.385.029.6 640

Biperiodic Electrostatic Focusing for High-Density Electron Beams.—K. K. N. Chang. (*Proc. Inst. Radio Engrs*, Nov. 1957, Vol. 45, No. 11, pp. 1522-1527.) The potential valley formed by combining two counteracting periodic electrostatic fields is theoretically steeper than in previous focusing systems and should maintain stable flow in thick hollow beams. Proper cancellation of the space-charge field is also obtained. Preliminary experiments indicate that a travelling-wave valve can operate without using any magnets. See also 1954 of 1957.

621.385.029.6 : 621.3.072.6 641

Automatic Frequency Control for a Pulsed Klystron.—P. D. Ulm. (*Elect. Commun.*, June 1957, Vol. 34, No. 2, pp. 136-140.) The klystron frequency is compared with that of a stable microwave resonator. The frequency-error information derived from one pulse is delayed and applied to correct the next.

621.385.029.6 : 621.372.8 642

Delay-Line Valves.—F. W. Gundlach. (*Nachrichtentech. Z.*, June 1957, Vol. 10, No. 6, pp. 265-276.) A theory is derived for valves containing periodic waveguide structures. It is similar to recurrent-network theory and accounts for the properties of the valve in both forward and backward operation.

621.385.029.64 643

Slalom Focusing.—J. S. Cook, R. Kompfner & W. H. Yocom. (*Proc. Inst. Radio Engrs*, Nov. 1957, Vol. 45, No. 11, pp. 1517-1522.) A linear array of line charges produces two equipotential surfaces which contain exact electron trajectories.

Such a field is obtained by placing an array of positive wires between two negative plates; this structure can focus a ribbon-type electron beam. A backward-wave oscillator with this slalom focusing generated oscillations in the range 3.3-4.3 kMc/s.

621.385.029.65 644

A Versatile Source of Millimetre Waves.—C. F. Hempstead & A. R. Strnad. (*Bell Lab. Rec.*, July 1957, Vol. 35, No. 7, pp. 241-245.) A number of simplifications in design and improvements in fabrication of backward-wave oscillators are described, including a re-designed electron gun assembly. The latest versions of the backward-wave oscillator deliver 5-10 mW at between 45 000 and 57 000 Mc/s; oscillation has been achieved at 200 000 Mc/s.

621.385.032.213 : 537.533 645

On the Electron Gun with Hairpin Cathode: the Intensity of Emission and the Nature of the Electron Source.

—K. T. Dolder & O. Klemperer. (*J. Electronics Control*, Nov. 1957, Vol. 3, No. 5, pp. 439-454.) Emission per unit solid angle is maximum for zonal rays when grid bias is just sufficient to prevent multiple source formation and cathode-to-grid distance is of the order of one grid-aperture radius. Experiments show that emission can be direct from the cathode tip, or pass through a cross-over, or be drawn from a virtual cathode. The last condition yields the highest emission over a relatively large solid angle.

621.3.032.213.13 646

Barium-Supplied Oxide-Coated Cathodes.—T. Imai. (*J. phys. Soc. Japan*, July 1957, Vol. 12, No. 7, p. 831.) The beneficial effects on emission of excess Ba in the coating layer of oxide-coated cathodes are described and methods of introducing the Ba are discussed.

621.385.032.213.13 647

Activation of an Oxide Cathode by Deposition of Alkaline Earth Metal Ions via a Mass Spectrometer.—R. M. Matheson, L. S. Nergaard & R. H. Plumlee. (*RCA Rev.*, Sept. 1957, Vol. 18, No. 3, pp. 385-431.)

621.385.032.213.13 648

: 621.317.332.029.63

The Impedance of the Oxide-Coated Cathode at Ultra-high Frequencies.—L. J. Herbst. (*Brit. J. appl. Phys.*, July 1957, Vol. 8, No. 7, pp. 277-282.) The impedance of the cathode was measured on a number of disk-seal triodes at frequencies between 500 and 2 365 Mc/s.

621.385.032.213.13 : 621.327.5 649

The Emission from Oxide Cathodes in Low-Pressure Discharges.—M. A. Cayless. (*Brit. J. appl. Phys.*, Aug. 1957, Vol. 8, No. 8, pp. 331-336.) Cathodes in fluorescent lamps are considered. The zero-field emission at a pressure of a few mm is found experimentally to be about 10 times that in a vacuum. Various processes of field and secondary emission are described.

621.385.032.213.2 650

The Effect of Oxygen and Sulphur on the Thermionic Emission from Matrix Cathodes.—J. F. Richardson. (*Brit. J.*

appl. Phys., Sept. 1957, Vol. 8, No. 9, pp. 361-362.) "The poisoning of the emission from matrix cathodes by oxygen and sulphur is reversible. Recovery of the emission is more rapid from oxygen poisoning. The shape of the recovery curves indicates that the poisoning agent is present on the surface and has also diffused into the cathode pores."

621.385.032.26 : 537.533 651

Exact Electrode Systems for the Formation of a Curved Space-Charge Beam.—R. J. Lomax. (*J. Electronics Control*, Oct. 1957, Vol. 3, No. 4, pp. 367-374.) An analytical method of determining the shape of the Pierce-type electrodes required to maintain a two-dimensional space-charge beam is given, which is valid when the edge of the beam is curved. The method is applied to a solution of the space-charge equations given by Meltzer (957 of 1957); this leads to a completely enclosed electrode system.

621.385.1.01 652

Recommendations of the Special Committee on Valves of the N.T.G. (Nachrichtentechnische Gesellschaft) concerning Definitions in the Field of High-Vacuum Diodes and Grid-Controlled Vacuum Tubes.—(*Nachrichtentech. Z.*, May 1957, Vol. 10, No. 5, pp. 257-262.) Many of the German terms and definitions given are based on those recommended by the I.R.E. Committee on Electron Tubes.

621.385.2 : 621.3.011.4 653

The Capacitance between Diode Electrodes in the Presence of Space Charges.—I. A. Harris: C. S. Bull. (*Proc. Inst. elect. Engrs*, Part B, Nov. 1957, Vol. 104, No. 18, p. 598.) Comment on 3357 of 1957 and author's reply.

621.385.3.029.63 654

The Design and Life of Planar Microwave Transmitting Tubes.—H. D. Doolittle. (*Trans. Inst. Radio Engrs*, May 1957, Vol. PGVC-8, pp. 31-35. Abstract, *Proc. Inst. Radio Engrs*, July 1957, Vol. 45, No. 7, p. 1039.)

621.387 : 621.3.015.532 655

The Corona Triode.—G. A. Ostroumov. (*Dokl. Ak. Nauk S.S.S.R.*, 11th Aug. 1957, Vol. 115, No. 5, pp. 919-921.) The principle and circuit of an amplifying device is described which consists of a sharp point and a blunt electrode as anode with a high voltage between them, so that a corona is formed. For operation at high voltages the anode is of a tubular shape. See also 2927 of 1956 (Hertz).

MISCELLANEOUS

621.3.002.2/3 656

Miniaturization of Electronic Equipment.—D. A. Findlay. (*Electronics*, 1st Oct. 1957, Vol. 30, No. 10, pp. 177-204.) A report dealing with design and materials, various classes of components, and production techniques.

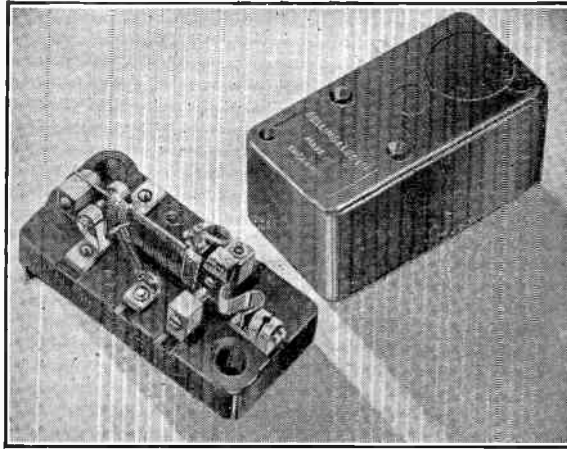

L.413
DELAY SWITCH
 auto-resetting

"BELLING-LEE" Thermal Switches

These current-operated, bi-metal switches are designed for circuit protection and to control circuits requiring a particular time lag of operation. They are rated up to 5 amp. with contact voltages up to 250 volts A.C. They will trip currents of up to 20 amp. at 250 volts A.C., 5 amp. at 50 volts D.C., 2.5 amp. at 100 volts D.C. and 100 mA at 250 volts D.C.

L.415 is the hand resetting version. It is for use in circuits which should be remade at the discretion of the operator.

Normally open, normally closed or changeover contacts are available and the switches can be calibrated to individual requirements to a maximum time delay of 30-60 secs. Auxiliary contacts can be fitted to L.413 to "make" or "break" with main contacts. For L.415 these can be used for the "break" operation only. These switches are available with series, parallel or independent heaters rated up to 48 volts maximum.

Special thermal switches can be designed and manufactured to specific requirements where warranted.

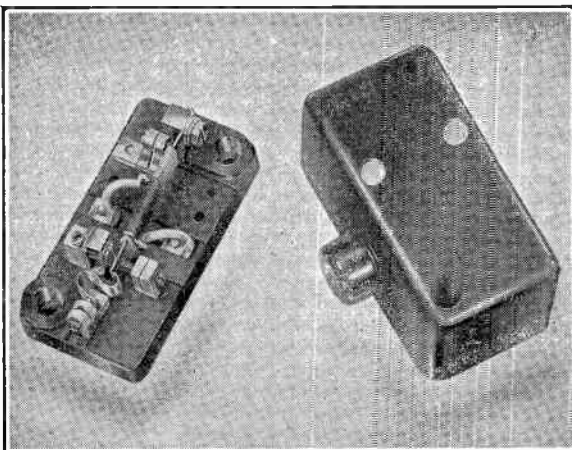

L.415
DELAY SWITCH
 hand-resetting

"MINITRIP" L.430 & L.430B

This simple, resettable cutout, designed primarily for overload protection in radio and television receivers has an almost infinite number of applications in the electrical and electronics fields, (e.g. small power tools, computer circuit protection, protection of automation equipment, etc.) It is especially valuable in cases where fire and safety regulations demand protection against harmless small overloads, and a traditional wire fuse sufficiently closely rated will not withstand normal switching surges.

The surge resistance is such that an overload of 40 times rated current for 0.02 seconds does not cause tripping, damage, or an alteration in characteristics.

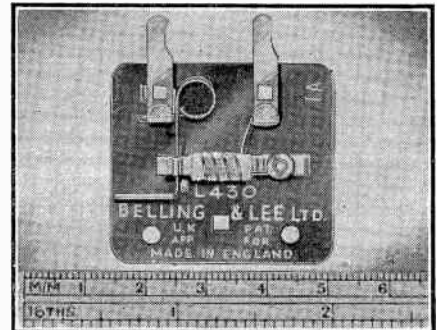

Should a short-circuit produce an abnormally large sustained overload it is possible for the "Minitrip" to be destroyed, but protection is still given.

A "Minitrip" is cheaper than a fuse and fuseholder, and provides better protection characteristics.

RATINGS

100, 150, 200, 250, 300, 500 and 750 milliamperes, and 1 ampere.

Other ratings can be supplied to order up to 2 amperes.

BELLING & LEE LTD
 GREAT CAMBRIDGE ROAD, ENFIELD, MIDDX., ENGLAND

Telephone: Enfield 3322 • Telegrams: Radiobel, Enfield

ADCOLA
PRODUCTS LIMITED
 (Regd. Trade Mark)

**Soldering Instruments
 and Equipment**



Comprehensive
 Range of Models
 P.V.C. Cable Strippers
 Solder Dipping Pots
 Supplied in
ALL VOLT RANGES

**A PRODUCT
 FOR
 PRODUCTION**

**RADIO, TV
 RADAR
 ELECTRONICS
 TELECOMMUNICATIONS
 ETC.**

(Illustrated)
 Protective Shield
 List No. 68

$\frac{3}{16}$ " Detachable
 Bit Model
 List No. 64

Traditional British Quality and Workmanship

ADCOLA PRODUCTS LIMITED

Head Office, Sales and Service:
GAUDEN ROAD, CLAPHAM HIGH STREET
LONDON, S.W.4 Telephones MACAULAY 3101 & 4272

Wilkinsons
Special Purpose Tools
for the Radio,
Electrical and
Electronic Engineer

No. 23119 Taper nose adjusting and P.V.C. insulating stripping plier (size 6")

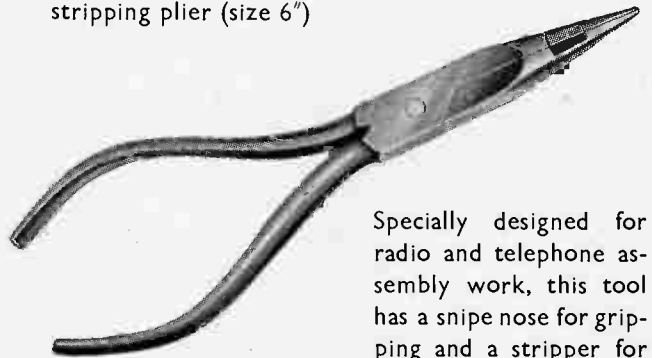

Specially designed for radio and telephone assembly work, this tool has a snipe nose for gripping and a stripper for removing P.V.C. insulation from one diameter of wire, a different tool being required for each diameter of wire which requires stripping

No. 23113 Bent duckbill nose (size 5 1/2")

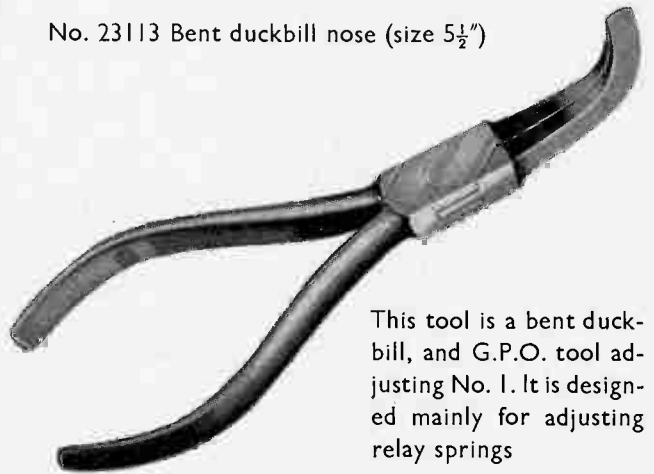

This tool is a bent duck-bill, and G.P.O. tool adjusting No. 1. It is designed mainly for adjusting relay springs

Wilkinsons Tools Ltd.
 (A member of the Staveley Coal & Iron Co. Ltd. Group)
Kerfoot Street, Warrington
England

X57



GERMANIUM JUNCTION RECTIFIERS

— finned bridge units

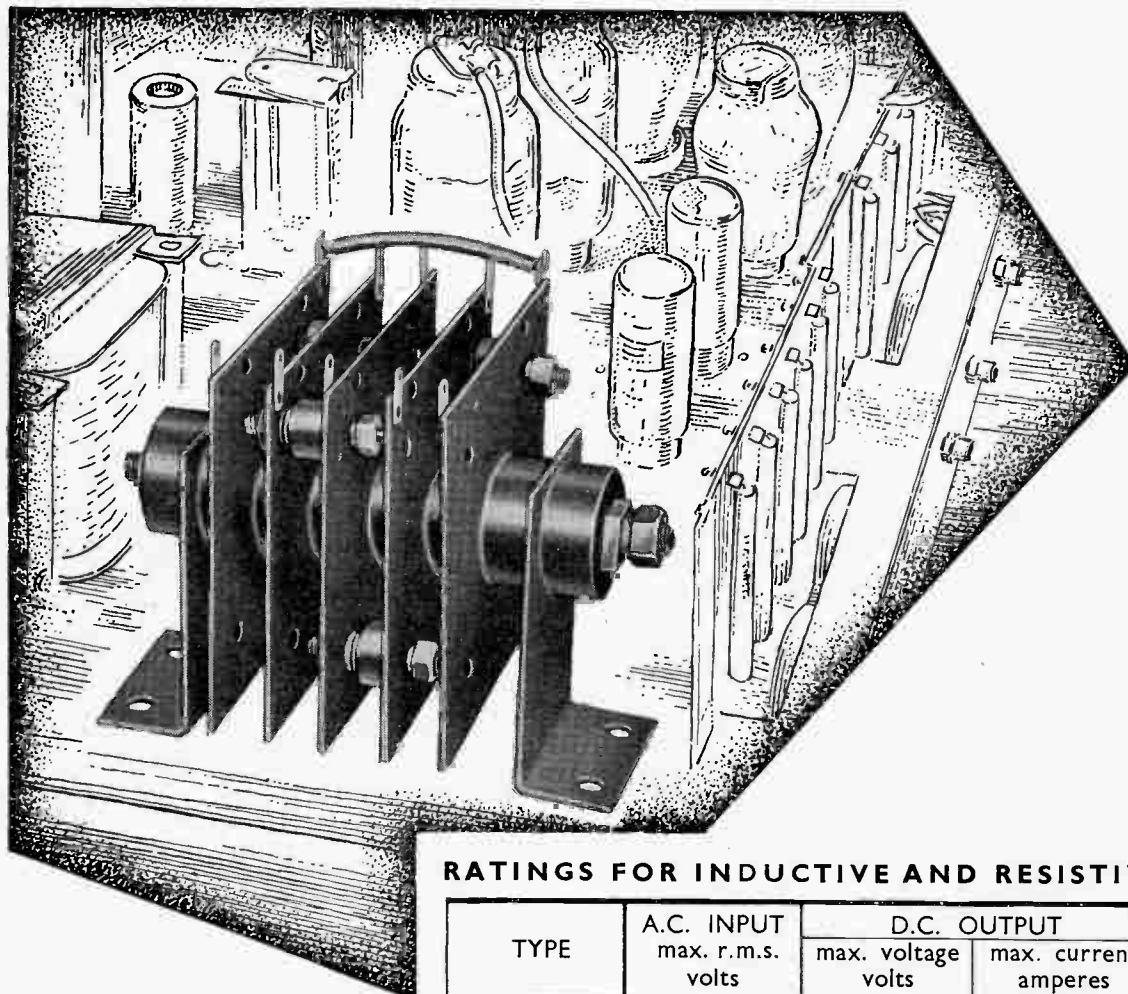

RATINGS FOR INDUCTIVE AND RESISTIVE LOADS

TYPE		A.C. INPUT max. r.m.s. volts	D.C. OUTPUT		OVERALL LENGTH inches
			max. voltage volts	max. current amperes	
SINGLE-PHASE	GA31-A	140	125	2.0 at 40°C	3½
	GA41-A	53	47	2.0 at 60°C	3½
	GA51-A	210	187	2.0 at 40°C	3½
	GA61-A	106	94	2.0 at 60°C	3½
	GA52-A	340	303	2.0 at 40°C	5
	GA62-A	170	151	2.0 at 60°C	5
	GA53-A	510	455	2.0 at 40°C	6½
	GA63-A	254	227	2.0 at 60°C	6½
THREE-PHASE	GB31-A	140	188	3.0 at 35°C	4½
	GB41-A	53	71	3.0 at 55°C	4½
	GB51-A	210	283	3.0 at 35°C	4½
	GB61-A	106	143	3.0 at 55°C	4½
	GB52-A	340	458	3.0 at 35°C	6¾
	GB62-A	170	229	3.0 at 55°C	6¾

The well-known range of BTH germanium junction rectifiers is now available made up into convenient bridge units ready for incorporation in your equipment.

BRITISH THOMSON-HOUSTON

THE BRITISH THOMSON-HOUSTON CO., LTD., RUGBY ENGLAND

an A.E.I. Company

A5184

A.C.
DIFFERENTIAL
CURRENT
METER

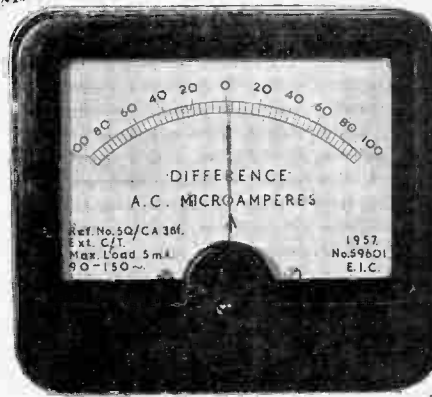

We also make *Phase Sequence Indicators, Synchrosopes and Frequency Meters* all up to 5,000 c.p.s. and full range of *M.C. and M.I. Instruments.*

Ask for new Catalogue.

Useful for the design of a.c. bridges.
Sensitive to current differences of 1 in 1,000.
Made for frequencies from 50 to 5,000 cycles per second.
Indicates small differences in the magnitude of two a.c. currents.

THE ELECTRICAL INSTRUMENT CO. (HILLINGTON) LTD.

BOSWELL SQUARE · INDUSTRIAL ESTATE · HILLINGTON · GLASGOW · S.W.2 · Telephone Halfway 1166 and 2194

Tinsley

CONSTANT AMPLITUDE

VALVE MAINTAINED TUNING FORK

Type 5224CA

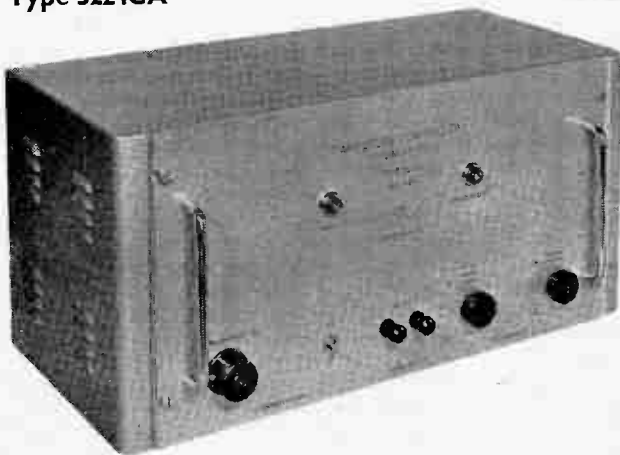

... with frequency characteristics approaching those of a crystal!

25-100 c/s according to specification

Due to a patented circuit incorporated in this design, the amplitude of the vibrating system is maintained constant. The system is not subjected to a constant straining, polarisation nor to any electromechanical shock. Energy is supplied to the fork whilst the limbs are moving in one direction only. The instantaneous voltage generated in the pick-off coil is strictly proportional to fork velocity and is therefore free from harmonics.

H. TINSLEY & CO. LTD

Write for list 69A for full details

Werndee Hall, South Norwood, London, S.E.25 · Addiscombe 6046-7-8

It doesn't matter whether you call it . . .

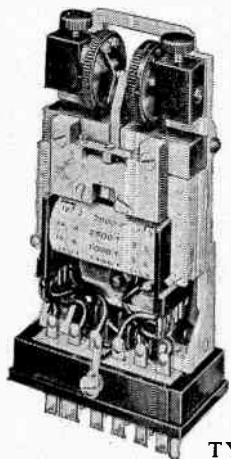

TYPE 3

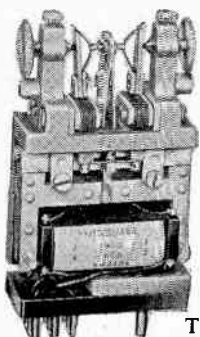

TYPE 4



TYPE 5

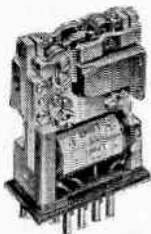

TYPE 51

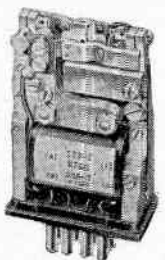

TYPE 6

5 Basic types are available each with several variations for special purposes.

the **CARPENTER** Polarized Relay

or the Carpenter **POLARIZED** Relay

or the Carpenter Polarized **RELAY**

it is the polarized relay, with the **UNIQUE** combination of superlative characteristics, that has solved, and is continuing to solve many problems in . . .

**High speed switching · Control
Amplification · Impulse repetition**

for : Industrial recording

Aircraft control and navigational equipment

Automatic machine control

Analogue computers

Temperature control

Servo mechanisms

Submarine cable repeaters

Burglar alarm and fire detection equipment

Nuclear operational equipment

Biological research

Theatre lighting "dimmer"
and colour mixing equipment

Teleprinter working

Automatic pilots

Remote control of Radio links

Theatre stage-curtain control

Long distance telephone dialling

V.F. Telegraphy

etc, etc, etc.

Therefore — if your project, whatever it may be, calls for a **POLARIZED** relay, with high sensitivity, high speed without contact bounce, freedom from positional error, and high reliability in a wide range of temperature variations, *you cannot do better* than use a **CARPENTER POLARIZED RELAY**.



Write or 'phone for technical data —

TELEPHONE MANUFACTURING CO. LTD.

DEPT. 407, HOLLINGSWORTH WORKS, DULWICH, LONDON, SE21

TELEPHONE: GIPSY HILL 2211

Fine wires always in demand for precision work

Lewcos Insulated Resistance Wires
with standard coverings of cotton, silk,
glass, asbestos, standard enamel and
synthetic enamel are supplied
over a large range of sizes

Send for our new leaflet

LEWCOS

Insulated Resistance Wires



THE LONDON ELECTRIC WIRE COMPANY AND SMITHS, LIMITED • LEYTON • LONDON • E.10

PIRTOID

SYNTHETIC RESIN BONDED LAMINATE

brings you

MATERIAL SOLUTIONS

to your

CURRENT PROBLEMS



... because the range of PIRTOID Paper and Fabric base laminates affords all the machining qualities needed with consistent uniform dielectric and mechanised strength. Read this booklet, sent gladly on request.

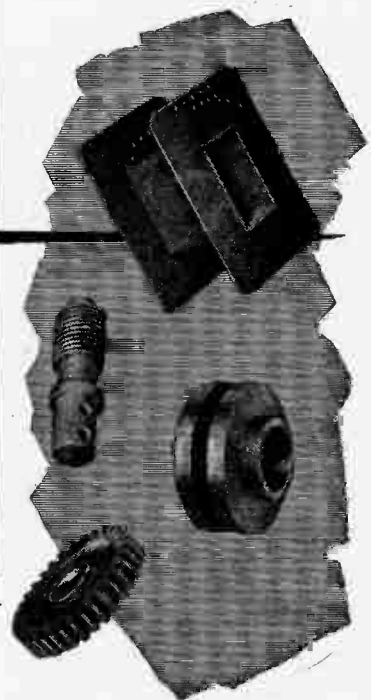

H. CLARKE & CO. (MANCHESTER) LTD

Atlas Works, Patricroft, Manchester

Telephone Eccles 5301-2-3-4-5

dmCK4

CONVERSION CORNER

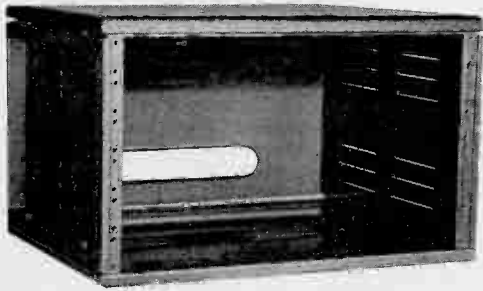

THE POLYRAC INSTRUMENT CASE

Incorporating a new design technique which enables a bench instrument case, accommodating a 19" x 10 1/2" panel, to be converted into 2, 3, 4 or 5 tier units by the addition of side frames tapped to standard G.P.O. spacing

Write for leaflet CJ12

MICROWAVE

INSTRUMENTS LIMITED

WEST CHIRTON INDUSTRIAL ESTATE · NORTH SHIELDS · NORTHUMBERLAND

BIGGEST TIME & MONEY SAVER in WORK CLAMPING

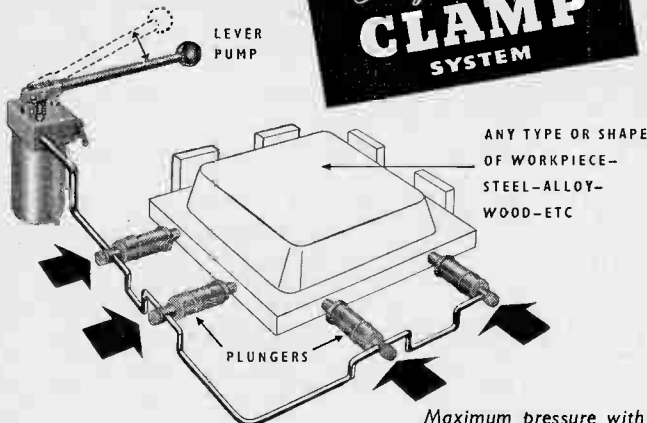

These plungers can exert a pressure of from 800lbs—4 tons.
Can be used in groups of any number.

Maximum pressure with smallest plungers

Easily adaptable to any fixture design

Simultaneous plunger action

Minimum floor to floor time.

Send today for illustrated brochure 243/J2

POWER JACKS
LIMITED
MAYLANDS AVENUE · HEMEL HEMPSTEAD
TEL: BOXMOOR 3800 GRAMS: NEWSORBER, HEMEL HEMPSTEAD

Berco/BPT Line Voltage Regulators* hold the voltage

to within $\pm 1\%$

(28 STANDARD SIZES—1-115 KVA)

Berco/B.P.T. Voltage Regulators are at work in transmitting stations . . . at international airports . . . on ocean going liners . . . wherever designers want a strong, reliable unit for accurate voltage control. Berco/B.P.T.'s team of consultant engineers are always at your service. Study the features below, and you'll agree our Line Voltage Regulators prove Berco/B.P.T. know how!

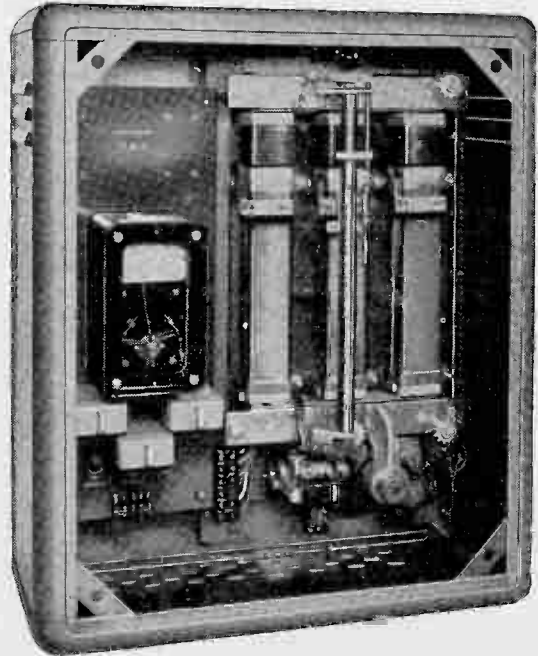

* BERCO/B.P.T. Line voltage regulators. Ask for List 606.

- 1 Voltage held to within $\pm 1\%$.
- 2 Unaffected by variations in supply volts, load, load power factor, frequency.
- 3 No wave form distortion.
- 4 28 standard ratings cover 1 KVA to 115 KVA.
- 5 Oil immersed and air cooled types.
- 6 Standard designs ensure good delivery.

BERCO/B.P.T. pioneered this type of Line Voltage Regulator . . .

BERCO/BPT KNOW HOW

THE BRITISH POWER TRANSFORMER CO., LTD.,
in association with

THE BRITISH ELECTRIC RESISTANCE CO., LTD.,
QUEENSWAY · ENFIELD · MIDDLESEX

Telephone: HOWord 2411 : Telegrams: Vitrohm, Enfield

BR 1411

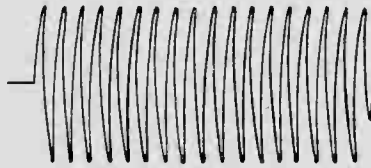

Another outstanding new instrument*

Shorts

LOW-FREQUENCY DECADE OSCILLATOR

This oscillator has been designed for testing servo-mechanisms and electrical systems where inputs of extremely low distortion and accurate amplitude are essential. It employs three drift-corrected computing-type amplifiers to generate a sinusoidal oscillation in the range 0.01 to 110 c/s, according to the setting of the 3-decade frequency control. "Step" and "Ramp" functions may also be generated, and the total distortion is less than 0.5%.

* By the same team that designed the Shorts General Purpose Analogue Computer

All enquiries to:

SHORT BROTHERS & HARLAND LTD.

Computer Sales Department 208a Regent Street, W.1. REGent 8716

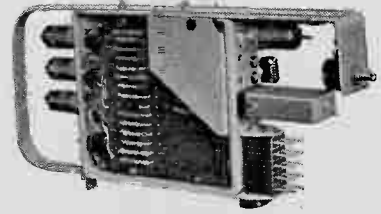

One of the three printed circuit drift-corrected plug-in amplifiers used in the Oscillator.

A New Wide Range Delayed Square Pulse Generator

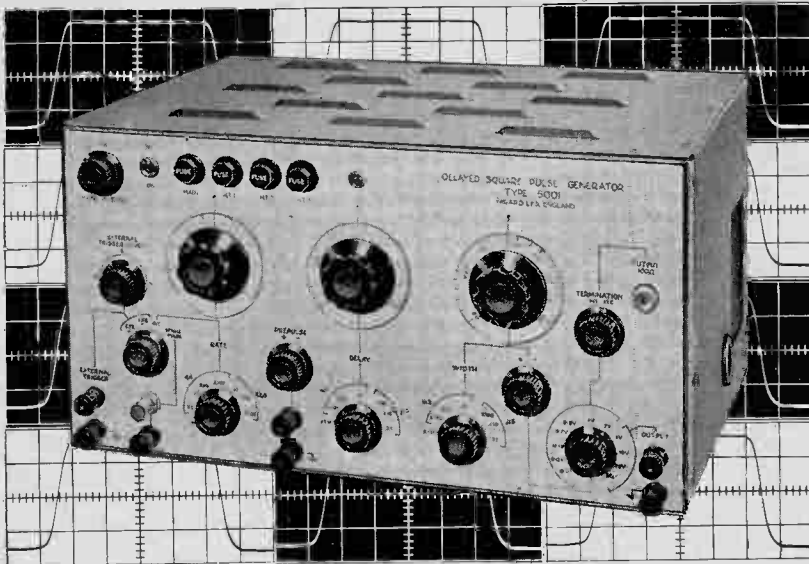

SINGLE PULSE MODEL 5001
DOUBLE PULSE MODEL 5002
WITH ACCURATE TIME & VOLTAGE CALIBRATIONS

RISE TIME 10 mμsec independent of pulse width

SQUARE WAVE OUTPUT—0.25 c/s to 2.5 Mc/s
Waveforms show 0.2 μsec pulse on 25 cm/μsec sweep
10 million to 1 range of pulse rate, width and delay calibrated by direct reading dials within 5%

INTERNAL MULTIVIBRATOR of new type gives highly stable frequencies continuously variable from 0.1 c/s to 1 Mc/s

EXTERNAL TRIGGER from signals of any waveform and polarity at amplitudes down to 0.2 V and frequencies up to 2.5 Mc/s

SINGLE PULSES at any range setting by push button

DELAY OF PRE-PULSE to main pulse—jitter free and continuously variable from 0.2 μsec to 2 secs
Pre-pulse output 20 volts positive or negative—0.2 μsec wide

MAIN PULSE amplitude—20 mV to 50 V positive or negative

MODEL 5002 has the same characteristics but can produce either single pulses or two consecutive pulses separated by the delay interval
This will shortly be available, and is a most useful instrument for computer development

★ **OUTPUT VOLTAGE**
CALIBRATED TO WITHIN ± 2%

Negligible overshoot on any range—no sag on long pulses. Width continuously variable from 0.2 μsec to 2 secs. ± 5%. The most accurate and versatile box of pulses yet made available to electronic engineers.



NAGARD LIMITED, 18 Avenue Road, Belmont, Surrey

Telephone VIGilant 9161/2

VALVE RETAINERS

Electrothermal Valve Retainers are available to fit any type, make or size of valve. Whatever the problem, a suitable Valve Retainer can always be supplied. Inter-Service type approved, they can be specified and used with confidence. Write now for your copy of Electrothermal Valve Retainer and Data Manual.

Also available—
Precision Resistors, Valve Cap Connectors, C.R.T. Connectors Wiring Jigs, Heating Mats for Telemetering Equipment, Heat Dissipators for sub-miniature valves, etc.

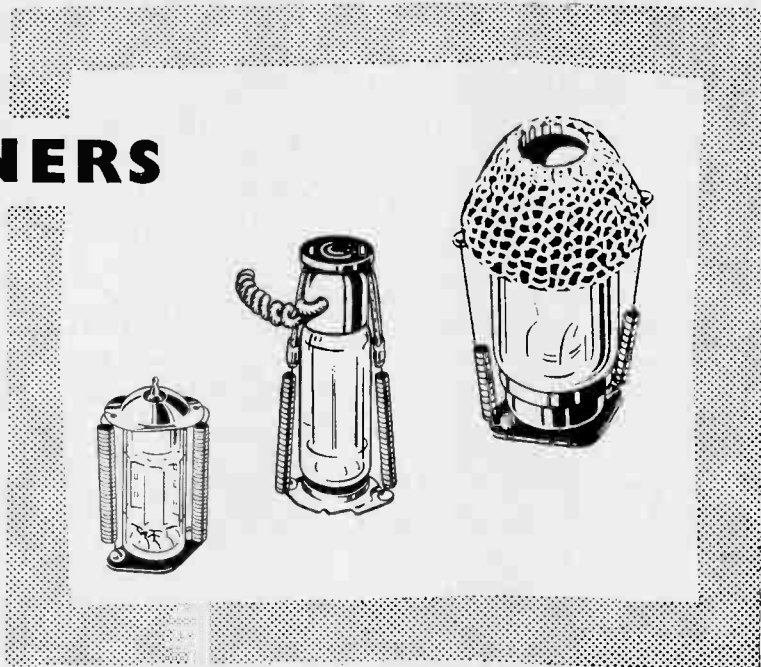

Please request leaflet

ELECTROTHERMAL



ENGINEERING LIMITED, 270 NEVILLE ROAD, LONDON, E.7 GRAngeWood 9911

Precision Potentiometers...

- ★ S.E.I. Metal cased Precision Potentiometers cater for the stringent requirements of the electronic and aircraft industries. Robust and reliable under adverse conditions, they incorporate a specially designed wiper and slipping assembly which combats vibration and reduces starting torque.
- ★ A special clamping ring can be supplied which enables the body of the Potentiometer to be adjusted to any angular position before fixing. By a similar arrangement, up to six units can be ganged on a single shaft, yet independent phasing of the units can still be achieved.
- ★ Special insulated terminal seals are used for exterior connections.
- ★ A wide range of resistance values is available.
- ★ We shall be pleased to consider any special requirements. Write for leaflets.

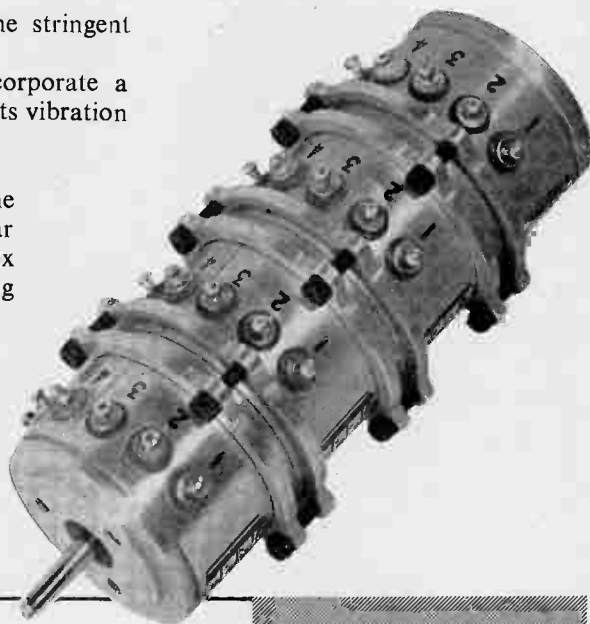

SALFORD ELECTRICAL INSTRUMENTS LTD.

Peel Works · Silk St · Salford 3 · Lancs · Tel. Blackfriars 6688

London Sales Office: Tel: Temple Bar 4669

A SUBSIDIARY OF THE GENERAL ELECTRIC CO. LTD. OF ENGLAND

G.E.C.



L.F. PHASE METER TYPE 206

THIS instrument has been designed to enable measurements of gain and phase-shift to be made on four-terminal networks operating in the frequency range 20 c/s-100 kc/s. Phase is indicated directly on a six-inch meter having four scales and the gain or loss values are indicated by the difference between two attenuator settings.



- Frequency Range:** 20 c/s to 100 kc/s
- Accuracy:** $\pm 2^\circ$ from 100 c/s to 20 kc/s
 $\pm 5^\circ$ at other frequencies
- Input Level:** 1 mV to 1V
- Difference in Input Level:** Up to 60 db
- Input Impedance:** 12 Mohms
- Attenuators:** Calibrated 50 db step and 10 db slidewire attenuators with an accuracy of ± 0.2 db for each 10 db.

Full details of this or any other Airmec instrument will be forwarded gladly upon request

AIRMec

L I M I T E D

H I G H W Y C O M B E

B U C K I N G H A M S H I R E

Telephone High Wycombe 2060

Cables Airmec High Wycombe

TEST KEYS

Double-press key with change-over contacts and hold-down knob. Unused and in excellent condition. Price £3 15 0

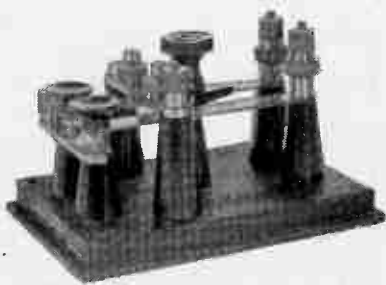

LOW INDUCTANCE RESISTANCE BOX



4-decade, range 0 to 11110 ohms
Nominal Accuracy 0.1%.
Unused and in excellent condition.
Price £10 10 0

Z & I AERO SERVICES LTD

14 South Wharf Road, Paddington, London, W2
Telephone AMBassador 0151/2

THE WORLD'S GREATEST BOOKSHOP

FOYLES

★ ★ FOR BOOKS ★ ★

FAMED CENTRE FOR

Technical Books

JOIN THE SCIENTIFIC BOOK CLUB!
You buy Books published at 10/6, 12/6, 15/-
and more for *ONLY* 4/- Write for details.

119-125 CHARING CROSS ROAD, LONDON, WC2
GERrard 5660 (20 lines) Open 9-6 (including Saturdays)
Two minutes from Tottenham Court Road Station



A.I.D.

Approved

- TRANSFORMERS** of all types up to 25 KVA for Single or Three Phase operation, Phase conversion, etc.
- MAINS** Output and Special Purpose Transformers for Radio Equipment; Chokes, etc.
- COILS** for Contactors, E.M. Brakes, Air Valves, etc., and coil WINDINGS for all purposes.
- SOLENOIDS** for A.C. and D.C. Operation.

W. F. PARSONAGE & CO LTD
INDUCTA WORKS
PARK RD BLOXWICH WALSALL
TELEPHONE: BLOX. 66464

NOW IN FULL PRODUCTION

VACUUM



SINTERED PERMANENT MAGNETS

*for
all Industries*

Write for literature
and samples



DARWINS LTD

TELEPHONE SHEFFIELD 49049

TELEX No. 54-215

FITZWILLIAM WORKS · TINSLEY · SHEFFIELD · 9 · ENGLAND

D.91.

No other PRECISION WIRE-WOUND RESISTORS have all these features

1 Available manufacturing tolerances down to $\pm 0.05\%$ at 20°C . $\pm 2^\circ\text{C}$.

2 Overall stability after consecutive tests under extreme conditions (see below) better than 0.10% —normally 0.05% , or better.

3 Temperature coefficients $\pm 0.12\%$ or $\pm 0.02\%/^\circ\text{C}$., or negligible (using manganin wire).

4 Rugged hermetically sealed construction featuring:—

(a) Robust plated brass case.

(b) Ceramic end seals soldered in, and siliconed to prevent moisture tracking.

(c) Insulation resistance to case $> 10^{10}\Omega$.

5 Lead-out wires are isolated from winding wires by the ERG intermediate floating wire system, and securely soldered to end seals—no strains or stresses can, therefore, be transmitted to the winding.

6 All ERG Tropical Precision Wire-wound Resistors are wound for minimum inductance consistent with a high voltage resistance.

7 Available in seven different sizes, five also with stud fixing—see table—specials and matched pairs manufactured to order.

8 On Ministry Approved Lists.

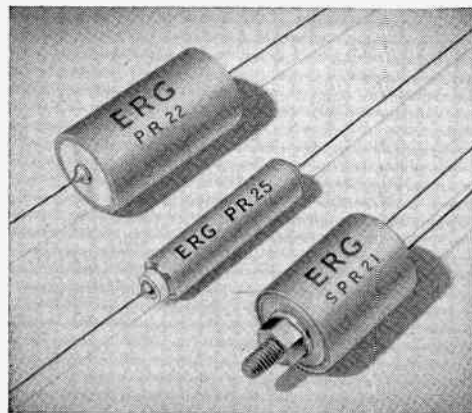

Type		Dimensions		Watts Rating $^\circ\text{C}$.			Range Ω	
Standard	Stud	L $\pm 1/16$	O.D. $\pm 10\%$	20	50	70	Min.	Max.
PR 21	SPR 21	1"	$\frac{3}{8}$ "	0.5	-32	-16	0.1	330K
PR 22	SPR 22	1 $\frac{1}{8}$ "	$\frac{3}{8}$ "	1.0	-65	-32	0.1	500K
PR 22A	SPR 22A	1 $\frac{1}{8}$ "	$\frac{3}{8}$ "	1.0	-65	-32	0.1	750K
PR 23	SPR 23	1 $\frac{3}{8}$ "	1"	1.5	1.0	-5	0.1	2 Meg
PR 24		1 $\frac{7}{8}$ "	$\frac{1}{2}$ "	1.0	-65	-32	0.1	350K
PR 25		1 $\frac{7}{8}$ "	$\frac{1}{2}$ "	0.5	-32	-16	0.1	100K
PR 26	SPR 26	2 $\frac{1}{2}$ "	1"	2.0	1.32	-65	0.1	2.5 Meg

Test	Duration	Spec.	Average % Change
Full DC Load ...	1,000 hours		.013
Tropical Exp. ...	84 days	RCS II	.027
Climatic Cycles ...	6 Cycles	RCS II Climatic	.01
Tropical Exposure +			
Light DC Load ...	2,500 hours	RCS III	.02
Voltage Tests ...	After 3 months		No change

● These tests have been carried out consecutively over a three-year testing period and total average change is less than 0.05%.



Other products include Vitreous Coated, Silicone & Glass Bond, and Carbon Resistors.

ERG INDUSTRIAL CORPORATION LTD · 18 MANCHESTER STREET · LONDON · W.1 · Tel: WELbeck 8114/5

Precision heat treatment of electronic valve components

Used by leading manufacturers in the electronic industry, the Royce High Temperature Hydrogen Furnace provides for precision heat treatment of nickel, chrome, tungsten, molybdenum and other special alloys. Suitable for temperatures up to 1750°C. Pure alumina lining and insulation. Hydrogen atmosphere throughout. Automatic or hand control.

For details write for leaflet RF.5

ROYCE ELECTRIC FURNACES LTD

Designers and manufacturers of furnaces, ovens and kilns for all industries
SIR RICHARD'S BRIDGE · WALTON-ON-THAMES · SURREY

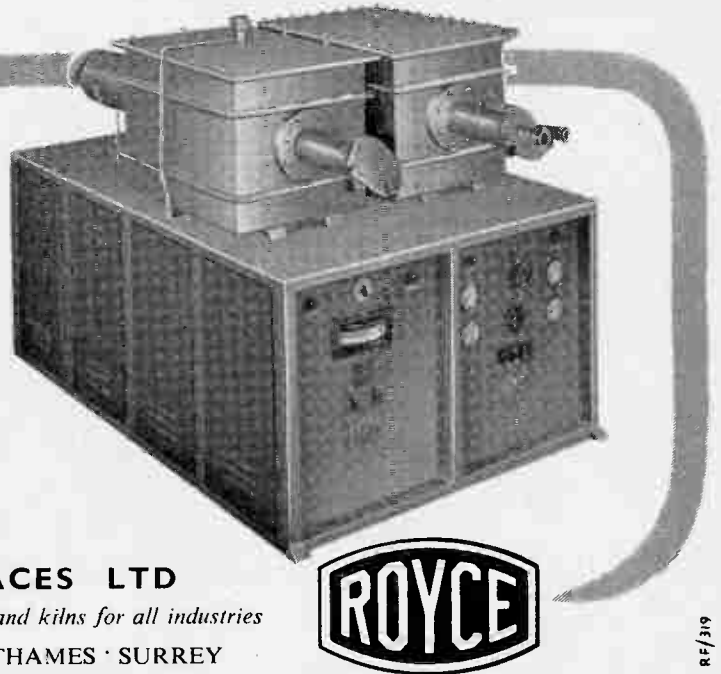

RF/39

The following vacancies exist in the

EDISWAN-MAZDA

Applications Laboratories

1. **CIRCUIT DEVELOPMENT ENGINEERS**
for Television Receiver Problems
2. **CIRCUIT DEVELOPMENT ENGINEERS**
for Sound Receiver Problems
3. **ENGINEERS**
for Development Work on U.H.F.
4. **ENGINEERS**
for Development Work on Transistor Circuits and their application in the Industrial and Entertainment fields
5. **ENGINEERS**
for Development Work on Valve Circuits and their application in the Industrial and Entertainment fields
6. A vacancy also exists in connection with the preparation of Technical Data for Publication

The above Laboratories are very well equipped with the most up-to-date facilities and provide congenial working conditions. Owing to the expanding interests, excellent prospects are available for suitable candidates.

Starting salaries in accordance with experience, qualifications and age.

Candidates with engineering or physics degree, H.N.C., or equivalent qualifications, should apply in writing to the Personnel Superintendent, Siemens Edison Swan, Ltd., Brimsdown, Enfield, Middlesex. Applications will be treated as confidential.

DIPLOMATIC WIRELESS SERVICE FOREIGN OFFICE

Applications are invited from qualified candidates to fill, by competitive interview, the following posts in the North Buckinghamshire area:

ONE SENIOR SCIENTIFIC OFFICER TWO SCIENTIFIC OFFICERS

Candidates must be British subjects or citizens of the Irish Republic born within the Commonwealth or in the Irish Republic of parents born within those territories.

The Senior Scientific Officer should possess Honours Degree in Physics or Engineering, or equivalent qualifications, and have at least three years' experience of working on Radio or Electronic Equipment.

Scientific Officers should possess similar qualifications.
Salary Senior Scientific Officer £1,078 rising to £1,265 per annum.

Salary Scientific Officers £565 rising to £995 per annum.

QUALITY CONTROL INSPECTOR

Candidates must be over 21 years of age and have experience in Testing Radio and Electronic Equipment.

Pay for 44-hour week 182s. 4d. plus a merit award up to a maximum of 70s. 0d. per week, depending upon skill and ability.

Closing date for applications ten days from the appearance of this advertisement.

Write, giving age, qualifications and experience to:

**Chief Establishment Officer,
Diplomatic Wireless Service,
Foreign Office,
London, S.W.1**

ELECTRONIC & RADIO ENGINEER

CLASSIFIED ADVERTISEMENTS

Advertisement Rates. 6d. per word, minimum charge 6/-, each paragraph charged separately. Remittances payable to Iliffe & Sons Ltd., Dorset House, Stamford St., S.E.1. Series discount of 15% is allowed for 12 consecutive insertions.

Box Numbers are available at an additional charge of 2/- to defray cost of registration and postage. Replies should be addressed Box No. 0000, c/o "Electronic & Radio Engineer", Dorset House, Stamford Street, London, S.E.1.

Semi-Display advertisements with centralized lines £1/15/- per single column inch—no additional charge for Box Numbers. The Publishers are not responsible for clerical or printers' errors although every care is taken to avoid mistakes.

Press date for the March 1958 issue is first post 21st February 1958

SITUATIONS VACANT

COMMONWEALTH OF AUSTRALIA Patent Office EXAMINERS OF PATENTS

APPLICATIONS are invited for permanent positions as Examiners of Patents, Grade I (LA1,043-LA1,493), in the Australian Patent Office to undertake the official scientific, technical and legal work in connection with Patent Applications.

VACANCIES exist for Electronic (Computer, Television or Radar) Engineers or Scientists, Telephone Engineers, Organic Chemists and Mechanical Engineers.

APPLICANTS must have an appropriate degree or diploma or have achieved a professional qualification, e.g. A.M.I.Mech.E., A.M.I.E.E. or A.R.I.C.

COMMENCING salary will depend on qualifications and experience and will not exceed LA1,313 per annum. Advancement beyond LA1,313 is dependent upon passing prescribed Patent Law examinations. Further opportunities exist for promotion to Grade 2, Grade 3 and Supervising Examiner (LA1,993). All salaries are in Australian currency and will commence from the date of embarkation.

ALL appointments are for Canberra. A limited number of new unfurnished houses are available on a rental basis for married appointees, and modern guest house accommodation will be provided for other successful applicants.

ASSISTED passages can be arranged by the Commonwealth Immigration Authorities in London for successful applicants and, if married, their wives and dependent children.

APPLICATION form and further particulars may be obtained from The Public Service Board Representative, Australia House, Strand, London, W.C.2.

EARLY application is advised. [1168]

CHIEF Telecommunication Engineer required by Iraqi Ports Administration, Basrah, on contract for one year in first instance. Total emoluments, including salary, allowances and Provident Fund contributions equivalent to £1,940 a year for single man and up to £1,988 a year for family man. Free passages. Liberal leave on full salary. Candidates should possess A.M.Brit.I.R.E. and 1st class P.M.G. Cert., or C. & G. Final Cert. in Radio Communications and 1st class P.M.G. Cert. or A.M.I.E.E. with specialist knowledge of telecommunication work. They should also have a working knowledge of I.C.A.O. Operational (Aviation Wireless) requirements. Write to the Crown Agents, 4 Millbank, London, S.W.1. State age, name in block letters, full qualifications and experience and quote M2C/42590/EO. [1161]

PHYSICISTS and Electronic Engineers. Applications are invited for the following interesting and progressive posts:

- Servo Engineer—for work on the analysis and synthesis of servos connected with a missile guided system. Experience in servo-theory is essential.
- Systems Engineer—for the design and development of missile guidance systems.
- Electronic Engineer—for design and development work on missile fire control systems. An interest in pulse circuitry and transistor techniques is desirable.

FOR the above posts a degree, or equivalent, is required, with a minimum of two years' experience in industry. Applicants should be capable of taking some technical responsibility, and controlling the activities of one or two assistants.

STARTING salary would depend upon qualifications and experience. Further progress in salary and status would be determined by ability to take responsibility.

APPLICANTS should write to The Personnel Manager (Ref. 149C), de Havilland Propellers, Ltd., Hatfield, Herts. [1162]

SITUATIONS VACANT

SOUTH AFRICAN COUNCIL FOR SCIENTIFIC AND INDUSTRIAL RESEARCH NATIONAL TELECOMMUNICATIONS RESEARCH LABORATORY

APPLICATIONS are invited for the post of Assistant Research Officer at the above Laboratory in Johannesburg. Candidates should hold a university degree in Mathematics or Physics. Duties include the compilation of ionospheric data and the preparation of radio propagation predictions.

FURTHER details and application forms are obtainable from the South African Scientific Liaison Officer, Africa House, Kingsway, London, W.C.2. [1165]

AN Electronic Engineer, aged 25-30, is required by the Development and Research Department of Crompton Parkinson, Limited. The work, which gives scope for originality, covers a wide field of industrial electronic applications, including speed control of machines and development of special purpose instruments, etc. A degree or equivalent is essential. Apply with full particulars and salary required to Reference WE, Crompton Parkinson, Limited, Chelmsford, Essex. [1171]

SALES Engineer required with connections in the Electrical and Electronics Industry, for Sales Office engaged in the marketing of Relays and similar Electro-mechanical Devices. Duties will consist of evaluating customers' requirements by correspondence and by personal contact. Applicants should possess H.N.C. or equivalent and have had previous sales experience. Pension and Bonus Scheme after qualifying period. Write giving full details of experience, age, etc., to Personnel Manager, Telephone Manufacturing Co., Ltd., Martell Road, West Dulwich, S.E.21. [1169]

SENIOR Supervising Technician required by East African Land Forces Organisation for service with civilian staff in Kenya. Appointment on contract for one tour of 24-45 months in first instance. Salary scale (including inducement pay) £1,215 rising to £1,566 a year. Commencing salary according to age, qualifications and experience. Gratuity at rate of 13 1/3% of total salary drawn. Outfit allowance £40 payable in certain circumstances. Free passages. Liberal leave on full salary. Candidates, 30-50 years of age, must have served apprenticeship in electrical engineering, be able to supervise the inspection and repair of telecommunication equipment and instruments, and be fully conversant with military fire control and telecommunication equipment. Preference will be given to candidates who are Corporate Members I.E.E. Write to the Crown Agents, 4 Millbank, London, S.W.1. State age, name in block letters, full qualifications and experience and quote M2C/42471/EO. [1164]

ASSISTANT Engineer Grade II required by East African High Commission Directorate of Civil Aviation on probation for pensionable employment. Gross salary according to age and qualifications up to £1,173 a year in scale £813 rising to £1,341 a year. Outfit allowance £30. Free passages. Liberal leave on full salary after each tour 30-36 months. Candidates, who should hold at least two second-year and preferably one third-year C. & G. Certs. in Telecomms. Principles of Radio, must have had at least three years' experience in erection and maintenance of ground station transmitters, radio and radar navigational aids and aerial systems. Up-to-date knowledge of workshop practice and teleprinter and perforator equipment essential. Experience of diesel electric power plant maintenance an advantage. Write to the Crown Agents, 4 Millbank, London, S.W.1. State age, name in block letters, full qualifications and experience and quote M2C/42260/EO. [1166]

SITUATIONS VACANT

BURY ST. EDMUNDS TECHNICAL INSTITUTE

APPLICANTS are invited for appointment from 1st September, 1958, as assistant Grade B (salary £650 x £25—£1,025) for Radio and Television Servicing Work to Final C. & G. level. Industrial experience in Radio work is essential and teaching experience desirable.

FORMS of application and further information from the Principal, Technical Institute, Grove Road, Bury St. Edmunds, Suffolk, to whom completed forms should be returned as soon as possible. [1170]

BOOKS, ETC.

"LAPLACE Transforms for Electrical Engineers." By B. J. Starkey, Dipl. Ing., A.M.I.E.E. A presentation of the theory of the Laplace transformation in which a physical vocabulary rather than a purely mathematical one is used as far as possible in an attempt to attain the utmost simplicity. This method of analysis has become of increasing importance to electrical engineers in many fields during recent years, and the work is designed to provide a thorough treatment of the subject in a language with which they will be familiar. 30s. net from all booksellers. By post 31s. 2d. from the publishers: Iliffe & Sons, Ltd., Dorset House, Stamford Street, London, S.E.1.

"ABACS or Nomograms." By A. Giet. Translated from the French by H. D. Phippen and J. W. Head. Most engineers have made use of nomograms at some time in their careers, and are fully alive to the fact that they are a very convenient tool when the same formula has to be solved repeatedly for several sets of variables. It is fair to say, however, that only a small proportion of even those who habitually employ nomograms know how to construct them for their own use. Most of the comparatively small literature on the subject is written for mathematicians and is extremely difficult for the practical engineer to comprehend. This book is essentially practical, and not only demonstrates the many and varied applications of the abac or nomogram, but shows how even those without highly specialised mathematical knowledge may construct their own charts. 35s. net from all booksellers. By post 36s. from the publishers: Iliffe & Sons, Ltd., Dorset House, Stamford Street, London, S.E.1.

"TELEVISION Engineering: Principles and Practice." Vol. III: Waveform Generation. By S. W. Amos, B.Sc. (Hons.), A.M.I.E.E. and D. C. Birkinshaw, M.B.E., M.A., M.I.E.E. The third volume of a comprehensive work on the fundamentals of television theory and practice, written primarily for the instruction of B.B.C. Engineering Staff. This volume gives the application in television of sinusoidal, rectangular, sawtooth and parabolic waves and shows the mathematical relationship between them. The main body of the text is devoted to the fundamental principles of the circuits commonly used to generate such signals, the treatment being largely descriptive in nature and therefore less mathematical than that of the previous volume. The work is intended to provide a comprehensive survey of modern television principles and practice. 30s. net from leading booksellers. By post 31s. from Iliffe & Sons, Ltd., Dorset House, Stamford Street, London, S.E.1.

SERVICE

ASSEMBLY and Winding Capacity Electronic Equipment supervised by technicians experienced in modern technique applicable to computers, V.H.F. and high voltage oscillatory circuits. D.T.V. Contracts Dept., 134/136 Lewisham Way, New Cross, S.E.14. Tideway 6666, Ext. 1. [1046]

SERVICE

TRANSDUCTORS, magnetic amplifiers and automatic control equipment manufactured to customers' requirements. Let us develop and produce the complete equipment for you. Moderate charges, prompt service and delivery. Able Engineering Co., Ltd., 6 Singer Street Chambers, Singer Street, London, E.C.2. Tel.: CLE 3695. [1163]

STEEL SHELVING

100 bays of brand new adjustable STEEL SHELVING, 72" high x 34" wide x 12" deep, stove enamelled bronze green. Sent knocked down, 6-shelf bay—£3 15s. 0d.

Sample delivered free.

N. C. BROWN LTD.

EAGLE STEELWORKS

HEYWOOD, LANCS. Telephone 69018

RESEARCH AND DEVELOPMENT

Physicists or electrical engineers are required for research and development work with an organisation in outer North-east London area manufacturing industrial and marine instruments.

Commencing salary range:
£1,000-£1,400

Qualifications:

Preferably an honours degree. Some years' experience of research and development in electronics and telecommunications.

Experience in ultrasonics or light mechanical engineering would also be an advantage.

A contributory pension scheme is available, and assistance in housing or removal expenses may be given in suitable cases.

Applications, which may be made in strictest confidence, should give full details of qualifications, previous experience, age and salary required, and be addressed to Box 3960, c/o *Electronic & Radio Engineer*.

SERVICE

WINDING capacity available at very competitive rates. Quick delivery. Multi-winding, relay winding, layer winding and wave winding. Also automatic wire cutting, stripping, soldering and tagging of bare and P.V.C.-covered lead wires. Nesco Products, Ltd., 149 Stanwell Road, Ashford, Middlesex. Tel.: Ashford, Middlesex 3555/2640. [1167]

OLD-ESTABLISHED PUBLIC COMPANY wishes to acquire interest in business in Greater London Area manufacturing electrical instruments and/or electronic equipment.

Existing management retained.

Write in confidence to Box No. 3971,
c/o *Electronic & Radio Engineer*.

METROPOLITAN-VICKERS ELECTRICAL COMPANY LTD.

DEVELOPMENT ENGINEERS

for

ELECTRONICS DEPARTMENT

Graduate Engineers or Physicists with two or more years experience in the field of microwave techniques or microwave receiver systems are required for theoretical or practical work in the development laboratories of the Radar Division. Applicants are requested to write, quoting reference F.10, to:

Personnel Manager
Metropolitan-Vickers Electrical Co., Ltd.
Trafford Park
Manchester, 17

TRANSISTOR and PRINTED CIRCUIT COMPONENTS

Radio Components:

The rapid development of transistors and printed circuit techniques has given rise to an interesting field for design and application of new components for these fields. Permanent, pensionable posts are offered to development engineers wishing to undertake advanced development work of this kind. The company's laboratories, situated in the London area, are fully equipped and offer agreeable working conditions. Write to Box No. 3736, c/o "E. & R.E.", details of age, experience and qualifications, which will be regarded as strictly confidential.

Anderton

Cyfil Circlips
stock ranges
from 1/16" to 15"



TYPE 1300



TYPE 1400



TYPE 1500

Write for DATA SHEETS
to Dept. A.3, ANDERTON
SPRINGS LTD., BINGLEY

Telephone: 2388, 2351 & 2226
Telegrams: Circlips, Bingley

CIRCLIPS

A.I.D., A.R.B., I.F.V. approved

Index to Advertisers

	PAGE		PAGE		PAGE
Adcola Products, Ltd.	26	Foyle, W. & G., Ltd.	34	Plessey, Ltd.	17
Advance Components, Ltd.	7	General Electric Co., Ltd., The	4	Power Controls, Ltd.	11
Aero Research, Ltd.	16	Goodmans Industries, Ltd.	2	Power Jacks, Ltd.	31
Airmec, Ltd.	34	Institute of Radio Engineers	21	Rola-Celestion, Ltd.	5
Anderton Springs, Ltd.	38	Kelvin & Hughes, Ltd.	38	Royce Electric Furnaces, Ltd.	36
Appointments Vacant	36, 37, 38	London Electric Wire Co., Ltd.	30	Salford Electrical Instrument Co., Ltd.	33
Belling & Lee, Ltd.	25	Lyons, Claude, Ltd.	1	Salter, Geo., & Co., Ltd.	4A, 4B
British Electrical Resistance Co., Ltd.	31	Magnetic Devices, Ltd.	6	Servomex Controls, Ltd.	3
British Insulated Callender's Cables, Ltd.	Cover ii	Marconi Instruments, Ltd.	20	Short Bros., & Harland, Ltd.	32
British Thomson-Houston Co., Ltd.	27	Metropolitan-Vickers Electric Co., Ltd.	38	Siemens Edison Swan, Ltd.	18, 36
Brown, N. C., Ltd.	38	Microwave Instruments, Ltd.	31	Solartron Electronic Group, Ltd.	9
Clarke, H., & Co. (Manchester), Ltd.	30	Mullard, Ltd.	15, 24	Steatite & Porcelain Products, Ltd.	10
Darwins, Ltd.	35	Multicore Solders, Ltd.	Cover iv	Telegraph Condenser Co., Ltd.	Cover iii
Diplomatic Wireless Service	36	Nagard, Ltd.	32	Telephone Mfg. Co., Ltd.	29
Dubluer Condenser Co. (1925), Ltd.	22	Newmarket Transistor Co., Ltd.	12	Thomas, Richard & Baldwin, Ltd.	13
Electrical Instrument Co. (Hillington), Ltd.	28	Parsonage, W. F., & Co., Ltd.	34	Tinsley, H., & Co., Ltd.	28
Electrothermal Engineering, Ltd.	33	Plessey Components, Ltd.	8	Unbrako Socket Screw Co., Ltd.	14
ERG Industrial, Ltd.	35			Wilkinson Tool Co., Ltd.	26
Ferranti, Ltd.	19			Z & I Aero Services, Ltd.	34

Printed in Great Britain for the Publishers, Iliffe & Sons, Ltd., Dorset House, Stamford Street, London, S.E.1, by Gibbs & Bamforth, Ltd., St. Albans. Distributed in U.S.A. by Eastern News Company, 306 West 11th Street, New York, 14.

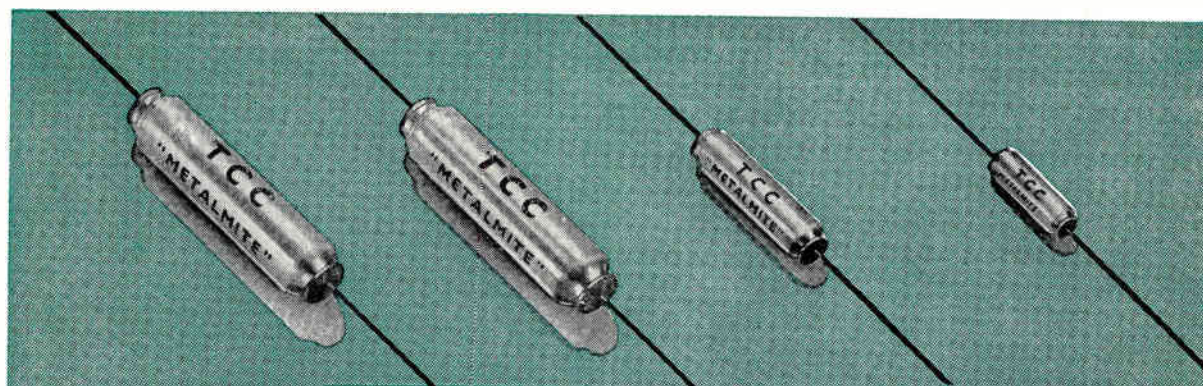

SUPER TROPICAL "METALMITES"

The T.C.C. "Metalmite" ranges of condensers set a new standard both for compactness and ability to withstand extreme tropical conditions: satisfactory insulation resistance is maintained after extensive tests at 100°C. and 100% humidity, thus conforming to the requirements of Government specification R.C.S. 131. "Metalmites" are suitable for use in miniature receivers and transmitters, hearing aids, and in the most compact types of portable equipment.

Their construction is of the well-proved T.C.C. technique of winding non-inductively layers of paper dielectric to each solid aluminium foil, all impregnated under vacuum, and finally hermetically sealed in aluminium tubes with synthetic rubber bungs. Plastic protective sleeving can be supplied if required.

Capacity tolerance $\pm 25\%$
Temperature range $-40^{\circ}\text{C. to } +100^{\circ}\text{C.}$

SUPER TROPICAL "METALMITES"

Capacity $\mu\text{F.}$	Working Volts D.C.		Dimensions in inches		Type No.	List Price Each
	At 70°C.	At 100°C.	L.	D.		
.001	1,000	650	$1\frac{1}{8}$.34	CP49W	1/10
.002	1,000	650	$1\frac{1}{8}$.34	CP49W	1/10
.001	500	350	1	.2	CP30S	1/9
.005	500	350	1	.25	CP32S	1/10
.01	500	350	1	.34	CP33S	1/10
.05	500	350	$1\frac{1}{8}$	$\frac{7}{16}$	CP37S	2/1
.01	350	175	1	.25	CP32N	1/8
.02	350	175	1	.34	CP33N	1/9
.05	350	175	$1\frac{1}{8}$	$\frac{8}{16}$	CP35N	2/-
.1	200	100	$1\frac{1}{8}$	$\frac{8}{16}$	CP36H	2/2

SUPER TROPICAL MINIATURE "METALMITES"

.0002	500	350	$\frac{11}{16}$.2	CP110S	2/-
.0003	500	350	$\frac{11}{16}$.2	CP110S	2/-
.0005	500	350	$\frac{11}{16}$.2	CP110S	2/-
.001	350	175	$\frac{11}{16}$.2	CP110N	2/-
.002	350	175	$\frac{11}{16}$.22	CP111N	2/-
.005	200	100	$\frac{11}{16}$.22	CP111H	2/-
.01	200	100	$\frac{11}{16}$.25	CP112H	2/-
.01	350	175	$\frac{11}{16}$.34	CP113N	2/2

DETAILS OF COMPLETE RANGES AVAILABLE ON REQUEST

CONDENSER SPECIALISTS
SINCE 1906

THE TELEGRAPH CONDENSER CO. LTD

RADIO DIVISION • North Acton • London W3 • Tel: ACO rn 0061

British made SAVBIT now helps U.S.A. manufacturers

* Below is part of an advertisement from the U.S.A. "Electronics"

Now ready!

SAVBIT

A SPECIAL ALLOY AVAILABLE ONLY IN ERSIN



FIVE-CORE SOLDER

Simplified Explanation

	Before Soldering	During Soldering	After Soldering
In soldering with straight tin/lead alloys...	Tin/Lead Solder + Copper Tip Solder contacted by copper tip...	Molten Tin/Lead/Copper + Copper Tip absorbs tip metal to saturation...	Tin/Lead/Copper Joint + Copper Tip and wears out tip rapidly!
Whereas... In soldering with new SAVBIT ALLOY...	Tin/Lead/Copper Solder + Copper Tip Copper-saturated SAVBIT solder...	Molten Tin/Lead/Copper + Copper Tip cannot borrow copper from the iron...	Tin/Lead/Copper Joint + Copper Tip which recovers hardly any wear.

THIS EXPLAINS HOW SAVBIT ALLOY STOPS THE WEARING OUT OF COPPER TIPS

Two years ago, Multicore introduced a special alloy for soldering silver-plated ceramics, containing a 2% silver content, so that it would not absorb silver from the ceramic. The same patented principle has now been applied to prevent the copper of soldering iron tips being absorbed into solder alloys! Until now, incorporation of copper in a solder alloy to more than 0.3% of the tin content was discouraged, since it was believed that copper might slow the flow of solder in making seams. An extensive investigation under actual working conditions on television assembly lines has now proven that a copper-loaded alloy does not effect the speed of soldering, when making the joints which form 98% of the soldering processes in the assembly and manufacture of all electronic equipment.

WEAR OF COPPER TIPS

Most engineers have presumed that the wear of copper soldering iron tips used on

assembly lines was caused by (1) oxidation of the copper due to heat, (2) attack of the flux on the copper bit, and (3) absorption of the copper from the tip into the tin of the solder alloy. However, these investigations have proven conclusively that reasons (1) and (2) are not the explanation.

On the other hand, comparative tests between Ersin Multicore Solder with the new SAVBIT copper-loaded alloy, and solders containing pure tin/lead alloys have indicated that a reduction of about 9/10 in tip wear can be achieved by the use of SAVBIT ALLOY! It is a fact that the tip of an iron which needs resurfacing after 1,000 joints with normal tin/lead alloys can last for 10,000 or more similar joints before requiring resurfacing, using Ersin Multicore SAVBIT ALLOY. (See illustration.) Therefore, it is hardly necessary to emphasize the great economies that can be effected in soldering iron maintenance by using this new alloy. Equally important, a higher

standard of soldering is guaranteed throughout the life of the iron, because it stays in first class condition much longer!

CHARACTERISTICS AND SPECIFICATIONS

SAVBIT ALLOY is now available in Ersin Multicore 5-core solder, containing non-corrosive extra-fast Ersin Flux, in 14, 16 and 18 gauge.

MELTING POINT: Virtually the same as standard tin/lead alloys.

ELECTRICAL CONDUCTIVITY, TENSILE AND SHEAR STRENGTH: No appreciable difference between SAVBIT and normal tin/lead alloys. Strength of SAVBIT slightly greater.

IMPORTANT

SAVBIT is one of a number of alloys developed for the industry by Multicore. In addition to SAVBIT, Ersin Multicore, the world's finest cored solder, is also available in all the standard tin/lead alloys and diameters, in 1 lb. cartons and 7 lb. reels. Multicore contains 5 cores of exclusive, high speed, non-corrosive Ersin Flux. This great solder, so widely-limited, has never been equalled for speed of operation, effective prevention of rejects and, in the long run, lowest cost for superior results.



SAVBIT ALLOY has been impressively proven on the assembly lines of England's greatest manufacturers. We will be pleased to furnish testimonials.

Address U.S.A. inquiries on company letterhead to Dept MS167

MULTICORE SALES CORPORATION
PORT WASHINGTON, N. Y.

Canadian Inquiries:
CHARLES W. POINTON LTD.
& Alton Ave., Toronto, Canada

Inquiries regarding other territories:
MULTICORE SOLDERS LTD.
Hemel Hempstead Herts., England

SAVBIT FOR FACTORIES



Available on 7 lb. and 1 lb. reels in 14, 16 and 18 s.w.g. Bulk prices on application. Please write for Technical Information.

SAVBIT FOR SERVICE ENGINEERS



Approx. 170ft. of 18 s.w.g. on a reel. Packed in a carton.
15/- each (subject)
Cat. Ref. R18SAV.



SAVBIT CARTONS

5/- each (subject)

Cat. Ref.	S.W.G.	App. L'gth.
CI SAV 14	14	20 ft.
CI SAV 16	16	30 ft.
CI SAV 18	18	53 ft.



BIB WIRE STRIPPER AND CUTTER

3/6 each (subject).

BIB RECORDING TAPE SPLICER
For the professional and amateur recording enthusiasts.

16/3 each (subject).



MULTICORE SOLDERS LTD., MULTICORE WORKS, HEMEL HEMPSTEAD, HERTS. (BOXMOOR 3636)