

WIRELESS ENGINEER

THE JOURNAL OF RADIO RESEARCH & PROGRESS

AUGUST 1954

VOL. 31

No. 8

THREE SHILLINGS AND SIXPENCE

The PERFECT TEST TEAM



RADIO SHOW

Stand **61**

EARLS COURT
Aug. 25—Sept. 4



The illustration depicts a set of modern "AVO" testgear being used to measure the "Q" of the secondary winding of the second I.F. transformer on a chassis of unknown characteristics—just one of many tests which can be performed by this combination of instruments.

A signal of predetermined frequency from the "AVO" Wide Range Signal Generator is being fed into the Electronic Test Unit, where it is amplified and fed to the secondary winding of the transformer. The Electronic Testmeter is connected across the tuned circuit under test and from the readings obtained and the controls of the Electronic Test Unit, the "Q" of the circuit can be determined.

The three instruments, shown as a team, cover a very wide field in measurement and form between them a complete set of laboratory testgear, ruggedly constructed to withstand hard usage.



ELECTRONIC TESTMETER

A 56-range instrument combining the sensitivity of a delicate galvanometer with the robustness and ease of handling of an ordinary multi-range meter. Consists basically of a highly stable D.C. Valve Millivoltmeter free from mains variations and presenting negligible load on circuit under test. Switched to measure:—

D.C. Volts: 5mV to 14,000V.
D.C. Current: 0.5μA to 1 Amp.
A.C. Volts: 1V to 2,500V R.M.S.
up to 2 Mc s.
1V to 250V R.M.S.
up to 200 Mc s.

A.C. Power Output: 5mW to 5 Watts.
Decibels: -10db to 20db.
Zero level 50 mW.
Capacitance: 0.001μF to 50μF.
Resistance: 20hm to 10 Megohms
Operates on 100-130v. and 200-260v.
50-60 c/s A.C. Mains.

£40



ELECTRONIC TEST UNIT

For measuring small values of A.C. voltage, inductance, capacity, and "Q" at radio frequencies. Although designed primarily for use with "AVO" instruments, it can be used with any suitable Signal Generator Valve Voltmeter combination.

As a Wide Range Amplifier, it is capable of an amplification factor of 40. 2-12db between 30c/s and 20 Mc s.

As a Capacitance Meter, it covers measurements at radio frequency from 5pF to 300pF in two distinctly calibrated ranges.

As an Inductance Meter, it gives direct measurements from 5μH to 50mH in six ranges.

As a "Q" Meter, it indicates R.F. coil and condenser losses at frequencies up to 20 Mc s.
Operates on 100-130v. and 200-260v.
50-60 c/s A.C. mains.

£27



WIDE RANGE SIGNAL GENERATOR

An instrument of wide range and accuracy for use with modern radio and television circuits. Turret coil switching provides six frequency ranges covering 50 Kc/s to 80 Mc s.

Range 1. 50 Kc/s—150 Kc/s
2. 150 Kc/s—300 Kc/s
3. 500 Kc/s—1.5 Mc s
4. 1.5 Mc s—5 Mc s
5. 5-5 Mc s—80 Mc s
6. 20 Mc s—80 Mc s

Accuracy to within 1% of scale marking. Gives sensibly constant signal of good wave-form, modulated or unmodulated, over entire range. Minimum signal less than 1μV at 20 Mc s and less than 3μV between 20 and 80 Mc s. Gives calibrated output from 1μV to 50mV.

Operates on 100-130v. and 200-260v.
50-60 c/s A.C. Mains.
Battery-operated model also available.

£30

Sole Proprietors and Manufacturers:—

THE AUTOMATIC COIL WINDER & ELECTRICAL EQUIPMENT CO., LTD.
WINDER HOUSE · DOUGLAS STREET · LONDON · S.W.1

Telephone: VICTORIA 3404 9

NEW edition of this **INVALUABLE CATALOGUE** plus a unique service

This 258 page Catalogue is published every two years. It is invaluable to the Research Engineer, Works Production Manager, Professor or other worker. It is Entirely Free.

Your written application also automatically places you on our Monthly Mailing List. This service ensures that you receive regularly the latest information covering Laboratory apparatus for use in the Electrical, Radio, Broadcasting, Telephone Engineering, Cables and Communications, Musical Reproduction, "Talkie," Electrical Recording, Physical and Acoustical Research, and Allied Fields. Over 2,500 Persons or Firms in Great Britain are already on our list.

And now a few words about service. Our unique Monthly Service covers primarily the despatch of "The General Radio Experimenter," a monthly house organ published by "G.R." In this Journal is published all information concerning new "G.R." items, so that all readers are kept abreast of latest developments. In addition there often appear authoritative articles of great importance covering many aspects of laboratory measurements, as well as "production practice."

The "General Radio Experimenter" service is entirely free and there is no expressed or even implied obligation to make purchases. We do, however, request certain reasonable information from applicants for admission, these being: Surname, full Christian Names, full address of employers (if not self employed), and, if possible, type of work or chief interests. Please also state academic qualifications. Additions to our lists are entirely at our discretion.

All applications should be addressed to:

CLAUDE LYONS LIMITED

ELECTRICAL AND RADIO LABORATORY APPARATUS

180, Tottenham Court Road, London, W.1 and 76, Oldhall Street, Liverpool 3, Lancs.



THE "G.R." EXPERIMENTER
IS APPROACHING
ITS 30TH BIRTHDAY

Standard magnetic alloys for component designs of maximum efficiency

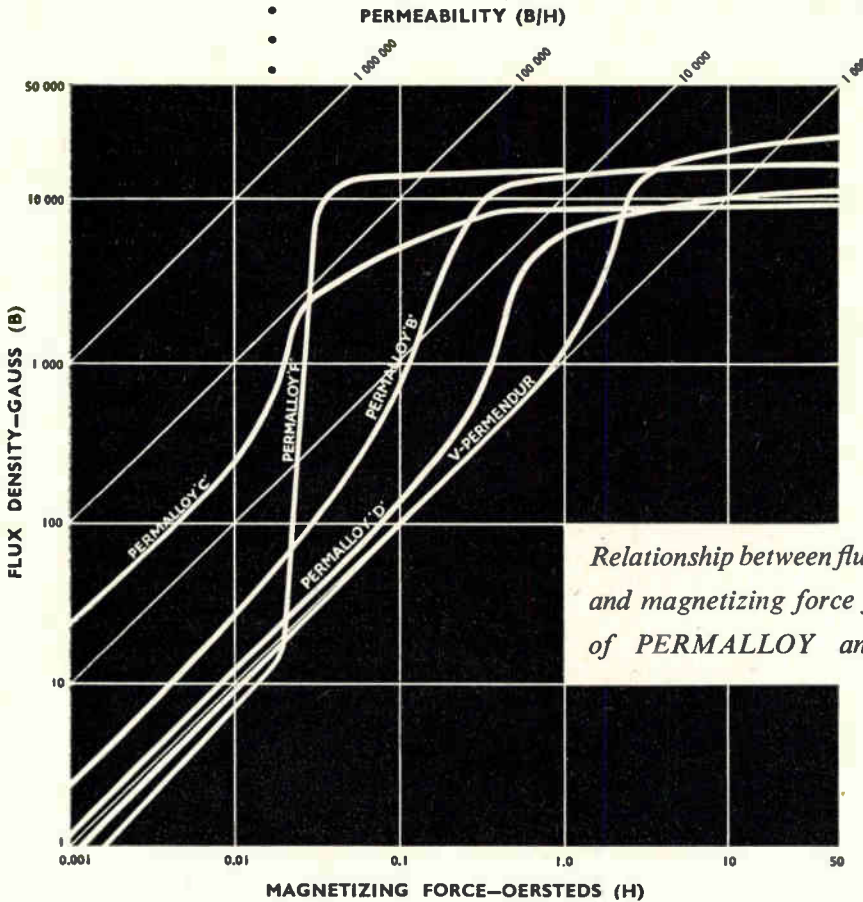

Relationship between flux density, permeability and magnetizing force for the various grades of PERMALLOY and V-PERMENDUR.

Please ask for further particulars.

High quality and consistency, backed by first-class service, are important features in this range of *Standard* magnetic alloys. As large-scale users of Permalloys in communication, electronics and other fields, *Standard* enjoy the unique advantage of observing these alloys under normal working conditions, a factor which has played an important part in their development.



Standard Telephones and Cables Limited

Registered Office: Connaught House, Aldwych, W.C.2

TELEPHONE LINE DIVISION: North Woolwich, London, E.16



Marconi Electronic Counter Type TF 922/1

**Direct reading up to
one million impulses
per second**

Type TF 922/1 is an a.c. mains operated, direct reading six-decade instrument either for counting a million periodic or random impulses at rates up to one million per second, or for the measurement of time intervals up to one second in microsecond steps.

The indication is given by illuminating the appropriate translucent figure in each of six vertical rows of 0 to 9 at the front of the instrument.



CAPACITY: Up to 999,999 units as counter, or to 0.999,999 sec. as timer; resolution time 1 microsec.

ACCURACY: As a counter, 100%. The tolerance when measuring time intervals is 1.0 microsec.

POWER SUPPLY: 200 to 250 volts, 40 to 100 c/s, approx. 200 watts.

MARCONI INSTRUMENTS

SIGNAL GENERATORS · BRIDGES · VALVE VOLTMETERS · Q METERS · WAVEMETERS
FREQUENCY STANDARDS · WAVE ANALYSERS · BEAT FREQUENCY OSCILLATORS

MARCONI INSTRUMENTS LTD · ST. ALBANS · HERTS · TELEPHONE: ST. ALBANS 6160/9

Midland Office: 19 The Parade, Leamington Spa

Northern Office: 30 Albion Street, Kingston-upon-Hull

Export Office: Marconi House, Strand, London, W.C.2.

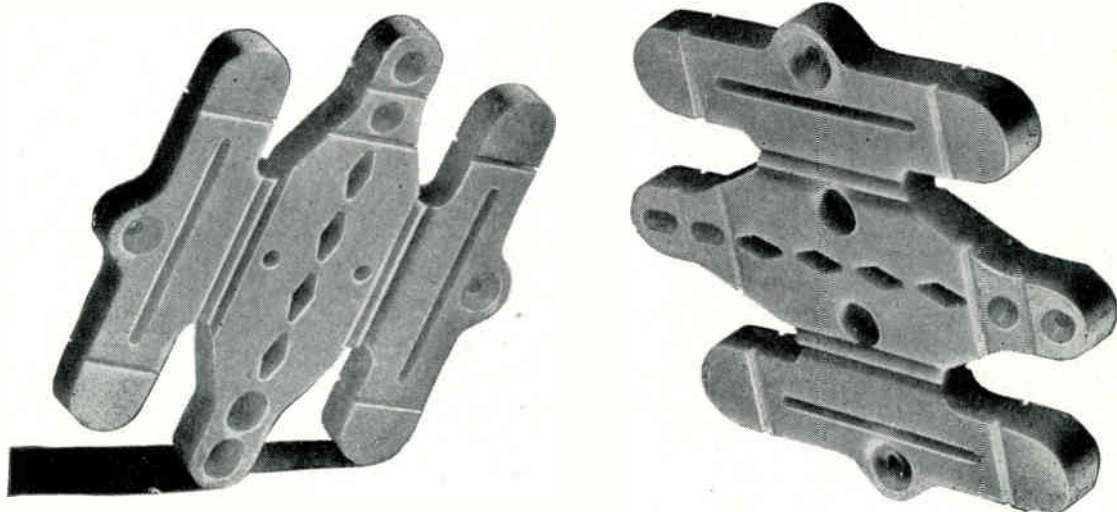

**from every
point of view**

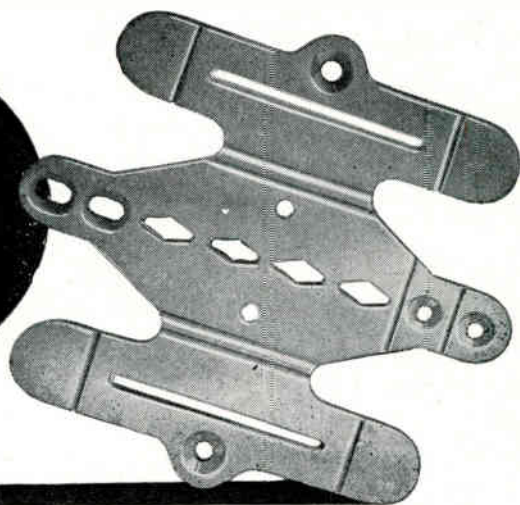

'Frequentite' is the most suitable insulating material for all high frequency applications. Seventeen years ago we introduced the first British-made low-loss ceramic, and consultation with us before finalising the design of new components is a wise precaution.

STEATITE & PORCELAIN PRODUCTS LTD.

Head Office: Stourport-on-Severn, Worcestershire. Telephone: Stourport 111. Telegrams: Steatins, Stourport



S.P.66

NEW Multi-Purpose Oscilloscope



TYPE 531

You just plug in the proper vertical preamplifier to have at your service a wide-band dc oscilloscope, a wide-band high-gain oscilloscope, a wide-band dual-trace oscilloscope, or a differential-input high-gain dc oscilloscope. The Type 53-Series Plug-In Units are small, weigh less than 6 lbs. each, and you can change them in a few seconds.

This new instrument is designed to make your oscilloscope dollar go farther. Development of additional plug-in units already in progress will increase the versatility of the Type 531, and assure its modernity well into the future. *But your greatest gain is the many hours of valuable engineering time you save through its use.*

OSCILLOSCOPE CHARACTERISTICS

24 Calibrated Sweeps

0.1 $\mu\text{sec}/\text{cm}$ to 5 sec/cm . Accurate 5-x magnifier permits calibrated sweep times to 0.02 $\mu\text{sec}/\text{cm}$. Sweep continuously variable from 0.02 $\mu\text{sec}/\text{cm}$ to 12 sec/cm . Sweep calibration accurate within 3%.

New Cathode-Ray Tube

Tektronix T51P metallized CRT has helical post-accelerating anode; deflection-plate leads are brought out of the neck.

DC-Coupled Vertical Output Amplifier

Designed for use with any of the Type 53-Series Plug-In Units.

Balanced Delay Network

Provides 0.25- μsec vertical signal delay.

Horizontal Input Amplifier

Sensitivity 0.2 v/cm to 20 v/cm , continuously variable.

Internal or External Triggering

Amplitude level selection or automatic triggering.

Amplitude Calibrator

Square wave, 0.2 mv to 100 v in 18 steps, accurate within 3%.

DC-Coupled Unblanking

CRT Beam Position Indicators

Electronically Regulated Power Supplies

- Plug-In Vertical Preamplifiers
- 10-KV Accelerating Potential
- 600,000,000 to 1 Sweep Range
- Direct-Reading in Time and Amplitude
- Versatile Triggering Circuitry

PLUG-IN UNIT CHARACTERISTICS



Type 53A Wide-Band DC Plug-In Preamplifier—dc to 10-mc passband, 0.035- μsec risetime. Sensitivity 0.05 v/cm to 50 v/cm , ac or dc, continuously variable, with nine calibrated steps from 0.05 v/cm to 20 v/cm . Two input connectors with 80-db isolation. Price \$85.

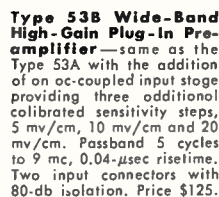

Type 53B Wide-Band High-Gain DC Plug-In Preamplifier—same as the Type 53A with the addition of an oc-coupled input stage providing three additional calibrated sensitivity steps, 5 mv/cm , 10 mv/cm and 20 mv/cm . Passband 5 cycles to 9 mc, 0.04- μsec risetime. Two input connectors with 80-db isolation. Price \$125.

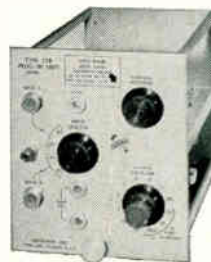

Type 53C Dual-Trace Plug-In Preamplifier—two identical amplifier channels, each with dc to 8.5-mc passband, 0.04- μsec risetime, sensitivity 0.05 v/cm to 50 v/cm continuously variable with 9 calibrated steps from 0.05 v/cm to 20 v/cm . Electronic switching triggered by oscilloscope sweep, or free running at about 100 kc. Polarity reversal switches. Price \$275.

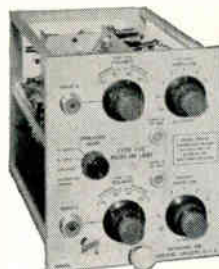

Type 53D Differential High-Gain DC Plug-In Preamplifier—sensitivity 1 mv/cm at dc to 250 kc— with passband increasing to 750 kc at 50 mv/cm and lower. Sensitivity in calibrated steps—1 mv/cm to 50 v/cm , or continuously variable—1 mv/cm to 125 v/cm . Differential input. Price \$145.

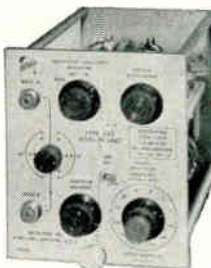

Price \$995 plus price of desired plug-in units
Now in Quantity Production

For complete specifications and shipping schedules call your Tektronix Field Engineer or Representative or write to:



Tektronix, Inc.

P. O. Box 831D, Portland 7, Oregon • Phone: CYPRESS 2-2611 — Cable: TEKTRONIX

ALL PRICES F.O.B.
PORTLAND (BEAVERTON), OREGON



TYPE D-650-A

FEATURES

- Frequency range: I-II,110c/s and IO-III,100c/s.
- Frequency accuracy: $\pm 0.2\%$ or $\pm 0.5c/s$.
- Hourly frequency stability: $\pm 0.02\%$ over most of range.
- Maximum output:
 2W into 8000 ohms above 20c/s.
 50mW into 8000 ohms below 20c/s.
- Harmonic content: 1% at 1W output.
- Hum level: -80db relative to maximum output at 1000c/s.
- Power supply: 200-250V, 50c/s; 90W. or 95-125V, 60c/s; 90W.
- Dimensions: 17½ in. wide x 10½ in. high x 13 in. deep.
 (43.8 cm x 26.7 cm x 33 cm).
- Weight: 83 lb. (38 kg).

The *NEW* Muirhead-Wigan decade oscillator

THIS precision laboratory oscillator, which covers a range of I to III,100c/s with an overall frequency accuracy of $\pm 0.2\%$ or $\pm 0.5c/s$, employs the decade tuning system, by means of which the frequency can be set quickly and accurately on four decade dials and a range switch. This system of tuning ensures the highest possible frequency accuracy and stability. It also enables a given frequency setting to be repeated exactly, and permits the addition or subtraction of a fixed number of cycles per second, thus giving an incremental accuracy of an extremely high order. No other type of oscillator possesses all these advantages.

MAIL THIS COUPON FOR DESCRIPTIVE BROCHURE

NAME _____

POSITION _____

COMPANY _____

ADDRESS to which BROCHURE should be sent _____



MUIRHEAD & CO. LIMITED • BECKENHAM • KENT • ENGLAND

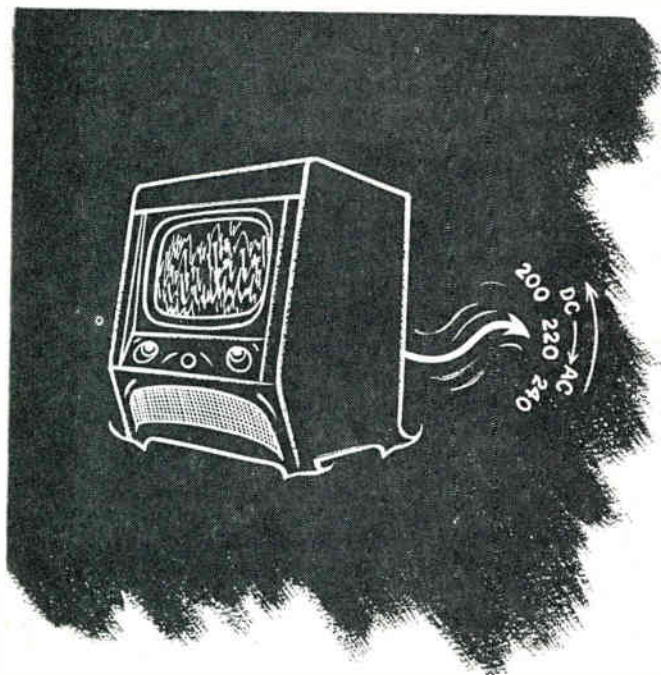

Your Mains Selection!

The current problem is: how to adjust radio and television sets to the prevailing mains supply? Our McMurdo 4-way voltage selector panel (type BVS4) makes short work of conversion. A *safe*, reliable adjustor insulated in bakelite, it features a common connection which can be shorted to *four separate pairs of connections* — very useful when there's a dual adjustment. For test equipment a finer adjustment can be obtained by our *6-way selector panel* available in nylon loaded bakelite.

THE • McMURDO • INSTRUMENT • CO • LTD

Victoria Works, ASHTEAD, Surrey
 Telephone: ASHTEAD, 3401

THE TIMES

and special supplements

THE TIMES has gained a special reputation for its supplements, for the great thing about a supplement is that it should be thorough.

That is why the supplement for the radio industry published separately by THE TIMES on August 23rd will be so well worth reading. The articles, on varied subjects ranging from the radio show and current trends in set design to detailed news of the latest developments in components, will be informative and authoritative to a high degree. Reports on the B.B.C.'s plans for sound and television, a special article on the use of navigational aids in the air and on the sea, communications equipment, electronics as an aid to production, and many other articles of general interest are included.

This supplement of 32 pages published by THE TIMES reviews the radio industry fully and lucidly. Those who serve that industry, and the public in general, will find it stimulating and valuable reading.

THE TIMES

Radio and Television Supplement

Published August 23rd

Price One Shilling

From all newsagents or direct from *The Times*, London, E.C.4, by post for 1s. 2d. inland, 1s. 2½d. abroad. Orders should be accompanied by a remittance.

Visit The Times stand (No. 42) at the Radio Show, Earls Court.

ROLA

.. the speaker you know by ear.

CELESTION

.. the foremost name in sound reproduction.

TRUVOX

.. all that the name implies.

**RADIO SHOW
1954**

STAND No.

3

As leading manufacturers of Loudspeakers over many years, for all commercial and industrial purposes, we shall be "at home" to all our friends as indicated above.

Rola Celestion Ltd.

FERRY WORKS, SUMMER ROAD,
THAMES DITTON,

Telephone: EMberbrook 3402

Who has a headache

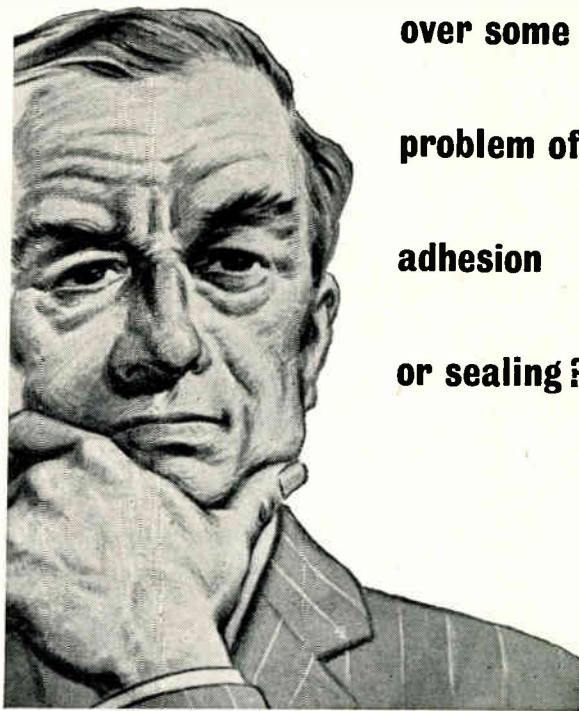

**over some
problem of
adhesion
or sealing?**

There are problems of adhesion and sealing peculiar to the electrical industry. For example, weather-proofing electrical components so that they are absolutely water-tight and oil-resistant—and we do mean *absolutely*. Don't keep these problems to yourself when all the time there might be just the grade of BOSTIK Adhesive or PRESTIK Sealing Strip to save the day. Write to us. Tell us everything you feel we should know. Then leave the rest to us. We have a technical representative in your area who will visit you at short notice on request.

100 to 1 the remedy is

Bostik

ADHESIVES & SEALING COMPOUNDS



SEALING STRIP

* Bostik' is the registered trademark of
B. B. CHEMICAL CO. LTD., Ulverscroft Rd., Leicester,
to whom all enquiries should be addressed.



LAMINATIONS FROM ALPHASIL GRAIN-ORIENTED STEEL,

0.013" in thickness, for all types of Transformer Cores. Also available 0.0045" in thickness for high-frequency applications. The sheets from which the Laminations are produced, 0.013" in thickness, have the following guaranteed maximum watts losses when tested with the flux path parallel to the direction of rolling, at an induction of 15 kilogauss and a frequency of 50 cycles.

Alphasil 37	maximum 0.51 watts per lb.
Alphasil 40	maximum 0.56 watts per lb.
Alphasil 44	maximum 0.62 watts per lb.

RICHARD THOMAS & BALDWIN LIMITED
Cookley Works, Brierley Hill, Staffs.

Head Office: RTSC HOUSE, PARK ST., LONDON, W.1

for every type of coil

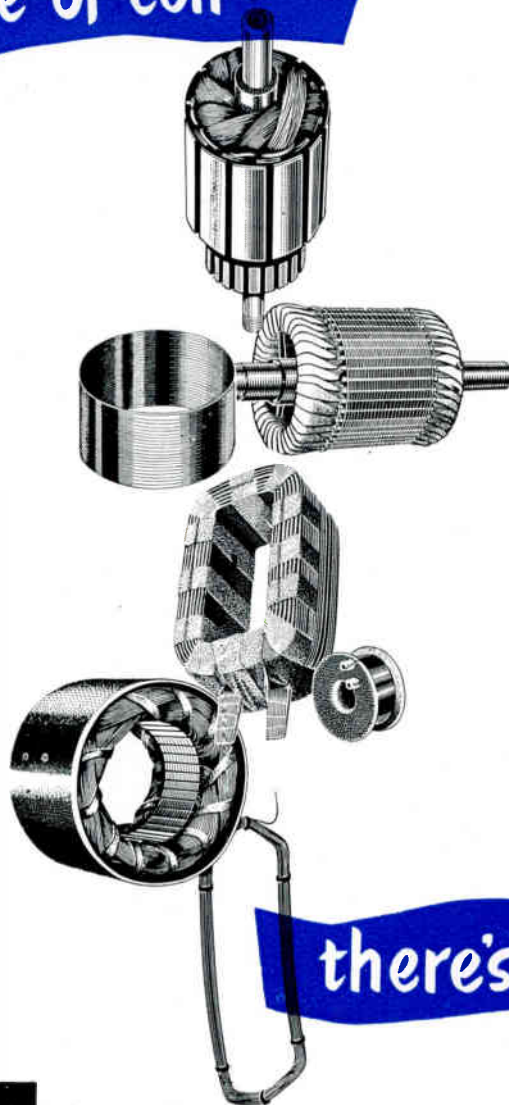

there's a

BICC

WINDING WIRE

USE OUR TECHNICAL ADVISORY SERVICE

If you are faced with a winding problem please ask for assistance; BICC technicians are always willing to give you the benefit of their experience. For most winding wire jobs the Publications listed will provide the data you require. They are available on request.

BRITISH INSULATED CALLENDER'S CABLES LIMITED



No. 266 *Insulated Winding Wires and Strips.*

No. 296 *"Bicaloc" Winding Wires (Self Bonding).*

No. 303 *Enamelled Oil Base Winding Wires.*

No. 322 *"Bicalex" Winding Wires (Synthetic Enamel).*

No. 328 *"Fifty - Three" Enamelled Winding Wires.*

21 Bloomsbury St., London, W.C.1

WIRELESS ENGINEER, AUGUST 1954

AUTOMATIC FREQUENCY MONITOR (20 Mc/s)

Designed for the measurement of any frequency in the range 10 c/s to 20 Mc/s with a basic accuracy of ± 1 part in $10^6 \pm 0.1, 1.0,$ or 10 c/s. Higher accuracies available if required. The unknown frequency is determined by counting the number of cycles that pass through a 'gate' open for a selectable time interval of 0.1, 1.0, or 10 seconds. The result is presented on eight panel mounted meters each scaled 0 to 9 and is in decimal notation. Full information available on request.

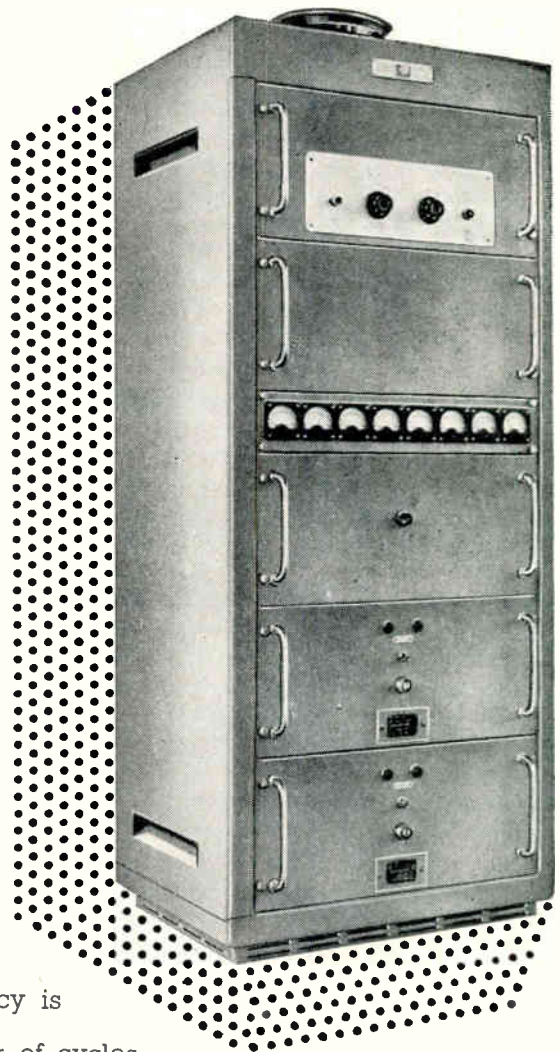

CINEMA-TELEVISION LIMITED

A Company within the J. Arthur Rank Organisation

WORSLEY BRIDGE ROAD · LONDON · SE26

Telephone HITHer Green 4800

SALES AND
SERVICING AGENTS

F. C. Robinson & Partners Ltd.,
287 Deansgate, Manchester, 3

Hawnt & Co., Ltd.,
89 Moor St. Birmingham, 4

Atkins, Robertson & Whiteford Ltd.
100 Torrisdale Street, Glasgow, S.2

Automatic recording of audio frequency and vibration spectra is now possible with our

AUTOMATIC FREQUENCY SPECTRUM RECORDER type 2311

a combination of the Audio Frequency Spectrometer type 2109, equipped with 27 fixed third-octave filters for the standardized main frequencies covering the range from 35 to 18,000 c/s and three weighting networks conforming to ASA and DIN standards, and our High Speed Level Recorder type 2334. The two instruments are connected by means of a chain drive, and the time interval for each individual filter can be selected by means of the gears in the Level Recorder and runs from 0.48 sec. to 1½ hours. Special preprinted recording paper is available to provide a frequency scale directly for the spectra. An example of a complete analysis recorded this way is shown below.

Analysis of an automobile horn

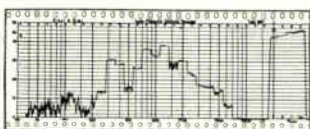

For full details please write to London office:

Rocke International, Ltd.,
59, Union Street, S. E. 1.
Tel: Hop 4567.



Brüel & Kjær

Adr. Nærum, Denmark . Telephone: Nærum 500 . Cable: Brukja, Copenhagen



Quartz Crystals of any shape and size cut and ground precisely to specification and coated, if required, with Gold, Silver, Aluminium or Rhodium, etc.



Brookes Crystals Ltd.

Suppliers to Ministry of Supply, Home Office, B.B.C., etc.
EARLSWOOD STREET, LONDON, S.E.10
Telephone: GREenwich 1828
Grams: Xtals, Green, London. Cables: Xtals, London

4th Ed. Ready this month

RADIO VALVE DATA

For designers, servicemen,
dealers and amateurs . . .

The fourth edition of this reference contains full details of some 2,000 types of British and American radio valves, and 150 cathode-ray tubes.

The main tables give the electrical characteristics of each valve, and separate tables show their base connections. Sub-divisions of the main tables further classify the valves into obsolete, replacement or current types, as recommended by the makers. An index enables any valve to be found in the tables quickly and without trouble. A new feature is the comprehensive list of equivalents.

Published for "Wireless World"

3s. 6d. net By Post 3s. 9d.

Obtainable from booksellers or direct from:—

Iliffe & Sons Ltd., Dorset House, Stamford Street, London, S.E.1

Clearly—you get better pictures with this **ALUMINIZED** cathode ray tube

You cannot beat the new Ediswan Mazda Aluminized Cathode Ray Tubes for picture quality or length of life. Ediswan Aluminizing gives 60% brighter pictures with greater depth of contrast. The improved ion trap tetrode electron gun effectively traps harmful ions within the tube. Ediswan production methods, including the special in-line exhausting process, guarantee a higher, more uniform standard of efficiency. For complete satisfaction recommend Ediswan Mazda cathode ray tubes.

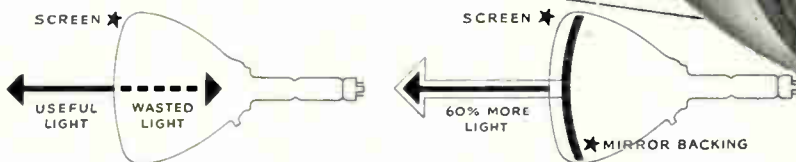
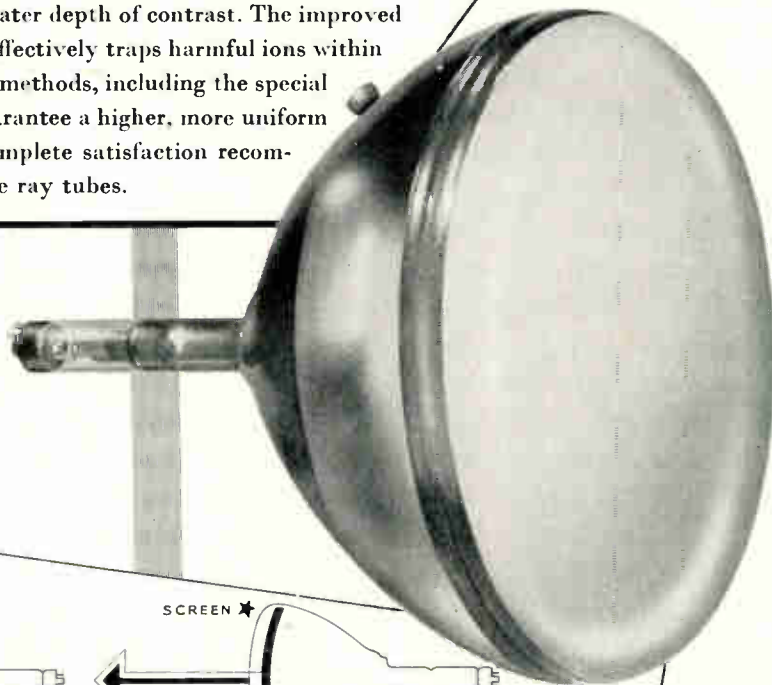

Without Aluminizing

Without Aluminizing, tubes waste half their light by backward reflection. To counteract this the brilliance must be increased which shortens tube life.

With Ediswan Aluminizing

Ediswan aluminized tubes have a mirror backing to the screen. All the light is thus thrown forward giving brighter, clearer pictures, and extra life.

Quicker Service

Ediswan are the only company to have 6 fully equipped cathode ray tube service Depots throughout Great Britain, thus providing better, quicker tube testing should the need arise. Also, 18 Ediswan District Offices carry stocks of tubes.

EDISWAN

MAZDA

ALUMINIZED CATHODE RAY TUBES

THE EDISON SWAN ELECTRIC COMPANY LIMITED
155 Charing Cross Road, London, W.C.2, and branches

Member of the A.E.I. Group of Companies

This is what an

M.R.S.T., Assoc. I.E.E., M.Brit. I.R.E.
F.T.S., A.Mus.T.C.L., M.I.M.I.T. ★

says about the

TRUVOX

TAPE DECK MARK III

"The Truvox Tape Deck is a winner . . . the best I have heard, disregarding the price. . . . a fine piece of precision engineering."

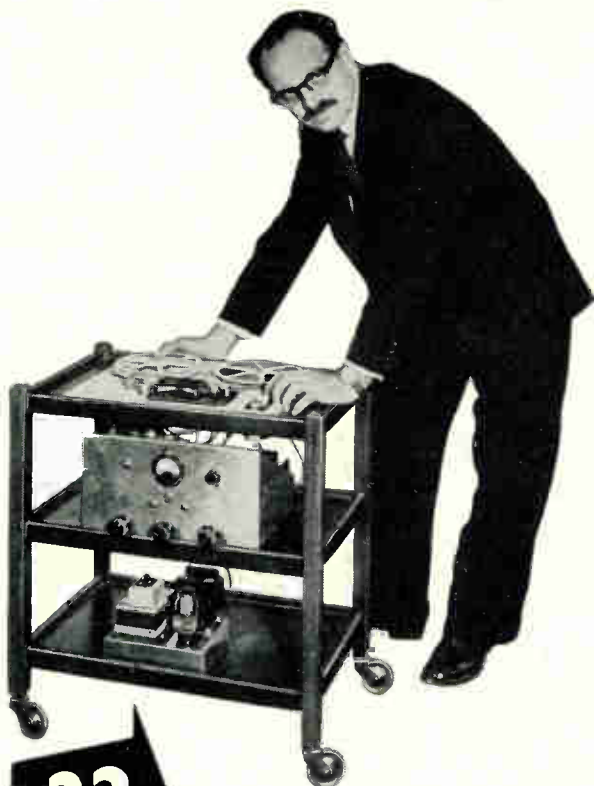

**22
GNS.**

**TRUVOX
PRODUCT**

★ Mr. J. G. C. Gilbert pictured here with his complete "lash up" recorder, is Head of Northern Polytechnic Dept. of Telecommunications Engineering. He is better known to the public as John Gilbert of the B.B.C. Inventors' Club.

The Deck is supplied with complete details of an amplifier specially designed to achieve maximum efficiency.

TRUVOX LIMITED, Sales Office,
15 Lyon Road, Harrow, Middx.

Please send me full details of the TRUVOX Tape Deck Mark III.

Name

Address

W.E.2.

Excellence in design..

Specialists in Sub-miniature Telecommunication Components

**AIR
DIELECTRIC
TRIMMERS**

70pF

Illustration (approx.)
actual size



OXLEY

TYPE APPROVED CAT. A
No. 464

12 Vane type
500 Volts
Width 16.5 mm
Length 22 mm
Height 19 mm
Insulation 10,000 megs.
Power factor less than .001
Temp. Coeff. 50 parts/
million/° C.

DEVELOPMENTS CO. LTD.
ULVERSTON, NORTH LANCs.
Tel. ULVERSTON 3306.

THE **WORLD'S** BEST
PAINT REMOVER

"TIX"

Removes Paint or Even Cellulose
in Minutes. Gloves NOT Required
NON-INFLAMMABLE

READY
FOR
USE

**FREE
TRIAL TIN**
Send 4d. stamp for postage

JUST
BRUSH
ON

DEVON PAINTS LTD.
Dept. T.91
BARNSTAPLE, NORTH DEVON

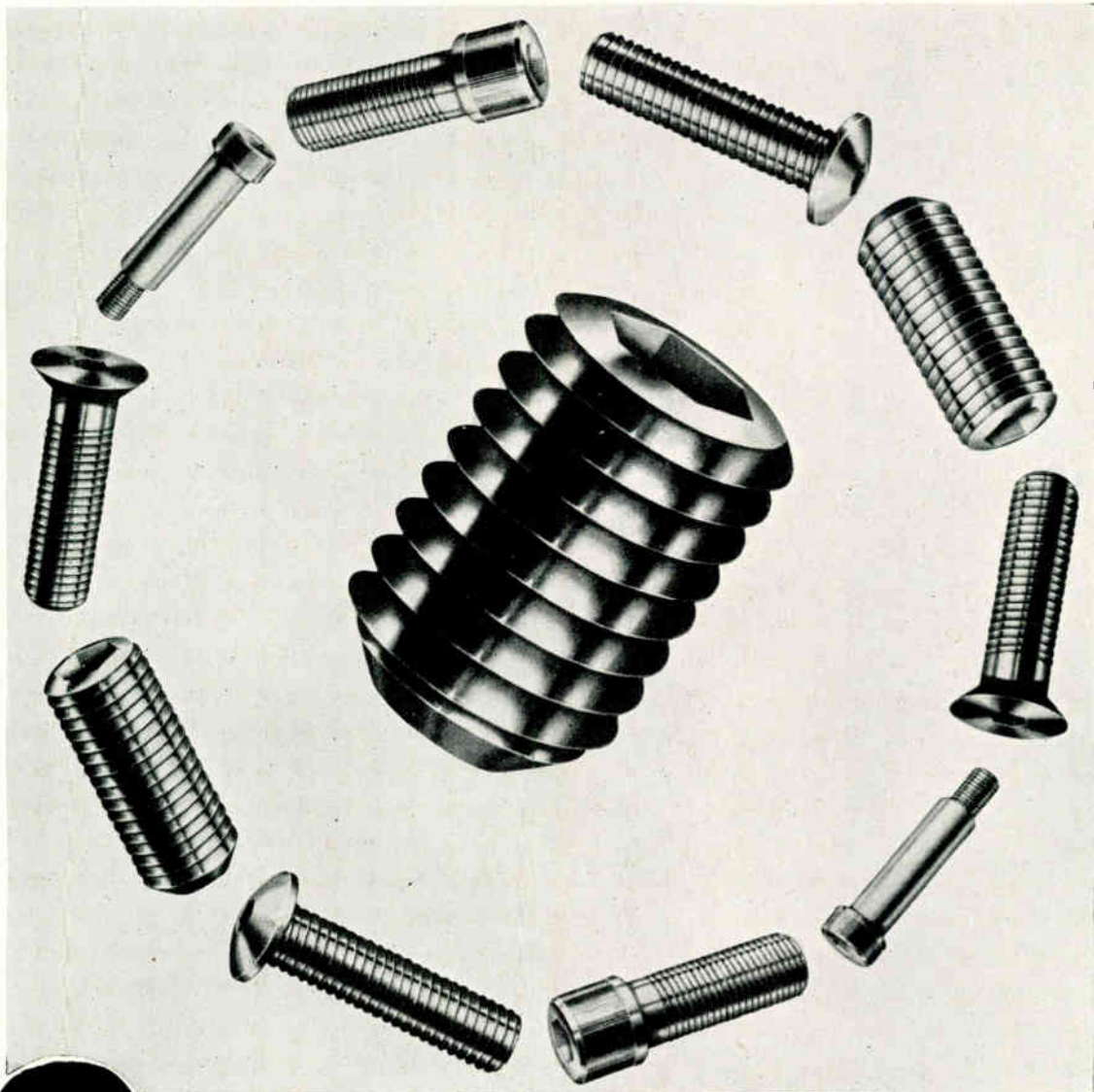

One of the gems in a select circle

UNBRAKO

UNBRAKO set screws—gems of precision and hardness—are relied upon for a thousand and one applications in every branch of engineering. Unbrako screws are made in all standard sizes and threads, and those particularly applicable to the Wireless and Electrical Industries—from 6 BA Set screws and 8 BA Cap screws.

Available from UNBRAKO distributors throughout the world.

**UNBRAKO
COVENTRY**

**SOCKET SCREW CO LTD
ENGLAND**



Mullard Ferroxcube being extruded into rods for H.F. cores.

MAGNETIC MATERIALS

Extensive research and manufacturing facilities have established Mullard as the leading producers of magnetic materials. They were the first, for example, to introduce Ferroxcube, the world's most efficient magnetic ferrite; 'Ticonal' anisotropic permanent magnets, renowned for their high stability and high energy output; and Magnadur, an entirely new type of permanent magnet with the insulating properties of a ceramic.

The wealth of experience gained from these developments is available to all users of magnetic materials through the Mullard advisory service. An enquiry to the address below will put a team of specialised engineers at your disposal.



Mullard

'TICONAL' PERMANENT MAGNETS • MAGNADUR (Formerly Ferroxdure)
PERMANENT MAGNETS • FERROXCUBE MAGNETIC CORE MATERIAL

MULLARD LTD., COMPONENT DIVISION, CENTURY HOUSE, SHAFTESBURY AVENUE, LONDON, W.C.2.

WIRELESS ENGINEER

The Journal of Radio Research and Progress

ESTABLISHED 1923

Managing Editor: HUGH S. POCOCK, M.I.E.E.

Editor: W. T. COCKING, M.I.E.E. Technical Editor: Professor G. W. O. HOWE, D.Sc., LL.D., M.I.E.E.

Editorial Advisory Board:

P. A. T. BEVAN, B.Sc., M.I.E.E. (British Broadcasting Corporation); Professor E. B. MOULLIN, Sc.D., M.I.E.E.; A. H. MUMFORD, O.B.E., B.Sc.(Eng.), M.I.E.E. (G.P.O. Engineering Department); R. L. SMITH-ROSE, C.B.E., D.Sc., Ph.D., M.I.E.E. (Department of Scientific and Industrial Research)

Volume 31 · Number 8

C O N T E N T S

AUGUST 1954

Editorial: Negative Ions in Cathode-Ray Beams ..	195
Van der Pol's Equation by Ziya Akcasu	198
Impedance Transformation by Four-Terminal Networks by S. Fedida, B.Sc.(Hons.)	204
L. F. Compensation for Video Amplifiers—Part 2 by J. E. Flood, Ph.D.	214
Correspondence	222
Standard-Frequency Transmissions	222
Abstracts and References. Nos. 2281—2549	A.161-A.182

Published on the fifth of each month

Annual Subscription: Home and overseas £2 7s. 0d; Canada and U.S.A. \$7.50
(Including Annual Index to Abstracts and References)

Editorial, Advertising and Publishing Offices: Dorset House, Stamford Street, London, S.E.1

Telephone: Waterloo 3333 (60 lines) · Telegrams: Wirenger, Sedist, London

BRANCH OFFICES AT BIRMINGHAM · MANCHESTER AND GLASGOW

POWER

and VERSATILITY

FROM AUDIO TO VERY HIGH FREQUENCIES



QV06-20

TETRODE

Valve requirements of extremely diverse equipments, from servo amplifiers to video modulators, are ideally met by the new Mullard beam tetrode, QV06-20.

This compact and rugged valve with an anode dissipation of 20 watts will function equally well as driver, frequency multiplier, power oscillator or output valve at all frequencies up to 60 Mc/s. With ratings reduced the frequency of operation may be increased to 175 Mc/s.

One QV06-20 as a class "C" amplifier will deliver 52 watts at 60 Mc/s, and two in a class "AB1" push-pull amplifier will provide 82 watts of audio power. The mutual conductance is 7 mA/V, and even with relatively low anode voltages a large output can be obtained with small driving power.

The anode connection of the QV06-20 is brought out to a top cap, and this feature, together with a short metal base screen which is connected to a base pin, ensures excellent separation between input and output.

The QV06-20 is directly equivalent to the popular American 6146. Further details of the QV06-20 and other valves in the comprehensive Mullard range are readily obtainable from the address below.

Heater:	Typical Applications	V _a (V)	P _{out} (W)	f (Mc/s)
V _h 6.3 V	R.F. Power Amplifier	600 320	52 25	60 175
I _h 1.25 A				
Limiting Values:	Class "C" Telegraphy and F.M. Telephony	400	32	60
V _a max. 600 V	Class "C" Anode and Screen-grid Modulated			
P _a max. 20 W	A.F. Power Amplifier or Modulator	600	82	A.F.
V _{g2} max. 250 V	(Two valves.)			
V _{g1} max. -150 V	Class "AB1"	600	90	A.F.
f max. 175 Mc/s	Class "AB2"			
Base Octal.				

Mullard



MULLARD LTD., COMMUNICATIONS & INDUSTRIAL VALVE DEPT., CENTURY HOUSE, SHAFTESBURY AVENUE, LONDON, W.C.2

MVT100

WIRELESS ENGINEER

Vol. 31

AUGUST 1954

No. 8

Negative Ions in Cathode-Ray Beams

IT is nearly twenty years since von Ardenne, who had come up against this problem in the practical development of the cathode-ray tube, published a paper on the subject in *Arch. für Elektrotech.* (p. 731, 1935), and there have since been a number of papers dealing with various aspects of the subject. *Philips Research Reports* for April 1954 contains an article in German by W. F. Niklas in which the subject is discussed and experiments described which were made with tubes specially designed for the purpose. The beam leaving the cathode contains a number of negative ions in addition to the electrons, and if the focusing is purely electrostatic they will both be equally focused on the screen. If, in such a tube, the ions are not so sharply focused, they must have originated from another source such as gaseous collision, and not from the cathode. This does not apply to a magnetic-lens system, which has a negligible effect on the ions. If the deflecting system of a television tube is electro-magnetic it has little effect on the ions, which consequently strike the screen at its centre and deactivate it, causing a dark spot called the ion burn. The article referred to discusses the origin of the ions and the ways in which they can be minimized or rendered harmless.

The experimental tube is shown in Fig. 1; it has an electrostatic focusing system producing a sharply-focused beam of negative ions; just where the beam emerges from the narrow tube, there is

a magnet (7) producing a field of about 2 Wb/cm^2 which deflects the ions to an extent depending on their mass. (9) indicates the path of the electrons which are deflected by the stray field of the magnet (7) and thus eliminated from the beam. The screen material is a mixture of zinc sulphide and zinc-cadmium sulphide, between which and the glass is a transparent metallic layer deposited

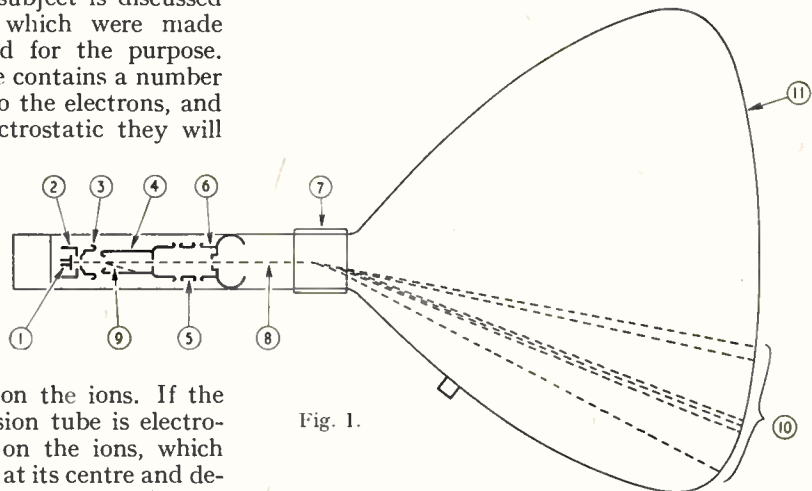

Fig. 1.

on the glass in order to prevent the setting up of any potential differences which might distort the spectrum. The voltage $V_3 = 300 \text{ V}$ and $V_4 = V_6 = 15,000 \text{ V}$; V_5 is adjusted to focus the beam on the screen with a current of about $50 \mu\text{A}$.

In order to interpret the spectra on the screen it is necessary to calibrate a tube. This was done

by dropping HCl on the Ba-Sr carbonate cathode and then in the closed tube converting the carbonate into oxide. A and B in Fig. 2 show the resulting spectra; it was decided that point 1 corresponds to Cl^{37} and point 2 to Cl^{35} ; the greater intensity of point 2 agreed with the isotope ratio, viz. 70 to 80% Cl^{35} and 30 to 20% Cl^{37} . If m and m_x are the masses of two ions and d and d_x the distances of the spectrum points from the centre of the screen then $m_x/m = d^2/d_x^2$. Ions emanating from the cathode should all be focused with equal sharpness; a badly-focused point indicates that the relevant ions originated elsewhere. In Fig. 2 the points 1, 2 and 3 are sharp, whereas points 4, 5 and 6 are blurred (this is not very clear in the reproduction) and the author associates the former

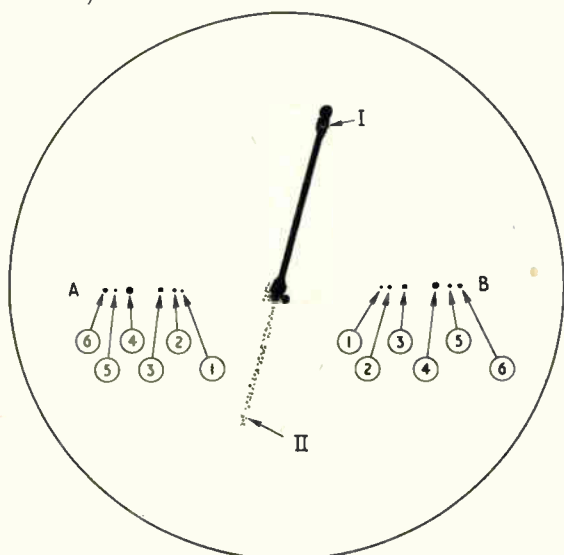

Fig. 2.

with cathode-ions and the latter with gas-ions. The pressure in the tube was about 5×10^{-7} cm. The gas-ions may have originated anywhere between the cathode and the accelerating anode, and therefore cannot focus at the same point, but most of them will be produced between the cathode and the low-voltage anode (3) where the electrons are moving slowly. A tube with specially arranged electrodes was made to test

TABLE

Point	Mass	Composition	Source
1	37	Cl^{37}	Cathode
2	35	Cl^{35}	Cathode
3	26	$\text{CN}, \text{C}_2\text{H}_2$	Cathode
4	16	O	Gas
5	13	CH	Gas
6	12	C	Gas

this point and it was concluded that most of the gas-ions were produced between the Wehnelt cylinder (2) and the 300-V anode (3). They would therefore attain a velocity only 2% less than those originating at the cathode.

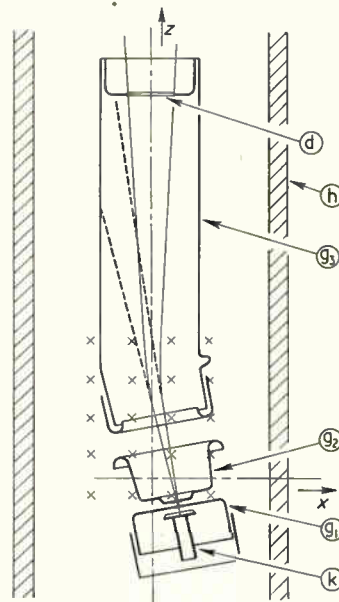

Fig. 3.

From the spectra shown in Fig. 2 the data corresponding to the six points are shown in the table.

If the vacuum is improved by means of a getter the points 4, 5 and 6 disappear when the pressure falls below 10^{-7} cm. If, however, gas is liberated by heating the metal parts of the gun until the pressure rises to 10^{-5} cm, the spectrum obtained is shown as I and II in Fig. 2. Part I is in the direction corresponding to negative ions, and Part II to positive ions. The continuity of the

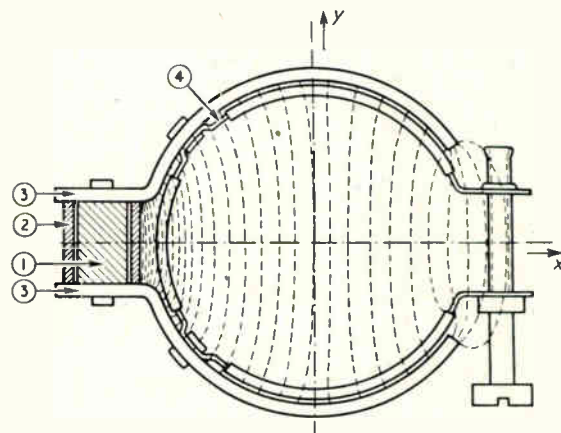

Fig. 4.

spectrum instead of separate points is explained by the continual ionization and the production of tertiary negative ions all along the path of the beam. The secondary positive ions which are responsible for the faint Part II of the spectrum are produced between electrodes (4) and (5) where the electric field is in the direction to accelerate them. Returning to the better vacuum, it is found that after the tube has been running for some hours, points 4, 5 and 6 and also point 3 become fainter; this the author ascribes to the continued action of the getter.

The gas-ions can thus be practically eliminated by thoroughly evacuating the tube or by means of an efficient getter; both gas- and cathode-ions can be reduced by preliminary running of the tube. In his 1935 paper, von Ardenne recommends deflecting the beam electrostatically out of the visible field during the formation period, thus protecting the screen. Niklas says, however, that it is not possible by simple means to remove the Cl components of the spectrum, since the chlorine may be produced by the glass of the tube. The author gives a large number of references to earlier work on the subject; one of these, entitled "negative-ion components in the cathode-ray beam", by Bachman and Carnahan, in *Proc. Inst. Radio Engrs* of 1938, covers much the same ground and provides a useful introduction to the paper by Niklas.

In another paper by the same author, entitled "An Improved Ion-trap Magnet" and published in *Philips Technical Review* for February-March 1954, a well-known device is described for removing the ions from the beam. In the experimental tube in Fig. 1 the electrons were deflected along the path (9) by the magnetic field and thus removed from the beam; in the ion-trap the axis of the electrodes is bent so that the deflected stream of electrons is utilized and the undeflected ions are trapped. This is shown in Fig. 3 where the ions follow the dotted path and strike the inner surface of the electrode while the deflected electrons pass through the opening and along the axis of the tube. The angle of deflection is 11° and it is important that the magnetic field distribution should be such that all the electrons are equally deflected so as to defocus the beam as little as possible. Fig. 4 shows the ordinary type of magnet employed for this purpose and Fig. 5

the new type. In both cases the Ticonal E permanent magnet (1) is surrounded by a bush (2) against which the soft-iron pole pieces (3) are clamped. The device is clamped on the tube by

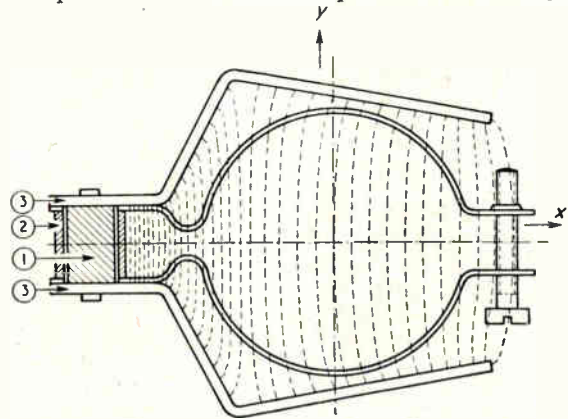

Fig. 5.

means of a non-magnetic padded strap (4) with a screw clamp so that its position can be adjusted. Since the angle of deflection depends on the strength of the magnetic field, it is essential that the strength of the field be uniform over the cross-section of the beam, and it was in order to obtain a more uniform field that the design of the magnet was changed to that shown in Fig. 5. The author says that the quality of the light spot is noticeably improved.

Acknowledgment is made to *Philips Research Reports* and to *Philips Technical Review* for permission to reproduce the illustrations.

G. W. O. H.

"WIRELESS ENGINEER" EDITORIALS

An index to the *Wireless Engineer* Editorials written by Professor G. W. O. Howe has been prepared by Dr. A. J. Small of Glasgow University. It covers the period January 1926 to May 1954 and is in three sections:— Index of titles, chronological; Index of subjects, and Index of names and authors.

As the titles of the Editorials do not fully describe all the subjects treated in them, the Subject Index is fully cross-referenced.

The index comprises 75 pages of quarto size with a limp paper binding, and is obtainable from Dr. A. J. Small, Electrical Engineering Department, The University, Glasgow, W.2, and costs 5s. including postage.

VAN DER POL'S EQUATION

Analytic Method of General Solution

By Ziya Akcasu

(Electronics Department, University of Southampton)

SUMMARY.—A new method for solving a quasi-linear equation of the form $x'' + x = \mu f(x)x'$ is proposed. The solution of the first approximation is obtained; it is compared with those given by others^{1,2,3,4} and found to be identical with them. The method is applied then to the second approximation and yields the interdependence between the amplitude and instantaneous frequency during the transient period. Finally, the effect of the harmonic content is calculated in the transient state as well as in the steady-state. The results are applied to a thermionic generator.

1. Introduction

IN this paper an attempt is made to solve a non-linear equation of the form

$$\frac{d^2x}{dt^2} + x = \mu f(x) \frac{dx}{dt} \quad \dots \quad (1)$$

where μ is a real number assumed to be small compared with unity, and where $f(x)$ is an analytical function of x . This equation represents a typical and general class of non-linear differential equations encountered in electrical circuits containing a non-linear dissipative element. In many applications, however, the original equation obtained directly from the circuit is of the integral form of the above, viz.,

$$\frac{dx}{dt} + \int x dt = \mu F(x) \quad \dots \quad (2)$$

where

$$F(x) = \int f(x) dx \quad \dots \quad (3)$$

$F(x)$ represents the current-voltage characteristic of the non-linear resistive element. As will be seen from the application given at the end of this paper, no constant term appears in this original equation. But generally this integro-differential equation is not suitable because of the integral term. Therefore, it is usually differentiated with respect to t . This leads to the equation (1) which is a special type of the more general non-linear differential equation

$$\frac{d^2x}{dt^2} + x = \mu f\left(x, \frac{dx}{dt}\right) \quad \dots \quad (4)$$

For this equation there exist several quantitative methods yielding approximate solutions.

In these methods it is generally assumed that the solution of the equation is of the form

$$x = a \sin(t + \theta) \quad \dots \quad (5a)$$

where a and θ are unknown functions of t . (For the sake of simplicity of expressions one sets $\omega = 1$, hence works with the normalized fre-

quency; see later.) It is obvious that this is equivalent to

$$x = b_1 \sin t + b_2 \cos t \quad \dots \quad (5b)$$

where b_1 and b_2 are again functions of t . Either of these solutions is substituted into the equation (1) and by this means two auxiliary equations are obtained from which a , θ or b_1 , b_2 can be found.

In this paper the same procedure will be followed, but the solution of 5(a) or 5(b) will be substituted into the equation (2) instead of into equation (1).

2. First Approximation

If the solution of the form 5(a) is substituted into (2) the first term becomes

$$\frac{dx}{dt} = \frac{da}{dt} \sin(t + \theta) + a \left(1 + \frac{d\theta}{dt}\right) \cos(t + \theta) \quad (6)$$

For the second term the integral $\int a \sin(t + \theta) dt$ must be evaluated. For this case, however, it is more convenient to use the solution of the form 5(b); e.g.,

$$\begin{aligned} \int (b_1 \sin t + b_2 \cos t) dt &= -b_1 \cos t + b'_1 \sin t \\ &- \int b''_1 \sin t dt + b_2 \sin t + b'_2 \cos t \\ &- \int b''_2 \cos t dt \quad \dots \quad (7a) \end{aligned}$$

or

$$\begin{aligned} \int [(b_1 + b''_1) \sin t + (b_2 + b''_2) \cos t] dt \\ = (-b_1 + b'_1) \cos t + (b_2 + b'_2) \sin t \quad (7b) \end{aligned}$$

where the dashes show the derivatives with respect to t . So far no assumption has been made about b_1 and b_2 . Now it is assumed that b_1 and b_2 vary slowly with time. As will be seen later, the second derivatives of b_1 and b_2 are of the order of μ^2 . As a first approximation b''_1 and b''_2 will be neglected in comparison with b_1 and b_2 .

Substituting $b_1 = a \cos \theta$, $b_2 = a \sin \theta$ into (7) there results

$$\begin{aligned} \int a \sin(t + \theta) dt &= \left(-a + a \frac{d\theta}{dt}\right) \cos(t + \theta) \\ &+ \frac{da}{dt} \sin(t + \theta) \quad \dots \quad (8) \end{aligned}$$

MS accepted by the Editor, October 1953

The third term gives:

$$F[a \sin(t + \theta)] = \phi_1(a) \sin(t + \theta) + \phi_2(a) \sin[2(t + \theta)] + \dots + \psi_0(a) + \psi_1(a) \cos(t + \theta) + \psi_2(a) \cos[2(t + \theta)] + \dots \quad (9)$$

where ϕ_i, ψ_i are Fourier coefficients of the function $F(a \sin u)$.

By combining the equations (2), (6), (8) and (9) and equating the coefficients of $\sin(t + \theta)$ and $\cos(t + \theta)$ one obtains

$$\frac{da}{dt} = \frac{\mu}{2} \phi_1(a) \dots \dots \dots \quad (10)$$

$$\frac{d\theta}{dt} = \frac{\mu}{2} \psi_1(a) \dots \dots \dots \quad (11)$$

where

$$\phi_1(a) = \frac{1}{2\pi} \int_0^{2\pi} F(a \sin u) \sin u \, du \quad \dots \quad (12a)$$

$$\psi_1(a) = \frac{1}{2\pi} \int_0^{2\pi} F(a \sin u) \cos u \, du = 0 \quad (12b)$$

Here all the harmonic terms have been disregarded.

The equations (10) and (11) are the auxiliary equations from which a and θ are to be solved. From (12b) it follows that $d\theta/dt = 0$; this means that the instantaneous frequency does not change with time.

The equations (10) and (11) are identical with those obtained in a different way by Kryloff and Bogoliuboff.² Nothing will be said in this paper about the stability of this solution since this question is widely investigated in the book just mentioned and also in that by Minorsky.³ But it must be recalled that the equations are obtained by ignoring second derivatives in (7b) and the harmonics in (9). The constant term in (9) represents the well-known detection current due even power terms in $F(x)$. This is also ignored since only the oscillatory solution is considered in this treatment.

3. Second Approximation

To illustrate the effect of the second derivatives of the amplitude, the normal linear differential equation will be first discussed. If it is assumed, that in the equations (2) and (9) $F(x) \equiv x$, then from equations (10) and (11) there follows:

$$\frac{da}{dt} = \frac{\mu}{2} a; \quad \frac{d\theta}{dt} = 0 \quad \dots \quad (13)$$

If a and θ are solved from these equations and substituted in (5a) one obtains

$$x = C e^{\mu t/2} \sin(t + \theta_0) \quad \dots \quad (14)$$

where C and θ_0 are the constants of integration. On the other hand the exact solution of the linear differential equation

$$x'' + x = \mu x'$$

is known to be

$$x = C e^{\mu t/2} \sin \left[\left(\sqrt{1 - \frac{\mu^2}{4}} \right) t + \theta_0 \right] \quad (15)$$

The two solutions (15) and (16) differ in the frequency. This difference cannot be due to the neglect of harmonics, because there are no harmonics in a linear circuit. Hence the discrepancy can only be due to the neglect of the second derivative in equation (7b). To prove this point a solution of the form $x = a \sin(\omega t + \theta_0)$ is substituted in the above linear equation. In this solution ω and θ_0 are constants and a is a function of time which can easily be determined.

The result is

$$\frac{da}{dt} = \frac{\mu}{2} a$$

$$\omega = \sqrt{1 - \frac{1}{a} \frac{d^2 a}{dt^2}} = \sqrt{1 - \frac{\mu^2}{4}} \quad \dots \quad (16)$$

From this it follows that the frequency of linear oscillations depends on the second derivative of the amplitude. It also follows that the solution of the first approximation (14) is accurate as far as the amplitude is concerned.

If the second derivatives are to be taken into account, integration by parts must be carried one stage further than is done in (7a). Hence

$$\int (b_1 \sin t + b_2 \cos t) dt = -b_1 \cos t + b'_1 \sin t + b''_1 \cos t - \int b''_1 \cos t dt + b_2 \sin t + b'_2 \cos t - b''_2 \sin t + \int b''_2 \sin t dt \quad (17)$$

$$\int [(b_1 - b''_2) \sin t + (b_2 + b''_1) \cos t] dt = (-b_1 + b'_1 + b'_2) \cos t + (b'_1 + b_2 - b''_2) \sin t \quad \dots \quad (18)$$

It is assumed that

$$\frac{b''_2}{b_1} \ll 1 \quad \text{and} \quad \frac{b''_1}{b_2} \ll 1$$

This means that the third derivatives can be neglected in comparison with the original functions. Substituting in (18) $b_1 = a \cos \theta$ and $b_2 = a \sin \theta$

$$\int a \sin(t + \theta) dt = (-a + a\theta' + a'' - a\theta'^2) \cos(t + \theta) + (a' - 2a'\theta' - a\theta'') \sin(t + \theta) \quad \dots \quad (19)$$

The evaluation of this integral is given in Appendix I.

By combining the equations (2), (6), (9) and (19), and equating the coefficients of \sin and \cos terms one obtains

$$\frac{da}{dt} - \frac{1}{2} \frac{1}{a} \frac{d}{dt} \left(a^2 \frac{d\theta}{dt} \right) = \frac{\mu}{2} \phi_1(a) \quad \dots \quad (20)$$

$$\left(\frac{d\theta}{dt}\right)^2 - 2\frac{d\theta}{dt} = \frac{1}{a} \frac{d^2a}{dt^2} \quad \dots \quad (21)$$

Since the first approximation has been found sufficiently accurate for obtaining the amplitude, the second term in (20) will be ignored. The first term in (21) will also be neglected since $(d\theta/dt)^2$ is of the order of μ^4 .

Instead of using equations (10) and (11) a and θ are solved from the equations

$$\frac{da}{dt} = \frac{\mu}{2} \phi_1(a) \quad \dots \quad (22)$$

$$\frac{d\theta}{dt} = -\frac{1}{2} \frac{1}{a} \frac{d^2a}{dt^2} \quad \dots \quad (23)$$

and the values obtained substituted into $x = a \sin(t + \theta)$. Thus an improved solution is found. The instantaneous frequency is obtained by differentiating $(t + \theta)$ with respect to t whence

$$\omega = 1 - \frac{1}{2} \frac{1}{a} \frac{d^2a}{dt^2} \quad \dots \quad (24)$$

It must be realized that ω is the normalized frequency; i.e., $\omega_0^2 = 1/LC$ is supposed to be unity. By substituting d^2a/dt^2 from (22), one obtains

$$\omega = 1 - \frac{\mu^2}{8} \theta_1(a) \frac{d\phi_1(a)}{dt} \quad \dots \quad (25)$$

4. Effect of Harmonics

It is seen from the equation (25) that the influence of the amplitude variations on the frequency is of the order of μ^2 . On the other hand, it has been shown by Kryloff and Bogoliuboff² that the reduction in the frequency due to the harmonics is also of the order of μ^2 . It follows that to ignore the harmonics as done in the previous section is not justified if one is interested in frequency changes of the order of μ^2 . It is the purpose of this section to take into account the harmonics as well as the second derivatives.

For the sake of simplicity it will be assumed that $F(x)$ is an odd function of x ; i.e., that $F(x) = -F(-x)$. In this case the Fourier series of $F(a \sin u)$ contains, as can easily be seen, only odd sine terms. Hence

$$F(a \sin u) = \phi_1(a) \sin u + \phi_3(a) \sin 3u + \phi_5(a) \sin 5a + \dots \quad (26)$$

It is also assumed that in the solution only the third harmonic is pronounced. Then the solution will be of the form

$$x = a \sin(t + \theta) + b \cos[3(t + \alpha)] \quad \dots \quad (27)$$

where a , θ , b and α are functions of time. It must be borne in mind that dx/dt may not be equal to $d\theta/dt$ during the transient period whereas it is known to be so for the stationary oscillations.

As done previously, the expression (27) for x must be substituted in equation (2).

Then the first term is

$$\begin{aligned} \frac{dx}{dt} &= \frac{da}{dt} \sin(t + \theta) + a \left(1 + \frac{d\theta}{dt}\right) \cos(t + \theta) \\ &+ \frac{db}{dt} \cos[3(t + \alpha)] - 3b \left(1 + \frac{d\alpha}{dt}\right) \sin[3(t + \alpha)] \end{aligned} \quad \dots \quad (28)$$

With the help of the formula given in Appendix I the second term becomes

$$\begin{aligned} \int x dt &= (-a + a\theta' + a'') \cos(t + \theta) \\ &+ a \sin(t + \theta) + \frac{b}{3} (1 - \alpha') \sin[3(t + \alpha)] \\ &+ \frac{b'}{9} \cos[3(t + \alpha)] \quad \dots \quad (29) \end{aligned}$$

When evaluating this integral the second derivatives of the third harmonic are neglected because these quantities which are small in themselves appear with a factor $1/9$.

The third term in equation (2) requires a comparatively longer calculation. At this stage it is assumed that the amplitude of the third harmonic is small in comparison with that of the fundamental. It follows from this that

$$\begin{aligned} F[a \sin(t + \theta) + b \cos 3(t + \alpha)] &\simeq F[a \sin \\ (t + \theta)] &+ \frac{dF[a \sin(t + \theta)]}{d[a \sin(t + \theta)]} b \cos 3[(t + \alpha)] \end{aligned} \quad \dots \quad (30)$$

If the function $\frac{dF(a \sin u)}{d(a \sin u)}$ is expanded into a Fourier series

$$\begin{aligned} \frac{dF(a \sin u)}{d(a \sin u)} &= \psi_0(a) + \psi_2(a) \cos 2u \\ &+ \psi_4(a) \cos 4u + \dots \quad (31) \end{aligned}$$

The coefficients can be calculated in terms of those that are already determined in equation (26). If the equation (26) is differentiated with respect to u one obtains

$$\begin{aligned} \frac{dF(a \sin u)}{du} &= \frac{d[F(a \sin u)]}{d(a \sin u)} a \cos u = \phi_1(a) \cos u \\ &+ 3\phi_3(a) \cos 3u + 5\phi_5(a) \cos 5u + \dots \end{aligned}$$

Dividing this by $(a \cos u)$, evaluating the terms $\frac{\cos 3u}{\cos u}$, $\frac{\cos 5u}{\cos u}$, \dots

and combining it with (31) gives (see Appendix 2)

$$\left. \begin{aligned} \psi_0(a) &= \frac{1}{a} [\phi_1(a) - 3\phi_3(a) + 5\phi_5(a) \dots] \\ \psi_2(a) &= \frac{2}{a} [3\phi_3(a) - 5\phi_5(a) + \dots] \\ \psi_4(a) &= \frac{2}{a} [5\phi_5(a) - 7\phi_7(a) + \dots] \end{aligned} \right\} \quad (32)$$

Combining the equations (27), (31) and (2) and denoting $3(\theta - \alpha)$ by δ gives

$$F(x) = \left[\phi_1(a) + \frac{b}{2} [\psi_2(a) - \psi_4(a)] \sin \delta \right] \sin(t + \theta) + \left[3 \frac{b}{a} \phi_3(a) \cos \delta \right] \cos(t + \theta) + \left[b\psi_0(a) + \frac{b}{2} \psi_6(a) \cos 2\delta + \phi_3(a) \sin \delta \right] \cos 3(t + \alpha) + \left[\phi_3(a) \cos \delta - \frac{b\psi_6(a)}{2} \sin 2\delta \right] \sin 3(t + \alpha) \dots \dots \dots (33)$$

Finally, the equations (28), (29) and (33) are substituted into (2) and sin and cos terms are equated. Then

$$\frac{d\theta}{dt} = -\frac{1}{2a} \frac{d^2a}{dt^2} + \frac{3}{2}\mu \frac{\phi_3(a)}{a} \cos \delta \dots \dots (34)$$

$$\frac{da}{dt} = \frac{\mu}{2} \left[\phi_1(a) + \frac{b}{a} [\psi_2(a) - \psi_4(a)] \sin \delta \right] \dots (35)$$

$$b \left(\frac{4}{5} + \frac{d\alpha}{dt} \right) = -\frac{3}{10}\mu \phi_3(a) \cos \delta + \frac{\mu}{2} b \psi_6(a) \sin 2\delta \dots \dots \dots (36)$$

$$\frac{db}{dt} = \frac{9}{10}\mu \left[b\psi_0(a) + \phi_3(a) \sin \delta - \frac{b}{2} \psi_6(a) \cos 2\delta \right] \dots \dots \dots (37)$$

From these equations a , θ , b and α can be found. In equation (35) the last term shows the effect of the third harmonic on the amplitude of fundamental frequency. As will be seen from the formulae (39) and (42), obtained below for b and δ , the magnitude of the second term is of the order of μ^2 and, therefore, can be neglected.

The same applies to $d\alpha/dt$ and to the last term in (36). Hence equation (35) gives

$$\frac{da}{dt} = \frac{\mu}{2} \phi_1(a) \dots \dots \dots (38)$$

from which a can be found as a function of time, and (36) gives b in terms of a ; i.e.,

$$b = -\frac{3}{10}\mu \phi_3(a) \dots \dots (39)$$

Here $\cos \delta$ is set equal to unity. The error due to this approximation is of the order of μ^2 because δ is proportional to μ .

The change in the frequency of the fundamental is obtained by combining the equations (34) and (39), whence

$$\frac{d\theta}{dt} = -\frac{1}{2a} \frac{d^2a}{dt^2} - 4 \frac{b^2}{a^2} \dots (40)$$

The first term on the right-hand side of (40) is the change due to the varying amplitude and therefore applies only to the transient period. The second term shows the effect of the third harmonic.

The change in the frequency of the third harmonic (i.e., $d\alpha/dt$) will now be found.

It seems appropriate to evaluate $d\delta/dt$ rather than $d\alpha/dt$, because the former gives, during the transient period, the deviation of the 'third harmonic' from three times the fundamental frequency. For the stationary oscillations it is known that this deviation is zero. It must be recalled that δ was equal to $3(\theta - \alpha)$ and consequently

$$\frac{d\delta}{dt} = 3 \left(\frac{d\theta}{dt} - \frac{d\alpha}{dt} \right) \dots \dots (41a)$$

or

$$\frac{d\delta}{dt} = 3\omega_f - \omega_h \dots \dots (41b)$$

where the subscripts f and h refer to fundamental and harmonic respectively.

By differentiating equation (39) with respect to t and substituting da/dt from (38) one obtains

$$\frac{db}{dt} = -\frac{3}{16}\mu^2 \frac{d\phi_3(a)}{da} \phi_1(a)$$

Combining this with (37) gives

$$\delta = \frac{3}{8}\mu [\phi_1(a) - 3\phi_3(a) + 5\phi_5(a)] - \frac{5}{24}\mu \frac{\phi_1(a)}{\phi_3(a)} \frac{d\phi_3(a)}{da} \dots \dots (42)$$

With the help of the equations (38), (39), (40) and (42) one can determine the unknown quantities in (27) and thus obtain the solution required.

5. Application

Consider a valve oscillator with a tuned anode circuit (Fig. 1). The currents in the

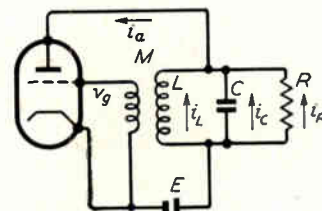

Fig. 1. Valve oscillator with tuned-anode circuit.

circuit are expressed in terms of the p.d. v across C as follows:—

$$i_R = \frac{v}{R}; i_C = C \frac{dv}{dt}; I_L = I_0 + i_L = I_0 + \frac{1}{L} \int v \cdot dt \quad I_a = \psi(v_a + \mu v_g) \quad (43)$$

where I_0 is the d.c. component of the current in the inductance and where the function $\psi(v_a + \mu v_g)$ shows the non-linear valve characteristic. v_a stands for the effective anode voltage; i.e., $v_a = E - v$.

Remembering that $v_g = \frac{M}{L} v$ one can write

$$I_a \text{ as follows} \quad I_a = \psi(E + kv)$$

$$\text{where } R = \left(\mu \frac{M}{L} - 1 \right)$$

Kirchhoff's equation for the currents gives

$$i_c + i_r + I_L = I_a$$

or

$$i_c + i_r + i_L = I_a - I_0 = i_a \quad (44)$$

where i_a and i_L are the varying components of the currents in the valve and in the inductor respectively.

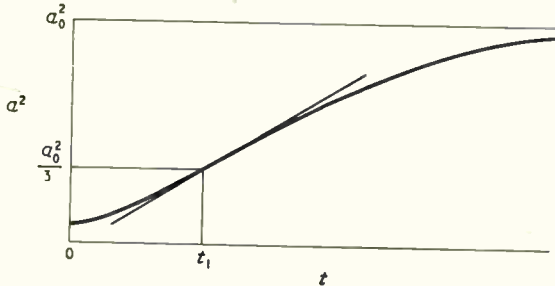

Fig. 2. This curve represents equation (51) for the triode oscillator under consideration.

Since E is a constant voltage, i_a can be expressed as a function of v ; i.e.,

$$i_a = \phi(v) \quad \dots \quad (45)$$

By substituting from (43) into (44) and denoting

$$\frac{1}{\omega_0 C} \left[\phi(v) - \frac{v}{R} \right] \text{ by } \mu F(v) \text{ one obtains}$$

$$\frac{dv}{dt} + \int v dt = \mu F(v) \quad \dots \quad (46)$$

where t is the normalized time; i.e., $t = \omega_0 \tau$, and $\omega_0^2 = 1/LC$.

It is assumed now that the characteristic of the non-linear resistive element takes the form

$$F(v) = v(1 - \gamma v^2) \quad \dots \quad (47)$$

For $v = a \sin u$ (47) becomes

$$F(a \sin u) = a(1 - \frac{3}{4}\gamma a^2) \sin u + \frac{\gamma a^3}{4} \sin 3u \quad (48)$$

Thus, the coefficients in equation (26) are now

$$\left. \begin{aligned} \phi_1(a) &= a \left(1 - \frac{a^2}{a_0^2} \right) \\ \phi_3(a) &= \frac{1}{3} \frac{a^3}{a_0^2} \end{aligned} \right\} \quad \dots \quad (49)$$

where $a_0^2 = 4/3\gamma$.

From (38) it follows that

$$\frac{da}{dt} = \frac{\mu}{2} a \left(1 - \frac{a^2}{a_0^2} \right) \quad \dots \quad (50)$$

From (50)

$$a = \frac{a_0}{\sqrt{1 + ca_0^2 e^{-\mu t}}} \quad \dots \quad (51)$$

where c is the constant of integration. For large values of t , a approaches a_0 , the amplitude of the steady-state oscillation.

For the amplitude of the third harmonic, equation (39) gives

$$b = -\frac{\mu}{8} \frac{a^3}{a_0^2} \quad \dots \quad (52)$$

The instantaneous angular frequency of the fundamental is obtained from (40) as follows

$$\omega = 1 + \frac{d\theta}{dt} = 1 - \frac{1}{2a} \frac{d^2 a}{dt^2} - \frac{\mu^2}{16} \frac{a^4}{a_0^4} \quad \dots \quad (53)$$

or, evaluating $d^2 a/dt^2$ from (50),

$$\omega = 1 - \frac{\mu^2}{8} \left(1 - \frac{a^2}{a_0^2} \right) \left(1 - 3 \frac{a^2}{a_0^2} \right) - \frac{\mu^2}{16} \frac{a^4}{a_0^4} \quad \dots \quad (54)$$

It must be recalled that ω shows the normalized frequency. The curves representing equations (51) and (54) are shown in Figs. 2 and 3 respectively. From the graph it is seen that the frequency of oscillation is at first smaller and then larger than the steady-state value.

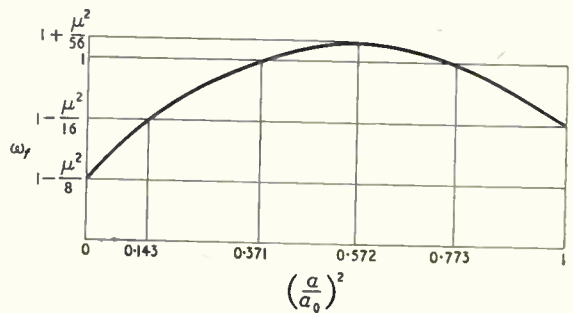

Fig. 3. Equation (54) produces this curve for the example considered.

To find the frequency of the '3rd harmonic', equation (42) must be investigated. By substituting the terms $\phi_1(a)$ and $\phi_3(a)$ from (49) into (42) one obtains

$$\delta = -\frac{\mu}{8} \left(2 + \frac{a^2}{a_0^2} \right) \quad \dots \quad (55)$$

Differentiating (55) with respect to t ,

$$\frac{d\delta}{dt} = 3\omega_f - \omega_h, \text{ viz.,}$$

$$\frac{d\delta}{dt} = -\frac{\mu^2}{8} \frac{a^2}{a_0^2} \left(1 - \frac{a^2}{a_0^2} \right) \quad \dots \quad (56)$$

Fig. 4 shows $-\frac{d\delta}{dt}$ as a function of $\left(\frac{a^2}{a_0^2} \right)$. It follows that the frequency of the '3rd harmonic' is slightly larger than three times that of the fundamental during transient time.

Fig. 5 represents the amplitude of the '3rd

harmonic' as a function of $(a/a_0)^2$ during transient time.

The solution for the steady-state oscillation is obtained by replacing a by a_0 in equations (52), (54) and (55).

Hence

$$x = a_0 \sin \left[\left(1 - \frac{\mu^2}{16} \right) t + \theta_0 \right] - \frac{\mu a_0}{8} \cos 3 \left[\left(1 - \frac{\mu^2}{16} \right) t + \theta_0 + \frac{\mu}{8} \right] \quad (57)$$

With the exception of the last term $\mu/8$ this solution is identical with that obtained by Kryloff and Bogoliuboff.

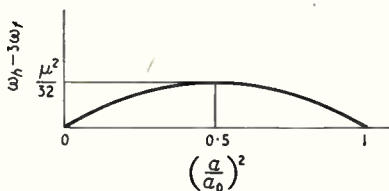

Fig. 4

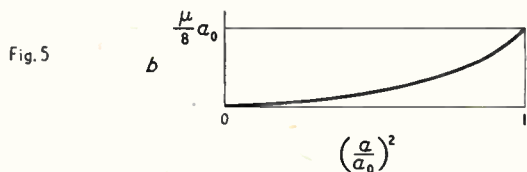

Fig. 4 (above). Relation between $d\delta/dt$ and a^2/a_0^2 .

Fig. 5 (below). Amplitude of 'third harmonic'.

6. Conclusion

The use of the integro-differential equation has made it possible to deal more rigorously than before with conditions during transient period. The resultant formulae apply to the circuits containing the non-linear resistive element, whose current-voltage characteristic is an odd function. Amplitude and frequency of the fundamental and '3rd harmonic' are obtained both for the transient period and for the steady-state. The method can be applied to a resistive characteristic of a more general nature.

Acknowledgments

The author wishes to express his thanks to Professor E. E. Zepler, Electronics Department, University of Southampton, for his helpful suggestions and encouragement in the preparation of this paper.

APPENDIX 1

To evaluate the integral $\int a \sin(t + \theta) dt$ it is convenient to define a complex function $X = ae^{j\theta}$

$$\int a \sin(t + \theta) dt = \text{Imag.} \left[\int X e^{jt} dt \right]$$

Integrating the latter by parts

$$\int X e^{jt} dt = (-jX + X' + jX'')e^{jt} + j \int X''' e^{jt} dt.$$

Neglecting jX''' in comparison with X

$$\int X e^{jt} dt = (-jX + X' + jX'')e^{jt}.$$

Substituting $X = ae^{j\theta}$ in the last equation

$$\begin{aligned} \int X e^{jt} dt &= [-ja + a' + ja\theta' + j(a'' + j2a'\theta' \\ &\quad + ja\theta'' - a\theta'^2)]e^{j(t+\theta)} \\ &= j[-a + a\theta' + a'' - a\theta'^2]e^{j(t+\theta)} \\ &\quad + [a' - 2a'\theta' - a\theta'']e^{j(t+\theta)} \end{aligned}$$

Retaining only imaginary terms gives

$$\begin{aligned} \int a \sin(t + \theta) dt &= [-a + a\theta' + a'' - a\theta'^2] \cos(t + \theta) \\ &\quad + [a' - 2a'\theta' - a\theta''] \sin(t + \theta) \end{aligned}$$

APPENDIX 2

Let the function $F(a \sin u)$ be an odd function of $a \sin u$. Then

$$F(a \sin u) = \phi_1(a) \sin u + \phi_3(a) \sin 3u + \phi_5(a) \sin 5u + \dots$$

Differentiation with respect to u gives

$$\begin{aligned} \frac{dF(a \sin u)}{du} &= \frac{dF(a \sin u)}{d(a \sin u)} a \cos u = \phi_1(a) \cos u \\ &\quad + 3\phi_3(a) \cos 3u + 5\phi_5(a) \cos 5u + \dots \end{aligned}$$

Dividing by $(a \cos u)$ gives

$$\begin{aligned} \frac{dF(a \sin u)}{d(a \sin u)} &= \frac{\phi_1(a)}{a} + 3 \frac{\phi_3(a)}{a} \frac{\cos 3u}{\cos u} \\ &\quad + 5 \frac{\phi_5(a)}{a} \frac{\cos 5u}{\cos u} + \dots \end{aligned}$$

On the other hand

$$\begin{aligned} \cos(2k + 1)u &= \cos u \cos 2ku - \sin u \sin 2ku \\ &= \cos u \cos 2ku - \frac{1}{2}[\cos(2k - 1)u - \cos(2k + 1)u] \end{aligned}$$

Hence

$$\frac{\cos(2k + 1)u}{\cos u} = 2 \cos 2ku - \frac{\cos(2k - 1)u}{\cos u}$$

This recurrence formula gives for $k = 0, 1, 2, \dots$

$$1 = 1$$

$$\frac{\cos 3u}{\cos u} = 2 \cos 2u - 1$$

$$\frac{\cos 5u}{\cos u} = 2 \cos 4u - 2 \cos 2u + 1$$

$$\frac{\cos 7u}{\cos u} = 2 \cos 6u - 2 \cos 4u + 2 \cos 2u - 1$$

Substituting these expressions in (1) one obtains

$$\begin{aligned} \frac{dF(a \sin u)}{d(a \sin u)} &= \frac{1}{a} [\phi_1(a) - 3\phi_3(a) + 5\phi_5(a) - \dots] \\ &\quad + \frac{2}{a} [3\phi_3(a) - 5\phi_5(a) + 7\phi_7(a) - \dots] \cos 2u \\ &\quad + \frac{2}{a} [5\phi_5(a) - 7\phi_7(a) + 9\phi_9(a) - \dots] \cos 4u + \dots \end{aligned}$$

REFERENCES

- "Theory of Oscillations", A. Andronow and C. E. Chaikin, edited and trans. by S. Lefschetz, Princeton University Press, New Jersey, 1949.
- "Introduction to Non-Linear Mechanics", N. Kryloff and Bogoliuboff, trans. by S. Lefschetz, Princeton University Press, New Jersey, 1943.
- "Introduction to Non-Linear Mechanics", N. Minorsky; J. W. Edwards, Ann. Arbor, 1947.
- "Forced Oscillations in Non-Linear Systems", M. L. Cartwright; see Chapter IV of "Contributions to the Theory of Non-Linear Oscillations", edited by S. Lefschetz, Princeton University Press, New Jersey, 1950.

IMPEDANCE TRANSFORMATION BY FOUR-TERMINAL NETWORKS

Use of Graphical Methods

By S. Fedida, B.Sc.(Hons.), A.C.G.I., A.M.I.E.E.

SUMMARY.—The purpose of this paper is to present a study of the impedance transformation occurring between the input and output terminals of a network, to discuss the corresponding geometrical relationships and to apply these relationships to the field of impedance measurement.

LIST OF SYMBOLS

- $Z_{1s}(Z_{2s})$ Input impedance of four-terminal network at terminals 1(2), when terminals 2(1) are short-circuited.
- $Z_{1\infty}(Z_{2\infty})$ Input impedance of four-terminal network at terminals 1(2), when terminals 2(1) are open-circuited.
- $Z_s(Z_\infty)$ Short-circuit (open-circuit) input impedance of symmetrical networks.
- $Z_1(Z_2)$ Image impedance at terminals 1(2) of network.
- Z_0 Characteristic impedance of network.
- $Z_{1L}(Z_{2L})$ Impedance of load connected to terminals 1(2) of network.
- $Z_{1in}(Z_{2in})$ Input impedance at terminals 1(2) of network for an arbitrary impedance $Z_{2L}(Z_{1L})$.
- K Reflection coefficient of normalized impedance Z (see Section 1), defined as:

$$K = \frac{Z - 1}{Z + 1}$$

When K is followed by a subscript it becomes the reflection coefficient of the impedance with the same subscript, unless otherwise specified in the text.

1. Introduction

A LINEAR four-terminal network can, in general, be regarded as an impedance transformer. Short lengths of transmission lines are commonly used as such and it is useful, when dealing with problems involving the use of these elements, to be clear about some of the possible geometrical interpretations of such transformations, particularly when impedance charts have to be used. Often these geometrical properties indicate methods by which impedance measurements can either be speeded up, made more accurate or self-checking.

Impedances will be represented geometrically according to the Argand diagram convention,¹ where the real part of an impedance is plotted along a horizontal axis and the imaginary part along a vertical axis.

In Fig. 1, for example, vector OP is made to represent an impedance Z , as indicated in the bracket to the right of point P . If Z should vary in magnitude, direction or both, point P will trace a curve, which will be denoted the locus of Z .

All impedances will be assumed to be normalized in terms of some impedance Z' , which is generally the purely real characteristic impedance of a transmission line, used for high-frequency measurements or as a transmission component. In some cases, however, Z' may be the internal impedance of a generator connected to the network as, for example, in Section 3.2. In all insertion-loss determinations both generator and line impedances are assumed to be equal and purely real.

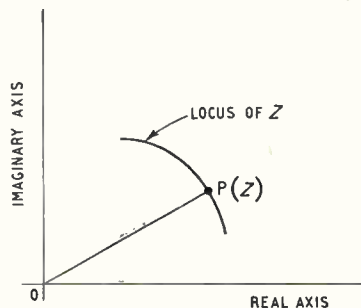

Fig. 1. Illustration of the Argand diagram to represent impedances.

The reflection coefficient of an impedance Z with respect to the normalizing impedance Z' is given by the well-known formula:

$$K = \frac{Z - Z'}{Z + Z'}$$

If the same symbol Z is now made to represent the same impedance normalized in terms of Z' , then the above formula simplifies to:

$$K = \frac{Z - 1}{Z + 1} \quad \dots \quad (1)$$

The normalizing impedance will always be chosen in such a way that equation (1) remains valid.

The reflection coefficient K will be treated as a vectorial quantity and it will be plotted as if it were an impedance, with the difference that its magnitude cannot exceed unity and its real part can take negative values. This type of plot is the well-known "Smith's Chart" diagram for transmission lines.

MS accepted by the Editor, August 1953

In order to avoid confusion it is convenient, in general, to plot the variations of load and input impedances on separate diagrams, even though these diagrams make use of the same co-ordinate systems.

We shall in this study make great use of the following set of formulae relating the input and load impedances of a four-terminal network, in terms of the short-circuit and open-circuit parameters of the latter:

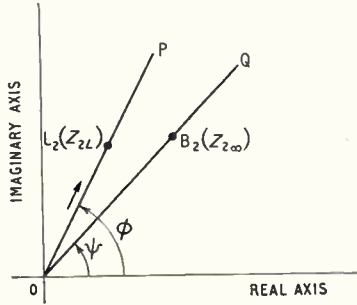

Fig. 2. Load-impedance diagram; constant-phase locus.

$$Z_{1in} = Z_{1\infty} + \frac{Z_{1\infty}(Z_{2s} - Z_{2\infty})}{Z_{2\infty} + Z_{2L}} \quad \dots \quad (2)$$

$$Z_{2in} = Z_{2\infty} + \frac{Z_{2\infty}(Z_{1s} - Z_{1\infty})}{Z_{1\infty} + Z_{1L}} \quad \dots \quad (3)$$

When the network is symmetrical (2) and (3) become

$$Z_{in} = Z_{\infty} + \frac{Z_{\infty}(Z_s - Z_{\infty})}{Z_{\infty} + Z_L} \quad \dots \quad (4)$$

Equations (2), (3) and (4) define a bilinear transformation^{2,3} between the variables Z_{in} and Z_L and it can be proved that if one variable, say Z_L , varies in such a way that its locus is a circle (a straight line is considered to be a circle of infinite radius), then the locus of the other is also a circle.

This general theorem will be used throughout except when a direct derivation of the required result can be easily made.

2. Impedance Transformations in Cartesian Co-ordinates

We shall in this section analyse the types of input impedance loci obtained when the load impedance varies in certain specified ways.

The analysis is made simpler if equations (2), (3) and (4) are put in the following forms:

$$\frac{Z_{1in} - Z_{1s}}{Z_{1in} - Z_{1\infty}} = - \frac{Z_{2L}}{Z_{2\infty}} \quad \dots \quad (5)$$

$$\frac{Z_{2in} - Z_{2s}}{Z_{2in} - Z_{2\infty}} = - \frac{Z_{1L}}{Z_{1\infty}} \quad \dots \quad (6)$$

$$\frac{Z_{in} - Z_s}{Z_{in} - Z_{\infty}} = - \frac{Z_L}{Z_{\infty}} \quad \dots \quad (7)$$

2.1. Constant-Phase Circles

Let us assume that the load impedance Z_{2L} varies in magnitude while keeping a constant phase ϕ , say, and let ψ be the phase angle of $Z_{2\infty}$.

We can write

$$Z_{2L} = |Z_{2L}| e^{j\phi} \text{ and } Z_{2\infty} = |Z_{2\infty}| e^{j\psi}$$

When these values are inserted in equation (5) we obtain

$$\frac{Z_{1s} - Z_{1in}}{Z_{1\infty} - Z_{1in}} = \frac{|Z_{2L}|}{|Z_{2\infty}|} e^{j(\pi + \phi - \psi)} \quad \dots \quad (8)$$

Let L_2 and B_2 (Fig. 2) be the points in the load-impedance diagram representing Z_{2L} and $Z_{2\infty}$, and OP and OQ the radial lines through L_2 and B_2 . OP represents a constant-phase locus for the impedance Z_{2L} .

If A_1 , B_1 and C_1 (Fig. 3) represent the impedances Z_{1s} , $Z_{1\infty}$ and Z_{1in} , respectively, in the input-impedance diagram, then the vectors C_1A_1 and C_1B_1 represent the impedances $(Z_{1s} - Z_{1in})$ and $(Z_{1\infty} - Z_{1in})$, respectively. These two impedances can be expressed as follows

$$Z_{1s} - Z_{1in} = A e^{j\alpha_s}, \quad Z_{1\infty} - Z_{1in} = B e^{j\alpha_{\infty}}$$

where A and B are positive real numbers and α_s and α_{∞} are the angles shown in the figure.

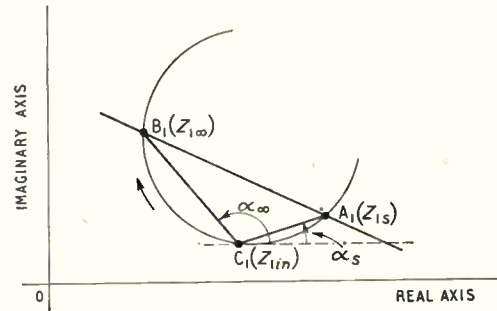

Fig. 3. Input-impedance diagram; constant-phase locus.

When these values are inserted in equation (8) we obtain

$$\frac{A}{B} e^{j(\alpha_s - \alpha_{\infty})} = \frac{|Z_{2L}|}{|Z_{2\infty}|} e^{j(\pi + \phi - \psi)} \quad \dots \quad (9)$$

from which we deduce

$$\alpha_s - \alpha_{\infty} = \pi + \phi - \psi \quad \dots \quad (10)$$

and consequently

$$\angle C_1B_1, C_1A_1 = \pi + \angle OQ, OP \quad \dots \quad (11)$$

where $\angle C_1B_1, C_1A_1$ represents the angle through which it is necessary to rotate C_1B_1 , around C_1 , to make it coincide with C_1A_1 . Similarly $\angle OQ, OP$ represents the angle through which it is necessary to rotate OQ to make it coincide with OP .

If now we increase the magnitude of Z_{2L} , starting from zero, while leaving its phase angle ϕ fixed, L_2 moves outward along OP , the angle

$\frac{1}{C_1 B_1} \cdot C_1 A_1$, according to equation (11), remains constant and it follows that C_1 moves from A_1 to B_1 along an arc of circle.

Hence for every line of constant phase, such as OP , there corresponds in the input-impedance diagram an arc of circle, such as $A_1 C_1 B_1$, the locus of the transformed impedance.

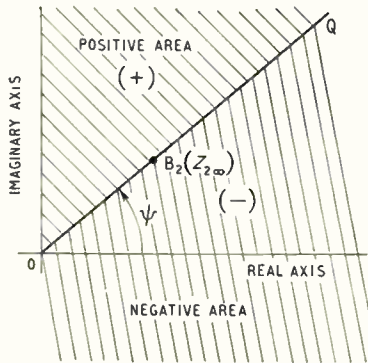

Fig. 4. Load-impedance diagram; positive and negative areas.

It is convenient at this point to divide the load-impedance diagram into two areas, with a common boundary at OQ (Fig. 4). The top area is such that $\phi - \psi$ is positive and it will consequently be called the positive area, while the bottom one will be called, for similar reasons, the negative area.

For every point in the positive area $\alpha_s - \alpha_\infty$ is, according to equation (10), greater than π radians and consequently the corresponding point in the input-impedance diagram lies below the line $A_1 B_1$. Similarly, to points in the negative area correspond points above the line $A_1 B_1$.

We may, therefore, divide the input-impedance diagram (Fig. 5) into two areas, with a common boundary at $A_1 B_1$, corresponding to the two areas in the load impedance diagram.

For purely capacitive load impedances ($\phi = -\frac{\pi}{2}$), $\alpha_s - \alpha_\infty$ is equal to $\frac{\pi}{2} - \psi$ and,

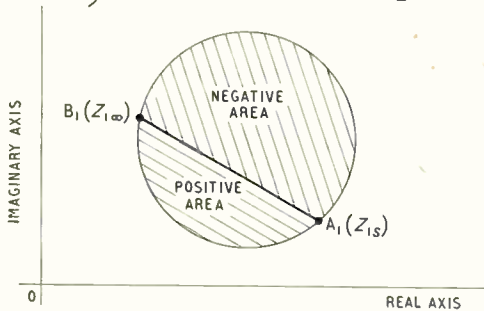

Fig. 5. Input-impedance diagram; positive and negative areas.

provided $\psi > 0$, it is smaller than $\pi/2$ radians; it follows that the centre of the arc of circle in the input-impedance diagram, corresponding to the negative imaginary axis, is in the negative area.

For purely inductive load impedances ($\phi = +\frac{\pi}{2}$),

$\alpha_s - \alpha_\infty = \frac{3\pi}{2} - \psi$ and consequently the arc of circle corresponding to the positive imaginary axis is a continuation of the arc of circle corresponding to the negative imaginary axis. The complete circle corresponding to the imaginary axis we shall call the reactance circle.

When the phase angle of the load impedance is between $-\frac{\pi}{2}$ and $+\frac{\pi}{2}$, the corresponding arcs of circle are contained within the reactance circle.

As ϕ increases from $-\frac{\pi}{2}$ to $+\frac{\pi}{2}$, $\alpha_s - \alpha_\infty$ increases

from $\frac{\pi}{2} - \psi$ to $\frac{3\pi}{2} - \psi$ and the point representing

the input impedance transfers from the negative area to the positive area. When ϕ is equal to ψ , the constant-phase arc of circle coincides with the straight line $A_1 B_1$.

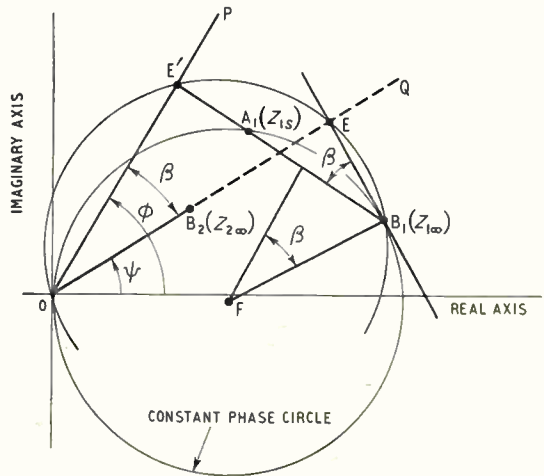

Fig. 6. Input-impedance diagram; construction of constant-phase circle corresponding to line OP .

Hence a four-terminal network transforms the right-hand side of the load-impedance diagram into the interior of the reactance circle, and the left-hand side of the load-impedance diagram into the remainder of the input-impedance diagram, outside the reactance circle.

The phase circle corresponding to a given load impedance can be found as follows: let OP (Fig. 6) be the phase line of the given load impedance, plotted in the input-impedance diagram, and circle of centre F the corresponding

phase circle. If B_1E is the tangent at B_1 to circle F , E its intersection with OQ and E' the intersection of B_1A_1 with OP , then, since, according to equations (10) and (11), the angles shown as β in the figure are equal, it follows that points E , E' , E and B_1 are on a common circle and consequently point E can be determined by the intersection of OQ with the circle passing through O , E' and B_1 . The required phase circle passes through A_1 and B_1 and it is tangential at B_1 to EB_1 . An alternative construction, shown in Fig. 7, makes use of the tangent at A_1 to the required phase circle, and of the intersection H of OQ and A_1B_1 .

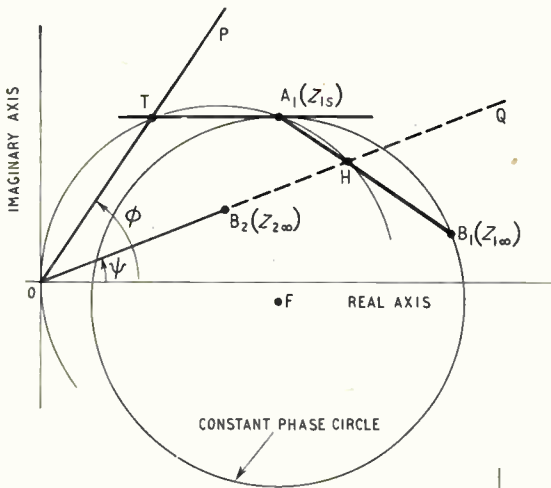

Fig. 7 (above). Input-impedance diagram; alternative construction of constant-phase circle corresponding to line OP .

Fig. 8 (right). Input-impedance diagram; construction of constant-phase circle corresponding to line OP , for symmetrical networks.

A much simpler construction can be used when the four-terminal network is known to be symmetrical (Fig. 8). If C_1 is any point on the required phase circle and C_2 the intersection of AC_1 and OP , then points O , C_1 , B and C_2 are on the same circle, because of the equality of the angles shown as β in the figure.

Hence to find any point C_1 on the required phase circle, draw a circle, such as S , through B and O , intersecting the given phase line OP at C_2 . C_1 is found at the intersection of AC_2 with circle S .

2.2. Constant-Modulus Circles

We have examined in the above paragraph the correspondence between input and load impedances of a four-terminal network, when the

load impedance varies in such a way as to keep a constant-phase angle. We shall in this section examine the case of a load impedance, Z_{2L} , the magnitude of which remains constant.

The load-impedance diagram is obviously a semi-circle centred at the origin.

Equation (9) indicates that when $|Z_{2L}|$ is constant, the ratio A/B , which represents the ratio of the distances C_1A_1 to C_1B_1 (Fig. 9), is also constant. Hence it can be shown that the locus of C_1 is a circle, the centre of which is on line A_1B_1 , and, furthermore, that all such circles are orthogonal to any circle passing through A_1 and B_1 . The mesh of constant-phase and constant-magnitude circles is consequently made up of two families of mutually-orthogonal circles. A typical set of such circles is shown in Fig. 10.

The orthogonality property mentioned above can be deduced directly from the form of equation (2) which suggests that Z_{1in} and Z_{2L} are two conjugate functions and it is possible to pass from one to the other through the use of a conformal transformation.⁴ The constant-phase lines and constant-magnitude circles in the load-impedance diagram are obviously two families of orthogonal circles. Hence the corresponding families of circles, in the input-impedance diagram, are also orthogonal.

When the magnitude of the load impedance

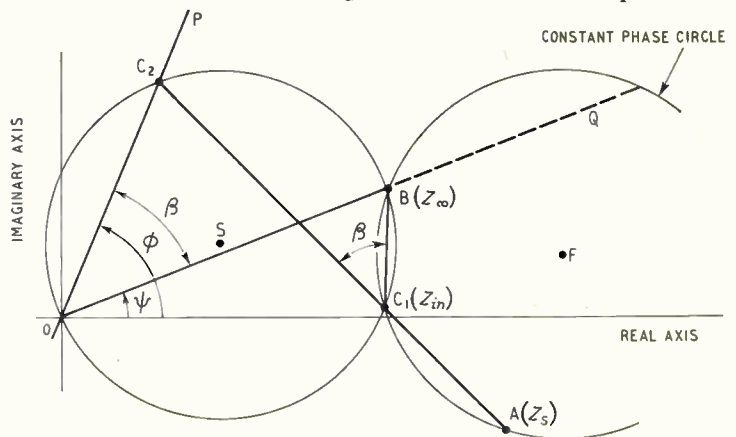

equals $|Z_{2∞}|$, the ratio of the lengths C_1A_1 to C_1B_1 is unity. The corresponding constant-magnitude circle is in this case the straight line M_1M_2 (Fig. 9).

To construct a constant-modulus circle corresponding to a given load impedance we first determine a point C_1 (Fig. 9), such that

$$\frac{|C_1A_1|}{|C_1B_1|} = \frac{|Z_{2L}|}{|Z_{2∞}|} \dots \dots \dots (12)$$

We now draw a circle through A_1 and B_1 , the reactance circle C , say, and we determine point

C'_1 , on line CC_1 , such that $|CC_1| \times |CC'_1| = R^2$, where R is the radius of the circle of centre C . The circle of centre M , on A_1B_1 , passing through C_1 and C'_1 , can be shown to be orthogonal to circle C ; and since C_1 satisfies equation (12), it is the desired constant-magnitude circle.

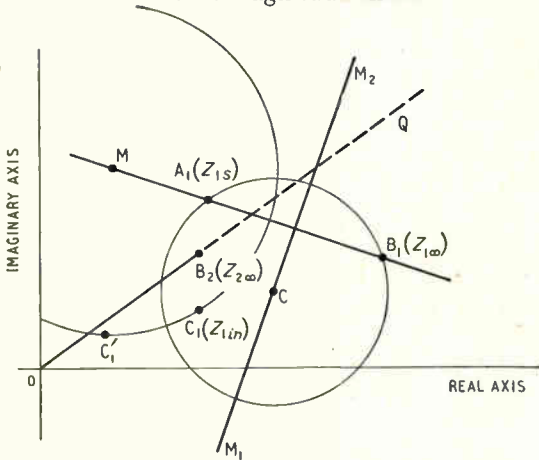

Fig. 9. Input-impedance diagram; construction of constant-modulus circle corresponding to a load impedance of a given magnitude.

For the particular configuration of A_1 , B_1 and B_2 , chosen in Fig. 9, we find that input impedances, corresponding to magnitudes of load impedances smaller than $|Z_{2\infty}|$, are represented by points to the left of M_1M_2 , the perpendicular to A_1B_1 , drawn through C . Similarly, input impedances corresponding to magnitudes of load impedances larger than $|Z_{2\infty}|$, are represented by points to the right of M_1M_2 .

2.3. Constant-Resistance Circles

We shall now investigate the effect of varying the reactance component of the load impedance while leaving the resistance component constant.

It is convenient for this study to rearrange

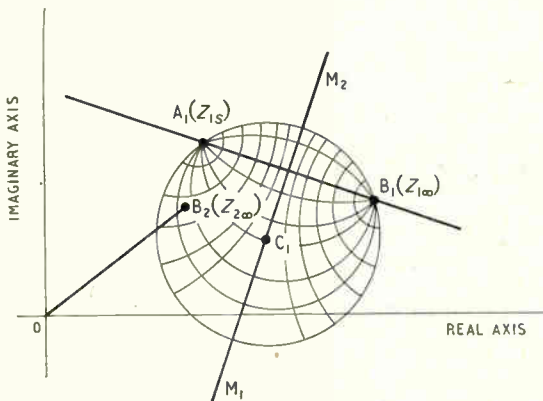

Fig. 10. Input-impedance diagram; typical mesh of constant-phase circles (centres on M_1M_2) and constant-magnitude circles (centres on A_1B_1).

equation (2) as follows

$$(Z_{1in} - Z_{1\infty})(Z_{2L} + Z_{2\infty}) = Z_{1\infty}(Z_{2s} - Z_{2\infty}) \quad (13)$$

If OP and OB_2 represent the impedances Z_{2L} and $Z_{2\infty}$, respectively (Fig. 11), then OP' represents the impedance $(Z_{2L} + Z_{2\infty})$. Similarly if OA_1 , OB_1 and OQ represent the impedances Z_{1s} , $Z_{1\infty}$ and Z_{1in} , respectively (Fig. 12), then B_1Q represents the impedance $(Z_{1in} - Z_{1\infty})$.

According to equation (13) the product of vectors OP' and B_1Q is equal to a complex constant, or in other words B_1Q is equal to the inverse of OP' , multiplied by the complex number

$$Z_{1\infty}(Z_{2s} - Z_{2\infty}) = Ue^{j\gamma} \quad (14)$$

where U and γ are real constants. Let OP' be moved to $B_1P'_1$, in the input impedance diagram, and B_1Q_1 be a vector such that

$$B_1P'_1 \times B_1Q_1 = 1 \quad (15)$$

To obtain B_1Q we rotate B_1Q_1 through the angle γ and multiply its magnitude by U . We have thus performed a complex inversion, around B_1 as pole, of inversion factor $Ue^{j\gamma}$.

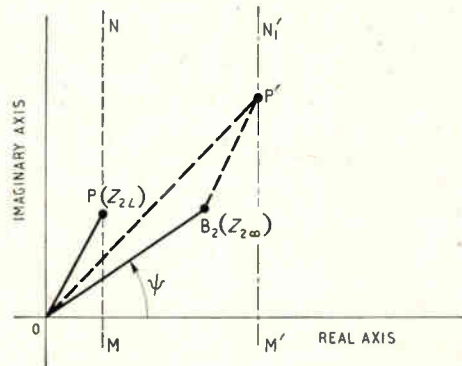

Fig. 11. Load-impedance diagram; constant-resistance locus.

If now the resistance component of the load impedance is kept constant, while its reactance component is varied, the locus of P' in the load-impedance diagram is the straight line $M'N'$, while that of P'_1 , in the input-impedance diagram, is M_1N_1 . It can easily be shown, using equation (15), that the locus of Q_1 is a circle of centre D_1 , on the perpendicular B_1S to M_1N_1 . The subsequent transformation of Q_1 to Q , transforms circle D_1 to a circle of centre D .

For every specific value of the resistance component of the load impedance there exists a circle such as D_1 and a circle such as D . All circles such as D_1 have their centres on B_1S , therefore all circles such as D have their centres on a straight line through B_1 . Since the reactance circle of centre C is also a constant-resistance circle, it follows that all constant-resistance circles have their centres on line B_1C .

It can also be shown, using the diagrams of Figs. 11 and 12, that the radius r of a constant-resistance circle is given by the formula

$$r = \frac{1}{2} \frac{|Z_{2\infty}| \cdot |Z_{1s} - Z_{1\infty}|}{R + |Z_{2\infty}| \cos \psi} \quad \dots \quad (16)$$

where R is the constant-load resistance.

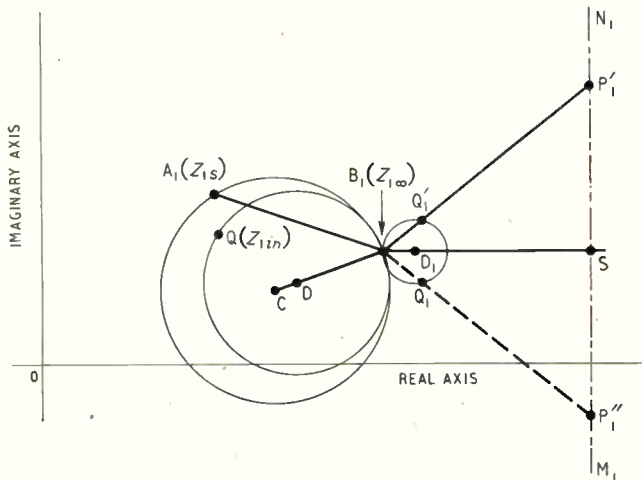
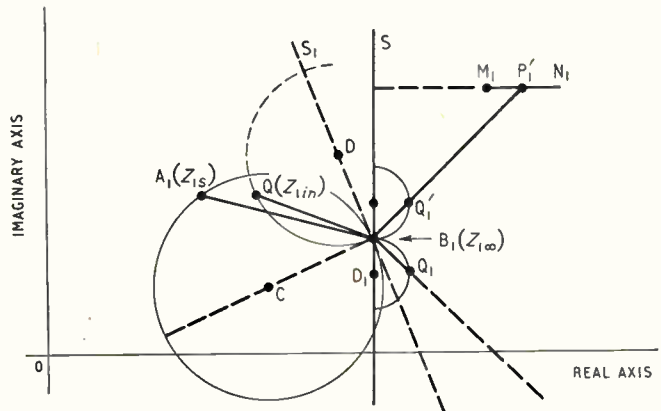
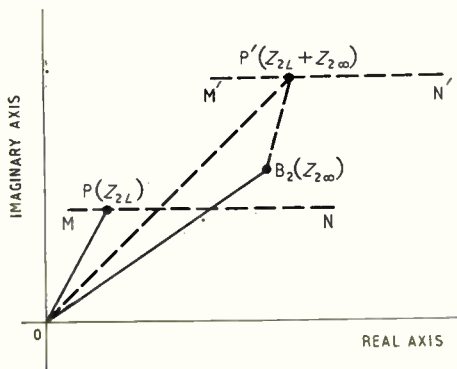

Fig. 12 (above). Input-impedance diagram; constant-resistance circles.

Fig. 13 (below). Load-impedance diagram; constant-reactance locus.

Fig. 14 (right). Input-impedance diagram; constant-reactance circles.



complex inverse of each other. We can transfer OP' to $B_1P'_1$ and consider B_1 to be the pole of the inversion.

As in Sect. 2.3, we can obtain Q_1 , the inverse of P'_1 , and derive Q from Q_1 by a complex multiplication of $Z_{1\infty}(Z_{2s} - Z_{2\infty})$. Since the locus of P' is the straight line M_1N_1 , the locus of Q_1 is an arc of circle, with its centre D_1 on B_1S_1 , the line parallel to the imaginary axis, passing through B_1 , and the locus of Q is therefore also an arc of circle of centre D .

B_1S_1 is the locus of the centres of all circles such as D_1 , consequently the locus of the centres of all circles such as D is a straight line B_1S_1 .

Since the constant-resistance and constant-reactance lines in the load-impedance diagram are mutually orthogonal, it follows (Sect. 2.2) that the constant-resistance and constant-reactance circles in the input-impedance diagram are also mutually orthogonal. From this we deduce that the locus B_1S_1 of the centres of the constant-reactance circles is the tangent at B_1 to all the constant-resistance circles, and in particular to the reactance circle of centre C .

It can be shown, using the diagrams of Figs. 13 and 14, that the radius x of a constant-reactance circle is given by the formula

$$x = \frac{1}{2} \frac{|Z_{2\infty}| |Z_{1s} - Z_{1\infty}|}{X + |Z_{2\infty}| \sin \psi} \quad \dots \quad (17)$$

where X is the constant-load reactance.

The radius x becomes infinite when

$$X = -|Z_{2\infty}| \sin \psi \quad \dots \quad (18)$$

and the corresponding constant-reactance circle becomes the straight line B_1C . The load-impedance locus is a line parallel to the real axis and passing through B_2 , while the input-impedance

locus is the diameter of the reactance circle, passing through B_1 .

A typical mesh of constant-resistance and constant-reactance circles is shown in Fig. 15. The similarity with constant-resistance and

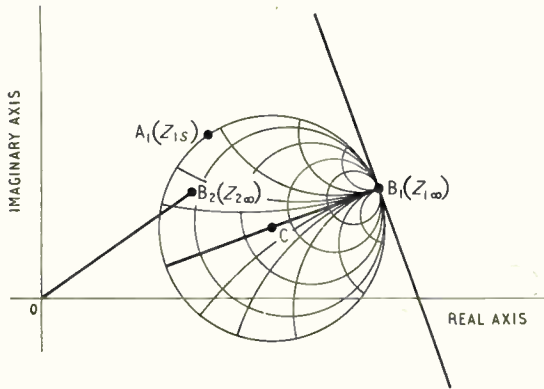

Fig. 15. Input-impedance diagram; constant-resistance and constant-reactance circles.

constant-reactance circles in the Smith Chart is obvious. Smith Chart markings could be used provided R is normalized to $|Z_{2\infty}| \cos \psi$ and X to $|Z_{2\infty}| \sin \psi$.

2.5. Circles of Constant-Load Reflection Coefficient

Another family of circles of great importance, from the practical point of view, is made up of the input-impedance loci obtained when the load impedance varies in such a way as to keep its reflection coefficient with respect to unity constant.

This reflection coefficient we have already defined in Section (1) by equation (1). The importance of this family of circles lies in the fact that a constant-reflection coefficient termination can in practice be very easily realized in high-

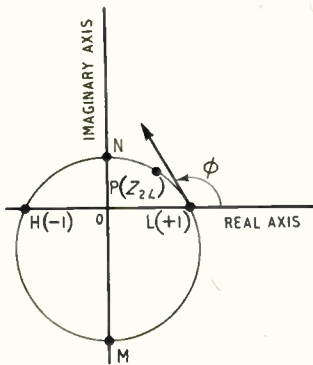

frequency systems, and in the case of low-loss networks it is the only kind of termination which can provide reasonably accurate results.

Fig. 16. Load-impedance diagram; load-impedance locus for constant phase of reflection coefficient.

If the locus of the load impedance Z_{2L} is a circle passing through the points L and H (Fig. 16), which represent the impedances $Z_{2L} = +1$ and $Z_{2L} = -1$, respectively, then the phase angle of the load-reflection coefficient is constant

and equal to the angle ϕ . The proof of this can be very simply obtained from equation (1), using the method illustrated in Sect. 2.1.

The corresponding input-impedance locus (Fig. 17) is therefore also a circle passing through the points H_1 and L_1 corresponding to H and L , and cutting the resistance circle R (which corresponds to the real axis in the load-impedance diagram), at an angle ϕ .

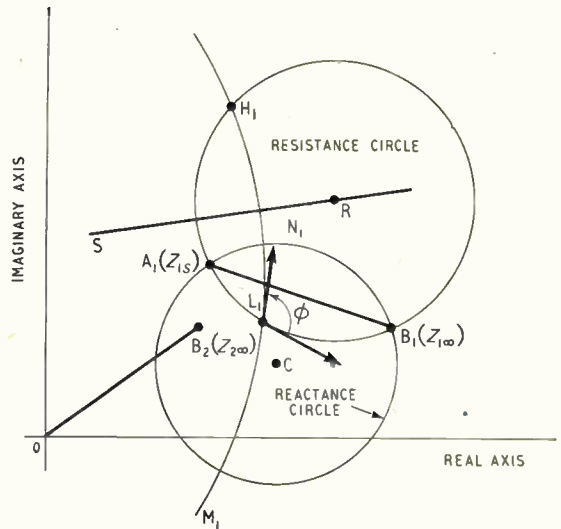

Fig. 17. Input-impedance diagram; input-impedance locus for constant phase of reflection coefficient.

All circles of constant phase of reflection coefficient in the load-impedance diagram pass through H and L and they are consequently orthogonal to the imaginary axis. The corresponding circles in the input-impedance diagram consequently pass through H_1 and L_1 and they are orthogonal to the reactance circle. It follows that points H_1 and L_1 are the inverse of each other about the reactance circle (i.e., if X_0 is the

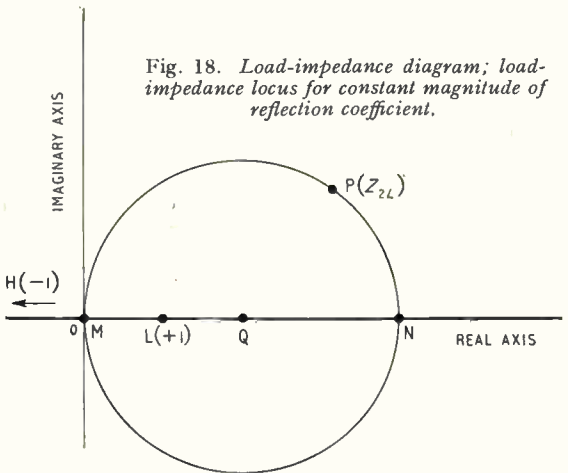

Fig. 18. Load-impedance diagram; load-impedance locus for constant magnitude of reflection coefficient.

radius of the reactance circle, then $|CL_1| \times |CH_1| = X_0^2$.

If, on the other hand, the magnitude of the load-reflection coefficient remains constant, while the load impedance, Z_{2L} , varies, the representative point P (Fig. 18) describes a circle centred on the real axis.

This can be deduced from equation (1) if we rewrite it as follows*

$$K_{2L} = \frac{Z_{2L} - 1}{Z_{2L} + 1} = \frac{OP + OH}{OP + OL} = \frac{LP}{HP} \quad (19)$$

If the magnitude of K_{2L} is constant then equation (19) shows that the ratio of the distances from P to the two fixed points L and H is constant. It follows that the locus of P is a circle centred on the straight line through L and H.

Since K and Z are, according to equation (1), conjugate functions, the circles of constant-magnitude and those of constant-phase of

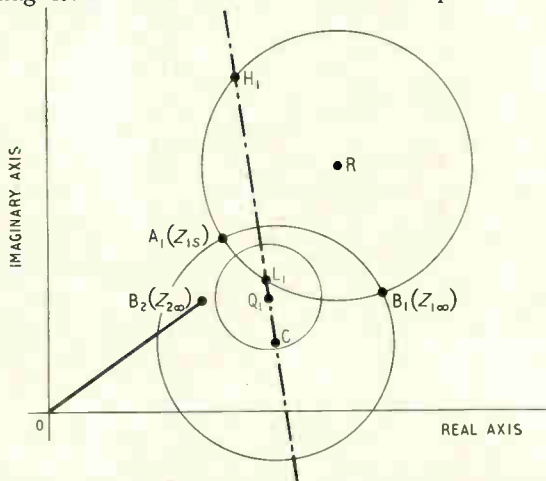

Fig. 19. Input-impedance diagram; constant magnitude of input-impedance locus for reflection coefficient.

reflection coefficient, both in the load-impedance and in the input-impedance diagrams, are orthogonal.

A typical mesh of constant-phase and constant-magnitude of reflection coefficient circles is shown in Fig. 20. The constant-phase circles pass through points L_1 and H_1 and therefore the constant-magnitude circles have their centres on line L_1H_1 (Fig. 19). The reactance circle is one of the latter circles, since the magnitude of the reflection coefficient K_{2L} of a purely reactive load impedance Z_{2L} is always unity; the phase of K_{2L} depends, of course, on the magnitude of Z_{2L} .

3. Transformations in the Smith Chart

Instead of plotting impedances in Cartesian co-ordinates, we can make use of the set of

*Note: The use of black-face type for a symbol such as OP denotes the vector OP.

curvilinear co-ordinates known as the Smith Chart. The use of this new set of co-ordinates is equivalent to a change of variable from impedance Z to reflection coefficient K , according to the relation expressed by equation (1), and to a plot

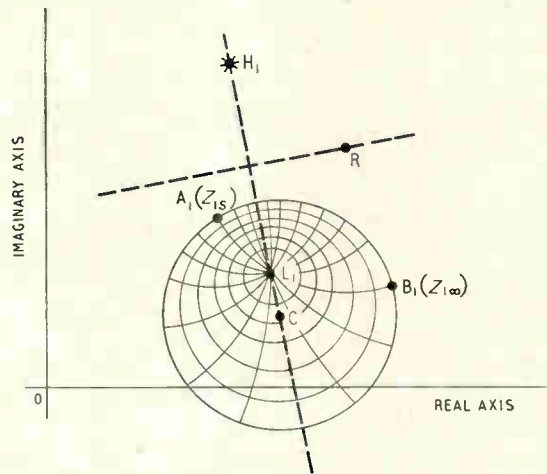

Fig. 20. Input-impedance diagram; mesh of constant magnitude and constant phase of load-reflection coefficient circles.

of K in Cartesian co-ordinates. To emphasize the relationship between the Smith Chart representation and a plot of reflection coefficients, we shall sometimes refer to the plot of a reflection-coefficient locus on the Smith Chart as a K -diagram, by analogy with impedance diagrams. We shall, therefore, have input K -diagrams and load K -diagrams, and the object of this section is to find the correspondence between load and input K -diagrams for four-terminal networks.

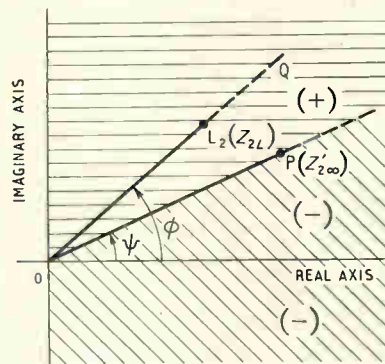

Fig. 21. Load-impedance diagram; a constant-phase locus (line OQ).

This correspondence can be obtained algebraically by making use of equations (1) and (5), from which we can derive the following relation

$$\frac{K_{1in} - K_{1s}}{K_{1in} + K_{1∞}} = -\frac{Z_{2L}}{Z_{2∞}} \frac{1 - K_{1s}}{1 - K_{1∞}} \quad (20)$$

This equation is of the same nature as equation (5) and therefore capable of the same geometrical interpretations.

3.1. Constant-Phase Circles in the Smith Chart

Let A_1 , B_1 and C_1 (Fig. 22) be the points representing the reflection coefficients of the short-circuit input impedance (K_{1s}), the open-circuit input impedance ($K_{1\infty}$) and the input impedance (K_{1in}) for an arbitrary load impedance Z_{2L} . We can express the vectors appearing in equation (20) thus

$$K_{1\infty} - K_{1in} = |K_{1\infty} - K_{1in}| e^{j\phi_{\infty}} \quad \dots \quad (21)$$

$$K_{1s} - K_{1in} = |K_{1s} - K_{1in}| e^{j\phi_s} \quad \dots \quad (22)$$

$$\frac{1 - K_{1s}}{1 - K_{1\infty}} \cdot \frac{1}{Z_{2\infty}} = \frac{1 + Z_{1\infty}}{1 + Z_{1s}} \cdot \frac{1}{Z_{2\infty}} = \frac{1}{Pe^{j\psi}} \quad (23)$$

$$Z_{2L} = |Z_{2L}| e^{j\phi} \quad \dots \quad \dots \quad (24)$$

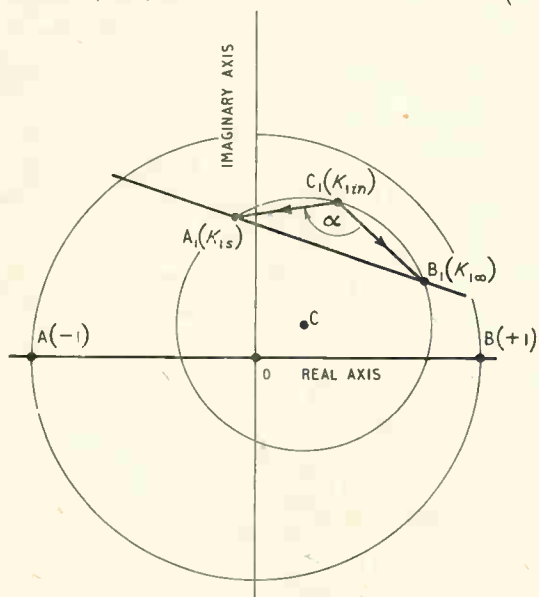

Fig. 22. Input reflection-coefficient (K) diagram; constant-phase circle (circle of centre C).

Equation (20) now becomes

$$\frac{|K_{1s} - K_{1in}| e^{j(\phi_s - \phi_{\infty})}}{|K_{1\infty} - K_{1in}|} = \frac{|Z_{2L}|}{P} e^{j(\pi + \phi - \psi)} \quad (25)$$

and therefore $\frac{|K_{1s} - K_{1in}|}{|K_{1\infty} - K_{1in}|} = \frac{|Z_{2L}|}{P} \quad \dots \quad (26)$

and $\alpha = \phi_s - \phi_{\infty} = \pi + \phi - \psi \quad \dots \quad (27)$

where P and ψ are functions of the network alone and α is the angle $\angle B_1 C_1 \cdot C_1 A_1$.

If the load impedance, Z_{2L} , varies in such a way that its phase angle, ϕ , remains constant (Fig. 21), then angle α is also constant and the locus of C_1 is an arc of circle through A_1 and B_1 . It follows that for every load-impedance phase

angle such as ϕ , there exists a constant-phase circle passing through A_1 and B_1 .

Let OP represent the vector $Pe^{j\psi}$ in the load-impedance diagram. We can divide this diagram into two areas, meeting along OP , as indicated in Fig. 21, each labelled with the sign of the half of the imaginary axis it contains. When the load impedance is in the positive area angle ϕ is greater than ψ , consequently α is larger than π radians and C_1 must lie above the line $A_1 B_1$, for the particular disposition of A_1 and B_1 , chosen in the figure. Similarly, if the load impedance is in the negative area, then C_1 lies below $A_1 B_1$.

If the load impedance is a pure reactance, the locus of the point C_1 is a complete circle of centre C . For any other phase angle, the corresponding constant-phase locus is an arc of circle wholly contained within the reactance circle. As in the case of the input-impedance mapping, the network transforms the right-hand side of the load-impedance diagram into the interior of the reactance circle, plotted in the input K -diagram.

Let us define an impedance $Z'_{2\infty}$ such that

$$Z'_{2\infty} = Z_{2\infty} \frac{1 + Z_{1s}}{1 + Z_{1\infty}} = Z_{2\infty} \frac{1 - K_{1\infty}}{1 - K_{1s}} \quad (28)$$

In terms of $Z'_{2\infty}$ equation (20) becomes

$$\frac{K_{1in} - K_{1s}}{K_{1in} - K_{1\infty}} = - \frac{Z_{2L}}{Z'_{2\infty}} \quad \dots \quad (29)$$

and, but for a change in one of the parameters, equations (29) and (5) are identical. It follows that the geometrical constructions established in Section 2, hold equally well for the input K -diagrams, provided the input parameters are

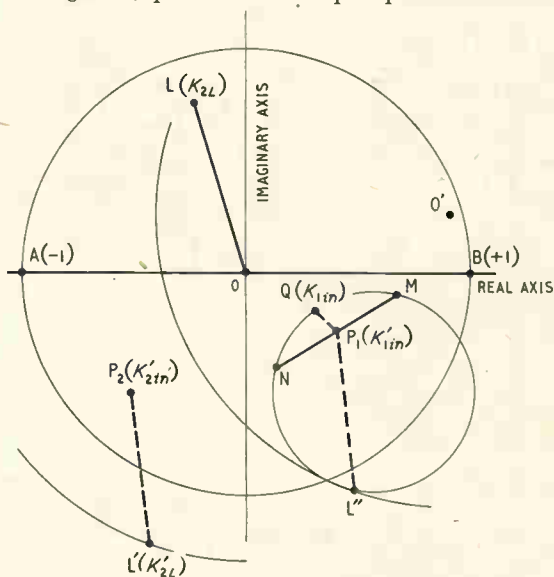
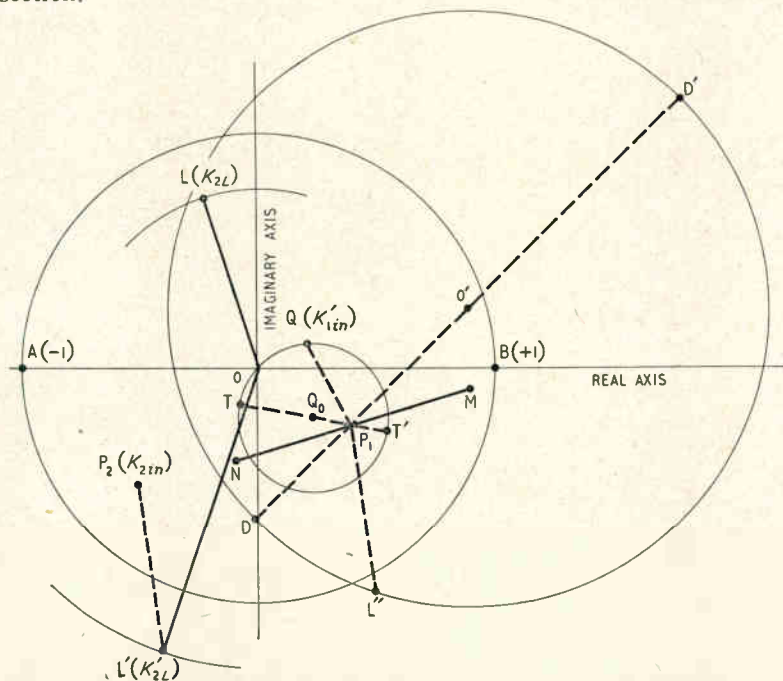

Fig. 23. Input reflection-coefficient (K) diagram; relation between complex insertion loss and input and load reflection coefficients, for unsymmetrical networks.

replaced by their reflection coefficients and that $Z_{2\infty}$ is replaced by $Z'_{2\infty}$, the other output parameter remaining unchanged.

In view of this, the derivation of constant-phase, constant-modulus, constant-resistance and constant-reactance in the input K -diagram will not be repeated. The constant reflection-coefficient circles, however, because of their great importance, will be examined more thoroughly, at the risk of a little repetition, in the next section.



K_{1in} = Reflection coefficient at terminals 1 of network when the load impedance has any value Z_{2L} .
 K'_{2in} = Reflection coefficient at terminals 2 of the network when the load impedance is equal to unity.
 K_{2L} = Reflection coefficient of Z_{2L} , the load impedance at terminals 2.
 K'_{2L} = The inverse of K_{2L} (i.e., $K'_{2L} = 1/K_{2L}$).
 (It is important to note in connection with the above definitions that the assumption of a generator impedance of unity implies that impedances are normalized to the generator impedance. The reflection coefficients are also expressed in terms of the same impedance.)
 Let P_1 and P_2 (Fig. 23) represent K'_{1in} and K'_{2in} , while L and Q represent K_{2L} and K_{1in} . Given L we can determine the point L' , representing K'_{2L} , the inverse of K_{2L} .

We have
 $P_1Q = K_{1in} - K'_{1in}$
 $P_2L' = K'_{2L} - K'_{2in}$
 If L'' is a point such that $P_1L'' = P_2L'$ and M and N

Fig. 24. Input reflection-coefficient diagram; the derivation of a constant-load reflection-coefficient circle.

3.2. Constant-Load Reflection-Coefficient Circles

The importance of this family of circles is due to the fact that a simple determination of the insertion loss of a quadripole is made possible through their use.

It can be proved that the complex insertion loss S of a quadripole is related to the network and load parameters by the following equation

$$S^2 = (K_{1in} - K'_{1in})(K'_{2L} - K'_{2in}) \quad \dots \quad (30)$$

where

S = Complex insertion loss of four-terminal network defined as the ratio of the currents flowing into a load impedance Z_{2L} when the latter is (a) connected direct to a generator (assumed here to be of unity impedance) and (b) connected to the same generator through the network.

K'_{1in} = Reflection coefficient at terminals 1 of network when the load impedance is unity.

such that $PM = -PN = S$, then we can rewrite equation (30) as

$$PM^2 = PN^2 = P_1Q \cdot P_1L'' \quad \dots \quad (31)$$

which is the well-known condition for the four-points M, N, Q and L'' to lie on a common circle. PM and PN are the geometric means of P_1Q and P_1L'' and it can be easily proved that the direction NP_1M bisects the angle QP_1L'' .

If now the load impedance Z_{2L} varies in such a way that the magnitude of its reflection coefficient remains constant, the locus of L (Fig. 24) is a circle, concentric with and within the unity circle, while the locus of L' is a circle concentric with the unity circle, but outside it. The locus of L'' is the displaced locus of L' ; its centre is at O' , such that $OO' = P_2P_1$. According to equation (31) P_1Q can be obtained by multiplying the inverse of P_1L'' by the constant S^2 . Since the inverse of a circle is also a circle, it follows that the locus of Q is a circle, the centre of which is on TT' , the straight line through P_1 , such

that NP_1M is the bisector of angle $D'P_1T'$, where DD' is the diameter through P_1 of the locus of L'' .

For every magnitude $|K_{2L}|$ of load reflection coefficient, there corresponds a circle for the input reflection coefficient K_{1in} . These circles, which we shall call, for brevity, the Q circles,

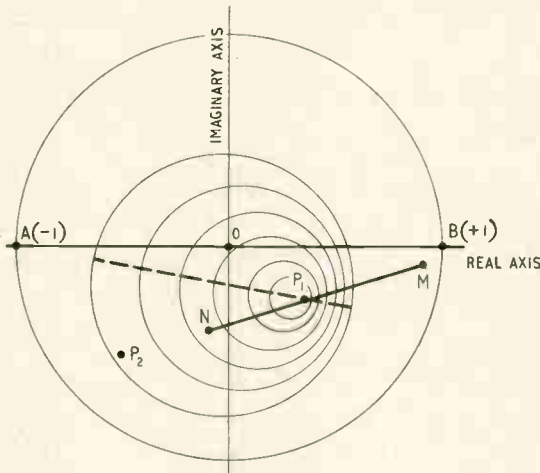

Fig. 25. Input reflection-coefficient plane; the mesh of constant-load reflection-coefficient circles.

are all centred on line TT' . When the magnitude of K_{2L} is very small (i.e., the load impedance is nearly equal to unity) the locus of L is a very small circle, that of L'' is a very large one and the corresponding Q circle is very small. Its radius becomes vanishingly small as $|K_{2L}|$ tends to zero.

(To be continued)

When $|K_{2L}|$ is at its maximum value of unity, the corresponding Q circle coincides with the reactance circle. A typical mesh of Q circles is shown in Fig. 25.

It is useful to note that in the case of symmetrical networks, since P_1 and P_2 are one and the same point, the centre O' of the displaced load circles coincides with O .

We can now calculate the radius of a given Q circle from Fig. 24 and equation (31). We have

$$|P_1T'| = \frac{|S^2|}{|P_1D'|} \dots \dots \dots (32)$$

$$|P_1T| = \frac{|S^2|}{|P_1D|} \dots \dots \dots (33)$$

$$|P_1D'| = |K'_{2in}| + |K'_{2L}| \dots \dots (34)$$

$$|P_1D| = |K'_{2L}| - |K'_{2in}| \dots \dots (35)$$

If R is the radius of a given constant-reflection coefficient circle, we have

$$2R = |P_1T| + |P_1T'| \dots \dots \dots (36)$$

$$2R = |S^2| \left[\frac{1}{|K'_{2L}| - |K'_{2in}|} + \frac{1}{|K'_{2L}| + |K'_{2in}|} \right] \dots \dots \dots (37)$$

$$2R = |S^2| \frac{2K'_{2L}}{|K'_{2L}|^2 - |K'_{2in}|^2} \dots \dots (38)$$

Replacing K'_{2L} by $1/K_{2L}$ we obtain

$$R = \frac{|S^2| |K_{2L}|}{1 - |K'_{2in}|^2 |K_{2L}|^2} \dots \dots (39)$$

L.F. COMPENSATION FOR VIDEO AMPLIFIERS

Part 2. Negative-Feedback Amplifiers

By J. E. Flood, Ph.D., A.M.I.E.E.

SUMMARY.—The method outlined in Part 1 for designing amplifiers with indicial responses having the highest possible order of compensation is applied to negative-feedback amplifiers. If β is independent of frequency, the overall response is an optimum when the indicial response of the μ -path is an optimum and the order of compensation is the same. If β is made frequency-dependent by including a capacitor in the feedback path, compensation can be obtained which is one order higher than that obtainable from the μ -path alone.

The method is applied to some simple circuits, including cases where a coupling or a decoupling circuit is outside the feedback loop. Some of the results are confirmed by experiment.

1. Introduction

DISTORTION at low frequencies affects the indicial response of an amplifier (i.e., its response to a unit step) causing it to depart from the ideal flat top. The indicial response can be made as flat as possible by causing as many as possible of its differential coefficients to be zero at

$t = 0$. If the first r derivatives vanish, the indicial response is said to have r th-order compensation. A general method for obtaining the highest possible order of compensation was described in Part 1 of this paper. In this part of the paper the method is applied to some typical negative-feedback amplifier circuits.

2. Amplifier with β Independent of Frequency

If the indicial response of the μ -path of the amplifier is $\mu(p)1$ and the feedback fraction β_0 is independent of frequency, then the overall indicial response of the amplifier with feedback is

$$h(p)1 = \frac{\mu(p)}{1 + \beta_0 \mu(p)} 1$$

The sign convention is chosen so that μ and β_0 are both positive quantities when the feedback is negative.

Let
$$\mu(p) = \mu_0 \frac{p^n + a_1 p^{n-1} + a_2 p^{n-2} + \dots + a_q p^{n-q} + \dots + a_n}{p^n + b_1 p^{n-1} + b_2 p^{n-2} + \dots + b_q p^{n-q} + \dots + b_n} \dots \dots (1)$$

Then
$$h(p)1 = \frac{\mu_0}{1 + \mu_0 \beta_0} \cdot \frac{p^n + a_1 p^{n-1} + \dots + a_q p^{n-q} + \dots + a_n}{p^n + d_1 p^{n-1} + \dots + d_q p^{n-q} + \dots + d_n} 1 \dots \dots (2)$$

where $d_q = [b_q + \mu_0 \beta_0 a_q] / [1 + \mu_0 \beta_0] \dots (3)$

The overall response therefore has r th-order compensation when $a_1 = d_1, a_2 = d_2, \dots, a_r = d_r$. But from equation (3), $a_q = d_q$ when $a_q = b_q$. The overall response of the feedback amplifier therefore has r th-order compensation when the response of its μ -path has r th-order compensation. In particular, a maximally-flat overall response ($r = n - 1$) requires that the μ -path shall have a maximally-flat indicial response. The procedure for obtaining an optimum overall response is thus to design the μ -path to have an indicial response with the highest possible order of compensation.

3. Effect of Networks outside the Feedback Loop

3.1. Coupling Circuit outside the Feedback Loop

If the feedback voltage is applied to the cathode of the first valve, as shown in Fig. 1, then any coupling circuit between its grid and the input terminals is outside the feedback loop. If the coupling circuit comprises capacitance C_c and resistance R_g , its indicial response is $p/(p + \alpha)1$ where $\alpha = 1/C_c R_g$. If the indicial response of the amplifier is given by equation (2), then the overall response, including the coupling circuit, is given by

$$h(p)1 = \frac{p}{p + \alpha} \cdot \frac{\mu_0}{1 + \mu_0 \beta_0} \cdot \frac{p^n + a_1 p^{n-1} + \dots + a_q p^{n-q} + \dots + a_n}{p^n + d_1 p^{n-1} + \dots + d_q p^{n-q} + \dots + d_n} 1$$

$$= \frac{\mu_0}{1 + \mu_0 \beta_0} \cdot \frac{p^{n+1} + a_1 p^n + \dots + a_q p^{n-q+1} + \dots + a_n p}{p^{n+1} + D_1 p^n + \dots + D_q p^{n-q+1} + \dots + D_n p + D_{n+1}} 1 \dots \dots (4)$$

where $D_q = d_q + \alpha d_{q-1} \dots \dots (5)$

$\therefore (1 + \mu_0 \beta_0) D_q = b_q + \alpha b_{q-1} + \mu_0 \beta_0 (a_q + \alpha a_{q-1}) \dots \dots (6)$

from equation (3)

$\therefore a_q = D_q$ when

$a_q = b_q + \alpha (b_{q-1} + \mu_0 \beta_0 a_{q-1}) \dots (7)$

The overall response now has r th-order compensation when the coefficients a_1, a_2, \dots, a_r and b_1, b_2, \dots, b_r of the indicial response of its μ -path satisfy equation (7).

It is interesting to compare the effect of adding a coupling circuit to the amplifier outside its feedback loop with the effect of adding a coupling circuit inside the loop. If a coupling circuit with

time-constant $1/\alpha'$ is added to the amplifier whose indicial response is given by equation (1), the response of the μ -path including the coupling circuit is

$$\mu(p)1 = \mu_0 \frac{p}{p + \alpha'} \cdot \frac{p^n + a_1 p^{n-1} + \dots + a_q p^{n-q} + \dots + a_n}{p^n + b_1 p^{n-1} + \dots + b_q p^{n-q} + \dots + b_n} 1$$

$$= \mu_0 \frac{p^{n+1} + a_1 p^n + \dots + a_q p^{n-q+1} + \dots + a_n p}{p^{n+1} + B_1 p^n + \dots + B_q p^{n-q+1} + \dots + B_n p + B_{n+1}} 1$$

where $B_q = b_q + \alpha' b_{q-1}$

The overall indicial response is therefore given by equation (4) where, from equation (3):

$D_q = [B_q + \mu_0 \beta_0 a_q] / [1 + \mu_0 \beta_0]$

$\therefore (1 + \mu_0 \beta_0) D_q = b_q + \alpha' b_{q-1} + \mu_0 \beta_0 a_q (8)$

and $a_q = D_q$ when

$a_q = b_q + \alpha' b_{q-1} \dots \dots (9)$

The overall response now has r th-order compensation when the coefficients a_1, a_2, \dots, a_r and b_1, b_2, \dots, b_r satisfy equation (9). The difference in form between equation (6) and equation (8) shows that, in general, the addition of a coupling circuit has a different effect on the overall indicial response depending on whether it is inside or outside the feedback loop.

3.2. Anode Decoupling Circuit outside Feedback Loop

If the feedback voltage is taken from the cathode of the last valve, as shown in Fig. 1, then any decoupling network in its anode circuit is

outside the feedback loop. If the last stage has an anode load resistance R_a , a decoupling resistance R_d and decoupling capacitance C_d , its indicial response is of the form

$$h(p) \mathbb{1} = \frac{\mu_0}{1 + \mu_0 \beta_0} \frac{p^{n+1} + A_1 p^n + \dots + A_q p^{n-q+1} + \dots + A_{n+1}}{p^{n+1} + D_1 p^n + \dots + D_q p^{n-q+1} + \dots + D_{n+1}} \mathbb{1}$$

where G is the nominal stage gain, $\gamma = 1/R_a C_d$ and $\lambda = 1/R_d C_d$.

$$G \frac{p + (\gamma + \lambda)}{p + \lambda} \mathbb{1}$$

where G is the nominal stage gain, $\gamma = 1/R_a C_d$ and $\lambda = 1/R_d C_d$.

If the indicial response of the amplifier, excluding the last stage, is given by equation (2), then the overall response including the last stage, with its decoupling circuit, is

$$h(p) \mathbb{1} = \frac{p + (\gamma + \lambda)}{p + \lambda} \cdot \frac{\mu_0}{1 + \mu_0 \beta_0} \frac{p^n + a_1 p^{n-1} + \dots + a_q p^{n-q} + \dots + a_n}{p^n + d_1 p^{n-1} + \dots + d_q p^{n-q} + \dots + d_n} \mathbb{1}$$

$$= \frac{\mu_0}{1 + \mu_0 \beta_0} \frac{p^{n+1} + C_1 p^n + \dots + C_q p^{n-q+1} + \dots + C_{n+1}}{p^{n+1} + D_1 p^n + \dots + D_q p^{n-q+1} + \dots + D_{n+1}} \mathbb{1}$$

where $C_q = a_q + (\gamma + \lambda) a_{q-1}$

and $D_q = d_q + \lambda d_{q-1}$

$$\therefore (1 + \mu_0 \beta_0) D_q = b_q + \lambda b_{q-1} + \mu_0 \beta_0 (a_q + \lambda a_{q-1}) \dots \dots (10)$$

and $C_q = D_q$ when

$$a_q + a_{q-1} [\lambda + \gamma (1 + \mu_0 \beta_0)] = b_q + b_{q-1} \quad (11) \quad \text{and}$$

The overall indicial response therefore has r th-order compensation when the coefficients a_1, a_2, \dots, a_r and b_1, b_2, \dots, b_r of the indicial response of its μ -path satisfy equation (11).

It is interesting to compare the effect of adding a decoupling circuit to the amplifier outside its feedback loop with the effect of adding a decoupling circuit inside the loop. If a decoupling circuit with time-constants $1/\gamma'$ and $1/\lambda'$ is added to the amplifier whose indicial response is given by equation (1), the response of the μ -path including the decoupling circuit is

$$\mu(p) \mathbb{1} = \mu_0 \frac{p + (\gamma' + \lambda')}{p + \lambda'} \frac{p^n + a_1 p^{n-1} + \dots + a_q p^{n-q} + \dots + a_n}{p^n + b_1 p^{n-1} + \dots + b_q p^{n-q} + \dots + b_n} \mathbb{1}$$

$$= \mu_0 \frac{p^{n+1} + A_1 p^n + \dots + A_q p^{n-q+1} + \dots + A_{n+1}}{p^{n+1} + B_1 p^n + \dots + B_q p^{n-q+1} + \dots + B_{n+1}} \mathbb{1}$$

The overall indicial response is therefore given by

where $A_q = a_q + (\gamma' + \lambda') a_{q-1}$

and $B_q = b_q + \lambda' b_{q-1}$

where, from equation (3),

$$D_q = [B_q + \mu_0 \beta_0 A_q] / (1 + \mu_0 \beta_0)$$

$$\therefore (1 + \mu_0 \beta_0) D_q = b_q + \lambda' b_{q-1}$$

$$+ \mu_0 \beta_0 [a_q + (\gamma' + \lambda') a_{q-1}] \dots \dots (13)$$

and $A_q = D_q$ when

$$a_q + a_{q-1} (\gamma' + \lambda') = b_q + b_{q-1} \lambda' \dots \dots (14)$$

The difference in form between equation (13) and

equation (10) shows that, in general, a decoupling circuit has a different effect on the indicial response depending on whether it is inside or outside the feedback loop. However, equations (14) and (11) are identical when

$$\lambda' = \lambda \dots \dots (15)$$

$$\gamma' = \gamma (1 + \mu_0 \beta_0) \dots \dots (16)$$

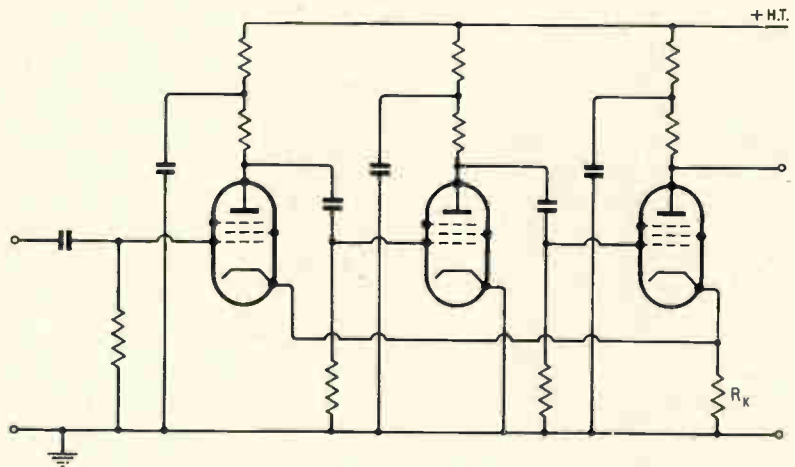

Fig. 1. Amplifier with feedback taken from the cathode of the third valve.

The condition for an amplifier with a decoupling circuit outside the feedback loop to have r th-order compensation is therefore the same as that for an amplifier with an additional decoupling circuit inside the loop having the same time-constant $C_d R_d$ but $1/(1 + \mu_0 \beta_0)$ times the time-constant $C_d R_a$.

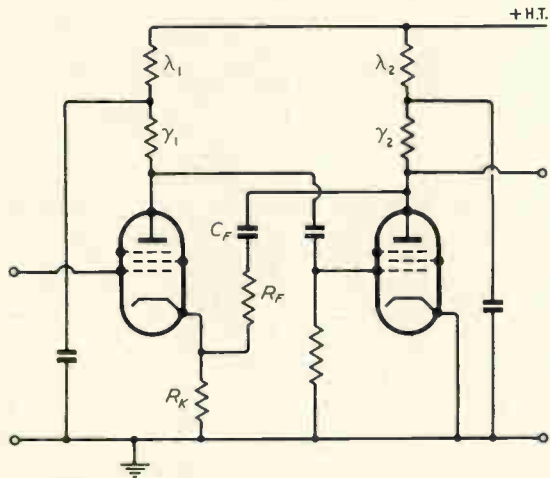

Fig. 2. Amplifier with feedback taken from the anode of the second valve.

4. Amplifier with a Capacitor in the Feedback Path

The amplifiers considered in the previous sections each have a feedback fraction β which is independent of frequency. However, it is often necessary to include a capacitor in the feedback path in order to block d.c., as shown in Fig. 2. β is then frequency-dependent and the indicial response of the feedback path is

$$\beta(p) \mathbb{1} = \beta_0 \frac{p}{p + \sigma} \mathbb{1} \quad \dots \quad (17)$$

where $\beta_0 = R_K / (R_K + R_F)$ and $\sigma = 1 / C_F (R_K + R_F)$

If the response of the μ -path is given by equation (1) then the overall indicial response of the amplifier is

$$\begin{aligned} h(p) \mathbb{1} &= \frac{\mu(p)}{1 + \mu(p) \cdot \beta(p)} \mathbb{1} \\ &= \frac{\mu_0}{1 + \mu_0 \beta_0} \frac{p^{n+1} + c_1 p^n + \dots + c_q p^{n-q+1} + \dots + c_{n+1}}{p^{n+1} + d_1 p^n + \dots + d_q p^{n-q+1} + \dots + d_{n+1}} \mathbb{1} \end{aligned}$$

where

$$\begin{aligned} c_1 &= a_1 + \sigma, & d_1 &= (\mu_0 \beta_0 a_1 + b_1 + \sigma) / (1 + \mu_0 \beta_0) \\ c_2 &= a_2 + a_1 \sigma, & d_2 &= (\mu_0 \beta_0 a_2 + b_2 + b_1 \sigma) / (1 + \mu_0 \beta_0) \\ \dots & & \dots & \\ c_q &= a_q + a_{q-1} \sigma, & d_q &= (\mu_0 \beta_0 a_q + b_q + b_{q-1} \sigma) / (1 + \mu_0 \beta_0) \\ \dots & & \dots & \\ c_{n+1} &= a_n \sigma, & d_{n+1} &= b_n \sigma / (1 + \mu_0 \beta_0) \end{aligned}$$

$\therefore c_q = d_q$ when

$$a_q + a_{q-1} \sigma (1 + \mu_0 \beta_0) = b_q + b_{q-1} \sigma \dots \quad (18)$$

Now equation (18) is identical with equation (14) when

$$\gamma' = \mu_0 \beta_0 \sigma \quad \dots \quad (19)$$

and $\lambda' = \sigma \quad \dots \quad (20)$

The conditions for r th-order compensation when a capacitor is added to the β -path are thus equivalent to the conditions when a stage of anode decoupling is added to the μ -path with the values of $R_d C_d$ and $R_a C_a$ given by $1/\sigma$ and $1/\mu_0 \beta_0 \sigma$ respectively, provided that the values of μ_0 and β_0 are unchanged. Alternatively, by identifying equation (18) with equation (11), it follows that adding the capacitor to the β -path is equivalent to adding a decoupling circuit outside the feedback loop with the values of $R_d C_d$ and $R_a C_a$ given by $1/\sigma$ and $(1 + \mu_0 \beta_0) / \mu_0 \beta_0 \sigma$ respectively. The capacitor in the β -path can thus be used to compensate for the effects of coupling circuits in much the same way as decoupling circuits are used.

An amplifier with a capacitor in the β -path can thus be made to have compensation one order higher than the corresponding circuit with β independent of frequency. Consequently, it is sometimes advantageous to include a capacitor in the feedback path for low-frequency compensation even when it is not required to block d.c. For example, the feedback path of the amplifier in Fig. 1 can be modified as shown in Fig. 3 to provide capacitance coupling between the first and last cathode. Another method of obtaining the indicial response given by equation (17) from the β -path of Fig. 1 is to shunt R_K by an inductor. However, the addition of series capacitance or shunt inductance to the β -path increases the phase-shift round the loop at low frequencies and may lead to an oscillatory indicial response, or even to instability, unless the amplifier initially has an adequate margin of stability.

5. Amplifiers whose Response is Determined by Coupling Circuits Alone

5.1. Single-Stage Amplifier

For a single stage with a coupling circuit comprising capacitance C_c and resistance R_g

$$\mu(p) = \mu_0 \frac{R_g}{R_g + 1/pC_c} = \mu_0 \frac{p}{p + \alpha}$$

where $\alpha = 1/C_c R_g$

If β is independent of frequency then the overall indicial response is given by

$$\begin{aligned} h(p) \mathbb{1} &= \frac{\mu_0 p / (p + \alpha)}{1 + \mu_0 \beta_0 p / (p + \alpha)} \mathbb{1} \\ &= \frac{\mu_0}{1 + \mu_0 \beta_0} \cdot \frac{p}{p + \alpha'} \mathbb{1} \end{aligned}$$

where $\alpha' = \alpha / (1 + \mu_0 \beta_0)$

The indicial response of the feedback amplifier is thus of the same form as that of the amplifier without feedback. The effect of the feedback is to multiply the time-constant of the amplifier by the feedback factor $(1 + \mu_0 \beta_0)$. The initial rate at which the indicial response decays is thus reduced in the same proportion as the gain is reduced by the feedback.

If the feedback path contains a capacitor then $\beta(p)$ is given by equation (17) and

$$\begin{aligned} h(p) \mathbb{1} &= \frac{\mu_0 p / (p + \alpha)}{1 + \mu_0 \beta_0 p^2 / (p + \alpha)(p + \sigma)} \mathbb{1} \\ &= \frac{\mu_0}{1 + \mu_0 \beta_0} \cdot \frac{p^2 + \sigma p}{p^2 + d_1 p + d_2} \mathbb{1} \end{aligned}$$

where $d_1 = (\alpha + \sigma) / (1 + \mu_0 \beta_0)$

and $d_2 = \alpha \sigma / (1 + \mu_0 \beta_0)$

It is thus possible to obtain first-order compensation. We require $\sigma = d_1$ and this is obtained when

$$\alpha = \mu_0 \beta_0 \sigma \dots \dots \dots (21)$$

5.2. Multi-Stage Amplifier

For an n -stage amplifier with time-constants $1/\alpha_1, 1/\alpha_2, \dots, 1/\alpha_n$

$$\mu(p) = \mu_0 \frac{p^n}{(p + \alpha_1)(p + \alpha_2) \dots (p + \alpha_n)}$$

The μ -path thus has a zero-order indicial response. If β is independent of frequency then the overall response also has zero-order compensation. If the feedback path contains a capacitor, then $\beta(p)$ is given by equation (17) and the overall indicial response is

$$\begin{aligned} \frac{\mu(p)}{1 + \mu(p) \cdot \beta(p)} \mathbb{1} &= \frac{\mu_0 p^{n+1} + \mu_0 \sigma p^n}{\mu_0 \beta_0 p^{n+1} + (p + \alpha_1)(p + \alpha_2) \dots (p + \alpha_n)} \mathbb{1} \\ &= \frac{\mu_0}{1 + \mu_0 \beta_0} \cdot \frac{p^{n+1} + \sigma p^n}{p^{n+1} + d_1 p^n + \dots + d_r p^{n-r+1} + \dots + d_{n+1}} \mathbb{1} \dots \dots (22) \end{aligned}$$

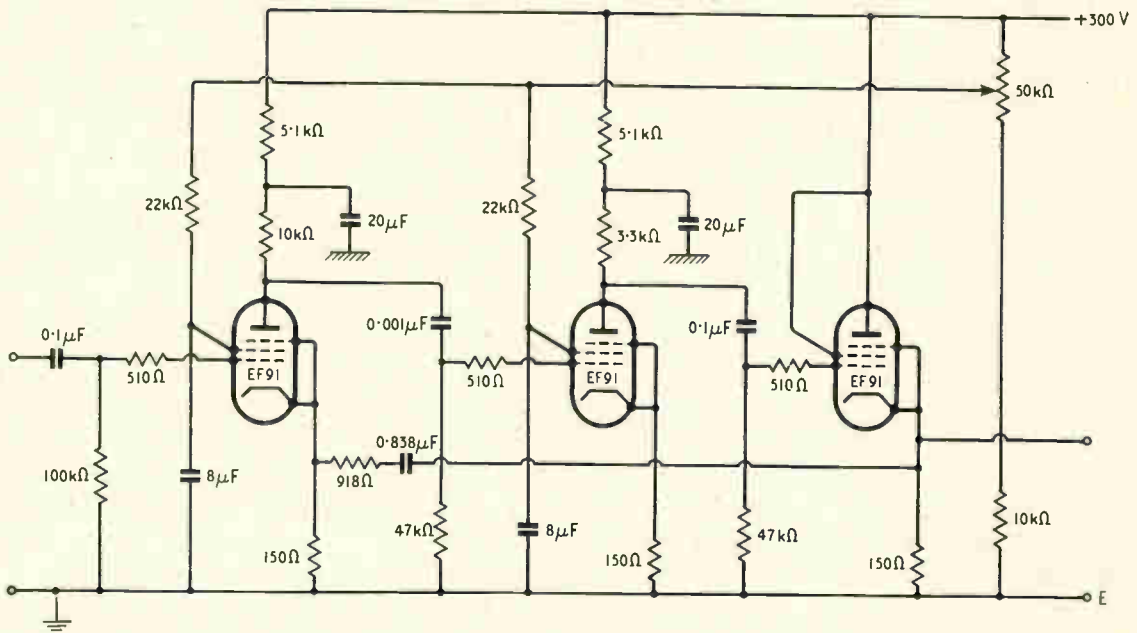

Fig. 3. Experimental amplifier with negative feedback.

$$\text{where } d_1 = \left\{ \sigma + \sum_{r=1}^n \alpha_r \right\} / [1 + \mu_0 \beta_0]$$

First-order compensation is thus obtained when $\sigma = d_1$

$$\therefore \mu_0 \beta_0 \sigma = \sum_{r=1}^n \alpha_r \quad \dots \quad (23)$$

If the amplifier has a resistance-capacitance coupling circuit which is outside the feedback loop then the overall indicial response is given by

$$h(p) \mathbf{1} = \frac{p}{p + \alpha_0} \cdot \frac{\mu(p)}{1 + \mu(p) \cdot \beta(p)} \mathbf{1}$$

$$= \frac{\mu_0}{1 + \mu_0 \beta_0} \cdot \frac{p^{n+2} + \sigma p^{n+1}}{p^{n+2} + D_1 p^{n+1} + \dots + D_r p^{n-r+2} + \dots + D_{n+2}} \mathbf{1}$$

where $D_r = d_r + \alpha_0 d_{r-1}$ [from equations (5) and (22)].

First-order compensation is thus obtained when

$$\sigma = D_1 = b_1 + \alpha_0$$

$$\therefore \mu_0 \beta_0 \sigma = \sum_{r=1}^n d_r + (1 + \mu_0 \beta_0) \alpha_0 \quad \dots \quad (24)$$

Comparing equations (23) and (24) it is seen that, in this case, the effect of the external coupling circuit on the condition for first-order compensation is equivalent to an additional coupling circuit inside the feedback loop with a time constant equal to that of the external coupling circuit divided by $(1 + \mu_0 \beta_0)$.

6. Amplifier with a Single Stage of Coupling and Decoupling

If the amplifier has a single stage of anode decoupling and a single coupling circuit, then from equation (12) of Part 1:

$$\mu(p) = \mu_0 \frac{p^2 + p(\gamma_1 + \lambda_1)}{p^2 + p(\alpha + \lambda_1) + \alpha \lambda_1}$$

where $\alpha = 1/R_g C_c$, $\gamma_1 = 1/R_a C_d$, $\lambda_1 = 1/R_d C_d$.

The μ -path thus gives a first-order indicial response when $\gamma_1 = \alpha$. If β is independent of frequency then the overall response also has first-order compensation.

If the feedback path contains a capacitor and has time-constant $1/\sigma$ then Section 4 shows that its effect is equivalent to a second stage of anode decoupling whose time-constants $1/\gamma_2$ and $1/\lambda_2$ are given by equations (19) and (20) as

$$\gamma_2 = \mu_0 \beta_0 \sigma \text{ and } \lambda_2 = \sigma$$

The conditions for compensation of the feedback amplifier therefore correspond to those for an amplifier without feedback having one coupling circuit and two stages of anode decoupling. It was shown in Section 4.1 of Part 1 that this could be made to give second-order

compensation. The conditions for second-order compensation, from equations (17) and (18) of Part 1 are

$$\alpha = \gamma_1 + \gamma_2$$

$$\text{and } \gamma_1 \gamma_2 = \gamma_1 \lambda_1 + \gamma_2 \lambda_2$$

$$\text{which gives } \alpha = \gamma_1 + \mu_0 \beta_0 \sigma \quad \dots \quad (25)$$

$$\text{and } \lambda_1 = \mu_0 \beta_0 \sigma (1 - \sigma/\gamma_1) \quad \dots \quad (26)$$

7. Amplifier with Two Stages of Anode Coupling, One Coupling Circuit and a Capacitor in the Feedback Path

The typical feedback amplifier circuit shown in Fig. 2 has two stages of anode decoupling and one

coupling circuit in the μ -path and a capacitor in the β -path. Let the two anode circuits have time-constants $1/\lambda_1$, $1/\lambda_2$, $1/\gamma_1$, $1/\gamma_2$ and the feedback path a time-constant $1/\sigma$. It is shown in Section 4 that the effect of the feedback capacitor is equivalent to a third stage of anode decoupling whose time-constants ($1/\gamma_3$, $1/\lambda_3$) are given by equations (19) and (20) as

$$\gamma_3 = \mu_0 \beta_0 \sigma$$

$$\lambda_3 = \sigma$$

The overall indicial response is therefore equivalent to that of an amplifier without feedback having one coupling circuit and three stages of anode decoupling. It was shown in Section 4.4 of Part 1 that this gives third-order compensation when the following conditions are satisfied:

$$\alpha = \gamma_1 + \gamma_2 + \gamma_3$$

$$\gamma_1 \gamma_2 + \gamma_2 \gamma_3 + \gamma_3 \gamma_1 = \gamma_1 \lambda_1 + \gamma_2 \lambda_2 + \gamma_3 \lambda_3$$

$$\gamma_1 \lambda_1 (\lambda_2 + \lambda_3) + \gamma_2 \lambda_2 (\lambda_1 + \lambda_3) + \gamma_3 \lambda_3 (\lambda_1 + \lambda_2)$$

$$= \lambda_1 \gamma_2 \gamma_3 + \lambda_2 \gamma_1 \gamma_3 + \lambda_3 \gamma_1 \gamma_2 + \gamma_1 \gamma_2 \gamma_3$$

If we put $\gamma_1 = \gamma_2 = \gamma$ and $\lambda_1 = \lambda_2 = \lambda$ these equations give

$$\alpha = 2\gamma + \gamma_3 \quad \dots \quad (27)$$

$$\lambda = \frac{1}{2}(\gamma + 2\gamma_3 - \gamma_3 \lambda_3/\gamma) \quad \dots \quad (28)$$

and

$$\gamma^4 + 4\gamma^2 \gamma_3 \lambda_3 + 2\gamma \gamma_3 \lambda_3 (\gamma_3 - \lambda_3) - \gamma_3^2 \lambda_3^2 = 0 \quad \dots \quad (29)$$

Substituting for γ_3 and λ_3 in equation (29) gives

$$\gamma^4 + 4\gamma^2 \sigma^2 \mu_0 \beta_0 + 2\gamma \sigma^2 \mu_0 \beta_0 (\mu_0 \beta_0 - 1) - \sigma^4 (\mu_0 \beta_0)^2 = 0 \quad \dots \quad (30)$$

which enables the required value of σ to be obtained for any particular numerical values of γ and $\mu_0 \beta_0$. By solving equation (30) as a quadratic for $\mu_0 \beta_0$ it can be shown that $\mu_0 \beta_0$ is only real and positive for $0 < \gamma < \frac{1}{2}\sigma$. In most

cases $\mu_0\beta_0 \gg 1$ so that $\gamma \ll \mu_0\beta_0\sigma$ and equation (30) reduces to

$$2\gamma\sigma^3(\mu_0\beta_0)^2 - \sigma^4(\mu_0\beta_0)^2 = 0$$

$$\therefore \sigma = 2\gamma \quad \dots \quad (31)$$

and substituting in equations (27) and (28) gives

$$x = 2\gamma(1 + \mu_0\beta_0) \quad \dots \quad (32)$$

$$\text{and } \lambda = \frac{1}{2}\gamma \quad \dots \quad (33)$$

The error involved in using equation (31) instead of the exact equation (30) is less than 1% for $\mu_0\beta_0 > 2$ and less than 0.1% for $\mu_0\beta_0 > 7.4$.

8. More Complicated Circuits

Circuits which are more complicated than those considered in the previous sections can often be made to have indicial responses with higher orders of compensation, but the calculations are correspondingly more difficult. In many practical cases, however, it is sufficient to obtain first- or second-order compensation. A complicated circuit can then be dealt with by considering it as a number of simpler stages connected in tandem, each of which can be made to have the required order of compensation.

Consider, for example, an amplifier whose response is determined by two coupling circuits and two stages of anode decoupling in the μ -path, a capacitor in the β -path and one coupling circuit and one decoupling circuit outside the feedback loop.* Section 4 shows that the effect of the capacitor in the β -path on the order of compensation is equivalent to adding a decoupling circuit outside the loop. The feedback amplifier can therefore be considered as equivalent to an amplifier with two coupling circuits and two anode decoupling circuits and with β independent of frequency, connected in tandem with another amplifier without feedback which has one coupling circuit and two decoupling circuits. Section 2 shows that the feedback amplifier gives the same order of compensation as its μ -path. The two equivalent amplifiers each with two decoupling circuits can be made to have second-order compensation as shown in Section 4 of Part 1. The overall indicial response then also has second-order compensation.

9. Stability Considerations

An indicial response with a high order of compensation is very flat in the neighbourhood of $t = 0$, but that condition gives no control of the ultimate behaviour of the response with increasing time. If an amplifier has been designed to have an indicial response with a high order of compensation it does not therefore necessarily follow that

it will be stable. Consequently, it is still necessary to check the $\mu\beta$ characteristics of the amplifier to ensure that it has an adequate stability margin.

Consider, for example, an amplifier whose response is entirely determined by three coupling circuits in the μ -path with equal time-constants. It can be shown that this amplifier only satisfies the Nyquist stability criterion if $\mu_0\beta_0 < 8$. If a capacitor is added to the β -path, to give first-order compensation of the indicial response, the increase in phase-shift round the feedback loop results in the amplifier being unstable if $\mu_0\beta_0 > 4.05$. If more feedback is required, the time-constants of the coupling circuits must be made unequal.

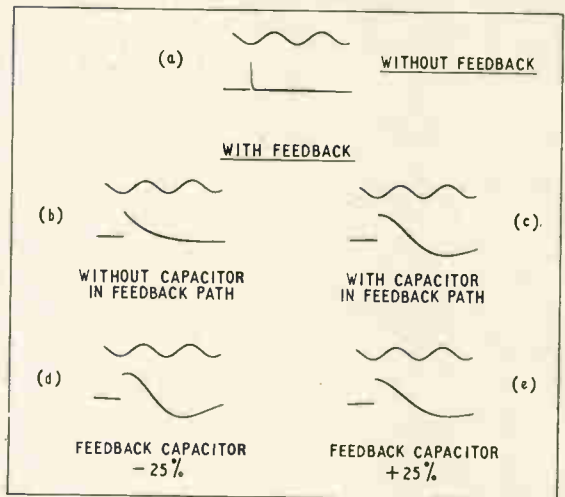

Fig. 4. Oscillograms of response of model amplifier to a 50-c/s square wave. (The timing wave is 500 c/s.)

10. Experimental Work

Fig. 3 shows an amplifier which was built in order to obtain some experimental verification of the theory. The values of the components determining the time-constants of the coupling circuits were accurate to within 1%. The time-constants of the decoupling circuits are of the order of 100 times those of the coupling circuits and β -path, which were made much smaller than normal in order to avoid distortion being introduced by the oscilloscope amplifier. The effects of time-constants other than those of the coupling circuits and the β -path are therefore negligible and the analysis given in Section 5.2 is applicable.

The screen voltage of the valves was adjusted so that the voltage gain at high frequencies with the feedback path disconnected was 135, then $(1 + \mu_0\beta_0) = 20$. The value of capacitance required in the feedback path to obtain first-order compensation [calculated from equation (24)] was $0.838 \mu\text{F}$.

*i.e., the circuit of Fig. 1 with the feedback path modified as shown in Fig. 3.

Oscillograms were taken of the response of the amplifier to a 50-c/s square-wave input voltage. Because the period of this wave is long compared with the amplifier time-constants, the response to each edge of the waveform is substantially independent of its predecessors and approximates closely to the indicial response. A double-beam oscilloscope was used with the output voltage deflecting one beam and a 500-c/s sinewave calibrating signal deflecting the other beam.

Fig. 4(a) shows the response to the 50-c/s square wave of the amplifier without feedback and Fig. 4(b) shows the response with feedback but without the capacitor in the β -path. Negative feedback has made the response decay much more slowly but the response is still of the zero-order type. Fig. 4(c) shows the response with the 0.838- μ F capacitor in the β -path. The initial flatness of the response indicates that first-order compensation has been obtained, but it is accompanied by a large amount of overshoot. Figs. 4(d) and 4(e) show the effect on the response of a $\pm 25\%$ variation of the capacitance in the β -path. Oscillograms were also taken of the response of the amplifier to a 500-c/s square wave. Fig. 5 shows the results obtained (a) with β independent of frequency and (b) with the 0.838- μ F capacitor in the feedback path.

The gain-frequency response of the amplifier was measured with and without feedback and the results obtained are shown in Fig. 6. Application of negative feedback makes the gain-frequency response flat down to very much lower frequencies, but the inclusion of the capacitor in the feedback path causes a considerable peak in the response, thus confirming that a flat gain-frequency response is not the criterion for a flat indicial response.

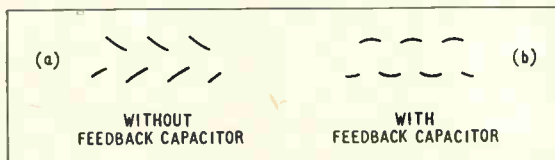

Fig. 5. Response of model amplifier to a 500-c/s square wave.

11. Conclusions

The method outlined in Part 1 for designing amplifiers with indicial responses having the highest possible order of compensation is applicable to negative-feedback amplifiers. If the amplifier has a feedback fraction β which is independent of frequency, the overall response has r th-order compensation when the μ -path has an r th-order response. If the μ -path is designed to be maximally flat the overall indicial response will also be maximally flat.

If β is made frequency-dependent, an amplifier

can have a higher order of compensation than is obtainable from the μ -path alone. It is shown that the effect on the order of compensation of adding a capacitor to the β -path is equivalent to adding a stage of anode decoupling to the μ -path. This assists in offsetting the effects of the coupling circuits and enables compensation to be obtained which is one order higher than that obtainable when β is independent of frequency.

The method has been applied to some simple circuits, including cases where a coupling circuit or an anode decoupling circuit is outside the feedback loop. Some of the results have been verified by experiment. A high order of compensation of the indicial response does not necessarily imply stability. It is still necessary to check the design of the amplifier to ensure that it is stable.

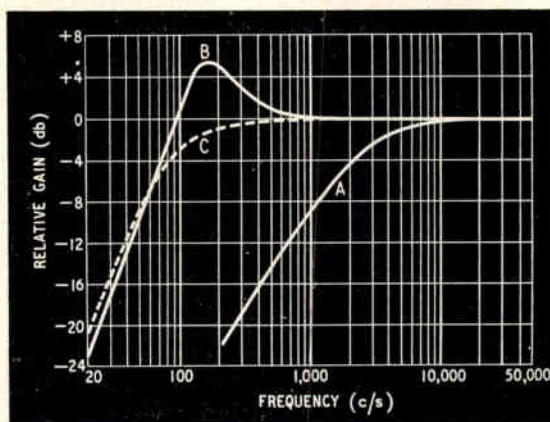

Fig. 6. Frequency response of a model negative-feedback amplifier; A, without feedback; B and C, with and without a capacitor in the feedback path.

Acknowledgments

Acknowledgment is made to Siemens Brothers & Co., Ltd., for permission to publish the paper. The author is greatly indebted to Mr. A. G. Simms for his help in the mathematical work contained in the Appendices. Thanks are also due to Mr. H. A. Showell for his assistance in the experimental work.

NATIONAL RADIO EXHIBITION

The 21st National Radio Show will be held at Earl's Court, London, from 25th August to 4th September inclusive (except Sunday). It will be open from 11 a.m. until 10 p.m. and admission will cost 2s. 6d. (children 1s.)

TECHNICAL LITERATURE

Marconi Instruments 1954 Catalogue

A 200-page bound catalogue which deals with over 70 different equipments for telecommunications measurement and industrial electronics. Functional diagrams of the apparatus are included. Available to senior engineers and executives on request to Marconi Instruments, Ltd., St. Albans, Herts.

CORRESPONDENCE

Cathode-Coupled Amplifier Formulae

SIR,—The discussion of the cathode-coupled amplifier by T. W. Brady⁶ in the May issue of *Wireless Engineer* is an excellent addition to the knowledge of this circuit, which presently is finding many applications; for example, in extremely wide band distributed amplifiers (cut-off frequency approaching 1,000 Mc/s)^{2,3}. With direct reference to Fig. 1, reprinted from Mr. Brady's article,⁶ this writer wishes to add some additional formulae, covering the grid input admittance, the cathode impedance, and the gain. These formulae have been found highly useful, and perhaps provide a complement to Mr. Brady's graphical method.

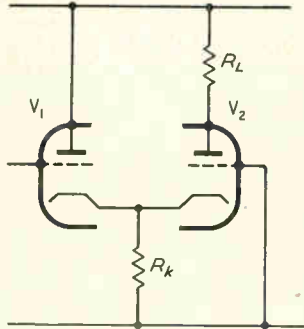

The input admittance has the form

$$Y_{in} \approx j\omega C_{gk} \frac{g_{m2} + 1/R_k + j\omega C_k}{g_{m1} + g_{m2} + 1/R_k + j\omega(C_{gk} + C_k)} \quad (1)$$

where R_k is the cathode resistor, C_{gk} grid-cathode capacitance, and C_k the shunting stray cathode capacitance. Since at higher frequencies the cathode lead inductance L_k plays an unfortunate role in creating a conductance across the tube input, the formula including L_k is of interest (for simplicity given for identical tubes),

$$Y_{in} \approx j\omega C_{gk} \frac{1 + g_m R_k - \omega^2 L_k C_k + j\omega(g_m L_k + C_k R_k)}{[1 + 2g_m R_k - \omega^2 L_k(C_{gk} + C_k) + j\omega[2g_m L_k + R_k(C_{gk} + C_k)]]} \quad (2)$$

The cathode output impedance Z_0 seen through the cathode impedance Z_k looking into the circuit with R_L extended to become the load impedance Z_L , is, for identical tubes,

$$Z_0 \approx \frac{r_a(r_a + Z_L)}{(\mu + 1)(2r_a + Z_L)} \quad (3)$$

This formula may be easily derived if Thévenin's theorem is applied to the constant-voltage equivalent circuit of the cathode-coupled amplifier, and the writer's 'output impedance theorem' applied.⁴

The complex gain has the form, with R_k extended to become Z_k ,

$$A(\omega) \approx \frac{g_{m1} g_{m2} Z_L}{g_{m1} + g_{m2} + 1/Z_k} \quad (4)$$

The use of the 'Korman equivalent triode'^{1,2} is often helpful in computation work on the cathode-coupled amplifier (in U.S.A. often referred to as the 'paraphase' amplifier). The tube coefficients for the equivalent triode are

$$\mu_{eq} = -\mu \frac{H}{1 + H} \quad (5)$$

$$r_{aeq} = r_a \frac{1 + 2H}{1 + H} \quad (6)$$

$$g_{meq} = -g_m \frac{H}{1 + 2H} \quad (7)$$

$$H = g_m Z_k \left(1 + \frac{1}{\mu}\right) \approx g_m Z_k \quad (8)$$

As an example of the use of this method, the approximate gain formula in Equ. (4), for the case of $g_{m1} = g_{m2}$, may be quickly derived, considering the cathode-coupled amplifier as an equivalent triode with a plate load Z_L .

HARRY STOCKMAN.

Scientific Specialties Corporation,
Boston 35, Massachusetts, U.S.A.
27th May 1954.

REFERENCES

- ¹ Sziklai-Schroeder, "Cathode-Coupled Wide-Band Amplifiers", *Proc. Inst. Radio Engrs.*, Oct. 1945, Vol. 33, No. 10.
- ² Korman, N. I. "Cathode-Coupled Triode Amplifiers", *Proc. Inst. Radio Engrs.*, Jan. 1947, Vol. 35, No. 1, p. 48.
- ³ Furlow, W. M., Jr., and Kings, L. "A Theoretical and Experimental Study of the Use of Triodes in a Distributed Amplifier Circuit", Melpar, Inc., Contract SC-52588 (1952).
- ⁴ Stockman, H. "Output Impedance Theorem", *Wireless Engineer*, March 1954, Vol. 31, No. 3, p. 75.
- ⁵ Stockman, H. "DC to Kilomegacycles Wide Band Amplifiers", Proceedings of the 1954 Electronic Components Symposium, Washington.
- ⁶ Brady, T. W. "Cathode-Coupled Valves" *Wireless Engineer*, May 1954, Vol. 31, No. 5, p. 111.

STANDARD-FREQUENCY TRANSMISSIONS

(Communication from the National Physical Laboratory)

Values for June 1954

Date 1954 June	Frequency deviation from nominal: parts in 10 ⁸		Lead of MSF impulses on GBR 1000 G.M.T. time signal in milliseconds
	MSF 60 kc/s 1429-1530 G.M.T.	Droitwich 200 kc/s 1030 G.M.T.	
1	-1.2	-1	+36.4
2	-1.1	-1	+36.9
3	-1.1	-2	+36.5
4	-1.1	-1	NM
5	-1.1	-2	NM
6	-1.2	-2	NM
7	-1.2	-1	NM
8	-1.1	-1	+36.4
9	-1.1	-1	+36.4
10	-1.3	-1	+35.4
11	-1.2	-2	+35.0
12	-1.1	-2	NM
13	-1.1	-2	NM
14	-1.2	-2	+34.6
15	NM	-1	+33.6
16	-1.1	-1	NM
17	-1.1	-1	+33.2
18	-1.1	-1	+33.1
19	NM	-3	NM
20	NM	-2	NM
21	-1.1	0	NM
22	-1.1	-1	+36.5
23	-1.1	0	+37.0
24	-1.1	-1	+37.7
25	-1.1	0	+38.4
26	-1.1	-5	NM
27	-1.1	-1	NM
28	-1.1	0	+40.3
29	-1.0	0	+40.8
30	-1.0	-1	+41.1

The values are based on astronomical data available on 1st July 1954.
NM = Not Measured.

ABSTRACTS and REFERENCES

Compiled by the Radio Research Organization of the Department of Scientific and Industrial Research and published by arrangement with that Department.

The abstracts are classified in accordance with the Universal Decimal Classification. They are arranged within broad subject sections in the order of the U.D.C. numbers, except that notices of book reviews are placed at the ends of the sections. U.D.C. numbers marked with a dagger (†) must be regarded as provisional. The abbreviations of journal titles conform generally with the style of the World List of Scientific Periodicals. An Author and Subject Index to the abstracts is published annually; it includes a selected list of journals abstracted, the abbreviations of their titles and their publishers' addresses.

	PAGE	
Acoustics and Audio Frequencies	161	A
Aerials and Transmission Lines	163	dimensional equation of motion of a polytropic gas with adiabatic index $\gamma = -1$ is solved for an arbitrary piston motion. More detailed results are given for the case of sinusoidal motion. See also 294 of February.
Automatic Computers	165	534.213.4
Circuits and Circuit Elements	165	2277
General Physics	167	A Method of Measuring Discontinuity Effects in Ducts.—W. K. R. Lippert. (<i>Acustica</i> , 1954, Vol. 4, No. 2, pp. 307-312.) The method is based on a transmission-line analogy. The experimental technique makes use of a non-reflecting terminal and a probe microphone for exploring the sound field on each side of the discontinuity. From the measurements the characteristic reflection and transmission factors and the equivalent impedance matrix are derived.
Geophysical and Extraterrestrial Phenomena	169	534.213.4
Location and Aids to Navigation	171	2278
Materials and Subsidiary Techniques	171	The Measurement of Sound Reflection and Transmission at Right-Angled Bends in Rectangular Tubes.—W. K. R. Lippert. (<i>Acustica</i> , 1954, Vol. 4, No. 2, pp. 313-319.) Experimental equipment is described and results are discussed for symmetrical and asymmetrical discontinuities. The measurements agree well with the theory of Miles (<i>J. acoust. Soc. Amer.</i> , 1947, Vol. 19, p. 572) and prove that the phase relations of the characteristic factors which have been derived theoretically for loss-free cases are valid.
Mathematics	175	534.213.4
Measurements and Test Gear	175	2279
Other Applications of Radio and Electronics	177	On the Theory of Sound Reflection in an Open-Ended Cylindrical Tube.—H. Levine. (<i>J. acoust. Soc. Amer.</i> , March 1954, Vol. 26, No. 2, pp. 200-211.) Reflection coefficient R and end correction l are incorporated into a boundary-value formulation of the wave propagation problem. Two techniques are described for solving the integral equations involved: a variational procedure giving approximate results, and a method based on initial modification of an integral equation which yields exact values for R and l for a tube of circular cross-section. Results obtained by the two methods are compared.
Propagation of Waves	178	534.232
Reception	179	2280
Stations and Communication Systems	179	Suppression of Flexural Vibrations of Barium Titanate.—C. L. Darner. (<i>J. acoust. Soc. Amer.</i> , March 1954, Vol. 26, No. 2, pp. 256-257.) BaTiO ₃ in thickness resonance develops an intense shear mode of vibration which sets up flexural waves and gives a directivity pattern with strong side lobes. The flexural waves are suppressed in a particular 1-Mc/s transducer by forming square $\lambda/2$ indentations along its edges.
Subsidiary Apparatus	180	534.232 : 537.228.1
Television and Phototelegraphy	180	2281
Transmission	181	Characteristics of Radiating Variable-Resonant-Frequency Crystal Systems.—W. Welkowitz & W. J. Fry. (<i>J. acoust. Soc. Amer.</i> , March 1954, Vol. 26, No. 2, pp. 159-165.) One-dimensional theory of piezoelectric systems is applied to ADP and BaTiO ₃ transducers with Hg backing, operating in water. Curves are presented
Valves and Thermionics	181	

ACOUSTICS AND AUDIO FREQUENCIES

534.13	2274
Study of the Acoustic Properties of Granular Substances excited to Shear-Mode Vibrations.—M. L. Exner, W. Güth & F. Immer. (<i>Acustica</i> , 1954, Vol. 4, No. 2, pp. 350-358. In German.) Measurements of the mechanical impedance were made in the range 100-4 000 c/s on closely-packed granular carbon, using a rigid vibrometer. For small-amplitude vibrations the resonance frequencies are higher in fine-grain material and the damping less than in coarse-grain material. A decrease in velocity of propagation with increasing grain radius was observed. Results are in general agreement with those obtained by other methods.	
534.2-14	2275
Wave Propagation in a Randomly Inhomogeneous Medium: Part 3.—D. Mintzer. (<i>J. acoust. Soc. Amer.</i> , March 1954, Vol. 26, No. 2, pp. 186-190.) The assumption of a restricted pulse length made in part 1 (931 of April) is examined. The conditions necessary for the assumption to be valid are investigated. The coefficient of variation for a series of sound pulses of arbitrary length and the correlation function for successively received pulses are evaluated. Part 2: 1633 of June.	
534.21-13	2276
Finite Amplitude Sound produced by a Piston in a Closed Tube.—J. B. Keller. (<i>J. acoust. Soc. Amer.</i> , March 1954, Vol. 26, No. 2, pp. 253-254.) The one-	

showing (a) power output as a function of frequency, (b) resonance-frequency shift as a function of backing length, and (c) bandwidth as a function of frequency. A system in which half the crystals have a natural resonance frequency twice that of the others can be operated over a continuous frequency range of about 5.3 : 1.

534.24-14

2282

On Nonspecular Reflection at a Rough Surface.—J. W. Miles. (*J. acoust. Soc. Amer.*, March 1954, Vol. 26, No. 2, pp. 191-199.) The reflection of a plane wave at a rough interface separating two fluid media is examined neglecting second-order terms in the magnitude of roughness. Exact solutions are obtained for the case of a sinusoidal boundary. For reflection of a pulse from a perfectly reflecting sinusoidal boundary, the boundary acts as a band-pass filter of the nonspecular components of the reflected wave; outside the pass-band, reflection is specular and distortionless. Analysis for a boundary not perfectly reflecting shows that the pass-band is independent of the properties of the reflecting medium.

534.321.9

2283

An Ultrasonic Double-Reflector Concentrator.—L. D. Rozenberg. (*C. R. Acad. Sci. U.R.S.S.*, 11th Aug. 1953, Vol. 91, No. 5, pp. 1091-1094. In Russian.) Theory and description of a system consisting of a paraboloid located inside a coaxial ellipsoid and having its focus coincident with one of the foci of the ellipsoid. A plane wave incident normally on the external surface of the paraboloid is concentrated at the second focal point of the ellipsoid. The geometrical conditions for velocity- and pressure-focusing are derived and shown graphically in system-parameter form. A similar system was described by Barone (603 of 1953).

534.321.9 : 534.2

2284

Conditions for obtaining the Greatest Concentration of Ultrasonic Radiation.—L. D. Rozenberg. (*C. R. Acad. Sci. U.R.S.S.*, 11th Feb. 1954, Vol. 94, No. 5, pp. 845-848. In Russian.) Theoretical investigation of focusing to obtain maximum pressure or maximum velocity at the focal point of (a) reflected or refracted plane waves, and (b) waves from curved radiators such as barium titanate or quartz. The variation of the focusing factor with the aperture is shown graphically for five different systems.

534.321.9 : 61

2285

Ultrasonid and Medicine. A Survey of Experimental Studies.—J. F. Herrick & F. H. Krusen. (*J. acoust. Soc. Amer.*, March 1954, Vol. 26, No. 2, pp. 236-240; *Proc. nat. Electronics Conf., Chicago*, 1953, Vol. 9, pp. 235-243.) A critical review of the applications of ultrasonics in therapy, diagnosis and biological measurements. 43 references.

534.321.9-14 : 534.6

2286

Measurements of Sound Absorption in Aqueous Salt Solutions by a Resonator Method.—O. B. Wilson, Jr., & R. W. Leonard. (*J. acoust. Soc. Amer.*, March 1954, Vol. 26, No. 2, pp. 223-226.) Measurements have been made in the frequency range 50-500 kc/s, using a modified reverberation technique. Results are presented for $MgSO_4$ solutions in particular, and for sea water.

534.6 : 534.321.9 : 537.228.1

2287

Very Small Ultrasonic Probes for Acoustic-Field Measurements in Liquids.—G. Bolz. (*Z. angew. Phys.*, Feb. 1954, Vol. 6, No. 2, pp. 54-59.) Theoretical and experimental investigation of the performance of

piezoelectric probes small compared with wavelength. Suitable crystals have only one piezoelectric axis; the best is tourmaline; $BaTiO_3$ may also have advantages. The crystal is mounted on the tip of a thin wire making contact with its metallized face. Sensitivity increases with frequency and probe surface area, and is practically independent of direction when crystal dimensions are one eighth the wavelength in the liquid. A tourmaline probe for 1 Mc/s was capable of measuring acoustic powers as low as 5×10^{-5} W/cm².

534.612 : 534.321.9 : 535.314

2288

The Study of a Sound Field by means of Optical Refraction Effects.—J. Kolb & A. P. Loeber. (*J. acoust. Soc. Amer.*, March 1954, Vol. 26, No. 2, pp. 249-251.) The broadening of a slit image when a light beam traverses an ultrasonic field can be calculated by a method based on Wiener's theory of refraction of light in a liquid with refractive index varying continuously in one plane. The application of the principle for investigating pressure distribution in a stationary sound wave in the frequency range below 1 Mc/s is illustrated. A simple method of measuring wavelength is outlined.

534.614-14 : 534.321.9

2289

The Dispersion of the Velocity of Sound in Water between 500 and 1500 kc/s.—T. K. McCubbin, Jr. (*J. acoust. Soc. Amer.*, March 1954, Vol. 26, No. 2, pp. 247-249.) Ultrasonic waves at 500 and 1500 kc/s were transmitted simultaneously by a transducer in water at 26°C. Measurements were made of the change in relative phase between the two signals received by a second transducer at different distances from the first. The velocities at the two frequencies are equal to within 1 part in 290 000.

534.845

2290

Perforated Facing and Sound Absorption.—U. Ingard. (*J. acoust. Soc. Amer.*, March 1954, Vol. 26, No. 2, pp. 151-154.) An analytical study is made of the absorption characteristics of a porous layer with perforated facing. The latter contributes to the total impedance not only a mass reactance but also an additional acoustic resistance which may be larger than that of the porous layer itself. This obtains only when the porous material is in close contact with the facing, and is due to the near-field (higher-mode) losses in the porous material around the perforations. The effect on the absorption characteristics is considerable.

534.845

2291

Propagation, Interference, Reflection, Absorption, Diffusion of Acoustic and Ultrasonic Waves rendered Visible by the Schlieren Method.—F. Canac. (*Acustica*, 1954, Vol. 4, No. 2, pp. 320-328. In French.) A detailed description of the schlieren method and its application to the study of absorption and reflection of various materials. Reduced-scale models of coffered ceilings and other structures were also examined. Working frequencies were normally 10 and 23 kc/s, but 69 kc/s and 4 kc/s have also been used.

621.395.623.7

2292

Useful Absolute Efficiencies of Typical Loudspeaker Systems.—R. K. Vepa & N. K. Trivedi. (*Acustica*, 1954, Vol. 4, No. 2, pp. 329-332.) An objective criterion is proposed, called the 'useful absolute efficiency'. This is defined as the ratio of the acoustic power output, radiated in the forward direction and contained within a 100° cone, to the electrical power input from a matched resistive generator. Tests were made in the open air on three types of loudspeaker at 400, 1 000 and 3 000 c/s. Results are compared with computed axial efficiencies.

621.395.623.73 2293
Studies on the Cone-Type Loudspeakers: Part 4 — On the Effects of the Surrounding Device of the Cone-Type Dynamic Loudspeakers.—T. Nimura & K. Kido. (*Sci. Rep. Res. Inst. Tohoku Univ., Ser. B*, March 1953, Vol. 4, No. 2, pp. 205–219.) The sound-pressure minima and cone-velocity maxima which occur in the 1–2-kc/s region of the frequency response of a circular conical loudspeaker are caused by the corrugated surround. By using an obliquely-cut circular cone or an elliptical cone, a nearly level frequency-pressure characteristic can be obtained over a wide frequency range. Part 3: 3328 of 1952 (Nimura & Matsui).

621.395.623.74 : 537.585 2294
Pressure Effects of Ionic Currents in Atmospheric Air with various Discharge Configurations.—Löb. (See 2365.)

621.395.625.3 2295
Magnetic Recording.—M. Camras. (*Proc. Instn Radio Engrs, Aust.*, March 1954, Vol. 15, No. 3, pp. 61–69; *Convention Record Inst. Radio Engrs*, 1953, Part 3, pp. 16–25.) Outline of principles and problems involved.

621.395.625.3 : 621.397.5 2296
A System for Recording and Reproducing Television Signals.—Olson, Houghton, Morgan, Zenel, Artzt, Woodward & Fischer. (See 2517.)

681.84/85 2297
The Dynamic Restoring Forces on Gramophone Pickups.—W. Mühe. (*Funk u. Ton*, March 1954, Vol. 8, No. 3, pp. 147–162.) The factors investigated experimentally were: (a) effect of test-record groove characteristics on the restoring-force/frequency curve of various types of pickup, (b) the relation between restoring force and needle tracking, and (c) relation between restoring force and record wear. Both the C.C.I.R. and German standard test records were used. Results show that the restoring force for the majority of pickups was too high at low frequencies, causing poor tracking or even jumping the groove at high amplitudes. An optimum needle pressure therefore exists.

AERIALS AND TRANSMISSION LINES

621.315.212 : 621.3.018.75 2298
Reduction of the Distortion of Pulses transmitted by a Perfectly Uniform Coaxial Line by Frequency Translation.—R. Cazenave. (*Onde élect.*, Feb. 1954, Vol. 34, No. 323, pp. 147–152.) Analysis of the response of an ideal transmission line indicates the advantages of frequency translation for reducing amplitude and phase distortion, using a modulator and high-pass filter, with a phase-shift network for regrouping the transmitted frequencies at the receiving end. Unit-pulse response characteristics are compared for operation with and without the filtering and the phase-correction stages. A numerical calculation is made for transmission over 9 km of 2.6/9.4 coaxial cable with cut-off frequency 300 kc/s.

621.315.212(083.74) 2299
Choice of the Correct Characteristic Impedance for High-Frequency Cables.—F. Gutzmann. (*Fernmeldetechn. Z.*, March 1954, Vol. 7, No. 3, pp. 136–139.) In fixing a standard characteristic impedance for all h.f. cables, considerations of maximum voltage and maximum operating temperature are inconclusive. Attenuation is the only satisfactory criterion. The relation of characteristic impedance to cable dimensions for a prescribed maximum attenuation is discussed. Comparison of different cables shows that standardization to a value of 50 or 75Ω is impracticable. About 60Ω is the only possible value.

621.372.2 2300
Some Wave Properties of Helical Conductors.—J. H. Bryant. (*Elect. Commun.*, March 1954, Vol. 31, No. 1, pp. 50–56.) An analysis is made of the velocity of propagation and the relation between the longitudinal field and total power flow in systems comprising a helical line with inner and/or outer coaxial cylinders. Results are shown graphically as functions of frequency.

621.372.2 2301
An Experimental Investigation of the Properties of Corrugated Cylindrical Surface Waveguides.—H. E. M. Barlow & A. E. Karbowski. (*Proc. Instn elect. Engrs*, Part III, May 1954, Vol. 101, No. 71, pp. 182–188.) Brass rods of $\frac{3}{8}$ -in. outer diameter having shallow transverse external corrugations uniformly distributed along the length of the rod, were used to guide cylindrical surface waves at frequencies in the range 2.5–10 kMc/s. Provided there are more than two corrugations within the guide wavelength, higher-order surface waves are not present. The results of measurements of the surface reactance are shown graphically. An approximate expression for the surface reactance of a corrugated surface is derived which is in reasonable agreement with the experimental results, provided that the slot width is less than the slot depth, and that each wavelength includes several corrugations.

621.372.8 2302
Pass Band and Dispersion of Waveguides loaded with Circular Irises.—R. Combe. (*C. R. Acad. Sci., Paris*, 26th April 1954, Vol. 238, No. 17, pp. 1697–1699.) Approximate formulae are derived. Calculations are made of the permissible tolerances on the dimensions of the waveguide elements and on the frequency and temperature variations to obtain a value of λ_c within prescribed limits. Results are compared with those obtained experimentally for Al guides for $\lambda = 10$ cm with a permissible variation of 1 mm. Application is particularly relevant to linear accelerators for electrons.

621.372.8 2303
The Dimensioning of Loaded Waveguides for the H_{10} Mode.—H. Weber. (*Telefunken Ztg.*, March 1954, Vol. 27, No. 103, pp. 44–53.) Characteristic impedance, cut-off frequency and propagation constant are computed for an unloaded rectangular waveguide with and without losses, using an equivalent-circuit method. The results are extended to a waveguide loaded with a longitudinal undercut section, stray capacitance at the load edges being taken into account. Equations derived are plotted, and examples illustrate their application in determining the dimensions or characteristics of waveguides for specific purposes.

621.372.8 2304
Transmission Loss of the Waveguide having Thin Dielectric Film on its Inner Wall.—H. Uchida, Y. Mushiake & S. Nishida. (*Sci. Rep. Res. Inst. Tohoku Univ., Ser. B*, March 1953, Vol. 4, No. 2, pp. 287–298.) Equations are derived for the approximate transmission losses of a rectangular waveguide for an H_{10} wave, and of a circular waveguide for E and H waves. The equations are valid only at frequencies which are not near the cut-off frequency. The calculated attenuation constant of a rectangular waveguide with an 0.01-cm layer of enamel is $\sim 9.76 \times 10^{-3}$ db/m at 4 kMc/s, that of a circular waveguide is $\sim 3.22 \times 10^{-3}$ db/m at 4 kMc/s for the E_{01} wave.

621.372.8 2305
A Reflectionless Waveguide Termination.—J. Smidt. (*Appl. sci. Res.*, 1954, Vol. B3, No. 6, pp. 465–476.) The characteristics of an H-plane T-junction provided with a movable short-circuiting plunger and a movable

dissipating element of arbitrary nature are discussed. A matrix-algebra method is used for calculating the coefficients determining the optimum positions of the plungers and the values of the reflection coefficients. Calculated and measured values for a termination for operation at about 9 kMc/s are in good agreement.

621.372.8 : 551.594.6

2306

Propagation of a Pulse in a Waveguide.—M. Cotte. (*Onde élect.*, Feb. 1954, Vol. 34, No. 323, pp. 143-146.) Analysis of the propagation of a disturbance which can be resolved into components of similar mode but different frequency (2447 of 1948) is extended to the case of a waveguide with walls of finite conductivity. Two cases are distinguished: (a) H_{0n} waves in which the wavefront corresponds approximately to a pulse delay proportional to the distance travelled; (b) E_{mn} or H_{pn} waves suffering in addition a dispersion increasing as the square of the distance; this dispersion is the same for all E_{mn} waves. Results relating to circular waveguides may have application to the propagation of atmospherics.

621.372.8 : 621.385.029.64

2307

Output Windows for Tunable Magnetrons.—T. S. Chen. (*Electronics*, May 1954, Vol. 27, No. 5, pp. 170-173.) Design data and nomograms are given for metal diaphragms with ceramic windows used for sealing the magnetron output waveguide and for coupling power to the transmission line. Both single-frame and double-frame (sandwich) types are discussed.

621.396.67

2308

The Impedance of an Antenna above a Circular Ground Plate Laid upon a Plane Earth.—G. Bekefi. (*Canad. J. Phys.*, March 1954, Vol. 32, No. 3, pp. 205-222.) Analysis given by Storer (586 of 1952) is extended to include the case when the system is laid upon an imperfectly conducting earth. The expression for the aerial impedance is stationary with respect to small variations about its true value of the unknown radial electric field over the surface of the earth. Numerical results are given for the case of a ground plate large compared with λ . The effect of variations of the dielectric constant of the earth is shown. Results are in satisfactory agreement with those obtained, using Monteath's theory (2648 of 1951). An alternative variational formula applicable to plates of smaller diameter gives the impedance in terms of radial currents flowing in the plate.

621.396.67

2309

The Theory of a Linear Antenna: Part 2.—Y. Nomura & T. Hatta. (*Technol. Rep. Tohoku Univ.*, 1953, Vol. 18, No. 1, pp. 90-104.) The directivity and receiving quality of the linear aerial are investigated by the method developed in part 1 (3201 of 1953). The radiation field round the transmitting aerial is calculated as the sum of partial fields due to Fourier components of the aerial current; the properties of the receiving aerial follow from those of the transmitting aerial. The radiation patterns of some asymmetrically fed aeriels are shown. The method is similar to, but more general than, that of Hara (*Hochfrequenztechnik und Elektroakustik*, Dec. 1934, Vol. 44, No. 6, pp. 185-193.)

621.396.67

2310

Antenna-Scattering Measurements by Modulation of the Scatterer.—H. Scharfman & D. D. King. (*Proc. Inst. Radio Engrs.*, May 1954, Vol. 42, No. 5, pp. 854-858.) A laboratory method is described in which scattering from an object under test is compared with that from a standard scatterer (e.g. a metal sphere) by mounting the two objects at opposite ends of a horizontal column mounted in turn on a rotating vertical shaft, and irradiating them alternately from a horn emitter. The horn is in one arm of a slightly unbalanced hybrid-T arrangement,

and a fraction of the power scattered back to it is passed to the detector arm. Synchronous detection is used; because of the rotation of the objects, the phase of the back-scattered signal varies rapidly with respect to that of the local signal. Curves obtained for the back-scattering cross-section of dipoles with lengths of 0.4λ – 1.6λ are in good agreement with theoretical and experimental curves obtained by other workers. The method is applicable over the frequency range from about 1 to 5 kMc/s.

621.396.67 : 621.372.21

2311

Losses in Parallel-Wire Lines.—J. Arsac, P. André & R. Zaccari. (*Onde élect.*, Feb. 1954, Vol. 34, No. 323, pp. 170-177.) With a view to the application of open-wire feeders for radio-astronomy aerial systems, calculations are made of ohmic and radiation losses in the frequency range 150–1 500 Mc/s. For 2-wire lines 500 wavelengths long, with conductors a wavelength apart, and neglecting height factors, non uniformities and oxidation effects, graphs are drawn showing total losses as a function of characteristic impedance for 4 wire diameters and 6 frequencies.

621.396.67 : 621.396.96

2312

General Theory of Plane-Wave Scattering from Finite, Conducting Obstacles with Application to the Two-Antenna Problems.—J. E. Storer & J. Sevick. (*J. appl. Phys.*, March 1954, Vol. 25, No. 3, pp. 369-376.) The variational techniques of Levine & Schwinger (1583 of 1952) are used to obtain approximate solutions for the free-space scattering by a number of finite, perfectly conducting obstacles whose interactions are explicitly accounted for. The result gives the far-zone scattered-field distribution in terms of the obstacle currents. Variational expressions are obtained for the total scattering and for the back-scattering cross-sections. The complete mathematical development for the problem of the back-scattering cross-section of two identical non-staggered unloaded aeriels oriented parallel to the incident field is presented, and results for the case of broadside radiation for half-wave and full-wave aeriels are shown graphically.

621.396.67.029.6 : 621.397.62

2313

Switch-Tuned U.H.F.-V.H.F. [indoor television receiving] **Antenna.**—G. Hills. (*Tele-Tech.*, Jan. 1954, Vol. 13, No. 1, pp. 93-108.) A dipole 25 in. long with elements shaped from metal strips to form two cones attached to metal end caps is used. In the v.h.f. band the tuning adjustment matches the aerial to the 300- Ω input lead. For the u.h.f. band a correcting network compensates the series inductance and distributed capacitance of the standard selector switch used.

621.396.677.3

2314

The Principle and the Design of Yagi-Uda Antenna: Part 1.—S. Uda & Y. Mushiaki. (*Sci. Rep. Res. Inst. Tohoku Univ., Ser. B*, March 1953, Vol. 4, No. 2, pp. 299-312.) Using Hallén's theory (*Nova Acta Regiae Societatis Scientiarum Upsaliensis*, Series IV, No. 4, Vol. 11, 1938, pp. 3-44) for the current distribution in a linear aerial, the effective lengths of the transmitting and receiving aeriels are calculated. Expressions for the self and mutual impedances of the elements and the input impedance of the aerial system are given and a general expression for the radiation characteristic is derived. The effective length factors of aerial elements are also shown graphically.

621.396.677.45

2315

Wide-Frequency-Range Tuned Helical Antennas and Circuits.—A. G. Kandoian & W. Sichak. (*Elect. Commun.*, March 1954, Vol. 31, No. 1, p. 49.) Correction to paper abstracted in 1304 of May.

621.396.677.85

2316

Reflection of Electromagnetic Waves at Metal-Plate Media.—G. Piefke. (*Arch. elekt. Übertragung*, March 1954, Vol. 8, No. 3, pp. 101–110.) A theoretical investigation is made of the transmission and reflection of a plane wave incident normally on a system of infinitely thin metal plates spaced a distance a apart and aligned parallel to the electric field. A detailed analysis is made for the wavelength range $1 < 2a/\lambda_0 < 2$, considering (a) a plane wave incident normally on the system, and (b) a TE_{10} wave proceeding from the medium into free space. Reflection coefficients are equal in magnitude in the two cases, but the phase angles are different. For the transmission coefficients conditions are reversed, the phase angles being equal and the magnitudes different. Phase-angle curves obtained are used to determine the thickness and position of a dielectric plate placed behind the system for no reflection to occur. See also 1879 of 1951 (Lengyel).

AUTOMATIC COMPUTERS

681.142

2317

Arrangement of Batteries and Relays permitting the Solution by Analogy of Nonlinear Partial Differential Equations by means of a Chain of Resistances and Capacitances.—A. Blanc. (*C. R. Acad. Sci., Paris*, 29th March 1954, Vol. 238, No. 13, pp. 1377–1378.)

681.142

2318

Scale Factors for Analog Computers.—J. B. Reswick. (*Product Engng*, March 1954, Vol. 25, No. 3, pp. 197–201.) Description of a design technique whereby scale factors relating analogue variables to the variables of the system investigated are first determined for true-time operation.

681.142

2319

A Time-Sharing Analog Multiplier.—H. Freeman & E. Parsons. (*Trans. Inst. Radio Engrs*, March 1954, Vol. EC-3, No. 1, pp. 11–17.) The circuit is based on the same principle as that of Broomall & Riebmán (2546 of 1952). Accuracy to within 0.2% is achieved for a range of input voltages from 0 to 210 V when the comparator voltage lies between 0 and 75 V, depending on the circuit arrangements. 400 multiplications per second were made, indicating the suitability of the circuit for time-sharing techniques, but higher rates of operation seem possible.

681.142

2320

System Organization of the DYSEAC.—A. L. Leiner & S. N. Alexander. (*Trans. Inst. Radio Engrs*, March 1954, Vol. EC-3, No. 1, pp. 1–10.) DYSEAC is a general-purpose high-speed digital computer incorporating the following special facilities: (a) external-transfer operations concurrent with internal computing, such transfers referring directly to any area of the internal storage system; (b) adjustment of speed of internal programme so that it proceeds in step with the external programme; (c) interruption of a programme for interpolation of new orders.

681.142

2321

A Simple Analogue Divider.—J. L. Douce. (*Electronic Engng*, April 1954, Vol. 26, No. 314, pp. 155–156.) A circuit is described which provides an output voltage proportional to the ratio between two input voltages, a pulse of duration inversely proportional to one input being used to gate the other input. The results are accurate to within 5% over a wide range of inputs.

681.142

2322

An Operational-Digital Feedback Divider.—M. A. Meyer, B. M. Gordon & R. N. Nicola. (*Trans. Inst. Radio*

Engrs, March 1954, Vol. EC-3, No. 1, pp. 17–20.) In this divider the input pulses operate directly on the output, the circuit forming a closed feedback loop in which the desired quotient corresponds to the only possible steady state. The accuracy of the system can be selected by using the appropriate number of significant digits from the eleven available.

CIRCUITS AND CIRCUIT ELEMENTS

621.3.011.2/3

2323

New High-Frequency Proximity-Effect Formula.—A. C. Sim. (*Elect. Commun.*, March 1954, Vol. 31, No. 1, pp. 63–66.) Reprint. See 2918 of 1953.

621.314.25 : 621.372

2324

An R.M.S.-Sensitive Phase-Shifting Circuit.—H. J. Fraser. (*Proc. Instn Radio Engrs, Aust.*, March 1954, Vol. 15, No. 3, pp. 59–60.) A circuit delivering an output whose phase depends on the r.m.s. value of the input uses a tungsten-filament diode as r.m.s. current detector. The diode is operated with 50-c/s voltage on the anode, and a voltage derived from the a.c. component of anode current is added to a fixed 50-c/s voltage to give the resultant variable-phase output. Applications for control purposes are mentioned.

621.314.632 + 621.314.7

2325

The Double-Base Diode: A Semiconductor Thyatron Analog.—Aldrich & Lesk. (See 2535.)

621.316.842.012.3

2326

A Nomograph to Facilitate the Design of Single Layer Resistance Windings.—R. S. Read & I. Mills. (*Instrum. Practice*, March 1954, Vol. 8, No. 3, pp. 215–217.)

621.316.86 : 537.312.6

2327

How to use Thermistors.—F. K. Bennett. (*Product Engng*, March & April 1954, Vol. 25, Nos. 3 & 4, pp. 182–185 & 200–204.) Review of thermistor characteristics and applications with tabulated data for rod, disk, washer and bead types.

621.316.86 : 621.396.822

2328

Current-Noise in Composition Resistors.—D. A. Bell & K. Y. Chong. (*Wireless Engr.*, June 1954, Vol. 36, No. 6, pp. 142–144.) Because of the inherent inhomogeneity of the resistor material, and because the noise depends on the square of the current density, modifications of the resistor structure at a few points of high current density can have a large effect on the noise without greatly affecting the d.c. resistance. Experimental evidence in support of this view is given. The effect may account for the observed lack of correlation between noise and d.c. resistance with large currents. Measurements made on resistors of the same rating but different types indicate a relation between noise coefficient and shape factor.

621.318.57

2329

A New High-Speed Bistable Device for Pulse Sharpening.—Y. Druet. (*Onde élect.*, Feb. 1954, Vol. 34, No. 323, pp. 130–134.) Description of a triode-hexode flip-flop circuit (648 of 1953) generating 3×10^6 pulses/sec, and its application in switching and scaling circuits.

621.372

2330

RLC Canonic Forms.—F. M. Reza. (*J. appl. Phys.*, March 1954, Vol. 25, No. 3, pp. 297–301.) A class of RLC networks is defined, which has canonic structure in the Foster sense. LC and RL-RC networks and networks with slight dissipation may belong to this class, in which case their analysis or synthesis is simplified. Examples of network synthesis illustrate the method.

621.372

Bounds Existing on the Time and Frequency Responses of Various Types of Networks.—A. H. Zemanian. (*Proc. Inst. Radio Engrs*, May 1954, Vol. 42, No. 5, pp. 835-839.) Six theorems are presented relating the transient and steady-state responses of linear, stable, fixed, lumped-constant networks. Fourier-transform analysis is used. Physical interpretations are discussed, rise times and settling times being considered. The overshoot or undershoot of the response to a step-current input for a RC driving-point impedance cannot be $>100\%$.

621.372

Corner Plots.—G. E. Anner. (*Radio & Telev. News, Radio-Electronic Engng Section*, March 1954, Vol. 51, No. 3, pp. 14-18, 26.) An approximation to the shape of the actual response curve for RL and RC circuits is obtained by suitable combinations of straight lines called corner plots. The parameters involved are defined, and rules for their determination by inspection of the circuit derived. The method is not restricted to impedances but may also be applied to network transfer functions, and is discussed in Bode's 'Network Analysis and Feedback Amplifier Design', Chapter XV.

621.372 : 512.831

Matrix Analysis of Multiterminal Transducers.—J. Shekel. (*Proc. Inst. Radio Engrs*, May 1954, Vol. 42, No. 5, pp. 840-847.) The multiterminal transducer is defined as a network with a set of n input terminals and a set of n output terminals. It can be represented by its impedance, admittance or transfer matrix. Special properties of networks exhibiting symmetry and/or reciprocity are discussed. The representation is classed as definite or indefinite according as the voltage reference terminals are or are not specified. Simple networks can be analysed by inspection; more complicated networks may be treated as cascades of simple ones. The method is illustrated by deriving the transfer matrices of some simple networks, including a distributed-amplifier section.

621.372.413

Natural Vibrations of an Open Cavity.—M. Jessel. (*C. R. Acad. Sci., Paris*, 15th March 1954, Vol. 238, No. 11, pp. 1205-1206.) The field is expressed in a manner taking account of a set of oscillation modes associated with the cavity openings.

621.372.413.012.3

Cavity-Resonator Design Charts.—N. A. Spencer. (*Electronics*, May 1954, Vol. 27, No. 5, pp. 186-188.) Charts applicable to square-section and to circular-section cavities are given.

621.372.5

A Generalization of Weissfloch's Transformation Law.—H. Lueg. (*Arch. elekt. Übertragung*, March 1954, Vol. 8, No. 3, pp. 137-141.) The transformation law relating to a loss-free quadripole between homogeneous lines is generalized by showing that all points on the transformation curve can be correlated with corresponding positions on the input and output lines between which the quadripole acts as an ideal transformer with a reactance in parallel. See also 992 of April.

621.372.5.015.3 : 621.376.3

Transient Response in F.M.—I. Gumowski. (*Proc. Inst. Radio Engrs*, May 1954, Vol. 42, No. 5, pp. 819-822.) "The f.m. response to the unit impulse and the unit step function is calculated for a network whose transfer function is known. A meaning is assigned to the associated Fourier integrals, which diverge in the Riemann sense. The method is generalized to any input

function which vanishes for negative t . As an illustration of the method the impulse and the step f.m. responses of a single tuned circuit are calculated."

621.372.54 : 621.315.212

Filter using Coaxial Transmission Line as Elements.—H. B. Yin & T. U. Foley. (*RC.A Rev.*, March 1954, Vol. 15, No. 1, pp. 62-74.) Exact equivalent circuits are presented for coaxial line elements with sleeve or undercut sections, taking account of capacitance or inductance effects at the discontinuities. From the corresponding equations the performance of filters comprising one or more of such elements can be predicted in terms of image impedance, cut-off frequency, attenuation and band limits. Measurements on a two-section low-pass filter confirm the theory.

621.372.54.029.62

Variable U.S.W. Filters.—K. H. Krambeer & F. Künemund. (*Frequenz*, March 1954, Vol. 8, No. 3, pp. 65-77.) Results of an investigation of filters with distributed circuit elements and their equivalents with lumped L, C, R , indicate the circuits suitable for u.s.w. use. The filters described, which consist of adjustable cavity resonators and short lines, include separating filters for metre-band television and an adjacent-channel suppressor for transmitters and transmitter-receivers.

621.373.412

Notes on a Cause of Frequency Instability of Partially Plated Piezoelectric Crystals (Proximity Effect).—W. J. 't Hart. (*Tijdschr. ned. Radiogenoot.*, March 1954, Vol. 19, No. 2, pp. 116-117. In English.) External field conditions may have a marked effect on the resonance frequency of partially plated crystals. Movement of an object close to the resonator may produce a relative frequency shift of the order of 10^{-6} or even 10^{-5} . As an extreme example, a shift of about 10 c/s was produced by hand effect in a 1-Mc/s AT-cut crystal of diameter 29 mm and electrode diameter 9 mm, the equivalent resistance simultaneously increasing by 10%. A qualitative explanation of the effect is given by reference to equivalent circuits.

621.373.421.1

The Fluctuating Character of the Establishment of Oscillations in an Oscillator.—I. S. Gonorovskii. (*C. R. Acad. Sci. U.R.S.S.*, 11th Feb. 1954, Vol. 94, No. 5, pp. 869-872. In Russian.) The build-up of oscillations in an LCR -oscillator by white-noise potential fluctuations is considered theoretically.

621.373.421.11

A Wide-Band Oscillator using a Conical-Helix Tuning Inductor.—J. S. Chatterjee. (*Proc. Instn elect. Engrs*, Part III, May 1954, Vol. 101, No. 71, pp. 165-170.) Description of an oscillator working over a frequency range of 45 : 1 and using a single tank circuit between the grid and the anode of a triode. The tuning circuit consists of (a) a variable inductor formed by two conical helices connected at their apices by a large capacitor, and (b) two variable cylindrical capacitors. For the high-frequency end the leads connecting the coils to the grid and the anode are used as transmission lines, the main tuning circuit being automatically isolated. Methods of calculating the oscillation frequency in terms of the circuit parameters are described, simplifying assumptions being made. A description is given of the design and performance of an experimental model for the range 10-450 Mc/s.

621.373.52 : 621.314.7

Internal Oscillations and Microwaves in Transistors.—Hollmann. (See 2540.)

621.374 : 621.314.7

2344

Transistors convert Sine Waves to Pulses.—R. E. McMahon, I. L. Lebow & R. H. Baker. (*Electronics*, May 1954, Vol. 27, No. 5, pp. 160–161.) A circuit using eight point-contact transistors to amplify, limit and differentiate a sine-wave input is described. The power-supply unit uses junction diodes. The frequency range is 10 c/s–200 kc/s, minimum input is 5 V, pulse output 35 V maximum, pulse rise time $<0.05 \mu\text{s}$, pulse width adjustable from 0.3 to $1 \mu\text{s}$, and output impedance 300–400 Ω .

621.375.2.024 : 621.317.3

2345

A Mains-Supplied Indicating D.C. Amplifier with Linear Response.—W. Oesterlin & A. G. Braun. (*Arch. tech. Messen*, Feb. 1954, No. 217, pp. 41–44.) A 4-stage unit for use in conjunction with a piezoelectric transducer and a Duddell oscillograph for obtaining indicator diagrams is described. An electrometer valve is used as input to a first preamplifier stage, from which cable connection is made to the remaining amplifier stages and the oscillograph. Amplifier stability is good, and effects of valve aging not apparent.

621.375.4

2346

Some Circuit Considerations of the Transistor.—Y. Watanabe. (*Sci. Rep. Res. Inst. Tohoku Univ., Ser. B*, March 1953, Vol. 4, No. 2, pp. 331–387.) A detailed discussion of the single-stage transistor amplifier and in particular of the "unity coupler" condition. Stability criteria are also discussed. Since four useful varieties of a single-stage amplifier exist, a two-stage amplifier can take 16 different forms. These are divided into four groups, (a) high power gain, (b) low terminating resistance, (c) high terminating resistance, and (d) bilateral type. The latter is an emitter-base-base-emitter circuit and is suitable for obtaining high gains.

621.376.332

2347

A Triode F.M. Discriminator.—I. G. Baxter. (*Electronic Engng.*, April 1954, Vol. 26, No. 314, pp. 146–147.) The triode is arranged to operate as a gated rectifier, with the gating time, and hence the rectified output, dependent on the input frequency. A sine wave with the straight portion extending over about one radian can be used for the input waveform. For a particular circuit in which the rectified output should theoretically change by about 20 V for a frequency change of 1%, the measured change for this frequency difference was about 7.5 V. The output is proportional to input amplitude as well as to frequency.

621.396.6

2348

Minimizing Contact Potential in Apparatus Design.—E. C. J. Marsh. (*Electronic Engng.*, April 1954, Vol. 26, No. 314, pp. 148–152.) Consideration is given particularly to the design of radio equipment required to function under adverse conditions such as exposure to humid or salt-laden atmosphere. A table reproduced from the Inter-Services document RCS/1000 gives the potentials of various metals in sea water against the saturated calomel electrode, as a guide to the choice of metal coatings; the latter may be applied by electroplating, spraying or hot dipping.

621.396.667

2349

Signal-Operated Tone Compensation.—E. C. Miller. (*Electronics*, May 1954, Vol. 27, No. 5, pp. 184–185.) A triode valve is used as variable element of a circuit which boosts amplifier response at both ends of the a.f. range to compensate for the reduced response of the ear; the amount of boost thus varies automatically with the input level.

GENERAL PHYSICS

535.42 : 538.566

2350

On Diffraction by a Strip.—A. Erdélyi & C. H. Pappas. (*Proc. nat. Acad. Sci., Wash.*, Feb. 1954, Vol. 40, No. 2, pp. 128–132.) Limitations of the integral-equation and Fourier-Lamé methods of dealing with the problem of diffraction by a strip or slit are discussed. The variational technique of Levine & Schwinger (1583 of 1952) can be used to obtain an approximate value of the far-zone field in a form which is stationary with respect to small variations about its true value of the current induced in the strip. A calculation using this representation, and assuming as a rough approximation a uniform-density distribution of current in the strip, gives a good approximation to the value of the far-zone field. The scattering cross-section is then found by using the scattering theorem [1898 of 1950 (Pappas)].

535.42 : 538.566

2351

Diffraction of Electromagnetic Waves, Radiated from an Arbitrarily Oriented Electric or Magnetic Dipole, at an Ideally Conducting Half-Plane.—Yu. V. Vandakurov. (*Zh. eksp. teor. Fiz.*, Jan. 1954, Vol. 26, No. 1, pp. 3–18.) The solving of this problem is simplified by writing Maxwell's equations in a general form, so as to include the case of a conducting medium with a finite permeability, and by including a magnetic current for reasons of symmetry. The equation $\Delta P + k^2 P = T$ is solved for different boundary conditions of P . In particular cases P represents components of the electric or magnetic fields or vector potentials, T is a function of position which is zero except in a small volume element surrounding the dipole, and $k^2 = (\epsilon\omega - 4\pi\sigma)\mu\omega/c^2$ with the usual notation for the dielectric constant, angular frequency, electrical conductivity, permeability, velocity of light, and $\sqrt{-1}$. The solutions for various orientations of the dipole are given in the form of definite single integrals which can be evaluated.

537.122 : 539.23

2352

Energy Loss of Electrons in Passage through Thin Films.—L. Marton & L. B. Leder. (*Phys. Rev.*, 1st April 1954, Vol. 94, No. 1, pp. 203–204.) Energy-loss values of 30-keV electrons passing through thin evaporated films of 21 metals and insulators are tabulated. Reasonable agreement with calculations of Pines & Bohm (1021 of April) and Pines (1376 of May) is shown.

537.2

2353

The Field \vec{E} and the Induction \vec{D} of a Point Electric Charge in Space.—É. Durand. (*C. R. Acad. Sci., Paris*, 5th April 1954, Vol. 238, No. 14, pp. 1478–1480.)

537.311.1

2354

Solid State Electronics.—K. K. Darrow. (*Research, Lond.*, Jan.–April 1954, Vol. 7, Nos. 1–4, pp. 2–9, 46–53, 94–100 & 137–141.) A general account of the mechanism of electronic conduction in solids.

537.311.31 : 539.234

2355

Notes on the Comparison between the Study of an Imperfect Contact and Experimental Results on Thin Metal Films.—N. Nifontoff. (*C. R. Acad. Sci., Paris*, 15th March 1954, Vol. 238, No. 11, pp. 1200–1202.) Continuation of investigation of the conduction mechanism in thin films [3258 of 1953 (Nifontoff & Perrot)].

537.52 : 537.533

2356

Electron Ejection by Slow Positive Ions Incident on Flashed and Gas-Covered Metallic Surfaces.—J. H. Parker, Jr. (*Phys. Rev.*, 15th March 1954, Vol. 93, No. 6, pp. 1148–1156.)

- 537.52 : 537.533 2357
Liberation of Electrons by Positive-Ion Impact on the Cathode of a Pulsed Townsend Discharge Tube.—R. N. Varney. (*Phys. Rev.*, 15th March 1954, Vol. 93, No. 6, pp. 1156-1160.)
- 537.52 : 537.56 2358
Ionization Processes in the Electrical Breakdown of Gases.—F. L. Jones. (*Brit. J. appl. Phys.*, Feb. 1954, Vol. 5, No. 2, pp. 49-53.) A brief review.
- 537.525.6 : 537.562 2359
Diffusion Cooling of Electrons in Ionized Gases.—M. A. Biondi. (*Phys. Rev.*, 15th March 1954, Vol. 93, No. 6, pp. 1136-1140.) Measurements made during low-pressure Ne and Ar afterglows show a reduction in ambipolar diffusion coefficient characteristic of diffusion cooling which is not observed when He is present.
- 537.533.8 2360
The Mechanism of Secondary Electron Emission.—A. O. Barut. (*Phys. Rev.*, 1st March 1954, Vol. 93, No. 5, pp. 981-984.) A simple theory based on the constant energy loss per unit path length of primary electrons accounts quantitatively for the variation of secondary electron yield below its maximum value. The theory can be extended to include a Bethe-type energy loss at high primary energies. Relations between secondary electron emission and atomic structure are discussed. Secondary emission in insulators and semiconductors is also considered.
- 537.533.8 2361
Explanation of the Inaccuracy of Secondary-Electron Measurements.—O. Beer. (*Ann. Phys., Lpz.*, 15th Feb. 1954, Vol. 14, Nos. 3-5, pp. 201-214.) A recording arrangement used for the measurements is described. A variation of δ , the secondary-electron ratio, with beam density was observed in several metals. This variation is probably due to the formation of positive ions at the target. When this is taken into account, the secondary-electron velocity distribution is found to be independent of temperature in the range 200-500 C, contrary to several other published results.
- 537.533.8 2362
Threshold of Secondary Electron Emission of Nickel and Molybdenum.—A. R. Shul'man & E. I. Myakinin. (*C. R. Acad. Sci. U.R.S.S.*, 11th Aug. 1953, Vol. 91, No. 5, pp. 1075-1078. In Russian.) The threshold is defined as the minimum energy of primary electrons for which the number of slow secondary electrons differs from zero. Experimental results show that it is equal to the work function, within the limits of experimental error. The velocity distribution of secondary electrons (including reflected electrons) at various primary electron energies, and the effect of pre-treatment of Mo by heating at 2 500 K for a period up to 10 days, are discussed and the experimental results shown graphically.
- 537.533.8 2363
Effective Depth of Secondary-Electron Emission.—N. D. Morgulis & N. G. Nakhodkin. (*C. R. Acad. Sci. U.R.S.S.*, 21st Feb. 1954, Vol. 94, No. 6, pp. 1029-1032. In Russian.) An experimental investigation is reported. The principal conclusions are that the effective depth of secondary-electron emission is smaller in metals than in semiconductors, that it is independent of the primary-electron energy, and that there is no direct relation between the secondary-emission efficiency and the emission depth.
- 537.56 : 538.63 2364
Theory of Plasmas in the presence of a Constant Magnetic Field of Arbitrary Intensity superimposed on an
- Oscillating Electric Field.**—R. Jancel & T. Kahan. (*C. R. Acad. Sci., Paris*, 1st March 1954, Vol. 238, No. 9, pp. 995-996.) Generalization of results obtained previously (2196 of July and back reference).
- 537.585 : 621.395.623.74 2365
Pressure Effects of Ionic Currents in Atmospheric Air with various Discharge Configurations.—E. Löb. (*Arch. elekt. Übertragung*, Feb. 1954, Vol. 8, No. 2, pp. 85-90.) The mechanical pressures produced by steady and modulated ion currents were investigated theoretically for parallel-plate, concentric-sphere, and concentric-cylinder electrode systems and experimentally for a point-and-plate system. The agreement between theoretical and experimental results is good. The investigation is of interest in relation to the ionic loudspeaker.
- 538.114 2366
A Refinement of the Pauling Theory of Ferromagnetism.—G. Felsenfeld. (*Proc. nat. Acad. Sci., Wash.*, March 1954, Vol. 40, No. 3, pp. 145-149.) The theory formulated by Pauling (3586 of 1953) is modified to take into account the nonuniform electron density in ferromagnetic crystals.
- 538.3 2367
Electrodynamics without Potentials.—L. Infeld & J. Plebanski. (*Proc. roy. Soc. A*, 9th March 1954, Vol. 222, No. 1149, pp. 224-227.) By means of a more general approach based on the e.m. field and not potential, field equations of a general type are derived. These contain the equations of Dirac's new theory of electrodynamics (1574 of 1952) as an important special case.
- 538.3 2368
Maxwell's Tensor.—S. Slansky. (*C. R. Acad. Sci., Paris*, 8th March 1954, Vol. 238, No. 10, pp. 1103-1104.) Without modifying the classical e.m. field equations it is possible to replace Maxwell's tensor by another which gives the same expression for the Lorentz force but a different and in some ways more satisfactory expression for the distribution of energy in the field.
- 538.56 : 537.525 2369
Self-excitation of Oscillations in a Gas Discharge at High Pressures.—M. E. Gertsenshtein. (*Zh. eksp. teor. Fiz.*, Jan. 1954, Vol. 26, No. 1, pp. 57-63.) The interaction of sound and electron waves in a gas-discharge plasma at pressures ≥ 100 mm Hg is considered theoretically. The possibility is shown of self-excitation of a definite range of frequencies. See also Zaitsev (2778 of 1952) for work at ~ 1 mm Hg.
- 538.566 2370
Group Velocity.—P. Poincelot. (*C. R. Acad. Sci., Paris*, 22nd March 1954, Vol. 238, No. 12, pp. 1289-1291.) Continuation of previous work (3420 of 1952). Theory applicable to the ionosphere and to waveguides is given.
- 538.566 : 537.56 2371
The Excitation of Plasma Oscillations.—D. H. Looney & S. C. Brown. (*Phys. Rev.*, 1st March 1954, Vol. 93, No. 5, pp. 965-969.) A beam of high-energy electrons, injected into the plasma of a d.c. discharge from an auxiliary electron gun, excited oscillations in the plasma, the standing-wave patterns set up for varying values of electron-beam density and thickness of the ion space-charge sheath being investigated by a movable probe. Discontinuous changes in oscillation frequency occurred as either the electron density or the sheath thickness was varied, but the frequencies were in accordance with the Tonks-Langmuir relation and Wehner's transit-time relation (2875 of 1951) in both cases. The results confirm

that the mechanism of energy transfer involved is a v.m. process as suggested by Wehner, and indicate that the oscillation is a longitudinal pressure wave set up in the plasma electrons.

538.569.4 2372
Zeeman Effect and Line Breadth Studies of the Microwave Lines of Oxygen.—R. M. Hill & W. Gordy. (*Phys. Rev.*, 1st March 1954, Vol. 93, No. 5, pp. 1019–1022.) Experiments with applied fields < 100 gauss gave results in accordance with weak-field Zeeman theory. The two important mechanisms involved are rotational resonance interaction and quadrupole-quadrupole interaction.

538.569.4 2373
Absorption of U.H.F. Radio Waves in the Range 250–920 Mc/s by Substituted Benzenes: Part 3.—D. K. Ghosh. (*Indian J. Phys.*, June 1953, Vol. 27, No. 6, pp. 285–293.) Measurements have been made on chlorobenzene, bromobenzene, *o*-xylene and *m*-xylene at room and lower temperatures; the positions of absorption peaks are reported.

538.61 2374
Relations between Magneto-optical Phenomena in the Visible and Radio Regions of the Spectrum.—A. Kastler. (*C. R. Acad. Sci., Paris*, 1st March 1954, Vol. 238, No. 9, pp. 1007–1009.)

621.3.032.44 2375
The Distribution of Temperature along a Thin Rod Electrically Heated in Vacuo: Part 1—Theoretical.—S. C. Jain & K. S. Krishnan. (*Proc. roy. Soc. A*, 9th March 1954, Vol. 222, No. 1149, pp. 167–180.) An integral expression derived for the temperature distribution can be expanded as a convergent power series. For evaluation two regions are defined: region *A*, in the middle of the rod, and region *B*, the portions outside *A*. In the *A* region temperature distribution is parabolic; in the *B* region it is practically the same as in the corresponding end region of an infinitely long rod. An analytical expression is obtained for the temperature at the centre of a rod as a function of its length. For a summary of the analysis see *Nature, Lond.*, 23rd Jan. 1954, Vol. 173, No. 4395, pp. 166–167.

GEOPHYSICAL AND EXTRATERRESTRIAL PHENOMENA

523.7/.8 : 621.396.822 2376
Antenna and Receiver Measurements by Solar and Cosmic Noise.—J. Aarons. (*Proc. Inst. Radio Engrs*, May 1954, Vol. 42, No. 5, pp. 810–815.) The sun and various intense cosmic sources of r.f. radiation which have been previously measured are used as calibration sources for determining aerial patterns and receiver sensitivities for radio-astronomy investigations. Practical procedure is outlined. Inaccuracies are involved in evaluating background radiation, contours and solar energy distribution, but the technique is sufficiently accurate for checking field instruments.

523.72 : 621.396.822 2377
Radio Evidence of the Ejection of Very Fast Particles from the Sun.—J. P. Wild, J. A. Roberts & J. D. Murray. (*Nature, Lond.*, 20th March 1954, Vol. 173, No. 4403, pp. 532–534.) Dynamic spectra of Type-III r.f. bursts (fast frequency drift, duration 5–10 sec) are discussed. The observations were made using a spectroscope with a frequency range 40–240 Mc/s. Harmonic pairs are commonly observed, as in the case of the longer duration Type-II bursts previously studied [391 of February (Wild et al)]; from a comparison of the profiles for the fundamental and the second harmonic it appears that a

low-frequency cut-off process occurs in this case also. The observed properties of Type-III bursts can be accounted for by associating the frequency drift with motion of a disturbance such as a corpuscular stream travelling outwards through the solar atmosphere. Several possible mechanisms are considered.

523.72 + 523.8] : 621.396.822 : 061.3 2378
Washington Conference on Radio Astronomy — 1954.—(*J. geophys. Res.*, March 1954, Vol. 59, No. 1, pp. 149–201.) The aim of the conference was to present a comprehensive survey of the present state of work in the field, to examine some of the most critical problems, and to indicate possible future lines of research. Summaries of some of the papers are given. For a short report see *Science*, 30th April 1954, Vol. 119, No. 3096, pp. 588–591.

523.8 : 621.396.822 2379
Generation of Radio Noise by Cosmic Sources.—J. H. Piddington; F. Hoyle. (*Nature, Lond.*, 13th March 1954, Vol. 173, No. 4402, pp. 482–484.) Critical comment on 125 of January and author's reply.

523.852.2 : 621.396.822] : 523.165 2380
On the Nature of the Discrete Radio Sources.—R. Q. Twiss. (*Phil. Mag.*, March 1954, Vol. 45, No. 362, pp. 249–258.) Investigation of results of measurements of radio noise from a source in Cassiopeia shows that the noise may be due to interaction of cosmic ray electrons with the local magnetic field if the average value of the latter is of the order of 10^{-2} gauss. The r.f. power received should then vary at least as rapidly as $\nu^{6/2}$ below a critical frequency in the range 10–20 Mc/s.

550.372 2381
Effective Radio Ground-Conductivity Measurements in the United States.—R. S. Kirby, J. C. Harman, F. M. Capps & R. N. Jones. (*Nat. Bur. Stand. Circular*, No. 546, 26th Feb. 1954, 87 pp.) The results of ground-conductivity determinations made at 621 broadcasting stations, at frequencies between 540 kc/s and 1.6 Mc/s, are presented in a series of maps, more than 7 000 radials being shown. The degree of correlation between the effective conductivity and the nature of the surface soil is insufficient for purposes of prediction.

550.381 : 537.12 2382
Electron Inertia and Terrestrial Magnetism.—C. Darwin. (*Proc. roy. Soc. A*, 23rd March 1954, Vol. 222, No. 1151, pp. 471–476.) Analysis shows that electron-inertia effects make no appreciable contribution to the geomagnetic field.

550.384 2383
The Areal Distribution of Geomagnetic Activity as an Aeromagnetic Survey Problem near the Auroral Zone.—L. W. Morley. (*Trans. Amer. geophys. Union*, Dec. 1953, Vol. 34, No. 6, pp. 836–840.)

550.384 2384
On the Dynamo Theory of Geomagnetic Field Variations.—S. K. Chakrabarty & R. Pratap. (*J. geophys. Res.*, March 1954, Vol. 59, No. 1, pp. 1–14.) Chapman's expression for the current function is solved in the most general way, assuming that the main component in atmospheric oscillation is semidiurnal, and using the same conductivity function as Chapman. Tables of (a) coefficients of the current function, and (b) numerical equinoctial values of the coefficients deduced by the authors and by Chapman are given. The *Sq* variations of *H* and *V* are deduced and compared with the results of observations at Abinger and Alibag, and with Chapman's analysis. In these calculations, the phase of the atmospheric oscillations has been taken as 275°, and results compare well with observations.

550.384.4

The Lunar Diurnal Variations of the Earth's Magnetic Field for All Elements at Amberley, N.Z., based on Five Years' Observations.—J. M. Bullen & C. H. Cummack. (*N.Z. J. Sci. Tech. B*, March 1954, Vol. 35, No. 5, pp. 371-377.)

2385

550.385

Very Long Sequences of Geomagnetic Activity and its Annual Variation.—B. N. Bhargava & A. M. Naqvi. (*Nature, Lond.*, 13th March 1954, Vol. 173, No. 4402, pp. 498-499.) A study was made of the recurrence tendency of geomagnetic activity for the period 1950-1953. Two long sequences of storms were identified, mainly associated with solar M regions. The mean recurrence period for each of the sequences was 27.05 days. Characteristic annual variation is attributed to the approach of the earth's projection on the solar disk towards the zones of maximum solar activity.

2386

550.385 : 551.510.535 : 551.594.5

Magnetic Storms, Aurorae, Ionosphere and Zodiacal Light.—E. O. Hulburt. (*Sci. Mon.*, Feb. 1954, Vol. 78, No. 2, pp. 100-109.) General account of observed phenomena and review of theories which have been advanced in attempts to explain them.

2387

551.510.5

Study of Atmospheric Ions in a Nonequilibrium System.—C. G. Stergis. (*J. geophys. Res.*, March 1954, Vol. 59, No. 1, pp. 63-66.) The variation with time of the concentration of small ions in the atmosphere in a nonequilibrium system has been determined theoretically and in two sets of experiments. If the atmosphere is relatively unpolluted, equilibrium conditions may not be restored after disturbance until a time of about 15 minutes has elapsed.

2388

551.510.53

The Dissociation of Oxygen in the High Atmosphere.—M. Nicolet & P. Mange. (*J. geophys. Res.*, March 1954, Vol. 59, No. 1, pp. 15-45.) The O₂-O transition region is investigated, using recent rocket data on atmospheric transmission of solar radiation in the spectral region of the Schumann-Runge continuum of O₂. Observational data can be represented by a complete mixing of the atmosphere which causes the vertical distribution of molecular oxygen to follow atmospheric scale height. Mixing and diffusing processes are responsible for a shift in the transition region to lower heights than given by photochemical equilibrium considerations, thus the transition region must be associated with the mesopause. Airglow, formation of ionosphere regions, and dissociation of nitrogen are briefly discussed in the light of this theory.

2389

551.510.535

Motion of the Storm-D Regions.—V. Agy. (*Nature, Lond.*, 6th March 1954, Vol. 173, No. 4401, pp. 445-446.) Results of an analysis at the National Bureau of Standards of ionosphere data from 17 stations for the four years 1949-1952 do not support Piggott's hypothesis of coherent motion of storm-D regions (1672 of 1953).

2390

551.510.535

Propagation of a Plane Aerodynamic Wave of Semi-diurnal Oscillation Period through a Plane Ionosphere in a Uniform Magnetic Field.—I. Lucas. (*Arch. elekt. Übertragung*, Feb. 1954, Vol. 8, No. 2, pp. 91-95.) Analysis is based on the momentum equation for the gas and the tensor equation of electric conduction derived earlier [2085 of July (Lucas & Schlüter)]. Frequency and wavelength correspond to the atmospheric oscillations caused by tidal effects of the sun and the moon. The solution

2391

indicates that e.m. damping of the atmospheric oscillations will occur at > 300 km height. The electrical conductivity in a horizontal and in a vertical magnetic field is expressed as a function of the neutral-gas density.

551.510.535 : 550.38

Dynamo Theory of Geomagnetic Tides.—I. Lucas. (*Arch. elekt. Übertragung*, March 1954, Vol. 8, No. 3, pp. 123-131.) Plasma theory and results of earlier analysis [2085 of July (Lucas & Schlüter)] are applied in deriving a differential equation expressing height-integrated ionospheric current as a function of latitude. Taking account of Coriolis forces and assuming a velocity amplitude of 60 cm/s for tidal oscillations at E-layer height, the calculated magnitude of geomagnetic tides is in agreement with recorded data, in particular as regards the large tidal amplitudes at the magnetic equator. The theory is consistent with the assumption that the negative particles in the E layer are predominantly electrons rather than ions.

2392

551.510.535 : 551.55

Ionospheric Wind Analysis by Meteoric Echo Techniques.—L. A. Manning, A. M. Peterson & O. G. Villard, Jr. (*J. geophys. Res.*, March 1954, Vol. 59, No. 1, pp. 47-62.) The procedure for finding vector average wind (3052 of 1950) is shown to be unaffected by the presence of turbulent wind components. Expressions are derived for the r.m.s. values of the horizontal and vertical wind components. Sources of errors are discussed in detail.

2393

551.510.535 : 551.55 : 550.384

Winds in the Upper Atmosphere deduced from the Dynamo Theory of Geomagnetic Disturbance.—E. H. Vestine. (*J. geophys. Res.*, March 1954, Vol. 59, No. 1, pp. 93-128.) Simple dynamo theory of winds moving along and perpendicular to the geomagnetic field is developed, and various wind systems are discussed which might account for certain phases of magnetic storms. A possible wind system for the main phase of a magnetic storm shows some measure of agreement with diurnal atmospheric motions deduced from radio-star scintillations and auroral motions. The role of such wind systems in modifying the effective transverse conductivity of the ionosphere is uncertain. Both the flux of X rays producing ionization and the dynamo airflow in the E region are apparently the same on days of magnetic storms as on days prior to them.

2394

551.510.535 : 551.594.5 : 550.384

Correlation of Magnetic, Auroral, and Ionospheric Variations at Saskatoon: Part 2.—J. H. Meek. (*J. geophys. Res.*, March 1954, Vol. 59, No. 1, pp. 87-92.) "The relations between magnetic, auroral, and ionospheric observations are summarized with reference to the occurrence of positive and negative magnetic bays. Auroral light associated with positive bays occurs at a higher geomagnetic latitude than that associated with negative bays. The magnetic and auroral light variations are compared to Martyn's theory of the aurora. If the latter is accepted, the conclusion is reached (1) that most aurora is caused by positively charged particles, and (2) that the conditions described for the early phase actually exist throughout most of a disturbance." Part 1: 1768 of June.

2395

551.510.535 : 621.396.11.029.5

Some Results of Sweep-Frequency Investigation in the Low-Frequency Band.—J. M. Watts & J. N. Brown. (*J. geophys. Res.*, March 1954, Vol. 59, No. 1, pp. 71-86.) Frequency-sweep measurements in the range 50-1100 kc/s are reported. Day-time records show traces of three strata whose virtual heights are between 70 and 110 km, of which the lowest—not always observed—produces only

2396

a weak echo, and one sometimes suggesting that scattering is taking place at randomly located clouds. Night-time records show an intermediate layer between the E and F layers, which is erratic in appearance, but seems to have continuity with the daytime E layer during sunset. Traces characteristic of magneto-ionic splitting are exhibited for this intermediate layer. Polarization and virtual-height records for the F layer at night are shown and the effects of moderate ionosphere disturbances are demonstrated.

551.510.535 : 621.396.822 : 523.8 **2397**
Influence of the Ionosphere on the Reception of Galactic Radiation of Frequency 29.5 Mc/s.—É. J. Blum, J. F. Denisse & J. L. Steinberg. (*C. R. Acad. Sci., Paris*, 26th April 1954, Vol. 238, No. 17, pp. 1695-1697.) Analysis of continuous measurements recorded at Marcoussis from May 1949 to April 1950 indicates that galactic radiation at 29.5 Mc/s is attenuated by the ionosphere, the effect being due partly to the F₂ layer and partly to the D layer. The results agree qualitatively with those obtained by Mitra & Sham (1426 of May) using a frequency of 18.3 Mc/s.

551.578.1 : 621.396.96 **2398**
Errors inherent in the Radar Measurement of Rainfall at Attenuating Wavelengths.—Hitschfeld & Bordan. (See 2404.)

551.578.4 : 621.396.96 **2399**
Radar Evidence of a Generating Level for Snow.—Gunn, Langleben, Dennis & Power. (See 2405.)

551.594 : 621.396.11.029.62 **2400**
Atmospheric Electricity and Long-Distance Very-High-Frequency Scatter Transmissions.—Isted. (See 2497.)

551.594.13 **2401**
The Electrical Conductivity of the Atmosphere over the Pacific Ocean.—S. C. Coroniti & E. Heaton. (*Trans. Amer. geophys. Union*, Dec. 1953, Vol. 34, No. 6, pp. 833-835.) Conductivity measurements were made at altitudes of 3.8, 5.2 and 6.4 km and between geomagnetic latitudes of 22° and 45° N. The rate of production of ion pairs computed from the measurements agrees well with that computed from cosmic-ray data.

551.594.6 : 621.372.8 **2402**
Propagation of a Pulse in a Waveguide.—Cotte. (See 2306.)

LOCATION AND AIDS TO NAVIGATION

621.396.93 **2403**
Re-radiation from Resonant Ship's Aerials.—J. H. Moon. (*Marconi Rev.*, 2nd Quarter 1954, Vol. 17, No. 113, pp. 61-63.) Experiments show that it is not always necessary to isolate other aerials on board when operating the direction finder. An indication is given of the distances at which various types of aerial may be used at the same time as the direction finder without impairing its accuracy.

621.396.96 : 551.578.1 **2404**
Errors inherent in the Radar Measurement of Rainfall at Attenuating Wavelengths.—W. Hitschfeld & J. Bordan. (*J. Met.*, Feb. 1954, Vol. 11, No. 1, pp. 58-67.) An equation is derived giving rainfall rate at a given range in terms of received power level; this equation takes account of attenuation due to intervening rain, and includes a calibration constant expressing the radar performance. At attenuating wavelengths (3 cm and, to a lesser extent, 5.6 cm) a small error in this constant causes a large error in the result. Correcting for attenuation is therefore not recommended unless the calibration error can be held within very narrow limits.

621.396.96 : 551.578.4 **2405**
Radar Evidence of a Generating Level for Snow.—K. L. S. Gunn, M. P. Langleben, A. S. Dennis & B. A. Power. (*J. Met.*, Feb. 1954, Vol. 11, No. 1, pp. 20-26.) An analysis is presented of precipitation patterns obtained during the winter of 1951-1952 on an AN/TPS-10A radar at Montreal Airport. Trail patterns were observed on 19 out of 22 days; on 13 stable days well defined snow trails were detected.

621.396.96 : 621.396.67 **2406**
General Theory of Plane-Wave Scattering from Finite, Conducting Obstacles with Application to the Two-Antenna Problems.—Storer & Sevick. (See 2312.)

621.396.962.33 **2407**
The L.C.T. [Laboratoire Central de Télécommunications] Radar Receiver with Elimination of Fixed-Target Echoes.—H. Tanter. (*Onde élect.*, Feb. 1954, Vol. 34, No. 323, pp. 99-109.) Description of 10-cm phase-comparison pulse radar equipment. Two types are in production: a single receiver for mobile use and a 3-receiver unit for master stations. Theoretical sensitivity and practical performance in respect of range, fixed-target echo elimination and 'visibility' factor for moving targets are discussed.

621.396.963.3 **2408**
Information Cells on Intensity-Modulated C.R.T. Screens.—D. Levine. (*Proc. Inst. Radio Engrs.*, May 1954, Vol. 42, No. 5, p. 853.) Correction to paper abstracted in 743 of March.

MATERIALS AND SUBSIDIARY TECHNIQUES

536.587 : 548.55 : 546.289 **2409**
Temperature Regulator used in Producing Germanium Crystals.—G. J. Lehmann & C. A. Meuleau. (*Elect. Commun.*, March 1954, Vol. 31, No. 1, pp. 19-26.) English version of paper abstracted in 1788 of June.

537.226 **2410**
Ferroelectricity and Crystal Structure: Part 2.—H. D. Megaw. (*Acta cryst.*, Camb., 10th Feb. 1954, Vol. 7, Part 2, pp. 187-194.) Part 2 of 1789 of June.

537.228.1 : 548.0 **2411**
Piezoelectric Crystals.—S. Kelly. (*Wireless World*, June & July 1954, Vol. 60, Nos. 6 & 7, pp. 275-280 & 345-348.) A survey of properties and applications. Two main classes are distinguished, for use (a) as resonators, (b) as transducers. Attention is devoted particularly to materials for gramophone pickups, viz., Rochelle salt, ADP and polycrystalline BaTiO₃.

537.311.33 **2412**
Intermetallic Semiconductors.—E. W. Saker & F. A. Cunnell. (*Research, Lond.*, March 1954, Vol. 7, No. 3, pp. 114-120.) A simple account is given of the various types of binding forces in solid elements and binary compounds or alloys. The characteristics of the compounds between the metals and the 'near-metals' of Groups IVB, VB, and VIB of the periodic table are discussed in terms of the binding forces. For transistor production, compounds from groups III and V have the important advantages of wider energy gaps than Ge and lower melting points than Si.

537.311.33 **2413**
Band Structure in Disordered Alloys and Impurity Semiconductors.—H. M. James & A. S. Ginzburg. (*J. phys. Chem.*, Nov. 1953, Vol. 57, No. 8, pp. 840-847. Discussion, pp. 847-848.) The band structure is treated

by a method which involves counting the number of nodes in a solution of the wave equation with energy E as a means of determining how many states of the system have energies lower than E . An illustrative example shows how the sharply defined 'impurity band' of a crystal with regularly placed impurities is replaced by a broadened region of high energy-level density when the impurities are randomly arranged.

537.311.33 : 535.215 : 538.639 2414

Theory of the Photomagnetochemical Effect.—P. Aigrain & O. Garreta. (*C. R. Acad. Sci., Paris*, 12th April 1954, Vol. 238, No. 15, pp. 1573-1575.) From theory previously given [2015 of 1953 (Aigrain & Bulliard)] it is predicted that even in a uniform magnetic field the currents produced in a semiconductor by illuminating its surface will give rise to a mechanical couple. The estimated value for a Ge cylinder of height 2 cm and diameter 0.5 cm, illuminated over a quarter of its surface at an intensity of 5×10^{17} photons/cm²/s, is 0.25 dyne.cm for a field strength of 6 000 gauss.

537.311.33 : 535.37 2415

Luminescence of Carborundum Crystals on Passage of Current.—M. Schön. (*Z. Naturf.*, July 1953, Vol. 8a, No. 7, pp. 442-446.) The observed luminescence is attributed to the recombination of electrons and holes at lattice defects, the process being the inverse of that occurring in crystal phosphors. The energy diagram is established, and a formula is derived for the light yield. The relative importance of recombinations in the n , p and junction regions is examined. Luminescence intensity is proportional to current intensity for high values of the latter; there is a threshold value below which no luminescence occurs. The temperature dependence of this threshold, of the slope of the luminescence/current curve, and of the luminescence spectrum is discussed.

537.311.33 : 537.29 2416

Theory of the Effect of a Strong Field in Semiconductors.—A. I. Gubanov. (*Zh. tekhn. Fiz.*, Feb. 1954, Vol. 24, No. 2, pp. 308-319.) A short survey including experimental and theoretical work published in Russia up to 1953. The thermoelectron and impact ionization mechanisms of the strong-field effect are considered and relevant formulae are given. Frenkel's thermoelectron-ionization theory is generalized to include the case of an exponential dependence of the electron energy on its distance from the centre binding the electron. The image forces occurring in the theory of solid rectifiers are calculated.

537.311.33 : [546.28 + 546.289] 2417

Segregation of Impurities during the Growth of Germanium and Silicon Crystals.—R. N. Hall. (*J. phys. Chem.*, Nov. 1953, Vol. 57, No. 8, pp. 836-839. Discussion, p. 839.) "The segregation factors of impurities picked up by a growing crystal of germanium or silicon have been found to depend upon the growth rate and crystal orientation as well as upon the degree of stirring in the melt. This dependence is generally much greater for donor impurities than it is for acceptors and makes possible the growth of crystals containing large numbers of p - n junctions suitable for use in rectifiers and transistors. The assumption that impurity atoms are preferentially adsorbed at the surface of the crystal leads to an expression for the growth-rate variation which is consistent with the experimental results. Calculated impurity distributions are presented for a number of periodic growth cycles of practical interest."

537.311.33 : [546.28 + 546.289] 2418

Piezoresistance Effect in Germanium and Silicon.—C. S. Smith. (*Phys. Rev.*, 1st April 1954, Vol. 94, No. 1,

pp. 42-49.) The complete tensor piezoresistance has been determined experimentally for n - and p -type Si and Ge, and expressed in terms of the pressure coefficient of resistivity and two simple shear coefficients. One of the shear coefficients for each material is exceptionally large and cannot be explained in terms of known mechanisms. An electron transfer effect due to the structure of the energy bands in Si and Ge could account for this, but for p -type Ge an additional mechanism must be envisaged.

537.311.33 : [546.28 + 546.289] 2419

Equilibrium Thermochemistry of Solid and Liquid Alloys of Germanium and of Silicon: Part 1—The Solubility of Ge and Si in Elements of Groups III, IV and V.—C. D. Thurmond. (*J. phys. Chem.*, Nov. 1953, Vol. 57, No. 8, pp. 827-830. Discussion, p. 830.)

537.311.33 : [546.28 + 546.289] 2420

Equilibrium Thermochemistry of Solid and Liquid Alloys of Germanium and of Silicon: Part 2—The Retrograde Solid Solubilities of Sb in Ge, Cu in Ge, and Cu in Si.—C. D. Thurmond & J. D. Struthers. (*J. phys. Chem.*, Nov. 1953, Vol. 57, No. 8, pp. 831-834. Discussion, pp. 834-835.)

537.311.33 : 546.28 2421

Drift Mobilities in Semiconductors: Part 2 — Silicon.—M. B. Prince. (*Phys. Rev.*, 15th March 1954, Vol. 93, No. 6, pp. 1204-1206.) The drift mobilities of holes in n -type and of electrons in p -type material were measured for specimens with a range of resistivities from 0.3 to 30 Ω .cm at 300°K. For single crystals of resistivity $>10 \Omega$.cm the mobility at 300°K of holes is $\mu_p = 500 \pm 50$ cm/s per V/cm and of electrons is $\mu_n = 1200 \pm 100$ cm/s per V/cm. The temperature dependence of mobility measured on two specimens of resistivity $>10 \Omega$.cm, is given by $\mu_n = 5.5 \times 10^8 T^{-1.5}$ and $\mu_p = 2.4 \times 10^8 T^{-2.3}$. Part 1: 1462 of May.

537.311.33 : 546.28 2422

Optical Investigations of Impurity Levels in Silicon.—E. Burstein, E. E. Bell, J. W. Davison & M. Lax. (*J. phys. Chem.*, Nov. 1953, Vol. 57, No. 8, pp. 849-852. Discussion, p. 852.) Measurements were made on a number of p -type specimens, including boron-doped single crystals, over the range 2-38 μ . Ionization energies of impurities and excited states of the impurity atoms are reported.

537.311.33 : 546.289 2423

Drift Properties of the Cyclotron Resonance in Germanium.—B. Lax, H. J. Zeiger, R. N. Decker & E. S. Rosenblum. (*Phys. Rev.*, 15th March 1954, Vol. 93, No. 6, pp. 1418-1420.) Measurements were made at 8.895 kMc/s at 4.2°K on n - and p -type Ge. For n -type Ge the resonance-curve shape depends on sample orientation, but not on sample shape or size. Results can be explained by a conduction-band structure in which the energy surfaces consist of eight ellipsoids of revolution lying along the [111] axes.

537.311.33 : 546.289 2424

Changes of Surface Conductivity of Germanium with Ambient.—S. R. Morrison. (*J. phys. Chem.*, Nov. 1953, Vol. 57, No. 8, pp. 860-863. Discussion, p. 863.) The influence of the ambient medium on the conductivity and change in contact potential on illumination was investigated experimentally. The results are compared with those obtained by Brattain & Bardeen (1698 of 1953). The conductivity changes can be correlated with changes in a space-charge layer at the free surface of the semiconductor.

537.311.33 : 546.289 2425
Theory of the Galvanomagnetic Effects in *n*-Germanium.—S. Meiboom & B. Abeles. (*Phys. Rev.*, 1st March 1954, Vol. 93, No. 5, p. 1121.) Calculations of magnetoresistance coefficients, based on stated assumptions, agree very well with values measured at room temperature by Pearson & Suhl (166 of 1952), but agreement is less good with measurements made at 77°K.

537.311.33 : 546.289 2426
Infrared Absorption, Photoconductivity, and Impurity States in Germanium.—W. Kaiser & H. Y. Fan. (*Phys. Rev.*, 1st March 1954, Vol. 93, No. 5, pp. 977-980.) "Photoconductivity in gold-doped germanium at liquid nitrogen and liquid helium temperatures shows a long wavelength tail beyond the fundamental absorption edge, which falls off sharply at about 6 microns corresponding to 0.21 eV. This value agrees well with the acceptor activation energy determined by electrical measurements. For copper-doped germanium at low temperatures both absorption and photoconductivity show a maximum at about 22 microns corresponding to 0.055 eV. This value also agrees with the acceptor activation energy given by Hall effect measurements. At room temperature more absorption is found in the region 2 to 5 microns as compared to *p*-type germanium doped with indium and aluminum. This is likely to be due to photoionization from a deeper level 0.25 eV above the valence band."

537.311.33 : 546.289 2427
Experimental Evidence concerning Degeneracy in Germanium.—E. M. Conwell. (*Phys. Rev.*, 1st March 1954, Vol. 93, No. 5, p. 1118.) Comment on 1465 of May (Adams).

537.311.33 : 546.289 2428
Calculation of the Energy-Band Structures of the Diamond and Germanium Crystals by the Method of Orthogonalized Plane Waves.—F. Herman. (*Phys. Rev.*, 15th March 1954, Vol. 93, No. 6, pp. 1214-1225.)

537.311.33 : 546.289 2429
Effect of Nickel and Copper Impurities on the Recombination of Holes and Electrons in Germanium.—J. A. Burton, G. W. Hull, F. J. Morin & J. C. Severiens. (*J. phys. Chem.*, Nov. 1953, Vol. 57, No. 8, pp. 853-859. Discussion, p. 859.) "Nickel and copper impurities are found to increase the rate of recombination of holes and electrons in germanium single crystals. The measured dependence of lifetime on resistivity at room temperature is consistent with the Shockley-Read-Hall theory of recombination at traps near the middle of the forbidden band. The capture cross sections for holes and electrons have been estimated for these traps produced by nickel and copper. Additional evidence for such traps is also given by conductivity, Hall effect, photoconductivity and optical absorption measurements. Nickel or copper contaminations of the order of 10^{-10} atom fraction could account for the recombination rates observed in ordinary germanium crystals at room temperature."

537.311.33 : 546.289 2430
Diffusivity and Solubility of Copper in Germanium.—C. S. Fuller, J. D. Struthers, J. A. Ditzemberger & K. B. Wolfstirn. (*Phys. Rev.*, 15th March 1954, Vol. 93, No. 6, pp. 1182-1189.) Measurements were made in the temperature range 700°-900°C both by resistivity and radioactivity methods. The average diffusivity is $2.8 \pm 0.3 \times 10^{-8}$ cm²/sec and the solubility has a maximum at about 875°C of 4.0×10^{16} atoms of Cu per cm³. Results support the conclusion that one Cu atom contributes one conducting hole at room temperature. The thermal conversion effect in Ge is explained by a

temperature-dependent solution and precipitation of Cu. Acceptor and diffusion properties of Cu in Ge are accounted for by decreased electron affinity of Cu at higher temperatures.

537.311.33 : 546.289 2431
Transmission of Electrons and Holes across a Twin Boundary in Germanium.—E. Billig & M. S. Ridout. (*Nature, Lond.*, 13th March 1954, Vol. 173, No. 4402, pp. 496-497.) The technique developed by Haynes & Shockley (2109 of 1949) for investigating the diffusion of minority carriers in an ambipolar semiconductor is used. A slice about 0.5 mm thick was cut from a single crystal of *n*-type Ge, with the twinning plane perpendicular to the surface. Graphs are presented of the variation of the signal picked up by a probe as its distance from an interrupted infrared illuminating spot is varied. The results indicate that twin boundaries do not impede the passage of electrons or holes to any appreciable extent.

537.311.33 : 546.561-31 2432
The Semiconductor Properties of Cu₂O: Part 8—Electrical Conductivity at 0°C as Function of Position inside Specimen.—C. Fritzsche. (*Ann. Phys., Lpz.*, 15th Feb. 1954, Vol. 14, Nos. 3/5, pp. 135-140.) An increase of conductivity with distance from the surface of the sample was observed and was found to have been produced by the particular cooling process used in the preparation of the sample. The results are discussed. Part 7: 438 of February (Nieke).

537.311.33 : 546.723-31 2433
Electrical Properties of α -Fe₂O₃.—F. J. Morin. (*Phys. Rev.*, 15th March 1954, Vol. 93, No. 6, pp. 1195-1199.) Measurements reported in 1009 of 1952 are discussed. A theoretical model giving quantitative agreement with experimental data assumes conduction to involve only electrons and holes in the *d* levels of Fe ions. Another model giving qualitative fit assumes conduction in the *sp* bands of oxygen in addition.

537.311.33 : 546.74-31 2434
Electrical Properties of NiO.—F. J. Morin. (*Phys. Rev.*, 15th March 1954, Vol. 93, No. 6, pp. 1199-1204.) Measurements of the conductivity, Seebeck effect and optical transmission of NiO are reported and discussed on the basis of the two models suggested in 2433 above. NiO like α -Fe₂O₃ is an oxide with partially filled *d* levels, but with simpler characteristics. The first model gives quantitative agreement with experiment, the second does not.

537.311.33 : 546.812 : 539.231 2435
Transparent Semiconducting Oxide Films.—R. E. Aitchison. (*Aust. J. appl. Sci.*, March 1954, Vol. 5, No. 1, pp. 10-17.) Highly transparent tin oxide films with a surface resistance between 50 and 10 000 Ω /square have been prepared by spraying a mixture of SnCl₄ and organic alcohol or acid on to heated glass. Pure SnO layers have a negative temperature coefficient of resistance; this is increased by addition of In₂O₃ and decreased by addition of Sb₂O₅. Measurements of transparency and resistance are reported; effects of impurities are discussed. Applications to electrical screening, electroluminescent panels, etc., are mentioned.

537.311.33 : 546.817.221 2436
Further Evidence of the Energy Gap of Lead Sulfide.—G. R. Mitchell & A. E. Goldberg. (*Phys. Rev.*, 15th March 1954, Vol. 93, No. 6, pp. 1421.) The wavelength dependence of the photovoltaic effect in a *p-n* junction in a synthetic single crystal indicates an energy gap of 0.4 eV, in agreement with measurements on the photo-electromagnetic effect in galena and the long-wavelength limit for thin films.

537.311.33 : 621.372.413

2437

A Resonant-Cavity Study of Semiconductors.—Hsi-Teh Hsieh, J. M. Goldey & S. C. Brown. (*J. appl. Phys.*, March 1954, Vol. 25, No. 3, pp. 302-307.) A solution of Maxwell's equations is obtained for a resonant cavity with an axial post of arbitrary electrical properties. This gives the dielectric coefficient and conductivity of the post in terms of the natural frequency and Q of the cavity. In the region of a particular value of conductivity, a relatively small change in conductivity gives rise to a transition from a cylindrical to a coaxial mode. The theory is particularly useful in the study of semiconductors.

537.311.33 : 621.396.822

2438

Noise in Semiconductors: Spectrum of a Two-Parameter Random Signal.—S. Machlup. (*J. appl. Phys.*, March 1954, Vol. 25, No. 3, pp. 341-343.) The spectrum is calculated of a random signal which may be in one of two states, where the mean lives σ and τ of the two states may be different. The form of the spectrum is the same as for the case of equal lives, the single parameter occurring in that case being replaced by $2[(1/\sigma) + (1/\tau)]^{-1}$. Application of the results to a consideration of noise in semiconductors shows that the assumption that trapping and releasing of carriers are uncorrelated processes is a good approximation provided the mean time during which a carrier is trapped is long compared with the mean time during which it is free to move. Hence trapping may be the process responsible for the current-dependent noise.

537.311.33 : 669-492.2

2439

The Electrical Conductance of Pressed Powders, in particular of Zinc Oxide.—J. C. M. Brentano & C. Goldberg. (*Phys. Rev.*, 1st April 1954, Vol. 94, No. 1, pp. 56-60.) Experiments are described, mainly on ZnO, in which the d.c. conductance of the powder pressed between parallel plates in an evacuated chamber is determined for different pressures and temperatures. A model based on the change of the energy gaps with pressure is developed which accounts for the phenomena observed. Transient changes of conductance with time are observed for which only tentative explanations are suggested.

538.221

2440

Variation of the Permeability of Irons and Steels as a Function of Mechanical Stresses.—J. Creusot. (*C. R. Acad. Sci., Paris*, 15th March 1954, Vol. 238, No. 11, pp. 1203-1205.) Curves representing $B = f(T)$, obtained from measurements of the induction B of specimens subjected to a constant magnetizing field and a variable tensile stress T , in some cases exhibit plateaux. The occurrence of these is related to the existence of the maximum-stability equilibrium state [1102 of April (Creusot & Langevin)] in the specimen.

538.221 : 538.67

2441

Magnetic Domains by the Longitudinal Kerr Effect.—C. A. Fowler, Jr. & E. M. Fryer. (*Phys. Rev.*, 1st April 1954, Vol. 94, No. 1, pp. 52-56.) Rotation of the polarization plane of obliquely incident light reflected from a polished SiFe single crystal revealed the anti-parallel domains lying in the surface.

538.221 : 546.74

2442

Magnetic Behaviour of Thin Single-Crystal Nickel Films.—L. E. Collins & O. S. Heavens. (*Phil. Mag.*, March 1954, Vol. 45, No. 362, pp. 283-289.) The coercivity of monocrystalline Ni films grown epitaxially on the (100) face of rocksalt was studied as a function of thickness over the range 200-1 000 Å. The high coercivity characteristic of a single-domain structure was observed and the maximum value agrees approximately with that calculated from the anisotropy constants.

A.174

538.221 : [621.318.124 + 621.318.134

2443

Investigation of Paramagnetism of Some Ferrites.—F. Gal'perin, G. Dmitrakova & L. Molodtsova. (*C. R. Acad. Sci. U.R.S.S.*, 11th Feb. 1954, Vol. 94, No. 5, pp. 833-834. In Russian.) Results are given graphically of magnetic-susceptibility determinations for $MnO.Fe_2O_3$, $MgO.Fe_2O_3$ and $CoO.Fe_2O_3$, at temperatures between about 100° and 1 200°K.

538.221 : 621.318.13

2444

Dependence of the Coercivity of Magnetically Soft Materials on the Thickness of the Lamination.—V. A. Zaikova & Ya. S. Shur. (*C. R. Acad. Sci. U.R.S.S.*, 1st Feb. 1954, Vol. 94, No. 4, pp. 663-665. In Russian.) Experimental investigation of the coercivity of laminations of Fe, Ni, Fe-Ni alloys with 36-87% Ni, and Fe-Si alloys with 1-4% Si. In all cases but one, a critical thickness between 0.03 and 0.07 mm was found, below which the coercivity increases very rapidly. The results are shown graphically and are tabulated.

538.221 : 621.318.134

2445

Relaxation Phenomena of Irreversible Magnetization Processes in High-Permeability Ferrites.—T. Einsele. (*Z. angew. Phys.*, Feb. 1954, Vol. 6, No. 2, pp. 70-80.) Results of pulse measurements on ferroxcube IVB, siferrit and-permenorm (1826 of June) are analysed. Relaxation phenomena of irreversible processes can be expressed by a simple power law. Determination of the relaxation time τ of reversible magnetization by a d.c. pulse technique is only possible under certain conditions. The magnetization of a ferrite with a linear rising branch to the static hysteresis loop can be resolved into reversible and irreversible components; in this case τ can be determined and conforms to results of a.c. measurements.

538.221 : 621.318.134

2446

Temperature Dependence of Ferromagnetic Resonance Line Width in a Nickel Iron Ferrite: a New Loss Mechanism.—J. K. Galt, W. A. Yager & F. R. Merritt. (*Phys. Rev.*, 1st March 1954, Vol. 93, No. 5, pp. 1119-1120.) The ferromagnetic-resonance line width for the [111] direction was measured on two single-crystal spheres of a Ni-Fe ferrite at 24 kMc/s over the temperature range 4°-400°K. Results for temperatures below room temperature suggest that a major cause of losses in many ferrites is the relaxation associated with crystallographic transitions characterized primarily by electronic rearrangements.

546.289 : 548.55

2447

Recrystallization of Germanium from Indium Solution.—J. I. Pankove. (*RC.A Rev.*, March 1954, Vol. 15, No. 1, pp. 75-85.) A detailed description, illustrated with photographs, is given of the nature of the crystal growth obtained on cooling a Ge-in-In solution in contact with a Ge single crystal. The homogeneous recrystallized p -type region forms a single crystal with the original n -type seed. The p - n junction appears to coincide with the alloy front, the transition between the n and p regions being very abrupt. The recrystallized region is of very low resistivity.

546.561 : 535.215

2448

Negative Photoconductivity of Cuprite.—A. N. Krongauz & V. K. Lyapidevski. (*Zh. eksp. teor. Fiz.*, Jan. 1954, Vol. 26, No. 1, pp. 115-119.) The dependence of the photoconductivity on the voltage applied across the crystal and on the illumination intensity was investigated experimentally; the results are shown graphically. For every value of the illumination intensity there is a corresponding value of applied voltage above which the current variation due to the illumination changes from positive to negative. An explanation is

WIRELESS ENGINEER, AUGUST 1954

given in terms of the number of electrons in the conduction band. The theoretical formulae are in agreement with experimental results.

546.681 2449
Gallium Purification by Single Crystal Growth.—W. Zimmerman, 111. (*Science*, 26th March 1954, Vol. 119, No. 3091, pp. 411–412.) High-purity Ga required for investigations of intermetallic compounds was obtained by the recrystallization method involving zone purification and single-crystal growth, using the Kryopoulos technique.

546.719 2450
Rhenium Metal — its Properties and Future.—L. W. Kates. (*Mater. & Meth.*, March 1954, Vol. 39, No. 3, pp. 88–91.) Rhenium is a ductile metal resembling Mn chemically and W physically. In the field of electronics it may prove useful for the manufacture of contacts, thermocouple alloys, cathodes and cathode heaters. Its resistivity at high temperature is greater than that of W, thus permitting use of more rugged filaments. Re is still relatively rare; it does not occur as a massive mineral but is found as a minor constituent in molybdenite, and can be recovered from flue dust from molybdenum-bearing copper ore.

621.315.612 2451
Reduction in the Loss Factor of Certain Ceramics by Heat Treatment.—H. Rawson. (*Nature, Lond.*, 6th March 1954, Vol. 173, No. 4401, p. 447.) Measurements of the dielectric constant and loss tangent of steatite, forsterite and other ceramics before and after treatment for 60 hr at 1 000°C are reported. It is suggested that this type of heat treatment will make possible the commercial production of ceramics with reduced losses.

621.315.612.6 : 537.226 2452
Dielectric Losses in Silicate Glasses.—V. A. Ioffe. (*Zh. tekh. Fiz.*, April 1954, Vol. 24, No. 4, pp. 611–621.) The temperature dependence of the loss angle was determined experimentally at 1 Mc/s in the range 12°–420°K for K₂O-, Na₂O-, PbO-, PbO-MgO-, Na₂O-K₂O-, and PbO-TiO₂-silicate glasses. Measurements were also made at 3×10^6 and 3×10^8 c/s. The relation between loss angle and composition at 8.78×10^9 c/s and at room temperature was determined for the first three types of glasses. Results are shown graphically.

621.315.613.1 2453
Electrical Properties of Indian Mica: Part 5 — D.C. Resistivity.—S. S. Mandal & P. C. Mahanti. (*Indian J. Phys.*, June 1953, Vol. 27, No. 6, pp. 294–304.) Report of measurements of volume and surface resistivity of various qualities of red and green muscovite micas. The influence of humidity, temperature and pre-heating is investigated.

621.315.616.96 2454
Epoxy Resins.—R. A. Johnson. (*Electronic Engng.*, April 1954, Vol. 26, No. 314, pp. 136–142.) A survey of the properties and applications of araldite casting resins, covering Type B and the more recently developed Types D, F, 33/896 (flexible), 33/912 (expanded) and 33/915 (impregnating).

666.3 : 621.791.3 2455
Ceramic-Metal Seals of the Tungsten-Iron Type.—D. G. Burnside. (*RC.A Rev.*, March 1954, Vol. 15, No. 1, pp. 46–61.) Ceramic-to-metal sealing processes used in valve manufacture are briefly reviewed and desirable properties of the ceramics and sealing metals are indicated. A method is described for obtaining a firmly

adherent bonding layer on the ceramic surface by brushing or spraying on a mixture of W and Fe powders and firing in a reducing atmosphere.

669.15.71 2456
16-Percent Aluminum-Iron Alloy Cold Rolled in the Order-Disorder Temperature Range.—J. F. Nachman & W. J. Buehler. (*J. appl. Phys.*, March 1954, Vol. 25, No. 3, pp. 307–313.) Cold rolling at 575°C of hot-rolled material gave an alloy of highly fibred structure having good resistance to oxidation and good magnetic properties.

MATHEMATICS

519.272.119 2457
Estimation of Correlation Coefficients from Scatter Diagrams.—G. R. Sugar. (*J. appl. Phys.*, March 1954, Vol. 25, No. 3, pp. 354–357.)

517.63(083.5) 2458
Tables of Coefficients for the Numerical Calculation of Laplace Transforms. [Book Review]—H. E. Salzer. Publishers: United States Department of Commerce, Washington, 1953, 36 pp., 25 cents. (*Beama J.*, March 1954, Vol. 61, No. 201, p. 96.) "A very useful set of tables for those working in the field of transient and nonlinear phenomena."

MEASUREMENTS AND TEST GEAR

621.317 : 621.383.2 2459
The Photodiode: Investigation of the Total Current and of the Differential Current in an Asymmetrical Arrangement.—Deloffre, Pierre & Roig. (See 2543.)

621.317.3 : 621.315.212 2460
Coaxial Radio-Frequency Connectors and their Electrical Quality.—M. C. Selby, E. C. Wolzien & R. M. Jickling. (*J. Res. nat. Bur. Stand.*, March 1954, Vol. 52, No. 3, pp. 121–132.) Errors due to connectors used in impedance measurements made by the slotted-line technique are discussed. A definition is given of the connector as a component part of a connecting transformer which is completed by a supplementary line section; when the connecting transformer is short-circuited at either end a voltage node appears at the other end. The quality of the connectors is indicated by the transformation corrections needed to obtain accurate termination admittances. Node-shift methods are described for finding these corrections for various types of connector. Typical measurement results are presented for frequencies from 100 to 900 Mc/s. The technique is also useful for determining the quality of lines.

621.317.3.029.3(083.74) 2461
I.R.E. Standards on American Recommended Practice for Volume Measurements of Electrical Speech and Program Waves, 1953.—(*Proc. Inst. Radio Engrs.*, May 1954, Vol. 42, No. 5, pp. 815–817.) Standard 53 I.R.E. 3S2.

621.317.328.029.62 : 621.396.67 2462
An Experimental Field-Strength Meter for Band III.—G. T. Clack. (*J. Telev. Soc.*, Jan./March 1954, Vol. 7, No. 5, pp. 205–210.) A detailed description, with component values, is given of the circuit of a receiver for measurements of aerial gain and directivity at frequencies from 170 to 220 Mc/s. Input sockets are provided for 80-Ω and 300-Ω termination. The design provides for interchangeable tuning units for different bands. An i.f. of 34 Mc/s is used. Field tests with several types of aerial are reported, and the effect on the polar diagram of varying the spacing and length of a parasitic element is illustrated.

- 621.317.34.018.75 : 621.315.212 **2463**
Equipment for Measuring the Elongation of a Short-Duration Signal.—J. Bendayan. (*Onde élect.*, Feb. 1954, Vol. 34, No. 323, pp. 153–162.) Elongation of a pulse trace due to double reflection is used to assess the overall effect of cable discontinuities. Two sets of equipment for recording this elongation are described. For long cables a direct measurement is made of the pulse 'tail' at the remote end of the cable. For cables less than about 500 m in length an echo technique is used in which two sets of pulses with different repetition rates are transmitted along the cable, which is terminated by an equalizer.
- 621.317.343.018.75 : 621.315.2 **2464**
New Developments in Pulse Technique for Cable Testing.—J. Oudin. (*Onde élect.*, Feb. 1954, Vol. 34, No. 323, pp. 163–169.) The improvement in sensitivity of an echo meter attained by operating at suitably high gain with a system of amplitude and phase correction is limited ultimately, if a c.r. tube is used, by imperfections of vision. To maintain a fine trace and extend the range of fault location, integration techniques are necessary. The principles of (a) a delay-line system and (b) an auxiliary-pulse system with mechanical recording of the echo trace are described.
- 621.317.4 : 621.385.833 **2465**
Electron-Optical Shadow Method of Magnetic-Field Mapping.—L. Marton, J. A. Simpson & S. H. Lachenbruch. (*J. Res. nat. Bur. Stand.*, Feb. 1954, Vol. 52, No. 2, pp. 97–104.) Modifications of the method described by Marton & Lachenbruch (1211 of 1950) are indicated. Iterative analysis procedures are illustrated by the mapping of an otherwise inaccessible ferromagnetic domain field.
- 621.317.4 : 621.395.625.3 **2466**
Magnetic Recording Tape.—H. G. M. Spratt. (*Wireless World*, June 1954, Vol. 60, No. 6, pp. 264–267.) An arrangement for measuring the coercivity and remanence of recording tape is described. A large-size radio-receiver mains transformer is modified by providing a large air gap in the centre limb. Two search coils arranged in series opposition are placed in the gap and the tape sample is threaded through one of them. The differential voltage obtained, proportional to dB/dt , is applied to the Y-plate amplifier of a c.r.o. while a voltage proportional to H is applied to the X-plate amplifier. By including an integrating circuit in front of the Y-plate amplifier the B/H curve can be displayed.
- 621.317.411.029.64 **2467**
Measurement of Ferromagnetic Permeability at Micro-wave Frequencies.—G. S. Sanyal & J. S. Chatterjee. (*Indian J. Phys.*, June 1953, Vol. 27, No. 6, pp. 328–339.) The method uses a cylindrical cavity of nonmagnetic material with a detachable end plate. Resonance frequency and Q are measured first with the nonmagnetic end plate in position and then with a plate of the test material substituted. Relevant theory is given, the set-up is described, and results are reported for nickel and soft iron.
- 621.317.45 **2468**
Nondestructive Sensing of Magnetic Cores.—D. A. Buck & W. I. Frank. (*Elect. Engng, N.Y.*, Feb. 1954, Vol. 73, No. 2, p. 110.) Digest of paper published in *Trans. Amer. Inst. elect. Engrs*, 1953, Vol. 72, pp. 822–830. The sense of the remanent magnetic flux in a core of the type used in digital-computer storage devices is detected by applying a small pulsed quadrature field to the core, thus rotating the field vector momentarily. This change of flux induces in a sensing coil wound on the core a voltage pulse whose sign depends on that of the remanent flux.
- 621.317.7 **2469**
The Application of Counter-Rotating Fields to Electrical Measuring and Indicating Devices.—R. L. Russell & N. W. Hodges. (*Proc. Instn elect. Engrs*, Part II, April 1954, Vol. 101, No. 80, pp. 178–182.) Two oppositely rotating magnetic fields which may or may not be of the same magnitude and frequency are combined to produce a resultant field of zero or low angular velocity, with which the moving element aligns itself. Various e.s. and e.m. applications of this principle are discussed.
- 621.317.7.025.001.4 **2470**
Alternating-Current-Instrument Testing Equipment.—A. H. M. Arnold. (*Proc. Instn elect. Engrs*, Part II, April 1954, Vol. 101, No. 80, pp. 121–131. Discussion, pp. 131–133.) An account is given of the equipment and methods used at the National Physical Laboratory for calibrating a.c. indicating instruments by comparison with standard meters.
- 621.317.71 **2471**
Voltage Transformer for Current Measurement.—A. Lutz & G. Poklekowski. (*Fernmeldetechn. Z.*, March 1954, Vol. 7, No. 3, pp. 105–110.) A valve voltmeter circuit is described for measurement of current in circuits at high potential with respect to earth. The effect of the valve circuit on the current to be measured and the leakage current from the high-potential circuit through the valve are compensated by (a) a four-terminal network in the grid circuit, or (b) a suitable cathode resistor automatically biasing the valve. Details of a practical circuit are given in which both methods of compensation are applied. This operates in the frequency range 30 c/s–1 Mc/s over the current range 0.01–100 mA with power consumption $0.4 \mu W$ –4 mW and error <3%. It compares favourably with thermocouple and rectifier-bridge instruments.
- 621.317.715 : 621.383.4 **2472**
Photoelectric Measurement of the Displacement of a Luminous Spot.—A. Thulin. (*C. R. Acad. Sci., Paris*, 15th March 1954, Vol. 238, No. 11, pp. 1210–1212.) The system uses a differential photoconductive cell arrangement to obtain a current proportional to the displacement of the spot, and is stabilized against fluctuations of illumination and sensitivity.
- 621.317.738 **2473**
Two Probe-Type Capacitance Meters.—L. Medina. (*J. Brit. Instn Radio Engrs*, May 1954, Vol. 14, No. 5, pp. 233–236.) Reprint. See 215 of January.
- 621.317.75 **2474**
A Spectrum Analyser for the Range 100 c/s to 100 000 c/s.—K. R. McLachlan. (*J. Brit. Instn Radio Engrs*, May 1954, Vol. 14, No. 5, pp. 217–229.) "The specification is given of an analyser to measure the spectral distribution of the noise emanating from an air jet, and several methods of performing this analysis are discussed. The development of a practical instrument is described which uses a variable-frequency selective amplifier with a Wien bridge as the frequency-dependent feedback network, and some details of its performance are given. Errors due to the short time available for analysis are derived and some of the less familiar aspects of the circuits used, such as a symmetrical-to-asymmetrical convertor, are analysed."
- 621.317.761 + 621.373.421.13 **2475**
A Quartz-Crystal-Controlled Frequency Meter and Master Oscillator of High Accuracy.—E. Kettel. (*Telefunken Zig*, March 1954, Vol. 27, No. 103, pp. 27–31.) Frequency meter Type FM 312/1 comprises a frequency

analysing unit of heterodyne type, a variable-frequency oscillator with frequency regulated by the analysing unit, and a standard-frequency generator. The frequency error is $\pm 1 \times 10^{-7} \pm 0.2$ c/s between 1 kc/s and 3 Mc/s. The range is 1 kc/s–300 Mc/s when the instrument is used as a frequency meter, and 1–32 Mc/s for use as a master oscillator. Parasitic oscillation is 80 db below desired oscillation level. The standard-frequency generator is a 100-kc/s quartz crystal enclosed in a double thermostat. Provision is made for comparison with an external frequency standard.

621.372.8.001.4 : 621.396.96 2476

A Hybrid-Ring Method of Simulating Higher Powers than are available in Waveguides.—L. Young. (*Proc. Instn elect. Engrs*, Part III, May 1954, Vol. 101, No. 171, pp. 189–190.) A radar waveguide component must be tested at powers higher than those nominally available from the magnetron generator, since operating conditions render a safety margin of 50–100% or more necessary. The component is inserted in one arm of a hybrid ring in front of the plunger and the standing wave pattern is moved across the component, a second plunger maintaining a nonreflecting load to the magnetron. The effective power is then twice that of the magnetron. The method of connecting n such hybrid rings, giving a power multiplication of 2^n , is explained. It cannot be used to test high-power loads or any component that absorbs or radiates power.

621.385.029.6.001.4 2477

Magnetron Stability Tester.—H. S. Bennett & A. A. Kirilloff. (*Tele-Tech*, March 1954, Vol. 13, No. 3, pp. 96–97 . . 167.) The main sections of the tester are (a) radar power supply and modulator, (b) measurement apparatus for valve current, voltage and magnetic field, and (c) slotted line and dummy terminal line with associated measurement gear. Different kinds of magnetron may be tested over different frequency bands, and all factors involved in stability of operation can be determined.

621.396.822.029.65 : 537.54 2478

A Gas-Discharge Noise Source for Eight-Millimeter Waves.—T. J. Bridges. (*Proc. Inst. Radio Engrs*, May 1954, Vol. 42, No. 5, pp. 818–819.) Noise sources of a type previously described [e.g. 185 of 1952 (Johnson & Deremer)] are adapted for operation¹ at 8 mm λ by reducing the dimensions of the gas tube and increasing the pressure. Measured noise levels of tubes with neon and argon fillings are 18.2 db and 15.9 db respectively above room-temperature levels. These figures are in good agreement with values calculated from gas-discharge theory.

621.397.62.001.4 2479

Measurements on Television Receivers: Part 2—Measurement of Transmission Characteristics of Television Receiver Circuits.—O. Macek. (*Arch. tech. Messen*, Feb. 1954, No. 217, pp. 29–30.) The factors which are important in estimating performance of the r.f. and demodulation stages, and the suitability of square waves for testing delay characteristics are discussed. Part 1: 2397 of 1953.

OTHER APPLICATIONS OF RADIO AND ELECTRONICS

536.53 : 621.396.822 2480

Measurement of the Absolute Temperature of a Metallic Conductor based on the Voltage produced by Thermal Agitation of the Electrons in the Conductor.—R. Aumont, J. Romand & B. Vodard. (*C. R. Acad. Sci., Paris*, 22nd March 1954, Vol. 238, No. 12, pp. 1293–

1296.) Results obtained with a modified form of the arrangement described by Garrison & Lawson (947 of 1950) are reported. Determinations are accurate to within about 1° at temperatures up to 780°K.

621.317.083.7 2481

Optical System for the Transmission of Information.—G. Cortellesa & R. Querzoli. (*Nuovo Cim.*, 1st March 1954, Vol. 11, No. 3, pp. 321–322.) Brief description of a telemetering system using a light beam modulated at a frequency which depends on the magnitude measured.

621.383.2 : 621.386 2482

Possibilities and Limitations of Image Intensification.—E. Fenner & O. Schott. (*Z. angew. Phys.*, Feb. 1954, Vol. 6, No. 2, pp. 88–95.) The limit set by fundamental brightness fluctuations of a point image is defined. Electron-optical image converters, television pick-up tubes and scanning systems for X-ray image intensification are described and their performances assessed. 46 references.

621.384.6 : 621.311.6 2483

An R.F. Generator for Nuclear Energy Studies.—L. Kornblith, Jr. (*Electronics*, May 1954, Vol. 27, No. 5, pp. 142–145.) Description of the power-supply equipment for the 450-MeV synchrocyclotron at Chicago. A 40-kW frequency-sweep oscillator is tuned between 18.2 and 28.4 Mc/s by means of a motor-driven capacitor. The output is pulsed so as to use only the descending part of the frequency sweep; the pulsing is performed by means of a photocell circuit actuated from mirrors on the capacitor shaft.

621.384.612 2484

Orbital Instabilities due to the Coupling between Radial and Vertical Oscillations in the Cosmotron.—J. Seiden. (*C. R. Acad. Sci., Paris*, 1st March 1954, Vol. 238, No. 9, pp. 1010–1012.)

621.384.612 2485

Space-Charge Forces in Strong-Focusing Synchrotrons.—S. E. Barden. (*Phys. Rev.*, 15th March 1954, Vol. 93, No. 6, pp. 1378–1380.) Relatively small changes in the average field gradient produced by space-charge effects may, when the number of magnet sectors is $\gg 10$, create conditions favourable to forced resonances due to imperfections in magnet alignment. This places strict limitations on the admissible space-charge forces, more particularly in the case of beams of heavy particles.

621.384.622.1 2486

Linear Accelerator for Electrons, with Preliminary Bunching.—M. Papoular. (*C. R. Acad. Sci., Paris*, 8th March 1954, Vol. 238, No. 10, pp. 1115–1117.) Use of the preliminary bunching device described with a 1-MeV accelerator gave an increase of 100% in the number of electrons attaining this energy, without adversely affecting the spectral distribution of energy.

621.385.833 2487

Notes on Chromatic Aberration of Electron Lenses.—H. Grümm. (*Ann. Phys., Lpz.*, 15th Feb. 1954, Vol. 14, Nos. 3/5, pp. 193–200.) Formulae for determining the chromatic aberration are derived using wave-mechanics theory of electron optics. The possibility of correcting the aberration in the case of a bell-shaped magnetic field is shown.

621.385.833 2488

Calculation of the Axial Potential in a Three-Electrode Electrostatic Lens.—P. Ehinger. (*C. R. Acad. Sci., Paris*, 22nd March 1954, Vol. 238, No. 12, pp. 1306–1308.) The

three-electrode lens with thick middle electrode is treated by applying the method previously developed for a two-cylinder lens (1877 of June) to the two halves of the system.

621.385.833 2489

A Simple Stigmator for Magnetic Electron Lenses.—S. Leisegang. (*Optik, Stuttgart*, 1954, Vol. 11, No. 2, pp. 49-60.) Asymmetry is compensated by means of iron inserts in the pole pieces. Axial astigmatism can be reduced to about 0.1μ , and a resolving power of 1μ can be attained.

621.387.424 2490

Operating Characteristics of Counters with External Cathode and Pure Methyl-Alcohol Filling.—D. Blanc. (*Nuovo Cim.*, 1st March 1954, Vol. 11, No. 3, pp. 231-240. In French.)

621.387.424 2491

Response of a Pulsed Geiger Tube.—H. B. Rosenstock. (*J. appl. Phys.*, March 1954, Vol. 25, No. 3, pp. 275-282.) The advantage of operating with pulsed rather than steady voltages on the tube is that higher radiation intensities can be measured; but if the duration of the pulse is comparable to the spread time of the discharge, the output-current/radiation-intensity relation will be nonlinear, since the resulting current surge may not reach its maximum before the end of the pulse. Using probability considerations, this relation is calculated as a function of the response of the tube under ordinary operating conditions. If the discharge initially spreads rapidly, an approximate general relation not involving the spread mechanism can be established. The response to be expected in two types of tube is discussed in detail.

PROPAGATION OF WAVES

621.396.11 2492

Ground-Wave Propagation at Ultrahigh Frequencies.—(*Nature, Lond.*, 27th March 1954, Vol. 173, No. 4404, pp. 573-574.) Two papers presented at the I.E.E. are summarized. The first, by Saxton & Harden, gave results of an experimental investigation of the effects of irregular terrain on ground-wave propagation at frequencies of 102.6 and 593.6 Mc/s. The second, by Saxton, compared results of such investigations with the corresponding conditions for transmission over a smooth earth, for propagation at frequencies between 50 and 800 Mc/s.

621.396.11 2493

Ionospheric Propagation.—R. Gea Sacasa. (*Rev. Telecomunicación, Madrid*, March 1954, Vol. 10, No. 35, pp. 24-32. In Spanish and English.) Report and comment on U.S. document 224 presented at the C.C.I.R. conference, London, 1953, discussing certain optimum-working-frequency and m.u.f. predictions for 1950 and 1951. See also 1773 of 1953.

621.396.11 : 535.42 2494

On the Theory of Diffraction of Electric Waves by Many Parallel Screens.—Y. Nomura. (*Sci. Rep. Res. Inst. Tohoku Univ., Ser. B*, March 1953, Vol. 4, No. 2, pp. 231-248.) Expressions are derived for the intensity of a wave diffracted by two parallel screens, representing two mountain ranges, and the results are extended to the case of more than two parallel screens. The wave arriving by the shortest path, i.e. suffering the smallest number of diffractions, accounts for the major part of the resulting intensity. The effect of the image aerial is also considered.

A.178

621.396.11 : 551.510.535 2495

A Note on Sweep-Frequency Backscatter Observations.—R. Silberstein. (*J. geophys. Res.*, March 1954, Vol. 59, No. 1, pp. 138-139.) A typical range/frequency record obtained with improved equipment is shown, and the identification of backscatter sources of particular echoes briefly discussed.

621.396.11 : 621.317.353.3 : 550.38 2496

Influence of the Earth's Magnetic Field on the Interaction of Radio Waves in the Ionosphere.—I. M. Vilenski. (*Zh. eksp. teor. Fiz.*, Jan. 1954, Vol. 26, No. 1, pp. 42-56.) The discussion of the Luxemburg effect and cross-modulation (3095 of 1953) is extended to take account of the earth's magnetic field. A formula for the depth of cross-modulation is derived in terms of functions of the transmitter frequencies, the effective number of electron collisions and the gyromagnetic frequency. Calculations show that values of cross-modulation depths obtained by Cutolo (2617 of 1950) and Shaw (1472 of 1951) can be reconciled if the E layer is assumed to have been lower by 5-10 km in the former than in the latter experiments. The formulae apply to night-time conditions only.

621.396.11.029.62 : 551.594 2497

Atmospheric Electricity and Long-Distance Very-High-Frequency Scatter Transmissions.—G. A. Isted. (*Alarconi Rev.*, 2nd Quarter 1954, Vol. 17, No. 113, pp. 37-60.) During an investigation of long-distance transmissions in the frequency band 30-100 Mc/s, it was observed that signals transmitted over distances of 500 km or more arrived at the receiver in a series of bursts, many of which were grouped in trains. At the same time, electrical discharges from clouds were observed, often having the same time arrangement as the signal bursts. Theory is developed to explain how these discharges, though occurring in the lower atmosphere, can give rise to pockets of intense ionization in the E region. The theory indicates that ordinary clouds, rather than storm clouds, are the main generators maintaining the fine-weather vertical potential gradient. It is also suggested that when energy is transferred from discharging clouds to fine-weather areas, continuous partial ionization of the E-region conduction path is set up, and in extreme cases may result in the formation of sporadic E; and that this partial ionization together with the ionization bursts is mainly responsible for very-long-distance transmission in the v.h.f. band. For a brief account see *Wireless World*, July 1954, Vol. 60, No. 7, pp. 343-344.

621.396.81 : 621.396.65 2498

Reliability of U.S.W. Radio Link extending far beyond the Horizon.—H. J. Fründt. (*Telefunken Ztg.*, March 1954, Vol. 27, No. 103, pp. 41-43.) Field-strength recordings made at the Berlin end of a Berlin-Harz 60-Mc/s f.m. link are analysed. According as atmospheric refraction effect is or is not taken into account, the computed field strength is equalled or exceeded for 85% or 99.5% of the time respectively. This fact is of interest in planning. Signal/noise ratio in the individual channels is an important factor in reliability of operation; computation shows that some 14.5 db of noise is due to electrical apparatus and machines in the Berlin area. Over the period of a year, causes of service interruptions and their durations in percentage of time were (a) fading, 1.62%, (b) equipment failure, 3.37%, (c) transmission-line and cable connections, 5.82%, (d) other causes, 1.69%.

621.396.812.3 2499

Prolonged Space-Wave Fadeouts at 1046 Mc/s Observed in Cheyenne Mountain Propagation Program.—B. R. Bean. (*Proc. Inst. Radio Engrs.*, May 1954, Vol. 42, No. 5, pp. 848-853.) The transmitter used in these propagation tests is located on the sheer face of the

WIRELESS ENGINEER, AUGUST 1954

mountain, at a height of about 2 800 ft. Receiving sites at three different distances are used, all with standard dipoles 43 ft above the surrounding plains. Records obtained during the first year of continuous operation exhibit prolonged fades, often more than 20 db below the monthly mean level and lasting from one minute up to several hours. Their occurrence coincides with widespread superrefraction as evidenced by enhanced signals beyond the radio horizon and ground modification of the refractive-index profile. The results emphasize the need to provide sufficient transmitter power when planning u.h.f. radio links with high-altitude transmitters and low-altitude receivers.

RECEPTION

621.396.621 2500
Radio Receiver Installations for Telegraphy and Single-Sideband Telephony in the Overseas Service. Developmental Principles and Practical Experience.—K. Fischer, W. Vesper & G. Vogt. (*Telefunken Ztg.*, March 1954, Vol. 27, No. 103, pp. 14–26.) The development of Type EST 110 Kw/1 receiving equipment for telephony, and Type EST 111 Kw/1 for telegraphy is described and the technical problems involved are discussed. The equipment consists basically of a double-superheterodyne receiver with variable first i.f. and first local oscillator crystal-controlled. Frequency accuracy to within ± 2 kc/s at 30 Mc/s is achieved for ambient temperatures between 15° and 25°C and mains supply variations < 10%. Special demodulation circuits to deal with standard types of wave, and a.f.c. and a.v.c. are provided. Each installation comprises at least two receivers, so that diversity operation is possible.

621.396.621 : 621.376.3 2501
Mobile F.M. Broadcast Receiver Design.—K. Onder. (*Electronics*, May 1954, Vol. 27, No. 5, pp. 130–133.) Distortion due to multipath transmission is reduced by making the limiter and discriminator bandwidth much greater than normal [734 of 1950 (Arguimbau & Granlund)]. An experimental receiver designed on this principle was tested in a car; the results indicated that ignition interference was also eliminated.

621.396.82 : 621.376.33 2502
Interference in Non-idealized F.M. Receivers.—H. Marko. (*Arch. elekt. Übertragung*, March 1954, Vol. 8, No. 3, pp. 111–122.) The effect of imperfect demodulator performance on the level of unintelligible interference, crosstalk and noise is analysed. Limiter, discriminator and detector characteristics are examined and design requirements for interference suppression in each stage are discussed.

STATIONS AND COMMUNICATION SYSTEMS

621.376.3 : 621.3.018.78 : 621.372.5 2503
Harmonic Distortion of Frequency-Modulated Waves by Linear Networks.—R. G. Medhurst. (*Proc. Instn elect. Engrs*, Part III, May 1954, Vol. 101, No. 71, pp. 171–181.) The expression connecting the distortion of the modulating signal with the distortion of the r.f. spectrum when a f.m. carrier is passed through a linear network is used to obtain the harmonic distortion when the modulating signal is a single tone. It is assumed that departures of the phase characteristic of the network from linearity, and of the amplitude characteristic from constancy, are small. Tables of functions involved in calculating distortion by this method are provided and comparison is made with the result obtained by van der Pol (2310 of 1946) and with some measurements.

621.376.5 2504
Gaussian Pulses.—J. P. Vasseur. (*Onde élect.*, Feb. 1954, Vol. 34, No. 323, pp. 139–142.) See 1905 of June.

621.376.56 2505
Transmission of Information by Integration of Coded Signals.—H. Harmuth. (*Arch. elekt. Übertragung*, March 1954, Vol. 8, No. 3, pp. 132–136.) The need for transmitting information regarding the position of individual pulses in a p.c.m. system is eliminated if decoding is effected by suitable integrations of a pulse group. For a given channel capacity the transmitted power required is only 3 db above the theoretically required value, compared with 9 db for a pulse-amplitude detecting system. A system based on performing three integrations of a five-unit pulse group to give all but two of the 32 possible pulse sequences is outlined. The maximum possible error due to a pulse being missed can be reduced by using a suitable alphabetic code.

621.394.13 2506
Code Convertors for the Interconnection of Morse and Teletypewriter Systems.—R. O. Carter & L. K. Wheeler. (*Proc. Instn elect. Engrs*, Part III, May 1954, Vol. 101, No. 71, pp. 151–157. Discussion, pp. 158–164.) Automatic convertors for the two directions of conversion and with Morse perforated-tape storage are described.

621.394.14 2507
Telegraph Codes and Code Convertors.—T. Hayton, C. J. Hughes & R. L. Saunders. (*Proc. Instn elect. Engrs*, Part III, May 1954, Vol. 101, No. 71, pp. 137–150. Discussion, pp. 158–164.) Codes in use for submarine cable and radio circuits are reviewed from the point of view of their traffic-carrying capacity and freedom from undetectable errors. The effects of distortion and of particular methods of working on the error rate, and methods of eliminating errors are discussed. A 7-unit/5-unit electronic converter and a 5-unit/7-unit mechanical converter are described.

621.394.7 + 621.395.7 2508
Unit Construction Practice (UCP) applied to Line-Transmission Equipment.—K. W. Harrison. (*Proc. Inst. Radio Engrs*, May 1954, Vol. 42, No. 5, pp. 822–829.) By standardizing a small number of functional units a flexible method of designing complete carrier-transmission equipments is provided. Bulk is reduced by efficient use of mounting space rather than by special miniaturization techniques.

621.396.41 : 621.374.5 2509
Electrical Delay Networks for Time Selection in Multichannel Systems.—H. Härtl & F. Rumpel. (*Fernmeldetech. Z.*, March 1954, Vol. 7, No. 3, pp. 118–122.) The design and construction of a lumped-element delay network is described. Design is based on the properties of an *m*-derived filter section. A unit comprises 125 similar sections, coils being assembled coaxially on the same former. Overall delay is 125 μ s and upper cut-off frequency about 400 kc/s. Operating characteristics are discussed.

621.396.61 + 621.396.62 2510
A New Mobile Phase-Modulated Transmitter-Receiver Unit.—J. Anderson & W. D. Meewezen. (*Proc. Instn Radio Engrs, Aust.*, Feb. 1954, Vol. 15, No. 2, pp. 31–42.) The transmitter crystal oscillator circuit is noncritical in component values and has low a.f. distortion. An a.f. amplifier-limiter circuit prevents overloading of the oscillator. The frequency multiplication factor from crystal to aerial is 48. Power output is 24 W at 170 Mc/s, and the units for the 70–85-Mc/s and 156–170-Mc/s bands

differ only in the tuning circuits. Conversion from 6.3-V to 12.6-V operation is simple, and the same transmitter will give the higher output required from a base station transmitter if used with an a.c. h.v. supply unit. The double-superheterodyne receiver units for the two bands are identical apart from the r.f. and first mixer stages.

621.396.65 : 621.396.81 **2511**
Reliability of U.S.W. Radio Link extending far beyond the Horizon.—Fründt. (See 2498.)

621.396.933 **2512**
A Single-Sideband Controlled-Carrier System for Aircraft Communication.—G. W. Barnes. (*Proc. Instn elect. Engrs*, Part III, May 1954, Vol. 101, No. 71, pp. 121–130. Discussion, pp. 130–135.) A transmission system is proposed in which the carrier amplitude is made to vary inversely as the sideband amplitude. This system provides a.f.c. over a wider range than is usual and avoids the use of a very narrow carrier filter. A four-phase balanced modulator is used. The outphasing method of sideband rejection is applied in the receiver, which is provided with automatic carrier-frequency control using an electromechanical system with a memory for operation on the intermittent-carrier systems. Flight trials with experimental equipment are reported.

SUBSIDIARY APPARATUS

621.3.013.783 **2513**
Shielding Nomograph.—J. F. Sodaro. (*Electronics*, May 1954, Vol. 27, No. 5, p. 190.)

621.311.69 : 621.362 **2514**
Thermoelectric Generator TGK-3.—V. Daniel'-Bek, A. Voronin & N. Roginskaya. (*Radio, Moscow*, Feb. 1954, No. 2, pp. 24–26.) Description of a paraffin-lamp-driven generator for use with battery-type receivers. The outputs are 2 V, 2 A for the vibrator h.t. unit and 2 V, 0.5 A for heaters. A 1.2-V, 0.36-A tapping is also provided. Semiconductor-type thermoelements are mentioned as being more efficient than pure-metal thermocouples.

TELEVISION AND PHOTOTELEGRAPHY

621.397.2 : 621.3.018.78 **2515**
The Distortion in Television Signals by Attenuation and Phase Distortion in the Transmission System.—F. Bath & H. Kaden. (*Arch. elekt. Übertragung*, Feb. 1954, Vol. 8, No. 2, pp. 55–68.) Analysis shows that for satisfactory transmission of a black/white edge the demands on the video-signal transmission system are more exacting than for satisfactory transmission of a picture element. The conditions satisfying these demands are introduced in the coefficients of the Fourier expansions of the expressions for attenuation and phase distortion of the system. Tolerance curves for the permissible distortion, as function of frequency, are deduced from statistical considerations of distortion in the sections of the transmission system.

621.397.5 : 535.623 **2516**
Colour Television on 405 Lines.—(*Wireless World*, June 1954, Vol. 60, No. 6, pp. 256–257.) Account of a demonstration given in London, on a closed circuit. Comparison was made between a system with colour subcarrier inside the monochrome channel and one with the colour channel outside the monochrome channel. Better colour pictures were obtained with the latter system, but because of the extra bandwidth required use of this system in Bands I and III would involve

overlap between the monochrome signal of one channel and the colour signal of the adjacent channel. A camera with only two pickup tubes was used for live scenes, one tube producing a normal-definition monochrome signal and the other producing two low-definition colour signals. For another account see *Elect. J.*, 14th May 1954, Vol. 152, No. 20, p. 1601.

621.397.5 : 621.395.625.3 **2517**
A System for Recording and Reproducing Television Signals.—H. F. Olson, W. D. Houghton, A. R. Morgan, J. Zenel, M. Artzt, J. G. Woodward & J. T. Fischer. (*RCA Rev.*, March 1954, Vol. 15, No. 1, pp. 3–17.) Details are given of a magnetic-tape system. For monochrome television $\frac{1}{4}$ -in. tape is used, carrying one track for the video signal and one for the sound. For colour television $\frac{1}{4}$ -in. tape is used carrying five tracks, for the red, green, blue, synchronization and sound signals. A servomechanism is used to provide the required constancy of tape speed. This speed is 30 ft/s with the equipment described, and the width of the available frequency band is >3 Mc/s. The audio signals are modulated on to a 150-kc/s carrier for recording. Demonstrations of the system given at Princeton in December 1953 are briefly reported.

621.397.61 **2518**
Low-Level-Modulation Vision Transmitters, with Special Reference to the Kirk O'Shotts and Wenvoe Stations.—E. McP. Leyton, E. A. Nind & W. S. Percival. (*Proc. Instn elect. Engrs*, Part III, May 1954, Vol. 101, No. 71, pp. 190–191.) Discussion on 274 of January.

621.397.611.2 **2519**
Vidicon Film-Reproduction Cameras.—H. N. Kozanowski. (*J. Soc. Mot. Pict. Telev. Engrs*, Feb. 1954, Vol. 62, No. 2, pp. 153–162.) The advantages of the vidicon pickup tube for televising film are discussed, and a description is given of a complete camera unit, including deflection, video and control circuits. Equipment is under development for enabling transparent or opaque stills to be interspersed with films.

621.397.62 **2520**
Choice of a Television-Receiver Intermediate Frequency to suit the C.C.I.R. Standard.—W. Holm & W. Werner. (*Funk u. Ton*, March 1954, Vol. 8, No. 3, pp. 129–138.) Considerations of interference by other services, various transmitter harmonics, etc., show that the optimum European television sound i.f. is 33.4 Mc/s and vision i.f. 38.9 Mc/s. The use of these frequencies may require precautions against second-harmonic interference in channel 4 and sixth-harmonic interference in channel 8. Sound in channel 7 may be interfered with by the fifth harmonic of the vision i.f. if the latter is mistuned by $+50$ kc/s.

621.397.62 **2521**
"Leningrad" T-2 — Modern Russian TV Receiver.—(*Tele-Tech*, Jan. 1954, Vol. 13, No. 1, pp. 90–92.) Circuit diagram and chassis photographs of this 8-in.-screen receiver are shown.

621.397.62 **2522**
How to Handle Ringing in Television Design.—L. Beiser. (*Electronics*, May 1954, Vol. 27, No. 5, pp. 162–167.) A discussion of the precautions necessary in the design of the various parts of the receiver deflection system to avoid extraneous vertical-bar patterns on the raster caused by transient oscillations in the output circuits.

621.397.62 **2523**
A Direct-Drive Scanning Circuit.—E. Jones & K. E. Martin. (*J. Telev. Soc.*, Jan./March 1954, Vol. 7, No. 5,

pp. 190-199.) A circuit based on that described in U.S.A. patent No. 2555831 (Tourshou) is discussed. The operation differs fundamentally from that of the widely used Blumlein energy-recovery circuit. The scanning coil is in series with an anode inductor whose function is to store energy during the scanning stroke and give it up during the flyback; but there is no coupling between the two coils. D.c. is excluded from the scanning coil and a h.v. winding is provided on the anode inductor. A practical circuit is illustrated, with component values.

621.397.62 : 535.623 : 621.385.831 **2524**
Beam-Deflection Tube Simplifies Color Decoders.—R. Adler & C. Heuer. (*Electronics*, May 1954, Vol. 27, No. 5, pp. 148-151.) See 2244 of July.

621.397.62 : 621.314.7 **2525**
A Symmetrical-Transistor Phase Detector for Horizontal Synchronization.—B. Harris & A. Macovski. (*RCA Rev.*, March 1954, Vol. 15, No. 1, pp. 18-26.) A junction transistor with identical collector and emitter junctions is used in place of a conventional double diode as a balanced phase detector for controlling the line-deflection oscillator of a television receiver. The circuit is gated by application of synchronizing pulses to the transistor base, while the comparison sawtooth voltage is applied to the collector-emitter. Wide variations in the absolute values of the transistor parameters, in the degree of symmetry of the transistor, and in the temperature are tolerable.

621.397.62 : 621.385 **2526**
Investigation of Ultra-High-Frequency Television Amplifier Tubes.—Wen Yuan Pan. (*RCA Rev.*, March 1954, Vol. 15, No. 1, pp. 27-45.) An investigation is made of the possibility of improving receiver performance by including an u.h.f. amplifier stage. Various types of available valve, including planar, pencil and miniature, are considered from the point of view of noise, gain and stability. The results indicate that no substantial advantage is obtainable with any of the available valves, particularly when the additional cost is taken into account.

621.397.62 : 621.397.335 **2527**
A Critical Review of Synchronizing Separators with Particular Reference to Correct Interlacing.—G. N. Patchett. (*J. Brit. Instn Radio Engrs*, May 1954, Vol. 14, No. 5, pp. 191-214.) See 2918 of 1952.

621.397.62.001.4 **2528**
Measurements on Television Receivers: Part 2—Measurement of Transmission Characteristics of Television Receiver Circuits.—Macek. (See 2479.)

621.397.7 : 628.972 **2529**
Television Lighting Routines.—W. R. Ahern. (*J. Soc. Mot. Pict. Telev. Engrs*, March 1954, Vol. 62, No. 3, pp. 189-196. Discussion, pp. 196-198.) Description of the lighting installation at N.B.C. studio 8H and account of the lighting procedure for a typical play.

621.397.828 : 621.396.61.013.78 **2530**
Screening Materials for TVI.—R. Glaisher. (*Short Wave Mag.*, March 1954, Vol. 12, No. 1, pp. 16-18.) The radiation from a 50-Mc/s test transmitter screened with different materials was measured. The conductivity of mesh screens is improved by bonding with solder strips at 2-in. intervals; this greatly reduces effects of oxidation. Close-stranded copper mesh thus treated is only slightly less effective at 50 Mc/s than copper-plated steel, the best of the solid materials tested.

TRANSMISSION

621.376.22 : 621.3.018.783 **2531**
Intermodulation Distortion in Rectifier Modulators.—D. G. Tucker. (*Wireless Engr*, June 1954, Vol. 36, No. 6, pp. 145-152.) Distortion due to interference of the modulation voltage with the rectifier-switching function of the carrier is studied. Analysis previously given by Belevitch (2184 of 1949 and 1633 and 2167 of 1950) for the case of a single modulation tone is extended to deal with modulation by two or more tones. The rectifiers are assumed to be linear. For the case of two modulation tones values of all third-order distortion terms are tabulated based on first- and third-order modulation. An appendix extends this in general form to all orders of modulation and to second- as well as third-order distortion.

621.376.54 **2532**
Pulse Duration Modulator Circuit.—F. Butler. (*Electronic Engng*, April 1954, Vol. 26, No. 314, pp. 153-155.) Adaptation of the pulse-generator circuit described by Levell (364 of 1953) for single-channel voice-communication purposes. Smooth changes of pulse duration between 12.8 and 0.7 μ s are obtained on applying a direct control voltage of value between 15 and 280 V via a high resistance. The pulse-duration/control-voltage characteristic has the form of a rectangular hyperbola. The circuit of a complete modulated generator is illustrated. Trigger pulses with a repetition rate adjustable to 12 kc/s are provided; modulation frequencies up to 6 kc/s are hence permissible. A method of reducing distortion is indicated.

621.396.61 : 621.314.22.029.51/53 **2533**
Tankless Low-Frequency Transmitter.—P. Gomard. (*Electronics*, May 1954, Vol. 27, No. 5, pp. 154-156.) Reduction of the size of a transmitter by use of iron-cored h.f. transformers was described by Deise & Gregory (1284 of 1950). The transmitter here described covers the frequency bands 280-330 kc/s and 400-510 kc/s, using a straight wide-band amplifier with coupling transformers wound on ferrite cores. The oscillator is coupled to the amplifier through a low-pass filter, separate filters being used for the two bands. The output stage comprises eight Type-807 valves in push-pull parallel. The design of the output transformer is considered particularly; the measured temperature rise of 37°-39°C at the ferrite core is in fair agreement with the calculated value.

621.396.61.013.78 : 621.397.828 **2534**
Screening Materials for TVI.—Glaisher. (See 2530.)

VALVES AND THERMIONICS

621.314.632 + 621.314.7 **2535**
The Double-Base Diode: A Semiconductor Thyatron Analog.—R. W. Aldrich & I. A. Lesk. (*Trans. Inst. Radio Engrs*, Feb. 1954, Vol. ED-1, No. 1, pp. 24-27.) The double-base diode consists of a single-crystal Ge bar with a single p-n junction and two base contacts. With suitable biasing current flowing between these contacts a junction-base characteristic with a stable negative-resistance region can be obtained, the order of magnitude of the junction currents being much greater than that of the emitter input characteristic of the point-contact transistor. The device is thus suitable for relaxation-oscillator and switching applications; some simple circuits are illustrated.

621.314.632 **2536**
Diode Theory in the Light of Hole Injection.—J. A. Swanson. (*J. appl. Phys.*, March 1954, Vol. 25, No. 3,

pp. 314-323.) Classical diode theory, as applied to metal point contacts made to an n -type semiconductor, is adequate only for small forward voltages at which, under certain conditions, hole current may be negligible. The shape of the predicted diode characteristic is not affected by hole injection at low voltages. For voltages exceeding a critical value, dependent on the resistivity of the material, the spreading resistance is comparable to the barrier resistance, and it is the hole-injection process which accounts for continued rectification. The extent to which the spreading resistance is decreased by hole injection depends on the ratio, γ , of hole current to total current. The effect of γ on the characteristic at high voltages is considered, and a method of measuring γ is indicated.

621.314.7 2537

Frequency Variations of Junction-Transistor Parameters.—R. L. Pritchard. (*Proc. Inst. Radio Engrs*, May 1954, Vol. 42, No. 5, pp. 786-799.) The equivalent-T-network representation of the transistor is adopted in which the four independent small-signal parameters to be considered are the emitter resistance, the base resistance, the parallel combination of collector resistance and capacitance and the effective current-amplification factor. Analysis given by Early (874 of 1953) is extended to account for observed frequency variation of collector impedance. The transistor voltage/current relations are calculated for the theoretical model using the grounded-base connection.

621.314.7 2538

High-Frequency Operation of P-Type Point-Contact Transistors.—F. L. Hunter & B. N. Slade. (*RCA Rev.*, March 1954, Vol. 15, No. 1, pp. 121-134.) The characteristics of n -type and p -type Ge point-contact transistors are compared. Higher operating frequencies can be attained with the p -type because of the greater mobility of the minority carriers, which in this case are electrons. An α -cut-off frequency as high as 50 Mc/s with a point spacing of 0.001 in. has been attained in amplifier transistors, and an operating frequency as high as 425 Mc/s with oscillator transistors.

621.314.7+621.314.63] : 621.318.57 2539

Switching Time in Junction Diodes and Junction Transistors.—R. H. Kingston. (*Proc. Inst. Radio Engrs*, May 1954, Vol. 42, No. 5, pp. 829-834.) An approximate solution for the transient occurring when a junction diode is switched from forward to reverse conduction is obtained by considering the behaviour of the minority carriers. Two phases are distinguished, (a) a constant-current phase in which the flow is limited by the external resistance, (b) a 'collection' phase in which the current decays at a rate determined by the minority-carrier lifetime and by the diode dimensions. The duration of the two phases is determined theoretically for a planar junction, a hemispherical junction and a narrow-base diode. By considering the diode in the last of these cases as the emitter-base combination of a transistor, the corresponding collector-current transient is found.

621.314.7 : 621.373.52 2540

Internal Oscillations and Microwaves in Transistors.—H. E. Hollmann. (*Naturwissenschaften*, March 1954, Vol. 41, No. 6, p. 136.) An effect in transistors superficially similar to Barkhausen oscillations is briefly reported. The oscillation frequency is proportional to the square root of the collector current and depends on the effective electrode capacitances. In the case of point contact transistors with high α -cut-off frequencies the fundamental resonance frequency is about 100 Mc/s and the microwave harmonics are capable of exciting cavity resonators. For a fuller account, in English, see *Tele-Tech*, April 1954, Vol. 13, No. 4, pp. 75-77.

621.314.7 : 621.397.62 2541

A Symmetrical-Transistor Phase Detector for Horizontal Synchronization.—Harris & Macovski. (See 2525.)

621.314.7.012.8 2542

Transistor Characteristics.—H. Beneking. (*Arch. elekt. Übertragung*, Feb. 1954, Vol. 8, No. 2, pp. 69-74.) The representation of transistors by equivalent quadripoles is discussed and the advantages of one particular representation are illustrated by two numerical examples. The equivalent of various other II and T networks is shown.

621.383.2 : 621.317 2543

The Photodiodode: Investigation of the Total Current and of the Differential Current in an Asymmetrical Arrangement.—L. Deloffre, E. Pierre & J. Roig. (*C. R. Acad. Sci., Paris*, 15th March 1954, Vol. 238, No. 11, pp. 1213-1215.) Modified methods of operating the photodiodode (1249 of April) are described. Either gas-filled or vacuum-type photocells can be used.

621.383.5 : 621.396.822 2544

Shot Dependence of p - n Junction Phototransistor Noise.—A. Slocum & J. N. Shive. (*J. appl. Phys.*, March 1954, Vol. 25, No. 3, p. 406.) Measurements of a.c. short-circuit noise current in a band about 400 c/s wide centred at 1 000 c/s have been made on seven p - n junction phototransistors with low d.c. reverse saturation dark current. Results show that for bias voltages < 20 V, and d.c. bias current $< 300 \mu\text{A}$, noise current is given within a factor of 2 by the theoretical shot noise current, and is independent of temperature. For bias voltages > 20 V, and d.c. bias current $> 300 \mu\text{A}$, the noise current is considerably in excess of shot noise current.

621.385 : 621.397.62 2545

Investigation of Ultra-High-Frequency Television Amplifier Tubes.—Wen Yuan Pan. (See 2526.)

621.385.029.6 2546

Electron-Beam Focusing with Periodic Permanent-Magnet Fields.—J. T. Mendel, C. F. Quate & W. H. Yocom. (*Proc. Inst. Radio Engrs*, May 1954, Vol. 42, No. 5, pp. 800-810.) Microwave-valve beams can be focused by a system of N permanent magnets arranged periodically along the beam, having a total weight theoretically only $1/N^2$ that of a permanent magnet producing a uniform field over the same length, for comparable results. For certain combinations of beam voltage and magnetic field, 'stop bands' are produced in which the beam becomes unstable and no current reaches the collector; design procedure for avoiding this effect is indicated.

621.385.029.63 2547

The Effect of Space Charge on Beam Loading in Klystrons.—T. G. Mihran. (*Proc. Inst. Radio Engrs*, May 1954, Vol. 42, No. 5, p. 862.) Analysis indicates that space charge can be neglected in calculating primary electron beam loading but must be taken into account for secondary electron beam loading.

621.385.029.63 2548

Improvement of Power Output from Pulsed Klystrons.—J. H. Jasberg. (*Proc. Inst. Radio Engrs*, May 1954, Vol. 42, No. 5, p. 849.) Klystrons of the type described by Chodorow et al. (580 of February) have been modified to give considerably higher outputs and improved efficiencies.

621.385.83 : 621.397.62 : 535.623 2549

Beam-Deflection Tube simplifies Color Decoders.—R. Adler & C. Heuer. (*Electronics*, May 1954, Vol. 27, No. 5, pp. 148-151.) See 2244 of July.

DATA for the Designers File

If you are designing Audio Frequency Amplifiers it is highly probable that you will need the Ediswan V. 1505.

The Ediswan V. 1505 is a radiation cooled triode with a directly heated thoriated tungsten filament and anode dissipation of 275 watts. A pair of these valves in push-pull can provide an audio power output of approximately 1,000 watts. It is equivalent to the American Type 212E.

RATING

Filament Voltage	14 volts
Filament Current	6.5 amps
Maximum Anode Voltage	3,000 volts
Maximum Filament Emission	4 amps
Maximum Anode Dissipation	275 watts
Mutual Conductance (gm)	8*
Amplification Factor	16*
Anode Impedance (r_a)	2,000 ohms*
Maximum Operating Frequency at full rating	1.5 Mc/s
Audio Power Output	1,000 watts (2 valves)

* Taken at $V_a = 2,000$ volts; $I_a = 150$ mA.



AVERAGE CHARACTERISTICS

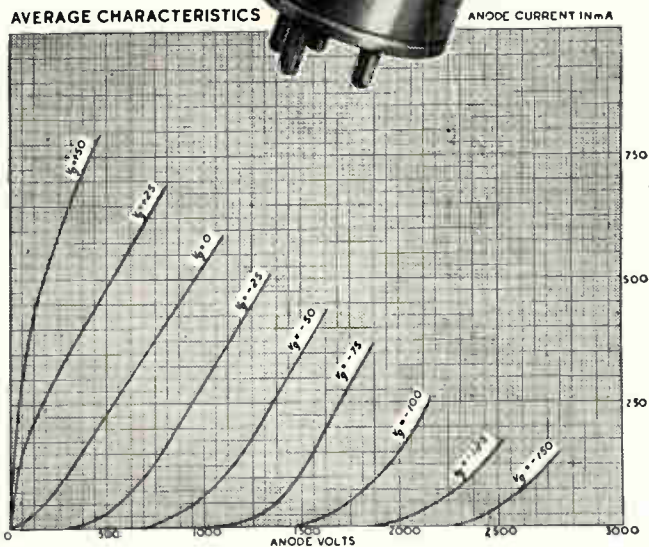

The Savage V.L.F. Amplifier incorporates the V. 1505

This amplifier has been designed to supply power at low frequency for Vibration Research and Testing. The continuous output rating is 1,000 watts at frequencies from 6 c/s to 2,000 c/s

EDISWAN

INDUSTRIAL AND TRANSMITTING VALVES

THE EDISON SWAN ELECTRIC CO. LTD.,
155 CHARING CROSS ROAD, LONDON, W.C.2

Member of the A.E.I. Group of Companies

Technical Control

Close technical control of production is an all-important factor in the manufacture of Telcon Metals. Accurate tests and measurements are made at various stages in the course of production and the illustrations show two of the many routine examinations conducted in our well-equipped laboratories.



Precision measurement of magnetic characteristics of toroidal Mumetal cores by the Ferrometer.

Routine Factory testing of Mumetal toroidal cores.



TELCON METALS

MAGNETIC ALLOYS—Mumetal, Radiometal, H.C.R., Rhometal, Permendur, R2799, 36/64, Dust.
RESISTANCE ALLOYS—Pyromic, Calomic, Telcuman, Telconstan, Telconal.
SPECIAL ALLOYS—Thermostatic Bimetals 140, 400, 15, Telco seal, Invar, Beryllium-Copper.

The Telegraph Construction & Maintenance Co. Ltd

Head Office: 22 Old Broad Street, London, E.C.2
 Telephone: LONDON WAl 7104

Enquiries to: Telcon Works, Greenwich, London, S.E.10
 Telephone: GREENWICH 3291



NEW!

The Manning-Carr Miniature Polarised Relay



Actual Size

DATA—A Sensitivity of 25 milli-watts and capable of handling mains voltage on the contacts with alternating currents up to 0.25 amps. Being polarised it has the advantage that the Armature contact can be biased to lock in either direction by suitable adjustment of the contact screws, which provides a useful facility where pulse operation is required. Speed of operation is also high and the Relay will follow A.C. frequency of 50 c.p.s. Resistance up to 8,000 ohms, which is acceptable for Anode circuits. Alternatives to specification if required. *Sole Concessionaires.*

POST OFFICE TYPES 3,000 AND 600 RELAYS

to specification. Tropicalising, impregnating and Services jungle finish if required. Delivery 3-4 weeks. *Manufacturers to H.M. Govt. Depts., and leading contractors.*

L. E. SIMMONDS LTD.
 5 BYRON ROAD, HARROW, MIDDX.
 Telephone: Harrow 2524—0315.

A valuable new book for
television service engineers

Television Receiver Servicing

By E.A.W. Spreadbury, M.Brit. I.R.E. Vol. I Time Base Circuits

Although written specially for the radio servicing engineer who wishes to embark on TV servicing, this book will be invaluable to everyone interested in TV receiver fault-finding. It is written for the practical man in terms he understands, and is fully illustrated by many clear diagrams. It is strongly recommended to prospective candidates for the R.T.E.B.—City & Guilds TV Servicing Certificate Examinations and will be of help in the Practical Test.

Now ready 21s.net by post 21s. 8d.
 Published for 'Wireless and Electrical Trader'

From booksellers or from:— Publishing Dept.

DORSET HOUSE, STAMFORD ST., LONDON, S.E.1

Thoughts on Power Supply Lead to Solartron

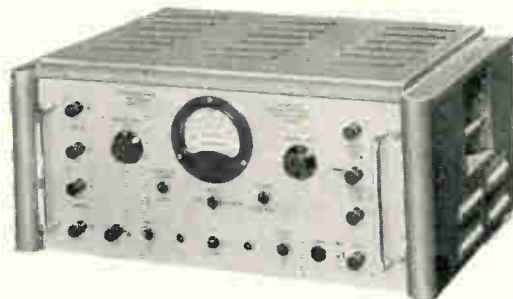

REGULATED POWER SUPPLY SRS 151A

D.C. Output: 20—500 volts + Ve or -Ve, 0—300 m/a.
Stabilisation: 1 part in 400 for $\pm 10\%$ mains change.
Source Impedance: 3 ohms.
Hum Level: 8 millivolts maximum.
A.C. Output: Two 6.3 volt outputs at 5 amps.

TWIN REGULATED POWER SUPPLY SRS 152

D.C. Output Parallel Condition: 0—500 volts
+ Ve or -Ve, 0—300 m/a.
D.C. Output Series Condition: 0—1000 volts
+ Ve or -Ve, 0—150 m/a or
0—500 volts + Ve and 0—500 volts -Ve.
Stabilisation: 0.2% for a $\pm 10\%$ mains input
change.
Ripple: Less than 8 millivolts.
A.C. Output: Two 6.3 volt outputs at 5 amps.

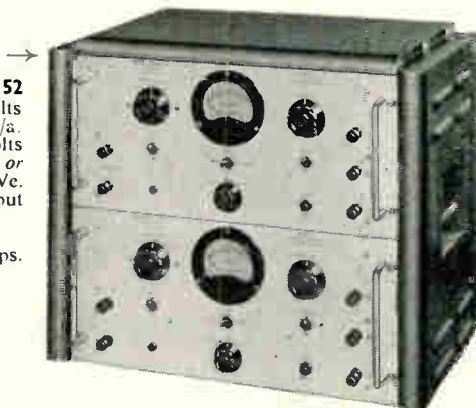

SOLARTRON VARI-PACK SRS 153

D.C. Output Voltage: 0—500 volts positive or negative.
D.C. Output Current: 100 m/a up to 350 volts.
50 m/a up to 450 volts.
A.C. Output: 4 or 6.3 volts at 3 amps.
Ripple: 0.2 volt maximum.



POWER SUPPLY SUB-UNIT SRS 154B

D.C. Output Voltage (Isolated): 250 volts + Ve or -Ve.
D.C. Output Current: 0—50 m/a.
A.C. Output: 6.3 volts 4 amps. C.T. 6.3 volts 1 amp.
D.C. Resistance: 0.5 ohm.
Stability Factor: 400 : 1.
A.C. Impedance: 0.05 ohm.
Ripple and Noise Content: Less than 200 μ volts.

POWER SUPPLY SUB-UNIT

SRS 155B

D.C. Output Voltage (Isolated): 250 volts + Ve or -Ve.
D.C. Output Current: 10—100 m/a.
A.C. Output: 6.3 volts 4 amps C.T. 6.3 volts
2 amps C.T. 6.3 volts 1 amp.
D.C. Resistance: Less than 1 ohm.
Stability Factor: 500 : 1.
A.C. Impedance: 0.05 ohm.
Ripple and Noise Content: Less than 100 μ volts.



SOLARTRON

ELECTRONIC GROUP LTD.

Solartron Works, Queen's Road, Thames Ditton, Surrey.

Tel: Emberbrook 5611.

Cables: Solartron, Thames Ditton



'We'd need a special rubber moulding . . .

For over a century when a problem like that has arisen, men responsible for production planning and buying have thought at once of P. B. Cow. Knowing the vast resources of the P. B. Cow organisation were always at their service.

Today, we are proud to offer an *unparalleled service to every industry*. A large team of experts, experienced in the latest and most up-to-date methods of production, is available to solve *your* problem. Experts who will bring to the job all the knowledge acquired in advising and supplying leading companies the world over.

So whenever you have a problem that concerns rubber, write or phone for one of our technicians to call. He will be fully qualified to help and advise you.

P. B. COW SERVE
Agriculture
Dairy
Motor Car
Radio
Television
Shipbuilding
Public Utilities
General Engineering
Pharmaceutical

WE SPECIALISE IN:

Production of Rubber to Metal bonded parts, Anti-vibration and Resilient Mountings, Oil Seals, Handmade Fabricated Parts, Proofed Fabrics in Natural or Synthetic Rubbers for every purpose, and Air Buoyancy work of all descriptions.

...get in touch with **P. B. COW**

RUBBER THAT IS RUBBER

P. B. Cow & Company Ltd., Rubber Manufacturing Specialists for every Industry. Industrial Division: 470 Streatam High Road, London, S.W.16.
Phone: Pollards 4481.



High Sensitivity

DOUBLE PURPOSE METER

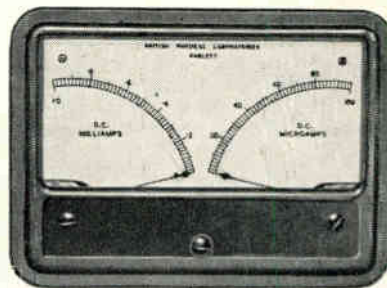

★
PANEL
MOUNTING

Moving Coil Ranges
from 15μA
Moving Iron Ranges
from 5 Milliamps

Movements are independent of each other and any two ranges may be incorporated. Panel space is saved and it enables more convenient observation of inter-dependent electrical quantities. Send for prices and full specification.

BRITISH PHYSICAL LABORATORIES



RADLETT, HERTS.

Tel.: Radlett 5674/5/6

London Stockist:

M. R. Supplies Ltd., 68 New Oxford Street, W.C.1

dm BP.20

A CAREER AS A REGULAR ARMY OFFICER FOR QUALIFIED ENGINEERS

MECHANICAL, ELECTRICAL AND ELECTRONIC ENGINEERS are required as officers in the Corps of Royal Electrical and Mechanical Engineers.

THERE ARE TWO METHODS OF ENTRY. These are either:—

- (1) On a short-service commission (which offers a good opportunity of obtaining a permanent commission) with a gratuity of about £100 for each completed year of service on leaving, or
- (2) On a Permanent Regular Commission with a valuable pension and a terminal grant of £1,000 (tax free).

Candidates must be physically fit and not yet 29 years old, and have passed or be exempt from examinations of either the Institution of Mechanical Engineers or the Institution of Electrical Engineers as required for graduates, or have a University degree in Natural Science or Engineering. In addition 2½ years' experience as an engineer (or 1½ years' in the case of University graduates) is normally required.

The pay which Army officers may expect is according to the following table:—

Rank	Normal Age	If single	If married
Lieutenant	23	£686	£831
Lieutenant	25	£723	£860
Captain	27	£860	£997
Major	34	£1,188	£1,325
Lt.-Colonel	42	£1,453	£1,581
Colonel	45	£1,791	£1,919
Brigadier	49	£2,065	£2,184

(Note:—This is the U.K. scale; there are various additions in certain overseas stations. In this table the figures of a single officer's pay include an element for food and accommodation which are normally provided in kind. This has been done to provide a direct means of comparison with civilian scales of pay.)

For further details please write to:—

The War Office (AG1 Officers' C), London, S.W.1—Quote this Publication.

ACHIEVEMENT

in Fuse-Link Construction



THE L.1055 is available in ratings from 60 mA to 25 A, but at present this new construction applies only to ratings of 500 mA and over. It is hoped to include the lower ratings later, but in the meantime, industry will be supplied with our original design in which we have always minimised the problems that "all-in-one" construction* obviates.

*Caps that come loose are things of the past; they are now locked to the glass by a unique internal soldering technique, which bonds caps, filament and glass into one unit. The glass has to break before the caps will move, and as the caps are coded, the risk of random replacement by wrong ratings is obviated. Standard size $1\frac{1}{4}$ " x $\frac{1}{4}$ " dia.

- **More consistent electrical and Mechanical performance**
- **Caps, filament and glass held as one—no cement to deteriorate**
- **Filament hermetically sealed**
- **Caps permanently fixed**
- **Rating coded on caps**
- **Clean finish caps, no solder blobs**

*Please write for
catalogue P.347/W.E.*

BELLING & LEE LTD
GREAT CAMBRIDGE ROAD, ENFIELD, MIDD., ENGLAND



CARPENTER POLARIZED RELAYS

— have these outstanding features

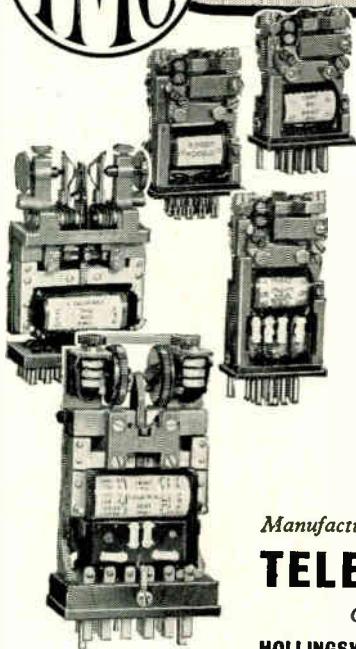

The Carpenter Polarized Relay will respond to weak, ill-defined or short-duration impulses of differing polarity, or it will follow weak alternating current inputs of high frequencies and so provide a continuously operating symmetrical changeover switch between two different sources.

Five basic types are available with a wide range of single and multiple windings.

Particulars of the type best suited to your purpose will be gladly supplied if you will send us your circuit details.

- High operational speed**
- High sensitivity**
- Freedom from contact rebound**
- No positional error**
- High contact pressures**
- Accuracy of signal repetition**
- Exceptional thermal stability**
- Ease of adjustment**

Manufactured by the sole licensees :

TELEPHONE MANUFACTURING CO. LTD

Contractors to Governments of the British Commonwealth and other Nations

HOLLINGSWORTH WORKS · DULWICH · LONDON SE21

Tel: GIPsy Hill 2211

Anderton



Cyril Circlips stock ranges from 1/16" to 10"



Write for DATA SHEETS to Dept. A.3., ANDERTON SPRINGS LTD., BINGLEY.

Telephone: 2226 & 2351. Telegrams: Circlips, Bingley.

CIRCLIPS

THE WORLD'S GREATEST BOOKSHOP

FOYLES

FOR BOOKS.

New and secondhand books on every subject. Large Technical dept. Stock of over three million volumes.

119-125, CHARING CROSS ROAD, LONDON, W.C.2
Gerrard 5660 (16 lines) ★ Open 9—6 (inc. Sat.)

APPOINTMENTS—The engagement of persons answering these advertisements must be made through the local office of the Ministry of Labour and National Service, etc., if the applicant is a man aged 18-64 or a woman 18-59 inclusive, unless he or she or the employer is exempted from the provisions of The Notification of Vacancies Order, 1952.

WEBB'S SERVICE DEPARTMENT

for complete renovation of complex communications receivers of any make

Test report issued showing sensitivity, selectivity, signal/noise equal to, or better than, makers' original figures.

WEBB'S RADIO,
14, SOHO STREET, LONDON, W.1

Ministry of Supply requires Electronic Engineer in London H.Q., to help plan production of radio communications equipment, assess firm's capacity and suitability, and liaison work. Qualifications: British of British parents. Recognised engineering apprenticeship and knowledge modern mass-production methods in electronic engineering. A.M.I.C.E. or M.E. or E.E. or exempting qualifications preferred. Salary—within £650-£1,000 p.a. according to age and qualifications. Not established but opportunities to compete for establishment may arise. Application forms from M.L. & N.S., T. & S.R., K26 King Street, London, S.W.1 quoting D 442/53A.

Wireless Station Superintendents required by the Nigeria Posts and Telegraphs Department for one tour of 18 to 24 months in the first instance. Option of appointment (a) on temporary terms with salary scale (including expatriation pay) £864 rising to £1,392 a year. Gratuity at the rate of £100/£150 a year, or (b) with prospect of pensionable employment with salary scale (including expatriation pay) £750 rising to £1,175 a year. Outfit allowance £60. Free passages for officer and wife. Assistance towards cost of children's passages or grant up to £150 annually for maintenance in U.K. Liberal leave on full salary. Candidates must have had wide practical experience of modern radio techniques and equipment, in particular V.H.F. equipment, and preferably also V.H.F. multi-channel equipment.

Write to the Crown Agents, 4 Millbank, London, S.W.1. State age, name in block letters, full qualifications and experience and quote M2C/30086/WJ.

G.E.C.

QUARTZ CRYSTAL ACTIVITY TEST SET

UNSURPASSED AS A SIMPLE & ACCURATE INSTRUMENT
FOR THE MEASUREMENT OF CRYSTAL PERFORMANCE

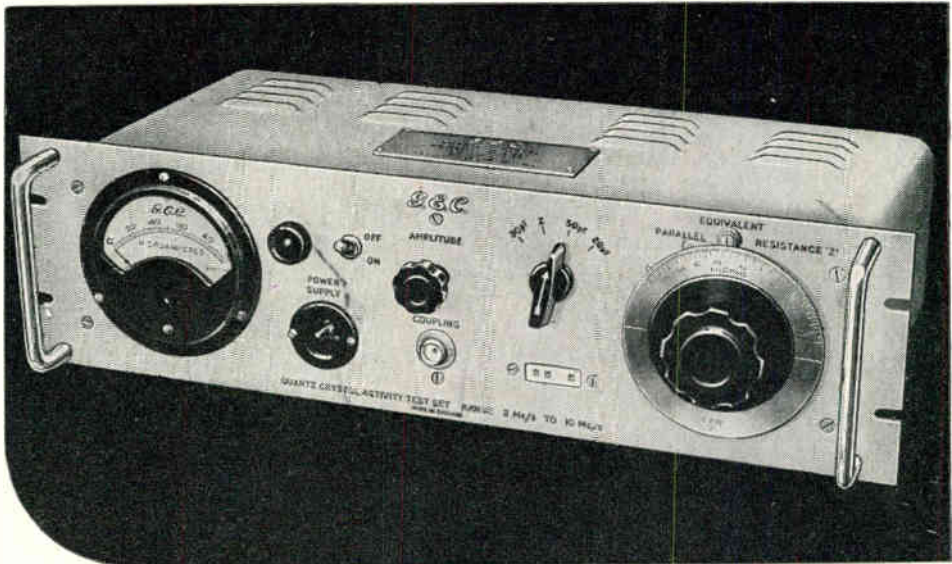

The G.E.C. Quartz Crystal Activity Test Set measures the equivalent parallel resistance of a quartz crystal when oscillating in a circuit having an input capacity of either 20 pF, 30 pF or 50 pF, the alternative capacities being selected by a switch.

The dial is calibrated and has a range of 4 kilohms to 130 kilohms and is direct reading. No calculation is necessary. Measurements can be made at any convenient amplitude of oscillation up to 10V. R.M.S. at the crystal terminals for crystals of normal activity.

The accuracy of the loss dial calibration is $\pm 2\%$.

WRITE FOR DESCRIPTIVE LEAFLET—

SALFORD ELECTRICAL INSTRUMENTS LTD.
PEEL WORKS : SILK STREET : SALFORD : LANCS.
Subsidiary of THE GENERAL ELECTRIC CO. LTD. OF ENGLAND

THE MULLARD RADIO VALVE CO., LTD., has senior and junior staff vacancies in several of its Development Departments situated in or near Mitcham, Surrey. The field in which applicants would be required to work are listed below:—

REF: Receiving Valve Development Department
W.1 (a) The general engineering development of receiving valves.

(b) Glass techniques, including the control of existing and experimental work on new methods.

(c) The investigation of manufacturing processes with a view to attaining closer control and further development.

REF: Gas-Filled Valve Development Department
W.2 (a) The technological development of hot cathode gas-filled rectifiers and thyratrons of all sizes and classes.

(b) The general development of cold cathode gas-filled valves including stabilisers and reference tubes and also multi-electrode types.

(c) Investigational work on gas discharge phenomena in relation to the tube classes mentioned under (a) and (b) above.

REF: U.H.F. and Transmitting Valve Development Department
W.3 (a) The technological development of magnetrons, klystrons, travelling wave tubes and kindred devices. This work includes metal-glass sealing, ceramic and metal brazing techniques.

(b) General development work on the more conventional glass, metal-glass and disc seal valves usually for the V.H.F. range.

(c) Investigational work on the effects of variation of mechanical structure and of changes in materials used for (a) and (b) above.

REF: Cathode Ray Tube Department
W.4 (a) The glass, mechanical and chemical technology of all types of cathode ray and kindred tubes including colour television tubes.

(b) Process development of methods used for the manufacture of new types of cathode ray tubes.

(c) Improvements in gun design including electron optical work.

REF: Semi-conductor Development Department
W.5 (a) The technological development of all types of semi-conducting devices including transistors and rectifiers.

(b) The investigation of semi-conducting materials to establish their possible application to practical devices.

(c) The development of processes and production methods for semi-conducting devices.

Applicants for the senior posts should be physicists, electrical engineers, or, where appropriate, physical chemists and should possess a university degree or equivalent qualifications.

For the more junior posts candidates should possess Advanced Level G.C.E. in science subjects or equivalent qualifications, or should be pursuing courses leading to H.N.C. or external degrees.

For both grades past experience in similar work is desirable but not essential.

The vacancies outlined above are caused by the expansion of the Company's activities in these fields. Salaries will be according to individual age and experience, and qualifications and can be considered as progressive. Company policy regarding the employment of scientific staff provides adequate prospects for advancement, and breadth of outlook is assured by opportunities of transfer to other fields of work within the Company's activities. There are facilities for further study and a Company Pension Scheme.

Applications in writing, which will be treated with the strictest confidence, should be addressed to the Personnel Officer, The MULLARD RADIO VALVE CO., LTD., New Road, Mitcham Junction, Surrey, quoting the appropriate reference number.

A large telecommunication manufacturing organisation have immediate vacancies for one senior and one junior engineer for interesting development work on transistor circuitry. Experience not essential, but would be an added qualification. Further vacancies exist for engineers to work on the development of multi-channel communication systems. Good salaries offered depending on age and experience. Apply in writing, stating age, experience and salary required to Box 6570, c/o *Wireless Engineer*.

THE MULLARD RADIO VALVE CO., LTD., has staff vacancies in its Central Testing and Quality Department. This department deals with the control of the quality of all the vacuum tube and semi-conductor products of the Company, using both direct and statistical methods, and is responsible for the investigation and further development of these methods.

Assistants are required for the following vacancies:—

REF: The design and construction of apparatus and equipment for testing radio valves and other vacuum devices. A knowledge of pulse techniques is involved.
W.6

REF: The testing by Quality Control methods of Cathode Ray Tubes of all types. Liaison work with other departments will be required.
W.7

REF: The supervision of a small section carrying out quality control testing and special measurements of receiving valves. Liaison work with other departments will be required.
W.8

REF: The testing of klystrons and similar U.H.F. devices and the development of testing techniques for this purpose.
W.9

REF: Testing and experimental work on semi-conducting devices of the crystal diode and transistor type.
W.10

Applicants for the above posts, which are permanent, should be Physicists or Electrical Engineers and should possess a university degree or equivalent qualification.

In addition to the above posts there are a number of less senior posts available for work in similar fields, for applicants who possess Advanced Level G.C.E. in science subjects or equivalent qualifications, or who are pursuing courses leading to H.N.C. or external degrees. Such applicants should quote reference W.17.

For both grades previous experience is desirable but not essential.

The vacancies outlined above are at or near the Company's Mitcham factory and are due to the expansion of its activities in these fields. Salaries will be according to individual age, experience and qualifications and can be considered as progressive. Company policy regarding the employment of scientific staff provides adequate prospects for advancement, and breadth of outlook is assured by opportunities of transfer to other fields of work within the Company's activities. There are facilities for further training and a Company Pension Scheme.

Applications in writing, which will be treated in the strictest confidence, should be addressed to the Personnel Officer, The MULLARD RADIO VALVE CO., LTD., New Road, Mitcham Junction, Surrey, quoting the appropriate reference number.

THE MULLARD RADIO VALVE CO., LTD., has staff vacancies in its Valve Measurement and Applications Laboratory. This department is concerned with the uses of thermionic devices of all kinds rather than with their manufacture. It provides information to the valve user, the development departments and to the manufacturing departments. For these purposes it carries out dynamic measurements and conducts circuit investigations connected with new applications. It also undertakes the design of some of the more specialised test equipment required for these investigations.

Due to expansion in this department, applications are invited from Electronic Engineers and Physicists for posts concerned with the following fields of specialised work.

REF: (1) Gas or mercury vapour thyratrons and rectifiers.
W.11

REF: (2) Ultra high frequency valves such as magnetrons, klystrons and travelling wave tubes.
W.12

REF: (3) Transmitting valves for communications and general industrial uses.
W.13

REF: (4) Pulse techniques associated with U.H.F. devices and thyratrons.
W.14

REF: (5) Receiving valves used for frequencies between 100 W.15 and 1,000/Mc/s.

REF: (6) Valves and semi-conductors used in computing and switching apparatus.
W.16

Applicants for any of the above posts should possess a university degree or equivalent qualification, and previous experience in similar work, although not essential, is considered an advantage.

In addition to the above posts, there are a number of less senior posts available for applicants who possess advanced level G.C.E. in science subjects or equivalent qualifications or who are at present pursuing courses leading to H.N.C. or external degrees. Such applicants should quote Ref. W.17.

The vacancies outlined are at or near the Company's Mitcham factory. Salaries will be according to individual age, experience and qualifications and can be considered as progressive. Company policy regarding the employment of scientific staff provides adequate prospects for advancement, and breadth of outlook is assured by opportunities of transfer to other fields of work within the Company's activities. There are facilities for further training and a Company Pension Scheme.

Applications in writing, which will be treated with the strictest confidence, should be addressed to the Personnel Officer, The MULLARD RADIO VALVE CO., LTD., New Road, Mitcham Junction, Surrey, quoting the appropriate reference number.

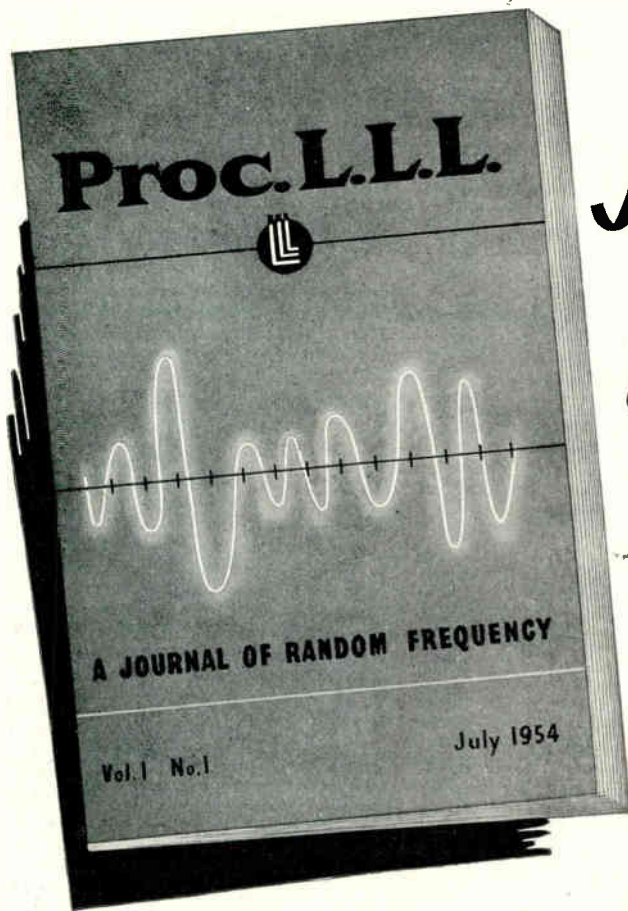

THE HOUSE JOURNAL

*- with a
difference*

DO you KNOW ...

- • • a £75 oscilloscope having a Y amplifier *flat* to 5 M/cs and a rise time of .07 uSec?
- • • an instrument that will make automatically 350 continuity and insulation tests in 40 seconds?
- • • an oscilloscope with an amplifier rise time of 7 millimicroseconds?
- • • the most convenient way of buying an American instrument when you have a genuine need for one?



If you are on our mailing list and have received your copy of PROC. L.L.L. the answer is yes in every case. If, however, selecting the right instrument for any job and getting it quickly is sometimes one of your problems, let us send you a regular copy.

LIVINGSTON LABORATORIES LTD

RETCAR STREET · LONDON · N19 · Tel: ARChway 6251

WIRELESS ENGINEER, AUGUST 1954

27

Opportunities for Engineers with the Guided Missiles Division of 'ENGLISH ELECTRIC'

The Guided Missiles Division of The ENGLISH ELECTRIC Company Limited, Luton, now wishes to fill a wide variety of vacancies. In particular, the following are required:

- Radio and Radar systems Engineers
- Circuit Development Engineers (including work on transistors)
- Engineers to design & engineer micro-wave equipment
- Instrumentation Engineers with transducer design experience
- Engineers for Field Trials Radar and Communications equipment (including some vacancies for Australia)

Houses are available for some of the Senior Engineers. There are also vacancies for Intermediate and Junior Engineers and Laboratory Assistants.

All these offer splendid opportunities for promotion in this new Industry.

Engineers should be Honours Graduates or have technical qualifications to H.N.C. or equivalent standard together with relevant experience.

Applications, quoting SA54, should be sent to Dept. CPS, 336/7 Strand, WC2.

'ENGLISH ELECTRIC'
'ENGLISH ELECTRIC' MARCONI NAPIER

Technical Sales/Service Managers required for British West African branches of large British company distributing domestic radio receivers, V.H.F. radiotelephone equipment, intercommunication telephones, domestic and commercial refrigerators, air conditioners, and office equipment. Good technical radio background essential. Refrigeration experience desirable. Familiarisation course arranged with U.K. manufacturers prior to departure for Africa. First class passage, sea/air, free furnished quarters, full pay on leave after approximately 18 months' tours, pension scheme. Apply in own handwriting stating age (preferably between 21 and 30), whether married or single, full details education, qualifications, national service and business experience. Original references should not be sent. Apply T.S.D., Box 6572, c/o Wireless Engineer.

Assistant Technical Supervisors required by the Nigerian Broadcasting Service for two tours of 15 to 18 months each in the first instance. Salary scale (including expatriation pay) £807 rising to £1,115 a year. Gratuity at the rate of £100/150 a year. Outfit allowance £60. Free passages for officers and wives. Assistance towards cost of children's passages or grant up to £150 a year for their maintenance in U.K. Liberal leave on full salary. Candidates should have some administrative ability and have had wide theoretical and practical experience of low-frequency amplifiers and radio equipment. Write to the Crown Agents, 4 Millbank, London, S.W.1. State age, name in block letters, full qualifications and experience and quote M2C/30482/WJ.

Electronic Engineer for Research Laboratory. Senior position for engineer with experience of research and design of special circuits at medium to low frequencies. Knowledge of Physics an advantage. Qualifications should include a good degree and preferably five years' experience in similar post. Interesting and rewarding work with excellent prospects for advancement. (Ref. 73.)

Senior Engineer for work in modern research laboratory on problems of high-speed switching, gas tube circuits and general pulse methods. Problems call for advanced techniques, good degree or equivalent in Electronic Engineering with not less than three years experience, required. (Ref. 74.)

Senior Servo-Mechanism Engineer for research work on complicated instrument type servo. Work involves analysis of present systems and design of new types. Experience of general electronics, gyro-mechanisms and analogue computers an advantage. This post calls for a man with excellent qualifications and at least three years' experience on similar problems. (Ref. 75.)

Write in detail, quoting Reference No. of position sought to: The Personnel Dept. (Technical Employment), De Havilland Propellers, Ltd., Hatfield, Herts.

Kuwait Oil Co., Ltd., require an Assistant Radio Engineer for service in Kuwait on the operation, maintenance and repair of marine and land radio communication equipment. Candidates must possess B.Sc. in electrical engineering or membership of the Institution of British Radio Engineers or Electrical Engineers, in addition have industrial experience on V.H.F. production development and be able to deal with all types of low- and medium-powered transmitters and receivers. Knowledge of hospital and other electronic equipment an advantage. Age under 35. Salary starting £830 p.a. clear plus generous allowances, pension scheme and kit allowance. Write for application form giving brief details and quoting K.1808 to Box D/69, c/o 191 Gresham House, E.C.2.

You can count on

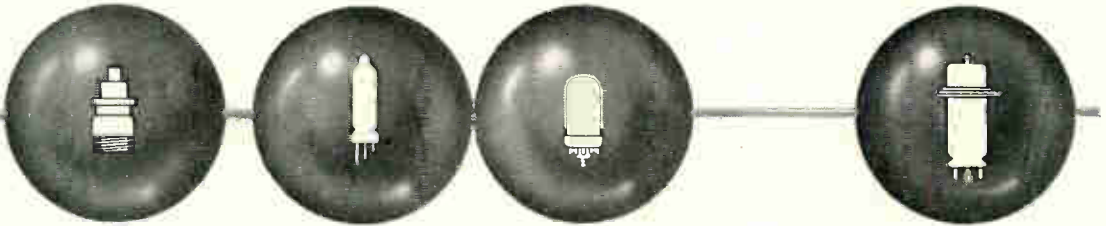

Communication and Industrial Valves

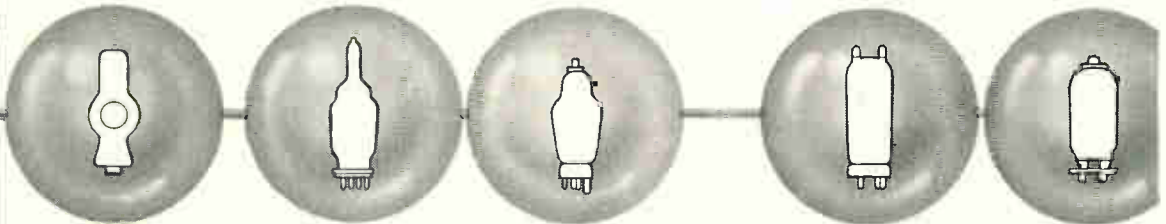

by *Standard*



In Standard's extensive range of high quality, long-life valves there are types for almost every purpose, including :—

Broadcast, Communication and Television Transmission
Airborne and Mobile V.H.F. Equipment
Microwave Links
Telephone and Telegraph Coaxial and Line Transmission
D.C. Power Supply Rectification
R.F. Heating
Counting and Computing
Motor Speed Control
Welding Control
Medical Diathermy
Voltage Stabilisation
X-Ray
Vacuum Measurement
Thermocouples

Standard engineers are always available for consultation; and designers and technicians in most branches of industry, who may wish to avail themselves of Standard's long experience in valve engineering, can be assured enthusiastic co-operation.

Standard Telephones and Cables Limited

Registered Office : Connaught House, 63 Aldwych, London, W.C. 2.

RADIO DIVISION · OAKLEIGH ROAD · NEW SOUTHGATE, LONDON, N.11

B.B.C. requires Engineer for Cinefilm Equipment Unit, in London. Applicants should be qualified engineers, preferably with degree in electrical engineering or physics and should have had considerable practical experience in use of modern high-grade cinematographic equipment, thorough knowledge of the principles of its design and of associated techniques relating to lenses, and of application of films for television purposes. First-class technical knowledge of such equipment and practice, including use of picture and sound-recording cameras, projectors, film stock, film processing, etc., and good knowledge of principles of television are called for. Experience in direction of other engineers desirable. Duties include planning, specification, ordering and testing of such equipment and conduct of correspondence. Starting salary £990 rising by annual increments to £1,320. Apply: E.E.O., B.B.C., London, W.1, quoting ref. 'E.943.W.E.'

Workshop Foreman required for the Nigerian Broadcasting Service for two tours of 15/18 months each in the first instance. Salary, etc., in scale £807 rising to £1,115 a year. Gratuity £100/£150 a year. Outfit allowance £60. Free passages for officers and wives. Assistance towards cost of children's passages or grant up to £150 annually for their maintenance in U.K. Liberal leave on full salary. Candidates should be experienced machinists, and familiar with all types of machine tools and with workshop organisation. Ability to read circuit diagrams advantageous. Write to the Crown Agents, 4 Millbank, London, S.W.1. State age, name in block letters, full qualifications and experience and quote M2C/30481/WJ.

EXPERIENCED RADIO TESTERS AND INSPECTORS

Required for production of communication and radio apparatus. Also instrument makers, wirers and assemblers for factory test apparatus. Apply Personnel Manager, E. K. Cole, Ltd., Ekco Works, Malmesbury, Wilts.

Development Engineers required for Research and Development work on Cold-Cathode Tubes.

Applicants should preferably have had experience in the Valve or Lamp Industry, or on closely related work. A Science degree, Engineering degree, or a similar qualification would be helpful. An attractive salary is offered in accordance with experience, ability and qualifications.

Please write giving details to the Personnel Officer, Eriasson Telephones, Ltd., Beeston, Nottingham. (Reference LK/3).

Kelvin & Hughes, Ltd., Barkingside, Essex, have vacancies for Research Engineers for experimental work relating to underwater sound apparatus. Applicants should be of Degree standard and should have a sound knowledge of communications, in particular electronics. Applications stating salary required should be addressed to the Personnel Manager.

B.B.C. requires Engineer for Cinefilm Equipment Unit in London. Applicants should have University degree in electrical engineering or physics or equivalent qualification and good technical knowledge of modern cinematographic practice, including picture and sound-recording cameras, projectors, film stock, film processing, etc. Duties include planning, specification, ordering and testing of equipment and conduct of correspondence. Starting salary £645 rising by five annual increments to £880. Apply: E.E.O., B.B.C., London, W.1, quoting ref. 'E.940.W.E.'

B.B.C. requires Engineer for Television Unit, Studio Equipment Section, in London. Applicants should have University degree in electrical engineering or physics or equivalent qualification and knowledge of principles of design of high-grade cinematographic equipment, preferably with practical experience in use of film in relation to television, and good knowledge of principles of television. Duties include specification, ordering, testing of equipment used for transmission of and making films (telerecordings) from television pictures, and under supervision planning, estimating and execution of projects involving this type of equipment, and liaison with manufacturers. Starting salary £645 rising by five annual increments to £880. Apply: E.E.O., B.B.C., London, W.1, quoting ref. 'E.941.W.E.'

B.B.C. requires Engineer with University degree or equivalent, in electrical engineering, for Transmitter Section of Planning and Installation Dept., in London. Specialised knowledge of transmitter drive technique as applied to precision crystal and variable frequency checking equipment desirable. Knowledge of V.H.F. and S.H.F. transmitting and receiving equipment and television principles an advantage. Duties include specification, installation and acceptance lists of such equipment. Applicants should be prepared to travel to all parts of U.K. as required. Salary £645 (may be higher if qualifications exceptional) rising by five annual increments to £880 max. Promotion prospects. Requests for application forms quoting ref. E.928.W.E. should reach E.E.O., Broadcasting House, W.1, within five days.

RECORDING EQUIPMENT

Engineer required with experience in the design and development of recording equipment. Should have degree or H.N.C.

Junior Engineers also required for work in this field. Superannuation Scheme.

Apply, giving full details of qualifications, experience, etc., to the Personnel Dept. (RL/10), E.M.I., Ltd., Hayes, Middx.

An opportunity occurs in progressive manufacturing concern in London area for Engineer aged 25/35 with electrical or physicist degree, on development and research work on high frequency telecommunication cable and associated testing equipment. Salary will be commensurate with qualifications and experience. Apply giving full particulars to Box 6571, c/o *Wireless Engineer*.

Kelvin & Hughes, Ltd., Barkingside, Essex, have vacancies for Technical Assistants for development of electro-mechanical and electronic instruments (Marine). Work involves initial experiments, sea-going trials, pre-production models and factory liaison. Occasional visits overseas are arranged.

Qualifications—Practical; five years workshop or drawing office experience. Academic; City and Guilds Telecommunications Final Group Certificate, or equivalent.

Applications stating salary required should be addressed to the Personnel Manager.

B.B.C. requires graduate electrical engineers for their Planning and Installation Department in London. Candidates, who should have completed National Service, must have had at least two years' industrial experience. Knowledge of, and interest in, television equipment or sound transmitter equipment an advantage. Starting salary £645 rising by five annual increments to £880. Promotion prospects. Requests for application form quoting ref. 'EX.8/W.E.' should reach Engineering Establishment Officer, Broadcasting House, London, W.1, within five days.

10 to 300 Mc/s
DIRECTLY
CALIBRATED

The Advance D1 Signal Generator has long been recognised as supreme in its sphere for accuracy, ease of operation and reliability.

Now comes the D1/D—an up-to-the-minute successor—possessing all those proven qualities, but plus the advantage of being DIRECTLY CALIBRATED. Whilst the range of the D1/D (10 to 300 Mc/s) is only slightly less than the original D1, its characteristics, given below, prove the

“D” series to be the finest V.H.F. instruments available in their price class.

- Frequency range 10 to 300 Mc/s
- Directly calibrated with an accuracy of plus/minus 1%
- Sine wave modulation 30% at 1000 c/s
- Square wave modulation approx. 50/50 at 1000 c/s
- Max. attenuation error at 300 Mc/s plus/minus 4 db
- Negligible stray field
- Light weight, only 34 lb.

the
Advance
V.H.F. SIGNAL GENERATOR

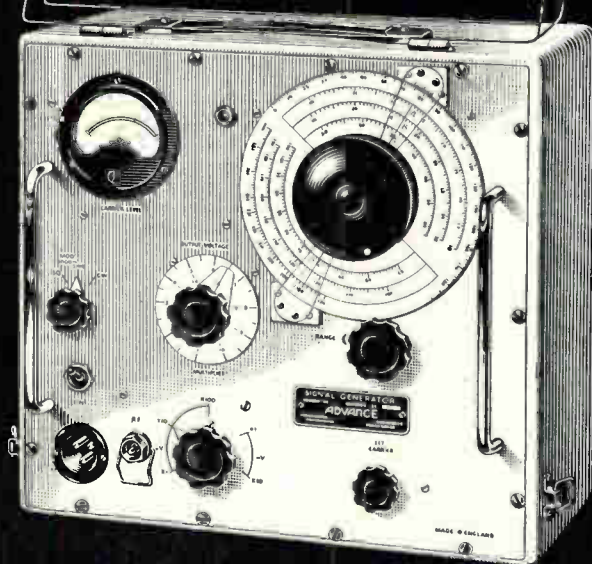

MODEL D1/D

Full technical details
available in Leaflet V26

Nett Price in U.K. **£97**

A valuable new book for
Electrical and Electronics Engineers

LAPLACE TRANSFORMS FOR ELECTRICAL ENGINEERS

By B. J. Starkey, Dipl. Ing., A.M.I.E.E. A presentation of the theory of Laplace transformation in which a physical vocabulary rather than a purely mathematical one is used as far as possible. This method of analysis has

become of increasing importance to electrical engineers in many fields, and the work is designed to provide a thorough treatment of the subject in a language with which they will be familiar. Published for "Wireless Engineer."

Ready now 30s. net BY POST 30s. 8d.

From booksellers or direct from Iliffe & Sons Ltd., Dorset House, Stamford St., London, S.E.1

PRE-SET CONTROL LOCK

Designed to lock the spindles of pre-set potentiometers or trimmers without rotational or lateral displacement of shaft. Will accept wide range of panel thicknesses.



Type P.

Very attractive appearance for panel mounting.



Type C.

Send now for leaflet L5



SUTTON COLDFIELD ELECTRICAL ENGINEERS
CLIFTON STREET, SUTTON COLDFIELD, BIRMINGHAM
Phone: SUT 5666

TECHNICAL BOOKS

A large selection of books on Radio and Electronics and all branches of Electrical Engineering always in stock. Catalogues available. Please state interests.

SCIENTIFIC AND TECHNICAL LENDING LIBRARY

Annual Subscription from TWENTY-FIVE SHILLINGS.

H. K. LEWIS & Co. Ltd.
136 Gower Street, London, W.C.1.

Telephone: EUSton 4282 (7 lines).

Business hours:—9 a.m. to 5.30 p.m.

Saturdays to 1 p.m.

Index to Advertisers

	PAGE		PAGE		PAGE
Advance Components, Ltd.	31	Foyle, W. & G., Ltd.	24	Solartron Laboratory Instruments, Ltd.	21
Anderton Springs, Ltd.	24	Iliffe Books	12, 20, 32	Standard Telephones & Cables, Ltd.	2, 29
Appointments Vacant	24, 26, 28, 30	Lewis, H. K., & Co., Ltd.	32	Steatite & Porcelain Products, Ltd.	4
Automatic Coil Winder & Electrical Equipment Co., Ltd., The	Cover ii	Livingston Laboratories, Ltd.	27	Sutton Coldfield Electrical Engineers	32
B.B. Chemical Co., Ltd.	8	Lyons, Claude, Ltd.	1		
Belling & Lee, Ltd.	23	Marconi Instruments, Ltd.	3	Tektronix, Inc.	5
British Insulated Callender's Cables, Ltd.	10	McMurdo Instrument Co., Ltd.	6	Telegraph Condenser Co., Ltd., The	Cover iii
British Physical Laboratories	22	Muirhead & Co., Ltd.	6	Telegraph Construction & Maintenance Co., Ltd., The	20
Brookes Crystals, Ltd.	12	Mullard, Ltd.	10, 18	Telephone Mfg. Co., Ltd.	24
Bruel & Kjaer	12	Multicore Solders, Ltd.	Cover iv	Thomas, Richard, & Baldwins, Ltd.	24
Cinema-Television, Ltd.	11	Oxley Developments Co., Ltd.	14	Times Publishing Co., Ltd. The	7
Cow, P. B., & Co., Ltd.	22	Rola Celestion, Ltd.	8	Truvox, Ltd.	14
Devon Paints Ltd.	14	Salford Electrical Instruments, Ltd.	25	Unbrako Socket Screw Co., Ltd.	15
Edison Swan Electric Co., Ltd.	13, 19	Simmonds, L. E., Ltd.	20	War Office (R.E.M.E.)	22
English Electric	28			Webb's Radio	24

Printed in Great Britain for the Publishers, Iliffe & Sons, Ltd., Dorset House, Stamford Street London, S.E.1.
at The Baynard Press by Sanders Phillips & Co., Ltd., Chrystell Road, London, S.W.9

FOCUS ON
LEADERSHIP

Hi-K CERAMIC DISC CONDENSERS

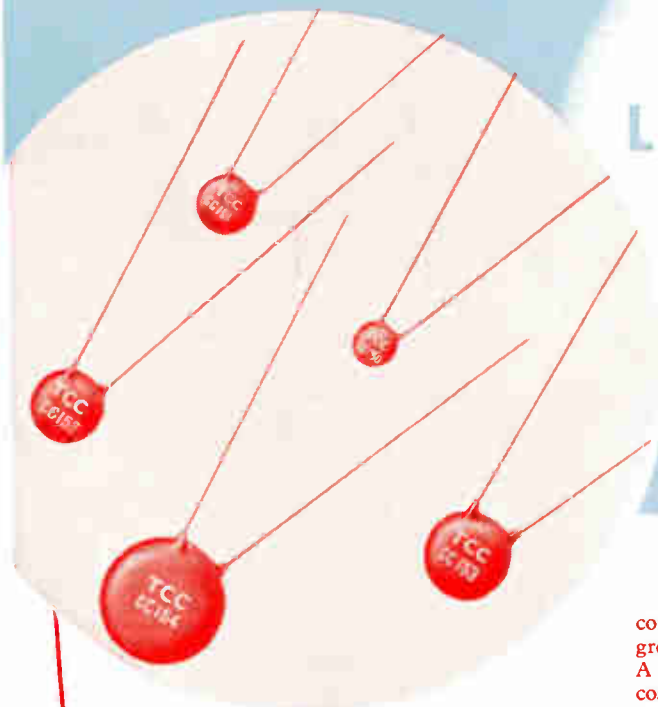

THESE Hi-K Discs are the latest addition to our comprehensive ranges of Ceramic Condensers, and are intended for de-coupling purposes in television receivers and spark suppression in small electrical apparatus. In both applications their effectiveness is greatly enhanced by their extremely low inductances.

EFFECT OF TEMPERATURE

In common with other Hi-K ceramic condensers, variations in capacity due to temperature changes may be quite substantial, a fact that should be borne in mind when selecting this type of condenser, and when specifying the capacity required for a particular application. Where such fluctuations of capacity are of no great importance, these Discs may be used as an alternative to condensers using other dielectrics.

CONSTRUCTION

The Dielectric is a specially selected material of the barium-titanate group with a dielectric

constant of 3,000, and an insulation resistance greater than 5,000 megohms.

A special non-cracking, heat resistant, protective coating (Finish 'G') is the standard finish. This thermo-setting compound adequately prevents the ingress of moisture, and does not soften or crack at temperatures up to 100°C.; it also provides electrical insulation, thus enabling the condenser to be mounted in contact with the chassis or other components.

Maximum Working Voltage

500v. D.C. or 250v. A.C.

Tolerance of Capacity —20% +80%

Capacity in pF	Dimensions in millimetres		T.C.C. Type Number
	Diameter	Thickness	
1,000	7.5	0.6	CC.150
1,500	7.5	0.6	CC.150
2,000	10.0	0.6	CC.151
3,000	12.5	0.6	CC.152
5,000	15.0	0.6	CC.153
10,000	22.0	0.8	CC.154

Approximately 2mm. should be added to these dimensions to allow for the protective coating.

Terminations are tinned copper wires 50mm. long.

THE TELEGRAPH CONDENSER CO. LTD

RADIO DIVISION

NORTH ACTON · LONDON · W.3 Tel: ACO n 0061



SPECIALISTS IN CONDENSERS SINCE 1906

NATIONAL RADIO
EXHIBITION
1954

Ersin Multicore FEATURES

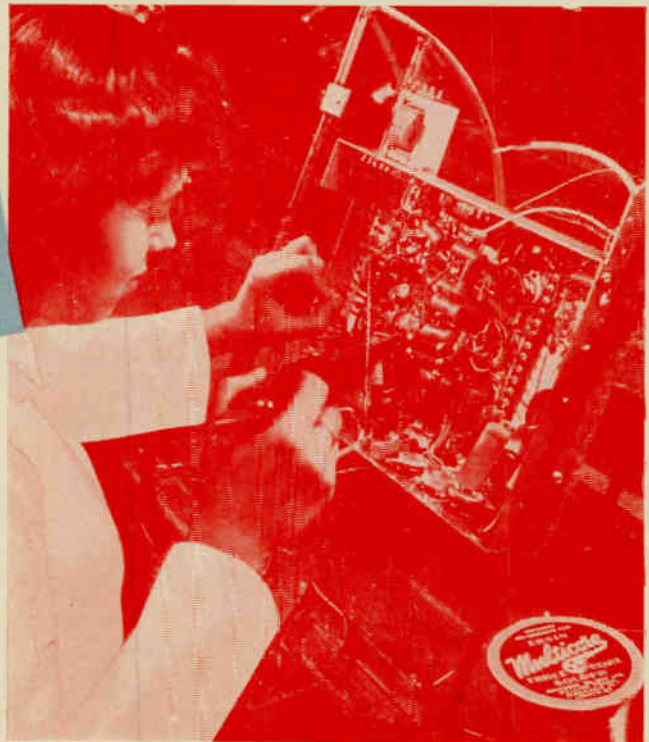

Ferguson T/V Assembly

At this year's National Radio show at Earls Court, operatives from Thorn Electrical Industries Ltd. will assemble Ferguson T/V Units on the Multicore Stand, No. 100 in the Main Hall.



Reliability of soldering processes is achieved by the use of Ersin Multicore Solder, which for nearly 15 years has been preferred by manufacturers in Europe and U.S.A.



For extra high speed soldering processes, Ersin Multicore Solder is supplied in all alloys and gauges with 5 cores AID approved Type 362 Ersin Flux.

TECHNICAL INFORMATION
Our Technical Staff will be available on our Stand, for consultation in connection with any problems on solders or soldering.



BUSH RADIO LTD.

E.M.I.—H.M.V.

G.E.C. LTD.

E. K. COLE LTD.

INSIST ON

Ersin Multicore

THE WORLD'S FINEST CORED SOLDER



PYE LTD.

PHILIPS ELECTRICAL LTD.

MULTICORE SLDERS LTD., MULTICORE WORKS, HEMEL HEMPSTEAD, HERTS. BOXMOOR 3636 (4 lines)