

WIRELESS ENGINEER

THE JOURNAL OF RADIO RESEARCH & PROGRESS

SEPTEMBER 1954

VOL. 31

No. 9

THREE SHILLINGS AND SIXPENCE

Bullers CERAMICS

FOR INDUSTRY

High quality material and dimensional precision are attributes of Bullers die-pressed products. Prompt delivery at competitive prices.



We specialise in the manufacture of

PORCELAIN

for general insulation

REFRATORIES

for high-temperature insulation

FREQUELEX

for high-frequency insulation

PERMALEX & TEMPLEX

for capacitors

BULLERS LIMITED

Porcelain Works:
MILTON,
STOKE-ON-TRENT
Stoke-on-Trent 22341

Sales Office:
6, LAURENCE POUNTNEY HILL,
LONDON, E.C.4
MANsion House 9971

Iron Works:
TIPTON,
STAFFORDSHIRE
Tipton 1691

BL11D

"VARIAC"

(Reg'd Trade Mark)

INFINITELY VARIABLE

auto transformers

The "VARIAC" is the original, continuously adjustable auto-transformer... the ideal control for varying the a-c voltage applied to any electrical, electronic, radar or communications equipment. Voltages from Zero to 17% above line are obtained by a 320-degree rotation of the shaft, which is equipped with a direct-reading dial, calibrated accurately.

"VARIAC" offers many real advantages over any other type of a-c control: compared with the losses of resistive controls they save their initial cost within about one year. They are available in various sizes from 170 VA up to 25 Kilowatts. 3-gang assemblies are also available for 3-phase working. Prices vary from £7.10.0 upwards.

Write for our Catalogue—Technical Manual V.549, which gives all possible information.



Request also our 20-page Supplementary Catalogue giving complete information on our new and complete range of A.C. Automatic Voltage Stabilisers: These range from 200 VA to 25 kVA. Performance is excellent, from No-Load to Full Load, and stability is quite unaffected by frequency variations. Prices are exceptionally low.

CLAUDE LYONS LTD.

ELECTRICAL AND RADIO LABORATORY APPARATUS ETC.

180, Tottenham Court Road, London, W.1. and 76, Oldhall Street, Liverpool 3, Lancs.

New Southern Factory, 4-10 Ware Road, Hoddesdon, Herts. (A.10 main London/Cambridge Rd. at junction of A. 602.)

Claude Lyons Ltd. are exclusive distributors of GENERAL RADIO equipment in this country. If you require information about their extensive range of instruments please tick appropriate square(s).

SOUND MEASURING AND ANALYSING EQUIPMENT
STANDARDS OF RESISTANCE, CAPACITANCE AND INDUCTANCE

BRIDGES OF ALL TYPES

OSCILLATORS AND AMPLIFIERS

STANDARD-SIGNAL GENERATORS

WAVEFORM-MEASURING APPARATUS

FREQUENCY-MEASURING EQUIPMENT

RADIO AND T.V. STATION MONITORS

LABORATORY METERS OF ALL TYPES

Name

Address

Employer

Position

unbrako STANDARDS



SEE OUR
STAND No. 5727
HALL 5 AT MILAN
September 14th—23rd, 1954



Made to the exacting quality specification of the world's largest specialist screw manufacturers, they are always obtainable from Unbrako Distributors throughout the world.

What are Unbrako standards?

Didn't you know? Well, they're the five types of socket head screws which you see illustrated. Precision formed, close tolerance screws which meet the everyday needs of engineering.

Available in B.S.F., Whitworth, B.A., Metric, A.N.C., A.N.F., and Unified threads in sizes from 8B.A. cap screws and 6B.A. set screws.

UNBRAKO SOCKET SCREW CO. LTD.
COVENTRY ENGLAND



-but COLOUR MATCHING to-day
depends upon
CONSTANT VOLTAGE....

In 1954 electronics provides the answer. In colour matching to-day, the precision instruments used must have a reliable and constant voltage supply, and this is one of the many applications Advance Constant Voltage Transformers fulfil so effectively.

*Full details given in folder
V/15 gladly sent on
request.*

Advance
CONSTANT VOLTAGE
TRANSFORMERS



ADVANCE COMPONENTS LTD.
MARLOWE ROAD, WALTHAMSTOW, LONDON, E.17
Telephone: LARKSwood 4366



An inexpensive yet precision instrument designed specially to meet the exacting needs of the modern service engineer and laboratory technician. With six frequency ranges covering 50 Kc/s. to 80 Mc/s., its accuracy is better than $\pm 1\%$ of the scale reading.

50 Kc/s.-150 Kc/s.	1.5 Mc/s.-5.5 Mc/s.
150 Kc/s.-500 Kc/s.	5.5 Mc/s.-20 Mc/s.
500 Kc/s.-1.5 Mc/s.	20 Mc/s.-80 Mc/s.

Scale sub-divisions provide more than adequate discrimination for use in television circuits. Note the starred features below, which combine to maintain a minimum signal of less than $1\mu\text{V}$ up to 20 Mc/s. and less than $3\mu\text{V}$ between 20 Mc/s. and 80 Mc/s.

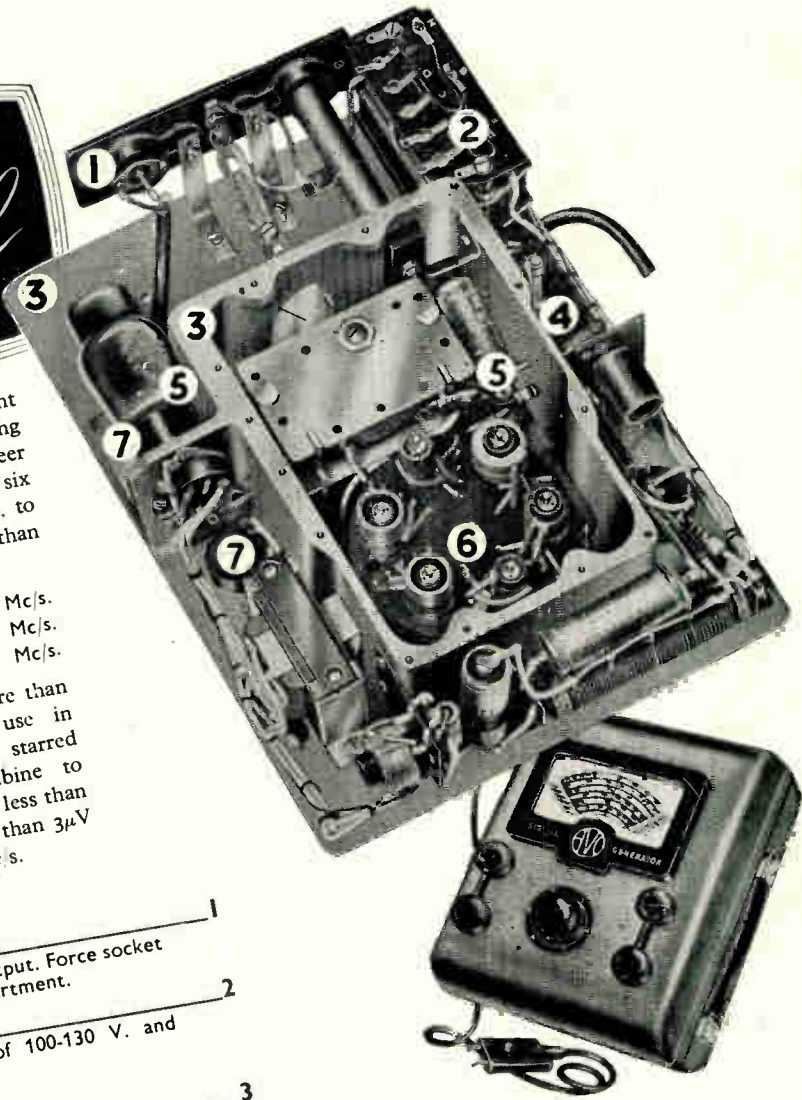

- ★ **OUTPUT** _____ 1
Co-axial socket for attenuated output. Force socket located totally within H.F. compartment.
- MAINS TRANSFORMER** _____ 2
Marked tagboard for inputs of 100-130 V. and 200-260 V., A.C. 50/60 c/s.
- ★ **CAST ALUMINIUM H.F. COMPARTMENT and CHASSIS** _____ 3
Large number of fixing holes for H.F. compartment cover ensures excellent electrical bonding and good screening.
- FUSE** _____ 4
Easily accessible when replacement is necessary.
- VALVES** _____ 5
Standard types run at a rating to ensure long life.
- TURRET COIL SWITCHING** _____ 6
Standard "AVO" practice.
- ★ **ATTENUATOR SYSTEM** _____ 7
Employs close tolerance, high stability midget carbon resistors, low reactance rotary potentiometer modified for H.F. operation with carefully designed screening.

- Other features include:
- ILLUMINATED SPOT RANGE SELECTOR**
Gives rapid identification of operational band with intensified lighting round precise frequency. Fine hair line gives close discrimination, particularly on high frequencies.
 - STOPS**
Separate stops prevent turning of dial with respect to condenser.
 - ★ **MAINS FILTER SYSTEM**
This is screened from main electrical assembly.
 - BUSHING PLATES**
Provide additional rigidity for rotary controls.
 - SLOW MOTION DRIVE**
Substantially free from backlash.

MAINS MODEL 100-130 V. and 200-260 V., A.C., 50-60 c/s.
OR BATTERY MODEL.....£30.

Sole Proprietors and Manufacturers:—

The AUTOMATIC COIL WINDER & ELECTRICAL EQUIPMENT CO. LTD.
WINDER HOUSE • DOUGLAS STREET • LONDON • S.W.1 Telephone: VICTORIA 3404/9



S.G.2.

You can bend it...

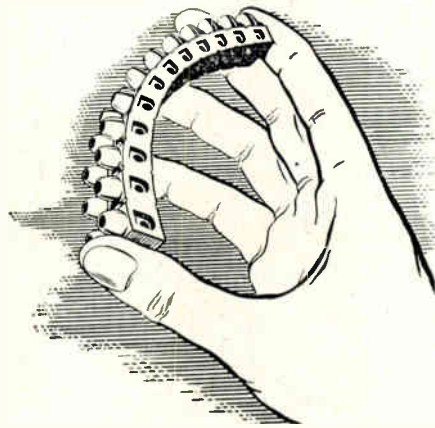

You can cut it...

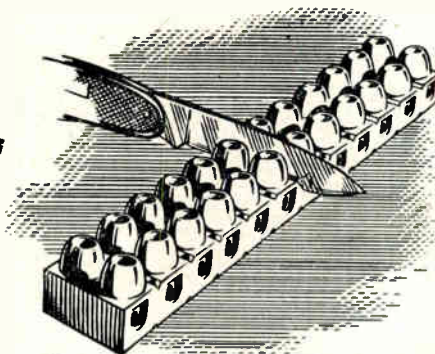

-but just try
and break **THIS**
terminal block!

THIS component revels in "rough going"; no surfaces are too uneven. Corners and curves that would preclude the use of a rigid type, are just the conditions that show up the novel and useful features of this flexible terminal block. In addition, many of the difficulties experienced when using the rigid type of block are overcome, e.g., broken mouldings due to tightening of screws, lost terminal screws, and the difficulty of modifying to the required number of ways.

In the "Belling-Lee" design the terminal screws are captive, the heads being firmly gripped by the resilient P.V.C. moulding and cannot be shaken or fall out, even when the block is mounted upside down, or carelessly mishandled.

The component can be cut with an ordinary pocket knife into smaller groups of terminals as required, and for the purpose of fixing, holes are provided between each pair of terminals.

- ★ Captive Terminal Screws
- ★ Flexible
- ★ Easily Sectionalised
- ★ Mechanically Shock-proof
- ★ Rating 5 amp. Up to 10 amp may be used at designer's discretion
- ★ 12 Way
- ★ Overall size 5" x .750" x .625" high. Holed centres spaced .425"

Please write for Leaflet P.378/W.E.

BELLING & LEE LTD
GREAT CAMBRIDGE ROAD, ENFIELD, MIDDX., ENGLAND

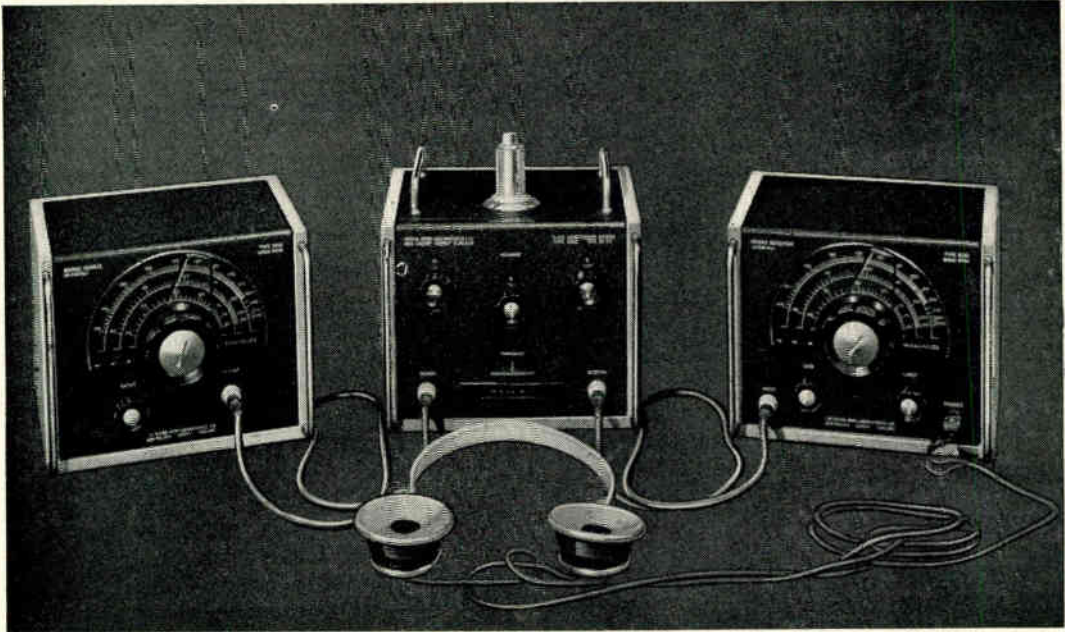

Bridge set-up for 50—250 Mc/s.

A.F., H.F., V.H.F. BRIDGES
 WAVE ANALYSER
 SIGNAL SOURCES
 COMPONENT TEST GEAR
 MICRO-WAVE EQUIPMENT
 AND COMPONENTS
 SPECIAL PURPOSE TEST GEAR

Modern technology produces constant demands for improved measurement facilities with increasing accuracy. In tackling this problem Wayne Kerr designers have the advantage of close association with Government research establishments, and this is reflected in the quality and versatility of WayneKerr Laboratory instruments.



THE WAYNE KERR LABORATORIES LIMITED · NEW MALDEN · SURREY · MALDEN 2202

An outstanding general purpose communication receiver



Justly acclaimed as Britain's finest post-war communication receiver the BRT 400 D is in widespread use by Military, Post and Telegraph and Broadcasting authorities throughout the world.

Combining first-class performance with a wide range of facilities, the BRT 400 D is equally suitable for both narrow-band telegraphy and wide-band telephony reception—with a very high standard of reliability.

It is available in either cabinet or rack mounting form, with a 500 kc/s crystal calibration unit as an optional extra. Normal operation is from an A.C. mains supply: an auxiliary power unit is available for 12 volt battery operation.

G.E.C.

BRT 400D

SHORT SPECIFICATION

BAND COVERAGE

0.150—0.385 Mc/s }
0.510—30.0 Mc/s } in 6 bands

SENSITIVITY

Better than 1.0 μ V for 1.5 watts output, over the whole band.

SIGNAL/NOISE RATIO

Standard input for 20 db:—

1.3—30.0 Mc/s	< 7.0 μ V
0.150—1.3 Mc/s	< 10.0 μ V

SELECTIVITY

Six switched bandwidths:—

0.5 kc/s	1.0 kc/s	2.0 kc/s
5.5 kc/s	9.0 kc/s	13.0 kc/s

OVERALL FIDELITY

Less than 2 db down at 50 c/s
Less than 6 db down at 5,500 c/s

A.G.C. CHARACTERISTICS

Output constant within 3 db for 100 db change in signal input.

OUTPUT CIRCUITS

At 2.5 or 15 ohms	2.5 watts
At 120 ohms	0.05 watts
At 600 ohms	0.2 watts

POWER SUPPLY

95—130 and 195—250 volts, 40/80 c/s. Also from 12 volt battery, using BRT 401 auxiliary power unit.

For the full specification please send for a copy of publication BC2084.

THE GENERAL ELECTRIC CO. LTD., MAGNET HOUSE, KINGSWAY, LONDON, W.C.2

WIRELESS ENGINEER, SEPTEMBER 1954

7



ACCURATELY MEASURED

L - AT 1 OR 10 kc/s
C - AT 1 OR 10 kc/s
R - AT D.C.

INDUCTANCE, CAPACITANCE, RESISTANCE and power factor measured quickly and accurately on this self-contained and robust instrument. Its industrial-designed appearance fits well in modern surroundings and partners its outstanding electrical performance.

UNIVERSAL BRIDGE TYPE TF 868/I

Inductance from $1\mu\text{H}$ to 100H , Capacitance from $1\mu\mu\text{F}$ to $100\mu\text{F}$, and Resistance from 0.1Ω to $10\text{M}\Omega$.

Single direct reading L.C.R. dial — no multiplying factors involved.

Continuously variable a.c. bridge voltage and automatic detector sensitivity control.

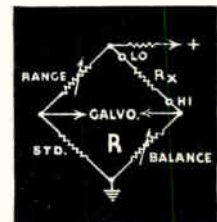
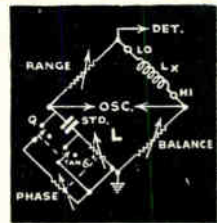

MARCONI INSTRUMENTS

SIGNAL GENERATORS · VALVE VOLTMETERS · Q METERS · FREQUENCY STANDARDS
BRIDGES · WAVEMETERS · WAVE ANALYSERS · BEAT FREQUENCY OSCILLATORS

MARCONI INSTRUMENTS LIMITED · ST. ALBANS · HERTS · Telephone: St. Albans 6161/7

Midland Office: 19 The Parade, Leamington Spa

Northern Office: 30 Albion Street, Kingston-upon-Hull

Export Office: Marconi House, Strand, W.C.2.

Why do they choose



'BICALEX' WINDING WIRES?

MANY OF THE LEADING MANUFACTURERS
OF ELECTRIC MOTORS USE 'BICALEX' WIRES



'Bicalex' Winding Wires give you all the well-recognized advantages of standard enamel winding wires, plus special advantages of their own. Some of these are listed on the right.

If you have any of the following jobs on hand you will find these wires of particular interest.

- ★ High-speed winding and applications where the fitting of preformed coils involves the possibility of mechanical damage.
- ★ Windings where space is limited or coil size must be a minimum.
- ★ Windings which are to be impregnated with quick-drying synthetic varnishes of high bonding strength.
- ★ Dry unimpregnated windings which may be subject to high humidity.

The dielectric strength of 'Bicalex' Winding Wires fully satisfies the requirements of B.S.1844. For fuller information write for Publication No. 322.

Brook Motors Ltd., Huddersfield, use large quantities of 'Bicalex' Winding Wires. The illustration shows a stator being wound with 'Bicalex' coils at their factory.

BECAUSE

THEY'RE TOUGH—to withstand rough handling

High-speed winding and its attendant rigours do not harm them. They can be stretched, twisted and even flattened without the insulation being damaged.

THEY'RE EXTREMELY FLEXIBLE

A wire may be wound round itself without the covering cracking. Operators like them for hand wiring jobs.

THEY RESIST NEARLY ALL VARNISH SOLVENTS

The use of 'Bicalex' Wires considerably extends the range of impregnating varnishes that may be used.

THEY WITHSTAND 110°C WITHOUT "AGEING"

Though 'Bicalex' coverings come under the category of Class "A" (organic) insulation, prolonged exposure to this temperature produces no "ageing" effect.

THEIR COVERING WILL NOT "TUBE"

The covering of 'Bicalex' Wires adheres completely to the conductor, thus guarding against damage by "plucking", or "tubing" on elongation.

THEY RESIST CONTAMINATED AND HUMID ATMOSPHERES

Acid or alkaline atmospheres do not damage the insulation. Its breakdown strength is not lowered by exposure to high humidity.



WINDING WIRES



BRITISH INSULATED CALLENDER'S CABLES LIMITED
21 BLOOMSBURY STREET · LONDON · W.C.1

Potted with 'Araldite'

For potting and sealing electrical components, 'Araldite' is without equal. In addition to its remarkable electrical and mechanical qualities, 'Araldite' offers outstanding adhesion to metals, whilst shrinkage on setting is exceptionally low. 'Araldite' is resistant to high temperatures, humidity and corrosive agents and satisfies the Services specification for the sealing and potting of electrical equipment. This new epoxy resin is being extensively used for potting and sealing components for radio, electronics and electrical engineering. Our illustration shows an inductance and mica dielectric capacitor network for shaping a transmitted radar pulse. Potting in 'Araldite'

Photo by courtesy of Telegraph Condenser Company Ltd.



ensures hermetic sealing and permits a reduction in size and weight.

These are the new Epoxies!

'Araldite' (regd.) epoxy resins are obtainable in the following forms:—

- Hot and cold setting adhesives for metals and most other materials in common use.
- Casting Resins for the electrical, mechanical and chemical engineering industries.
- Surface Coating Resins for the paint industry and for the protection of metal surfaces.

Full details will be sent gladly on request.

'Araldite'

epoxy casting resins

Aero Research Limited

A Ciba Company, DUXFORD, CAMBRIDGE. Telephone: Sawston 187

The new approach to Microwave Testing

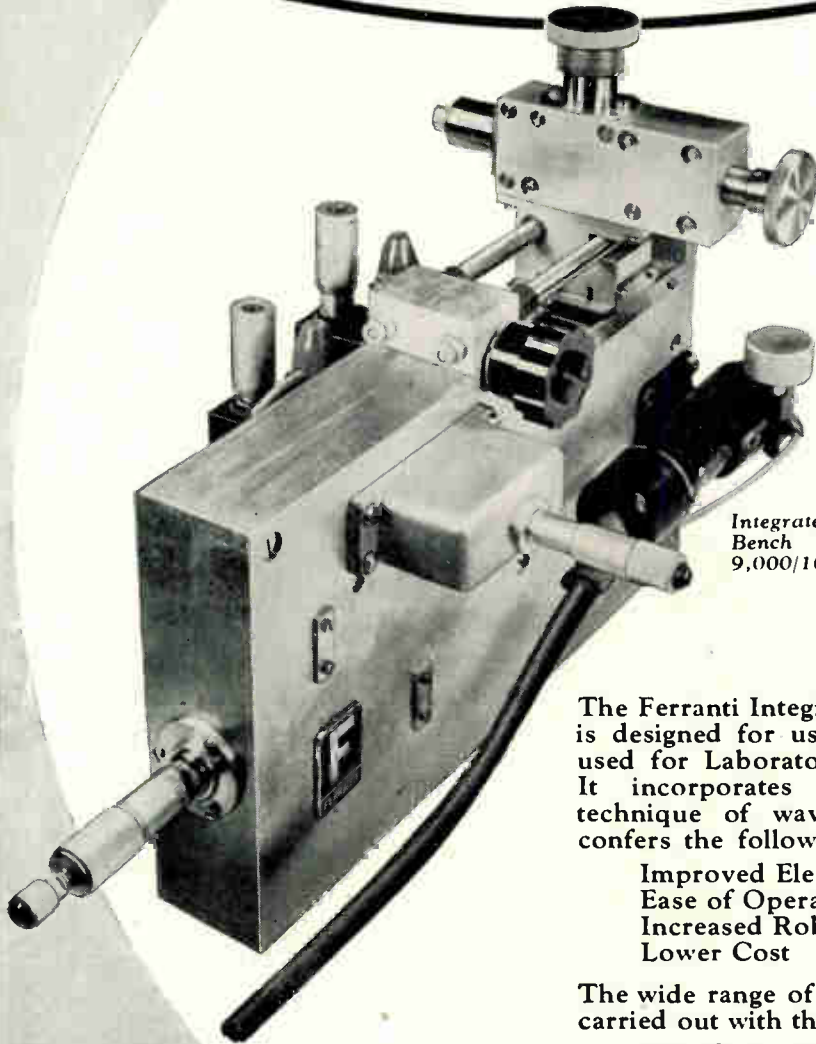

*Integrated Microwave Test
Bench Frequency Range
9,000/10,000 Mc/s.*

The Ferranti Integrated Microwave Test Bench is designed for use in the 3 cm. band and is used for Laboratory and Production Testing. It incorporates the 'MILLED BLOCK' technique of waveguide manufacture which confers the following outstanding advantages:

- Improved Electrical Characteristics
- Ease of Operation
- Increased Robustness
- Lower Cost

The wide range of standard tests which can be carried out with the equipment includes

- Impedance Measurement
- Voltage Standing Wave Ratio Measurement
- Attenuation Measurement
- Insertion Loss Measurement



FERRANTI LTD · CREWE TOLL · FERRY ROAD · EDINBURGH 5

London Office: KERN HOUSE, 36 KINGSWAY, W.C.2

INDUCTANCE MEASUREMENT

One of the most outstanding technical developments of
H. W. Sullivan Limited
is the Sullivan-Griffiths Precision Inductance Bridge.

Its range $1 \mu\text{H}$ to 100H ; its direct reading accuracy 0.1% or $0.1 \mu\text{H}$ (quite unaffected by temperature and having good frequency characteristics) and facilities provided for the direct reading measurement of resistance 0.01 ohm to 10 Megohms , capacitance $100 \mu\mu\text{F}$ to $1 \mu\text{F}$ and the inductance and losses of iron-cored inductances with superposed direct current up to 2 amperes . . . make this bridge invaluable to any factory or laboratory concerned with inductance measurements.

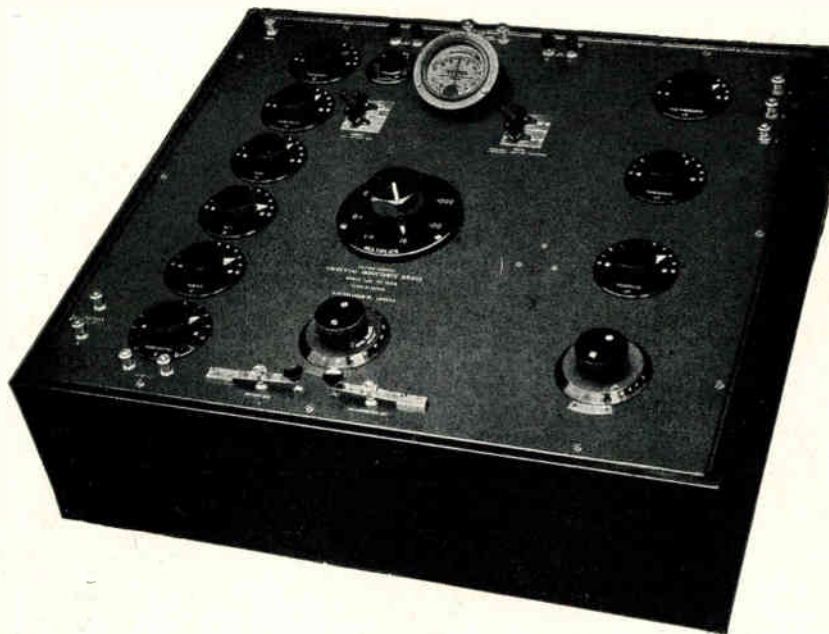

An advertisement of H. W. Sullivan Limited, London, S.E.15. Telephone: New Cross 3225 (Private Branch Exchange).

WIRELESS ENGINEER

The Journal of Radio Research and Progress

ESTABLISHED 1923

Managing Editor: HUGH S. POCOCK, M.I.E.E.

Editor: W. T. COCKING, M.I.E.E. Technical Editor: Professor G. W. O. HOWE, D.Sc., LL.D., M.I.E.E.

Editorial Advisory Board:

P. A. T. BEVAN, B.Sc., M.I.E.E. (British Broadcasting Corporation); Professor E. B. MOULLIN, Sc.D., M.I.E.E.; A. H. MUMFORD, O.B.E., B.Sc.(Eng.), M.I.E.E. (G.P.O. Engineering Department); R. L. SMITH-ROSE, C.B.E., D.Sc., Ph.D., M.I.E.E. (Department of Scientific and Industrial Research)

Volume 31 Number 9

C O N T E N T S

SEPTEMBER 1954

Editorial: Rotating Observers	223
Multiplex Television Transmission by J. Haantjes and K. Teer	225
Direct-Coupled Transitron by F. A. Milne and E. J. Miller, B.Sc.(Eng.)	234
Impedance Transformation by Four-Terminal Networks (conclusion) by S. Fedida, B.Sc.(Hons.)	239
Field-Strength Calculation by Kiyohisa Suda	249
New Books	251
Standard-Frequency Transmissions	252
Abstracts and References. Nos. 2550-2828 ..	A.183-A.204

Published on the fifth of each month

Annual Subscription: Home and overseas £2 7s. 0d; Canada and U.S.A. \$7.50
(Including Annual Index to Abstracts and References)

Editorial, Advertising and Publishing Offices: Dorset House, Stamford Street, London, S.E.1

Telephone: Waterloo 3333 (60 lines) Telegrams: Wirenger, Sedist, London

BRANCH OFFICES AT BIRMINGHAM · MANCHESTER AND GLASGOW

RECTIFIERS *to meet your* HIGH VOLTAGE *requirements*



XENON RANGE

... quick heating-up time ... freedom from effects of ambient temperature ... any mounting position ... suitable for fixed and mobile equipment.



MERCURY VAPOUR RANGE

... zirconium coated anode ... minimum bombardment of cathode ... extremely long life.

ABRIDGED DATA (All Half-wave Rectifiers)

	Type No.	British Services Type No.	Base	V_f (V)	I_f (A)	P.I.V. Max. (kV)	I_a (pk) Max. (A)	I_a (av) Max. (A)	Ambient Temperature Range (°C)
XENON	RR3—250	CV1835	4-pin UX	2.5	5.0	10 5	1.0 2.0	0.25 0.5	- 55 to + 75
	RR3—1250	CV2518	B4F	5.0	7.1	10	5.0	1.25	- 55 to + 70
MERCURY VAPOUR	RG1—240A	CV1626/1072	British 4-pin	4.0	2.7	6.5	1.25	0.25	+ 10 to + 40
	RG3—250	CV1625	Medium Edison Screw	2.5	5.0	10	1.0	0.25	+ 10 to + 40
	RG3—250A	CV32	4-pin UX	2.5	5.0	10	1.0	0.25	+ 10 to + 40
	RG3—1250	CV1629/152	Goliath Edison Screw	4.0	7.0	13	5.0	1.25	+ 10 to + 40
	RG4—1250	CV5	Goliath Edison Screw	4.0	11	13	5.0	1.25	+ 10 to + 40
	* 872A	CV642	B4F	5.0	7.5	10	5.0	1.25	+ 10 to + 40

* Supplied for replacement purposes

Mullard



MULLARD LTD · COMMUNICATIONS AND INDUSTRIAL VALVE DEPARTMENT
CENTURY HOUSE SHAFTESBURY AVENUE LONDON W.C 2

MVT 159

WIRELESS ENGINEER

Vol. 31

SEPTEMBER 1954

No. 9

Rotating Observers

WE have on several occasions emphasized the absolute character of rotation, and we have just received from a continental professor a letter referring to the June Editorial and asking if we can give a reference to "something in the literature about the principles of your fundamental affirmation that rotation is absolute".

When two or more bodies are moving linearly at different constant speeds, and even in different directions, it is open to an observer on any one body to assume that he is at rest and that the other bodies are moving; any statement of the speed of a body has no meaning unless the frame of reference is stated or inferred. When discussing the induction of e.m.f. due to the relative motion of conductors and magnetic poles, so long as the motions are purely linear one can explain the phenomena as due either to the conductor moving while the pole is at rest, as it would appear to an observer situated on the pole, or *vice versa*, as it would appear to an observer on the conductor.

To an observer firmly stationed on a solid body every point on the body appears to be at rest even if it is rotating. If, to an observer on one body, two points on another body appear to be moving at different velocities, then this second body is rotating. If in Fig. 1 the point A is moving at the moment relatively to any observer in the direction shown with velocity v_a ,

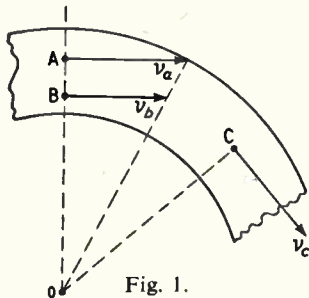

Fig. 1.

while the point B on the line perpendicular to v_a appears to be moving in the same direction with velocity v_b , then the body is rotating about the point O, or, more simply, if the points A and C are moving at the moment in the directions shown, the intersection O of the perpendiculars gives the point about which the body is rotating at the moment and v_a/OA or v_c/OC gives the angular velocity of the rotation.

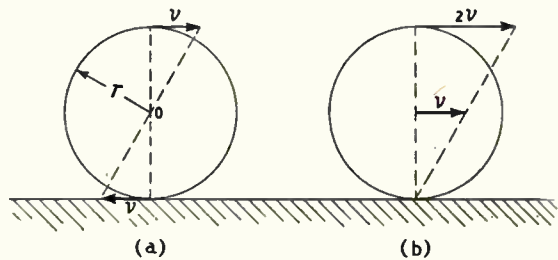

Fig. 2.

To take a well-known example, Fig. 2(a) shows the wheel of a vehicle as seen from the vehicle and Fig. 2(b) as seen by a stationary observer on the road. The rotation is the same in both cases, the angular velocity being v/r ; to the observer on the vehicle this is the only motion, but to the stationary observer there is a superposed linear velocity v . This shows that although the linear velocity is relative, the angular velocity of rotation is unaffected by the movement of the observer. An observer on a rotating body cannot assume that he is at rest; as I have said before he will have feelings that belie such an assumption and, unless he is firmly secured to the body, when the speed of rotation reaches a certain value he will be flung off, whatever views he may hold on

the subject. The only relativity about this is the relative linear velocities of the different parts of the body, which produce the absolute rotation.

In the above example, if the observer were securely fastened to the wheel at the other end of the axle, both wheels would to him appear to be at rest, while the vehicle and everything else would appear to be whirling round.

The letter to which we referred at the beginning continues as follows: "Two observers A and B are placed at different distances r_1 and r_2 from a common axis, about which they have angular velocities ω_1 and ω_2 . A produces an electromagnetic phenomenon due, say, to an electric charge uniformly distributed on the circle of radius r_1 and moving with A, the effects of which are observed by B. Do the results of the observation remain unchanged if the angular velocities ω_1 and ω_2 are changed without changing the difference $\omega_1 - \omega_2$? If the results vary, in what way do they change, and does the change disappear in the particular case of $r_1 = r_2$ or in the particular case of $\omega_1 = \omega_2$?"

This regards the phenomena from the point of view that seems to be very undesirable; viz., that of a rotating observer. When one places an observer on a rotor, is he supposed to ignore the centrifugal force and the giddiness that he experiences and assume that he is at rest and that the stator is rotating? Even if he were suitably secured and treated so that he would not be troubled about such details, would not his evidence be open to some doubt? Take the almost classic example in Fig. 3 of the cylindrical

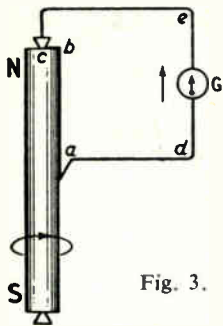

Fig. 3.

bar magnet rotated about its axis while an external circuit containing a galvanometer is connected by means of brushes between one end and the middle of the magnet. The galvanometer shows that a current is flowing in the circuit, and seeing that the external circuit is at rest in a magnetic field which is undergoing no change whatever either in magni-

tude or direction, whereas the path in the magnet is through a conductor; viz., steel, which is rotating in a magnetic field, viz., that within the magnet, which is also, speaking macroscopically, undergoing no change whatever either in magnitude or direction, no one can have any doubt as to the source of the e.m.f.

If now we imagine an observer firmly bound to the magnet, he will tell us that the magnet is at rest but that the external circuit and galvanometer are being rotated around it, thus cutting through the magnetic field and inducing an e.m.f. in the circuit. The observable phenomenon, viz., the current indicated on the galvanometer, would be the same in both cases, but the fact that he has to be fastened to the magnet shows that all his explanations are based on a false assumption, viz., that the magnet is not rotating. When the magnet is rotating all the magnetic flux emerging from the upper half of the magnet is cut by the conductor 'abc'; when the magnet is at rest and the external circuit rotating, the same flux is cut by the conductor 'adec'.

In the question put to us, a circle A is charged, say positively, while B is an observer moving about the same axis. When both are at rest B merely observes a stationary charge and its electric field—assuming that he is properly equipped for making such observations. If now A rotates, B observes the moving charge as a circular current producing a magnetic field in addition to the electric field. So long as B is at rest there is no difficulty, but if he now rotates there are real difficulties because the recognized laws of electromagnetism, like those of mechanics, are based on the assumption that the observer is not rotating. If A and B are rotating at the same speed, the charge on A appears to be at rest and the magnetic field presumably vanishes so far as B is concerned. To a stationary observer the magnetic field is still there and B is rotating in it. To go into this question more fully one would have to specify the type of body to which B was secured and the instruments with which he was equipped.

All this goes to prove that rotation is absolute; a body is either rotating or not rotating, independent of any observer. When one speaks of the speed of rotation of a body relative to that of another, one means merely $\omega_1 - \omega_2$; the values of ω_1 and ω_2 are, however, absolute and independent of any other body. From the examples that we have discussed it is obviously very undesirable to attempt the explanation of electromagnetic or mechanical phenomena from the point of view of a rotating observer. One can discuss what would happen if the rotor of a machine were at rest and the stator rotated, but this can be done without fixing a fictitious observer to the stator and running the machine in the normal way.

G. W. O. H.

MULTIPLEX TELEVISION TRANSMISSION

Sub-Carrier and Dot-Interlace Systems

By J. Haantjes and K. Teer

(Philips' Research Laboratories, N.V. Philips' Gloeilampenfabrieken, Eindhoven, Holland)

SUMMARY.—Systems for the transmission of several television signals within a single television channel are described in this article; they are based on the use of signal components which cancel out in two successive pictures.

A distinction is made between the sub-carrier and the dot-interlace systems. The typical characteristics of both systems are determined and, in particular, those characteristics which affect the separation of the signals at the receiver. Their application to colour television is considered and the conclusion is drawn that for this the sub-carrier system is to be preferred.

1. Introduction

IN the development of colour television it has been realized from the beginning that it is very desirable to be able to transmit several television signals within a single television channel. The colour and luminance of a picture element are determined by three independent values and, therefore, three sets of information have to be transmitted. From the point of view of bandwidth economy and compatibility with the black-and-white system, however, it is desirable to use the normal channel bandwidth.

Similar conditions occur in stereoscopic television and it is not impossible that in other future applications of television such a multiple transmission of television signals will be required.

This paper is concerned with this general problem of the multiple transmission of television signals. We shall discuss the simultaneous transmission of several separable television signals through a single transmission path, the bandwidth of the transmission channel being assumed to be less than the sum of the bandwidths of the individual signals.

In such a transmission system the spectra of the signals overlap and these spectra cannot, therefore, be entirely separated by means of filters. Consequently, multiple transmission involves the problem of adding to a certain television signal a second separable signal within the same band in such a way that its presence does not affect the quality of the picture corresponding to the first signal.

It is possible to solve this problem by using signal components of the transmission which are of opposite sign in two successive picture periods. Such signal components are barely visible in a television picture because, as far as the eye is concerned, the brightness modulation caused by such a signal component in one picture* cancels

out when combined with the brightness modulation due to the signal component of the successive picture.

Before the use of these signal components is considered, their visual effect on a television picture will be described.

2. Signal Components Cancelling in Two Successive Pictures

One example of a signal component of the kind described is a sine wave having a frequency which is exactly an odd multiple of one-half of the picture frequency. At any instant the phase of such a sine wave is opposite to its phase one picture period earlier. A second example is a sine wave of arbitrary frequency but with a certain definite phase shift at the start of each picture period, so that the sine wave is of opposite phase in successive pictures. The cancellation effect, which results from the use of sine waves having a special frequency or phase relation to the scanning frequencies, needs detailed examination.

A sinusoidal modulation of the brightness along an individual scanning line of a picture gives the appearance of successive bright and dark areas. These areas, occurring in successive lines, frames and pictures, produce a pattern which is an unwanted one and which is, therefore, an interference pattern. To investigate the nature of this pattern we shall consider two successive pictures built up of four frames interlaced in the usual way. The relative position of bright areas, corresponding to maxima of the sine waves, will be denoted as follows:—

in the first frame by A
(odd lines, first picture)

*The usual British television nomenclature is employed in this article; i.e., the visible picture is built up from lines, frames and pictures. In American terminology, lines, fields and frames are the equivalent words. As a result, the word 'picture' is used in a double sense to mean, generally, the entire visible picture seen by the eye and, specifically, one complete cycle of the scanning process, which is usually two frames. The context prevents this double meaning from causing ambiguity.

MS accepted by the Editor, April 1954

any continuous sine wave. It can, however, be obtained by using, as before, a sine wave with a frequency equal to an odd multiple of one-half of the line frequency but this time introducing a phase shift of alternately plus and minus 90° at the beginning of each frame.

Under these conditions it can be seen from Fig. 3 that there is no longer any definite direction in which the dots A, B, C and D can appear successively. It is no longer possible to draw any straight line through successive dots, as in the case of Fig. 2. An apparent movement of the dot pattern of the type described in connection with Fig. 2 is thus impossible.

LINE NO	1	A	C	A	C	A	C
.. 2		D	B	D	B	D	B
.. 3	C	A	C	A	C	A	C
.. 4		B	D	B	D	B	D
.. 5	A	C	A	C	A	C	A

Fig. 3. The dot pattern of an odd multiple of half the line frequency with a phase shift at the beginning of each frame of + and - 90° alternately.

However, this is not the only condition which can produce a moving pattern; a 'second-order' moving pattern can exist. If the eye is moved in such a way that the region of attention is shifted over half the dot distance during a picture period, the impression of pattern A will coincide with the impression of pattern C. Similarly, pattern B will coincide with pattern D. The observer perceives two patterns simultaneously, one caused by the coincidence of A and C and the other by the coincidence of B and D.

The frames coincide two by two, so the brightness of this second-order moving pattern will be less than that of the first-order pattern obtained with the arrangement of Fig. 2. Moreover, these second-order effects occur in both vertical and horizontal directions and are equally perceptible in all four directions. Because of this the stroboscopic effects are much less evident than with the Fig. 2 pattern.

3. The Sub-Carrier System

It is now necessary to consider how a sine wave can be used to carry a second set of information within the same band as that used for the main television signal. One possibility is to modulate the sine wave, using double-, vestigial- or single-sideband modulation, and then to employ it as a sub-carrier with the main signal.²

As already stated, multiples of half the picture frequency are of minor importance in the spectrum of a television signal.¹ In the case of a still

picture these frequencies are not present at all, because the signal is then periodic at the picture frequency. With a moving picture, however, they do exist, but they are of relatively small amplitude; in fact, it is almost true to say that in the higher regions of the video spectrum the only frequencies present are multiples of the line frequency.

Now when a sub-carrier has a frequency which is an odd multiple of one-half of the picture frequency and is itself modulated by a television signal, the resulting sidebands have frequencies which are also odd multiples of half the picture or line frequency. This is illustrated in Fig. 4, which shows the spectrum of the modulated sub-carrier. The whole of the second television signal is, therefore, transformed into signal components which are barely visible in a reproduction of the first and main picture.

The second signal can be represented by

$$S_2 \cos \omega_p t$$

where ω_p is the angular frequency of the sub-carrier. The total signal transmitted, which is henceforth called the 'transmission signal', can be represented by the expression

$$S_1 + aS_2 \cos \omega_p t$$

where a is a constant.

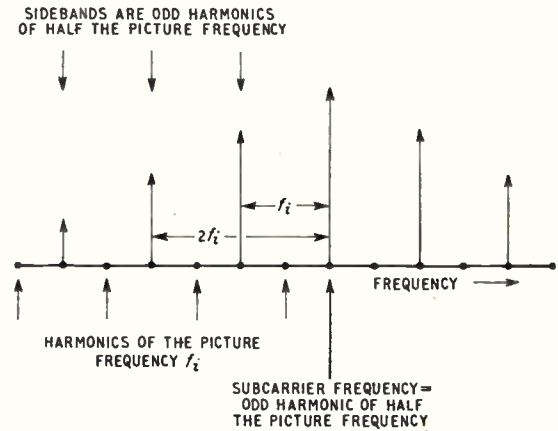

Fig. 4. The spectrum of a modulated sub-carrier.

When this signal is applied to a cathode-ray tube it will produce a visible picture corresponding to S_1 because the components of $S_2 \cos \omega_p t$ cancel each other in successive pictures. In order to obtain a picture corresponding to S_2 it is necessary to multiply the transmission signal by $\cos \omega_p t$; that is, to use synchronous detection. The result of doing this can be expressed as

$$\begin{aligned} & \frac{2}{a} \cos \omega_p t (S_1 + aS_2 \cos \omega_p t) \\ &= S_2 + S_2 \cos 2\omega_p t + \frac{2}{a} S_1 \cos \omega_p t \end{aligned}$$

If this signal is filtered in such a way that the component $S_2 \cos 2\omega pt$ is removed the result is

$$S_2 + \frac{2}{a} S_1 \cos \omega pt$$

This signal has the same character as the transmission signal and can, therefore, be used to represent the signal S_3 . If the constant a is chosen to be $\sqrt{2}$ the amplitude relation of the signals S_1 and S_2 is symmetrical.

If the sub-carrier is single-sideband modulated the results are similar. Apart from the advantage of smaller bandwidth of the modulated sub-carrier, single-sideband transmission has also the advantage of giving better signal-to-noise conditions at the receiver for S_2 . The extreme condition for single-sideband operation is shown in Fig. 5, where the two signals have the same bandwidth f_p , which is equal to the channel bandwidth. If it is required to transmit a third signal S_3 with S_1 and S_2 a second sub-carrier modulated by S_3 could be introduced. Another method, however, is to modulate one sub-carrier by S_2 as well as S_3 in such a way that they can be separated by synchronous detection.

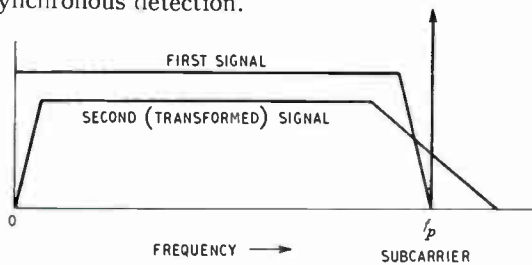
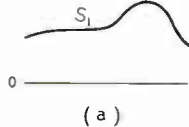

Fig. 5 (above). The transmission of two signals, each with bandwidth f_p , in a channel with bandwidth f_p , by means of a single-sideband modulated sub-carrier.



and are represented by the transmission signal and the two demodulator output signals. However, single-sideband transmission of a sub-carrier modulated by two signals is not possible without introducing cross-talk^{3,4} between S_2 and S_3 .

This method of transmitting three signals is used in the recently-accepted colour system of the U.S.A. and usually known as the N.T.S.C. system.

4. The Dot-Interlace System

4.1. Principles

Instead of using a sub-carrier system of the type just described, it is possible to transmit two or more signals in one channel by employing time-division multiplex. As applied to television, this is usually known as dot interlace.

In spite of its apparent difference, one can actually detect the presence of sub-carriers having similar frequency and phase relations to the scanning frequencies, as in the case of the nominally sub-carrier system. When the method was first developed, however, it was regarded purely from the time-division point of view⁴ and, initially, we also shall look at it in this way.

Suppose that a television signal S_1 has a bandwidth f_p and that this signal is multiplied by a series of pulses of infinitely-short duration. The result is a pulse series amplitude-modulated by S_1 as shown in Fig. 6.

Ideally, this signal is now fed to a perfect filter (i.e., a filter having a rectangular amplitude and a linear phase characteristic) which has a bandwidth

$$f_b = n f_p / 2$$

where n is an integer.

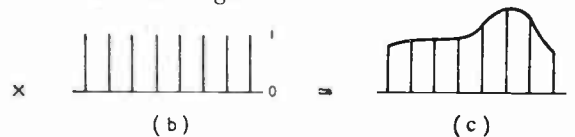

Fig. 6. The signal S_1 shown at (a) is multiplied by a series of infinitely-short pulses (b) to produce a pulse-modulated wave (c).

If S_3 is used to modulate a carrier $\sin \omega pt$ we get

$$\sqrt{2} S_3 \sin \omega pt$$

and if this is added to

$$S_1 + \sqrt{2} S_2 \cos \omega pt$$

the transmission signal becomes

$$S_1 + \sqrt{2} S_2 \cos \omega pt + \sqrt{2} S_3 \sin \omega pt$$

When this is multiplied by $\sqrt{2} \cos \omega pt$ we get

$$S_2 + \sqrt{2} S_1 \cos \omega pt + S_2 \cos 2\omega pt + S_3 \sin 2\omega pt$$

and after filtering the result is

$$S_2 + \sqrt{2} S_1 \cos \omega pt$$

When the transmission signal is multiplied by $\sqrt{2} \sin \omega pt$ and the same filtering process employed the result is

$$S_3 + \sqrt{2} S_1 \sin \omega pt$$

In this way the three signals can be separated

To find the output signal from this filter we consider its response to a single pulse. This response is well known⁵ and is proportional to

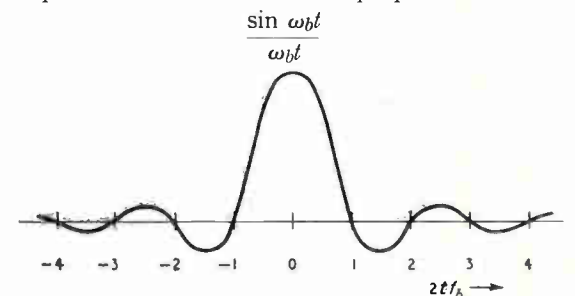

Fig. 7. The response of an ideal filter with bandwidth f_b to a single pulse.

which has the form shown in Fig. 7. This signal has a maximum for $t = 0$ and is zero whenever

$$t = \frac{1}{2}m/f_b$$

$$m = \pm 1, \pm 2, \pm 3, \text{ etc.}$$

If the signal fed to the filter is a modulated pulse train having a repetition frequency of $2f_b$, therefore, the maximum in the response to any individual pulse will coincide with the zeroes of the responses to all the other pulses. Hence, at $t = m/2f_b$, the value of the output signal depends

second is only possible in television and similar techniques.

As the repetition rate is f_p , the time interval between the pulses is $1/f_p$ and the interval between two zeroes in the response of the transmission filter is

$$\frac{1}{2f_b} = \frac{1}{nf_p}, \text{ for } f_b = \frac{nf_p}{2}$$

This interval between the pulses is, therefore, $1/n$ of the pulse interval. It follows that another $n - 1$ pulse series with suitable time shifts can be

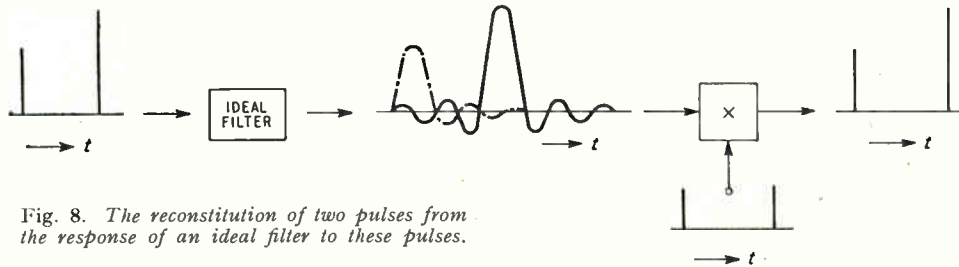

Fig. 8. The reconstitution of two pulses from the response of an ideal filter to these pulses.

only on the value of one single input pulse, which is the pulse having its maximum at that moment. Consequently, by multiplying the output signal from the filter by a second pulse train the original amplitude-modulated input pulse train can be reconstituted. This is shown diagrammatically in Fig. 8.

The bandwidth of the original signal S_1 is f_p and it would appear to be necessary to have a pulse repetition frequency of $2f_p$ because a minimum of $2f_p$ independent values per second are necessary to describe a signal of bandwidth f_p . However, this is not essential when S_1 is a television signal. In this case the pulse repetition frequency can be f_p only. The result is that only half as many signal values per second are transmitted as are necessary for the transmission of the entire information. In television, the transmitted time function is transformed at the receiver into a two-dimensional space function and, therefore, it is possible to add the missing values later on.

The signal values missing in a certain scan (comprising a picture period of two frames) of the picture can be transmitted during the following scan, assuming that the picture does not vary too much during one picture period. In this way the whole information content of a picture is transmitted as two series of interlaced signal values in two successive picture periods. It is plain, however, that this reduction in the number of signal values transmitted per

added to the filter input. The total input signal is then a pulse series with a pulse interval of $1/nf_p$. The $n - 1$ pulse series can be modulated by signals S_2, S_3, \dots, S_n . This is illustrated in Fig. 9 for the case of $n = 3$.

In order to separate the information, say, S_k , carried by one pulse series from the complex

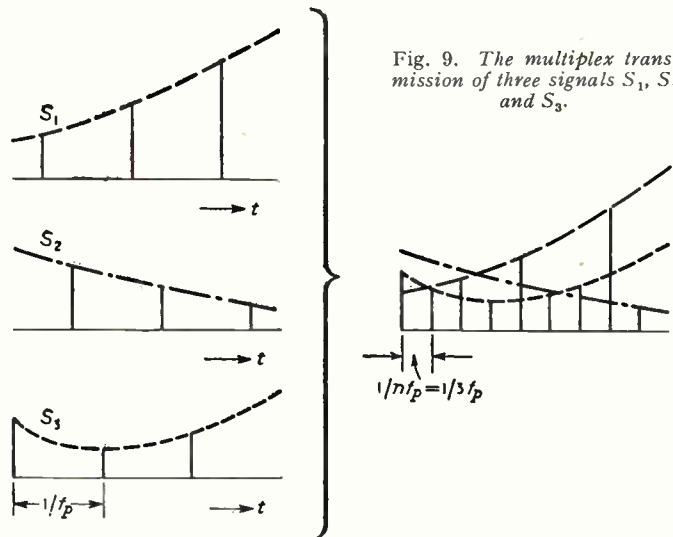

Fig. 9. The multiplex transmission of three signals S_1, S_2 and S_3 .

signal, this signal is multiplied by pulses of frequency and phase equal to those applied to S_k in the transmitter. This, of course, assumes that the delay time of the transmission path is zero; when it is not, it is only necessary to alter the phase appropriately.

The signal resulting from the multiplication is

fed to an ideal filter with bandwidth f_p , which is henceforth called the 'receiver filter'. As the bandwidth is the same as the repetition rate of the pulses, the filter response will show zeroes between

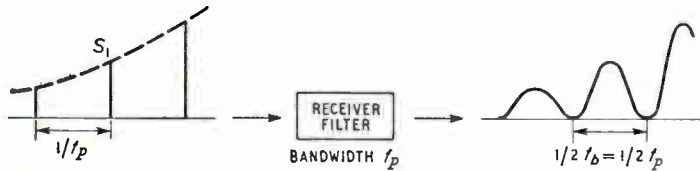
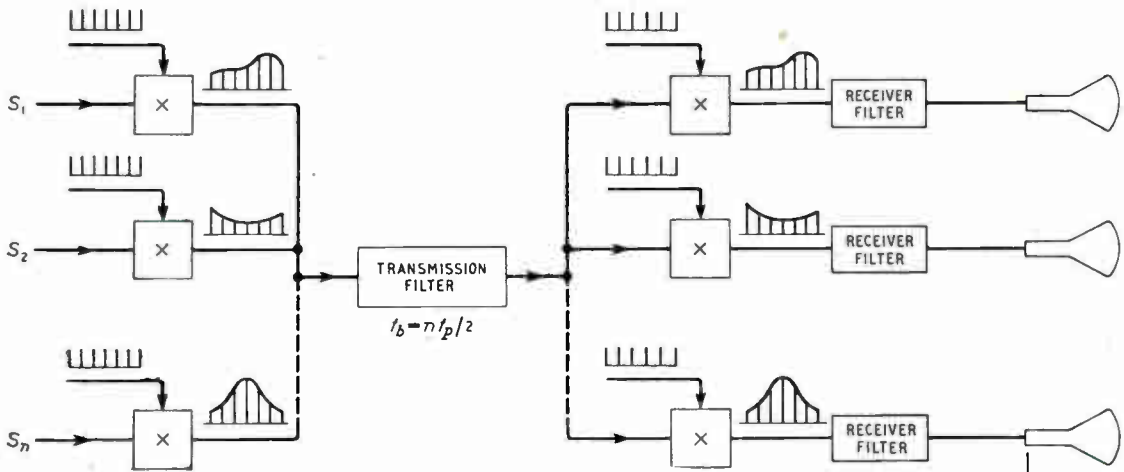

Fig. 10. The response of the receiver filter to the reconstituted pulse series modulated by S_1 .

the maxima corresponding to two adjacent pulses. This is depicted in Fig. 10. The missing signal values occur at instants which correspond with the zeroes in one picture period, and are transmitted in the following picture period. Because of the integrating properties of the eye, the picture obtained by reproducing the output signal appears much the same as that given by the reproduction of S_k itself.



short duration is

$$\propto \int_0^{\infty} \cos \omega t d\omega$$

and the response to it of an ideal filter with zero phase-shift is

$$\propto \int_0^{f_b} \cos \omega t d\omega$$

where f_b is the bandwidth of the filter.

Now suppose that, instead of the ideal rectangular characteristics, the filter has a response of the form shown in Fig. 12. This characteristic is down 50% at f_b and shows symmetry with respect to this point such that when a certain frequency $f < f_b$ is attenuated by a factor γ the frequency $f_b + (f_b - f) = 2f_b - f$ is attenuated by a factor $1 - \gamma$. The highest frequency transmitted by the filter is limited to $2f_b$.

The response of this filter to a pulse can be

To sum up, in a dot-interlace transmission system of the kind described, n television signals S_k ($k = 1, 2, 3, \dots, n$) with frequencies up to f_p , can be transmitted through a channel of bandwidth $nf_p/2$ and at the receiver the original picture can be reconstituted by a combination of two successive pictures. The complete system is shown schematically in Fig. 11.

4.2. Practice

As so far described the dot-interlace system depends upon the use of ideal filters and infinitely-short pulses, neither of which is possible in any practical system. It is, therefore, necessary to consider what happens when practicable filters and pulses are used.

The Fourier transform of a pulse of infinitely-

Fig. 11. The entire dot-interlace system for n signals.

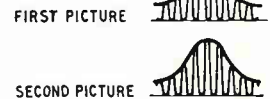

written as

$$\begin{aligned} & \propto \int_0^{f_b} [\gamma \cos \omega t + (1 - \gamma) \cos (2\omega_b - \omega) t] d\omega \\ & = \alpha \int_0^{f_b} \cos \omega t d\omega + \alpha \int_0^{f_b} 2(1 - \gamma) \sin \omega t \\ & \quad \sin (\omega_b - \omega) t d\omega \end{aligned}$$

The first integral represents the response of an ideal filter. The second must be considered for those instants when $t = m/2f_b$, where m is an integer.

At these instants the second integral is zero, and so the response of the filter is then the same as that of the ideal filter. It is only at these instants that the value of the transmission signal is used to determine the information signals at the receiver and so the results with the two types of filter are the same. The filter of Fig. 12 can, therefore, be used instead of the ideal filter. The phase characteristic must still be linear, but such a filter can be realized to a good degree of approximation.⁸

It can similarly be shown that the receiver filters, of bandwidth f_p , may have amplitude characteristics like that of Fig. 12. In this case the final result is not quite the same as with ideal filters. It can be shown that in the response the output signal equals the original signal at the instants which correspond to the $2f_b$ signal values, but that slight deviations in the output signal occur between these instants.

It is now necessary to consider the effect of the pulse shape. A train of infinitely-short pulses of repetition frequency f_p can be written as a Fourier series:

$$\begin{aligned} &\alpha [1 + 2 \cos (\omega p t + \phi) + 2 \cos \{2 (\omega p t + \phi)\} \\ &\quad + 2 \cos \{3 (\omega p t + \phi)\} + \dots] \\ &= \alpha \left[1 + 2 \sum_{m=1}^{\infty} \cos \{m (\omega p t + \phi)\} \right] \end{aligned}$$

At the transmitter the signals

$$\alpha S_k \left[1 + 2 \sum_{m=1}^{\infty} \cos \{m (\omega p t + \phi_k)\} \right]$$

are fed to the transmission filter. The highest frequency passed by this filter is $2f_b = nf_p$ and, as S_k does not contain frequencies above f_p , the component

$$S_k \cos \{m (\omega p t + \phi_k)\} \quad (m > n)$$

cannot contribute to the output.

Instead of multiplication by pulses of infinitely-short duration, multiplication by the waveform

$$P_k = 1 + 2 \sum_{m=1}^n \cos m (\omega p t + \phi_k)$$

may be employed, therefore, with the same result.

The number of harmonics of f_p which must be present in P_k depends upon the sharpness of cut-off of the transmission filter, and decreases with an increase of sharpness. In the extreme case of an ideal filter P_k must contain harmonics up to

$$\begin{aligned} &\frac{n}{2} + \frac{1}{2}, \quad n \text{ odd} \\ &\frac{n}{2}, \quad n \text{ even} \end{aligned}$$

In a similar manner it can be shown that in the receiver the waveform P_k can be used for separating the different signals, instead of infinitely-short pulses, to produce signals $S_k P_k$ at the input of the receiver filters. These filters, having a bandwidth f_p , cannot transmit the sidebands of the harmonics $3f_p, 4f_p, \dots, nf_p$ in P_k . The output signal will, therefore, have the same form if the input signal is

$$S_k [1 + 2 \cos (\omega p t + \phi_k) + 2 \cos \{2 (\omega p t + \phi_k)\}]$$

Moreover, from the component

$$2 S_k \cos \{2 (\omega p t + \phi_k)\}$$

only the lower sideband can contribute to the filter output; and when the cut-off is sharp, this contribution is almost negligible. The output signal is then nearly S_k + the sub-carrier f_p single-sideband modulated with S_k .

If we indicate the single-sideband modulation on the sub-carrier f_p by the operator Ω we can write for the resulting signal

$$S_k + \Omega S_k$$

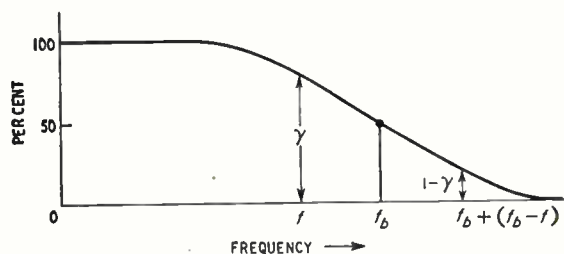

Fig. 12. The amplitude characteristic of a filter which can replace the ideal filter in the dot-interlace system.

4.3. Comparison with Sub-Carrier System

In two successive pictures the pulses must interlace; it is, therefore, necessary to reset the phase of P_k at the beginning of each picture period. This resetting becomes unnecessary, however, when there is a special relation between f_p and the picture frequency f_i , viz.,

$$f_p = (n + \frac{1}{2}) f_i$$

n being an integer.

When the beginning of each picture period is indicated as $t = 0$, the condition of interlace can be formulated as requiring that the angle ϕ_k in P_k must show a difference of π radians in two successive periods. Writing

$$1 + 2 \cos (\omega p t + \phi_k) + 2 \cos \{2 (\omega p t + \phi_k)\} + \dots$$

for the first scan, we get

$$1 - 2 \cos (\omega p t + \phi_k) + 2 \cos \{2 (\omega p t + \phi_k)\} - \dots$$

in the second scan.

We shall indicate the condition of interlace by a \pm sign

$$P_k = 1 \pm 2 \cos (\omega_p t + \phi_k) + 2 \cos \{2 (\omega_p t + \phi_k)\} \\ \pm 2 \cos \{3 (\omega_p t + \phi_k)\} + \dots$$

At this point in the discussion the presence of sub-carriers in a dot-interlace system becomes clear. Instead of talking in terms of time-duration multiplexing, therefore, we can speak of using several modulated sub-carriers (ω_p , $2\omega_p$, etc.) in the transmission. Half of them (the odd harmonics of f_p) have the nature of signal components which cancel out in successive picture periods (indicated by a \pm sign). When there are many signals, the description of the system in terms of sub-carriers is somewhat complicated; but where there are only a few, it may well simplify the analysis and the understanding of the transmission process.

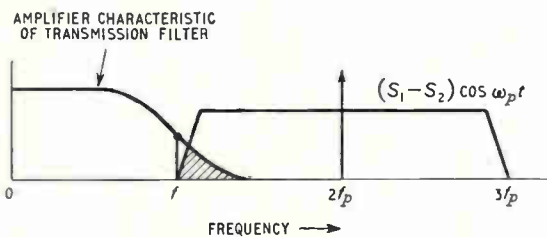

Fig. 13. The contribution of the component $(S_1 + S_2) \cos 2\omega_p t$ to the transmission signal of a dot-interlace system for two signals.

The question arises, therefore, as to how the sub-carrier system described in Section 3 and the dot-interlace method described here differ from one another. In both systems signal components of the kind discussed in the foregoing are present and in both systems the observer must depend upon the integrating effect of the eye if the picture is to look right. There is, however, an important difference when the picture is considered over only one picture period. In the sub-carrier system, interference in the desired signal is related to the unwanted signals, but the whole information is contained in one picture period. In the dot-interlace system, however, the unwanted signals cause no interference with the wanted one, and defects are related to the wanted signal itself and consist of the absence of half the information in one picture period. In this system two picture periods are needed to transmit all the information.

Before we go on to consider special cases of dot-interlace, it should be mentioned that in the analysis of the dot system it has been assumed that the picture is the same in two successive scans, so that signal values which are not transmitted in the first scan can be added in the second. The analysis can, therefore, only apply exactly to the transmission of a still picture. The authors have found experimentally, however, that with a

moving picture disturbing effects occur only under very special circumstances.

4.4. Dot-Interlace with Three Signals

In colour television three independent signals have to be transmitted, and a three-signal dot-interlace system would seem to be a suitable way of doing this. In such a system $n = 3$ and the channel bandwidth is

$$f_b = n f_p / 2 = 3 f_p / 2$$

and so three signals, each having a bandwidth of two-thirds of the channel bandwidth, can be transmitted without cross-talk.

When used for colour television, however, such a system has the following disadvantages:—

1. All signals have a bandwidth of two-thirds of the channel bandwidth; no information at all about detail in the picture corresponding to frequencies above two-thirds of the channel bandwidth is transmitted.
2. The sub-carrier has a frequency of two-thirds of the channel bandwidth, which is rather low. Interference, in both black-and-white and colour picture reception, will be much less if the sub-carrier is chosen to be on the upper side of the channel.

Some years ago a colour television system was proposed which was very similar to the system described above. The dot-frequency was at the upper end of the channel and it was consequently free from the disadvantages referred to. It was found, however, that a serious amount of cross-talk occurred between the three signals.^{9,10}

4.5. Dot-Interlace with Two Signals

When only two signals need be transmitted in a dot-interlace system the channel and signal bandwidths are equal,

$$f_b = n f_p / 2 = f_p$$

The waveforms of P_k , where $k = 1$ and 2 , are:—

$$P_1 = 1 \pm 2 \cos \omega_p t + 2 \cos 2\omega_p t$$

$$P_2 = 1 \mp 2 \cos \omega_p t + 2 \cos 2\omega_p t$$

The signal applied to the transmission filter is

$$S_1 P_1 + S_2 P_2 = S_1 + S_2 \pm 2 (S_1 - S_2) \cos \omega_p t \\ + 2 (S_1 + S_2) \cos 2\omega_p t$$

and this comprises:—

1. The sum of the two signals.
2. The difference between the two signals modulated on to a sub-carrier $\cos \omega_p t$.
3. The sum of the two signals modulated on to a sub-carrier $\cos 2\omega_p t$.

The signals S_1 and S_2 do not contain frequencies higher than f_p , and so the component (3) can contribute to the transmission only in so far as frequencies exceeding f_p can pass through the transmission filter. An example of how this can

occur is shown in Fig. 13 and it will be seen that only a small part of the lower sideband of $2f_p$ is transmitted; this is shown hatched.

It has already been pointed out that the dot-interlace system operates correctly when the cut-off of the filter is symmetrical with respect to f_p . In such a filter the transmission of a part of the modulated sub-carrier $2f_p$ [component (3)] is always correlated with a certain attenuation of the component (1) just below f_p .

It can be shown that the error introduced by this attenuation (which manifests itself as decreased definition of the desired picture and cross-talk with the highest frequencies of the unwanted signal) is corrected by that part of component (3) transmitted by the filter and shown by hatching in Fig. 13. This agrees with the findings of Section 4.2. Component (3) contributes less and less to the transmission as the sharpness of cut-off of the filter increases, and so the error introduced by its complete omission also decreases. When component (3) is omitted the transmission signal consists of $S_1 + S_2$ (apart from the attenuation of the highest frequencies by the transmission filter) and the single-sideband modulated sub-carrier f_p with the modulation signal $S_1 - S_2$.

If the single-sideband modulation on f_p is indicated by the operator Ω the transmission signal can be written as $S_1 + S_2 \pm \Omega(S_1 - S_2)$. In order to obtain the signal S_1 the received signal is multiplied by

$$P_1 = 1 \pm 2 \cos \omega p t + 2 \cos 2\omega p t$$

and the result is passed through a filter with a bandwidth f_p . When the cut-off of the receiver filter is not too flat the term $2 \cos 2\omega p t$ is of only minor importance, because both the received signal and the receiver filter have a bandwidth f_p and the situation is the same as in Fig. 13. If this term is omitted, therefore, the input to the receiver filter will be

$$\{S_1 + S_2 \pm \Omega(S_1 - S_2)\} (1 \pm 2 \cos \omega p t)$$

Keeping in mind that ΩS indicated the sub-carrier f_p single-sideband modulated with S , we can write for the filter output

$$S_1 + S_2 \pm \Omega(S_1 - S_2) \pm \Omega(S_1 + S_2) + S_1 - S_2 = 2(S_1 \pm \Omega S_1)$$

In this expression the attenuation of the highest frequencies of S_1 and S_2 has again been neglected.

This analysis in terms of modulated sub-carriers shows the same property as the dot-interlace system, treated in Section 4.1 in terms of pulse responses. The original signals can be obtained at the receiver, but with the addition of an undesired signal which is, however, related only to the desired signal itself.

It is now possible to answer the question, what is the difference between a modulated sub-carrier system and a dot-interlace system. In the first case the transmitted signal is

$$S_1 \pm \Omega S_2 \quad (\text{See Fig. 5})$$

and in the second case the signal is

$$S_1 + S_2 \pm \Omega(S_1 - S_2)$$

It can be seen, therefore, that, neglecting certain effects, a dot-interlace system is analogous to a modulated sub-carrier system. The dot-interlace system can be considered as a sub-carrier system in which the normal transmitted signal consists of the sum of the two original signals and in which the difference between the two signals is modulated on the sub-carrier.

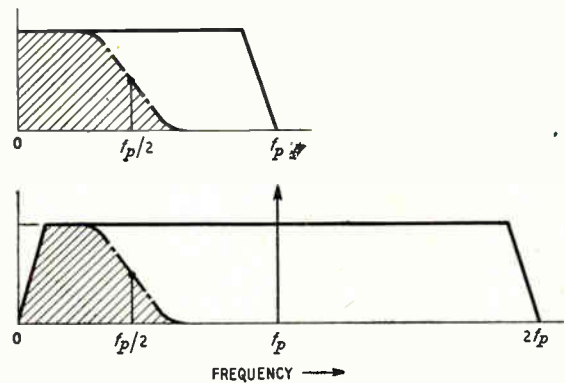

Fig. 14. The spectrum of the signal S when transmitted by a dot-interlace system for a single signal. - - - - = amplitude characteristic of the transmission filter.

4.6. One-Signal Application of Dot-Interlace

For the sake of completeness some mention should be made of the transmission of one signal only by dot-interlace. The channel bandwidth need be only $f_p/2$ for a signal containing frequencies up to f_p . ($n = 1$). The pulse waveform is

$$P = 1 \pm 2 \cos \omega p t$$

and the transmitted signal is

$$S (1 \pm 2 \cos \omega p t)$$

as far as it passes through the transmission filter of bandwidth $\frac{1}{2}f_p$. It thus contains one-half of the spectrum of S and one-half of the lower sideband of the modulated sub-carrier f_p .

The lower half of the spectrum of S is, therefore, transmitted in the normal way and the upper half as a part of the lower sideband of f_p , as shown in Fig. 14.

At the receiver the transmission signal is multiplied by P and the signal produced at the output of the receiver filter of bandwidth f_p is

$$S \pm \Omega S$$

(To be concluded.)

DIRECT-COUPLED TRANSITRON

By F. A. Milne, A.M.I.E.E., and E. J. Miller, B.Sc.(Eng.), A.M.I.E.E.

(P.O. Research Station)

PENTODE-VALVE circuits using a capacitor coupling between the screen grid and suppressor grid have now become familiar in many applications and are usually known as transitrons. This type of coupling, using the mutual effect of both grids upon the anode-current characteristic, is useful if repetitive operations are required. By using direct coupling (i.e., with a resistance network) the valve may be employed for semi-static operation and in this form it has many practical applications.

The features of this type of coupled circuit are less well known and only one reference to it has been traced.¹ However, this reference does not elaborate on its performance and gives no indication of its possible usage.

Some possible applications are:—

- (1) As a detector of direct voltage change; e.g., signal-level alarms, amplifier-gain alarm and light-sensitive cells.
- (2) As a detector of alternating-voltage change; e.g., peak suppressors and overload alarms.
- (3) As a rectifier of alternating voltages which exceed a given level; e.g., limited amplifiers.

Basic Circuit for D.C. Operation

The essential circuit is shown in Fig. 1. It will be seen that the screen-grid supply is obtained from the h.t. line, and that the suppressor-grid voltage is obtained by dividing the voltage between the screen grid and a negative supply in some fixed ratio. Usually the resistors used for obtaining the suppressor-grid voltage are such that their current does not materially alter the screen-grid voltage.

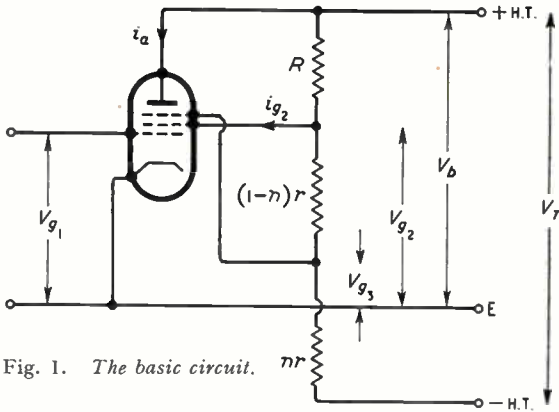

Fig. 1. The basic circuit.

MS accepted by the Editor, September 1953

This is not a necessity, but it does simplify calculations.

Fig. 2 shows the variation of anode current obtained by altering the control-grid voltage. The

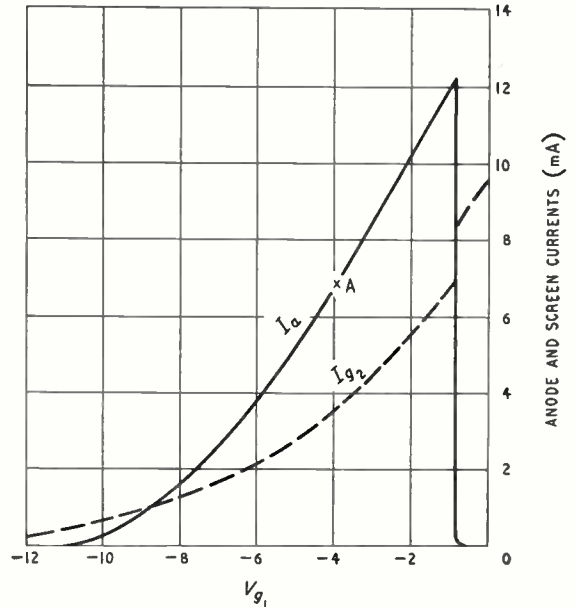

Fig. 2. Basic circuit—d.c. operation.

characteristic is similar to the normal pentode anode-current versus grid-voltage curve, but has a sharp cut-off at a control-grid voltage of approximately -0.8 . This sharp cut-off is the most useful feature of the circuit and is used in one form or another in all the applications to be discussed.

The screen-grid current characteristic is also shown in Fig. 2 and it will be seen that at the anode-current cut-off the screen-grid current is not only maintained but has an abrupt rise at the actual cut-off point.

It is interesting to note that the circuit has three stable states: (i) when the valve is completely cut off, (ii) when the valve is working normally such as at point A in Fig. 2, and (iii) when the anode current only is cut off.

The rapid anode-current cut-off is achieved by transitron action in the following manner. Consider a reduction in the negative control-grid voltage. There will then be an increase in the cathode current; in the normally-connected pentode this would result in an increase in anode

current and a proportionately smaller increase in screen-grid current. However, in this case the increase in screen-grid current reduces the screen-grid voltage due to the series resistor R . Now the suppressor-grid voltage, being derived from the screen-grid voltage by a fixed potential divider, also falls and diverts more of the anode current to the screen grid. Over the range of high negative control-grid voltage to the anode cut-off point, the suppressor grid is maintained positive and therefore has little influence. It is only when the suppressor grid becomes negative that it becomes effective. When it does become effective the diversion of the anode current to the screen grid is cumulative and a rapid anode-current cut-off ensues. Clearly, this cut-off is better defined if the valve used has a suppressor grid with a high degree of control over the anode current. This implies that the valve should have a short suppressor-grid base. In the curves shown, a CV 329 valve was used throughout.

Although a complete mathematical analysis of the operation is complex, a graphical method enables the essential features of operation to be deduced. When designing such a circuit it is usual to require the anode-current cut-off to occur before the control grid begins to draw current, and also that the anode current before cut-off should be at a maximum.

- Let V_b = h.t. line voltage
 V_t = total voltage between the h.t. line and the negative supply
 V_{g1} = control-grid voltage
 V_{g2} = screen-grid voltage
 V_{g3} = suppressor-grid voltage
 i_a = anode current
 i_{g2} = screen-grid current
 i_k = cathode current
 R_k = cathode resistance

nr and $(n-1)r$ are the values of the resistors supplying the suppressor-grid voltage from the screen-grid supply where n is less than unity.

From Fig. 1 it will be seen that:

$$V_{g3} = n (V_t - i_{g2}R) - (V_t - V_b) \\ = V_t (n - 1) + V_b - ni_{g2}R$$

where the current drawn by nr and $(1-n)r$ is neglected. If it is assumed that for anode-current cut-off V_{g3} must be zero, then in the above equation, values of n , i_{g2} and R must be determined. This can be done by drawing the valve characteristics of screen-grid current against control-grid voltage for various values of screen-grid voltage, as shown in Fig. 3. Load lines for various values of R are also shown and they are drawn for an h.t. supply of 250 V. The minimum permissible value of R can be determined such that the valve does not exceed its rated screen-grid dissipation. The other limiting factor is the

control-grid current which will occur at a control-grid potential of approximately -0.7 V. If loading of the control-grid circuit is to be avoided, the anode-current cut-off must be at approximately -1 V on the control grid and hence the value of i_{g2} at cut-off is determined. Substituting these values of i_{g2} and R in the above equation with $V_{g3} = 0$ a suitable value of n can be assigned.

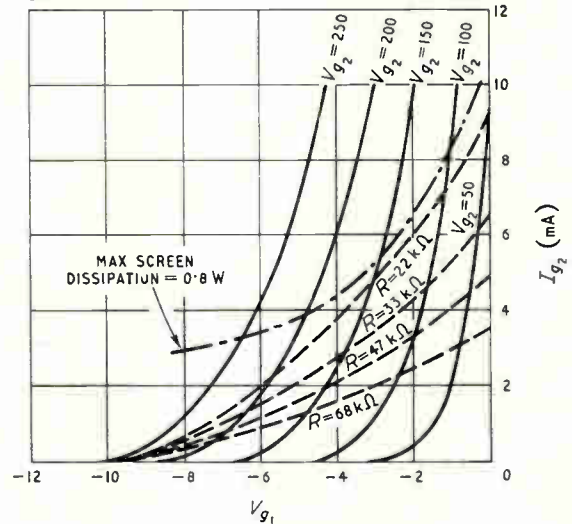

Fig. 3. Screen-grid current characteristics of valve Type CV 329; $V_a = 200$; $V_{g3} = 0$.

Basic Circuit with Feedback

The circuit so far discussed has an anode-current versus control-grid voltage characteristic of the form shown in Fig. 2, and this is true for any method of setting the control-grid voltage. If, however, a resistance is included in the cathode circuit this does not apply.

Consider a circuit such as that shown in Fig. 4. If the control-grid voltage with respect to earth is decreased from a high negative value, the anode-current characteristic will be similar to that of the original circuit, but the control-grid voltage will have to be increased to overcome the voltage appearing across the cathode resistance. This feedback voltage will be $i_k R_k = (i_a + i_{g2}) R_k$. This voltage will be zero when i_k is zero and large when i_k is large, thus the effective grid base of the valve can be controlled by the feedback.

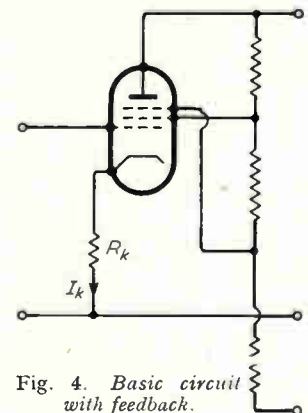

Fig. 4. Basic circuit with feedback.

Another interesting and important feature is the fact that after anode current has been cut off by the application of a sufficiently high value of positive control-grid bias, reducing the bias will not restore current at the same point at which it cut off because i_a is now zero and the feedback voltage is only that derived from i_{g2} . This feature gives the circuit a hysteresis factor which can be most useful.

Fig. 5 shows the characteristic of a typical circuit with the point at which cut-off occurs and the point where it restores. If the valve is so biased that it lies within these two points it is then in a state of unstable equilibrium and may be operated as a 'trigger'. This can be called the bias for self-locking operation shown as point B in Fig. 5.

Of course, if desired, the valve may be biased so that it is not self-locking and then the hysteresis factor may be employed to control the operate and restore characteristics of the circuit with respect to time or some other function.

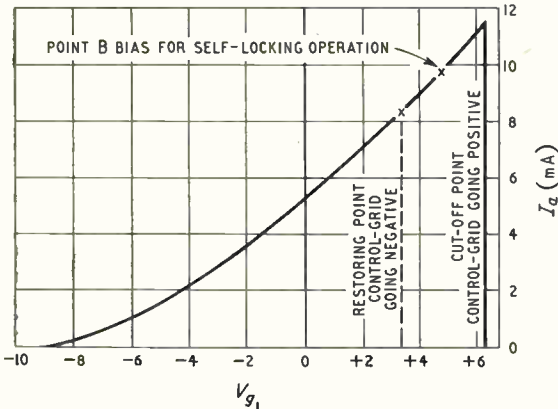

Fig. 5. Basic circuit with feedback; anode-current—grid-voltage characteristic.

Detector of Direct Voltage Change

(i) Amplifier Speech-Level Alarm

The circuit of Fig. 4 has been used as a speech-level alarm for an amplifier. Fig. 6 shows the actual circuit used. It will be noted that relays have been included in the anode and screen-grid circuits of the valve.

The requirement was to provide an alarm on a distribution amplifier for the Post Office Speaking Clock service. It was specified that an alarm should be given if the amplifier output level was reduced by 5 db but not if it was reduced by 4 db. Similarly, an alarm should be given if the output level was increased by 10 db. The overload and underload alarms were to be separately indicated. Clearly this underload-alarm condition was difficult to define as the Speaking Clock announce-

ment is of an indeterminate character and has many quiet periods.

The output of the amplifier was rectified by a conventional full-wave rectifier and smoothed, then applied to the control-grid of the transitron shown in Fig. 6. It will be seen from the circuit characteristics that the transitron sharp cut-off enables the strict underload-alarm condition to be met, with the additional advantage that the alarm is not self-restoring. Thus, where the amplifier is in a border-line case of underload, the alarm does not follow the speech level and operates only when the speech is at a minimum. In other words, the underload alarm is decisive and positive in action.

In normal conditions relays A and B are so arranged that contacts A_1 and B_1 are closed with B_2 open; in the case of an underload alarm, relay A releases and the alarm is given by contact A_1 since contact B_2 is open. In the case of an overload, the alarm is given through B_1 , while the underload alarm is not given since B_2 has closed.

A manual reset key is provided which releases the suppressor grid from its negative potential and allows the valve to conduct again.

The circuit is, of course, self-arming since under normal operating conditions both relays are held.

(ii) Amplifier Gain Alarm

In another case, the circuit of Fig. 4 has been used for an amplifier gain or distortion alarm. Here the output is continuously compared with the input of the amplifier, the circuit of Fig. 7 being used to perform this operation. It will be seen that the amplifier termination has a small resistor included in series. The voltage across this resistor is opposed by a similar voltage derived

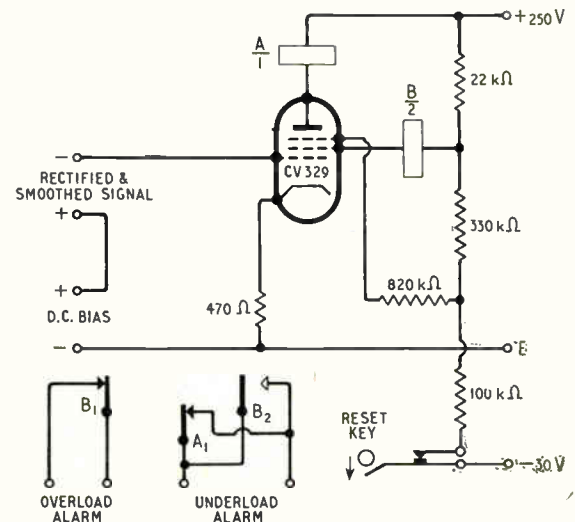

Fig. 6. Amplifier speech-level alarm.

from the input of the amplifier and applied across the primary of a transformer. There is a buffer cathode-follower in the case of the voltage obtained from the input of the amplifier.

The difference between these two voltages appears across the secondary of the transformer and is rectified and doubled. Before this direct voltage is applied to the transistron it has some degree of smoothing applied.

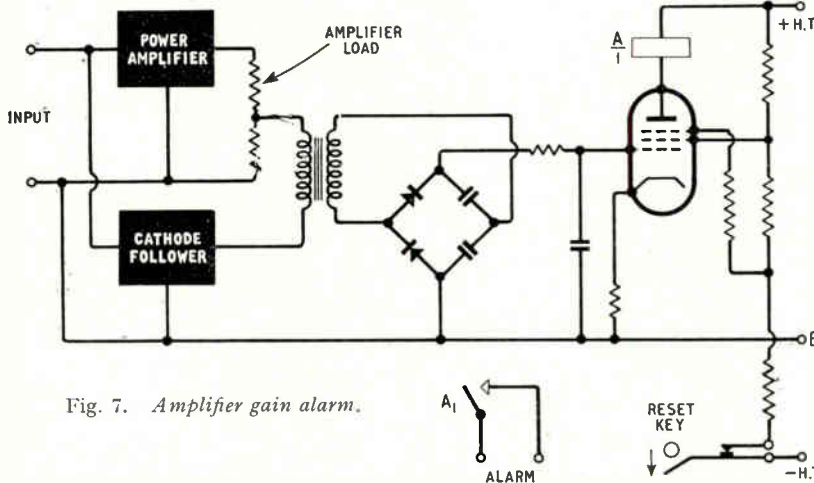

Fig. 7. Amplifier gain alarm.

As before, the circuit under fault conditions locks out and has to be reset manually. In this case, however, the alarm is given if the amplifier gain varies by more than a given amount about a mean value.

This type of alarm has the advantage that it can be made fast in action yet independent of the signal-input level. It is important to note, however, that the gain variation which can be tolerated is dependent on the signal level. Any undue distortion or hum arising within the amplifier will be immediately detected.

(iii) Light-Sensitive Cells

The circuit of Fig. 1 could be used following a photo-electric cell where an on-off operation is required. Normally where a valve follows a photo-electric cell, sufficient voltage must be derived from the photocell load to drive the valve negatively into cut-off in order to release an anode relay. Using the transistron and a photocell with a cathode load, the transistron could be driven positively into cut-off which would require less driving voltage since the transistron has a better-defined positive cut-off than the negative cut-off of a normal valve circuit. The attendant advantages would be a reduced photocell current in the working condition and less light required on the photocell cathode for efficient operation.

Basic Circuit for A.C. Operation

Consider the valve of Fig. 1 biased to the point A in Fig. 2. Now if an a.c. signal is also applied to the control grid the valve will function as a normal pentode amplifier with a resistive load provided that the control-grid excursions are not large enough to run into the point of anode-current cut-off. If the positive excursions are made so large that anode-current cut-off is encountered, it will be evident that considerable distortion of the output waveform results. The important feature of this is that a large distortion takes place at a well-defined point.

Fig. 8 shows the type of distortion that takes place and, in the case of a sine wave, it is almost a frequency doubling that occurs.

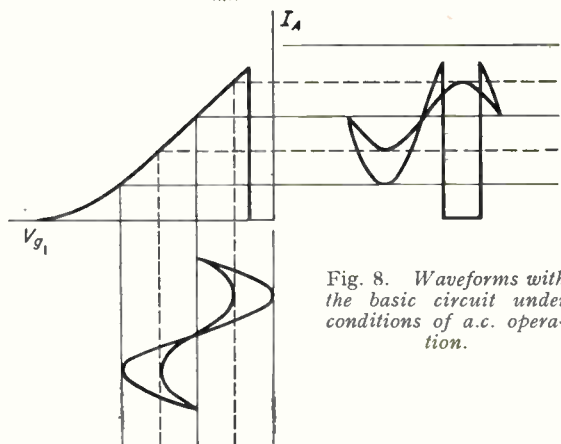

Fig. 8. Waveforms with the basic circuit under conditions of a.c. operation.

Feedback in Circuit for A.C. Operation

Consider, also, the effect of including a cathode resistor in the circuit. If an a.c. signal is applied, the circuit will behave as before for low-amplitude a.c. signals but where anode-current cut-off occurs, the valve, by suitable biasing (e.g., point B in Fig. 5) can be made to switch off and remain off until manually restored.

Alternatively, the bias point can be so arranged that on increasing the a.c. signal applied, the valve will switch off when anode cut-off is encountered and remain off until the a.c. signal is increased to the point where the anode current restores.

Detector of Alternating Voltage Change

Considering the a.c. operation of the circuit and the ability of the valve to cease operation when a high peak value of signal is encountered, it would appear eminently suitable as a peak-limiting stage. Some advantages would be obtained over the conventional diode limiter, namely, the level at which limiting takes place would be better defined and limiting could be performed at lower levels than would be possible with diodes.

Another possible use is an a.c. signal alarm where an alarm is required if an a.c. signal exceeds a given value. Such an alarm might be required for a

thermostatically-controlled oven where the control is exercised by an a.c. bridge. The transiron could be biased for self-locking operation and give an alarm when the bridge detector current exceeded a normal value.

Rectifier of Alternating Voltages

In an attempt to utilize one of these interesting characteristics of the transiron, an experimental limited amplifier was built. In this case, as shown in Fig. 9, the transiron had a capacitor across its anode load. The voltage appearing across this load was directly coupled to the control grid of one half of a 6SN7.

The other half of the 6SN7 was used as a triode amplifier and the two halves were coupled by a common cathode load. Now, clearly, for a small value of a.c. signal the transiron behaves as a normal pentode and the charge on the anode capacitor remains constant as the a.c. signal is increased. Hence the working point of the triode amplifier remains constant and the input-output characteristic of this stage remains normal. However, when cut-off of the transiron occurs,

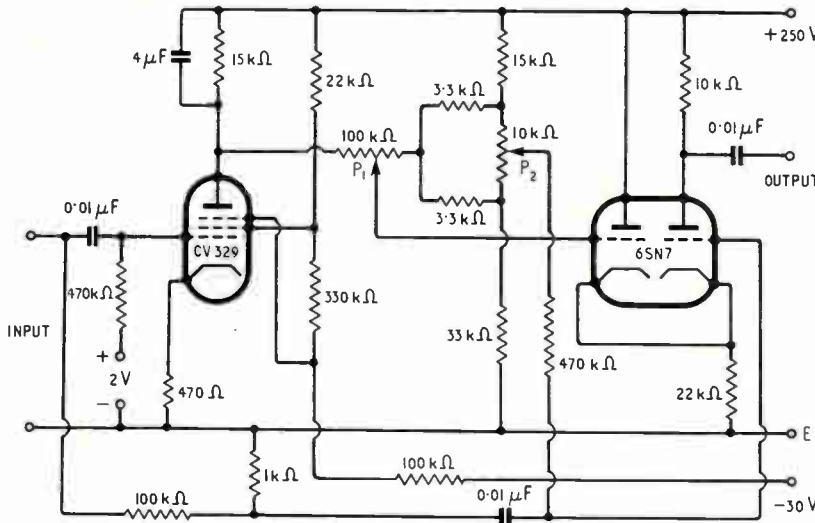

Fig. 9. Experimental limited amplifier.

charge on the anode capacitor is suddenly reduced and the working point of the triode amplifier is rapidly changed.

Two potentiometers have been included in the coupling of the 6SN7 to the transiron. Potentiometer P_1 determines the amount of the voltage

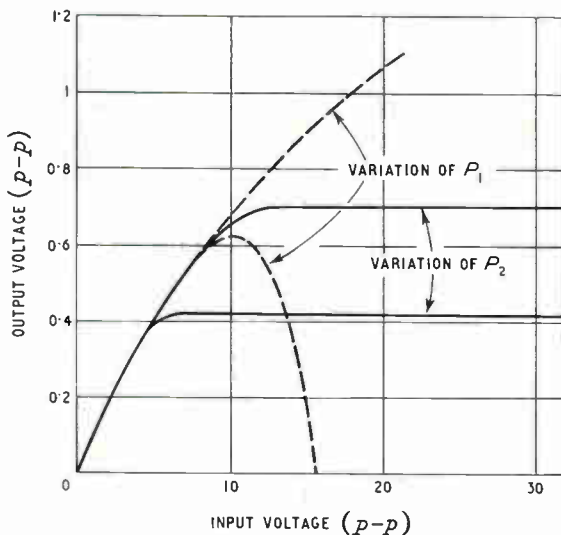

Fig. 10. Characteristics of experimental limited amplifier.

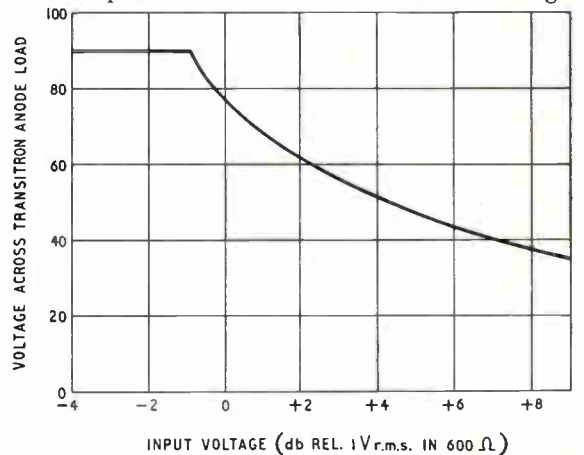

Fig. 11. Experimental limited amplifier; control-voltage characteristic.

change across the transitron anode load which actually reaches the grid of the 6SN7. Potentiometer P_2 determines the working point of the triode amplifier. Thus, in effect, P_1 decides the amount of level control applied and P_2 the level at which the control is applied.

Fig. 10 shows the characteristics that have been obtained with this amplifier, and it will be seen that by suitable adjustment of the potentiometers a limiting characteristic may be obtained which functions over a wide range of input levels. Of course, the experimental amplifier shown has no gain, but a considerable loss, due to the need of obtaining the correct levels for the limiting stage and for the transitron. Fig. 11 shows the change of voltage experienced at the transitron anode and clearly illustrates the well-defined and rapid change that occurs when the anode-current cut-off is reached. By a suitable matching of this characteristic with that of a controlled valve it should be possible to obtain an almost ideal

limiting characteristic. In a practical amplifier the transitron would derive its signal from the latter stages while controlling an earlier stage.

Other similar applications may come to mind such as an efficient frequency doubler or as the control element in a stabilized power supply with a flexible regulation characteristic.

Conclusions

Some possibilities of a little-known circuit have been explored but many more applications remain. In practice, the circuit requires careful design to overcome variations encountered between individual valves, but an exceedingly sharp trigger action can be produced.

The sensitivity of the circuit gives many circuit economies over conventional arrangements.

REFERENCE

¹ H. J. Reich, "Theory and Applications of Electron Tubes", H. J. Reich, Chapter 10, p. 351.

IMPEDANCE TRANSFORMATION BY FOUR-TERMINAL NETWORKS

Use of Graphical Methods

By S. Fedida, B.Sc., A.C.G.I., A.M.I.E.E.

(Concluded from p. 214, August issue)

4. Graphical Determination of Network Parameters

The investigation of Sections 2 and 3 has given us a good insight into the way in which the input impedance of a four-terminal network varies when the load impedance is made to change in certain specified ways. For example, if the phase angle of the load impedance remains constant, then the locus of the input impedance, either in the input-impedance or in the input reflection-coefficient diagrams is a circle. This is the case when, in high-frequency transmission lines, the load impedance is made up of a movable short circuit.

We shall now make use of this knowledge in the determination of some of the more important network parameters. These parameters, with certain exceptions, will not and, in general, cannot, be measured directly. Instead we shall make measurements of input impedance for certain known values of load impedance, or for unknown load impedances possessing certain known properties, e.g., pure reactances.

A purely reactive load impedance in high-frequency systems is a short-circuiting plunger, the position of which may be varied. A constant-conductance load can be obtained by means of a length of transmission line, terminated resistively at the far end, with a short-circuiting stub in shunt somewhere in front of it. A variable load of constant magnitude of reflection coefficient can be made up of a mismatched termination placed at the end of a line stretcher or, alternatively, it can be the input impedance of a matched attenuator, the output terminals of which are connected to a movable short circuit.

It is sufficient for the determination of any four-terminal network constants to measure, say, three out of the four open-circuit and short-circuit input impedances. Often, however, it is quicker to determine the required parameters directly.

The determination of open-circuit input impedances, in high-frequency systems, is none too easy since it involves the realization of a

good open circuit. This is usually obtained with the aid of a $\lambda/4$ length of transmission line shorted at the far end. For accurate measurements, short-circuiting pistons must be provided with micrometer screws and, in the case of hollow waveguides, a preliminary measurement of the correct transmission-line wavelength must be made.

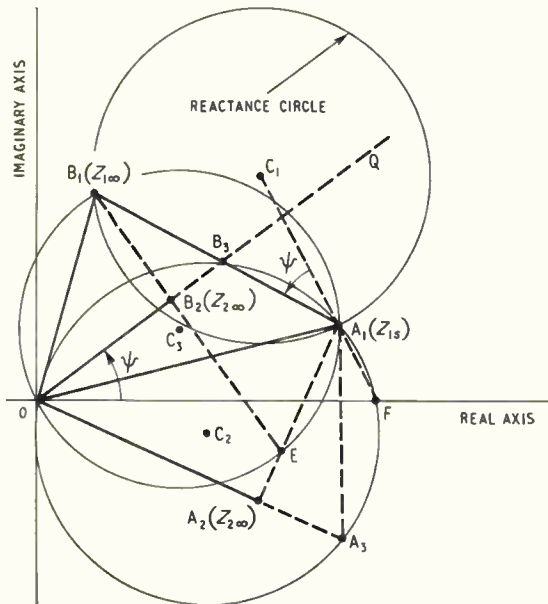

Fig. 26. Input-impedance diagram. Construction of open-circuit input impedances ($Z_{1\infty}$, $Z_{2\infty}$), given short-circuit input impedances (Z_{1s} , Z_{2s}) and reactance circle from terminals 1.

In view of these difficulties, it is preferable, especially when the necessary equipment is not available, to determine, instead, the short-circuit input impedances and the reactance circles. From this data the open-circuit input impedances can be deduced. This method has also the advantage of being self-checking and of smoothing out measurement errors, since the input-impedance points are known to lie on a circle.

4.1. Determination of Open-Circuit Input Impedance

4.1.1. Given short-circuit input impedance and reactance circle from terminals 1

This construction is of interest if both pairs of network terminals are accessible for measurements.

Let C_1 (Fig. 26) be the centre of the reactance circle, taken from terminals 1, A_1 , B_1 , A_2 and B_2 be points representing Z_{1s} , $Z_{1\infty}$, Z_{2s} , and $Z_{2\infty}$, respectively. Given C_1 , A_1 and A_2 it is required to determine points B_1 and B_2 .

If F is the intersection of radius C_1A_1 with the real axis and B the intersection of OB_2 with

A_1B_1 , the angles marked as ψ in the figure are equal and consequently points O , B_1 , A_1 and F are on a common circle. This property follows from the fact that to the imaginary axis and to line OQ in the load-impedance diagram, correspond the reactance circle and line A_1B_1 in the input-impedance diagram. Hence the angle $(\frac{\pi}{2} - \psi)$ at which these two pairs of lines intersect is the same, since it is preserved in the transformation (see Sect. 2.1).

Let A_3 be the intersection of OA_2 with circle C_2 . The two triangles OB_1B_3 and OA_1A_3 are similar since

$$\frac{Z_{1s}}{Z_{2s}} = \frac{Z_{1\infty}}{Z_{2\infty}} \dots \dots \dots (40)$$

and their angles at B_3 and A_3 subtend equal arcs on circle C_2 . Consequently their angles at B_1 and A_1 are equal and the circle of centre C_3 , passing through O , B_1 and A_1 is tangent at A_1 to A_1A_3 .

Finally, if E is the intersection of A_1A_2 and B_1B_2 , it must be on circle C_3 since, according to equation (40) the angles OB_1B_2 and OA_1A_2 are equal.

Using the above properties, we can, given C_1 , A_1 and A_2 , determine B_1 and B_2 as follows. First construct circle C_2 passing through O , A_1 and F , the latter point being the intersection of C_1A_1 with the real axis. Produce OA_2 to A_3 , and draw circle of centre C_3 , through O and A_1 and tangent at A_1 to A_3A_1 . The intersection of C_3 and C_1 provides B_1 , the point representing $Z_{1\infty}$.

To determine B_2 , find B_3 at the intersection of A_1B_1 with circle C_2 , and E , at the intersection of

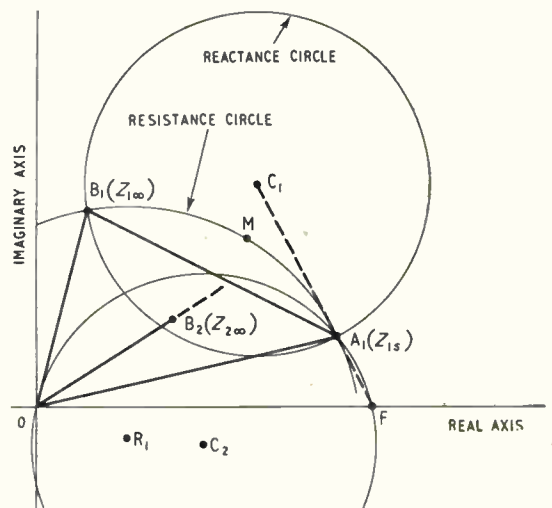

Fig. 27. Input-impedance diagram. Determination of open-circuit input impedances ($Z_{1\infty}$, $Z_{2\infty}$), given short-circuit input impedance (Z_s) input impedance due to a load impedance of unity (point M) and reactance circle, all measurements being taken from terminals 1.

A_1A_2 with circle C_3 . B_2 is the intersection of B_1E with OB_3 .

4.1.2. *Given short-circuit input impedance, input impedance due to a known resistive load and reactance circle, all measurements being taken from terminals 1*

It is not always convenient, or possible, in practice, to take measurements from both ends of the network, and in such cases the constructions given above cannot be used. An alternative method, making use of measurements taken from one end only of the network is given here. Let C_1 , A_1 and M_1 (Fig. 27), be the points representing the centre of the reactance circle, the short-circuit input impedance and the input impedance due to, say, a load impedance of unity, assuming all measurements to be made from terminals 1.

Point B_1 , representing the open-circuit input impedance from terminals 1, is found at the intersection of the reactance circle and the resistance circle (which represents the real axis). The latter is known to pass through A_1 and M_1 and to be orthogonal to the reactance circle. Its centre R_1 is thus simply determined.

If F is the intersection of C_1A_1 with the real axis, it has been proved, in 4.1.1 above, that the circle through A_1 , F and O intersects A_1B_1 at B_3 , so that the vector $Z_{2\infty}$ lies along OB_3 . The magnitude of $Z_{2\infty}$ is, according to equation (9), given by the ratio MB_1 to MA_1 , hence B_2 is easily found. Z_{2s} can now be determined by constructing a triangle OA_1A_2 (Fig. 26) similar to triangle OB_1B_2 .

4.1.3. *Case of symmetrical networks. Given short-circuit input impedance and reactance circle*

When the given network is known to be symmetrical, the construction given in 4.1.1 simplifies considerably. Referring to Figs. 26 and 28, we see that in this event point B_2 coincides with B_1 and A_2 with A_1 . It follows that the

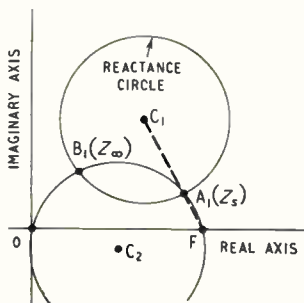

Fig. 28. *Input-impedance diagram. Construction of open-circuit input impedance (Z_{∞}), given short-circuit input impedance (Z_s) and reactance circle, for symmetrical networks.*

circle of centre C_2 , passing through O , A_1 and F , intersects circle C_1 at B_1 , the point representing the open-circuit input impedance.

4.2. Determination of Input Open-Circuit Reflection Coefficients

When the measured data is given in the Smith

Chart it is possible to determine the open-circuit input reflection coefficients using the methods indicated below.

4.2.1. *Given short-circuit input reflection coefficients and reactance circle from terminals 1*

The construction in the K diagram follows closely that in the impedance diagram explained in 4.1.1.

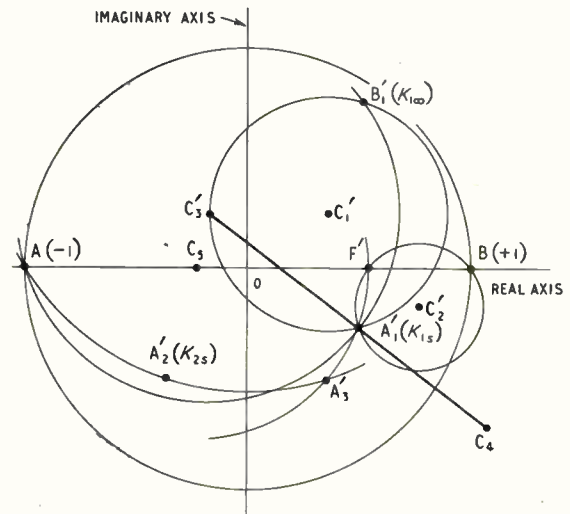

Fig. 29. *Input reflection-coefficient diagram. Determination of open-circuit reflection coefficients ($K_{1\infty}$, $K_{2\infty}$), given short-circuit reflection coefficients (K_{1s} , K_{2s}) and reactance circle from terminals 1 (circle of centre C'_1).*

Let C'_1 , A'_1 and A'_2 (Fig. 29) represent the centre of the reactance circle, taken from terminals 1, and the short-circuit input reflection coefficients from terminals 1 and 2 respectively. The circle corresponding to the radius $C'_1A'_1$, in Fig. 26, passes through A'_1 , which corresponds to A_1 and B , which corresponds to the points on C_1A_1 situated at infinity, and it has the property of being orthogonal to the reactance circle. Its centre is easily found at C'_2 and its intersection with the real axis is F' , which corresponds to F .

Similarly A'_3 , the point corresponding to A_3 , is found at the intersection of a circle of centre C'_3 , corresponding to circle C_2 , passing through F' , A'_1 and A , and a circle, corresponding to the line OA_2 , passing through A , B and A'_2 . The straight line A_1A_3 becomes the circle of centre C'_4 , passing through A'_1 , A'_3 and B . Finally, to circle C_3 corresponds a circle of centre C'_3 , passing through A and A'_1 and touching circle C'_4 at A_1 . B'_1 , the open-circuit input reflection coefficient, is found at the intersection of circles C'_1 and C'_3 .

The same general method can be used for the determination of B'_2 , the point corresponding to B_2 .

4.2.2. Given short-circuit input reflection coefficient, input reflection coefficient due to a known resistive load and reactance circle, it being assumed that all measurements are taken from terminals 1

In this case we follow closely the method indicated in 4.1.2.

We first draw the resistance circle of centre R'_1 (Fig. 30), which passes through A'_1 , M'_1 and is orthogonal to the reactance circle. The second

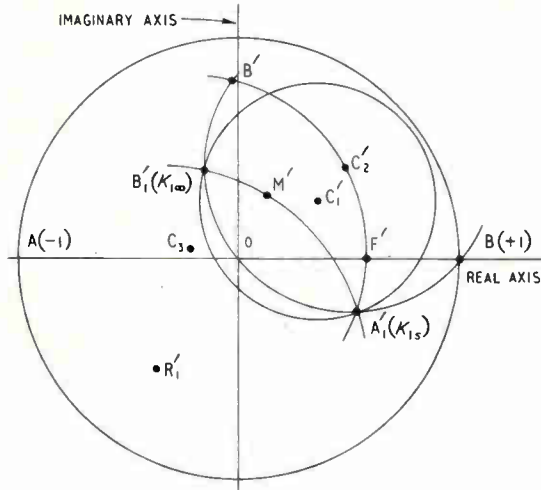

Fig. 30. Input reflection-coefficient diagram. Determination of open-circuit input reflection coefficient ($K_{1\infty}$), given short-circuit input reflection coefficient (K_{1s}), input reflection coefficient (point M'), due to unity load impedance and reactance circle (circle of centre C'_1), all measurements being taken from terminals 1.

intersection B'_1 , with the reactance circle, provides the open-circuit reflection coefficient from terminals 1.

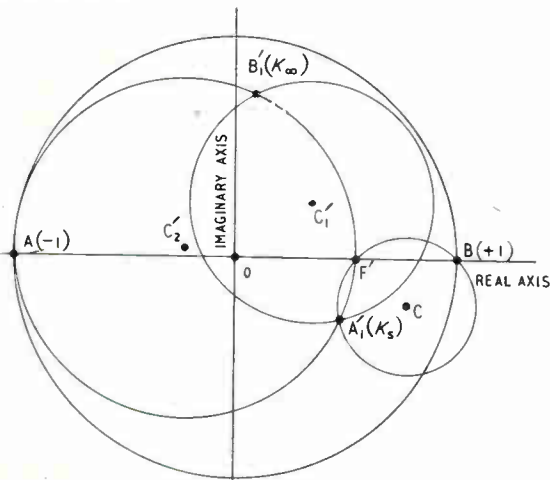

Fig. 31. Input reflection-coefficient diagram. Determination of open-circuit input reflection coefficient (K_{∞}), given short-circuit input reflection coefficient (K_s) and reactance circle (circle of centre C'_1), for a symmetrical network.

B'_3 , the point corresponding to B_3 , in Fig. 27, is found at the intersection of circle C_3 , through A, A'_1 and F'_1 , the latter point being determined as in the above paragraph, and circle C'_2 , corresponding to line A_1B_1 , which passes through A'_1, B'_1 and B . B'_2 , the point representing $K_{2\infty}$, is on the circle through B'_1, A and B , which corresponds to the line OB_3 . The magnitude of $Z_{2\infty}$ can now be readily determined from equation (20), all the terms in that equation being easily measurable on the chart.

4.2.3. Case of symmetrical networks. Given short-circuit reflection coefficient and reactance circle

Following the method of 4.1.3, we first determine the circle of centre C (Fig. 31), which corresponds to the radius C_1A_1 (Fig. 28). Circle C is orthogonal to circle C'_1 , the reactance circle, and it passes through A'_1 and B . Its intersection F' , with the real axis, corresponds to point F . To circle C_2 , in Fig. 28, corresponds circle C'_2 , passing through F', A'_1 and A . The intersection of C'_2 with C'_1 provides B'_1 , the point representing K_{∞} , the open-circuit input reflection coefficient.

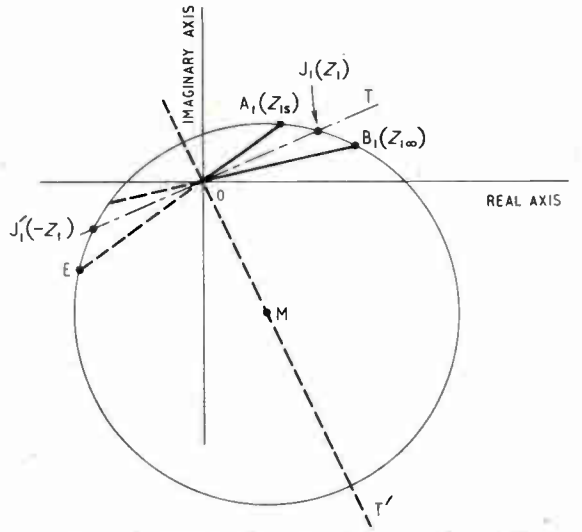

Fig. 32. Input-impedance diagram. Determination of image impedance (Z_1) given open-circuit and short-circuit input impedances ($Z_{1\infty}, Z_{1s}$) at terminals 1.

4.3. Determination of Image Parameters

4.3.1. Image impedance

It is known that the image impedances Z_1 and Z_2 are related to the open-circuit and short-circuit impedances by the following equations

$$Z_{1s} \cdot Z_{1\infty} = Z_1^2 \quad \dots \quad (41)$$

$$Z_{2s} \cdot Z_{2\infty} = Z_2^2 \quad \dots \quad (42)$$

For a symmetrical network (41) and (42) reduce to

$$Z_s \cdot Z_{\infty} = Z_0^2$$

Equation (41), for example, indicates that Z_1 is the geometric mean of the open-circuit and short-circuit impedances, measured at terminals 1 of the network, and it can therefore be determined geometrically as follows.

Let A_1 and B_1 (Fig. 32) represent Z_{1s} and $Z_{1\infty}$, respectively. J_1 , the point representing Z_1 , is found at the intersection of the bisector OT to angle B_1OA_1 , and the circle through A_1 and B_1 , the centre M of which is on the perpendicular OT' to OT .

Since J_1 is on the bisector OT , the phase angle of the impedance represented by J_1 is the arithmetic mean of the phase angles of Z_{1s} and $Z_{1\infty}$. Furthermore, if E and J'_1 are the second intersections of the straight lines OA_1 and OJ_1 , respectively, with the circle of centre M , it is known that

$$|OE| = |OB_1|, |OJ_1| = |OJ'_1|$$

and $|OJ_1| \cdot |OJ'_1| = |OA_1| \cdot |OE|$.

Hence the magnitude of OJ_1 is the geometric mean of the magnitudes of Z_{1s} and $Z_{1\infty}$. It follows that the vector OJ_1 represents Z_1 .

4.3.2. Image transfer constant

We shall base the determination of the image transfer constant e^θ , of a four-terminal network on the following formulae

$$\frac{Z_{1in} - Z_1}{Z_{1in} + Z_1} = \frac{Z_{2L} - Z_2}{Z_{2L} + Z_2} e^{-2\theta} \quad \dots \quad (43)$$

$$\frac{Z_{2in} - Z_2}{Z_{2in} + Z_2} = \frac{Z_{1L} - Z_1}{Z_{1L} + Z_1} e^{-2\theta} \quad \dots \quad (44)$$

When the network is symmetrical (43) and (44) reduce to

$$\frac{Z_{in} - Z_0}{Z_{in} + Z_0} = \frac{Z_L - Z_0}{Z_L + Z_0} e^{-2\theta} \quad \dots \quad (45)$$

If Z_{2L} is made equal to zero, or infinity, Z_{1in} becomes Z_{1s} or $Z_{1\infty}$, respectively, and we obtain the following relations

$$\frac{Z_{1s} - Z_1}{Z_{1s} + Z_1} = -e^{-2\theta} \quad \dots \quad (46)$$

$$\frac{Z_{1\infty} - Z_1}{Z_{1\infty} + Z_1} = e^{-2\theta} \quad \dots \quad (47)$$

Similarly, if Z_{1L} is made equal to zero, or infinity, we obtain

$$\frac{Z_{2s} - Z_2}{Z_{2s} + Z_2} = -e^{-2\theta} \quad \dots \quad (48)$$

$$\frac{Z_{2\infty} - Z_2}{Z_{2\infty} + Z_2} = e^{-2\theta} \quad \dots \quad (49)$$

4.3.3. Image transfer constant in the impedance diagram

Let us rewrite equation (46) as follows

$$\left| \frac{Z_1 - Z_{1s}}{Z_1 + Z_{1s}} \right| e^{j(\alpha_1 - \alpha_s)} = e^{-2\alpha - 2j\beta} \quad \dots \quad (50)$$

where $\alpha_1, \alpha_s, \alpha$ and β are defined as below

$$Z_1 - Z_s = |Z_1 - Z_s| \cdot e^{j\alpha_1} \quad \dots \quad (51)$$

$$Z_1 + Z_s = |Z_1 + Z_s| \cdot e^{j\alpha_s} \quad \dots \quad (52)$$

$$\theta = \alpha + j\beta \quad \dots \quad (53)$$

If J_1 and J'_1 represent the impedances Z_1 and $-Z_1$ (Fig. 33), then $Z_1 - Z_s$ and $Z_1 + Z_s$ are represented by the vectors A_1J_1 and J'_1A_1 , respectively, where A_1 represents Z_{1s} . It follows that -2β is equal to the angle between A_1J_1 and J'_1A_1 , while the attenuation ratio, e^α , is equal to the square root of the inverse ratio of the above distances. The same relations apply in the case of symmetrical networks provided Z_{1s} and Z_1 are replaced by Z_s and Z_0 , respectively.

4.3.4. Image transfer constant in the Smith Chart

Let us start from equation (46) and subtract unity from both sides. We obtain

$$1 + e^{-2\theta} = \frac{2Z_1}{Z_1 + Z_{1s}} \quad \dots \quad (54)$$

If now we add unity to both sides we obtain

$$e^{-2\theta} - 1 = -\frac{2Z_{1s}}{Z_1 + Z_{1s}} \quad \dots \quad (55)$$

The ratio of equations (54) and (55) is

$$\frac{e^{-2\theta} - 1}{e^{-2\theta} + 1} = -\frac{Z_{1s}}{Z_1} = K_{-2\theta} \quad \dots \quad (56)$$

where $K_{-2\theta}$ is the reflection coefficient of $e^{-2\theta}$.

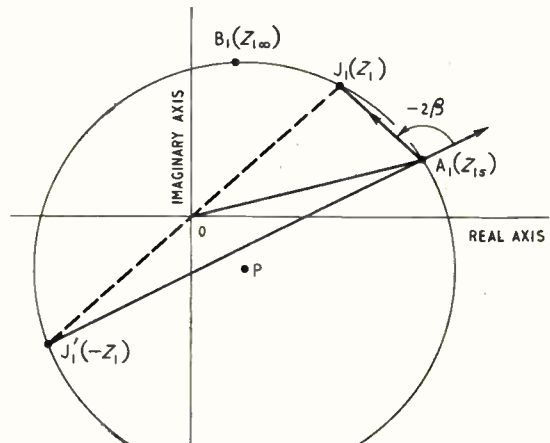

Fig. 33. Input-impedance diagram. Determination of image transfer constant, given Z_{1s} and $Z_{1\infty}$.

We can also deduce, in a straightforward manner, the reflection coefficient of $e^{2\theta}$. This is

$$K_{2\theta} = \frac{Z_{1s}}{Z_1} \quad \dots \quad (57)$$

If a Smith Chart, with the constant-phase and constant-magnitude circles, is available, it is a simple matter to calculate the reflection co-

efficient of the image loss, given the reflection coefficients of Z_{1s} and Z_1 . $K_{2\theta}$, can then, by reference to the above-mentioned circles, in the same chart, be converted into an attenuation and a phase change.

If the reflection coefficient K_1 , of the image impedance Z_1 , is not given, the value of $K_{2\theta}$ can be determined as follows

From equation (57), we find after squaring

$$(K_{2\theta})^2 = Z_{1s}^2 / Z_1^2 \quad \dots \quad (58)$$

Since $Z_1^2 = Z_{1s} \cdot Z_{1\infty}$, we obtain after substitution in (58)

$$(K_{2\theta})^2 = Z_{1s} / Z_{1\infty} \quad \dots \quad (59)$$

Again, using the constant-phase and constant-magnitude circles in the Smith Chart, $K_{2\theta}$ can be determined from the reflection coefficients of Z_{1s} and $Z_{1\infty}$.

If constant-phase and constant-magnitude circles are not already drawn, then the values of Z_{1s} and $Z_{1\infty}$, for use in equation (59) can be determined by the relation

$$Z = \frac{1 + K}{1 - K} \quad \dots \quad (60)$$

which can be easily derived from equation (1).

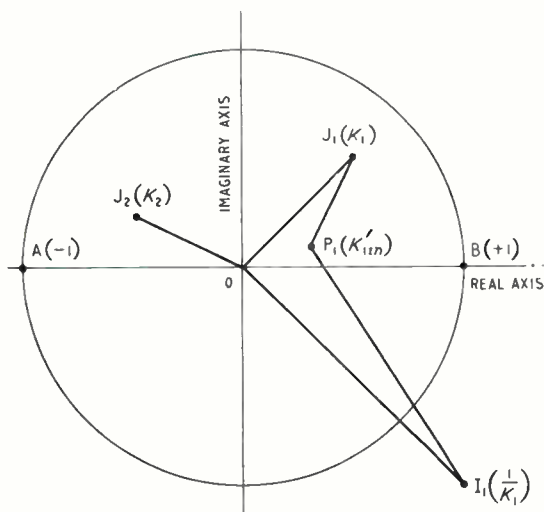

Fig. 34. Input reflection-coefficient diagram. Determination of image transfer constant given Z_1 , Z_2 and K'_{1in} (the input reflection coefficient when the load impedance is equal to unity).

If A, B and L (Fig. 34), are the points in the Smith Chart representing $K = -1$, $K = +1$ and the reflection coefficient of an impedance Z , then according to (60) the magnitude of Z is given by the ratio of the distances AL to LB, while its phase angle is equal to the angle through which LB must rotate, around L, to coincide with the direction AL.

4.3.5. Image transfer constant in the Smith Chart. Alternative method

Let us start from equation (43) and replace all impedances by their values in terms of reflection coefficients. We then obtain

$$\frac{1 + K_{1in}}{1 - K_{1in}} \frac{1 + K_1}{1 - K_1} = \frac{1 + K_{2L}}{1 - K_{2L}} \frac{1 + K_2}{1 - K_2} e^{-2\theta} \quad \dots \quad (61)$$

After cross-multiplying and simplifying we find

$$\frac{K_{1in} - K_1}{1 - K_1 K_{1in}} = \frac{K_{2L} - K_2}{1 - K_2 K_{2L}} e^{-2\theta} \quad \dots \quad (62)$$

This can be transformed into

$$\frac{K_{1in} - K_1}{K_{1in} - 1/K_1} = \frac{K_{2L} - K_2}{K_{2L} - 1/K_2} \cdot \frac{K_1}{K_2} e^{-2\theta} \quad \dots \quad (63)$$

For a load impedance of unity, $K_{2L} = 0$ and equation (63) becomes

$$\frac{K'_{1in} - K_1}{K'_{1in} - 1/K_1} = K_1 K_2 e^{-2\theta} \quad \dots \quad (64)$$

Where K'_{1in} represents in equation (64) the input reflection coefficient for a load impedance of unity.

If J_1, J_2, P_1 and I_1 (Fig. 34), represent the reflection coefficients K_1, K_2, K'_{1in} and $1/K_1$, then the left-hand side of equation (64) represents the ratio of the vectors PJ_1 and PI_1 . It follows that the image transfer constant can be simply determined from the figure.

A simpler method still is to make use of the open-circuit or short-circuit reflection coefficients. If, in equation (63), we make $K_{2L} = -1$ (i.e., $Z_{2L} = 0$), we obtain

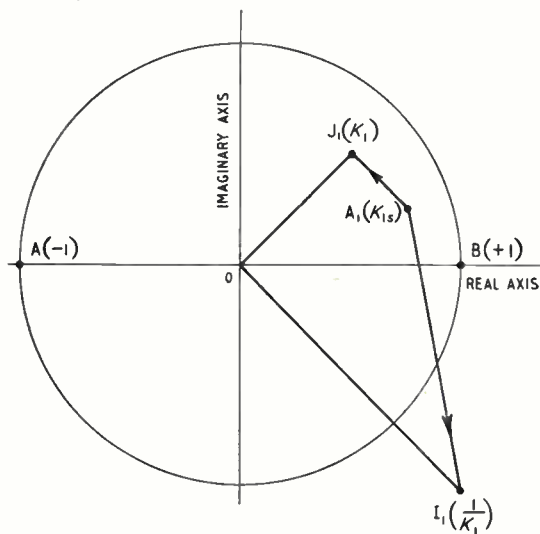

Fig. 35. Input reflection-coefficient diagram. Determination of image transfer constant given K_1 and K_{1s} .

$$\frac{K_{1s} - K_1}{K_{1s} - 1/K_1} = \frac{1 + K_2}{1 + 1/K_2} \cdot \frac{K_1}{K_2} e^{-2\theta} \quad \dots \quad (65)$$

which after simplification reduces to

$$\frac{K_{1s} - K_1}{K_{1s} - 1/K_1} = K_1 e^{-2\theta} \quad \dots \quad (66)$$

A similar relation can be obtained by making $K_{2L} = -1$ (i.e., $Z_{2L} = \infty$), when equation (63) becomes

$$\frac{K_{1\infty} - K_1}{K_{1\infty} - 1/K_1} = -K_1 e^{-2\theta} \quad \dots \quad (67)$$

If J_1, I_1 and A_1 (Fig. 35) represent the reflection coefficients $K_1, 1/K_1$ and K_{1s} , then the left-hand side of equation (66) represents the ratio of vectors $A_1 J_1$ to $A_1 I_1$. The image transfer constant can be easily measured off the diagram.

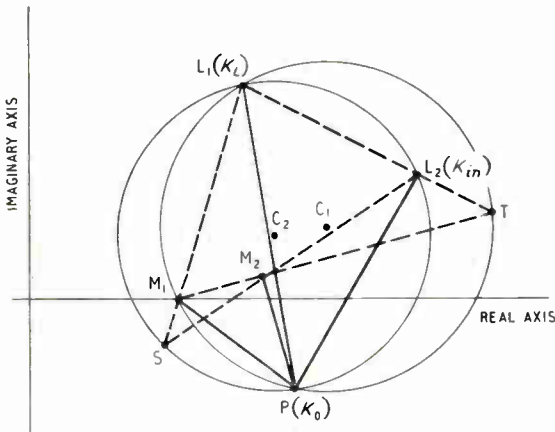

Fig. 36. Input reflection-coefficient diagram. Determination of reflection coefficient, K_0 , of characteristic impedance of symmetrical network, assuming $K_0 < 0.1$.

In practice it may not always be possible to place I_1 within a reasonable size of chart, especially when K_1 is very small (i.e., when the image impedance Z_1 is nearly equal to unity). In such cases it is possible to use an approximate formula, the accuracy of which increases as K_1 reduces in value.

If we neglect K_1 in the denominator of equation (66) we find

$$K_1 - K_{1s} = e^{-2\theta} \quad \dots \quad (68)$$

This indicates that the image transfer constant is given directly by the vector $A_1 J_1$ (Fig. 35), provided K_{1s} is so small as to be negligible compared with $1/K_1$.

4.3.6. Case of symmetrical networks in the Smith Chart

Equations (66), (67) and (68) and the corresponding geometrical applications can be used equally well when the network is symmetrical, in which case $K_{1s}, K_{1\infty}$ and K_1 become K_s, K_∞ and K_0 , respectively.

Equation (63) becomes

$$\frac{K_{in} - K_0}{K_{in} - 1/K_0} = \frac{K_L - K_0}{K_L - 1/K_0} e^{-2\theta} \quad \dots \quad (69)$$

4.3.7. Image parameters in the case of nearly-matched low- or moderate-loss networks

We shall assume that the image impedances of the given network are fairly close to the generator impedance, or in the case of very high frequencies to the characteristic impedance of the measuring line; in other words, that K_1 and K_2 are less than 0.1. This assumption implies that Z_1 and Z_2 are within 10% of unity and we can therefore neglect K_{1in} and K_{2L} in the denominators of equation (63) to obtain

$$\frac{K_{1in} - K_1}{K_{2L} - K_2} = e^{-2\theta} \quad \dots \quad (70)$$

If the given network is known to be symmetrical, then equation (70) reduces to

$$\frac{K_{in} - K_0}{K_L - K_0} = e^{-2\theta} \quad \dots \quad (71)$$

Let L_1 and L_2 (Fig. 36) be the points representing load and input reflection coefficients, respectively, and P the point representing the characteristic impedance of the network. Equation (71) can be written as

$$\frac{PL_1}{PL_2} = e^{-2\theta} \quad \dots \quad (72)$$

If M_1 and M_2 are two other points having the same relation as L_1 and L_2 , then P can be found at the intersection of two circles such as C_1 and C_2 passing through a pair of points out of the four points L_1, L_2, M_1 and M_2 and either of points S or T , where S is the intersection of $L_1 M_1$ and $L_2 M_2$ while T is the intersection of $L_1 L_2$ and $M_1 M_2$.

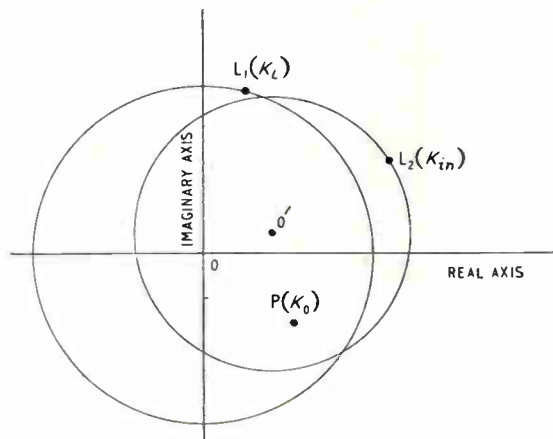

Fig. 37. Input reflection-coefficient diagram. The constant load reflection circle for symmetrical low-loss network, the characteristic impedance of which is nearly equal to unity.

impedance, then the radius of the reactance circle (for which $|K_{2L}| = 1$) is equal to $|S|^2$, the power loss of the network [i.e., the ratio of the power delivered to the load when the latter is connected to the generator (a) via the network and (b) direct].

If K'_{2in} is either not small or unknown, we can determine an input reflection-coefficient circle for a small value of load reflection coefficient, K_{2L} . The radius R of this circle is given by equation (78). It is clear that if the insertion loss is high, then $|S|^2$ is correspondingly small, and the radius R is very small, since K_{2L} has already been assumed to be small also. It follows that this approximation is not of great practical use if the insertion loss is high. When, however, the insertion loss is small or moderate, the approximation can be used.

Provided either K'_{2in} or K_{2L} is as small as 0.1, which is equivalent to a standing-wave ratio of 1.2, then the insertion loss is known to an accuracy of at least 1%, which is sufficient for most purposes. The final choice of K_{2L} depends mainly upon whether a circle of reasonable size is obtained.

4.4.5. Insertion-loss determination in the case of symmetrical networks

The methods outlined in Sects 4.4.1 to 4.4.4 are equally well applicable to symmetrical networks, with certain simplifications.

In the case of 4.4.1 and 4.4.3, points P_1 and P_2 coincide (we shall call the common point P) and the displaced inverse circles of centre O' are all concentric with the unity circle.

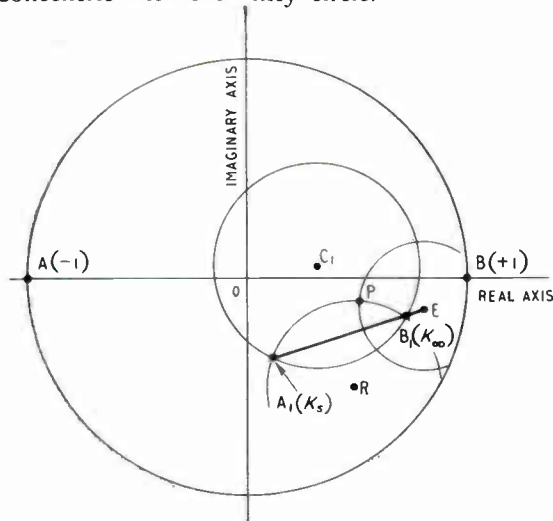

Fig. 41. Input reflection-coefficient diagram. Determination of point P , representing the input reflection coefficient at primary of symmetrical network, with secondary terminated in unity impedance, given reactance circle C_1 and primary reflection coefficient, K_s , with short-circuited secondary.

If, however, a well-matched load is not available for the determination of P , the reactance circle and the short-circuit input reflection coefficient can be used instead.

Let A (Fig. 41) be the primary input reflection coefficient with the secondary short-circuited, and C_1 , the reactance circle. We first determine B_1 , the point representing the primary input reflection coefficient with the secondary open-circuited, using the method indicated in Sect. 4.2.3.

The point P , since it represents the primary reflection coefficient with the secondary terminated in unity impedance, is on the resistance circle. This passes through A_1 and B_1 and it is orthogonal to the reactance circle.

If now we apply equation (20) to symmetrical networks we obtain

$$\frac{K_{in} - K_s}{K_{in} - K_\infty} = -\frac{Z_L}{1 + K_\infty} \cdot \frac{1 - K_s}{1 - K_\infty} \quad \dots \quad (79)$$

which simplifies to

$$\frac{K_{in} - K_s}{K_{in} - K_\infty} = -\frac{Z_L(1 - K_s)}{1 + K_\infty} \quad \dots \quad (80)$$

When Z_L is made equal to unity, equation (80) becomes

$$\frac{K'_{in} - K_s}{K'_{in} - K_\infty} = -\frac{1 - K_s}{1 + K_\infty} \quad \dots \quad (81)$$

The geometrical equivalent of equation (81) is, neglecting the angular information,

$$\frac{|A_1P|}{|B_1P|} = \frac{|A_1B|}{|AB_1|} = \text{constant} \quad \dots \quad (82)$$

Therefore P is also on a circle centred on A_1B_1 and orthogonal to the reactance circle. The intersection of this circle with the resistance circle determines P .

4.5. Determination of Transmission Efficiency⁶

If we define the transmission efficiency of a quadripole as the ratio of output to input power when the quadripole is inserted in an otherwise matched transmission line, we can prove that

$$T_1 = \frac{S^2}{1 - |K'_{1in}|^2} \quad \dots \quad (83)$$

and

$$T_2 = \frac{S^2}{1 - |K'_{2in}|^2} \quad \dots \quad (84)$$

where the transmission efficiency is T_1 when the power flow is from terminals 1 to terminals 2 and T_2 when the direction of power flow is reversed.

If we compare (84) with (39), we see that if the load reflection coefficient, K_{2L} , is made equal to unity (the load is then a pure reactance), then

the radius of the reactance circle taken from terminals 1 is equal to T_2 . It follows therefore that in order to determine T_1 we must take the reactance circle from terminals 2.

Since, however, it is not always possible to take measurements from terminals 2, the following method enables the necessary data to be obtained from terminals 1 only. Determine the reactance circle, and the input reflection coefficients first with a matched load, then with a short circuit at the secondary terminals. Using the method indicated in Sect. 4.4.2, determine P_2 , the point representing the input reflection coefficient at the secondary, when the primary is terminated in a matched load, and the insertion-loss vector S . Given P_2 and S , determine the secondary reactance circle, by the reverse

procedure of Sect. 4.4.1 or obtain T_1 direct from equation (83).

Acknowledgment

The writer wishes to thank the Chief of Research, Marconi's Wireless Telegraph Company Limited, for permission to publish this paper.

REFERENCES

- ¹A. G. Warren, "Mathematics Applied to Electrical Engineering" Chap. I, Chapman & Hall, 1944.
- ²Dr. F. Feldtkeller, "Einführung in die Vierpoltheorie der Elektrischen Nachrichtentechnik", Verlag von S. Hirzel, Leipzig II, Edition 1942.
- ³A. C. Bartlett, "The Theory of Electrical Artificial Lines and Filters", Chap. VIII, Chapman & Hall, 1930.
- ⁴A. G. Warren, "Mathematics applied to Electrical Engineering", Chap. XII, Chapman & Hall, 1944.
- ⁵R. W. Beatty, "Determination of Attenuation from Impedance Measurements", *Proc. Inst. Radio Engrs*, August 1950, Vol. 38, pp. 895-897.
- ⁶A. L. Cullen, "Measurement of Microwave Transmission Efficiency", *Wireless Engineer*, August 1949, Vol. 26, pp. 255-257.

FIELD-STRENGTH CALCULATION

New Method for Mixed Paths

By Kiyohisa Suda

(NHK, Japan Broadcasting Corporation, Tokyo)

SUMMARY.—A simple method for the calculation of field strength over mixed paths is explained with the aid of a comparison with measured values of field strength. An equivalent conductivity is obtained from the 'numerical distance' and field strength is calculated easily by conventional curves.

Introduction

THE calculation of medium-wave field strength over a composite path, such as part land and part sea, has been the subject of discussion for many years and it is difficult to estimate field strength in mountainous countries. A number of methods have been tried, however, with various degrees of success, among which three methods, proposed by P. P. Eckersley, Somerville and G. Millington,¹ seem to be practically useful. Values calculated by the three methods were compared with the observed results in the paper by H. L. Kirke,² and none of the three methods can give a complete solution for all conditions.

The method proposed by G. Millington, however, was provisionally adopted for the calculation of ground-wave field strength over a mixed path by the 6th General Assembly of the C.C.I.R., Geneva, 1951, and it was recommended that further experimental results should be obtained to verify the method and, in addition, that this problem should be studied theoretically and experimentally.

A new method (Equivalent Conductivity Method), simpler than the Millington method, has recently been devised by the author and a brief description of the method is given below together with the comparison with measured values of field strength.

Equivalent Conductivity Method

As is well known, A. Sommerfeld has defined the so-called 'numerical distance'³ for the calculation of ground-wave propagation over a homogeneous plane earth; i.e.,

$$\rho = \left| \frac{k_1^4}{k_2^4} \cdot \frac{k_1^2 - k_2^2}{k_1^2} \cdot \frac{k_1 d}{2} \right| \quad \dots \quad (1)$$

where

- ρ = numerical distance
- $k_1 = \omega/c$ (in the air)
- $k_2^2 = (\epsilon\omega^2 + j\sigma\omega)/c^2$ (in the earth)⁴
- ω = angular velocity
- c = light velocity
- σ = conductivity
- ϵ = dielectric constant
- d = actual distance

In the practical case ($|k_2^2| \gg k_1^2$ and $\sigma\omega \gg \epsilon\omega^2$),

MS accepted by the Editor, November 1953

a real numerical distance is derived from equation (1), and is

$$\rho = K \frac{d}{\sigma} \dots \dots \dots (2)$$

($K = \text{const.}$)

for a given frequency.

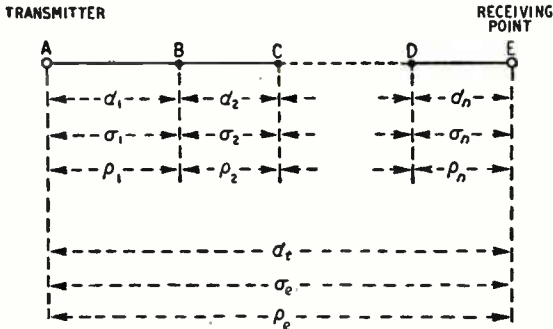

Fig. 1. Composite path comprising parts A, B, C, D and E; d = actual distance; σ = conductivity and ρ = numerical distance.

$$\begin{aligned} &= \rho_1 + \rho_2 + \dots + \rho_n \\ &= K \left(\frac{d_1}{\sigma_1} + \frac{d_2}{\sigma_2} + \dots + \frac{d_n}{\sigma_n} \right) \\ &= K \times \sum \frac{d_n}{\sigma_n} \dots \dots \dots (3) \end{aligned}$$

From equation (3) the equivalent conductivity between A and E is obtained as follows:

$$\frac{d_t}{\sigma_e} = \sum \frac{d_n}{\sigma_n}$$

or
$$\sigma_e = \frac{d_t}{\sum \frac{d_n}{\sigma_n}} \dots \dots \dots (4)$$

Putting σ_e = equivalent conductivity for the path A—E, the field strength at E can easily be obtained from conventional field-strength curves, say, the F.C.C. (Norton) curves.

Experimental Verification

Some verification of the method has been obtained with the aid of experimental measurements carried out in England, Denmark and

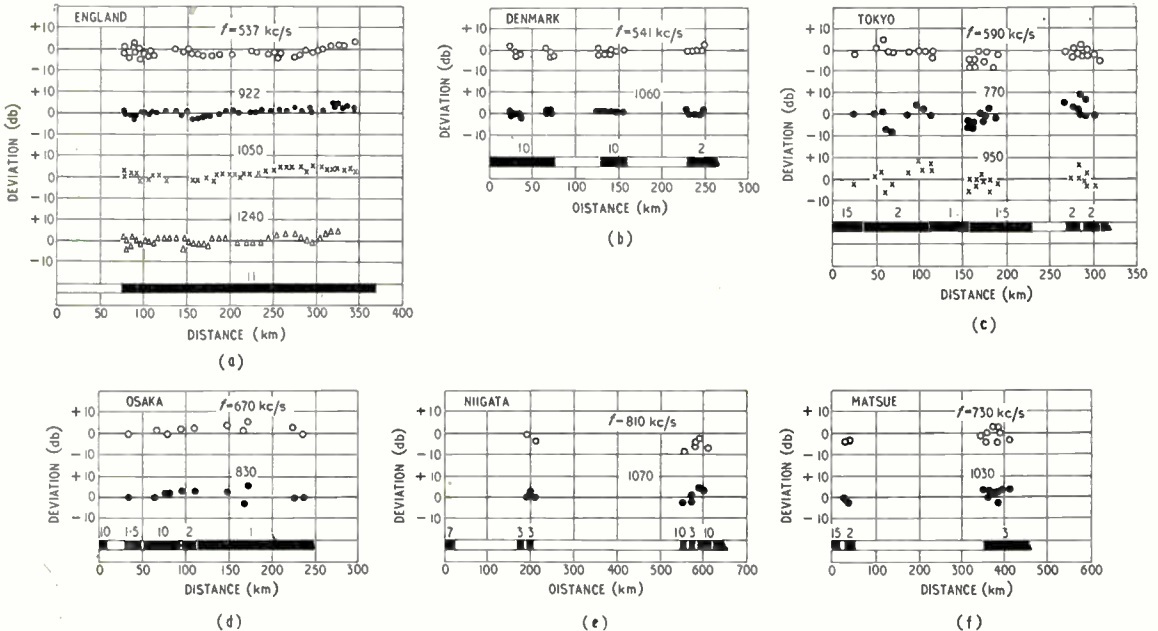

Fig. 2. The results obtained in various places and for various frequencies f are illustrated here. The points indicate the deviation of the measured from the calculated values. At the bottom, the land parts of the path are shown shaded with their conductivities in 10^{-14} c.g.s. e.m.u. marked against them. The other parts represent sea for which the conductivity is taken as $5,000 \times 10^{-14}$ c.g.s. e.m.u.

In Fig. 1, conductivities of each of the sections AB, BC, CD, DE, are assumed to be uniform (they are equivalent conductivities considering the geographical conditions as well as mountains, rivers, valleys, buildings, etc.), and we get

$$\rho_e = K \frac{d_t}{\sigma_e}$$

Japan. The results of measurements in England are quoted from Ref. (2), those in Denmark from Ref. (4), and those in Japan are abstracted from the field intensity measurements of NHK broadcasting stations during 1947–1951. The comparisons are shown in Fig. 2, among which (c)—(f) refer to the Japanese measurements.

The deviation is smaller than ± 10 db and, in general, the calculated values well agree with experimental results.

Conclusion

This method is derived from the 'numerical distance' defined by A. Sommerfeld and has an advantage in the ease of calculation of field strength at many points; e.g., in predicting the coverage of broadcasting stations. The fundamental problem with the method is to estimate conductivities for each of the sections in Fig. 1. and these are determined by geographical

conditions, considering various values of conductivities derived from many field-strength measurements.

REFERENCES

- ¹ G. Millington, "Ground Wave Propagation over an Inhomogeneous Smooth Earth", *Proc. Instn elect. Engrs*, Part III, January 1949, Vol. 96, p. 58.
- ² H. L. Kirke, "Calculation of Ground-Wave Field Strength over a Composite Land and Sea Path", *Proc. Instn Radio Engrs*, May 1949, Vol. 37, p. 489.
- ³ A. Sommerfeld, "Über die Ausbreitung der Wellen in der drahtlosen Telegraphie", *Annalen der Physik*, Bd 28, 1909.
- ⁴ G. Millington and G. A. Isted, "Ground Wave Propagation over an Inhomogeneous Smooth Earth, Part 2, Experimental Evidence and Practical Implications", *Proc. Instn elect. Engrs*, Part III, July 1950, Vol. 97, p. 209.

NEW BOOKS

Electrical Transients

By L. A. WARE and G. R. TOWN. Pp. 222 + xi. The MacMillan Company (New York), 10 South Audley Street, London, W.1. Price 33s. (\$4.75).

The authors are professors of electrical engineering in the State University of Iowa and the Iowa State College respectively and they have written this book for use "in a course in transient circuits at the senior level". They believe, however, that it could be "used with junior electrical engineering students". They state that no background beyond differential equations is required.

The introduction is largely a refresher course in the solution of ordinary differential equations of simple kind in relation to electrical transients. The Laplace transform is introduced in Chapter 2 and simple applications of it are treated in Chapter 3. The remaining chapters are headed:—Compound, switching and transition transients; The RLC circuit; A.C. applied e.m.f.'s; Miscellaneous applied e.m.f.'s; Repeated and discontinuous e.m.f. functions; and Vacuum-tube circuits. There are three appendices.

Although in one sense the content of the book agrees with the title, in another it is much more about the Laplace transform. The whole essence of the book is how to solve problems on transients in electrical circuits by means of the Laplace transform. So much is this the case that the reviewer was quite surprised to find, on closing the book, that its title is "Electrical Transients"; he had quite thought it to be "An Introduction to the Laplace Transform"!

As an introduction to the transform the book is quite a good one and it certainly provides one of the easiest paths available to those who wish to learn how to use it. This is because most of the theory and proofs are omitted, as they should be in an elementary book. However, in spite of this, the treatment is not as good as it could be; a simpler one is possible.

It is surprising that the authors should write down their circuit equations in ordinary differential form and then translate them into Laplace notation. One of the major advantages of the Laplace system, which it shares with the Heaviside operational calculus, is that it enables one to write down the circuit equations exactly as for the steady-state a.c. case merely by writing pL in place of $j\omega L$ and $1/pC$ instead of $1/j\omega C$.

There is, it is true, a reference in a footnote to the possibility of substituting s (which the authors rather inconveniently use instead of the usual p) for $j\omega$. The suggestion is, however, that having written an equation in terms of $j\omega$ one can then substitute s for it. This would be a dangerous practice for one would be liable to overlook terms in which the ' j ' had disappeared by squaring.

It is strongly implied in this book that the major advantage of the Laplace transform over other methods is the ease with which initial conditions are dealt. The authors ignore the fact that they are equally easily dealt with in the Heaviside system. They also ignore the real difficulty of all methods, which is that of finding the roots of the denominator of the p -equation when it is of higher degree than the second, as it is in all but fairly simple cases. No mention is made of the possibility of obtaining a solution in the form of a power series in t . Such a solution can always be obtained but it is not always useful, of course; sometimes, however, it is very useful, for conditions may be such that a few terms of the series will suffice.

The authors have slipped on p. 208 where they ascribe to the circuit of Fig. 9.18 a property which it does not possess. Their mathematics are right but they draw the wrong conclusion from them; it is a minor slip which is obvious by inspection of the circuit.

W. T. C.

Fields and Waves in Modern Radio (2nd Edition)

By SIMON RAMO and JOHN R. WHINNERY. Pp. 576 + viii. Chapman & Hall, Ltd., 37 Essex Street, London, W.C.2. Price 70s.

The first edition of this book appeared in 1944. The present one differs mainly in the use of m.k.s. units, extra problems, the addition of new material and the deletion of some of the less useful parts. The new material includes a chapter on microwave networks and discussions on horns, slot aerials, etc., in the chapter on radiation.

The book, which is of American origin, opens with a chapter on oscillation and wave fundamentals. Chapter 2 deals with the equations of stationary electric and magnetic fields, and Chapter 3 with the solutions to static field problems. Maxwell's equations and high-frequency potential concepts are then treated and followed by circuit concepts, skin effect and circuit impedance elements.

In Chapter 7, the propagation and reflection of electromagnetic waves is discussed and followed by Guided electromagnetic waves, Characteristics of common waveguides and transmission lines, Resonant cavities, Microwave networks, and Radiation.

From this brief summary of its content, the book would appear to be little different from many others. The difference lies in the treatment, which is unusually clear. The subject is one which necessarily involves a fairly high standard of mathematics, but the authors have endeavoured to explain things in physical terms as well as by equations. They have tried, in fact, to make the equations mean something. This is a very laudable effort

and they have, in a great measure, succeeded although not entirely.

On the whole, the treatment is one of the best, if not the best, that we have met. It is least satisfactory in connection with radiation, but this is only in comparison with the rest of this book. The treatment of this especially difficult subject is at least as good as that given elsewhere.

W. T. C.

Radio Laboratory Handbook (6th Edition)

By M. G. SCROGGIE, B.Sc., M.I.E.E. Pp. 436. Published for *Wireless World* by Iliffe & Sons, Ltd., Dorset House, Stamford Street, London, S.E.1. Price 25s.

This new edition has been almost entirely re-written and is greatly enlarged. It covers the fundamental principles of measurement, sources of power and signals, indicators, standards, and composite instruments such as bridges and Q meters. Later chapters treat the technique of measurement and the reduction of errors.

In spite of its title, the scope is by no means confined to radio. Most of the methods and apparatus are applicable to many branches of electronics where radio-like equipment and components are so widely used.

Radio Valve Data (4th Edition)

Compiled by the Staff of *Wireless World*. Pp. 100. Published for *Wireless World* by Iliffe & Sons, Ltd., Dorset House, Stamford Street, London, S.E.1. Price 3s. 6d.

This reference book contains data on the characteristics and operating conditions of over 2,000 types of British and American valves, cathode-ray tubes and transistors. The data is presented in tabular form and includes valve-base connections. The valves are grouped into current, replacement and obsolete types, a list of equivalents is given and there is an index.

Industrial Electronics

By Dr. R. KRETZMANN. Pp. 234. Cleaver-Hume Press, Ltd., 31 Wright's Lane, Kensington, London, W.8. Price 25s.

This book is one of the Philips' Technical Library Series, and it is "concerned with industrial electronics and, by accepted convention, this means electronic circuits in applications other than those for purposes of telecommunication". Part I covers the principles of the various types of valve employed and Part II deals with electronic devices—covering relays, counting circuits, timers, rectifiers, lamp dimmers, speed-temperature control, resistance welding, motor control, h.f. induction heating, ultrasonic soldering and r.f. dielectric heating.

The Electronic Musical Instrument Manual (2nd Edition)

By ALAN DOUGLAS. Pp. 221+ix. Sir Isaac Pitman & Sons, Ltd., Parker Street, Kingsway, London, W.C.2. Price 30s.

Practical Wireless Circuits (16th Edition)

By F. J. CAMM. Pp. 217. George Newnes Ltd., Southampton Street, Strand, London, W.C.2. Price 10s. 6d.

CABMA Register, 1954-55, of British Products and Canadian Distributors

Pp. 780. Published jointly by Kelly's Directories, Ltd., and Iliffe & Sons, Ltd., for the Canadian Association of British Manufacturers and Agencies. Obtainable in the U.K. from Iliffe & Sons, Ltd., Dorset House, Stamford Street, London, S.E.1. Price 42s.; in Canada, from J. Reg. Beattie, British Trade Centre, Royal Bank Buildings, Toronto; price \$7.50.

This book is an alphabetical directory of British manufacturers and distributors and gives details of 4,500 British firms which are classified by products in a

Buyers' Guide. The details include their distribution arrangements in Canada. There is a French-English Glossary and an identification of products by Proprietary Names and Trade Marks.

JUBILEE OF THE THERMIONIC VALVE

On 16th November 1954 it will be exactly 50 years since Sir Ambrose Fleming applied for the British Patent for his thermionic valve. The Institution of Electrical Engineers is celebrating this by three lectures on the valve to be given by Sir Edward Appleton, Professor G. W. O. Howe and Dr. J. Thomson on this date. The proceedings will be opened by the Lord President of the Council, the Marquess of Salisbury.

There will also be an exhibition of historical apparatus at the Institution.

BRIT.I.R.E. MEETING

20th September. "Computing Circuits in Flight Simulators", by A. E. Cutler, B.Sc., Ph.D., to be held at London School of Hygiene and Tropical Medicine, Keppel Street, Gower Street, London, W.C.1, at 6.30.

STANDARD-FREQUENCY TRANSMISSIONS

(Communication from the National Physical Laboratory)

Values for July 1954

Date 1954 July	Frequency deviation from nominal: parts in 10 ⁸		Lead of MSF impulses on GBR 1000 G.M.T. time signal in milliseconds
	MSF 60 kc/s 1429-1530 G.M.T.	Droitwich 200 kc/s 1030 G.M.T.	
1	-0.7	0	+42.0
2	-0.6	0	+40.7
3	-0.6	0	NM
4	-0.6	0	NM
5	-0.6	0	+39.6
6	-0.7	+1	+39.3
7	-0.7	+1	+38.3
8	-0.8	0	+37.7
9	-0.7	+1	+37.2
10	-0.7	0	NM
11	-0.7	0	NM
12	-0.6	0	+36.4
13	-0.7	+1	+36.6
14	-0.6	0	NM
15	-0.6	0	+36.4
16	-0.5	0	+35.9
17	-0.5	0	NM
18	-0.5	+1	NM
19	-0.6	0	+34.8
20	-0.6	+1	+34.6
21	-0.6	+1	+33.5
22	-0.6	0	+32.8
23	-0.5	+1	+32.1
24	-0.5	0	NM
25	-0.5	0	NM
26	-0.5	+1	+27.5
27	-0.5	+1	+29.0
28	-0.5	+2	+27.9
29	-0.5	+1	+26.9
30	-0.5	0	+25.2
31	-0.5	+2	NM

The values are based on astronomical data available on 1st August 1954.
NM = Not Measured.

ABSTRACTS and REFERENCES

Compiled by the Radio Research Organization of the Department of Scientific and Industrial Research and published by arrangement with that Department.

The abstracts are classified in accordance with the Universal Decimal Classification. They are arranged within broad subject sections in the order of the U.D.C. numbers, except that notices of book reviews are placed at the ends of the sections. U.D.C. numbers marked with a dagger (†) must be regarded as provisional. The abbreviations of journal titles conform generally with the style of the World List of Scientific Periodicals. An Author and Subject Index to the abstracts is published annually; it includes a selected list of journals abstracted, the abbreviations of their titles and their publishers' addresses.

	PAGE	534.64	2553
	A		
Acoustics and Audio Frequencies	183	Acoustic Impedance Measurement using a Resonance Method. —M. A. Ferrero & G. G. Sacerdote. (<i>Acustica</i> , 1954, Vol. 4, No. 3, pp. 359–364.) See 2545 of 1953.	
Aerials and Transmission Lines	184		
Automatic Computers	185	534.64	2554
Circuits and Circuit Elements	185	Determination of High Mechanical Input Impedances of Solid Bodies in the Frequency Range 50–3 000 c/s. —W. Elling. (<i>Acustica</i> , 1954, Vol. 4, No. 3, pp. 396–402. In German.) An electromechanical vibrometer is described and measurements on walls, ceilings and Al plates are reported. The results show that the reactive part of the impedance of ceilings and walls is an inductance at low frequencies and a stiffness at high frequencies; the change-over occurs at about 150–300 c/s, where the resistive part of the impedance is a maximum.	
General Physics	188		
Geophysical and Extraterrestrial Phenomena	189		
Location and Aids to Navigation	192		
Materials and Subsidiary Techniques	193		
Mathematics	195		
Measurements and Test Gear	195		
Other Applications of Radio and Electronics	197		
Propagation of Waves	197		
Reception	199	534.78	2555
Stations and Communication Systems	199	The Experimental Study of Speech. —D. B. Fry. (<i>Nature</i> , Lond., 8th May 1954, Vol. 173, No. 4410, pp. 844–846.) A survey of recent work on the analysis and synthesis of speech.	
Subsidiary Apparatus	200		
Television and Phototelegraphy	201		
Transmission	202		
Valves and Thermionics	202	534.845	2556

ACOUSTICS AND AUDIO FREQUENCIES

534.232 : 534.321.9 2550
Devices for generating Ultrasonic Waves in Air, using Vibrating Cylinders, Pistons, Spheres and Cubes.—V. Gavreau & M. Miane. (*Acustica*, 1954, Vol. 4, No. 3, pp. 387–395. In French.) Electrodynamical types of ultrasonic generator are particularly suitable for laboratory acoustic measurements. Focused arrangements and regenerative systems for high frequencies (77 kc/s) are described. Visual methods for studying the vibrations of the emitting surfaces are discussed. Application to the absolute calibration of microphones at ultrasonic frequencies is indicated.

534.44 2551
Investigation of Nonperiodic [noise] Processes by means of Autocorrelation and Fourier Analysis.—M. L. Exner. (*Acustica*, 1954, Vol. 4, No. 3, pp. 365–379. In German.) The two methods were compared by analysing filtered noises and hisses. For frequency and bandwidth determinations the Fourier-analysis method is preferred, but for energy-distribution determinations the autocorrelation method is better.

534.614 2552
The Effect of Slip on Sound Propagation.—D. E. Weston. (*Proc. phys. Soc.*, 1st March 1954, Vol. 67, No. 411B, p. 265.) Comment on 615 of March (Caro & Martin).

534.846.6 2557
Polycylindrical Systems and the Diffusion of Sound Waves.—R. Lamoral. (*Onde élect.*, March 1954, Vol. 34, No. 324, pp. 308–309.) A study was made of the suppression of echoes in rooms by means of polycylindrical surfaces, using 1:50 reduced-scale models and frequencies between 5 and 30 kc/s. The results are presented in a family of curves for different distances between source and reflecting surface. Echo suppression improves as this distance increases, and at all distances is best for wavelengths between 0.5 d and d (d = cylinder chord).

621.395.6 2558
Developments in Sound Reproduction.—(*Wireless World*, July 1954, Vol. 60, No. 7, pp. 313–317.) Review of products shown at exhibitions held by the Radio and Electronic Component Manufacturers' Federation, the Association of Public Address Engineers, and the British Sound Recording Association.

621.395.61 : 621.391.5 2559
The "Vagabond" Wireless Microphone System.—Phinney. (See 2765.)

621.395.625 **2560**
Congress on Sound Recording — Paris 1954.—H. J. Houlgate. (*Wireless World*, July 1954, Vol. 60, No. 7, pp. 348–350.) About 60 papers were presented and discussed at the 'International Conference on Sound Recording Processes and their Extension to the Recording of Information', held in April 1954. Points from the discussions and items of interest in the associated exhibition are noted. The full text of many of the papers and abstracts of others are given in *Onde elect.*, March 1954, Vol. 34, No. 324, pp. 193–294.

621.395.625.3 **2561**
Synchronized Magnetic Tape Recording.—R. H. Ranger. (*Trans. Amer. Inst. elect. Engrs*, 1953, Vol. 72, Part 1, *Communication and Electronics*, pp. 581–586.) The longitudinally magnetized sound track on a $\frac{1}{4}$ -in. tape for use with film is synchronized by recording on the same tape a control track consisting of transverse-magnetization signals derived from the a.c. power driving both the tape and the camera.

AERIALS AND TRANSMISSION LINES

621.372 **2562**
Coupled Wave Theory and Waveguide Applications.—S. E. Miller. (*Bell Syst. tech. J.*, May 1954, Vol. 33, No. 3, pp. 661–719.) Theory applicable to coupled transmission lines, including waveguides and helical lines, is developed. For loose coupling, when very little power is transferred, the length of the coupling region can be reduced by tapering the coupling. For tight coupling distributed uniformly in the direction of propagation, energy is exchanged periodically provided that the attenuation and phase constants of the two lines are equal or nearly so. Experiments have confirmed the theory. Applications include pure-mode couplers in multimode systems, and wave filters.

621.372.8 : [537.562 + 621.318.134] **2563**
Topics in Guided-Wave Propagation through Gyromagnetic Media: Part 1—The Completely Filled Cylindrical Guide.—H. Suhl & L. R. Walker. (*Bell Syst. tech. J.*, May 1954, Vol. 33, No. 3, pp. 579–659.) "The characteristic equation for the propagation constants of waves in a filled circular guide of arbitrary radius is written in terms of magnetizing field and a carrier density, which are shown essentially to determine the dielectric and permeability tensors for a gas discharge plasma and for a ferrite. The complex structure of the spectrum of propagation constants and its dependence upon radius and the two parameters are analysed by a semigraphical method, supplemented by exact formulae in special regions. Thus the course of individual modes may be charted with fair accuracy."

621.372.8 : 538.614 **2564**
Gyrotropic Waveguide.—M. A. Gintsburg. (*C. R. Acad. Sci. U.R.S.S.*, 21st March 1954, Vol. 95, No. 3, pp. 489–492. In Russian.) The theory is developed of e.m. propagation in a bounded anisotropic medium, in particular in waveguides which are partly or completely filled with a medium with μ_{ik} and ϵ_{ik} varying with direction. Such 'gyrotropic' (rotation-producing) media can be obtained by using the Faraday or Kerr effects or similar phenomena. The final set of equations derived indicates a method of determining the components of the non-symmetric tensors representing μ_{ik} and ϵ_{ik} by means of a resonator. See also 2710 of 1952 (Suhl & Walker).

621.396.67 **2565**
An Experimental Study of a Microwave Periscope.—J. Drexler. (*Proc. Inst. Radio Engrs*, June 1954, Vol.

42, No. 6, p. 1022.) Experiments were made to test the validity of the theoretical result obtained by Jakes (1243 of 1953) that it is possible to obtain more power from a combination of aerial and reflector than from the same aerial located at the reflector position. For one particular case the gain of the combination was 2.3 db above that of the aerial alone.

621.396.67 : 621.397.6 **2566**
Cosecant Antenna aids U.H.F.-TV Coverage.—J. E. Martin & J. Ruze. (*Electronics*, June 1954, Vol. 27, No. 6, pp. 138–142.) An aerial designed to give uniform field strength over the service area comprises four vertical tubes of structural steel, of outer diameter 4 in., arranged with their cross-sections in a square and their axes 5 in. apart, these tubes constituting the outer conductor of a coaxial system. Rings of slot radiators with centres spaced one wavelength apart are formed between steel welding members. Details are given of feed arrangements and radiation patterns obtained. Coverage was tested by operation at a television station on 790 Mc/s.

621.396.67.012.12 : 517.864 **2567**
The Maximal Directivity Coefficient of Linear and Plane Aerials.—L. D. Bakhrakh. (*C. R. Acad. Sci. U.R.S.S.*, 1st March 1954, Vol. 95, No. 1, pp. 45–48. In Russian.) The radiation-pattern function is given in terms of a series of Mathieu functions of aerial length, l , in wavelengths, λ , and of direction angle, of orders up to the n th (see 1675 of June). The condition for the directivity coefficient to be a maximum in a given direction, for a given value of n , and expressions for the resultant field and aerial losses are derived. Results of calculations for $l/\lambda = 10.58$ are shown graphically.

621.396.676 : 621.396.93 **2568**
U.H.F. Omnidirectional Antenna Systems for Large Aircraft.—W. Sichak & J. J. Nail. (*Trans. Inst. Radio Engrs*, Jan. 1954, Vol. AP-2, No. 1, pp. 6–15.) Experiments have been made on models to investigate the siting of aerials on different types of aircraft. Analysis of results is based on the probability of attaining free-space-dipole range for all azimuth angles and $\pm 30^\circ$ elevation. The operation of dual aerial systems for navigation and traffic-control equipment is discussed. Direct parallel feed of dual aerials gives an interference region where individual radiation patterns overlap; in this region, a radar beacon may operate satisfactorily but the performance of d.m.e. is uncertain. Delay-line, switching and phase-shift systems of operation are considered. The simplest common-aerial arrangement is the operation of nose and tail aerials in parallel, with hybrid multiplexing.

621.396.677.3 **2569**
A Method for Calculating the Current Distribution of Tscheybscheff Arrays.—D. Barbiere. (*Proc. Inst. Radio Engrs*, June 1954, Vol. 42, No. 6, p. 1021.) Discussion on 1211 of 1952.

621.396.677.43 **2570**
Rhombic Antennas for Transmitting Stations.—L. Leng. (*Brown Boveri Rev.*, Oct. 1953, Vol. 40, No. 10, pp. 407–416.) The radiation diagram of a rhombic aerial is analysed taking account of the attenuation due to radiation. Values of maximum gain attainable with a single rhombic of characteristic impedance 600 Ω are noted and the design and application of single and double rhombic aerials for point-to-point transmission and for transmission to a specific zone are considered.

621.396.677.43.011.21 **2571**
Mutual Impedance of Stacked Rhombic Antennas.—J. G. Chaney. (*Trans. Inst. Radio Engrs*, Jan. 1954,

Vol. AP-2, No. 1, p. 39.) A formula derived earlier (3199 of 1953) is integrated for the case of two identical rhombic aerials; the resultant expression involves associated sine and cosine integral functions.

621.396.677.71

2572

Mutual Coupling Considerations in Linear-Slot Array Design.—M. J. Ehrlich & J. Short. (*Proc. Inst. Radio Engrs*, June 1954, Vol. 42, No. 6, pp. 956-961.) An experimental study was made of the external coupling between slots in adjacent resonant waveguides on a finite ground plane. Measurements were made of the field strength in one of the guides on exciting the other guide, and of the change in input admittance of the driven slot due to the presence of the parasitic slot, with matched termination of the parasitic waveguide. The results indicate that the slot-coupling effect can generally be neglected in the design of linear slot arrays.

621.396.677.83 : 621.396.96

2573

Torque Requirements of a Radar Antenna.—M. Mark. (*Elect. Engng, N.Y.*, March 1954, Vol. 73, No. 3, pp. 262-264.) Results are given of wind-tunnel tests on an experimental radar aerial. The torque required to rotate the aerial varied with azimuth position, elevation angle, pivot location, speed of rotation, and wind velocity. The combined results are evaluated on the basis of dimensionless parameters.

621.396.677.85

2574

The Electromagnetic Field near a Dielectric Lens.—D. C. Hogg. (*J. appl. Phys.*, April 1954, Vol. 25, No. 4, p. 542.) The field components along the electric and magnetic diameters differ considerably near the lens surface. The spacing between successive maxima of field intensity along the magnetic diameter near the optic axis is of the order of the wavelength in the dielectric. Virtual sources along the aperture edge, as suggested by Andrews (3141 of 1950), can account for these observations.

AUTOMATIC COMPUTERS

681.142

2575

Solutions of Boundary-Value Problems on Automatic Computing Equipment.—F. M. Verzuh. (*Trans. Amer. Inst. elect. Engrs*, 1953, Vol. 72, Part I, *Communication and Electronics*, pp. 813-821.) Report of an investigation in which five types of digital computer and one differential analyser were compared as regards their suitability for solving boundary-value problems.

681.142

2576

A Progressive Code Digital Quantizer.—F. Raasch. (*Trans. Amer. Inst. elect. Engrs*, 1953, Vol. 72, Part I, *Communication and Electronics*, pp. 567-571.) Description of an analogue-to-digital converter which receives information from a graph reader and gives a corresponding numerical indication. Several circuits are shown, based on the principle of comparing the analogue voltage with the sum of a finite geometric series.

681.142

2577

The Manchester University High-Speed Digital Computer.—D. B. G. Edwards. (*J. Brit. Instn Radio Engrs*, June 1954, Vol. 14, No. 6, pp. 269-278.) See 978 (Kilburn et al.) and 979 (Pollard & Lonsdale) of April.

681.142

2578

A Mercury Delay-Line Memory Unit.—R. D. Ryan. (*Proc. Instn Radio Engrs, Aust.*, April 1954, Vol. 15, No. 4, pp. 89-95.) The storage unit in the C.S.I.R.O.

digital computer [1050 of 1953 (Beard & Pearcey)] is described; a method is discussed of interspersing the pulses of one loop between those of another loop, thus doubling the storage capacity.

681.142

2579

A Review of Magnetic and Ferroelectric Computing Components.—V. L. Newhouse. (*Electronic Engng*, May 1954, Vol. 26, No. 315, pp. 192-199.) High-speed digital storage devices may be classified as delay-line or random-access types, with subdivisions in each case for regenerative and nonregenerative devices. The more important magnetic and ferroelectric storage units are critically discussed and possible future lines of development indicated. 26 references.

681.142

2580

An Arithmetic Unit for Automatic Digital Computers.—J. R. Stock. (*Z. angew. Math. Phys.*, 15th March 1954, Vol. 5, No. 2, pp. 168-172. In English.) Discussion of the requirements for the arithmetic unit of a computer with magnetic-drum store, with particular reference to the computer for the Swiss Federal Institute of Technology. Operation with fixed or floating decimal point is provided for.

681.142

2581

Magnetic Switching Circuits.—R. C. Minnick. (*J. appl. Phys.*, April 1954, Vol. 25, No. 4, pp. 479-485.) Magnetic circuits to produce the logical operations of 'and' and 'or' are described, which may be combined to produce any switching function of any number of input binary variables. The only components used are magnetic cores, wire and resistors. There is no extremely sensitive parameter in these circuits which must be adjusted carefully in order to ensure proper operation.

681.142 : 512

2582

A Simplified Solution and New Application of an Analyser of Algebraic Polynomials.—L. Lukaszewicz. (*Bull. Acad. polon. Sci.*, 1953, Vol. 1, No. 3, pp. 103-107. In English.) A description is given of an analyser circuit in which complex numbers are represented by sinusoidal voltages of frequency ~ 500 c/s, with amplitude corresponding to the modulus and phase corresponding to the argument of the number.

681.142 : 621.385.832

2583

An Electron-Beam Tube for Analog Multiplication.—E. J. Angelo, Jr. (*Rev. sci. Instrum.*, March 1954, Vol. 25, No. 3, pp. 280-284.) An electron beam of large circular cross-section and uniform current density is projected through an e.s. deflection system on to a metallic target made up of four quadrants insulated from one another. The currents collected by one diagonal pair of quadrants are arranged to oppose those collected by the other pair, thus the algebraic sum of the currents in the quadrants is proportional to the product of the deflection voltages. The design and performance of the system is discussed.

CIRCUITS AND CIRCUIT ELEMENTS

621.314.2

2584

Prevention of Ionization in Small Power Transformers.—L. Medina. (*Proc. Instn Radio Engrs, Aust.*, May 1954, Vol. 15, No. 5, pp. 114-115.) The ionization-onset voltage is raised, for a given total thickness of insulation, by inserting foils in the insulation so as to split it into n sections with $1/n$ of the total voltage across each section. Design details and test results for a typical transformer are given.

621.316.8 + 621.319.4 2585

Some Characteristics and Limitations of Capacitor and Resistor Components.—L. Podolsky & J. K. Sprague. (*Trans. Inst. Radio Engrs*, March 1954, No. PGCP-1, pp. 33-46.) Six types of film-dielectric capacitors are examined with respect to their performance. Specifications for a new and reliable type of metallized-paper capacitor, at the pilot-plant development stage, are given. A satisfactory method for power rating of precision bobbin resistors is explained.

621.318.134 : 621.318.5 2586

Stressed Ferrites having Rectangular Hysteresis Loops.—H. J. Williams, R. C. Sherwood, M. Goertz & F. J. Schnettler. (*Trans. Amer. Inst. elect. Engrs*, 1953, Vol. 72, Part I, *Communication and Electronics*, pp. 531-537.) To obtain the rectangular hysteresis loop required in ferrite cores used in switching and storage devices, the cores are stressed by encasing them in plastics which shrink during polymerization.

621.318.4 2587

Temperature Fields in Electrical Coils: Numerical Solutions.—P. J. Schneider. (*Trans. Amer. Inst. elect. Engrs*, 1953, Vol. 72, Part I, *Communication and Electronics*, pp. 768-771.) The computation of the steady temperature fields in coils by the relaxation method is described and illustrated.

621.318.435 2588

Saturable Reactors with Inductive D.C. Load: Part 2—Transient Response.—H. F. Storm. (*Trans. Amer. Inst. elect. Engrs*, 1953, Vol. 72, Part I, *Communication and Electronics*, pp. 182-192.) Part 1: 3527 of 1953.

621.318.57 2589

A Graphical Method for Flip-Flop Design.—R. F. Johnston & A. G. Ratz. (*Trans. Amer. Inst. elect. Engrs*, 1953, Vol. 72, Part I, *Communication and Electronics*, pp. 52-56.)

621.318.57 2590

Switching in Bistable Circuits.—R. S. Mackay. (*J. appl. Phys.*, April 1954, Vol. 25, No. 4, pp. 424-429.) All triggering processes seem capable of description in terms of a curve with a region of negative slope, points on this curve representing unstable states, while points on a positive slope represent stable states. A negative-resistance circuit in which the voltage is a multiple-valued function of current was constructed so that details of the triggering process could be observed on an oscilloscope screen. By suitable periodic sampling a slow-motion representation of the transition between two states is obtained.

621.318.57 2591

An Electronic Random Selector.—R. W. Walker. (*J. Brit. Instn Radio Engrs*, June 1954, Vol. 14, No. 6, pp. 262-268.) Criteria for recognition of random series are stated and methods for producing such series are discussed. A description is given of an arrangement in which pulses are applied to a circuit which is gated periodically; any pulse passing through the gate triggers a multivibrator which is in turn coupled to a pair of mechanical registers. Two such circuits make up the complete selector enabling four mechanical registers to operate. Use of the selector in psychical research is mentioned.

621.318.57 : 621.314.7 2592

The Transient Response of Transistor Switching Circuits.—I. L. Lebow & R. H. Baker. (*Proc. Inst. Radio Engrs*, June 1954, Vol. 42, No. 6, pp. 938-943.) Transient response of the point-contact transistor in a

grounded-base circuit is considered, using a linearized equivalent circuit. The required trigger voltages for both directions of switching are found experimentally to be greater than suggested by the static characteristic, and to depend on trigger pulse width to a different extent for the two directions. To fit these findings it is assumed that cut-off frequency is high when the transistor is switched off and low when it is switched on. The one-shot multivibrator is discussed in the light of these assumptions.

621.318.57 : 621.387 2593

A Cold-Cathode Scaling Unit.—C. D. Florida & R. Williamson. (*Electronic Engng*, May 1954, Vol. 26, No. 315, pp. 186-191.) The five-decade scaler uses dekatrons, interstage coupling being by cold-cathode gas-filled trigger triodes. The resolving time is $\sim 500 \mu\text{s}$, which makes it suitable for application in conjunction with G-M counter tubes. Operation under varying climatic conditions has been satisfactory.

621.319.4 : 621.315.612.4 2594

The Effect of Minor Constituents in High Dielectric Constant Titanate Capacitors.—W. W. Coffeen. (*Trans. Amer. Inst. elect. Engrs*, 1953, Vol. 72, Part I, *Communication and Electronics*, pp. 704-709.) Additives used to modify the dielectric properties of BaTiO_3 are classified into two groups, those which alter the position of the Curie peak and those which lower its height. BaSnO_3 and PbSnO_3 are typical of the first group, while MgSnO_3 , $\text{Bi}_2(\text{SnO}_3)_3$, MgTiO_3 and CaTiO_3 are typical of the second. The effect of composition on nonlinearity and aging is discussed. See also 191 and 192 of January.

621.319.4.001.4 2595

Breakdown and Leakage Resistance Investigation of Metallized-Paper Capacitors.—J. Burnham. (*Trans. Inst. Radio Engrs*, March 1954, No. PGCP-1, pp. 3-17.) The basis of comparison between conventional paper and metallized-paper capacitors is discussed. Experiments on units with polyester impregnants suggest that, if self-healing is of primary importance, a pure aliphatic hydrocarbon type of impregnant will give best results.

621.372 : #17.948 2596

Applications of Integral Equations to the Solution of Nonlinear Electric Circuit Problems.—L. A. Pipes. (*Trans. Amer. Inst. elect. Engrs*, 1953, Vol. 72, Part I, *Communication and Electronics*, pp. 445-450.) The technique described gives practical results in many cases where the approximate solution of the integral equation may be effected by means of Laplace transforms.

621.372.52 + 621.375.4 2597

Junction Transistor Circuits.—(*Radio & Electronics*, Wellington, N.Z., 1st March 1954, Vol. 9, No. 1, pp. 18-19. .23.) Application of the CK722 *p-n-p* junction-type transistor in single-stage and cascaded amplifiers and in l.f. and r.f. oscillators, is described and illustrated by eight circuit diagrams. The transistor collector characteristics, and operating data and typical circuit component values are given.

621.372.55 2598

Spectrum or Waveform Equalization?—D. A. Bell. (*Wireless Engr*, July 1954, Vol. 31, No. 7, pp. 171-174.) The method of equalization in which signals obtained by differentiation or integration are added to the main signal [1936 of 1953 (Gouriet)] is compared with the commoner method using filters. Empirical design is simpler with the former method, but the need for additional amplification at high frequencies is not avoided. The different requirements of communication and servo systems are indicated.

621.372.8 : 538.614

2599

New Effect caused by Gyromagnetic Phenomena.—K. M. Polivanov. (*C. R. Acad. Sci. U.R.S.S.*, 21st March 1954, Vol. 95, No. 3, pp. 501-503. In Russian.) Theory is given of a device similar to that described by Kales et al. (2040 of July).

621.373

2600

Effects of Harmonics on the Frequency of Oscillation as well as on the Asymmetry of the Resonance Curves.—A. E. Mostafa. (*Trans. Amer. Inst. elect. Engrs*, 1953, Vol. 72, Part I, *Communication and Electronics*, pp. 309-314.) The nonlinear equations representing the free and synchronized oscillations are transformed into linear equations with periodically varying coefficients, and complete solutions are obtained. The relation between frequency variation and harmonic content is derived. Experimental results supporting the theory are reported.

621.373

2601

The First Order Behavior of Separable Oscillators.—D. C. de Packh. (*Trans. Amer. Inst. elect. Engrs*, 1953, Vol. 72, Part I, *Communication and Electronics*, pp. 450-455.) Analysis is given for oscillators whose linear and nonlinear elements are separable in the first order. Theoretical and experimental results indicate that, apart from adjustments of the linear elements, the major factor for obtaining frequency stability and smooth control is the suppression of the even-power terms in the amplitude characteristic.

621.373 : 621.396.822 : 530.145

2602

Quantum Theory of a Damped Electrical Oscillator and Noise: Part 2 — The Radiation Resistance.—J. Weber. (*Phys. Rev.*, 15th April 1954, Vol. 94, No. 2, pp. 211-215.) The results obtained in part 1 (3243 of 1953) are extended to include damping and noise due to a radiation resistance and expressions for the mean square noise voltage and available noise power are derived which are shown to be the same as those previously obtained. They are also extended to apply to a single mode of a cavity resonator.

621.373 : 621.396.822 : 530.145

2603

Vacuum Fluctuation Noise.—J. Weber. (*Phys. Rev.*, 15th April 1954, Vol. 94, No. 2, pp. 215-217.) The possibility of observing vacuum fluctuations by measuring the resultant electron stream noise when an electron stream interacts with a damped oscillator is discussed. An electron stream is shown to provide a means of precise measurement of the mean square noise e.m.f. for certain modes. The circuit must be at low temperature.

621.373.421 + 621.375.23].001.2

2604

Block-Diagram Solutions for Vacuum-Tube Circuits.—T. M. Stout. (*Trans. Amer. Inst. elect. Engrs*, 1953, Vol. 72, Part I, *Communication and Electronics*, pp. 561-567.) Full paper. See 1346 of May.

621.373.421.13.029.65

2605

Millimeter Waves from Harmonic Generators.—C. M. Johnson, D. M. Slager & D. D. King. (*Rev. sci. Instrum.*, March 1954, Vol. 25, No. 3, pp. 213-217.) Fundamental and harmonic powers obtainable at wavelengths down to 1.9 mm, using a Si-crystal frequency multiplier with different types of reflex klystron, have been measured. Three types of multiplier are compared; these are (a) a commercial Si crystal mounted upright on the exterior face of the harmonic waveguide; (b) a crystal with windows cut in the face so that the tungsten whisker is exposed; (c) a whisker and Si block mounted in the waveguide. Arrangement (b) is the most satisfactory for wavelengths below 4 mm. The performance

of arrangement (c) as a detector is discussed. A crystal harmonic generator used with a narrow-band amplifier will furnish enough power at 3-mm wavelength to give a dynamic range of 50-60 db.

621.373.424 : 621.396.621.54

2606

Variable-Frequency Crystal-Controlled Receivers and Generators.—Wadley. (See 2759.)

621.373.431 + 621.373.444.1

2607

A Modified Miller Timebase Circuit.—R. D. Ryan. (*J. sci. Instrum.*, March 1954, Vol. 31, No. 3, pp. 73-75.) High linearity and rapid flyback are achieved by using a blocking oscillator to charge the feedback capacitor in the Miller-type circuit. Compensation is provided for variations in the blocking-oscillator characteristics. A unit giving sweep durations of 5 μ s-15 ms with either triggered or continuous operation is described.

621.375.2.024 : 621.387

2608

Transient Response of Glow Discharges with Applications.—Mackay & Morris. (See 2828.)

621.375.223

2609

L.F. Compensation for Video Amplifiers: Part 1—Amplifiers without Feedback.—J. E. Flood. (*Wireless Engr*, July 1954, Vol. 31, No. 7, pp. 175-186.) Response to unit-step input is considered. The departure from the ideal flat-top response caused by low-frequency distortion can be reduced by making the differential coefficients of the output function equal to zero at $t = 0$. The order of compensation is designated by the number of derivatives equal to zero. General theory is given and is applied to some typical resistance-coupled amplifiers. A single RC-coupled stage can have second-order compensation, and multistage amplifiers can have higher orders of compensation. Experimental results confirm the analysis.

621.375.23 : 621.317.44

2610

An Electronic Voltage Integrator.—R. Madey & G. Farly. (*Rev. sci. Instrum.*, March 1954, Vol. 25, No. 3, pp. 275-279.) A feedback amplifier integrating circuit is described. The amplifier comprises a cascode-connected direct-coupled circuit with filament drift compensation and internal positive-feedback adjustment. The integrator is used with a search coil for magnetic-field measurements in the range 500-15000 gauss; accuracy is within 1%.

621.375.23.029.4

2611

A High-Efficiency High-Quality Audio-Frequency Power Amplifier.—A. B. Bereskin. (*Trans. Inst. Radio Engrs*, March/April 1954, Vol. AU-2, No. 2, pp. 49-60; *Convention Record Inst. Radio Engrs*, 1954, Part 6, pp. 18-24.) The circuit uses a Type-12AX7 valve as phase-inverter-amplifier-driver stage direct-coupled to two output beam tetrodes operating in class B push pull, with 24 db of feedback. The output transformer has a bifilar-wound primary, and the feedback winding is electrostatically shielded from the secondary but very closely coupled to it. Full-power output is 60 W at frequencies < 3000 c/s. Design of the circuits and performance details are described.

621.375.23.029.4

2612

The Cascode as a Low-Noise Audio Amplifier.—R. L. Price. (*Trans. Inst. Radio Engrs*, March/April 1954, Vol. AU-2, No. 2, pp. 60-64.)

621.375.3

2613

The Influence of Magnetic Amplifier Circuitry upon the Operating Hysteresis Loops.—H. W. Lord. (*Trans. Amer. Inst. elect. Engrs*, 1953, Vol. 72, Part I, *Communication and Electronics*, pp. 721-728.) An analysis limited

to the steady-state characteristics of single-phase saturated magnetic amplifiers. Only resistive loads are considered.

621.375.3 2614
High-Speed Magnetic Amplifiers.—A. E. Maine.

(*Electronic Engng.*, May 1954, Vol. 26, No. 315, pp. 180-185.) Units based on Ramey's half-wave amplifier are discussed, and the development of a new series of amplifiers is described. The basic type is a reversing-phase-input/reversing-d.c.-output amplifier. Circuit modifications are explained for obtaining (a) reversing d.c. output for reversing d.c. input, and (b) reversing-phase a.c. or reversing polarity d.c. output. Other possible modifications are indicated.

621.375.3 : 621.318.1 2615
Theory of Magnetic Amplifiers with Square-Loop Core Materials.—H. F. Storm. (*Trans. Amer. Inst. elect. Engrs.*, 1953, Vol. 72, Part I, *Communication and Electronics*, pp. 629-637. Discussion, pp. 637-640.)

621.375.4 : 621.314.7 2616
Temperature-Stabilized Transistor Amplifiers.—H. J. Tate. (*Electronics*, June 1954, Vol. 27, No. 6, pp. 144-147.) Design equations are derived and nomograms presented for determining the temperature variation of the operating point of a junction-transistor amplifier. Application of the information for temperature stabilization is indicated. Numerical examples are given.

621.375.4 : 621.314.7 2617
Transistors in Amplifier Output Stages.—M. J. O. Strutt. (*Scientia elect.*, Zürich, Oct. 1953, Vol. 1, No. 1, pp. 2-17.)

The optimum effective load impedance and the efficiency are calculated using idealized characteristic curves. The results for point-contact and junction-type transistors in class A and in class B push-pull amplifiers are compared with the corresponding formulae for triodes and pentodes. Distortion, the efficiency limit, and circuit design are also briefly considered.

GENERAL PHYSICS

530.112 2618
Proposal for a New Aether-Drift Experiment.—L. Essen. (*Nature, Lond.*, 17th April 1954, Vol. 173, No. 4407, p. 734.) Comment on Furth's proposal (1726 of June) and suggestion for an alternative experimental procedure.

535.22 2619
Precision Determination of the Velocity of Light Derived from a Band Spectrum Method: Part 2.—D. H. Rank, J. N. Shearer & T. A. Wiggins. (*Phys. Rev.*, 1st May 1954, Vol. 94, No. 3, pp. 575-578.) From measurements of the rotational constant B_{000} for HCN by the method of exact orders (*J. opt. Soc. Amer.*, 1953, Vol. 43, p. 952) and by a microwave method, the value of c is $299\,789.8 \pm 3.0$ km/s.

536.49 : 621.319.4 2620
Further Experiments on the Thermoelectric Effect (Costa Ribeiro Effect).—A. Dias Tavares. (*Ann. Acad. bras. Sci.*, 31st March 1953, Vol. 25, No. 1, pp. 53-59. In English.)

The experiments described establish that on solidification of liquid naphthalene, negative charges are expelled from the solid into the liquid phase, the resultant positive charge being distributed within the solidified dielectric. See also 648 of 1952 (Ribeiro).

536.49 : 621.319.4 2621
Further Quantitative Experiments on the Costa Ribeiro Effect.—A. Dias Tavares. (*Ann. Acad. bras. Sci.*, 31st

Dec. 1953, Vol. 25, No. 4, pp. 353-373. In English.) In an investigation of the thermoelectric effect (2620 above and back reference), measurements were made of the charge within a solidified naphthalene dielectric by means of a Faraday cage and electrometer. The relation between the charge and the mass is constant. For small crystals this specific residual charge ρ is twice the induced charge per unit mass. Impurities alter the value of ρ considerably.

537.221 2622
Contact Charging between a Borosilicate Glass and Nickel.—J. W. Peterson. (*J. appl. Phys.*, April 1954, Vol. 25, No. 4, pp. 501-504.)

Contact charging of glass spheres rolling on clean Ni was studied under conditions of controlled cleanliness, humidity and gas pressure. The effect of a transverse electric field is important only for high surface conductivity. Surface conduction limits the maximum charge, which also varies with pressure due to gaseous discharge between the sphere and the metal.

537.311.33 2623
A Chemical Approach to the Treatment of Electronic Spin in Semiconductors.—J. H. Crawford, Jr. & D. K. Holmes. (*Proc. phys. Soc.*, 1st March 1954, Vol. 67, No. 411A, pp. 294-295.)

A method due to Fowler (*Proc. roy. Soc. A*, 1933, Vol. 140, p. 505), in which the electrons and the neutral and ionized donors are treated as chemical entities, affords a simple approach in the non-degenerate case. The results obtained agree with those of Landsberg (78 of 1953) when the occurrence of neutral donors containing unpaired and paired electrons is taken into account.

537.311.62 2624
Theory of the Anomalous Skin Effect in a Magnetic Field.—M. Ya. Azbel' & M. I. Kaganov. (*C. R. Acad. Sci. U.R.S.S.*, 1st March 1954, Vol. 95, No. 1, pp. 41-44. In Russian.)

Extension of work by Reuter & Sondheimer (1354 of 1949) to take account of the effect of a steady magnetic field.

537.311.62 : 535.137 2625
The Effect of Relaxation on Microwave Measurements of the Anomalous Skin Effect.—R. G. Chambers. (*Physica*, April 1953, Vol. 19, No. 4, pp. 365-370.)

The ratio of the conductivity to the mean free path of an electron in Bi at microwave frequencies estimated on the basis of Dingle's theory (2626 below) is $1.53 \times 10^7 \Omega^{-1} \text{cm}^2$ compared with $2.74 \times 10^7 \Omega^{-1} \text{cm}^2$ given earlier by Pippard & Chambers (996 of 1953), neglecting relaxation effects. This discrepancy and the discrepancy for normal metals are discussed.

537.311.62 : 535.137 2626
The Anomalous Skin Effect and the Reflectivity of Metals.—R. B. Dingle. (*Physica*, April, Aug. & Dec. 1953, Vol. 19, Nos. 4, 8 & 12, pp. 312-364, 729-736 & 1187-1199.)

Expressions derived by Reuter & Sondheimer (1354 of 1949) are considerably simplified. Numerical results obtained include calculated values of surface resistance and reactance in the microwave region for both specular and diffuse electron reflection.

537.52 2627
Some Aspects of Breakdown Streamers.—L. B. Loeb. (*Phys. Rev.*, 15th April 1954, Vol. 94, No. 2, pp. 227-232.)

537.523 2628
The Electric Strength of Air in Nonuniform Fields at Radio Frequencies.—J. B. Whitehead, D. L. Birx & C. F. Miller. (*Trans. Amer. Inst. elect. Engrs.*, 1953,

Vol. 72, Part I, *Communication and Electronics*, pp. 520-524.) Measurements were made of the breakdown potential of atmospheric air between a cylinder and an axial wire, over the frequency range 2-16 Mc/s. The breakdown voltage is about 30% below the 60-c/s value at 2 Mc/s, and decreases at the average rate of 120 V per Mc/s as the frequency is raised above this point. The results are explained by a modified Townsend theory. The discharge occurs during the part of the cycle when the wire is positive with respect to the cylinder.

537.525 2629
The Secondary-Electron Resonance Mechanism of Low-Pressure High-Frequency Gas Breakdown.—A. J. Hatch & H. B. Williams. (*J. appl. Phys.*, April 1954, Vol. 25, No. 4, pp. 417-423.) Breakdown field strengths were measured in air and H₂ at frequencies from 25 to 90 Mc/s between internal electrodes separated by 1-4 cm. By suddenly applying a high voltage, and reducing it slowly, an upper breakdown curve was observed. This curve, the lower breakdown curve and cut-off frequency data together define a breakdown region. The secondary-electron resonance theories developed by Danielsson and Gill & von Engel (1906 of 1948) are extended.

537.525.3 : 621.387.424 2630
Dynamics of Corona Discharge between Cylindrical Electrodes.—L. Colli, U. Facchini, E. Gatti & A. Persano. (*J. appl. Phys.*, April 1954, Vol. 25, No. 4, pp. 429-435.) The screening action of the space charge is responsible for the constancy and stability of the average discharge current. Fluctuations are explained as a response of the system having a definite resonance frequency to the statistical fluctuations of the photoelectric current. Theoretical predictions are confirmed by experiment.

537.533 2631
The Work Function of Irregular Metal Surfaces.—T. J. Lewis. (*Proc. phys. Soc.*, 1st March 1954, Vol. 67, No. 411B, pp. 187-200.) Calculation of the image potential for spherical and prolate spheroidal bosses on an otherwise smooth surface shows that this potential might be reduced to 50% of its value for an ideal plane surface. Since the image potential is likely to form a large portion of the work function for most metals, the work function will be significantly reduced when the surface is rough.

537.533.8 2632
Effect of the Energy Distribution of Electrons on the Average Secondary-Emission Yield of an Insulator.—J. Salmon. (*J. Phys. Radium*, March 1954, Vol. 15, No. 3, p. 190.) An expression for the average yield in terms of electron temperature is calculated for pyrex, the electron energy distribution being Maxwellian.

537.56 2633
A Model for Collision Processes in Gases: Part 1—Small Amplitude Processes in Charged and Neutral One-Component Systems.—P. L. Bhatnagar, E. P. Gross & M. Krook. (*Phys. Rev.*, 1st May 1954, Vol. 94, No. 3, pp. 511-525.)

537.568 2634
Electron-Ion Recombination at Low Pressures.—S. Borowitz. (*Trans. Amer. Inst. elect. Engrs.*, 1953, Vol. 72, Part I, *Communication and Electronics*, pp. 430-435.) Experiments throwing light on the nature of the fundamental processes involved are discussed; the molecular ion is thought to play a decisive part. The evidence is consistent with the hypothesis of dissociative recombination.

538.114 2635
The Tensor Formulation of Ferromagnetic Resonance.—J. A. Young, Jr. & E. A. Uehling. (*Phys. Rev.*, 1st May 1954, Vol. 94, No. 3, pp. 544-554.)

538.12 : 538.653.12 2636
Twisted Magnetic Fields in Conducting Fluids.—J. W. Dungey & R. E. Loughhead. (*Aust. J. Phys.*, March 1954, Vol. 7, No. 1, pp. 5-13.) The formation of loops in the lines of force of a twisted magnetic field confined within a cylinder of radius *R* is discussed by the method of normal modes. The condition obtained for loop formation is that the pitch of the twisted field be less than πR . The velocity of Alfvén waves in this model is also discussed.

538.248 2637
Diffusion After-Effect in Weak Alternating Fields. Validity of Rayleigh's Law.—A. Marais. (*C. R. Acad. Sci., Paris*, 3rd May 1954, Vol. 238, No. 18, pp. 1782-1784.)

538.561 : 537.56 2638
On the Excitation of Oscillations in a Thermal Plasma.—M. Sumi. (*J. phys. Soc. Japan*, Jan./Feb. 1954, Vol. 9, No. 1, pp. 88-92.) Plasma oscillations are considered for an arbitrary distribution of electron beams. The fundamental equations are derived assuming a weak signal and the absence of static fields. The dispersion relation derived is applied to the case of excitation of thermal plasma by an injected electron beam, and the rate of wave growth is determined. The numerical results are compared with results obtained by Merrill & Webb (*Phys. Rev.*, 15th June 1939, Vol. 55, No. 12, pp. 1191-1198).

538.566 : 535.42 2639
The Vector Wave Function Solution of the Diffraction of Electromagnetic Waves by Circular Disks and Apertures: Part 2—The Diffraction Problems.—C. Flammer. (*J. appl. Phys.*, April 1954, Vol. 25, No. 4, p. 543.) Correction to paper abstracted in 708 of March.

539.145 2640
Determination of h/e by a New Method.—F. G. Dunnington, C. L. Hemenway & J. D. Rough. (*Phys. Rev.*, 1st May 1954, Vol. 94, No. 3, pp. 592-598.) The method involves the determination of the excitation potential of He from the ground state to the lowest permitted singlet level. The value of h/e obtained is $(1.3790 \pm 0.0002) \times 10^{-17}$ erg.sec/e.s.u.

621.3.032.44 2641
Temperature Distribution in an Electrically Heated Filament.—K. S. Krishnan & S. C. Jain. (*Nature, Lond.*, 1st May 1954, Vol. 173, No. 4409, pp. 820-821.) A practical general solution is given for a filament of finite length heated in vacuo. See also 2375 of August.

537.533.8 2642
Physics and Applications of Secondary Electron Emission. [Book Review]—H. Bruining. Publishers: Pergamon Press, London, and McGraw-Hill, New York, 178 pp., 25s. or \$5. (*J. atmos. terr. Phys.*, May 1954, Vol. 5, No. 2, pp. 114-115.) The book "covers practically everything of importance, and should serve as an admirable guide to workers in all branches of electronics".

GEOPHYSICAL AND EXTRATERRESTRIAL PHENOMENA

523.7 : 550.38 2643
Relation between the Appearance of the Yellow Coronial Line and Geomagnetic Activity.—J. F. Denisse & P. Simon. (*C. R. Acad. Sci., Paris*, 3rd May 1954, Vol. 238, No. 18, pp. 1775-1778.) From observations of

the yellow coronal line it is possible to identify those solar-activity centres whose passage across the central meridian is accompanied by an increase of geomagnetic activity.

523.72 : 537.562

2644

Space-Charge-Wave Amplification in a Shock Front and the Fine Structure of Solar Radio Noise.—H. K. Sen. (*Aust. J. Phys.*, March 1954, Vol. 7, No. 1, pp. 30–35.) The dispersion equation corresponding to the non-Maxwellian velocity distribution of the particles in a shock front is derived. The roots indicate frequency bandwidths of space-charge-wave amplification decreasing with the shock strength. It is suggested, in agreement with Denisse & Rocard (1900 of 1952), that the storm bursts of narrow bandwidth originating in shock fronts constitute the elementary fine-structure components of solar radio noise bursts.

523.72 + 523.74] : 621.396.822

2645

Thermal Radio Emission from the Sun and the Source of Coronal Heating.—J. H. Piddington & R. D. Davies. (*Mon. Not. R. astr. Soc.*, 1953, Vol. 113, No. 5, pp. 582–596.) A statistical analysis is made of data obtained from measurements of solar radiation at frequencies between 600 and 9400 Mc/s. The total radiation is separated into a component associated with sunspots and a 'basic' component showing no such connection. Results indicate that (a) sunspot radiation and the very hot regions responsible for it diminish less rapidly than the spot area and exist for a month or more after the spot has vanished; (b) the basic component at some frequencies is much lower than previously believed; (c) S-regions above the sunspots are the source of coronal energy, and gases spreading from them can completely replace the corona in about four days.

523.72 : 621.396.822

2646

Solar Radio Emissions at 4-Metres Wavelength during 1947–50 inclusive and their Relations to Solar Activity.—J. S. Hey. (*Mon. Not. R. astr. Soc.*, 1953, Vol. 113, No. 5, p. 653.) Summary of R.R.D.E. Report No. 372, Oct. 1952. Bursts at 4.1-m λ , of duration $> \frac{1}{2}$ min. and of intensity over a certain minimum, are analysed for correlation with solar flares. The medium lag of bursts behind associated flares is about a minute, but the dispersion of the time differences is such that an appreciable proportion of the bursts precede the flares. Secondary controlling factors seem to exist both for the solar phenomena and the related ionospheric phenomena. Analysis of the distribution of bursts confirms that there is a greater chance of bursts in association with flares on the eastern half of the sun's disk than on the western half.

523.72 : 621.396.822

2647

Observation of the Partial Solar Eclipse (February 14, 1953) at the Wavelength of 10 Centimeters (3000 Mc/s).—K. Aoki. (*Rep. Ionosphere Res. Japan*, Sept. 1953, Vol. 7, No. 3, pp. 109–115.) The diameter of the sun observed at this wavelength is 5% greater than that of the visual disk. Limb brightening is observed. Asymmetry in the eclipse curve is attributed to a local bright region round sunspots, where the values of electron density in chromosphere and corona are enhanced.

523.72 : 621.396.822

2648

The Distribution of Radiation across the Solar Disk at Metre Wavelengths.—P. A. O'Brien. (*Mon. Not. R. astr. Soc.*, 1953, Vol. 113, No. 5, pp. 597–612.) Measurements were made at wavelengths of 1.4, 3.7 and 7.9 m using variable-aperture interferometers and phase-switching receiver systems. The size of the emitting disk increases with increasing wavelength. Experiments with interferometers inclined at various angles to the solar axis of

rotation showed the radiating shape of the sun to be elliptical; the radial distance at which the brightness temperature was reduced to half was about 25% greater at the equator than in the polar direction.

523.72 : 621.396.822

2649

Distribution of Radio-Frequency Brightness across the Solar Disk and the Derivation of a Model Corona.—P. A. O'Brien & C. J. Bell. (*Nature, Lond.*, 30th Jan. 1954, Vol. 173, No. 4396, p. 219.) The derivation of a model consistent with observations previously reported (2648 above) is discussed.

523.72 : 621.396.822.029.62

2650

Solar Radio Asymmetry at 4-Metres Wavelength.—J. S. Hey & V. A. Hughes. (*Nature, Lond.*, 24th April 1954, Vol. 173, No. 4408, p. 771.) The greater frequency of observation of solar bursts at 4.1 m in association with flares on the eastern half of the sun's disk [1368 of 1949 (Hey et al.)] may be due to absorption of bursts from the western half in ionized streams. This would account for the lack of evidence of asymmetry at 1.5 m, for which wavelength absorption is much less. An analysis of this asymmetry with reference to geomagnetic activity is being made.

523.852 : 621.396.822

2651

Intensities of Discrete Radio Sources in Cygnus and Cassiopeia at 22.6 Mc/s.—J. S. Hey & V. A. Hughes. (*Nature, Lond.*, 1st May 1954, Vol. 173, No. 4409, pp. 819–820.) Measured intensities are 9.4×10^{-22} and 4.6×10^{-22} W m² (c/s) for the sources in Cassiopeia and Cygnus respectively. Comparison with intensities measured previously at higher frequencies indicates that in the spectrum of the Cassiopeia source intensity is proportional to (frequency)^{1.2}, the variation in the Cygnus source being similar except at lower frequencies, where the rate of increase of intensity is reduced.

523.852.3 : 621.396.822

2652

Radio Emission from the Perseus Cluster.—J. E. Baldwin & B. Elsmore. (*Nature, Lond.*, 1st May 1954, Vol. 173, No. 4409, p. 818.) Results of observations at 3.7-m λ , using radio-interferometer apertures of 14 λ and 157 λ , provide confirmation for the identification of the radio source with NGC 1275.

523.854 : 621.396.822

2653

Galactic Radiation at Radio Frequencies: Part 7—Discrete Sources with Large Angular Widths.—J. G. Bolton, K. C. Westfold, G. J. Stanley & O. B. Slee. (*Aust. J. Phys.*, March 1954, Vol. 7, No. 1, pp. 96–109.) Observations with a 72-ft reflector at a frequency of 150 Mc/s, with the sea interferometer at 110 Mc/s, and with the azimuth interferometer at 100 Mc/s, revealed the existence of a number of sources of angular width $> 1^\circ$. The observations are described and discussed; the limitations of interference techniques are summarized. Part 6 : 1756 of June (Bolton, Slee & Stanley).

523.854 : 621.396.822

2654

Galactic Radiation at Radio Frequencies: Part 8—Discrete Sources at 100 Mc/s between Declinations $+50^\circ$ and -50° .—J. G. Bolton, G. J. Stanley & O. B. Slee. (*Aust. J. Phys.*, March 1954, Vol. 7, No. 1, pp. 110–129.) One hundred and four discrete sources have been found. Individual sources are compared in position and flux density with those of previous surveys. The observed distribution of sources is discussed. Several identifications with visible sources are suggested. Part 7 : 2653 above.

523.854 : 621.396.822

2655

A Comparison of the Intensities of Cosmic Noise observed at 18.3 Mc/s and at 100 Mc/s.—C. A. Shain. (*Aust. J. Phys.*, March 1954, Vol. 7, No. 1, pp. 150–164.) The

principal conclusion of this comparison is that the background radiation cannot be made up of the radiation from sources of the type observed so far, although a small polar component may be due to the extragalactic sources. Absorption in interstellar gas has a considerable effect on the intensity variations of background radiation with direction observed at 18.3 Mc/s.

523.854 : 621.396.822 : 550.510.535 **2656**

Observations of the General Background and Discrete Sources of 18.3-Mc/s Cosmic Noise.—C. A. Shain & C. S. Higgins. (*Aust. J. Phys.*, March 1954, Vol. 7, No. 1, pp. 130–149.) A survey of a broad strip of sky, centred on declination -32° , has been made using an aerial with beam width to half power of 17° . Previous results concerning the background distribution of brightness have been confirmed and 37 discrete sources have been detected. The distribution of these sources is shown. No correlation was found between the occurrence of scintillations and published ionospheric data, but the observations are consistent with an origin of scintillations in irregularities of dimensions about 4 km at a height of about 500 km.

523.854 : 621.396.822.029.62 **2657**

Galactic Radio Sources of Large Angular Diameter.—R. H. Brown, H. P. Palmer & A. R. Thompson. (*Nature, Lond.*, 15th May 1954, Vol. 173, No. 4411, pp. 945–946.) Preliminary results are given of measurements of the apparent angular width of sources previously observed [1408 of May (Brown & Hazard)].

523.854.22 : 621.396.822 : 621.396.677.3 **2658**

Wide-Band Radio Interferometer.—V. V. Vitkevich. (*C. R. Acad. Sci. U.R.S.S.*, 21st Aug. 1953, Vol. 91, No. 6, pp. 1301–1303. In Russian.) The use of a wide-band amplifier, with the frequency characteristic given, in conjunction with an aerial system consisting of two or four aeriels in line or 16 aeriels arranged symmetrically in a square, results in very high resolution. In the example quoted radio sources separated by an angle of $15'$ can be resolved. The theory of the interferometer is given and the general form of the directional characteristic is shown.

550.384 **2659**

Geomagnetic Bay Disturbances and their Nonuniform Induced Components within the Earth.—H. Wiese. (*Z. Met.*, Feb./March 1954, Vol. 8, Nos. 2/3, pp. 77–79.) The bay disturbance is considered as the field of a travelling dipole in the auroral zone, the direction of travel depending on time of day. The induced component within the earth exhibits local variations depending on the conductivity; a 'dynamic' anomaly is observed in an area in Central Europe, the vertical component being a maximum in the north and a minimum in the south when the ionosphere current is directed southward.

550.385/386 : 525.233 **2660**

The Use of Earth-Potential Measurements for Magnetic and Ionospheric Storm Indication.—A. H. De Voogt. (*J. Atmos. Terr. Phys.*, May 1954, Vol. 5, No. 2, pp. 108–110.) Using the underground telephone cable system, potentials are measured in directions as nearly parallel and perpendicular to the magnetic meridian as possible. Each of the cable circuits is over 100 km long and is provided with several earthing points at the ends. The recorders are housed in the control room of the PTT station Radio-Kootwijk.

551.5 : 621.396.11.029.6 : 061.3 **2661**

Radio-Meteorology: Conference in Texas.—Saxton. (See 2751.)

551.510.3 : 535.325 **2662**

A Preliminary Survey of Tropospheric Refractive Index Measurements for U.S. Interior and Coastal Regions.—C. M. Crain, J. R. Gerhardt & C. E. Williams. (*Trans. Inst. Radio Engrs.*, Jan. 1954, Vol. AP-2, No. 1, pp. 15–22.) Results of some 700 recordings made between July and December 1952 using airborne refractometers at heights up to 25 000 ft are summarized. The existence of large differences in refractive index near certain cloud boundaries is confirmed. See also 1759 of June (Crain et al.).

551.510.535 **2663**

Atmospheric Space Charge.—W. D. Parkinson : J. A. Chalmers. (*J. Atmos. Terr. Phys.*, May 1954, Vol. 5, No. 2, pp. 106–108.) Comment on 131 of January and author's reply.

551.510.535 **2664**

The Evaluation of Ionospheric Observations.—G. Crawert & H. Lassen. (*Z. angew. Phys.*, March 1954, Vol. 6, No. 3, pp. 136–143.) A critical discussion of the various methods used in calculating the height distribution of the charge-carrier concentration and other parameters, from experimentally determined $h'f$ curves. The corrections and the estimation of errors in the calculated F-layer height in the presence of an E layer and the effect of neglecting the E layer in this calculation are discussed. An approximate method is indicated for taking the geomagnetic field into account.

551.510.535 **2665**

Semidiurnal Currents and Electron Drifts in the Ionosphere.—J. A. Fejer. (*J. Atmos. Terr. Phys.*, May 1954, Vol. 5, No. 2, p. 103.) Correction to paper abstracted in 1420 of May.

551.510.535 **2666**

A Subsidiary Layer in the E Region of the Ionosphere.—R. Naismith. (*J. Atmos. Terr. Phys.*, May 1954, Vol. 5, No. 2, pp. 73–82.) Echoes from sporadic-E can be distinguished from those from a layer at 90–100 km height. It is suggested that the ionization in this layer results from the impact of meteors on the atmosphere and that it may therefore be called the meteoric E layer. The distinctive properties may be used to extend the use of the ionosphere for intermediate-distance radio communication.

551.510.535 **2667**

Origin of the Ionospheric E Layer.—K. Raver & É. Argence. (*Phys. Rev.*, 15th April 1954, Vol. 94, No. 2, pp. 253–256.) Critical discussion of theories of formation based on (a) ionization of O_2 by ultraviolet light, and (b) ionization by solar soft X-rays. The intensity of incoming radiation seems insufficient, in view of absorption, in case (a), but, from Elwert's computations (*Z. Naturf.*, 1952, Vol. 7a, No. 2, pp. 202–204), sufficient in case (b). Provided dissociation of O_2 occurs in a high transition layer of considerable thickness, both processes may be involved, but process (b) seems the more important.

551.510.535 **2668**

Multiple Stratification of the F Layer at Ibadan.—N. J. Skinner, R. A. Brown & R. W. Wright. (*J. Atmos. Terr. Phys.*, May 1954, Vol. 5, No. 2, pp. 92–100.) Observations made during the period December 1951–January 1953 are reported. In the F_2 layer there is a maximum occurrence of ridges around 1000 and 1500 hours, the first maximum being the more pronounced. A seasonal variation is found, a maximum number of ridges being observed when the midday minimum of f_oF_2 occurs early in the day. A lunar semidiurnal variation is detectable

during the morning hours. Formation of ridges is also observed in the F_1 layer, but there is little relation to those of the F_2 layer. Possible phases of vertical drift velocities that could explain the observations are discussed.

551.510.535

2669

On the F_2 Layer Distribution in Polar Region.—T. Obayashi. (*Rep. Ionosphere Res. Japan*, Sept. 1953, Vol. 7, No. 3, pp. 118–121.) Results of an analysis of monthly mean values of f_0F_2 , $h'F_2$, f_0F_1 and f_0E for March 1951 are summarized. In a region along the auroral zone where the $h'F_2$ values are anomalously high, maxima occur at noon and midnight, and the region rotates round the earth with the sun. The increase of apparent height of the F_2 layer is due to wave retardation in the F_1 layer during daytime in high latitudes.

551.510.535

2670

A Theory of Distribution and Variation of the Ionospheric F_2 Layers.—K. Maeda. (*Rep. Ionosphere Res. Japan*, Sept. 1953, Vol. 7, No. 3, pp. 81–107.) "A brief description is first given on the results of our recent studies, which have led to the conclusions of inhibition of vertical ionospheric current, enhancement of conductivity, dynamo current and vertical drift of charged particles near the geomagnetic equator and suppression of daytime electron density of F_2 layer caused by an upward drift of electrons. The treatment is extended to the case of ionospheric storm accompanied with geomagnetic storm. The comparison of the theoretical and observational results is made for the cases of undisturbed as well as disturbed states of F_2 layer. The agreement is generally good for undisturbed case, but not quite satisfactory for disturbed case. The mechanism of dynamo in the ionosphere is discussed and a hypothetical consideration concerning a wind system during a storm is given."

551.510.535 : 523.3 : 621.396.11

2671

Lunar Radio Echoes and the Faraday Effect in the Ionosphere.—Murray & Hargreaves. (See 2748.)

551.510.535 : 523.75

2672

The Enhancement of Ionospheric Ionization during Solar Flares.—A. P. Mitra & R. E. Jones. (*J. Atmos. Terr. Phys.*, May 1954, Vol. 5, No. 2, pp. 104–106.) Study of the recombination coefficient in the lower ionosphere, based on the decay of sudden phase anomalies at 16 kc/s and on sudden enhancements of atmospherics, gives values much smaller than those reported by Bates & Seaton (1407 of 1950). Measurements of the delay between the time of maximum flare and the times of maxima of sudden phase anomalies and sudden enhancements of atmospherics also suggest smaller values. These results indicate that for any height the value of the recombination coefficient remains unaltered during a sudden ionospheric disturbance and that the sudden increase in electron concentration is due to an increase in the rate of electron production in the layer.

551.510.535 : 523.78

2673

Corpuscular Eclipse in the F_2 Layer and its Association with Solar Flares and M-Regions.—P. K. S. Gupta & S. N. Mitra. (*Nature, Lond.*, 1st May 1954, Vol. 173, No. 4409, pp. 814–816.) A survey of present knowledge on solar sources of corpuscular streams and on corpuscular velocities. The drop in the F_2 -layer ion density occurring approximately five hours before the maximum of the optical solar eclipse is briefly discussed and it is suggested that in future F_2 -layer observations should commence at least seven hours before the moment of totality.

551.510.535 : 621.396.11.029.53

2674

High Multiple Radio Reflections from the F_2 Layer of the Ionosphere at Brisbane.—Baird. (See 2750.)

551.593

2675

The Effect of Rayleigh Scattering and Ground Reflection upon the Determination of the Height of the Night Airglow.—E. V. Ashburn. (*J. Atmos. Terr. Phys.*, May 1954, Vol. 5, No. 2, pp. 83–91.)

LOCATION AND AIDS TO NAVIGATION

621.396.9 : 621.396.621

2676

Aircraft Receiver for VOR-ILS and Communications.—G. W. Gray. (*Electronics*, June 1954, Vol. 27, No. 6, pp. 180–184.) Description of complete navigation and communication equipment. C.r.o. presentation of omnirange signal and c.r. indicator for instrument landing system right-left signals are provided. High sensitivity is achieved in the omnirange receiver by using the extremely low bandwidth of about 6 c/s in order to reduce noise. Special arrangements are made to avoid errors due to possible phase shifts resulting from use of this narrow band.

621.396.93 + 621.398] : 621.396.665

2677

Sequentially Gated Automatic Gain Control.—M. Eliason. (*Electronics*, June 1954, Vol. 27, No. 6, pp. 186–188.) The arrangement described, which is applicable to navigation and telemetry systems, supplies a control voltage which holds receiver output constant within ± 1 db when pulse signals are received from two or more transmitters in turn on the same frequency but with widely different strengths. Separate a.g.c. circuits corresponding to each transmitter are provided and are gated sequentially in synchronism with the transmitters.

621.396.933 : 621.396.621

2678

Airborne Loran Receiver — the AN/APN-70.—R. R. Freas. (*Trans. Inst. Radio Engrs.*, March 1954, Vol. ANE-1, No. 1, pp. 17–25.) The AN/APN-70 equipment was designed primarily for improved operating convenience and reliability as compared with older types. Improvements introduced include (a) time-difference information presented directly on counter dials, (b) possibility of operation on the new l.f. channels, giving instantaneous indication of position, (c) a.f.c. of the timing oscillator, (d) independent gain control for signals from each ground station, (e) high-sensitivity aerial coupler, and (f) all circuits and components selected for their reliability.

621.396.96 : 621.316.726

2679

Automatic Tuning for Primary Radar.—S. Ratcliffe. (*Wireless Engr.*, May–July 1954, Vol. 31, Nos. 5–7, pp. 122–131, 153–165 & 187–192.) Research into the basic techniques of automatic frequency correction is reported and design principles are discussed with particular attention to the requirements of airborne microwave radar equipment. For convenience, the frequency control is applied to the receiver rather than the transmitter, maintenance of the desired i.f. being more important than the absolute frequency. The frequency variations to be controlled may be either long-term, such as those due to changes in ambient temperature or pressure, or short-term, such as variations in magnetron frequency due to changes in the matching during rotation of the scanner. Receiver bandwidth and sensitivity are considered in relation to the conditions under which it may be economical to use an a.f.c. system with a response rapid enough to deal with scanner pulling. Circuits with the smallest possible number of pre-set adjustments should be used; adoption of a wide-band a.f.c. system is advantageous from this point of view.

621.396.96 : 621.396.676

2680

U.H.F. Omnidirectional Antenna Systems for Large Aircraft.—Sichak & Nail. (See 2568.)

621.396.962.3

Improved Demodulator for Radar Ranging.—C. E. Goodell. (*Electronics*, June 1954, Vol. 27, No. 6, pp. 170-171.) Gaps due to loss of echo pulses as a result of scattering, absorption, etc. are filled in by pulses generated in the demodulator. Range errors are thus reduced.

621.396.965

Antenna Scan Considerations.—D. Levine. (*Trans. Inst. Radio Engrs.*, March 1954, Vol. ANE-1, No. 1, pp. 26-40.) Three types of scan are considered, (a) the spiral scan, (b) the simple conical scan, (c) sector scanning, the aerial having simple harmonic motion. In general a harmonic type of sector scan is to be preferred to a uniformly rotating system of n aerials, provided the total angle of scan is $< 229 \cdot 2^\circ/n$. A figure of merit for a sector scan having nonharmonic motion is also derived.

MATERIALS AND SUBSIDIARY TECHNIQUES

531.788.7

Pressure Measurement with the Pirani Gauge.—K. D. Mielenz. (*Z. angew. Phys.*, March 1954, Vol. 6, No. 3, pp. 101-104.) The design of a Pirani gauge is discussed on the basis of expressions for the thermal losses of the heater wire and for the sensitivity of the gauge when used in a Wheatstone bridge. For maximum sensitivity the requirements include a galvanometer with high voltage sensitivity, low-resistance bridge arms, a low external temperature obtained by immersing the gauge in liquid air, and low heater-wire temperature obtained by using high-resistivity wire. These requirements were confirmed experimentally by measurements at pressures down to $1 \cdot 7 \times 10^{-5}$ Torr.

531.788.7

A Simple Thermionic Vacuum Gauge.—G. K. T. Conn & H. N. Daglish. (*J. sci. Instrum.*, March 1954, Vol. 31, No. 3, pp. 95-96.) The gauge described is similar in essentials to that of Bayard & Alpert (2785 of 1950), but is much easier to construct.

533.583

Influence of Electronic Impact on the Rate of Sorption of Gases on to Getter Materials.—S. Wagener. (*Nature, Lond.*, 10th April 1954, Vol. 173, No. 4406, pp. 684-685.) Experiments made with Ba and Mg getters, using a Knudsen gauge and a special diode to produce electron impact, indicate that the introduction of the latter does not materially affect the gettering rate.

535.215 : 538.632 : 546.311.12

Electronic Hall Effect in the Alkali Halides.—A. G. Redfield. (*Phys. Rev.*, 1st May 1954, Vol. 94, No. 3, pp. 537-540.) The Hall mobility of electrons in NaCl, KCl, KBr and KI was measured using the technique described in 2687 below.

535.215 : 538.632 : 549.211

Electronic Hall Effect in Diamond.—A. G. Redfield. (*Phys. Rev.*, 1st May 1954, Vol. 94, No. 3, pp. 526-537.) The crystal is placed between two glass plates coated with a very thin semiconducting film. An electrometer is connected to the upper plate and the potential of the lower plate is varied. To make a measurement the magnetic field is applied in opposite directions alternately, the crystal being illuminated and the potentiometer adjusted to give zero deflection on the electrometer for each direction. The Hall angle can be obtained approximately from the measured voltage change and the electrode geometry. Sources of error and corrections are considered in detail. Electronic mobility varies as $T^{-3/2}$

2681

and is about 1 800 cm/s per V/cm at 300°K, the corresponding figures for holes being $T^{-3/2}$ and 1 200 cm/s per V/cm.

535.215 : 546.289

Photoconductivity in Gold-Germanium Alloys.—R. Newman. (*Phys. Rev.*, 15th April 1954, Vol. 94, No. 2, pp. 278-285.) Photoconductivity in n - and p -type gold-doped Ge was investigated at 77° and 22°K. The low-energy thresholds for impurity photoconduction are compatible with the activation energies measured by electrical methods. In some n -type specimens quenching effects were observed, with prominent quench bands at 0.8 and 0.66 eV. Characteristics of the quenching were measured as functions of light intensity, applied voltage and temperature. No complete explanation is offered.

535.215 : 546.431-31 : 539.234

External Photoemission of Thin Films Deposited by Evaporation from Barium Oxide.—S. Narita. (*J. Phys. Soc. Japan*, Jan./Feb. 1954, Vol. 9, No. 1, pp. 22-27.) Experimental investigation of films deposited on Mo and on Ta surfaces is reported. The variation of the energy distribution of the photoelectric emission and the thermionic work function with layer thickness is shown graphically and the change from metallic-type photoelectric emission, expressed by Fowler's equation, to the semiconductor type is noted. The dependence of photoelectric emission on the plane of polarization of the incident light is also shown graphically.

535.37

Comparative Measurements of Electron-Excited Luminescent Screens for Front Viewing and for Back Viewing.—B. Deubner & F. Hieber. (*Z. angew. Phys.*, March 1954, Vol. 6, No. 3, pp. 112-115.) Light-yield measurements were made on Cu-activated ZnS screens excited by a 40-kV electron beam incident at 45°. Screens of various thicknesses were used, with and without an Al base. Maximum yields in transmission-type screens, equal to those of front-viewing types, were obtained using an Al layer separated by collodion from the luminescent material. The resolution at various grain sizes was also measured. The results are shown graphically.

535.37 : 546.817.221

Photoluminescence of PbS in the Infrared Region of the Spectrum.—L. N. Galkin & N. V. Korolev. (*C. R. Acad. Sci. U.R.S.S.*, 21st Sept. 1953, Vol. 92, No. 3, pp. 529-530. In Russian.) Brief account of method and results of an investigation of photoluminescence in the region 2-3.5 μ .

537.226

Photodielectric Effect [dielectric loss change].—J. Roux. (*J. Phys. Radium*, March 1954, Vol. 15, No. 3, pp. 176-188.) A critical survey of work done on this subject. Most crystalline phosphors exhibit the effect, the magnitude of which depends largely on the phosphor type and preparation, and is greatly influenced by the nature and intensity of the excitation radiation, and by the intensity and frequency of the electric field applied to measure the capacitance of the material. A decay in the effect closely following the decay in phosphorescence is observed. Some relation between phosphorescence and dielectric loss change exists, but its exact nature has not been established.

537.226 : 538.56.029.4/.6

The Radio Spectrum and Structure of Solids: Part 1—Debye Absorption in Solids, at Frequencies within the Radio Spectrum, and Lattice Defects.—M. Freymann & R. Freymann. (*J. Phys. Radium*, March 1953, Vol. 14,

No. 3, pp. 203-211.) In the study of solids by examination of their dielectric properties, two types of dipole must be distinguished, (a) dipoles associated with orientation of molecules or groups of atoms, and (b) dipoles associated with lattice defects. Experimental methods used to measure absorption at frequencies between 300 kc/s and 300 kMc/s are surveyed.

537.226 : 538.56.029.4/.6

2694

The Radio Spectrum and Structure of Solids: Part 2—Debye Absorption in Water in the Free and in the "Bound" State.—M. Freymann & R. Freymann. (*J. Phys. Radium*, March 1954, Vol. 15, No. 3, pp. 165-175.) Critical examination of experimental data with a view to extending the theory developed in part 1 (2693 above) to ionic crystals and semiconductors.

537.311.3 : 539.23

2695

Tentative Explanation of the Conduction Mechanism of Thin Granular Metal Layers.—N. Nifontoff. (*C. R. Acad. Sci., Paris*, 10th May 1954, Vol. 238, No. 19, pp. 1870-1872.) Experimental results on the variation of the resistance of granular metal layers can be explained by assuming the existence of a more or less continuous impurity-rich semiconductor layer between the grains. An electron passing from one grain to another then crosses two metal-semiconductor boundaries, the resistance being localized almost entirely at the reverse boundary.

537.311.3 : 539.23

2696

High-Frequency Resistance of Thin Films.—R. Broudy & H. Levinstein. (*Phys. Rev.*, 15th April 1954, Vol. 94, No. 2, pp. 285-289.) Measurements on evaporated Ge, Rh and Au films show that for uniform films the decrease of resistance with frequency is due to simple self-capacitance. When the ratio of the a.c. and d.c. resistances is plotted against the product of frequency and d.c. resistance, data for uniform films of each material fall on a single curve. The presence of non-uniformities in the film produces an additional decrease of resistance with frequency corresponding to the degree of variation in resistance per unit length.

537.311.3 : 539.23 : 621.383.4

2697

High-Frequency Resistance of Photoconducting Films.—R. Broudy & H. Levinstein. (*Phys. Rev.*, 15th April 1954, Vol. 94, No. 2, pp. 290-292.) PbTe photocells were prepared by evaporation under controlled conditions, and the resistance/frequency characteristic measured for various types of illumination. The degree of irregularity in response correlated with the degree of nonuniformity of the film, the nonuniformity detected decreasing on exposure to light.

537.311.33

2698

Semiconducting Compounds and the Scale of Electronegativities.—C. H. L. Goodman. (*Proc. phys. Soc.*, 1st March 1954, Vol. 67, No. 411B, pp. 258-259.) In considering the relation between the ionic component of bonding and energy gap, suggested by Welker (1798 of June) a useful guide to the ionicity of a binary compound can be obtained from the electronegativity difference of its elements. Correlation between energy gap and electronegativity difference exists for certain compounds between groups III and V and between groups II and VI of the periodic table. Mobility values for HgSe, InSb and HgTe support this hypothesis. HgSe may be of particular interest for semiconducting devices such as crystal triodes.

537.311.33 : 546.23

2699

Experimental and Theoretical Investigation of the Isothermal and the Adiabatic Hall Effect in Se.—R. Diestel. (*Z. Naturf.*, Aug. 1953, Vol. 8a, No. 8,

pp. 453-457.) The isothermal and adiabatic Hall coefficients are calculated for a p -type semiconductor. The difference between the two values decreases rapidly with increasing thermal conductivity of the lattice, but even for substances, such as Se, with low thermal conductivity the difference amounts to only about 1%. This result is confirmed by measurements on Se.

537.311.33 : 546.23

2700

Hole Conduction in Crystalline Selenium.—W. Schottky. (*Z. Naturf.*, Aug. 1953, Vol. 8a, No. 8, pp. 457-459.) Results obtained by Diestel (2699 above) indicate that the value of the thermoelectric force for Se found from direct measurement is more than twice the value found from Hall-effect measurements. It is tentatively suggested that the discrepancy can be explained by assuming an impurity-band conduction mechanism rather than conduction by free holes.

537.311.33 : [546.24 + 546.3-1-24-23

2701

Electrical Properties of Pure Tellurium and Tellurium-Selenium Alloys.—A. Nussbaum. (*Phys. Rev.*, 15th April 1954, Vol. 94, No. 2, pp. 337-342.) Measurements of resistivity and Hall coefficient for pure single-crystal Te and for six different single-crystal TeSe alloys with a maximum Se content of about 15% by weight were made over the temperature range 90°-550°K. An increase in the forbidden-band width and a lowering of the upper anomalous Hall-coefficient reversal temperature with increased Se content was observed.

537.311.33 : 546.24.03

2702

Electrical Properties of Tellurium Crystals at Very Low Temperatures.—T. Fukuroi, S. Tanuma & Y. Muto. (*Sci. Rep. Res. Inst. Tohoku Univ., Ser. A*, Feb. 1954, Vol. 6, No. 1, pp. 18-29.) The electrical conductivity, the Hall effect and the magnetoresistance effect were investigated in the temperature range from 1.7°K to room temperature, using both pure single crystals of Te and Te crystals including 0.01% Sn. The results are tabulated and shown graphically.

537.311.33 : 546.28

2703

Hall Mobility of Electrons and Holes in Silicon.—P. P. Debye & T. Kohane. (*Phys. Rev.*, 1st May 1954, Vol. 94, No. 3, pp. 724-725.) Mobility/resistivity curves are shown, obtained at 295°K on single-crystal specimens of n and p type ranging in resistivity from 0.1 to 94 Ω .cm and from 0.025 to 110 Ω .cm respectively. For the highest resistivity values the mobility for electrons is about 1 900 cm/s per V/cm and for holes 425 cm/s per V/cm.

537.311.33 : 546.289

2704

Resistivity Striations in Germanium Crystals.—P. R. Camp. (*J. appl. Phys.*, April 1954, Vol. 25, No. 4, pp. 459-463.) Variations in conductivity may be made visible by electroplating, with CuSO₄ as electrolyte, since more copper will be deposited on regions having low resistivity. Pulsed voltage is applied. Maximum visual contrast is obtained by suitably adjusting the resistivity of the electrolyte, the magnitude and duration of the pulses and the pulse repetition frequency.

537.311.33 : 546.289 : 621.396.822

2705

Noise in Germanium Filaments at Very Low Frequencies.—B. V. Rollin & I. M. Templeton. (*Proc. phys. Soc.*, 1st March 1954, Vol. 67, No. 411B, p. 271.) Measurements using the technique previously proposed (2039 of 1953) are reported.

537.311.33 : 546.482.21.03 : 539.234

2706

The Optical and Electrical Properties of Cadmium Sulphide Films.—G. Kuwabara. (*J. phys. Soc. Japan*, Jan./Feb. 1954, Vol. 9, No. 1, pp. 97-102.) An experi-

mental investigation of evaporated films shows that the optical properties are reproducible and similar to those of CdS single crystals, while the electrical properties depend on the conditions of evaporation and after-treatment. A close correlation between dark conductivity and photosensitivity was found. The results are shown graphically and are discussed.

537.311.33 : 546.682.86 **2707**

Electrical Properties of InSb.—H. Weiss. (*Z. Naturf.*, Aug. 1953, Vol. 8a, No. 8, pp. 463–469.) Continuation of work described by Welker (1798 of June). Measurements of conductivity, Hall effect and magnetoresistance are reported. Both *n*- and *p*-type samples were observed, depending on the impurity concentration. At room temperature, the highest value of electron mobility found was 41 000 cm²/s per V/cm, and the greatest variation of resistance in a magnetic field of 10 000 gauss amounted to 150%.

537.311.33 : 548.5 **2708**

Crystal Growth by the Tip Fusion Method.—P. H. Keck, S. B. Levin, J. Broder & R. Lieberman. (*Rev. sci. Instrum.*, March 1954, Vol. 25, No. 3, pp. 298–299.) The main feature of the method described is the fusion of the tip of the boule into a sessile drop by means of a tungsten ring heated by h.f. induction. A continuous stream of powder is supplied from above, and the growing crystal is withdrawn slowly downward from the hot zone. Polycrystalline Si boules about 1 in. long and $\frac{1}{2}$ in. in diameter were grown at a rate of 1 in. per hour.

538.221 : 539.234 **2709**

The Magnetization of Very Thin Iron Films.—W. Reincke. (*Z. Phys.*, 15th March 1954, Vol. 137, No. 2, pp. 169–174.) Iron films evaporated on to glass plates were suspended by spun thread in a magnetic field and set in torsional oscillation. Susceptibility was calculated from the oscillation period, the field strength, the moment of inertia of the plates, and the volume of the film. Film thickness *d* was measured optically. Results are in agreement with calculations of Klein & Smith (1675 of 1951). Magnetization starts to decrease at value $d = 125 \text{ \AA}$, disappearing at $d = 11 \text{ \AA}$. For $d < 100 \text{ \AA}$ saturation is reached at much lower field strengths than are required for thicker films.

538.221 : 621.318.134 **2710**

Magnetic-Dispersion Spectrum of a Ni-Zn Ferrite.—I. Lucas. (*Z. angew. Phys.*, March 1954, Vol. 6, No. 3, pp. 127–130.) The decrease of permeability with increasing frequency is explained on the basis of superposition of sharp spin-resonances. From the distribution function of characteristic frequencies, approximate formulae are derived for the observed relation between the static susceptibility and the lower limiting characteristic frequency, the dispersion of the loss factor at low frequencies and the decrease of permeability at high frequencies. The width of the dispersion spectrum is determined by the internal demagnetization at the Weiss-domain boundaries.

538.221 : 621.318.134 **2711**

Magnetic Behaviour of some Ferrites.—K. F. Niessen. (*Physica*, Nov. 1953, Vol. 19, No. 11, pp. 1127–1132.) Calculations based on a series of measurements on mixed crystals of nickel ferrite and nickel titanate, $\text{Fe}_{2-2a}\text{Ni}_{1-a}\text{Ti}_a\text{O}_4$, with $0 < a < 0.5$, show that the Ti appears to be distributed statistically amongst the tetrahedral and octahedral sites of the spinel when $a \ll 1$ but appears to show preference for the tetrahedral sites as *a* increases.

538.221 : 621.318.134.029.64/.65 **2712**

Resonance Absorption in Ferrites.—T. Okamura. (*Sci. Rep. Res. Inst. Tohoku Univ., Ser. A*, Feb. 1954,

Vol. 6, No. 1, pp. 89–108.) An experimental investigation over the frequency range 9.45 kMc/s–47 kMc/s at room temperature and at -195°C is reported. The real spectroscopic splitting factor, *g*, which is independent of frequency and temperature, was determined for ferrites of Ni, Mn, Ni-Zn and Mn-Zn by using the corrected Kittel resonance formula. A semi-empirical formula for the internal field is given. Results for true *g*-values and the internal fields are tabulated and the latter compared with calculated values.

538.221 : 621.318.134.029.64/.65 **2713**

The Effect of the Anisotropy and the Relaxation Phenomena on the Shift of Ferromagnetic Resonance in Polycrystalline Ferrites.—M. Date. (*Sci. Rep. Res. Inst. Tohoku Univ., Ser. A*, Feb. 1954, Vol. 6, No. 1, pp. 109–113.)

548.55 : 546.78 **2714**

Thermionic and Surface Properties of Tungsten Crystals.—G. F. Smith. (*Phys. Rev.*, 15th April 1954, Vol. 94, No. 2, pp. 295–308.) The relation between the production process for single crystals and types of surface structure was studied, and thermionic constants were determined for various crystallographic directions.

548.55 : 546.833 **2715**

Growth and Surface Properties of Tantalum Crystals.—M. H. Nichols. (*Phys. Rev.*, 15th April 1954, Vol. 94, No. 2, pp. 309–313.) A study of Ta on the lines of 2714 above.

621.315.612.4 : 546.431.824-31 **2716**

Anomalous Temperature Coefficient of Permittivity in Barium Titanate.—K. W. Plessner & K. A. Cook. (*Nature, Lond.*, 10th April 1954, Vol. 173, No. 4406, pp. 682–683.) A negative temperature coefficient of permittivity was observed in a very pure ceramic BaTiO₃ sample subjected to alternations of temperature around the Curie point. The anomaly is related to the co-existence of the cubic and tetragonal phases. The observations support the view that the transition at about 120°C is a first-order transition.

MATHEMATICS

519.2 **2717**

Statistics of a Population with Creation and Recombination Dependent on Existing Numbers.—D. A. Bell. (*Proc. phys. Soc.*, 1st March 1954, Vol. 67, No. 411B, pp. 227–231.) "Populations liable to loss by recombination are likely to have a rate of loss proportional to the square of the number present; and the distribution function is then related either to a Bessel function or to a Laguerre polynomial, according as the rate of creation is either constant or dependent on the complement of the number already present." Statistics of the number of particles present are then no longer the same as those of the density fluctuations in a perfect gas.

MEASUREMENTS AND TEST GEAR

621.3.014(083.74) **2718**

Preliminary Development of a Magnetron Current Standard.—E. P. Felch & J. L. Potter. (*Trans. Amer. Inst. elect. Engrs.*, 1953, Vol. 72, Part I, *Communication and Electronics*, pp. 524–531.)

621.316.84(083.74) **2719**

The Behaviour of Gold-Chromium Standard Resistors under Load.—A. Schulze & D. Bender. (*Z. angew. Phys.*, March 1954, Vol. 6, No. 3, pp. 132–136.) The effect of loads up to 1 W on the resistance of 1- Ω , 10- Ω and 100- Ω resistors was measured; the results are tabulated.

- 621.317.335 : 537.228.1 **2720**
Methods for Measuring Piezoelectric, Elastic, and Dielectric Coefficients of Crystals and Ceramics.—W. P. Mason & H. Jaffe. (*Proc. Inst. Radio Engrs*, June 1954, Vol. 42, No. 6, pp. 921-930.) Various methods are reviewed, with a view to standardization. For investigating small specimens, the click-oscillator method and the balanced-capacitance-bridge methods are suitable. The dynamic method involving measurements of resonance and antiresonance frequencies, low-frequency capacitance, and resonance resistance is recommended as simplest and most accurate for large-size specimens with high values of Qr , where r is the ratio of the crystal capacitances. Quasi-static methods are useful for crystals having a low value of Qr , for determining the sign of the piezoelectric coefficients, and for production checks. Hydrostatic methods are useful for complicated crystals and for measuring a sum of two of the coefficients of electrostrictive ceramics.
- 621.317.373 : 621.317.755 **2721**
Cathode-Ray-Tube Protractor or Synchroscope.—H. Sohon. (*Elect. Engng, N.Y.*, March 1954, Vol. 73, No. 3, pp. 220-221.) Description of a bridge-type RC phase-shifting network for use with a c.r.o. for measurement of the phase difference between two signals. The angle is indicated on the calibrated c.r. tube screen by the major axis of the elliptical trace.
- 621.375.3.015.3.001.4 **2722**
A Transient Analyzer for Magnetic Amplifiers.—E. J. Smith. (*Trans. Amer. Inst. elect. Engrs*, 1953, Vol. 72, Part I, *Communication and Electronics*, pp. 461-465. Digest, *Elect. Engng, N.Y.*, March 1954, Vol. 73, No. 3, p. 218.) The response time of the magnetic amplifier is obtained directly by comparing the saturation phase angle with a reference phase angle marked by a train of pulses.
- 621.317.41 **2723**
An Automatically Recording Magnetic Balance.—T. Hirone, S. Maeda & N. Tsuya. (*Sci. Rep. Res. Inst. Tohoku Univ., Ser. A*, Feb. 1954, Vol. 6, No. 1, pp. 67-76.) Description of instrument for determining the magnetization temperature characteristics of small samples over the range from the temperature of liquid He to $\sim 1000^\circ\text{C}$.
- 621.317.411 + 621.317.335.3] : 621.318 **2724**
Theory of Measurement of μ and ϵ of Semiconducting Ferrromagnetics.—K. M. Polivanov. (*C. R. Acad. Sci. U.R.S.S.*, 1st March 1954, Vol. 95, No. 1, pp. 61-64. In Russian.) The method used for determining the complex electrical impedances of a specimen in an electric circuit or a magnetic field is analogous to the open- and short-circuit method of determining characteristic impedance and propagation constant of a long line. Expressions for the complex impedances in terms of the complex values of μ and ϵ are given. The advantages of using rod or ring specimens in a coaxial line are noted.
- 621.317.7 : 621.396.822 : 621.397.828 **2725**
Impulse Noise Generators.—M. V. Callendar. (*Electronic Engng*, May 1954, Vol. 26, No. 315, pp. 200-203.) Two generators are described, suitable for testing sound or vision receivers for their response to impulsive noise from car ignition systems and other sources. One is based on a spark plug with variable gap and controllable output. The other is a thyatron generator, providing pulses with any desired time relation to the synchronizing pulses. Calibration of these generators is considered.
- 621.317.7.029.64 **2726**
Integrated Microwave Test Bench.—(*Wireless World*, July 1954, Vol. 60, No. 7, pp. 351-352.) X-band test equipment comprising wavemeter, attenuator, slotted line, etc. is milled out of one solid block of light alloy instead of being assembled from separate units. Losses and undesired reflections are thus reduced.
- 621.317.7.029.64 **2727**
Microwave Measuring Equipment.—P. M. Ratcliffe. (*J. Brit. Instn Radio Engrs*, June 1954, Vol. 14, No. 6, pp. 243-259. Discussion, pp. 260-261.) A survey dealing with instruments for field and factory, as well as for laboratory use, at centimetre wavelengths. The measurable quantities in this band are wavelength (in preference to frequency), power (with emphasis on heating effect), and normalized impedance (in terms of electric and magnetic field). Equipment described includes capacitance-loaded-line and resonant-cavity wavemeters, thermistor-type milliwattmeter, neon-tube tester for s.w.r., directional couplers, spectrum analyser, noise generator and a complete radar test set for the 3-cm waveband.
- 621.317.727.029.63 **2728**
Accurate Radio-Frequency Microvoltages.—M. C. Selby. (*Trans. Amer. Inst. elect. Engrs*, 1953, Vol. 72, Part I, *Communication and Electronics*, pp. 158-163.) Coaxial-type r.f. micropotentiometers developed at the National Bureau of Standards (1712 of 1951) are described in detail.
- 621.317.734.028.3 **2729**
An Instrument for Measurement of Very High Resistance.—F. J. Lynch & C. L. Wesenberg. (*Rev. sci. Instrum.*, March 1954, Vol. 25, No. 3, pp. 251-255.) An instrument for accurate measurement in the range 10^9 - $10^{13}\Omega$ is described. A constant current flows through the resistor under test and potential drop is measured by an electrometer. The constant current is the displacement current flowing through a standard capacitor when the potential difference across it changes linearly with time. Provision is made for measuring resistance with 3 mV-10 V dropped across the resistor. Accuracy of the instrument is within about 0.5%.
- 621.317.755 : 621.3.015.3 **2730**
A Method for the Measurement of Phase and Amplitude Variations of Transient High-Frequency Phenomena.—A. Essmann. (*Z. angew. Phys.*, March 1954, Vol. 6, No. 3, pp. 115-120.) A development is described of the method of Nijenhuis (2485 of 1941) for a continuous visual presentation of phase and amplitude changes produced, e.g. by an amplifier, by means of a brightness-modulated spiral c.r.o. trace. The complete circuit, operation and application of this phase- and amplitude-analyser are given and the traces obtained with a two-stage amplifier and with a detuned single-stage amplifier are shown photographically. Phase angles can be read to within $\pm 1^\circ$.
- 621.317.78.029.64 **2731**
40- to 4 000-Microwatt Power Meter.—R. W. Lange. (*Trans. Amer. Inst. elect. Engrs*, 1953, Vol. 72, Part I, *Communication and Electronics*, pp. 492-494.) Description of an instrument for use at 10 kMc/s, comprising a temperature-compensated bolometer bridge using a bead thermistor as power detector.
- 621.397.62.001.4 : 535.623 **2732**
Color-Bar Generator produces I-Q Signals.—A. F. Boscia. (*Electronics*, June 1954, Vol. 27, No. 6, p. 143.) Test signals for alignment of the Q and I demodulators

for reception of N.T.S.C. colour-television signals are obtained from a colour-bar generator by control of blue-green and blue-red overlap.

621.317 2733
Electronic Measurements. [Book Review]—F. E. Terman & J. M. Pettit. Publishers: McGraw-Hill, 1952, 707 pp., 72s. 6d. (*J. atmos. terr. Phys.*, May 1954, Vol. 5, No. 2, p. 112.) The emphasis is "on the fundamental principles of measurement and of their synthesis into more elaborate techniques for specific purposes or circumstances . . . The presentation of the material is comprehensive and yet critical."

OTHER APPLICATIONS OF RADIO AND ELECTRONICS

532.542 2734
Electromagnetic Velometry: Part 2—Elimination of the Effects of Induced Currents in Explorations of the Velocity Distribution in Axially Symmetrical Flow.—A. Kolin & F. Reiche. (*J. appl. Phys.*, April 1954, Vol. 25, No. 4, pp. 409-413.) No correction for the effects of induced currents is required if very fine unshielded wires can be used as electrodes. This is possible if the quantity measured is the potential gradient along a cross-section diameter at 45° to the direction of the magnetic field. Part 1: 3981 of 1945 (Kolin).

615.471 2735
Determination of the Resultant Dipole of the Heart from Measurements on the Body Surface.—D. Gabor & C. V. Nelson. (*J. appl. Phys.*, April 1954, Vol. 25, No. 4, pp. 413-416.) Theory was developed and verified by measurements in electrolyte tank models of the human thorax.

621.372.029.64 : 621.313.001.4 2736
Microwaves Used to Observe Commutator and Slip Ring Surfaces during Operation.—A. H. Ryan & S. D. Summers. (*Elect. Engng. N.Y.*, March 1954, Vol. 73, No. 3, pp. 251-255.) Variations in the position of a reflecting surface are used to change the effective length of the open collinear arm of a magic-T. A change of 0.5 mil can be detected by means of the apparatus described operating at a frequency of 24 kMc/s. Typical records are shown.

621.384.612 2737
Overcoming the Critical-Energy Effect in the Strong-Focusing Synchrotron.—E. Bodenstedt. (*Z. Naturf.*, Aug. 1953, Vol. 8a, No. 8, pp. 502-503.) At a critical energy value the stable equilibrium of the phase oscillation becomes unstable and the focusing action changes into a defocusing one. A theoretical estimation indicates that it is not possible to avoid the transition through this critical value. The difficulty is overcome by using a large even number of accelerating gaps grouped in two systems, and distributing the phase of the accelerating voltages so that particles are focused in passing through the gaps of the first system and defocused in passing through the gaps of the second system; when the particle energy reaches the critical value the two systems reverse.

621.384.622.1 2738
Alternating-Gradient Electrostatic Focusing for Linear Accelerators.—L. C. Teng. (*Rev. sci. Instrum.*, March 1954, Vol. 25, No. 3, pp. 264-268.) Analytical study of the application of alternate convergent and divergent lenses to a standing-wave heavy-particle linear accelerator.

621.385.833 2739
An Electron-Optical Method of Imaging Objects with Magnetic Inhomogeneities.—G. V. Spivak, N. G. Kanavina, I. N. Chernyshev & I. S. Sbitnikova. (*C. R.*

Acad. Sci. U.R.S.S., 21st Sept. 1953, Vol. 92, No. 3, pp. 541-543. In Russian.) A secondary-emission electron microscope, by means of which both the geometrical and the magnetic irregularities of the specimen can be detected, is briefly described, typical photographs are shown and the method of operation is briefly compared with the electron-optical shadow method used by Marton & Lachenbruch (1211 of 1950).

621.385.833 : 061.3 2740
Fifth Annual Convention of the German Association for Electron Microscopy, Innsbruck, 1953.—(*Optik, Stuttgart*, 1954, Vol. 11, No. 3, pp. 97-148.) The text is given of the following papers presented at the convention:—
Image Formation in the Electron Microscope (pp.101-117).—W. Glaser.
Report of French Work in the Field of Electron Microscopy during the Past Year (pp. 118-120).—R. Bernard.
Electron Microscopy at Cambridge (pp. 121-132).—V. E. Cosslett.
Electron-Microscope Investigations at the A.E.I. Research Laboratory, Aldermaston, England (pp. 133-144).—M. E. Haine.
Report of Swiss Work in the Field of Electron Microscopy (pp. 145-148).—E. W. Schütz.

621.387.424 2741
The Temperature Dependence of the Characteristics of [self-quenching] Gas-Filled Geiger-Müller Counter Tubes.—H. J. Mader. (*Z. Phys.*, 15th March 1954, Vol. 137, No. 2, pp. 216-227.)

621.387.424 2742
Electron Transit Times in Geiger Counters.—J. R. Heirtzler. (*Rev. sci. Instrum.*, March 1954, Vol. 25, No. 3, pp. 243-245.) Using a photoemission technique, the transit time of an electron between the cylinder and the central wire of a self-quenching Geiger counter has been measured as a function of overvoltage for different vapour fillings at different pressures. Results are presented in graphs.

621.387.424 2743
Particle Detectors of Geiger-Müller (G-M) Counter Type.—A. Benoit. (*Le l'ide*, March 1954, Vol. 9, No. 50, pp. 1475-1491.) Operating principles are outlined and technological aspects discussed. 27 references.

621.398 2744
Parachute-Borne Telemetering System.—M. L. Greenough & C. C. Gordon. (*Electronics*, June 1954, Vol. 27, No. 6, pp. 148-151.) Description of a low-cost semi-expendable unit for transmitting data during the parachute descent. Seven information channels are provided, each sampled 100 times per second. The operating range is 2-10 miles. For a shorter account see *Tech. News Bull. nat. Bur. Stand.*, June 1954, Vol. 38, No. 6, pp. 81-82.

621.398 + 621.396.93 : 621.396.665 2745
Sequentially Gated Automatic Gain Control.—Eliason. (See 2677.)

PROPAGATION OF WAVES

538.566 2746
Some Stochastic Problems in Wave Propagation.—J. Feinstein. (*Trans. Inst. Radio Engrs*, Jan. & April 1954, Vol. AP-2, Nos. 1 & 2, pp. 23-30 & 63-70.) "The effect of random height variations associated with a conducting surface upon the characteristics of reflected wave energy is ascertained by the methods of physical

optics. Average received power, its variance, angular and frequency power spectra, and the field correlation pattern are determined in terms of the statistical parameters of the surface. Volume type problems are treated by ascertaining the effect of refractive index fluctuations within a slab upon an emergent wave-front, and then generalizing to a continuous medium. The results are applied to various problems encountered in tropospheric and ionospheric wave propagation."

538.566 : 535.312

2747

The Scattering of Electromagnetic Waves by Turbulent Atmospheric Fluctuations.—F. Villars & V. F. Weisskopf. (*Phys. Rev.*, 15th April 1954, Vol. 94, No. 2, pp. 232–240.) "The statistical theory of turbulence is applied to the problem of density fluctuations in the troposphere and the ionosphere. For suitable wavelengths, for which the so-called similarity region (Kolmogoroff spectrum) of the spectrum of turbulence is relevant, a closed formula can be given for the scattering cross section. It contains as only parameter the turbulent power dissipation S , and its angular dependence is given by $(\sin \frac{1}{2}\theta)^{13/3}$, θ being the scattering angle. The values of S required to explain ionospheric scattering are in excellent agreement with values found from investigations of meteor trails. Tropospheric data cannot be fitted with the assumptions of dry-air turbulence alone. The inference is that humidity fluctuations play an essential part in tropospheric scattering." If certain assumptions are valid, only a very small value of large-scale humidity fluctuations is required to account for the observed scattering.

621.396.11 : 551.510.535 : 523.3

2748

Lunar Radio Echoes and the Faraday Effect in the Ionosphere.—W. A. S. Murray & J. K. Hargreaves. (*Nature, Lond.*, 15th May 1954, Vol. 173, No. 4411, pp. 944–945.) Fading of lunar echoes has been investigated at Jodrell Bank; the frequency used was 120 Mc/s. 50 000 echoes were photographed and analysed. It is suggested that long-period fading observed during the day is due to rotation of the plane of polarization of the radio waves as they traverse the ionosphere in the presence of the earth's magnetic field; this view is supported by analysis based on the Appleton-Hartree magneto-ionic theory. Confirmation was obtained from experiments in which a vertical and a horizontal receiving dipole were alternately switched into operation.

621.396.11 : 621.317.353.2 : 551.510.535

2749

Effect of Nonlinearity of the Medium on Radio Waves Propagated in the Ionosphere.—I. M. Vilenski. (*C. R. Acad. Sci. U.R.S.S.*, 21st Sept. 1953, Vol. 92, No. 3, pp. 525–528. In Russian.) Assuming a square-law nonlinearity of the ionosphere, and neglecting the effect of the geomagnetic field, the field strength of the third harmonic of a monochromatic radio wave is calculated. Substitution of numerical values in the approximate formula derived indicates that the effect should be measurable for a 500-kW transmitter operating at $\omega = 10^8$. A more exact calculation is made of the effect produced by a modulated radio wave. The nonlinearity in this case causes not only a change of amplitude and phase but also a noticeable change of the depth of amplitude modulation, production of harmonics of the modulation frequency and the appearance of phase modulation which is large at low modulation frequencies and small at high ones. The expressions, which contain parameters such as the effective number of electron-molecule collisions, may be useful for determining the ionospheric parameters more simply than by the cross-modulation method.

621.396.11.029.53 : 551.510.535

2750

High Multiple Radio Reflections from the F₂ Layer of the Ionosphere at Brisbane.—K. Baird. (*Aust. J. Phys.*,

March 1954, Vol. 7, No. 1, pp. 165–175.) Continuous night-time records of multiple F₂ reflections at normal incidence have been made at 2.28 Mc/s, and the echo patterns have been classified. Statistical analyses of occurrences of up to the 10th multiple showed that (a) if no account is taken of the presence or absence of E_s, the frequency of occurrence increases towards dawn, (b) there is no correlation between the number of reflections observed and the virtual height of the region, (c) there is no correlation with 'range duplications', (d) inverse correlation between high multiple F reflections and presence of E_s occurs only when the lower region is blanketing, and (e) there is no correlation between high multiples and the travelling disturbances described by Munro (2504 of 1950). High multiples show maxima at the equinoxes. Oblique incidence records indicated no reflections beyond the fifth multiple.

621.396.11.029.6 : 551.5 : 061.3

2751

Radio-Meteorology: Conference in Texas.—J. A. Saxton. (*Nature, Lond.*, 24th April 1954, Vol. 173, No. 4408, pp. 761–764.) Report and comment on the conference held in November 1953. Papers on tropospheric wave propagation dealt with propagation beyond the horizon, scattering by turbulent layers, measurements of atmospheric refractive index, research at 100–1 000 Mc/s by the National Bureau of Standards, prediction of propagation conditions and experiments on 8-mm waves. Other sessions were devoted to thunderstorm and tornado atmospherics, cloud and precipitation physics and weather forecasting from radar observations. See also 230 of January.

621.396.81

2752

The Mechanism and Distribution of Short-Period Fading under Conditions of Ionospheric Turbulence.—F. Minozuma & H. Enomoto. (*Proc. phys. Soc.*, 1st March 1954, Vol. 67, No. 411B, pp. 211–216.) "Fading phenomena are discussed in terms of the variations of optical paths produced by the turbulent ionosphere. A simple model of turbulence in the ionosphere can predict the fading speeds found in practice, and some of the physical constants involved can be deduced from the variation of field intensity with time. The technique can be applied to determine fading speed and the amplitude distributions needed for communication purposes."

621.396.812.029.62

2753

V.H.F. Field Intensities in the Diffraction Zone.—R. N. Ghose & W. G. Albright. (*Trans. Inst. Radio Engrs.*, Jan. 1954, Vol. AP-2, No. 1, pp. 35–38.) A solution of the general wave equation is obtained assuming a refractive-index/height variation of exponential form which fits the required boundary conditions. An expression for field strength as a function of the height and the separation of transmitting and receiving aerials is derived. Calculated values of signal strength are compared with measured values.

621.396.812.3.029.62

2754

A Preliminary Study of Fading of 100-Mc/s F.M. Signals.—R. L. Riddle & C. R. Ammerman. (*Trans. Inst. Radio Engrs.*, Jan. 1954, Vol. AP-2, No. 1, pp. 30–34.) A statistical study is made of short-period fading over a mountainous path of about 120 miles under typical midday conditions. Signal amplitudes have an essentially Rayleigh distribution; amplitude variations have a Gaussian distribution. Speed of fading and values of effective wind velocity are determined statistically; the latter are compared with measured values.

RECEPTION

621.396.621 2755

The Response of a Panoramic Receiver to C.W. and Pulse Signals.—H. W. Batten, R. A. Jorgensen, A. B. Macnee & W. W. Peterson. (*Proc. Inst. Radio Engrs*, June 1954, Vol. 42, No. 6, pp. 948-956.) A quantitative investigation is made of the dependence of output amplitude, output pulse width and apparent bandwidth of a panoramic superheterodyne receiver on signal frequency, input pulse width, actual bandwidth, sweep rate, and type of i.f. amplifier. The measured response of a receiver with single-tuned i.f. amplifier to rectangular-envelope pulses is compared with the theoretical response of a receiver with a Gaussian-shaped i.f. characteristic to Gaussian-envelope pulses. The agreement between the two cases justifies the application of the Gaussian-case analysis to most practical design problems.

621.396.621 : 621.396.812.3 2756

An Analysis of Dual Diversity Receiving Systems.—A. H. Hausman. (*Proc. Inst. Radio Engrs*, June 1954, Vol. 42, No. 6, pp. 944-947.) "A method is presented for evaluating dual diversity receiving systems by relating the characteristics of the receiving equipment to the signal levels at both receiving antennas. The characteristics of the receiving equipment are described by relating the quality of the output traffic to the input signal level. The input signal levels are in turn described in terms of the bivariate Rayleigh probability distribution function. The method is sufficiently general to enable extension to evaluate triple diversity systems and is independent of the frequency range over which diversity fading phenomena occur. The method can also be simplified to examine the over-all effectiveness of a nondiversity receiving system."

621.396.621 : 621.396.9 2757

Aircraft Receiver for VOR-ILS and Communications.—Gray. (See 2676.)

621.396.621.029.55 : 621.396.662.076.2 2758

Notes on Permeability Tuning for Short Waves.—P. Rohan. (*Proc. Inst. Radio Engrs, Aust.*, May 1954, Vol. 15, No. 5, pp. 111-113.) Methods of achieving linear dial calibration are discussed. Formulae are derived for calculating the components of the resonant circuits for band changing and band spreading. Numerical examples are given.

621.396.621.54 : 621.373.424 2759

Variable-Frequency Crystal-Controlled Receivers and Generators.—T. L. Wadley. (*Trans. S. Afr. Inst. elect. Engrs*, Feb. 1954, Vol. 45, Part 2, pp. 77-90. Discussion, pp. 90-99.) The systems described are based on heterodyning the harmonic spectrum of a crystal oscillator by means of a v.f.o. and mixer so that a fixed-frequency filter can be used and interpolation between harmonics is easily effected. General principles applied to generators and receivers are discussed. Detailed consideration is given to the design of (a) a generator for frequencies up to 20 Mc/s derived from a 100-kc/s crystal, and (b) a receiver operating at frequencies up to 30 Mc/s with multiple heterodyning based on a 1-Mc/s crystal. In the latter the local oscillator is a generator of the type described and the outputs from the v.f.o. and the harmonic filter are applied respectively to the first and second mixers; a final i.f. of 456 kc/s is derived in a 2-3-Mc/s interpolation receiver. Alternative circuits are considered and performances discussed.

621.396.621.54.029.5 2760

Wide-Band Communication Receiver.—(*Wireless World*, July 1954, Vol. 60, No. 7, pp. 333-334.) A 12-valve receiver, model CAT, designed to an Admiralty specifica-

tion for use in naval vessels, has a frequency range of 60 kc/s to 31 Mc/s, covered in eight switched ranges. The set is a double superheterodyne, but is switched to single-heterodyne operation on some of the ranges. The i.f. bandwidth can be adjusted over a wide range in four discrete steps.

621.396.621.59 2761

A New Method for Treating Electron Tubes when used as Superregenerative Detectors.—A. E. Mostafa & M. El-Shishini. (*Trans. Amer. Inst. elect. Engrs*, 1953, Vol. 72, Part I, *Communication and Electronics*, pp. 207-213, 283-289 & 290-297.) Analysis is given based on treating the valve as a periodically varying element and applying the methods of superposition and successive approximation used for the solution of circuits having periodically varying resistances. Multiple resonance, the characteristic noise, the building up of oscillations to an amplitude depending on the quenching source and the valve non-linearity, and the condition for stability of super-regeneration are discussed in relation to the no-signal condition. The a.v.c. action, sensitivity, selectivity, stability and synchronization with the signal are considered. Numerical illustrations are given and experimental investigations described.

621.396.823 : [621.376.2].3 2762

Impulse Noise in Amplitude-Modulation and Frequency-Modulation Systems.—D. Maurice. (*Onde élect.*, March 1954, Vol. 34, No. 324, pp. 303-307.) Results of a B.B.C. survey are discussed. For a f.m. system with maximum frequency swing of ± 75 kc/s and pre- and de-accentuation with 50- μ s time constant, the improvement in signal/noise ratio over a comparable a.m. system with no accentuation is 26 db for both impulse noise and circuit noise above a threshold value of signal intensity. The effect of impulse noise with peak values greater than and less than carrier level on arrival at the f.m. limiter is analysed by the rotating-voltage-vector method. A family of curves based partly on calculation and partly on measurement shows how the interference from motor cars in a city street depends on the maximum frequency swing of the f.m. receiver.

STATIONS AND COMMUNICATION SYSTEMS

621.376.5 2763

Theoretical Fundamentals of Pulse Transmission: Part 1.—E. D. Sunde. (*Bell Syst. tech. J.*, May 1954, Vol. 33, No. 3, pp. 721-788.) Theory is given in a form useful both for investigating existing pulse transmission systems and for designing new ones. The relation between the pulse transmission characteristic and the frequency response characteristic is discussed, and characteristic distortion due to system imperfections is considered. Methods of evaluating pulse distortion from gain and phase deviations are presented, and the resulting limitations on pulse transmission rates in low-pass symmetrical and asymmetrical sideband systems are examined.

621.39 2764

Communications for Civil Defense.—C. A. Armstrong. (*Trans. Amer. Inst. elect. Engrs*, 1953, Vol. 72, Part I, *Communication and Electronics*, pp. 315-326.) Discussion of the requirements for dealing with attack warning and disaster control in the U.S.A.

621.391.5 : 621.395.61 2765

The "Vagabond" Wireless Microphone System.—T. W. Phinney. (*Trans. Inst. Radio Engrs*, March/April 1954, Vol. AU-2, No. 2, pp. 44-48; *Proc. nat. Electronics Conf., Chicago*, 1953, Vol. 9, pp. 103-110.) Combined microphone and f.m. transmitter equipment for a public

address system, designed to be carried or worn, is described. The system uses inductive coupling between the transmitter and the receiver, and a carrier frequency of approximately 2.1 Mc/s. The subminiature transmitter which weighs <1 lb, is contained in a stick-type microphone housing 1½ in. in diameter and 12 in. long. Two printed circuit plates form the main chassis, the unit, after assembly, being filled with casting resin. A microphone cartridge of special design provides the desired pre-emphasis. A ferrite-core transmitting inductor 3 in. long is used. Battery life is 40 operating hours.

621.394.395 **2766**
Telephony and Telegraphy.—L. H. Harris. (*Proc. Instn elect. Engrs*, Part 1, May 1954, Vol. 101, No. 129, pp. 83-92.) A survey covering developments in materials, components and equipment since 1946. 100 references.

621.396.1(94) **2767**
Frequency Bands allotted to Australian Radio Services as at 1/7/53.—(*Proc. Instn Radio Engrs, Aust.*, May 1954, Vol. 15, No. 5, pp. 120-121.)

621.396.44 **2768**
Program Transmission over Type-N Carrier Telephone.—R. L. Case & I. Kearney. (*Trans. Amer. Inst. elect. Engrs*, 1953, Vol. 72, Part 1, *Communication and Electronics*, pp. 791-795.)

621.396.5 **2769**
The New Jersey Turnpike — a Unique Highway Communication System.—P. F. Godley, J. R. Neubauer & D. R. Marsh. (*Trans. Amer. Inst. elect. Engrs*, 1953, Vol. 72, Part 1, *Communication and Electronics*, pp. 360-369.) Description of the radio system for this busy road, comprising seven 950-Mc/s stations forming the backbone of the system, five 150-Mc/s stations for communication with mobile units, about 75 mobile units of the police, maintenance, etc., and about 86 toll booths at 17 interchange stations.

621.396.61/62 **2770**
Ships' Lifeboat Radio.—(*Wireless World*, July 1954, Vol. 60, No. 7, p. 308.) A transmitter-receiver approved by the British G.P.O. and Ministry of Transport has an improved kite to raise the aerial to a height of about 200 ft. Daylight ranges of over 500 miles have been obtained with radiated power of 4 W. An alternative fixed aerial is supported on an 18-ft mast. Brief details are given of the set, which transmits on 500 kc/s and 8.634 Mc/s and receives on 500 kc/s only. Power is provided by a hand-turned generator.

621.396.65.029.6 **2771**
Microwave Radio Relay Systems Symposium, New York, November 5-6, 1953.—(*Trans. Inst. Radio Engrs*, April 1954, Vol. MTT-2, No. 1, pp. 1-107; *ibid*, July 1954, Vol. CS-2, No. 2, pp. 1-107.) The text is given of the following papers presented at the symposium:—
 The Microwave System of the Michigan-Wisconsin Pipeline Company (pp. 1-8).—W. P. Maginnis & H. Place.
 Microwave Site Selection in Undeveloped Country (pp. 9-15).—R. D. Pynn.
 Microwave Repeater Site Planning and Development (pp. 16-31).—R. D. Chapman.
 Remote Control of Standby Engine Generator Sets over a Microwave System (pp. 32-35).—R. L. Halvorson.
 Applications of Compandors to F.M. Radio Systems with Frequency Division Multiplexing (pp. 36-40).—M. C. Harp, M. H. Kebby & E. J. Rudisuhle.
 A Double-Sideband Amplitude-Modulated Multiplex System for Use over Microwave Radio (pp. 41-49).—N. B. Tharp.

A Microwave System for Trunk Service (pp. 50-59).—J. J. Lenehan.

A Microwave Radio System for Pipeline Use (abstract only) (pp. 60-62).—E. Dyke.

Microwave and V.H.F. Radio Installation for the Union Electric System (pp. 63-83).—G. W. Fox.

Microwave Radio Relay Link for Military Use (pp. 84-88).—S. Metzger.

Transco Microwave System (pp. 89-92).—H. A. Rhodes.
 Microwave Testing with Millimicrosecond Pulses (pp. 93-99).—A. C. Beck.

Theoretical Aspects of Microstrip Waveguides (abstract only) (pp. 100-102).—G. A. Deschamps.

Considerations in Klystron Design for Microwave Relay Systems (pp. 103-107).—R. W. Olthuis.

621.396.712 **2772**
The Transmitting Centre of the Institut National Belge de Radiodiffusion (I.N.R.) at Wavre-Overijse.—M. Dick. (*Brown Boveri Rev.*, Oct. 1953, Vol. 40, No. 10, pp. 370-394.) Detailed illustrated description of station layout and equipment. See also 1128 of 1953 (Hansen).

621.396.933 **2773**
The Information Content of Air-Ground Messages.—G. W. Grier, Jr. (*Trans. Inst. Radio Engrs*, March 1954, Vol. ANE-1, No. 1, pp. 5-16.) Records of air/ground communication during the landing of aircraft were analysed with a view to assessing (a) the general reliability of the information conveyed, and (b) whether the best possible use was being made of the available channel space. It is suggested that the position- and altitude-reporting functions of the pilot be taken over by a transponder.

621.396.933 **2774**
Some Channel Allocation Problems in Air-Ground Voice Communications.—W. W. Felton. (*Trans. Inst. Radio Engrs*, March 1954, Vol. ANE-1, No. 1, pp. 41-51.) Discussion based on measurements of the factors limiting the number of aircraft under simultaneous control per channel, including the maximum utilization of the channel, and the amount of communicating time per aircraft.

621.39.001.11 **2775**
Communication Theory. [Book Review]—W. Jackson (Ed.). Publishers: Butterworths Scientific Publications, London, 1953, 532 pp., 65s. (*J. atmos. terr. Phys.*, May 1954, Vol. 5, No. 2, p. 111.) "The publication of this book constitutes a very satisfactory conclusion of a symposium on 'Applications of Communication Theory', which was held at the Institution of Electrical Engineers, London in September 1952... The volume now available comprises the complete text of the thirty-eight papers presented at the various sessions together with the discussions, some of which are most illuminating and considerably enhance the value of the individual contributions."

SUBSIDIARY APPARATUS

621.526 : 061.3 **2776**
Servomechanism Papers.—(*Trans. Inst. Radio Engrs*, March 1954, Vol. CT-1, No. 1, pp. 1-70.) Six papers presented at a convention held in San Francisco, August 1953, with editorial:
 Trends in Feedback Systems (pp. 2-8).—O. J. M. Smith.
 Nonlinear Control Systems with Random Inputs (pp. 9-18).—R. C. Booton, Jr.
 A Method of Analysis and Synthesis of Closed-Loop Servo Systems containing Small Discontinuous Non-linearities (pp. 19-34).—D. T. McRuer & R. G. Halliday.

Stability of Feedback Systems using Dual Nyquist Diagram (pp. 35-44).—P. Jones.
 Optimum Lead-Controller Synthesis in Feedback-Control Systems (pp. 45-48).—L. G. Walters.
 On the Comparison of Linear and Nonlinear Servomechanism Response (pp. 49-55).—T. M. Stout.
 Predictor Servomechanisms (pp. 56-70).—L. M. Silva.

621.3.013.783 2777
The Use of Steel Sheet for the Construction of Shielded Rooms.—A. M. Intrator. (*Trans. Amer. Inst. elect. Engrs.*, 1953, Vol. 72, Part I, *Communication and Electronics*, pp. 599-604. Discussion, pp. 604-605.)

621.316.722.1 : 621.385.3 2778
Self-Heating Triode for Voltage Stabilization.—Hopkins. (See 2824.)

621.35 : 537.311.33 : 535.21 2779
Sun powers Telephone.—(*Electronics*, June 1954, Vol. 27, No. 6, pp. 196, 198.) Brief description of a battery comprising an array of Si strips, each about $\frac{1}{2}$ in. \times 2 in., which when exposed to sunlight gives a current of 24 mA/cm² at about 0.5 V.

TELEVISION AND PHOTOTELEGRAPHY

621.397.24 : 26 2780
European Television.—J. T. Dickinson. (*Wireless World*, July 1954, Vol. 60, No. 7, pp. 319-321.) Discussion of engineering problems involved in the recent international exchange experiments, in which networks operating on 405-, 625-, and 819-line standards were interconnected. The main items of the agreed performance specifications are indicated. Results were promising.

621.397.242 : 621.395.51 2781
The London-Birmingham Television-Cable System.—T. Kilvington, F. J. M. Laver & H. Stanesby. (*Proc. Instn elect. Engrs.*, Part I, May 1954, Vol. 101, No. 129, pp. 117-119.) Discussion on 2625 of 1952.

621.397.26 2782
Transmission Characteristics of the Berlin-Leipzig Television Link.—G. Megla. (*NachrTech.*, March 1954, Vol. 4, No. 3, pp. 98-102.) The technical and economic considerations which led to the adoption of a radio relay network operating with a frequency of about 1.5 kMc/s are discussed, and calculations of transmitter powers required for adequate point-to-point service are given. Distances up to 82 km are covered using a 10-W f.m. transmitter with a parabolic-reflector aerial with a gain of 3.63 neper. The effect of atmospheric conditions on field strength is briefly discussed.

621.397.26 : 621.396.65.029.64 2783
Microwave Relay for Japanese Television.—T. Nomura, K. Suzuki, S. Mita & N. Sawazaki. (*Electronics*, June 1954, Vol. 27, No. 6, pp. 152-156.) Description of the seven-station, 288-mile Tokyo-Osaka relay, which operates with alternate transmitting and receiving frequencies of 4.000 and 4.045 kMc/s. The design had to take account of high free-space attenuation and deep fades. Necessary gain was provided by incorporating a 3-stage travelling-wave amplifier giving an output of about 3 W at each repeater, and by using high-gain paraboloidal aerials of diameter 13.1 ft. The repeaters are of double-heterodyne type, converting the microwave signal first to 70 Mc/s and then to 115 Mc/s.

621.397.26 : 621.396.65.029.64 2784
The Manchester-Kirk o'Shotts Television Radio-Relay System.—G. Dawson, L. L. Hall, K. G. Hodgson, R. A. Meers & J. H. H. Merriman. (*Proc. Instn elect. Engrs.*,

Part I, May 1954, Vol. 101, No. 129, pp. 93-109. Discussion, pp. 109-114.) The link comprises seven intermediate stations for a total path length of 247 miles, and operates in the 3.9-4.2-kMc/s band. Duplicate equipment is provided at each station, with stand-by power supply and automatic changeover facilities. All intermediate stations are unattended, a 4-wire line circuit for supervision and control linking them to the terminal points. Only two carrier frequencies are used, each repeater transmitting on one frequency in both directions and receiving on the other frequency from both directions. F.m. is used; the overall repeater bandwidth is 16 Mc/s. A travelling-wave amplifier provides the output of each repeater. Transmitter power is 1 W. Details are given of equipment and propagation tests. Outage time from all causes was <0.04% in the period June 1953-January 1954.

621.397.5 2785
Development of Television Service Standards and Application to Design of a Television Broadcast Network.—O. W. B. Reed, Jr. (*Trans. Amer. Inst. elect. Engrs.*, 1953, Vol. 72, Part I, *Communication and Electronics*, pp. 838-850.) A discussion of frequency allocation and coverage problems in the U.S.A.

621.397.61 2786
Technical Characteristics of FTL Type No. 20-B U.H.F. Television Transmitter.—E. M. Bradburd. (*Trans. Amer. Inst. elect. Engrs.*, 1953, Vol. 72, Part I, *Communication and Electronics*, pp. 555-561.) Details are given of both sound and picture transmitters. F.m. is used for the sound transmitter and grid modulation in a wide-band amplifier for the picture transmitter. Vestigial-sideband filter and diplexer units are analysed and the construction of the cavity resonators is described.

621.397.62 2787
Television I.F. Inquiry.—G. H. Russell. (*Wireless World*, July 1954, Vol. 60, No. 7, pp. 322-325.) Review of a report prepared by the European Broadcasting Union on the basis of replies to a questionnaire, addressed to manufacturers in a number of countries, on television receiver problems. The relative importance of six major causes of interference listed varied according to local conditions; in Belgium, Denmark, Germany, Holland and the U.S.A. the most important consideration was second-channel interference, whereas in Sweden and the U.K. it was i.f. breakthrough. Oscillator radiation from nearby receivers is considered of relatively little importance. Values of i.f. in use and expected to be in use in the near future are tabulated. The different television standards used in Western Europe are summarized, and problems in the production of multistandard receivers are mentioned.

621.397.62 : 535.623 2788
Color Demodulators for Television Receivers.—E. G. Clark & C. H. Phillips. (*Electronics*, June 1954, Vol. 27, No. 6, pp. 164-166.) A circuit based on use of a split-anode heptode valve is described; this permits high-level demodulation using one valve only. Alternative cascade-connected circuits use double-triode and pentode-triode combinations.

621.397.62.001.4 : 535.623 2789
Color-Bar Generator produces I-Q Signals.—Boscica. (See 2732.)

621.397.82 2790
The Measurement of Random Monochrome Video Interference.—J. M. Barstow & H. N. Christopher. (*Trans. Amer. Inst. elect. Engrs.*, 1953, Vol. 72, Part I, *Communication and Electronics*, pp. 735-741.) Two

problems are considered, (a) the relative importance of interference in different parts of the video spectrum, and (b) whether the visual mechanism sums the interference effects in various parts of the spectrum in such a way that the overall effect can be uniquely related to an overall measurement. Subjective tests are described; the results indicate that random television interference can be measured with a power meter having frequency weighting, with sufficient accuracy to be of value in the design and maintenance of television transmission circuits.

TRANSMISSION

621.396.61 : 2791
A Million-Watt Naval Communication Transmitter.—J. C. Walter. (*Trans. Amer. Inst. elect. Engrs*, 1953, Vol. 72, Part 1, *Communication and Electronics*, pp. 369–374.) See 821 of 1953 (Hobart).

621.396.61 : 621.373.421.13 + 621.375.2 : 2792
A Survey of Quality Problems in Transmitting Equipment.—H. Neck. (*Brown Boveri Rev.*, Oct. 1953, Vol. 40, No. 10, pp. 395–400.) Tolerances in a.m. transmitters are considered. The operation of a quartz-crystal oscillator for maximum stability is discussed and principles of determining amplifier distortion by intermodulation measurements are illustrated. A method of designing an a.f. amplifier based on equivalent-circuit analysis is outlined; it involves a certain mismatch of components but gives improved response at low and high frequencies at high modulation levels.

621.396.61 : 621.385.712 : 2793
Air Cooling of Medium- and High-Power Transmitters.—Klein. (See 2803.)

VALVES AND THERMIONICS

621.314.632 : 546.289 : 2794
The "Photo-Aftereffect" of Germanium Crystal Rectifiers.—M. Kikuchi & T. Onishi. (*J. phys. Soc. Japan*, Jan. Feb. 1954, Vol. 9, No. 1, pp. 130–131.) The reduction of the rectifier resistance, as a result of illuminating the point contact for 90 sec, was observed; experiments were made to elucidate the physical processes underlying this phenomenon. The results are briefly discussed.

621.314.632 : 546.289 : 2795
Germanium Diodes from Spherical Pellets.—W. C. Dunlap, Jr. (*J. appl. Phys.*, April 1954, Vol. 25, No. 4, pp. 448–451.) .15-mil Ge spheres are produced within a few minutes in very large quantities by blowing molten high-purity Ge from a graphite crucible. The spherical pellets can be annealed, ground, etched, and assembled into diodes by techniques easily adaptable to mass production. The diode has a sphere-plane contact in place of the conventional whisker contact. Peak back-voltages in the range 50–100 V are easily obtained.

621.314.7 : 2796
A Point-Emitter/Junction-Collector Transistor.—R. H. Kingston. (*J. appl. Phys.*, April 1954, Vol. 25, No. 4, pp. 513–515.) A transistor structure using a planar $p-n$ junction as a collector, and a point contact as an emitter is analysed. Theory indicates that for maximum frequency cut-off the plane containing the emitter point should be nearly parallel to the collector junction. The base resistance is a critical function of the spacing between the emitter point and the collector junction. Experimental models with modified emitter-collector configuration approaching the $p-n-p$ structure give improved frequency cut-off.

621.314.7 : 2797
The Effect of Junction Shape and Surface Recombination on Transistor Current Gain.—A. R. Moore & J. I. Pankove. (*Proc. Inst. Radio Engrs*, June 1954, Vol. 42, No. 6, pp. 907–913.) Current gain, α , of alloy-type transistors is calculated for some particular three-dimensional geometries, using a method based on analogy with current flow in a conducting sheet, and assuming that surface recombination is the dominant factor in minority-carrier loss. The hole-flow field is plotted on a scale model. The method enables the surface recombination velocity s to be found from simple measurements; s may be useful as a criterion of surface quality. A calculation indicates that transit-time dispersion, due to unequal path lengths in transistors with nonparallel junctions, is not significant at frequencies below 1 Mc/s.

621.314.7 : 2798
On the Variation of Junction-Transistor Current-Amplification Factor with Emitter Current.—W. M. Webster. (*Proc. Inst. Radio Engrs*, June 1954, Vol. 42, No. 6, pp. 914–920.) The modification of the field in the base region by the injected carriers decreases the mean carrier transit time, reducing the effect of surface recombination and leading to an increase of α_{cb} as the emitter current increases. The simultaneous increase of conductivity of the base increases the rate of volume recombination and reduces emitter efficiency. The combination of the two effects gives rise to the observed decrease of α_{cb} at both high and low values of emitter current. The variation of α_{cb} with emitter current is about four times as great in $p-n-p$ as in $n-p-n$ type transistors.

621.314.7 : 2799
P-N-I-P and N-P-I-N Junction Transistor Triodes.—J. M. Early. (*Bell Syst. tech. J.*, May 1954, Vol. 33, No. 3, pp. 517–533.) A modified $p-n-p$ junction transistor is described in which the n -type base region and the p -type collector region are separated by a relatively thick region of intrinsic semiconductor almost free of impurity centres. This permits establishment of a thick collector depletion layer at relatively low voltage, thus producing low collector capacitance and high collector breakdown voltage, which in turn lead to an extension of the high-frequency limit of operation and of the permissible power dissipation. Calculations based on theory indicate that oscillations at frequencies as high as 3 kMc/s may be possible. Experimental units have been produced with emitter diameter 0.01 in. and collector diameter 0.015 in., having stable gain without compensation of 20.5 db at 10 Mc/s and oscillating at frequencies up to 95 Mc/s. The $n-p-i-n$ type transistor is formed by a corresponding modification of the $n-p-n$ type.

621.383.27 : 2800
Investigations of the Dark Current of Secondary-Electron Multipliers with Cs-Sb Photocathodes.—N. Schaetti, W. Baumgartner & C. Flury. (*Helv. phys. Acta*, 15th June 1953, Vol. 26, Nos. 3/4, pp. 380–383. In German.) Continuation of investigations reported in 1518 of 1953 (Schaetti & Baumgartner). Results for Cs-Sb photocathodes are compared with those previously obtained for Li-Sb.

621.383.5 : 2801
Tentative Electronic Interpretation of Inertia Phenomena in Photocells.—G. Blet. (*C. R. Acad. Sci., Paris*, 26th April 1954, Vol. 238, No. 17, pp. 1704–1705.) By assuming that the conductivity of the barrier layer is proportional to the number of free electrons per unit volume, curves are derived for the potential build-up on illumination, for various illumination intensities; these

agree with experimentally obtained curves. The time constant is a characteristic intrinsic to the unilluminated barrier layer and independent of cell geometry and excitation wavelength.

621.385 2802

How to use Valves.—(*Elect. Times*, 18th March 1954, Vol. 125, No. 3254, p. 400.) A note summarizing the first two parts of British Standard Code of Practice C.P.1005, covering general recommendations and receiving valves, c.r. tubes and rectifiers.

621.385-712 : 621.396.61 2803

Air Cooling of Medium- and High-Power Transmitters.—W. Klein. (*Brown Boveri Rev.*, Oct. 1953, Vol. 40, No. 10, pp. 401-406.) An illustrated description is given of different air-cooling arrangements based on the radiator system described earlier [2933 of 1950 (Schärl)]]. For a 135-kW medium-wave transmitter one low-pressure and two high-pressure blowers and an exhaust fan are used. More modern, simplified systems are shown in a 100-kW long-wave and a 25-kW medium-wave installation.

621.385.001.4 2804

A Comparison of 6AK5 and 5654 Tubes.—F. A. Paul. (*Trans. Inst. Radio Engrs*, March 1954, No. PGCP-1, pp. 18-32.) Vibration and shock tests are reported. Type-5654 valves, which are electrically equivalent to Type 6AK5 but are designed for increased reliability, gave very much better results, particularly in vibration tests.

621.385.004.15 2805

Reliability of Electron Tubes in Military Applications.—E. R. Jervis. (*Proc. Inst. Radio Engrs*, June 1954, Vol. 42, No. 6, pp. 902-906.) A statistical study was made of valves removed from military equipment as unsatisfactory. The factors leading to the removal are grouped under (a) maintenance and operating conditions, (b) environment, (c) application, and (d) inherent valve weaknesses. About one third of the valves were found not to be defective. The results indicate the importance of adequate maintenance routine. Excessively high operating temperature is the predominant cause of valve deterioration. The removal rate of the improved 'reliable' valves is only between a quarter and a third of that for the corresponding prototypes. Further improvement in respect of reliability can be achieved by applying known methods.

621.385.029.6 2806

Miniature Radio Valves.—V. Anisimov. (*Radio, Moscow*, March 1954, No. 3, pp. 54-56.) Graphs and tables are given of the characteristics of a new series of Russian 6-3-V subminiature valves designed for use in u.s.w. receivers. The series includes two pentodes, two triodes, a diode, a 150-V voltage stabilizer and a thyatron. The base connections are indicated on the valve label.

621.385.029.6 2807

Space-Charge Waves in Plasma Streams.—J. Labus & K. Pöschl. (*Arch. elekt. Übertragung*, Feb. 1954, Vol. 8, No. 2, pp. 49-54.) Extension of analysis given previously [2182 of 1953 (Labus)]. The phase velocities and phase eigenvalues are derived for the case of an electron beam in a finite magnetic focusing field.

621.385.029.6 2808

Application of Perturbation Theory to the Traveling Wave Tubes.—M. W. Muller & W. L. Beaver. (*J. appl. Phys.*, April 1954, Vol. 25, No. 4, pp. 542-543.) An expression is derived for the incremental propagation constant as a function of the interaction term.

621.385.029.6 2809

Amplification of Electromagnetic Waves due to Displacement of an Electron Beam in Crossed Electric and Magnetic Fields bounded by Resistive Walls.—O. Doehler & G. Guillaud. (*C. R. Acad. Sci., Paris*, 3rd May 1954, Vol. 238, No. 18, pp. 1784-1786.) Small-signal analysis is presented for a particular arrangement of the general type described by Birdsall et al. (3147 of 1953). Using values of the field given by Maxwell's equations, a second-degree equation is derived for the propagation constant, the solution of which corresponds to one amplified and one attenuated wave. If one of the walls is perfectly conducting, one of these waves disappears. If the magnetic field exceeds a certain value two further waves are obtained with real propagation constants.

621.385.029.6 : 621.372.2 2810

Transmission-Line Analog of a Modulated Electron Beam.—S. Bloom & R. W. Peter. (*RCA Rev.*, March 1954, Vol. 15, No. 1, pp. 95-112.) The differential equations expressing wave propagation along an electron beam with laminar flow and along a lossless nonuniform transmission line are shown to be identical within certain limits. Conditions in the beam can hence be investigated by means of established transmission-line theory and by measurements on a transmission-line model of the beam. The method is illustrated by a study of space-charge-wave propagation in a planar diode, using a slotted coaxial-line model with a tapered inner conductor and making measurements of the standing-wave pattern.

621.385.029.6 : 621.372.2 2811

Space-Charge-Wave Amplification along an Electron Beam by Periodic Change of the Beam Impedance.—R. W. Peter, S. Bloom & J. A. Ruetz. (*RCA Rev.*, March 1954, Vol. 15, No. 1, pp. 113-120.) The common basis of various types of single-velocity space-charge-wave amplifier is established; the impedance of the beam can be changed by changing the beam voltage or diameter or the diameter of the surrounding drift tube. The transmission-line analogy developed by Bloom & Peter (2810 above) is used to determine the amplification bands of the space-charge-wave amplifier by analogy with the filter stop bands of the corresponding line.

621.385.029.6 : 621.373.423 2812

Analysis of the Backward-Wave Traveling-Wave Tube.—H. Heffner. (*Proc. Inst. Radio Engrs*, June 1954, Vol. 42, No. 6, pp. 930-937.) For low beam currents the valve acts as a high-gain high-Q voltage-tuned filter. As the beam current is increased, self-oscillation is produced, the frequency of which is controlled by the beam voltage to any value within the pass band. Analysis is presented for small-signal operation. See also 587 of February.

621.385.029.6.002.2 2813

Manufacture of a Magnetron.—(*Elect. Commun.*, March 1954, Vol. 31, No. 1, pp. 2-18.) Photographs illustrate various stages in the manufacture and testing of the Type-4J52 magnetron.

621.385.032.213.1.027.51.6 2814

High-Power Industrial Vacuum Tubes having Thoriated-Tungsten Filaments.—R. B. Ayer. (*Trans. Amer. Inst. elect. Engrs*, 1953, Vol. 72, Part I, *Communication and Electronics*, pp. 121-125.) Valves of this type (2660 of 1952) have given uninterrupted service for periods up to 22 months at anode voltages up to 17 kV.

621.385.032.216 2815

Negative Ion Emission from Oxide-Coated Cathodes: Part 1.—F. A. Vick & C. A. Walley. (*Proc. phys. Soc.*, 1st March 1954, Vol. 67, No. 411B, pp. 169-176.) Simple mass-spectrometer investigations are described. The predominant ions were Cl, originating mainly in the glass

envelope. A correlation between Cl ion current and cathode poisoning was established, the poisoning being appreciable when the modulator was more than 8 V positive with respect to the cathode.

621.385.032.216

2816

Negative Ion Emission from Oxide-Coated Cathodes: Part 2.—W. Grattidge & A. A. Shepherd. (*Proc. phys. Soc.*, 1st March 1954, Vol. 67, No. 4113, pp. 177-186.) Report on mass-spectrometer investigation of the ions emitted on activation and during cathode life. The variation of Cl ion emission with temperature and field was studied. No correlation with electron emission was found. It is probable that Cl ions are mainly responsible for ion burn in c.r. tubes.

621.385.032.216

2817

The Activation of Thermionic Cathodes Coated with Thoria and Zirconia.—G. Mesnard. (*J. Phys. Radium*, March 1954, Vol. 15, No. 3, pp. 151-155.) Experiments using ZrO_2 on W and Mo bases, ThO_2 on Pt and Mo bases, and complex layers give results suggesting that dissociation of the oxide may be an important cause of activation. For a more detailed account of the work see *Le Vide*, Jan. 1954, Vol. 9, No. 49, pp. 1448-1453.

621.385.032.216

2818

Moulded Thermionic Cathodes made of Nickel and Alkaline Earth Oxides.—G. Mesnard & R. Uzan. (*Le Vide*, March 1954, Vol. 9, No. 50, pp. 1492-1507.) The method of preparing cathodes by compressing and sintering a mixture of Ni powder and co-precipitated barium and strontium carbonates is described. Measurements on experimental valves are reported, for steady-state and for pulsed operation. The effects of current activation and heat treatment are demonstrated. The influence of sintering temperature and atmosphere and of the composition of the mixture is investigated.

621.385.032.216

2819

On the Electron Bombardment Effect for Deposited Barium Oxide Films.—T. Imai. (*J. phys. Soc. Japan*, Jan./Feb. 1954, Vol. 9, No. 1, pp. 28-37.) In valves with oxide cathodes, oxide films are deposited on the other electrodes by evaporation during pumping, activation and normal operation. When these films are subjected to electron bombardment, as in the case of anode and screen grid, gas is liberated, and the cathode emission decreases in consequence. The emission from the films increases or decreases on electron bombardment, according as the films are deposited at low or high cathode temperature.

621.385.032.216 : [546.431-31 + 546.431.64

2820

Electronmicroscopic Observation of the Change of Forms of the Coated Oxide Particles of the Oxide Cathode by the Activation.—T. Hibi. (*Sci. Rep. Res. Inst. Tohoku Univ., Ser. A*, Dec. 1953, Vol. 5, No. 6, pp. 573-580.) Results indicate that the degree of activity of oxide particles is related to structural changes occurring at various depths from the surface, as shown in 16 photographs. The changes in barium carbonate particles are also shown photographically and are briefly discussed.

621.385.15

2821

Potential Distribution and Prevention of a Space-Charge-Induced Minimum between a Plane Secondary Electron Emitter and Parallel Control Grid.—G. C. Sponser. (*J. appl. Phys.*, March 1954, Vol. 25, No. 3, pp. 282-287.) The critical electrode spacing required to avoid formation of a minimum is derived from a potential-distribution analysis.

621.385.15 + 621.385.832] : 621.3.018.75

2822

Some Experiments on Beam-Deflection Devices and Electron Multipliers for Millimicrosecond Pulses.—C. H.

Vincent. (*Onde élect.*, Feb. 1954, Vol. 34, No. 323, pp. 119-122.) "An experimental tube with two fast deflector systems has been built and used to indicate coincidences between pulses in coaxial lines with millimicrosecond accuracy. Another tube incorporating an electron multiplier is being constructed as a possible means of amplifying millimicrosecond pulses and for the purpose of studying the characteristics of electron multipliers when delivering large current pulses of millimicrosecond duration."

621.385.15.032.23

2823

Methods of Processing Silver-Magnesium Secondary Emitters for Electron Tubes.—P. Rappaport. (*J. appl. Phys.*, March 1954, Vol. 25, No. 3, pp. 288-292.) Processing experiments under controlled conditions involving various atmospheres, baking times and temperatures were carried out. To produce the best emitter, in which subsequent evaporation of Mg after overheating was almost eliminated, the Ag-Mg alloy was baked first in a low-pressure water-vapour atmosphere for 30 minutes at 550°C, then at standard pressure in an oxygen atmosphere for 5 minutes at 700°C.

621.385.3 : 621.316.722.1

2824

Self-Heating Triode for Voltage Stabilization.—E. G. Hopkins. (*Wireless Engr.*, July 1954, Vol. 31, No. 7, pp. 169-171.) The valve described has two planar oxide cathodes with a planar grid between them, and two auxiliary anodes which clamp the grid circuit alternately to the two cathodes. A circuit is shown in which the valve is connected between an a.c. supply and a small fixed load, and acts as a stabilizing variable resistance.

621.385.3/.4].001.4 : 621.396.822.029.45

2825

Oscillographic Measurements of Valve Noise in Audio-Frequency Channels.—G. V. Subhadramma. (*Indian J. Phys.*, July 1953, Vol. 27, No. 7, pp. 359-367.) Measurements made on one tetrode and several triode valves over the frequency range 375-1 320 c/s are reported. For a given frequency channel, the triode curves for noise/filament-current exhibit a maximum, in some cases followed by a minimum, for a given anode voltage, while the tetrode curve exhibits a saturation effect. The position of the maximum is the same for all frequencies, but the height of the maximum increases with frequency. For given filament current the amount of noise varies inversely as anode voltage. The absolute values of equivalent noise voltage range from about 20 to 200 μV .

621.385.3.029.62

2826

V.H.F. High-Power Transmitting Tubes.—R. Hübner. (*Brown Boveri Rev.*, Oct. 1953, Vol. 40, No. 10, pp. 417-421.) Description of the construction of BTL-type triodes with thoriated tungsten cathodes and air cooling.

621.385.832 : 681.142

2827

An Electron-Beam Tube for Analog Multiplication.—Angelo. (See 2583.)

621.387 : 621.375.2.024

2828

Transient Response of Glow Discharges with Applications.—R. S. Mackay & H. D. Morris. (*Proc. Inst. Radio Engrs.*, June 1954, Vol. 42, No. 6, pp. 961-964.) Experiments were made with neon and argon lamps, the discharge being maintained by a fixed voltage with a signal voltage superimposed; the voltage variation across a series resistance was observed oscillographically. Transient responses consistent with observed frequency responses were obtained, the response time and characteristic overshoot corresponding to an inductance approaching 1 H. Application of standard neon lamps as level-changing coupling elements in direct-coupled amplifiers is indicated.

MANUFACTURERS OF
EQUIPMENT, and
DEVELOPMENT GROUPS
are invited to send
today for this NEW

complete catalogue of Ediswan Clix
Radio, Television and Electronic
Components. Just write "Components
Catalogue please" on your
business letterhead and
we will send you a copy.

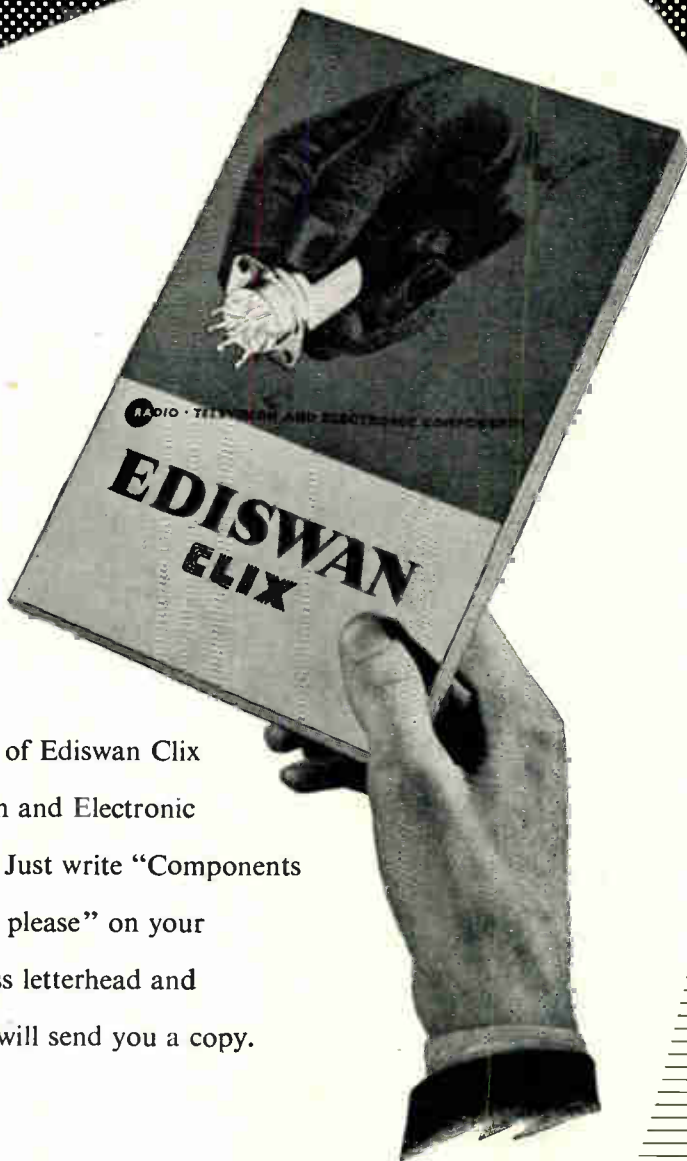

EDISWAN

CLIX

RADIO COMPONENTS

THE EDISON SWAN ELECTRIC COMPANY LIMITED, *Member of the A.E.I. Group of Companies*
155 Charing Cross Road, London, W.C.2 and Branches. Telephone: Gerrard 8660. Telegrams: Ediswan, Westcent, London.
C.R.1a Radio Components Sales Office: 21 Bruton Street, London, W.1 Telephone: Mayfair 5543

Put your name on our mailing list
for

TECHNIQUE

A JOURNAL OF INSTRUMENT ENGINEERING

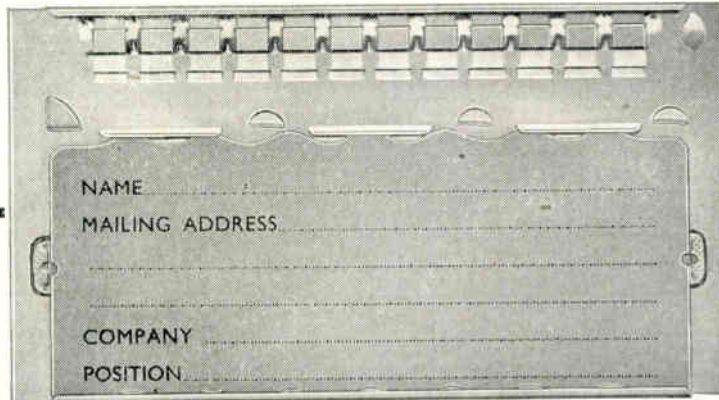

NAME

MAILING ADDRESS

.....

COMPANY

POSITION

120

MUIRHEAD & CO. LTD · BECKENHAM · KENT · ENGLAND
MAKERS OF HIGH GRADE PRECISION ELECTRICAL INSTRUMENTS

If the Cap Fits

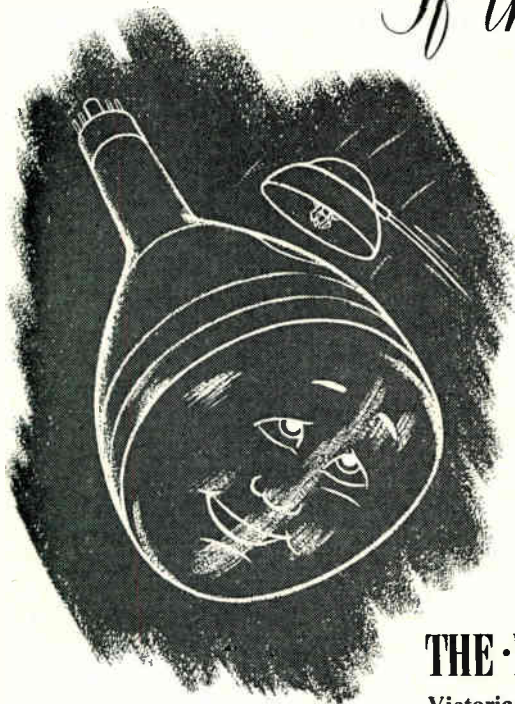

No doubt about it—it's bound to be a perfect fit if it's a McMurdo CT8/P Cavity Cap! It's specially designed to fit the new television cathode ray tubes with cavity caps *without* soldering or loading. Here's how: we mould an E.H.T. connecting cable into a polythene shroud which acts like a suction cap and seals off the CRT cap. No soldering or loading is necessary so the possibility of a corona discharge around the tube connection is nicely avoided.

THE · McMURDO · INSTRUMENT · CO · LTD
Victoria Works, Ashtead, Surrey · Telephone: ASHTEAD, 3401

Flying Spot Telecine Equipment

The equipment provides a television picture of exceptionally high quality from 16 mm. films and 2 x 2 in. miniature film slides. A 'fast pull down' type of film projector is used and a similar mechanism serves for television systems having field repetition rates of either 50 or 60 fields per second. Thus any type of fixed or moving prism system is obviated.

The 16 mm. Projector, Turret Slide Scanner, Optical Change-over Assembly, Flying Spot Scanning Unit and the PEC Amplifier are mounted on top of the steel cabinet which houses the auxiliary units and power units.

The equipment can be fully controlled locally and remote controlled for stopping and starting of the film projector, change-over from film to slides and selection of any one of eight slides.

**Editions of the BD 678
are available for 405,
525, or 625 line systems**

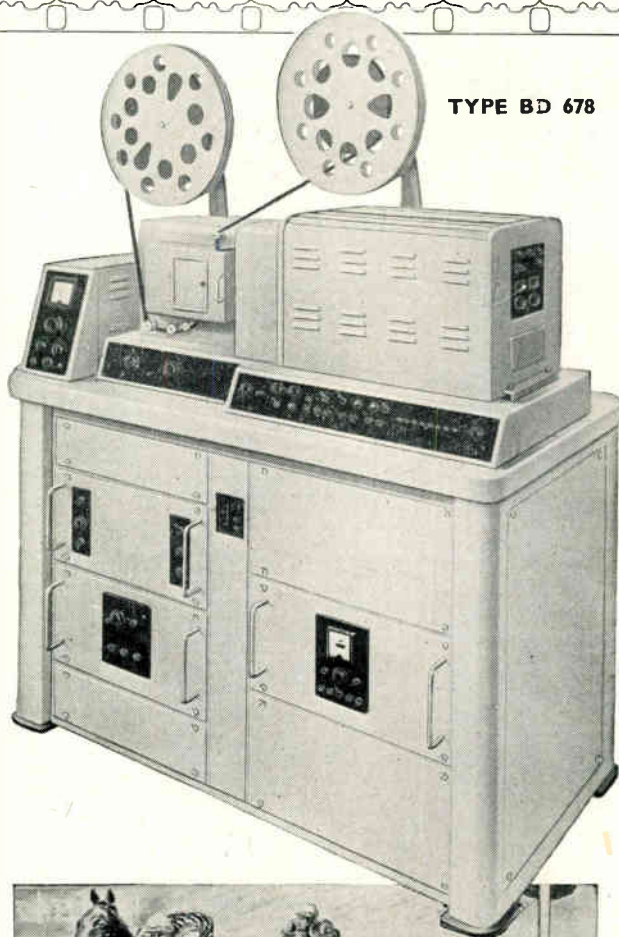

MARCONI

Complete Broadcasting and Television Systems

Marconi Equipment has been installed in every one of the B.B.C. Television transmitter stations and in the U.S.A., South America, Canada, Italy and Thailand

MARCONI'S WIRELESS TELEGRAPH COMPANY LIMITED • CHELMSFORD • ESSEX



'This will need special rubber mouldings . . .

For over a century when a problem like that has arisen, men responsible for production planning and buying have thought at once of P. B. Cow. Knowing the vast resources of the P. B. Cow organisation were always at their service.

Today, we are proud to offer an *unparalleled service to every industry*. A large team of experts, experienced in the latest and most up-to-date methods of production, is available to solve *your* problem. Experts who will bring to the job all the knowledge acquired in advising and supplying leading companies the world over.

So whenever you have a problem that concerns rubber, write or phone for one of our technicians to call. He will be fully qualified to help and advise you.

P. B. COW SERVE
Agriculture
Dairy
Motor Car
Radio
Television
Shipbuilding
Public Utilities
General Engineering
Pharmaceutical

WE SPECIALISE IN:
Production of
Rubber to Metal
bonded parts, Anti-
vibration and Resilient
Mountings, Oil Seals,
Handmade Fabricated
Parts, Proofed Fabrics
in Natural or
Synthetic Rubbers
for every purpose, and
Air Buoyancy work
of all descriptions.

...get in touch
with **P. B. COW**

RUBBER THAT IS RUBBER

P. B. Cow & Company Ltd., Rubber Manufacturing Specialists for every Industry. Industrial Division: 470 Streatham High Road, London, S.W.16.
Phone: Pollards 4481.



BROOKES *Crystals*

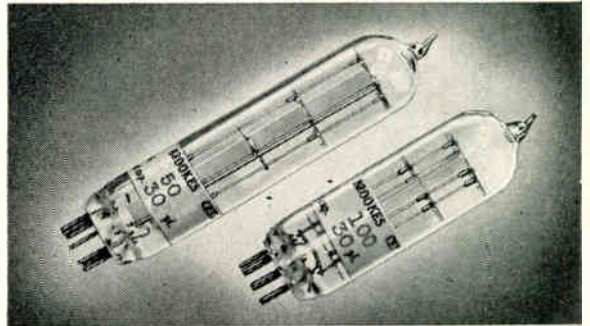

mean **DEPENDABLE** frequency control

● *Illustrated above are*
Left:
Type G2 Crystal Unit
Frequency 50 kc/s.
Right:
Type G1 Crystal Unit
Frequency 100 kc/s.

ALL Brookes Crystals are made to exacting standards and close tolerances. They are available with a variety of bases and in a wide range of frequencies. There is a Brookes Crystal to suit your purpose—let us have your enquiry now.



Brookes Crystals Ltd.

Suppliers to Ministry of Supply, Home Office, B.B.C., etc.
EARLSWOOD STREET, LONDON, S.E.10
Telephone: GR^Eenwich 1828
Grams: Xtals, Green, London. Cables: Xtals, London

Excellence in design..

AIR DIELECTRIC TRIMMER

(Protected by Acetate Case)

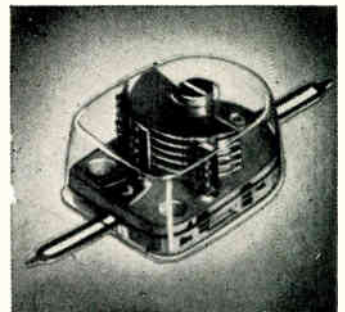

Capacities from 4 to 70pF in voltages of 500 and 1000 D.C. Width 16.5mm. Length 22mm. Acetate dust cover optional. Insulation over 10,000 megohms. Power factor less than .001.

O X L E Y

DEVELOPMENTS CO. LTD.
ULVERSTON, NORTH LANCs.
Tel. ULVERSTON 3306

TRUVOX

Introduce

DICTATION ATTACHMENT

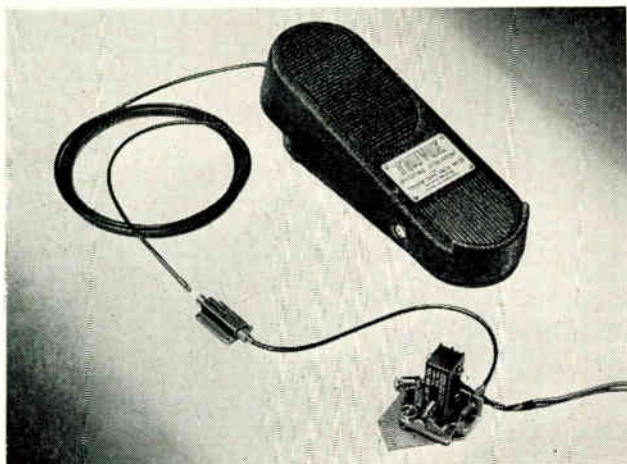

This attachment enables the users of Truvox Tape Decks and Recorders fitted with this Tape Deck to use their machine for dictating. A typist can make transcriptions straight on to the typewriter. List Price 4 gns. Foot pedal only for Recorders previously fitted for this attachment. List Price 3 gns.



TRUCALL TELEPHONE ATTACHMENT

This device is designed to enable two-way recordings of telephone conversations to be made. It is attached to the instrument by a suction cup, on the right-hand side, when looking at the Desk set. List Price 2 gns.

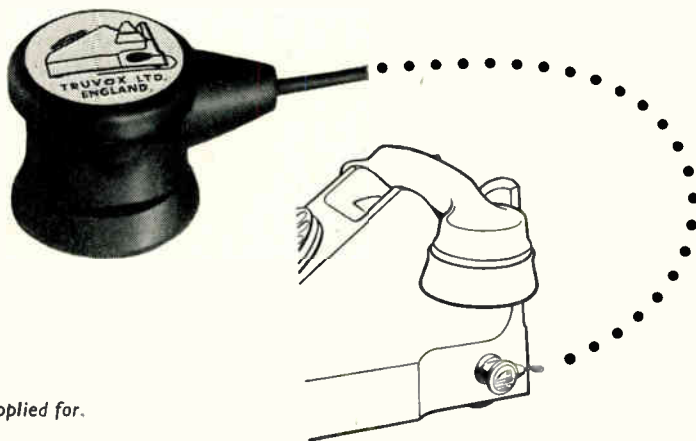

All items Patents applied for.

TRUVOX RADIO JACK

Enables playing and recording of either of two broadcast programmes (200-500 metres). B.S.S. Jack (Continental Jack available soon).

List Price £2. 18. 6
Plus P/Tax £1. 1. 5

TRUVOX TAPE DECK Mk III

For building into Complete Tape Recorders. List Price 22 gns.

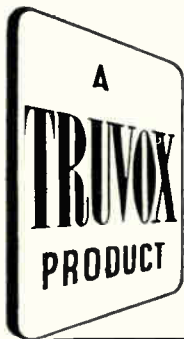

Full details available on request from the manufacturers.

TRUVOX LIMITED

HARROW MIDDLESEX

Sales Office: 15 Lyon Road, Harrow, Middlesex. Telephone: Harrow 9282
Tech. & Service Depts.: 328 The Broadway, Station Road, Harrow, Middlesex. Telephone: Harrow 4455



KLYSTRON POWER UNIT

Type 698B

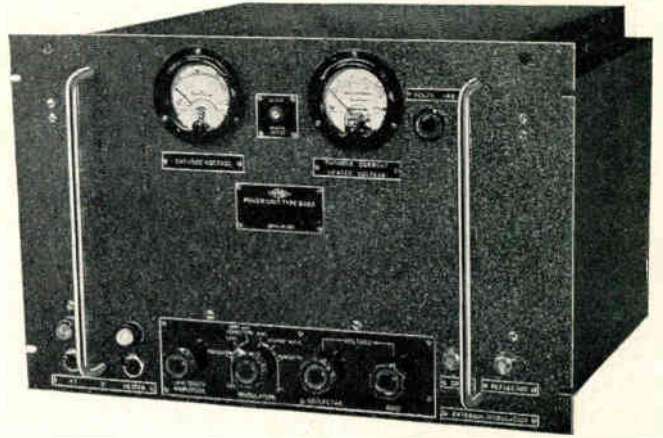

THE POWER UNIT TYPE 698B is designed to provide H.T. and L.T. supplies for high-voltage Klystron valves. All the H.T. supplies are stabilised, the output voltage change being less than 0.5% of the input voltage change. Internal oscillators provide square-wave and sawtooth modulation, and switching enables either the internal modulation, or modulation from an external source, to be applied to the grid or reflector voltages. A switch position is also provided for operation under c.w. conditions. This instrument, which operates from 210-250 volts, 50 c/s mains, is suitable for bench use, or flush mounting on a standard 19-in. rack.

Full details of this or any other Airmec instrument will be forwarded gladly upon request.

AIRMEC
L I M I T E D

HIGH WYCOMBE

BUCKINGHAMSHIRE

ENGLAND

Telephone: High Wycombe 2060

Cables: Airmec, High Wycombe

GEALLOY CORES

FOR RADIO and T.V. APPLICATION

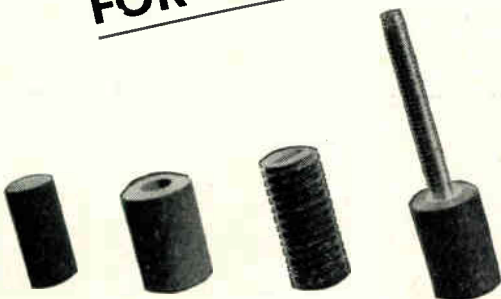

GRADE M.E.

Low cost cores for frequencies up to 50 Mc/s.

GRADE M.F.

High quality cores for frequencies up to 300 Mc/s.

Write for List No. GRC 5303/6

SALFORD ELECTRICAL INSTRUMENTS LTD.

PEEL WORKS · SILK STREET · SALFORD 3 · LANCs

LONDON OFFICE: MAGNET HOUSE, KINGSWAY. TEMPLE BAR 4669

A Subsidiary of THE GENERAL ELECTRIC CO. LTD. of ENGLAND

Now available...

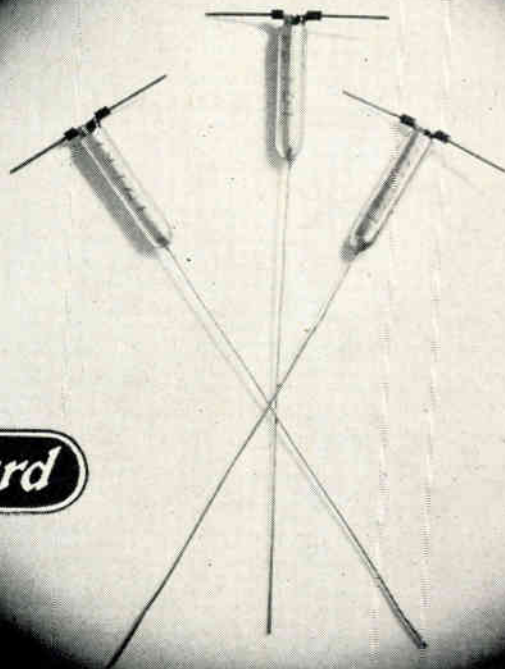

Standard

high-
grade

TRANSISTORS

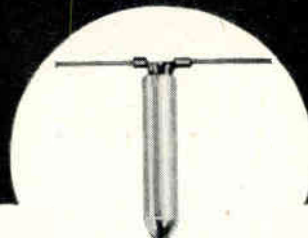

Actual size

Pioneers in semi-conductor development and manufacture **Standard Telephones and Cables Limited** were also first to produce transistors in Europe.

Two types of germanium point contact transistors are now available for immediate delivery.

Code 3X/100N—for control and switching circuits.

● Code 3X/101N—for use as an amplifier or oscillator.

Enquiries are also invited for *Standard Junction* type transistors.



Standard Telephones and Cables Limited

(Registered Office: Connaught House, A'dwyck, London, W.C.2.)

RADIO DIVISION, OAKLEIGH ROAD, NEW SOUTHGATE, N.11



ELECTRONIC COMPONENTS

FADERS and ATTENUATORS. Precision-built stud type. Complete range available for covering all types of networks from potentiometers to balanced 'H.'

Impedance and loss per step to customers' requirements.

QUADRANT FADERS. A range introduced as alternatives to our rotary type. Plug-in facilities for rapid interchangeability.

ROTARY STUD SWITCHES. Basic design and quality as on faders and attenuators.

SINE COSINE POTENTIOMETERS. Precision built to accuracy $\pm 1\%$.

PLUG and SOCKETS. 2, 4, 6, 8, 12, 18, 24 and 33 way. Can be supplied with patent locking device.

MINIATURE WIRE WOUND, VITREOUS & LACQUERED RESISTANCES. Resistance range: 1ohm to 200 K.ohms; 1 - 25 watt; Tolerance $\pm 1\%$, 2% and 5%.



ELECTRONIC COMPONENTS, WEEDON ROAD INDUSTRIAL ESTATE, NORTHAMPTON



CARPENTER

POLARIZED RELAYS

have these outstanding features

- HIGH OPERATIONAL SPEED • HIGH SENSITIVITY**
- FREEDOM FROM CONTACT REBOUND**
- NO POSITIONAL ERROR • HIGH CONTACT PRESSURES**
- EXCEPTIONAL THERMAL STABILITY • EASE OF ADJUSTMENT • ACCURACY OF SIGNAL REPETITION**

The Carpenter Polarized Relay will respond to weak, ill-defined or short-duration impulses of differing polarity, or it will follow weak alternating current inputs of high frequencies and so provide a continuously operating symmetrical changeover switch between two different sources. Five basic types are available with a wide range of single and multiple windings. Particulars of the type best suited to your purpose will be gladly supplied if you will send us your circuit details.

Manufactured by the sole licensees

TELEPHONE MANUFACTURING CO. LTD

Contractors to Governments of the British Commonwealth and other Nations

HOLLINGSWORTH WORKS, DULWICH, LONDON, SE21

Telephone GIPsy Hill 2211

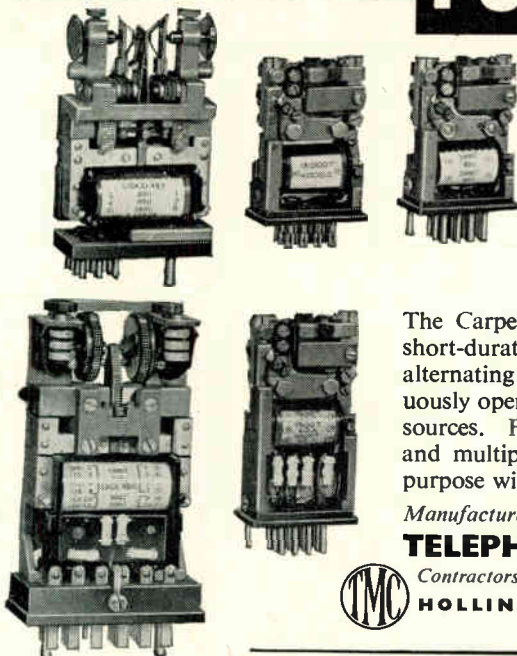

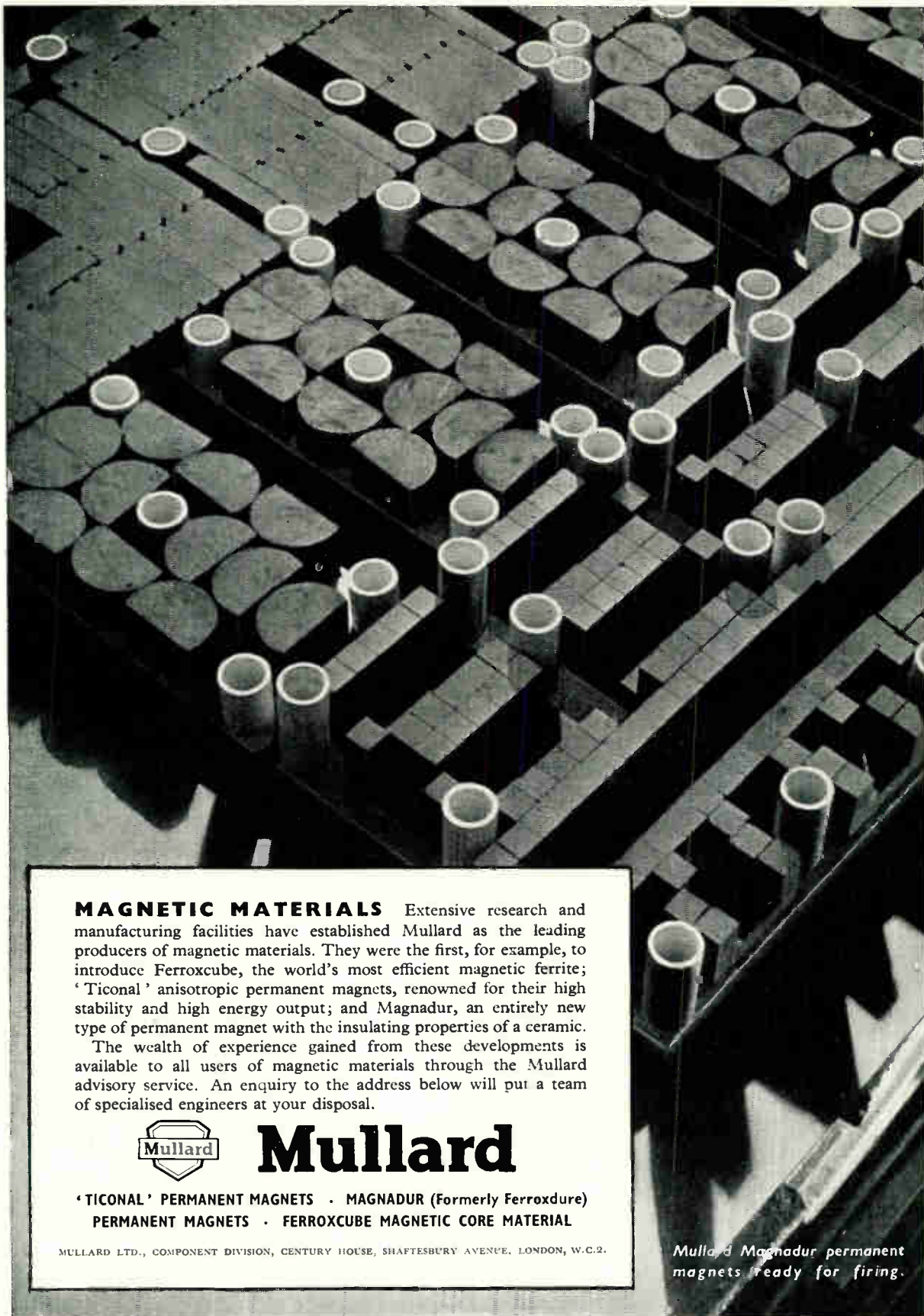

MAGNETIC MATERIALS Extensive research and manufacturing facilities have established Mullard as the leading producers of magnetic materials. They were the first, for example, to introduce Ferroxcube, the world's most efficient magnetic ferrite; 'Ticonal' anisotropic permanent magnets, renowned for their high stability and high energy output; and Magnadur, an entirely new type of permanent magnet with the insulating properties of a ceramic.

The wealth of experience gained from these developments is available to all users of magnetic materials through the Mullard advisory service. An enquiry to the address below will put a team of specialised engineers at your disposal.



Mullard

· TICONAL' PERMANENT MAGNETS · MAGNADUR (Formerly Ferroxdure)
PERMANENT MAGNETS · FERROXCUBE MAGNETIC CORE MATERIAL

MULLARD LTD., COMPONENT DIVISION, CENTURY HOUSE, SHAFTESBURY AVENUE, LONDON, W.C.2.

Mullard Magnadur permanent magnets ready for firing.

Opportunities for Engineers with the Guided Missiles Division of 'ENGLISH ELECTRIC'

The Guided Missiles Division of The ENGLISH ELECTRIC Company Limited, Luton, now wishes to fill a wide variety of vacancies. In particular, the following are required:

- Radio and Radar systems Engineers
- Circuit Development Engineers (including work on transistors)
- Engineers to design & engineer micro-wave equipment
- Instrumentation Engineers with transducer design experience
- Engineers for Field Trials Radar and Communications equipment (including some vacancies for Australia)

Houses are available for some of the Senior Engineers. There are also vacancies for Intermediate and Junior Engineers and Laboratory Assistants.

All these offer splendid opportunities for promotion in this new Industry.

Engineers should be Honours Graduates or have technical qualifications to H.N.C. or equivalent standard together with relevant experience.

Applications, quoting SA54, should be sent to Dept. CPS, 336/7 Strand, WC2.

'ENGLISH ELECTRIC'
'ENGLISH ELECTRIC' MARCONI NAPIER

Anderton

*Cyrl Circlips
stock ranges
from 1/16" to 10"*



Write for DATA SHEETS to Dept. A.3., ANDERTON SPRINGS LTD., BINGLEY.
Telephone: 2226 & 2351.
Telegrams: Circlips, Bingley.

CIRCLIPS

THE WORLD'S GREATEST BOOKSHOP

FOYLES
FOR BOOKS

New and secondhand Books on every subject. Large Technical dept. Stock of over three million volumes.

119-125, CHARING CROSS ROAD, LONDON, W.C.2
Gerrard 5660 (16 lines) ★ Open 9-6 (inc. Sat.)

EXPERIENCED RADIO TESTERS AND INSPECTORS

Required for production of communication and radio apparatus. Also instrument makers, wireers and assemblers for factory test apparatus. Apply Personnel Manager, E. K. Cole, Ltd., Ekco Works, Malmesbury, Wilts.

APPOINTMENTS—The engagement of persons answering these advertisements must be made through the local office of the Ministry of Labour and National Service, etc., if the applicant is a man aged 18-64 or a woman 18-59 inclusive, unless he or she or the employer is excepted from the provisions of The Notification of Vacancies Order, 1952.

POLYTHENE

H. F. EQUIPMENT
(AMBYTHENE BRAND)

ENQUIRIES INVITED FOR
SPECIAL MOULDINGS OF
COMPONENTS

AMPLEX APPLIANCES (KENT) LTD.
19 DARTMOUTH ROAD, HAYES, BROMLEY, KENT.
(RAVensbourne 5531)
All export enquiries to
ANTEX LTD., 3 TOWER HILL, LONDON, E.C.3

BOROUGH POLYTECHNIC
Borough Road, S.E.1

Crystal Valves and Transistors

A course of 10 lectures principally dealing with junction transistors will be given by specialists during afternoons 3-5 p.m., or evenings 7-9 p.m., on Tuesdays, commencing Tuesday, 19th October, 1954.

Fee for the course £2 2s. 0d.

Fundamental Principles of Pulse Techniques

A course of 20 lectures will be held on Monday evenings 7-9 p.m. commencing Monday, 25th October, 1954.

Fee for the course £3 3s. 0d.

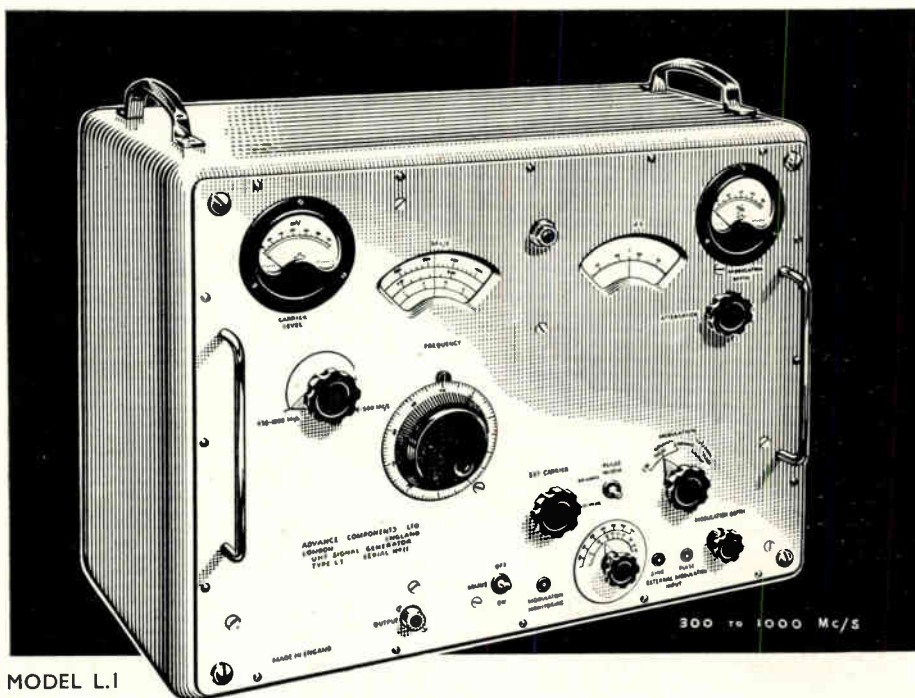

MODEL L.1

Operating in the decimetre wave region, this Signal Generator has been designed to meet the increasing requirements of the development laboratory at Ultra High Frequencies. Besides a wide frequency range and reliable attenuator system, provision is made in the L.1 for both internal and external sinewave and pulse modulation. Full technical details are available on request.

Write for Folder V.25

Advance

U.H.F. SIGNAL GENERATOR

Nett price in U.K. £375

ADVANCE COMPONENTS LTD., MARLOWE ROAD, WALTHAMSTOW, LONDON, E.17

Telephone: LARKSWOOD 4366/7/8

ELECTRONIC ENGINEERS

An exceptional opportunity exists for research and development engineers, wishing to work in a rural area of S.W. England. The posts are permanent, pensionable and carry top rate salaries. Houses and flats are available. The working conditions are ideal, the laboratories being housed in a new building designed for the purpose, close to a well-known country town in the heart of one of the most attractive districts. The work offers the maximum amount of interest, being concerned with a new super-priority Government Development Project undertaken by a Company famous in the electronic industry. The vacancies are for:

1. **SENIOR ENGINEERS**, with good academic background in physics or engineering and 7-10 years experience of research or development, covering a wide range of electronic techniques, but special knowledge of VHF and UHF fields would be an advantage.
2. **ENGINEERS**, as above, but applicants with more limited experience will be considered.
3. **JUNIOR ENGINEERS**, with a degree or equivalent in physics or engineering. Previous practical experience not essential.

Applications should be made, in strict confidence, with full details, to Box No. 7262 c/o W.E.

E.G.13

The War Office requires for No. 35 Base Workshop R.E.M.E., Old Dalby, Leicestershire: one Mechanical Engineering Officer (Main Grade) to control workshop repairing radar and associated equipment. Knowledge and experience of modern electronic and allied engineering progress and process methods and technique of management essential, also ability to organise large repair programmes and production. Inclusive salary range £960-£1,240 (Provincial). Applicants must be British of parentage and Corporate Members of the Institution of Electrical Engineers or have passed or be exempt from Sections A and B of their membership examination. Starting salary fixed according to age, qualification and experience on range quoted. Annual increments subject to satisfactory service. Post temporary but long-term possibilities. Application forms from M.L.N.S., Technical and Scientific Register (K), 26 King Street, London, S.W.1, quoting D.258/54.A.

KENT EDUCATION COMMITTEE MEDWAY COLLEGE OF TECHNOLOGY

Required September, or as soon after as possible: Assistant Lecturer (Grade B) in Telecommunications and Radio Engineering. Applicants should be graduates or similarly qualified to teach to the standard of the City and Guilds Telecommunication Engineering Certificate and the Radio and Television Servicing Certificates, and must have had sound industrial experience. Previous teaching experience is desirable but not essential. Salary in accordance with Burnham Technical Scales, 1954, which have not yet been published. The existing Grade B scale is £490 × £25—£765 basic with additions for approved qualifications, training and experience. Opportunity for extra paid evening teaching. Forms of application from the Registrar, to be returned to him as soon as possible, at Medway College of Technology, Horsted, Chatham.

A. V. ROE & CO., LTD., WOODFORD AERODROME, CHESHIRE, have vacancies in their newly formed **Weapons Research Division**.

Simulator Development

Electronics Engineer with Honours Degree in Physics or Engineering and having experience on the design of electronic computers or simulators.

The vacancy is for someone to take charge of and build up a team which will be working on Simulator Development.

Trials

Electronics Engineer with Physics Degree and a wide practical experience of telemetering.

The vacancy is for someone to take charge of and build up a team for the development of trials instrumentation.

Good salaries and prospects, pension and life assurance scheme.

Apply giving full particulars of academic training and experience to:—**A. V. ROE & CO., LTD., Weapons Research Division, Woodford, Cheshire.**

The Electronics Department of a large manufacturing company requires enthusiastic and experienced senior and junior electronic and electro-mechanical engineers for new developments in internal and commercial instrumentation work. The company is situated in pleasant countryside on the outskirts of Wolverhampton. A super-annuation scheme is in operation. Initial salaries will be commensurate with ability and there are good opportunities for advancement.
—Box 7263, c/o *Wireless Engineer*.

TRINITY HOUSE, LONDON

Applications are invited for appointment to the post of Experimental Officer in the Electrical and Electronics Department of the Corporation of Trinity House, for work in connection with the development of electrical and electronic navigational aids. This includes the development of optical systems for fog detection apparatus, development of fog signals, audio monitoring equipment and automatic control and indication equipment. Salary scale: £720 rising to £890 per annum. The minimum qualifications required are a Science Degree, Corporate Membership of the Institute of Electrical Engineers or equivalent. All candidates must be medically fit and of British Nationality. The appointment is on an unestablished basis. Applications should be made in writing to the Secretary, Trinity House, London, E.C.3, not later than 16th September, 1954, stating age, occupation, qualifications and experience, and enclosing copies of recent testimonials.

Clearly—you get better pictures with this ALUMINIZED cathode ray tube

You cannot beat the new Ediswan Mazda Aluminized Cathode Ray Tubes for picture quality or length of life. Ediswan Aluminizing gives 60% brighter pictures with greater depth of contrast. The improved ion trap tetrode electron gun effectively traps harmful ions within the tube. Ediswan production methods, including the special in-line exhausting process, guarantee a higher, more uniform standard of efficiency. For complete satisfaction recommend Ediswan Mazda cathode ray tubes.

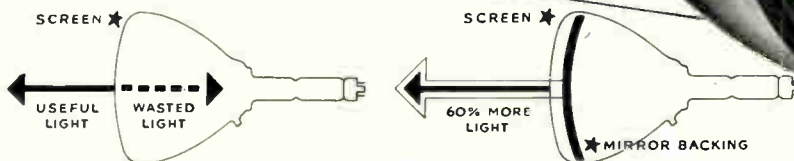
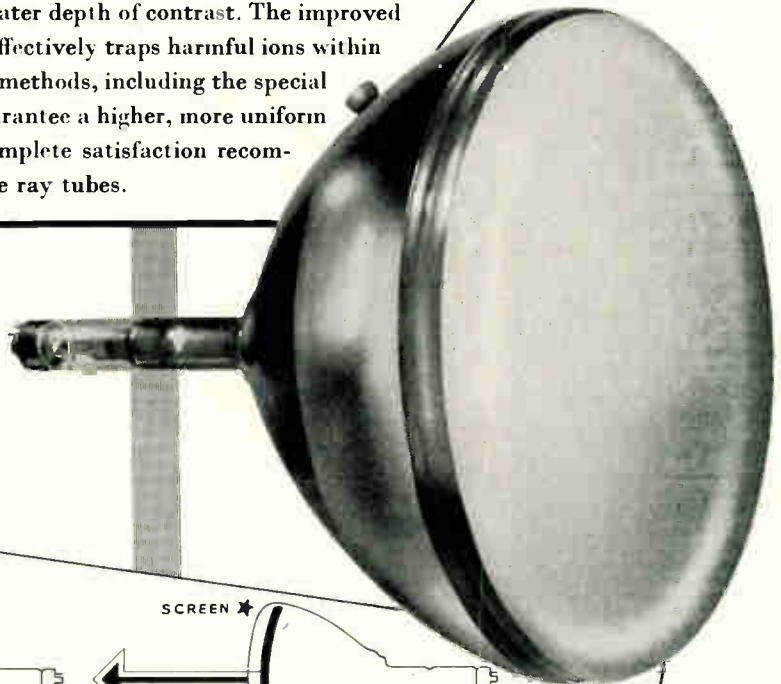

Without Aluminizing

Without Aluminizing, tubes waste half their light by backward reflection. To counteract this the brilliance must be increased which shortens tube life.

With Ediswan Aluminizing

Ediswan aluminized tubes have a mirror backing to the screen. All the light is thus thrown forward giving brighter, clearer pictures, and extra life.

Quicker Service

Ediswan are the only company to have 6 fully equipped cathode ray tube service Depots throughout Great Britain, thus providing better, quicker tube testing should the need arise. Also, 18 Ediswan District Offices carry stocks of tubes.

EDISWAN

MAZDA

ALUMINIZED CATHODE RAY TUBES

THE EDISON SWAN ELECTRIC COMPANY LIMITED
155 Charing Cross Road, London, W.C.2, and branches
Member of the A.E.I. Group of Companies

Ministry of Transport and Civil Aviation: Telecommunications Technical Officers, Grade III. The Civil Service Commissioners invite applications from men for at least three pensionable posts. Age at least 23 and under 28 on 1st August, 1954, with extension for regular service in H.M. Forces. Candidates must possess (a) the O.N.C. in Electrical Engineering, or (b) City and Guilds Intermediate Certificate in Telecommunications Engineering, plus City and Guilds Certificate Radio III, or (c) City and Guilds Certificates Telecommunications Principles III (or higher) and Radio III (or higher), or (d) produce evidence of an equivalent standard of technical education. They must also have had not less than eight years' experience in an appropriate telecommunications field, including manufacturing or maintenance or operation.

London salary £480 (at age 23) to £670 (somewhat lower in Provinces). Starting pay up to £580 at age 28 or over on entry. Promotion prospects.

Further particulars and application forms from Civil Service Commission, Scientific Branch, 30 Old Burlington Street, London, W.1, quoting No. S207/54. Application forms must be returned by 8th October, 1954.

Development Engineers required for Research and Development work on Cold-Cathode Tubes.

Applicants should preferably have had experience in the Valve or Lamp Industry, or on closely related work. A Science degree, Engineering degree, or a similar qualification would be helpful. An attractive salary is offered in accordance with experience, ability and qualifications.

Please write giving details to the Personnel Officer, Ericsson Telephones, Ltd., Beeston, Nottingham. (Reference LK/3.)

Electronic Digital Computers. Mathematicians with first or second-class Honours Degrees are invited to apply for vacancies in the English Electric team at present working in collaboration with the National Physical Laboratories at Teddington in the design and operation of Advanced and Electronic Computers. Please reply to Dept. C.P.S., 336-7 Strand, W.C.2, quoting Ref. 1352.

Electronic Engineer required for the Research Laboratory of The English Electric Valve Co. at Chelmsford. Applicants should have a Science Degree or equivalent qualifications, together with considerable experience in the design of circuits for experimental Television and Radar equipment. Apply, giving details of qualifications, experience and salary required to Central Personnel Services, The English Electric Co., Ltd., 336-7 Strand, London, W.C.2, quoting Ref. 440F.

A Canadian Telecommunications Manufacturer has vacancies for qualified Engineers with at least five years' design experience in one or more of the following fields:—

- Communications Measuring equipment.
- Television Test equipment.
- Precision Waveguide Components and Measurements.
- Modulation Techniques (including FM).
- Wideband I.F. and other V.H.F. techniques.
- Microwave Antennae design.
- Telecommunications System design.

These appointments are in connection with long-term development of equipment primarily for commercial applications.

Salaries \$6,000 upwards according to experience and qualifications. Transportation for family to Canada will also be provided.

Applications, giving full details of age, experience and qualifications, should be addressed to Dept. C, Dept. of Labour of the Government of Canada, 61 Green Street, London, W.1.

War Office require temporary Assistant Engineers for No. 2 War Office Signal Regiment, Droitwich, Worcester and Bampton, Oxon. Salary payable on range £375-£765 (provincial). Starting salary according to age, qualifications and experience. Must be British of British parentage and possess either City and Guilds of London Institute Certificate in Telecommunications Principles (First Class in Grade I or Second Class in Grade II) and first-class certificates in one of following: Telephone Exchange systems, Telegraphy, Radio or Line Transmission/or City and Guilds Intermediate Certificate in Telecommunications Engineering/or first-class certificate in Telecommunication Principles Grade I or above and two other certificates in different Telecommunication subjects which should be first class in Grade I or II or first or second class in Grade III or above. Higher National Certificate in Electrical Engineering or Inter B.Sc. will be accepted. Write, giving date of birth, education, full details of qualifications and experience of posts held (including dates) to E.A.394, Appointments Officer, Ministry of Labour and National Service, 1-6 Tavistock Square, W.C.1, by 20th September, 1954. No original testimonials should be sent. Only candidates selected for interview will be advised.

Edison Swan Electric Co., Ltd., have a vacancy for an Engineer experienced in mechanical and electronic design to take charge of their Special Products Development Laboratory.

Ediswan also require Engineers with experience in the fields of electro-medical and industrial electronics design.

Please write to 155 Charing Cross Road, W.C.2, stating experience and salary required. The envelope should be marked "S.P. Lab."

Kelvin & Hughes, Ltd., Barkingside, Essex, have vacancies for Technical Assistants for development of electro-mechanical and electronic instruments (Marine). Work involves initial experiments, sea-going trials, pre-production models and factory liaison. Occasional visits overseas are arranged.

Qualifications—Practical; five years' workshop or drawing office experience. Academic; City and Guilds Telecommunications Final Group Certificate, or equivalent.

Applications stating salary required should be addressed to the Personnel Manager.

An opportunity occurs in progressive manufacturing concern in London area for Engineer aged 25/35 with electrical or physicist degree, on development and research work on high-frequency telecommunication cable and associated testing equipment. Salary will be commensurate with qualifications and experience. Apply giving full particulars to Box 6571, c/o *Wireless Engineer*.

Electronic Digital Computers. Electronics Engineers with an interest in mathematics, are required by English Electric to work on fault diagnosis and maintenance of advanced digital computers, in the London area. Please reply to Dept. C.P.S., 336-7 Strand, W.C.2, quoting Ref. 1353.

Birmingham Chartered Patent Agents require the services of a qualified man trained in electronics and dynamics. Excellent prospects. Send particulars of training and career to Box No. 7246.

Kelvin & Hughes, Ltd., Barkingside, Essex, have vacancies for Research Engineers for experimental work relating to underwater sound apparatus. Applicants should be of Degree standard and should have a sound knowledge of communications, in particular electronics. Applications stating salary required should be addressed to the Personnel Manager.

LONGEST SCALE — SMALLEST SPACE

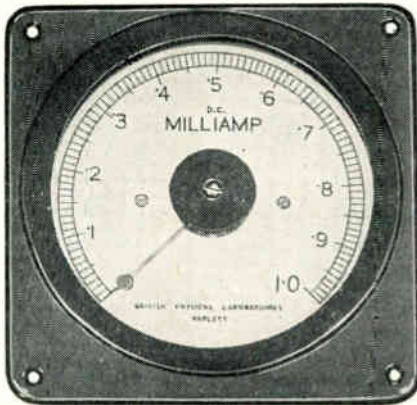

This compact, robust D.C. Milliammeter is flush mounting and is ideal for use in restricted space.

SCALE LENGTH: 9"
RANGE FROM 0-500 μ A

**The meter with the
dead beat movement**

The meter measures only 5" across and the depth behind the panel is only 2" yet it retains a scale length of 9". It is available with spade or knife-edge pointer and special scales can be supplied to customer's specification if required. Send for prices and full details.

BRITISH PHYSICAL LABORATORIES

Radlett, Herts.

Tel : Radlett 5674/5/6

LONDON STOCKIST: M. R. SUPPLIES LTD., 68 NEW OXFORD STREET, LONDON, W.C.1.

dmBP19

Manufacturers of all types of

SCIENTIFIC INSTRUMENT CASES and CHASSIS in METAL

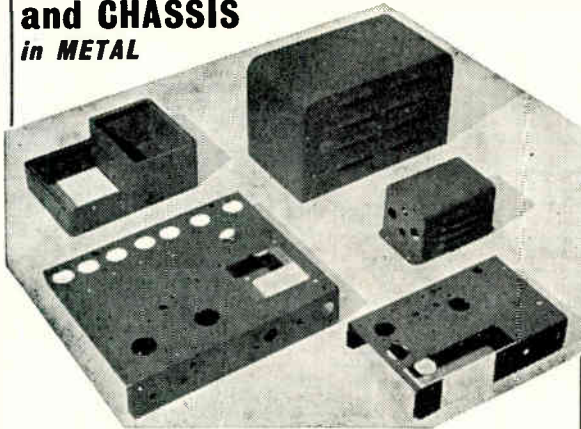

GENERAL SHEET METAL WORK
for the Trade

CHASE PRODUCTS (Engineering) LTD

27 PACKINGTON RD., SOUTH ACTON, W.3
Acorn 1153-4 and at LEEDS

4th Ed. *Now available*

RADIO VALVE DATA

For designers, servicemen,
dealers and amateurs . . .

The fourth edition of this reference contains full details of some 2,000 types of British and American radio valves, and 150 cathode-ray tubes.

The main tables give the electrical characteristics of each valve, and separate tables show their base connections. Sub-divisions of the main tables further classify the valves into obsolete, replacement or current types, as recommended by the makers. An index enables any valve to be found in the tables quickly and without trouble. A new feature is the comprehensive list of equivalents.

Published for "Wireless World"

3s. 6d. net By Post 3s. 9d.

Obtainable from booksellers or direct from:—

Hiffe & Sons Ltd., Dorset House, Stamford Street, London, S.E.1

A new edition of an invaluable reference book

RADIO LABORATORY HANDBOOK

6th Edition

now ready

25s. net BY POST 26s. 3d.

Obtainable from booksellers or direct from

Iliffe & Sons Limited Dorset House Stamford Street London S.E.1

By M. G. SCROGGIE, B.Sc., M.I.E.E.
This well-known practical work describing laboratory equipment and methods of operation has now been entirely re-written and greatly enlarged. Among the subjects considered are layout and furnishing of premises, methods of measurement, sources of power and signals, indicators and other instruments and circuit and signal measurements. There is a comprehensive reference section, and the text is supplemented by many photographs, diagrams, graphs and tables. 8 $\frac{3}{4}$ " x 5 $\frac{1}{2}$ ". 460 pp.

SPECIALISED REPAIR SERVICE

WEBB'S Radio

specialise in the repair and alignment of complex communication receivers

All makes of British and American communication receivers completely overhauled to satisfy makers' original test specification. Calibration over entire coverage of tuning range. We issue a test report giving sensitivity—selectivity—signal/noise ratio on I.F.'s, and sensitivity—image ratio—signal/noise—A.V.C. characteristics overall.

Recognised Service Agents for
EDDYSTONE, R.C.A., HALLICRAFTER, etc.

WEBB'S RADIO

14 Soho Street, London, W.1. Gerrard 2089.

PROBE UNIT

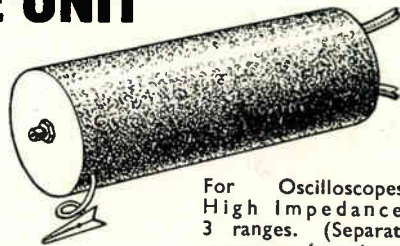

Send for
leaflet 24

For Oscilloscopes.
High Impedance.
3 ranges. (Separate
power supply optional)

SUTTON COLDFIELD ELECTRICAL ENGINEERS
CLIFTON STREET, SUTTON COLDFIELD, BIRMINGHAM

Phone: SUT 5666

Index to Advertisers

	PAGE		PAGE		PAGE
Advance Components, Ltd.	3, 25	Electronic Components, Ltd.	22	Mullard, Ltd.	14, 23
Aero Research, Ltd.	10	English Electric.	24	Oxley Developments Co., Ltd.	18
Airmec, Ltd.	20	Ferranti, Ltd.	11	Salford Electrical Instruments, Ltd.	20
Amplex Appliances (Kent), Ltd.	24	Foyle, W. & G., Ltd.	24	Standard Telephones & Cables, Ltd.	21
Anderton Springs, Ltd.	24	General Electric Co., Ltd.	7	Sullivan, H. W., Ltd.	12
Appointments Vacant.	24, 26, 28	Hunt, A. H. (Capacitors), Ltd.	Cover iv	Sutton Coldfield Electrical Engineers.	30
Automatic Coil Winder & Electrical Equipment Co., Ltd., The.	4	Iliffe Books.	29, 30	Telegraph Condenser Co., Ltd., The.	Cover iii
Belling & Lee, Ltd.	5	Lyons, Claude, Ltd.	1	Telephone Mfg. Co., Ltd.	22
British Insulated Callender's Cables, Ltd.	9	Marconi Instruments, Ltd.	8	Truvox, Ltd.	19
British Physical Laboratories.	29	Marconi Wireless Telegraph Co., Ltd.	17	Unbrako Socket Screw Co., Ltd.	2
Brookes Crystals, Ltd.	18	McMurdo Instrument Co., Ltd.	16	Wayne Kerr Laboratories, Ltd., The.	6
Bullers, Ltd.	Cover ii	Muirhead & Co., Ltd.	16	Webb's Radio.	30
Chase Products (Engineering), Ltd.	29				
Cow, P. B., & Co., Ltd.	18				
Edison Swan Electric Co., Ltd.	15, 27				

Printed in Great Britain for the Publishers. Iliffe & Sons, Ltd., Dorset House, Stamford Street London, S.E.1,
at The Baynard Press by Sanders Phillips & Co., Ltd., Chrystell Road, London, S.W.9



Leadership on Show

The Annual Radio Show has once again demonstrated the proud position occupied by T.C.C. Condensers — they were in the majority of chassis exhibited, as they have been at so many previous Shows. This leadership is not easily achieved nor easily held: only by constant research and development can we maintain our jealously-guarded reputation for quality. We were glad to welcome so many of our friends at our Stand, where they were able to see some of our latest productions.

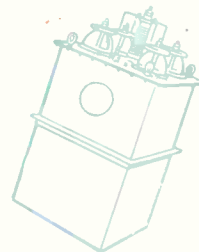
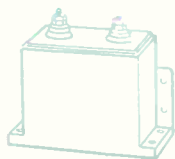

THE TELEGRAPH CONDENSER CO. LTD

RADIO DIVISION • NORTH ACTON LONDON • W.3 • Telephone: ACOrrn 0061 (9 lines)

SPECIALISTS IN CONDENSERS SINCE 1906

When it's a question of MINIMUM SIZES ...



**HUNTS
METALLISED PAPER
CAPACITORS**

HUNTS METALLISED PAPER CAPACITORS MIDGET MOLDSEAL TUBULARS **TYPE W99**

Specification:
Heat moulded housing ensuring an adequate seal against moisture. Wire leads soldered directly to capacitor unit in a manner ensuring freedom from intermittent contact (strength of joint exceeds tensile strength of wire lead).

RANGES			
Working Voltage	Temperature Range	Capacitance μF	Size *
150 D.C.	-40 C to + 71 C	0.004 to 0.01 0.02 to 0.04	A B
400 D.C.	-40 C to + 85 C	0.001 to 0.003 0.004 to 0.01	A B
600 D.C.	-40 C to + 85 C	50pf to 0.001 0.002 to 0.004	A B
300 A.C.	-40 C to + 71 C	50pf to 0.001 0.002 to 0.004	A B

SIZES * A = $\frac{1}{8}$ " x $\frac{1}{16}$ " B = $\frac{1}{4}$ " x $\frac{1}{8}$ "

Capacitance Tolerance:
Standard $\pm 20\%$ (Closer tolerance available)
Insulation Resistance:
20,000 megohms per second at 1,000 working voltage
Power Factor:
than 2% at 1,000 per second at 20

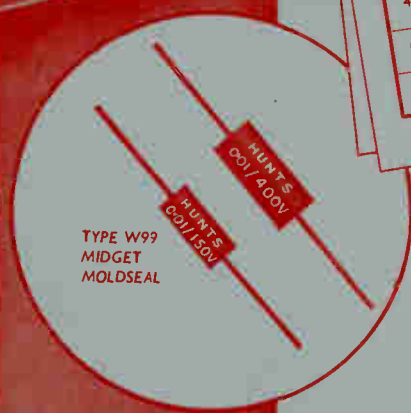

TYPE W99
MIDGET
MOLDSEAL

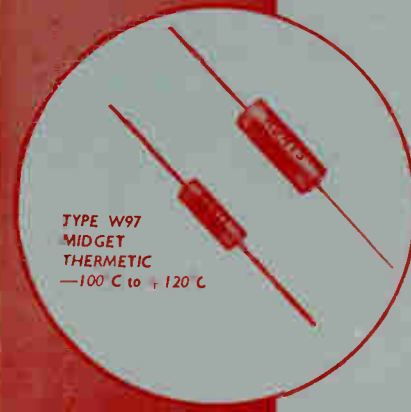

TYPE W97
MIDGET
THERMETIC
-100 C to + 120 C

Look to HUNTS!

For maximum reliability. Hunts capacitors for radio and electronic equipment include many types designed to meet the need of designers for decreased dimensions.

Type W99 listed above is just one example taken from Hunts unparalleled range of capacitors for every purpose.

Years of specialisation in nothing but capacitor design and manufacture has enabled us to achieve and maintain that long-lasting reliability, and outstanding performance which characterises every Hunt product.

Please write for leaflet giving full details of types for all applications.



A. H. HUNT (Capacitors) LTD., WANDSWORTH, LONDON, S.W.18 BATTERSEA 1083-7
and in Canada HUNT CAPACITORS (Canada) LIMITED, AJAX, ONTARIO