

2

To be Completed in about 20 Fortnightly Parts

1^s/₃^d

HARMSWORTH'S WIRELESS ENCYCLOPEDIA

For Amateur & Experimenter

ALU—AUD

CONSULTATIVE EDITOR
SIR OLIVER LODGE, F.R.S.

LEADING CONTRIBUTORS

PROF. J. A. FLEMING, F.R.S.
INVENTOR OF THE FLEMING VALVE

PROF. W. H. ECCLES, F.R.S.
PRESIDENT, RADIO SOC. OF GT. BRITAIN

E. V. APPLETON, M.A., D.Sc.
OF THE CAVENDISH LABORATORY, CAMBRIDGE

N. W. McLACHLAN, D.Sc.
RESEARCH ENGINEER, MARCONI CO.

CAPT. P. P. ECKERSLEY,
CHIEF ENGINEER, BRITISH BROADCASTING CO.

WILLIAM LE QUEUX, M.INST.R.E.
PIONEER IN AMATEUR TRANSMISSION

MAJ. RAYMOND PHILLIPS, I.O.M.
INVENTOR OF WIRELESS CONTROL METHODS

*J. LAURENCE PRITCHARD, F.R.Ae.S., Technical
Editor, with expert editorial and contributing staff*

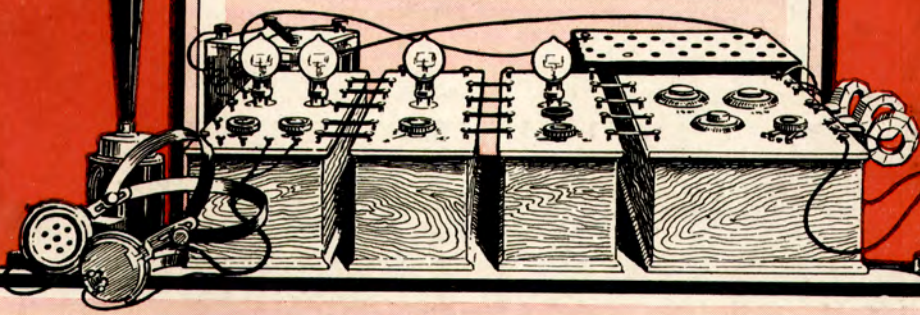

The Only ABC Guide to a Fascinating Science-Hobby

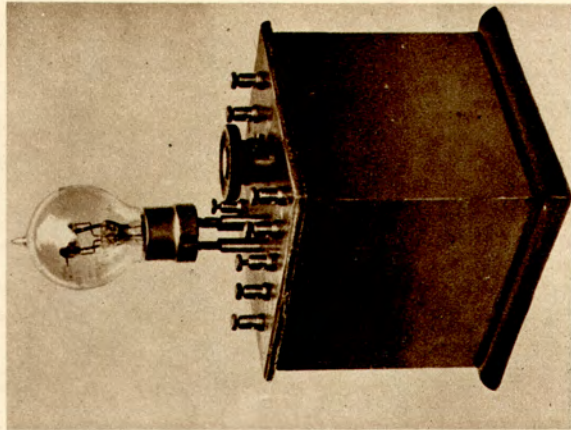

Fig. 13. The amplifier completed

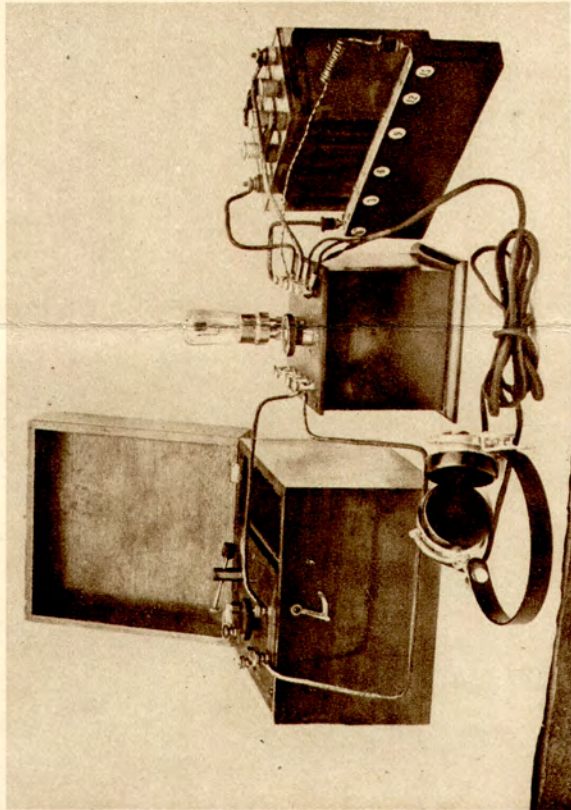

Fig. 14. The completed unit connected up to a crystal receiving set

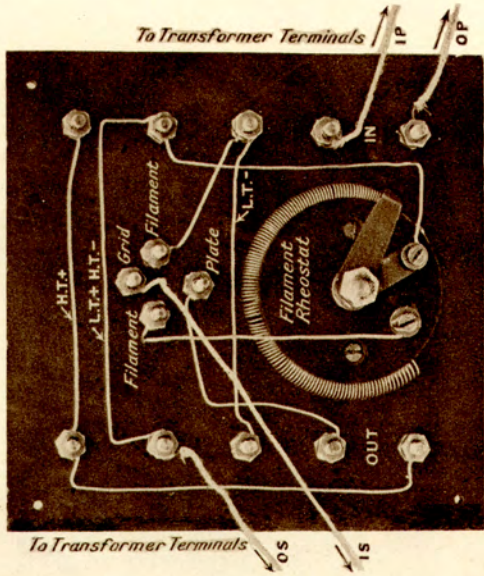

Fig. 15. How the back of the panel is wired

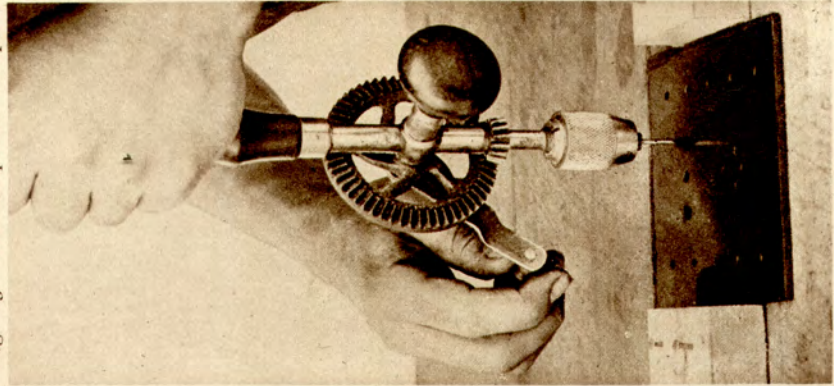

Fig. 16. Drilling the ebonite panel

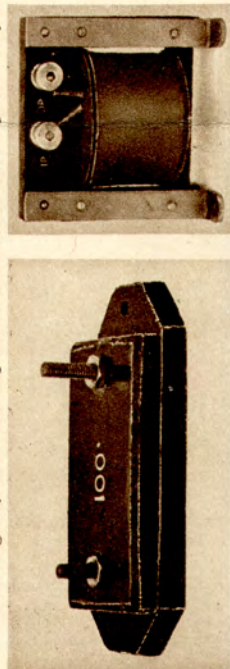

Fig. 17. Fixed condenser wired across transformer



Fig. 18. Low-frequency transformer

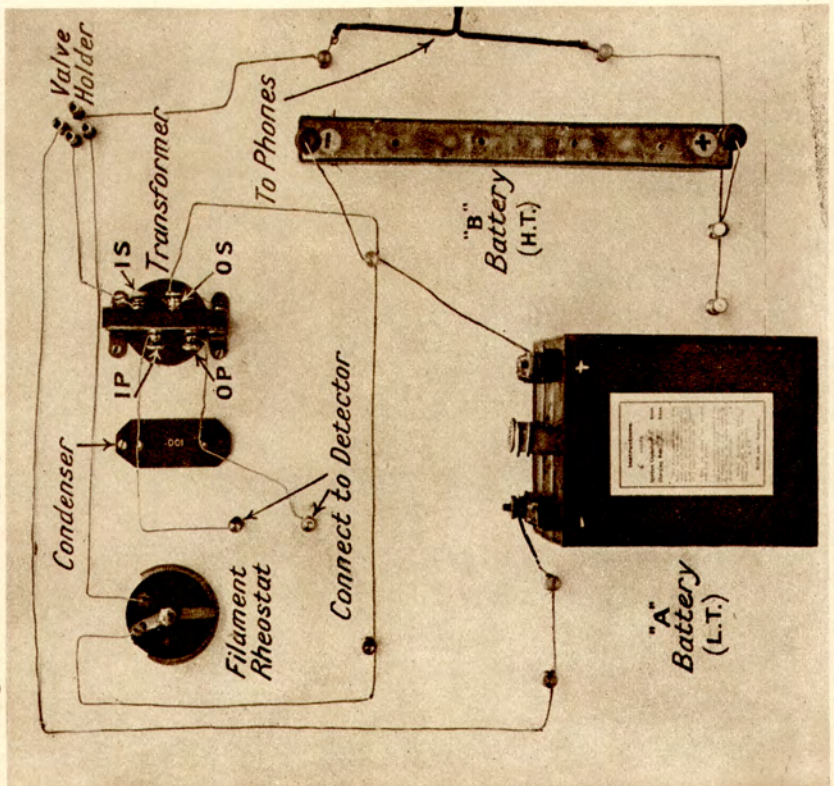

Fig. 19. Rheostat

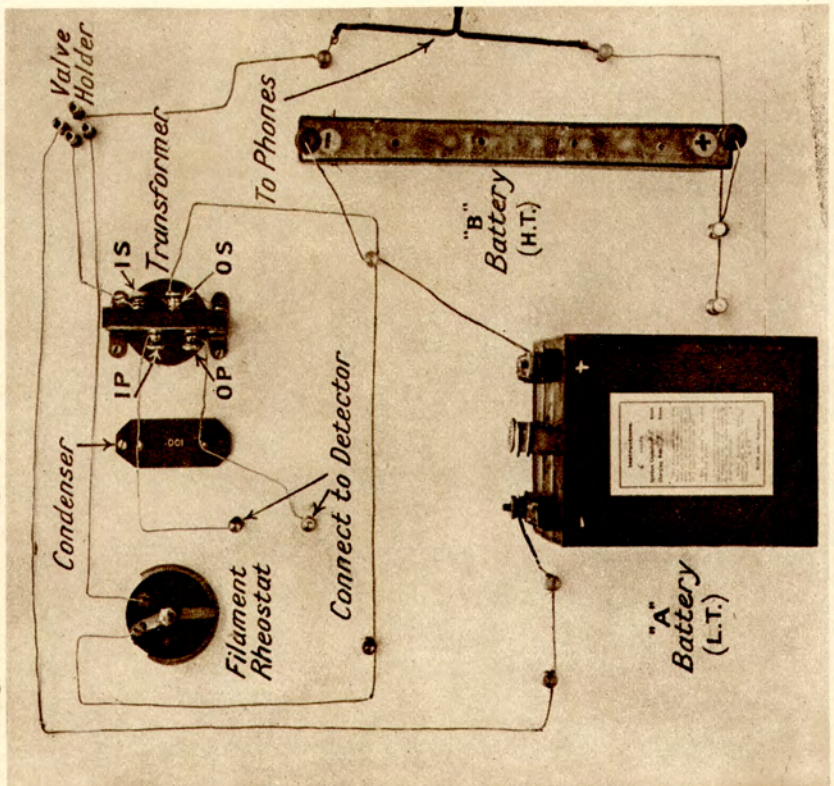

Fig. 20. Photographic lay-out of the wiring of whole of the parts

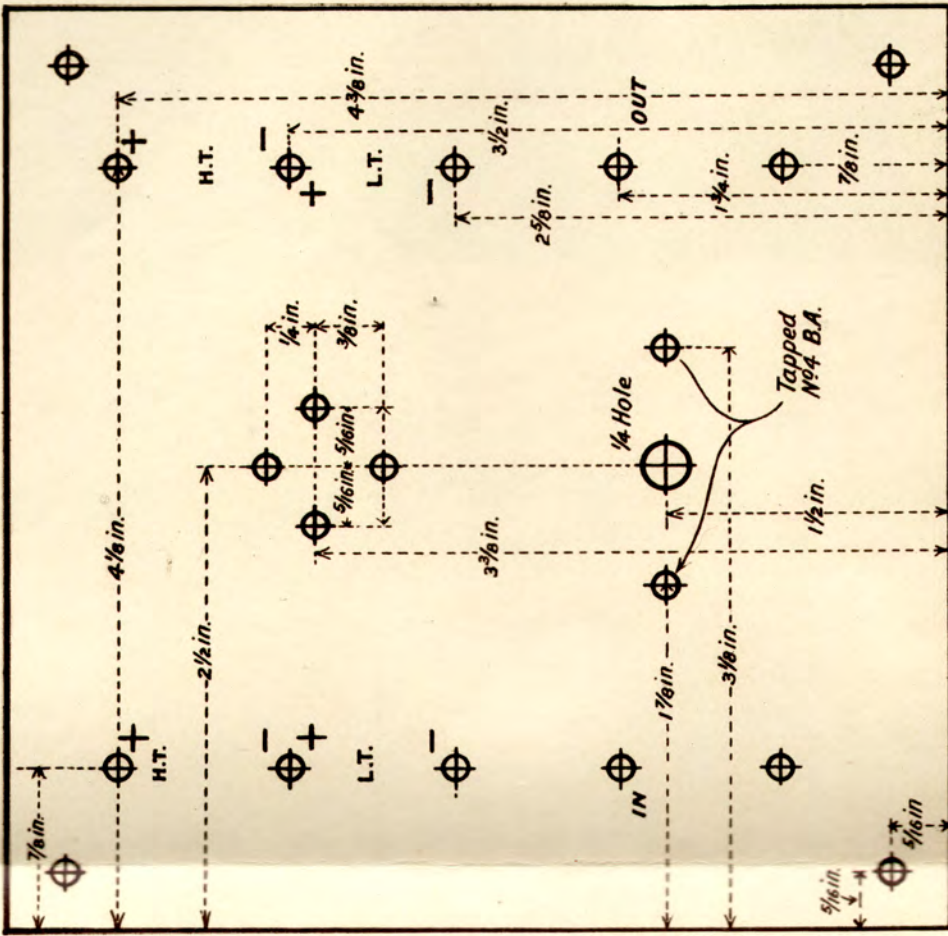

Fig. 21. Diagram of the panel lay-out reproduced exact size so that it may be traced

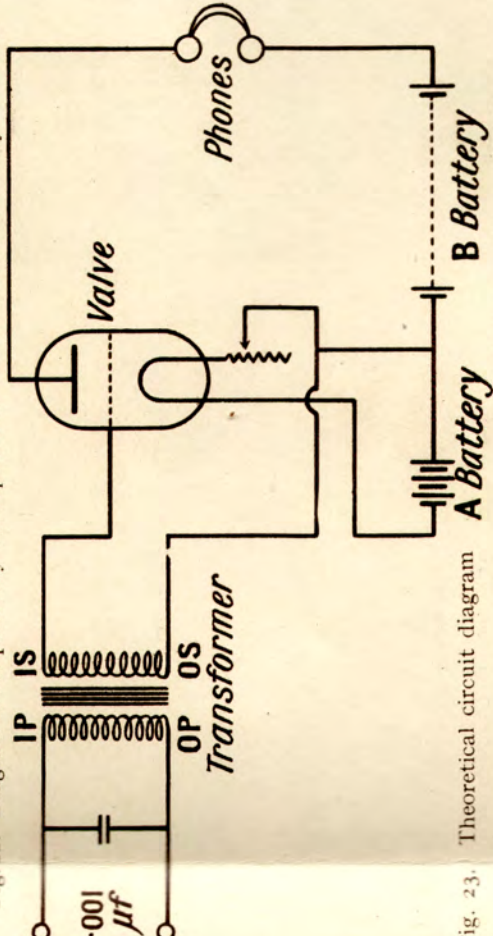
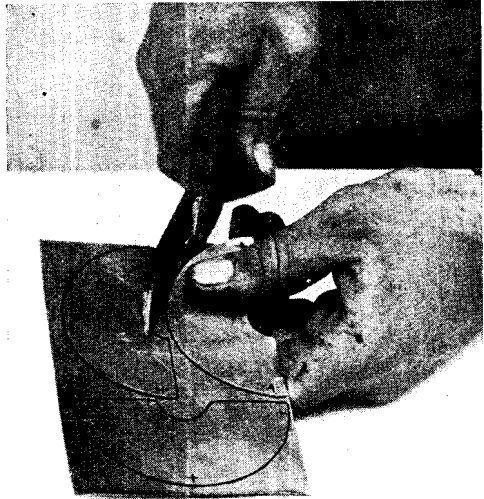

Fig. 22. Theoretical circuit diagram

AMPLIFIER: MEASUREMENTS, WIRING, CONSTRUCTION, AND COMPLETE SET OF COMPONENTS FOR A ONE-VALVE, LOW-FREQUENCY AMPLIFIER ON THE UNIT SYSTEM

for instance, the plates for a variable condenser. Sheet metal of a thickness of about $\frac{1}{16}$ in. can be cut readily with ordinary tinman's snips. The pattern of the piece can be drawn on the sheet metal, either with a pencil or Indian ink, and then cut to shape with the snips or shears. Fig. 5 shows this operation and also how, by resting the left hand upon the table, one of the points of the snips or shears may rest upon the table beneath the sheet of aluminium while the other is above it. This gives a greater purchase on the handles, and better command of the tool, than is the case if the metal be cut by merely holding it in the left hand.

A drilling operation is shown in Fig. 6, and shows how, by clamping several of the sheets together in a hand vice, the whole block can then be held together in the bench vice and holes drilled through all of them simultaneously. When drilling, the drill should be run at as high a speed as possible, and it is imperative that the drill should be thoroughly well sharpened and have a very keen cutting edge. Similar lubricants may be used as for turning and milling. In drilling it is not necessary to exert any great pressure, and especially so when the drill is on the point of emerging from the metal. The drill



CUTTING SHEET ALUMINIUM

Fig. 5 Ordinary tinman's snips are used in cutting sheet aluminium. The photo shows the method of holding a sheet on the bench for cutting

should be, as it were, held back by the hand, and only rotated. It will feed itself through quite fast enough, and some back pull tends to produce a better-shaped and clean hole.

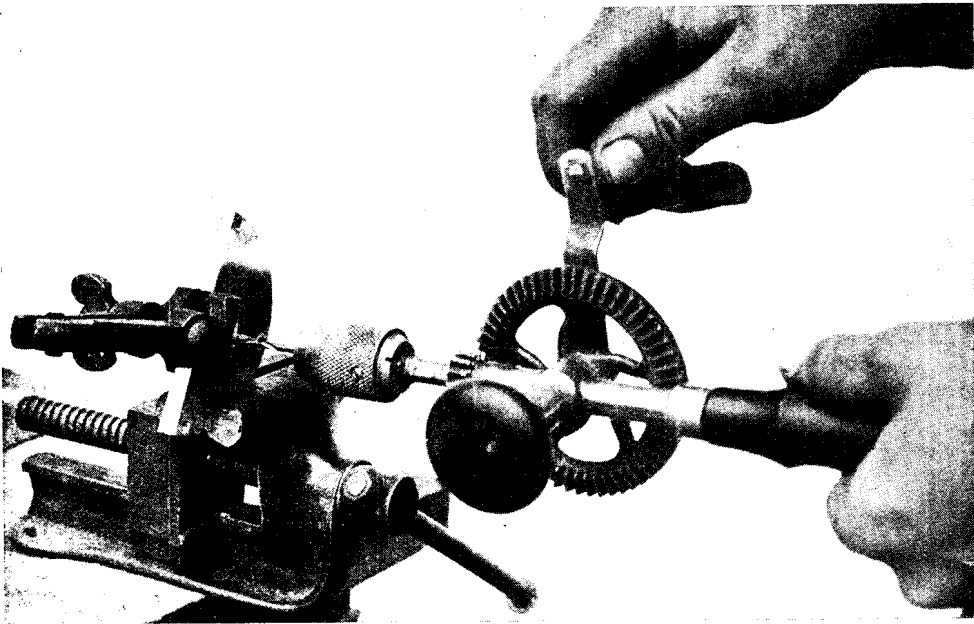

DRILLING ALUMINIUM CONDENSER PLATES

Fig. 6. Several plates may be drilled together. Speed is more important than pressure, and the bit or drill must be very sharp and lubricated. The plates must be firmly clamped

Soldering Aluminium. Aluminium is soldered with difficulty, owing to the rapidity with which it expands. Many proprietary brands of aluminium solder are on the market and are fairly successful in use, if the makers' instructions are rigorously followed. As an example, one of these, known as the alumina process, is illustrated in Fig. 7. By this process, before commencing operations on castings and heavy work, all parts should be thoroughly cleaned up with a file and the edges bevelled around the fracture or holes, to present as large a surface as possible for the application of the solder. All parts should be carefully supported to avoid movement of the material while the soldering is in progress. If an extensive hole is to be filled in, it should be suitably packed up with asbestos, sand, plaster of paris, or other suitable material.

The parts to be repaired should then be heated until, on applying the solder, it runs freely in a bright, liquid state. The solder should then be vigorously brushed, while

times, when a sticky appearance of the surface will indicate that a thorough amalgamation has been effected. A good plan, in cases where edges have to be soldered, is to scrub them with the teeth of an old hack-saw blade, which will sometimes give better results than a brush. The joint should be built up, without stint of solder, until the repair is complete. Just before the solder has set hard, a finish should be effected with a spatula, care being taken not to move the parts until the solder has set hard, or the job will have to be done afresh.

Soldering and Spinning Sheet Aluminium

For soldering thin sheets, or similar work, such as the tone arm of a loud speaker, as illustrated in Fig. 7, the parts to be soldered should first be thoroughly cleaned. The work should then be heated so that the solder, when applied, runs in a bright, silvery liquid. This may be accomplished by placing it over a gas ring, by a soldering iron, a spirit lamp or blow lamp, or a gas-heated blow lamp, according to the quantity of heat absorbed by the metal before the solder melts when rubbed against the work. While the solder is still liquid, it should be brushed in with a wire brush, or may be scratched in with a pocket knife, steel knitting needle, or any such sharp instrument. This operation should be repeated so as to ensure proper amalgamation. In the absence of a wire brush, a file card could be used, and the filling in continued until the work is completed.

When finished, the soldered surfaces should be cleaned with a file and emery cloth, and finished by polishing.

Aluminium can be brought to shape under a power press or punches, and can also be spun. In the latter case the aluminium is mounted in a spinning lathe, and pressed over to shape with a spinning tool on to a former or wooden plate mounted on the headstock of the lathe. Vaseline is a good lubricant to use for this operation. A final finish to aluminium may be imparted by polishing, this being carried out in substantially the same way as that adopted for other sheet metals. The polishing wheels must, however, run at a very high speed, 2,500 to 3,000 revolutions per minute, at least.

Primarily, polishing is accomplished by sanding with Frenet sand on a leather bob.



SOLDERING ALUMINIUM

Fig. 7. The alumina process illustrated in the soldering of the bend in the tone arm of a loud speaker

still liquid, into the joints with a stiff steel wire brush. The brush should be pressed hard and moved rapidly from side to side with a vibrating movement. The brush should not be used with a backward and forward movement, as is usual when brushing a boot, as this will brush the solder off, and not into the metal. The brushing should be repeated two or three

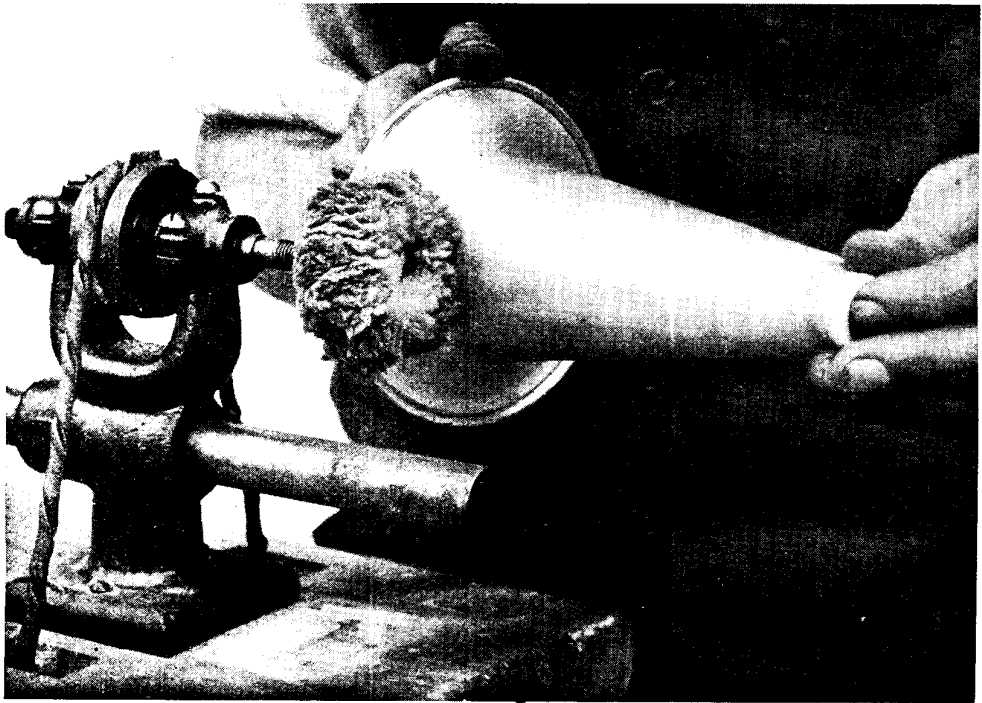

POLISHING ALUMINIUM

Fig. 8. Lime is used in conjunction with a polishing mop for imparting a finish to the surface of aluminium. The mop is rotated at a suitable speed and large parts may be held in contact by hand

This is followed with a greasy tripoli compound, using an ordinary canvas or linen bob. A final finish is imparted by buffing with dry lime and polishing mop, as illustrated in Fig. 8. A matted finish is obtained by thoroughly cleaning the metal by washing in hot water and immersing for a few minutes in a hot solution of caustic soda. This is then thoroughly well washed off and parts dipped into cold diluted nitric acid. This removes the black deposit which is formed as a result of the treatment with the caustic soda. The job is completed by washing with hot water, and drying off in sawdust in the usual way.

Aluminium may be burnished by the use of an ordinary agate burnisher lubricated with olive oil.

ALUMINIUM PAINT. Colouring and protective paint much used on exterior metal work as a preventive from rusting. The paint is composed of a spirit vehicle, and the pigment is in the form of a fine powder obtained from the metal itself in process of manufacturing. It is applied with a brush in the ordinary way, on a properly prepared ground, or priming coat. The metal should first be cleaned thoroughly

by vigorous brushing with a wire brush, or other suitable method, according to the nature of the work, and two coats of the paint are usually sufficient to give a satisfactory result. It is obtainable in small quantities in tins from ironmongers, and is a useful means for covering the earth wire after attaching it to the water pipe or other earthing medium. The coating of paint is in effect a film of metal, and this assists to make and maintain a good electrical connexion. The paint should be well stirred before use. *See Painting.*

AMALGAM. An alloy of mercury with another metal or metals. It forms the basis of metallic mixtures employed for fixing the crystal to the holder of a detector. These are plastic when newly made, but harden in a short time, and may expand or contract considerably in doing so, according to their composition. Many amalgams are formed by the direct contact of the mercury with the metal, of which tin, copper, cadmium, silver, and gold are commonly used. An amalgam used in electrical work is composed of tin and zinc. Some such amalgam can be used as a cement for metal. It is worked

into the crack or damaged part in the plastic state, and soon sets hard, making an efficient repair, where no mechanical stress has to be sustained. In many types of battery the zinc plates are coated with amalgam to reduce polarization. One of the useful applications of amalgam is in setting a crystal in its cup. See Alloy; Leclanché Cell.

AMBROIN. An insulating material composed of silicates saturated in copal by a special process of manufacture. It is durable, uniform in texture, and non-hygroscopic. This latter property is a valuable one in wireless work, as the variations caused by changes in the dampness of an insulator are more noticeable in wireless than other branches of electrical work.

Various grades of ambroin are available, having different characteristics. It resists high temperatures rather better than ebonite, and has a higher tensile

strength. Ambroin has a tensile strength in the neighbourhood of 2,100 lb. per sq. in. as against 1,100 for ebonite.

The material can be machined without much difficulty. Drilling is best accomplished with a flat drill revolving at 450 revolutions per minute as an average, increasing for small drills and decreasing for larger sizes. Turning is carried out with hard cast steel tools, running at about the same speed as for drills.

Grinding is accomplished by emery and oil, or for finer finishes with water and pumice powder. Polishing is done on the same lines as for wood, and colouring is effected by the use of a shellac polish stained with aniline dyes. A small quantity of oil will suffice to give an excellent finish. Sawing is carried out with a hard steel saw, working it carefully, avoiding crowding by not pressing the saw too much nor attempting to cut too quickly. See Ebonite.

THE AMMETER : ITS VARIETIES AND USES

An Instrument Essential for Exact Experimental Work

Types and uses of ammeters are described in this article. Their commercial use and the measurement of very large and very small currents are dealt with. See also Abbreviations; Ampere; Voltmeter

Ammeters (symbol $\text{---}\textcircled{A}\text{---}$) indicate by the position of a pointer on a dial the current flowing through an electric circuit of which they form part.

For commercial use these instruments generally fall under either of two classes—the “moving-iron” or the “moving-coil” type. In the first a soft iron armature carrying the pointer is caused to deflect by magnetic repulsion between two pieces of soft iron similarly polarized by current flowing in a coil surrounding them; in the second case a very light coil of copper or silver wire is pivoted in such a way between the poles of a permanent magnet that any magnetic field produced by current flowing round the coil crosses the field axis of the permanent fixed magnet, and the coil being free to turn, takes up a new position which is the resultant of the two forces, the pointer attached to it traversing a scale. Current is led into and out of the moving coil by phosphor bronze hair-springs. As these can only carry a limited amount of current, internal or external shunts are provided when the current is in excess of that which can be safely

carried by the moving coil, by-passing the bulk of the current and limiting the active portion to the carrying capacity of the moving coil and its attachments.

Both these types depend for their action upon electro-magnetic principles, and the scales of such instruments can be calibrated to read in either volts, amperes, milli-volts, or milli-amperes. Currents of radio frequency, however, are generally measured by an entirely different class of instruments, depending for their action on the expansion of a wire or strip due to the heat produced by the passage of an electric current, and are known as “hot-wire” ammeters or thermal instruments.

Other instruments of a somewhat similar nature are those which depend on thermo-electric effects, where an electro-motive force is generated at the junction of two dissimilar metals in proportion to the temperature imparted to it by an electrically heated wire. This is the effect discovered by Seebeck and Peltier.

The principle of each is illustrated by diagram in Fig. 1 and Fig. 2. In Fig. 1, current flowing through wire A B causes it to heat and expand. This movement is

communicated to the needle or pointer C by a thread which passes round the arbor, E, and is anchored to a light-tension spring, D, so that expansion of the wire A B communicates a rotary motion to E, and the needle C traverses the scale, the slack being taken up by spring D.

In the thermo-electric ammeter, Fig. 2, a pair or "couple" of dissimilar metals, A B, have their junction attached to the hot wire C D, carrying the current to be measured. The instrument E is to all

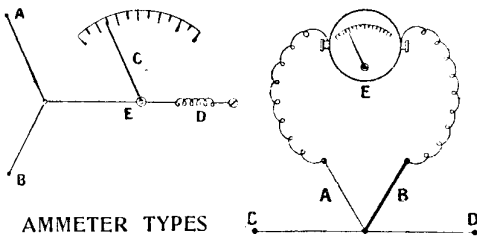

AMMETER TYPES

Fig. 1 (left) illustrates the principle of the hot-wire ammeter, the current flowing through the wire A B causing it to heat and expand. Fig. 2 (right) shows the thermo-electric ammeter. In this is included a pair of dissimilar metals A and B, which have their junction attached to a hot wire C D, carrying the current to be measured

intents and purposes a simple galvanometer or milli-voltmeter, and reads in proportion to the E.M.F. generated in the thermo-couple, but is calibrated to represent the equivalent value of the current in amperes which would produce that deflection. The E.M.F. of a thermo-couple is almost directly proportional to the temperature of the junction.

Moving-coil instruments cannot be used to measure alternating currents, since the needle would try to oscillate in step with every change of the direction of current in the coil. The moving-iron type, however, can be successfully employed on either direct or alternating circuits, provided the latter are not of too high a frequency, that is, comparable with ordinary commercial frequencies used on lighting and power distribution systems. The hot-wire instrument is also suitable for either kind of current, since the effective or mean value of an alternating current is equal to that of the same amount of steady direct current.

In the thermo-couple ammeter, the heating effect produced is irrespective of the direction of current along the wire C D in Fig. 2, and can, therefore, be measured by a direct-current or moving-

coil instrument at E. The heat developed will vary as the square of the current, and the thermo-couple E.M.F. will follow closely along the same law. Currents of radio-frequency can only be measured on instruments of the hot-wire or thermo-couple type.

When currents of more than a few amperes are to be measured it is not practicable to pass such an amount through a single heating wire, and if shunted in the ordinary way applicable to commercial frequencies they may show considerable inaccuracies with every change of frequency and wave-length. Consequently it is necessary to employ a special form such as illustrated in Fig. 3.

Here the current divides up among a number of platinum-iridium strips in a frame, and passes from one terminal, A, through the frame with its multiple strips, to terminal B in equal amounts, whatever may be the change in circuit conditions and frequency. The heat expansion of

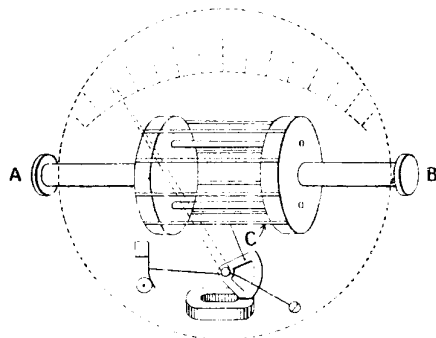

AMMETER FOR HEAVY CURRENTS

Fig. 3. Special form of hot-wire meter for direct readings of large currents which pass through a frame between terminals A and B, consisting of a number of platinum strips

the lower wire, C, causes it to dip, and this movement is taken up by the tension wire and control spring, and is converted into rotary motion of the pointer as before explained. A damping device is added in the form of a copper quadrant or vane oscillating between the poles of a small permanent magnet. The eddy currents induced in this vane in accordance with Lenz's law will tend to retard or wipe out the cause producing them, in so doing slowing down and damping its oscillations.

Ammeters used for the measurements of very large currents, whether direct or alternating, at commercial frequencies, are

usually provided with "shunts," which are carefully calibrated resistances connected across the main terminals and bearing an exact ratio of the resistance of the instrument coil itself. A shunt thus diverts or shunts off a greater or lesser proportion of the total current in the circuit, according to the relative resistances of the instrument coil and the shunt path, and, without overloading the instrument windings, enables the same

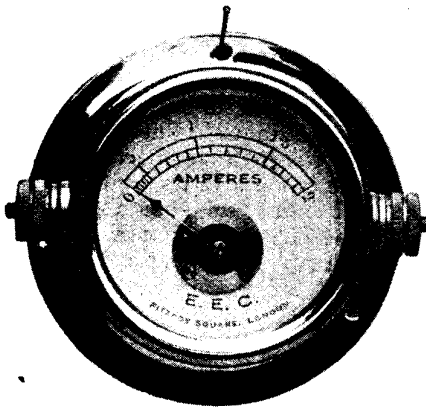

PANEL AMMETER

Fig. 4. A simple ammeter suitable for mounting on the panel of a valve set

ammeter to be used for measuring currents far in excess of its normal carrying capacity.

A shunt having a resistance exactly one-ninth that of the instrument coil would pass nine parts of current through the shunt and one part through the coil, increasing the useful range of the instrument tenfold. The actual indications of the ammeter pointer would in such cases be multiplied by ten to obtain the correct figure. In the same way any other multiplying power of the instrument scale could be obtained by varying the ratio of shunt resistance to coil resistance, current dividing between the branched paths inversely as their respective resistances.

Fig. 4 is a photographic illustration of a simple model of an ammeter suitable for panel mounting and for testing the current consumption of the filament-heating circuit. Other types are made of the pocket or portable variety.

AMPERE. In electricity the unit of current. It is the constant electric current which, when passed through a neutral solution of nitrate of silver, deposits in one second on the cathode or negative pole 0.001118 of a gramme of silver. It is one-tenth of the absolute unit of current—that is, the unit based on the centimetre, gramme, and second. A current of one ampere is produced by an electro-motive force of one volt applied to a conductor which has a resistance of one ohm. An electric current in amperes is measured by means of an ampere meter or ammeter. The quantity of electricity that flows per second past a given point in a conductor which is carrying a current of one ampere is called a coulomb.

There is an important relation between the current, C , measured in amperes, the electro-motive force, E , measured in volts, and the resistance, R , measured in ohms. This relation is $C = E/R$, and enables the number of amperes to be calculated from the known resistance and E.M.F. of a circuit. See Ammeter; Electro-motive Force; Ohm; Volt.

AMPERE HOUR. The commercial unit of quantity of electric current. It is the quantity of electricity which flows in one hour through a circuit carrying a constant current of one ampere. It is equal to 3,600 coulombs. An ampere second and an ampere minute have values of one coulomb and sixty coulombs respectively. See Coulomb.

AMPERE'S RULE. This is a rule first enunciated by Ampere by which the relation between the deflection of a magnetic needle and the direction of an electric current may be remembered.

Ampere supposed a man swimming along a wire in the direction of the current flow, facing the needle. The north pole of the needle will then always deflect towards his left hand. If the wire is wound round a wooden former of some kind, and the needle placed in it, it becomes, in effect, a galvanometer, and enables the direction as well as the force of the current in a circuit to be ascertained. See Galvanometer.

AMPERE TURN. Unit of magnetomotive force. The number of ampere turns of a circuit equals the product of the number of amperes flowing in the circuit multiplied by the number of turns in the circuit. Thus, one ampere turn is one ampere flowing through one turn,

six ampere turns is three amperes flowing through two turns or two amperes flowing through three turns, and so on.

When a bar of iron has wrapped round it a coil of wire conveying a current it becomes magnetized, and is known as an electro-magnet. The strength of this magnet depends not only on the number of amperes flowing, but also on the number of times the amperes pass round it—that is, on the number of ampere turns. There is a limit to the strength of the magnet for a given piece of iron, and any further increase in the current or number of turns has little or no effect.

AMPLIFICATION. The process by which, or the extent to which, an amplifier increases power, voltage, or current without sensible change in wave form.

An amplifier is distinguished from a relay from the fact that in an amplifier the local currents it controls follow every fluctuation of the weaker impulses.

Amplification effects obtained by means

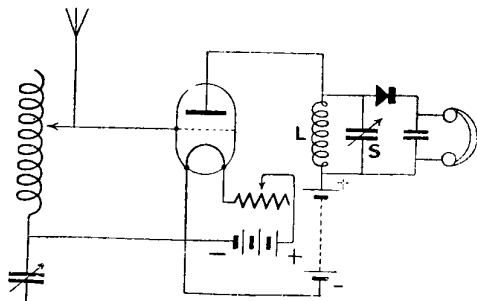

HIGH-FREQUENCY AMPLIFICATION

Fig. 1. In the circuit diagram here given the arrangement provides for radio-frequency amplification, oscillatory changes of potential occurring in the aerial circuit

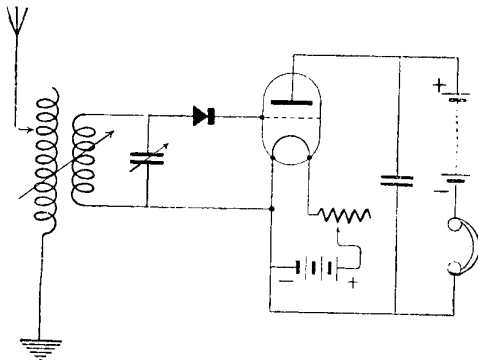

LOW-FREQUENCY AMPLIFICATION

Fig. 2. In this case audio-frequency amplification takes place. Rectification has taken place before the currents reach the valve

of the thermionic valve depend upon the following principles. When the valve is in proper adjustment a small change of grid potential causes a large change in the anode current. In the case of radio-frequency amplification, the oscillatory changes of potential occurring in the aerial circuit due to incoming waves being impressed upon the grid give rise to similar oscillations in the circuit marked L S in Fig. 1, which is connected to the anode and some source of high potential direct current, but these oscillations are of much greater amplitude. Being oscillatory, it is necessary to provide for their subsequent rectification, which can be done by a crystal detector, for instance.

To obtain audio-frequency amplification the valve is connected in the circuit at a point where the currents have already undergone rectification, as in Fig. 2.

In either of the above cases the detector might be a suitably arranged valve or a number in series, the anode of one actuating the grid of the next, so obtaining various stages of amplification. See Amplifier; Dual Amplification.

AMPLIFICATION FACTOR. Of power, voltage, or current. The ratio of the power, voltage, or current available at the output terminals of an amplifying device to the power, voltage, or current at the input terminals under certain specified conditions, such as given output or given input. The amplitude in each case must be such that no saturation or threshold effects of any kind are involved.

In multiple-stage amplification a separate negative grid bias battery may be necessary. This is merely to bias the grid potential, and there is practically no current discharge, as the grid, being negative, does not allow an electron current to flow around the grid circuit. As a general rule the grid bias battery should have an electro-motive force about one-fifteenth of the anode voltage, but different valves have different characteristics, and variations in this respect are known as the amplification factor.

AMPLIFICATION RATIO. Of a three-electrode thermionic valve. The numerical ratio of the tangent of the anode current grid voltage slope to that of the anode current anode voltage slope of the characteristic surface of the three-electrode thermionic valve with the particular adjustments under consideration. See Characteristic Curve.

AMPLIFIERS: THEIR PURPOSES AND CONSTRUCTION

Their Theory, Working, & How to Make Them Fully Explained

In this article amplifiers for high-frequency and audio- or low-frequency purposes are described and illustrated in detail. The amateur is given full instructions for making no fewer than five different amplifiers for crystal and valve sets, one being shown on a special photogravure plate. See also *A Battery*; *Audio-Frequency*; *Intervalve Transformers*; *Rheostats*; *Valve*, etc.

An amplifier is a device by means of which the input power is used to control a local source of energy in such a way that, provided the limits of saturation are not reached, there is approximately proportional relation between the magnitudes of the controlling and the controlled powers, without sensible change in wave form.

In actual practice amplifiers are divided into several classes according to the purpose for which they are required. Amplifiers for broadcast reception may be classified under two headings.

Those that amplify the ether waves before they have been rectified are known as high-frequency amplifiers, since they deal with the radio, or high-frequency, waves as they are intercepted by the aerial wire. The other class is known as audio, or low-frequency, amplifiers, since they increase the volume of sound in the telephone receivers by amplifying the rectified waves. In any system for the reception of telephony sent out by a broadcasting station the ether waves are of such high frequency, or, as it were, vibrating so quickly, that they are inaudible in any telephone or in the ears of the listener, and the function of the receiving set is to convert them into lower frequency waves capable of being heard with the aid of the telephone and human ears. The success with which this can be done depends upon a great many considerations, all of which are dealt with under their appropriate headings elsewhere in this Encyclopedia.

High- and Low-Frequency Waves

It is sufficient to say here that there are two sets of waves available. First, the high-frequency waves, and, secondly, the low-frequency, or audible, waves; and by the use of suitable apparatus, known under the general heading of amplifiers, it is possible so to modify the waves that their strength is increased. But as it is the high-frequency waves that are intercepted by the aerial, the effect of amplifying them before they are rectified is to

increase the range of the instrument. By amplifying the audible, or low-frequency, waves the strength of signals received by any particular apparatus is increased. Hence, in general the high-frequency or radio-frequency amplifiers are generally used to increase the distance from which signals can be received.

Low-frequency amplifiers are used to increase the volume of a signal that can already be heard with the apparatus. The latter are also used to operate a loud speaker and to control the power impulses delivered to any desired appliance of that character, such as a gramophone receiver. As a rule, the listener-in will find it desirable to add a stage of low-frequency amplification to a set and to become familiar with its use before going in for high-frequency amplification, which presents greater difficulties to the amateur.

Amplification for All Purposes

A practical arrangement is ultimately to have a receiving set with a stage or stages of high-frequency amplification, and either a crystal or valve for rectification, and one or two stages of low-frequency amplification. Such a combination enables several different broadcasting stations being heard with ample strength. With such modifications as may be necessary, the same applies to the reception of signals by the Morse or other code adopted for telegraphic transmission.

There are numerous ways of amplifying the high- and low-tension currents. The simplest is by the use of an amplifying valve, this being virtually an ordinary three-electrode valve wired into the particular circuit in a manner appropriate to that circuit, with the result that the incoming ether waves are amplified and delivered to the rectifier at a higher amplitude than that at which they entered. The reasons for this, and also the ways in which this most valuable property of a valve can be applied to any suitable circuit, are fully described in the articles on high-frequency amplification, and also under the heading *Valve*. Other

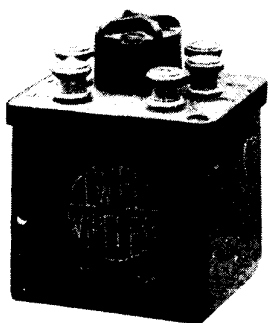

Fig. 1. Elwell one-stage low-frequency amplifying unit



Fig. 2. Elwell high-frequency amplifier

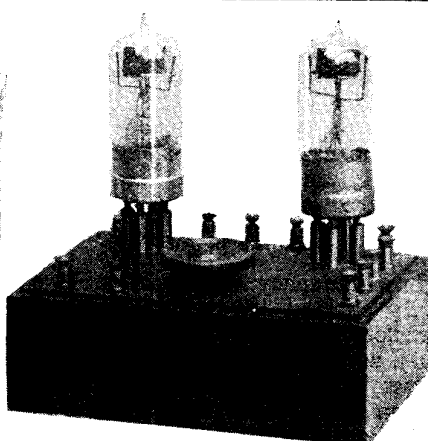

Fig. 3. Low-frequency 2-valve amplifier, controlled by one rheostat

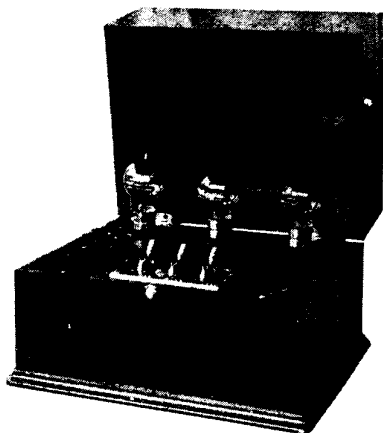

Fig. 4. Three-valve power amplifier for loud speaker

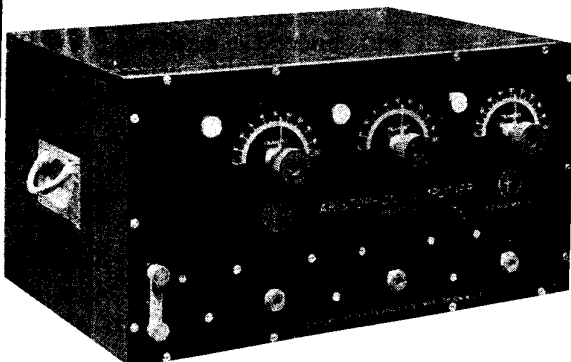

Fig. 5. Three-valve Aristophone amplifying unit

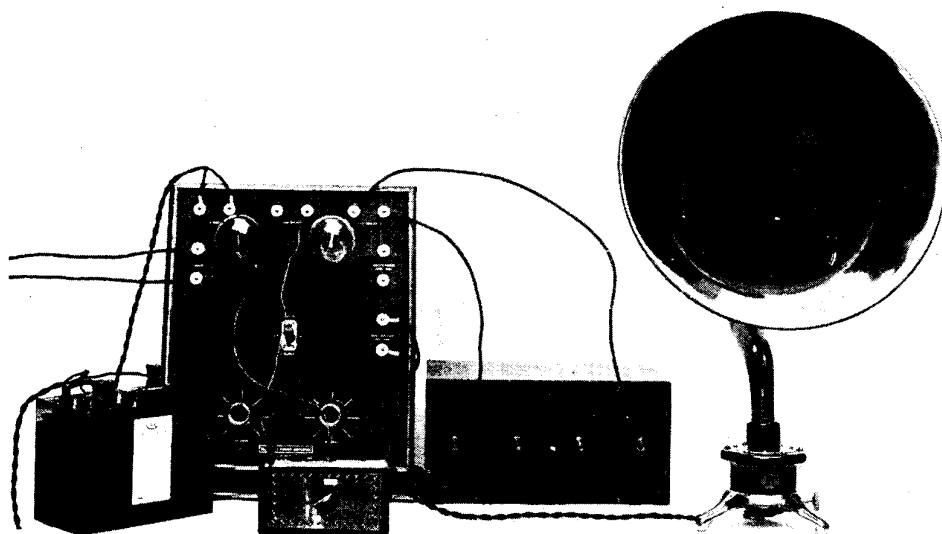

Fig. 6. Connections and arrangements of a Burndept power amplifier with high and low tension batteries and loud speaker

AMPLIFIER: STANDARD EXAMPLES OF COMPLETE UNITS

methods are by the use of inter-valve transformers of the open core type and by a condenser system. Amplifying effects are also possible by the use of valves in cascade, by reactance capacity coupling, and by the use of suitable resistances and potentiometers.

Amplifiers of All Types

Low-frequency amplification is extensively effected by means of inter-valve transformers of the audio-frequency type (*q.v.*), as well as by the use of a valve or valves. Other methods are by means of carbon rods, more or less on the lines of a microphone, and by a relay action. Some types of loose-coupled tuning inductances also give an amplifying effect.

The theoretical consideration of the subject is dealt with under the headings of Low Frequency and High Frequency (*q.v.*), these notes being restricted to the construction of the amplifier itself.

Amplifiers suited to the needs of the listener-in are here illustrated and described. They are representative of numerous excellent patterns readily available on the open market. Fig. 1 shows a self-contained, one-stage low-frequency amplifier as supplied by C. F. Elwell, Ltd. Its special feature is the use of a sealed iron case which contains the transformer. This ensures the minimum of local effect, and eliminates interference due to the possible proximity of other wires or apparatus in a circuit. The terminals are arranged on a regular system, so that any of the units can be assembled in any appropriate order. Alternatively, the sets can be screwed to the interior of a case or to a panel, according to the arrangement of the other components.

For the Home Constructor

A somewhat similar design is embodied in the Radiocraft sets, of which Fig. 2 is an example. These are intended for the use of the home constructor, and enable the experimenter to build up reliable apparatus. The unit illustrated is a high-frequency set. It is enclosed in a sealed case, and suited to the broadcast wavelength band of from 350 to 600 metres. The moulded top forms the valve socket.

A simple pattern of two-stage low-frequency amplifier is shown in Fig. 3. This has two valves set erect on the rear of a panel mounted on a mahogany case. Both the filaments are controlled through

one rheostat. This reduces the tuning arrangements to a minimum, the adjustment of the rheostat and the variations possible on the high- and low-tension batteries being the only adjustments provided or necessary.

A powerful three-valve amplifier is shown in Fig. 4, suitable for use on such duty as the operation of a loud-speaking device such as the Magnavox. The valves are the regulation Marconi Osram, specially adapted for such work. The arrangement of the cabinet container is such that the cover can be closed when the instrument is not in use. A three-stage switching device is incorporated, and so arranged that the first switch to be thrown is that on the right. This brings the first stage of amplification into operation, and as the other switches are thrown, the remaining stages of amplification are successively brought into play. This allows the desired amount of amplification to be controlled to a nicety. When listening in to a nearby broadcasting station, there is no need for more than one or possibly two stages of amplification to get perfectly strong and clear reception. On tuning in to a long-distance station, the remaining stages can be switched in to increase the signal strength.

Enclosed Type of Amplifier

Another type of fully-enclosed amplifier is that shown in Fig. 5, as made by the C. F. Elwell Co. It comprises three stages of low-frequency amplification. In this design all the apparatus is enclosed within the case, which is made of polished mahogany, with an ebonite panel at the front and a hinged lid at the top. Valve windows are fitted at the front to permit of inspection of the valves. The other special feature is the use of telephone jacks. These are a kind of automatic switch in the form of a plug which, when pressed into the socket seen at the bottom of the case beneath the filament control knobs, automatically closes all the necessary circuits, and thus switches on the desired stage or stages of amplification. The simple action of introducing or withdrawing the jack performs all the switching actions necessary. When all are withdrawn the circuits are all opened, and the aerial connexions are earthed. With Mullard valves this set utilizes a 6-volt low-tension battery for filament heating and a 120-volt anode battery.

The complete arrangement of a power amplifier is shown in Fig. 6, which illustrates the connexions between a Burndept power amplifier, the high- and low-tension batteries, and the loud speaker. The leads to the left are connected to the telephone terminals (not shown in the photo). The accumulator on the left supplies the current to heat the filament of the two special power amplifying valves seen in place on the panel. A separate 30-volt high-tension dry battery energizes the grid circuits of the valves, while the case on the right is used to house a powerful high-tension dry battery with terminals for voltages of 120, 180, and 240 respectively. Such an amplifier will supply energy enough to actuate several small types of loud speaker, which can be placed around the room or elsewhere. This obviates the harsh blare so often accompanying the use of a single large-size loud speaker. With the choice of one or both valves in operation, and selection of the number and type of loud speakers, this arrangement provides full selectivity as regards volume of sound, and avoids difficulties associated with the use of a single high-powered speaker.

Amplifier for a Crystal Set. Most amateur listeners-in who live within twenty miles or so of a broadcasting station begin with a crystal set, because it is not only the cheapest form of receiving apparatus, but because it is also the simplest to tune and keep in order. Nearly all who have listened on a crystal set for any time, however, either decide to have a more powerful valve set, or alternatively amplify the crystal set they already possess.

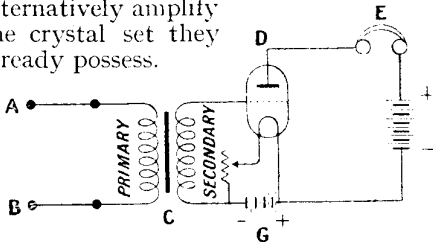

ONE-VALVE AMPLIFIER FOR CRYSTAL SET

Fig. 7. To employ a loud speaker with one valve connexions are made, as indicated by this diagram, to the telephone terminals, A B, of the original crystal set as described in the text

Here is described a one-valve amplifier which may be used on any standard or home-made crystal set without altering the latter in any way. Such an amplifier will, within a few miles of a broadcasting

station, allow the use of a loud speaker, if a good aerial is used. In any case, the amplification will be sufficient to enable a number of extra telephones to be used without any serious loss of hearing. General measurements only are given, as it is clear that particular measurements will have to be adopted for the crystal set with which the amplifier will be used.

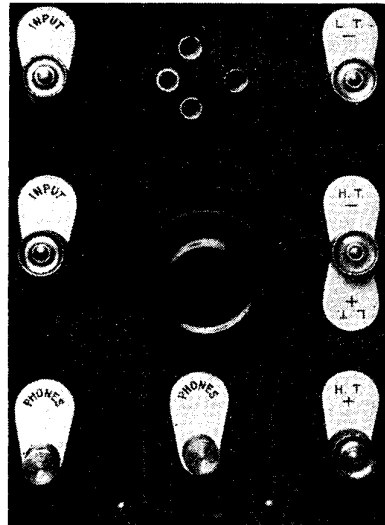

PANEL OF SINGLE VALVE AMPLIFIER

Fig. 8. This panel is of ebonite, but other material may be employed. Terminal indicators make connecting up simple and prevent reversing current by mistake

The amplification used is known as low-frequency amplification. It can only be used so long as the original crystal set is able to pick up broadcasting items. The low-frequency amplifier and crystal set is more powerful than a single-valve set, and almost equals that of a two-valve set.

Fig. 7 shows the diagram of the connexions for the set under consideration. A and B are the telephone terminals of the original crystal set. They are joined to the primary of a step-up inter-valve transformer, C. The variations in the primary caused by the wireless signals are stepped up in the secondary winding. This leads to the grid of the valve, thence to the plate or anode D, to the telephones E, and finally the circuit is completed through the high-tension battery, F, and the filament.

Fig. 8 is a photograph of the front of the panel. It may be of ebonite, and will

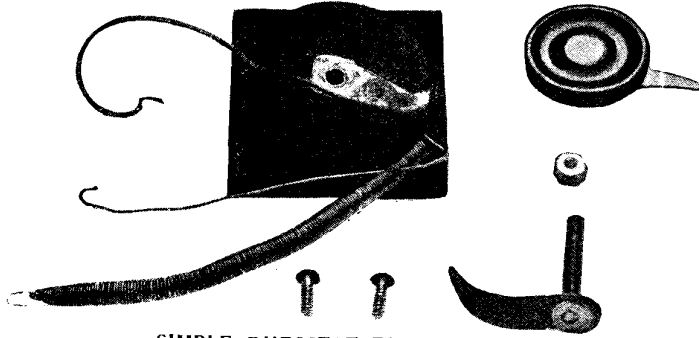

SIMPLE RHEOSTAT FOR AMPLIFIER

Fig. 9. Complete set of parts of home-made filament resistance, showing simplicity of construction

look better in that material; but a dry piece of hardwood, well coated with shellac varnish on both sides, or even a piece of beaver board soaked in hot paraffin wax, will answer the purpose. The dimensions of the panel are $4\frac{1}{4}$ by $5\frac{3}{4}$ in.

The seven terminals should be evenly spaced close to the edges, as shown, and either a valve holder or valve pins fitted at the top edge of the panel. If pins are used it is important that their positions should be marked carefully from the valve itself. The grid and the plate should be on the left and right respectively. The ebonite should be drilled and tapped for screws. Trying to force a screw in, as in wood, will only result in splitting the ebonite. Under the heading Ebonite full particulars are given of the methods of working in this material.

The filament resistance can be made or bought. It is a simple piece of apparatus to make, and details of construction (Fig. 9) are as follows: Plane up a piece of hardwood $2\frac{3}{4}$ in. square by $\frac{3}{4}$ in. thick. On this draw a circle $2\frac{3}{8}$ in. in diameter, and cut round this circle a groove to a depth of $\frac{3}{8}$ in. As this will not show when the amplifier is complete, a quick way of making the groove is to burn it out with a red-hot poker.

A wound filament resistance wire should have its larger end fastened to a small piece of brass bent to a right angle. The other end of this brass angle piece is fixed to the edge of the groove, as shown in Fig. 10. A hole should be drilled through the centre of the wood block, and a piece of brass cut and fitted to act as a contact and stop. Another piece of thin springy-brass should now be cut to act as a contact on the resistance wire. This brass

contact should be about 2 in. in length and $\frac{1}{2}$ in. in width, tapering slightly towards the end.

Through the end of this fitting to the centre of the block a hole should be cut and a length of 2 B.A. rod soldered. The other end of the brass contact is bent sufficiently to give a firm contact on the resistance wire. A nut and knob and a brass pointer complete

the filament resistance. Figs. 9 and 10 make the construction quite clear.

Fig. 11 shows the method of mounting the low-frequency transformer. For this a wooden bracket is required, fitted on at the bottom of the panel. The transformer should be either of the wire core type shown, or have laminated stampings as a core. The transformer is an important part of the amplifier, and to try to save money by buying a cheap one will only result in money being thrown away. The panel should finally be mounted in a box.

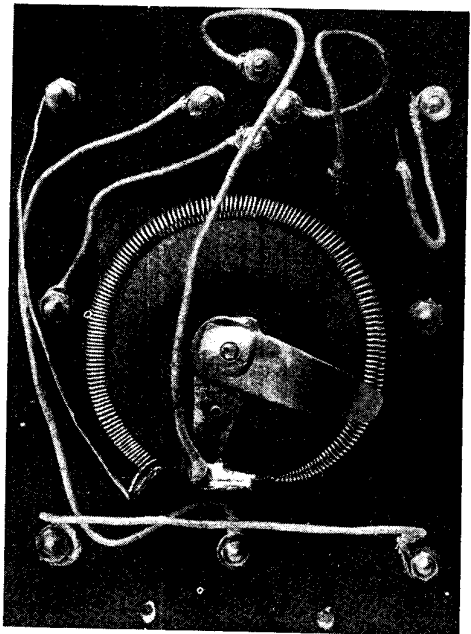

FILAMENT RESISTANCE WIRING

Fig. 10. On the left of the photograph the bare wire is connected to the bottom of the coiled resistance wire. The wire crossing the rheostat connects filament to switch

A rough box covered with Rexine or imitation leather paper will make a neat job, without going to the trouble of staining, varnishing, and polishing.

Figs. 11 and 12 show the wiring of the amplifier and the complete set respectively, ready for reception. A 4-volt or 6-volt accumulator is shown, and a high-tension battery. The latter may be made from a dozen pocket lamp batteries. The brass strip terminals or contacts should be joined together, the long of one to the short of the next, and so on. There will be left one long brass contact, the negative terminal, and one short contact, the positive terminal. One of the wires joining up to the high-tension battery should be tried out at various points to obtain the position of the loudest signals. This, of course, in conjunction with the filament resistance. Before this trial the crystal set should be disconnected from the amplifier and adjusted in the usual way with the telephones to give the best results.

Before putting in the valve and switching on the batteries, connect up a pocket lamp bulb with the two filament pins of the valve holder, and then turn on the filament resistance. The bulb should then glow. If it fuses the connexions have been wrongly made, and they should be carefully gone over again. This precaution will avoid burning out the filament of the valve—an expensive accident.

Amplifiers for Valve Sets. The foregoing is a simple form for use with any crystal set, but the amateur will find it advantageous to have an amplifier that is readily adaptable to many other units of the receiving set. Such a type is illustrated in the folding plate facing page 76, and is so devised that it can readily be

incorporated with other units of similar size, so that almost any combination can be wired together to form a multi-valve set, either with or without crystal reception. On the unit system each element is arranged with terminals in certain regular

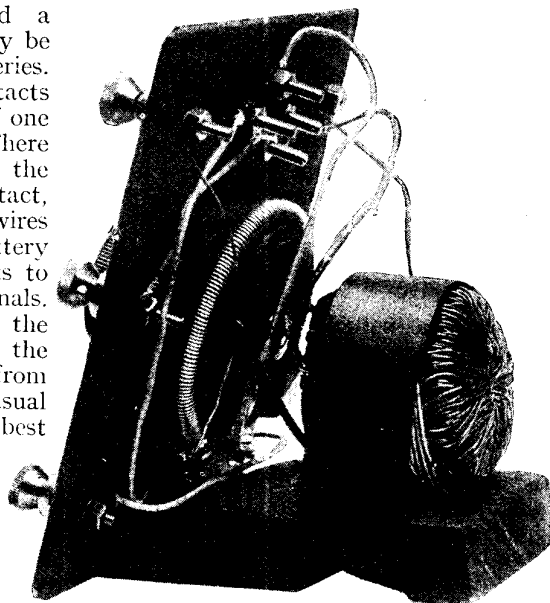

BACK OF AMPLIFIER PANEL COMPLETE

Fig. 11. A low-frequency transformer of the wire-core type is mounted on a wooden bracket fitted at the bottom of the panel

places, according to the design of the set, so that it is only necessary to connect like terminals on any of the sets to be sure that the wiring is all correct. The design and detailed arrangements of such sets can be modified to suit individual requirements.

For example, the cases could be omitted and the elements assembled on the ebonite panel joined into a separate framework,

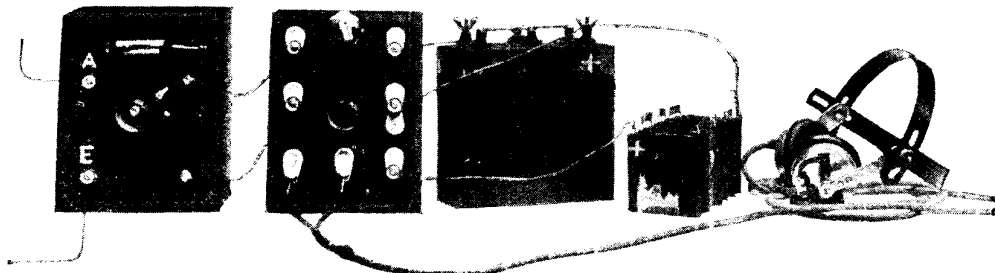

WIRING UP THE ONE-VALVE AMPLIFIER FOR A CRYSTAL SET

Fig. 12. The complete unit has been laid out and wired to show the sequence in which the connexions are made. The telephone wires now join the amplifier panel, but were previously connected up with the complete crystal set on left

and the whole enclosed in a cabinet of suitable proportions. As a rule, however, the experimenter will find it more convenient to utilise the units as separate components, and to mount them each in a separate case. In the pattern illustrated the case is made of mahogany, and each unit is similarly constructed. It follows that if two or three stages of low-frequency amplification are needed it is only necessary to build that number of sets and connect them together.

The amateur can purchase such sets ready to assemble, or the different pieces can be obtained as required and the bulk of the work done in the home workshop. There is nothing difficult about any of the operations involved in making this low-frequency amplifier. The tools needed are few and inexpensive, and likely to be found in every home.

The Unit Low-Frequency Amplifier

The finished article is shown in Fig. 13 (on the plate), and comprises a rectangular case made of mahogany, on the top of which is screwed an ebonite panel. This supports the necessary terminals and the valve legs, as well as the filament resistance. The latter is fixed to the underside of the panel, and only the control knob protrudes through the top. Within the case are an intervalve transformer and a fixed condenser. The panel is shown drilled and marked ready for assembly. The components can be purchased as shown or built up separately.

The first step in making the set is to mark out accurately the ebonite panel, as if this be done in a careless or slovenly manner the result will be unsatisfactory. To get good results commence by truing up one edge of the ebonite by filing it carefully with a second cut file, and finishing with sandpaper. With this as a guide, square off two sides, marking the lines with a sharp knife or incising them with the point of a scriber. Saw the panel to these lines and true them up as before, and similarly mark and finish the remaining edge. Then mark out the positions of all the holes by squaring off, and working only from two edges. The lay-out of the panel is given in full size on the plate, so that it can be traced off to make a template. If this is done the tracing should be made on tracing cloth, not paper, as the latter stretches when mounted.

Carefully centre punch the holes and drill them with a sharp drill in a small hand-drilling machine. To hold the panel while doing this, lay it flat on the bench and temporarily nail two pieces of wood against two opposite sides as shown in Fig. 16. This leaves the hands free to manipulate the drill.

Do not press too heavily on the drill, and when it is nearly through the panel hold the drill back and allow it to feed itself through the last few turns, as this tends to prevent it tearing and leaving a jagged edge. Take care to hold the drill upright all the time drilling is in progress, or the hole will be out of truth.

Clean off the slight burr at the edge of the hole with the point of a larger drill held in the hand, or use an ordinary carpenter's centre bit and give it a turn or so to countersink the hole very slightly. This will ensure the terminals or screws bedding firmly on to the panel. The indicating marks can now be engraved on the face and also on the underside. This is done with the point of a graver or simply incised with the point of a sharp pocket-knife. They can be marked by stamping them with ordinary branding stamps, but take care to work cautiously or the panel will be cracked or broken. The incisions are filled with flat white paint, and the surface afterwards cleaned off with a rag moistened with turpentine.

The next step is to fix all the terminals in place by putting them through the appropriate holes and securing them with a nut on the underside. The terminals should be so placed that all the holes are pointing outwards—that is, towards the sides of the case, and the nuts screwed up tightly to keep the terminal from twisting.

Connecting up the Panel

The filament rheostat is shown in Fig. 19, and is readily purchasable at low cost. The method of making it is described under the heading Rheostat (*g.v.*).

The valve legs are fixed in the same way as the terminals. The rheostat is fixed by means of two screws which pass through the boss or centre part of the rheostat and into tapped holes in the panel. It merely requires screwing into place, as shown in Fig. 20. The next step is a very important part of the work, viz., the wiring of the panel, and the way in which this is done will affect the result considerably.

The work has been simplified, for there are no soldered joints to make in the present design. All connexions are made with nuts. The wiring is shown in the circuit diagram, Fig. 23, and a view of the underside of the panel is given on the plate, showing the whereabouts of each wire (Fig. 15).

Tinned copper wire about No. 16 gauge is convenient, as it is clean and bright and ensures good connexions. It is covered with Systoflex or thin rubber tubing slipped on to the lengths of wire after they have been cut to length. To ensure neat joints the ends of the wire should be turned into an eye by means of round-nosed pliers, and the eye made so that it will just slip on to the terminals.

Place the eye on the terminal so that as the nut is tightened it tends to draw the wire into the joint, and not press it out of position. When a wire goes to two or more terminals, the eye should be turned in the run of the wire to avoid cutting it, as this ensures a better electrical connexion.

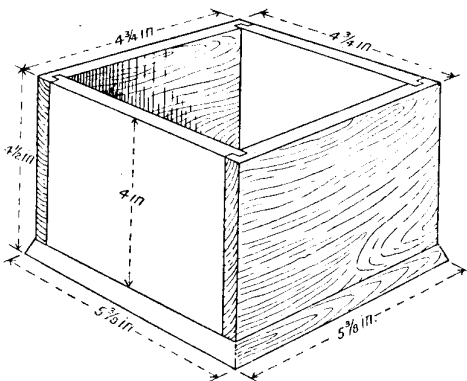

CASE FOR THE L.F. AMPLIFIER

Fig. 25.—Diagram showing the complete case, with dimensions as a guide to construction. The method of joining is made clear.

When all the wiring on the panel is complete, there will be four loose ends of wire remaining, and these have to be connected to the transformer. This will be placed in the bottom of the case, consequently the wires must be well insulated and sufficiently long to reach.

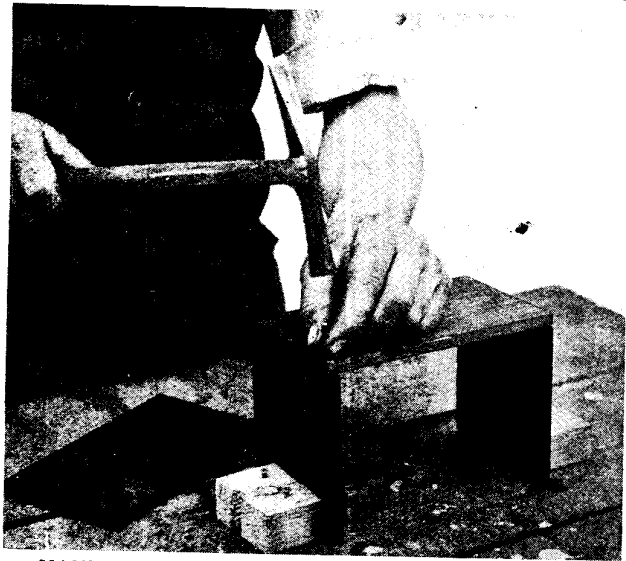

MAKING THE LOW-FREQUENCY AMPLIFIER CASE

Fig. 24. How the two ends of the case are kept up during nailing is seen here, which shows the simplest method of making the case. Note the wood blocks on either side of the work.

The transformer (Fig. 18) is best purchased ready for use. When doing so, get the best quality, as an indifferent transformer is a potent source of noises. On inspection, it will be seen that there are two sets of terminals, generally marked S O, S I, and P O, P I. These are the terminations of the secondary and primary windings respectively, and are the terminals to which the wires from the panel have to be attached. The condenser (Fig. 17) is screwed to the bottom or side of the case, on that side of the transformer marked P I, P O. The wires attached to the condenser terminals are connected to those on the transformer which are marked P I, P O, respectively.

The case is made to the dimensions given (Fig. 25) by housing the sides into the end pieces or by making the joints with dovetails. Alternatively obtain thin wood about $\frac{3}{8}$ in. thick. Cut a strip, and plane up the edges. Then square off the end with a set square, and mark off for the two side pieces and the two end pieces. Saw them off, and clean up the ends. Place the two ends upright on the bench, supporting them with blocks of wood.

Place one of the side pieces on the ends, and secure with four nails or panel pins, as shown in Fig. 24. By resting the left hand as shown, the top piece is held down and the nailing can easily be accomplished.

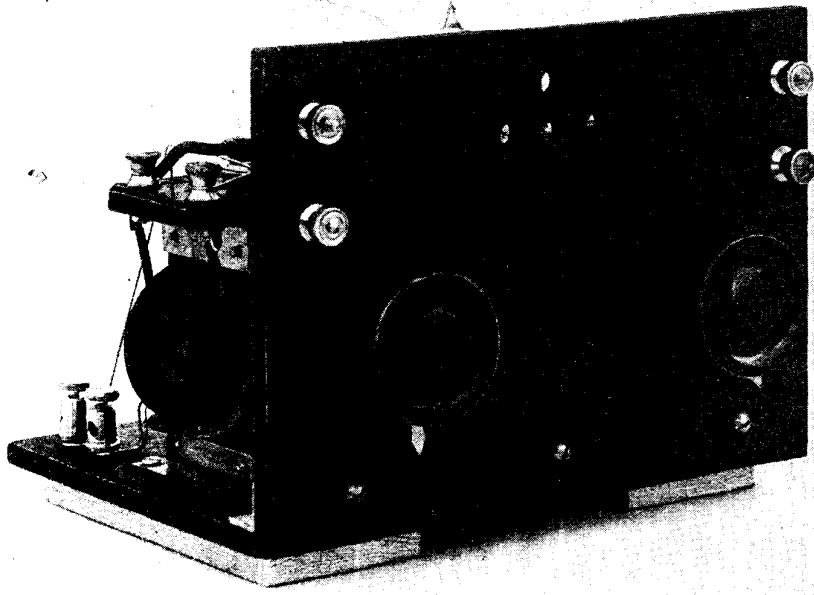

OPEN FRAME PANEL FOR THE TWO-VALVE AMPLIFIER

Fig. 26.—Although not mounted in an enclosed case, the amplifier is designed to present an appearance marked for neatness and simplicity. With clean workmanship this is accomplished as the photograph shows

The whole is then inverted, and the other side nailed on in the same way. The base is simply a plain piece of wood of the requisite size secured with fine screws or nails. If made in this way, the result will be a neat and strong case that only needs staining and polishing in any desired colours and style to present a good appearance (Fig. 13).

The transformer is simply screwed to the bottom and the condenser fixed, and both wired as described, the panel placed on the top of the case, and secured with four fine brass screws. A valve has to be inserted into the valve holder. The filament switch handle should be turned to the left, to the off position, and the crystal, or other receiving set, connected to the terminals marked I N, the high and low-tension batteries to the terminals marked H.T. and L.T., respectively. This arrangement is shown on the plate in Fig. 15. The telephone terminals on the receiving set are always connected to the I N terminals on this class of L.F. amplifier.

When used with other units in a set, the terminals will all be needed, but when wired to some other set, as in Fig 15, the duplicated terminals are disregarded. The

layout of the wiring is shown in Fig. 21. Each part shown in the diagrams and in the photographic reproductions has been so set out that the wiring can readily be traced and the corresponding parts wired accordingly.

Two-Valve Low-Frequency Amplifier.

The construction of a two-valve, low-frequency amplifier for use with any receiving set need present no great difficulties, especially if the open frame style of construction be adopted. This allows the wiring to be carried out without difficulty, and obviates the need for a case, as all the parts are erected on the baseboard and panel.

The general appearance is shown in Fig. 26, and the neatness of the panel is very apparent. All the external fittings are two filament rheostat control knobs and two sets of terminals, those on the right for the connexions from the detector, and the others for the telephone or loud speaker connexions.

For the construction of this instrument two ebonite panels are needed, each measuring 7 in. long and 5 in. wide. They should be a full $\frac{7}{16}$ in., or preferably $\frac{1}{4}$ in. thick. They have to be squared up

as already described, and then marked out as shown in the diagrams (Figs. 27 and 30). All the holes should be drilled and tapped as marked on the diagrams, and then the filament resistances screwed to the back of the front panel.

This is joined to the base by means of a strip of angle brass, which is screwed to each of the panels by means of three round-headed brass screws (Fig. 27). These pass through the ebonite and are tapped into the brass, as is clearly visible in Fig. 29.

Two valve holders are now required, and the type with a flange at the bottom is suitable for this design, as it can be screwed into position without difficulty. In this type of holder the valve sockets terminate in plain pegs, and these have to be cut off short so that the holder can rest flat on the baseboard. The underside of the holder is hollow, and this allows room for the soldered connexions to be made to each of the pins and the cavity subsequently filled with paraffin wax.

The wire may be tinned copper about 18 gauge and some 12 in. or so in length, as this allows sufficient to permit attachment to the proper terminals. The wire is attached to the pins by turning an eye on the end of the wire and pressing it on to the end of the pin. Grooves are formed in the base of the holder, and on one of them the wires should be arranged as in Fig. 31. But on the other, the lower wire should turn out on the right-hand side, as this saves

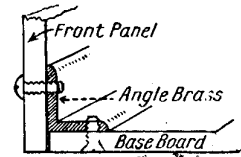
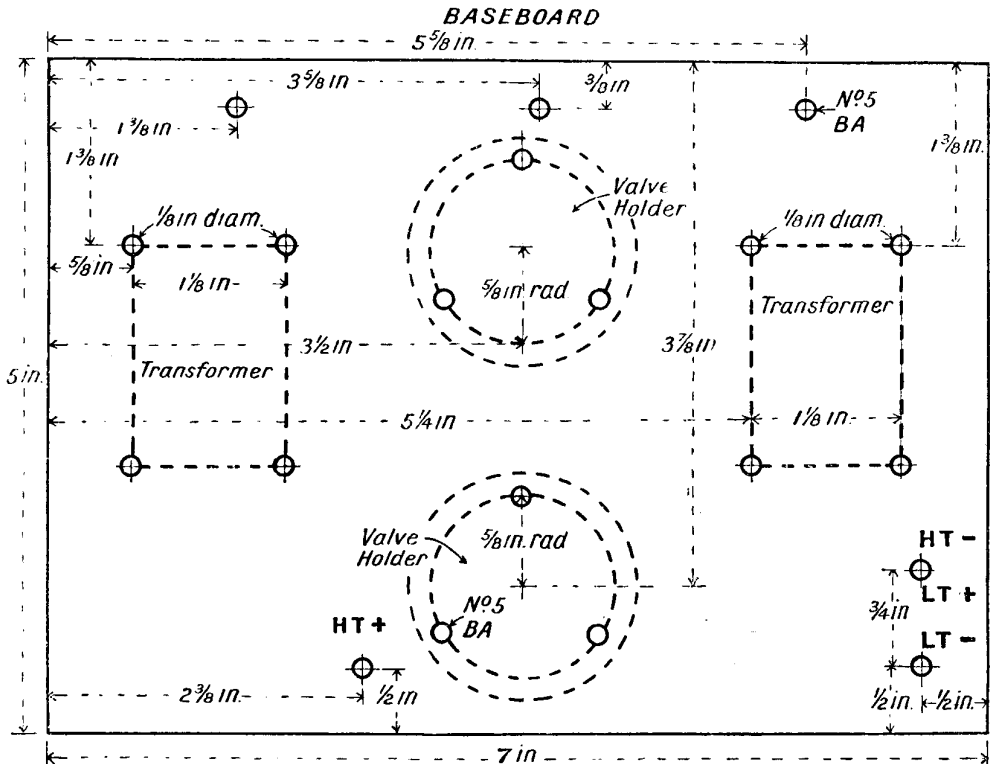

Fig. 27.—How the angle joint is made

another turn in the wire when the wiring up is in progress.

To solder the wires to the pins, take a well-tinned soldering iron and heat it thoroughly, dip the end into the soldering acid, touch the ends of the pins with it, run a little solder on to the point of the iron and touch it on to the end of the



DETAILED PLAN OF THE TWO-VALVE AMPLIFIER BASEBOARD

Fig. 28.—Before commencing the work of construction the baseboard should be carefully marked out from the dimensions shown above. Care should be taken to see that the dimensions of the components to be employed agree with the plan before marking out

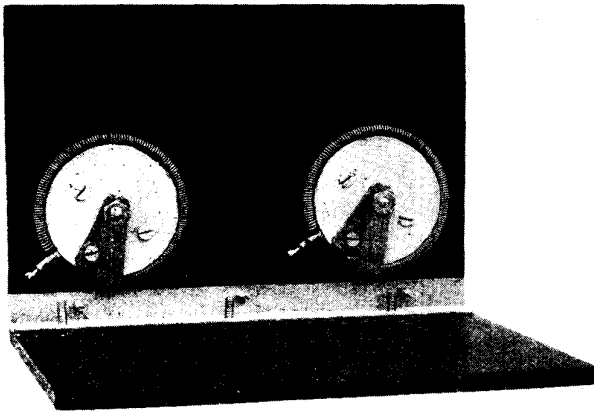

TWO-VALVE AMPLIFIER, OPEN FRAME BASE AND PANEL

Fig. 29. A strip of angle brass, tapped for round-headed brass screws, is employed to hold the panel at right angles to the baseboard. The rheostat switches must not be allowed to make contact with the angle brass

the pins are also clean. By doing this, there is a minimum of acid transferred to the joint.

Thoroughly clean the ends of the wires and remove all traces of the soldering acid that will show in the form of a slight film on the base, and give the wire a coat of shellac varnish on all parts within the base. Two transformers are needed, and these should be of the best quality. A reliable type is illustrated in Fig. 32, but any other suitable size or make can be incorporated. What is wanted is an audio-frequency, or low-frequency, intervalve transformer, with a ratio of 4 or 5 to 1.

Unless a thoroughly good article be obtained, manufactured from sound material and correctly designed and proportioned, with perfect insulation of the windings,

pins, when the solder will flow neatly around the joint if all the wire is clean and

and correctly designed and proportioned, with perfect insulation of the windings,

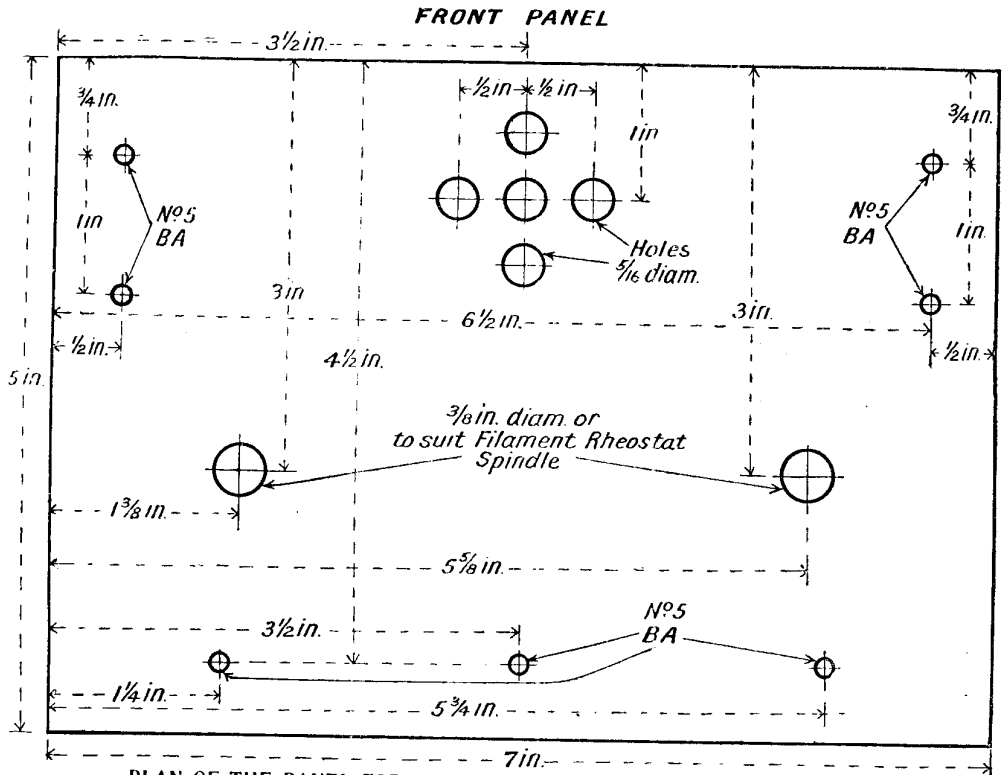

PLAN OF THE PANEL FOR THE OPEN FRAME TWO-VALVE AMPLIFIER

Fig. 30. Lay-out of the panel is important. Not only the appearance of the finished unit is affected, but inaccuracy may cause loss of efficiency. The holes should not be bored until the whole lay-out of the panel has been measured and marked, when any mistake is easily rectified

there will be a certain amount of noise when the instrument is working, and it will be difficult, if not impossible, to get rid of it. If another size transformer be used, the holding down screw holes in the baseboard will have to be drilled to suit.

The transformers are secured to their base with four wood screws, which pass clear through the holes in the ebonite and bite into wooden battens placed beneath the baseboard. These battens can be 2 in. wide, $\frac{1}{2}$ in. thick, and $4\frac{1}{2}$ in. long. The next step is to screw the holders to the base with three round-headed brass screws, which bite into holes tapped into the base.

The wires from the filament terminals on the holders can now be attached to the

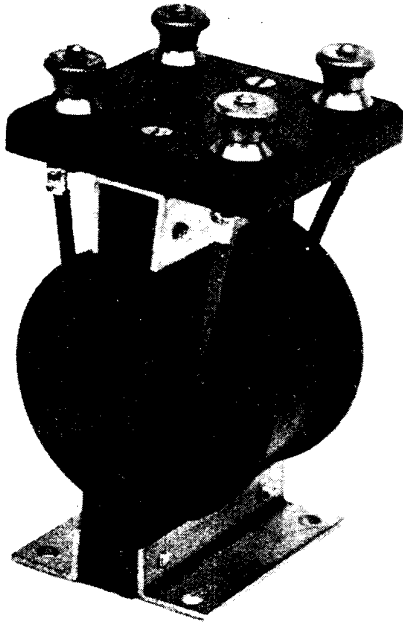

SUITABLE TRANSFORMER

Fig. 32. In choosing transformers the audio-frequency type illustrated may be used. For the amplifier described the best transformers procurable should be obtained, with a ratio of not more than 4 or 5 to 1

terminals on the filament resistance. The wires can be left plain and bare, but if this is done, extra care must be taken to keep them clear of any others. The safest plan is to cover all the wires with Systoflex or rubber tubes, slipped on when the wire has been cut to length. The whereabouts of the wires are shown in the wiring diagram (Fig. 33), and

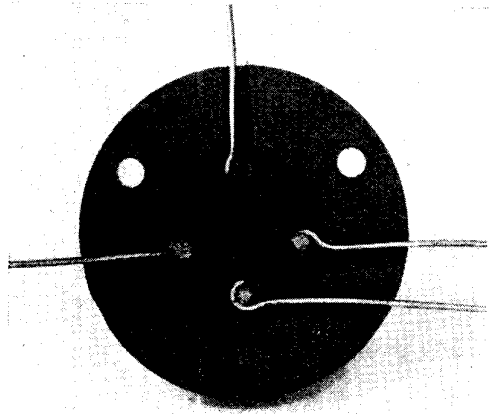

WIRING THE VALVE HOLDER

Fig. 31. After the pegs of the holder have been cut level to allow the flange to rest flat on the baseboard the wires are soldered on, and any surplus solder is filed level with the bottom of the flange

also from a study of the illustrations, Figs. 34 to 37. All the wires can be soldered to their terminals, or secured with lock nuts. It is sometimes considered that soldered connexions are essential. But if the nuts are tightened up well, and the wire is neatly bent into the form of an eye, there is nothing against the method, and it avoids the messy process of soldering.

The transformers can then be fixed in place, one at a time, and wired as far as possible. The work at this stage is shown in Fig. 34, showing one of the transformers wired up, the two holders wired, and the four wires for the remaining transformer in position ready to connect. This having been done, the valves can be placed in position, as shown in Fig. 35, which gives the appearance of the amplifier from the rear. The plan of the apparatus is shown in Fig. 36, which also

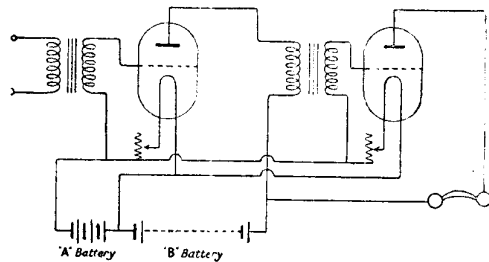

THEORETICAL CIRCUIT DIAGRAM

Fig. 33. The arrangement of the circuit may be followed from this diagram, which should be consulted when constructing the amplifier

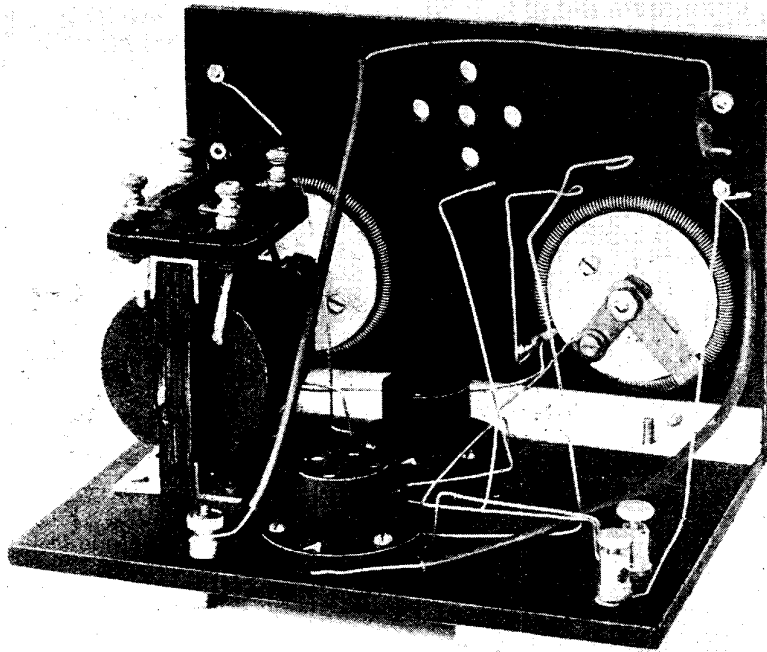

HOW THE TWO-VALVE AMPLIFIER IS WIRED

Fig. 34. For the purpose of showing how the rheostat and other parts are wired, the valves and one of the transformers have been removed, the four wires for which are seen disconnected. All the other wiring is shown complete

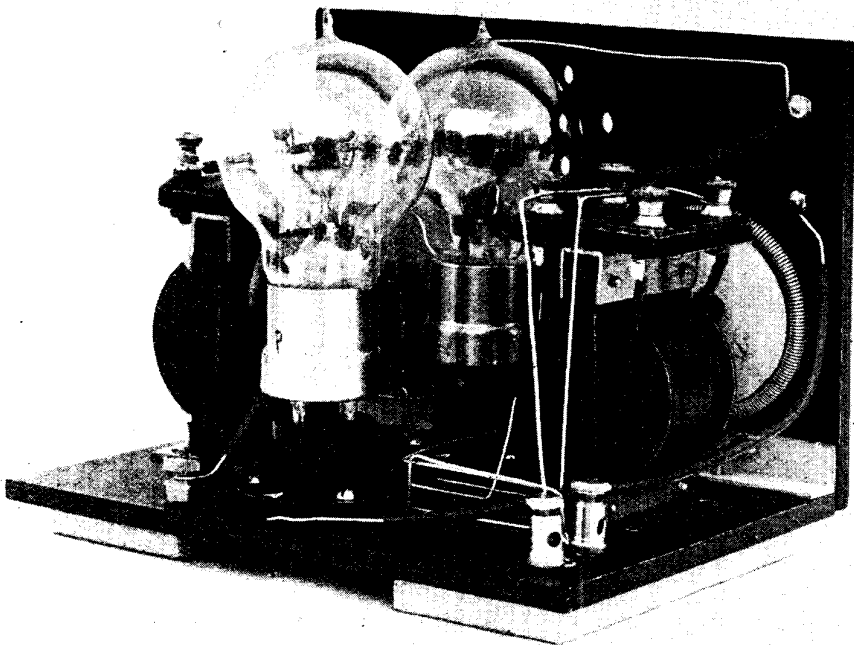

THE COMPLETE AMPLIFIER, SEEN FROM THE REAR OF THE PANEL

Fig. 35. The terminal connexions may be seen in this complete set. The two terminals at the right-hand bottom corner are for connecting low-tension negative (nearest) and low-tension positive and high-tension negative (rear). The terminal on the left connects high-tension positive

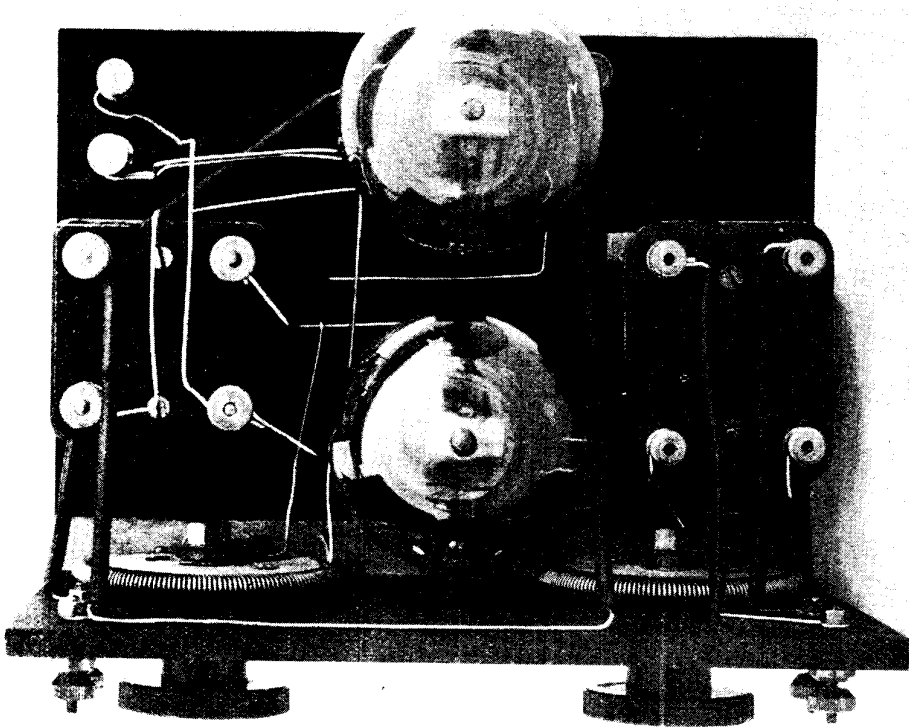

THE COMPLETE TWO-VALVE AMPLIFIER SEEN FROM ABOVE

Fig. 36. Plan view of the finished instrument, showing advantages of the open frame construction. From this the simplicity and lack of intricate detail is very apparent

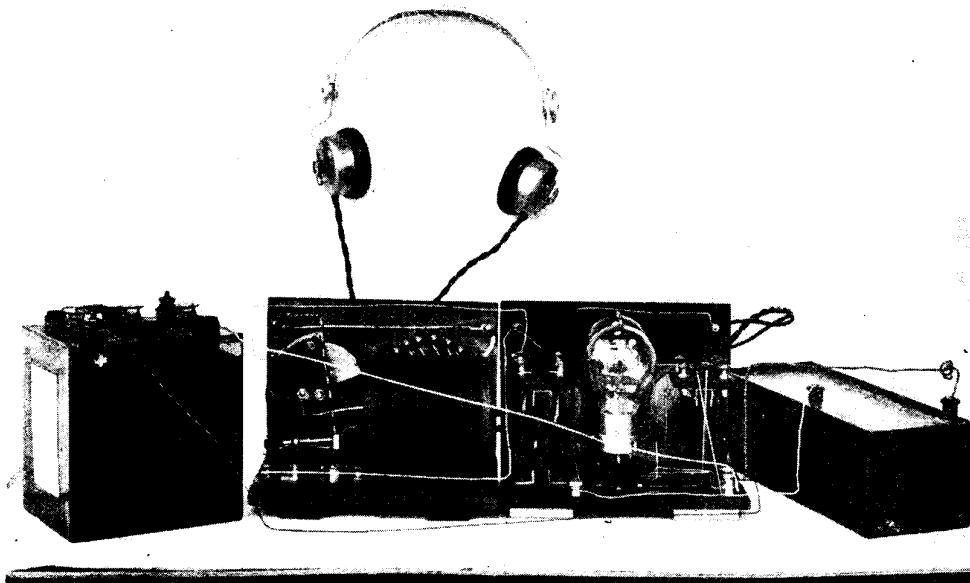

AMPLIFIER AND CRYSTAL DETECTOR OPEN FRAME UNITS CONNECTED UP

Fig. 37. The amplifier is shown wired up to the crystal receiving and tuning set and to the batteries. The method of connecting up the units is easily followed when this photograph is compared with those that precede it. The crystal detector is mounted on the baseboard of the tuner, making a compact outfit

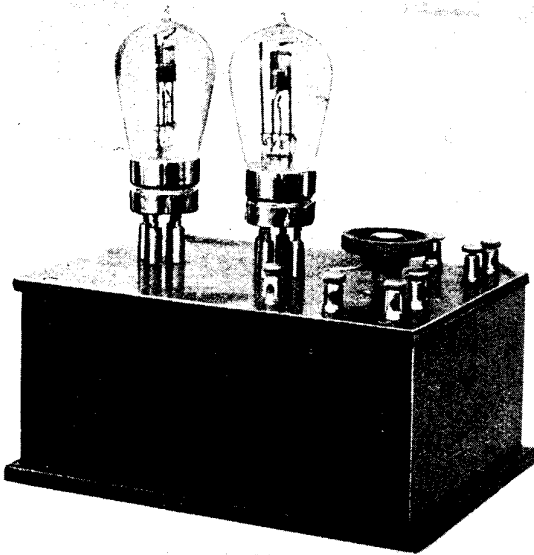

TWO-VALVE DULL EMITTER AMPLIFIER

Fig. 38. A simply designed two-valve amplifier using dull emitter valves is shown. These valves take a very small amount of current and permit the use of dry batteries, or, at least, of small accumulators, in place of large accumulators

shows very clearly the relative positions of the several parts.

This amplifier can be connected to any receiver. And one such arrangement is shown in Fig. 37, where the amplifier has been wired to a crystal set, formed by attaching a crystal detector to a tuning set with a tapped inductance and a small variable condenser. The low tension or A battery (*q.v.*) is seen at the left, the high tension or B battery at the right as well as the headphones.

The set, wired up as shown, at a distance of 30 miles from 2 L.O. London brings in the signals with splendid strength, rendering speech and music with clarity and a very pure tone.

Two-Valve Amplifier with Dull Emitter Valves. The problem of amplification with minimum current consumption is one which appeals to those without facilities for charging accumulators. To such, the claims of the dull emitter valves have much to recommend them, especially on the score of low current consumption. This should not in any case exceed 2 volts, and in many cases does not exceed one or 1.8 volts, consequently it is practicable to utilise good size dry batteries in place of accumulators. Such batteries can readily be obtained

and sent home by post or rail, and kept in stock some six months or more until wanted.

Another advantage is that the batteries can be left standing for a good length of time without deterioration. There is no acid to spill and no fumes to corrode adjacent metal work. Good quality dry batteries, however, should be used and the best possible connexions made between the various parts of the apparatus, as, obviously, the smaller the current available, the more important it is that all connexions and parts be of the maximum efficiency.

A two-valve amplifier designed along these lines is illustrated in Figs. 38 to 45. The back of the panel wiring is shown in Fig. 39, and indicates that the minimum of wire, both numerically and from the point of view of length, has been used in the lay-out. Only one rheostat is employed to control the filaments of both the

valves. High grade inter-valve transformers are used and all connexions made by lock-nut joints. This obviates the need for any soldering, and, if the wire be properly turned around between the nuts, ensures a perfectly satisfactory joint for small amplifiers of the type illustrated.

The valves are mounted on valve legs attached to the ebonite panel, and the positions of the various holes are given in Fig. 40. The panel, which should be $\frac{1}{4}$ -in. thick, is marked out accordingly, taking care first to square up the edges of the

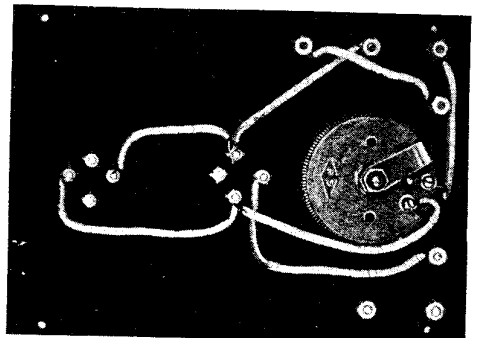

PANEL WIRING FOR THE DULL EMITTER AMPLIFIER

Fig. 39. How the two valves are wired to one rheostat is shown in this back view of the panel

panel and laying off the positions by working with a set-square from two adjacent edges, or alternatively working from the centre lines outwards. The holes may be drilled with an ordinary twist drill, if care be taken in its manipulation. It should run at a fairly high speed and should be backed out frequently to prevent the ebonite clogging. Clean off any burrs which may show on either side with a rose-headed countersink, especially where the drill emerges. Obtain a filament rheostat complete and attach it to the lower part of the panel, screw the valve legs in place, and test them for accuracy with an old valve, the pins of which are known to be correct. Screw the terminals into the various holes marked in the diagram. The theoretical wiring diagram is shown in Fig. 41, and the practical arrangement of the parts in Fig. 42.

One wire is attached from the L.T. plus terminal to the two filament terminals marked Fil. plus (Fig. 40). Another wire connects the resistance wire on the rheostat to the two filament terminals marked Fil. minus. The H.T. plus terminal is con-

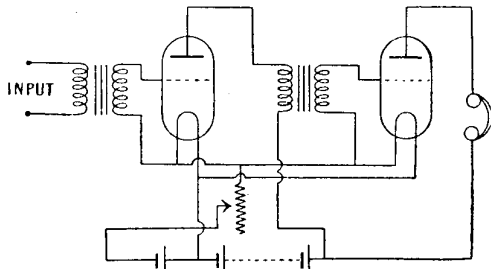

DULL EMITTER AMPLIFIER CIRCUIT

Fig. 41. A theoretical wiring diagram for the circuit incorporating two dull emitter valves as an amplifying unit

nected to one of the telephone terminals, the plate or anode terminal of the second valve to the other telephone terminal. The grid of the first valve connects to one of the secondary terminals on the first transformer, the other secondary terminal to the Fil. minus terminal.

The two primary terminals on the first transformer are connected to the two

input terminals, and the terminals on the primary side of the second transformer to the plate of the first valve and the H.T. plus terminal respectively. The secondary of the second transformer is connected to the grid of the second valve and to the Fil. minus terminal respectively.

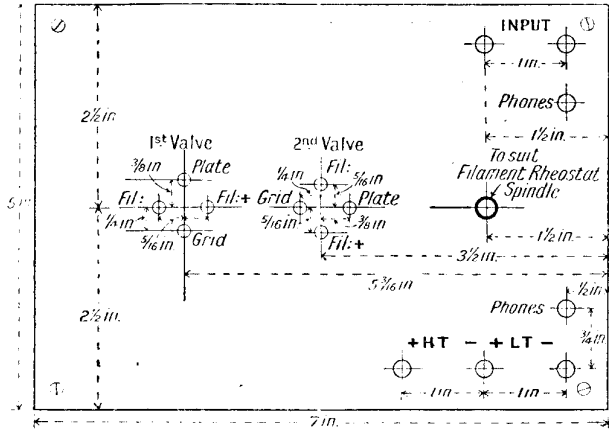

LAY-OUT OF THE PANEL

Fig. 40. Dimensions are given for the construction of the panel of an amplifier employing dull emitter valves

The L.T. minus terminal is connected to the moving arm contact on the rheostat.

Having completed the wiring to the underside of the panel, fix the transformers to the inside of the case with small, round-headed screws, as shown in Fig. 43, and complete the wiring by attaching the ends of the wires from the panel to the correct terminals of the transformers. The easiest way for the amateur to do this is to leave a sufficient length of wire to enable the panel to be lifted up clear of the bottom of the case, as in Fig. 42, to permit getting the fingers in between the panel and the case to attach the wires to the terminals and tighten them up.

Now test the whole circuit by means of a test lamp, consisting of a pocket flash-lamp bulb and a little holder, plugging it into the filament terminals of each valve holder in turn trying the low-tension current through it.

The filament terminals of both valves must be tested in this way, and if desired two test lamps may be employed simultaneously. For this purpose the lamps must be only 2-volt bulbs, or if the ordinary 4-volt flash-lamp bulbs are used they should be lighted by a flash-lamp battery connected to the L.T. terminals of the amplifier. If any doubt remains

as to the correctness of the grid and plate circuits and H.T. circuit, test the set with a pair of ordinary valves.

One objection to the dull emitter valve is its considerable expense, and if an unfortunate error be made in the wiring, and the filament is burnt out, the cost of replacing the valves is very heavy. The set wired up as shown in Fig. 43 proved

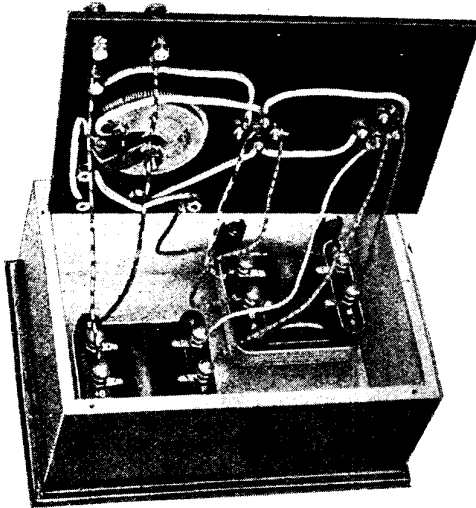

DULL EMITTER AMPLIFIER COMPLETE

Fig. 42. Sufficient length of wire is allowed to enable the panel to be raised without disconnecting the wires. They are coloured to make them clear in the photograph

entirely satisfactory in use with a crystal set, used at a distance of over 30 miles from the nearest broadcasting station. No parasitic noises are apparent, and the increase in volume of sound is amply sufficient for all purposes. The adjustment of anode and filament voltage to avoid howling is rather critical.

The operation of the valves follows along the same lines as the ordinary type of filament valve. The great point to remember is that under no circumstances whatever must the voltage be increased above 2, or preferably not over 1.8. The makers of the valve generally attach a slip, either to the valve or to the carton in which it is packed, stating the best voltage for the filament circuit and for the anode circuit, and these instructions should be noted and followed.

The exact size of the case will have to be modified according to the size of the transformers that are used. Several patterns that are low in height are on the

market, and are suitable for the apparatus. The Connecticut pattern, shown in the illustrations, is particularly suitable, as when set horizontally it occupies very little space. They are entirely shrouded in iron shields to prevent noises due to stray currents and other effects due to interaction between the components.

The dimensions for the case are given in Fig. 45, and the choice of construction is really limited to three essential ways. The parts can simply be cut to length and glued, screwed, or nailed together, or the edges and corners may be dovetailed together, or the ends of the end pieces can have a tongue worked on them, and grooves cut across the inside faces near the end of the side pieces. Whichever method is adopted, it is desirable that the case should be rectangular, with neatly formed joints. The edges should be perfectly in line to present a flat, level surface whereon to bed the base board and ebonite panel respectively. This will naturally result if the corners are made perfectly square.

Should the case be slightly out of truth, that is, if it rocks about when set on a flat surface, the high parts should be carefully planed down until the frame stands flat and true. The bottom may be glued and screwed to the sides, the exterior stained and polished, or finished in any desired manner. The ebonite panel is

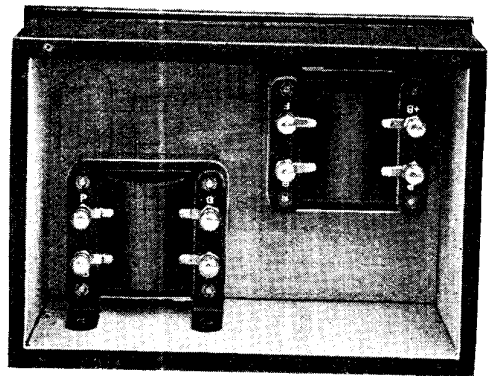

MOUNTING INTER-VALVE TRANSFORMERS

Fig. 43. The two transformers are attached to the case in the position shown. They are then wired up, the wires being left long enough for handling with the panel raised

simply screwed to the top. Before screwing it down, see that the wires are neatly arranged to all the terminal nuts, the connections are all tight, and that no un-insulated parts can come in contact and cause a short circuit.

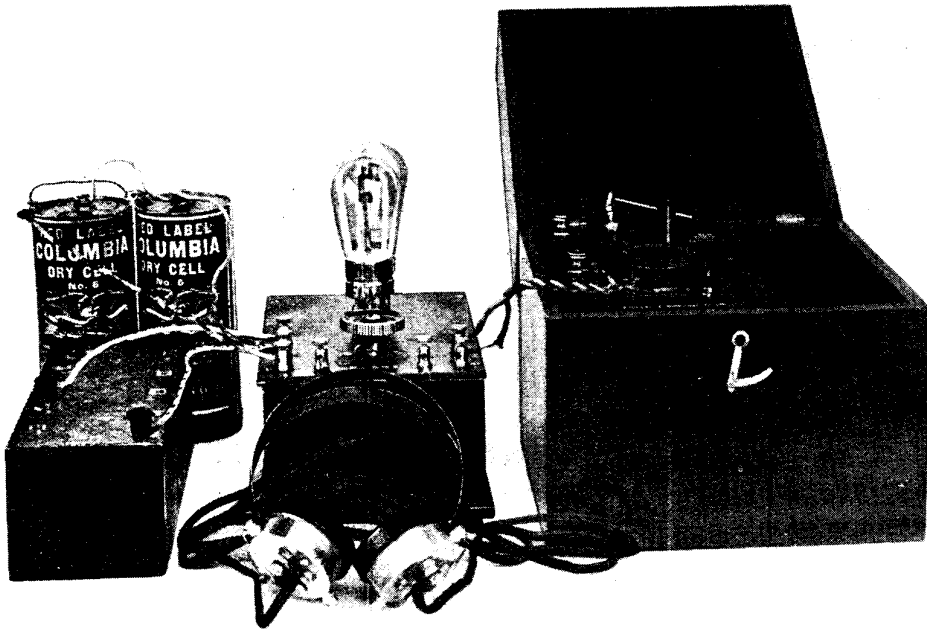

TWO-VALVE DULL EMITTER AMPLIFIER READY FOR USE WITH CRYSTAL DETECTOR

Fig. 44. This set, which includes a crystal detector and the amplifier described, gave satisfactory results over 30 miles from a broadcasting station. Amplification for all purposes was effected, and with critical adjustment parasitic noises and howling entirely eliminated.

The operation of the set is simplicity itself. Connect the high-tension positive lead to the high-tension plus terminal, and the negative from the high-tension battery to the positive lead from the low-tension battery; then connect both wires to the terminal marked H.T. minus L.T. plus. The low-tension negative lead goes to the terminal marked L.T.--. The two terminals marked input are connected to the detector and tuner, and simply take the place of the telephone terminals. The two terminals marked telephones are for the attachment of the telephones or loud speaker, as the case may be. Thus this set can be applied to any receiving set by simply attaching it to the terminals where the telephones are normally attached, and connecting the telephones to the telephone terminals on the amplifying unit.

High-Frequency Amplifiers. The construction of a high-frequency amplifier for any individual circuit necessitates a knowledge of the wiring and theory, so that it is impracticable to apply any particular H.F. amplifier indiscriminately to any circuit. The use of a well-designed set of

units overcomes the difficulty, and ensures the values of all the components being correctly proportioned.

One such set is illustrated, Fig. 46, as a part of a complete selection of units supplied by the Peto-Scott Co. The complete components for the H.F. transformer

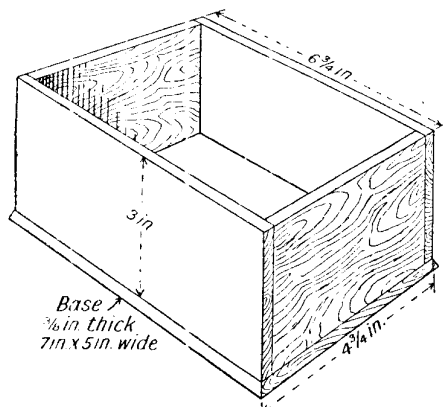

SIMPLE CASE FOR THE AMPLIFIER

Fig. 45. The case for the dull emitter valve amplifier described is simply made according to the dimensions given in this diagram.

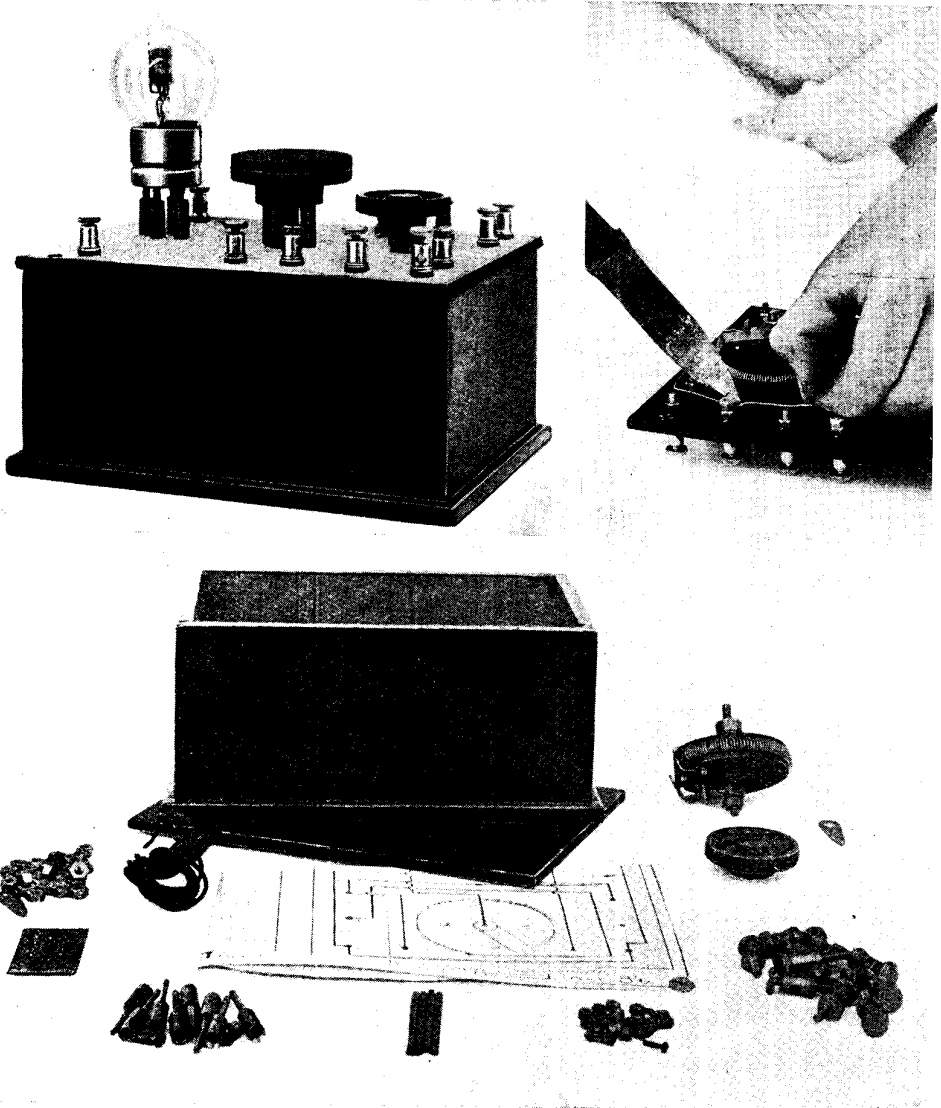

CONSTRUCTING A HIGH-FREQUENCY AMPLIFIER FROM PURCHASED COMPONENTS

Fig. 46. The complete H.F. amplifier shown (above, left) was constructed from component parts supplied by the Peto-Scott Co. Fig. 47. All that an amateur needs for the home construction of this amplifier is seen laid out (below). The plug-in transformer and valve are, of course, omitted. Fig. 48 (above, right). Soldering two wires which meet at the same terminal

are supplied in the form illustrated in Fig. 47, which shows the parts together with the case. With sets of parts of this character the amateur without any practical constructive experience can safely undertake the making-up of his own apparatus.

The first step is to fix all the terminals and the filament rheostat to the underside of the panel, securing the latter with

screws. The wires have then to be placed and connected to the terminals. None of the wires need be soldered if soldering is a difficulty, but it makes a neater job to solder them when two wires have otherwise to terminate at the same point. Moreover, greatly superior results are obtained when all connexions are properly soldered.

This is a simple soldering job, and the method is shown in Fig. 48, the great

point being to avoid making a mess; therefore keep the point of the iron on the wire, as illustrated.

The disposition of the wires beneath the panel is shown in Fig. 49, prior to slipping the insulating sleeving on to them. By fixing the wires in this way the exact lengths are found, and the result is neater than cutting random lengths and then attaching them to the terminals. Reference should also be made to the circuit diagram (Fig. 50).

When carrying out the wiring be careful to run the wires to the proper terminals, especially to those on the valve legs. The case is shown ready finished in Fig. 51, and the panel has to be screwed to the top of it with four small brass wood screws, one at

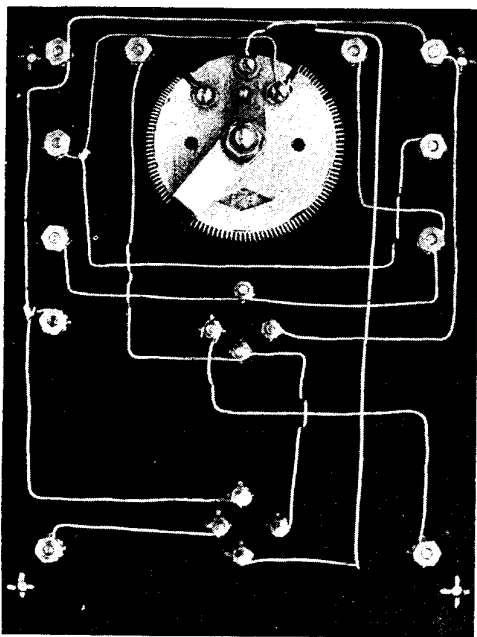

H.F. AMPLIFIER PANEL WIRING

Fig. 49. The wires are shown bare. Sleeving should not be added until the lengths of wire have been measured, temporarily connected, and joints noted

each corner of the case. The completed instrument only requires a high-frequency transformer of suitable wavelength range to be plugged into the centre set of valve legs, and an amplifying valve into the others. The instrument is then connected up with other units of the same make to amplify the incoming signals, which are subsequently rectified, and, if

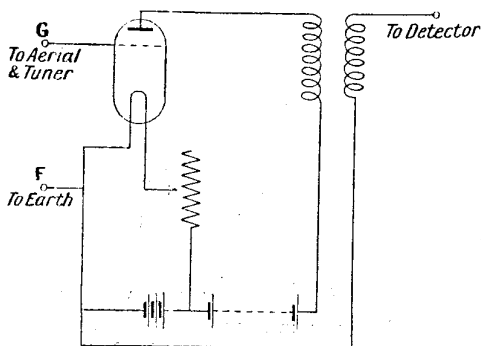

H.F. AMPLIFIER CIRCUIT

Fig. 50. The theoretical circuit diagram of the high-frequency amplifier unit described

desired, further increased in volume by means of an audio-frequency amplifier.

AMPLIFYING TELEPHONE. A telephone receiver having mounted upon it a microphone. A diagrammatical representation of such an arrangement, Fig. 1, comprises a telephone receiver, T, connected to a detector. The microphone, or microphonic contact, is made directly upon the diaphragm of the telephone. The incoming signals being amplified by the microphone, are reproduced on the telephone with increased strength.

Constructional difficulties of such an instrument are largely due to those associated with the weight of the microphone, which will have to be very small, or the movements of the diaphragm will be largely damped. This type of amplifying telephone is chiefly used in telegraph work, when it can be tuned to the spark frequency.

Another method which the experimenter may adopt is to connect the

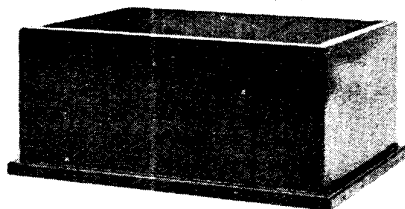

AMPLIFIER CASE FINISHED

Fig. 51. The finished appearance of the H.F. amplifier case can be made to correspond with that of the detector unit

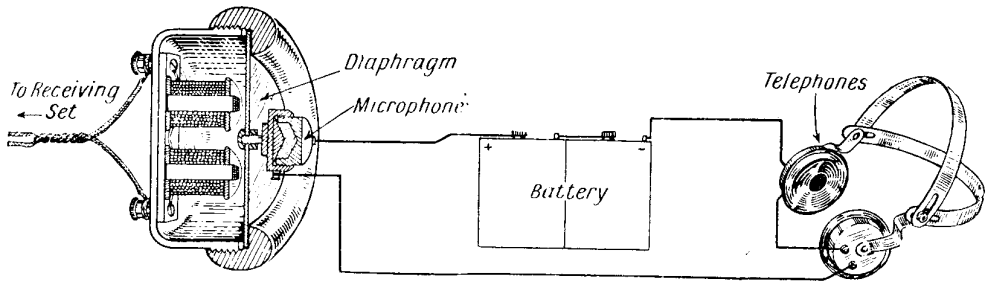

WIRING OF AN AMPLIFYING TELEPHONE

Fig. 1. Diagrammatic arrangement of application of microphone to telephone. The sectional view of the microphone shows how the connexion is made with the battery and the head telephones

telephone receiver by means of cardboard or other tube, fitted closely on to the cap of the telephone. The other end is connected to the mouthpiece of the microphone, which is put in circuit in the usual way with the low-tension battery and the two telephones, as shown in the circuit diagram, Fig. 2. The incoming signals in

without distortion when the valve operates in the manner described.

The characteristic curve of a valve is illustrated, and in this case the best operation is attained when the filament voltage is practically 4, and the voltage between the anode and the filament is about 75 volts. In this case all the curves have substantially the same characteristic. The curve shows the variation of the anode current with the grid voltage, both increasing together.

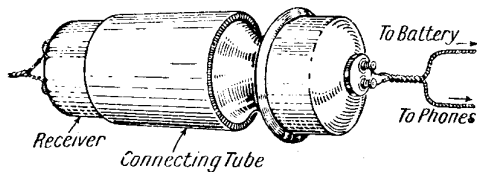

Fig. 2. An amplifying telephone made for connecting to an ordinary telephone receiver by means of a tube adaptor

this case are acoustically coupled, in that the speech reproduced by the telephone is transmitted in the form of acoustic waves to the microphone, which amplifies them and hands them on to the second telephone with greatly increased signal strength. With all such arrangements the experimenter should be prepared to face the necessary trouble in making trials and adjustments to secure the best results. The slightest variation will often make all the difference between success and failure. Microphonic amplifiers of this type generally need ample signal strength to operate them.

A practical point with any valve used for amplification purposes is that it shall function without setting up, or amplifying

AMPLIFYING VALVE. Any make of valve specially adapted for use on amplifying circuits. In considering the characteristic curve of valves, it will be found that in most of them there is a straight line part, and an amplifying valve is one that has been designed to operate at its highest efficiency on this straight part of the curve. When speech variations are applied to the grid circuit of the valve, they reappear in an amplified state in the anode circuit

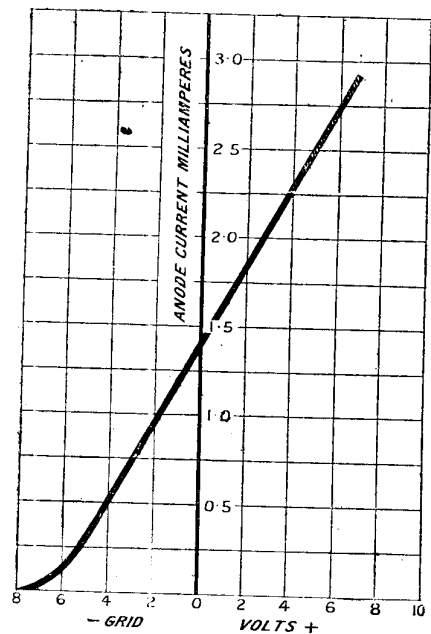
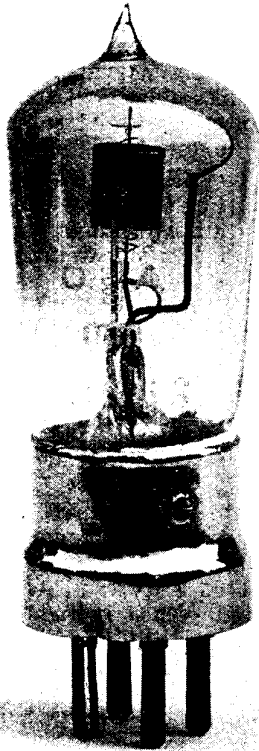

Fig. 1. A characteristic curve is shown of an amplifying valve which operates best when the filament voltage is 4, and the voltage between the anode and filament is 75



AN AMPLIFYING VALVE

Fig. 2. The efficiency of the valve used for amplifying signals depends upon its ability to perform its function without setting up or amplifying internal noises

any internal noises, such as those that may be occasioned by vibration of a constituent part of the valve. Another point is that it shall deal as equitably as possible with the incoming signals without regard to the actual variations of current flowing through the valve circuits. These and other matters are dealt with in the article on Valves (*q.v.*). See Characteristic Curves.

AMPLION LOUD SPEAKER. A well-known example of a loud speaker. It is made in various patterns and sizes, adapted to the varying needs of listeners-in. These loud speakers can be used with any multi-valve receiver when sufficient power is available. This is generally obtained by the use of a sufficient number of stages of low-frequency amplification. In use the instrument has only to be connected in place of the head 'phones.

The external appearance of one model is shown in Fig. 1, and the details of the

mechanism in Fig. 2. From this it will be seen that there is an external case which is attached to the front part of the base, with the diaphragm in a vertical plane. The sound waves are then directed straight into the tone arm, and travel thence through the tapering arm to the bell mouth. The instrument stands firmly on the table on the three legs formed on the lower part of the tone arm and receiver holder. This tends to eliminate noises due to vibration.

The diaphragm is large in diameter, and secured to the face of the case by means of six screws, and the diaphragm is adjustable to enable the very best results to be obtained from signals of varying intensity. In some models the receiver can be removed and replaced by another of different resistance.

The diaphragm is actuated by twin magnets wound with wire of a gauge to give the desired resistance. The use of low-resistance windings (120 ohms) and a telephone transformer is recommended, as it tends to eliminate capacity effects and permits the use of more robust windings,

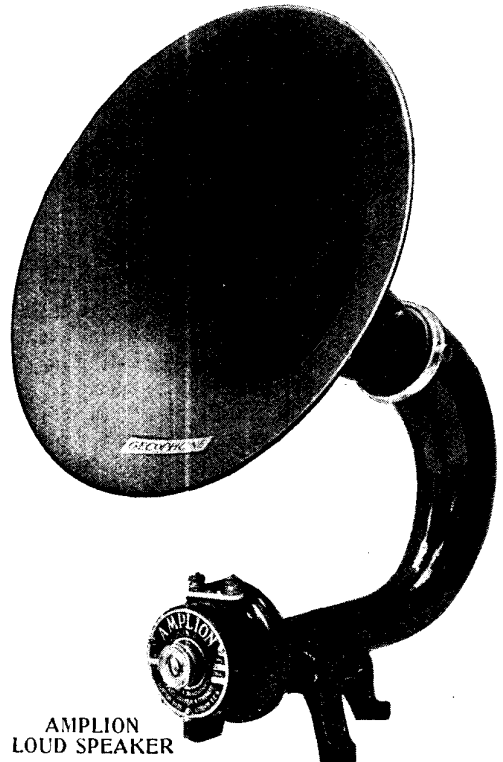

AMPLION LOUD SPEAKER

Fig. 1. This form of loud speaker, known as the Amplion, is made in many patterns and sizes

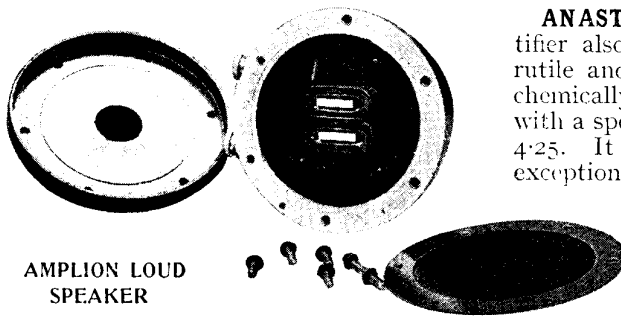

Fig. 2. Details of the mechanism of the loud speaker will be seen to resemble largely those of an ordinary telephone receiver

but windings of 500, 2,000, and 4,000 ohms are available. Other types are made to attach directly to a wall, or with an attachment so that the instrument can be suspended from the ceiling. See Loud Speaker.

AMPLITUDE. In a wave system, amplitude is the distance above or below the zero line to which the crest or trough of the waves reach. In a damped wave system the amplitude is continuously reducing in magnitude, and in a continuous system the amplitude is of the same value.

This is explained by the diagram showing a damped wave system as compared with a continuous wave system. The crest of the wave is called the node, and the trough the antinode. In sound waves the amplitude varies according to the nature of the wave. See Ether; Sound Wave; Frequency; Waves.

AMYL-ACETATE. A solvent of celluloid, and the chief constituent of many forms of celluloid cement. It has the distinguishing odour of pear drops, and can be obtained from the chemist.

To make a useful celluloid cement it is only necessary to place in a clean glass or earthenware jar small pieces of celluloid, adding the amyl-acetate until the celluloid has been dissolved to the consistency of thin cream. It should be applied immediately to the parts to be united.

Amyl-acetate is also used to facilitate the unfastening of joints in celluloid, as, for example, the top of an accumulator case. It should be brushed on the joint and the parts separated at the required point. The chemical formula is $C_7H_{14}O$. The mixture is highly inflammable, and should never be used anywhere near a naked light or flame. See Accumulator; Celluloid.

ANASTACE. A potential mineral rectifier also found in the forms known as rutile and brookite. It can be obtained chemically in the form of brownish lumps with a specific gravity varying from 3.9 to 4.25. It is insoluble in all acids with the exception of concentrated sulphuric. See Crystals.

ANCHOR GAP. In the De Forest system of radio-telegraphy a small gap is placed in the circuit from aerial to earth, called an anchor spark gap. The object of this is to provide protection from lightning discharges. See Lightning Arrester.

ANDERSON BRIDGE. Instrument for measuring small inductances as used in wireless telegraphy.

The best form of Anderson Bridge is that modified by Dr. J. A. Fleming. The inductance to be measured is joined in as one arm in a Wheatstone bridge.

In Fig. 1 the coil whose inductance is to be measured is shown at AB. Suppose it has an inductance L and a resistance R. R_1 and R_2 are two resistances or ratio arms, and the inductance resistance is balanced on the bridge for steady currents against these resistances and the

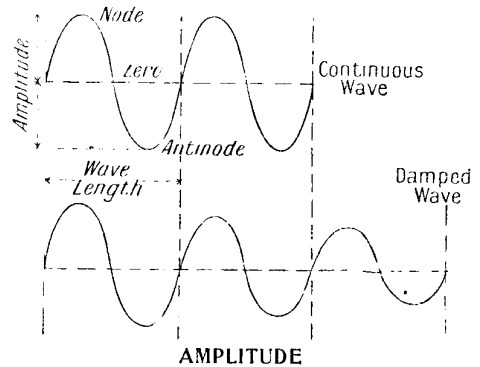

From this diagram will be seen the difference between amplitude in a continuous and damped train

variable resistance R_3 , called the measuring arm. Then we have, with the usual Wheatstone bridge theory:

$$R = R_2 R_3 / R_1 \dots \dots \dots (1)$$

From (1) we can obtain an adjustment so that the galvanometer, G, does not deflect if the battery key shown in the diagram is closed first and the galvanometer key afterwards. Closing the galvanometer key first, however, and the battery key second causes a sudden

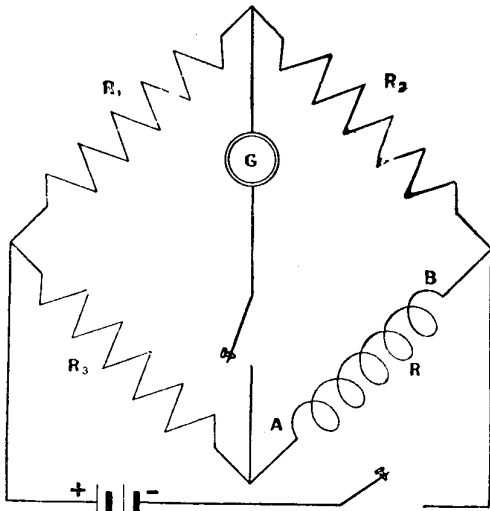

ANDERSON BRIDGE INDUCTANCE MEASURER
 Fig. 1. Resistance balancing circuit A B represents the coil whose inductance is to be measured

deflection of the galvanometer needle due to the inductance L.

The circuit is now modified as shown in Fig. 2. The galvanometer is replaced by the telephone receiver, T, and a variable resistance, R_4 , is joined in series with it and with a fixed condenser, C. The resistance should be non-inductive, and the capacity of the condenser about $\frac{1}{3}$ microfarad. B is an ordinary buzzer joined in series with the battery.

The variable resistance is now operated until the minimum sound is heard from the buzzer in the telephone when the contact keys are closed. It may be that the resistance can be so varied that no sound is heard, but this is not a necessary part of the experiment. When the minimum sound is heard in the telephone the Anderson bridge is then balanced for inductive currents, and the self-induction coefficient, L, may then be calculated from the equation:

$$L = C; R_4(R + R_3) + R_1R_2 \quad (2)$$

where C is the capacity of the condenser and R_4 the adjusted resistance when the minimum sound is heard in the telephone. All resistances are measured in ohms, the capacity of the condenser in microfarads, and the required inductance is given in microhenrys. See Inductance; Resistance; Wheatstone Bridge.

ANELECTRIC. A body which is not electrified by friction—that is, a conductor. It is the opposite of a dielectric (*q.v.*) or nonconductor. There is no hard-

and-fast line of division between dielectrics and anelectrics, all the former probably allowing a small amount of current to leak through them, though often too small to be detected by electrical measuring instruments. All metals are anelectrics. See Conductor.

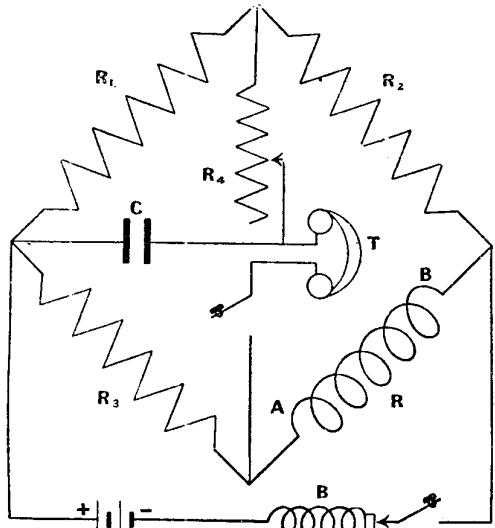

ANDERSON BRIDGE MODIFIED CIRCUIT

Fig. 2. An ordinary buzzer will be seen in series with the battery. When the minimum sound is heard in the telephone the bridge is balanced for inductive currents

ANGLE BRASS. This is the name given a strip of brass bent into an angle. It is drawn or rolled from sheet brass in all the smaller sizes from $\frac{1}{8}$ in. to 1 in., and is measured by the widths from the outside edges to the angle. Generally, the size of each part of the strip is equal. It is usually of the simple form illustrated in Fig. 1, although occasionally it takes the form with rounded corners shown in

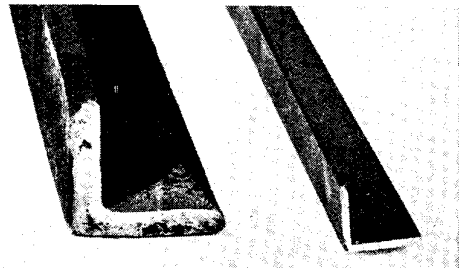
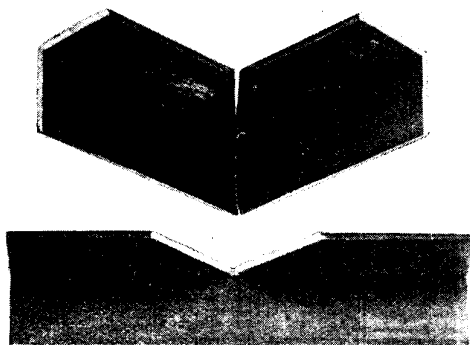

Fig. 1
 Fig. 2
TWO FORMS OF ANGLE BRASS

Fig. 1. Sheet brass has been bent to shape
 Fig. 2. An example of angle brass drawn to shape

Fig. 2. The type illustrated in Fig. 1 is bent up in rolls from sheet. That shown in Fig. 2 is drawn to shape, or extruded through angle dies of the desired size and shape.

Angle brass is employed for joining metal parts and sheet material which might be placed at an angle to each other. Brass is used because it is easy to work, and can be readily soft-soldered to the object it is joining if it is suitable. It can be



ANGLE BRASS CORNERS

Fig. 3. The method of making a corner in a strip of angle brass is seen from these two examples. The bottom photograph shows the V-shape cut made to the desired angle. The top view is of the corner nearly closed.

softened by annealing, *i.e.*, by heating to dull redness and plunging in cold water, and bent to the required form.

Angle brass is a little difficult to bend nicely in a plane parallel to one of its faces unless the radius is comparatively large, and the material is well annealed. Thinner material of the type illustrated in Fig. 1 will be found to be more troublesome in this respect than the thicker angle and that made to the profile Fig. 2. Sharp bends are best made in the manner illustrated in Fig. 3. Silver solder should be used to make the joints at the butted portion of the angle. Brazing with brass spelter may endanger the material, and soft solder will only produce a joint of inferior strength.

For a 90 deg. (right angle) bend, the angle of the notch will be 90 deg. The angle of any other bend may be predetermined by subtracting the

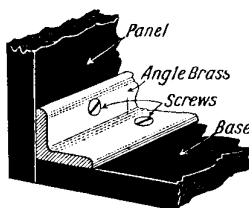
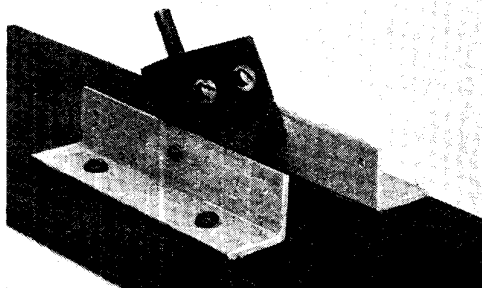

Fig. 5. Two ebonite plates held at right angles by the use of angle brass

from 180 deg.—that is to say, if the notch angle is 60 deg., then the bend will be $180 - 60 = 120$ deg.

Another use for angle brass in wireless work is the construction of coil mountings, especially those for panel mounting. The illustration, Fig. 4, shows the parts for a three-coil mounting, with one of the coil receptacles in place. These are simply made from ebonite, with one valve leg protruding and one socket embedded in the ebonite. The connexions are made by screws on the side. The receptacles are free to move on two pivots made from round-headed brass screws, No. 4 B.A. size, tapped into the ebonite. Extension handles or other control methods may be added, according to the purpose for which the mounting is required.

Another application of angle brass especially handy to the experimenter is illustrated in Fig. 5, which shows how, by screwing strips of angle brass to the junction between two ebonite plates, it



COMMON USE FOR ANGLE BRASS

Fig. 4. In making a coil holder, and in numerous other cases, small sections of angle brass make a simple and convenient component

is easily possible to build up all manner of panels and other parts for apparatus of all kinds. In some instances, angle brass may be used as an earthing connexion, especially in cases where metallic shields are placed around any of the parts to avoid body capacity effects. For a good effect, the brass should preferably be nickel-plated or polished and lacquered, as it then retains its lustre.

ANGLE CELLULOID. The name given to strips of celluloid bent to an angle. Celluloid, being a homogeneous material which can be moulded and which is ductile when heated, can easily be formed into similar shapes to metal. As a result, angle celluloid is made to produce strong joints between sheets of celluloid to be

fitted together at the edges, as, for example, in celluloid accumulator cases. It may be bent, when rendered soft by immersion in hot water, and may be stuck or welded to other celluloid articles by a solution of celluloid in its solvent, amyl acetate, generally known as celluloid cement.

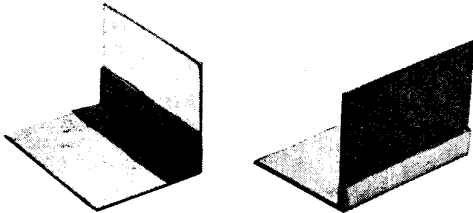

ANGLE CELLULOID

This material can be used with celluloid in the same way that angle brass is employed with harder substances. Here a repair is shown

The photograph shows the method of repair of the edges of an accumulator container by means of angle celluloid.

ANGLE OF DIP. Angle which the magnetic needle makes with the horizon. At the magnetic poles the needle is vertical, and horizontal at the magnetic equator. The angle is measured by means of an instrument known as the dip-circle.

ANGLESITE. Mineral crystallized form of lead sulphate, $PbSO_4$. Transparent and colourless, though occasionally stained brown with impurities, it may be formed from lead sulphide, the well-known galena crystal, by burning the latter in air. Anglesite has been used as a crystal rectifier, but not with great success. See Crystal.

ÅNGSTRÖM UNIT. Unit of measurement. One Ångström unit is generally written \AA A.U., and is the ten-millionth part of a millimetre, or the ten-thousandth part of a micron. The diameter of an atom is between two and five Ångström units. See Atom; Electron; Unit.

ANGULAR FORCE. The product of a force and its perpendicular distance from an axis of reference. The algebraic sum of all the angular forces acting on a body is known as the torque or twisting moment or turning moment. Angular forces are important in electrical machinery, as dynamos, high-speed alternators, and the like. See Torque.

ANHYDROUS. Word meaning destitute of water, and applied to many particular forms of substances. An anhydride is an oxide which becomes an acid when water is added, or is regarded as an

acid from which water has been removed, and which combines with basic oxides to form salts. SO_2 , or sulphur trioxide, is anhydrous sulphuric acid, the addition of water alone to the trioxide, which in itself has no caustic properties, forming sulphuric acid (*q.v.*).

ANION. Term used in electrolysis to denote the constituent of the electrolyte which migrates towards the anode, or the metallic conductor at which the electric current enters the electrolyte. The photograph shows an electric current being passed through a solution of common salt. The sodium in the salt is liberated as the cathode decomposes the water and liberates hydrogen, shown bubbling through the water in the photograph. At the anode, chlorine is evolved. This is the anion,

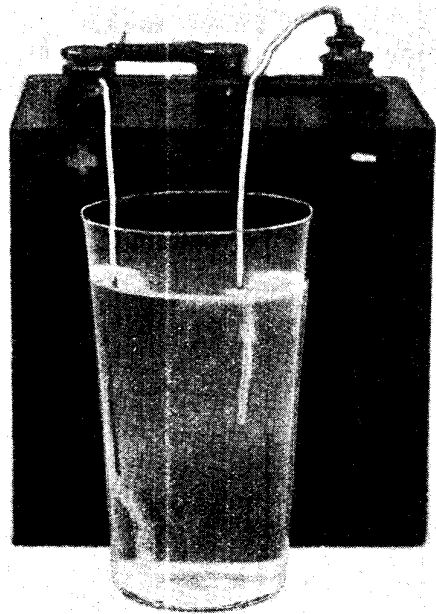

ELECTROLYSIS OF A SALT SOLUTION

An interesting photograph showing the action which occurs when the anion migrates to the anode during the electrolysis of a salt solution. Hydrogen bubbling through the water may be seen liberated at the cathode

and it may dissolve the wire or anode, or may liberate oxygen from the water, according to the concentration of the solution and the nature of the anode. See Cathode; Cation; Ionisation.

ANISOTROPIC CONDUCTOR. One whose conductivity varies with the direction of the applied electro-motive force. In the case of certain crystals this

peculiarity is strongly defined, and the material is said to have unilateral or asymmetrical conductivity. It is this peculiarity which enables crystals to act as rectifiers for wireless telephony. See Crystal.

ANNEALED IRON WIRE. Soft iron wire which has been heated and cooled to so modify the molecular structure as to increase its magnetic susceptibility. Iron, being the chief of the para-magnetic bodies, acquires magnetism at a varying rate, according to the strength of the magnetising forces; and after removal of the magnetising force it returns more or less to its original condition. It may, however, retain as much as 90 per cent of the magnetism temporarily. The purpose of annealing the wire is to assist the tendency to acquire and lose magnetism as quickly as possible. This reduces the magnetic hysteresis; that is, the property

of a magnetic body in which the magnetism lags behind the magnetising force.

Annealed iron wire of the highest quality is, therefore, an important item in the construction of many pieces of apparatus used in wireless—for example, the bundle of wires employed as the core in some types of transformer. In such cases the continuance of magnetic effects after removal of the magnetising forces is objectionable, and often results in parasitic noises in the telephones. It is not suggested that annealing the iron is the only process to eliminate such effects, but annealing is a method that is beneficial, as it causes a rearrangement of the structure of the metal in such a way that it is more susceptible to magnetic changes. Some of the Norwegian and Swedish irons appear to be most suited to electrical work, and are amenable to thorough annealing. See Annealing; Iron; Magnetism.

ANNEALING : ITS PURPOSES AND PROCESSES

An Important Process in Efficient Instrument Making

The heat treatment of various metals is dealt with in this article. Their behaviour while undergoing the process of annealing is explained, and comparisons made with regard to temperatures. See also Annealed Iron Wire; Ductility; High-Frequency; Low-Frequency; Magnetism; Valve

A process whereby metals and other materials are made softer by a heat treatment, generally with the object of making them more readily workable by altering their physical and electrical properties. In wireless work, copper and iron are probably the metals that are most usually annealed, the former to increase the ductility, as in the case of a wire or conductor which has to be sufficiently soft to be able to coil easily round a former of comparatively small diameter. Iron is most frequently annealed to alter its electrical properties, as a well-annealed soft iron wire plays an important part in many pieces of apparatus needed in wireless work.

Glass when annealed is to some extent toughened, as the processes involved have the effect of relieving internal stresses and making the material more homogeneous. The annealing process is also used to effect the same result in the case of cast and wrought metals—for instance, cast iron. In a typical example the casting may be of somewhat unequal cross-sectional areas, and as it cools down after the pouring process the metal cools

more quickly where it is thin than it does in the thick parts, consequently there are certain severe strains set up in the molecular structure of the metal. In badly-proportioned castings these strains may result in an absolute fracture of the parts, and in any case the metal may be very near its breaking point. To relieve these internal strains the metal is annealed, that is, it is heated to a certain temperature, and maintained at that temperature for a length of time, with the result that the molecules of the metal are able to rearrange themselves in a more stable manner, and the strains are thereby greatly diminished.

This is an important matter, especially in parts that have to withstand severe strains, such as parts of a dynamo or generator. The same applies to wrought and rolled metal, the manufacturing processes tending to harden the material and to set up internal stresses, generally of a local character. In the case of a wire used as a conductor, this might result in fracture, as if the wire were suspended from the usual insulators the movement occasioned by the wind or other

causes would not be uniformly resisted by the structure of the metal, those parts initially stressed having a tendency to fail, owing to the virtual overload at those places where the wire is internally stressed above the normal.

Iron when well annealed has better magnetic properties than are present before treatment, probably due to the more orderly arrangement of the structure of the metal. The structure of the metal may be imagined as a series of very small bar magnets, all free to move when the metal is heated sufficiently; then by the ordinary laws of magnetic attraction these magnetons, as they may be called, will turn towards their neighbours in a disorderly manner, and the poles of these little magnets will be pointing in different directions. This represents the state when the metal is not magnetised, but when magnetised the magnetons are more

or less arranged in an orderly manner, with their like poles pointing in the same direction.

The result of heating the metal sufficiently, and for a sufficient length of time, frees the magnetic stresses and allows the magnetons to rearrange themselves in an unordered manner. Consequently, a permanent magnet, if annealed, will lose its magnetism wholly or in part; and a para-magnetic body, such as iron, will be rendered more efficient, in that it will be able to be magnetised and lose its magnetism without lagging so much behind the magnetising force. The proper annealing of metals is, therefore, a matter of some importance in wireless work, where the highest efficiency is needed.

Annealing by Amateurs. Annealing processes, as they can be carried out by the average amateur, are a matter largely dependent upon the source of heat

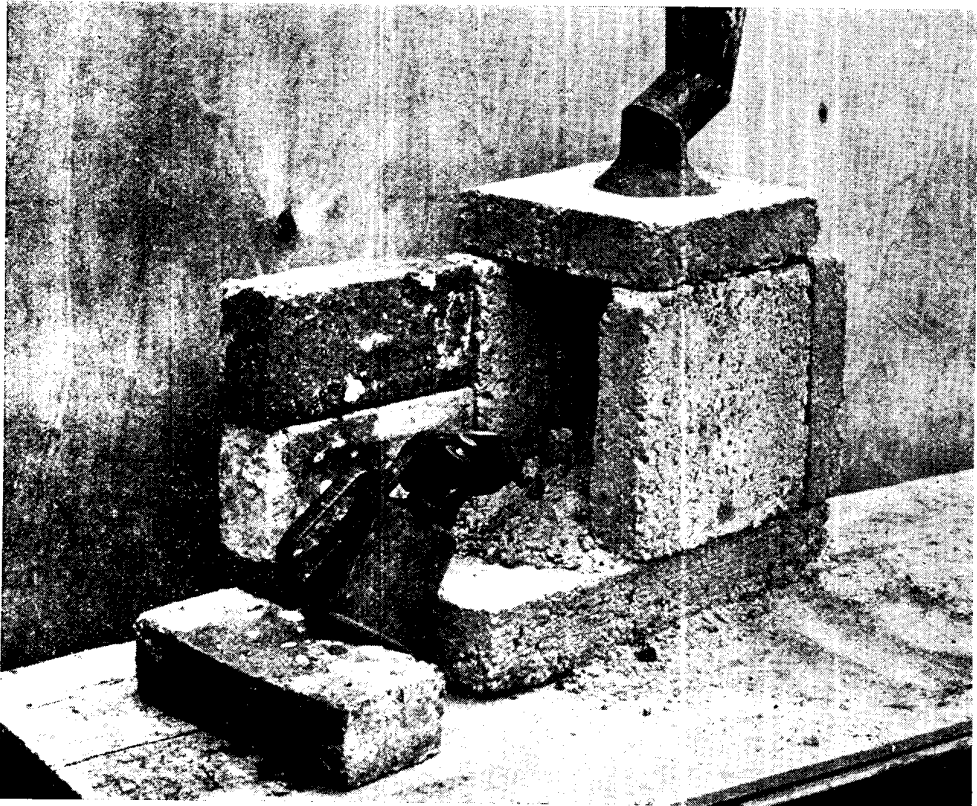

METHOD OF CARRYING OUT ANNEALING FOR AMATEURS

Fig. 1. Amateurs can anneal small objects by the aid of firebricks, which are built up to form a heat-retaining chamber. It will be noticed that the chimney is angular. The top brick with the chimney erected should be prepared last, as it may be found that the dimensions of the structure require enlarging when the work is prepared for annealing



PROCESS OF ANNEALING IRON WIRES

Fig. 2. The side and top have been removed to show how the wires are packed. Care must be exercised to ensure that the chamber contains the work without the ends of the wires protruding at the entrance, as the chamber is closed after the source of heat is removed to allow cooling to take place as slowly as possible.

available, and the nature and size of the parts to be dealt with. Small things, as, for example, a bundle of wires for the core of a transformer, can be annealed by building up a box-like structure with firebricks, somewhat on the lines illustrated in Fig. 1.

Actual dimensions will be determined in practice by the size of the parts to be handled, but a convenient-sized brick for the purpose measures 9 in. square. A longer one is used for the base, and measures 9 in. wide and about 15 in. long. Three firebricks are used for the sides and end respectively; a fourth has a hole made through the top to accommodate a smoke-pipe. The hole is made by carefully chipping away with a sharp chisel. The pipe is secured by luting it with fire-clay.

The disposition of the parts is shown in the two illustrations, one with the whole of the bricks in place, the other with the side and top removed to show

the interior. The source of heat is in this case a powerful paraffin blowlamp, and this is blocked up with bricks and shielded with other bricks as shown, the whole so arranged that the flames from the lamp can play into the interior of the furnace. This is partly filled with wood ash, charcoal, asbestos, or any similar material. The wires are embedded in it, and the blowlamp set going. The wires speedily heat up to a good red heat, the lamp is left burning steadily to keep up the heat, and after about half an hour can be removed, and the glowing mass covered with more hot ash or asbestos, and the front closed with another firebrick, and the whole left to cool off as slowly as possible.

The same system is employed with any class of iron or steel. The great practical point is to keep the work hot as long as possible, and to allow it to cool off gradually. An essential point is to exclude the air as much as possible from the surface of the

metal, as otherwise the surface will oxidize or scale badly. A common practice is to enclose the articles to be heated in a container, such as a piece of wrought iron pipe, closed at the ends with caps. The work is packed tightly with powdered charcoal, and any external openings in the container luted with fireclay. The whole is then heated in the furnace and left there to cool.

Annealing copper is carried out on much the same lines, but the temperature is lower. Essentials are to see that the copper is uniformly heated, and that it be left in the furnace to cool slowly. Brass is annealed in the same way, with due regard to the temperature. It is sometimes recommended to anneal copper and brass by heating to a dull red heat and plunging into cool water. This is a perfectly effective way of softening the metal, but there is a chance that the heating and cooling will not be uniform, and the result will be the sheet or wire will be very soft in places and comparatively hard in others. The slower process is to be preferred. On no account should the metal be overheated, as if allowed to burn it will be ruined. Iron and steel anneal at a good bright red heat, copper at a dull red only just discernible in subdued daylight, brass about the same. Zinc anneals at a temperature a little above that of boiling water, say about 300 F.

Aluminium is difficult to anneal, and should not be heated to the visible red condition, as it speedily melts; it is also prone to other thermal changes, often of a detrimental character. In wireless work it is sometimes necessary to anneal metal during the progress of the work, as, for example, in the making of a trumpet for a loud speaker. This, if spun, will have to be annealed from time to time, as the metal hardens during the shaping process.

ANODE. The name commonly applied to one element of a thermionic valve, and also to the circuit of which it forms part. It is the principal electrode for the attraction of the electrons forming the emission current of a thermionic valve. It is sometimes referred to as the plate, or plate circuit. A typical three-electrode valve is illustrated in section in the photograph, and the anode is clearly visible. This consists usually of a plate of metal, and, in the pattern illustrated, is bent round to form a tube, approximately $\frac{3}{8}$ in. in diameter and $\frac{5}{8}$ in. in length.

It is supported on one side by an upright wire, the other end of which is fixed into a glass piece formed in the bottom of the globe. This glass centre piece also serves to isolate the four wires, two of which are conductors for the filament circuit, one for the grid circuit, and the other for the anode circuit. This, as can be seen in the illustration, comes out from the bottom of the globe, and is embedded in pitch, or some similar filling, between the globe and the brass holder. The lower end of this is closed by a disk of ebonite, in which the four valve legs are fitted. One of them is connected with the wire from the anode, and is the anode terminal or plug. The

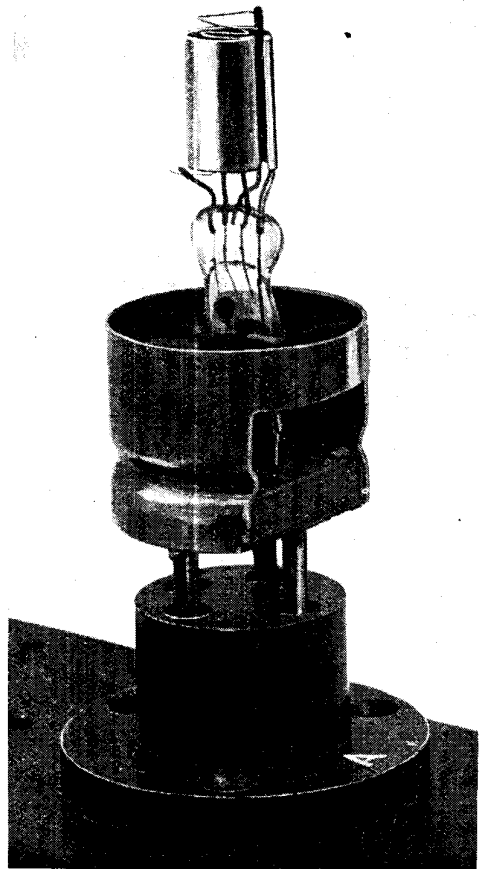

ANODE OF THREE-ELECTRODE VALVE

In the cut-away portion will be seen the connexion from the plate leg of the valve, which continues through the glass stem and joins the thick wire on right, which holds the vertical cylindrical-shaped anode or plate.

function of the thermionic valve is fully described under that heading in this Encyclopedia.

In arc transmitters the anode or positive electrode is usually of copper. In the Poulsen arc system the arc is struck between a copper anode and a carbon cathode. The copper anode is hollow and water-cooled, the water circulating inside the electrodes through tubes provided for the purpose. A special extension tip is usually provided on the end of the cylindrical copper anode to localize the arcing point.

The T.Y.K. arc usually employs electrodes of brass for the anode and magnetite for the cathode. In the mercury vapour arcs there is one anode of iron or graphite to two cathodes of mercury. In Vreeland's arc oscillator there are two anodes of carbon and one cathode of mercury.

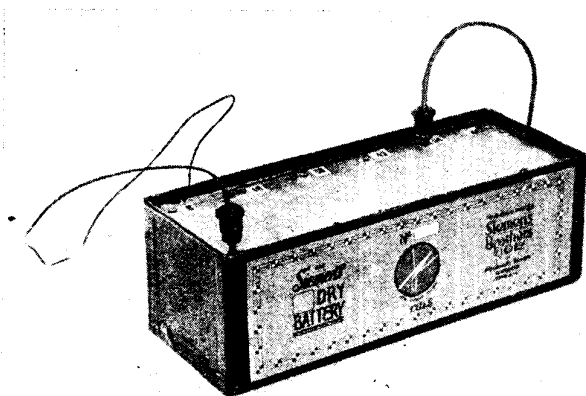

BATTERY FOR ANODE CIRCUIT

A high-tension battery is employed to supply current for the anode circuit. The battery illustrated is tapped at intervals of three volts up to sixty-six volts. Wander plugs are used to engage the tappings required.

In the Moretti arc the electrodes are of copper, the anode being a hollow copper tube water-cooled, and the cathode a solid copper rod. The Ruhmer arc employs electrodes of aluminium wires. The wires are in continuous movement, so that a fresh metal surface is regularly being presented for striking the arc and keeping it constant in length.

In electrolysis, ions which move upstream, *i.e.*, against the current, were called anions and their terminus the anode by Faraday. In the case of the electrolysis of water, the anode is the plate at which the oxygen is given off. See Filament; Grid; Valve.

ANODE BATTERY. A high-tension battery for supplying current to the anode circuit (*q.v.*). The voltage required will be governed by the number of valves and the nature of the circuit and its components, and may vary from 15 to 240 or more, but the quantity of current, or amperage, is exceedingly small, and consequently the battery can conveniently be composed of a number of cells, all of them small in size. In the example illustrated, the anode battery has a capacity of 66 volts, but as it is necessary to vary the voltage according to the requirements of the circuit, the cells are connected together in series, and sockets are provided at convenient intervals to enable the plugs to be inserted into them.

These plugs are generally known as wander plugs (*q.v.*), and are attached to the wires, the other end of which is connected to some part of the apparatus.

The negative may remain in the first socket, which is marked -- (the minus sign), the positive plug being inserted into whichever socket is appropriate to the required voltage. Batteries of this class are available, tapped in steps of three, six, or more volts. That is to say, the voltage can be varied, *e.g.*, by 3-volt stages, from 3 volts up to 66, or whatever the capacity of the particular battery may be.

Furthermore, if it is necessary to have two or more separate circuits from the same battery, assuming it to be of suitable capacity, additional plugs connected to the ends of the appropriate wires may be inserted into any part of the battery. In all cases one plug will be negative and the other positive. For example, if four plugs are in use, the first pair, for, say, a 60-volt circuit will be plugged into the -- socket, and the 60-volt socket. A further circuit may be 24 volts, in which case the negative plug can be introduced into the 12-volt socket, and the other into the 36-volt socket.

Anode batteries of the type illustrated are generally composed of dry cells (*q.v.*), but high-tension accumulators may be used instead, and when facilities for charging are available, are preferable. See B Battery; Valve.

ANODE CIRCUIT: ITS PRINCIPLE AND ITS FUNCTION

Circuit in which Oscillations may be Rectified and made Audible

A description is here given of the connexions and arrangement of the instruments incorporated in the anode circuit. Its functions are explained and the use of reaction in this circuit is also dealt with. See under such headings as Anode Battery ; Reaction ; Transmission

In a receiving set the anode circuit is a circuit which includes the anode or plate of the valve, telephones, high-tension battery, the low-tension battery, condenser, and the filament. It is in this circuit that the greatest effects are produced from the incoming signals.

The possibilities of the anode circuit as a means of increasing signal strength by reaction, the advantages of the tuned anode circuit embodying inductance and capacity, and the applications of resistance capacity couplings and transformer couplings are matters of the utmost interest to the experimenter, but it is desirable to first appreciate the elementary functions of the anode circuit itself.

In its simplest form for use in the receiving set it comprises a three-electrode valve, high and low tension batteries, filament resistance, telephones, and fixed condenser. These are generally represented by the theoretical circuit diagram shown in Fig. 1, and a typical set of components such as those illustrated in position and wired up in Fig. 2.

Commencing from the H.T. battery, a wire goes from the plus or positive terminal to the telephone terminal and thence from the other telephone terminal to the anode terminal on the valve holder. From the negative side of the H.T. battery a wire goes to the positive side of the L.T. battery.

A fixed condenser is shunted across these wires by others connected from the tele-

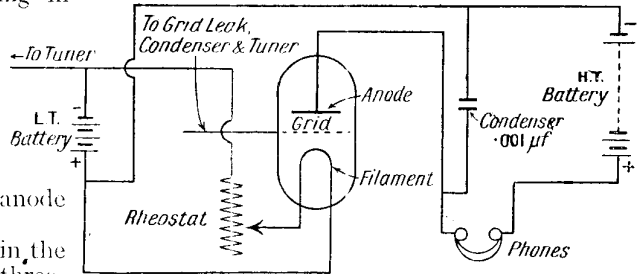

SIMPLE ANODE CIRCUIT

Fig. 1. This is a diagrammatical representation of the circuit, which is shown wired up and laid out in Fig. 2

phone terminal to the condenser and from the other side of the condenser to the negative side of the H.T. battery. From the positive side of the L.T. battery a wire is taken to the filament terminal.

A separate wire connects the second filament terminal on the holder to the contact arm on the rheostat and thence by another to the negative side of the L.T. battery. In some

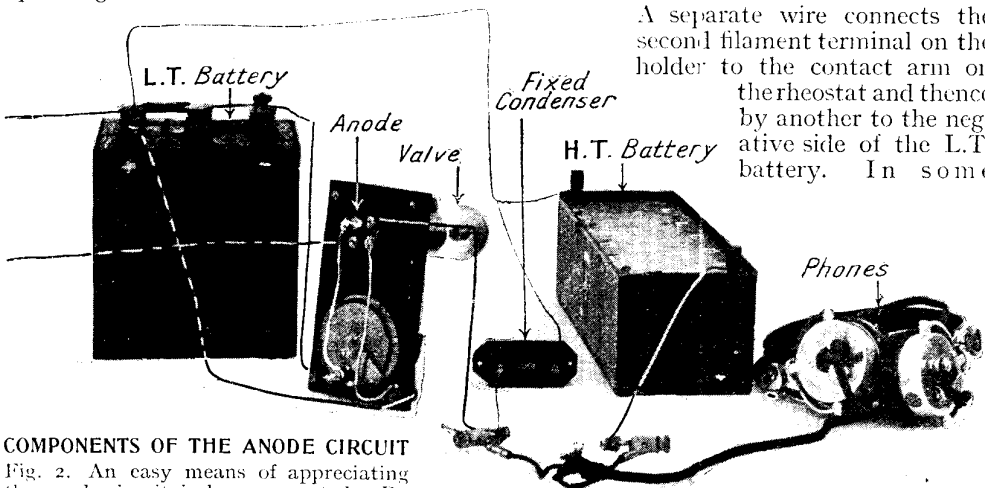

COMPONENTS OF THE ANODE CIRCUIT

Fig. 2. An easy means of appreciating the anode circuit is here presented. By following the wires and tracing the flow of current from the anode battery and accumulator, it is a simple matter to understand the part played by the circuit in making audible in the telephones transmitted messages which are first received as unrectified oscillating currents

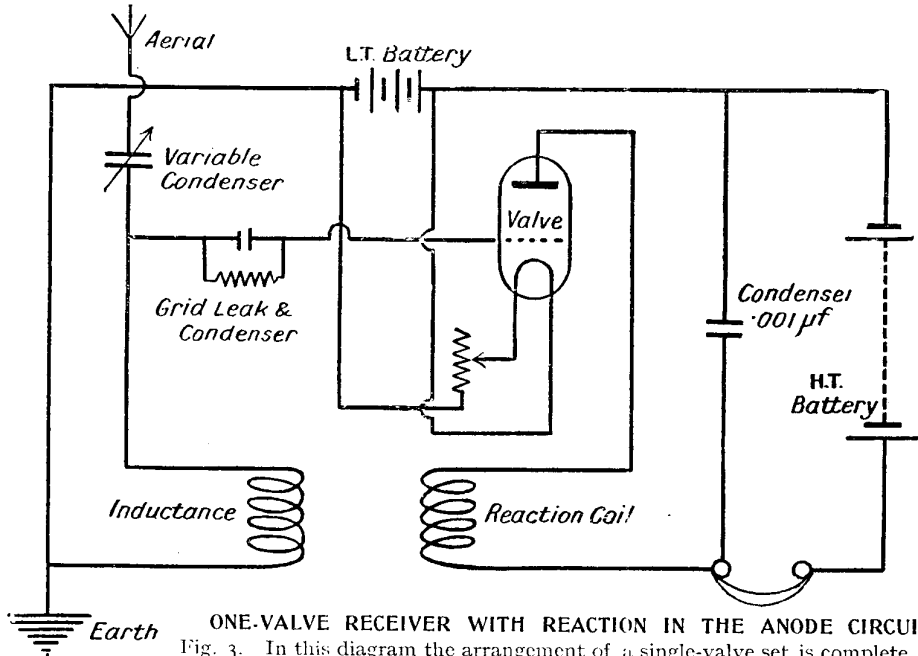

ONE-VALVE RECEIVER WITH REACTION IN THE ANODE CIRCUIT

Fig. 3. In this diagram the arrangement of a single-valve set is complete, and the anode circuit is easily distinguished by comparison with the simple anode circuit given in Fig. 1. In this case reaction is employed

cases the L.T. wires are reversed, the negative going to the filament direct, but the essentials of the simple anode circuit in a receiving set are the wires and apparatus shown in Figs. 1 and 2.

The action of the valve is fully described under the heading Valve, but at this point it is sufficient to say that the tuned incoming signals are delivered to the grid of the valve, and this modifies the

resistance to the flow of electrons which takes place between the anode and the filament and thereby alters the resistance and characteristics of the anode circuit. The result is that the electric oscillations radiated by the transmitting station are rectified and, to a certain extent, amplified, and subsequently reproduced by the telephones with exactly the same characteristics. Hence signals become audible.

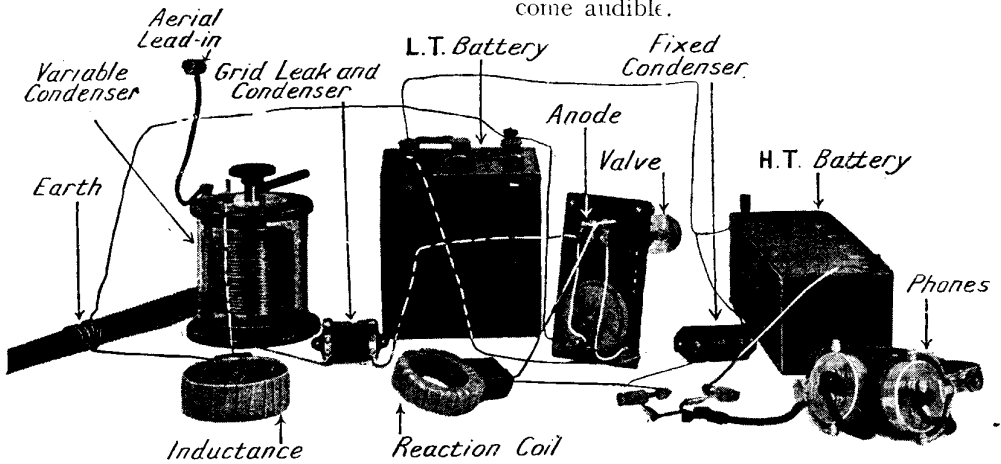

ANODE CIRCUIT IN A SINGLE-VALVE RECEIVER USING REACTION

Fig. 4. This layout of a complete set of components makes thoroughly clear the working of a single-valve set using reaction, the circuit diagram of which is given above (Fig. 3)

The value of the condenser, the resistance of the telephones, the voltage of the battery, and also the method by which they are connected together, all have a bearing upon the efficiency of the anode circuit. Their arrangement and values will be determined according to the particular objects in view. For example, when receiving with a single valve detector, a simple circuit such as that in Fig. 1, with the addition of the necessary aerial circuit, a grid leak condenser, and a grid circuit, are all that are required to enable the anode circuit to perform its functions completely.

A simple way of doing this is illustrated in the form of a theoretical circuit diagram in Fig. 3, and typical apparatus is shown wired up in Fig. 4. In this case the aerial and grid circuits are also included, to render the functions of the anode circuit more plain. The values of all the components of the whole of the circuits illustrated will, in every case, have to be appropriate to the actual circuit in which they are incorporated.

But in essence they all perform the same purpose. In this case the circuit is substantially as the former example, but the wire from the plate is taken to the reac-

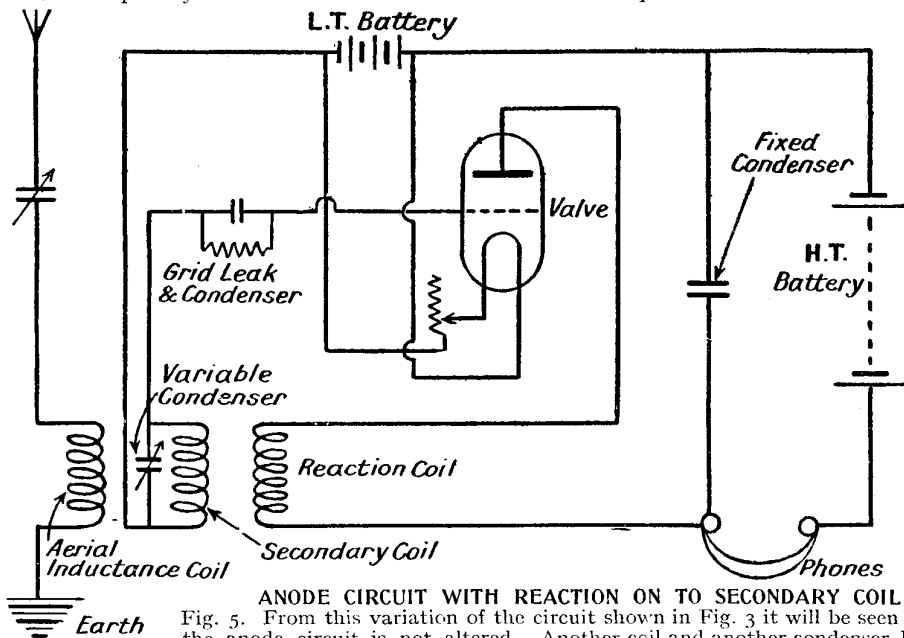

ANODE CIRCUIT WITH REACTION ON TO SECONDARY COIL
 Fig. 5. From this variation of the circuit shown in Fig. 3 it will be seen that the anode circuit is not altered. Another coil and another condenser have been added and the complete set slightly changed without disturbing the wiring of the anode. This diagram should be compared with the photographic layout in Fig. 6

Modified Anode Circuit. When signal strength is not sufficient for this method, or for any other reason it is desired to modify the anode circuit, various other arrangements have to be adopted. As the current flowing in the anode circuit of the detector valve is a modified edition of the current flowing in the grid circuit, and has the same characteristics, it is possible to feed back some of the energy of the amplified anode current to the grid circuit, provided some suitable means be adopted for doing this. Such an arrangement is known as a back coupling, feed back circuit, or a reaction coupling.

tion coil, and passing through it the circuit is continued to the telephones as before. Thus the reaction coil is simply an addition to the anode circuit between the anode and the telephones. The aerial circuit consists of the aerial lead-in wire, a variable condenser, and an inductance coil in series—that is, the aerial wire goes to the condenser and thence to the inductance coil and from it to earth. The grid leak and condenser (Fig. 3) are connected by a wire from the aerial circuit between the condenser and inductance. In practice, the two coils shown are fitted to a coil holder or stand, and capable of movement relative to one another.

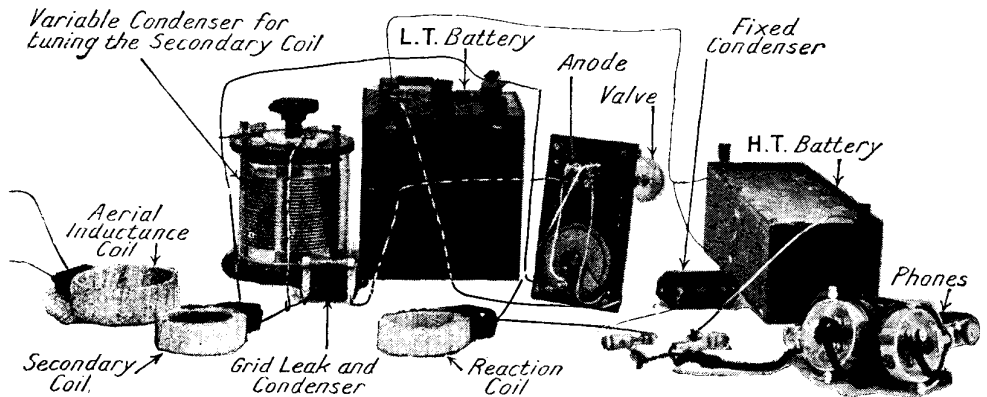

ANODE CIRCUIT IN A RECEIVER USING REACTION WITH A SECONDARY COIL

Fig. 6. The aerial inductance coil is wired to aerial via a condenser, and to earth. How the remaining components are wired is apparent from this layout and from the theoretical diagram in Fig. 5. The grid leak and condenser may be mounted together as shown, or separately, but in the same order.

The modified anode circuit, as illustrated in Figs. 3 and 4, includes the addition of a reactance coil. The amplified radio-frequency current flowing through it is able to feed back some of its energy to the grid circuit if the coil in the anode circuit be brought into proximity with the coil in the tuning circuit. The value of the current fed back in this way will be governed by various conditions, including the values of the coils, but chiefly the extent of the feed back is determined by the closeness of the coils to one another. The greater part of the current may be fed back under some conditions.

Anode Circuit Reaction. When such a circuit is constructed in this way it may have the effect of radiating oscillations by feeding back too much current from the anode to the grid circuit, and the valve generates oscillations continuously. When this happens, the receiving set virtually becomes a small transmitter, and sends out ether waves which would cause interference to near-by listeners-in, and for this reason such receiving circuits are prohibited in Great Britain by the Post-master-General.

To overcome this difficulty, reaction of the anode circuit should be arranged to

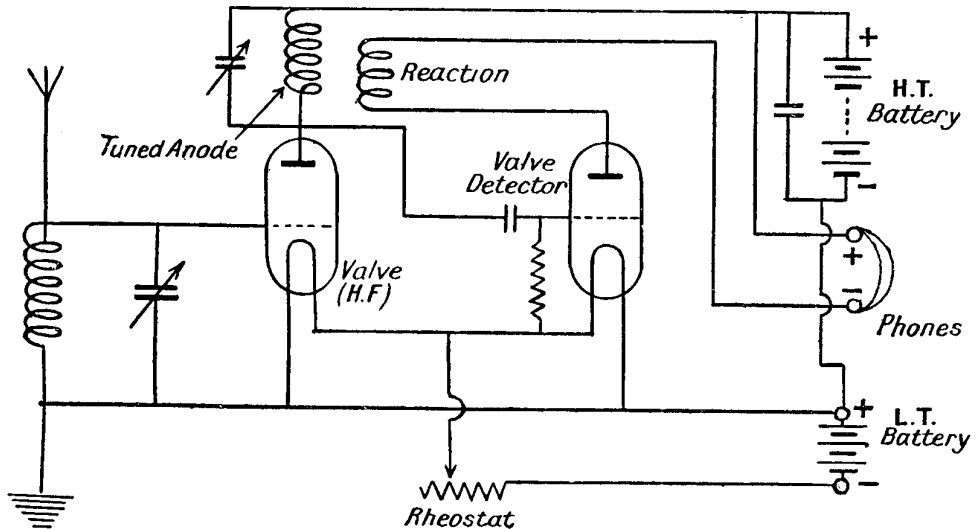

ANODE CIRCUIT OF A TWO-VALVE RECEIVER

Fig. 7. A two-valve receiver with one stage of high-frequency amplification is represented in this theoretical diagram. The arrangement includes tuned anode, with reaction and one detector valve

feed back on to a secondary circuit, and such an arrangement is shown in the form of a theoretical diagram in Fig. 5, with the corresponding typical parts wired up in Fig. 6. A comparison of these with the former two illustrations will show the essential nature of the changes that have been made.

In the first case the incoming waves flow through the inductance coil in the aerial circuit, and are tuned to the desired wavelength by a variable condenser or other appropriate means. The secondary, or grid circuit, coil is placed in proximity to the aerial inductance coil, and a current is thereby induced in the grid circuit coil, the magnitude of which may be controlled to some extent by bringing the secondary coil nearer to or farther away from the aerial inductance coil. In this way the inductance in the aerial circuit is magnetically coupled to the inductance in the secondary circuit. There is no other connexion; the aerial circuit is otherwise isolated. The reaction coil is coupled to the secondary coil, so that the oscillations generated by the valve are practically confined to the anode and secondary circuits. The amount of the feed back is controlled by moving the reaction coil nearer to or farther from the secondary, or by other appropriate means, according to the nature of the particular circuit.

When this is done, the range of the set and the signal strength are considerably increased, as such an arrangement becomes a regenerative single-valve receiver set, the valve acting as a detector, and to some extent as an amplifier. When more than one valve is used the anode circuit is further complicated in that it has two or more valves to deal with, and the more numerous stages in which such amplification is effected.

One simple and practical method is shown in Fig. 7 in the form of a theoretical circuit diagram. In this case the anode circuit is in two sections. First, there is the ordinary reaction fitted to the one valve in the detector circuit, and what

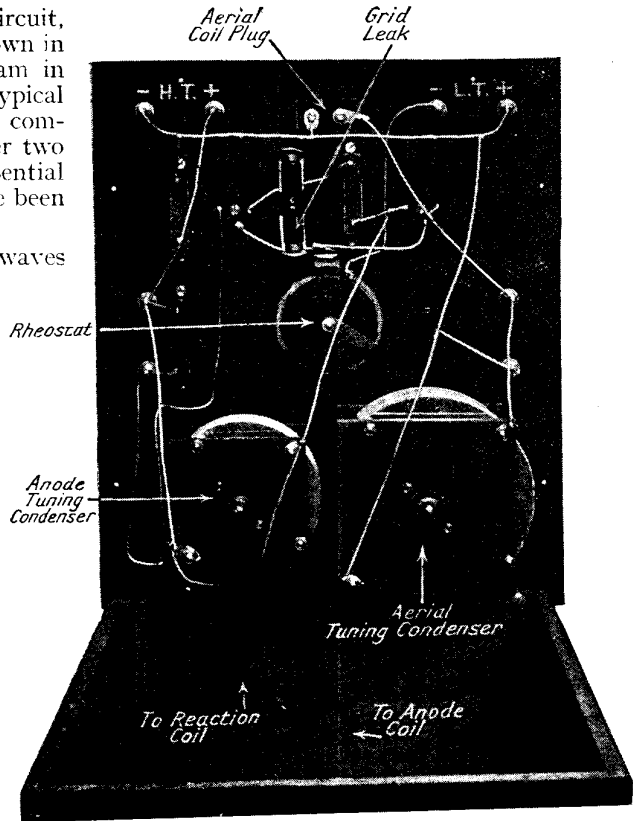

ANODE CIRCUIT

Fig. 8. A view of the under side of a two-valve receiver is portrayed. A clear idea of the wiring of the anode circuit is given, and it will be noticed that only one filament resistance is employed for the two valves

is known as a tuned anode circuit on the other, the high-frequency valve. This is done to enable the valves of the two sections of the anode circuit to be tuned to attain the maximum signal strength or range, according to the nature of the circuit. The tuning may be effected in various ways, and in the case illustrated in Fig. 7 comprises a plug-in coil with a variable condenser shunted across it. Such a circuit is known as a single stage of radio-frequency amplification with tuned anode coupling and reaction. In the second the valve acts as a detector.

The illustration, Fig. 8, shows the apparatus in such a circuit wired up, as it appears from the under side of the panel. The location of the three coils is apparent from the position of the wires in the case and the two connexions at the top of the panel. The appearance of

a practical receiving set embodying such a circuit as that in Fig. 7 is shown in Fig. 9.

This is an excellent example of the application of the tuned anode principle on a standard two-valve set, the Ethophone Home Construction No. 2, made up from constructional parts supplied by Burndept, Ltd. The components are sold at a price which includes the B.B.C. fees and Marconi licence, thus enabling anyone to make up and use the set with an ordinary Post Office receiving licence.

In the case of transmission circuits the anode plays substantially the same function, in, as it were, the reverse direction. In this case, they deliver signals or speech in the form of modulated waves to the aerial, which radiates them through the ether. The principles of transmission are fully dealt with in the article on Transmission.—*E. W. Hobbs, A.I.N.A.*

ANODE COIL. A coil of insulated wire employed in an anode circuit of a valve set to provide reactance or for other purposes, as explained in the article on anode circuit (*q.v.*). A typical example of a multi-layer Burndept coil is illustrated,

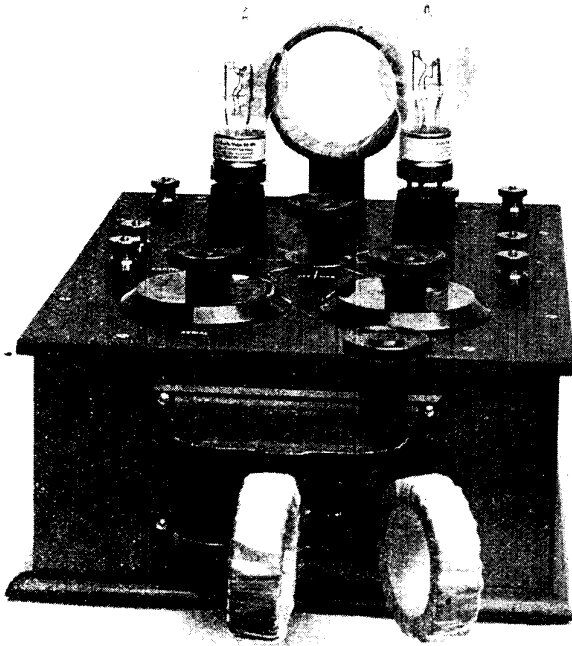

FINISHED APPEARANCE OF TWO-VALVE SET

Fig. 9. What this set consists of may be seen from the theoretical diagram, Fig. 7, which shows clearly the anode circuit, and Fig. 8. Here the components are finally assembled and the set is ready for use. Burndept material has been employed

which shows the method by which the wires are wound upon the tubular former. The wire is arranged in this way by a special manufacturing process which provides air spaces between the coils, and ensures the maximum efficiency by reducing the distributed capacity to a minimum. The ends of the wire are connected through an ebonite block to terminals, one in the form of a plug and the other in the form of a socket. They are made in this way so that coils of different values may be obtained and utilized for tuning to different wave-lengths.

The coils are finished by wrapping them with insulating material, part of which has been removed from the coil shown in the illustration to reveal the arrangement of the wires. Many other forms of plug-in coil are available, and under the general heading of anode coils may be included basket coils (*q.v.*), duo-lateral, Igranic, and others. In some cases a loose coupler or variometer may be employed. These two comprise separate coils which can be adjusted relatively to each other, and

are suitably connected into the circuit in the manner shown in the various diagrams given in this Encyclopedia.

The wireless experimenter, or those desirous of listening-in at long ranges, and having apparatus suitable for the purpose, can utilize anode coils of different values with considerable increase in signal strength and selectivity.

By the proper choice of coils, indeed, the tuning of a set may be very greatly simplified. The inclusive wave-lengths of any coil, or set of coils, used should be ascertained from the makers, where possible, before being used.

An anode coil to tune to wave-lengths of from 300 to 1,500 metres may consist of a winding of No. 30 double-cotton-covered wire on a tubular cardboard former $2\frac{1}{2}$ in. in diameter and $5\frac{1}{2}$ in. in length. Tenappings should be taken

from this at half-inch intervals. A suitable reaction coil for the anode will consist of 100 turns of No. 38 double - silk - covered wire on a tube 3 in. in diameter.

ANODE CONTROL.

In wireless telephone transmission this is the method of modulating the electric oscillations by causing the microphone speech currents to act on the anode circuit of the oscillating valve. Anode control is also known as choke control. An additional valve, known as the control valve, is employed. See Choke Control.

ANODE CONVERTER.

Small motor generator of the magneto type. Made by the M.L. Magneto Syndicate, it can be operated by an ordinary 6-volt accumulator. The current from the accumulator passes through a rheostat. The transformed current from the generator is taken through two choke coils, shunted by two condensers, ensuring an even flow of current. With this machine the high-tension battery may be dispensed with. The steady H.T. current from the anode converter ensures noiseless reception.

By means of the appliance, absolute control can be obtained of the anode potential through the variable resistance which regulates the input of the low-tension battery. The greater the supply



MULTI-LAYER ANODE COIL

This Burndept coil, which is seen plugged into holder, has been partly stripped to show the method of winding

of current from the low-tension battery the higher the H.T. voltage, so exactly the right voltage can be obtained for working the set. There is no stop and change over, which is necessary with the wander plugs of the ordinary accumulator, so the reception is continuous. The converter, in fact, acts as a tuner. The diagram shows the circuit of the anode converter.

The converter may be worked from an ordinary 6-volt accumulator, and its consumption at 6 volts is only 1-15 amperes. The converter delivers a high-tension E.M.F. up to 120 volts, and one intended for power amplifier work or transmission will provide a potential of 500 volts.

ANODE CURRENT.

The current flowing between the anode and the remaining electrodes of a thermionic valve. To understand the anode current it is necessary to consider briefly the action of the valve itself. When a current is passed through the filament of a two-electrode

valve, electrons flow from the heated filament to the anode plate, when the latter has a positive potential with respect to the filament. If the anode plate is connected to a battery to give the latter a positive potential, there is a flow of current which may be measured by means of a galvanometer.

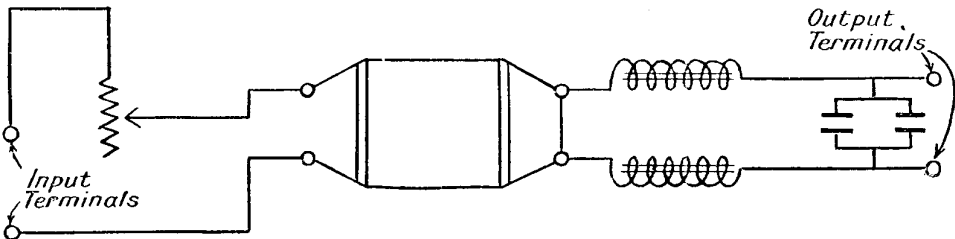

CONNEXIONS OF THE ANODE CONVERTER

This diagram shows the circuit connexions of the apparatus made by the M.L. Magneto Syndicate, using an ordinary 6-volt accumulator. The converter transforms the low-tension current into high-tension, giving an even supply of current to the anode. It avoids the use of wander plugs, and so permits continuous reception

In the three-electrode valve, a third electrode, called the grid, is fixed. This consists of a spiral wire, a disk with a large number of holes in it, a wire gauze frame, or other forms. Its function is simply to stop as many or as few of the electrons from passing from the filament to the anode plate as may be required.

The grid may be given a varying potential, negative or positive. When the grid potential is zero the flow of electrons is not

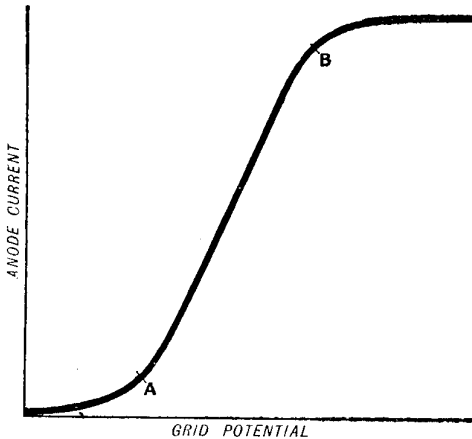

ANODE CURRENT CURVE

In this characteristic curve the current is plotted against voltage. The positions of A and B depend upon construction of valve and filament temperature

interrupted. When negative, some of the electrons are repelled and are unable to reach the anode plate. The anode current is therefore decreased. When the grid is at a positive potential the flow of electrons is increased. Some are attracted to the grid and flow round the grid circuit, but the greater number pass through the open mesh, or the spiral grid wire, to the anode, and so increase the anode current. Small variations in the grid potential cause large variations in the anode current.

The figure shows a characteristic curve of a three-electrode valve for the anode current plotted against the grid potential. It will be noticed that the curve slopes gradually from zero potential until it reaches the point A, when it rises rapidly at a practically constant rate, and then bends at a point B, from which it becomes practically horizontal. The positions of the points A and B depend upon the con-

struction of the valve and the temperature to which the filament is heated.

By the use of the grid, or control electrode as it is sometimes called (from the fact that it controls the flow of electrons to the anode), the straight part of the curve may be more usefully employed than if the grid is not used. It is this part of the curve which is important in amplification. In this part of the curve the anode current changes are very much greater for a given change in grid potential than in the parts of the curve below A or above B. See Anode Voltage; Electron; Filament; Grid; Valve.

ANODE REACTANCE COIL. A coil intended to be used in the anode circuit to provide a measure of reaction, as when one valve in a two-valve set is used as a high-frequency amplifying valve, followed by a detector. There are many ways in which the unit can be employed. For example, it can be used in a single-valve regenerative circuit, or almost any circuit with two or more valves, where reaction on the anode is needed. It consists, in one typical example, of a plug-in coil that is placed in the holder for a transformer, and comprises a tapped coil with a reaction coil as a separate element. This is capable of being tuned by moving the reaction coil nearer to, or farther from, the other. The tappings are provided to enable the coil to be used for various wave-lengths, thus avoiding the need for several separate coils.

A well-known example of the anode reactance coil comprises an air core

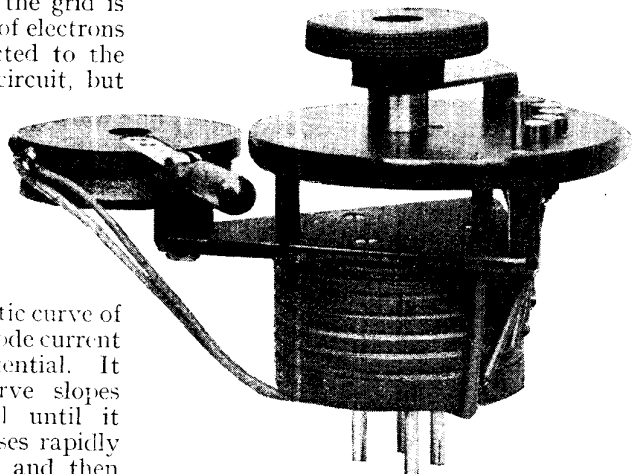

ANODE REACTANCE COIL

Fig. 1. The photograph shows a plug-in tapped coil with the reactance coil on the left. Tappings will be seen on the right of the plug-in coil

inductance for reactance capacity coupled radio-frequency amplification. The wire is wound in the form of a coil on a grooved cylinder with twelve tapping points. The

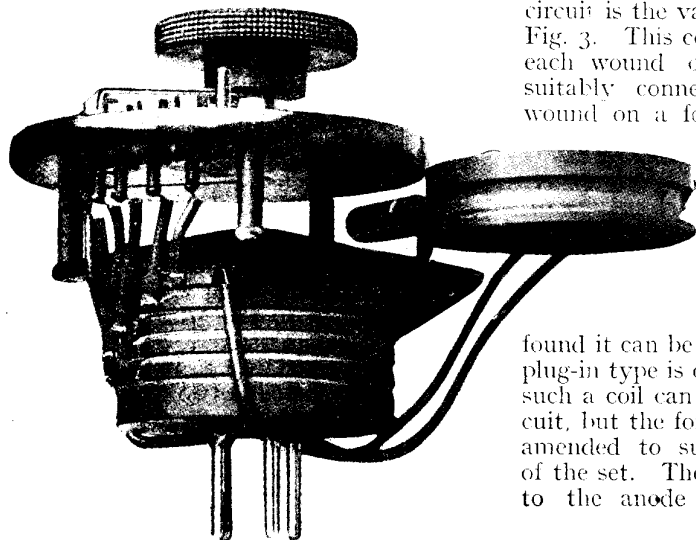

TAPPED ANODE REACTANCE COIL

Fig. 2. How the tappings are taken and wired to the studs of the switch will be seen from this view of the coil shown in Fig. 1

impedance value of the tappings should be so arranged that the value of the reactance is practically uniform for all the wave-lengths available with the instrument.

Generally, a separate tuning condenser is unnecessary with such a device, as if properly proportioned the capacity of the windings should be sufficient to render the coils self-tuning. In the pattern illustrated, Figs. 1 and 2, there are six tappings. Contact is made by means of the contact arm on the top of the coil. The arm is provided with a knurled ebonite knob, but if desired a long extension handle could be fitted in its place. The reaction coil is separately mounted on a pivot supported by an extension plate of ebonite attached to the top of the coil. The reaction coil is wound on an ebonite former, which is supported by a metal arm fitted with a long handle with an ebonite knob. Connexions between the reaction coil winding and the terminals are by means of two flexible wires well insulated. These permit the coil being turned around on its pivot, thus varying the tightness of the coupling.

Such devices need to be well made and very carefully wound, and they should also be handled carefully to obviate risk of damage. Another type of reaction coil that can be employed in the anode circuit is the variometer type, as shown in Fig. 3. This consists of two coils of wire, each wound on a separate former and suitably connected. The inner coil is wound on a former smaller in diameter than the other and it is pivotally mounted so that it can be turned on its axis by means of the ebonite knob at the top. This is calibrated, so that once the best tuning point has been

found it can be noted for future use. The plug-in type is one of many ways in which such a coil can be added to an anode circuit, but the form of the terminals will be amended to suit the other components of the set. The application of such a coil to the anode circuit of a single-valve

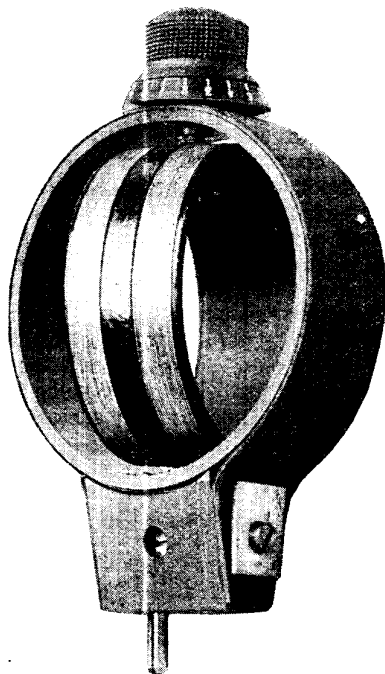

ANODE REACTANCE VARIOMETER

Fig. 3. The variometer shown is calibrated for anode tuning. It is designed for plugging-in as a convenient means of inserting into the anode circuit. Other designs of variometers are also used for the same purpose

receiver is shown in Fig. 4. The values of the coils will have to be appropriate to the wave-length band to be dealt with or the general arrangement of the set as a whole.

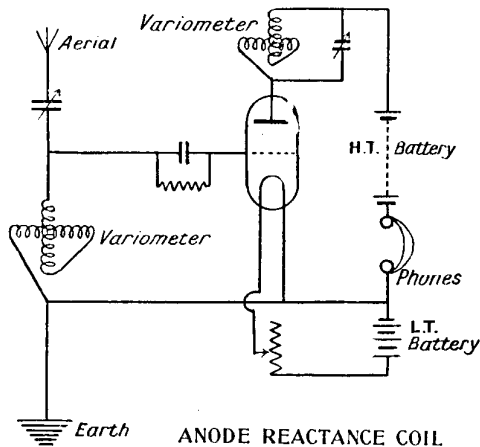
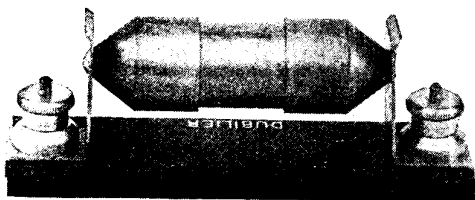

Fig. 4. A variometer as represented in Fig. 3 is shown diagrammatically applied to the anode circuit of a single-valve receiver

ANODE RESISTANCE. A non-inductive resistance employed in the anode circuit. The application of such a resistance is exemplified in many of the circuits given through this Encyclopedia. A typical example is that shown in Fig. 1, as applied to a two-valve receiver with resistance capacity coupling between the valves. The function of the resistance is to build up an amplified potential across the terminals of this resistance. This amplified radio-frequency current is handed on to the grid of the second valve, where it is rectified in the usual way. The anode resistance is generally of the order of 50,000 to 100,000 ohms. Such circuits are not suited to short wave-length reception, and are practically useless compared with others for wave-lengths of 1,000 metres or less. The amplification secured



DUBILIER ANODE RESISTANCE

Fig. 1. Non-inductive anode resistances of this type vary from 50,000 to 100,000 ohms. The function of this component is to set up an amplified potential in the anode circuit

with resistance capacity coupling of this character is not so great as that from the tuned anode circuits more generally adopted for reception of broadcasting.

The action of a resistance in the anode circuit is to set up an amplified current in the anode circuit, and to apply it to the grid of the next valve. This amplification is due to the resistance offering a considerable impedance to the flow of current, and this sets up oscillations which are handed on through the condenser to the grid circuit. This may in some cases build up an excessive voltage on the grids, as it cannot leak away fast enough through the grid circuit resistances, a condition that can be dealt with by applying a positive voltage to the grid through the agency of a potentiometer.

The anode resistance is, in appearance, a cylinder supported in two metal contact brackets attached to an ebonite base. The contacts are provided with terminal nuts to facilitate attachment of the necessary wires. A good example is the Dubilier, illustrated in Fig. 1. This can be obtained in various values, that is with a resistance of known amount and stated value in ohms. Another type is the Mullard, shown in Fig. 2; this can also be obtained on a base with contact plates,



MULLARD ANODE RESISTANCE

Fig. 2. Another example of anode resistance. This can also be obtained mounted on a base with contact plates, or a universal holder can be made, as shown in Fig. 3

or may be attached to clips on a fixed condenser.

Anode resistances are not standardized as regards their size, and to accommodate the various makes it is a good plan for the experimenter to make a universal holder with an adjustable holding device.

One simple way of doing this, shown in Fig. 3, is to make a base of ebonite about 5 in. long and $\frac{3}{4}$ in. wide. This should be about $\frac{1}{4}$ in. thick, and when squared up is drilled with four small holes in the corners for the holding-down screws. Two other holes are drilled, near the ends, for two telephone terminals. One of them is fixed at the end, and acts as a support for the pointed cap of the resistance. The other end is provided with a screw with a recess drilled into the head of it, and this should be about $1\frac{1}{2}$ in. long.

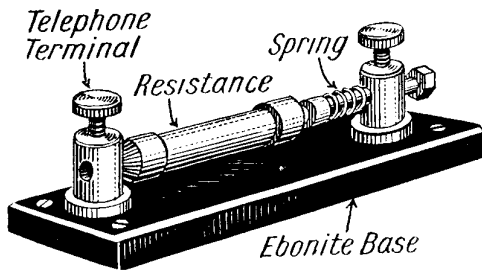

ANODE RESISTANCE HOLDER

Fig. 3. Provision may be made for adapting any size of anode resistance to a permanent mount by the construction of the holder here shown

It should fit nicely in the hole through the terminal, and can be fitted with a small spring to press it into contact with the cap on the resistance, in which case the end should have a nut screwed tightly to it so that the spring does not press it right out when the resistance is removed. In use, the resistance is placed into the hole in one terminal and held there by the spring-pressed screw.

The resistances can be made from stout paper (cartridge paper is as good as any), and this is coated with a mixture of graphite and paste. When quite dry, it can be cut into strips, wrapped in a little tube of paper, and capped at the ends with brass ferrules pointed to fit the holder. The exact values of every resistance made in this way will have to be tested, as the values will vary with each piece of paper. As a start, try a piece about $1\frac{1}{2}$ in. long and $\frac{1}{4}$ in. wide, which should work out somewhere in the neighbourhood of 60,000 ohms. Another method is to roll up a strip of paper and draw resistance lines on it with a soft lead pencil. The ends should be capped with metal, secured with a mixture of graphite and some graphite paste such as aquadag, mixed in the proportions of about 1 of the aquadag to 4 of the graphite, the latter well washed in absolute alcohol.

ANODE TAPPING POINT. The point on the inductance in the main oscillating circuit of a valve generator which is connected to the anode of the valve.

In continuous wave transmission the value of the anode circuit inductance can be so chosen that it gives a maximum oscillating current in the anode circuit. This adjustment on the oscillating circuit is the anode tapping point, and is generally known as the anode tap.

ANODE VOLTAGE. The voltage between the anode and the negative terminal of the filament of a thermionic valve.

The figure shows diagrammatically how the effect of anode voltage on anode current may be measured. A simple two-electrode Fleming valve has been considered in the diagram. A is the plate, G a galvanometer. The filament terminals are connected to a battery and filament resistance, to enable the current through the filament to be varied. The anode is connected to a battery, as shown. When the voltage of B_2 is varied, the anode potential varies with respect to the fila-

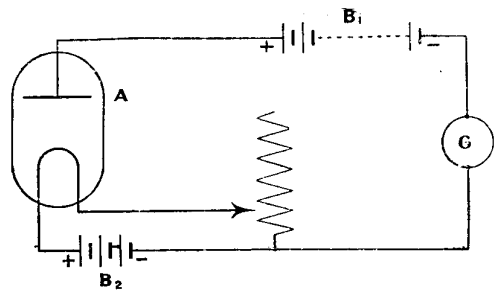

ANODE VOLTAGE AND CURRENT

How the effect of anode voltage on anode current may be measured is here indicated

ment. The increase of potential on the anode increases the number of electrons flowing from the filament, and so increases the current which is registered by the galvanometer. See Anode Current.

ANTENNA. The system of conductors in a wireless station for radiating or absorbing ether waves. The term aerial (*q.v.*) is more generally used.

ANTI-CAPACITY GRID LEAK. Type of variable grid leak with an anti-capacity extension arm. One such form of grid leak consists of a semicircular lead pencil grid leak, which has a number of brass studs fitted in its path to act as tapings to vary the resistance. The base of the grid leak is made of an insulating material, and in the centre is mounted a phosphor-bronze switch arm. This arm has fitted on it a knob, across the top of which is cut a slot. The leak gives an effective and sensitive control of the rectifying valve and enables surface noises and cracklings to be considerably reduced, if not eliminated altogether. The extension handle is an insulating rod, and a small brass pin at one end fits into the slot cut in the knob on the switch arm. See Grid Leak.

ANTI-CAPACITY SWITCHES: CONSTRUCTION AND USES

Important Considerations in Wireless Equipment Design

The methods of making and the materials used are here described. Their advantages as compared with other types of switches and their adaptability for various requirements are also explained. See also Capacity; Switch, etc.

It is sometimes important in wireless equipment that contingent apparatus, like switches, should have a small electrical capacity. Capacity is an electrical function which has a hydraulic analogy to the stretching and contraction of a diaphragm fitted over the open end of a water pipe which is subjected to intermittent pressure of water within the pipe. Electrical capacity is obtained by placing at the ends of a conducting wire comparatively large areas of thin metal, separated by a dielectric, *i.e.*, by a high-value insulating material, as shown in Fig. 1.

If such a device were made into a switch, in the manner shown in Fig. 2, it would have a large capacity. Here the type of switch is, in effect, two metal plates separated by a dielectric, air, and a fresh capacity would be introduced into circuit. Ordinary electric light tumbler switches have a relatively big capacity, and should not be used in the high-

frequency circuits of a wireless outfit. Fig. 3 shows a type of switch which has a relatively small capacity, and one which is much better to use than the type shown in Fig. 2. No large opposing surfaces capable of absorbing electrical forces are presented in this design. Knife switches, as in Fig. 4, are also employed to achieve the same object.

Many of the handles of wireless instruments are made long, so that the hand of the operator, while using them, does not act as a condenser, introducing capacity, and upsetting the adjustments he is making. Unless the receiving set is properly connected and insulated, there is always likely to be trouble through body capacity.

The Buradep is an example of the use of wires for contacts in an anti-capacity switch, and is shown in Fig. 5. It is operated by throwing over the ebonite switch handle which engages the tops of

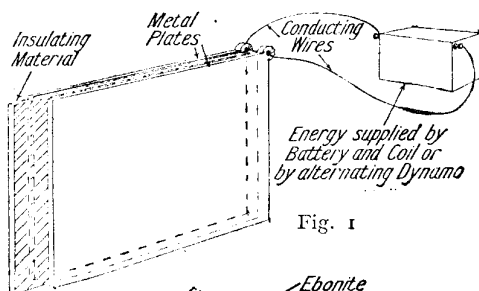

Fig. 1

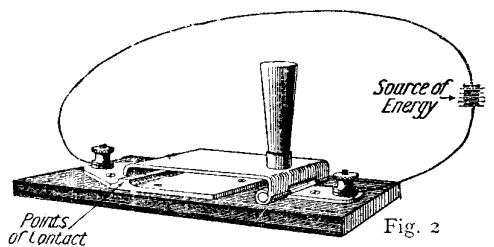

Fig. 2

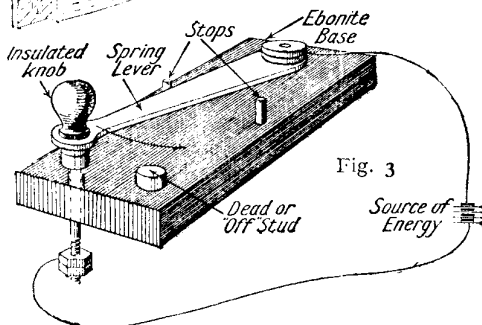

Fig. 3

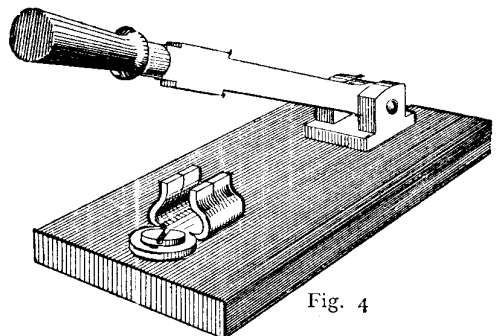
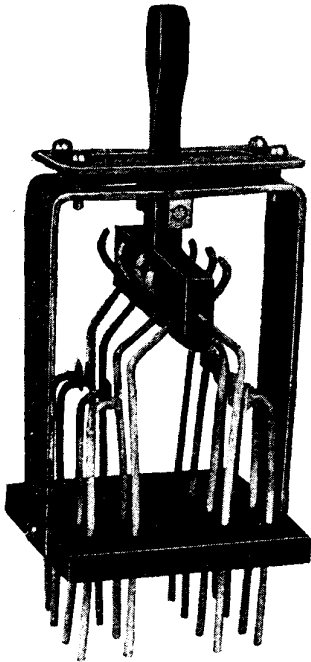

Fig. 4

MINIMIZING CAPACITY IN THE DESIGN OF SWITCHES

Fig. 1. How capacity is obtained in an electrical circuit. Fig. 2. This form of switch, owing to its two large surfaces parallel to each other separated by an insulator (air), has a relatively large capacity. Fig. 3. The purpose of this switch, which is of small inherent capacity, is cutting in capacity instruments. Fig. 4. A very usually adopted type of switch is the knife switch, which has small capacity

the contact wires on one or other side, according to the direction in which it is moved. The circuit is broken when the handle is vertical. The action is clearly appreciated by a comparison of Fig. 6, showing the switch in the off position, and Fig. 5, with the contact made to the right-hand side set of wires.



HOME-MADE ANTI-CAPACITY FOUR-WAY SWITCH

Fig. 8. A simply-made type of switch with wire contacts for panel mounting. It would be suitable for use with a high-tension battery

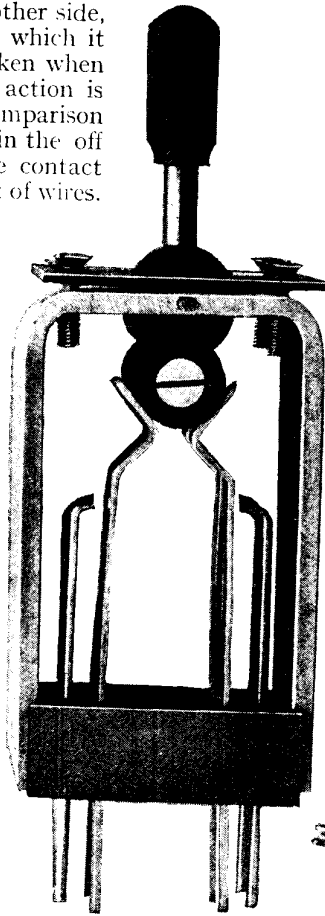

ANTI-CAPACITY SWITCHES

Fig. 6 (above). Burndept switch, with wire contacts, in off position. Fig. 7 (right). Economic Electric Co.'s switch for panel mounting with blade contacts operated by a cam



Fig. 5. The Burndept switch making contact with right-hand set of leads

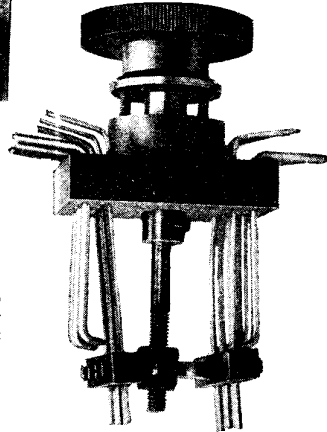

Another type is that by the Economic Electric Company, shown in Fig. 7. This is intended for panel mounting, and is operated by rotating the knob. This moves a cam-shaped lever which rocks a moving bar at the base of the switch, and thus moves the contact blades into or out of contact with the wires that are fastened to the stout ebonite plate at the top of the switch.

The connecting wires are attached to the contact blades at the top, and are thus very conveniently placed for panel work, as they are adjacent to the back of the panel and away from other wires.

There are thus fewer loose wires and less risk of any interference between them.

How to Make an Anti-capacity Switch.

The construction of a change-over or double-pole switch on anti-capacity lines, is not difficult. It does not call for any elaborate tools, neither is any particular mechanical ability necessary. Moreover, the switch can be arranged to act as a double-pole switch, as a double-throw switch, or as a multi-way. The number of contacts can be varied, increasing or decreasing them as occasion necessitates. The accompanying drawings and illustrations (Figs. 8 to 15) show a four-way

switch. Fig. 9 illustrates one method of attaching the wires, whereby, for example, the positive and negative wires from the low or high-tension battery circuit can be connected to separate contacts embedded in the T-shaped portion of the control handle or switch arm. The result is that in the vertical position the circuits are entirely broken and the current does not pass at all.

When the handle is thrown over to the right its position is shown in Fig. 9. The

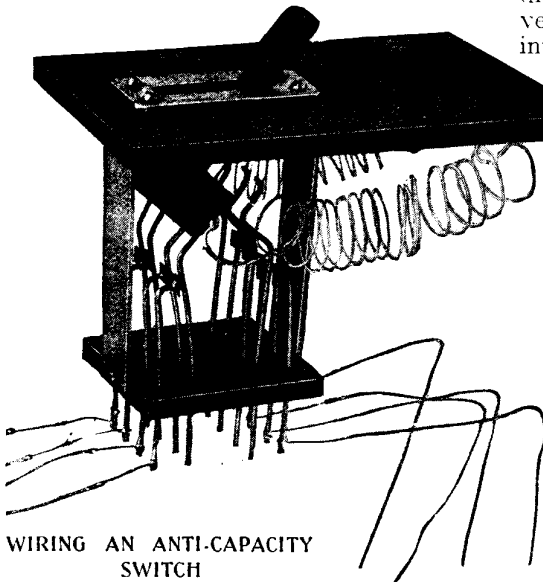

WIRING AN ANTI-CAPACITY SWITCH

Fig. 9. The method of attaching the wires and the manner in which the panel is fixed may be seen from this example.

plus side of the circuit is then connected to the two wires on the left-hand side of the base, and the minus side of the circuit to the other two on the same side of the base. When the switch is thrown over to the opposite side of the slot, contact is made with the wires on the right-hand side of the base and in similar order. The intermediate wires are not connected anywhere. They are merely moving parts whose function is to act as spring connectors between the contacts embedded in the handle and those on the ends of the upright contact arms.

The capacity effects are thereby reduced to a minimum, and by varying the number of the wires and the arrangement of the contacts in the handle, a great many intricate circuits can be controlled from the one point.

An alternative method of wiring is to omit the leads to the contacts in the handle, and to connect alternate wires to the upright contacts on the base plate, so that when the switch is thrown, contact is made between two adjacent contact arms.

The method of construction is quite simple. First prepare a baseboard from a piece of ebonite, $\frac{1}{4}$ in. thick and to the dimensions given in Fig. 11. Mark out the number of switches as shown, and drill sixteen holes $\frac{1}{16}$ in. in diameter vertically through it. File two slots into opposite sides for the fitting of the U-shaped brass standard shown in Figs. 10 and 12, and drill and tap holes into the baseboard to accommodate No. 7 B.A. screws, which attach the standard to the base. A slot must be cut through the top of the standard to permit the switch handle to swing to and fro, as shown in Figs. 10 and 12.

Two bearings have now to be made to support the spindle upon which the switch handle turns, and these can be made from two small brass telephone terminals, which are riveted into holes drilled in the top of the standard. The sides of the tele-

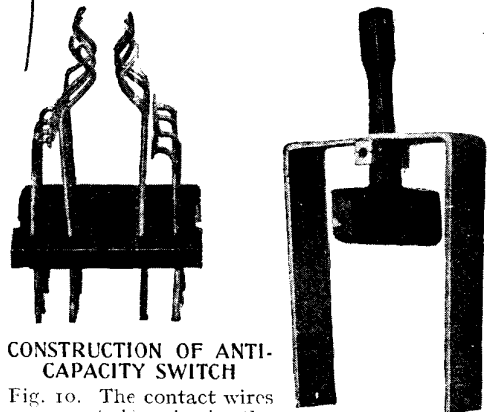

CONSTRUCTION OF ANTI-CAPACITY SWITCH

Fig. 10. The contact wires are mounted by piercing the ebonite base. The standard and handle are shown as a separate part

phone terminals are then filed away flush with the standard and with the walls of the slot. The binding screws are not required, and may be set aside for some future use. The only other work on the standard is that of drilling and tapping four holes at the top for the four No. 7 B.A. screws which attach it to the panel

and hold the outside guide plate in position on the front of the panel. This is clearly shown in Figs. 8 and 9.

A slot has to be cut through the panel, and holes drilled for the passage of the screws. When bending the corners of the standard, take care not to bend the brass too sharply, or it may crack. It can be pressed over a good way with the fingers if one part is held in the vice, and the final straightening up can be effected by gentle hammering.

The switch handle, as shown in Figs. 10 and 14, is T-shaped, and can be sawn to shape with a hack saw from a piece of ebonite at least $\frac{1}{8}$ in. thick, and preferably $\frac{3}{8}$ in. The dimensions are given in Fig. 14. Next cut four slots in the wide part of the T, or head, making these the same width as the upright wires are thick—that is, slightly over $\frac{1}{16}$ in. Then drill a $\frac{3}{32}$ in. hole through each end of the T, terminating these at the second slot, or just slightly beyond it, but so that there is at least $\frac{1}{4}$ in. of ebonite separating the two holes. A piece of plain brass rod is then inserted into the holes, and if the parts are correctly fashioned in accordance with the drawings, the rod will be visible through the slots. Drill a $\frac{1}{16}$ in. hole through the pivot point of the handle, bringing this carefully in register with the holes in the bearings in the top of the standard, and provide a brass pin, which should pass freely through the holes in the bearings and fit tightly into the ebonite switch handle.

The next step is to prepare eight sets of contact arms. These are made from No. 16 gauge hard brass wire, bent to the shapes shown respectively in Figs. 10 and 15. The bending can be accomplished by means of pliers and applying the bent wire to a full-size drawing of the exact shape for them. If any number of these wires are to be made, it will be preferable to file up an odd piece of metal to the correct profile and bend the wire by pressing and tapping it on this block. This method will ensure greater uniformity of results.

Then insert the eight long wires, by working them through the holes in the base, and bending them slightly until they all stand up parallel with each other and in line, and so positioned that when the switch handle is vertical they do not

touch the contact bar in the switch handle, but the angle point on the wire is just slightly entering the slot in the ebonite. This will prevent them wandering about, and ensure that contact is broken. Now turn the switch over as far as it will go in one direction, and it will be found that the contact rod in the ebonite handle then engages the bent-back part of the wires, and their springiness keeps them in firm contact. Throw the switch over as far as it will go in the opposite direction, and the contacts on that side are quickly made. It should be noted, also, that when the switch is returned to the off position, contact is not made with any of the eight upright wires.

In the ordinary way, such switches would be sufficiently good for low-tension currents, but it is desirable to add a second break, Fig. 15, and this is accomplished by making eight short, upright contact arms from similar-sized wire, and bending them over at right angles at one end, soldering to these ends little contact plates, about $\frac{1}{8}$ in. square, made from hard-rolled sheet brass.

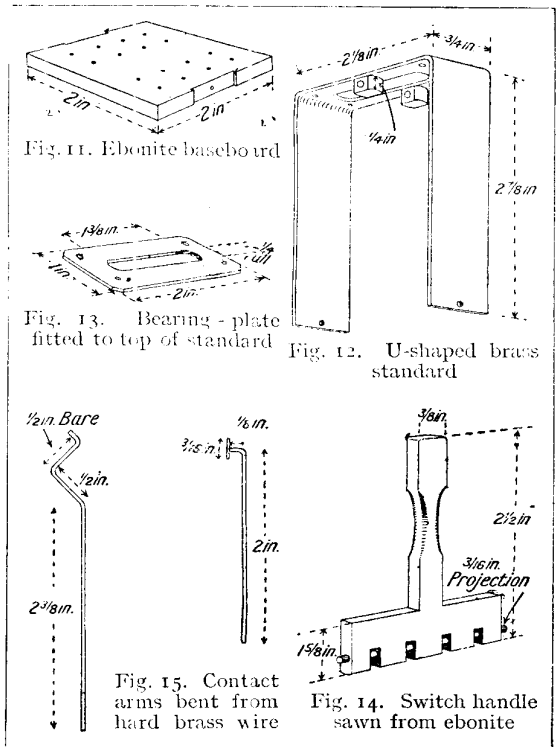

CONSTRUCTIONAL DETAILS FOR THE ANTI-CAPACITY SWITCH

These rods, when so prepared, are pressed through holes in the baseboard, and when the switch is in the off position contact should be doubly broken, the first break being between the contact bar in the switch handle and the upright wires, and the second between the back of the upright wires and the contact faces of the short-contact wire arms. These can be bent outwards or forwards slightly, to accomplish this severance of the contact between them.

Next throw the switch arm over as far as it will go, and observe that contact is now made between the contact bar at the top and also between the upright wires and the contact plates at the bottom, as shown in Fig. 9. The wires should be cleaned and polished to ensure the best contact.

The method of attaching the wires, by soldering them to the ends of the contact wires, is shown in Fig. 9, and also the two-coiled flexible leads soldered to the contact arms in the switch handle. These leads should be sufficiently flexible to allow the switch handle to move freely, but should not be coiled more than is necessary. The most convenient way of doing this is to coil up a sufficient length of wire, and solder one end to the contact bar in Fig. 9, and afterwards to pull out the coil and straighten it up, connect it to its proper terminal, and cut off any surplus.

The best finish for the metal work is bright nickel plating. The parts may be sent to the platers with instructions to bright nickel-plate them. On their return, they can be reassembled, but will probably be found to be slightly bent. Such inaccuracies should be remedied, the switch operated a few times, taking care to note that it makes perfect contact and also a perfect break. A test may be made by coupling up a dry battery to the contacts and the switch handle, and using a bell or buzzer, connecting across the lead from each pair of contact wires in turn.—*E. W. Hobbs, A.I.N.A.*

ANTI-LOGARITHM. The logarithm of a given number is looked out in the tables. The number for a given logarithm can also be looked out, and is called its anti-logarithm. *See* Logarithm.

ANTINODES. Points of greatest amplitude in a train of waves or oscillations. These points are also sometimes known as loops or loops of potential. In a

system which has a non-uniform distribution of root mean square current or voltage, any point at which the root mean square value is at its maximum is called an antinode of current or of voltage respectively. *See* Root Mean Square; Wave.

ANTI-SPARK DISKS. These are disks of ebonite, which form part of the construction of the Bradfield insulator, a leading-in insulator used in wireless transmitting sets. Three such anti-spark disks are usually fitted at equally spaced intervals along the ebonite tube, and assist in preventing sparking over the surface in wet weather. *See* Bradfield Insulator.

ANTI-SULPHURIC PAINT. A mixture that is not affected detrimentally by sulphuric acid. It is obtainable from electrical sundries supply stores, and is used on woodwork, metal, and other substances to protect it from the attack of an acid or the fumes given off by it, as, for example, the interior of the carrying case for a small accumulator as employed for the filament lighting circuit in a wireless receiver set. The use of this class of paint on the stand for a set of accumulators saves the wood from rapid decay. The constituents of such paints vary considerably, and include such materials as Burgundy pitch, beeswax, asphaltum, and compositions such as a mixture of raw rubber, linseed oil, litharge, and a trace of slacked lime. Vaseline and other fatty substances and thick oils are useful in emergency, and can be applied to the surface of the woodwork.

APERIODIC. Dead beat. Instruments, such as ammeters, voltmeters, and galvanometers in general, depending for their indications upon a swinging pointer or needle, have a natural period of oscillation depending upon the length of the pointer and the controlling force. This causes the pointer to overshoot the mark in the first deflection, and then to swing to and fro with a continually decreasing amplitude, until it finally comes to rest. In some cases the interval between the first swing and the final stage of rest is inconveniently long, and especially when the impulse giving rise to the deflection is itself transient or of variable intensity. It is consequently important, in order to obtain a quick and accurate reading, that this natural period of oscillation should be reduced to a minimum by some damping

device which, without affecting the final accuracy of the reading, will allow the final position of the pointer to be reached quickly and without lost motion.

There are various ways of reducing this period of swing, such as decreasing the weight and leverage of the moving parts, so as to lessen their moment of inertia, or by increasing the controlling force by comparison with the deflecting force. The latter, however, appreciably decreases also the sensitiveness of the instrument.

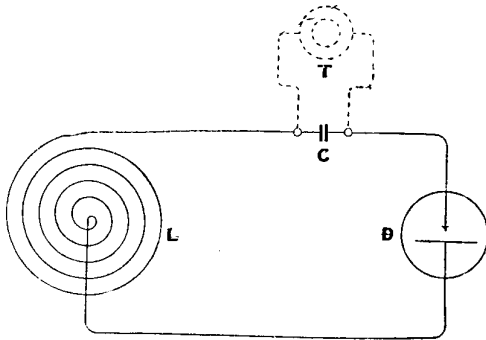

APERIODIC CIRCUIT

Oscillatory currents are rendered aperiodic by means of the detector D. Inductance is shown at L, telephones at T, and condenser C

Other methods of damping which do not affect the sensitivity are : (1) Air damping, by attaching a light vane to the pointer, which moves in a more or less confined space after the manner of a dashpot. (2) Oil damping, the vane attached to the pointer dipping into a small vessel containing oil or glycerine. And (3) Magnetic damping, which is accomplished by causing the pointer to swing a copper vane between the poles of a permanent magnet, thereby setting up induced eddy currents which retard the motion.

Instruments that are so well "damped" as to come to rest without getting up a periodic swing are called "dead-beat," or "aperiodic." Hot-wire and moving-coil instruments are in this class; moving-iron instruments are only relatively dead-beat.

In an aperiodic aerial system no tuning condensers are used in the acrials, which are closed loops. This construction enables them to pick up oscillations of any frequency and simplifies direction finding.

APERIODIC CIRCUIT. This is a circuit containing inductance and capacity in parallel with which is a contact detector, and a socket for a head telephone. In the figure the inductance is shown at L, the

detector at D, the capacity at C, and sockets for the telephone at T. Oscillatory currents induced in this circuit are rendered aperiodic by means of the detector, and then made audible by means of the telephone placed in the socket. In the actual apparatus the inductance coil would usually be mounted in the flat case, which could be rotated on a stand in order to obtain the best position for mutual inductance between it and the transmitter. The detector can be plugged into the same base together with a fixed condenser, and for use it is then only necessary to plug in the telephone to the socket provided.

APPARENT POWER. The power as shown by measuring instruments need not be a measurement of the true power. In an alternating current circuit, for example, the apparent power is that indicated by the product of voltmeter and ammeter readings, and is seldom the true power. The apparent power is the product of the mean effective value of the voltage across the circuit multiplied by the mean effective value of the current therein, as read by the ammeter and voltmeter. The apparent power is always given in kilovolt-amperes, usually written KVA, 1,000 volt-amperes. Kilowatts are used to express the true power obtained from the reading of a wattmeter. The ratio of the watts to the volt-amperes is called the power factor.

APPLETON, EDWARD VICTOR. Born at Bradford, in 1892, and educated at St. John's College, Cambridge, where he took



Dr. E. V. APPLETON

Dr. Appleton has made a special study of the thermionic valve, and contributes the article on "Valves for Reception" to our Encyclopedia

first-class honours in natural science, Appleton for some years made a special study of the thermionic valve, on which he has become one of the leading authorities in Great Britain. He has been engaged in research work on valves at the Cavendish Laboratory, Cambridge, and

has contributed articles on the subject to a number of scientific journals. He is a member of the Thermionic Valve Subcommittee of the Radio Research Board and has written one of the articles on "Valve" for this Encyclopedia.

ARC. The standard definition of an arc is a luminous discharge of electricity through a gas in which the material of one or both electrodes is volatilized, and takes place in the conduction of the current, whether continuous or alternating. The temperature of the arc is assumed to be the same as the boiling point or the vapour point of the negative electrode. This is nearly always carbon, which vaporizes direct from the solid state. In wireless the word is often synonymous with any device which generates oscillations by means of the electric arc—in fact, an arc transmitter. See Arc Oscillator; Arc Transmitter.

ARCING SPARK. The continuous discharge that sometimes takes place between the spark knobs of a transmitter is sometimes very troublesome when the capacity in circuit is too small. The discharge commences at the same time as the energy is being given off to the oscillating circuit, and if the current persists for a longer time than the natural period of the circuit, it is known as an arcing spark. Bad arcing takes the form of a hot red spark, with a thick, furry appearance, and is very destructive to the knobs or points. A white crisp spark is the correct condition of discharge, and has a distinctive crackling noise.

ARC LAMP. The arc lamp in its relation to wireless matters is an apparatus of great importance. It is one of, if not the oldest, means of generating continuous waves of radio-frequency, and is the outcome of investigations made by Duddell and Poulsen. Duddell was the first to discover that if a direct current arc is struck between two carbon rods, and has its terminals shunted by another circuit containing inductance and capacity in series, an alternating current appears in this latter circuit, and when its frequency is within the limits of audibility a musical note is produced. This was the "singing arc" of Duddell. Suitable variations in the shunted circuit result in waves of radio-frequency being emitted.

The explanation of this phenomenon is as follows: The conducting circuits offered by the incandescent particles of carbon be-

tween the electrodes of the arc lamp when at work differ in one very important respect from the behaviour of ordinary metallic conducting circuits. The resistance of an ordinary conductor is a more or less constant quantity, subject to small molecular differences arising from changes of temperature; but the resistance of the arc is by no means constant, and increases as the applied potential is raised. In effect this means that the arc itself can be said to possess a "negative" resistance, or, in other words, small increases in the potential difference across the carbon electrodes lead to an actual *decrease* in the amount of resultant current which passes. The ordinary laws of potential, current, and resistance associated with Ohm's law cease therefore to apply in the customary way.

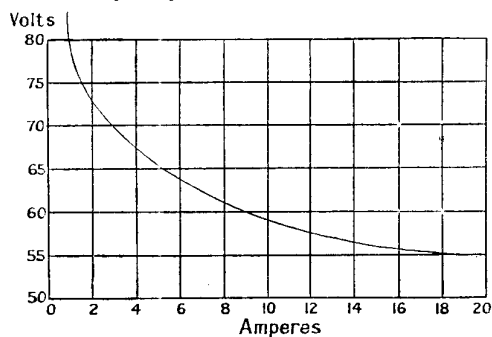

CHARACTERISTIC CURVE FOR CARBON ARCS

Curve showing how with carbon arcs burnt in air the potential increases as the current decreases. It is called the characteristic curve of the arc

If the ordinary continuous current arc, using carbon rods, has the current raised and the distance between the arcs kept constant, we can measure the potential difference between the terminals and obtain what is known as a characteristic curve of the arc. Such a curve is shown in the diagram, plotted amperes against volts. It will be seen from it that as the current, measured in amperes, increases the potential difference, measured in volts, between the electrodes falls, and, of course, vice versa. This is an important fact which is made use of in the arc transmitter.

If a condenser and inductance are shunted across the arc, the condenser takes current from the arc, assuming a constant current supply. The inductance should have a large ratio to the capacity, and its function is to prevent any rapid change in the value of the current passing through it. The current through the arc

being lessened, it follows from the characteristic curve that there is an increase in the potential difference between the electrodes of the arc, assisting in charging the condenser.

The condenser is by this means ultimately charged to a higher voltage than the normal potential difference across the arc terminals. It then discharges back through the arc, so increasing the current through the latter. Again, from the curve, it follows that there is a decreased potential difference between the arc terminals. The condenser discharges until its voltage is less than the normal arc voltage, the arc current falls, the potential difference between the terminals rises, and the cycle is repeated. The rate of charge and discharge of the condenser is dependent on a number of facts, as its capacity, the size of the inductance, the length of the arc, and so on.

The steeper the characteristic curve, the greater is the strength of the oscillations. The steepness of the characteristic curve depends greatly upon the materials used for the electrodes, and of the medium in which they are burning. The best electrodes are of silver, but the cost is prohibitive, and the best medium hydrogen, coal gas, or one of the hydrocarbons such as alcohol.

With arcs in air at ordinary atmospheric pressure, very high frequency oscillations are not obtainable. To obtain such high frequencies, a double oscillation circuit, one circuit being tuned to a harmonic of the other, is shunted across the arc terminals.

The simplest generator of radio-frequency oscillations is shown in Fig. 2. A direct current generator supplies the arc

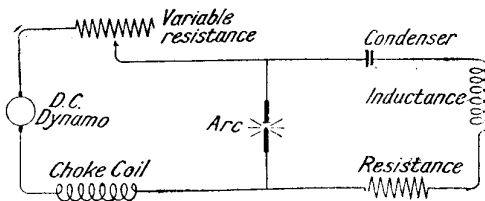

SIMPLE ARC GENERATOR CIRCUIT

Fig. 2. This diagram shows the simplest method of generating radio-frequency oscillations by means of an arc lamp. Practical circuits are shown in Figs. 3, 4, and 5

through a variable series resistance, controlling the current that passes to it, and a choking coil is also included in this circuit, which is more or less inoperative

where direct currents are concerned, but exercises a check against any alternating current tending to pass through the generator circuit. Oscillating current is shunted off the arc terminals, and this circuit contains inductance, capacity, and resistance, the values of which need careful selection and adjustment.

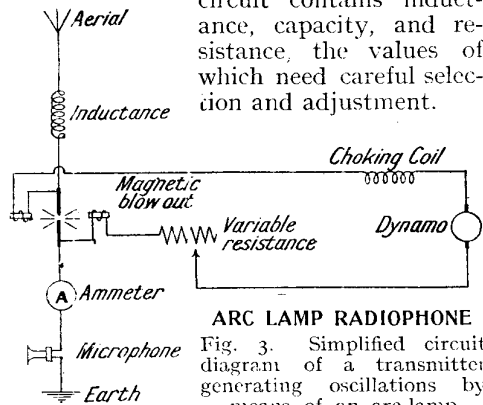

ARC LAMP RADIOPHONE

Fig. 3. Simplified circuit diagram of a transmitter generating oscillations by means of an arc lamp

A typical arc radiophone transmitter circuit is illustrated in Fig. 3, the connections being simplified as far as possible to exhibit merely the principles involved. Some improvement in overall efficiency results in adopting a method due to Fuller, and is shown in Fig. 4. In this circuit it is seen that in shunt with the arc is another condenser, while the series aerial condenser is further shunted with an inductance and a resistance. The function of this extra condenser is to act as a by-pass for the radio-frequency current, passing through aerial current as supply arc circuit which is

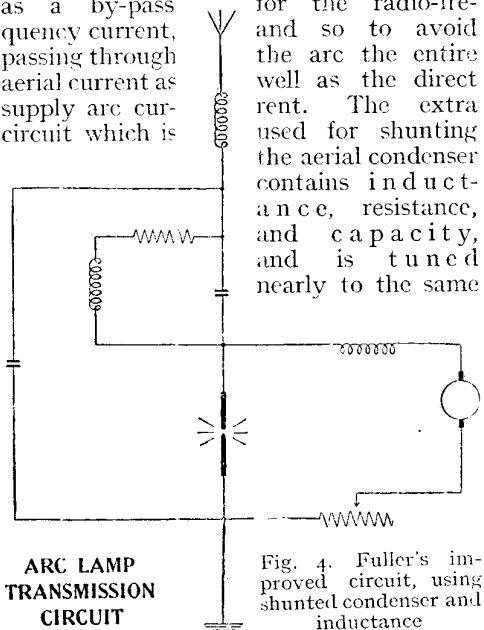

ARC LAMP TRANSMISSION CIRCUIT

Fig. 4. Fuller's improved circuit, using shunted condenser and inductance

frequency as that of the aerial current, thus acting as an absorbing circuit for such currents. Not only does this exercise a powerful choke action for the arc itself, but it assists the shunt condenser also in its action. The more powerful arc transmitting stations use a number of arcs, varying from three to twelve, in series.

The actual connexions of a six-arc set, which is serviceable for either transmission or reception, is shown in Fig. 5. The switch at X is provided for the purpose of diverting the aerial connexion from transmitter to receiver, and is arranged so that it can short-circuit the receiver while transmission is going on by means of auxiliary contacts. Switch Y connects the lines Q S when sending is going on and the arc is giving out oscillations. When receiving only, the oscillations are stopped by opening Q and S. At the same time, the resistance R becomes operative in restraining the amount of direct current supplied to the arcs. During transmission, any alternating current generated by the arc passes through condenser C, while any direct current passes through R. In this way current through the arc is prevented from rising too greatly when the oscillations cease. The microphone is connected across the aerial tuning inductance, which also serves for coupling, consequently the microphone serves the triple purpose of diminishing the coupling, shortening the radiated wave-length, and diminishing the aerial current by dissipating a portion of the available energy. See Arc Oscillator.—A. H. Avery, A.M.I.E.E.

ARCO, GRAF GEORG VON. Born at Grassgorschutz, Schlesien, he was educated at Berlin University and the Technical High School, Charlottenburg. Assistant to Professor Slaby, 1898, he was part inventor of the Slaby-Arco system of wireless telegraphy. He was appointed manager of the Gesellschaft für Drahtlose Telegraphie, 1903, and first carried out a practical wireless telephony demonstration over a distance of twenty-one miles in 1906. At the International Radiotelegraph Congress held in London, 1912, he exhibited a high-frequency alternator with static frequency step-up transformers, as now used in the high-power station of

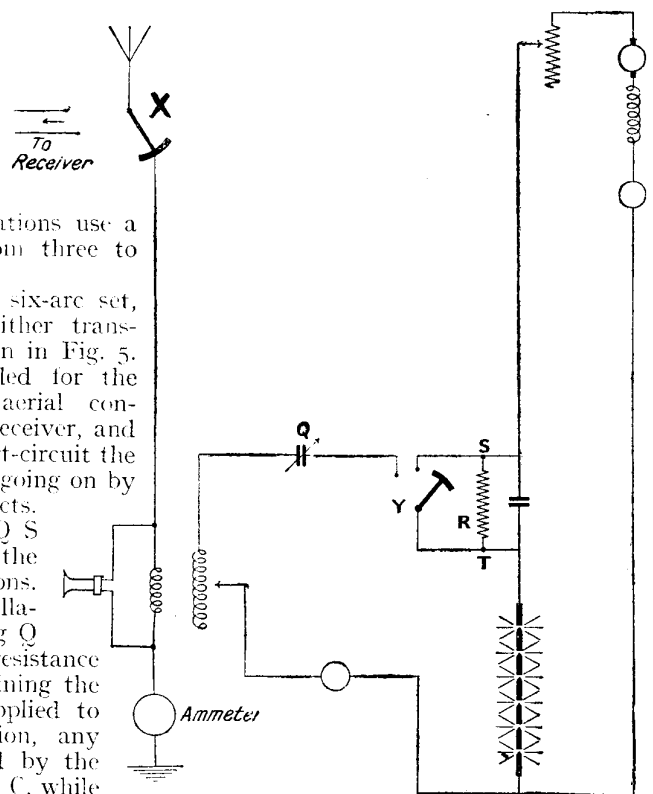

SIX-ARC SET FOR TRANSMISSION OR RECEPTION

Fig. 5. Transmission and reception are conducted by means of this multiple-arc set, power being increased according to the number of arcs used. When transmitting the receiver is short-circuited

Nauen. Arco has written a large number of papers on wireless, including quenched spark signalling, high-frequency alternators, the Telefunken singing spark system, long distance wireless transmission, as well as being the author of a considerable number of patents, including the valve receiver circuit for high-frequency amplification patented in collaboration with Meissner in 1914.

ARC OSCILLATOR. Device for production of oscillating electrical currents.

There are at least five methods in use for the production of continuous wave oscillations for wireless telegraphy and telephony. The first method is by use of arc generators. The second method employs rapid sparks of the quenched type, the wave train being caused to overlap so as to simulate pure continuous waves. The third method, which is less frequently used, is by the use of specially

constructed high-frequency alternators, the design and manufacture of which offer many mechanical difficulties. There is also a fourth method for production of waves by means of static frequency doublers, either of the magnetic type or depending on the use of special rectifiers. The fifth and most recent process involves the use of thermionic valves. It was discovered in 1899 by Duddell

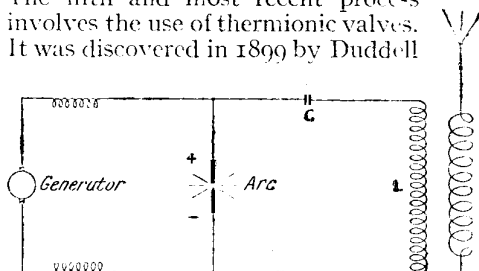

DUDELL'S ARC OSCILLATOR

Duddell's discovery that an electric arc shunted by a capacity and inductance oscillates is represented in this diagram

that if a direct current electric arc, such as used to be familiar for street lighting purposes, is shunted by a circuit containing both capacity and inductance, shown in the diagram at C and L respectively,

oscillations of a frequency equal to $\frac{1}{2\pi\sqrt{LC}}$ occur in the shunted circuit.

The origin of these oscillations may be explained as follows: On closing the condenser circuit when the arc is at work, current flows into it, causing a momentary reduction in the flow of current through the arc. The result is a fall of temperature so far as the arc is concerned, and its resistance increases, becoming a greater fraction of the main circuit than before. The resistance of the main circuit and the potential difference between the arc carbons then rises, causing a further flow of current into the condenser.

Eventually the accumulated condenser charge rises to a value comparable with that of the arc, the result being that flow of current to the condenser ceases and the arc is restored. As soon as the latter condition takes place, current in the arc again rises to its original normal value, its resistance falls, and as a consequence the potential difference between the carbons again falls; this train of events allows the condenser to discharge, and reverses the previous conditions.

The function of inductance in the shunted circuit is to provide electrical

inertia, whereby the circuit is carried past the stable condition and oscillations set up. The condenser thus alternately charges and discharges, the number of oscillations being accentuated by the inertia effect of the inductance present in the circuit. The oscillating energy is, of course, small compared with the energy supplied to the arc, and the system is therefore somewhat inefficient in use.

ARC TRANSMITTER. A device which generates oscillations by means of the electric arc.

Transmission of electric oscillations by means of the electric arc is carried out on the lines explained in the article dealing with arc oscillators. There are many modified forms of apparatus, mostly variations of the Duddell system. In the Poulsen system the arc is enclosed in an atmosphere of hydrocarbons, and a strong electro-magnetic field is provided at right angles to the arc in order to steady it. The proportion of energy thus used by the arc is much reduced in relation to the oscillation output. Poulsen also found that the employment of hollow copper water-cooled elements for the positive electrodes gave much better results than the use of carbon.

The arc transmitter possesses certain advantages over spark transmitters in being applicable equally to telephony and to telegraphy. Also continuous wave transmission for equal aerial power gives greater ranges of operation than damped train spark type transmission. The Telefunken Company at one time used an arc method of transmission, employing a number of arcs in series, the negatives being solid carbon rods and the positives vertical copper tubes cooled by water, and recessed at the lower ends to take hemispherical carbons. The carbons could be moved up or down by a handle when striking the arc to set it in operation. The atmosphere then liberated, consisting of carbon dioxide, collected round the copper electrodes, and served the same purpose as the hydrocarbon of the Poulsen type arc. There are many modifications still in use, but the underlying principles are practically the same.

The action of the Poulsen transmitter is not confined to carbon electrodes, but will work with electrodes of copper and other metals. Poulsen suggested the positive electrode should be copper and the negative carbon for high-frequency

oscillations, as used in wireless. Metallic electrodes are made hollow and water-cooled to ensure steadiness in oscillation, or air-cooled in other forms. Fig. 1 shows one method by which the electrodes are water-cooled.

As has already been stated, in the Poulsen arc a magnetic field is used to obtain steadier oscillations. The field is placed at right angles to the arc, and Fig. 2 shows the arrangement. The arc is enclosed, and burns in a medium of hydrogen and coal-gas, fresh gas being automatically introduced during the operation of the arc. The apparatus enclosing

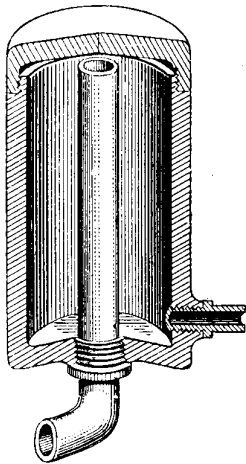

ELECTRODE FOR ARC TRANSMITTER

Fig. 1. Diagrammatic section of a water-cooled electrode for an oscillatory arc

the arc is air or water cooled. The latter method is invariably used on the more powerful transmitters. In the Poulsen transmitter the carbon is mechanically rotated to present a fresh surface to the magnetic field, to keep the temperature of the electrode down, and to obtain greater uniformity in the wearing away of the carbon rod.

In 1917 Pederson published the results of a series of experiments on the Poulsen arc. As a result of these experiments, he pointed out that the arc gives maximum efficiency when the supply voltage is a minimum, and with a constant supply circuit resistance when the supply current is a maximum. The arc, he added, works most efficiently with a magnetic field just strong enough to keep it steady. For the normal Poulsen arc, working with at least 10 to 15 amperes direct current, with an oscillatory wave-length of 1,000 metres or more, the ratio of the high-frequency current to the supply of current equals 0.707, so long as the ratio of inductance in microhenries to the capacity in microfarads is not less than 2,500.

The 5-kilowatt Elwell-Poulsen arc generator, illustrated in Fig. 3, comprises essentially a casing containing the

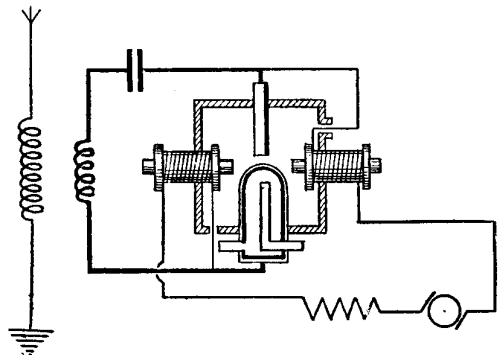

POULSEN'S ARC

Fig. 2. Arrangement of Poulsen's arc, with water-cooled copper anode

electrodes. The case is supported above the level of the two magnets set vertically on either side. The top of the case has radiating fins to dissipate the heat generated by the high temperature of the arc. Above this is the container for the alcohol or other hydrocarbon, in an atmosphere of which the two arcs are burnt. The two electrodes of this arc are separately illustrated in Figs. 4 and 5, the former showing the cathode and the latter the anode. Means are provided to cool the metallic element by passing a flow of water through internal passages within the water-jacket, the pipe connections for which are shown in Fig. 4. The cathode is generally of carbon, and automatically rotated by mechanical means. Fig. 3 shows the pulley-wheel for communicating the motion to the moving element.

An example of a 25-kilowatt arc is given in Fig. 7, which shows one of the Elwell-Poulsen arcs. This is a particularly neat design; the magnets are set in a horizontal position and the arc chamber between them in the usual way. The drip feeds are duplicated, and are seen on the top of the casing. A strong cast-iron framing supports the whole structure. The water-cooling pipes are visible in the lower centre of the illustration, and the details of the cooling system of the anode are shown in Fig. 6. The cooling jacket is detachable by undoing four nuts, thus facilitating attention as occasion demands. The details of the cathode are shown in Fig. 8. It is similarly detachable, and the bearing is water-cooled, the water pipes having provision for attachment of flexible pipes, avoiding the need of disconnection when replacing the anode element.

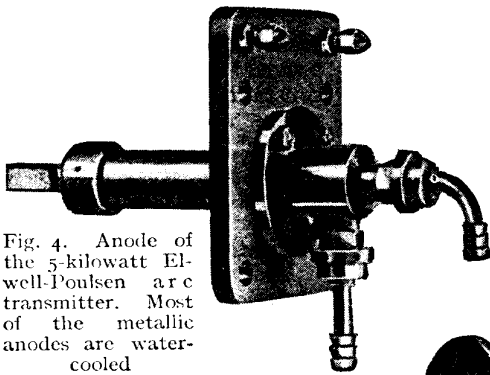

Fig. 4. Anode of the 5-kilowatt Elwell-Poulsen arc transmitter. Most of the metallic anodes are water-cooled

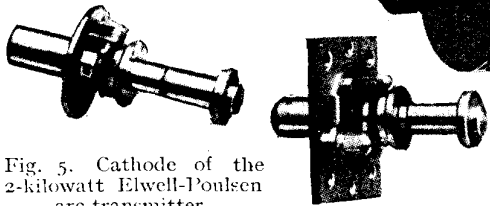

Fig. 5. Cathode of the 2-kilowatt Elwell-Poulsen arc transmitter

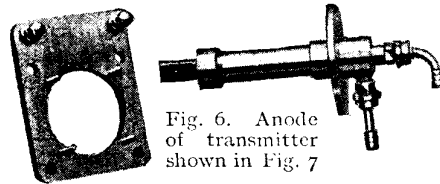

Fig. 6. Anode of transmitter shown in Fig. 7

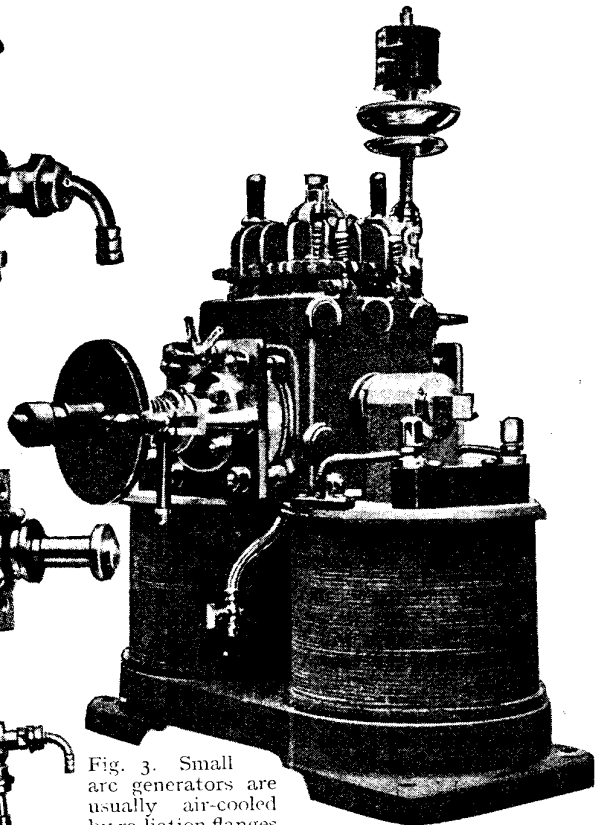

Fig. 3. Small arc generators are usually air-cooled by radiation flanges

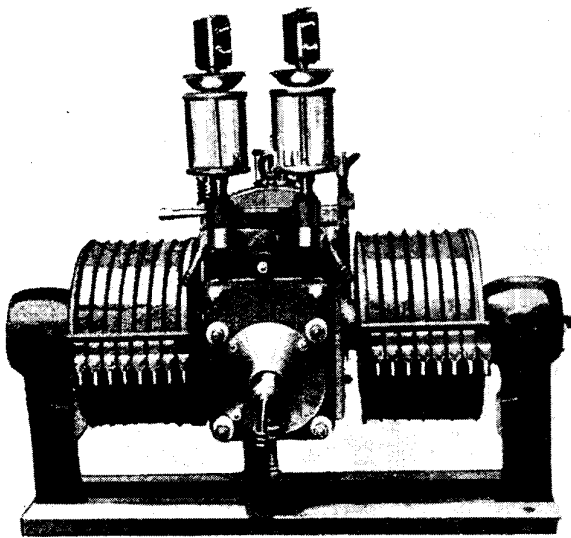

Fig. 7. Shows a 25-kilowatt arc transmitter of the Elwell-Poulsen type

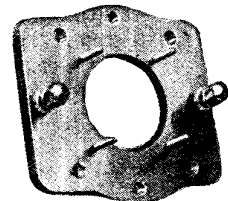
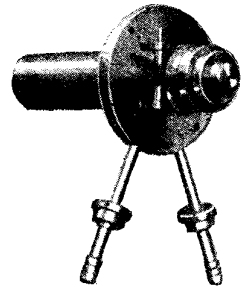
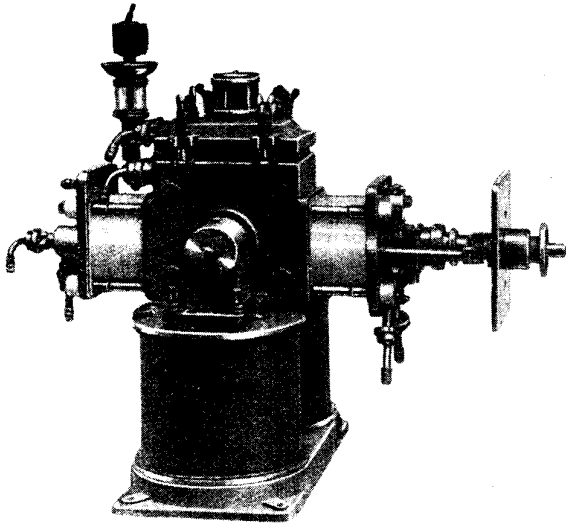

Fig. 8. Details of the cathode of the transmitter shown in Fig. 7



ELWELL-POULSEN 10-KILOWATT GENERATOR

Fig. 9. This is of the water-cooled variety, and of compact construction. Fly nuts will be seen on the head of the arc-case, and form a convenient means of interior inspection.

The Elwell-Poulsen type 10-kilowatt generator is illustrated in Fig. 9. It is of the water-cooled variety, and is a neat and effective model. Provision is made for the cooling of the head and the anode and cathode elements. The use of fly nuts on the head of the arc-case is a convenience when attention to the interior becomes necessary. Another model, the 2-kilowatt, is shown in Fig. 10, and is similar in general appearance to the larger 25-kilowatt pattern. It is noticeable for the air-cooling fins on the head, the means for quickly removing it, and the good arrangement of the controls.

In the Dubilier arc copper or bronze electrodes and carbon are used in a medium of hydrocarbon gas. The form of the arc is shown in part section in Fig. 12. At the base is shown the positive copper electrode in the form of the block, the carbon rod electrode being clamped in a holder fitted to a screwed bushing which allows for adjustment of the distance between the electrodes. The rod is held away from the copper block by means of a spring, and the arc can be struck by depressing the knob at the top of the gas container. Alcohol or methylated spirit is fed into the container from the drip feed shown in the top of the cover. This drip feed is fitted with a safety valve to keep a constant gas pressure around the

arc. Vaporized alcohol has proved a better medium for constant oscillations and a stable arc than hydrogen. Alcohol is also used in the Dwyer arc, and the whole apparatus is cooled by alcohol. An aluminium electrode replaces the usual carbon rod.

In the Moretti arc water is vaporized to provide an atmosphere, and two copper electrodes are generally used. In Fleming's so-called oil arc the atmosphere is provided by heavy lubricating oil. The carbon electrode is immersed in a bath of oil so that it just appears above the surface. The heat of the arc discharge vaporizes the oil and fills the space which is left between the surface of the oil and the top of the container, in which is fitted the copper electrode. The gas escapes through two

vent holes in the top of the electrode container. One of the outstanding features of this arrangement is the ingenious application of a chemical deposition process whereby the wear of the carbon electrode is compensated largely by the carbon

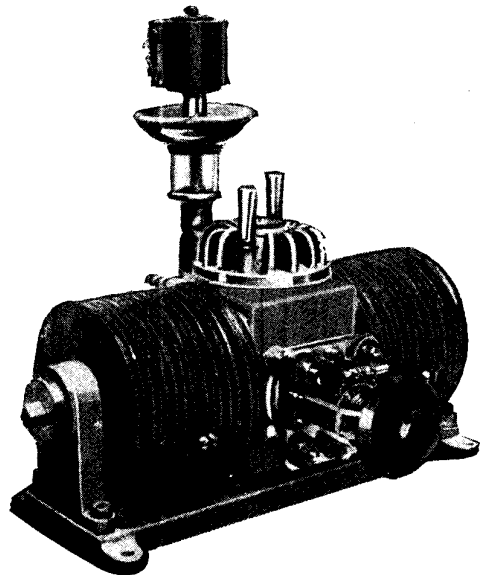

2-KILOWATT ARC GENERATOR

Fig. 10. Air-cooling fins on the head of this Elwell-Poulsen transmitter form a noticeable feature. Another advantage of this apparatus is the good arrangement of controls.

deposited upon it by the disintegration of the oil vapour. By this arrangement, too, the arcs are also left reasonably cool by the liquid oil.

An ingenious method of keeping the arc constant is that due to Rühmer. He uses two aluminium wires. The wires at one point pass close to one another, and at this point the arc is struck. Both wires are wound off reels of wire, and kept in steady motion by some mechanical means, as clockwork. By this means a new surface is continually being presented for the arc, so keeping it constant in length. The constancy of the arc length is of great importance, since the frequency of the oscillations is a function of it, and the fluctuations in it add considerably to the difficulties of tuning.

As Fleming uses suitable oils for the decomposition of the carbon to replace the carbon burnt away in the negative electrode, the Colin-Jeance apparatus uses a mixture of gases rich in carbon. The gases

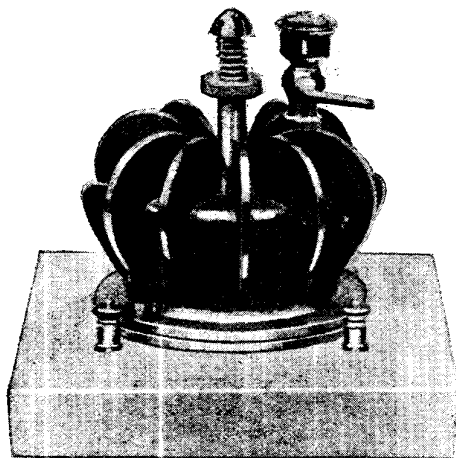

COMPLETE ARC GENERATOR

Fig. 11. An Elwell 100-watt complete arc generator is shown. This is suitable for amateur transmission.

are hydrogen and acetylene or hydrogen and acetone.

In the Japanese T.Y.K. arc, so called from the names of its inventors, Torikata, Yokoyama, and Kitamura, brass or copper electrodes are used with iron pyrites, magnetite, silicon, ferro-silicon, carborundum, molybdenite, or boron. In practice, it has been found that a brass positive electrode and a magnetite negative electrode give the best results. It is a remarkable fact that the carborundum and the other negative electrodes are nearly all rectifiers. See Colin-Jeance Arc; Poulsen Arc; T.Y.K. Arc.

ARGON. One of the gaseous elements. It is one of the minor constituents of the atmosphere, forming about 0.94 per cent by volume. Atomic symbol A. Atomic weight 39.9.

Argon is used in transmitting valves to increase the life of the filament. With large currents passing through, the filaments are rapidly disintegrated normally, and G. S. Meikle has shown that the rate of disintegration depends largely upon the nature of the gas in the bulbs. Only the purest argon is used, and the disintegration is considerably reduced, if not stopped altogether.

ARISTOPHONE RECEIVING SET. Valve and crystal receiving sets manufactured by the C. F. Elwell Co., Ltd. They range from the simple crystal set shown in Fig. 1 to the very elaborate multi-valve outfits. The crystal set is self-

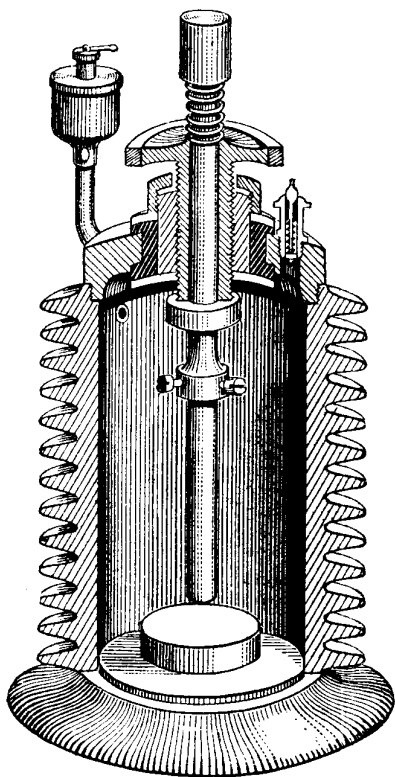

DUBILIER ARC

Fig. 12. A sectional diagram is given of a Dubilier arc. Copper and carbon electrodes are used in an atmosphere of hydrocarbon

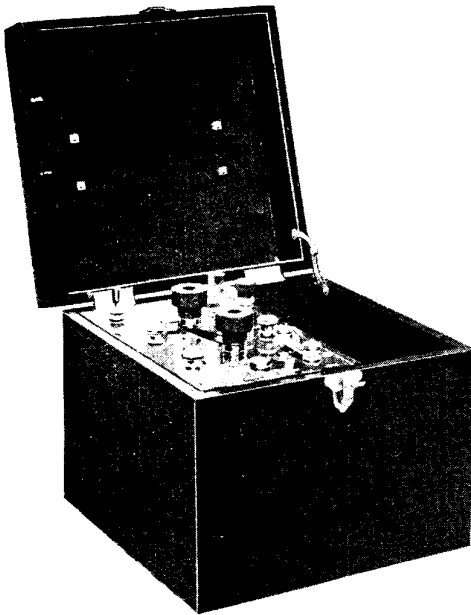

ARISTOPHONE CRYSTAL SET

Fig. 1. No. 11A Aristophone crystal set has variometer tuning and is said to have a range of forty-five miles from the broadcast station.

contained, and equipped with variometer tuning. It is claimed to have a receiving range, under good conditions, up to 45 miles from a broadcasting station. A compartment is provided to accommodate the super-sensitive headphones, which are plugged into a jack that is a feature of the Aristophone sets.

The two-valve receiving set No. 55, illustrated in Fig. 2, is a typical example

of a high-grade production. It embodies the Elwell system of plugs and jacks, which permits the telephones to be plugged in with a single movement which automatically closes the H.T. and the L.T. circuits, this switching on the current to the different points. The batteries are contained within the case, access being obtained by raising the lid.

Variometer tuning is adopted, and a safety switch is incorporated. The illustration shows all the necessary parts, including the aerial, insulators, lead-in tube, valves and batteries.

The first valve acts as a detector, the second as an amplifier, giving the set a normal range of 60 to 100 miles.

A regenerative four-valve set, known as the No. 53, is shown in Fig. 3. This has a range sufficient to receive the Continental broadcast concerts. The tuner covers a wide wave-length, and a selective tuning with variometer is incorporated. The automatic plug-in switch control is incorporated and enables any desired degree of amplification to be used, according to the proximity of the station to be received. Removal of the jack opens all battery circuits. All that has to be done at the close of a performance is to take out the telephones.

ARMATURE. That part of a dynamo machine in which the electro-motive force arising from electro-magnetic induction is generated. The piece of soft iron joining the poles of a horseshoe magnet is also called an armature. The term generally refers to dynamo armatures, and they are divided into two general

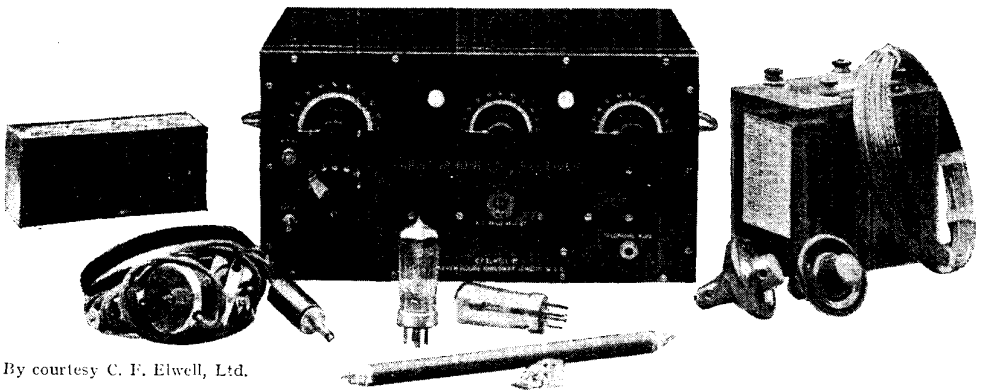

By courtesy C. F. Elwell, Ltd.

COMPONENTS OF A COMPLETE ARISTOPHONE TWO-VALVE RECEIVER

Fig. 2. All the necessary components, including aerial, insulators, lead-in tube, valves and batteries, are illustrated, which together form a two-valve No. 55 Aristophone Receiver. The Elwell system of plugs and jacks is employed in this set

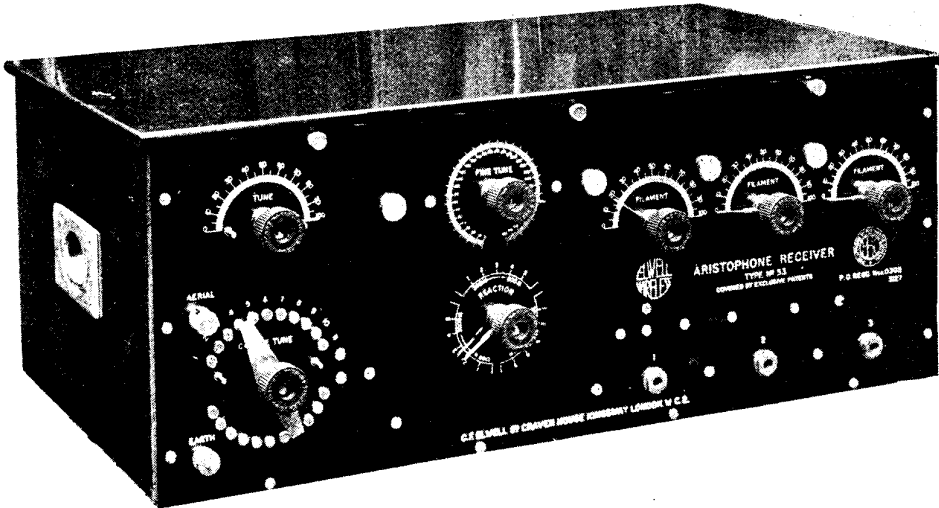

FOUR-VALVE ARISTOPHONE LONG-RANGE RECEIVER

Fig. 3. By the aid of this regenerative four-valve set it is possible to receive the broadcast concerts of the chief Continental stations, such as The Hague. It is known as the Aristophone Receiver, No. 53

classes: (1) According to shape; and (2) according to construction. To the first class belong cylindrical, drum, girder, and spherical armatures, and to the latter disk, multipolar, polarised, ring, shuttle, and unipolar armatures.

A dynamo consists of two main parts, one the body, usually of a circular formation, supporting within its shell a number of coil-surrounded projections known as field magnets. Within these there is the rotating part of the machine, running in bearings at either end, and known as the armature.

This armature consists of a number of slotted circular stampings of sheet iron, threaded upon the shaft. After assembly, they are clamped endways by rivets, or in small armatures by a nut, the whole forming a drum having longitudinal slots cut in its periphery throughout its whole length.

Insulated wire is wound in these slots, and connected so that the projections or poles between the slots, when a current is passed, become really a number of electro-magnets.

Special provision is made in rotary armatures of this type to protect the windings from being displaced by centrifugal force, and, except in the very smallest sizes, tape is wound around the windings in grooves cut for the purpose.

When the armature is rotated, a powerful magnetic field is built up by the field

magnets. As the armature is rotating within this field, the windings or conductors on the armature cut the lines of force, and by magnetic induction electric currents are generated in the armature and collected by the brushes of the machine. From there they are led to the accumulators, or for any other purpose required, as electric lighting, etc.

Another common form of armature is the vibrating type, which is found in the

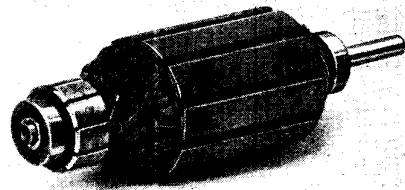

MULTIPOLAR ARMATURE

This is a small armature, as employed in wireless work. It has a built-up commutator and ball bearings

electric bell, the buzzer, and the diaphragms of telephones.

In the ordinary electric bell there is an electro-magnet of the horseshoe type, energised, when the push is pressed and the circuit closed, by the battery current. Held just away from the magnet tips is the armature, in this case a strip of soft iron. A flat spring normally keeps the

armature a few hundredths of an inch or so from the magnets. Just at the back of the armature, *i.e.* the surface farthest away from the magnets, is fixed a platinum or other contact. This normally, when the armature is stationary, makes contact with another platinum point rigidly attached to a pillar, but capable of adjustment towards or away from the armature by means of a screw.

The main current from the battery passes through the magnet windings, via the contacts just described. On the circuit being completed, the magnets are energized and attract the armature to them. This pulls the contacts apart, the armature flies back because the magnets are no longer energized, contact is again made, and the process repeats itself so long as the push is pressed.

The number of times per second that this takes place is governed by the inertia of the armature, and in the case of the electric bell, the additional weight of the hammer which is directly attached to it.

The lighter the armature, the greater the number of variations. In the case of the high-note buzzer used in wireless work a very thin sheet-metal armature is used.

The telephone receiver is very similar to the bell in principle. The armature in this case is a diaphragm or flat disk of iron, and is supported round its rim a few thousandths of an inch from the magnet faces. Here the current supplied to the magnets is of a pulsating character. This energizes the magnets either weakly or strongly, or at whatever frequency the current is, and the diaphragm responds exactly in accordance with the impulses it receives.

The term armature is only used in connexion with motors or generators or other direct-current using apparatus. In alternating current machines, particularly in the larger types, it is general practice for the field magnets to rotate within the stator. The stator is, in such machines, the equivalent of the armature in a D.C. machine. *See* Commutator; Dynamo.

ARMATURE BORE. The name given to the space between the poles of the field magnets in a dynamo wherein the armature rotates. It is important that this space be truly circular in section, and concentric with the axis of the armature. The air space between the poles of the

armature and those of the field magnets must be as small as possible for efficient generation or use of the electrical and magnetic currents in the fields. *See* Dynamo.

ARMATURE REACTION. The effect on the magnetic field of a dynamo machine due to the current carried by the armature. Carrying current does not affect directly the voltage which would be induced in a conductor, but it has an indirect effect. The currents which flow in the armature bars produce a magnetizing effect which may distort considerably the original distribution of the magnetic flux in the machine. In practice the total magneto-motive force of the armature conductors is calculated and combined with the original magneto-motive force of the field coils or exciting windings, so that the resultant magneto-motive force on the magnetic circuit may be determined.

Usually the magnetizing forces of the armature tend to neutralize the magnetizing of the field winding. To maintain the same amount of flux, therefore, the field winding has to be considerably increased as the load on the machine increases. The magneto-motive force due to each coil of the armature acts at right angles to the plane of the coil, and the number of ampere turns to which it is proportional is found by multiplying together the current in the coil and the number of turns. The resultant magneto-motive force may be regarded as due to the armature turns in a coil placed at right angles to the direction of this magneto-motive force; the number of ampere turns in such a coil is known usually as the armature reaction. *See* Dynamo.

ARMATURE STAMPINGS. The rotating portions of all dynamo electric machines which revolve in a strong magnetic field require lamination—that is to say, the iron cores supporting the windings need to be divided up into a number of thin sheets the plane of which is parallel with the direction of the magnetic lines.

If this were not done, the iron core itself would be subject to the same laws which govern magneto-electric induction, and would become the seat of an electro-motive force at right angles both to the direction of rotation and to the direction of the magnetic field, and large internal currents would be set up in the core, generating excessive heat and absorbing driving-power uselessly. The fact of laminating

the core while increasing the magnetic reluctance but very slightly in the direction of the field, interposes a high ohmic resistance in the direction of the induced electro-motive force along the core, sufficient by itself to prevent these internal or eddy current losses rising to a serious amount.

The increased resistance due to lamination is caused by the natural scale on the surface of the iron sheets from which the core stampings are punched, and is artificially increased by pasting thin paper over the sheets before stamping them out to shape or by treating the sheets with insulating varnish on one or both sides. Since the bulk of the magnetic lines are carried by the laminated core and few if any reach the shaft, there is no necessity to apply the principles of lamination to the shaft itself, and in any case it would be a practical impossibility in a part calling for the maximum of strength.

Losses through eddy currents are referred to also as core-losses or iron-losses, and it is natural that the thicker the sheets from which the stampings are formed the greater will be the core losses.

For direct-current motors and generators, running at normal speeds, the thickness of the stampings is usually 0.022 in., while for very high-speed dynamos, and for alternating-current machinery in general, a thickness of 0.018 in. is the standard. Armature stampings may take a great variety of form, but omitting those whose use is generally associated with toy machines, the principal classes are plain drum or ring types and slotted drum or ring types. In a ring-stamping there is a relatively large central opening allowing free circulation of air between the inner periphery and the shaft, and provision for mounting the stampings on the shaft by some kind of hub or spider.

In the drum type core the stampings are solid down to the shaft and mounted directly upon the latter, being provided with airways or vents in the case of larger machines, to promote cooling. The slots in the outside periphery of the stampings are variously shaped, some being totally enclosed, others semi-closed, and still others quite open with parallel sides.

The slotted types of armature core naturally provide much greater protection to the copper coils, which are embedded in them, and owing to the reduction in

air-gap between the rotating armature and the field magnet poles which they permit, greatly economize the amount of magnetizing power to be provided by the exciting coils on the field-magnet. See Armature ; Dynamo.

ARMoured WIRE. A conductor insulated and protected by an external covering of metal. Common forms suitable for amateur wireless purposes com-

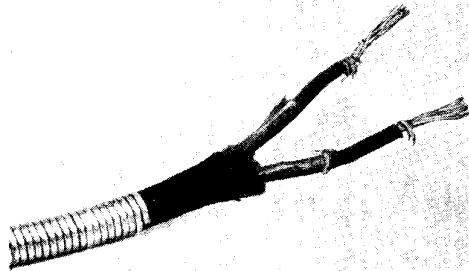

ARMoured TWIN WIRE

Coverings have been removed to show the construction of the twin armoured wire. On the right the stranded cores of the two wires are bare and their individual insulation is partly peeled off. On the left is the metallic armour covering

prise a wire insulated with rubber and cotton covering, and braided, and the whole of the exterior covered with a coil of tinned iron wire. Another pattern, as illustrated, consists of twin wires, each independently insulated and worked into the form of a rope. The exterior is protected and impregnated to render it waterproof, and covered on the outside with a tinned steel wire protection.

Such wires may be used for transmission of power from one point to another, can be laid indoors or out, and resist rough handling, especially when laid on the ground or side of a building. Another application of the use of armouring is for an earthing wire.

In making a connexion to such a cable, the armour should be untwisted carefully, the outer insulation removed, the two inner wires separated, and the insulation removed. The joints are then made in accordance with the circuit arrangements. They should be properly soldered, if connecting to some other wire, the joints insulated with insulation tape or other appropriate means, the whole well taped together, and if the armour is being used as an earth, it should be replaced by twisting it back, and joined to the armour of the other wires.

ARMSTRONG, EDWIN H. Born in the United States of America, December 18th, 1890, he was educated at Columbia University, where he specialised in wireless engineering. He served under Professor M. Pupin at Columbia University in the Hartley Research Laboratory, and is a director of the American Institute of Radio Engineers, the medal of which he has been awarded. Armstrong began experiments with wireless at the age of fifteen; and in 1913, while he was still a student at Columbia, he discovered the now famous feed-back circuit, which was the cause of litigation, spreading over a number of years in the United States of America, before his patents were upheld. In March, 1915, he described the circuits employed by him with the Plotron or hard-vacuum valve. Armstrong was the first to reveal that, with a certain value of

feed-back coupling between the plate and grid circuit, a valve would become a high-frequency generator. His patent was dated January 31st, 1913. His fame became world-wide when he announced his discovery of the super-regenerative circuit, one of the most widely discussed and important developments in wireless telephony. His paper on "Some Recent Developments of Regenerative Circuits," dealing with the super-regenerative circuits, was read before the Institute of Radio Engineers in New York on June 7th, 1922.

The originator of the super-regenerative circuit has a number of other important patents to his credit, some of which will undoubtedly have far-reaching effects. In conjunction with Professor Pupin he invented a method for the elimination of jamming, especially that due to strays.



**MAJOR E. H. ARMSTRONG, INVENTOR OF THE FAMOUS SUPER-REGENERATIVE CIRCUITS,
IN HIS LABORATORY**

The young American inventor, Major E. H. Armstrong, of Columbia University, has invented a number of regenerative and super-regenerative circuits which represent very considerable advances in radio work in the twentieth century, and are of such fundamental importance that they promise to affect materially the design of wireless receiving sets

ARMSTRONG REGENERATIVE CIRCUITS

Theory and Practice of Circuits with Great Appeal to the Experimenter

Commencing with the original circuit, we follow with explanations of the single-valve regenerative and the super-regenerative circuits. The practical aspect is covered by the construction of two types of receiver, a single-valve and a two-valve set. See such cognate articles as Anode Circuit ; Close Coupling ; Feed-back Circuit ; Grid Circuit. Also Dual Amplification ; Filter Circuit ; Flewelling Circuit ; Reaction

The invention of the regenerative circuits bearing this name is due to E. H. Armstrong, a young American whose work promises to materially affect the design of wireless receiving sets. The first of these circuits was evolved by Armstrong while a student at the Columbia College, and resulted from attempts to augment the incoming current from the aerial by feeding back a portion of the local battery current into the grid filament circuit. The circuit diagram, or hook-up as it is termed in America, was attested before the notary public on January 31st, 1913. This circuit is shown in Fig. 1, and is the forerunner of the many variations that have followed.

Armstrong first demonstrated his super-regenerative receiver before the Institute of Radio Engineers, New York. With a small loop aerial music and speech were heard with a loud speaker from Newark station. With an ordinary receiving set, using the same number of valves, the signals were barely audible. In both cases a detecting valve was used and two amplifying valves, and the results were so astounding that the Armstrong circuits have remained the most discussed of any circuits since wireless telephonic transmission became general.

A great many developments since that time have added to the general utility and scope of the circuit, and some of them are dealt with later. In considering the subject it is necessary to bear in mind that the principles involved are fundamental. It needs a review of the whole science of electricity if it is to be completely covered, as the questions and principles involved in super-regeneration are highly technical.

To attempt to understand the super-regenerative action, it is necessary to appreciate that of the ordinary regeneration or reaction receiver. This is fairly extensively used, and consists in tuning the anode circuit and the grid circuit, first tuning the primary or aerial circuit, then the grid, and finally the anode circuit. The reaction in the anode circuit increases the signal strength up to a certain point, and then the set commences to oscillate,

and the signals lose strength and disappear. They are brought back by reducing the couplings until the best results are found with the set on the point of oscillation.

What Armstrong accomplished was to so arrange matters that at the point of oscillation it was not necessary to detune. But, on the contrary, the reaction effect can be increased beyond the oscillation

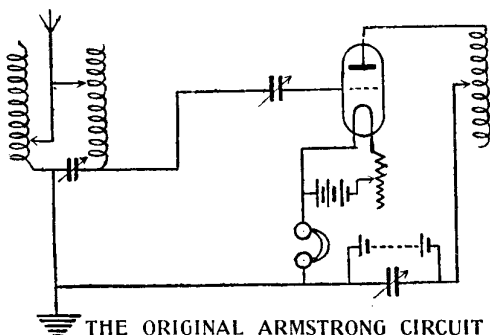

THE ORIGINAL ARMSTRONG CIRCUIT

Fig. 1. Armstrong's original idea of augmenting the incoming current from the aerial is shown in this circuit, on which have been built the many subsequent improvements

point of the ordinary reaction receiver, with the result that signal strength is enormously increased. This was accomplished by so arranging the circuit, the components, and their values, that the reaction circuit can be permitted to oscillate for a fraction of time, be stopped from oscillating, and restarted, all at predetermined and controlled frequency. The Armstrong circuits and receiving system are thus based upon a fundamental principle, and there are many possibilities yet to be developed. For the same reason, there are as many different detailed ways of arranging the circuits, while adhering to the principles enunciated by Armstrong.

The Armstrong Circuits. A number of valuable circuits are due to his inventive abilities, and are known under various titles of reference as regenerative and super-regenerative circuits. To follow out their development it is necessary to consider first the mode by which the electron relay thermionic valve acts as an amplifier of alternating current.

In Fig. 2 is shown an alternator, A, or other source of electric oscillations, connected to the grid, G, and filament, F, of the thermionic valve. The plate circuit, P, is supplied by the battery, B, which permits the passage through it of alternating current waves. In some cases, a condenser might be shunted across the battery to bypass this current without depending upon the plate circuit through P. In series with B are connected the direct current ammeter, A₁, and alternating current ammeter, A₂, and the primary of a transformer, T.

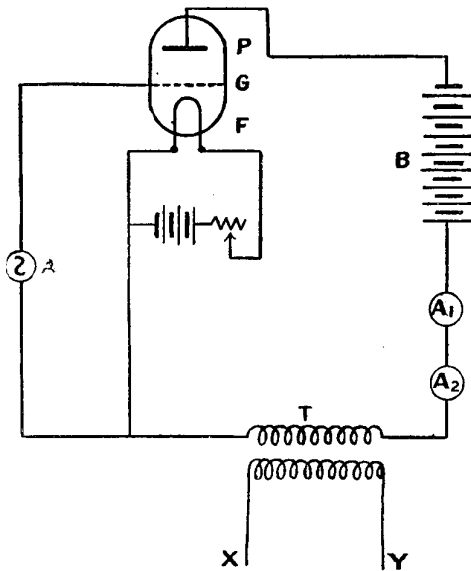

APPLICATION OF ALTERNATING CURRENT ENERGY

Fig. 2. Current amplification by the electron relay thermionic valve is shown in this diagram, and the principle of the arrangement should be considered when studying the progress of Armstrong's inventions

It is assumed that A does not impede the flow of alternating current in the plate circuit, but if it should do so this also must be overcome by shunting it with a condenser. The secondary terminals of the transformer T at X and Y constitute the output terminals of the amplifier.

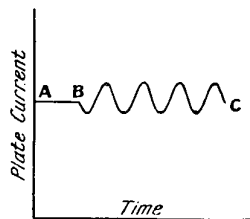

Fig. 3. Current values in the plate circuit

Under the conditions illustrated the plate circuit will remain at a steady value, and can be represented

by the portion A, B, in Fig. 3, when the alternator is not running. The effect of running the alternator is shown in the portion B, C, of Fig. 3, and in this figure it has been assumed that the mean value of the fluctuating portion, B, C, can be represented by the steady value A, B. In practice, however, this is seldom the case, since it may be modified by such causes as the grid circuit rectification flattening the grid current characteristic; also positive grid charges may cause the average plate current to vary up or down when an alternating potential difference is applied to the grid and filament.

In any case the pulsations of current in the plate circuit will be marked if the grid potential variations are sufficient, and these will be available at terminals X, Y, Fig. 2, as amplified energy. This device, as shown, can evidently be used either as an audio- or a radio-frequency amplifier; indeed, it is so used in ordinary receiving sets. The energy delivered to the terminals X, Y, is many times greater than that required at the terminals of the alternator or other oscillator. If, therefore, some of this energy could be transferred back by coupling or some similar means to the source of its origin, the oscillator itself might be dispensed with, but the circuit itself would continue to oscillate steadily in that case.

The so-called "regenerative" coupling is shown in Fig. 4. This should be compared with Fig. 2, to which it is similar in principle, and also in letter references, but the alternator has been replaced by the oscillating circuit, L₁, L₂, acting in conjunction with the variable condenser, C. In addition, there has been added a coupling, L₂, L₃ between the grid circuit L₁, L₂, C, and the plate circuit, L₃, B. Such a circuit as here shown will oscillate vigorously if the circuit constants are suitably chosen. The output energy is obtained by coupling to a coil inserted in the plate circuit. This type of oscillator is widely applied to long-distance reception used as a detector.

In working with various types of oscillating circuit it is essential that the grid connexion is made at such a junction point of the combined grid and plate circuits that the electro-motive forces impressed on the grid are in proper phase relation to the alternating currents flowing in the plate circuit, otherwise the system will not persist in oscillation.

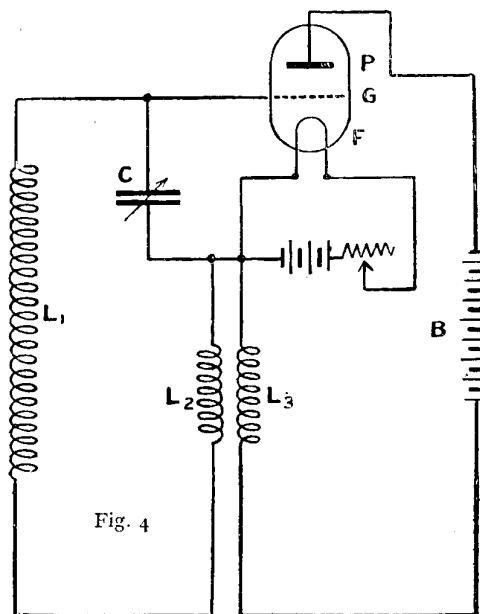

Fig. 4

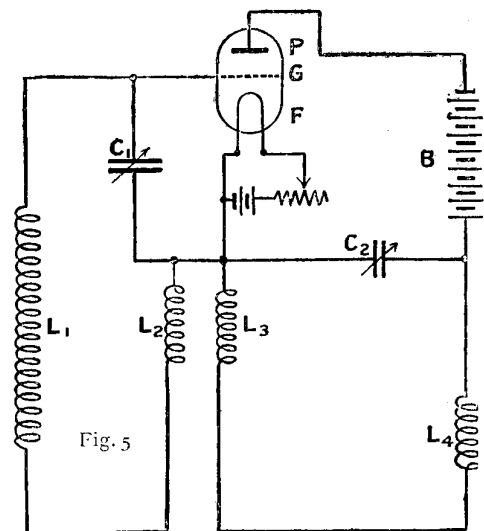

Fig. 5

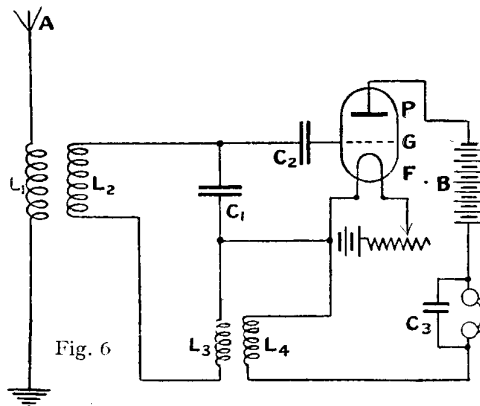

Fig. 6

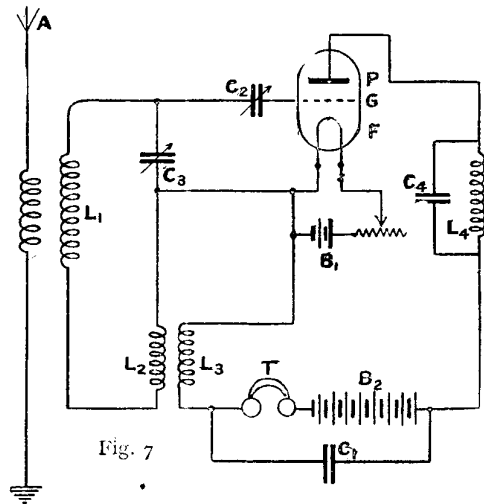

Fig. 7

EVOLUTION AND PROGRESS OF THE ARMSTRONG REGENERATIVE CIRCUITS

Fig. 4, which should be compared with Fig. 2, shows the "regenerative" coupling. It is improved upon in Fig. 5, while in Fig. 6 the valve is used as a regenerative relay. A further improvement by tuning the plate circuit is seen in Fig. 7

A further improvement of Armstrong's over the simple circuit shown in Fig. 4 is illustrated in Fig. 5. If compared with the last circuit it will be found to contain an added inductance, L4, in the plate circuit and a variable condenser, C2, across the terminals of L3 and L4, whereby the plate circuit may be tuned to the same frequency as the grid circuit. Such an arrangement greatly increases the efficiency and output of the oscillator.

A further example, using the valve as a regenerative relay by coupling the plate and the grid circuits, appears in Fig. 6.

This is adapted for telephonic reception with radio-frequency amplification. The grid circuit is coupled to the plate circuit by means of the inductive coupling, L3, L4. It was found that in the case of hard valves the regenerative amplification attainable by this means amounted to some fifty times the energy and seven times the audibility. The telephone, T, is here shunted by the condenser, C3, the purpose being to permit the passage of the radio-frequency current while choking audio-frequency currents back through the telephone receivers.

An improvement upon Fig. 6 is illustrated in Fig. 7. Here, in addition to regenerative coupling between the plate and grid circuits, there is tuning of the plate circuit by means of an inductance, L_3 , and a condenser, C_4 . As in the last example, the telephone receiver, T , and the plate battery, B_2 , are shunted by the by-pass condenser, C_1 .

Armstrong's Super-regenerative Circuit.

The circuits of this receiver were contained in a paper read before the Institute of Radio Engineers in June, 1922. As the name implies, regeneration is the underlying principle, but the application has been so extended that it has been termed a super-regeneration receiver.

An oscillatory circuit has ordinarily a positive resistance reactance, and any oscillatory current which flows in the circuit is due to an oscillatory electro-motive force overcoming the positive resistance of the circuit. When, however, the principle of reaction is utilized, continuous oscillations are set up in the circuit owing to the effective resistance of the circuit having been reduced. This reduction of effective resistance is equivalent to the introduction into the circuit of a negative resistance reactance equal to the positive resistance reactance.

There are, therefore, three possible relations between the positive and negative resistances; the positive resistance of the circuit can be greater than the negative resistance introduced, it can be equal to the negative resistance, or it can be less than the negative resistance.

The first condition is that met when a reaction circuit is used to amplify spark signals to the threshold point. An oscillatory electro-motive force impressed on the circuit, equal in frequency to the natural frequency of the circuit, will produce free and forced oscillations with a maximum amplitude equal to the effective resistance divided by the impressed electro-motive force, while the damping of the free oscillations is dependent on the effective resistance. The maximum amplitude is always finite, it is reached in a finite time, and the oscillations die away when the impressed electro-motive force is removed.

When the positive resistance of the circuit is equal to the negative resistance introduced, the effective resistance is reduced to zero. If an electro-motive force of the correct frequency is impressed

on the circuit the current starts to increase at a rate directly proportional to the impressed electro-motive force, and to the square root of the ratio of the capacity to the inductance of the circuit. Thus the current will reach a finite value if the electro-motive force is impressed for a finite time, and an infinite value if the electro-motive force is impressed for an infinite time. The current having reached a finite value in a finite time, will continue to oscillate indefinitely at the value attained at the time of removal of the impressed electro-motive force. It must be understood that although the circuit has zero effective resistance, the oscillatory current must be started by an impressed electro-motive force.

Actually, this condition cannot be obtained in practice, as, owing to the non-linear characteristic of the valve, a positive resistance always acts against the impressed electro-motive force, the circuit then fulfilling the conditions for amplification.

The case where the positive resistance reactance of the circuit is less than the negative resistance reactance introduced into it is met with in the ordinary reaction receiver, which is very generally used for the reception of continuous waves by the well-known "beat" method.

Armstrong's Use of Free Oscillations

An electro-motive force impressed on the circuit will produce a free and a forced oscillation, the amplitude of the forced oscillation being determined by the value of the impressed electro-motive force divided by the resistance of the circuit. The amplitude of the free oscillation will increase to infinity whether the impressed electro-motive force be removed or not. The initial amplitude of the free oscillation is proportional to the impressed electro-motive force, and this ratio is a constant over any finite interval of time. Again, the circuit must be set in oscillation by the application of an external electro-motive force, but once the oscillations are started they will continue to increase in amplitude whether or not the external force is removed.

Armstrong has greatly increased the amplification of valve receivers by making use of the free oscillations capable of production in an oscillatory circuit.

In a circuit containing inductance and capacity it is possible to vary periodically

the relation between the positive and negative resistance so that negative resistance is alternatively greater and less than the positive resistance. If the average value of the resistance is positive the circuit will not produce oscillations, but when the negative resistance is greater than the positive resistance any impressed electro-motive force will be greatly amplified. The amplitude of the oscillations set up while the negative resistance preponderates is directly proportional to the amplitude of the impressed electro-motive force.

The periodic variations of the negative and positive resistance values of the circuit may be obtained by varying either the negative or the positive resistance with respect to each other, or by varying both resistance values simultaneously.

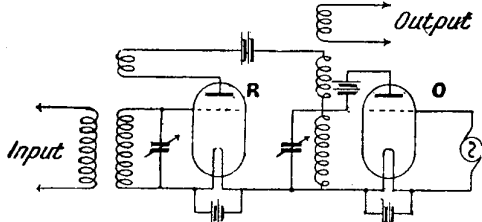

AN ARMSTRONG REACTIVE CIRCUIT

Fig. 8. In this valve amplifier Armstrong makes use of free oscillation. A second valve is employed for varying the plate potential

Fig. 8 illustrates the method of varying the negative resistance produced by a reaction circuit by varying the plate potential of the valve by means of a second valve the grid of which is connected to an alternating electro-motive force of suitable frequency.

In order to vary the positive resistance with respect to the negative resistance, the plate circuit of the second valve is

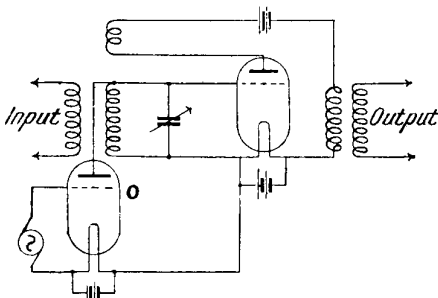

VARIATION OF POSITIVE RESISTANCE

Fig. 9. Connexions are here shown in a circuit in which the second valve has its plate connected across the first valve grid circuit, which is tuned

connected across the tuned grid circuit of the first valve. The grid circuit of the second valve is again connected to an alternating electro-motive force of suitable frequency. Fig. 9 illustrates the connexions of the circuits for this method.

Fig. 10 illustrates the method of varying simultaneously both the negative and positive resistances.

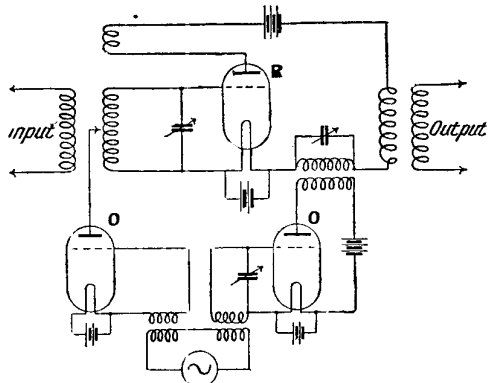

NEGATIVE AND POSITIVE RESISTANCE VARIATION

Fig. 10. Negative and positive resistances are varied simultaneously in this arrangement

The actual variations occurring in each circuit when connected as shown in Fig. 8 will be better understood by a study of Fig. 11. From this it will be seen that the frequency of variation—that is, the frequency applied to the grid of the valve O—produces a modulated amplified current causing the output current to have a frequency equal to the impressed frequency plus two side frequencies differing from the fundamental by the frequency of the variation.

Before dealing with some of the receiving circuits developed by Armstrong it will be useful to sum up the operation of the system.

Let the resultant resistance of the oscillatory circuit be a negative resistance

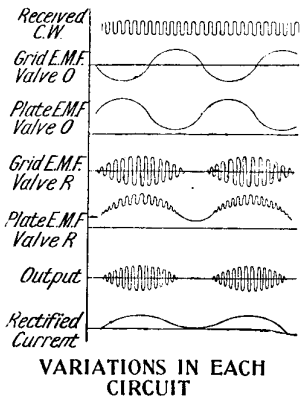

VARIATIONS IN EACH CIRCUIT

Fig. 11. Comparison may here be made between the electro-motive force in the grids, and in the plates of valves O and R. This diagram should be studied with Fig. 8

then any electro-motive force—in the form of a signal—impressed on the grid will produce oscillations which build up regularly until saturation is reached. The oscillations will continue unless stopped, and if not stopped in time, further signals will not be effective. By so connecting the oscillator valve, however, the oscillations are stopped after a definite interval of time, and the circuit is in a condition to be affected by the next signal, the result being that the signal is greatly amplified, and distortion prevented by periodically starting and stopping the valve oscillating at regular and controllable intervals of time.

Armstrong has developed several circuits incorporating the super-regeneration principle, but perhaps the two most useful

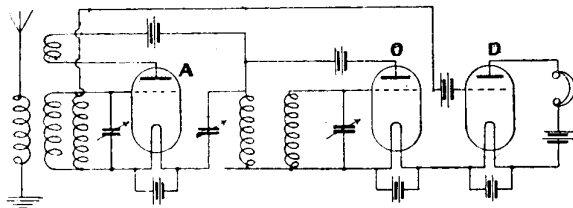

THREE-VALVE ARMSTRONG CIRCUIT

Fig. 12. In this circuit the oscillating valve, O, is employed to vary the negative resistance with respect to the positive resistance. A is a high-frequency valve, and the valve D is the detector

ones are those illustrated in Figs. 12 and 13. Fig. 12 shows the method of connecting three valves in order that the oscillator valve, O, shall vary the negative resistance with respect to the positive resistance, in a similar manner to that shown in Fig. 8. The first valve, A, is a high-frequency amplifier; the second valve, O, is the oscillating valve, and the third valve, D, is the detector. The plate voltage of the amplifying valve is varied at an audible frequency by means of the oscillating valve. If the oscillating valve generates a frequency above audibility, then the telephones can be connected in the plate circuit of the amplifying valve, thus dispensing with the detector valve.

Fig. 13 illustrates the method of connecting two valves in order to vary the positive resistance of the circuit with respect to the negative resistance. The first valve, R, acts as an amplifier and as a detector, while the second valve, O, is the oscillator.

The resistance of the tuned circuit, L, C, is varied in accordance with the variations of potential of the grid of the oscillating valve. When the potential of the oscillating valve grid is positive over half a cycle, current is taken from the tuned circuit through the grid of the oscillator, which results in an increase in the effective resistance of the circuit. When the potential of the oscillating valve grid is negative, during the second half of the cycle, no current is taken from the tuned circuit, so that the normal resistance of the circuit is unaltered.

Since the frequency of variation of the positive and negative resistances can be below audibility—it can be audible, or it can be above audibility—it becomes necessary to select the best frequency of variation in order to suit the type of signals received. Thus, when receiving continuous waves, when a "beat-note" is required, it is best that the variation be at an audible frequency; for modulated continuous waves and spark telegraphy the variation should be above audibility, in order to preserve the characteristic note of the transmitter; for telephony the variation should be above audibility.

Apart from the amplification properties of the super-regeneration receiver, there is the added advantage of its great selectivity with respect to spark interference when the frequency of variation is above audibility. This effect is due to the periodic stopping of the free

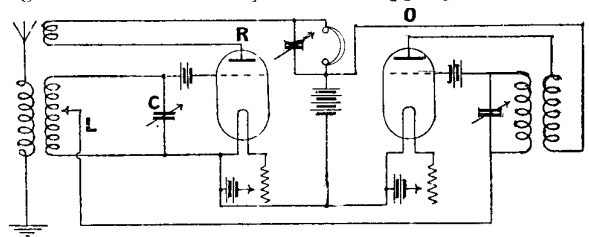

RESISTANCE VARIATION BY TWO VALVES

Fig. 13. It will be seen in this diagram that the resistance of the tuned circuit, L, C, is controlled in accordance with the grid potential of the valve O

oscillations of the circuits. In the ordinary reaction receiver, spark interference sets up a free oscillation which continues for a comparatively long time, while the energy of these oscillations is greater than that of the forced oscillation. On the other

hand, with the super-regeneration receiver the free oscillation is rapidly quenched, with a consequent reduction in the interference.

Super-regeneration receivers require a careful selection of the constants of the various parts and recognition of the fact that most of the adjustments are somewhat critical; but, nevertheless, there is no doubt that this receiver is a distinct step in advance of the ordinary reaction receiver.

In practical work with audio-frequency amplification, the use of a filter circuit (*q.v.*) is necessary to the proper functioning of the receiver.—*R. H. White, M.I.E.E.*

Construction of the Super-Regenerative Receiver. The preceding articles have explained the salient features of the Armstrong circuits; we now proceed to give instructions for making two examples embodying the Armstrong regenerative

methods. Two types of receiver are dealt with, the first a two-valve set for use with a loop or frame aerial and a loud speaker, the other a single-valve set.

Before commencing the construction of a receiving set on this system, as shown in Fig. 14, it is highly desirable to master the underlying principles on which it acts. The meaning of the terms used should be understood; they are all explained fully under their appropriate headings in this Encyclopedia, and reference should be made to them for additional information. The first step is to study the diagrams and the photographic illustrations, and, by comparing them with the theoretical explanations, to gain some comprehension of the system. Follow this by building up the set, and at every stage ascertain the why and wherefore of each part, and the reasons for its inclusion in the set.

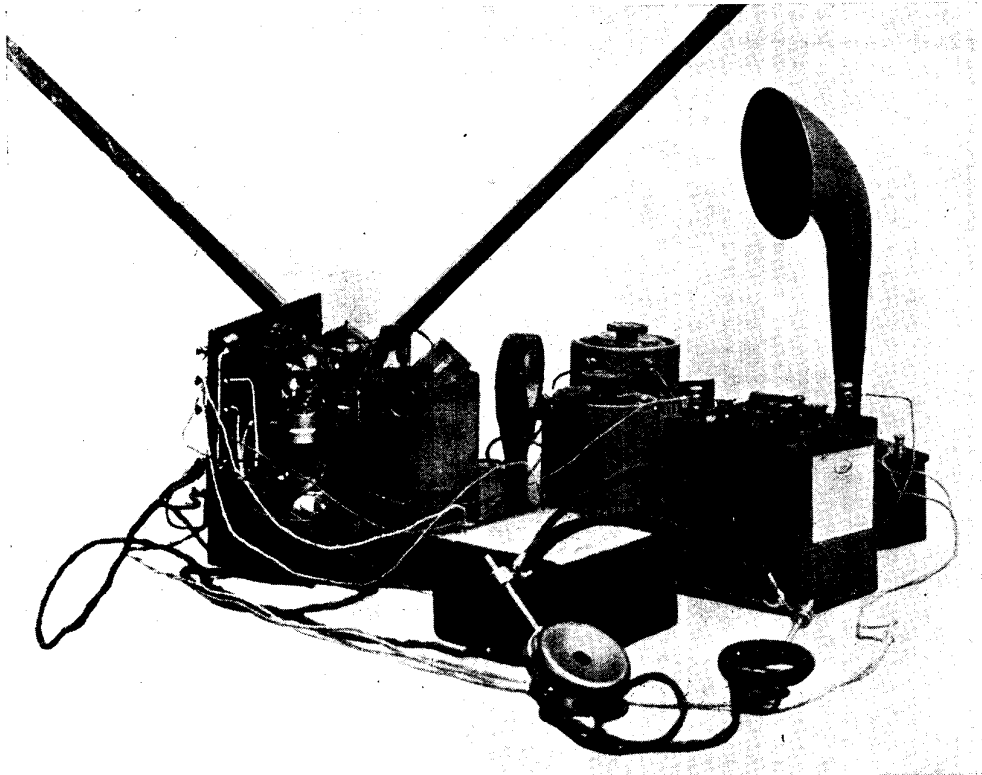

EXAMPLE OF AN ARMSTRONG SUPER-REGENERATIVE RECEIVER

Fig. 14. A careful examination of this photograph will inform the amateur about to construct such a set of the appearance of the precise components which are used. A frame aerial, not necessarily of the exact pattern of the one in the rear of the photograph, should be employed, though it should not exceed the one shown in size. A small frame aerial is desirable as a means of minimising the effects of self-oscillation. Details of the material and components used in the construction of the set are given on p. 141

In the first place, it must be appreciated that the fundamentals of super-regeneration are based on the better-known principles of reaction and the properties of the thermionic valve.

When radio-frequency impulses are impressed on the grid of such a valve in a receiving set, they are considerably amplified in the plate or anode circuit. Reaction consists of coupling these impulses back to the grid circuit of the valve, where they are amplified in the same way, making it possible to build up a weak signal to one of considerable strength.

One method consists of introducing a coil into the anode circuit, and so placing it that it establishes a magnetic coupling with the grid circuit or aerial tuning inductance. This has one important effect, as it reduces the effective radio-frequency resistance of the circuit. With such a method the use of a vario-coupler can be adopted as in this set; but whatever the nature of such a magnetic coupling, the tighter the coupling between the anode and grid circuits, the lower becomes the resistance of the circuit.

At last a point is reached where the valve itself will oscillate. This is recognized by a rushing sound in the telephones, which, on coupling still closer, becomes a shrill squeal. The oscillations act as a miniature transmitter and interfere with other people's reception. Partly for this reason the Armstrong circuit uses a small frame aerial to minimize the effects. At the point of regeneration where the rushing sounds occur, spark stations will be found to lose their natural, pure note, and, although greatly increased in signal strength, will sound harsh and raucous. The set is now approaching zero resistance, and a further increase in coupling will produce a negative resistance in the tuned circuits.

In the super-regenerative circuit, when the circuit assumes a negative resistance, the oscillations applied to the grid will build up to an enormous extent. When a modulated continuous wave is applied to the grid, the amplitude of the modulations is proportional to their original amplitude—that is to say, that a weak modulation is amplified in the same proportion as a strong modulation and vice versa. Unfortunately, in this state of negative resistance the valve will break

into oscillations on the slightest pretext and render reception impossible. What is required, therefore, is a means of introducing a large resistance into the tuned grid circuit in order to change the state of negative resistance to positive and thus check self-oscillation of the valve.

Armstrong has met this difficulty by the use of an oscillator circuit, tuned by means of large coils and variable condensers to a frequency of 10,000 cycles. In this case duo-lateral coils having between 1,250 and 1,500 turns will be found suitable. The anode of the oscillator valve, O, is connected through the telephones to the anode of the regenerator valve, R, Fig. 15.

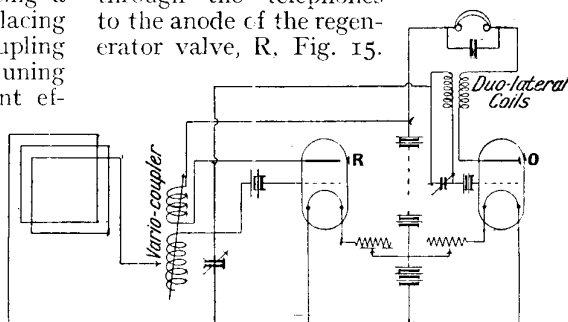

SUPER-REGENERATIVE RECEIVER

Fig. 15. Theoretical circuit diagram for the set illustrated in Fig. 14

A fixed condenser is shunted across the telephones to by-pass the high-frequency oscillations, which the impedance of the telephones would not allow to pass. In this way the anode voltage of the regenerator valve is varied at a frequency of 10,000 cycles. During the positive half cycle of the oscillator frequency, the anode of the regenerator is made more positive, thus increasing regeneration and signal strength. During the negative half cycles of the oscillator, the anode voltage is reduced to a low value, regeneration is checked, thus enabling the tuned circuit of the grid to assume a positive resistance, completely stopping all self-oscillation.

This anode voltage variation method can be assisted in another way. This is effected by introducing a positive resistance into the tuned grid circuit of the first or regenerative valve. The grid of the oscillator valve is connected to that of the regenerator. During the half cycle when the oscillator makes the grid of the first valve negative, no grid current is drawn, and by the super-regenerative action of the circuit the effective resistance is negative.

It is during this half cycle that signals are very greatly amplified. Now taking the other half of the oscillator cycle, a positive potential is given to the grid. The resistance of the circuit is now increased to several thousand ohms, and once more regeneration fails and a positive resistance stops any tendency to oscillate.

It will be noticed that Armstrong prefers to use a dry battery of two or three cells, the negative being connected to the grid, to accomplish rectification. Should it be desired, the ordinary methods of obtaining rectification may be used.

Hard valves must be used in both regenerative and oscillator circuits. Soft valves, which have a poor vacuum, or gas-filled valves are useless. This is owing to the very high plate voltages used. In fact, if procurable, small power valves can be used with considerable success.

The Armstrong super-regenerative circuit is such a radical departure from the standard regenerative circuits, and one upon which such a considerable amount of experiment has to be expended in order to obtain good results, that no attempt has been made in the construction of this set to make a cabinet-contained instrument. The set should be for purely experimental purposes only.

Really wonderful results can be obtained with it on a two-foot loop aerial, but it must be understood that great range and great signal strength is to some extent obtained by a sacrifice in tone quality.

A frame aerial must, under all circumstances, be used with the circuit, otherwise self-oscillation will cause annoyance to other listeners-in in the surrounding districts. In the circuit described, there are no components or materials which are not to be found amongst any amateur experimenter's stock or which cannot be bought easily. The actual set as made up was, in fact, constructed out of such surplus parts which were on hand.

The materials and components required are as follow:

- A vario-coupler with nine tapplings.
- One .001 mfd. variable condenser.
- One .005 mfd. variable condenser.
- One .005 mfd. fixed condenser.
- Two two-cell dry batteries.
- 70-100-volt H.T. battery.
- One 1,250 duo-lateral coil.
- One 1,500 duo-lateral coil.
- Two single coil holders on bases.

Two filament resistances.

One nine-stud switch.

Two valve holders.

Two R valves.

A two-foot (each side) frame aerial.

If the experimenter has at hand some duo-lateral coils of broadcast wave-length, these may be substituted for the vario-coupler, and a little experiment will decide the correct coils to use. It is merely a matter of getting the wave-length correct, and a very tight coupling between them. However, for those who have no such coils, the following description of the vario-coupler will enable them to make one. It is a very useful instrument to have at any time, and need not cost more than a few pence to make.

The stator is made out of a piece of straw-board tube, 4 in. in internal diameter and $4\frac{1}{2}$ in. long. The rotor is a piece of tubing $3\frac{1}{4}$ in. external diameter and $1\frac{5}{8}$ in. long. The stator has 9 tapplings, each of 10 turns, and is wound with 24-gauge D.C.C. copper wire. The rotor has 50 turns, 25 each side of the spindle, of 26-gauge enamelled copper wire. The ends of the rotor winding are connected one on each half spindle. Rubbing contacts conduct the currents away. The holes for the rotor spindles should be drilled as close to the top winding of the stator as possible.

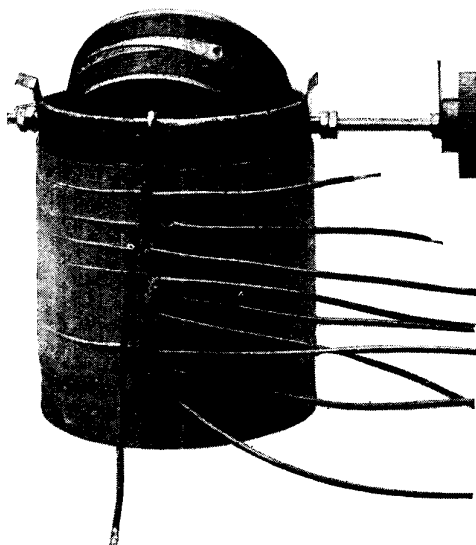

VARIO-COUPLER FOR REGENERATIVE SET

Fig. 16. A simply and cheaply made coupler with nine tapplings, wound on a straw-board tube. The rotor acts as a regenerative coupler between the anode and grid circuits. The latter includes the tapped inductance

without touching. Select a piece of straw-board tubing, as sound as possible, for the stator. Three-quarters of an inch from one end drill two small holes, into which the wire is to be threaded. Drill also two $\frac{1}{8}$ -in. diameter holes diametrically opposite for the spindles. The tube should now be impregnated by complete immersion in boiling paraffin wax. After immersion, stand it on its end to dry. Do not stand it on its side, as that will tend to make it become oval in shape.

The winding may now be proceeded with by threading the wire through the holes drilled for the purpose, leaving about a foot or so free for connecting up. The friction of threading two holes in this manner will be found sufficient to hold the wire firmly in place. Now wind the wire round the tube, pulling as tightly as possible all the while.

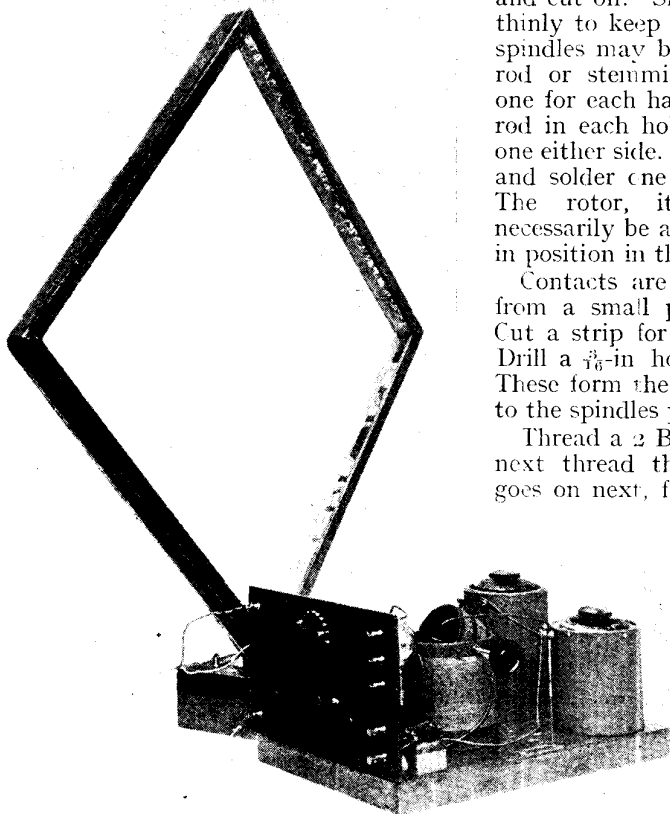

SIDE VIEW OF ARMSTRONG RECEIVER

Fig. 17. A suggestion for a diamond-pattern frame aerial may be obtained from this photograph, and a side view of the set described is given. The compact appearance of the apparatus will be appreciated

On the completion of the tenth turn, twist a loop in the wire very tightly. This loop should be left projecting from the tube in a position convenient for soldering another wire to the tapping switch. This procedure may then be repeated eight more times, until ninety turns are in place. The suggested ninety turns is an optional number. A greater or less number will merely affect the wave-length range of the receiving set proportionally.

The rotor should present no difficulties. Two $\frac{1}{8}$ -in. diameter holes are drilled centrally and diametrically opposite in the tube. Drill two small holes each side of the tube, as near the edge as possible, for the wire anchorage. Wind 25 turns on, then cross right over to the other side and wind on another 25 turns. Finally, pull the end of the wire through the anchorage, leave a few inches over, and cut off. Shellac may now be applied thinly to keep the wire in position. The spindles may be made of 2 B.A. screwed rod or stemming. Two pieces are cut, one for each half spindle. Put a piece of rod in each hole and fix with lock nuts, one either side. Bare the ends of the wire, and solder one end to each half spindle. The rotor, it will be found, must necessarily be assembled with the spindles in position in the stator.

Contacts are easily and quickly made from a small piece of thin sheet brass. Cut a strip for each about 1 in. by $\frac{1}{8}$ in. Drill a $\frac{1}{8}$ -in. hole near one end in each. These form the actual tags. To fix them to the spindles proceed as follows.

Thread a 2 B.A. washer on the spindle, next thread the tag. A spring washer goes on next, followed by two lock nuts.

A similar number of parts is assembled on the other spindle, and the lock nuts adjusted until the rotor becomes centrally situated with respect to the stator. The slight rigidity of the connecting wires attached to the collecting tags will be quite sufficient to keep them in position while the rotor is moving. Two small brackets must now be fitted to the bottom end of

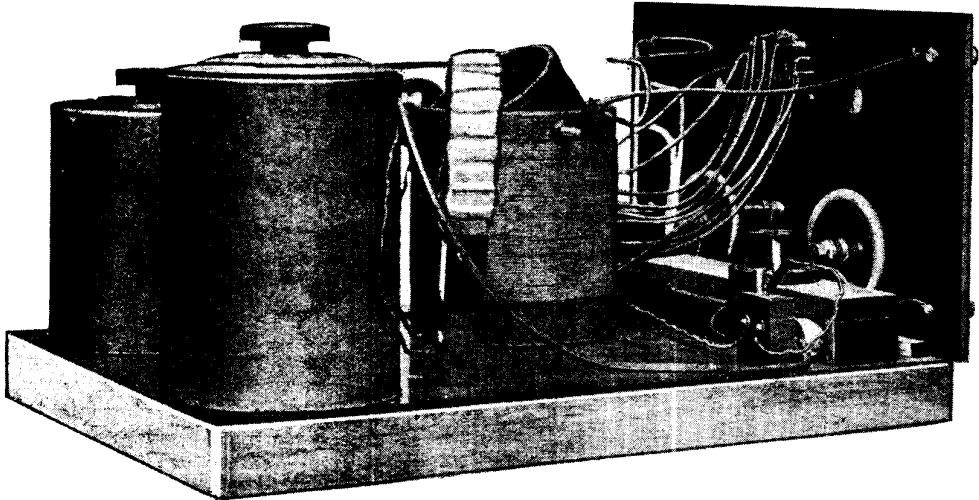

BACK VIEW OF ARMSTRONG RECEIVER

Fig. 19. At the right-hand corner behind the valve platform will be noticed the base plug and socket for the duo-lateral coil, which has been removed to show the back of the panel. The valves have also been removed. From the back ends of the switch studs will be seen the wires of the vario-coupler tapings. On the left the drum-shaped coverings are the outer walls of the condensers. The disposition of the valve holders should be noted

the strawboard tube to fix it to the base board. The vario-coupler is completed by the addition of a knob and pointer to either spindle. The pointer may be placed in line with the rotor to indicate its relative position.

The frame aerial, being the only other component requiring special consideration, may now be proceeded with. The one shown in the photograph, Fig. 17, was made from eight strips of mahogany 1 in. wide and $\frac{3}{16}$ in. thick. A frame aerial is always useful, and is worth making well. Mitre the corners carefully, and saw cut them in the way shown in the sketch, Fig. 18. Hot glue should be placed in the saw cuts and a thin piece of wood slipped in as shown. The grain

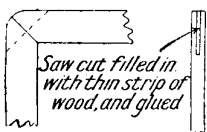

Fig. 18. Method of making a frame aerial corner

should be at 45° with that of the frame. A remarkably strong frame will result. Two separate frames must be made, separated by a one-inch length of ebonite tube or rod at each corner. These spacers should have nicks cut in them to keep the wires separated.

This done, the assembly may be proceeded with. Drill holes in the corners of the frames to take the fixing screws, place the frames in position with the

spacers in between, and screw up tightly. A brass bracket should be fitted each side of one corner to take the top of the pivot plate. The main consideration of the bearing is to obtain a free turning movement combined with rigidity. Providing that these conditions are complied with it is quite immaterial how the job is carried out. Flexible wire should be used to carry the current from the loop to the set connexions. The number of turns on the loop is, again, a matter for experiment, but from six to ten should be the correct number. Single flexible wire, as used for electric lighting, is an excellent material for the purpose, for it is stranded and well insulated.

Providing that the experimenter has obtained all his components, everything is ready for assembly. The base board shown in Figs. 19, 20, 21, measures $14\frac{1}{2}$ in. by 11 in. A study of the photographs and second wiring diagram, Fig. 22, will indicate the lay-out of the panel.

In a set of this description care should be taken to make all connexions as permanent as possible, and all components should be rigidly attached to the base. Means can nearly always be found to make a permanent job of even an experimental set without spoiling the components for other purposes. In order to keep the connexions, particularly in the grid circuits, as short as possible, the grid

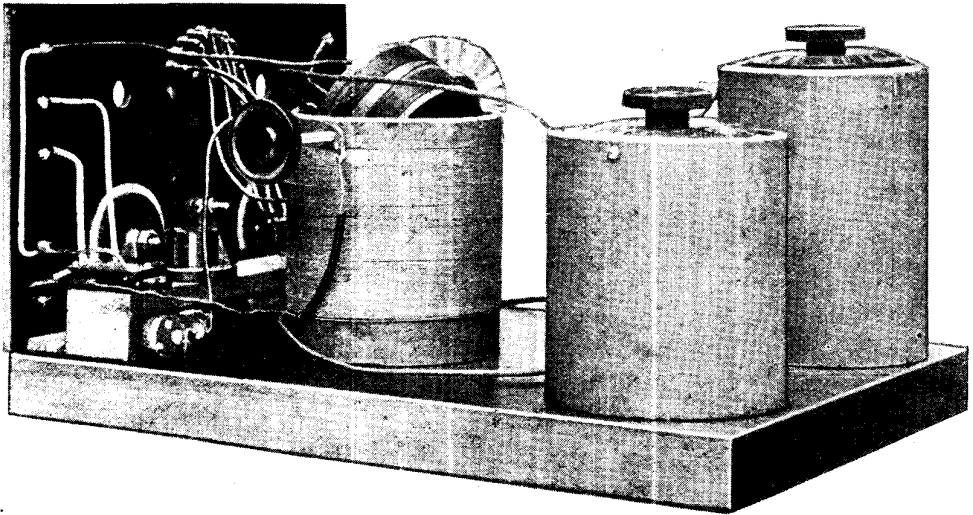

ARRANGEMENT OF VARIO-COUPLER AND CONDENSERS

Fig. 20. The manner in which the vario-coupler and tuning condensers are situated and wired is shown in this illustration. The accommodation of the biasing batteries beneath the valve mounting platform should be remarked. On the platform and immediately above the biasing batteries will be seen the fixed condenser which bridges the telephone terminals

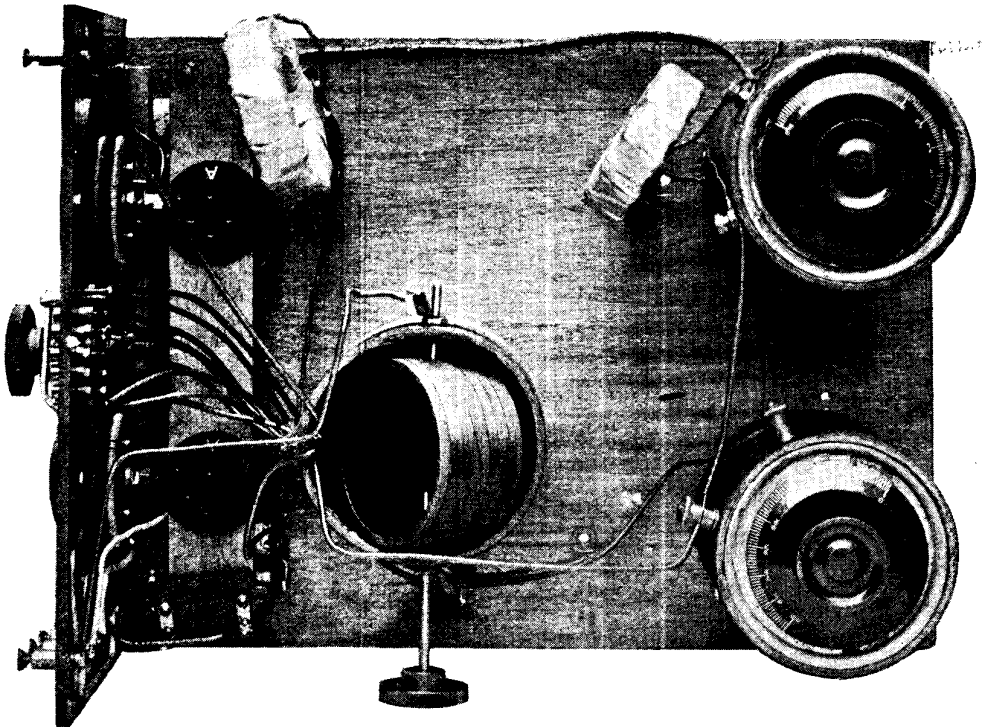

PLAN VIEW OF ARMSTRONG SUPER-REGENERATIVE RECEIVER

Fig. 21. Looking down upon the top of the constructed apparatus one is able to appreciate the spacing of the duo-lateral coils and the vario-coupler. The method of wiring the various parts may also be seen. Looking at the back of the panel it is necessary to take into consideration reflection in the ebonite, which has a tendency to repeat detail

batteries have been fixed actually on the set itself. They require no adjustment like the H.T. batteries, and no useful purpose is served in having them separate from the set itself.

For simplicity in wiring up after all the components are fixed it is recommended that the individual circuits should be connected separately.

Starting with the filament circuits is preferable, for it is not so important to make these so direct as the others, and they can be tucked out of the way before the space becomes limited.

connected to the bottom right-hand terminals, and the loop to the two terminals on the left.

Insert the valves in their sockets, and light them. If everything is in order, the slightest movement of any control should be accompanied by loud shrieking noises. It will, however, be found that these can be removed by adjustment of the condensers and the vario-coupler. Spark signals will be very loud but badly hetero-dync. C.W. or continuous wave signals will be quite clear and very strong. It will be noticed that a high note, more

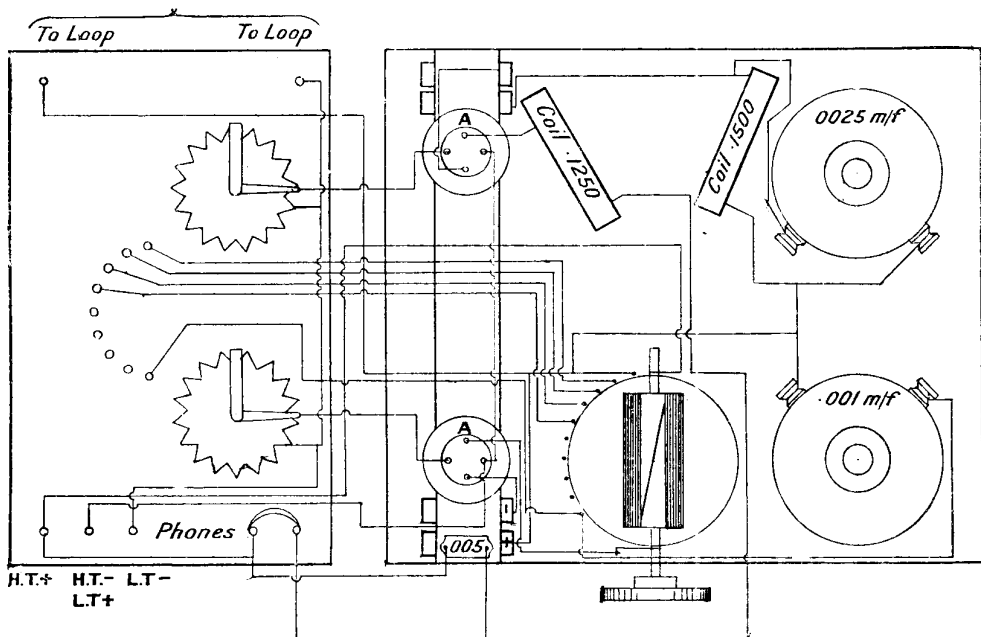

DIAGRAM OF LAY-OUT AND WIRING FOR THE ARMSTRONG TWO-VALVE RECEIVER

Fig. 22. For the purpose of guiding the amateur in the construction of his set, this diagram is given, with the panel projected in the same plane as the baseboard. Some of the details of wiring the vario-coupler have been omitted in order to simplify that portion of the diagram where overlapping would otherwise occur

The two large duo-lateral coils should be connected up by flex to their respective points in the circuit, and arranged so that they can be moved about quite a long way, some six inches, from each other.

In connecting the grid cells exercise care to see that the potential is on the correct side—i.e. negative to the grids. Looking at the front of the ebonite panel, the top° right-hand terminal is H.T. positive, the second H.T. negative and L.T. positive, and the third L.T. negative. The telephones or loud-speaker are con-

or less constant in pitch, is continuously audible. This, in most cases, is not removable except by the use of a special filter circuit (*q.v.*), which, for the purpose of simplicity, has not been included.

Most of the noises can be diminished by the very careful adjustments of the condensers and the vario-coupler rotor.

The construction of a single-valve set follows generally on the same lines, but in this case a few modifications are incorporated. The disposition of the separate parts is clearly shown in Fig. 24,

where the frame aerial is seen at the back, the battery at the right-hand side, and the tuning inductance on the left.

The theoretical circuit diagram given in Fig. 23 shows the scheme of the circuit. This set can be constructed along the lines described for the two-valve set.

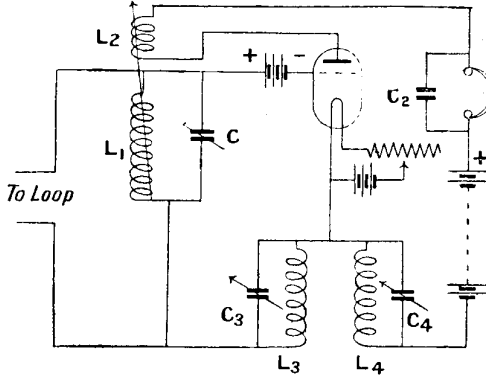

SCHEME OF SINGLE-VALVE CIRCUIT

Fig. 23. In this arrangement L_1 is tuning inductance, C_1 is tuning capacity of .001 mfd., C_2 telephone condenser, L_2 reaction coil, L_3 first oscillator circuit inductance (duo-lateral 1,250), C_3 first oscillator circuit capacity of .005 mfd., L_4 second oscillator inductance (duo-lateral 1,500), C_4 second oscillator capacity of .005 mfd.

The tuning inductance, L_1 , may be similar to that already described. The tuning capacity, C_1 , may be a variable condenser with a value of .001 mfd. The reaction coil, L_2 , is similar to that for the two-valve set. In the set illustrated these elements are assembled into a case seen on the extreme left in Fig. 26, and on the right in the plan view, Fig. 25.

The valve holder and filament rheostat are seen next to the tuning unit in Figs. 26 and 27. The grid-biasing battery rests upon the top of the panel between the valve and the filament rheostat knob. The various connexions are also clearly visible in all the illustrations. The first oscillator circuit capacity, C_3 , has a value of .005 mfd., and is of the type previously described. The first oscillator circuit inductance, L_3 , may be a duo-lateral coil with 1,250 turns. The second oscillator circuit capacity, C_4 , is a variable condenser with a value of .005 mfd.; the inductance, L_4 , in the second oscillator circuit may be a duo-lateral coil 1,500, and the fixed condenser, C_2 , has a value of .005 mfd.

The duo-lateral coils are mounted as in the two-valve set, on separate stands,

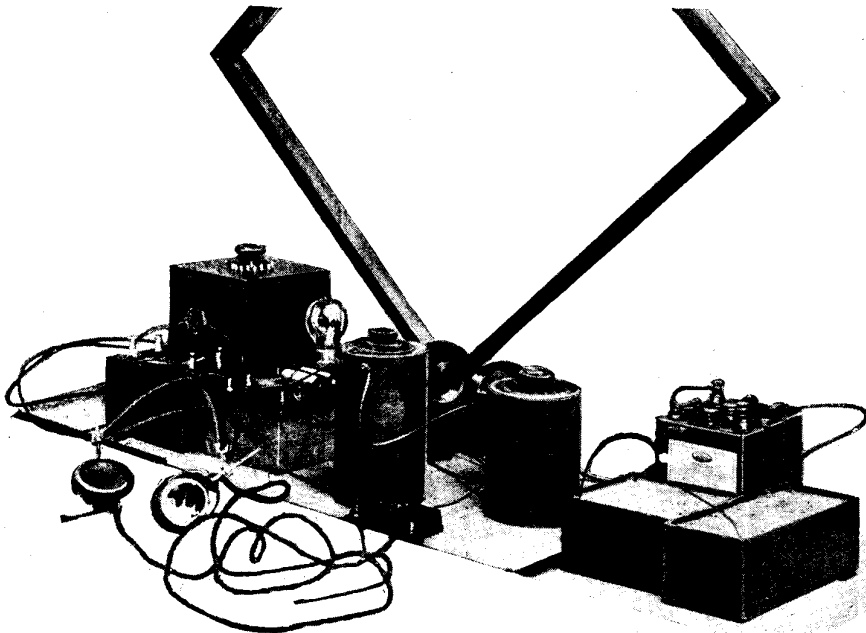

ARMSTRONG SUPER-REGENERATIVE SINGLE-VALVE RECEIVER

Fig. 24. Here laid out will be seen the components of an Armstrong super-regenerative single-valve set. The duo-lateral coils appear between the two tuning condensers, which are of the totally enclosed type. The construction of this set is carried out largely on the lines of the two-valve set previously described

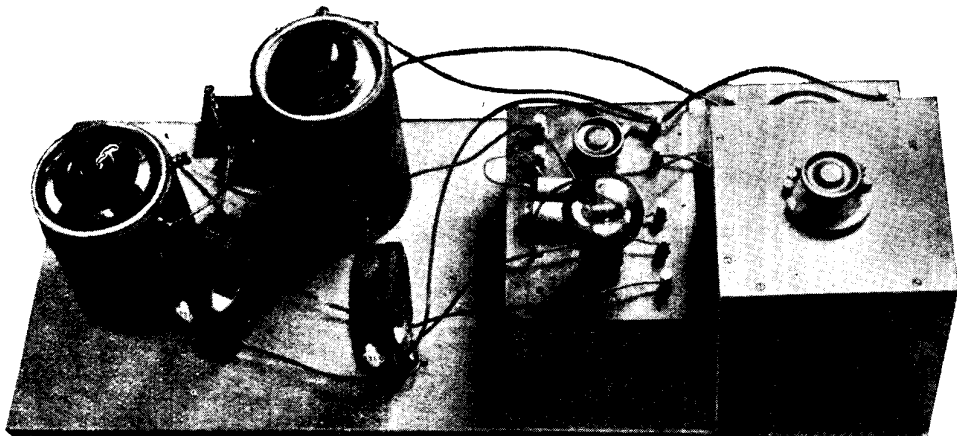

Fig. 25. On the right of the photograph is the container of the aerial tuning unit, and on the left the duo-lateral coils. The method of wiring can be seen from this plan view

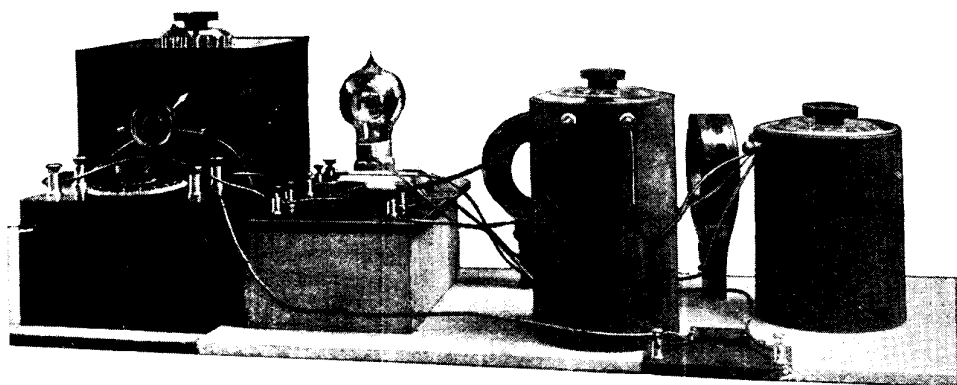

Fig. 26. This is a front view and shows how the condenser terminals are fixed. Behind the telephone terminals, which are mounted on the ebonite block in the foreground on the right, will be seen the fixed condenser

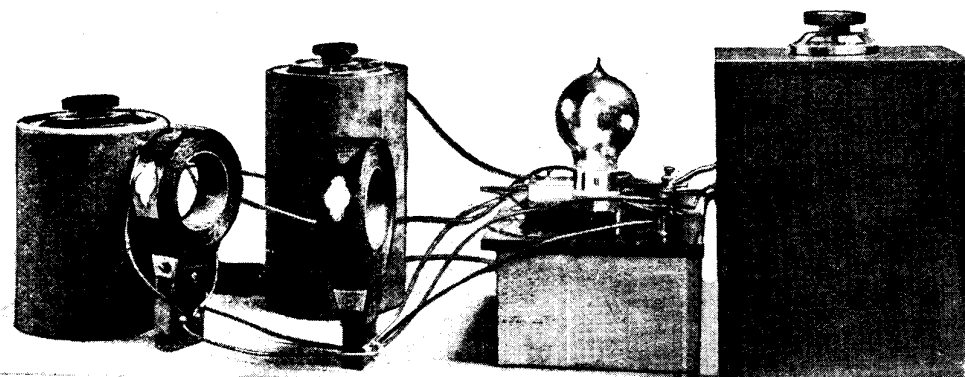

Fig. 27. A back view is here given, showing the disposition of the duo-lateral coils and condensers. The wiring is not difficult, but it is essential that the connexions should be perfect

THREE VIEWS OF THE AMATEUR-MADE ARMSTRONG SINGLE-VALVE RECEIVER

so that they can be adjusted relatively to each other. Any hard valve, such as an R or a small power valve, can be used.

The relative positions of these elements can be seen in Figs. 24 and 27. The former is a view from the front, and the latter a back view. The wiring does not present any difficulties, but it is essential that all the connexions be perfect. Operation of the set is much on the same lines as for the two-valve outfit; no written instructions are of much aid. The adjustments consist of turning condenser knobs and moving the tuning coils nearer or farther from each other, the reaction adjusted to the oscillation point and the regeneration effect obtained by adjustment of the oscillator circuits. There are likely to be some unusual noises at first, and some amount of radiation from the aerial, so unless a small loop is used, it will be best to tune in on Morse signals well away from any of the broadcast wave-lengths until some control of the set has been acquired by practical experience.—*R. B. Hurton.*

ARRESTER. Short name for the type of switch used in wireless, and better known as lightning arrester or earth switch (*q.v.*). See Aerial Switch; Earth Switch.

ARTIFICIAL MAGNET. A magnet produced by magnetizing a piece of previously unmagnetized steel. A natural magnet is the lodestone, a kind of iron ore. Artificial magnets are produced by stroking a bar of hard steel continuously in the same direction with another magnet. The bar may also be magnetized by passing an electric current through a wire which is coiled round it. See Electro-Magnet; Magnetism.

ASPHALTE. A natural mineral of a pitch-like character. It is used in wireless and electrical work as the basis of many insulating materials and compounds. Asphalte possesses the qualities of a fairly good electrical insulator, with the addition of considerable mechanical strength and flexibility. When suitably compounded it is waterproof and damp-resisting, is not greatly affected by oils, but is soluble in benzol or toluol, these being the most extensively used solvents. Asphalte is employed in the manufacture of numerous insulating varnishes and pastes. The electrical puncturing resistance varies according to the purity or otherwise of

the mixture, but is of the order of 5,000 to 15,000 volts per millimetre. The use of asphaltic compositions as a preservative coating for iron and steel work has much to recommend it, especially on exposed aerial masts and similar structures. Asphalte is also known under the name asphaltum. The natural asphalte should not be confused with the many artificial compounds, mixtures and oil residues commonly known under that name, and used for road-making and other purposes.

ASBESTOS. A fibrous, non-combustible mineral which has a composition of about 40 per cent of silica, 43 per cent magnesia, 1 to 3 per cent each of ferrous oxide and alumina, and some 14 per cent of water. Its disruptive strength as an insulator is of the order of 4,000 volts per millimetre.

Asbestos is of value in wireless work as an insulator, and also as a non-conductor of heat. It may be used with advantage in the proximity of resistances, as, for instance, the filament resistance in a panel set. After protracted periods of use the filament resistance may heat up, and this would be detrimental to the ebonite panel. This can be avoided to a large extent by interposing a piece of asbestos sheet or millboard between the panel and the resistance.

Another application of a like character is in the case of resistances used for accumulator-charging apparatus, where the heat is likely to be considerably more than in the former instance; in which case the asbestos sheet should be at least $\frac{3}{8}$ in. or more in thickness. The asbestos should be isolated from the resistance by means of an air gap, arranging this according to the details of the resistance; generally by mounting the element upon insulating blocks at each end, thus bringing the resistance wire some distance away from the back or sides of the frame.

Other forms of asbestos are available, such as cord or string, which may be wound round any parts liable to become heated. The thinner qualities can be wound in a very dry state, and the thicker varieties may be worked by first damping the cord with water, which will render it more pliable, and then winding it in place. This method is not to be recommended except when a very close packing is required; and time should be allowed for the asbestos to dry off thoroughly before

passing an electric current anywhere near it, as the dampness will cause a partial earth.

When working with asbestos millboard or sheet, it can generally be cut with a keen, sharp knife up to a thickness of a quarter of an inch. Above this, it can be sawn with a fine-toothed tenon or other saw, such as is used by carpenters, or with an ordinary hack-saw. The teeth of the saw should be wiped with a rag occasionally, whenever they show any tendency to choke.

Asbestos can be used as a basis of packing or cement, and can be mixed with fireclay, worked into a paste with water, and forced into any cracks or crevices, or worked around some part to be protected. Cubes of asbestos are excellent for building up around work to be brazed, as the radiant heat assists the brazing process.

ASTATIC COILS. Coils so wound that their currents produce no external magnetic field, and that a uniform alternating magnetic field induces no voltage in them. The coils are used as a standard of the measurement of inductances. The figure shows a way in which astatic coils are

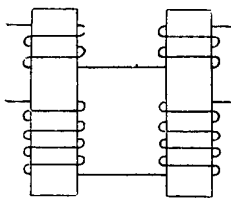

WINDING ASTATIC COILS

How the astatic coil is wound may be seen from this diagram, noting how the wire is introduced on to the formers

insulating material. The primary and secondary coils are wound evenly over one another, completely round the ring. See Inductance.

ASTATIC GALVANOMETER. A high degree of sensitiveness may be attained in a galvanometer by mounting the deflecting magnets in astatic pairs, that is, with the poles of the needles opposed to one another, so that there is very little directive control from the earth's magnetic meridian. Obviously, the same amount of deflecting force acting upon any moving part that is restrained by an independent controlling force will produce greater results in

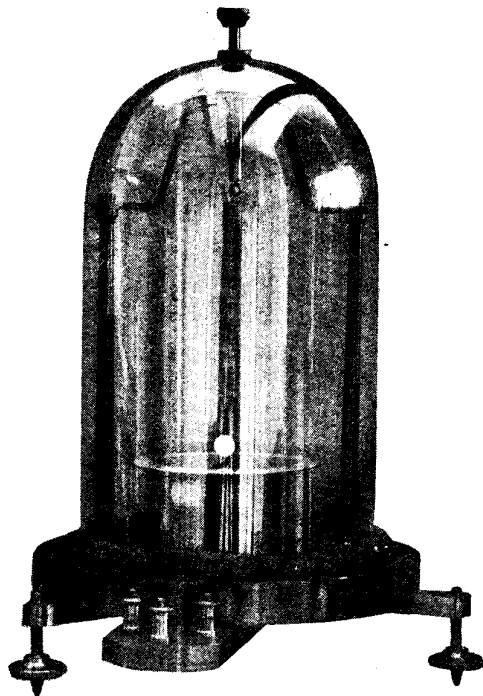

ASTATIC GALVANOMETER

Fig. 1. This instrument, which is of the laboratory type, is used for detecting small electric currents.

It is very highly sensitive
Courtesy J. J. Griffin & Sons, Ltd.

proportion to the weakening of the control. The controlling force tends to keep the needle in one position, the deflecting force impels it in another direction; and the resultant of the two determines its final position. A truly astatic combination of needles would not experience any control from the earth's field at all. But in practice this condition is impossible.

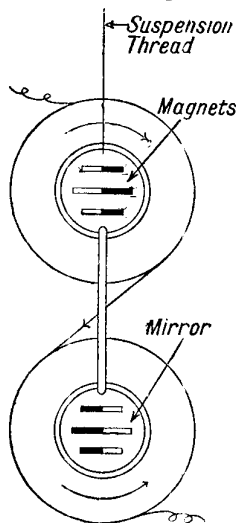

Fig. 2. From this diagram the movement of the astatic galvanometer will be understood

Kelvin's mirror galvanometer, employing astatic arrangements of the suspended needles, is illustrated in principle in Fig. 2. A number of tiny permanent steel

magnets are fixed to the back of a pair of concave mirrors suspended by a thread, and each group of magnets comes into the influence of a magnetic field originating from two coils of insulated copper wire wound on bobbins. One set of magnets has its poles placed in an opposite sense to those of the other set, so as to obtain the astatic combination desirable for extreme sensitivity, and in order that the deflecting impulses from the two coils should both act in the same direction the connexions from one bobbin to the other are reversed, so that current circulates right-handedly around one and left-handedly around the other.

Light as a Weightless Pointer

The suspended needles and the fixed coils are mounted in a brass case on a tripod stand, having an opening in the case to allow a beam of light to be projected on the concave mirror from a lamp provided for that purpose, and again reflected on to a distant screen placed at the correct focal distance. The faintest deflection of the mirror due to the current-carrying coils acting on the suspended magnets attached to the mirrors is then multiplied very considerably, as though by a long weightless pointer, which is, in effect, the beam of light between the mirror and the scale.

The galvanometer case has usually an adjustable permanent magnet made to slide in or out and to turn into any position, for the purpose of providing a very weak directive force upon the internal mirrors with their own magnets, otherwise it would be almost impossible to bring the spot of light to any definite position on the scale, and it would wander even while preparing for a reading.

An instrument of this type is capable of showing a scale deflection quite appreciable in extent, although the current flowing around the galvanometer coils is of the infinitesimal order of one fifty thousand millionth part of an ampere. It is naturally exceedingly delicate, and intended for laboratory use, hence the utmost care is required to protect the fine thread suspension from shocks. The instrument must also be kept well away from the influence of strong outside magnetic fields, and when actually in use anything likely to cause violent deflections of the mirror must be avoided. *See Galvanometer.*

ASTATIC PAIR. A magnetic needle freely pivoted has one of its ends directed always towards the magnetic north by the influence of the earth's magnetic force. If another exactly similar needle were mounted on the same support, but with its own north and south poles opposed to those of the first needle, any tendency of the one needle to turn in a particular direction would be counteracted by the tendency of the other to turn in the opposite direction. These two needles, rigidly connected and with their poles opposed, would be termed an "astatic pair," and although freely pivoted so that they could turn in any direction, would not come to rest in any particular way in regard to the earth's field, as its directive force would be neutralized. In practice it is very difficult to obtain a perfectly astatic pair, owing to the remote chance of exactly matching a pair of needles for magnetic strength, and in getting their magnetic axes in exact line with one another. Consequently, the forces urging one needle to set itself in the magnetic meridian are usually slightly overbalanced by the same forces acting on the other, and the pair as a whole ultimately come to rest in a more or less definite position after a considerable period of time. This almost complete elimination of the earth's controlling force on the pair enables a very sensitive instrument to be produced, extremely responsive to the impulses of its own deflecting coils.

ASYMMETRICAL EFFECT. This term is used in wireless for the non-directional effect which is a result of lack of symmetry in construction of a loop or frame aerial. *See* Frame Aerial.

ASYMMETRIC CONDUCTIVITY. A conductor is said to have asymmetric conductivity when it allows more current to flow in one direction than in the other. *See* Crystal; Valve.

ASYNCHRONOUS SPARK GAP. A rotary spark gap arranged to give a number of sparks in each cycle of an alternating current supply, the sparks not necessarily occurring at points of the same phase in successive cycles. *See* Spark Gap.

A.T.C. Standard abbreviation for Aerial Tuning Condenser, the condenser used in the aerial system.

A.T.I. This is the standard abbreviation for Aerial Tuning Inductance, the inductance used in the aerial system.

ATMOSPHERICS, or Atmospheric Disturbances. Stray ether waves due to natural causes. The term is also applied to the false signals produced thereby.

All wireless enthusiasts have, at some time or other, been annoyed at mysterious "clicks," grinding, and rumbling noises in the telephones, particularly during the summer weather. Many of these stray noises are due to atmospherics, or X's, as they are sometimes called. Electrical discharges, such as distant lightning, are the chief cause of audible atmospherics. Should a storm gather during reception, a click will occasionally be heard simultaneously with a flash of lightning. Apart from these low altitude discharges, the result of which is the click just described, there are the higher altitude disturbances, the cause of which is very little known. The indication of these disturbances in the receivers is a more prolonged and grating or grinding noise. It should be noted that although these interruptions are usually an indication of thunder, and often precede a thunderstorm, only instruments affected by electromagnetic waves, such as wireless receivers, are affected by them.

Miscellaneous Wave-Lengths

Observations made in connexion with this type of atmospherics prove that they have the same characteristics as wireless waves, inasmuch as they are electromagnetic waves, and therefore travel at the speed of 186,000 miles per second, and radiate in all directions from their source. Unlike wireless waves, however, they are not restricted to any one wave-length, and they are "damped," *i.e.* the amplitude or height of the wave gradually grows smaller and smaller the farther they travel. In this latter respect they are similar to the waves transmitted by the old type of spark apparatus.

It is possible to draw a simple analogy between electro-magnetic waves, which travel in the ether, and sound waves, which use air as their travelling medium. A wireless wave may be considered as being similar in formation to the wave transmitted in air by a tuning fork. The vibrations of a tuning fork are constant in frequency, and different notes struck by different forks can readily be distinguished by the human ear. On the other hand, an atmospheric disturb-

ance may be allied to the bang made by the discharge of an explosive. This bang is not a note, but a jumble of waves of all frequencies, all sent out at once.

While on the subject of air waves, it would be desirable to emphasize the fact that atmospherics are ether and not air disturbances, as their name might imply. The term atmospheric does, however, apply more accurately to a variety of disturbances which is not so well known. Floating about in the air are millions of small particles of moisture and dust, and which are all electrically charged to a greater or less degree. Some of these strike the aerial, and in doing so, transfer their electrical charge to it.

Disturbances Due to Dust and Moisture

Minute though these charges may be, their number is such that the resultant transference of energy becomes large enough to be recorded by such a sensitive instrument as a wireless telephone receiver. It will be seen that the number of such discharges may be more or less constant for a given period, for air is always in a state of motion, and these particles of foreign matter move with it. In a receiver where a continuous metallic connexion exists between aerial and earth by an inductance it is not likely that these discharges will make themselves known, for they will merely pass, via the inductance, straight to earth.

Should a series condenser be in circuit, however, without a leak, the tendency will be for all these electrical impulses to collect and charge up that condenser until the accumulated energy is sufficient to break down its insulation. The sudden discharge of this condenser to earth will induce a corresponding fluctuation in the receiver and cause a loud click in the telephones.

Faults in the Set Often Responsible

This type of disturbance will not usually give much trouble to the broadcast enthusiast, for the small aerials used in this short-wave reception do not present a great surface for the particles to discharge upon. These disturbances are often blamed for all kinds of noises which creep into a set, particularly if it be a valve set.

Noisy valves, batteries, and bad connexions are prolific causes of noises and interruptions, and it would be as well

for the experimenter to look to these things first, and, as far as possible, eliminate them. Loose connexions can be discovered by knocking the set with the hand while receiving. No noise, other than the usual microphonic hum of an oscillating valve, should be caused by so doing. Poor H.T. batteries will usually indicate themselves by mumbling, grating noises when the aerial and earth wires are disconnected. If the operator is certain that there are no loose connexions, and that the H.T. battery is quiet, the substitution of different valves for those in use will prove whether these are giving trouble or not.

A further cause of interruptions within the set itself is a leaky inter-valve transformer winding. As most radio enthusiasts have no instruments other than batteries and telephones with which to test insulation leaks, the only way to get at these faults is by substituting for the suspected component one which is known to be perfect. Should the substitution effect no improvement, then, obviously, the amateur must look for the trouble in another direction.

How to Eliminate Atmospherics

Should the whole circuit be examined and no faults discovered, then atmospherics must be the cause of the interruptions, and the following notes will indicate the lines to follow for their elimination. The first step in reducing atmospheric disturbances is to reduce the size of the aerial. Indoor and frame aerials are practically immune from them, and modern methods of high-frequency amplification more than compensate for any loss due to smaller aerial systems. Again, the enormous advantages of the frame aerial are its directional properties, which are of great value in reducing interference from powerful stations close at hand, and often well worth the use of high-frequency amplification to increase signal strength and range.

With regard to the second kind of atmospheric described—namely, the charging of a series condenser by minute charges from floating matter in the air, the obvious remedy is to use an aerial and earth system, the properties of which are such that a series condenser is unnecessary. This can often be effected by shortening the lead-in and earth wires. Except when receiving very short wave signals, below 200 metres, for instance, there should really be no need for a series condenser,

although the general trend of observations seem to indicate that series condensers give greater selectivity. Some experimenters connect a resistance of $\frac{1}{4}$ to $\frac{1}{2}$ megohm across their series condenser to ensure its continuous discharge.

The Rogers underground aerial and the Hoyt-Taylor balance of a coil aerial and an underground wire have both been used satisfactorily to reduce atmospherics.

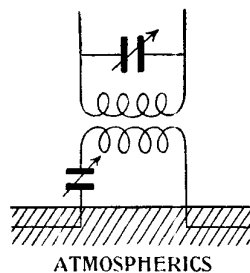

Fig. 1. The Rogers underground aerial for reducing or eliminating the effects of atmospherics

The Rogers underground aerial has two highly-insulated wires buried, Fig. 1, in the ground below the permanent water level. The wires are in a plane pointing towards the transmitting station. The extreme ends of the wire are well insulated, and the ends near the receiver

lead to the primary of the receiving apparatus. A variable condenser is fitted in series with one of the wires to enable the system to be tuned. The theory of the Rogers aerial is dependent upon the fact that the earth is a good conductor, and so atmospherics do not penetrate the surface to any great extent.

But though the greater part of the atmospherics are eliminated by this system, it is not so suitable for strong reception of the wave-lengths as used for Broadcast concerts and telephony as the ordinary overhead aerial. The strength of the signals received by the underground system is a function of the wave-length of the received signal, increasing with increase of wave-length. On wave-lengths of 600 metres or less the signals are less than 10 per cent of the strength of the overhead wire; but on 6,000 metres the signals are not very different.

In the Hoyt-Taylor system a frame aerial is balanced against an underground wire. The aerial consists of about 20 turns of wire, spaced about a foot apart, on a frame 30 ft. by 75 ft. The frame aerial is earthed, and its other end connected to an inductance. The latter is connected through a variable condenser to a variable resistance. The resistance is connected to an underground wire. The resistance is also connected direct to

earth through another variable resistance. The first resistance is loosely connected to the primary circuit. Fig. 2 shows the theoretical circuit of the system.

It is to be remarked that on the short

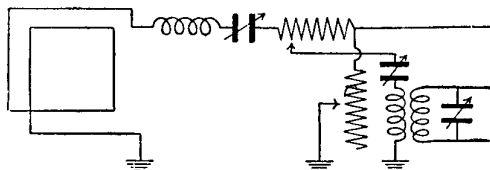

ATMOSPHERIC ELIMINATION

Fig. 2. The Hoyt-Taylor circuit shown in this diagram was designed for lessening atmospheric by the use of an earthed frame aerial

wave-lengths used in broadcasting the effect is never so great as on the much greater lengths used in wireless telegraphy.

Another method by which the effect of atmospheric may be lessened is by the use of two crystals or two valves in opposition. The principle of the opposing crystals or valves is that the sensitiveness of the detector is under control, and can be so adjusted that the required signal gives the maximum effect in the detector. Signals of ordinary strength affect one crystal, or detector, strongly; while signals due to strong atmospheric affect both almost to the same extent, and being opposed, cancel one another.

The use of two circuits, one tuned to the desired signals and the other not, has proved very effective in eliminating atmospheric. The oscillations set up in the two circuits are so arranged that they produce opposing effects in the telephones, and cancel out the atmospheric, while the tuned signals are still heard.

By decreasing the capacitance of the circuit and its resistance, and by increasing its inductance, the natural persistence, as it were, of the oscillations becomes greater, and so tends to kill atmospheric and strays. Instead of reducing the aerial, a small series condenser of about 0.00025 mfd. may be placed in series with the aerial. By the use of a smaller aerial or a frame aerial the signals from the transmitting stations are weakened, but the atmospheric are weakened at a greater rate, so that the relative interference becomes less.—*J. L. Pritchard, F.R.Ae.S.*

See Filter Circuit; Interference; Statics.

ATOM. The term given long ago to the ultimate particle of matter, which was supposed to be indivisible, or which, if

divided, would give something else than matter. Modern science has divided the atom of matter, and finds that it is composed of electric particles, which might be called atoms of electricity, and, again, are supposed to be indivisible. All matter is atomic in structure, and the atoms of matter combine to form molecules. The relative masses of the atoms of the chemical elements, referred to the mass of some standard atom, as that of hydrogen or oxygen, are known as their atomic weights. Thus the weight of a hydrogen atom being taken as unity, that of an oxygen atom is 16.

The approximate sizes of atoms have been arrived at in a number of ways. By considering the thickness of soap bubbles or oil films, for instance, Lord Kelvin and others concluded that the diameter of an atom must be of the order 10^{-8} cm., or what is called in spectroscopy an Angström unit. It is about the forty-millionth part of an inch.

At the end of last century Sir J. J. Thomson showed that minute corpuscles or electrons, of $\frac{1}{1800}$ the mass and $\frac{1}{100000}$ the diameter of the smallest and lightest atom of matter, could be extracted from substances of every kind—that is to say, that an electron is a constituent of all atoms. The electron had been previously named as the atom of negative electricity, but had never previously been isolated and measured.

The other constituent of atoms is what is now called the proton, and this is regarded as the atom of positive electricity. A proton is much heavier than an electron, though it is about the same size: indeed, it may be even smaller. It is the same weight as the atom of hydrogen, the lightest known atom of matter. All matter is believed to be built of protons and electrons arranged in a certain way: in other words, matter is composed of positive and negative electric charges.

The Rutherford-Bohr theory of the atom, which has been widely accepted, regards the atom of any element as a positively charged nucleus surrounded by revolving electrons; the positive and negative charges being equal, so that the grouping is neutral. More has to be discovered about the constitution of the nucleus; but it is in general believed to be composed of a definite number of protons and electrons tightly packed together, the number of protons being in

excess, and this extra positive charge being only neutralized by the satellite or planetary electrons revolving round the nucleus, held in their orbits by its electrical attracting force.

On this view the hydrogen atom is a single proton with a single electron revolving round it. The helium atom is believed to consist of a nucleus of four protons compacted with two electrons, and having two other electrons revolving round it. A helium nucleus, with its double positive charge, is vigorously expelled by radio-active substances, and then goes by the name of an alpha-particle. But it soon picks up two stray electrons and settles down as neutral or ordinary helium. The next atom of the chemical series is a nucleus containing three unbalanced protons with three revolving electrons. And so on, up the series, in regular succession, to the number 92, which is uranium. The number 88 is radium.

In insulators the electrons appear tightly attached to the atoms; but in metals they are loosely held, so that they can pass from one to another, and thus constitute an electric current. If the temperature be raised, so that the atoms are violently jostled, some of the electrons can evaporate, or escape from the surface, at a certain temperature.

Every escaping electron being a negative charge, the abandoned material becomes positive; and, if insulated, its positive charge can be demonstrated. This thermionic emission is the basic principle of the thermionic valve. For if in a vacuum bulb there be two terminals or electrodes connected to a high-tension battery, a stream of corpuscles will flow from the cathode to the anode, and it can only flow in that direction. Accordingly, if an alternating current is supplied to such a valve, all the alternate pulses are stopped and the other ones transmitted—which is the method of rectification, and hence the term "valve."—*Oliver Lodge, F.R.S.*
See Electron; Valve.

ATTENUATION. This is the decrease, as the distance from the transmitting station increases, of the amplitude of the electric and magnetic forces accompanying and constituting an electro-magnetic wave. It may be said to be the gradual weakening of the received impulses with distance from the transmitting instrument, while preserving their original quality and wave

shape. The coefficient of attenuation is that coefficient which, when multiplied by the distance of transmission through a uniform medium, gives the natural logarithm of the ratio of the amplitude of the electric or magnetic waves at that distance to the initial value of the corresponding quantities.

AU. This is the chemical symbol for gold. It is a contraction of the Latin for gold, Aurum. See Cat's Whisker; Geld.

AUDIBILITY. The ratio of the telephone current variation producing the received signal to that producing an audible signal. The latter is defined as a signal which enables the mere differentiation of dots and dashes to be determined. The measurement of audibility is an arbitrary one, and depends merely on the relative loudness of two signals received in different telephones. See Audibility Meter.

AUDIBILITY METER. It is desirable sometimes to be able to test the relative strengths of signals received from different stations, or even from one station using different instruments, and for such tests some arrangement is necessary for measuring the intensity of the signal.

An audibility meter (Fig. 1) can only be qualitative as to its indications, since in the natural order of things audibility can never be made the subject of exact measurement.

The circuit arrangements of an audibility meter are shown in Fig. 2 in the simplest form. The appliance merely consists of a

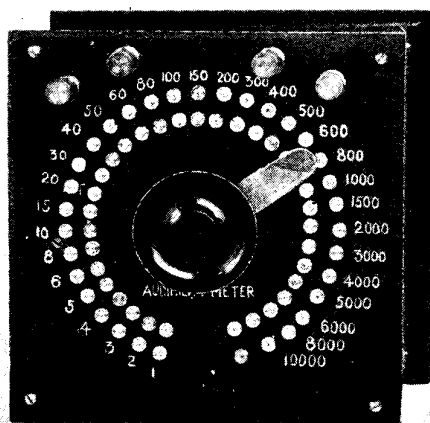

EXTERIOR OF AUDIBILITY METER

Fig. 1. External view showing the large series of stud contacts, and the telephone and receiving terminals

calibrated shunt resistance R, about equal to the resistance of the telephone receivers themselves. A non-inductive resistance box as used for ordinary testing purposes serves quite well. The value of the current in the telephone receiver is practically proportional to the energy of the incoming waves, so that a rough table of values based on audibility is easily made. For instance, a station which produces a sound just audible in the telephone receiver when all the resistance is in circuit is taken as the standard or zero point; if

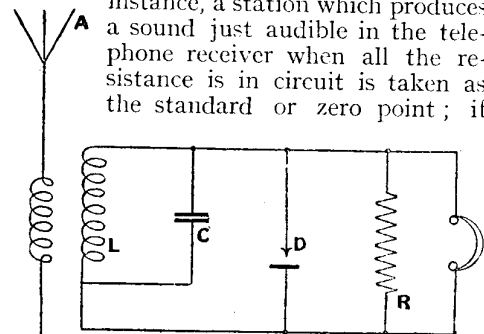

AUDIBILITY METER CIRCUIT

Fig. 2. The circuit arrangement of the audibility meter shows the shunt resistance across the telephones

another station is then found to produce a just audible sound with only one half of the resistance R in circuit, the new value can then be compared with the standard, and the result is expressed either as a unit or fraction of unit audibility, depending whether unit audibility is taken in the first place with the shunted resistance all in or with it all out. The letter references in the diagram are: A = aerial; L = inductance; C = capacity; D = crystal receiver; and T = telephone. It should be noted that this method can also be used to eliminate interference from weak stations, but it is only carried out at the expense of decreasing the intensity of the signals being received. It can also be used in connexion with a wave-meter.

Comparative audibilities can be measured also in another way—namely, by using a fixed value of resistance R in the circuit shown in Fig. 3, and then varying the tapping point for the shunted telephone connexion. Then, if the impedance of the telephone is great compared with that of the resistance R, the audio current will not be affected appreciably by any change in the shunt adjustment point. This, it is evident, is on the lines of an ordinary potentiometer measurement. Both these methods, however, fail to give absolute

audibility, which cannot be determined by any known means other than the interpretation of the human ear, and must therefore depend on the personal factor and the judgement of the operator.

The external appearance of an audibility meter is shown in Fig. 1, and comprises a polished wood case with a series of studs and a movable contact arm that passes across them in pairs. Two sets of terminals are provided for the telephones and the receiving set respectively. A usual size for the case is 8 in. square and about 3 in. in depth. The apparatus acts by providing a variable shunt around the telephones, and by using as a unit of comparison the number one. Taking this as the measure of a signal that is just audible, it becomes possible to reduce all signal strengths to this basic audibility by the introduction of an impedance into the circuit. The proportionate current flowing through the shunt being known, the audibility of

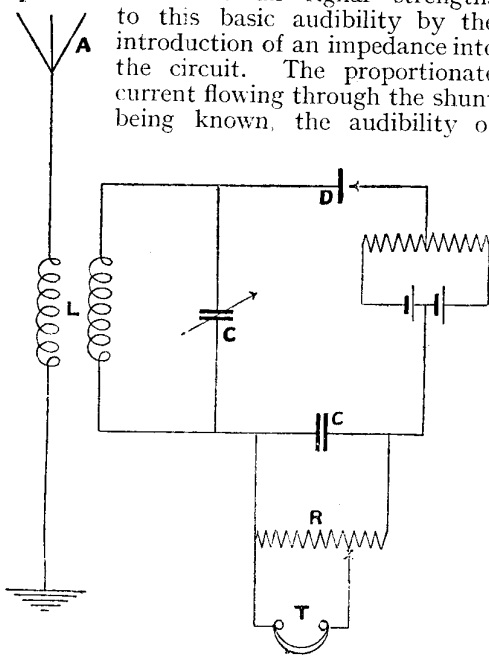

AUDIBILITY METER WITH POTENTIOMETER

Fig. 3. Method of using a fixed value of resistance with variable telephone connexion shunt point

the signals is determined by introducing sufficient impedance in series with the detector output to maintain a constant impedance across the detector. This is facilitated by the calibrations on the tapped contacts on the exterior, the figures thereon being comparative rather than absolute.

AUDIO-FREQUENCY. The range of audibility for the average human ear may lie between 200 and 20,000 waves per

second, although in certain cases individual sensitivity may considerably modify these figures. The average frequency of the sound waves due to human vocal mechanism in ordinary conversation may

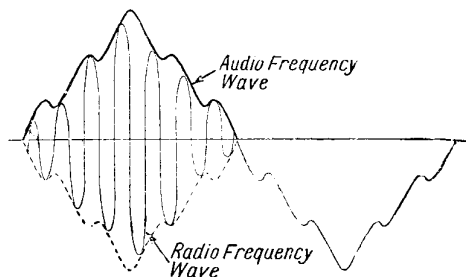

AUDIO-FREQUENCY

Radio-frequency waves are shown diagrammatically modulated to audio-frequency

be said to lie in the region of 800 waves per second. Since the aerial must emit at least one electro-magnetic wave modulated or controlled by the voice at an average of 800 waves per second for continuous speech, a continuous radiation of transmission waves at this minimum

method is therefore essential, which shall permit one sound wave to modulate a large number of electro-magnetic waves, and so reduce radio-frequency to audio-frequency. In the figure a continuous train of radio-frequency waves is shown, modulated by a current wave superimposed upon the radio waves by a microphone, the crest of which reproduces the interference caused by modifying the original amplitude, and resulting in a form and frequency adapted to telephonic response.

AUDIO-FREQUENCY AMPLIFIER. An audio-frequency amplifier is an instrument which amplifies wireless or other signals at audio, or hearing, frequency. The instrument is also known as a low-frequency amplifier or note magnifier, although the latter is not really correct for telephonic apparatus, but should be restricted to telegraphic instruments.

Audio-frequency amplifiers are always connected to a receiving set in the place of the telephone receivers. Thus it will be seen that the amplification takes place after the rectification. The construction of an amplifier will be considered in this article, and if the instructions given herewith are closely followed, the constructor will have an instrument which will amplify his signals, speech, or music with the absolute minimum of distortion and with sufficient volume to allow the use of the loud speaker.

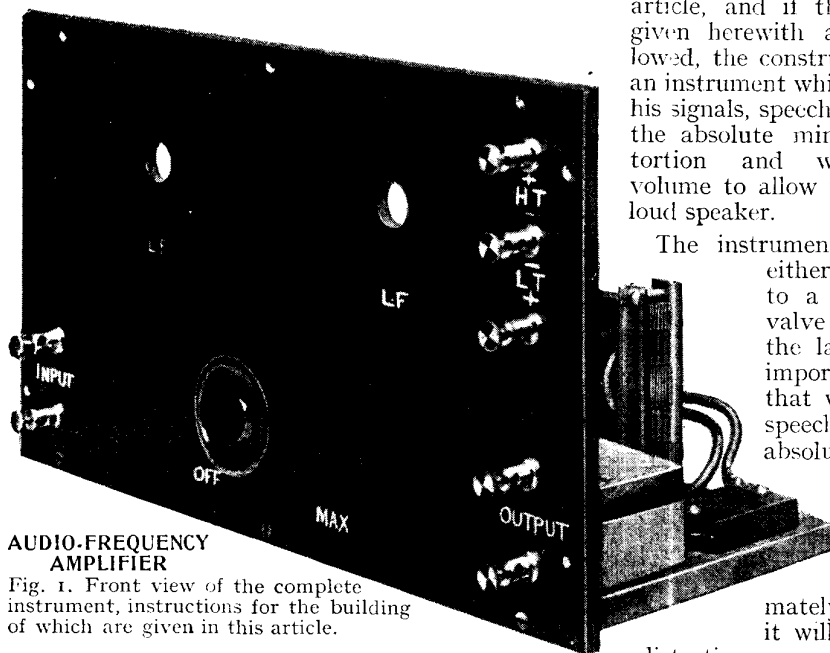

AUDIO-FREQUENCY AMPLIFIER

Fig. 1. Front view of the complete instrument, instructions for the building of which are given in this article.

The instrument, Fig. 1, may either be connected to a crystal set or valve set, but if of the latter type it is important to see that when receiving speech or music the absolute minimum

of reaction is used. The amplifier will magnify signals approxi-

mately 16 times, but it will also magnify

distortion as well. Reaction

frequency of 800 per second is necessary. The wave-length, however, that would be required for voice frequency is obviously impossibly great, being somewhere in the region of 375.200 metres. An alternative

improperly used is one of the chief causes of distortion. An inverted panel is used, with the valves inside the case behind the panel. The case itself is of very simple design, being merely a rectangular box,

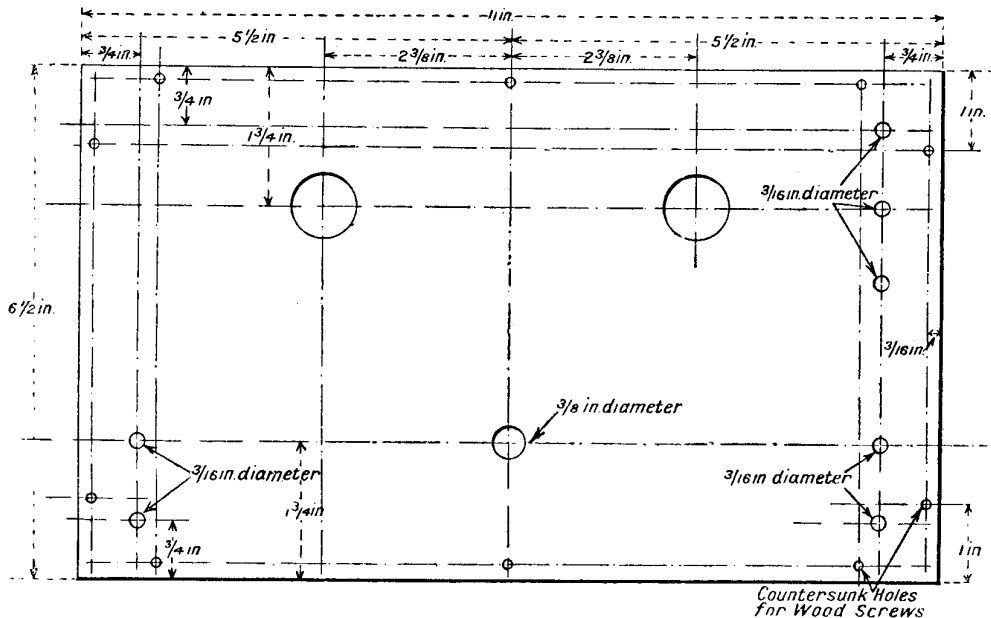

PANEL DIMENSIONS OF AN AUDIO-FREQUENCY AMPLIFIER

Fig. 2. To guide the amateur constructing this set, dimensions and lay-out scheme of the panel are given. Lead pencil should not be used when marking out the ebonite panel; lines should be lightly scratched with a steel scriber or any like instrument

and the finished instrument will be very neat in appearance. The valves used may be any of the R type. Dutch valves are quite useless for the purpose, as they are rectifiers only.

Success can only be assured by using the very best components, and the list of parts required given here will serve as an indication of cost. Above all things, do not buy cheap transformers, condensers, or ebonite. These three things, if of poor quality, will completely spoil the whole instrument. Cheap transformers are usually badly designed and leaky between the windings; cheap condensers are very often leaky and of quite uncertain capacity, and cheap ebonite often contains small particles of metal and other conducting matter.

The following material and components will be required:

Ebonite panel, 11 in. x 6 1/2 in. x 1/4 in. thick.

- 2 L.F. transformers (ratio 4 to 1).
- 2 .001 fixed condensers.
- 1 .002 fixed condenser.
- 7 terminals, with nuts.
- 2 flange type valve holders.
- 2 R valves.
- 1 66-volt H.T. battery.
- 1 filament resistance.

4 yards of varnished sleeving.

An assortment of 4 and 6 B.A. screws, nuts, washers, and a few wood screws. About 4 sq. ft. of 3/8-in. finish planed mahogany.

It is advisable to ask the dealer to cut the panel a little oversize, so that it may be filed smooth and square. On receiving the panel, carefully scribe the outline upon it with a steel scriber. Pencil should never under any circumstances be used for marking a panel, for graphite is a good conductor of electricity, and is difficult to remove completely from ebonite. Care should be exercised in scribing the lines at right angles, for nothing looks worse than a corner which is out of square, even by a few degrees. When holding the panel in the vice to file the edges, hold it between two pieces of wood. This will stiffen the job, besides preventing surface damage to the ebonite from the rough vice jaws. Having finished filing the edges, mark out all the holes on the back of the panel as in Fig. 2, which is a drawing showing the disposition of the holes on the back.

The holes near the edges should be countersunk just deep enough to receive the heads of the wood screws, and the valve peep-holes can be of any diameter.

In drilling large holes in ebonite, it is advisable to drill a small hole first, to act as a guide for the large drill, which should be operated from both sides, otherwise the ebonite may chip badly.

After drilling all holes, the ebonite should be matted on both sides with emery cloth. Grade "F.F." will be found most suitable. Glass or sandpaper should not be used, because the abrasive used in its manufacture is not uniform in size and deep scratches result, instead of a

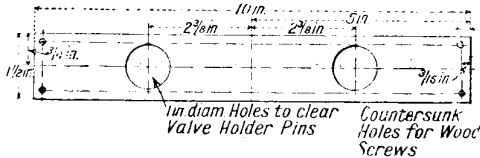

VALVE SHELF

Fig. 3. Dimensions of the valve shelf of the audio-frequency amplifier

smooth matt finish. Oil applied with a smooth rag after rubbing down will restore the colour of the ebonite. The panel may now be engraved as seen in the photograph

The filament resistance and terminals should be fitted next, as in Fig. 4. If the type of resistance shown in Fig. 7 is used, a 3/8th in. diameter hole is necessary to receive the brass knob. This should be pressed into the hole, and the holes for the fixing screws marked. After marking, take off the resistance again and drill the holes, countersinking them from the front. If the experimenter is skilled in the use of taps, a much neater job may be made by drilling blind holes for the screws, for a panel free from screw heads is infinitely preferable, although taking

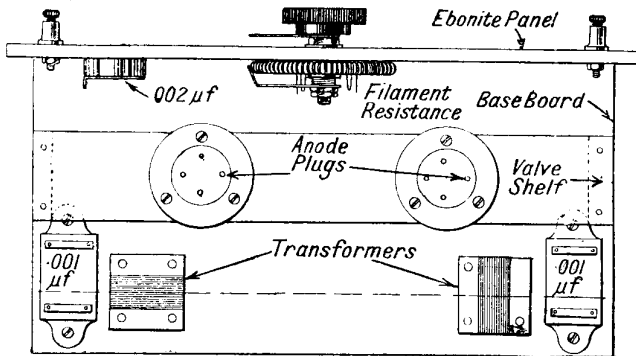

LAY-OUT OF COMPONENTS FOR A.F. AMPLIFIER

Fig. 4. From this diagram will be seen where the various components are placed in relation to one another. The 002 fixed condenser is shunted across the telephone terminals

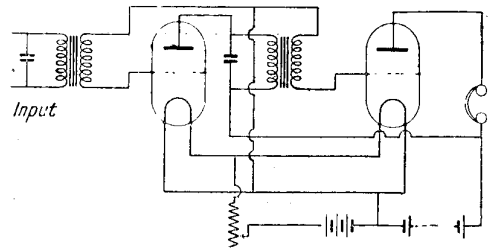

CIRCUIT OF A.F. AMPLIFIER

Fig. 5. Theoretical circuit diagram for the audio-frequency amplifier described. A fixed condenser can be shunted across the telephone terminals, as in Fig. 4

more time. In fitting the terminals, take care to pull the nuts up very tightly, for soldering tends to contract the ebonite, and loose terminals may result.

A piece of the 3/8-in. mahogany should now be cut to in. long and 5 in. wide.

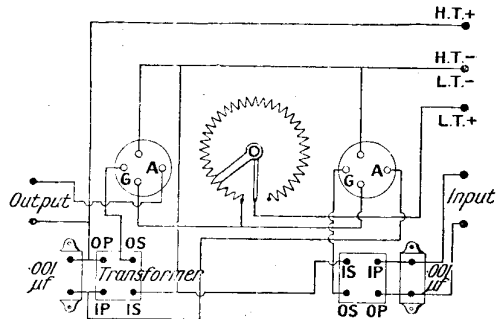

HOW THE CONNEXIONS ARE MADE

Fig. 6. Looking at the back of the panel of the audio-frequency amplifier, the connexions are made in the manner here indicated

This forms the baseboard upon which the transformers, condensers, and valve shelf stand. It should be secured to the bottom

of the panel by three wood screws 1 in. long. The panel will overlap the ends of the shelf by 1/2 in., and care should be taken to see that it is central, otherwise it will not fit into the case. Three other pieces of wood will also be required, one piece 10 in. by 1 1/2 in., and two small pieces 1/2 in. by 1 1/2 in. The long piece of wood is the shelf on which the valve-holders are fitted. The holes and their disposition are seen in Fig. 3. One of the small pieces of wood is secured to each end of

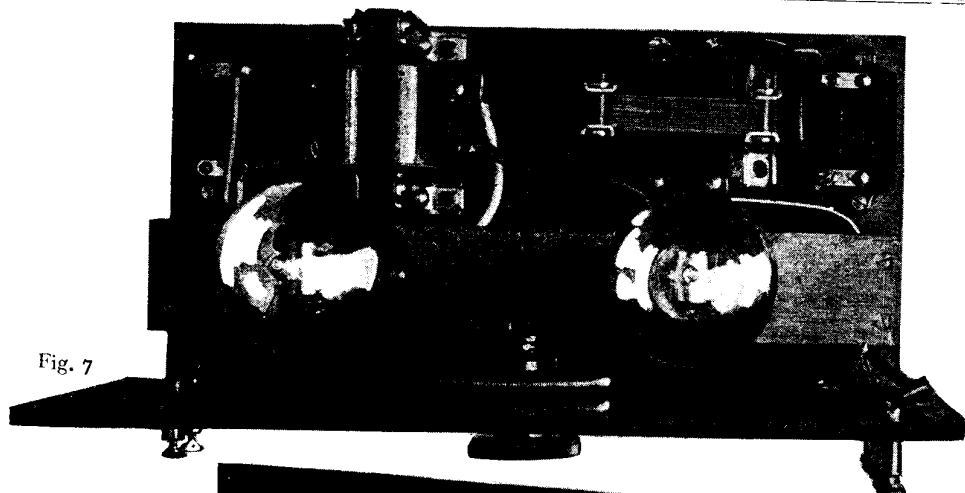

Fig. 7

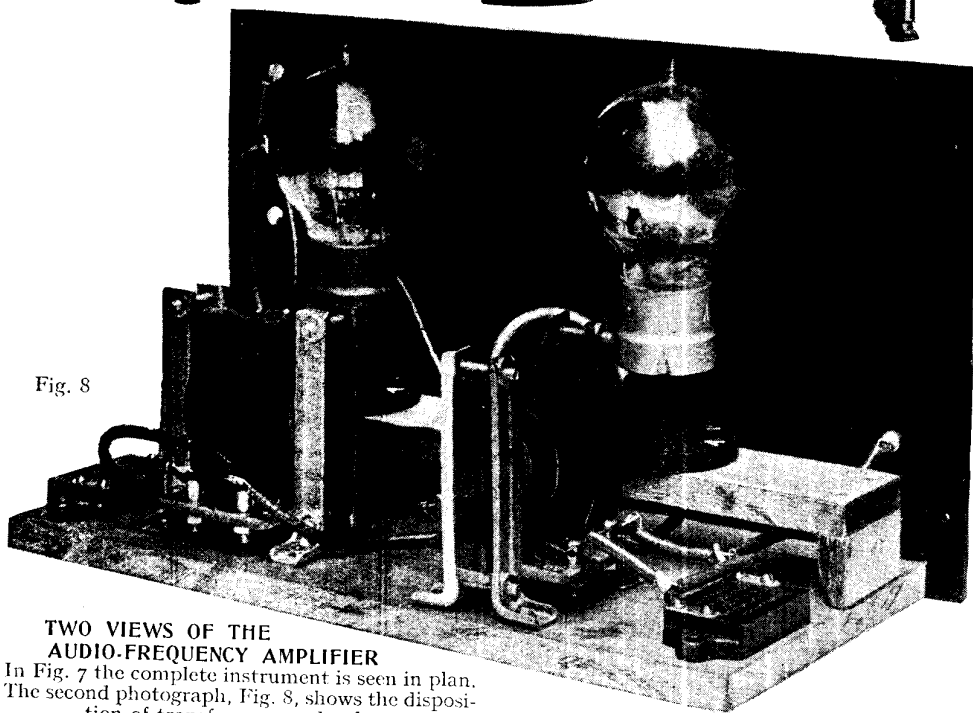

Fig. 8

TWO VIEWS OF THE AUDIO-FREQUENCY AMPLIFIER

In Fig. 7 the complete instrument is seen in plan. The second photograph, Fig. 8, shows the disposition of transformers and valves

the shelf. The valve holders are secured centrally over the 1-in. diameter holes, each by three wood screws. Before securing the shelf to the baseboard, a wire should be soldered to each tag on the valve holders, and the filament may be wired in parallel, as shown in the diagram. As the shelf overlaps a hole in each of the fixed condensers, these will be fixed more easily before the shelf is secured.

The next thing is to fix the shelf by screws in each support from the underneath side of the baseboard. The transformers

may now be fitted. By reference to the sketch showing the disposition of the components it will be seen that their cores are at right angles. This will prevent, as far as possible, distortion through interaction between themselves.

It now only remains for the wiring to be done. The diagram, Fig. 5, shows the theoretical circuit, and Fig. 6 the practical arrangement. Remember that the shortest connexion between two points is the best, and although it may look neat for the wires to follow the contour of the

various components and then to run them along the base or panel, only extra resistance, and possibly interaction, is being put into the circuit.

In all wireless soldering operations an absolute minimum of flux must be used, for flux is quite a good conductor, and if left on the panel will simply short circuit the connexions. Never use an acid flux.

The wiring completed, it now remains to test the instrument. Connect H.T. positive to the top terminal, H.T. and L.T. negative to the second, and L.T. positive to the third. The terminals marked "input" are connected to the telephone terminals of the receiver unit, and the telephones themselves to the "output" terminals on the amplifier. Place the valves in the sockets, as in Fig. 8, and turn the resistance to light then. Tapping the valves should cause a slight humming noise in the telephones. If it does not, it is a certain sign that something is wrong, and the batteries should be disconnected and the wiring gone over to see if any mistakes are apparent. If the instructions given are closely followed, the broadcasting should be positively deafening in the telephones. The best telephone resistance to use is 2,000 ohms.

The A.F. Amplifier Completed *

If everything is right with the amplifier the case should now be proceeded with. Cut the wood to the following sizes:

Bottom	11 $\frac{3}{8}$ in. \times 5 $\frac{3}{4}$ in.
Top	11 in. \times 5 $\frac{1}{2}$ in.
Back	10 $\frac{1}{4}$ in. \times 6 $\frac{1}{4}$ in.
Sides (2)	5 $\frac{3}{8}$ in. \times 6 $\frac{1}{8}$ in.

All the pieces should be squared, and then erected without screws to see if everything fits well. Should the case be in order, take it apart, apply glue to the edges, and screw the parts well together. Leave for at least twenty-four hours to set. It may now be sandpapered thoroughly, and, if thought desirable, stained and polished. The baseboard will be found to slide in the bottom of the case, the panel coming flush with the edges. Seven screws secure the panel to the case.

AUDIO-FREQUENCY TRANSFORMER.

An arrangement of coils of wire for use in conjunction with alternating currents whereby an alternating current passing through the primary winding induces a higher voltage current in the secondary winding at the same frequency as that of the applied current. Audio-frequency

transformers are those which operate at audible frequencies of 60 to 10,000 cycles per second. Their principal use in wireless work is to amplify the rectified signals passed on by the detector valve or the crystal detector. Audio-frequency transformers act on the same principle as other so-called static transformers, and the theoretical considerations of design are fully dealt with in the article on Transformers (*q.v.*).

Principles of the A.F. Transformer

To appreciate the points of an audio-frequency transformer it is as well to summarize briefly the application of the instrument in an amplifying circuit, as, for instance that of an audio-frequency amplifier, that can be added to an existing crystal detector or a single-valve detector. From either of these instruments there are two wires, or leads, that normally connect to the telephones. These wires are carrying the rectified, or audible frequency, current that, by actuating the diaphragm of the telephones, enables the signals to be heard by the ear. These signals may not, however, be sufficient in strength for good audibility, and the function of the amplifier is to increase their volume.

This is accomplished by a suitable circuit containing an audio-frequency transformer, the primary winding of which is connected directly to the terminals on the detector set in the place of the telephones. The primary winding is in reality nothing but a coil of well-insulated wire of appropriate resistance. The rectified currents which flow around this winding are of a pulsating character, and they set up a magnetic flux, or flow, which passes around the core of the transformer and thereby induces a current in the secondary windings. The induced current will have a different value according to the proportions of the transformer. Generally, this class of transformer has a step-up effect—that is, the induced current may have a greater voltage than that of the secondary, but a lower amperage.

The characteristics of the induced current will be similar to that of the primary as regards its fluctuations. Consequently, the telephones, when connected into the amplifier circuit, together with a suitable valve and controls, will receive much stronger impulses, but with the same frequency, and variation in the comparative

To Our Readers

IN offering this entirely new work to the very large and rapidly increasing public that is interested in the popularization of the science of Wireless, the publishers may be permitted to point out that not only is HARMSWORTH'S WIRELESS ENCYCLOPEDIA unique in being the very first effort to provide a complete and exhaustive work of reference in a highly specialized field of study, but that the thousands of photographs and drawings which its pages will contain have, with few exceptions, been expressly made for this work.

THE WIRELESS ENCYCLOPEDIA is one of a series of educational works issued by the same publishers, in which the instructional value of the photograph has been demonstrated to the full. Every item of Wireless equipment photographed for the pages of this work has been prepared and tested by experts. Where details of mechanism are illustrated, and the varying stages of their assembling shown, the mechanism has in every case been actually tried, as to its working accuracy, before the taking of the photograph, so that it might be claimed for the illustrations in the WIRELESS ENCYCLOPEDIA that they are not merely theoretical, but are photographic reproductions of "practical" pieces of mechanism.

IN this way, the Wireless experimenter who makes use of the literary and pictorial matter here provided for his guidance can be assured that at every turn such advice as he is given and such hints as he may derive from the information provided are soundly based upon actual practice and not merely upon theory. Every care has been taken to acknowledge proprietary circuits.

READERS will notice that the arrangement of the contents in the WIRELESS ENCYCLOPEDIA is strictly alphabetical, thus facilitating reference to the particular detail in which the reader may be for the moment most interested. In Part 1 a group of introductory articles of a general kind appeared, but in this and later parts the full number of pages will be devoted to the Encyclopedia proper. Each part will contain, in addition, a pictorial supplement either in colours or in photogravure.

**Order Part 3 to-day, and ask Your
Newsagent to reserve a copy of
every succeeding fortnightly part,
and so avoid disappointment**

The **AUTHORITATIVE** **Wireless Magazine**

EVERYONE who is interested in "Wireless" from a more scientific point of view than the average "listener-in" should read **WIRELESS REVIEW**. This fine weekly magazine is an invaluable guide to every new radio development. Accurate, reliable, and absolutely authoritative, it deals fully with the technical side of wireless work—both theoretical and practical—giving explanatory articles by the leading experts only, and being exceptionally well illustrated by photographs and diagrams. Sir Oliver Lodge, F.R.S., D.Sc., acts as Scientific Adviser-in-Chief, and the editorial board includes many of the most notable personalities in the world of wireless.

Wireless Review

AND SCIENCE WEEKLY.

Every **3^d** Tuesday.

Printed and Published every alternate week by the Proprietors, The Amalgamated Press (1922), Ltd., The Fleetway House, Farringdon Street, London, E.C.4. Sole Agents for South Africa: Central News Agency, Ltd.; for Australasia: Messrs. Gordon & Gotch, Ltd.; and for Canada: The Imperial News Co., Ltd. (Canada).
Subscription Rates: Inland and Abroad, 1s. 5½d per copy. November 20th, 1923.

D/R