

17

Have You Bound Your Second Vol. Yet? (See Back Pages)

1^s/₃^d

HARMSWORTH'S WIRELESS ENCYCLOPEDIA

For Amateur & Experimenter

OSC—POW

CONSULTATIVE EDITOR
SIR OLIVER LODGE, F.R.S.

THIS PART CONTAINS
**218 New Photos & Diagrams with 100
'How-to-Make' & Other Articles**

PANEL CONSTRUCTION
PLUG-IN CONTACTS
POLAR BLOK SYSTEM
POTENTIAL
POTENTIOMETER

Special Article by Dr. Fournier d'Albe
PHOTOGRAPHY BY WIRELESS

LARGE PHOTOGRAVURE PLATE:
PORTABLE RECEIVING SET

*J. LAURENCE PRITCHARD, F.R.Ae.S., Technical
Editor, with expert editorial and contributing staff*

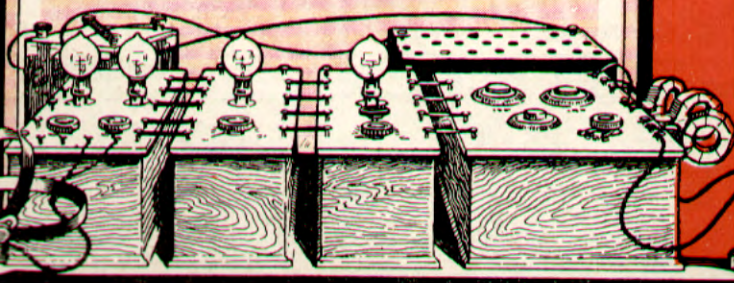

The Only ABC Guide to a Fascinating Science-Hobby

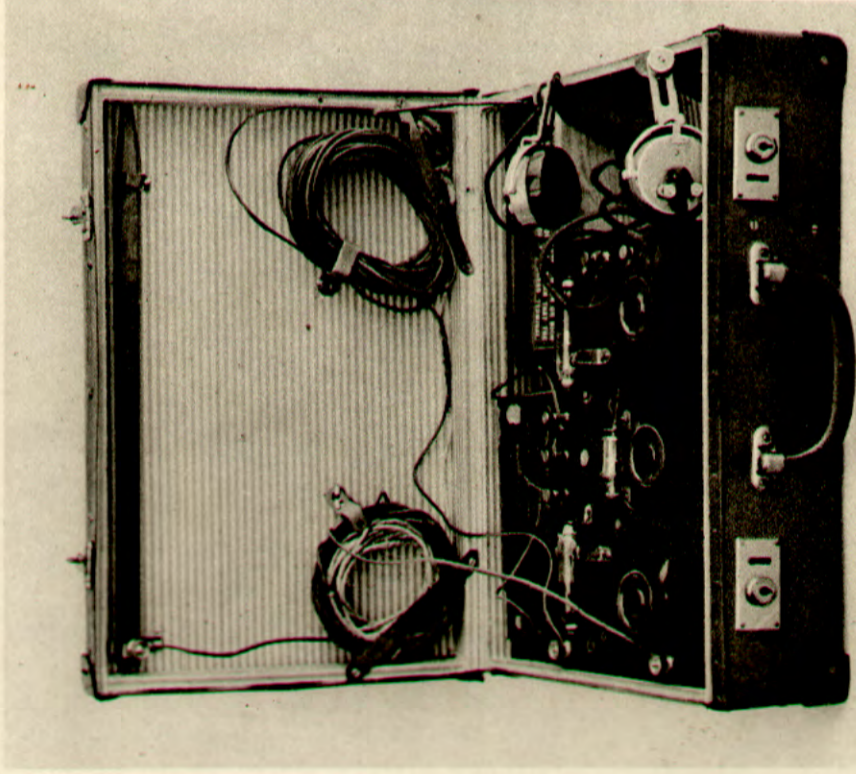

Fig. 2.—The portable set complete and ready for transport, showing positions of the batteries, telephones, aerial, and earth leads

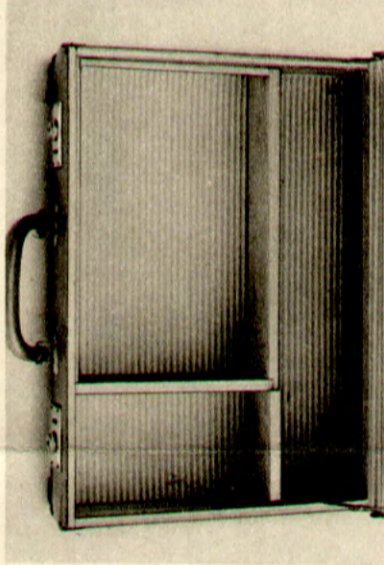

Fig. 3.—Before constructing the set the case is divided off into compartments

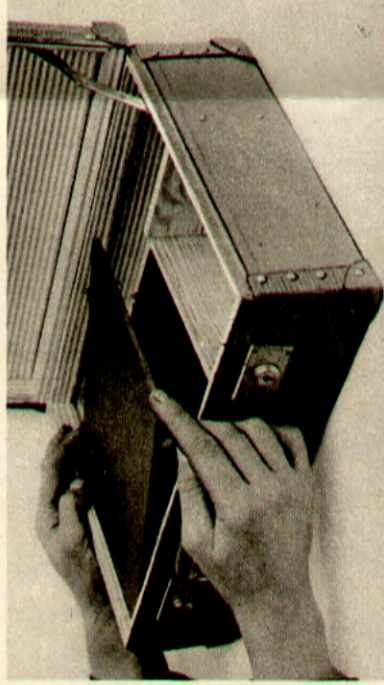

Fig. 4.—Ebonite sheet is cut and trimmed to the dimensions of the compartment to hold the panel



Fig. 5.—Holes are drilled in the panel for fitting the filament resistances. One is shown in position

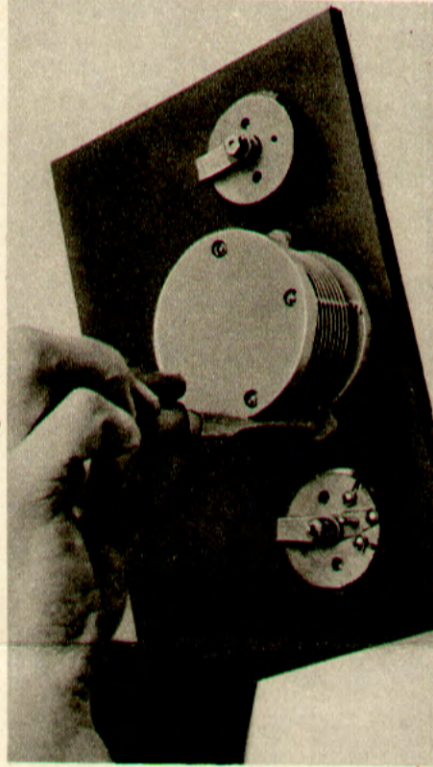

Fig. 6.—Between the two filament resistances the variable condenser is fitted; this is attached by a special top plate with lugs

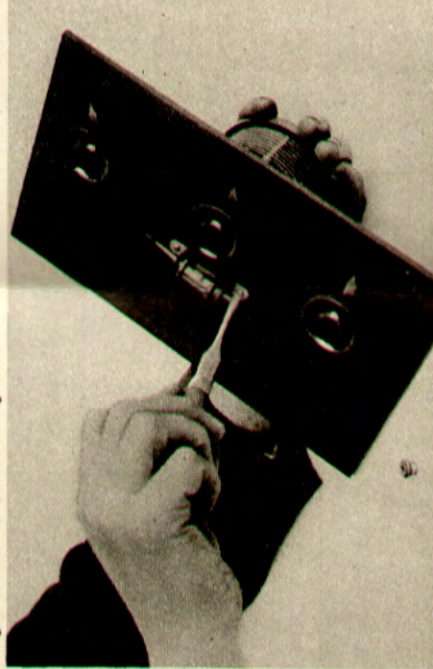

Fig. 7.—On the panel front a neat and efficient crystal detector is fitted

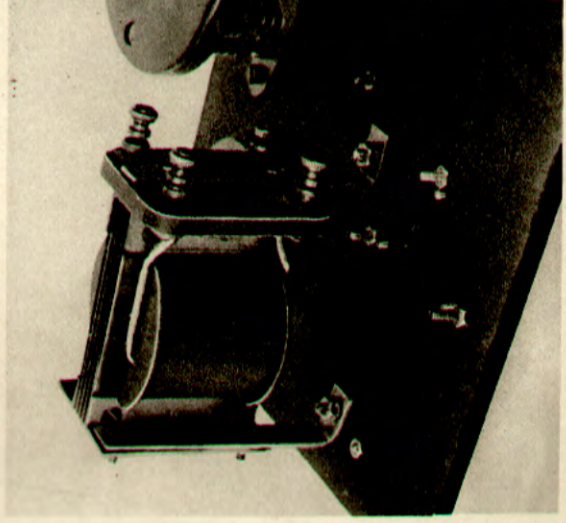

Fig. 8.—How the low-frequency transformer is secured to the panel by angle pieces

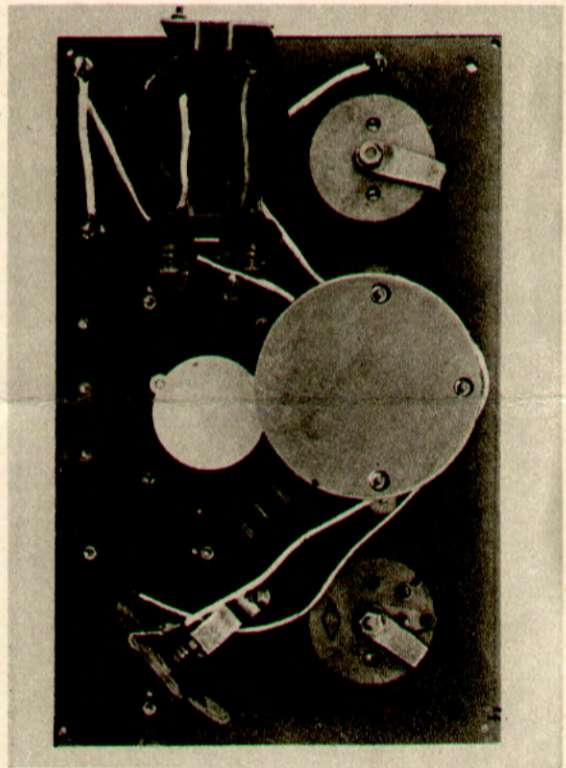

Fig. 9.—How the aerial tuning circuit is wired showing also the disposition of complete set of components



Fig. 10.—Clips are fixed to the panel to hold the two D.E.V. valves

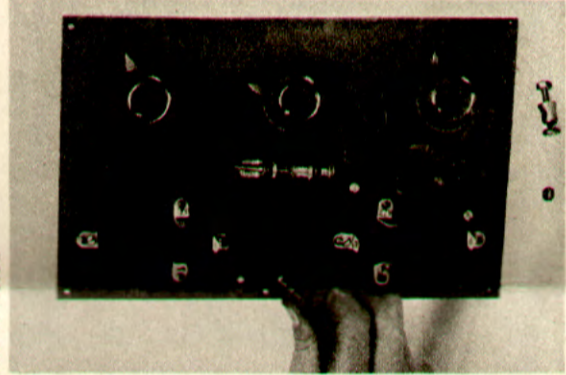

Fig. 11.—Fitting the three battery terminals to the panel



Fig. 12.—Portable set in use. The earth pin is stuck in the ground

PORTABLE SET: HOW TO MAKE A COMPACT RECEIVER EASILY CARRIED AND SUITABLE FOR USE IN ANY PLACE WHERE A TEMPORARY AERIAL CAN BE ERECTED

HARMSWORTH'S

WIRELESS ENCYCLOPEDIA

Third Volume

OSCILLATORY DISCHARGE. The effect resulting when two high potentials of opposite sign are allowed to neutralize each other through a conductor having the properties of inductance and low ohmic resistance. Such a phenomenon occurs in the discharge of a condenser across a closely adjusted spark gap. If the charged condenser is discharged through a wire of fairly high resistance, the discharge takes the form of a simple continuous discharge, which is graphically represented in Fig. 1, where the ordinates are plotted in terms of potential difference and the abscissae in terms of time.

The graph shows a gradual decrease, dependent on the factor of time for its complete discharge. If the same condenser is discharged in a circuit shown

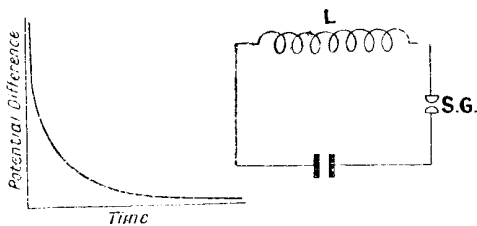

OSCILLATORY DISCHARGE CIRCUIT AND GRAPH

Fig. 1 (left). Simple continuous discharge is represented. Fig. 2 (right). Discharge in a closed circuit is oscillatory

in Fig. 2, having an inductance, L , a closely adjusted spark gap, S.G., and a low resistance, the resulting discharge will be of an oscillatory character. A simple mechanical analogy to the oscillatory condenser discharge may be found in a U-tube having a tap or other means of securing a variable outlet at the bend in the tube.

The tap is closed, and water poured in until one arm is filled. On suddenly opening the tap to its fullest extent, the water, representing an equalization of potential difference of the condenser,

immediately tends to find its own level. Owing to its inertia, it rushes up the empty side of the tube beyond its ultimate point of rest. When at a point rather below the previous level a return flow is occasioned, which is, once again, rather lower at its highest point than its previous level in the opposite tube. This process is continued until the level in each side of the tube is at rest at the same height.

An analogy to the simple continuous discharge shown graphically in Fig. 1 may be made by nearly closing the tap, representing the resistance in the condenser. The water poured in at one end will now slowly trickle through the small aperture until the water again finds its own level.

The graphical oscillatory discharge of a condenser is shown in Fig. 3, the ordinates being plotted for the amplitude of the oscillation and the abscissae for the frequency. A wave radiated from an oscillatory discharge of this nature is frequently known as a damped wave, and the succession of damped cycles is called a damped oscillation train.

The rate of the decrease of amplitude between successive cycles is chiefly proportionate to the resistance of the circuit, but varies also with the characteristic values of the different circuits, and is known as its logarithmic decrement (*q.v.*). A highly damped wave in oscillatory discharge is a broad wave, and is not sought for in transmissions, as it cannot

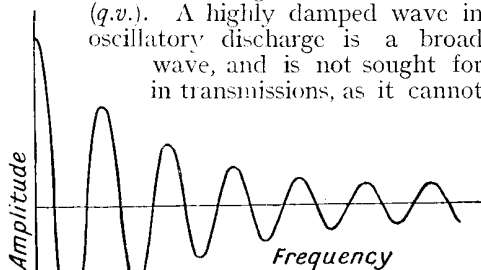

OSCILLATORY DISCHARGE OF A CONDENSER

Fig. 3. The wave radiated from an oscillatory discharge of this kind is a damped wave

be sharply tuned. The form of energy used for charging the condenser may be supplied by an electrical arc or an induction or spark coil. See Arc Lamp.

OSCILLION. Name sometimes given to the three-electrode valve. See Valve, and also under the names of particular valves, e.g. Mullard Valve, Plotron. See also Characteristic Curve.

OSCILLOGRAM. If a fine pointer or stylus is fitted in the free end of a tuning fork and a piece of smoked glass—or other material on which the pointer will mark—is drawn against the pointer in the same direction as the length of the fork, then a thin straight line is drawn on the glass. When the glass is fixed and the fork is set in vibration, the pointer will mark a short arc at right angles to the length of the prongs. There are, therefore, two motions at right angles to each other, and by compounding these motions a record is obtained of the vibrations of the tuning fork. To compound these two motions it is only necessary to move the plate in a straight line at right angles to the vibrations, at the same time keeping the fork in vibration. The result on the glass is a record in the form of a wave of the vibrations of the fork, or, in other words, an oscillogram.

Fig. 1 represents the plate moved in the direction A, while the stylus moves in the direction CD. The line AB represents the line drawn when the plate is moved in the direction A and the fork is

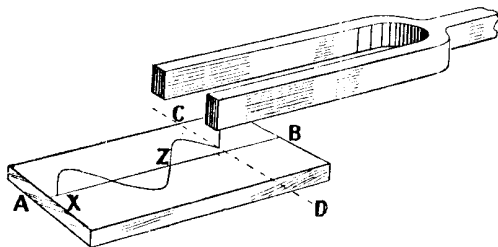

HOW AN OSCILLOGRAM MAY BE MADE

Fig. 1. Oscillograms may be made by the movement of a stylus attached to a tuning fork moving over a smoked glass plate

stationary, while CD shows the record produced when the plate is stationary and the fork is vibrating. When these two motions are compounded the wave-form XZ is obtained.

The movement of the stylus is twice the amplitude of the vibrations, hence the height of the wave from the central or

zero line AB will be equal to half the amplitude of the vibration. Again, it is possible to obtain the frequency of the vibrations by noting the time taken to move the plate over a definite distance. If the plate is moved from B to A in 2 seconds, and during that time 200 complete vibrations are recorded, then the frequency of vibration is $\frac{200}{2} = 100$ per second.

It will be seen that the number of vibrations in a given length is controlled by the speed of movement of the plate. If the plate is moved slowly, then the vibrations will be cramped, and by increasing the speed of the plate the vibrations can be spread out.

The oscillogram of a vibrating fork is, of course, a simple sine curve; but oscillograms of the current and potential variations in electrical circuits often depict very complicated wave-forms, and in order to interpret fully such oscillograms, they must be obtained under conditions that are both precise and capable of easy reproduction. The crude method shown above is, of course, useless for scientific measurements, but it can be so modified as to render it suitable for precision work.

For obtaining oscillograms of wave-forms of variables in an electric circuit, the tuning-fork is replaced by a thin strip of metal free to vibrate in an axis at right angles to the length of the strip, the strip being placed in a strong magnetic field. A mirror attached to the centre of the vibrating strip reflects a beam of light, which thus acts as the pointer. The moving plate is usually a photographic negative which is passed before the reflected beam in a measured—or calculated—interval of time. The record of the vibrations of the mirror or the oscillogram can then be studied, and the properties of the wave-form investigated. See next entry; Sine Curve.

OSCILLOGRAPH. Broadly speaking, the oscillograph consists of a moving coil mirror galvanometer, used in combination with a rotating or vibrating mirror, and a moving photographic plate or film.

The principle was first disclosed by M. A. Blondel in 1893.

It is well known that the oscillograph enables us to produce various curves and to study them. The formation of a curve requires motion in two directions at the same time. For instance, the vibrator of the oscillograph consists of a moving coil,

which in practice is usually reduced to its simplest form, *i.e.* a simple loop of wire stretched in a powerful magnetic field, Fig. 1. This loop has attached to it a small mirror, seen in the cut-away portion.

Now, if a magnetizing current is passed through the field windings so that a powerful magnetic field surrounds the stretched wires, then, if a direct current is passed through the wires, they will tend to move in such a manner that the mirror is rotated through a small angle in one direction. If the current is reversed the mirror will be turned in the opposite direction, whilst if an alternating current is passed through the wires the mirror will oscillate first in one direction and then in the other; and it will do this in synchronism with the frequency of the alternating current supply, that is, pro-

vides, in a vertical path across the path of the moving beam of light, then a curve will be traced on the plate. For instance, if the mirror turns from left to right whilst the plate falls, then a diagonal line will be drawn on the plate; but if the mirror comes to rest, and then turns back again whilst the falling plate is still in the path of the light beam, then the path of light on the plate will be a diagonal line, followed by a vertical one whilst the mirror is at rest, this portion being again followed by a diagonal line from right to left, as in Fig. 2.

It will be seen from the above that if in place of the direct current, first in one direction and then in the other, an alternating current is passed through the moving wires, then a curve will be drawn on the moving plate, and if the alternat-

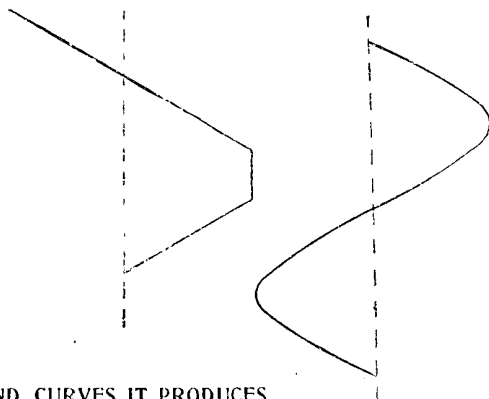
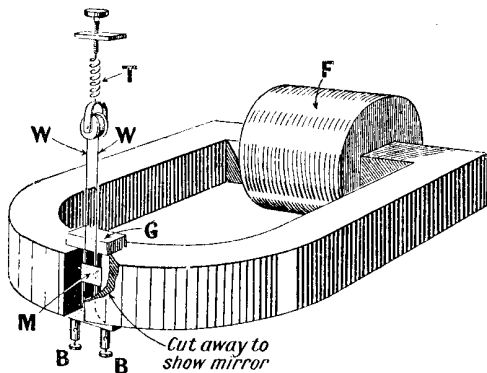

PRINCIPLE OF THE OSCILLOGRAPH AND CURVES IT PRODUCES

Fig. 1 (left). F is a field coil, W W are stretched wires, G is a guide for the wires, M a mirror, and T is a spring screw for adjusting the tension on the wires; B B are terminals. Fig. 2 (centre). Diagonal and straight paths traced by a beam of light falling on a moving photographic plate. Fig. 3 (right). This is the kind of curve which an oscillograph traces for alternating currents

vided that the inertia of the moving parts is low enough to allow them to move fast enough. For this reason the moving wires and mirror are made as light as possible.

If a spot of light is focused on the mirror it will be reflected, and, as the mirror is also concave, the spot of light reflected from it will fall as a point on to a screen placed at a suitable distance from the vibrator. When the mirror is caused to vibrate in the manner described above, this point of light will trace out a straight line on the screen. If we assume that this line of light is moving from right to left across the screen, then it is obvious that if the screen is replaced by a photographic plate, and if this is allowed to drop in

ing current is a pure one, then this curve will be a pure sine curve, as in Fig. 3.

Thus is constructed the elementary instrument. In practice it is less simple.

The wires must be very tightly stretched; they are best immersed in oil, which damps the free vibration of the wires, and renders them more dead-beat. As the mirror is also immersed in the oil-bath, the oil serves a second purpose, for there is refraction of the beam of light, which increases the movement of the spot of light on the screen or plate.

Again, in order that the instrument may be sensitive, it is very important that the magnetic field shall be strong, and that the air gap between the pole tips and the wires shall be as small as possible.

In the instrument as made by the Cambridge and Paul Company these points have received such careful consideration that their instrument will respond and give accurate results even at frequencies as high as 300 per second.

In using the oscillograph, it is often more convenient to examine the curve of the apparatus under test, rather than to photograph this curve; apparatus has therefore been devised which enables this to be done. Adjustments may be made to the alternator or other machinery which is under test whilst the effect of these adjustments is watched; then, when the desired adjustment is obtained, the resulting curve may be photographed.

The apparatus necessary for visual examination of the curves consists of a rotating mirror, arranged in such a manner that it rotates in synchronism with the alternations of the current which is under examination. In a more recent form of

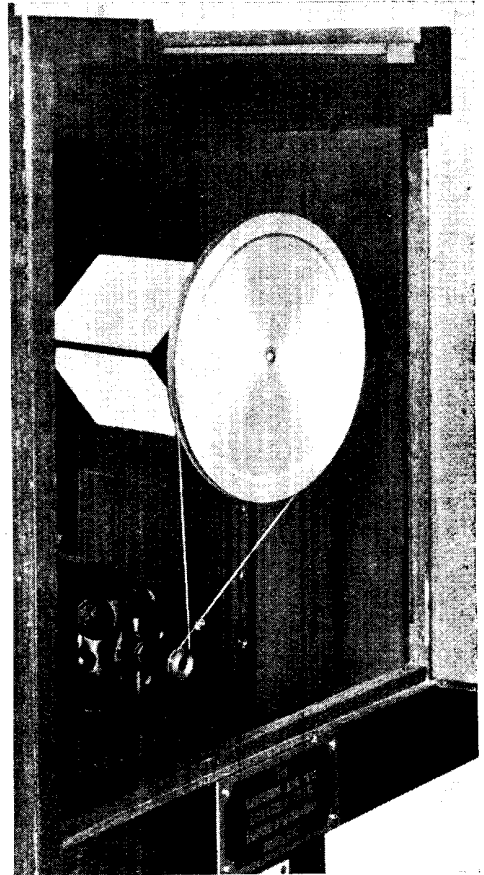

OSCILLOGRAPH MOTOR AND MIRROR

Fig. 4. Behind the rotating disk is a four-sided mirror. This is rotated at a slow speed as compared with the motor

Courtesy Cambridge and Paul Instrument Co., Ltd.

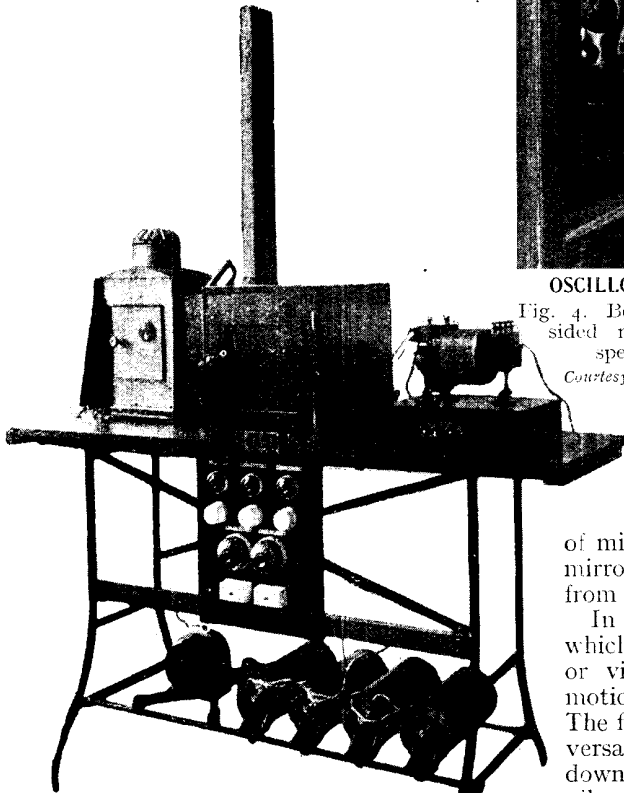

DUDELL OSCILLOGRAPH

Fig. 5. In the centre is the cupboard containing the electric motor; on the left is the lantern projector

Courtesy Cambridge and Paul Instrument Co., Ltd.

the instrument the mirror, instead of actually rotating, is caused to rotate partially, and then to fall back to its starting position. This type of mirror is known as the vibrating mirror, and is suitable for frequencies from 20 to 120 per second.

In either case the beam of light which is reflected from the rotating, or vibrating, mirror receives two motions at right angles to one another. The first from right to left and vice versa, and the second motion up and down. Caused by the rotating or vibrating reflecting mirror, the final beam of light as it leaves the rotating mirror is focused on to the plate of curved glass. A sheet of tracing paper may be stretched

over this glass, and the image of the spot of light will trace a curve on it. This curve will be repeated over and over again, exactly in the same place, but due to the comparative slowness of the action of the eye, the image persists and appears to stand still on the paper. It may be traced with a pencil on the paper, or photographic paper may be placed on the glass in place of the tracing paper, in which case a photographic record may be made of the curve.

Better methods of obtaining photographic records are, however, available: the first is the falling plate method, which has already been mentioned, and the second is the cinematograph camera. In both the action is somewhat similar. The plate or film is contained in a light-tight chamber which is provided with a narrow slot running across one face of it. The light from the mirror on the instrument passes backwards and forwards along this slot, whilst the plate or film passes in a direction at right angles to this at a uniform speed.

The use of the cinematograph camera enables much more prolonged changes to be recorded than is possible when using the falling plate camera. This longer record is of considerable value when studying the changes which take place at such times as the paralleling of alternators and the connecting of cables to alternating current supplies, as well as other conditions which produce surges. In general this type of instrument has been developed so that it is of very considerable value for all ordinary voltages, currents and frequencies which are commonly in use in commercial electrical engineering.

The oscillograph will work over a band of frequencies up to 300 per second. It is practically dead beat, and has a very low self-capacity and self-induction. It is very sensitive, and will respond to currents as small as .001 ampere, whilst it is made for use on circuits up to 50,000 volts without the use of transformers.

If oscillations of very high frequency, such as some of those used in sound and radio telegraphy and telephony, are to be recorded, no type of moving-coil oscillograph is suitable, as it is impossible to

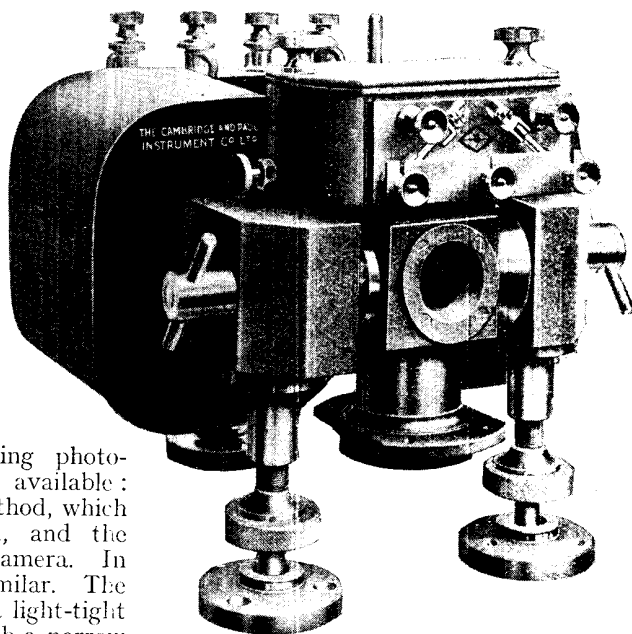

MAGNETIC CONTROL OF OSCILLOGRAPH

Fig. 6. Used with a very narrow air gap between the pole-pieces is a very powerful electro-magnet
Courtesy Cambridge and Paul Instrument Co., Ltd.

construct moving-coil instruments which will respond to these very high frequencies.

For this purpose we require an oscillograph whose moving parts are without weight, or, at all events, without appreciable weight. The solution has been found in the use of electrons for the moving parts, and perhaps the best practical application of this principle is the Western cathode ray oscillograph.—*R. H. White.*

Fig. 5 is an illustration of the complete Duddell oscillograph. The table is mounted on an iron stand, the latter supporting the various resistances and the switch and fuseboard. At the centre is a square cupboard containing the electric motor and rotary mirror, which are used in the projection of the waves. To the left of the cupboard is a lantern projector, using an arc lamp as a source of light. The light from this lamp is projected on to the mirror, which reflects it back through a slit in the cupboard side, on to any suitable screen erected for the purpose.

A close-up view of the motor and mirror is shown in Fig. 4. It will be seen that the mirror is rotated at a very slow speed compared with the motor. The gearing-reduction is effected by means of a large pulley on the mirror shaft, and a very

small one on the motor spindle. The mirror is a square box-like structure, having a reflecting surface on all four sides. The whole structure moves upon a horizontal spindle.

To the right of the central cupboard is the electro-magnetic apparatus where the actual oscillations are recorded.

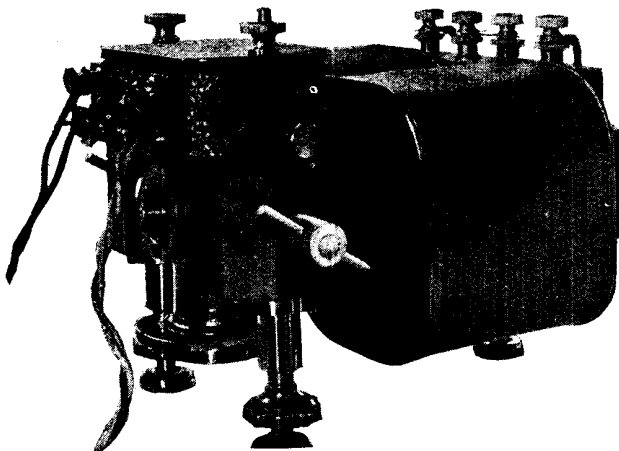

OSCILLOGRAPH ELECTRO-MAGNETIC CONTROL

Fig. 7. This is another view of the electro-magnetic control of the oscillograph

Courtesy Cambridge and Paul Instrument Co., Ltd.

Two views of the electro-magnetic control of the Duddell oscillograph are given in Figs. 6 and 7. The magnet used is very powerful, and has a very narrow air gap between the pole-pieces. In this air gap are placed two parallel strips of phosphor-bronze, the tension of which is conveniently adjustable. The plane in which those strips are situated is parallel with the magnetic field, and they are supported by bridge pieces. A very small mirror is fixed to these phosphor-bronze strips.

The latter are connected in the circuit of the current whose wave-form is desired to be ascertained, and the circuit is so arranged that the current passes up one strip and down the other. As the strips are situated in an intense magnetic field it follows that when they are energized by the current flowing through them, a deflection is caused which forces the mirror to move in accordance with that deflection. The reflections from this mirror are passed on through the optical system, and so on to the screen. See Cathode Ray; Cymoscope.

OSSIPHONE. Name applied to a form of telephone receiver invented by

S. G. Brown, which enables deaf persons to hear by having sound vibrations conveyed to the auditory nerve via the bones. It consists essentially of a reed-type telephone receiver having the diaphragm removed and a stylus bar attached to the reed projecting through the ebonite case. On top of the stylus bar is fixed a small round knob, projecting some distance from the instrument.

The photograph is an illustration of one form of ossiphone. In this instance the case is an oblong, box-like structure and the stylus bar a flat metal strip.

The ossiphone is held in the hand and, generally, the small knob is pressed lightly against the mastoid bone, *i.e.* the hard projection immediately behind the ear. In some cases other parts of the skull, such as the chin or teeth, will be found more effective. In the latter case a form of instrument with an ebonite mouthpiece is used.

For wireless work the ossiphone is obtainable in any resistance, and may be connected in a wireless circuit in precisely the same manner as in the ordinary wireless telephone receiver.

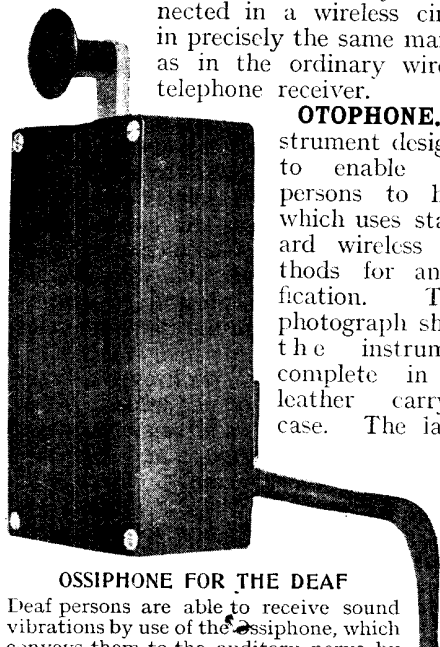

OSSIPHONE. Instrument designed to enable deaf persons to hear, which uses standard wireless methods for amplification. The photograph shows the instrument complete in its leather carrying case. The latter

OSSIPHONE FOR THE DEAF

Deaf persons are able to receive sound vibrations by use of the ossiphone, which conveys them to the auditory nerve by one of the bones in the skull

Courtesy S. G. Brown, Ltd.

is the same size and shape as an ordinary small attaché-case, and contains everything necessary for the operation of the instrument.

An extremely sensitive microphone is concealed inside one side of the case, a small hole being cut in the latter to allow the sound-waves access to the diaphragm. This microphone is connected to a two-stage valve amplifier, which in turn is

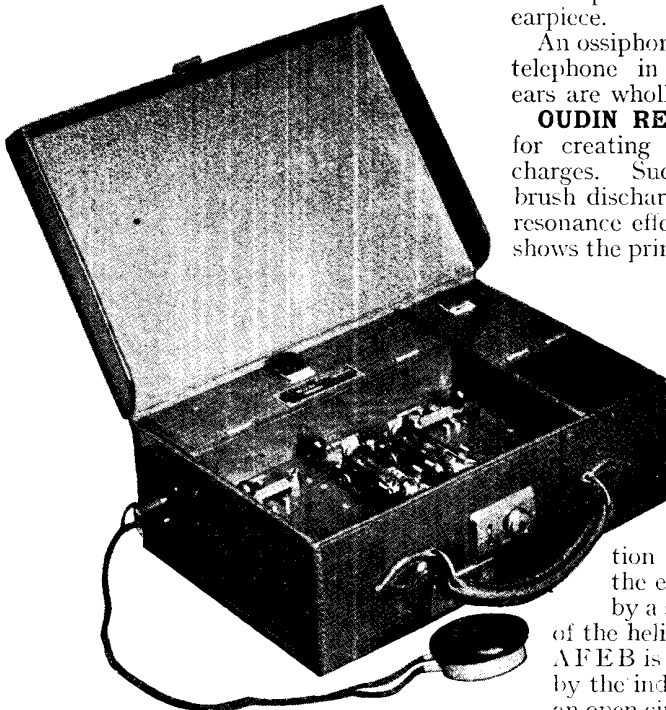

MARCONI OTOPHONE

This instrument uses standard wireless methods of amplification by means of valves to enable the deaf to hear

Courtesy Marconi's Wireless Telegraph Co., Ltd.

connected to a special single telephone earpiece. Switches are used to control the volume of sound in order to suit individual requirements. The valves, which are special low-temperature V24's, are clearly shown in the photograph. At the back of the valve panel is the high-tension battery, while to the right of the latter the six-cell low-tension battery is situated. The empty compartment on the right of the case is for the telephone receiver.

Even for very deaf persons, conversation by means of the otophone is a very simple matter, for the instrument is extra-

ordinarily sensitive. For instance, for ordinary conversational use, the case may be placed at any convenient position such as an adjacent table, or on the deaf person's knee. The switch shown near the carrying handle is put in the "on" position, and the microphone will then pick up all sounds from the other parties in the conversation. These impulses received are magnified enormously in the amplifier and received strongly in the earpiece.

An ossiphone may be substituted for the telephone in cases where the patient's ears are wholly insensitive to sounds.

LOUDIN RESONATOR. An instrument for creating high-frequency brush discharges. Such high-frequency electric-brush discharges are used in the study of resonance effects, and the circuit diagram shows the principle of the Oudin resonator.

A C is a helix of bare copper wire wound on an insulated former so that the coils do not touch one another. One end of the helix, A, is joined to an induction coil, and the helix is tapped by means of a sliding contact at B. This is connected through a condenser to the induction coil, G, and the tapping and the end of the helix are shunted by a spark-gap, F. The other end of the helix, D, is left free. The circuit AFEB is an oscillatory circuit excited by the induction coil G, while B C D is an open circuit in contact with it. By suitably choosing the point B, a brush discharge appears at D, showing that strong electric oscillations are being set up in the open circuit. This type of resonator is also largely used in medical work. See Brush Discharge; Oscillator.

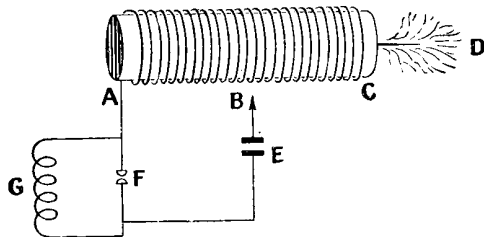

LOUDIN RESONATOR CONNEXIONS

High-frequency brush discharge is produced by this arrangement. The diagram shows the connexions

OVERLOAD RELEASE. Type of automatic cut-out applied particularly to motor starters, which causes the main circuit to be broken, should the current taken by the motor exceed its proper maximum. A close-up view of a standard form of overload release is given in the photograph. The device is movably fitted directly to the base of the motor starter.

It will be evident from the photograph that the device is of the electro-magnetic

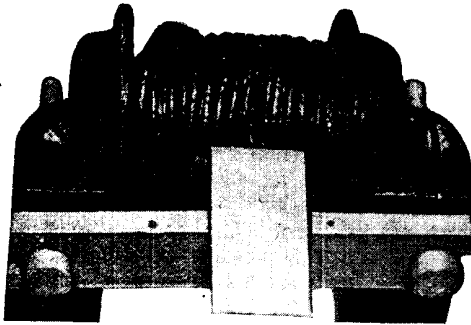

OVERLOAD RELEASE SWITCH

Automatic cut-out apparatus of this kind is applied to motor starters to prevent overload

type, having a movable armature which operates when powerfully attracted by the magnet. This occurs when an overload current is passing, and its action is to close two contacts. These contacts are connected to the no-volt release winding, and, therefore, that becomes non-magnetic, and the starter handle returns to its "off" position. See Auto-cut-out; No-volt Release; Switch.

OXIDATION. Term used to describe a chemical change on the surface of metals due to combination with oxygen. It is chiefly due in amateur wireless work to the effects of exposure to the atmosphere and to the presence of fumes from accumulators and the impurities in the atmosphere generally.

On iron and steel the oxidation is mostly caused by dampness, and is known as rusting. The remedies are to preserve the surface by isolating it from the air. This is done by the medium of paint, by various electro-deposition processes, and other means such as galvanizing and sherardizing. The amateur will prefer the former, as it is the easiest and cheapest. The preservation of the surface from oxidation by electro-deposition applies to small parts such as those on the set itself, and is chiefly exemplified by nickel and

silver-plating. The parts for an aerial mast can well be forged to shape and then sent to a firm that specialises in the work to have them galvanized. This is essentially a process whereby a skin or film of zinc is applied to the surface of the iron or steel, thereby making it very resistant to oxidation.

One pernicious effect of oxidation is found with copper or brass wires used in the aerial and earth leads. These, when exposed to the polluted atmosphere of a large city, soon corrode, and there is a slow but steady loss of signal strength. This is also the case with a buried earth plate, which, under some circumstances, will corrode or become coated with verdigris or similar surface accretion, which acts as a kind of insulator and reduces the efficiency of the set. Remedies are to use well-insulated aerial wires and lead-in connexions, and to clean the surface of the earth plates whenever necessary, or have them galvanized.

OXIDIZING. This is the term applied to the process whereby metal objects are changed in colour to a brown-bronze or black colour by the application of a chemical, or by electro-chemical means. In wireless work oxidizing is generally carried out, so far as the amateur is concerned, with a chemical mixture known as bronzing acid. This is highly poisonous, and should therefore be kept tightly corked in a clean glass bottle prominently labelled "Bronzing Acid, Poisonous."

In use it gives off a certain amount of fumes. These should not be inhaled. The bronzing acid has the effect, when applied to brass, bronze and other metals, of changing their colour to a beautiful bronze-black to deep black that harmonizes well with ebonite and imparts a high-grade finish to a home-constructed receiving set. To give the extra finish is not a difficult operation, and is one well worth carrying out by the amateur.

The essential requirement in oxidizing by this method is to prepare the metal so that it is mechanically clean. There must not be the least trace of grease of any kind on its surface, and on no account should the metal be touched with the bare hands, or the finger prints will appear after the oxidizing. The parts to be treated are first finished and polished in the ordinary way. A most convenient plan is then to boil them in soda water, rinse them thoroughly in very hot, clean

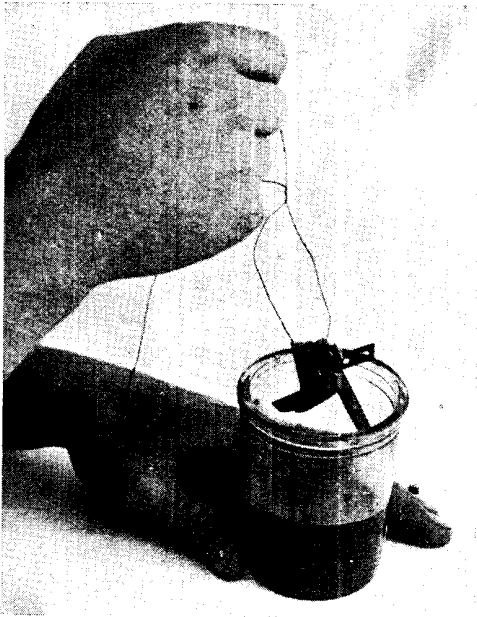

ACID BATH FOR OXIDIZING

Fig. 1. How the metal objects should be immersed in the bronzing acid is shown. They should not be touched with the hands

water, and then allow them to dry off naturally, or immerse them in absolutely dry, hot sawdust.

The bronzing acid can be applied in two ways. In the case of small parts, such as angle brackets and terminals and the like, these should previously be mounted upon a piece of thin wire, so that they can be handled without touching them. A sufficient depth of bronzing acid is then placed in a glass jar, and the objects immersed in the acid in the manner illustrated in Fig. 1. They should be kept in gentle motion the whole of the time they are in the acid and left therein until they have attained the desired colour. The time for this will depend on the temperature of the chemical and its strength. Immediately the desired colour is reached the articles are taken out of the acid and placed in clean boiling water, in which they should be rinsed thoroughly and allowed to dry.

Long or large work that cannot be conveniently dipped can be treated by preparing a pad of linen and dipping this into the bronzing acid. The work should be held in a gloved hand, as shown in Fig. 2, and the bronzing acid applied to the metal with the aid of the pad. Rather more skill is needed by this method to obtain a perfectly even surface. The finishing processes are alike in both cases.

Various other colours can be imparted to the work by the use of different chemicals. Most of them are highly poisonous, and for most practical work the bronzing acid does all that is necessary. Another pleasing finish is in the form of oxidized silver, in which case the articles are first silver plated and then treated. In this case the work to be oxidized should be thoroughly cleaned by immersion in a hot potash solution, rinsed and given an acid dip. It is afterwards thoroughly rinsed in a large quantity of clean water, and given a cyanide dip. It should then be rinsed thoroughly in hot clean water and then dried.

In this case the bronzing chemical consists of a solution of 1 oz. of barium sulphide to a gallon of water. This solution, when applied to the silvered work in either of the foregoing ways, gives the work a very pleasing light golden to brownish-black colour, according to the time for which the work is immersed in the solution and the strength of the solution. A very pleasing appearance is



BRONZING LONG OBJECTS

Fig. 2. When bronzing long metal objects a pad of linen should be dipped in the acid and applied as shown. The hand holding the object should be gloved

obtained by lightening the work locally, and this can be accomplished by rubbing the parts of the surface it is required to lighten with a little pumice, doing this with the tips of the fingers.

OXYGEN. One of the non-metallic gaseous elements, chemical symbol O, atomic weight 16. Oxygen forms about 21 per cent by volume of the earth's atmosphere, and is the most widely distributed of all the chemical elements. It occurs widely in combination, oxides forming a large part of the earth's crust, and eight-ninths by weight of water is oxygen. Liquid oxygen has remarkable magnetic properties, its permeability being equal to 1.00287 to 1.0041 as determined by different observers. Fleming points out that liquid oxygen is a substance which possesses four qualities found together in no other substance, namely, optical transparency, almost perfect non-conductivity, a magnetic permeability greater than unity, and a dielectric constant nearly 50 per cent greater than that of empty space.

Oxygen is conveniently obtainable by the experimenter in large solid steel cylinders, which are fitted with a special form of screw-down valve. The oxygen is forced into these cylinders under great pressure, and a relatively small cylinder, therefore, contains a large volume of the gas. As the pressure would be too high for normal use, a specially devised reducing valve is fitted which reduces the pressure to low values in the region of 100 lb. per square inch or thereabouts. The margin of safety with these cylinders is very large, and explosion is practically impossible. Nevertheless they should be carefully handled and preferably kept in the form of rope container which is specially made for them.



P. This is the chemical symbol for the non-metallic element phosphorus (*q.v.*).

PACKING. Term used in many senses. Packing in one aspect consists in protecting an article by covering it, or embedding it within a suitable container. By far the greatest care in packing of this description is needed for the protection of the valves used in wireless sets. All too frequently the valves are neglected in this respect by thoughtless owners, and the penalty is a shortened life for the valve.

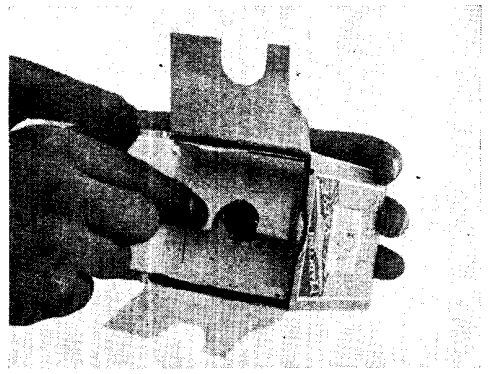

PACKING A VALVE

Fig. 1. Valves should be replaced in their cases when not in use. The valves can be abstracted and replaced without disturbing the packing arrangement

The makers always pack valves in a very secure manner, either in cotton-wool or with felt in a carton, or by the use of a specially designed box with fold-over portions such as that shown in Fig. 1. The box is made of several thicknesses of card, and the several portions are shaped so that the valve has only to be placed into the cavity formed for it and the four parts of the top folded over as shown, and the valve is secure. The use of these or other boxes for storage of valves while not in use will lengthen their lives.

Another example of packing is that necessary when a set has to be prepared for transport. When the set is to be taken by hand a carrying case made of stout wood, and just large enough to take the set, will answer well, and such a device is illustrated in Fig. 2, where the set is seen in the act of being placed into the case, and is secured therein with a few slips of wood screwed to the sides of the case to keep it in place and prevent movement.

When a complete receiving set has to be sent by rail it should be accommodated within a strong packing-case built with stout timber and strengthened with battens at the sides and bottom. The case should be divided into compartments to take the valves, each in a separate carton, and other compartments should be made for the batteries and the loud speaker. If the components be separated in this manner there will be little risk of their meeting with accidents en route. The loud-speaker trumpet can generally be taken apart and the smaller parts packed in

crumpled paper or wood-wool and the flare or mouthpiece be packed on top, as shown in Fig. 3. The whole is then covered with felt or several layers of crumpled paper and the lid screwed into place.

Packings are also used in quite a different sense, as, for example, those inserted under a valve holder to minimize vibration and the consequent microphonic noises. Some valves are more prone to show vibration than others, but the use of a disk of thick indiarubber inserted beneath the bottom of the valve

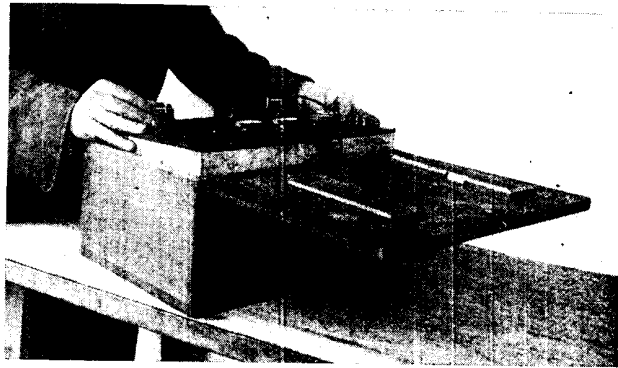

PACKING A RECEIVING SET

Fig. 2. Special transport cases are made for wireless sets. In this photograph a receiver is being placed securely in its case



HOW TO PACK A LOUD SPEAKER

Fig. 3. Loud speakers need very careful packing. The illustration shows how the instrument and trumpet are included in the same case. Paper is used as packing material

holder, as shown in Fig. 4, will act as a deterrent. The purpose of this type of packing is to minimize vibration, and similar packings are used to change the relative height of an object or to improve the insulation value.

One example of the use of a packing in this manner is shown in Fig. 5, where a condenser is seen applied to a wooden base or panel, and the insulation maintained at a high value with a packing piece consisting of a sheet of thin ebonite interposed between the condenser end plate and the wood. It is important to remember to insulate the screws as well as the condenser end-plate to maintain insulation.

Packings are extensively used for correcting the height of an object, such as a lathe tool when mounted in the tool post, as shown in Fig. 6, the packing in this case being required to raise the tool to the height of the lathe centres. Such packings may be of wood or metal, as convenient.

Very thin packing slips of sheet metal known as shimms are used for the purpose of providing a measure of adjustment between the inner faces of the two halves of a plummer block. They are applied



RUBBER PACKING BENEATH VALVE

Fig. 4. Under a valve holder rubber packing is placed as a means of reducing vibration and the microphonic noises which often result

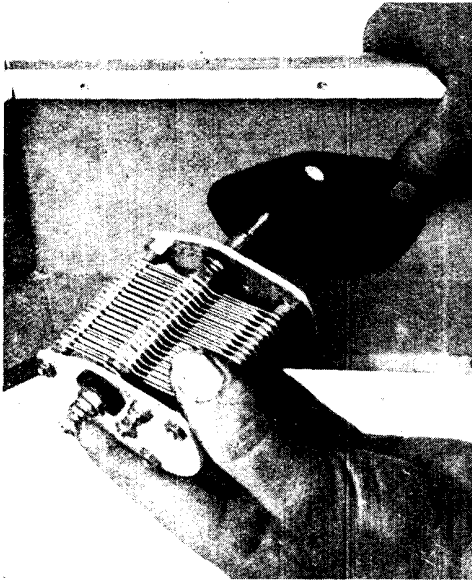

EBONITE PACKING FOR CONDENSER

Fig. 5. When a condenser is fixed on to a base-board it will be found better to pack it with an ebonite plate, as shown, to increase the insulation

as shown in Fig. 7, and as the shims are only a few thousandths of an inch in thickness, several may be needed to correct the fit of the bearing to the shaft. They are applied between the meeting faces of the

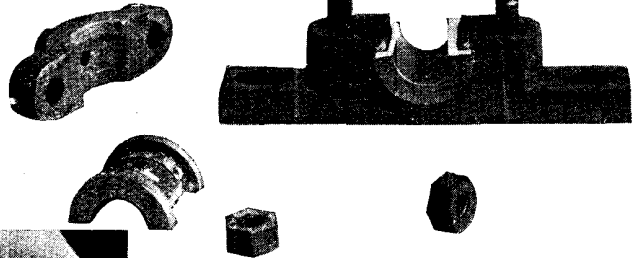

PACKING A PLUMMER BLOCK

Fig. 7. Very thin packing slips of sheet metal known as shims are used to pack up the inner faces of the two halves of a plummer block

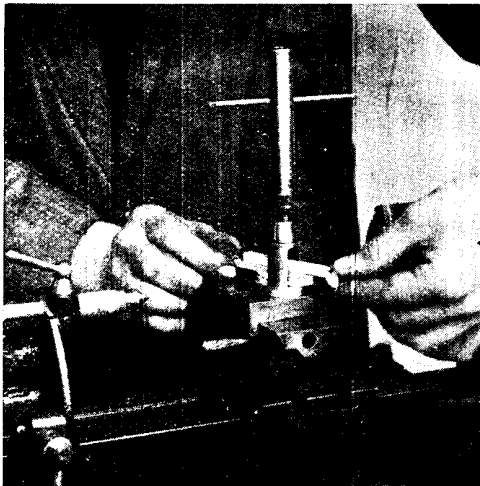

PACKING FOR LATHE TOOL

Fig. 6. Beneath a lathe tool metallic or wooden packing is placed. Packing is required to raise the tool to the proper height equivalent to that of the lathe centres

bearing bushes to keep them a small distance apart and allow the shaft to revolve freely. When the cap is tightened on to the bushes the shims are tightly pinched and held fast.

Hemp and tow are other extensively used packing materials for such purposes as the sealing of oil and water pipe joints, and also under suitable conditions to the glands of steam engines and other machinery.

PAINT AND PAINTING. Paint is a semi-fluid composition varying greatly in its ingredients. It is applied to materials for the purpose of changing the apparent colour, as a preservative, or as a means of improving the insulating qualities. The experimenter will have to do a certain amount of painting to the structures erected for the support of the aerial, as well as such operations as painting the various cases and containers for receiving-sets, battery boxes and the like.

The requisites for simple painting are

few and inexpensive; the more important are illustrated in Fig. 1 and show a paint kettle, that is, simply a can with a wire handle, or bail, a selection of suitable brushes for general use, a putty knife and a stripping knife. The paint is best purchased in tins ready for use, but it is well worth while to obtain the paint from a reputable maker, or as a branded article.

There are various qualities or grades of ordinary paints, prepared for specific purposes, and the chief of these are the paints intended for outside use, and those for internal application only. In addition, there are three grades for use in the appropriate order. These are commonly known as undercoatings, flat colours and finishing coats. The former are prepared

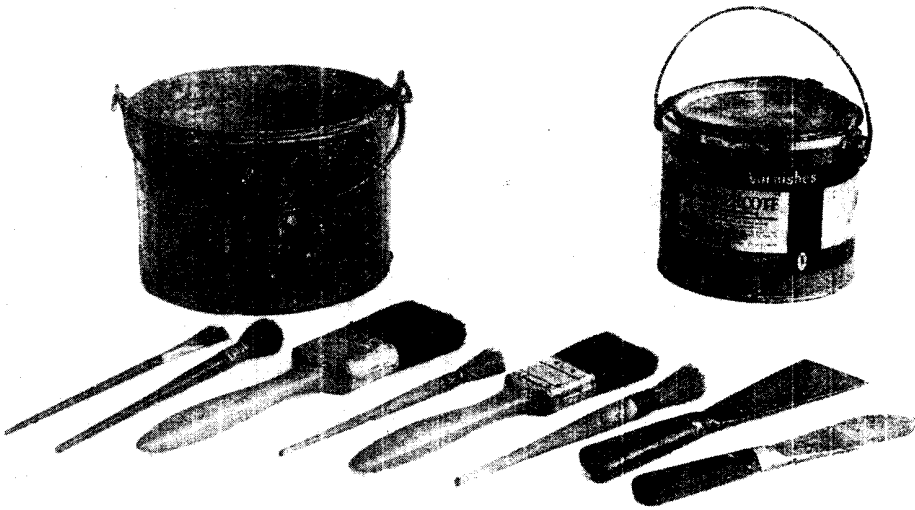

MATERIAL AND IMPLEMENTS FOR PAINTING

Fig. 1. Wireless experimenters and those who construct a good deal of apparatus, especially out of doors, should be equipped with a full complement of painting tools. The above selection sets forth the usual requisites, including a paint kettle, brushes for various purposes, putty knife and stripping knife

for direct application to the wood or other material, and their purpose is to fill the pores or grain and prepare it for the later coats. This is one of the most important and necessary steps in successful painting, and must never be omitted. A good general rule is to employ the undercoating supplied by the makers of the paint, as this is of the correct composition for the purpose and will take the succeeding coats without difficulty.

When the undercoating has been applied and has set hard, it has to be rubbed down with sandpaper, as shown in Fig. 2, and this is followed by a filler coat, which fills the pores and small cracks.

Any larger holes, such as those where a nail or screw has been inserted, should be filled with hard stopping or putty well worked into the holes with a putty-knife, as shown in Fig. 3.

The next step is to build up a good body of colour with several coats of flat colour. This is applied rather thin, and the purpose is to make a good, solid-looking coloured surface whereon to apply the last or finishing coat. This may be a plain paint, or may have some varnish incorporated in it. The latter is the better plan on outdoor work. Alternatively, employ a good grade of enamel.

Enamel is a form of paint, but dries with a fine lustrous surface, and is generally used on internal work, or on important exterior jobs. Paints are generally applied with a brush, although a great deal is done in the industry by spraying the paint on to the work under high air-pressure. The process is not as a rule applicable to amateur conditions.

In applying paint with a brush it is desirable to use one suited to the nature of the paint and to that of the work. For general small work use a sash tool or a small fitch. For comparatively large surfaces use a 2 in. ground flat brush, and on large rough work a still bigger brush. The paint is applied in much the same way, whether for the first or final coats, by holding the brush between the fingers and thumb as in Fig. 4 and working with even, broad strokes. The paint should work well, that is be thin enough to go on readily, but not so thin that it runs easily. The undercoating is brushed well into the work. Subsequent coats of flat colour should be lightly brushed and every effort made to obliterate brush marks. Final coats are applied rather more liberally, and enamel, especially, rather thicker, and worked with a flowing rather than a brushing motion.

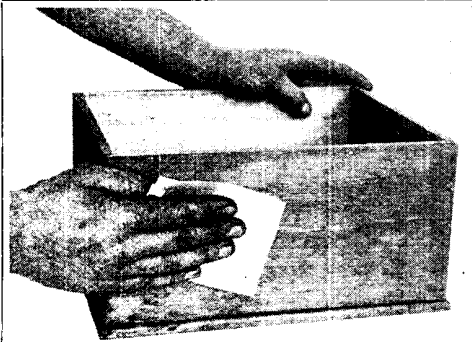

Fig. 2. Sandpaper is used to rub down the undercoating after it has set hard



Fig. 3. Large holes such as those made by nails should be filled in with hard stopping or putty



Fig. 4. Evenly drawn strokes should be made and the paint brush held between the fingers and thumb as illustrated

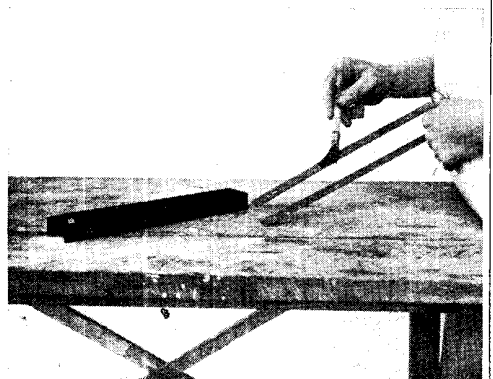

Fig. 5. Brunswick or similar black paint should be applied to iron after it has been rubbed down with emery paper

NECESSARY PROCESSES IN PAINTING

When painting ironwork the surface is first cleaned with emery paper or a rust remover. The paint used generally has a lead base; undercoats and final coats are used as before. Small iron parts, such as those for the aerial wire guys, should be painted black. Brunswick black dries with a shiny surface; Berlin black with a dull or eggshell semi-matt surface. Either are best applied with a small brush, working the long way of the iron, as shown in Fig. 5.

Most colours can be purchased ready for use, but when the tint has to be matched it is customary to employ a staining colour, and add it to the white or other coloured base to get the desired tint.

Metal work generally is best painted with a paint having a metallic base, such as a good aluminium paint. This is very durable on exterior work and on heated metal parts.

Another variety of paint is known as fireproof, and does, when properly applied, retard the effects of fire. Asbestos is usually one of the constituents. Insulating varnishes and paints are prepared, and often have pitch, asphalt or rubber in their composition. A simply made insulating paint is obtained by dissolving shellac (brown) in alcohol or methylated spirit.

Many varieties of preservative paints are made, such as solignum, and are admirable for the decoration and preservation of outdoor structures made of wood, such as a mast or the walls of a small workshop. This material is applied with a large brush, and such a brush should be kept specially for that work and none other.

Luminous paint is useful on some tuning dials, as it shows up the calibrations in a dark part of the set, as, for instance, within many cabinet sets.

An important item in all painting is never to apply a second coat until the first is properly hard. New paint should not be applied to old work until the latter has been cleaned and given a coat of undercoating. An enamelled surface must be cleaned and given an undercoat before following with another coat of enamel.

To accelerate drying, add patent dryers or terebine to the paint, if of ordinary quality, but follow the maker's instructions with all proprietary brands.—*E. W. Hobbs.*

PALLADIUM. One of the rare metallic elements belonging to the platinum group. Its chemical symbol is Pd, and atomic weight 106.2. It resembles platinum in many ways, and approaches steel in hardness. Palladium has a remarkable power of absorbing gases, and one of the most commonly used methods of controlling the vacuum in X-ray and similar bulbs is by making use of this property of the metal. A palladium wire is sealed through the glass of the vacuum bulb, and if the bulb contains hydrogen, say, and the internal end of the wire is heated, the gas is diffused through the wire into the air, so raising the vacuum in the bulb. Platinum is also employed in a similar way.

PANCAKE COIL. Type of flat disk-shaped inductance much favoured by amateurs on account of its cheapness and ease of construction. Coils of this type are not usually wound with any regard for self-capacity, but consist of thin disks of insulated wire held together by paraffin wax. Apart from their high self-capacity, pancake coils are rather difficult to mount and connect up to other parts of the apparatus. They also tend to give a set an untidy appearance. See Basket Coil; Coil; Oojah Coil; Slab Coil.

PANCAKE TRANSFORMER. A type of air-core transformer in which the inductances are composed of pancake or basket coils, arranged to give a fixed inductive coupling. Pancake transformers are suitable for high-frequency amplification where they may be used in the place of the ordinary plug-in high-frequency transformers. They hold an advantage over the latter in greater ease of construction and adaptability for experimental work. At the same time the pancake transformer has a rather higher efficiency than that which is obtainable from some other types of transformers.

Fig. 1 shows a completed transformer of the pancake coil variety, which may be easily constructed from odd pieces of ebonite and scrap material. The base and upright are cut from $\frac{3}{8}$ in. or $\frac{1}{4}$ in. ebonite, convenient sizes being 3 in. long by 2½ in. wide for the base, and 5 in. long by 1 in. wide for the upright member. The latter is attached to the base by means of a strip of right-angle brass cut off to the width of the vertical arm, and bolted to the base and the arm as seen in Fig. 1.

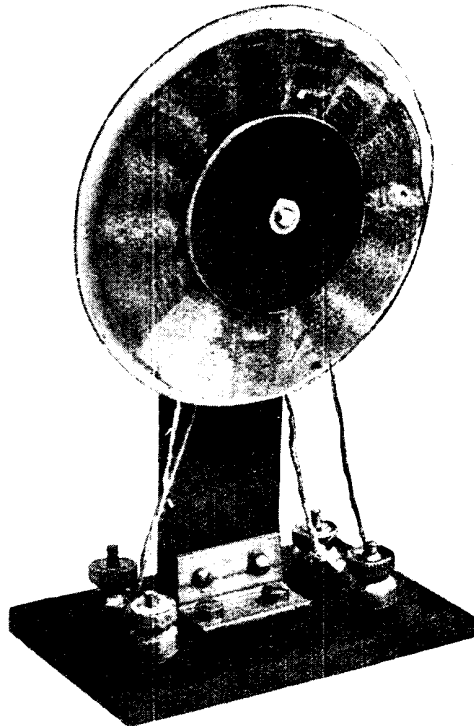

HOME-MADE PANCAKE TRANSFORMER

Fig. 1. This illustration shows the completed transformer. The ends of the basket coils are brought to terminals on the base

Four terminals for connexion to the coil ends are arranged conveniently on the base, in which also four holes, for screwing down the completed transformer are drilled as required. Another hole of $\frac{1}{8}$ in. in diameter is required, centrally situated at the top end of the vertical arm. The appearance of the transformer at this stage is shown in Fig. 2.

The size and conductive value of the pancake coils will depend on the use to which the transformer will be put, and also if used in tuned circuits, and the wave-length required. These factors must

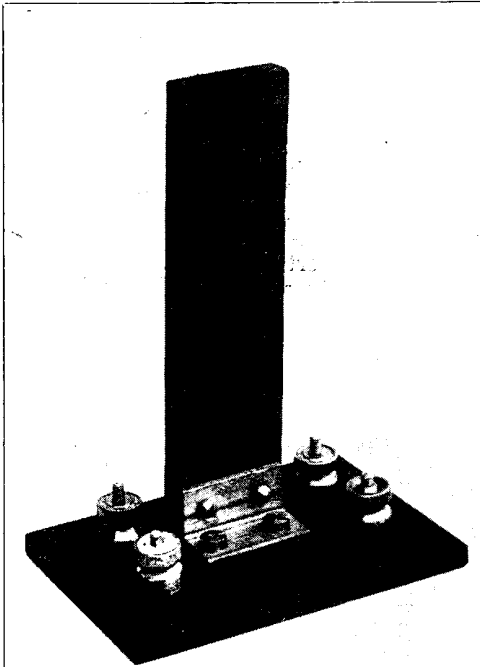

Fig. 2. Vertical from the base is an ebonite arm held by a brass angle piece

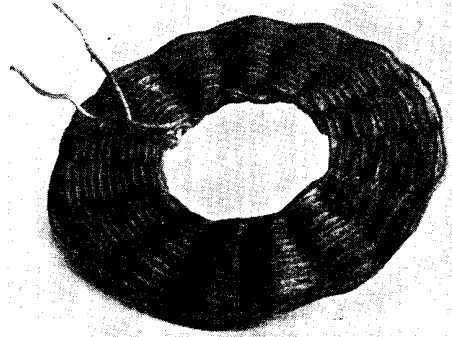

Fig. 3. Ends of the primary coil in the photograph are fastened by looping the wire through the coil

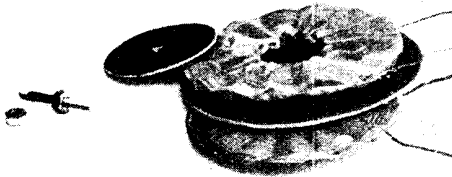

Fig. 4. Two basket coils are shown, with the separating disks arranged in order of assembly

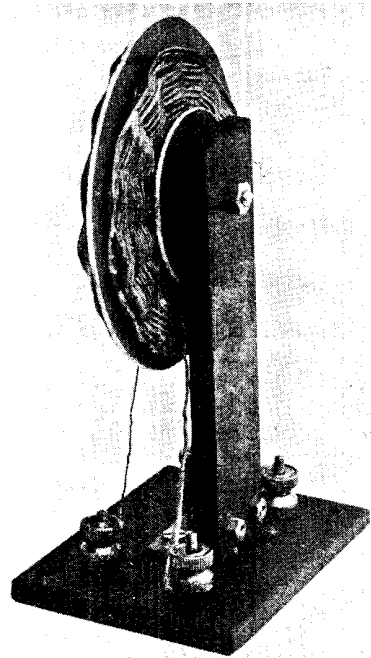

Fig. 5. In this photograph of the completed transformer the method of mounting and connecting the coils is clearly shown

HOW TO MAKE A PANCAKE TRANSFORMER AND ITS MOUNT

therefore be left to the experimenter's requirements. If the instrument is to be used as a coupling transformer in high-frequency amplification, the pancake coils must be matched in inductance value. If a step-up effect is required, the secondary coil must have a higher inductance value than the primary.

Fig. 3 shows the primary coil of the transformer under construction. In mounting the pancake coils, a disk of thin ebonite, having a central hole $\frac{1}{8}$ in. dia-

meter, is placed between the primary and secondary. A cardboard disk will be found quite satisfactory if it is well soaked in hot paraffin wax. Two smaller disks similarly drilled are placed on the outside of each coil when they are in position against each other. A short length of 4 B.A. rod, screwed at either end, is passed through the hole at the top of the vertical arm.

The ebonite washers and pancake coils are now slipped over the rod, and are

tightened in position by nuts screwed on at either end of the rod. Fig. 4 gives an idea of the method of assembly, where the washers, coils, and screwed rod are seen, the former being the order in which they are mounted. The rear view of the pancake transformer is shown in Fig. 5, in which the insulating disks are clearly seen. See Basket Coils; Oojah Coil; Inter-valve Transformer; Transformer.

PANEL. Name given to a sheet, usually of insulating material, which acts as a support for the principal components of a wireless set. In amateur sets the panel is generally made of ebonite, averaging about $\frac{1}{4}$ in. in thickness. There are a number of ready prepared panels which can be purchased, cut to a rectangular shape and provided with rounded or polished edges. They are sold in convenient sizes, either for single or multi-valve sets, and other purposes. Some of these panels are of ebonite, and others are of a composition, such as Celeron or other specially manufactured insulating material.

The most economical way of making a panel is to obtain a sufficiently large sheet from which to cut the principal panel, the remaining part of the sheet coming in for use when mounting individual component parts, making bushes, and so forth. The first step is to prepare the edge of the ebonite so that it is quite straight and true. This may be done with the aid of a file, as described under the heading Ebonite.

Having done this, the next and a most important step is to take a steel or other set square, and with the aid of a steel scriber, as in Fig. 1, draw a line at right angles to the edge and at a little distance from the edge. Lines should be incised upon the panel with a sharp cutting instrument, such as a scriber, as if they are marked with pencil and the graphite left on the panel, there is risk of surface leakage of the high-frequency electric current.

Proceeding with the marking out of the panel, the next process is to measure the length and draw a second line at right angles to the first working edge at the correct distance from the line previously drawn. Then, with the aid of a pair of dividers set at the correct breadth of the panel, mark off the dimensions along the lines across the panel, this operation being shown in Fig. 2. Using the steel rule or a straight edge, and with one of its edges in line with the two marks, draw a third line across the panel, as in Fig. 3.

The sheet of ebonite will now have drawn upon it two lines at right angles to the first edge and a third line parallel to it. The sheet has now to be cut to these lines, and the edges filed up true. Next with a steel rule or other straight edge, test to see that all these edges are really straight and true, using the rule in the manner illustrated in Fig. 4.

If any difficulty is experienced in sawing the edges straight, a practical plan, illustrated in Fig. 5, is to rest the sheet of ebonite on the work bench, fix a wooden stop on the bench opposite the worker, press the ebonite against it, and fix a batten to the ebonite with two screws, arranging it so that one edge of the batten registers with the line on the ebonite, where it is desired the saw cut is to be made. Then with the aid of a tenon saw, as used by woodworkers, saw the ebonite asunder, keeping the blade of the saw against the edge of the guiding batten, and keeping sufficient pressure on the top of the back of the saw with the fingers of the left hand.

Marking out the Panel

When the panel is prepared to a rectangular shape the next process is to mark it out very accurately for the centres of the holes for the fixing screws, the passage of spindles, and so on, of the apparatus to be attached to the panel. The best plan is to mark with chalk any two adjacent sides or edges of the panel which are at right angles to each other, and take all the dimensions from them.

Probably the panel will have a filament resistance and valve holder in line with each other, and these may be on the centre line of the panel, in which case this centre line may be drawn temporarily with ordinary flake white or Chinese white water-colour paint and a very fine brush. This will serve as a guide for positioning the various parts, the centres for filament resistance spindles, condensers, variable grid leak and other fittings, which should be marked first, and the positions for the fixing screw holes, if any, later on, when the best positions for them are known.

In any case, when the various centres have been determined, they should be punched with a sharp centre punch, as shown in Fig. 6, as a guide for starting the drill correctly. The great point in setting out the panel is to always work from two base lines at right angles to each other, and

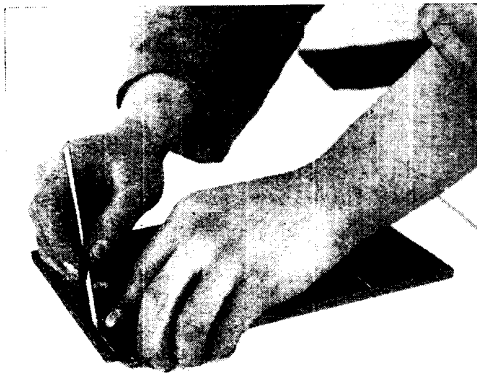

Fig. 1. First mark out the panel with a steel scriber. The edge should be a little distance from the rough end of the material

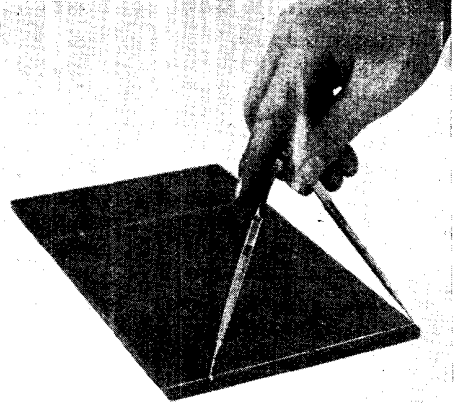

Fig. 2. Mark off equal distances along two reference lines which have been scribed on the panel to ensure cutting square



Fig. 3. Draw a line accurately at right angles to the first two. It is important that the panel be first marked out, or the work may be spoiled

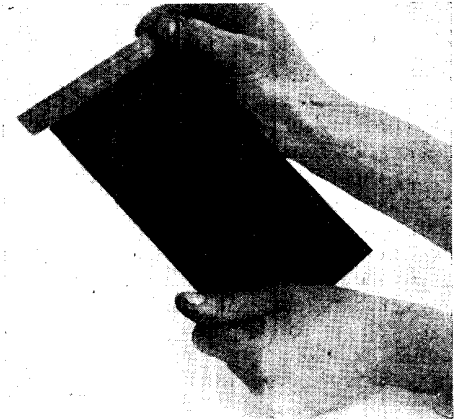

Fig. 4. Test the panel when it is cut out of the rough sheet of ebonite by applying a steel rule or set-square to ensure accuracy

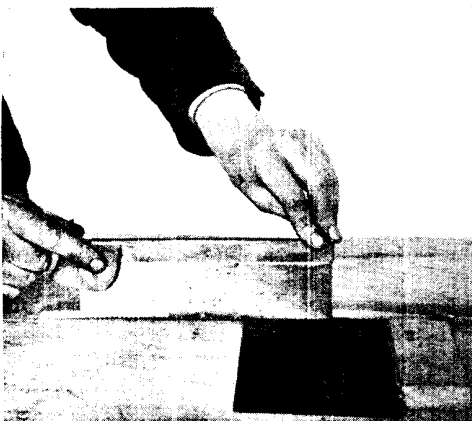

Fig. 5. Cut the ebonite with a tenon or brass-back saw, and use a batten fixed in position to act as a guide

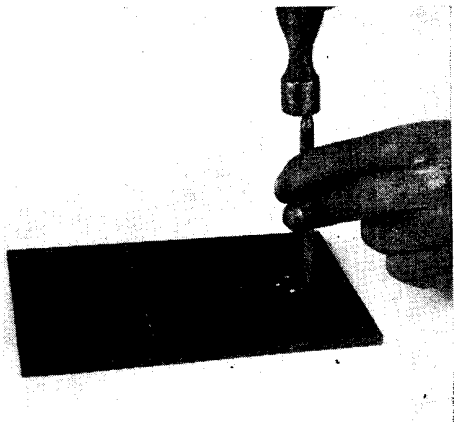
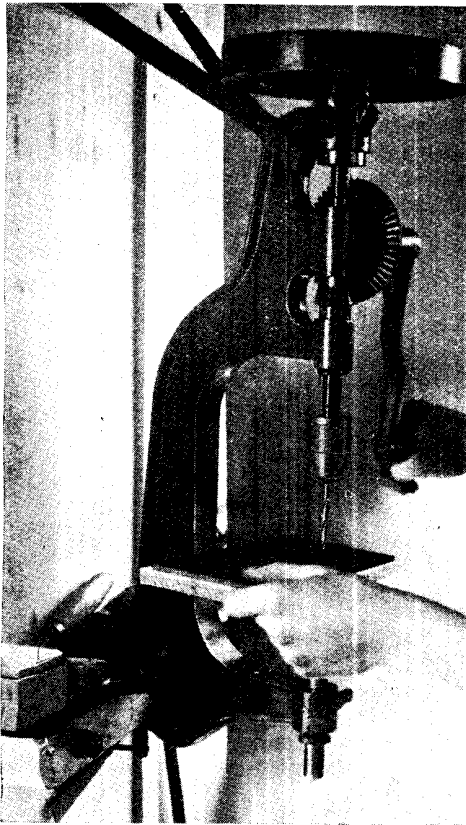

Fig. 6. Use a centre punch to mark the position of the holes and to provide recesses for the drill

SUCCESSIVE STAGES IN THE PREPARATION OF A PANEL



DRILLING A PANEL

Fig. 7. Smooth wood should be used to support the panel during drilling operations, especially if a small hand drilling machine is used.

not take progressive measurements, from point to point, as by doing so, any slight errors made at each step will ultimately add up to a considerable error. When drilling the panel, support it with a smooth piece of wood, as shown in Fig. 7, especially when using a small hand drilling machine.

When the panel has been made, the next step is to mount it in a cabinet or case.

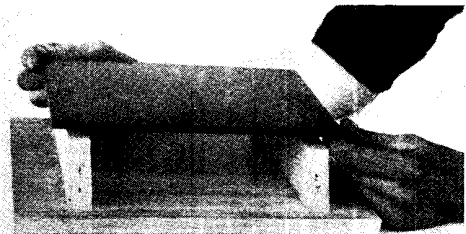

MOUNTING A PANEL ON CROSS-PIECES

Fig. 9. Another simple way of mounting a panel is by using wooden cross-pieces in this manner, leaving ample room for the wiring.

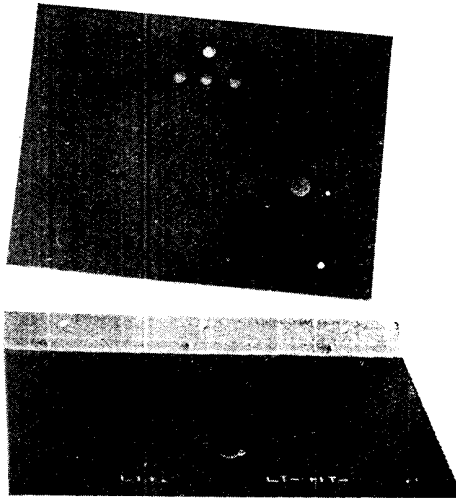

FIXING PANEL TO BASEBOARD

Fig. 8. Angle brass is used to hold a panel at right angles to its baseboard, as here illustrated.

For experimental purposes a simple and efficient plan, illustrated in Fig. 8, is to prepare a baseboard of ebonite or hardwood, and to secure the panel to the front of it with a strip of angle brass. This presents a neat appearance on the face, and at the same time obviates the need for a cabinet, and also gives ample access to the various components.

Another method that is very handy, especially for experimenters' sets, is illustrated in Fig. 9, and consists of making a plain wood baseboard with two cross-pieces upon it whereon to rest the panel, which is simply screwed in place. There is thus a gap between the panel and the baseboard, allowing the wiring ample room to avoid interaction effects. This plan can be followed with considerable success when a special circuit is being tried out, preparatory to mounting it in the cabinet.

There are many ways of mounting the panel in the cabinet, one effective method, illustrated in Fig. 10, being to fit a fillet, or narrow strip of wood, all around just inside the cabinet, drop the panel on to it, and secure it in position with a few small brass wood screws.

In general, points to observe in the construction of the panel are, first to make a full-sized drawing, showing the positions of all the parts, or to cut a piece of thick cardboard exactly to the size of the panel, and try the positions of the various components upon it. Either of these plans

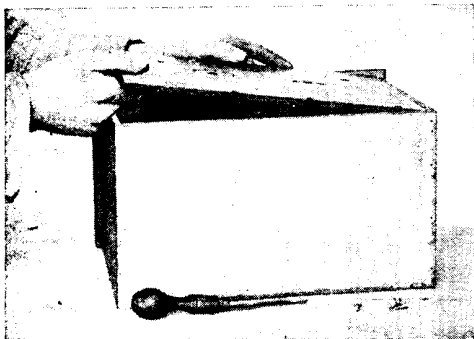

PANEL FOR A CABINET

Fig. 10. One of the most effective ways of mounting a cabinet panel is to put a narrow fillet of wood all round just inside the walls and drop the panel on it, fixing it with screws

will often save spoiling a piece of ebonite, and will tend to ensure a more symmetrical arrangement.

When making soldered connexions to fittings on the panel, always clear off every trace of soldering acid as soon as the work is complete. In mounting panels, take care that the support for them is perfectly flat, as if one end is tilted, for instance, there is grave risk of the panel being cracked when it is screwed into position. Such processes, and the various stages in the machining and working of ebonite, are fully dealt with under that heading in this Encyclopedia.—*E. W. Hobbs.*

See Aluminium; Ebonite; and under the names of the various tools, as Lathe.

PANNILL, CHARLES JACKSON. American wireless pioneer. Born in Petersburg, Virginia, May 13th, 1879, he entered the American Navy, 1898. In 1902 he took a post under Professor R. A. Fessenden, and carried out a series of wireless experiments at Hampton Roads, and inaugurated wireless communication between New York and Philadelphia.

Pannill was the first man to install wireless on board United States battleships. Afterwards he carried out a series of communication experiments between various parts of the United States, and erected a number of wireless stations. He joined the Marconi Wireless Telegraph Company of America in 1912, and became wireless adviser to the American Government, 1914, and assistant director of naval communications, 1917. Pannill is a fellow of the Institute of Radio Engineers and a member of the Washington Society of Engineers.

PAPER CONDENSER. A fixed condenser having paper as a dielectric. Such

condensers, being simple to construct, and requiring no expensive materials, lend themselves peculiarly to the requirements of the amateur who needs a condenser to be used in circuits where high voltages or high frequencies are not present.

For example, the condenser illustrated in the photographs, Figs. 1 and 3, was made for use in the primary circuit of a $\frac{1}{2}$ in. induction coil (*q.v.*) in order to obviate sparking at the platinum points of the interrupter.

To construct such a condenser, the following materials will be required:

Paraffin wax.

Some good quality cartridge paper.

Sheets of tinfoil.

6 in. copper wire.

Two terminals.

Suitable box or cabinet.

The condenser illustrated has forty plates cut to the shape shown in Fig. 2. Tinfoil is by far the best material for the purpose as, owing to its natural limpness, its cutting leaves no sharp corners or turned-up edges. This point is important where paper is used as a dielectric, for that material is easily punctured, and leakage may occur, with consequent loss.

It will be found an advantage to cut two templates exactly to the size and shape shown in Fig. 2. These may be made of zinc, or even cardboard. The foil should be placed between them, and cut with scissors to the desired shape. This method will preserve the foil from creasing. Forty plates will be required for this condenser.

The next step is the cutting of the paper rectangles which serve as the dielectric. As a margin of $\frac{1}{2}$ in. should be left all round the foil, the size of these paper rectangles will be 5 in. by 3 in. This will allow the lugs on the plates to project sufficiently. Forty-one pieces of paper must be cut, and after cutting they should be examined with the aid of a strong light to ensure a complete absence of pinholes. Should any

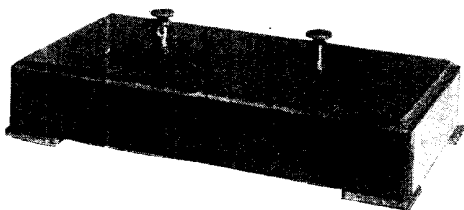

PAPER CONDENSER COMPLETE

Fig. 1. Paper condensers of this kind are easily made by the amateur out of the simplest material

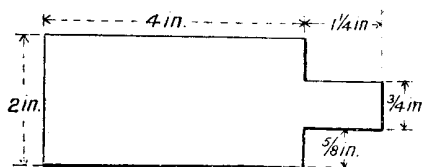

DIMENSIONS FOR PAPER CONDENSER

Fig. 2. Forty pieces of tinfoil of the size given are required, and forty-one pieces of paper are also used in the paper condenser.

holes be found the sheet containing them must be scrapped and a perfect one substituted for it.

The paper must now be impregnated with paraffin wax. This will ensure any moisture which may be present in the paper being driven out, and, further, it will prevent subsequent dampness becoming absorbed.

The assembly of the condenser may now be undertaken. First, place one of the impregnated paper sheets upon the table, and place one of the tinfoil sheets above it. The main body of the latter should be centrally situated with respect to the paper, leaving the lug projecting at one end. Another sheet of paper must now be imposed on the foil, followed by another piece of foil, having its lug projecting over the opposite end of the paper that the first one projected over. This procedure of alternations of paper and foil must now be continued until the final layer of paper is in position.

The result of this will be a rectangular block of paper and foil with a bank of lugs projecting at both ends. Now take two lengths of wire, about 4 in. long, and bind one end of each piece tightly round a lug. Care must be exercised here not to split or tear any of the foil. This done, the foil composing the lugs should be bent round the wire in the manner indicated in Fig. 3. The whole condenser may now be immersed in melted paraffin wax, soaked for a few minutes, and then taken out and left for the wax to solidify. This process will result in a finished product similar to that shown in Fig. 3.

All that now remains is for the condenser to be mounted in its cabinet. This may follow the lines of that shown in Fig. 1, but its size or shape is relatively unimportant, provided it is large enough for the purpose. The only electrical consideration is that the wood used for the cabinet be a good insulator, for the mounting of the terminals is made direct

upon it. Dry mahogany would be suitable, for the voltage used must not be excessive in a condenser having paper for a dielectric.

The wires must be connected to the underside of the terminals, and the condenser block inserted in the cabinet. The whole of the interior should now be filled with wax and allowed to set, after which the bottom may be put on, care being taken not to puncture the condenser with any screws or nails which may be used for the purpose.—*R. B. Hurton.*

See Block Condenser; Condenser.

PARAFFIN PAPER. Term used to describe any good quality paper impregnated with paraffin wax. It can be



PAPER CONDENSER LUGS AND CONDUCTORS

Fig. 3. How the foil composing the lugs of the condenser is fixed round the conducting wires is shown

purchased in ready prepared sheets, and in this form is most convenient to the amateur experimenter for insulation or dielectric purposes. When, however, a small quantity only is required, one simple way of preparing it is to get sufficient sheets of good quality notepaper, and cut them to the requisite size.

The next step is to obtain some paraffin wax, either from the chemist's or from an electrical sundries store. One pound will be quite sufficient for most ordinary needs. When obtained, it should be broken into pieces, placed in a small iron saucepan, and gently melted over a spirit stove or other source of gentle heat. As soon as it is liquid the paper should be immersed in the molten wax, as shown in Fig. 1.

The paper is moved about in the molten wax and then withdrawn and held for a few moments over the saucepan as shown in Fig. 2, while the surplus wax drops back into the saucepan. During the whole of the process care must be taken to prevent any of the wax falling on to the spirit flame, as it is highly inflammable and ignites easily. The flame from a spirit lamp is quite sufficient, and in the case of emergency it is quickly extinguished.



PREPARING PARAFFIN PAPER FOR INSULATION PURPOSES

Fig. 1 (left). Good quality paper is immersed in paraffin wax which is melted. Fig. 2 (right). The paper should be held over the saucepan for a few moments after soaking in the wax to allow the surplus to drain away properly

When the sheets have been dipped they should be hung up by their corners from a lath or suspended from cords in a warm place and left to dry, after which they may be cut to shape and used as desired. See Condenser; Insulation; Paraffin Wax.

PARAFFIN WAX. Mixture of solid hydrocarbons obtained from crude petroleum, and also yielded in large quantities by the Scottish shale oil industry. The dielectric constant of paraffin wax is from 2 to 2.3.

Paraffin wax is a most useful substance to the wireless experimenter, and a supply should always be kept in stock. It makes a very good insulator. It is not always convenient or desirable to use an ebonite panel or baseboard, and a good wood that has been thoroughly dried and then impregnated with paraffin wax will be found to make as good an insulator as may be wanted. When winding inductance coils, it will improve the insulation if the coils, after winding, are soaked in paraffin wax.

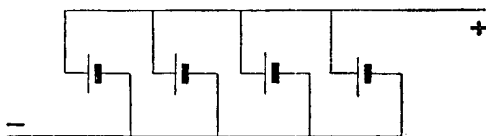

CELLS WIRED IN PARALLEL

Fig. 1. Corresponding poles are wired in this battery of four cells. All the positive poles are taken to a common lead and all the negative poles are wired similarly, so wiring in parallel

Sufficient wax should be melted in a saucepan to cover the coil. The latter should be immersed for a few minutes, and then brought out and the wax allowed to set. Cardboard formers for inductances are better impregnated with wax before winding. The former should be placed on end while it is drying, or otherwise the tube will become oval in shape. On the plate facing page 204 will be found a photograph showing how a basket coil should be impregnated with paraffin wax.

Paraffin wax will be found useful to the experimenter as a stopping. An ebonite panel that has been discarded for one purpose, and is required for another, always looks unsightly with a number of unused holes drilled in it. These holes may be stopped with wax, and then blackened with brunswick black. See Dielectric; Insulation.

PARALLEL. Term used in electricity to denote the way various parts of a circuit are joined together. Thus resistances are said to be in parallel or cells are said to be in parallel when joined up in a certain way to form a battery. Fig. 1 gives the theoretical diagram showing how a number of single cells are joined together in parallel, and on page 215 appears a photograph showing the practical arrangement of this method of wiring. It will be seen that all the negative elements of the cells are joined together and all the

positive for a parallel connexion. When a number of cells are joined in parallel, the total electro-motive force is equal to the electro-motive force of one cell, and the total internal resistance is equal to the internal resistance of one cell divided by the number of cells in parallel. Connecting cells in parallel is equivalent to enlarging the plates, and the object of connecting cells in this way is to obtain a larger current.

When a greater electro-motive force is required the cells are joined in series, as explained under that heading, and when a larger current and a larger electro-motive force are required, the cells are joined partly in series and partly in parallel.

Fig. 2 shows how resistances are joined in parallel. Four resistances are shown, and the current, the direction of which is indicated by the arrows, has a choice of four paths. The current passes through the resistances in a proportion which varies inversely with the resistance of each path. The larger the resistance the smaller the current which passes through, and vice versa. Thus, in the diagram, if R_1 is

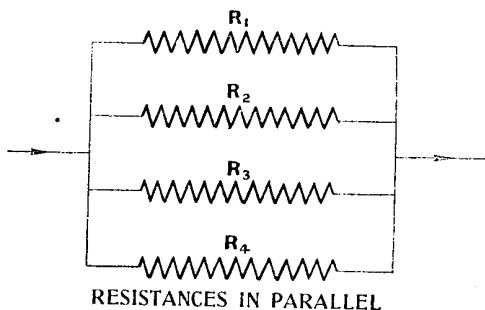

Fig. 2. Four resistances are shown wired in parallel. The current which passes along each path is in inverse proportion to the resistance

greater than R_2 , then the current passing through R_1 is less than the current passing through R_2 .

The amount of current passing through the different resistances joined in this way is proportional to the reciprocals of the resistances, *i.e.* to $1/R_1$, $1/R_2$, $1/R_3$, and $1/R_4$, and the total resistance is equal to the reciprocal of the sum of the reciprocals of the individual resistances. If R is the total resistance, this last statement can be expressed by the equation

$$1/R = 1/R_1 + 1/R_2 + 1/R_3 + 1/R_4$$

The capacity of a number of condensers arranged in parallel is the sum of their

separate capacities. On page 259 is given a diagram showing how condensers are joined up in parallel. This is a useful fact for the experimenter, who often has a number of fixed condensers, none of which is of exactly the correct value. By joining two or more in parallel he can often obtain the right capacity required for his particular circuit, as he can lessen capacity by joining in series. See Accumulator, page 15; Battery; Capacity; Resistance; Series.

PARAMAGNETIC. In the classification of magnetic substances the term paramagnetic is applicable to those which are feebly magnetizable and attracted to any appreciable extent only by a body capable of exerting a considerable magnetizing force. In some textbooks the term is used to embrace all substances other than diamagnetic, without regard to the extent of attraction, provided the latter occurs in the slightest degree. The general practice, however, is to make a further subdivision of magnetic bodies and classify them as (a) ferromagnetic, or strongly magnetic, or (b) paramagnetic, defined as above.

Under the latter heading are included manganese, platinum, cobalt, nickel, etc. The permeability of such substances is considerably less than that of ferromagnetic materials, and their reluctivity accordingly higher. See Magnetism.

PARASITIC NOISES. Any form of noise found in a receiving set which is not due to transmitted signals or telephony. A prolific cause of such noises is atmospheric, and reference should be made to that heading for information on that subject. Noises from other causes may easily be confused with atmospheric, and for that reason are very difficult to trace. Generally speaking, however, atmospheric may be ruled out if the noises continue day after day with fair regularity.

Crystal sets are usually free from noises, and should any occur they may generally be attributed to bad or loose connexions. When this is discovered, the bad connexion should be re-soldered, and the noise should cease. Occasionally a high wind may cause a bare aerial lead-in wire to swing against adjacent buildings. Should the latter be damp, the current will, of course, run straight to earth, and a click will occur in the telephones whenever the wire touches the building.

Noises in valve sets are frequently caused by old or worn-out H T. batteries. The connexions to the zinc elements in dry batteries become corroded with the passage of time, with the result that proper electrical connexion becomes weak and uncertain. Again, one or two cells may run down before the others, and these will form a resistance, uncertain and frequently varying in value. These may usually be discovered by placing a small flash-lamp bulb across each cell in turn. Any cell which does not light the lamp to its correct brilliancy should be immediately short-circuited by a piece of copper wire or removed from the battery, and the latter reconnected.

Bad contacts on variable condensers and filament rheostats will result in noises when they are rotated, and they will immediately show themselves when this is done. Fixed condensers sometimes deteriorate, and this produces an uncertain dielectric. The substitution of a condenser that is known to be perfect for the doubtful one is the guide to the trouble.

A further cause of noise is a leaky winding in high- or low-frequency transformer. Here, again, unless instruments are available, the trouble can only be discovered by substitution of the suspected component. The use of too high a plate voltage will frequently cause a leak in the insulation of a L.F. transformer. Rewinding is the only remedy.

Searches for these faults should be carried out systematically, the attention being given to the rectifier first, and then on to each amplifier in turn. It is very seldom that L.T. accumulators cause noises, and these may be ruled out until all other apparatus has been tested.

Telephone leads sometimes develop leaky insulation at the ends where the connecting tabs are fitted, or at the dividing joint. These leaks may invariably be discovered by jerking the leads about with the hand while listening to a transmission. Should the noises cease or increase in intensity or frequency while this is done, it is almost certain that the leads are at fault. See *Faulcs*.

PARING CHISEL. Name given to a tool used in woodwork particularly adapted for cutting across the end grain of timber. A typical paring chisel is illustrated in Fig. 2, from which it will be seen that it consists essentially of a long blade and a hardwood handle. Two varieties are made, one with bevelled edges, as illustrated, and the other with the ordinary regulation edges similar to the regulation firmer chisel. The bevelled variety is generally the most useful to the amateur, as the bevel facilitates horizontal and vertical

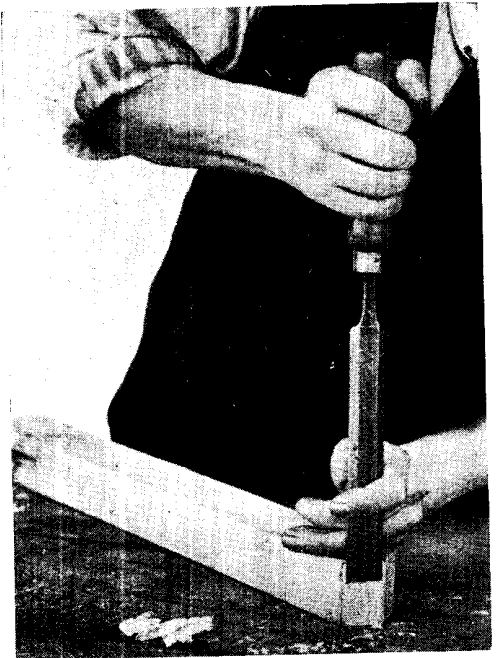

PARING CHISEL IN USE

Fig. 1. How the paring chisel is held and guided by the fingers of the left hand is clearly shown. The shaping of the end of a guy-wire post is being carried out

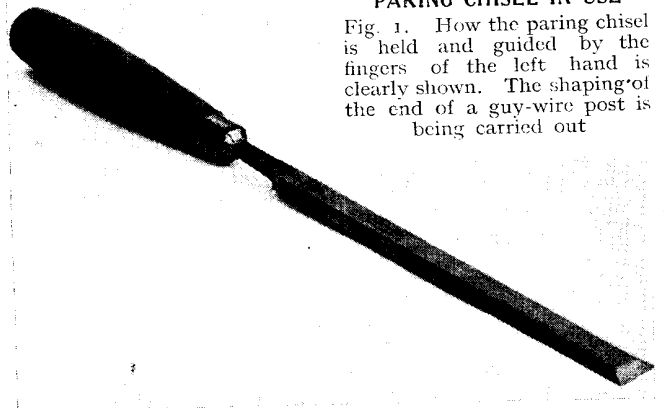

BEVELLED PARING CHISEL

Fig. 2. Bevelled paring chisels, as illustrated above, are very useful to the wireless experimenter who constructs his own wood parts. They are adapted for cutting across the grain

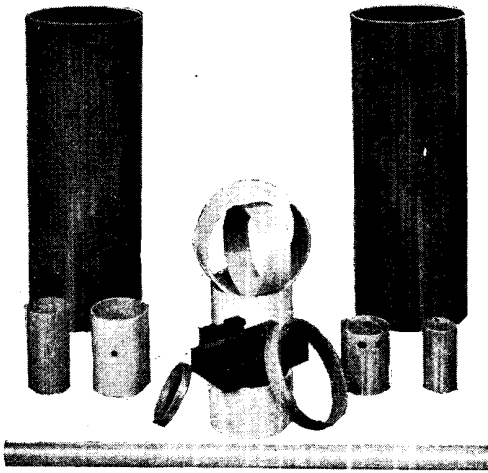

PAXOLIN TUBES

Fig. 1. Paxolin is an insulating material made of paper impregnated with a varnish consisting of phenol and formaldehyde, and above are examples of tubing made of the material

Courtesy Micanite and Insulators, Ltd.

paring, enabling chips to get away rather more freely than with the other pattern.

The method of use for the amateur is to grasp the handle firmly with the right hand and to guide and steady the blade between the fingers and thumb of the left hand. The first and second fingers should encircle the blade and the thumb be kept at the back of it. Cutting is effected by pressing the chisel vertically downwards, or horizontally across the wood according to the nature of the work in hand at the moment. A typical operation is illustrated in Fig. 1, and is that of shaping the end of a post from which to make a support for a guy-wire for an aerial mast.

Paring chisels should be kept very keen by grinding when necessary and sharpening on an oilstone. See Chisel; Firmer Chisel.

PARTITION INSULATOR. Name given to any form of insulator used for passing a wire through or making a connexion through a wall or some similar partition. Many of the well-known makes of lead-in tubes are partition insulators. See Lead-in Insulator.

PAXOLIN. Name of a well-known form of insulating material manufactured by the Micanite and Insulators Co., Ltd. It is made entirely of paper impregnated

with varnish. The chief constituent of the varnish is a substance made by a condensation of products of phenol and formaldehyde.

Paxolin is made in two qualities, Admiralty and standard. The dielectric strength of the Admiralty quality is 500 volts per mil approximately, depending upon the thickness of the sheet. The material is non-inflammable, is very tough,

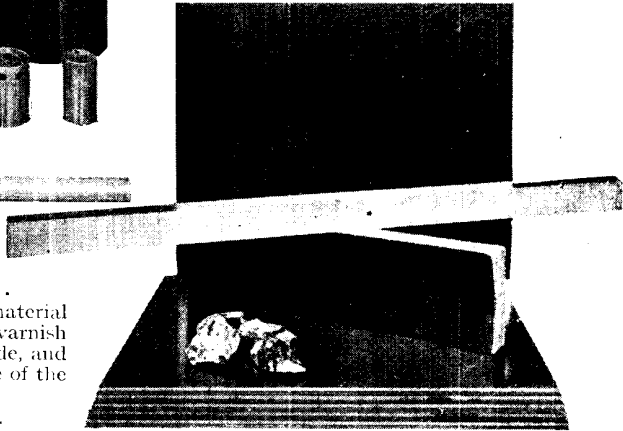

PAXOLIN ROD AND SHEET

Fig. 2. Rod and sheet paxolin is obtainable in all sizes and shapes. There are two qualities, Admiralty and standard

Courtesy Micanite and Insulators, Ltd.

and can be drilled, tapped, threaded, sawn, turned, planed, and will take a good polish. It is practically non-hygroscopic, and will not swell or lose its shape when exposed to dampness. It is made in the form of tubes, as shown in Fig. 1, of any size according to requirements, or in the form of rods and sheets (Fig. 2). Paxolin is also made in the form of washers, bobbins, disks, troughs and channels.

Standard sheets for the Admiralty quality are 23 in. by 40 in., with thicknesses varying from $\frac{1}{4}$ in. up to 1 $\frac{1}{2}$ in. Standard quality Paxolin may be obtained in the same sizes. This quality of the material is mechanically just as strong, but it is not quite so non-hygroscopic as the Admiralty quality. See Bakelite; Ebonite; Mica; Micanite.

Pb. This is the chemical symbol for lead, a contraction from the Latin name, plumbum, of the metal. See Lead.

P.D. This is the standard abbreviation for potential difference. See Electromotive Force; Potential.

PEDERSEN, P. O. Danish wireless authority. Born at Sig, near Varde, Jutland, June 10th, 1874, he was educated at the Royal Technical College, Copenhagen, 1892, and became chief engineer, 1899-1902, of Telegrafonen, Ltd., for exploiting the Poulsen arc system of wireless telegraphy. In 1912 he became professor at the Royal Technical College, Copenhagen, and was appointed a member of the International Electro-technical Commission.

Pedersen is on the board of many wireless companies, is a fellow of the Institute of Radio Engineers, president of the Danish Institute of Civil Engineers, 1922, and a fellow or member of many foreign scientific societies. In 1922 he was appointed technical adviser in wireless to the Department of Public Works.

Professor Pedersen is one of the leading wireless authorities in the world, and has written a large number of authoritative and standard works on wireless and contributed widely to scientific papers and journals on the subject.

PELTIER EFFECT. The passage of an electric current through a circuit composed of dissimilar metals gives rise to certain thermal phenomena at the junction of such metals, viz. the production of heat at one junction and its absorption at the other. Assume an electro-motive force to be applied to the ends of a thermopile constructed of bismuth and antimony (shown in part in the figure), so that a current is caused to flow in the direction indicated by the arrow heads.

In passing from bismuth to antimony the current will absorb heat, with a consequent cooling of the junction. The reverse will occur at the next junction, where the current will evolve heat and the junction will undergo a rise in temperature. The reversal of the current will cause a series of opposite effects, i.e. the latter will be cooled and the former heated.

This effect, which was discovered by Peltier and duly named after him, is the converse of the Seebeck effect, and it is

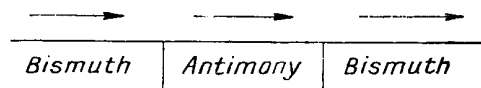

PELTIER THERMAL EFFECT

Peltier discovered that if a current is passed in the direction indicated by the arrows there is a heat change at the junction of the metals

to be noted that the applied current cools those junctions which, if heated, would cause a thermo-electric current to flow in the same direction, and vice versa.

The production of heat due to resistance is quite distinct from that which has its origin in the Peltier effect. The former occurs throughout the whole of the circuit, whereas in the latter case the evolution of heat is manifested only at the junction of dissimilar metals. Further, while the "joule effect" is proportional to the square of the current and independent of its direction, the Peltier effect is reversible, and varies directly with strength of the current. See Thermopile.

PERFORATED CELLULOID. Sheets of celluloid relatively thin and pierced with a great number of small holes. Corrugated sheets of this material are often used for the separators of accumulators. The purpose of the perforations is, to permit free circulation of the electrolyte; that of the corrugations to add to the virtual thickness of the separator. See Accumulator; Storage Battery.

PERIKON DETECTOR. Name given to a crystal rectifier which is a combination of the two crystals zincite and chalcopyrites. Occasionally the latter crystal is substituted by bornite or tellurium. The use of two minerals in combination requires a special type of detector. Fig. 1 is an excellent example of an early pattern two-cup detector. The lower cup is intended for the chalcopyrites, for these crystals are larger and much less expensive than zincite. Contact adjustment is effected by swinging the metal arm upon which the inverted cup is suspended, and by rotating the ebonite knob. Movement of the latter only affects the cup adjustment through the medium of a flat spring, so that this arrangement naturally tends to make the adjustment more stable.

Figs. 2 and 4 are illustrations of a high-grade perikon detector of modern design. It will be seen that it is much less cumbersome than its predecessor and, furthermore, the crystals themselves are entirely enclosed within a glass tube. The tension of the spiral spring shown inside the glass is variable by rotating a brass screwed sleeve which surrounds the operating rod. A noteworthy feature of this detector is the cups, which are in two parts, one being screwed over the other. This design, which is clearly shown in Fig. 2, allows good contact between the crystal

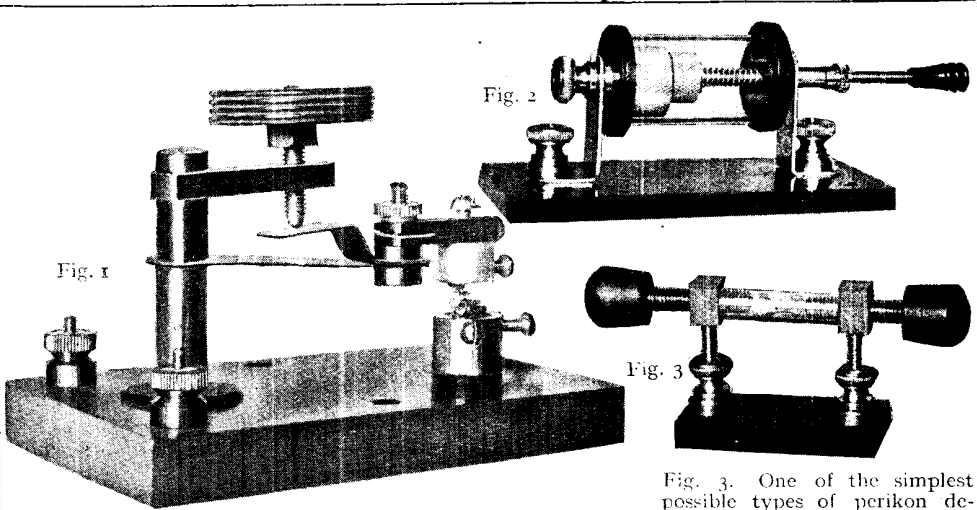

Fig. 1. Chalcopyrites is used as the crystal in the lower cup and zincite in the upper cup. Adjustment is made by the flat spring and knobs. Fig. 2. Perikon detector enclosed in a glass tube to keep the crystals free from dust. The contact is adjustable by a spring and the cups screw over one another

Fig. 1, Courtesy Economic Electric Co., Ltd., and Fig. 2, T. O. Buss

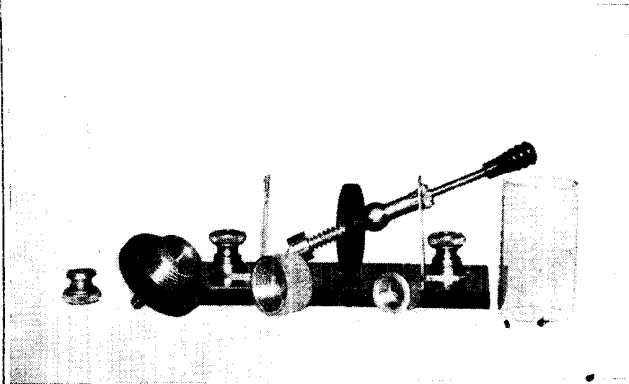

Fig. 4. Parts of the detector in Fig. 2 are disassembled to show the construction. Note how the cups screw over one another

Courtesy T. O. Buss

Fig. 3. One of the simplest possible types of perikon detector. It needs very little adjustment

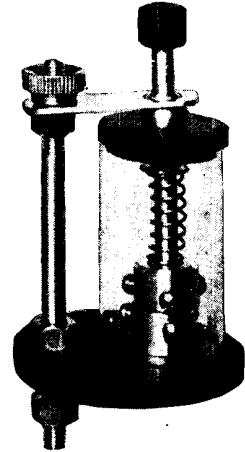

Fig. 5. Vertical type of perikon detector. The pressure between the two crystals is adjusted by a spring

Courtesy A. Bedford and Sons

EXAMPLES OF PERIKON CRYSTAL DETECTOR

and the brass to be made with a minimum of trouble, and without the aid of fusible metal.

Another pattern of perikon detector is shown in Fig. 3. This kind of detector is of the simplest possible construction, and while allowing practically no adjustment, it is stated that excellent results are obtained by its use. A vertical pattern is shown in Fig. 5 which is similar to Fig. 2. This is also of the glass-covered

type, adjustment being effected by movement of the rod at the top and the correct compression of the spiral spring.

How to Make a Perikon Detector. The construction of a perikon detector can be undertaken in several ways. One is illustrated and described. The experimenter should remember that the objects are to provide a firm support for the two crystals and some means for adjusting the pressure between the faces, with the addition of

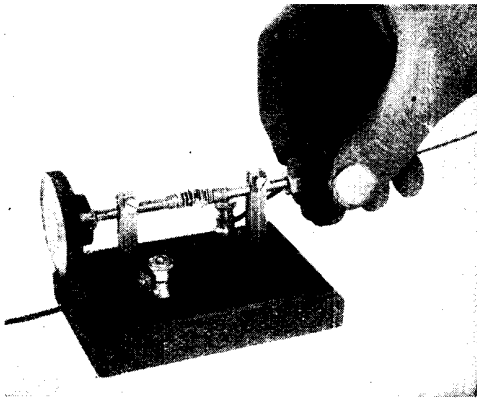

HOME-MADE PERIKON DETECTOR

Fig. 6. Two screwed rods are used for adjusting the crystals, which are held in wire springs

means for thoroughly searching the surfaces of both crystals. The type illustrated enables this to be done in a simple manner, as each crystal is held in an adjustable holder. The means for adjustment are shown clearly in Fig. 5, and comprise an ebonite knob at the end of each of the two screwed rods which, through the medium of wire springs, hold the two crystals.

The first step is to prepare a little ebonite base about 4 in. long and 2 in. wide. Drill holes in the corners for holding-down screws and well countersink them. Two other holes should be drilled for the two posts and two for the contact terminals, locating the former on the centre line and the latter one at each side of the base and opposite the posts. The holes for the latter should be about $\frac{1}{2}$ in. from each end. To give a neat and finished appearance the edges of the base should be bevelled. The next step is to cut two pieces of square rod $1\frac{1}{2}$ in. long and turn or file them true and flat at the ends. A small hole is then drilled and tapped in the lower part of each post and a screw provided for each. These screws have to pass through the base from beneath and hold the posts firm and upright, as shown in Fig. 7.

The upper part of each post is drilled and tapped for the screwed rod, which passes through the post at right angles to its length.

To hold the screwed rods when the best setting is found, small pinching or clamp screws are fitted to the upper part of the posts. The slot shown in Fig. 7 is then cut with a hack-saw, and the result is that when the screw is tightened

the slot is contracted and the spindle held firmly. Next, fit ebonite knobs to the two screwed spindles, which should be about 2 in. long, and erect both posts and spindles and test for alinement, making any adjustments necessary to bring the two spindles into line with each other. Remove the posts and the spindles and make two tapered brass wire springs. The smaller ends should fit on to the ends of the screwed spindles, and are simply screwed thereon and secured with a touch of solder, although this should not be necessary if the springs fit tightly and have to be screwed into place, as shown in Fig. 8.

The crystals have now to be fixed to the outer ends of the springs by placing them into the open ends thereof with the aid of a pair of tweezers, as shown in Fig. 9. If the spring be slightly untwisted by turning the crystal slightly the wire will make firm contact and hold the crystal quite firm. The parts are then assembled into their proper places and the two contact strips of thin copper fitted beneath the posts and connected to the two terminals by tightening the nuts in the usual way. The shape and proportions of these parts are clearly shown in Fig. 10. To complete the detector, the ebonite base is mounted on a small wooden base with chamfered edges and with recesses where necessary to clear the ends of the terminal nuts beneath the ebonite base. Adjustment of the crystal is effected by turning the two ebonite knobs, and also by a partial revolution of the wire springs on the spindle itself.

This brings fresh contact faces into engagement, and as the crystals can be moved around bodily in the spring clips it is possible thoroughly to search the whole of both and ascertain the two most sensitive spots.—*E. W. Hobbs.*

See Chalcopyrites; Crystal; Crystal Detector; Zincite.

PERIOD. Time required for one complete alternation of an alternating current or for one complete oscillation in a wave train. An alternating current is one which periodically changes direction in its circuit. It flows in one direction with varying strength, and then reverses and flows for an equal time in the opposite direction.

The time between the beginning of the current in one direction and its beginning again in the same direction is called a complete period or cycle. The number of complete periods per second is called the

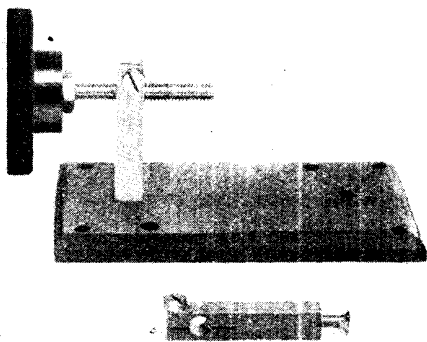

Fig. 7. One post is shown fixed to the base, the other detached, to reveal the slot and clamping screw

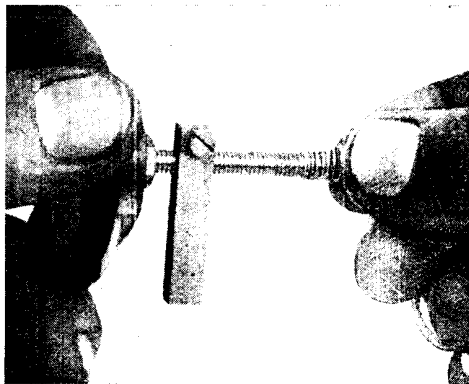

Fig. 8. Fixing the spring, which screws on to the rod, but may be held in position with a touch of solder



Fig. 9. Into the spring holder the crystal is fixed. A pair of tweezers should always be used when handling crystals. The spring grips the crystal

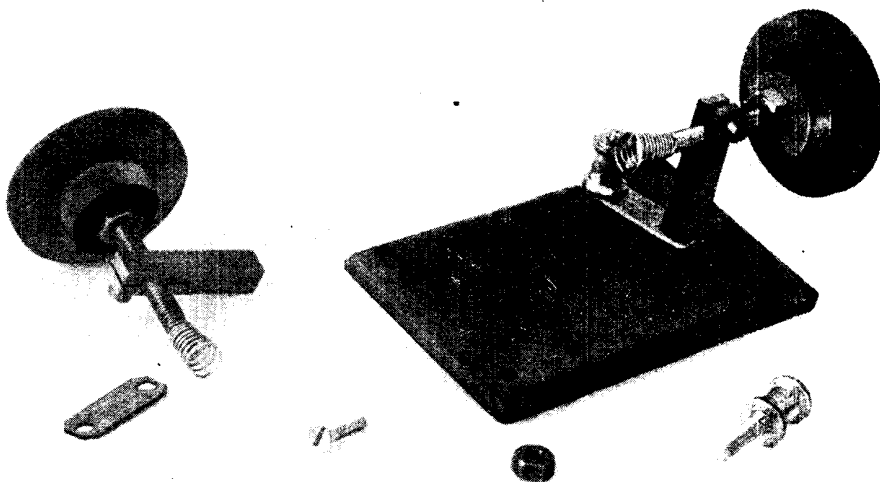

Fig. 10. Copper contact pieces and how they are used are shown in this photograph of the partly assembled home-made perikon detector

CONSTRUCTIONAL DETAILS OF THE HOME-MADE PERIKON DETECTOR



BAR MAGNETS AND MAGNETIC FIELD

Fig. 1. Permanent bar magnets should be placed with their north poles to south poles and keepers across the ends

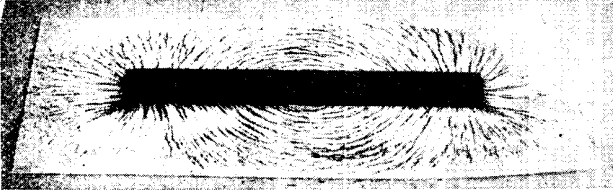

Fig. 2. This photograph shows clearly the magnetic field which surrounds a magnet. The field is indicated by iron filings

frequency of the current. See Alternating Current; Cycle; Frequency; Oscillation; Phase; Wave.

PERMANENT MAGNET. A steel bar, usually straight or horseshoe-shaped, which has been magnetized. Such a magnet is magnetized by contact with another permanent magnet or by being placed inside a coil of wire through which a strong electric current is passed. One usual way to magnetize a steel bar by contact is to draw one pole of the energizing magnet along it repeatedly from the centre to the end. The other half is then treated in a similar way with the other pole of the energizing magnet. Magnets of this kind lose their strength gradually with age. A horseshoe permanent magnet should have an iron keeper across its poles when it is not in use, and bar magnets should be arranged in pairs, north pole of one to the south of the next, and keepers across the ends (Fig. 1). The illustration, Fig. 2, shows a permanent bar magnet and the magnetic field which surrounds it. See Magnet; Magnetism.

PERMEABILITY, The ratio of the magnetic induction B to the magnetizing force H . It is the property of concentrating magnetic lines of force possessed by all magnetic substances. If an iron core is inserted in a solenoid it will be found that the flux will be increased to a very great extent, depending upon the quality of the iron and the extent to which it fills the magnetic circuit. This multiplying effect that the iron has on the flux is the permeability. Put in another way, it is the conducting or carrying power

the iron has for the lines of force, similar to the electrical conductivity of a conductor. See B.H. Curve; Flux; Magnetic Density; Magnetism.

PERMEANCE. The reciprocal of reluctance. Reluctance is a measure of the difficulty of forcing flux through a given path, while permeance is a measure of the ease with which it can be forced through. See Magnetism; Magneto-motive Force; Permeability; Reluctance.

PETERSEN, HERMOD.

Scandinavian wireless pioneer. Born in Christiania, 1875, he was educated at Bergen Technical College, and Polytechnic University, Karlsruhe. From 1900-13 he was chief of the telegraph schools in Norway, and carried out

the first Norwegian experiments in wireless telegraphy as early as 1901. He was appointed in 1906 a member of the first International Conference on Wireless Telegraphy at Berlin, and in 1913 was appointed chief of the Norwegian Wireless Department, and in control of all the Norwegian ship stations. Petersen is the author of a number of standard textbooks on wireless.

PEUKERT DISCHARGER. Name given to a form of spark gap invented by W. Peukert. Fig. 1 shows a section of this spark gap, in which oil is used as a dielectric instead of air. D_1 is a flat stationary metal disk set close to a similar disk, D_2 , which revolves at a speed of about 800 revolutions per minute. The space between the disks is about $\frac{1}{32}$ in., or about 1 mm., and the disks themselves are of silver-plated copper, brass, or steel. The disks are

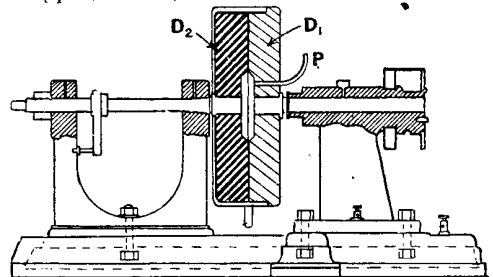

SECTIONAL DIAGRAM OF PEUKERT DISCHARGER

Fig. 1. Chief working parts of a Peukert discharger, a form of spark gap using two metal disks for electrodes. D_1 is a stationary disk, while D_2 revolves. Oil or alcohol fed through pipe P covers the faces of both disks

insulated from one another, and the disk, D_1 is pierced so that its surface can be kept flooded by oil through the pipe, P. The complete gap may alternatively be immersed in oil. The oil is flung outwards by the relative speed of the disks, and so forms a thin film of oil between them.

The gap is supplied with direct current of anything up to 900 volts, and the oil film between the disks is continually being pierced, and it shunted by a condenser in series with an inductance, the circuit sets up rapidly damped oscillations. Instead of oil, alcohol may be used, with more satisfactory results.

Fig. 2 shows the external appearance of the Peukert spark gap. Here it will be noticed the disks have been placed horizontally.

PHANTOM AERIAL. This is the name given to a substitute aerial for tuning a transmitting set. It consists of a condenser, resistance, and an inductance which can be varied to simulate the electrical characteristics of a real aerial.

PHASE. The phase of an alternating or oscillating electro-motive force or current at any moment denotes the stage or state of a complete cycle which has been reached at that moment. If two sine waves, which may be taken to represent

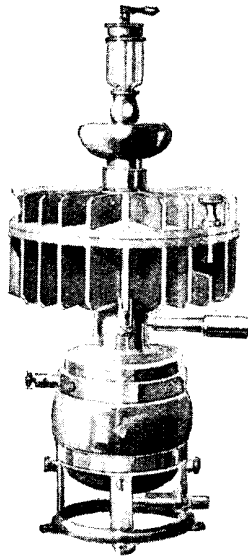

EXTERIOR OF PEUKERT DISCHARGER

Fig. 2. Disks of this Peukert discharger are placed horizontally

pressure or current, rise from zero, reach their maxima, and fall again to zero at identical moments, they are said to be in phase, but if they do not complete similar portions of their full time period at the same instant, they are out of phase.

The two quantities represented by the graphs in Fig. 1, although of different amplitude, are in phase; those in Fig. 2 are out of phase.

PHASE ANGLE. In the construction of a sine curve, reproduced here for reference,

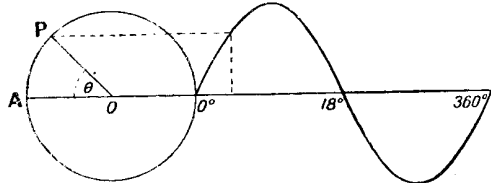

MEANING OF PHASE ANGLE

Represented graphically is the wave-form of an alternating current to show the meaning of the words phase angle

to represent graphically the wave-form of an alternating electro-motive force or current, a point P is assumed to revolve with uniform velocity round a circular path, centre o. The angle θ formed by the radius Po and the horizontal axis Ao is known as the angle of phase.

In view of the uniformity of the motion of P, the angle θ will vary directly with time, and at any constant is equal to $2\pi n t$ radians, where n = number of complete revolutions P makes per second (= frequency or periodicity) and t = time in seconds during which the motion has been occurring. See Alternating Current; Frequency; Oscillations; Sine Curve.

PHASE DIFFERENCE. In the accompanying diagram, Fig. 1, it can be seen that the two quantities represented by the curves, although of the same frequency, do not rise and fall in unison.

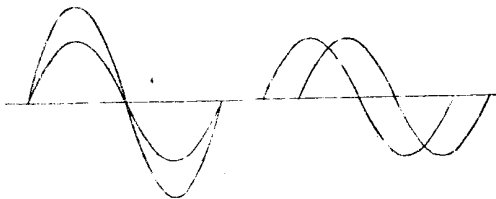

CURRENT IN PHASE AND OUT OF PHASE

Fig. 1 (left). Two alternating currents are represented in phase. Fig. 2 (right). Here two alternating currents are shown out of phase

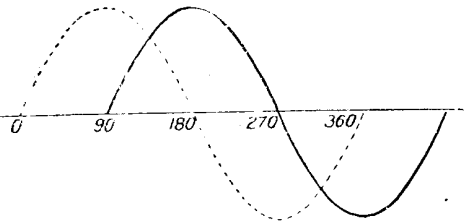

PHASE DIFFERENCE

Fig. 1. How one curve lags behind the other. The dotted curve rises to a maximum when the full line curve is a minimum, and vice versa

Starting from the left-hand side of the horizontal axis of time, the dotted line rises from zero value and reaches a maximum in advance of the full line curve, and similarly passes through every part of the cycle ahead of the other. It may be said, therefore, to lead the other in phase, or conversely, the full line lags behind the dotted curve. In other words, a difference of phase exists between the two.

The graphical representation of a cycle of alternating electro-motive force or current by a sinusoidal curve permits phase differences to be measured in degrees, as set out along the time basis, taking 360° to represent a complete period.

The dotted line has a phase such that it reaches a maximum positive value at a

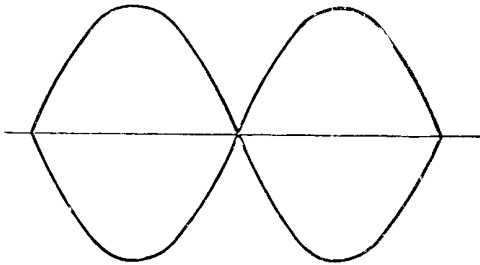

CURVES IN ANTIPHASE

Fig. 2. How two curves rise and fall together, but in an opposite sense, is shown. One is at a positive maximum and the other is at a negative maximum. These curves are said to be in antiphase

time represented by 90°, and the full line a phase such that it reaches a similar position at a time represented by 180°. The phase difference is therefore 90°, and the quantities indicated by the curves are in quadrature. If two curves rise and fall together, but in the opposite sense, they are said to be in antiphase. Such a state is represented in Fig. 2.

In comparing the phases of wave-forms it is not necessary to choose the maximum positions, as above. This is usually the most convenient, but any other point serves equally well.

A most important application of the angle of phase difference occurs in reckoning the true power in an alternating current circuit. In this case one curve is taken to represent electro-motive force, and the other the current to it. The true power in watts is given by the formula

$$W = EC \cos \theta,$$

where W = watts ; E = virtual volts ; C = virtual amperes ; θ = angle of lag or lead.

The highest value to which the cosine of the angle can rise is unity, given by an angle of 0°, the value decreasing to zero when the angle reaches 90°. From this it is clear that the smaller the angle of lag or lead the greater the actual power in the circuit. If the phase difference assumes large proportions the current is almost wattless.

The reason for the existence of phase differences in such a circuit lies in the presence of inductance and capacity ; the effect of the former is to cause the current to lag behind the electro-motive force by an angle which may reach, but can never exceed 90°, while capacity causes the current to lead the electro-motive force in phase. See Alternating Current ; Oscillation ; Wave.

PHASE SWINGING. This is the term used for the getting out of step of synchronous generators or motors, due to momentary fluctuations of pressure, produced by uneven running of machines. The term hunting is also used for phase swinging.

PHILLIPS, RAYMOND. British wireless expert. Born October 6th, 1879, he was educated at Edgbaston, Birmingham, Schorne College, Buckinghamshire, and Windsor High School. For three years he was engaged on railway construction and repair with special application to electric railways. In 1902 he invented a system of automatic train control and a



MAJOR RAYMOND PHILLIPS

This British wireless expert is a specialist in wireless control from a distance, particularly of airships. He has contributed the article on Control by Wireless to this Encyclopedia

number of appliances for electric railways and tramways which were widely adopted.

In 1905 he took up the study of wireless, and specialized in the control of mechanism at a distance by wireless. In 1910 he patented a system for controlling airships by wireless, and by means of a working model demonstrated how an airship could be controlled. The following year Phillips brought out his system of direct selection for the wireless control of musical instruments. During the Great War Phillips was an inspector of ordnance machinery, and in 1921 was appointed a member of the Inter-Allied Commission of Control in Germany. He is the author of many articles on wireless control, and has written *Control of Machines by Wireless Waves* for this Encyclopedia.

'PHONE. This is a common abbreviation for headphone and also for telephone. See Headphone; Telephone.

PHOSPHOR-BRONZE. Name given to an alloy consisting essentially of copper, tin and phosphorus, and also containing small quantities of iron, zinc and lead. Generally, it is composed of about 80 to 90 per cent of copper, about 6 per cent of tin, about .03 per cent of phosphorus, with small quantities of iron, lead and zinc.

Phosphor-bronze is used extensively for lining shaft bearings. It is also em-

ployed, particularly in wireless work, in the form of stranded wire for transmitting and receiving aeriels. Another form of aerial comprises a flat strip of phosphor-bronze about $\frac{1}{2}$ in. in breadth and about $\frac{1}{4}$ in. in thickness, a form which combines strength with good surface area.

Another extensive and practical use for phosphor-bronze in wireless work is in the form of contact blades for the moving arms of many forms of switch. Comparatively thin phosphor-bronze wire is excellent for springs, especially when these are required to be non-magnetic.

Phosphor-bronze can be turned and filed in much the same way as steel.

PHOSPHORUS. One of the non-metallic chemical elements. Its chemical symbol is P and its atomic weight 30.77. It does not occur free in nature, and is chiefly valuable for its many compounds. Perfectly pure phosphorus is white and has the solidity of wax. It is usually yellow in colour, however, owing to the presence of impurities. The element is a non-conductor of electricity, and is usually made in sticks, kept in glass-stoppered bottles under water.

Phosphorus enters into the composition of many metallic alloys, and is nearly always present in commercial iron and steel. Its most important alloy is phosphor-bronze.

PHOTOGRAPHY BY WIRELESS, OR RADIO-PHOTOGRAPHY

By E. E. Fournier d'Albe, D.Sc.

Here are described the methods by which photographs or other pictures can be transmitted by wireless telegraphy or telephony, as well as by the ordinary telegraph line or cable. The author, who has himself carried out much original work on the problems involved, gives an historical account of the subject, as well as details of the latest processes. See related headings, as Selenium; Television

The transmission of photographs by wireless telegraphy or telephony has been accomplished by several experimental methods, though up to the time of writing none of them is in regular use.

The difficulty of telegraphing a picture, as compared with a printed message, is due to the fact that it consists of a much greater number of elements. A square inch filled with small print contains at the most about 1,000 letters, and as it takes from one to four Morse signals to telegraph each letter, we must allow for 4,000 signals per square inch. A square inch of a picture, on the other hand, cannot be divided up into less than 100,000 patches, each of uniform density, if it is to retain its clearness and detail. In order to

indicate the density of each patch we require a scale of at least six gradations, but as these can be indicated by simple combinations of the Morse dot and dash, we need only allow two signals for each patch, so that the total number to be telegraphed is 200,000 per square inch of picture. It is, therefore, fifty times more difficult to transmit a picture than it is to transmit a printed message covering the same area, and it takes fifty times as long.

The whole field of vision of the human eye consists of about 100 million points of light, each representing a nerve-ending of the retina. The field of "distinct" vision consists of some 10,000 points, corresponding to as many nerve endings on the "yellow spot," the most sensitive

portion of the retina. All images of objects we see consist, therefore, of separate points or patches, but they are so small and so close together as to give the impression of a uniform or graduated surface.

The moon as seen with the naked eye (Fig. 1) consists of not more than 600 such patches, and if the figure is held at such a distance from the eye as just to cover the moon (20 feet), the amount of detail seen is exactly the same as in the moon itself. The actual size of the moon's image on the retina is only one-fiftieth of an inch, but it covers 700 nerve-elements of the retina. The moon's image as seen by the naked eye could therefore be completely telegraphed by transmitting 700 signals representing the density of as many patches, and ensuring that they would be arranged in the proper order.

Any other picture can be treated in the same way, but several different methods may be used for estimating or gauging the depths of the elements at the transmitting station, and for reproducing and correctly assembling the elements at the receiving station. Three of these methods will now be described.

Synchronized Line Method. We may consider the ideal picture as having 300 patches to the inch, or 90,000 to the square inch. It is not considered necessary, as a rule, to transmit all these individually, since a recognizable picture

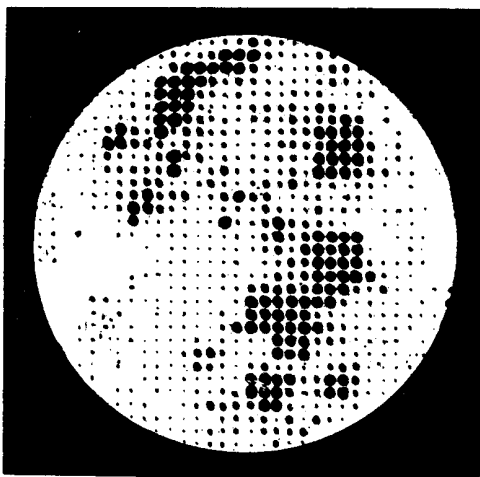

HOW AN IMAGE MAY BE BROKEN UP

Fig. 1. If this diagram is looked at from a distance of 20 ft. it will be found to represent the moon as seen by the naked eye. Thus it is seen that such an image can be broken up into separate patches

can be obtained with a much smaller number of elements. An ideal line picture would consist of 300 parallel lines one inch long, ruled close together so as just to fill up the square inch, and each line varying in depth according to the density of the 300 patches it represents. If, instead of this, there are only 75 lines to the inch, each line will pass over four patches abreast, and its depth will represent the average density of four contiguous patches at any given point. This amount of definition suffices for many practical purposes. A portrait so transmitted in 1907 is shown in Fig. 2.

The parallel lines are usually produced by means of a close spiral on a cylindrical surface. The first practical realization of the transmission of designs and handwriting was achieved by Caselli (1856), whose pantelegraph or "telewriter" contained a cylinder covered with tinfoil, on which the message or design was written with insulating ink. A contact-pin traced a fine screw line on the cylinder as it revolved. The contact was broken wherever the pin passed over the ink, and the "makes" and breaks of the current were transmitted over the telegraph line to a similar cylinder revolving in synchronism with the sending cylinder, the design being reproduced by electro-chemical action.

When the sensitiveness of selenium to the action of light was discovered (Willoughby Smith, 1873), many proposals were made to utilize it for the purpose of telephotography. Senlecq (1878) proposed to substitute a plate consisting of a large number of small selenium cells for Caselli's tinfoil, and to transmit each point of a picture by a separate wire (see Television). Perosino (1879) proposed to use a single selenium cell exposed in succession to various parts of the photograph, and to reproduce it by chemical action on a synchronous cylinder at the receiving station, connexion being by a single wire. After numerous other attempts, the first practical solution of the problem of phototelegraphy was attained by A. Korn in 1904, who transmitted a photograph from Munich over a distance of 500 miles, using selenium at the transmitting station.

He wound the negative on a glass cylinder. A strong, narrow beam of light fell upon the point of the negative, passed through the glass, and was then reflected upon a prism in a direction parallel to the

axis of the cylinder, falling finally upon a single selenium cell placed at the end of the cylinder. The brighter and darker portions of the negative transmitted the light to a greater or lesser extent, and the current transmitted by the selenium along the telegraph line varied accordingly. At the receiving station the current was sent through a vacuum tube, which became brighter or darker with the changes of the current. These variations in brightness were recorded on another cylinder covered with photographic paper, and revolving in synchronism with the first cylinder.

After some further experiments, Korn in 1907 transmitted the portrait of King Edward VII from Paris to London (Fig. 2). In this case reception was made by a "light relay" consisting of a small aluminium shutter attached to two parallel wires traversing a strong magnetic field, on the principle of the oscillograph of Blondel or Duddell, who, however, used mirrors instead of shutters. A somewhat similar method was used by Thorne Baker in England for the transmission of press photographs.

A different method of transmission, which avoids certain troubles inherent in the use of selenium, is based upon the property of bichromated gelatine of becoming insoluble under a strong illumination. This method, originally proposed by Mr. Campbell Swinton, has been developed with considerable success, particularly by M. Edouard Belin, of La Malmaison, Paris. He exposes a film of bichromated gelatine under the negative to be transmitted and then moistens it, whereupon the unexposed portions of the gelatine swell up, while the gelatine under the white portions of the negative does not.

The picture, thus obtained in relief, is wound on a cylinder, and a soft style is made to trace a screw-line on it as before. The style actuates a microphone, whose resistance is increased and diminished in accordance with the rise and fall of the relief. The microphone is put in circuit with an alternating current produced by an electrically driven tuning-fork, and the rising and falling current thus produced is transmitted over a telephone line. At the receiving station the current passes through an oscillograph, and a beam from a small gas-filled lamp is reflected from the mirror of the latter, and records the picture on a synchronized cylinder. The difficulties of synchronism are overcome

by stopping the receiving cylinder at every revolution until the transmitting cylinder starts on the next revolution.

Several attempts have been made to apply the various line methods to the wireless transmission of pictures, but no great success has yet been achieved in that direction, largely on account of the difficulties of synchronization, in which an error of even a thousandth of a second is fatal to definition. Belin has lately used



PORTRAIT TELEGRAPHED BY KORN'S METHOD

Fig. 2 This portrait of King Edward VII was telegraphed from Paris to London in 1907 by Korn's line method, using selenium cells

a method of synchronizing by means of chronometers timed by wireless signals, which eliminates some of the difficulties.

Code Method. An alternative method is to reduce a picture to a code before transmitting it as a more or less ordinary telegram. This method requires no synchronization, and is therefore much simpler as regards mechanism. The principle is as follows: The picture to be transmitted is divided up into a large number of patches—approaching the "ideal" number as closely as circumstances permit—and to every patch is assigned a letter indicating its density or depth of shading. These letters are arranged in lines, each of

which represents a narrow strip of the picture. The lines of code letters are then telegraphed in the ordinary way, either by land-line, cable or wireless telegraphy. At the receiving station the code letters are used to reproduce the picture by producing, photographically or otherwise, an array of patches in the order and density indicated by the code.

This was the method used by the writer for the first experiment in broadcasting a picture, made at the London station of the British Broadcasting Company on Empire Day, May 24th, 1923. A photograph of the King was chosen as a suitable subject for the day, and as transmission had to be done by wireless telephony, and the time was limited to fifteen minutes, the number of code letters had to be reduced to a minimum. It was reduced to 30 lines of 20 letters each. The photograph was accordingly divided up into 600 patches, and their average density was indicated by a scale of seven letters or symbols chosen for their unmistakable sound when spoken.

A perfectly white or blank patch was indicated by the vowel O, a light shade by a full-stop, dictated as "stop," and the other densities in order of darkness by the letters X, I, J, G, and M respectively, of which X was supposed to represent a note of exclamation. Since the vowel sounds of all these letters are different, they could hardly be mistaken for each other. The complete code of the picture was the following:—

```

1 . . . . . GJJJJJG
2 . . . . . GMGJXGJJG . .
3 . . . . . GMMIIGGGJJG .
4 . . . . . G.OOOOOO.MM .
5 . . . . . GG.OO.OO.OO.MJ .
6 . . . . . MG.OOO.OO.OO.GJ .
7 . . . . . MG.OOO.OO.OO.JJ .
8 . . . . . GJIO.XJG.OIJJ .
9 . . . . . MIJM.GJX.IGJX .
10 . . . . . MG.M.GIXX.IGJX .
11 . . . . . GGG.O.O.OJGGI .
12 . . . . . JIGG.O.IJJJ .
13 . . . . . GJMJI.XO.XGJO .
14 . . . . . GMMXMMGI.JG .
15 . . . . . GMGMMMGG.IIG .
16 . . . . . IGMGJMGM.I.XO .
17 . . . . . GMJGGJJIX .
18 . . . . . MMIIX.XXXJ .
19 . . . . . IMXXXIJJJJ .
20 . . . . . MGJIGMJJJJ .
21 . . . . . MMXMJIJJGM .
22 . . . . . MMG.MJ.IJGGG.X
23 . . . . . MMMMMM.MMM.MM .
24 . . . . . GMMMMMMGM.MMX .
25 . . . . . GMMMMMMGM.MGJI .
26 . . . . . GGIGMMGG.XIMJ.GGJI.J
27 . . . . . MJIMMMJJ.GMGGIGGJJG
28 . . . . . GIGMMMMJJIGGGIGGJJG
29 . . . . . JIGMMMMJXIGGGJJGJJG
30 . . . . . IJMMMMMIJJGIIIGGGG
    
```

As the beginning of each line was announced to the listeners, and the letters were dictated in groups of fives, mistakes

could hardly be made. As a matter of fact, some 250 correct reproductions, mostly made by juvenile listeners in various parts of England, were sent in to the B.B.C. One of these is given in Fig. 3. It was made by placing dots of different sizes in rows on squared paper in accordance with the code, M being represented by the largest dot.

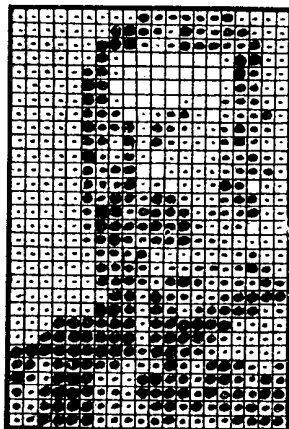

BROADCASTED PORTRAIT

Fig. 3. This portrait of King George V was obtained by wireless telephony from the London station in 1923 by use of the code shown in the adjacent column

The result was very coarse-grained, owing to the small number of elements into which the picture was divided. But that is only a matter of how much time is available for transmission.

A code was employed by Mr. Sanger-Shepherd in 1919 for transmitting a picture of the yacht race for the America Cup. The picture

was coded automatically by means of selenium, which worked six punches. According to the density of the patch being transmitted, from one to six punches perforated a tape simultaneously, and the tape was then used on the tape transmitter of a Transatlantic cable.

As each signal counted as a word, the transmission was very costly, but the result was perfect. At the receiving station a beam of light was passed through the perforated tape in such a manner that the light from all six perforations was concentrated on one point of the film on the receiving cylinder. The photographic density was thus governed by the number of holes perforated simultaneously in the transmitting tape, and the original was reproduced as a negative.

The advantage of the code method is that it can be transmitted with equal ease by ordinary and by wireless telegraphy.

By a somewhat similar method the portraits shown in Fig. 4 were transmitted by ordinary telegraph instruments in precisely the same way as ordinary messages.

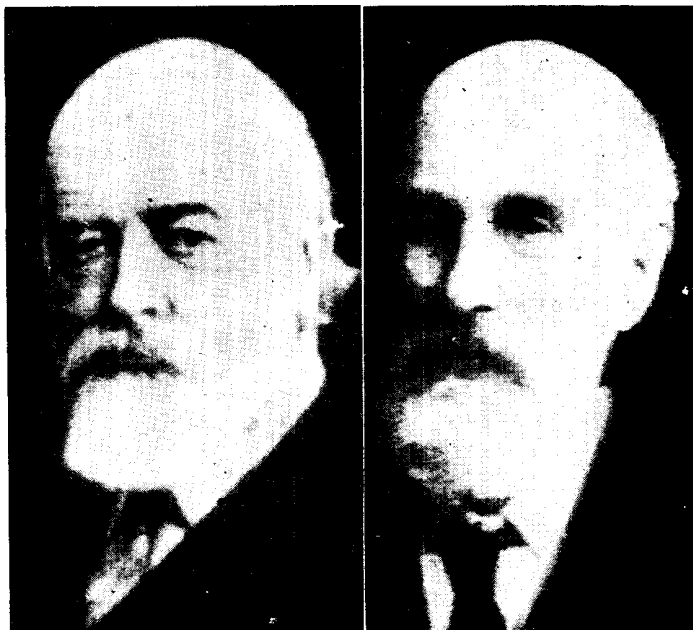

PHOTOGRAPHS SENT OVER TELEGRAPH LINES

Fig. 4. This portrait of Sir Oliver Lodge was telegraphed to Halifax, Nova Scotia, and that of Sir William Barrett (on the right) to Berlin by means of ordinary perforated telegraph tape on standard instruments. The tape was prepared by a perforator in circuit with a rotating cylinder on which were fixed five prints of the portrait being telegraphed

Perforated telegraph tape was prepared from a series of five photographs of the portrait, each photograph being of different density. The five films were coated on flexible metal plates, which were mounted on a cylinder with contact points in similar positions against the faces of the prints. As the cylinder revolved the contacts made electrical connexion except where the photographic film in the fully exposed portions acted as an insulator. The cylinder was in circuit with a tape perforator. At the receiving end the tape was passed through a machine in which light, passing through the holes in the tape, affected a photographic film and so reproduced with considerable accuracy the original picture.

Resonance Method. A third method has recently been devised by the writer. It consists in transmitting a narrow pencil of intermittent light through a transparent replica of the picture to be transmitted, and allowing the transmitted light to fall upon selenium. The selenium, in circuit with a battery and loud-speaking telephone, converts the luminous vibrations into sound vibrations of the same fre-

quency, say 800 per second. This gives a musical note which can be transmitted by ordinary wireless telephony, and received in a loud speaker at any receiving station. The loudness of the note will vary with the transparency of the portion of the picture traversed, so that loudness will represent light, and silence will represent blackness.

At the receiving station the sound is made to act upon an acoustic resonator, which produces a small patch of light of an intensity proportional to the loudness of the sound. This patch of light is photographed, and represents a patch of the original picture. In this way the whole picture may be transmitted in the time re-

quired for the transmission of a single line.

PHOTOPHONE. Instrument for using light waves as carrier waves for telegraph or telephone signals.

There are two principal methods of imposing the voice modulations on the light wave. The first is to modulate the source of the light waves. This might be accomplished by striking an arc between carbon electrodes, the apparatus being so arranged that the arc burns in a powerful magnetic field. If this magnetic field is caused to vary in accordance with the speech variations, then the arc also will vary in accordance with these, but the modulation will not be deep. The speech will only produce a shallow ripple on the top of the light waves. This is not an ideal condition, for just as in radio-telephony, so in photo-telephony it is desirable to modulate almost to the maximum.

The second method is to place some sort of valve between the source of the light and the distant receiver. This valve would be placed near the transmitter, arranged to open and close in accordance with the speech modulation, letting a variable amount of light pass to the receiver.

In 1889 Graham Bell disclosed in a patent specification a method for modulating the light beam after it had left the source. In this specification he described the grids, each consisting of equal parallel strips which were alternatively transparent and opaque. These two grids were arranged one behind the other. One grid was fixed, whilst the other was free to move up and down. Thus in one position the opaque strips fall into line, leaving a free passage for the light beam between them; in the second case the movable grid having been moved, so that its opaque bars fall on top of the spaces in the fixed grid, the light would be cut off.

Bell proposed to attach the movable grid to a diaphragm, which when spoken on to would deflect and cause the movable grid to slide over the fixed one. The difficulty of constructing a movable grid which was light enough to be moved by the microscopic deflections of the diaphragm prevented the device being used.

A second device of the same author consists of a polished curved diaphragm, which serves the purpose of a reflector. If light is falling on to the surface of this reflector it will be reflected as a beam. When sound waves strike the reflector they will be deformed, with the result that the reflected beam will have a variable divergence. If, therefore, a receiver is situated at a distance, and is so arranged that it receives only a portion of the shady beam, it will be seen that the amount of light falling on this receiver will vary in accordance with the bending of the reflector at the transmitter.

In 1916 Dr. Rankin investigated means of controlling the intensity of a beam of light by means of human speech. He succeeded in producing a practical and reliable means of transmitting speech by light, over a distance of 1½ miles.

Realizing that the inertia of a physical grid precluded its commercial application, Rankin decided to use the image of the grid instead of the actual grid.

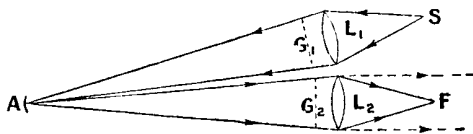

PHOTOPHONE BEAM MODULATION

Fig. 1. S is a source of light, and its beam traverses a lens, L₁, and grid, G₁, and is reflected from a mirror, A, through grid G₂ and lens L₂, to F

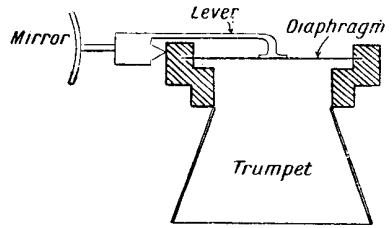

PHOTOPHONE MIRROR AND DIAPHRAGM

Fig. 2. How the mirror A in Fig. 1 is attached to the diaphragm needle actuated by sound waves

As the image of the grid could be made large or small at will by suitable optical arrangements, it was unnecessary to construct diminutive grids. Further, it was possible to fix both grids, and only to move the image of one of them.

The method of doing this will be better understood by reference to Fig. 1.

Here A is a small curved galvanometer mirror, about one centimetre in diameter, which may be so attached to the diaphragm that it is caused to oscillate about an axis perpendicular to the plane of the paper.

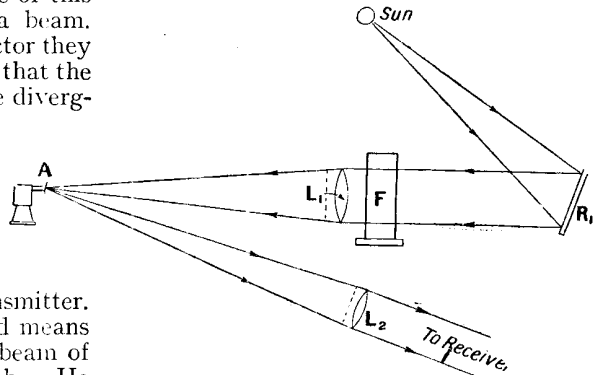

SENDING SOUND BY SUNBEAMS

Fig. 3. Sound may be transmitted by wireless waves sent along a beam of sunlight by this method. The rays of the sun are passed through a water filter, F, to reduce heat radiation

S is the source of light.

L₁ is the first lens.

G₁ is a physical grid consisting of alternate opaque and transparent strips, mounted perpendicular to the plane of the diagram.

G₂ is a second grid, having the same dimensions as G₁.

The distance AG₁ is equal to AG₂.

Now the lenses are so arranged that L₁ forms an image of the source of light

S on the mirror A, therefore the curvature of A will not affect the divergence of the beam of light from it, but it ensures that all the light passing through any point of G_1 falls on a corresponding point of G_2 . It is clear, therefore, that for one angular position of A the image of the grid G_1 will fall exactly on the top of the actual grid G_2 , so that there will be clear strips for the light to pass through, whilst for another angular position of A the image of G_1 will fall exactly between the bars of G_2 . In this case no light at all will pass through L_2 .

These are the two extreme cases; any slight movement of A between these two extremes will cause a modulation of the light beam.

The voice may be made to move the mirror A in many ways, but Dr. Rankin has found that the most direct method was the most satisfactory. He found that a good quality gramophone sound box gave good results. The mirror was attached in place of the needle, as shown in Fig. 2.

The diaphragm was of mica, whilst a short trumpet or mouthpiece was added behind the diaphragm.

When speech vibrations fall on the diaphragm it is caused to vibrate. This movement is communicated, by means of the lever, to the mirror, which is caused to move through a very small angle.

Small though this angle is, it is sufficient, provided the distances AG_1 and AG_2 (Fig. 1) are great enough to move the image of G_1 across the grid G_2 , and thus to control the outgoing light waves, which by correctly adjusting the position of L_2 may be formed into a parallel beam suitable for long-distance working.

Before leaving the transmitter it should be mentioned that it is not necessary to use an artificial source of light, as in Fig. 1. This may be replaced by the sun, provided that the sun's rays are passed through a

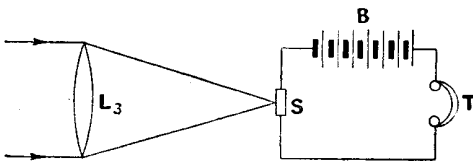

PHOTOPHONE RECEIVER

Fig. 4. From the transmitter in Fig. 3 the beam of light is received on a selenium cell S. Selenium is sensitive to changes of light, and the current through the telephones is varied as the light varies

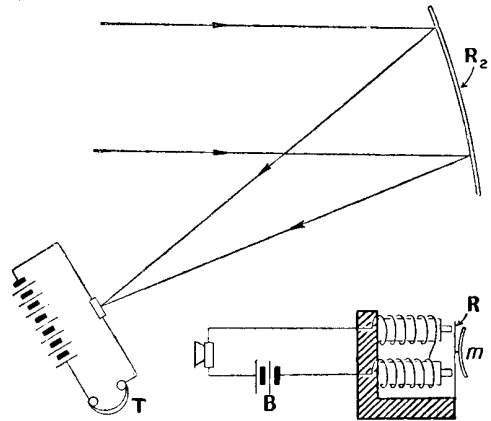

PHOTOPHONE REFLECTOR AND MICROPHONE

Fig. 5 (left). Instead of the lens in Fig. 4 a large reflector may be used, being less costly. Fig. 6 (right). This diagram shows how a microphone may be used instead of the sound box to vibrate the mirror

water filter, as shown in Fig. 3, to remove most of the thermal radiation.

With this arrangement a plane mirror R_1 is arranged to reflect the light from the sun through the thermal filter F, thence through the lens L_1 , which focusses an image of the sun on the mirror A, which is attached to the transmitter. The parallel beam of light is transmitted to the distant receiver (Fig. 4), which may be situated a mile or more away.

The receiver consists of a large lens L_3 , Fig. 4, which brings the beam of light to a focus on to the selenium cell S. In practice it has been found best to have the cell slightly in front of the focal point. In series with the cell is a battery and a pair of telephones. The fluctuations of intensity of the light falling on the selenium cell will cause it to vary in resistance, with the result that a variable current will flow from the battery B through the telephones T. This current will vary in accordance with the speech modulations, so that the telephones will reproduce the sounds falling on the transmitter.

Reverting again to Fig. 4, it will be seen that the lens L_3 has to focus the light beam on to the selenium cell S. In practice the beam of light will not be truly parallel: it will be slightly divergent, therefore the lens L_3 (Fig. 4) should be far larger than L_2 (Fig. 3) if it is to catch all the light which passes through L_2 . Actually it will not be practicable to have the L_3 very large, as the cost would be very high. As

the size of this lens will affect the sensitiveness of the receiver, it should be as large as possible, or may be replaced by a reflector R_2 , which is more economical than a large-sized lens (see Fig. 5).

The sun reflector (Fig. 3, R_1) is a plane mirror, 9 in. in diameter. Each of the lenses, L_1 and L_2 (Fig. 3), has a focal length of about 3 ft., whilst they have apertures of about $5\frac{1}{2}$ in. These apertures are covered by the grids, which are made so that they have alternate grids of opaque and transparent material, each .1 in. in width. The radius of curvature of the mirror A is also about 3 ft. When using a collecting lens, L_3 (Fig. 4), of only 7 in. diameter, and a Pointolite lamp for the source, Dr. Rankin found he could transmit speech over half a mile. With an arc lamp in place of the Pointolite the distance was considerably increased, whilst the sun multiplied the distance many times, to several miles.

There are many alternative arrangements of this method of transmitting speech, but only one is given here.

In place of the gramophone sound-box an ordinary microphone may be employed, which is connected either directly or through an amplifier to the magnetic system shown in Fig. 6. The modulated current passing from the microphone through the coils will cause the reed R to bend, thus deflecting the mirror M. This arrangement will be found more convenient, as it enables connexion to be made with ordinary telephone lines.

Lastly, the range may be increased by using amplification at the receiving end. At present only a small degree of amplification can be employed, as the selenium cell produces noises which with amplification are serious, although without amplification they are almost inaudible.

Dr. Rankin gives a circuit for the receiver (Fig. 7) which provides for the addition of an ordinary low-frequency amplifier, such as is used in radio-telegraphy.—*R. H. White.*

See Photography by Wireless; Selenium; Television.

PICKARD, GREENLEAF WHITTIER.

American wireless inventor. Born at Portland, Maine, February 14th, 1877, he was educated at Westbrook Seminary, Lawrence Scientific School, Harvard, and the Massachusetts Institute of Technology. He took up the study of wireless from the beginning, and invented a new crystal detector and a radio compass. From 1902-6 he was on the engineering staff of the American Telephone and Telegraph Company, and in 1902 brought out a system of wireless transmission. He was the inventor of the method used by the American navy during the Great War for reducing static interference. Pickard is a fellow of the American Institute of Electrical Engineers, past president and fellow of the Institute of Radio Engineers, and the author of many papers on wireless.

PIEZO ELECTRICITY. Name given to a branch of electricity which is concerned with the electrical charges exhibited by certain substances when subjected to stresses. The effect of pressure was discovered by F. and P. Curie in 1880. Curie found that a piece of quartz suddenly subjected to a stress, as a tension or a compression, developed an electric charge upon its surface.

This property is possessed by a large number of crystals, as quartz, tourmaline, Rochelle salt, silicate of zinc, etc. Rochelle salt has been found to exhibit the phenomenon to the greatest extent, and many experiments have been carried out with Rochelle salt crystals. On July 12th, 1923, the Western Electric Company, at the Institute of Civil Engineers, demonstrated some of the effects of pressure on Rochelle salt crystals with a view to their utilization in wireless.

If a crystal of Rochelle salt is fitted with suitable contacts on its opposite sides, say of tinfoil, and a diaphragm is attached to one end of the crystal, then when an alternating current is passed through the crystal the diaphragm vibrates. This is because the crystal alternately lengthens and contracts a small amount due to the alternation of current. The crystal exhibits a charge of electricity if stretched or compressed, and, conversely, if an alternating E.M.F. is passed through it, it contracts or expands, so vibrating the diaphragm. The arrangement may thus be made to act as a telephone receiver, and, in fact, sound has been reproduced in this way with remarkable purity.

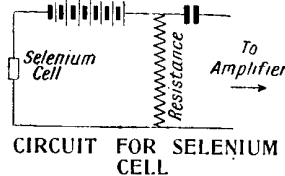

Fig. 7. An amplifier may be used by employing this circuit for the selenium cell of the photophone

In the experiment of the Western Electric Company a Rochelle salt crystal was fixed to a gramophone needle, so that the vibrations of the latter stressed the crystal and induced electric charges on it. The resultant current was amplified by a valve amplifier and gave remarkably clear results. This experiment showed that the crystal could be used for transmitting purposes.

The study of piezo crystals for wireless purposes is still in its infancy, but the possibilities opened up by their peculiar property has concentrated a great deal of attention on the subject.

Similar experiments to those of the Western Electric Company have been carried out by various observers, and F. E. Smith, F.R.S., points out that the gramophone experiment may be applied in such a way that hundreds of telephone receivers may be operated by it.

PILE WINDING. This is another name for bank winding, and is so called because the wires forming the winding are piled up in successive turns on top of the previous turns of the coil. *See* Bank-wound Coil; Lap Wound.

PILOT LAMP. A lamp connected permanently in a circuit to denote the presence of current in that circuit. Such a lamp is of great use in certain branches of electrical work. For instance, in accumulator charging, the presence of a lamp in the circuit would enable the operator to tell at a distance whether all was well or not, for not only would the mere glowing of the lamp indicate that current was present, but its brilliancy would give a rough idea of the voltage of the generating plant.

Wireless receivers and transmitters are sometimes fitted with a pilot lamp, to indicate whether filament or untransformed high-tension supply is present. This is particularly useful where the valves are concealed within the receiver.

PITCH. In mechanics the pitch of a screw thread is the distance from the centre of one thread to the centre of the next measured along the line parallel to the axis of the screw. It is also the distance in inches or millimetres measured along a line parallel to the axis of the screw between the point where it cuts any thread of the screw and the point at which it next meets the corresponding part of the next thread. The reciprocal of the pitch measures the number of turns

per inch or millimetre. *See* Lathe; Screw; Thread.

PITCH. Name given to a black, soft to hard substance which is one of the products of coal tar, or one of the mixtures of hydrocarbons which remain after the distillation of oils and fatty acids. Its hardness varies with its temperature, and when heated sufficiently it forms a viscous liquid. Its use in wireless is chiefly confined to the sealing of the tops of accumulators and the like.

Pitch is a good insulator, and forms a constituent of many insulating compositions. It can be applied hot, for which purpose the pitch is generally placed in a strong iron pot and carefully melted over a slow fire. The pitch itself is very inflammable, and much care should be exercised in the heating process to guard against the pitch becoming ignited.

A better plan, when it can be adopted, is to place the vessel containing the pitch in a larger one full of boiling water. The molten pitch can be used to embed conductors and the like, and may also be employed for closing the tops of accumulators, filling in the ends of small plugs, in insulated handles, and in any place where it is desired to close an aperture with a material that is an electrical insulator.

A more convenient method of using it is in the form of a plastic composition, which can be worked cold, or at a very low temperature. If the fingers are badly soiled through handling the pitch, a good solvent is naphtha, or, failing that, paraffin oil. To minimize the effects the hands may be moistened with water from time to time, as this reduces the chance of the material adhering to the hands.

One of the chief uses of pitch is in the sealing of dry batteries, such as those used for the ordinary flash-lamp batteries with three cells. All the intervening space between the cells is filled in with pitch, which has the effect of making its ultimate construction one of great solidity. Apart from that, however, its insulating properties are valuable. *See* Dry Cell.

PITCH: in Sound. A term which is practically synonymous with frequency. A sound is said to have a high pitch when its frequency is high. The middle C of a piano has a pitch or frequency of 256 cycles per second, for example, and the ordinary piano has a pitch of 27.2

to 4,138.4. The range of pitch for the human voice in singing is from 60 for a low bass to about 1,300 for a very high soprano. See Frequency.

PLAIN AERIAL TRANSMITTER. A form of transmitter in which the spark gap is placed directly in series with the aerial. See Spark Gap.

PLANES AND PLANING. A plane is a woodworker's tool consisting essentially of a body, with a cutting tool secured within it in such a way that the cutting edge of the tool protrudes slightly from one of the faces of the holder or body. Fig. 1 shows four standard planes which will be found serviceable to the wireless experimenter.

These include, first, the jack plane. This consists of a long, rectangular block

adjustably attached to it by means of a slot and screw.

When the iron of a jack plane is to be sharpened, it is necessary to remove it from the body of the plane, and this may be accomplished by grasping the body of the plane in the left hand with the fingers gripping the bottom or sole, and the thumb pressing against the hardwood wedge; the front part of the body of the plane is then struck a sharp blow with a hammer, held in the right hand. This will loosen the wedge, which may then be easily withdrawn with the fingers and the plane iron removed. The plane iron is then sharpened by grinding, as

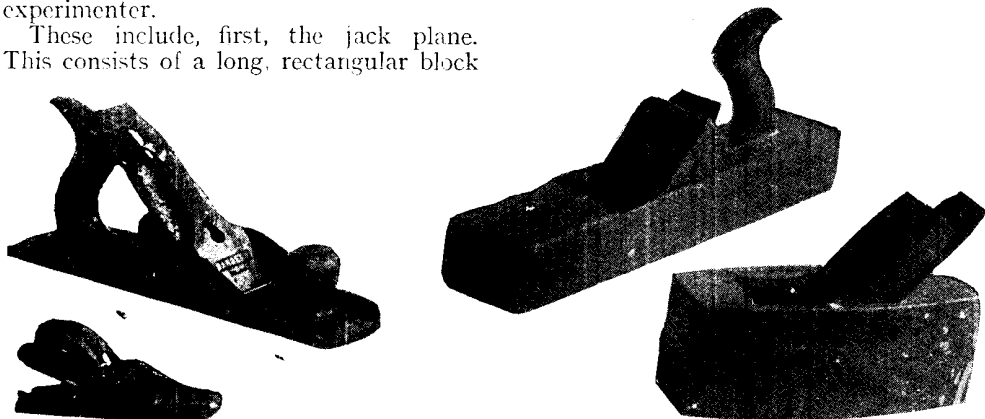

PLANES USEFUL FOR THE WIRELESS EXPERIMENTER

Fig. 1. Four planes needed by the wireless experimenter are the large and small metal planes on the left in this photograph and the jack plane on the top right and smoothing plane on the bottom right, the two latter being made of wood

of hardwood, usually beech, with a rectangular aperture, triangular in cross-section, cut from the top surface downwards, and finishing in a rectangular slot about $\frac{1}{4}$ in. wide at the bottom face or sole of the plane. The slot terminates about $\frac{1}{4}$ in. or so from each of the two side edges of the sole of the plane. A shaped handle is fixed on the top surface, while the cutting edge, or plane iron, is inserted into the recess until the bottom edge slightly protrudes through the slot in the sole of the plane, being held in position by a wedge of hardwood.

The blade, or plane iron, has a backing iron, or cover, screwed on the face of the plane iron which is not ground, this acting as a means of breaking up the shavings as they curl up before the cutting edge, and thus preventing tearing the wood. This backing iron is generally placed about $\frac{1}{8}$ in. from the cutting edge of the iron, and

described in the article on grinding (*q.v.*), and a fine edge imparted by rubbing on an oilstone (*q.v.*).

To replace the plane iron in the body, the iron, with the cover again attached, is placed in the slot with the bevelled part of the cutting edge to the rear, thus bringing the cover, or back iron, to the front of the plane iron. The hardwood wedge should then be inserted in front of the plane iron, the latter placed in its approximate position, with the cutting edge protruding slightly through the slot in the sole of the plane, and the wedge lightly tapped home.

The amount of projection of the cutting edge can be ascertained by tilting the plane to an angle and casting the eye along the sole, as in Fig. 3. The cutting edge should protrude rather less than $\frac{1}{16}$ in. below the surface of the sole. If it does not protrude, it can be tapped out by



REMOVING BLADES OF PLANES FOR SHARPENING

Fig. 2 (left). In order to loosen the blade of a smoothing plane a sharp blow with a hammer is delivered on the back end of the wood body. Fig. 3 (right). To remove the blade from a metal plane a screw device is operated at the rear of the blade in the case of the larger type illustrated at the left-hand side of Fig. 1

tapping the rear of the body with a hammer or mallet, or if it protrudes too much, it can be drawn back by tapping the fore end of the body as if removing the blade. In either case the wedge should be lightly tapped home afterwards. There is no need to hit the plane hard to adjust the blade or to remove it; it only requires a single sharp tap. Care should be taken when replacing the iron to see that it is perfectly flat and level with the surface of the sole, as if it projects more on one side of the plane than on the other, an uneven cut will be made, which will probably spoil the work.

The next plane illustrated in Fig. 1 is a small plane with a wooden body, known as a smoothing plane. This consists of a much smaller block of hardwood, usually beech, and is meant for use on smaller work than that on which the jack plane is used. In this case there is no handle, but the ends of the body are tapered, so that quite a good grip is provided without the handle. The plane iron and wedge are essentially the same as for the jack plane already described, although they may be smaller.

In this case the plane iron is removed by sharply tapping the back of the body with a hammer or mallet, with the plane held in the left hand in the same manner as for the jack plane. It should be noted that it is the back face of the plane which is tapped in the case of the smoothing plane (Fig. 2), as distinct from the front top face of the jack plane. The plane iron is sharpened and replaced in the manner already described, care being taken to get the cutting edge horizontal to the face of the sole of the plane. Generally, the corners of the plane iron are slightly rounded, this being done in the grinding process.

Many workers prefer the use of a plane with a metal body, and these in the smaller sizes are very useful. This type of plane has the advantage that there is not the same tendency to warp and get out of truth which is sometimes the case with a plane with a wooden body. Another point is its greater durability and means of fine adjustment. Two examples are illustrated in Fig. 1, the larger being known as a smoothing plane and the smaller one as a block plane.

There are many detail variations in these planes, but in their essentials they are alike. Usually, metal planes are provided with a mechanical device for adjusting the iron, including levelling, moving the iron sideways with a knurled nut, and adjusting for the depth of cut. In the example illustrated in Figs. 1 and 3 this is accomplished by means of a small lever under the top end of the plane iron, and by the small knurled nut seen towards the bottom of the back of the plane iron, the former being used for adjusting the movement sideways, while the latter is used for the fine adjustment of the depth of cut. In this type of plane the plane iron is removed by unscrewing a screw on the front of the plane iron and withdrawing the wedge and blade.

Metal planes of this type are generally provided with a metal handle at the back of the body and a small hand grip, in the form of a hardwood knob, on the front part of the plane body. The general appearance can be seen from the illustration. The smaller type of metal plane, known as the block plane, is for use on very small work, and may often be used where a larger one would be very awkward to

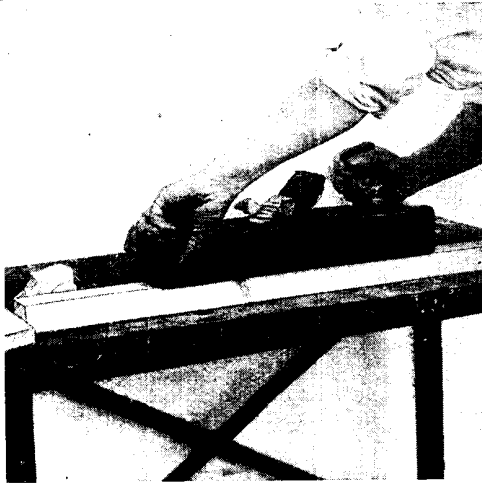

Fig. 4. Both hands are used for planing with a jack plane. The left hand holds the fore part of the body



Fig. 5. On the nose of the large metal plane is a knob, which is held by the left hand for guiding and exerting pressure



Fig. 6. Smoothing is the final step in planing, and the finish of the wireless cabinet or wood-work being made depends largely upon this operation. The larger type of plane is used to take off the rough surface of the wood, followed by the smoothing plane

HOW PLANES ARE HANDLED WHILE IN USE

manipulate. These are not generally provided with handles, and represent the smoothing plane of the wooden variety.

In use, the larger patterns of plane are generally manipulated with both hands simultaneously, as in Fig. 4, the right hand gripping the handle at the back and the left grasping the front part of the body, with the fingers over towards the left. A metal smoothing plane is held in the same manner, as in Fig. 5, the left hand gripping the knob at the front, but in the case of the smaller wooden smoothing planes the right hand grasps the back part of the

body, as in Fig. 6, while the left is rested upon the front, with the fingers grasping the front face of the body.

The actual planing is carried out by pushing the plane forwards with the arms, letting the body join in the forward movement, the plane iron being adjusted to give the cut desired. In the case of the very small block planes, one hand only is generally needed, but their use is chiefly restricted to chamfering the edge of a piece of timber, or for smoothing rough end surfaces. They are of no real use for obtaining a large flat surface.

If the surface to be planed is large and rough, the first cut should be made with a large jack or trying plane, setting the iron to a fairly deep cut. This should be followed by a finer cut. If the surface to be planed is narrow, this can be made with a smoothing plane. For long work a large plane will be found most suitable.

Other planes are obtainable for making mouldings and rebates, these having specially shaped bodies and plane irons, but they are all used in the same way.

The plane should be manipulated in the direction of the grain whenever possible, as this gives a cleaner cut and prevents the surface of the wood being torn. When planing the end of the grain, the plane should be worked carefully from side to side, and not directly across the grain. A good plan is to bevel and then work the other side down to the same level, or clamp the piece to be planed between two odd pieces of board and then plane right across.

The care and attention that should be given to a plane includes frequent sharpening of the plane iron and occasional oiling of the body with linseed oil. They should be placed, when not in use, in a position where they are not likely to be knocked over or otherwise damaged.

—E. W. Hobbs.

See Cabinets ; Grindstone ; Oilstone ; Rebating.

PLANTE PLATES. The Planté storage cell or accumulator was originally made by placing two plates of metallic lead in a vessel containing dilute sulphuric acid. These plates were then connected to an electric generator, and a current sent through the cell, which decomposed the electrolyte and oxidized the positive plate. The cell was then discharged, but since the action was confined to the immediate surface of the plates, the energy given out was small. By repeated charging and discharging the oxidation penetrates deeper into both plates and the storage capacity of the cell is increased.

Planté showed that the time occupied by the forming process could be considerably lessened by pickling the plates in dilute nitric acid and washing them in a ten per cent solution of sulphuric acid. After this they are electrically formed, and these formed plates are known as Planté plates. Other methods have been tried, as the Faure pasted plates. See Accumulator Plate ; Faure Plate.

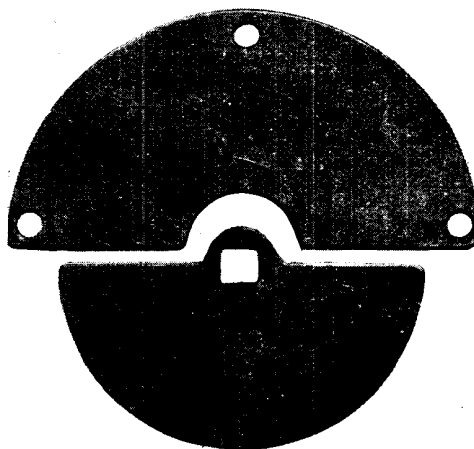

CONDENSER PLATES

Fig. 1. Fixed and moving plates of a standard air condenser are illustrated. The top one is the fixed plate, and the bottom one, which fits on a square-shaped spindle, is the moving plate.

PLATE. Word used in wireless and electrical engineering in a number of ways. Accumulator plates, Fig. 2, are the elements in storage batteries, and are usually made of lead or lead compounds. Earth plates are large plates of sheet iron buried in the earth, to which conducting wires are attached to make a good earth connexion. The

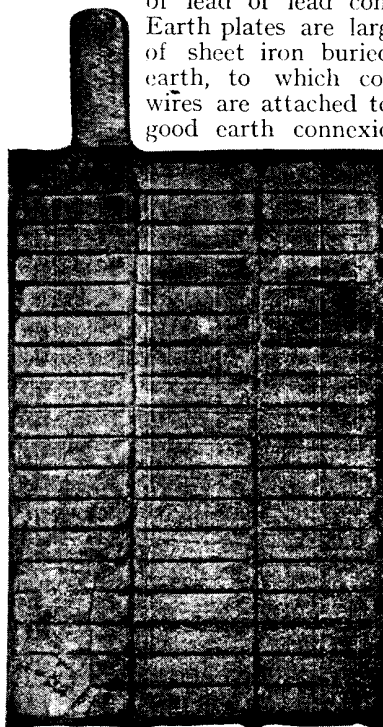

ACCUMULATOR PLATE

Fig. 2. Accumulator plates are usually made of lead, with a grid-like formation which holds the active paste.

plate of a valve is the principal electrode for the attraction of the electrons forming the emission current of a thermionic valve and is more usually known as the anode. The vanes of a variable condenser are sometimes called the fixed and movable plates, and are shown in Fig. 1. See Accumulator Plate; Anode; Condenser; Earth Plate; Faure Plate; Planté Plate.

PLATE CIRCUIT. This is another name for the anode circuit, described in this Encyclopedia under Anode Circuit.

PLATINOID. An alloy of about 75 per cent of brass, 23 per cent of nickel, and 2 per cent of tungsten. These proportions vary considerably, however. The metal is one of the german silver group of alloys, and is very largely used in the making of resistances.

PLATINUM. One of the metallic elements. It is a hard, white, lustrous metal, chemical symbol Pt, atomic weight 195. Platinum is very ductile, and, next to gold and silver, is the most malleable substance known. It is not affected by nitric, hydrochloric or sulphuric acids, and resists oxidation at any temperature.

Platinum is used in the construction of electric light filaments, in the preparation of standard weights and measures, in photography, etc. In wireless use is made of platinum in a number of ways.

The metal has a remarkable power of absorbing or occluding gases, and it is for this reason used for increasing the vacuum in vacuum tubes, as explained under the heading Palladium. E. Taege experimented with various metals for the electrodes of quenched spark gaps, and found that platinum was one of the best metals to use, while platinum-iridium electrodes gave the best results of all. The pitting and wearing of the metal electrodes, causing irregularities in working of the gap, are to a large extent lessened by the use of platinum-iridium.

PLIERS. Implement for grasping small objects, mostly those made of metal. In essence pliers are composed of two levers pivotally connected near one end, the long ends of the levers being known as the handles and the other ends as the jaws. There are many different patterns of pliers, but all of them are manipulated in much the same way, that is, to grasp the handles firmly with one hand, thereby forcing the jaws tightly together, thus enabling a secure grip of an object to be obtained.

There are several different types, some of which are illustrated in Fig. 1, including side-cutting pliers, round-nosed, flat-nosed, gas and nut pliers. The side-cutting pliers shown in Fig. 1 have their jaws formed with a cutting edge on each

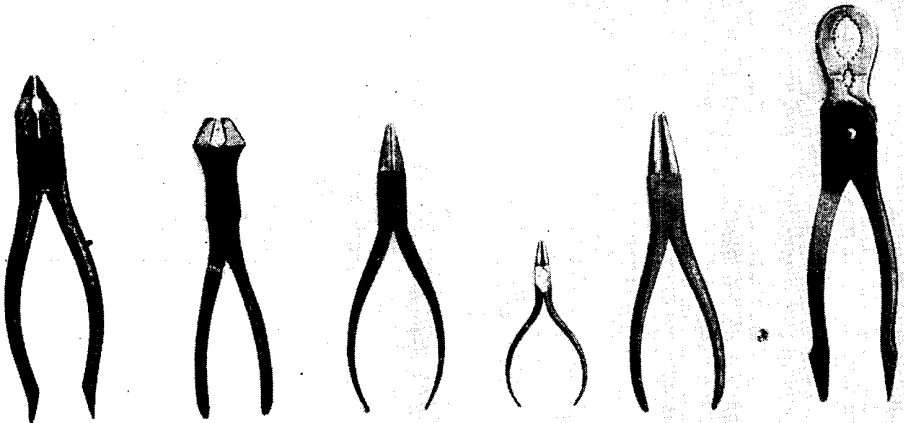

PLIERS FOR ALL PURPOSES IN WIRELESS WORK

Fig. 1. One of the most essential tools of the wireless constructor is a good pair of pliers. For various purposes different kinds of pliers are made, and this photograph illustrates a selection which covers practically all the requirements of the worker in wireless. From left to right they are: cutting, nut, snout nose, small round nose, round nose, and gas pliers.

jaw, the cutting being effected by pressing the handles together, thereby bringing the cutting edges together.

The round-nosed pliers shown in Fig. 1 have round-sectioned jaws, and are very handy for working in restricted areas. Their action is, however, the same, the material or object being grasped between the jaws. The flat-nosed type illustrated is made with flat jaws, their inner surface being serrated to give a better grip on the object. The type known as gas pliers, shown also in Fig. 1, has a large and a small aperture, both having serrated edges, the larger one being



nearer the outer end, the smaller aperture being nearer the pivoting point. The inner faces make their use very convenient when it is required to grip any round object, such as a rod, firmly.

The type of pliers known as nut pliers is illustrated in Fig. 1, and has its jaws formed in such a manner as to give a good grip on the flats of a nut. By this means nuts in otherwise inaccessible positions may be easily screwed up or unscrewed.

Fig. 2 shows a type of pliers extensively used in wireless work, known as electrician's insulated pliers. This type has specially insulated handles, and is very useful for handling conductors, or working in positions where an electric shock is possible. In using this pattern of pliers every care should, however, be taken to avoid a shock by keeping the metal part of the pliers away from contact with any live conductors.

The pattern illustrated is of the side-cutting type of pliers, and in all other respects, except for the insulated handles, which are covered with guttapercha, is similar to the ordinary type of side-cutting pliers. The cutters are situated at the inner end of the jaws, nearest the pivoting pin, and a small aperture is formed between the cutters and the outer end of the nose, or jaws.



INSULATED AND ROUND-NOSED PLIERS

Fig. 2 (left). Insulated pliers avoid risk of electric shock. The handles are covered with insulating material. Fig. 3 (above). Round-nosed pliers are used for making eyes or loops in wire

Other types of pliers are made for special purposes, and of these the parallel-action pliers are perhaps the most useful to the experimenter. They vary from the normal only in so far that the jaws open parallel to each other, and not at an angle. Another variant, that is particularly useful on brass and copper work, is formed with smooth jaws, as these do not bruise the work so badly as those with the normal serrated jaws.

An operation that has often to be performed in the wiring of a receiving set is that of forming an eye on the end of wire intended to act as a conductor. This can easily be accomplished with the aid of a pair of round-nosed pliers in the manner illustrated in Fig. 3. The first stage is to

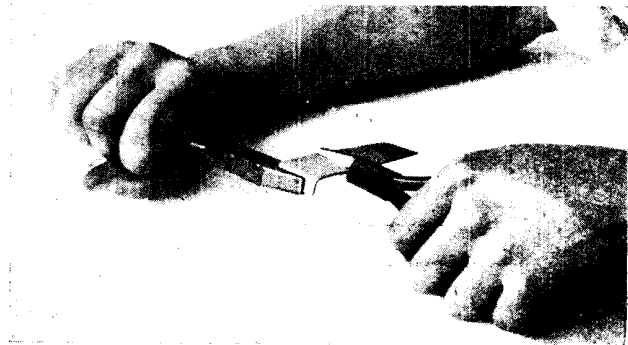

FLAT-NOSED PLIERS FOR STRIP METAL

Fig. 4. Strip metal can be bent to shape by using two pairs of flat-nosed pliers in the manner shown in this illustration. Paper, leather or foil may be used between the jaws to avoid damaging the work

bend the wire to an angle at a small distance from the end, grip this part of the wire with the round-nosed pliers, and twist the latter with the right hand, while holding the wire with the left, or, if preferred, with a second pair of pliers. The twisting action results in the turning of an eye on the end of the wire in a neat and workman-like manner.

Another operation, shown in Fig. 4, shows the use of two pairs of flat-nosed pliers in the forming of a strip of brass for the purpose of a contact arm for an inductance switch. The extremity of the strip is turned over at right angles so as to bear firmly on the contact studs. This part of the work can easily be done with the aid of pliers in the manner illustrated in Fig. 4.

On finished work, or when the surface is to be plated or lacquered, the jaws on the pliers should be covered with a piece of leather, thick paper, or even a piece of copper foil, to prevent the jaws bruising the work. In the use of the pliers, a firm grip of the handles is necessary, and the implement should be manipulated with a positive action and the work held firmly, thereby minimizing the risk of damage to its surface.

Still another type of pliers is that known as the vice pattern. This generally takes the form of the ordinary parallel-action pliers with a set-screw arranged on one of the jaws. When a piece of material is to be held in the pliers for any length of time, this set-screw is tightened up, the jaws then being held together firmly, while the hand is free to lose its grip on the handles.

The care and attention that should be given to pliers chiefly consists of keeping the pivot pin fairly tightly adjusted, so that there is not too much play in the jaws or between the cutting edges. The jaws and pivoted joint should be frequently lubricated, while the whole implement benefits from an occasional rub over with an oily or greasy rag.

PLIODYNATRON. The pliodynatron is a thermionic valve of the dynatron type. Like the dynatron, it depends on the emission of electrons from the plate, after that

plate has been bombarded by the emission from the cathode.

Although in appearance the pliodynatron is not unlike the ordinary four electrode valve, it must not be confused with it.

In the dynatron the two outer electrodes are both at positive potential relative to the filament, whereas in the ordinary thermionic valves it is usual to work the grid at a negative potential. Again, in the dynatron the two outer electrodes are close together, and are separated from the filament by a relatively large space. In ordinary valves the grid is generally near to the filament, and there is a larger space between filament and plate than there is between filament and grid.

The pliodynatron is employed as a powerful amplifier. It has been stated that by employing two pliodynatrons in series an amplification of 10,000 times has been obtained, whilst a single valve, under ideal conditions, will give an amplification of 1,000 as compared with an ordinary three-electrode valve giving an amplification of about 15 times.

The action of the pliodynatron will be best understood by regarding it simply as a dynatron, with the addition of an ordinary control grid, which is situated close to the filament, as in an ordinary valve. See Dynatron; Four-electrode Valve.

PLIOTRON. The pliotron is the ordinary hard-vacuum three-electrode valve, which is now so generally in use.

In order that a valve may be strictly

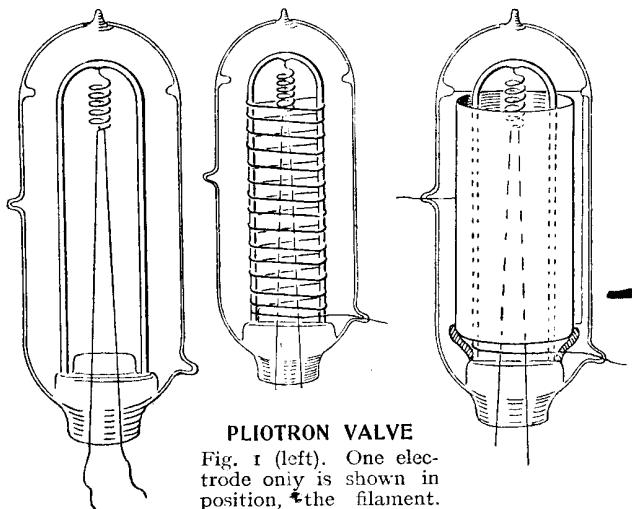
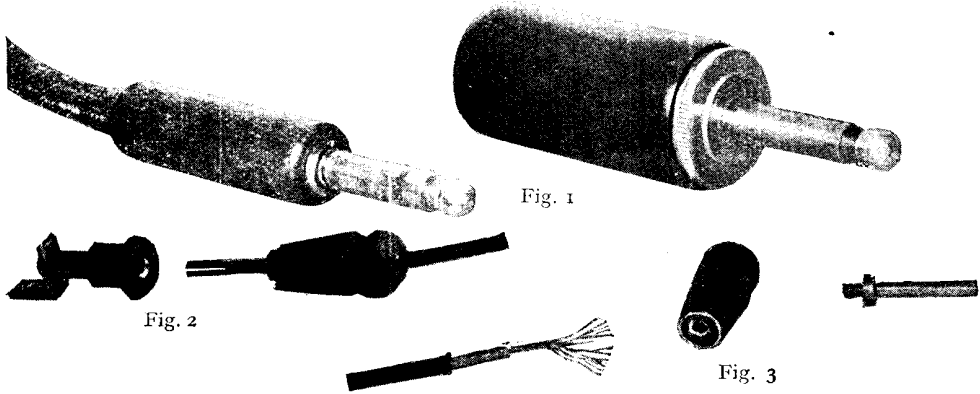

Fig. 1 (left). One electrode only is shown in position, the filament.
Fig. 2 (centre). Here the grid has been added. Fig. 3 (right). The filament, grid and anode are in position in this diagram



PLUGS USED FOR MAKING TEMPORARY CONNEXIONS

Fig. 1. Examples of standard telephone plugs are shown. These are used with special sockets known as jacks. Fig. 2. Plugs may be made by the amateur, as in this case, where a standard valve leg is used, which fits into a jack made of a valve socket. Fig. 3. Components of a home-made plug consist of a stranded wire, which is soldered to a valve leg after passing through an ebonite handle

a plotron, it is necessary that the vacuum be very high—in fact, high enough to preclude the possibility of ionization. The grid must also be near the filament, and the anode separated from the cathode by the grid.

If the grid is left out of a plotron, then the valve is known as a kenotron.

It is general practice in America, where the above name is applied to the three-electrode valve, to construct the grid as a flat spiral wound on two supports (Fig. 2) around the filament (Fig. 1), whilst the anode is either made of wire zigzagged on a frame, or is often made as a circular plate (Fig. 3).

The plotron may be used for rectification, amplification, magnification or oscillation, or if arranged in a suitable circuit may be made to perform several of these functions at one and the same time.

In England the plotron is generally known as a three-electrode valve. See Valves for Reception.

PLUG. Term used to describe a cylindrical, slightly tapered metallic end to a conductor. The plug is used in conjunction with a socket, clip, or other convenient means for completing the circuit, customarily taking the form of a socket in the shape of a hollow, cylindrical member adapted to receive and to effect good electrical contact with the plug. The

plugs shown in Fig. 1 are used in conjunction with a special form of socket, incorporated to form a switch, usually known as a plug and jack, and are dealt with under the heading Jack in this Encyclopedia.

The ordinary types of plug are single pole, that is to say, they break connexion in one wire only. Several such plugs may be incorporated into one holder, and thereby make or break connexion between any other number of conductors. The use of simple plugs is a great convenience in many forms of portable or adaptable receiving sets, particularly those with several valves. By the use of plugs it is possible to change the connexions over and use one or more valves at will, varying the direction of the current through a reaction coil, or cut it out of the circuit altogether, and provide a variety of circuit modifications.



HOW TO CONNECT A HOME-MADE PLUG

Fig. 4. Passing the wire through the insulating handle, the strands are bared and soldered to the valve leg. The wire is then pulled back so that the plug base fits into the handle

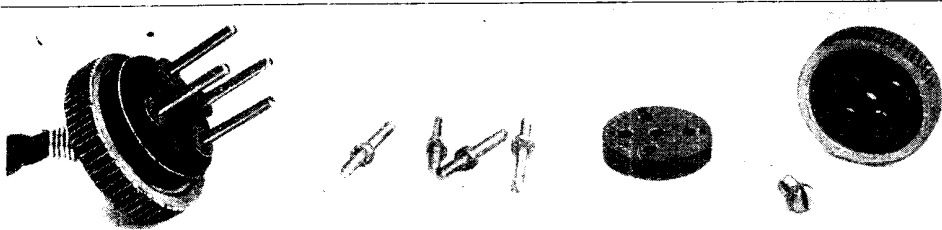

Fig. 5. Connexions for H.T. Fig. 6. Components of the four-pin plug are shown dissembled. and L.T. batteries can be Four valve legs are used as pins, and the ebonite disks are screwed together made by this plug.

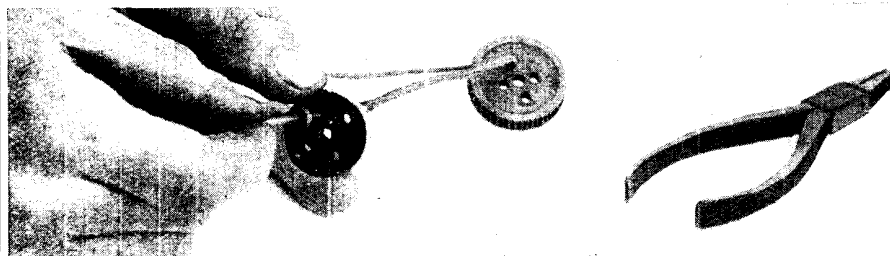

Fig. 7. This photograph shows the assembling of the first wire. Note how the wire is threaded through both disks. The assembly must be done very carefully to ensure sound contacts



Fig. 8. When the four wires are connected they are coaxed back through the pierced disk as the pin holder is fixed in position

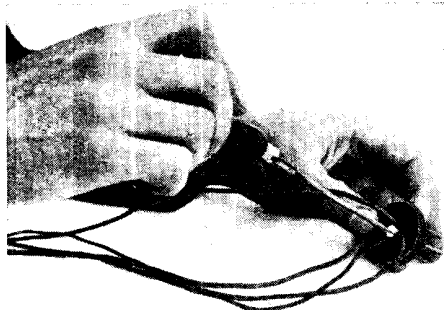

Fig. 9. By a central screw the cap and the other disk are held together. The plug is held tightly between the fingers while the screw is adjusted

HOW TO MAKE A FOUR-PIN CONTACT PLUG

A typical application of this principle is illustrated in Fig. 2, showing a simple home-made type of single-pole plug. The handle is formed from a piece of rod ebonite turned to shape and drilled and tapped to take a standard valve leg.

Contact is made with a simple socket formed from an ordinary valve socket attached to an angle piece of brass. The socket is insulated with an ebonite sleeve. All that is required to make such plugs is a sufficient number of valve legs and ebonite handles. The connecting wire is preferably single flex, and the insulation should be bared from the end, as shown in Fig. 3. The wire is then passed through the handle, as shown in Fig. 4, and the

screwed part of the valve leg screwed home. This expands the wire into the handle, and holds the valve leg securely in contact with it.

A most useful adaptation of the same principle is shown in Fig. 5, as arranged for four separate conductors. Such a plug is very useful for connecting the high- and low-tension battery leads to a set, as when the plug is withdrawn all the current is cut off from it. The components are shown separately in Fig. 6, and these comprise two ebonite disks, four valve legs, and a central brass screw. The smaller disk is drilled to take the four valve legs, and these should be spaced in accordance with the dimensions of an ordinary valve-holder,

which can do duty as the socket. The other disk or cap is drilled in a similar manner, and both have a central hole to enable them to be screwed together. The cap is preferably knurled on the rim and recessed on the underside so that the smaller disk can fit into it.

To wire the plug insert one single flexible wire through a hole in the cap, and then attach to it the nut of the valve leg, as shown in Fig. 7, taking care there are no loose ends of wire to cause a short circuit. Attach the remaining wires in a similar manner, and then coax them backwards until the smaller disk fits into the cap, as shown in Fig. 8, completing the work by tightening the central screw, as illustrated in Fig. 9. The flexible wires should be of different colours to distinguish them, and may be plaited together for the sake of neatness. See Jack.

PLUGGING. Commonly used term to describe the process of closing an unwanted aperture with a permanently fitted piece of material. In wireless work, plugging is most often adopted for the filling of holes in an ebonite panel.

There are two ways in which this can be performed. The simplest and least efficient is to employ hard black wax, and to run this in the hole in a plastic condition, cleaning it off smoothly with the aid of a warmed knife-blade. Chatterton's compound can be used in the same way.

A better plan is illustrated in Figs. 1 and 2, and consists of preparing a slightly tapered piece of ebonite rod of the correct size for the hole. This is then driven lightly into position with a hammer, as shown in Fig. 1, the panel being supported on a small bench vice.

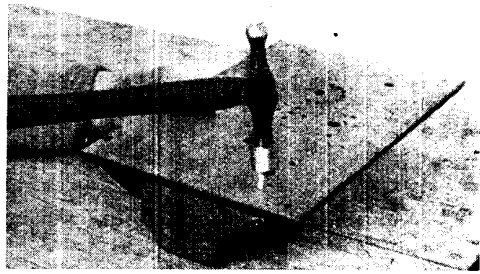

PLUGGING A PANEL

Fig. 1. Holes are plugged in a panel by slightly tapering the existing holes and driving a similarly tapered plug home with a hammer

The plug is driven up tightly, and the surplus ends sawn off with a hack-saw, as shown in Fig. 2. The surface should then be finished off by rubbing with very fine emery paper, and may be matted in the usual way. If carefully done, the plugged hole is practically invisible.

PLUG-IN COIL. General term used to describe any type of inductance, or other coil, connexions to which are effected by means of plug contacts, attached to the ebonite base or support for the windings. One of the great advantages of the plug-in coil is that it facilitates the selection of the most appropriate coil values for any particular purpose. For instance, with any receiving set normally employed for reception of broadcasting, one coil will be found most suitable for wave-lengths from, say, 350-450 metres, while slightly larger coils will be found most suitable for those stations of a higher wave-length.

This change can be effected in a moment by withdrawing the one coil and substituting another. Similarly, much larger coils can be interchanged when it is

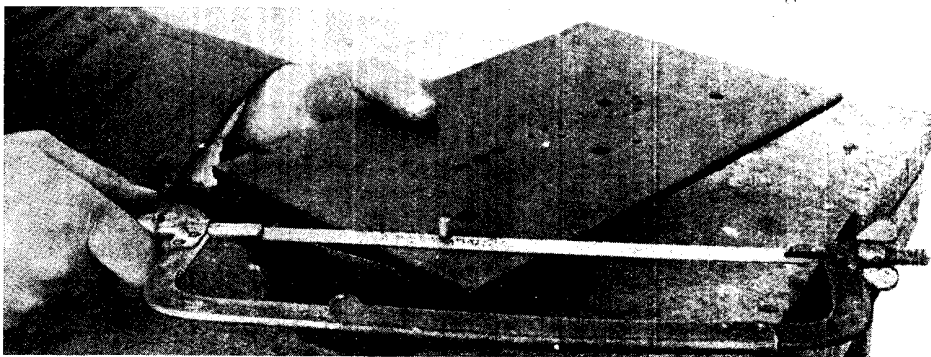

SAWING OFF THE SURPLUS AFTER PLUGGING A PANEL

Fig. 2. Having driven the plug well home, the protruding end is roughly removed by sawing it off with a hack-saw. The cut should be made as near as possible to the panel, so that all that is necessary to complete the operation is to rub down the surface with emery paper

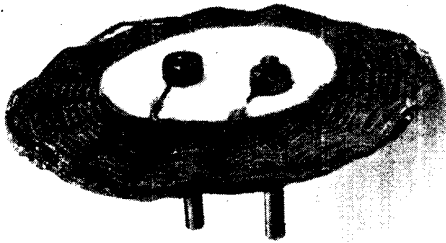

PLUG-IN COIL

An easily made device is an ordinary basket coil converted to one of the plug-in variety

desired to receive on the longer wavelengths, such as that from the Eiffel Tower station.

It is important, when using such coils, either to use all of the same manufacture, or to ascertain in which direction the coils are wound, as in some cases the set may function perfectly with a particular coil and give no signals at all with another, particularly in the case of reaction coils, the reason being that the windings are reversed. Most of the plug-in holders are nowadays arranged so that they can only be plugged in in one way, thus doing away with these objections. A simple method of converting an ordinary type of basket coil to one of the plug-in variety is illustrated. Two disks of card or ebonite are

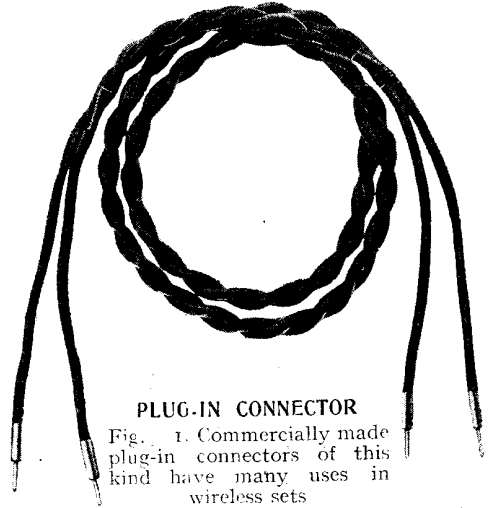

PLUG-IN CONNECTOR

Fig. 1. Commercially made plug-in connectors of this kind have many uses in wireless sets

used, and two valve legs as the plugs. The latter are connected respectively to the two ends of the coil windings. See Coil; Coil Holder.

PLUG-IN CONNECTORS. Term used to describe a number of patterns of conducting wires having terminal plug contacts attached to them. One example is illustrated in Fig. 1, as turned out commercially. This takes the form of a pair of flexible wires, each end of which is

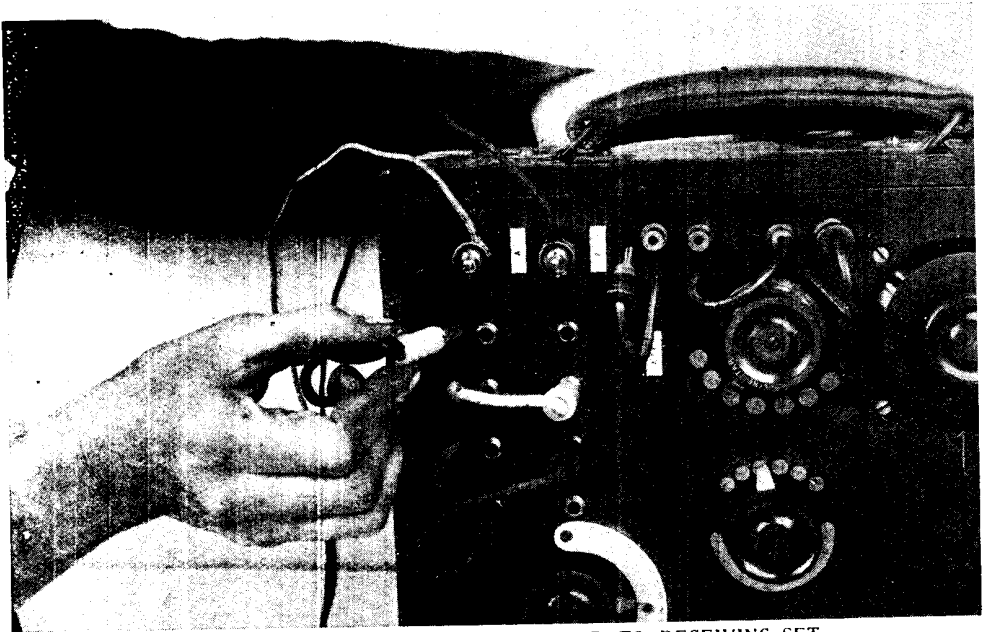

APPLICATION OF PLUG-IN CONNECTOR TO RECEIVING SET

Fig. 2. Plug-in connectors are very convenient for making temporary connexions in wireless apparatus, especially when frequent changes of wiring are necessary for experimental work

connected to a plain plug. These plugs or tags are simply inserted into sockets, clips, or the like, and thus effect quickly and efficiently the completion of a pair of circuits. They are also available for such purposes as the aerial and earth lead-in wires, and as extension cords for telephones and loud speakers.

The application of plug-in connectors to a portable receiving set is illustrated in Fig. 2, showing a single conductor in the act of being plugged into its place on the

in a reaction circuit. One practical advantage of this method is illustrated in Fig. 4, which shows how, by removing the plugs and crossing the connectors over, placing the plugs back in their sockets, the connexions of the reaction coil can be very quickly reversed, a feature of considerable interest and value with coils of varying manufacture, and particularly when the direction of their winding is not known.

It is important with all such plug-in connectors that the plugs themselves make perfect fit in the socket, for which purpose they should be slightly tapered, and the sockets in which they fit similarly tapered, so that when pressed well home firm contact is assured. *See* Conductor; Connecting Strips; Connecting Up; Connexions.

PLUG-IN CONTACTS. Expression applied to a variety of different kinds of demountable connectors. There are innumerable adaptations of the same principle, which consists essentially in one fixed part forming one side of the conductor and a movable portion forming the other side, each of these parts being separately attached to the conductor, and this in turn forming some part of the circuit.

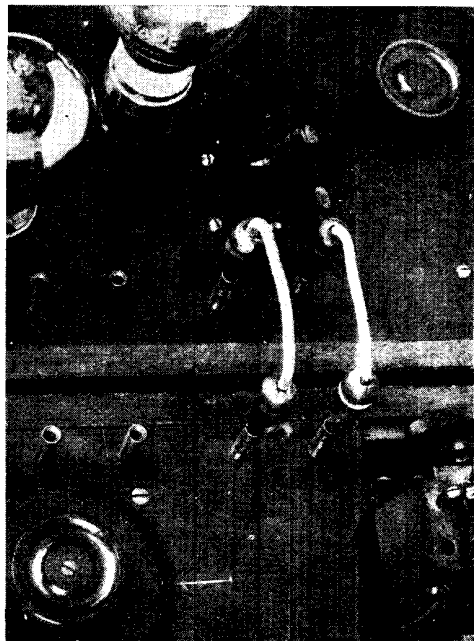

UNITS CONNECTED WITH PLUGS

Fig. 3. Two connectors are used in this case to complete a circuit to a reaction coil. The plug-in connectors are specially designed for this purpose

set and carrying the low-tension current. Another application is also shown in the same illustration, where the cords are seen emerging from holes in the panel and terminating in plugs which can be inserted into any one of several different sockets, according to the type of circuit under test at the moment.

In the case of the unit receiving sets and others of a like nature, connexion between the tuning unit and detector and other parts is often effected by means of connecting strip terminals. A more practical plan is to use plug-in connectors in the manner illustrated in Fig. 3, which shows a pair of such connectors employed

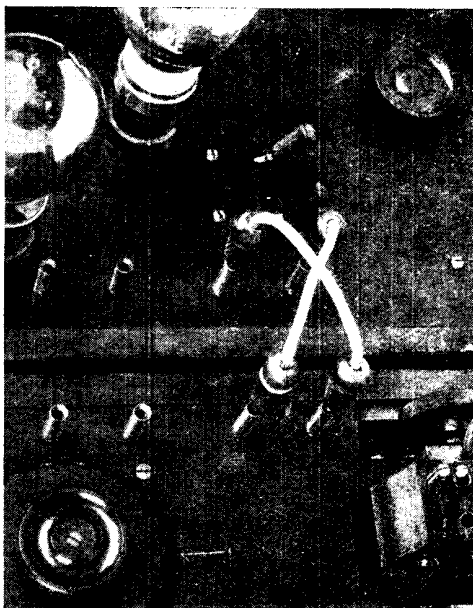

ALTERNATIVE PLUG-IN CONNEXIONS

Fig. 4. One of the advantages of the plug-in connector is that connexions may be reversed simply and quickly without rewiring, as in the case of reaction coils or transformer leads

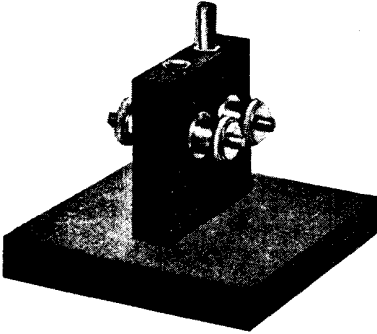

PLUG-IN CONTACTS

Fig. 1 (above). A coil may be plugged in to a simple holder of this design. Fig. 2 (right). Plug-in contacts are frequently used for three coil holders

Courtesy Fuller's Electric Co., Ltd.

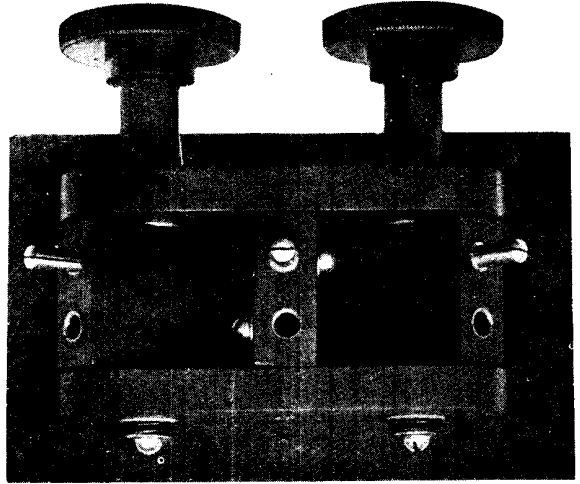

When the contacts are brought together the circuit is completed, and when separated the circuit is broken.

This type of contact is well exemplified in many forms of plug-in coils, transformers, and the like. One application is illustrated in Fig. 1, which shows a simple form of single-coil holder, the plug-in contacts being a replica of those of the holder, and consisting of one slotted peg and one slightly tapered socket, each provided with terminals for the connexions to the conductors. Another adaptation of the same principle is illustrated in Fig. 2, which shows a three-coil holder embodying the same points.

complete a circuit through any fitting of this type without using a coil in the circuit, a small ebonite block, with contact peg and socket fitted to it, and having these parts connected together by a metallic conductor, can be plugged into position to complete the circuit.

Another example takes the form of a four-prong contact, and is used in conjunction with a standard valve holder. As employed for a high-frequency transformer it is illustrated in Fig. 3. The two ends of the primary winding are brought to one pair of contacts, and the two ends of the secondary winding to the opposite two contacts. Consequently, when the device is pressed into the valve holder and

Should it at any time be desired to

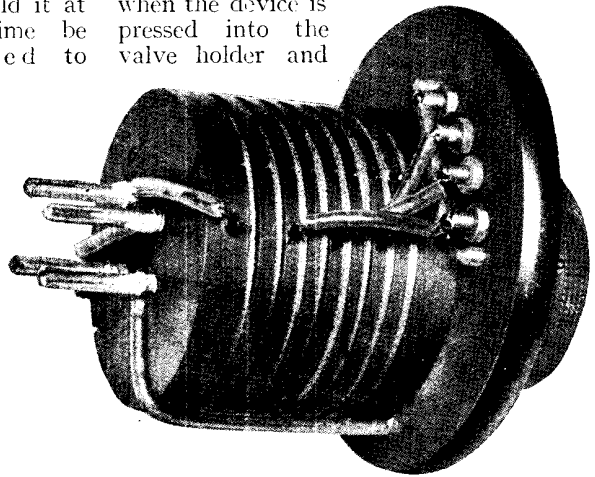
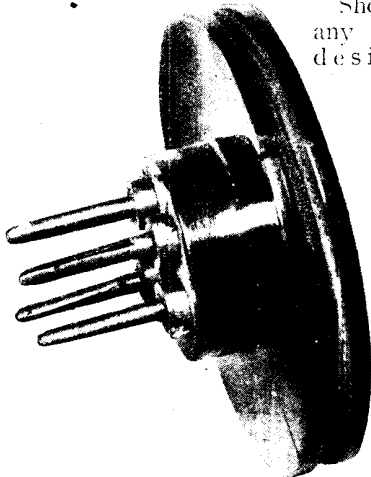

PLUG-IN CONTACTS ON TRANSFORMERS

Fig. 3 (left). For plugging-in a high-frequency transformer, a four-pin contact is used. This is a transformer by L. McMichael, Ltd. The legs are spaced as valve legs. Fig. 4 (right). In this example by the Economic Electric Co., Ltd., external wires are employed to connect the contact plugs

the latter properly wired up in the circuit, both primary and secondary circuits are completed. In this example the wiring is internal. In the example shown in Fig. 4 a similar principle is adopted, but in this case the ends of the transformer windings are brought outside the holder and directly connected to the contact pegs, and thus, should the wires be accidentally broken, their repair is thereby facilitated. Such outside connexions should be covered with systoflex or similar insulating sleeving if new wiring

ard valve pin and valve socket, the whole forming the fixed portion, which is normally attached to the underside of the panel so that no part of the peg or socket protrudes above its surface.

The movable block is similarly made, and consequently, when it is pressed home, perfect insulation is ensured. When the plug is removed the set of contacts is not liable to accidental short-circuiting. The first thing to do is to make up the base and fit to it a valve leg and socket. The base should be of ebonite, and should measure

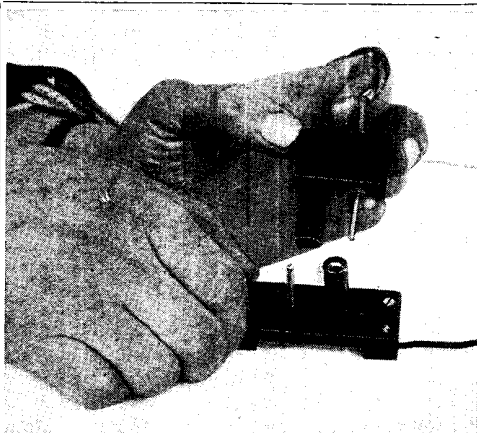

Fig. 5. When the contacts are plugged in the connexions are completely insulated

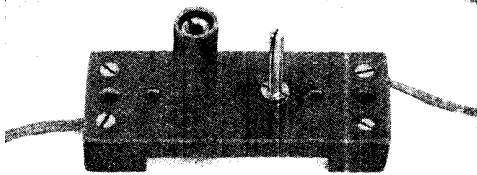

Fig. 6. Ebonite is used for making the base, which rests on two end pieces

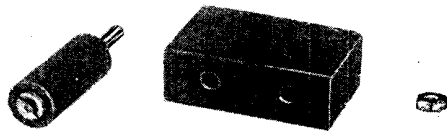

Fig. 7. Across the end of the socket a saw cut is made to enable it to be screwed into the base

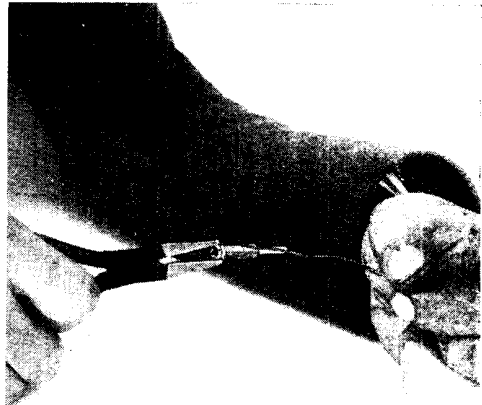

Fig. 8. This photograph shows how the wire is fitted by holding the socket with a pair of pliers and twisting the wire round it

HOW TO MAKE A PLUG-IN CONTACT DEVICE

is required, to prevent any accidental short-circuiting of the transformer windings.

The experimenter will find that plug-in contacts especially adaptable for individual needs provide a ready means for testing out a variety of different circuits with a minimum of alteration to the wiring. To be really efficient it is desirable that the contacts be insulated, so that there should be no risk of accidental short circuit, and one way by which this may be accomplished is illustrated in Fig. 5, which shows a home-made arrangement consisting of an ebonite base on which is mounted a stand-

about 3 in. long and 1 1/4 in. wide, and be provided with two small cross-pieces to give a clearance for the nuts which hold the leg and socket to the base. This is clearly shown in Fig. 6. The only part of this work which calls for special mention is the means adopted for bushing the socket with ebonite for good insulation.

The first step is to take a piece of ebonite tube and drill it out to fit closely on to the outside of the socket and then counterbore the end for a short distance. The socket should have a small groove turned on its outside at about 3/32 in. from its outer end,

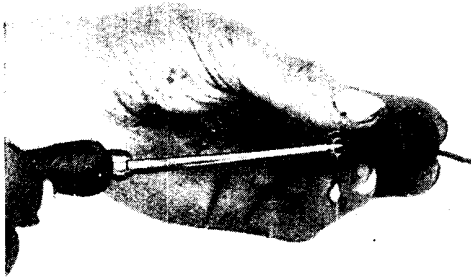

SCREWING THE SOCKET TO THE BASE

Fig. 9. Over the socket is placed the ebonite bush, and the socket is then screwed to the base as illustrated

and a little ring of wire be fitted into this groove and soldered into position, thus forming a ridge on the socket. The wire can readily be fitted by grasping the socket with a small pair of pliers and twisting the wire around in the manner shown in Fig. 8.

A saw-cut is made across the end of the socket to enable it to be screwed into the base. This simple method is applied to the construction of the plug portion, as shown in Fig. 7, the method of assembly in both cases being alike: namely, first place the

ebonite bush over the socket from the screwed end, and then the screw into its hole in the base with the aid of a screwdriver inserted into the slot cut for the purpose, and as shown in Fig. 9.

Care should be taken to keep the centre distance of the plugs and sockets exactly the same. The wires are best of the flexible pattern, and, when suitable, twin flex may be used. The two ends are attached to their respective ends of the screwed shanks of the valve leg, and the sockets either soldered or secured with a nut, which should be recessed into the ebonite plug. The aperture in the latter is filled subsequently with molten hard wax

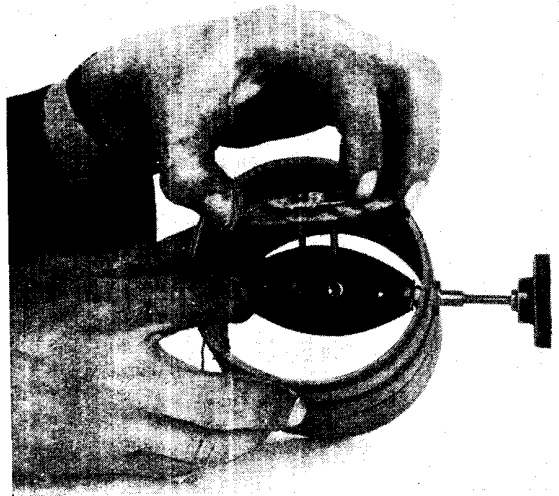

PLUG-IN REACTION COIL

Fig. 10. Another use for a plug-in contact is for adding a reaction coil to a special holder in the interior of the tuning inductance as illustrated

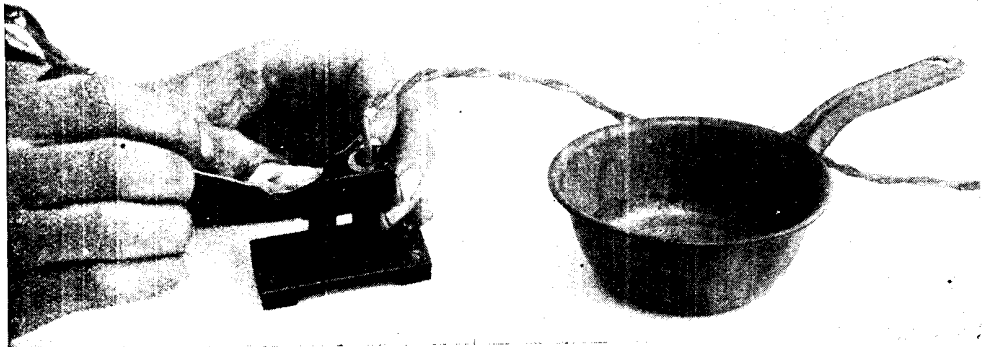

FILLING UP THE SOCKET RECESS WITH WAX

Fig. 11. Complete and perfect insulation is ensured by filling up the recess occupied by the wire and socket base with molten hard wax. The wax is best introduced with the aid of a spoon, care being taken to break any air bubbles in order that the aperture may be completely filled

introduced with small spoon, as shown in Fig. 11, thus ensuring complete and perfect insulation.

This type of contact can be adopted for tuning leads, connecting wires to loud speaker, low-tension battery leads, and so forth. Another type of easily-made contact of the plug-in type is illustrated in

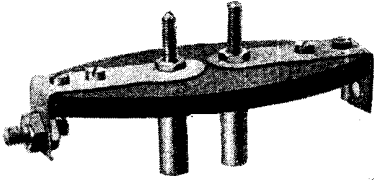

HOLDER FOR PLUG-IN COIL

Fig. 12. Plug-in contacts of the device for adding a reaction coil to a tuning unit are shown

Fig. 10, and shows the type adapted for interchangeable plug-in basket coils when used as a reaction coil in a tuning unit. In this case the basket coil is provided with two valve legs, or other pegs, each connected to one end of the winding. Contact is effected between them and the holder in the manner shown in Fig. 12, which shows a flat plate of ebonite, having two brass strip contacts attached to it, the ends of the contacts being bent over at right angles, drilled and provided with lock nuts and screwed spindle to enable it to be rotated within the tuning inductance.

On the inner ends of the contact strips contact is effected with the valve sockets by means of lock nuts securely tightened on to the contact blades, the latter being secured to the base with two small screws under it. These parts and the method of assembly are clearly shown in Fig. 13. It is very important to tighten up thoroughly the nut on the socket to ensure perfect electrical contact.—*E. W. Hobbs.*

See Coil Holders ; Contact ; Soldering ; Wiring.

PLUNGER. In wireless work, word used to describe a small cylindrical movable contact member. Plungers are chiefly used as a convenient means of effecting electrical contact between a fixed and moving member. One such example is illustrated, and shows a small spring-

pressed plunger on an ebonite holder from which it has been detached. The particular example illustrated forms part of a Polar filament resistance, the latter being wound in the form of two coils of resistance wire, one above the other, the pointed end of the plunger working between and making contact with both.

Other examples are found in the small spring-pressed plungers forming part of some types of valve holder, and also between the moving parts of various makes of coil holder. Plungers are also used

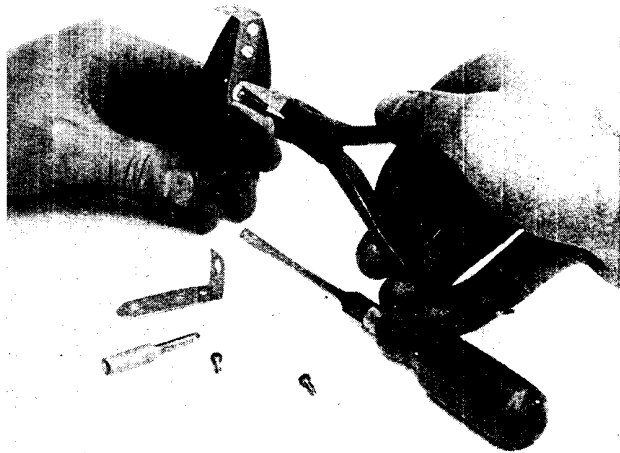

ASSEMBLING REACTION COIL PLUG-IN CONTACTS

Fig. 13. Fastened by nuts to the boat-shaped piece of ebonite are two contact strips and two valve sockets. The operator is here seen screwing up a nut on the leg of the socket mounted. One socket and one contact strip are shown dissembled

for locating centre points in setting out of pieces of apparatus, the plunger in such an example having a rounded end and dropping into a shallow depression, thus serving to check any further movement. See Crystal Receiver, page 582 ; Slider.

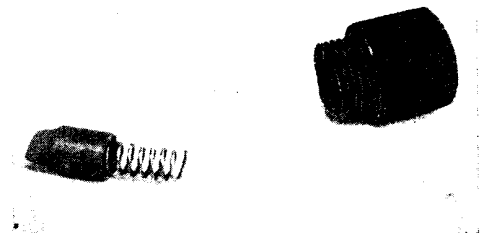

PLUNGER FOR HOLDERSTAT

This plunger is used with a combined filament resistance and valve holder known as a Holderstat. It is made by the Radio Communication Company

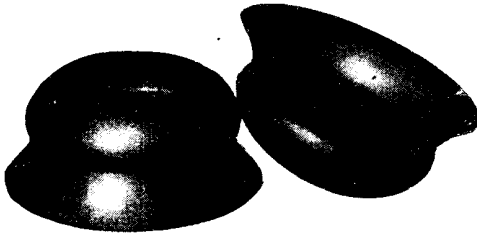

PNEUMATIC EARPADS

Attachments of this kind are used with earpieces of a telephone receiver to add to the comfort of the listener-in

PNEUMATIC EARPADS. Term used to describe a particular form of attachment used in conjunction with the earpieces of a telephone receiver. An example is illustrated, a feature of which is the particular method of manufacture, whereby part of the pads are made hollow and the cavities filled with air. The resiliency resulting from this arrangement makes the headphones very comfortable in use, and as the softness of the rubber earpads enables them to conform more readily with the contours of the head and ears, better reception often results, especially in the case of those normally hard of hearing.

For hygienic reasons the pads should be removed occasionally and washed in lukewarm water with a slight trace of disinfectant.

POINTER. A finger or indicator used for facilitating the judgement of the relative motion of one moving member in respect to another. A pointer has many uses in wireless work, and forms an essential part of many pieces of apparatus, such as the pointer on a potentiometer of the slider type; and those used in conjunction with a knob on filament resistances, variometers, loose couplers, rotary potentiometers, and on practically all forms of laboratory instruments which require a pointer and dial.

The pointers are attached to the knobs in various ways, and one simple form, shown in Fig. 1, consists of a triangular-shaped piece of thin sheet brass, which is attached to the knob by means of two small wood screws passed through a hole cut in the wide part of the base of the piece of brass, into the boss on the inside of the knob. A central hole is drilled in both pointer and knob for the passage of the spindle on which they are to be fitted. In this way the pointer and knob always move together, and a small

rotation of the knob gives a corresponding rotation of the pointer.

Another method of attaching a pointer to a knob is shown in Fig. 2. In this case a piece of 2 B.A. screwed rod is screwed into a hole drilled in the boss of the knob, a hole of corresponding size being drilled through the base of the pointer; while the pointer is held in place on the spindle, or 2 B.A. screwed rod, by means of a small brass nut screwed on to the spindle and tightened up against the pointer in the manner shown in the illustration.

This method of fixing the pointer has the advantage that the pointer can be moved independently of the knob, and allows the pointer to be turned to the zero point on the dial when the spindle and the piece of apparatus attached thereto is in that position. Care should be taken, however, to fix the pointer fairly tightly when once the desired position has been obtained, otherwise trouble will result by the knob moving through a short distance without the pointer rotating, and thereby destroying its fine adjustment qualities.

Still another method of fixing the pointer is illustrated in Fig. 3. In this case a piece of brass tube has been let into a hole bored into the boss of the knob, and a hole, corresponding in size to the outside diameter of the tube, drilled through the base of the pointer. The piece of tube should be of such a length that it projects about $\frac{1}{16}$ in. above the level of the pointer. The pointer is then fastened to the knob by riveting over the projecting edge of the tube, thereby holding the pointer firmly to the tube and knob. The edge of the tube is riveted over with the aid of a light ball peen hammer, using this with light, rapid strokes or blows. In this case the spindle is fitted into the tube in the knob.

In some cases the pointer may simply consist of a piece of round metal, generally brass, which is fixed in the outer rim of the knob, the pointed end being driven into a small hole in the outer rim of the knob. The upper or indicating end of the pointer is formed as shown in Fig. 4, with a spade end. This method of fastening has the advantage that the pointer cannot possibly move without the knob, and if a central line is drawn down the pointer to the point of the spade end, some very accurate adjustments may be

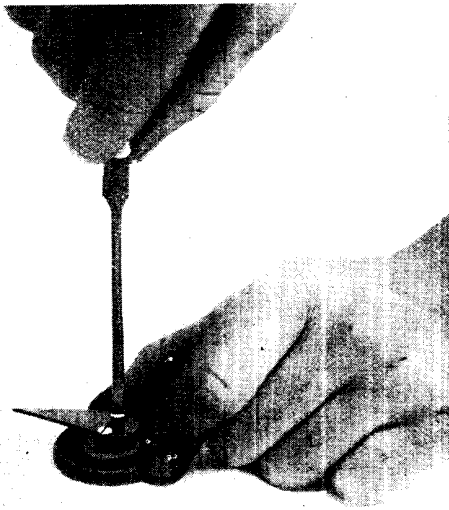

Fig. 1. Screwed to an ordinary turning knob is a simple pointer made of a triangular piece of brass

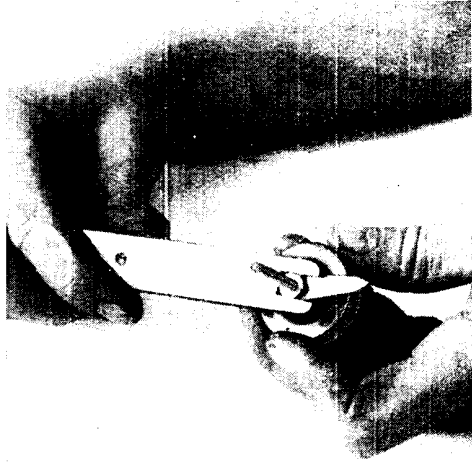

Fig. 2. By attaching a nut to the spindle, the pointer is fastened more quickly than by the method in Fig. 1



Fig. 3. Riveting is sometimes adopted as the method of attaching a pointer to a knob. A tubular projection is added to the knob



Fig. 4. Fixed to the outer edge of the knob is an easily made pointer with a spade end

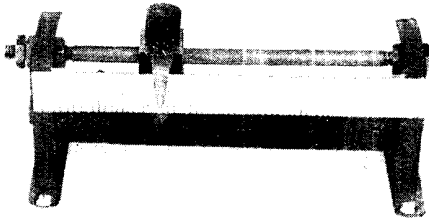

Fig. 5. Attached to a potentiometer is a simply made device which works with a scale

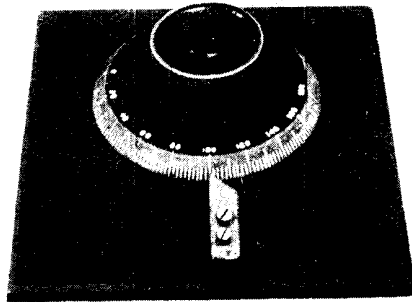
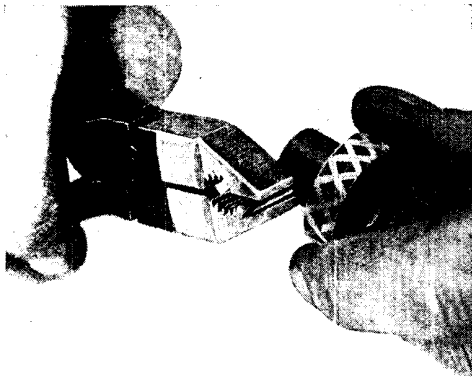

Fig. 6. In this case the pointer is fixed, and is composed of a strip of celluloid cut at an angle at one end

BEST FORMS OF POINTERS FOR VARIOUS WIRELESS INSTRUMENTS

made by getting this line in register with the calibrations on the dial, if such be used. This method of forming a central line in the pointer is almost always followed in laboratory instruments, where great exactitude is necessary, as the line can be brought into register with any of the very fine markings on the dials usually found on this class of instrument.

A rather different type of pointer is illustrated in Fig. 5. The foregoing have been of the rotary variety, but in this case a special pointer and longitudinal scale have been adapted to give some idea of the position of the slider and amount of potential passing through, for future reference.



POINTER FOR A GRID LEAK

Fig. 7. Screwed into a tapped hole in the boss is a pointed piece of brass wire, which makes a neat and very useful pointer for the variable grid leak

In this case the pointer is fastened over a short spindle which projects upwards from the body of the slider, the pointer being placed over the spindle and

the knob screwed down on top of it, thus holding it firmly in position. The pointer is bent over at an angle from the major part of its length, and thus comes perpendicular to the graduated scale. The point of this pointer should register exactly with that part of the slider which makes contact with the wiring on the potentiometer.

Fixed pointers of the type illustrated in Fig. 6 have advantages in some circumstances, such as the indication of the setting of a variable condenser. The pattern shown can be adapted to almost any type of variable condenser, and consists of a strip of celluloid with one end cut to a chisel point. The strip is secured by two screws to the side of the condenser dial; the chisel point bears on the edge of the dial, and thus clearly shows the setting.

The slight pressure exerted by the celluloid on the rim of the dial acts as a check and keeps it secure when set.

Pointers for small devices, such as a grid leak, are best made by turning a small diameter ebonite knob and serrating the edge, as shown in Fig. 7. The pointer is simply a pointed piece of brass wire screwed into a tapped hole in the boss, as shown in Fig. 7. The whole can be made quite small and neat, and has the advantage that the setting of the instrument can be noted and the same setting found again without delay after alteration to some other position.

Good and efficient pointers are a great practical advantage on all movable controls on wireless receiving or transmitting sets.—*E. W. Hobbs.*

See Dial.

POLAR BLOK RECEIVERS & HOW TO BUILD THEM

An Elastic System of Construction with Many Advantages

Here is described an ingenious system by means of which the least experienced amateur may easily build up multi-valve sets which, while adaptable for any experimental purposes, yet have all the advantages of the ordinary permanent cabinet-contained receivers. For tuning and other details of the sets described here see Amplifiers; High-frequency Amplifiers; Low-frequency Amplifiers

The Polar Blok is a system of construction of wireless receiving sets made by the Radio Communication Company.

This system is not a unit system, but one which is specially adapted for the wireless constructor and enables him to build any size set he requires, from a simple crystal receiving set to a seven- or eight-valve set, rapidly. By means of the Polar Blok system it is possible to start with a

simple circuit, say a crystal detector and tuner combination, and subsequently to add a valve as often as desired. The relative positions of the parts may be easily changed without dismantling the whole set, and the method of wiring is one which does away with soldering.

The basis of the Polar Blok construction is a tubular jointed frame forming spaces for the attachment of panels on which the

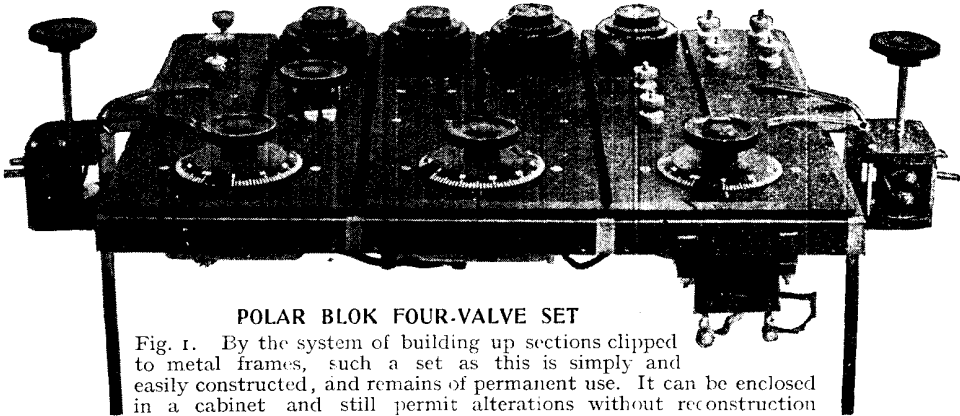

POLAR BLOK FOUR-VALVE SET

Fig. 1. By the system of building up sections clipped to metal frames, such a set as this is simply and easily constructed, and remains of permanent use. It can be enclosed in a cabinet and still permit alterations without reconstruction

various components are mounted. Two sizes are provided for, namely, full size panels, 5 in. by 4 in., and half panels, 2½ in. by 4 in. The frame can be joined to accommodate any combination of such panels.

The full construction of a four-valve set is shown here. This set will cover all the normal requirements of the listener-in. It is extremely sensitive, adjustable to any desired wave-length, is free from distortion, and gives loud-speaker strength for most of the British broadcasting stations. By means of the Polar Blok system the set may be erected in an evening by an

amateur who has had practically no experience in wireless. Either dull emitter or bright emitter valves may be used, and the cost of such a set in its components is less than the usual four-valve set sold commercially. The construction allows the amateur to incorporate his own ideas and vary the circuit as he pleases.

Fig. 1 shows the complete set without the coils and valves. The appearance of a one-valve set with coils and batteries is shown in Fig. 23. Fig. 2 shows the appearance of the underside of the set and the wiring, and Fig. 4 gives the wiring diagram.

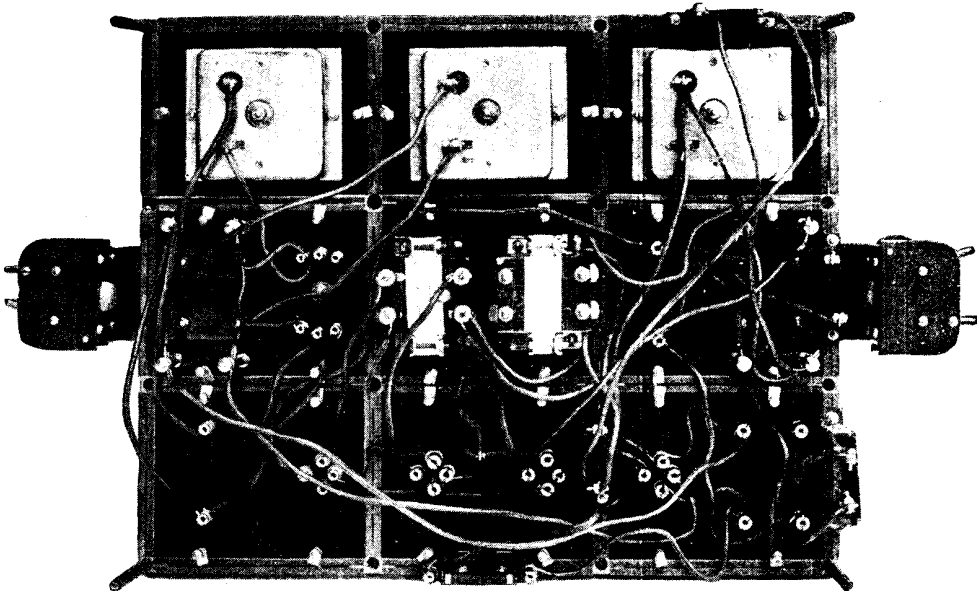

UNDERSIDE OF POLAR BLOK SET

Fig. 2. On the underside of the panel of the set shown in Fig. 1 the block formation of the instrument is seen. The wiring is carried out with specially heavily insulated wire, and all the connexions are made with special terminals which avoid all soldering difficulties

Courtesy Radio Communication Co., Ltd.

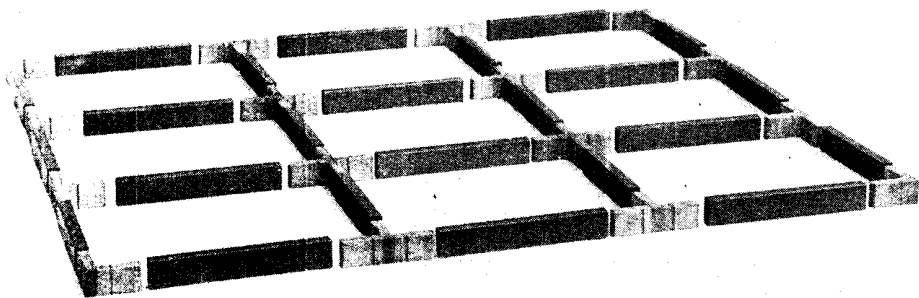

FOUNDATION OF A POLAR BLOK APPARATUS

Fig. 3. Components of the frame are fitted together on the plug-in principle. The construction is made up of square tubes, cruciform connectors, T-connectors, and corner connectors. Here are the necessary pieces for the set in Fig. 1 placed together, but not fitted

The first step in the construction is building up the frame. The frame is built up from four sets of components. These are the frame tubes, cruciform connectors, T-connectors, and corner connectors. The frame tubes are made in three lengths, though two such lengths only are required in the construction of the four-valve set. The sizes of the tubes are: $4\frac{5}{8}$ in. long, which form the support on the long side of a full panel; $3\frac{5}{8}$ in. long, which form the support on the short side of a full panel or the long side of a half panel; and $2\frac{1}{8}$ in. long, which form the support on the short side of a half panel. In the set described the two longer tubes alone are used.

The frame tubes are made of blued spring steel, and are divided on the underside so as to allow

small internal bosses to spring over the frame connectors and finally clip into the grooves provided for them. By this arrangement a joint is obtained which can easily be taken apart, but which is nevertheless perfectly rigid.

Fig. 3 shows the frame tubes and the three types of connector in place ready to fit into position. All the connectors should be mounted with the words Polar Blok uppermost, and all frame tubes should be clipped on them with their split sides underneath. There is only one way in which the various panels can be joined up together without straining the tubes. All tubes must be pushed home on their connectors until they click into position.

Each row of panels must be completed before proceeding with the next, or otherwise the constructor will find a corner left which cannot be filled in without straining or bending the tubes. Fig. 5 shows one row of panels being fitted to the centre row of panels. It should

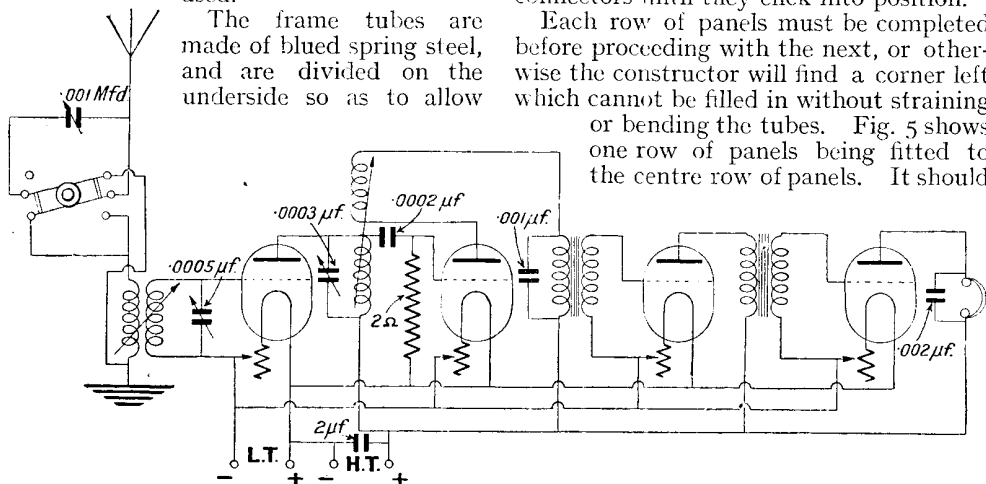

CIRCUIT DIAGRAM OF A FOUR-VALVE POLAR BLOK SET

Fig. 4. It will be seen that the circuit arrangement for the Polar Blok set is standard in character, and is not affected by the method of building up. The wiring of the set is carried out in the usual way, only the components are fitted together on the Blok system

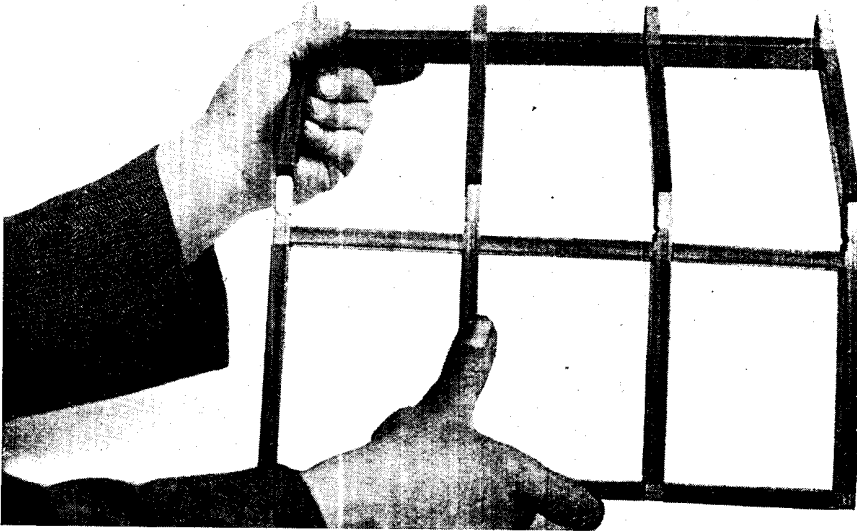

HOW TWO ROWS OF POLAR BLOK PANELS ARE JOINED

Fig. 5. Two rows of panels of a Polar Blok set are joined in this way. At the top is the centre row of panels. Note how all the tubes are being fed on evenly to their connectors. This is necessary, or the apertures will be strained

be noted that all the rows of joints are all fed on at the same angle. Fig. 6 shows two rows of panels being joined up the last row. All frames must be firmly pushed on to the connectors to ensure the joints are rigid.

Underneath the connectors will be found holes into which may be fitted temporary supports of steel rod while the set is in course of construction. These steel supporting legs are shown clearly in Figs. 1 and 2. Special legs are provided for Polar Blok sets for supporting the frame either at the four corners or at the sides. They are attached to the joints of the frame by pushing them on from underneath.

Fig. 7 shows the side legs, and the supporting arms are clearly seen which clip on to the frame tubes. Fig. 8 shows how these legs are clipped on from underneath the frame, and Fig. 9 shows the completed frame with the legs in position. The frame is now ready to receive the panel components. These components are as follows:

Two two-terminal half panels; four Holderstats, or combined filament resistances and valve holders; one four-terminal half panel; two half-panel coil holders; one half-panel series parallel switch; two half-panel low-frequency

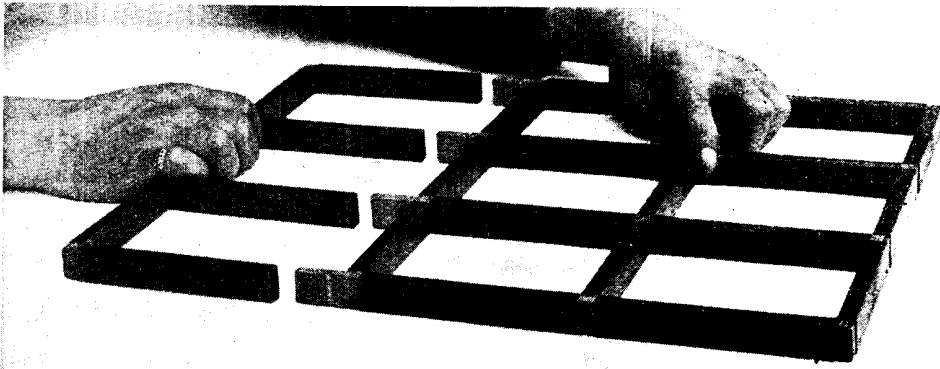

ENGAGING THE FINAL ROW OF POLAR BLOK PANELS

Fig. 6. Here the final row of panels is being attached. The tubes are about to engage the projecting pieces of the middle row of panels. When this is done, the foundation upon which the four-valve Polar Blok set in Fig. 1 is built is complete

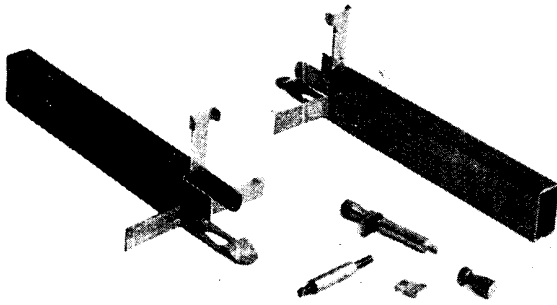

Fig. 7. These are side legs, showing the method of construction and the supporting arms for the frame tubes

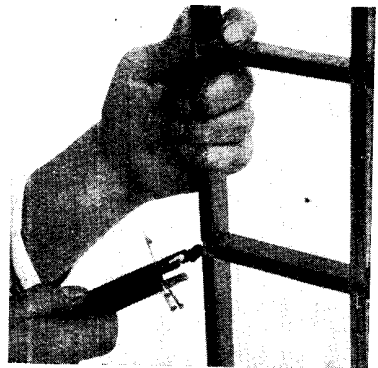

Fig. 8. Side legs are simply clipped on underneath the panel

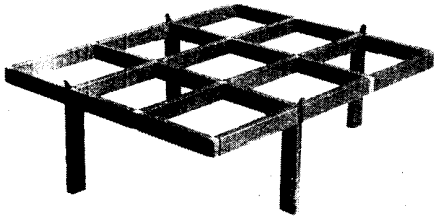

Fig. 9. With its legs in position, the frame is complete and ready to receive the panels. There are nine panels in all

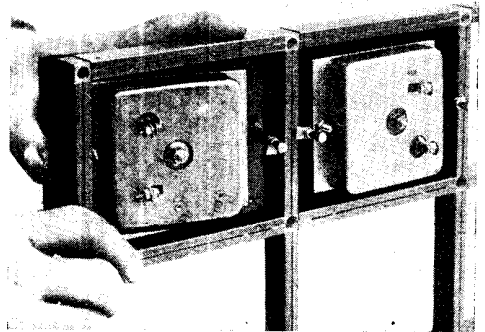

Fig. 10. One condenser panel is clamped in position on the frame, and a second is being fixed in position on the left

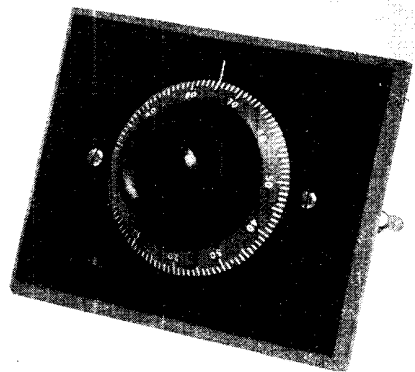
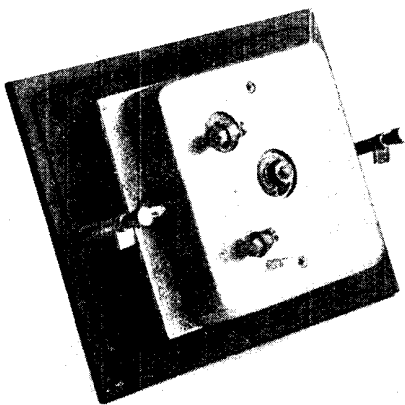

Fig. 11. Back and front of the variable condenser panels used in the Polar Blok unit. The condenser is of the mica disk type. The clip device for holding the panel to the frame is clearly seen in the back view

CONSTRUCTIONAL DETAILS OF THE POLAR BLOK UNITS

transformers; one full panel Polar condenser, .001 mfd. capacity; one full panel Polar condenser, .0005 mfd. capacity; one full panel Polar condenser, .0003 mfd. capacity; one fixed condenser with clips, .001 mfd. capacity; one fixed condenser with clips, .002 mfd. capacity; one fixed condenser, .2 mfd. capacity with clips; one fixed condenser with clips, .0002 mfd. capacity; one grid leak with clips, 2 megohms; heavily insulated wire.

firmly in position by tightening the pillars with the fingers only.

Fig. 10 shows one condenser panel fitted in position and held down by the clamping pillars, and another condenser being fitted into position. Fig. 11 shows the top and underneath sides of the condenser panel

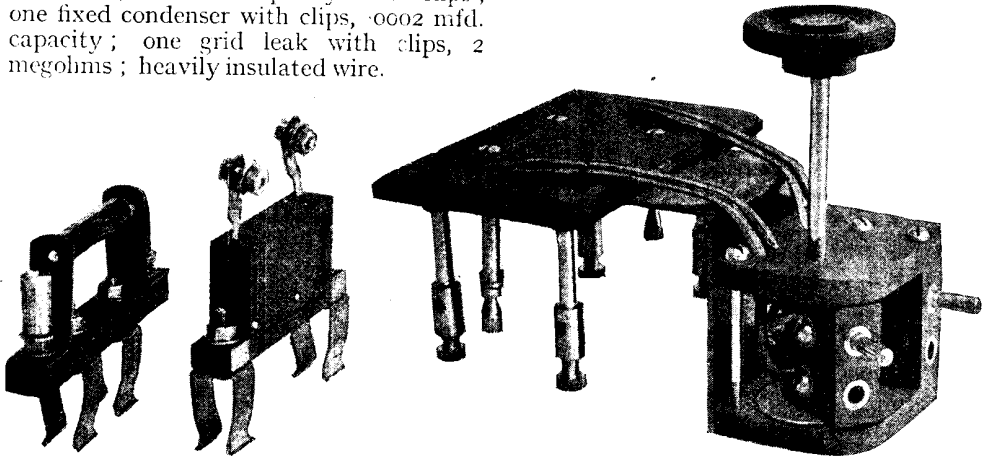

POLAR BLOK GRID LEAK, CONDENSER AND COIL HOLDER

Fig. 12 (left). On the left is a grid leak, and next is a fixed condenser. These are provided with clips which fasten on to the frame tubes on the Polar Blok system. Fig. 13 (right). Two-coil holders as used in the Polar Blok system; these are seen in position in Figs. 1 and 23. The moving coil has an ingenious vernier attachment, shown in detail in Fig. 14

The frame assembled, the next step is to fit in and clip firmly to the frame the various panel components. Fig. 7 shows two clamping pillars, one complete and one in its separate components. Each clamping pillar has a short thread on one end and a long one on the other. The short thread is screwed into the central hole found on two edges of each panel. These clamping pillars are shown in position on the underside of some of the panels illustrated. The pillars should be screwed firmly on to the panels with a light pair of pliers, but care should be taken not to exert too much pressure or the threads will be stripped.

On the long thread of the pillar should be mounted one of the small bent clamps in such a way that it bends towards the panel, and over this the knurled finger nut should be screwed down. When the panel has its two clamping pillars in position it can be placed in position on the frame, the clamping pieces being left free to turn so as to allow them to clear the sides of the tubes. The panel is held

with clamping pillars in position. These condensers are mica condensers, and are protected by a solid brass box; they are described under Disk Condenser.

Fig. 12 shows one fixed condenser with clips, and one grid leak with clips, as used in the construction of this set. These clip on to the frame tubes, and can be seen so clipped in Figs. 1 and 23.

Fig. 13 shows the two-coil holder panel. This panel is fitted with an ingenious

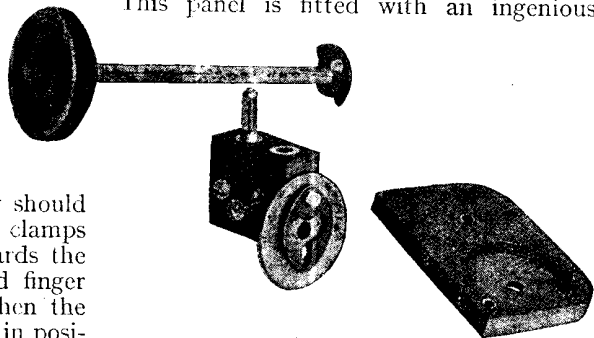

DETAILS OF VERNIER ADJUSTMENT

Fig. 14. Details of the vernier movement of the coil holder shown in Fig. 13. This allows a quick coarse movement, or a slow fine movement, by means of a rocking cam



POLAR BLOK HOLDERSTAT

Fig. 15. The Holderstat is fitted with a valve. This panel combines the functions of a filament resistance and a valve holder in one

vernier control which allows the moving coil to be adjusted quickly and coarsely, or slowly and finely, by rotation of the control knob quickly or slowly. This movement is shown in detail in Fig. 14, and is actuated by a rocking cam. Its construction is such that it is impossible for it to get out of order.

The Holderstats are panels which combine in one the functions of a filament resistance and a valve holder. Fig. 15 shows the Holderstat complete, fitted with a valve. Top and underside views of the panels are shown in Fig. 16, and the component parts in Fig. 17. In Fig. 15 the ebonite knob for actuating the resistance

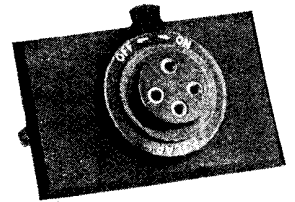
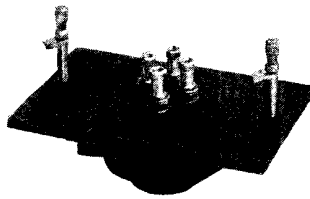

UNDERSIDE AND TOP OF HOLDERSTAT

Fig. 16. Underside and top views of the Holderstat panel, showing the general appearance of the device

is clearly shown. In this knob is fitted a plunger controlled by a spring. This plunger makes contact with the two coils of the resistance shown in Fig. 17, and ensures a smooth even contact.

The four-terminal and two-terminal half panels are shown in Fig. 18. This photograph shows very clearly the terminals for wiring. They are provided with screw-headed pillars. The wiring fits in between two brass washers, and is firmly held by the screwed down pillar. This kind of terminal allows wiring to be very rapidly carried out, or wires to be changed with the minimum trouble. The contact made is as good as a soldered contact without being, like the latter, fixed, and so making it difficult to dismantle any panel.

These terminals are fitted on all panels, and another view of them is shown in the series-parallel switch panel shown in Fig. 19. This switch allows the aerial tuning condenser to be switched in series or parallel with the aerial, and the method of wiring it is seen from the theoretical circuit diagram in Fig. 4. One terminal is a blank terminal.

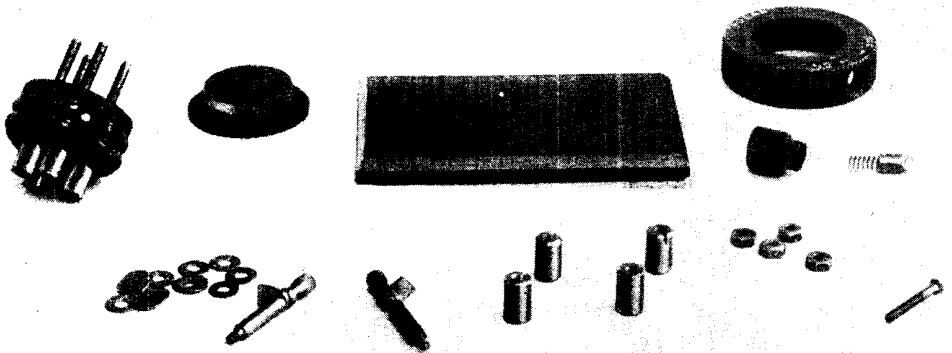

COMPONENTS OF THE POLAR BLOK HOLDERSTAT DISASSEMBLED

Fig. 17. From this photograph will be seen the simplicity of construction of the Holderstat. The filament resistance is shown on the left, and the actuating plunger and knob are shown on the right

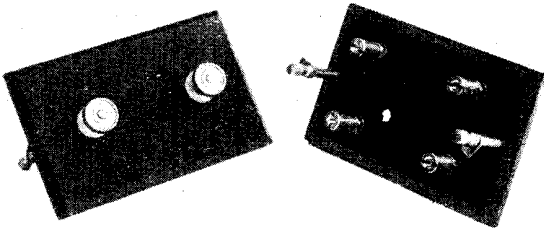

Fig. 18. Two terminal half panels are shown; one has two and the other four terminals. The underside of the latter is seen



Fig. 19. Using this switch, the aerial tuning condenser is in series-parallel with the aerial tuning coil

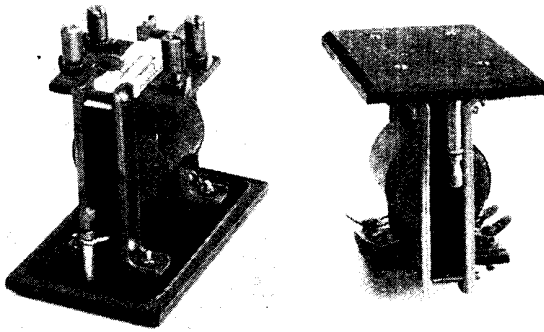

Fig. 20. Low-frequency transformer panels. These are fitted with different types of terminals, the one on the right having clips and that on the left terminals used with the system

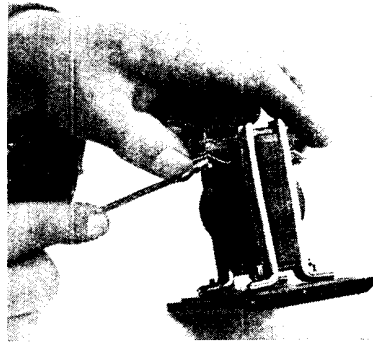

Fig. 21. How the wire is fitted in the spring-clip terminals of this type of low-frequency transformer is seen in this photograph

PANELS USED IN THE POLAR BLOK SYSTEM

Fig. 20 shows two types of low-frequency transformer panels, as used in the construction. The chief feature in which they differ is in the method of wiring. The transformer on the left is fitted with the usual screw-headed pillar terminals. That on the right has patent clip terminals. These spring clip terminals are pressed down and the wire passed through a hole drilled in the terminal. The tension of the spring holds the wire firmly in position, and it is the work of a moment to remove it. Fig. 21 shows how the spring clip is held down while the wire is being placed in position.

A one-valve detector set with reaction is shown in Fig. 23, and the theoretical circuit diagram in Fig. 22. From Fig. 23 it will be seen that it is a simple matter to construct a set containing any number of valves. The Polar Blok system is, in fact, a very elastic system of construction which allows experimenters to try out different circuits very rapidly.

Special cases for mounting are made with loose sides and ends, which can be built up in a very similar way to the frames. It is equally possible to mount any set built up with Polar Blok panels

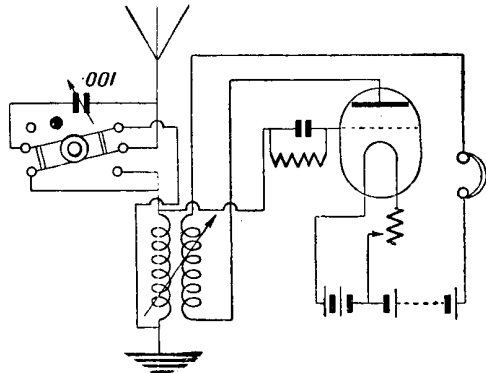

POLAR BLOK ONE-VALVE CIRCUIT

Fig. 22. Reaction is included in this one-valve set, which is built up easily and quickly with Polar Blok component parts

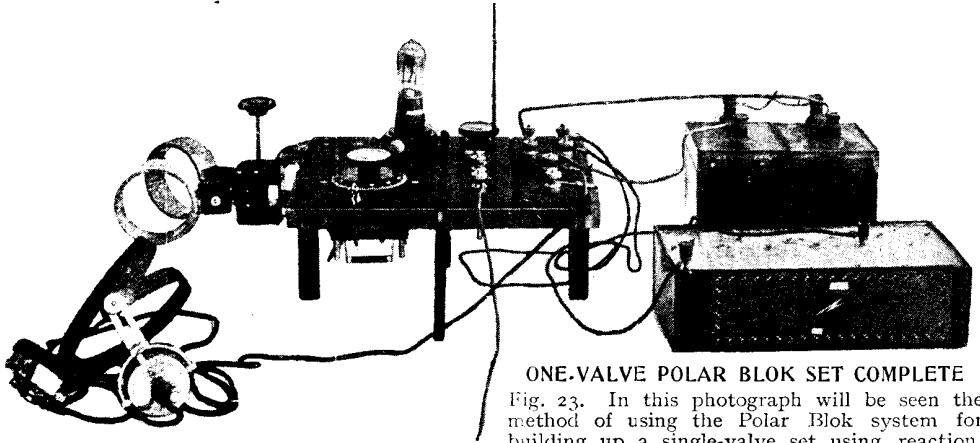

ONE-VALVE POLAR BLOK SET COMPLETE

Fig. 23. In this photograph will be seen the method of using the Polar Blok system for building up a single-valve set using reaction. Aerial and earth wires are in the centre, and the set is ready for reception

and components in the ordinary type of cabinet if changes in wiring or arrangement are not likely to be required. Such a set is of permanent value.—*J. Laurence Pritchard.*

POLAR CONDENSER. Disk type of condenser with mica dielectric. One of the principal features of the disk type of condenser, of which the Polar condenser is an example, is that it takes up very little space behind the panel. This is very

this condenser whereby a knob-rotation of nearly 360° is obtained is clearly indicated in this illustration. See Disk Condenser; Polar Blok.

POLAR FLUX. In magnetism the flux produced by the poles of a generator or electric motor, that is, the magnetic field. See Dynamo; Flux; Generator.

POLARIZATION. Term used to denote the action of certain primary cells in the emission of hydrogen from one plate and its deposition upon the other plate, with resultant increase in internal resistance of the cell. For instance, take the case of a

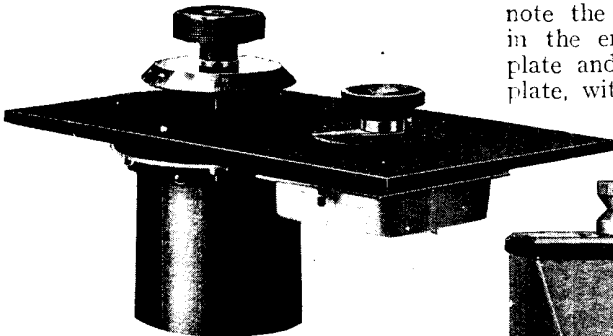

POLAR CONDENSER

Fig. 1. Mounted with an air condenser of the same capacity is a Polar condenser. The difference in size is very noticeable, and the advantage in space is at once obvious

Courtesy Radio Communication Co., Ltd.

clearly demonstrated in Fig. 1. Here a Polar condenser of $\cdot 001$ mfd. capacity is shown mounted by the side of a vane type of condenser of the same maximum capacity. The difference in volume of the two instruments is at once apparent.

The Polar condenser shown in Fig. 2 is mounted in a sloping cabinet of convenient shape. Connexions to the condenser itself are made by the two terminals shown at the top of the cabinet, which are mounted on a strip of ebonite. The feature of

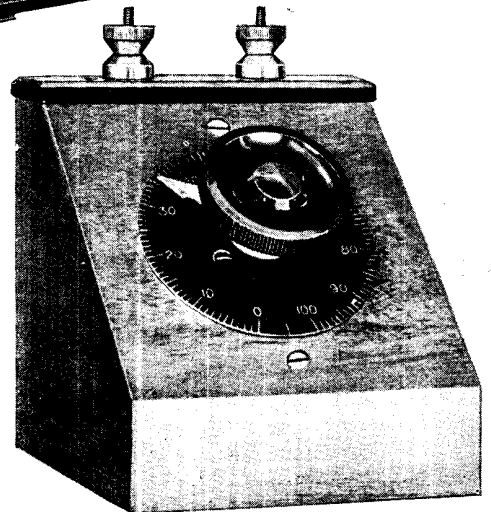

POLAR CONDENSER UNIT

Fig. 2. In this type of condenser there is a 360° rotation of the dial as compared with the more usual 180° . This allows of greater accuracy in use

Courtesy Radio Communication Co., Ltd.

simple cell having copper and zinc elements, and an electrolyte of dilute sulphuric acid. Should an attempt be made to take a large amount of current from this cell, then it would be found that hydrogen bubbles would appear at the copper plate. This is due to a molecular action within the cell whereby chemical separations and combinations take place, with a final action resulting in the deposition of hydrogen molecules on the copper element. Hydrogen possesses a high electrical resistance, with the natural result that the internal resistance of the cell is increased, for the effect is to surround the copper plate with an insulator.

In a cell of the simple type just described, polarization, as this chemical action is called, would very quickly render the cell practically useless, until it had been placed out of use, when it would soon recuperate. In the modern forms of primary cell, however, various devices have been incorporated in the electrical design to reduce polarization to a very large extent. The name given to such devices, which usually take the form of an additional chemical, is the depolarizer.

An excellent example of such a design is the well-known two-fluid type of Daniell cell. Here the positive element consists of a cylinder of copper containing a solution of copper sulphate. This solution is quite strong, and forms the depolarizer. A porous pot is placed in the centre of this copper cylinder, within which is the negative element of amalgamated zinc, surrounded by a weak solution of sulphuric acid. The copper sulphate solution is kept up to full saturated strength by means of copper sulphate crystals contained in a basket situated at the upper extremity of the copper cylinder. As the sulphate

solution is used up, it dissolves more crystals. See Accumulator; Daniell Cell; Depolarizer; Electrolytic Cell.

POLARIZED ELECTRO-MAGNET.

Name given to an electro-magnet whose core is permanently magnetized in one definite direction or polarity. In wireless work undoubtedly the most familiar example exists in the telephone receiver. Here the magnets are fitted with permanently magnetized cores, which are fitted with bobbins containing the windings. For this reason it is important that the direction of current through the magnet windings be of correct polarity, otherwise the cores will soon become demagnetized. It is essential in polarized magnets that the cores be made of hardened steel.

Electro-magnets may be polarized by having a strong permanent magnet adjacent to their own cores, although examples of this type are rarely found. See Electro-magnet; Magnet; Magnetism.

POLE. Word used in electricity and magnetism in a number of ways. A magnet has two poles, a north-seeking and a south-seeking pole, but usually erroneously known as the north and south poles respectively. A unit pole is one which is said to have unit strength when, if placed one centimetre away in air from another like and equal pole, the two will mutually experience a repulsive force equal to one dyne.

The positive and negative terminals of a cell are sometimes known as the positive and negative poles. See Charging Board; Consequent Poles; Dynamo; Flux; Generator; Magnetism; North Pole; South Pole, etc.

POLE-FINDING PAPER. Chemically prepared paper which is used to indicate the polarity of any direct current. This



HOW TO USE POLE-FINDING PAPER FOR TESTING CURRENT POLARITY

Pole-finding paper is chemically prepared paper used to indicate the polarity of a direct current. This photograph shows how the paper is used, the negative wire being that which causes the paper to become brown in colour

paper is usually manufactured in the form of a book, having perforated leaves divided into squares, so that conveniently-sized pieces of paper may be readily detached.

The method of using this paper is illustrated in the figure. Here it will be seen that the two wires, which represent both poles of the circuit, are placed upon the paper, great care being taken to see that they do not touch and form a short circuit. The wire which is connected to the negative pole of the circuit will cause a chemical action on the prepared paper, with the result that a dark brown mark will reveal

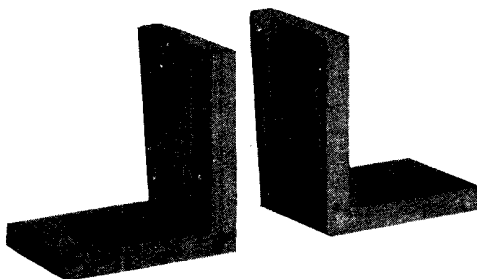

POLE-PIECES

Angle-shaped loud-speaker pole-pieces are illustrated. The lower portions of the laminæ above are riveted

Courtesy Joseph Sankey & Sons.

itself upon the removal of the wire. The positive will not leave any indication. It is therefore easy to tell the polarity of the circuit by this means. An alternative method to employ is to use a freshly cut potato. If the two ends of the current-carrying wires are placed $\frac{1}{2}$ in. apart on the moist surface, the negative pole will be quickly indicated by a dark stain. See Charging Board; Testing.

POLE MAST. Term generally applied to all types of aerial mast characterized by the fact that the mast is composed of one single element. In the example illustrated is seen a 3 in. diameter steel tube firmly jointed by means of screwed connecting sockets. At about one-third of its length a mast band is fitted, with another band at the upper end, to which are attached steel guy-wires, with their insulators, to maintain the mast in a vertical position. How to make such a mast is described under the heading Tubular Mast.

The twin-wire aerial is in this case supported on a light wooden spreader. The top of the mast is finished with a conical-shaped cap or finial, to prevent the entry of water to the interior. The whole should be well galvanized or painted before erection, and subsequently with regularity as is required to preserve it from rusting. See Aerial; Box Mast; Tubular Mast.

POLE-PIECES. Term used to describe a number of differently shaped pieces of metal, usually attached to a magnet winding to concentrate the lines of magnetic force or for constructional purposes. One example utilized in wireless work is illustrated, and

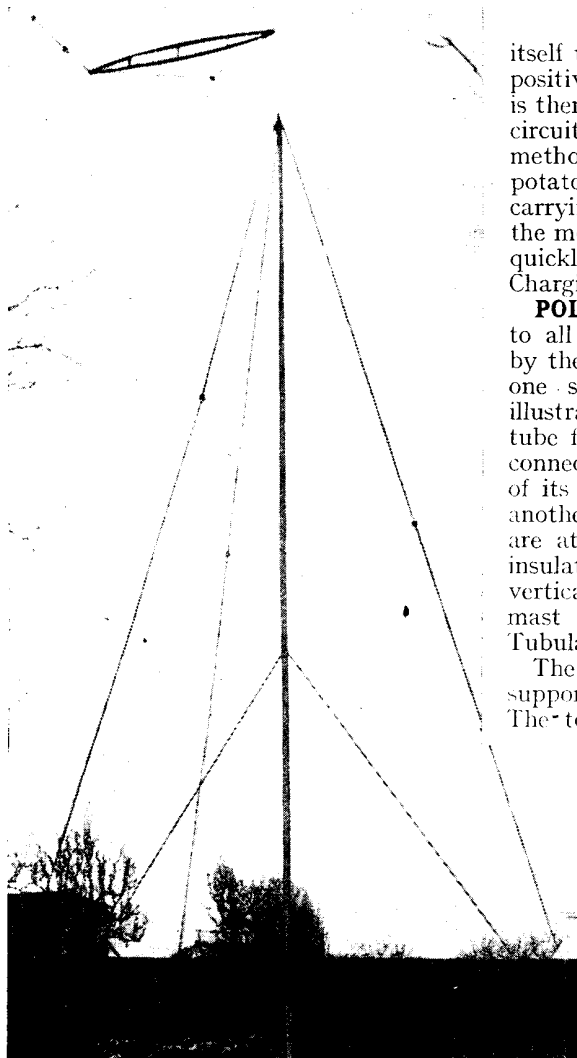

STEEL AERIAL POLE

Aerial poles or masts are sometimes of steel. This pole is 3 in. in diameter and is tubular. It is guyed near the centre and at the top

shows two L-shaped laminated pole-pieces made from special quality soft iron. These are used to form the pole-pieces of a loud-speaker mechanism.

The lower portions of the laminae alone are riveted; the upper parts, which tend to spring open, are constructed with a bobbin forced on to them, thus keeping them in position. The object in using the laminated pole-pieces in this way is to reduce the magnetic losses in the structure as a whole, and to add to the distortionless production of the music and speech, and for various other purely technical reasons

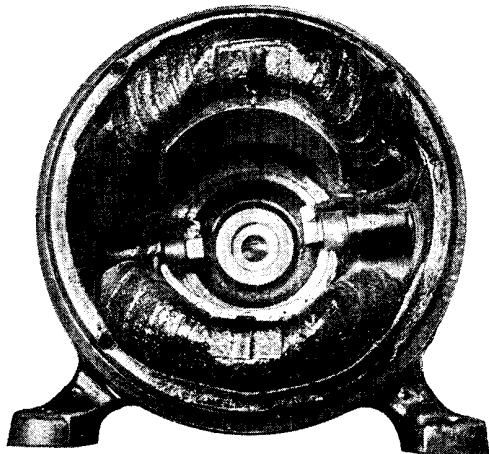

POLE SHOES

Fig. 1 (right). General shape of pole shoes. Fig. 2 (above). Projecting through the windings of a two-pole generator are the pole shoes

Courtesy General Electric Co., Ltd.

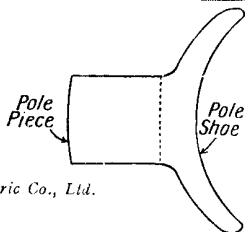

which are dealt with in the article on magnetism (*q.v.*). See Loud Speaker.

POLE SHOES. An extension fitted to the tip of a magnetic pole in order to increase the effective radius of the magnet. As a general rule, pole shoes are fitted only to electric generators and motors. Pole shoes may be added as an extra attachment to a pole, or, in the case of small examples, they may be made an integral part of the whole magnet. In either case the shape of the final product will approximate to that shown in Fig. 1, where the dotted line may be taken as the distinguishing mark between the pole-piece and the pole shoe.

The photograph, Fig. 2, shows the internal arrangements of a small two-pole

generator by the General Electric Co. In this picture the shoes may be seen projecting through the windings. It will be seen that in this instance they form an arc extending through approximately 90°. Apart from their magnetic properties, the

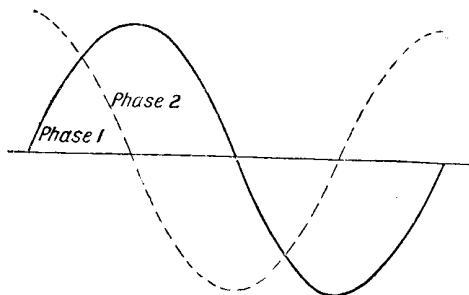

TWO-PHASE CURRENT

Fig. 1. Diagrammatic representation of two phases of current produced by the same machine

projections are useful in this case for preventing the windings (which are former-wound) from falling off the pole-piece.

POLYPHASE. Two or more alternating currents, invariably generated by the same machine, which are of the same frequency but not in phase with one another. For general practical purposes either two or three phases are used, and of these alternatives the latter is becoming the more popular amongst electrical engineers.

Figs. 1 and 2 are diagrammatic representations of two- and three-phase currents respectively. The two-phase current is

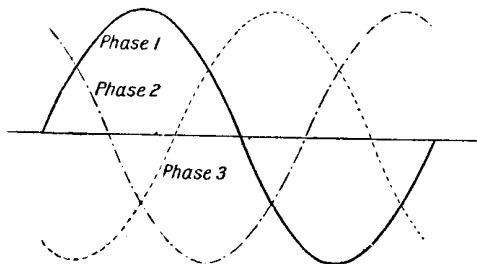

POLYPHASE CURRENT

Fig. 2. Three phases of an alternating current produced by the same machine are shown in this diagram

said to be out of step or phase by 90°, while a three-phase current is out of phase by 120°.

Three-phase circuits are always connected together in either one of two standard ways. One of these methods is known as "star" or "Y" grouping. The second system is known as "delta"

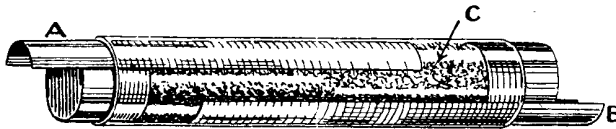

CONSTRUCTION OF A POPOFF COHERER

Fig. 1. Loosely packed metal filings (C) fill the glass tube of the Popoff coherer. A and B are platinum leaves

of "mesh" grouping. See Delta Grouping; Mesh; Phase.

POPOFF'S COHERER. Prof. A. S. Popoff, of Kronstadt, designed, in 1895, a filings coherer for use in the study of atmospheric electricity. The coherer consisted of a small glass tube loosely filled with metallic filings. Connexion was made to the filings by means of two thin leaves of platinum arranged on opposite sides of the tube, as shown in Fig. 1. The action of this coherer is the same as any similar type of imperfect contact coherer.

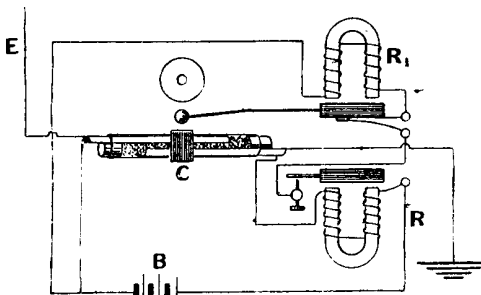

POPOFF COHERER CIRCUIT

Fig. 2. Popoff used this circuit for his coherer. E is the exploring rod, C the coherer, R the relay, R₁ the tapper, and B the battery

There is no evidence that Popoff used his coherer for the detection of electromagnetic waves, although he foresaw the possibility of its being used for this purpose. It was used, however, for the purpose for which it was designed, and in order to enable the circuit in which the coherer was included to return to its normal non-conducting condition after acting as a conductor, Popoff used a form of electromagnetic tapper. Fig. 2 shows the circuit used by Popoff. One terminal of the coherer was connected to a long rod, while the other terminal was connected to earth. Across the coherer was connected a battery, B, and a relay, R.

When an atmospheric discharge caused the coherer to become conductive, the battery, B, caused a current to flow through

the relay, R, and closed the contact, thus connecting the bell into circuit with the battery. The bell was so placed that the hammer, when vibrating, also tapped the coherer, thereby causing the coherer to become non-conductive and to be ready

for another atmospheric discharge. In parallel with the bell a telegraphic recording apparatus was connected, thus enabling a visible record of the discharge to be taken. See Coherer.

PORCELAIN. Name given to fine pottery of a partially translucent nature, usually glazed. Porcelain plays a large part in wireless work for the insulation of various parts of apparatus. It is shaped in the process of manufacture into convenient forms—for instance, more or less oval shapes for aerial insulators, and cup-shaped pieces for the support of panels and other parts of the apparatus.

It is also extensively employed for the bases of switches and other devices, the advantage being the ease with which it can be manufactured and fashioned into intricate shapes, with hollows, raised portions, and holes, for the reception of bolts and so on.

It is impervious to the action of the weather and impervious to the action of acids, with the exception of hydrofluoric acid, and as an electrical insulator has a very high value. It is not affected by any ordinary temperature likely to be met with in wireless work. See Egg Insulator; Insulation; Insulator, etc.

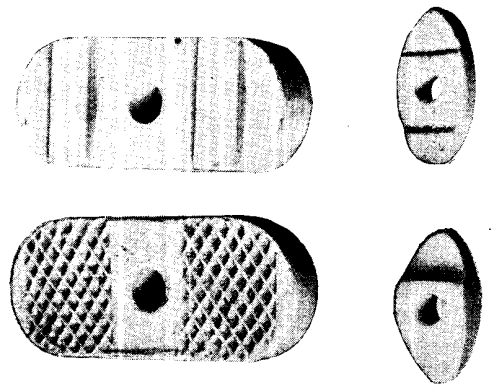

PORCELAIN CLEATS

Porcelain cleats are used for fastening conducting wires. There is an upper and lower part which are screwed together

Co. rtlesy Economic Electric Co., Ltd.

PORCELAIN CLEAT. Name given to a small, rectangular-shaped piece of porcelain employed for fastening conducting wires in electrical work. There are several different types of these cleats, all of them serving the same purpose. In the patterns illustrated the cleat takes the form of two elements. The larger is the outer or upper part, and covers the smaller or lower piece. Both are secured by a central screw which passes between the conductors, which are held in place by the shallow grooves or in the recessed portions of the two parts of the cleat. By these means the conductors are held firmly in position, and are insulated both from one another and from the surroundings. *See* Cleat; Insulation; Insulator.

PORCELAIN INSULATOR. General term used to describe all types of insulators made from porcelain, and to differentiate them from those made with other materials. The patterns most extensively used are those in connexion with the aerial system. Three examples are illustrated. *See* Insulator.



PORCELAIN INSULATORS

Three common examples of porcelain insulators are illustrated. These are all used largely in wireless work

POROUS POT. Name used to describe a type of container composed of some form of earthenware and used to separate some of the constituents of a primary battery. The example illustrated is the type used on the ordinary wet Leclanché cell. In this example the porous pot contains a mixture of black oxide of manganese, which surrounds a central element of carbon rod. The porous pot is placed in the centre of a larger glass container, wherein is placed the electrolyte. This gains access to the black oxide of manganese, so it can slowly percolate through the porous material of the pot. *See* Leclanché Cell; Primary Cell.

PORTABLE SETS FOR USE ANYWHERE

How to Construct a Set in a Suit Case Complete with Batteries and Aerial

Provided the construction is stable and a simple circuit, such as that described here, is adopted, it is not difficult to build a receiver that can be used anywhere at short notice at picnic parties and on other outdoor occasions. Portable pack transmitting and receiving sets for mule or horse transport are also described and illustrated. *See* Aerial; Crystal Receiver; Reflex Set, etc.

The object in designing a portable wireless set is to incorporate all the apparatus within the case, so that it may be set up ready for listening-in or dismantled with the minimum of time or trouble. These features must be accompanied with robustness of construction and absolute certainty of success in operation. Without the assurance that the set will meet these conditions, it is far more likely to be a burden to the picnic party or outdoor gathering than the somewhat novel luxury that the properly designed and constructed set should be. In the construction of a set, therefore, every care must be taken to ensure that it will not fail to work when called upon; and, to ensure this, no pains should be spared in ascertaining that all wires are firmly connected to their terminals and that the components are securely fixed in their positions.

Fig. 1 on the special plate gives an illustration of a portable set likely to meet general requirements. It is entirely self-contained, the telephones occupying a

space to the right of the set, the aerial and earth wire, and an earth pin used with the latter, being housed in the lid. The apparatus is built into an ordinary week-end case of stout fibre or leather which measures 15 in. by 11 in. by 5 in.

The set comprises one stage of high-frequency transformer-coupled amplification and rectification by a crystal detector, followed by a single stage of low-frequency amplification. This combination is sufficient to bring in at headphone strength local broadcasting up to 30 miles under conditions not at all favourable to good reception.

The aerial wire in the set described is composed of 50 ft. of rubber-covered flexible wire. There is a cheap brand of wire on the market suitable for this purpose which should not be confused with the much heavier rubber-covered wire used for car ignition. The latter variety is extremely expensive and too thick to permit the length required. One end of the aerial wire may be always attached

to the aerial terminal. The other end is secured to a small egg insulator, to which also is secured a length of blind cord or thick twine. This is used for attaching the aerial to a tree or other suitable elevated object.

The earth wire consists of the same wire as used for the aerial. One end of the earth wire may be permanently connected to the earth terminal, while the other end connects to the earth pin, of which details and method of fixing in the case are given later.

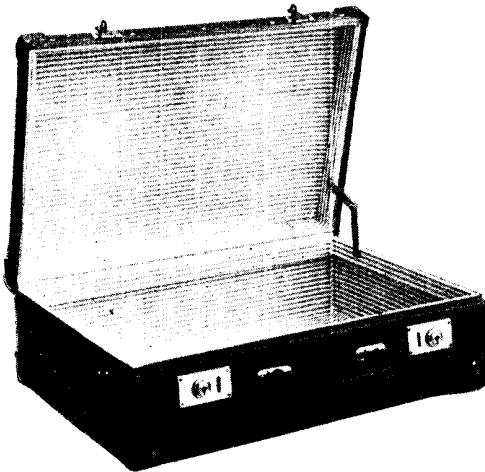

CASE FOR THE PORTABLE SET

Fig. 1. To hold the portable set a fibre week-end case of the kind shown in the photograph is very convenient

The valves used are Marconi-Osram D.E.V. These are dull emitters, and, as will be seen from the illustration in Fig. 2, are a radical departure from the ordinary type of valve. They are fitted into springy brass or copper clips, which form connexions with the electrodes of the valve. Once in position the valves need not be removed, as they can be carried quite safely in their clips, which obviates the necessity of extra space in the case. The low-tension battery used is a 3 volt Ever-Ready No. R479 and the high-tension battery a No. W19S of the same make, which gives 36 volts.

A convenient case is illustrated in Fig. 1, and was selected largely on account of the strength and durability of its fasteners. Many cheap cases are fitted with unreliable fasteners. These should be avoided, as considerable damage to the set might occur through the fasteners on the lid suddenly opening.

The case is partitioned with two lengths of $\frac{3}{8}$ in. deal. As shown in Fig. 3, one of the partitions extends the length of the case. It is secured to the case at its ends by means of 1 in. countersunk wood screws inserted from the outside of the case. The position of this strip is $6\frac{1}{2}$ in. from the front of the case. At a distance of $11\frac{1}{2}$ in. from the left side of the strip a channel is cut to a depth of $\frac{1}{8}$ in. which houses one side of the shorter of the two strips. The other end of the shorter strip is also secured from the outside. The underside of the partition strips is rounded off to the shape of the case. This is done by the trial and error method, where a guess at the correct curve is made and high parts planed off after offering up the strip to the case. The whole case should be placed on its side while fitting the curved sides of the strips.

A very good effect is obtained if the partition strips are covered with a material or papered to match the lining of the case. If this is done, however, it should be left until the whole of the woodwork has been fitted into position. Two fillets of wood, $\frac{1}{8}$ in. square are fitted to the panel partition to the left and front of the case, as is seen in Fig. 3. The ebonite panel is screwed to the top of the two partition strips and the fillets, so that the tops should be arranged flush with each other. The back of the telephone compartment may be left $\frac{1}{8}$ in. higher than the remainder of the long partition strip, so that when the ebonite panel is fitted it will come flush with the strip forming the back of the telephone compartment. This detail is shown in Fig. 4, where the ebonite panel is being offered up to its position.

The panel, which measures 11 in. in length and 7 in. in breadth, is $\frac{3}{8}$ in. in thickness, and should be selected with a matt surface on both sides. The panel is cut out and filed up to its size, when its edge should come flush with the outer sides of the two partitions. The filament resistances may now be fitted. They occupy a position 2 in. from the front edge of the panel and 2 in. from each of the shorter sides. The method of mounting the two filament resistances must of necessity vary with different valves. The majority have a $\frac{3}{8}$ in. brass bush protruding, which is pushed into a hole of similar diameter.

When in position the location of the holes for the fixing screws is made with a scriber, which is inserted into the fixing

holes of the filament resistances. Two blind holes are then drilled and tapped 4 B.A. and the screws inserted from the inside of the panel. This operation is shown in Fig. 5 on the plate facing page 1578. To the right in this illustration is seen the $\frac{3}{8}$ in. hole for the other filament resistance.

Any convenient type of variable condenser having a maximum capacity of .0005 mfd. may be used. Here, again, many different methods may be employed for fixing to the panel. A type now on the market has the outside of the condenser spindle bearing screwed, so that a nut fastens it to the panel by one central fixing. This type is recommended, if available. It very often happens that the experimenter has in his possession a variable condenser of the correct capacity but of the separate unit variety, which is in many cases extremely difficult to adapt for purposes of panel mounting on account of the shortness of the spindle.

Altering a Condenser for Panel Mounting

This condenser may often be altered to the panel-mounting type by removing the extremely thick condenser top-plate and replacing it with one cut from a piece of $\frac{3}{8}$ in. ebonite. A plate cut for this purpose should have a projecting lug left on either side of it by which it may be attached to the panel. The operation of mounting a condenser converted in this way is shown in Fig. 6.

The selection of a crystal detector used for rectification may be left to individual choice. If the experimenter possesses a detector of particular merit, it may be used in place of the type illustrated. For this purpose two holes are drilled near the detector, as shown in Fig. 2 of the completed set, so that the detector may be replaced with another if found inefficient. The detector is shown being fitted in Fig. 7.

To reduce the possibility of interaction with other parts of the apparatus, the transformer is mounted on two $\frac{1}{2}$ in. by $\frac{1}{8}$ in. brass brackets of a length to keep the transformer as far as possible from the panel, yet at the same time to keep it from contact with the side of the case. With a little adaptation, this principle can be applied to any other type of low-frequency transformer which may be used. The position of the transformer on the panel is shown in Fig. 8. Blind holes for fixing the transformer

brackets to the panel should not be trusted. Although at the expense of appearance, these brackets should be fixed with 4 B.A. countersunk screws, the heads of which are carefully sunk flush with the outside of the panel. These brackets are now secured with nuts on the inside.

The high-frequency transformer and its method of mounting next claim attention. A Sterling H.F. transformer suitable for broadcast wave-lengths is used. This is fitted with a novel method of tuning which takes the form of a damping plate of metal rotatable at a point on its circumference by a small ebonite knob.

As the set is designed purely and simply for broadcast wave-lengths, there is no objection to fixing the transformer permanently to the underside of the panel. This may be done by carefully drilling a 6 B.A. tapped hole at each corner of the transformer. A large hole is drilled in the centre of the panel and towards the back, through which the operating knob of the damping plate is passed. Two countersunk holes are drilled through the face of the panel which allow two 6 B.A. by $\frac{3}{4}$ in. countersunk screws to hold the transformer in position through the tapped holes already drilled. Care must be taken, in mounting the H.F. transformer, that sufficient room is allowed to enable the damping plate to swing clear of the transformer. The position for the H.F. transformer on the underside of the panel is shown in Fig 9 on the special plate.

Assembling the Aerial Tuning Coil

The only component remaining to be assembled is the aerial tuning coil. This, again, is permanently fastened into position to the inside of the set. A brass bracket is again used for this purpose, and is very similar in construction to the pair made to support the L.F. transformer. The coil may either be purchased or made according to the instructions under the heading Basket Coils. The aerial tuning coil is further strengthened by four bands of insulating tape, such as Empire cloth. In mounting the coil to its bracket, two washers of thin ebonite are cut and placed on either side of the coil. A central hole in these washers permits a 6 B.A. screw, passing through a hole in the brass bracket, to clamp the coil, a nut being used on the other side of the screw.

At this point it is as well to test the components for mechanical strength and

perfection. The condenser should be rotated to its maximum extent, to ensure that the plates do not touch. The filament resistances should also be turned, to ascertain that they move smoothly yet without any slackness. A spot of oil will greatly assist in this direction if applied in moderation to the actual moving parts of the components.

The two D.E.V. valves which, as previously stated, are used in the set, are mounted to the back of the panel so that they are in line with each other. Special clips are sold in which these valves are mounted, and these clips should be purchased with the valves. If the clips, however, are not available, the completion of the set need not be delayed, as they can easily be constructed from No. 22 gauge sheet brass.

The filament connexions of these valves are at either end, which consist of point-ended brass cups. The anode and grid connexions, which are on the side of the valve, have flat-ended cups. Two brass clips are therefore necessary. These are shown dimensioned in Fig. 13. The clips

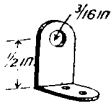

Fig. 13. Brass clip for portable set valves

are secured to the panel by means of 6 B.A. screws, of which one in each clip is longer than the other, and this longer screw is tightened up with a nut on the inside of the panel. The object of this is to allow a connecting wire to be soldered to it. In order to differentiate between the anode and grid connexions on the valve, the former is painted green.

When the clips have been made and assembled, which process is seen in Fig. 10, the valve is inserted, and if there is any tendency to slackness of fit, the valve should be removed and the slack clips bent in a little more. The valves can now be removed until the set is ready for testing.

Two hole-type terminals are placed to the right-hand side of the set so that they are convenient to the partition in which the telephones are carried. Battery terminals, of which three are required, are also placed close to the battery partition. These terminals are shown being fitted to this panel in Fig. 11.

The terminal to the left connects to high-tension positive the centre terminal to the negative side of that battery, and to the negative side also of the low-tension battery. The positive terminal of this battery connects to the terminal on the right. The aerial and earth terminals are placed respectively to the back and front of the left-hand edge of the panel. The positions of these terminals are given when the set is in the position shown in Fig. 2, that is, when the handle of the case is to the front and the open lid at the back.

If the experimenter is not accustomed to wiring up the more complex wireless circuits, he is recommended to tackle the problem piece by piece, and thus develop the wiring until it is completed. The wiring diagram of the set is given in Fig. 14, and lends itself extremely well to this method of wiring. It is a good plan, when working from a wiring diagram, to cross off all wires that have been connected. By this process of elimination it is not so easy to overlook any obscure connexions. Particular care should be taken to see that all connexions are soldered, and that no long lengths of wire are allowed to swing about loosely, as this will result in their becoming broken in time.

Having completed the wiring, all soldering paste or other foreign matter is carefully removed and the set screwed down to the partitions and fillets by means of wood screws placed at regular intervals along the edges. The earth pin consists of a $14\frac{3}{4}$ in. length of $\frac{1}{2}$ in. square steel rod which is tapered at one end to a point. At the other end a large brass terminal is screwed and soldered to the rod, which is shown with the terminal attached in Fig. 15.

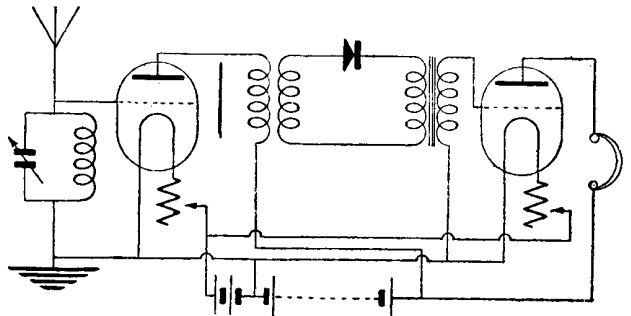

WIRING DIAGRAM OF PORTABLE SET

Fig. 14. Between the H.F. valve and the air-core transformer is a damping-plate. This is used as a method of tuning. The plate is rotated at a point on its circumference

The earth pin occupies a position at the top of the lid, as shown in Fig. 16. It is held in place by means of two brass clips fastened to the case with bifurcated rivets.



PORTABLE SET EARTH PIN

Fig. 15 (above). Fitted to the earth pin is a terminal for attachment of the earth wire. Fig. 16 (below). How the earth pin is clipped in at the top of the case lid

The lower corners of the lid of the case are occupied by two hanks of wire and a coil of stout string or blind cord. The aerial wire housed in the corner to the right-hand side of the set has a small egg insulator attached to one end, and the free end connects to the aerial terminal. One end of the hank of blind cord is also attached to the insulator. The hank of blind cord, together with a small coil connecting the earth pin to the earth terminal, occupies the left-hand corner of the lid. The method of securing the coils in position is clearly shown in Fig. 17, which shows the left-hand corner of the lid with a coil of wire fitted. The high- and low-tension batteries are now placed in their partition at the back of the case. Any tendency to rock about may be corrected with a slip or two of corrugated paper.

For the first test, the set should be attached to a good outdoor aerial, so that the best spot on the crystal may be found, and any adjustments made to secure maximum signal strength. If such an aerial is not available, the aerial wire used may be placed as high as possible—Fig. 12 on the plate. The earth pin should be placed in damp ground, which has much better conductivity than dry earth.—*W. W. Whiffin.*

Portable Pack Set. A form of portable set, very suitable for military work in mountainous regions, is the "Pack" set illustrated in Figs. 18 to 24. Fig. 20 shows the whole set packed up ready for transport by five animals—generally mules. It will be seen that everything, from aerial masts to engine and generator, is included in this

equipment. The masts are in short sections, each one telescoping into the next.

As far as possible the set is arranged in units of equal weight, so that each animal is given a similar load to carry. In each case a saddle is placed on the back of the mule, and over this saddle is a tubular steel framework, upon either side of which the parts of the apparatus are carried. The framework supporting the engine and generator is of much stronger construction than the others, for, as is shown in Fig. 18, it has to preserve these machines in alignment whilst they are working.

Fig. 19 shows an arrangement of the pack set ready for working. The picture illustrates an arrangement suitable for use in a tent or building. On the left is shown the framework supporting the $2\frac{3}{4}$ horsepower Douglas air-cooled engine and generator. It will be seen that these units are directly coupled by means of a long shaft running right across the framework. The engine has petrol and oil tanks situated just above it, and a starting handle may be seen attached to the lower portion of the crank-case.

The set in Fig. 19 has a switch and meter board inserted in the lead from the generator to the set. Plug-in connectors

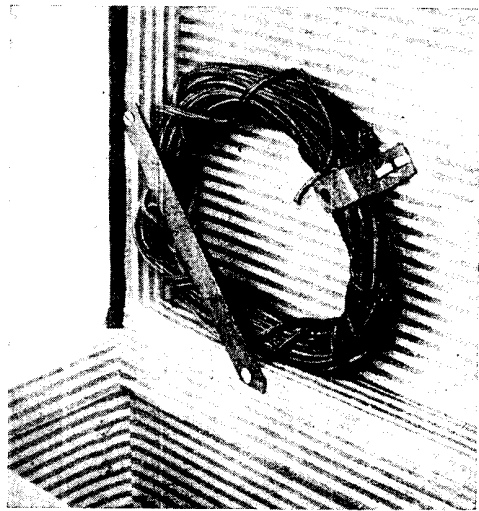

AERIAL OF PORTABLE SET

Fig. 17. In the left-hand lower corner of the lid is carried the coil of aerial wire. This is held in position with a brass strip and clip

PORTABLE SET AS USED ON EXPEDITIONS

Fig. 18. Where a table is available, as in a large tent, the portable set is erected in this way. Note the tubular steel framework, which is specially designed for fitting the saddle of a mule

Courtesy Marconi's Wireless Telegraph Co., Ltd.

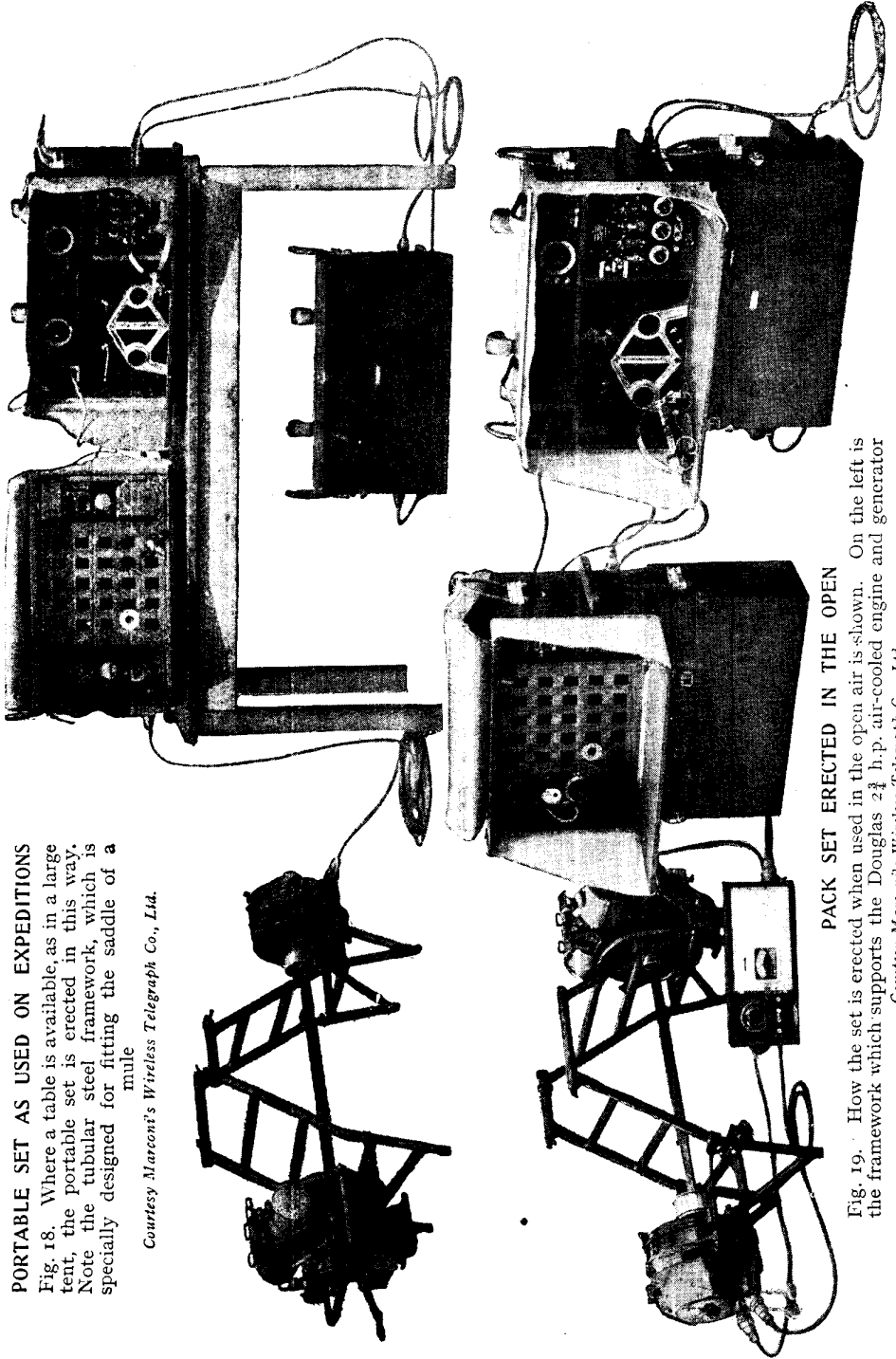

PACK SET ERECTED IN THE OPEN

Fig. 19. How the set is erected when used in the open air is shown. On the left is the framework which supports the Douglas 2½ h.p. air-cooled engine and generator
Courtesy Marconi's Wireless Telegraph Co., Ltd.

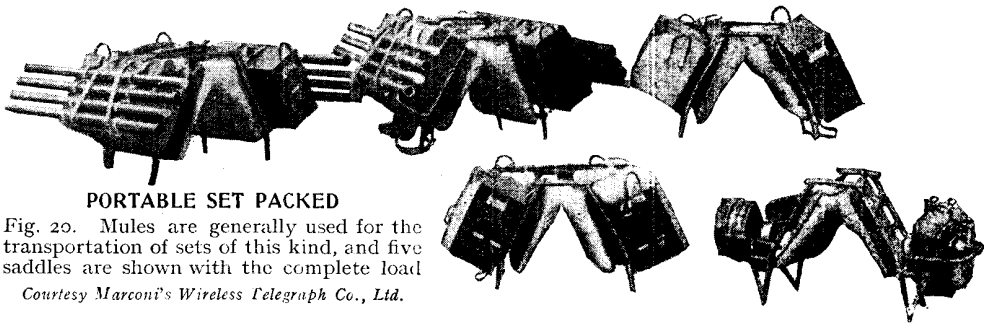

PORTABLE SET PACKED

Fig. 20. Mules are generally used for the transportation of sets of this kind, and five saddles are shown with the complete load

Courtesy Marconi's Wireless Telegraph Co., Ltd.

are used throughout to save time making connexions. The generator is a compound one, which supplies both low tension and high tension for both sets. It is totally enclosed to preserve its internal mechanism from dust and damp.

Fig. 21 shows the transmitter. It will be seen that the side of the cabinet folds down, and forms a convenient desk for messages, reports, etc., and also a support for the tapping key. The left-hand side of the transmitter cabinet houses the tuner. Here are fixed the controls for the aerial inductance and reaction. An aerial ammeter of the hot-wire type is also fitted. The valves are housed in the centre compartment behind the trellis screen. The latter cannot be removed without breaking circuit, and the button shown to the left of the screen must be depressed before attempting to obtain access to the interior.

An interrupter is shown on the right of the cabinet, immediately above the voltmeter. The latter reads from zero to 150 volts. Below the voltmeter is a switch which changes over the aerial circuit from send to receive.

Fig. 23 is an enlarged view of the receiver cabinet. The receiver is a four-valve instrument, comprising two high-frequency amplifiers, a rectifier and one stage of low-frequency amplification. Following standard Marconi practice, V24 valves are used for amplifying and "Q" for detecting. Below the valves are the knobs for the filament resistances and potentiometer. The tuner controls are arranged in a separate panel at the top of the cabinet, to the right. Only three controls are fitted, these being a condenser, note adjuster and reaction. A switch is provided which allows long and short wave-length signals to be received.

To the left of the receiver is shown a large transformer having a cast-metal frame. A small tapping key is also fitted

in this cabinet, this being shown in front of the receiver panel.

Fig. 24 is an illustration of a small portable transmitting and receiving set by Marconi's Wireless Telegraph Co., Ltd. Both transmitter and receiver are housed in the large wooden cabinet shown on the left-hand side of the picture. The transmitter is arranged for either C.W. or telephony working, the key for the former being shown on the bottom of the cabinet, to the left of the transmitting valve, and the microphone for the latter resting on the bench. The left-hand compartment contains the transmitter tuner and current-supply terminal board. Two long ebonite handles projecting through two slots in the woodwork are for varying the transmitting wave-length and resistance, respectively. A switch to the right of the main transmitting valve is for changing over from send to receive.

The receiver is a three-valve instrument employing V24-type valves for high- and low-frequency amplifying, and a "Q" for rectification. It should be noted that the central valve is inverted with respect to the others, as this arrangement allows of a smaller panel being used without any capacity effects due to adjacent contacts.

Above the valves are two knobs controlling the A.T.I. and reaction, while below them are two filament resistances for both transmitter and receiver.

The batteries shown below the bench are for the filaments of both instruments, and also for the high-tension supply to the receiver. The latter supply for the transmitter is obtained from the hand generator shown to the right of the main cabinet. This is intended to be driven at an average speed of 80 r.p.m., but practice in its use is required to obtain good results, for when running under load the power required varies, and to keep the

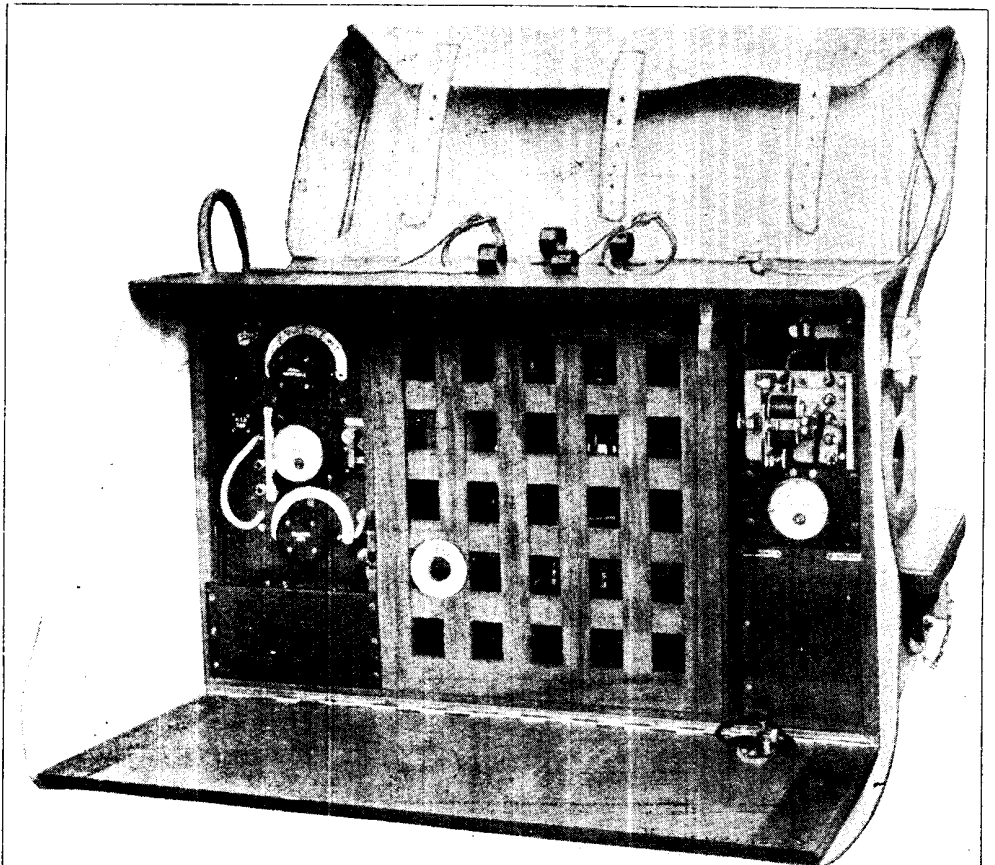

Fig. 21. With the side of the cabinet folded down the transmitter of the portable pack set is seen. The side forms a convenient table for taking down messages

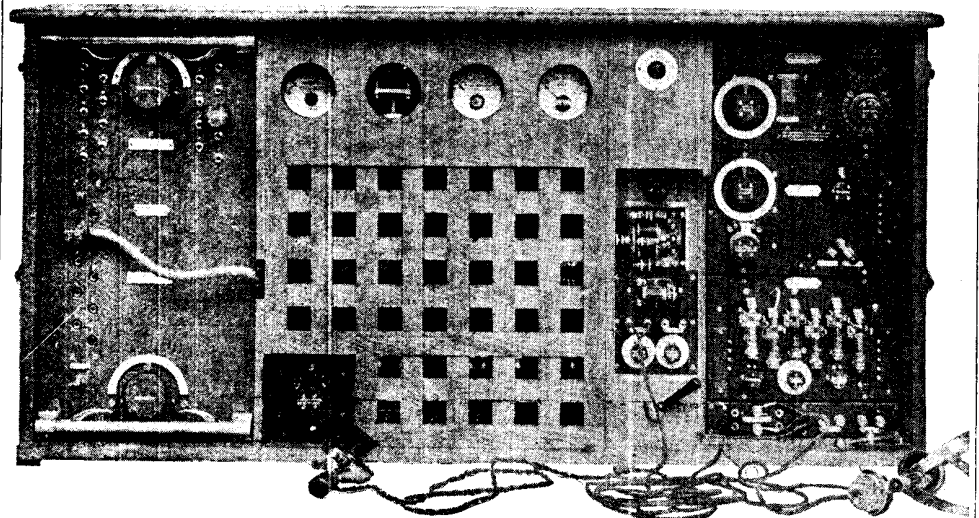

Fig. 22. Marconi's portable set in this photograph is known as type YC2. This is a combined transmitter and receiver housed in one cabinet. The transmitting gear is behind the trellis screen
Courtesy Marconi's Wireless Telegraph Co. Ltd.

DETAILS OF THE PORTABLE TRANSMITTER AND RECEIVER