

24

Final Part with Index. Order Your Bindings NOW!

1^s/₃^d

HARMSWORTH'S WIRELESS ENCYCLOPEDIA

For Amateur & Experimenter

UNI—ZIR

CONSULTATIVE EDITOR
SIR OLIVER LODGE, F.R.S.

Among the Contents of this Part are
VALVES FOR RECEPTION
by Dr. E. V. Appleton
VALVES FOR TRANSMISSION
by Dr. W. H. Eccles
WIRELESS WAVES
by Sir Oliver Lodge

Special Photogravure Plate :
RECEIVING SET WITH MYERS VALVES

COMPLETE CLASSIFIED INDEX

**Back Numbers to Complete Your Set
Can Still be Obtained!**

*J. LAURENCE PRITCHARD, F.R.Ae.S., Technical
Editor, with expert editorial and contributing staff*

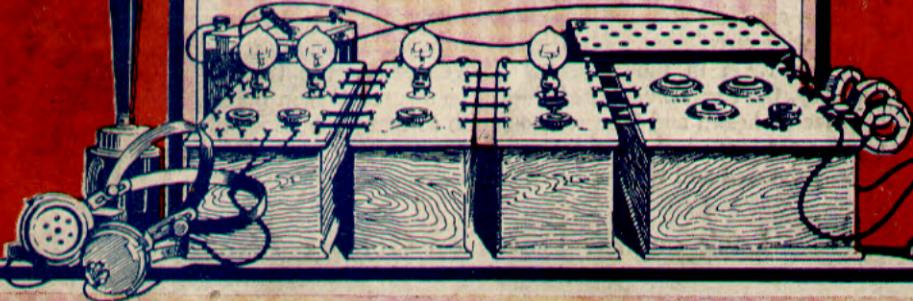

See Important Announcement "To Our Readers" Overleaf



Fig. 9. The neatness and compactness of this set, and the robustness of the Myers valves, make it particularly suitable for out-of-doors use

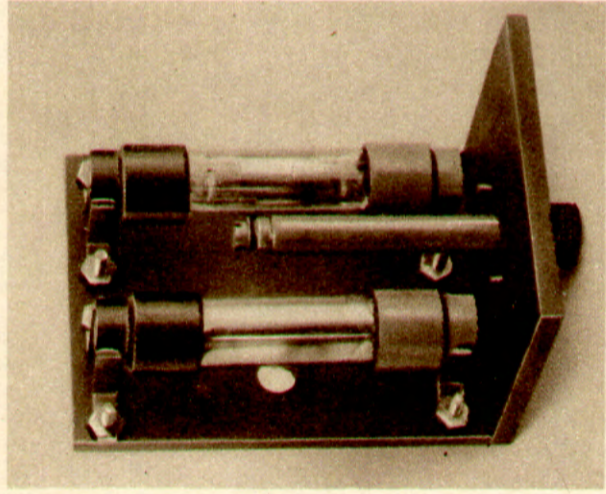

Fig. 10. How the Myers valves are mounted. The grid leak is shown between them

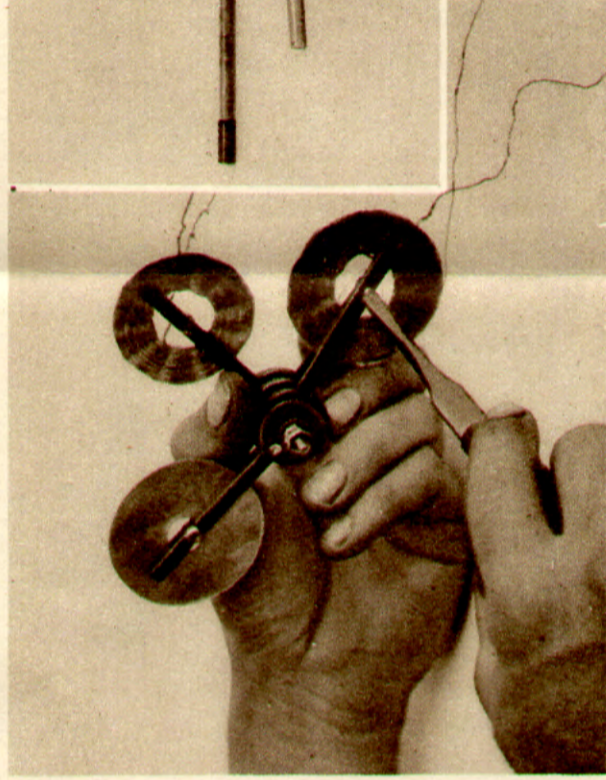

Fig. 11. Here are shown the two basket coils, forming the aerial coil and reaction coil, and the spade-tuning plate used in the receiver

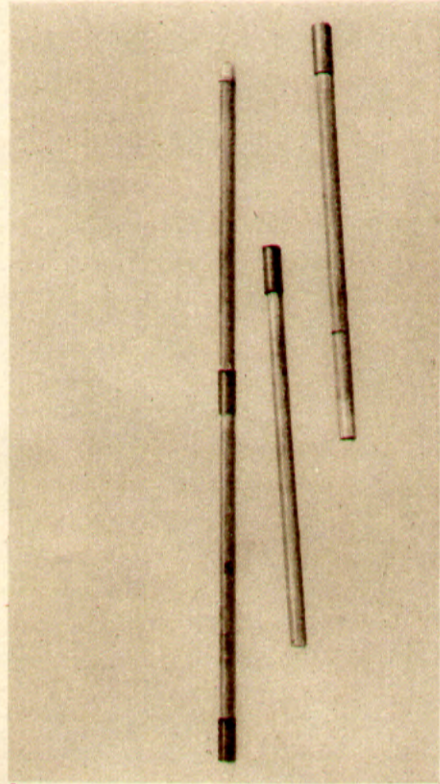

Fig. 12. Four telescopic rods, such as those illustrated here, are used to make the frame aerial

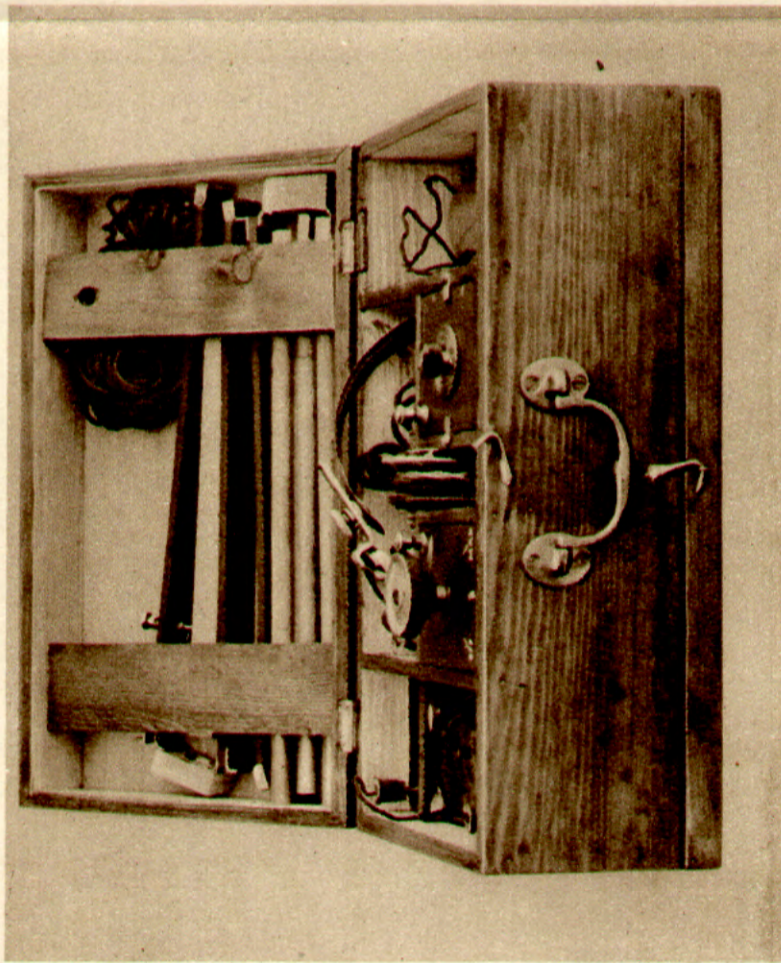

Fig. 13. Completed set built with Myers valves. The frame aerial packs in the lid of the case, which also holds batteries and telephones

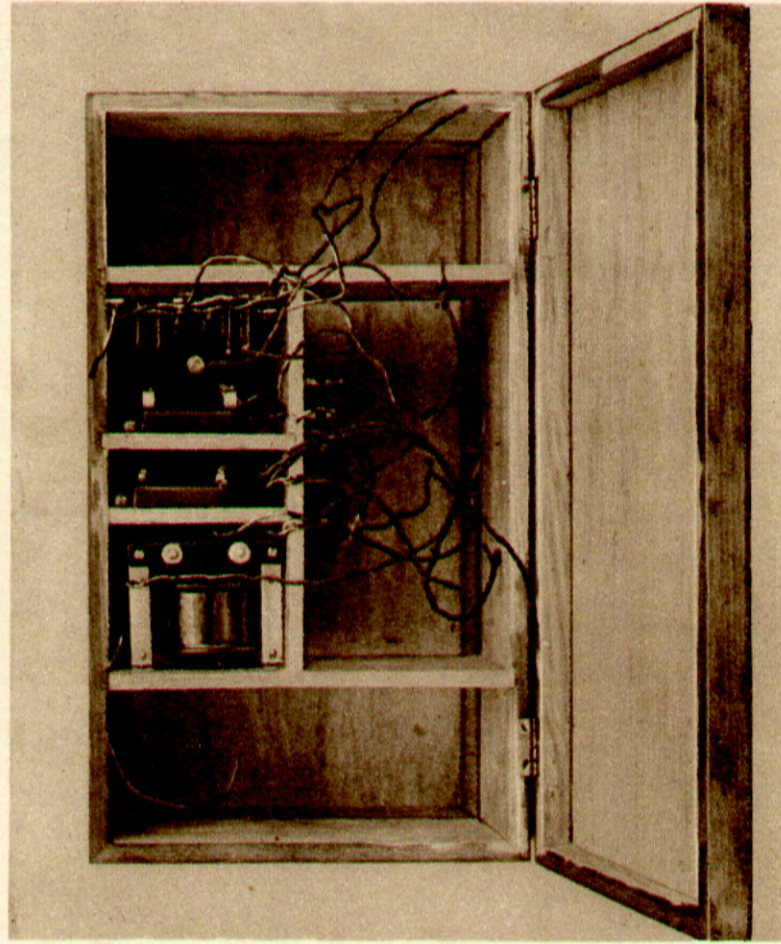

Fig. 14. Here are shown the compartments for the valves, grid leak and condenser, filament resistance and transformer, and the aerial and reaction coils



Fig. 15. Detail of the special holder for basket coils and spade tuner

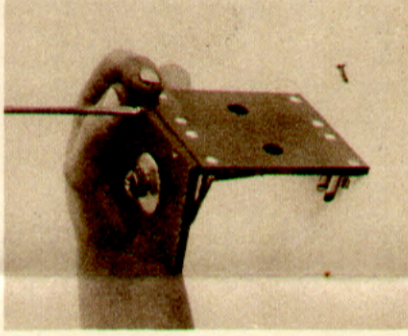

Fig. 16. Making up the valve panel and grid-leak support

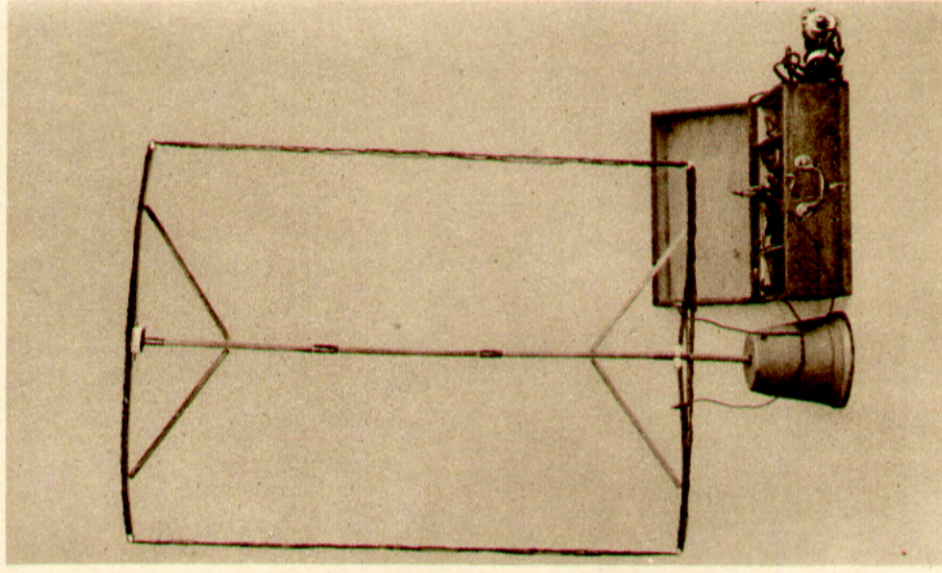

Fig. 17. Completed set erected and laid out for use indoors. Note the neat frame aerial

VALVE RECEIVING SETS: SUCCESSIVE STAGES IN THE BUILDING-UP OF A NOVEL AND EFFICIENT TWO-VALVE PORTABLE RECEIVER, USING MYERS VALVES

To Our Readers

SOME little time ago, in connexion with one of our other fortnightlies, a schoolmaster in Australia wrote to me that he was so delighted with the various part publications issued by this house that he felt he could only express his opinion by saying "If it's Harmsworth's, it's good."

AS the editor who has been responsible for so many of these works I was greatly pleased to have this very high testimony to their usefulness, and I am glad to say that my readers in all parts of the world are good enough to leave me in no doubt as to the high value they place upon HARMSWORTH'S part publications, by writing letters of appreciation, suggestion or helpful criticism.

OUR WIRELESS ENCYCLOPEDIA, the very first work of its kind to be published—immeasurably more comprehensive than any of the multitudinous books on the same subject that have appeared in this country or in the United States—has differed from most of our part publications in being limited to one, and that a highly specialized, subject. Yet I think we have succeeded in presenting every feature of Wireless as it is known to-day with the most illuminating detail and in a manner so attractive that even stark technicalities have become interesting.

WITH the completion of the WIRELESS ENCYCLOPEDIA and the concluding of the very famous HOUSEHOLD ENCYCLOPEDIA, my readers will rightly suppose that we are likely to be coming before them at an early date with new enterprises. Within a very few weeks they will see announcements of another HARMSWORTH fortnightly, and although it will have no remote association with Wireless, it will probably attract many of those who have been subscribing to the popular work, in the concluding part of which these notes appear.

THIS new publication, the title of which is to be HARMSWORTH'S HOME DOCTOR, will be found of engrossing interest to all who are in search of physical fitness. Within recent years there has been a very definite and growing movement in favour of raising the physical standard of the nation, and nothing that has been attempted in a literary way so far can be said to have offered anything comparable with the practical help provided in HARMSWORTH'S HOME DOCTOR.

IT is an entirely new work, every line of it written by eminent and experienced general practitioners and specialists in medicine and surgery and physical culture. Utterly free from all pruriency, splendidly illustrated with thousands of new and specially taken photographs, there is really no one who can fail to benefit by a study of its pages, so that I anticipate for it a very wide circulation. All Wireless enthusiasts who know what we have done for them in the WIRELESS ENCYCLOPEDIA—the thoroughness, the accuracy, the suggestiveness of it—can be assured that in the larger sphere of personal health and fitness, into which so many thousands of considerations enter, we shall provide in HARMSWORTH'S HOME DOCTOR a work equally detailed and vastly wider in its scope.

J. A. H.

Look out for Part I on October 14th.

the wood of the baseboard to avoid risk of their short-circuiting.

The intermediate connexions between the units, when needed, are best made with No. 16 gauge insulated copper wire. A small stock of these connecting wires can be cut to lengths of 6 or 7 in., and kept on hand with ready prepared bared ends to save time. A convenient number of units, enabling practically any two-valve circuit, with or without crystal detector, to be put up, should comprise two tuning units, two valve units, one low-frequency transformer unit, one crystal detector unit, one telephone connexion unit, one grid leak and condenser unit, and one or two fixed condenser units, although a greater or less number can be built at the start, according to circumstances.

Some possible combinations are illustrated in Figs. 17 to 24. Fig. 17 shows three units set up to form a complete

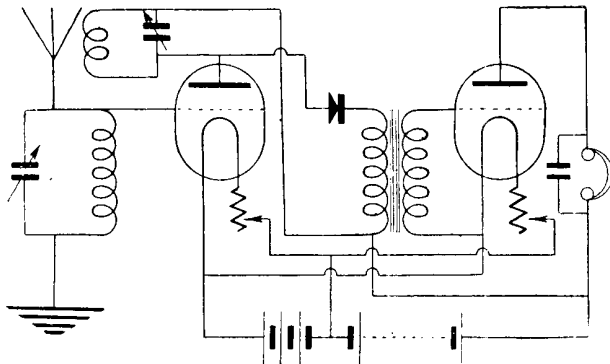

TWO-VALVE SET WITH UNIT COMPONENTS

Fig. 23. In page 2170 is shown the complete two-valve universal set with crystal detection, for which this is the circuit

crystal detector, while Fig. 19 shows the theoretical circuit diagram. It will be noted in this case that as no batteries are needed, one of the bus bars can be used for the aerial connexion and the other for the earth connexion, the only bridging wire that is needed being that between one side of the crystal detector and the telephone unit, the telephones themselves being attached to terminals thereon. In use a coil of appropriate value should be plugged into the coil holder. For ordinary broadcast reception on an average aerial, this may conveniently be a No. 2½ Burndept or a 35 or

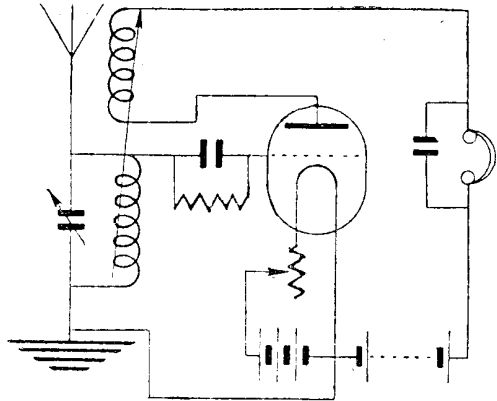

REACTION WITH UNIVERSAL UNITS

Fig. 22. This circuit diagram illustrates the connexions for the single-valve set with reaction, shown in Fig. 21

50 honeycomb. The crystal is adjusted to a sensitive spot, and the signals tuned in by the rotation of the condenser knob in the usual way.

A set up for a single-valve set is shown in Fig. 18, and the corresponding theoretical circuit diagram is given in Fig. 20. In this case the length of the baseboard permits the accumulator and high-tension battery to stand at either end, and the aerial and earth connexions are made direct to the coil holder, the bus bars being used for the high- and low-tension battery current distribution purposes, as already explained. The units employed are one tuning unit, grid leak and condenser unit, and the valve and telephone units.

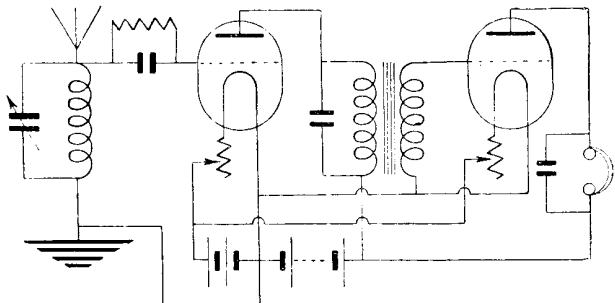

NORMAL TWO-VALVE CIRCUIT

Fig. 24. When the experimenter wishes to construct an ordinary two-valve set he will find that it is quickly set up with the universal unit set

The only bridging wires in this case are those from the aerial side of the plug-in coil holder to one side of the grid leak and to the grid terminal of the valve unit. Another bridging connexion is made between the anode terminal of the valve unit and one side of the telephone unit.

If it be desired to make a single-valve set with reaction, the same units are employed, with the addition of a second tuning unit, which in this case is used for reaction purposes. This arrangement is shown in Fig. 21, and the corresponding theoretical circuit diagram in Fig. 22.

It will be noted in this case that the units are turned around so that the two coils are facing each other, the variation of coupling being effected by sliding the aerial tuning unit nearer to or farther from the reaction unit, thus providing the requisite adjustment in an efficient manner.

Another system consists of a stage of tuned-anode high-frequency amplification with reaction on to the aerial. Rectification is by a crystal detector, which is followed by a stage of low-frequency amplification. The circuit arrangements are shown in the theoretical circuit diagram in Fig. 23.

Many other circuits can be put up without altering the units, their number being practically only limited by the time and patience of the constructor.



VACUUM. Space that has been emptied of all ponderable matter. In wireless the term is most generally used in connexion with valves and vacuum tubes. There is no such thing as a completely exhausted vacuum vessel, though a very high state of rarefaction may be produced by several means.

It is important in wireless, as well as in the study of the phenomena of vacuum tubes, that the vacuum should be maintained constant, or should be controllable in some way. Valves which contain any amount of gas give very different results from those which are almost entirely free from gas. A valve which contains a fairly large amount of gas is said to be soft, and one in which the vacuum is high is said to be hard. Nearly all the early valves, including the famous Round valve, were soft vacuum valves. See Round Valve; Valve.

VACUUM TUBE. Glass tube made in various shapes and filled with air or gases at pressures below that of the atmosphere. The pressure in any particular tube, as the cathode ray tube, may be considerably below that of the atmosphere, *i.e.* the vacuum may be high. There are many types of vacuum tubes. All have two or more electrodes fused through the glass of the tube so that electric charges may be passed through the tube. The effect of a high potential in a rarefied gas is to cause the interior of the tube to glow, the character and colour of the glow varying, naturally, with the nature of the contents.

The investigation into the character of the glow led ultimately to the discovery of X-rays and other rays, and the study of the rays now known to be given off when the tube is electrically excited has led to many further discoveries which have a most important bearing not only on an understanding of the nature of electricity, but also on the ultimate constitution of matter. See Cathode Ray Tube; Crookes's Tube; Electron; Geissler Tube; Ultra-violet Rays; Valve.

VALLAURI, GIANCARLO. Italian wireless authority. Born in Rome, 1882, he was educated at the Polytechnic School in Naples, making a special study of electricity. He was appointed lecturer in succession to the Polytechnic schools of Padua, Karlsruhe and Naples, and adviser to many commercial electrical firms. He inaugurated in 1912 at Naples one of the earliest courses in wireless telegraphy. In 1916 he was placed in charge of the Institute of Electricity and Wireless Telegraphy of the Italian Navy, and shortly afterwards was appointed professor of electrotechnics at the University of Pisa, and in charge of the supervisory work for the great wireless station of Coltano-centre. He is the author of a frequency doubler which employs a special three-leg transformer with two primary windings and two secondary windings on each of the two outer limbs and a common magnetizing winding on the central limb. Vallauri has made a special study of ferromagnetic phenomena, and has published a series of papers on ionic valves and other subjects connected with wireless.

VALVE HOLDER. Term used to describe a small component for the reception of a thermionic valve used in wireless work. The bulk of the valves employed by the amateur are of the standard four-pin,

three-electrode pattern, and the holders are generally composed of ebonite, either moulded or machined from the solid. In some cases ebonite substitutes or other compositions are employed. It is usually considered that the genuine ebonite holders are to be preferred on the score of good insulation.

to reduce capacity losses as much as possible, and consists of an ebonite plate with four sockets mounted upon it, each socket having a single metal contact to which connexions are made by means of round-headed screws and washers. Valve holders for Myers valves, and some of the Marconi and other makes which are

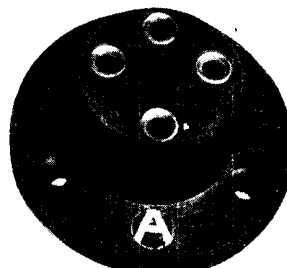
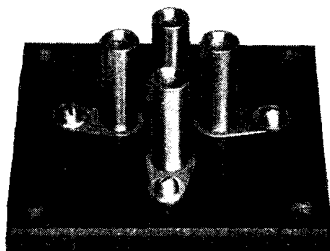
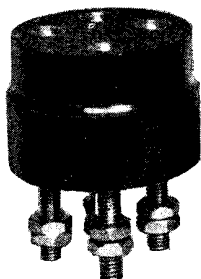

TYPES OF VALVE HOLDERS IN COMMON USE

Three varieties of ordinary thermionic valve holders are shown here. Left to right they are: the ordinary solid type, panel-mounting type, and the flanged variety, also for panel mounting

Courtesy Veto-Scott Co., Ltd.

Three useful types are illustrated. That on the left is the ordinary solid pattern, in which a circular piece of ebonite supports four valve sockets provided with nuts wherewith to fix the holder to the panel, and also to receive the ends of the connecting wires. On the right is a standard flange-type holder, the plate or anode terminal of which is clearly marked with the letter A. Connexions are made by soldering to the underside of the sockets, the wires passing through grooves formed in the flange.

arranged to be mounted parallel with the surface of the panel, usually employ four separate angular strips of metal, suitably shaped in accordance with the shape of the pins or terminals on the valve itself. See under the titles of the particular valves in this Encyclopedia, and also under Portable Receiving Set; Valves.

VALVE LEG. Name given to a small but very useful component chiefly employed by the amateur in the construction of various pieces of apparatus in which the pins are employed in conjunction with sockets to make a form of readily

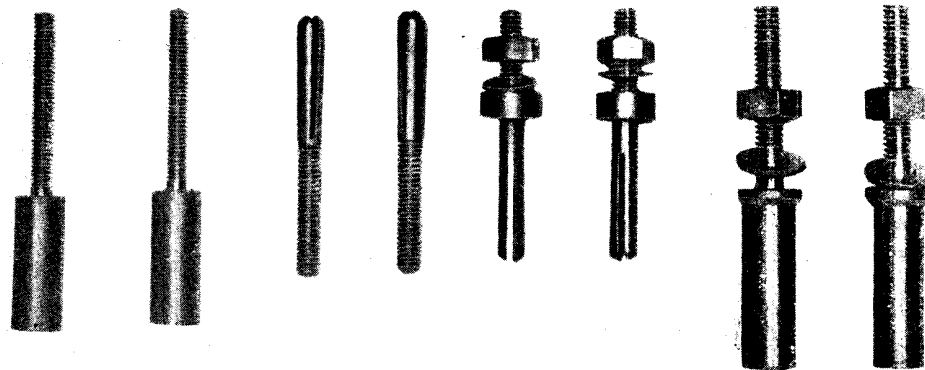

VALVE LEGS FOR USE IN WIRELESS CONSTRUCTION

Above are illustrated various common types of valve legs and their corresponding sockets. The amateur will find these extremely useful in construction for quick contacts

detachable connexion. Valve pins and sockets as usually supplied are illustrated. Four pins are shown in the centre. Those which are simply screwed are usually employed in valve caps and other small places. When provided with a collar and a washer they can be attached to ebonite plates and other devices for the construction of various plug-in contacts.

VALVE OSCILLATOR. Name given to a reaction or regenerative circuit so arranged and tuned that the coupling between the anode and the grid circuits is sufficient to

maintain a continuous interaction. *See* Armstrong Circuits; Oscillator; Reaction; Regeneration.

VALVE PANEL. Term used to describe a panel on which are erected the various components for the reception of valves in a wireless set. In large transmission stations the expression "valve panel" is often applied to composite structures used for a somewhat similar purpose.

VALVE PINS. Name sometimes applied to the peg or terminal attached to the cap of a valve. *See* Valve Leg.

VALVE RECEIVING SETS: THEIR USES AND CONSTRUCTION

How the Amateur may Construct Two Efficient Valve Sets

Many valve receiving sets have been described in this Encyclopedia, and they cover a wide enough range to suit any requirements of an amateur. The reader should consult all those headings dealing with particular sets, as Armstrong Receivers; Flewelling Receivers, etc., and also such cognate entries as Amplifiers; High-frequency Amplifier; Regenerative Sets, etc. For further information see such general headings as Tuning; Valves, etc.

Here is described the making of a simple two-valve and crystal set and also a set containing Myers valves, which have the advantage of being far less fragile than the ordinary valve.

The amateur-constructed set illustrated in Fig. 1 was designed with a view to economy in cost of construction and simplicity. It is a straightforward circuit of one high-frequency valve, a crystal detector, and one low-frequency valve, with reaction on the aerial tuning inductance. It is effective in operation and brings in, near 2 LO on a poor aerial, the local broadcasting quite loudly enough for good strength in the loud speaker (12 miles), whilst Birmingham, Bournemouth, Radiola, the Ecole des Postes et des Télégraphes and the Eiffel Tower come in excellently on the headphones.

Fig. 1 shows the general arrangement. It will be noticed that all terminals and fittings requiring insulation are mounted on pieces of ebonite, whilst the panel itself, measuring 13 in. by 9½ in., is of three-ply wood, large holes being cut so that all terminals, etc., may be clear. The three-ply should not be less than ¼ in. thick, and if faced with hardwood will polish up well. A strip of ebonite 10½ in. by 1 in. is cut for the terminals, spaced 1⅞ in. apart.

The valve sockets are mounted on similar ebonite 1½ in. square. The telephone terminals are on a strip 4 in. by 1 in., whilst the two valve sockets to accommodate the tuning coil are mounted on a piece similar to that for the valve holders. The arm for

the reaction coil is 4 in. long by 1 in. wide. All these pieces may be seen in Fig. 2. The crystal detector is purchased ready made mounted on ebonite. The two terminals may be removed and a pair of contact studs substituted in order that they may project well through the panel. Similar ebonite parts may be purchased ready assembled, and save the time of cutting and drilling.

The ebonite portions being prepared or purchased, the panel may be drilled with large holes for all metal parts to clear, which, with the exception of the valve sockets, will be ½ in. in diameter. It will be convenient at this stage to prepare the containing box, which is 6 in. deep and 13 in. by 9½ in., inside measurements. The box illustrated is cleaned up at the corners and edges and covered with imitation leather paper. A small fillet is fastened ¼ in. from the top edge, and the panel may be placed in position.

Two variable condensers are necessary, one for the aerial tuning of .0005 mfd. capacity and one for the anode of .0003 mfd. capacity, though two of .0005 mfd. value will give somewhat sharper anode tuning. The filament resistances may be of standard make, although those illustrated simply consist of two disks of wood 1½ in. in diameter and ¾ in. thick, around which is wrapped a piece of fibre 1 in. wide. Upon this is wound three yards of No. 24 gauge Eureka resistance wire, the contacts and stops being fashioned in the usual way, as described under the heading

Filament Resistance (*q.v.*). The low-frequency transformer needs no comment and should be fitted to the panel as indicated.

Care should be taken in setting out the various components to see that a reasonable margin is left all round, as it is of considerable assistance in wiring to be able to turn the panel completely

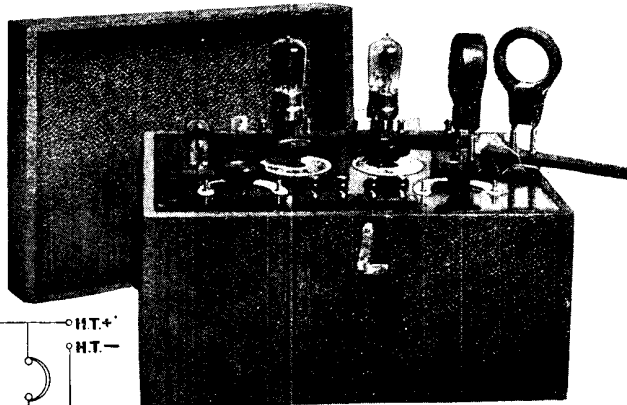

COMPLETE TWO-VALVE AND CRYSTAL SET

Fig. 1. In this set is employed a stage of high frequency and one of low, with a crystal as rectifier and detector. This set works a loud speaker at 12 miles from a broadcasting station

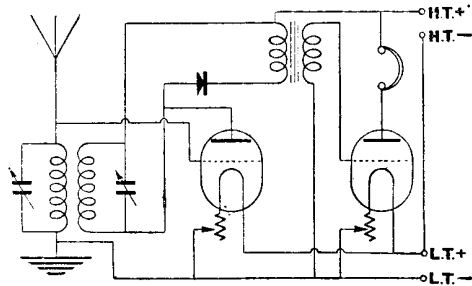

CIRCUIT DIAGRAM

Fig. 2. Here is given the theoretical circuit of the two-valve and crystal set shown in Fig. 1

upside down, the box then forming a protection for components fastened to the front while wiring.

The wiring, shown in Figs. 4, 5 and 6, is carried out with stiff tinned copper wire, which should be cut and bent to shape before soldering.

The set should operate without difficulty. Having joined up the batteries, connected the telephones and plugged in the coils, which may be of standard pattern honey-comb, basket or the like, the anode coil

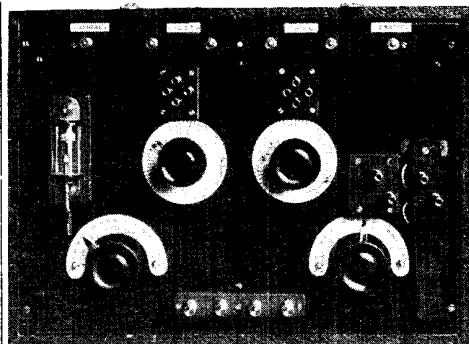

Fig. 3. Front view of the high-frequency, crystal and low-frequency set, showing the components in position and the various terminals for the connexions

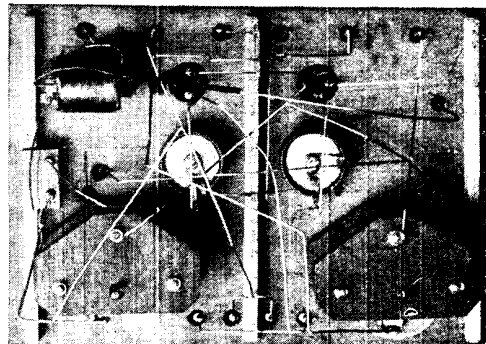

Fig. 4. Back of the panel, showing the wiring. Leads from the movable reaction coil are fastened by two contact studs mounted on ebonite, to which the stiff leads are soldered

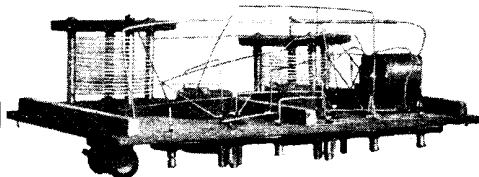

Fig. 5. Transformer side of the panel seen from the back. This view will help to make the wiring clear

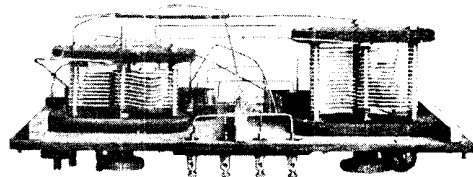

Fig. 6. Condenser side of the panel, showing the connexions in the wiring of the telephones and loud speaker

HOW THE VARIOUS STEPS IN THE CONSTRUCTION OF THE TWO-VALVE SET ARE CARRIED OUT



MYERS VALVE

Fig. 7. This type of valve is used in the construction of the set shown in the following illustrations. It is of unusual construction and practically unbreakable.

should be swung out at right angles to the aerial coil. The two condenser knobs should now be slowly revolved.

When a signal is heard, find the best positions for condensers and filament resistances. Now turn out the high-frequency valve and readjust the crystal to the loudest signals. The high-frequency valve may now be relit and adjusted to the best results. If it is desired to use reaction, the anode coil may be carefully brought closer to the aerial coil, readjusting both condensers as may be necessary. With careful adjustments a very great increase of signal strength may thus be obtained, care being taken to loosen the coupling as soon as any hissing or whistling is heard.

The Myers valves, Fig. 7, are made in two patterns for dry battery or accumulator operation, and are known as dull or bright emitters, according to the voltage. They are neat, compact, efficient in use and admirable for a portable set such as that shown in Fig. 13 on the photogravure plate.

The circuit of this portable set is given in Fig. 8; it is a

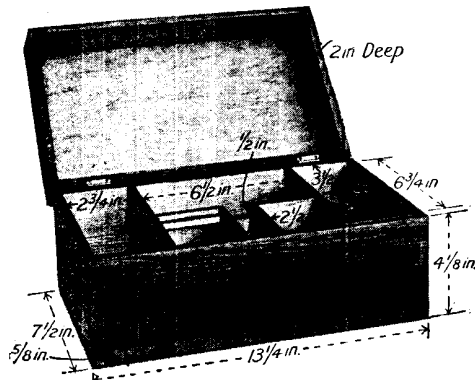

CABINET FOR THE MYERS VALVE SET

Fig. 9. Here the case for the set is illustrated. For the constructor's assistance all the main dimensions are given.

modified Flewelling, and has a stage of low-frequency amplification. The case shown dimensioned in Fig. 9, is $\frac{1}{4}$ in. thick with three-ply wood sides, is hinged on both sides and is provided with a handle for carrying. The two smaller central compartments, Figs. 13 and 14 on the plate, are occupied respectively by two Myers valves, a variable grid leak and condenser and the filament resistance and low-frequency transformer. The space between is occupied by the aerial coil, spade tuning plate and reaction coil separately adjustable, and as illustrated in Fig. 11 on the plate.

Details of the holders are given in Fig. 15; the angle brackets are screwed to the face of the case at the notched part seen in Fig. 18. The mode of mounting the valves and grid leak on an angular ebonite plate is clear from Fig. 10 on the plate. It should be noted that the valves are set with the red caps uppermost.

A similar angular piece is made and carries the filament resistance; the low-frequency transformer is screwed to the case side beneath the resistance coil. The various condensers are placed on the sides of the partitions and the whole is wired with flexible silk-covered wire.

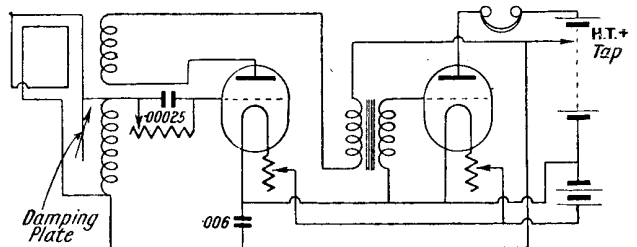

MODIFIED FLEWELLING CIRCUIT

Fig. 8. Theoretical circuit showing the connections to be made in the building of the Myers valve set.

The Myers valves are supplied with a set of parts for the construction of the holders, which consist essentially of angular plates of springy metal. These have to be bolted to the ebonite panel, and to fit properly the fixing screw holes should be drilled to accord with the paper template.

One way to do this is shown in Fig. 19. The paper is placed on the top of the panel and secured with a trace of some adhesive, and the holes marked by punching with a centre punch. In the present set the valves are set side by side, and consequently all the holes should be similarly marked.

and drilled. The angle pieces are then screwed and nutted in place and the screw heads well countersunk below the surface, the holes being filled with insulating wax as shown in Fig. 20. This is best melted in a small saucepan and

and both are mounted between two strips of thin ebonite screwed to the edge of ebonite disks about an inch in diameter, as is shown in Figs. 11 and 15 on the plate.

The disks should be knurled on the outside and mounted on a short length of screwed rod, each disk being separated by a spring washer. The rod is supported on small angle plates, as shown in Fig. 15 on the plate, and secured to them, when the holder is fixed to the case, by means of lock nuts.

The spade is a simple disk of aluminium, and secured, like the coils, by a central screw passed through the two blades on the holders.

Owing to the restricted space it is advisable to carry out the bulk of the wiring with single insulated flexible wire. This is readily done by drawing out the panels until the terminals are accessible and connecting the wires with nuts or by soldering. The high-tension battery

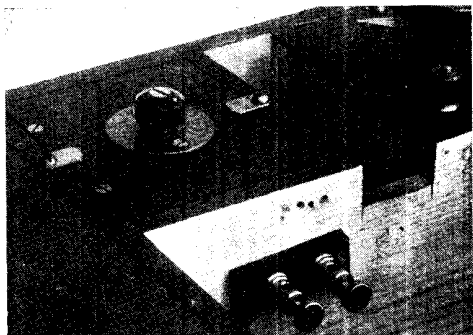

INTERIOR CONSTRUCTIONAL DETAILS

Fig. 18. The ebonite angle-piece in the left-hand compartment carries the grid leak and Myers valves as seen in Fig. 10

the surplus scraped off with the end or side of a blunt chisel.

This panel forms an inner lining to the valve chamber in the case, the top being enclosed by another smaller panel, to the centre of which is fixed the variable grid leak in the usual way. This panel is then secured to the valve panel by small brass screws passed into the edge of the valve panel, as shown in Fig. 16 on the plate. The whole is then secured in place in the case by means of two small turnplates of brass (Fig. 18)

The other panel is made in a similar manner and placed in position in the other partition in the case, but as the space is limited, select a filament that is thin and small in diameter, so that it will fit easily beneath the panel, as shown in Fig. 23. Tuning is effected in this set by the use of basket coils, which can be wound as described in the article on Basket Coils (*q.v.*), and the value should be that most appropriate to the local station's wave-lengths, so that when in use the spade will not have to be very closely coupled to tune the set.

The reaction coil is a similar basket coil,

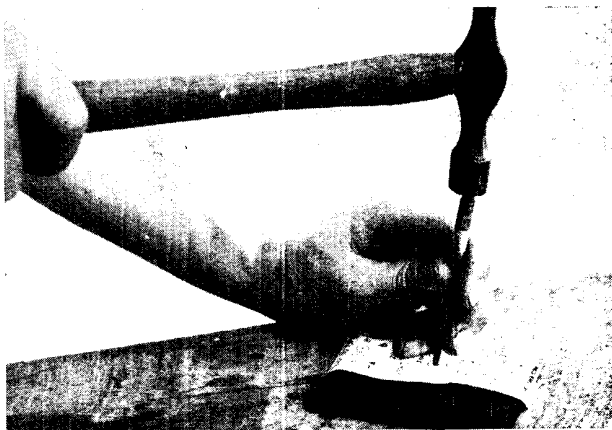

HOW THE DRILLING TEMPLATE IS USED

Fig. 19. Here is shown the method employed with the Myers valve-drilling template when marking out the panel

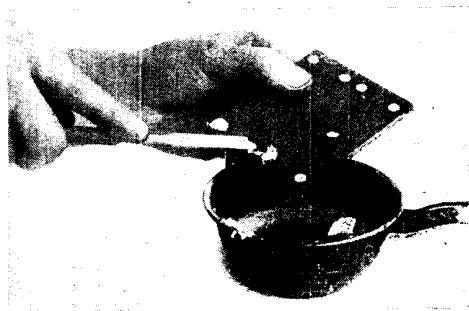

REMOVING SURPLUS WAX

Fig. 20. After filling up the screw holes in the panel the surface wax is scraped off the underside

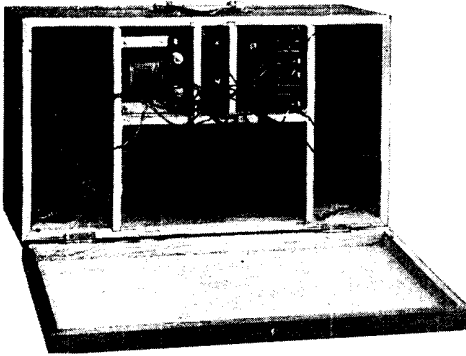

THE SET COMPLETELY WIRED

Fig. 21. In the building of this set the making of connexions is greatly simplified by using flexible wires

connexions terminate in wander plugs, which should be of different colours. They are seen to the left of Fig. 21, where they are shown in the high-tension battery compartment. The two connecting wires for the low-tension battery terminate in the opposite compartment and may have spade terminals.

The aerial may be a simple frame with collapsible members, which can be packed into the lid of the case.

The frame is composed of four tele-

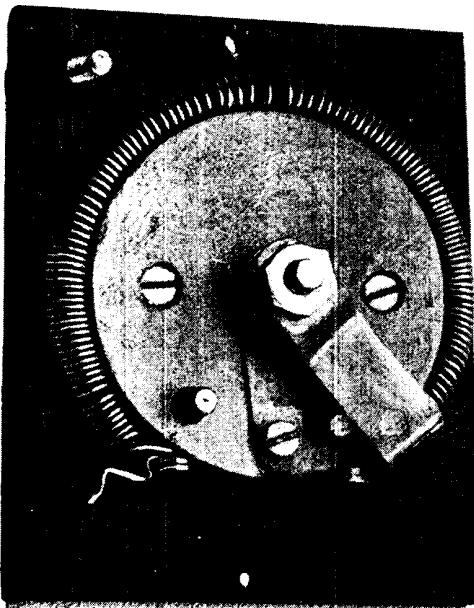

FILAMENT RESISTANCE

Fig. 23. It is important that this component should fit centrally on account of the very limited space available for it

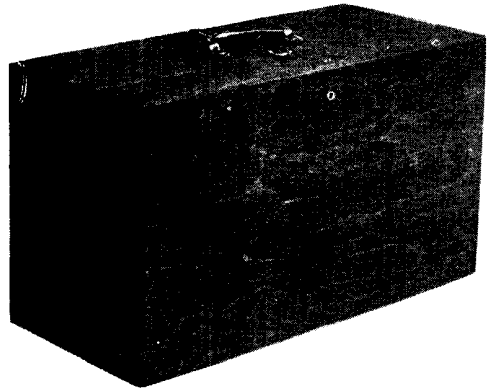

COMPLETE SET CLOSED

Fig. 22. When it is packed up the Myers valve set has a very neat and compact appearance. The weight is not heavy

scopic rods about 10 in. long, with a brass ferrule at one end, as shown in Fig. 12 on the plate. Two ebonite strips, about 1 in. wide and 9 in. long, are hinged to a small piece of hardwood, which has a hole through the centre for the passage of the central rod.

The ends of the ebonite strips have little strips of leather which hold the aerial wire in place. The lower of the strips, as shown in Fig. 17 on the special plate, has terminals for the two connexions from the frame aerial to the earth and aerial terminals on the set respectively. The aerial wire is preferably Litzendraht. Five or six turns are taken around the frame while it is laid flat on the workbench, and the ebonite strips supported in position by nails or blocks.

When the wires are wound and connected four struts of thin wood are cut to span the angle between the ebonite strips and the central rod, and are fitted into notches cut for the purpose of holding them in place, as in Fig. 17, where the aerial is held in an upright position by placing it in an inverted flower pot.

The frame aerial, batteries and telephones all pack into the case, as shown in Fig. 22. The frame is set up by pressing the end of the rod into the ground and connecting the set as shown in Fig. 10 on the plate, although better results are sometimes found by suspending the frame from a branch of a tree by means of a thin string, and using temporary longer connexions to the set. Tuning follows the system detailed under the heading Super-regenerative Set. See Portable Receiving Set.

VALVES EMPLOYED IN WIRELESS RECEPTION

By E. V. Appleton, M.A., D.Sc.

The choice of suitable valves to employ in a receiving set requires careful consideration, as certain circuits call for particular types, and the experimenter should study this detailed account of the different varieties that are available. Other references to the subject will be found in the constructional hints on different types of receivers and under names of specific valves. See also Valves for Transmission

In choosing a three-electrode valve for use as an amplifier or detector in a wireless receiver we are assisted by being able to predict its performance to some extent by an inspection of its static characteristics. These characteristics are curves illustrating the relations between the currents between the various electrodes and the potentials applied to the electrodes.

Before considering the various functions of a valve in a receiver it is therefore of interest for us to consider briefly the way in which the modern valve is designed.

The modern three-electrode valve consists essentially of a highly evacuated vessel containing a thermionic cathode (usually in the form of a filament which can be heated by passing a current through it), an anode and a current-controlling electrode, which generally takes the form of a wire mesh or grid, placed between the cathode and anode. It is essential for stability and constancy that the valve should be highly evacuated, and that the metal electrodes and the glass walls should be free from gas.

Modern valve technique in manufacture has been developed to such a stage that the ordinary hard receiving valve contains gas at a pressure as low as 1/100,000 mm. of mercury. In this way remarkable constancy of electrical action is attained.

In the design of the three electrodes of a valve, three factors are of importance and require specification. In the first place we wish to specify the total amount of electron current emitted by the filament when a certain power is dissipated in it. This will depend on the size of the filament and also on the nature of the material of which the filament is made. Secondly, we wish to specify the amplification factor (K) of the tube so that we may predict its performance as an amplifier. The amplification factor depends only on the geometrical shape of the electrodes. Thirdly, we wish to specify the internal resistance (R) of the tube, which depends on both the electron emission and the geometry of the electrodes.

These three quantities may, of course, be determined by an inspection of the static characteristics mentioned above. We can best realize their significance by a brief survey of the physics of the action of a three-electrode valve.

Fig. 1 shows a valve diagrammatically. Here F is the filament, heated to incandescence by current from the battery B_1 , G represents the grid or perforated electrode, while A is the anode and has a continuous surface. The anode is normally maintained at a positive potential with respect to the filament by the high-tension battery B_2 , while the potential of the grid can be made positive or negative with respect to the filament by means of the battery B_3 .

Since the positively charged anode attracts the negative electrons emitted by the filament, some of the latter in normal cases pass through the holes in the grid, arriving at the anode, so that an anode current (ia) is registered. But the journey of these electrons is made difficult by the repulsion that they exert on one another. For example, an electron just leaving the filament is repelled by the electrons which have got some distance on their journey towards the anode. The result is that all the electrons emitted by the filament are not collected by the anode unless the latter is very strongly positively charged, in which case a large anode battery (B_2) would be required.

We may, however, use an anode battery of medium voltage, which alone will cause only a fraction (*e.g.* a quarter to a half) of

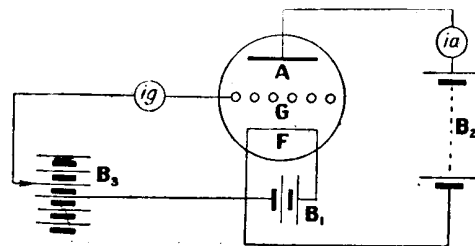

THERMIONIC VALVE THEORY

Fig. 1. This diagram illustrates the working of a valve. F is the filament, G the grid and A the anode

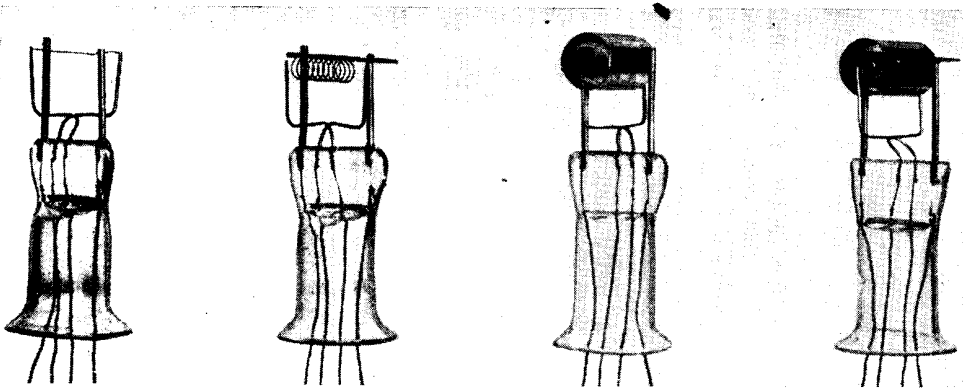

HOW THE MARCONI-OSRAM R VALVE IS ASSEMBLED

Fig. 2. On the left are shown the supports of the electrodes with the filament attached. It will be seen that the outer supports are for grid and anode. The grid is seen in position in the next illustration, while the anode is shown attached to its support in the third. On the right the construction is at the stage prior to fitting inside the bulb

the electrons to reach the anode, and use the grid to enable us to control the amount of electron current the anode receives. For definiteness let us suppose that the action of the anode is such that an increase of 20 volts in anode potential is required to increase the current to the anode by one milliamperere.

Further, let us suppose that we now make the grid slightly positively electrified with respect to the filament by means of battery B_g . Since the grid is nearer the filament than the anode, only a comparatively small grid potential is necessary to give it a large positive charge, and so give the electrons near the filament

the extra pull necessary to get them started on their journey to the anode.

These electrons very soon acquire a very high velocity (of the order of 10,000,000 centimetres per second) and, although they are all attracted by the positive charge on the grid, practically only the ones that hit the grid wires directly are caught by the grid, the remainder having sufficient momentum to enable them to get through the holes, after which they are caught by the anode.

The grid is therefore efficient in attracting the electrons but inefficient in catching them. Thus if we increase the grid potential we find the current to the

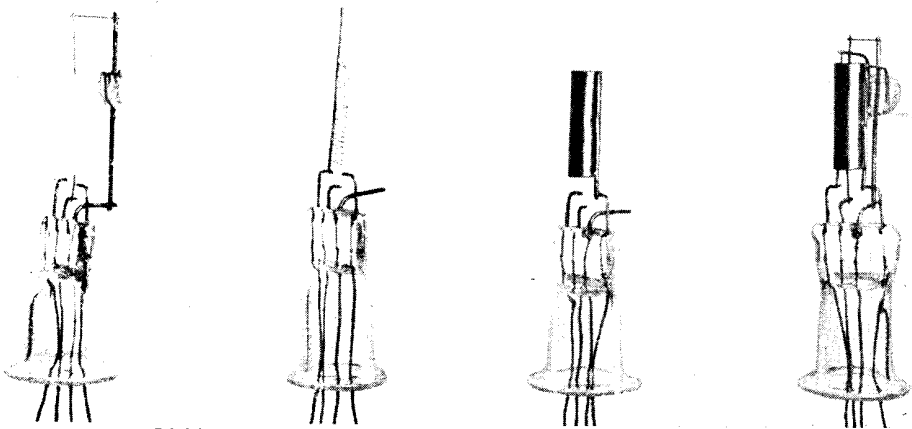

DULL EMITTER VALVES IN CONSTRUCTION: THE D.E.3

Fig. 3. An interesting feature of this valve is that the rod supporting the upper end of the vertical filament has a globular piece of glass attached. Into this glass two wires are fused to support the tops of the grid and anode, and the threefold purpose of this rod is seen on the right. The central illustrations show the fixing of grid and anode.

anode is increased, and in a typical valve we may find that this increase of anode current may be of the order of one milliampere for 2 volts increase of grid potential. Comparing this with the figure mentioned above for the change of anode current with change of anode potential, we see that the grid has 10 times the control action of the anode current possessed by the anode itself.

The figure 10 here represents the amplification factor of the tube, which depends on the dimensions of the grid and anode. For example, the closer the grid wires are together, or the bigger the distance between the grid and anode, the greater the amplification factor. Mathematical formulæ have been derived which enable us to calculate the amplification factor (K) from a knowledge of the dimensions of the electrodes, so that in most cases this quantity is known before the valve is exhausted.

The internal resistance (R_i) of the valve is the effective resistance between the filament and the anode for small changes of anode current. Thus in the example we have considered above the internal resistance is 20,000 ohms, since 20 volts anode potential change produce a current change of one milliampere. Its value can be determined mathematically if the electron emission and the electrode dimensions are known.

The total electron current is determined by the size and value of the filament and the temperature to which it is raised by the heating current. In the older type of R valve filaments of "pure" tungsten (they actually contain a small percentage of thoria to increase the tensile strength) are used. The high temperature ($2,300^\circ$ to $2,500^\circ$ absolute) required to give the necessary emission requires a comparatively large consumption of power in the filament (*e.g.* of the order of 3 watts), so that recently makers have developed filaments which are made of thoriated tungsten, and which give the same order of electron emission at much lower temperatures. Thoriated tungsten containing one to two per cent of thoria is used for most of these filaments.

It is only necessary to raise the temperature to $1,200^\circ$ to $1,600^\circ$ absolute to obtain the required emission, and this can be brought about by the expenditure of only .18 watt in the filament. Filaments of platinum or platinum alloy

coated with oxides (generally of the rare earths) are also made. These give a good emission of electrons at a very low temperature ($1,000$ to $1,200^\circ$ absolute).

The grids and anodes of receiving valves are usually made of nickel, though molybdenum is sometimes used. The arrangement of these electrodes round the filament is usually one of three types, as follows:—

(a) Cylindrical type. Here the anode is a cylinder with the filament along its axis, while the grid is a helix of wire or a mesh tube between the filament and anode. This design is the most suitable one for quantity production.

Examples: Marconi-Osram R (Fig. 2), D.E.2, D.E.3 types (Fig. 3).

(b) Flat-plate type. Here the grid and anode consist of pairs of plane rectangular electrodes of grid and plate form respectively, placed on opposite sides of the filament.

Examples: B.T.H. B.4 valve, Western Electric Co. 102 D.W.

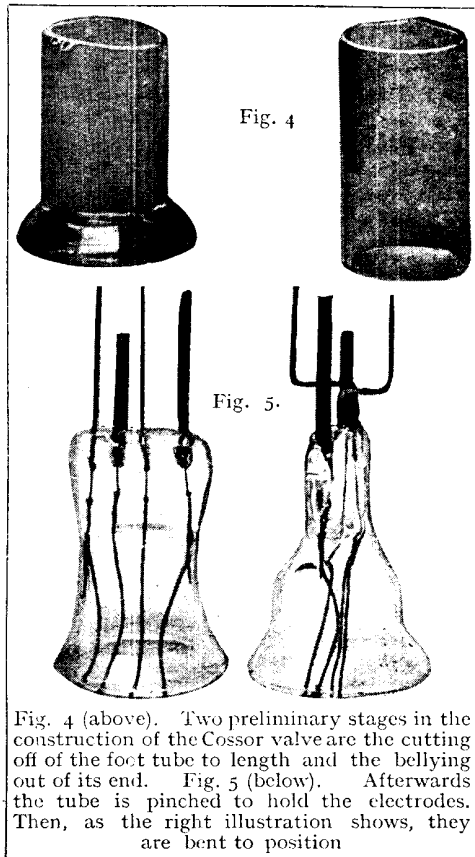
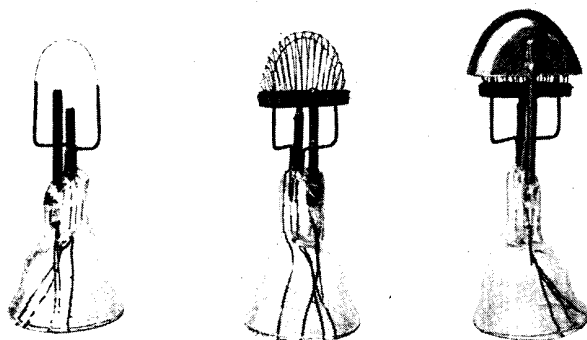

Fig. 4 (above). Two preliminary stages in the construction of the Cossor valve are the cutting off of the foot tube to length and the belying out of its end. Fig. 5 (below). Afterwards the tube is pinched to hold the electrodes. Then, as the right illustration shows, they are bent to position

HOW COSSOR RECEIVING VALVES ARE MADE



ERECTING FILAMENT, GRID AND ANODE OF COSSOR VALVES

Fig. 6. To the left of the illustration the hooped filament is seen; in the centre the grid is attached, and to the right the anode is seen completed.

(c) Helmet-shaped type. The filament is a loop covered by a hood-shaped grid and an anode of similar shape.

Examples: Cossor P.1 (Figs. 4-7) and P.2 valves.

When the electrode dimensions of a valve have been decided on and the electrodes fixed in the glass bulb, the valve is then exhausted. The object aimed at is to obtain as high a vacuum as possible, and that in the process the filament should suffer as little as possible so that it may have a long life afterwards. The gases to be removed come from the electrodes and the glass bulb.

The glass is heated by placing the whole valve in an electric oven while pumping is carried out, but the electrodes have to be heated by electron bombardment. To this end the filament current is run at about its normal value, while a potential of 1,000 to 1,500 volts is applied between it and the anode, the grid being connected to the filament. In this way it is possible to bring the anode to a temperature not far from its melting point. While these operations are being carried out, the exhausting proceeds simultaneously until finally, by the aid of a mercury ejector pump, the pressure is reduced to about 10 to 5 mm. of mercury. The valves are then sealed off and are ready for ageing and testing. The Marconi-Osram method of doing this will be described here.

It is found that, however complete the regular bombardment and exhaust may be, there is always a subsequent clean-up of gas while the valve is run under normal conditions. Before testing, therefore, all valves are aged by running

them for a limited time, varying from one to three hours, with normal filament current and grid and anode potential. The testing itself is very complete for every valve. The following tests are normally carried out.

(1) The insulation between the electrodes is tested. The resistance should be "infinite."

(2) The filament current and voltage to give correct electron emission are measured to see that they are according to specification.

(3) The degree of vacuum is tested by measuring the amount of "backlash." In this test the anode is maintained at a positive potential high enough to produce ionization by collision if gas molecules are present. The presence of positive ions is indicated by the presence of a grid current when the grid is maintained at a negative potential with respect to the filament. If this positive grid current is greater than a certain amount the valve is rejected. This test for "softness" is one which the amateur can carry out easily himself.

(4) The slope of the anode current-grid voltage characteristic (K_1) is found.

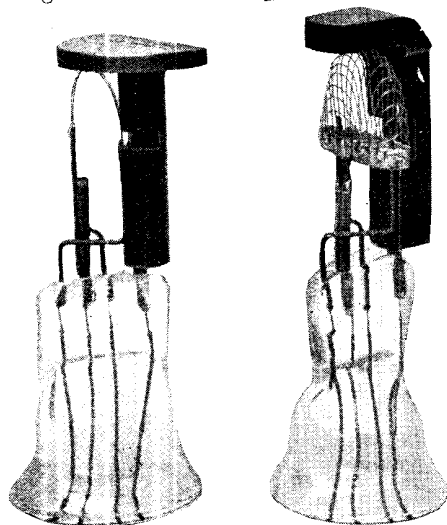

ADJUSTMENTS IN THE COSSOR VALVE

Fig. 7. On the left the jig is shown placed on the anode support to adjust the correct height of the filament; to the right another jig is similarly used for the grid.

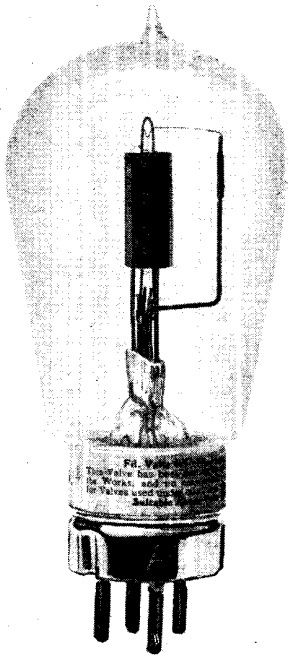

MARCONI-OSRAM POWER VALVE

Fig. 8. This is a powerful amplifying valve, taking an anode potential of 120 to 150 volts

(5) The slope of the anode current-anode voltage characteristic (K_2) is found.

From these quantities we can derive the amplification factor (K) and the internal resistance (R_i) of the valve, since

$$K = \frac{K_1}{K_2}$$

and

$$R = \frac{I}{K_2}$$

It ought to be mentioned that in many modern receiving valves the exhausting is not carried out solely by means of pumping. The clean-up of the gas can be assisted by chemical means. The chemicals used (*e.g.* phosphorus or magnesium) are known as "getters," and recently a procedure has been developed whereby valves are exhausted using a modified bombarding schedule in conjunction with chemical agencies. Valves made in this way can be recognized by their colour or sheen. For example, if phosphorus is used, the glass is amber or straw-coloured, (*e.g.* B.T.H. B.4 valve), while if magnesium is used the glass exhibits a silvery, mirror-like appearance (*e.g.* Marconi-Osram D.E.2 or D.E.3, Figs. 8-13).

Before 1920 almost all the valves sold in England for receivers were of the R type and had filaments of tungsten. But in 1920 the General Electric Co. produced commercially the first low-temperature filaments, using thoriated tungsten. (We except here the oxide-coated filaments of low-temperature type made by the Western Electric Co. of America, and which are now also made by the Mullard Valve Co.). The General Electric Co. dull emitter valve reproduced the characteristics of the well-known R valve, but its filament required only .36 ampere at 1.8 volts (*i.e.* .65 watt) instead of the 2.8 watts required by the ordinary R type.

A few months later a further step was made, and a valve requiring a filament current of only .06 ampere at 3 volts (*i.e.* .18 watt) was designed, but it was not at first put on to the market owing to difficulties of mass production. Ultimately, however, the difficulties were overcome, and these valves were sold to the public. For these low-temperature valves a very

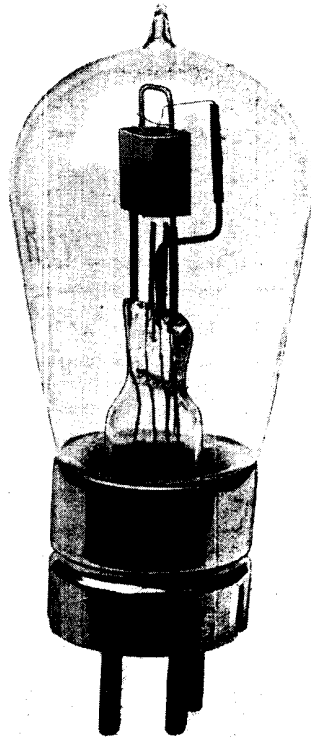

MARCONI-OSRAM R. 5V VALVE

Fig. 9. This type is one of proved efficiency that has a reputation for good results

high vacuum is essential for the maintenance of low-temperature emission. Now, the action of magnesium as a "getter" is even more efficient than phosphorus, so the former is used in the

manufacture of nearly all dull emitter valves. The magnesium is introduced in the form of a wire or ribbon heated at a definite stage in the bombarding process, and is finally deposited on the bulb walls.

Nowadays the tendency is all towards low-temperature emitters for reception purposes, and it is safe to say that the old R type, which certainly has played its part in wireless history, is obsolescent.

We now proceed to give an account of receiving valves made in England by standard makers. This is most conveniently done in the form of a table.

From the table (page 2191) it will be seen that there is a wide range of values from which we can choose for use in a valve receiver. Before giving further details as to the suitability of various types of valves for various functions in a valve receiver, it is necessary for us to consider in somewhat greater detail what these functions are and how far we can assist the valve to perform its functions by the use of suitable elements in our circuit design.

For simplicity we shall consider that each valve performs mainly only one function (though it is possible for a valve to do more than one). The



MARCONI-OSRAM D.E.R. VALVE

Fig. 10. This type, an oscillating, rectifying and amplifying valve, is suitable for replacing the bright emitter R valve

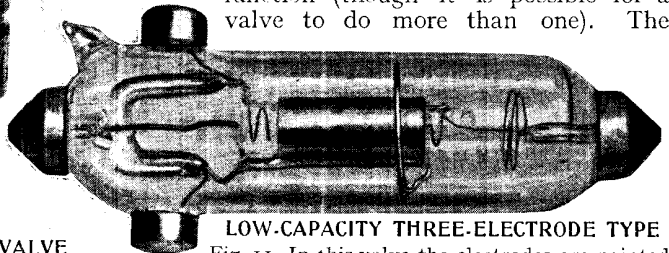

LOW-CAPACITY THREE-ELECTRODE TYPE

Fig. 11. In this valve the electrodes are painted in different colours to distinguish them. This valve is also a useful low-power high-frequency generator in local oscillators

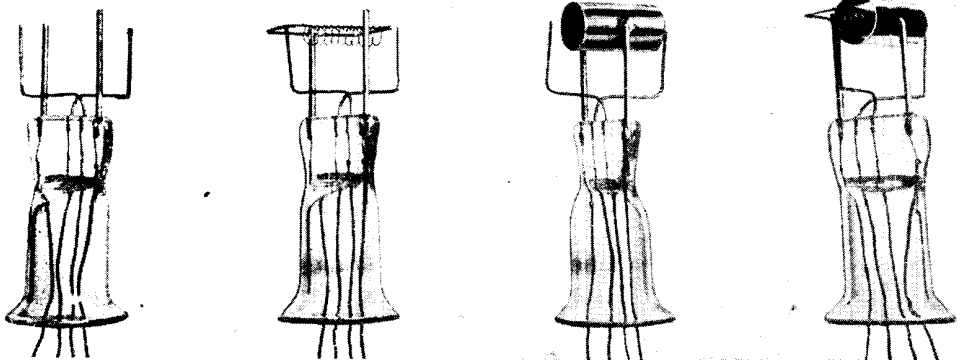

INTERNAL CONSTRUCTION OF THE MARCONI-OSRAM D.E.R. VALVE

Fig. 12. On the left are the supporting pillars of the electrodes. Next are the grid and its oblong support attached to the rear pillar. The third illustration shows the anode fixed to the front support, while the last shows the complete interior structure

RECEIVING VALVES: THEIR CHARACTERISTICS AND USES

This table, prepared by Dr. Appleton as a result of experimental determinations carried out in his laboratory, covers 16 of the valves in general use, and is of considerable value to the experimenter in determining the choice of a valve to meet general or special requirements

Maker	Type	Filament		Electron Emission	Anode Volts	Amplification Factor	Anode Resistance	Remarks
		Volts	Amps.					
Marconi-Osram Co.	R.	4	.70	6 m.a.	60-80	9	40,000 ω .	General purpose valves. Require accumulator 4-6 volts.
	R.Z.	5	.75	6 m.a.	40-60	9	40,000 ω .	
	D.E.1	1.8	.36	5 m.a.	30-45	9	40,000 ω .	General purpose valves of dull-emitter type. Require only one-cell accumulator.
	D.E.2	1.8	.24	5 m.a.	30-45	9	40,000 ω .	
	D.E.3	3.0	.06	6 m.a.	25-45	6	22,000 ω .	Suitable for detector, amplifier, and for loud speaker. Requires 4 volt accumulator with resistance, or can be run from dry cells.
	L.S.3	4	.65	6 m.a.	100	5	12,000 ω .	A valve for medium-size loud speakers.
L.S.5	5	.8	50 m.a.	150	5	6,500 ω .	Suitable for use with large loud speakers, and for telephone-repeater work.	
B.T.H. Co.	R	4	.63	—	45-60	—	—	Tungsten filament. Requires two-cell accumulator.
	B.4	6	.25	40 m.a.	40-100	6	7,000 ω .	Suitable for detector with 40 anode volts. For amplifier or loud-speaker work use 60-100 anode volts with negative grid bias of 3-5 volts. Dull emitter filament.
	B.5	3	.06	—	40-80	6	15,000-18,000 ω .	Dull emitter filament. Can be run from dry cells.
Cossor Valve Co.	P.1	4	.72 to .75	Exceeds 3.6 m.a.	30	6.6	18,000-20,000 ω .	Used as detector or L.F. amplifier.
	P.2	4	.72 to .75	Exceeds 3.6 m.a.	60-80	12	50,000-60,000 ω .	Specially designed for high-frequency amplification.
Edison-Swan Co.	R.	4	.75	—	50-100	8	25,000 ω .	General purpose valves. Require two-cell accumulators.
	A.R.	4	.65	—	30-80	5.5	22,000 ω .	
	A.R.D.E.	1.8	.30	—	20-50	10	25,000 ω .	Requires only one-cell accumulator. Dull emitter.
	A.R. .06	2.5-3	.06 to .07	—	20-50	—	—	Can be run from dry cells. Dull emitter filament.

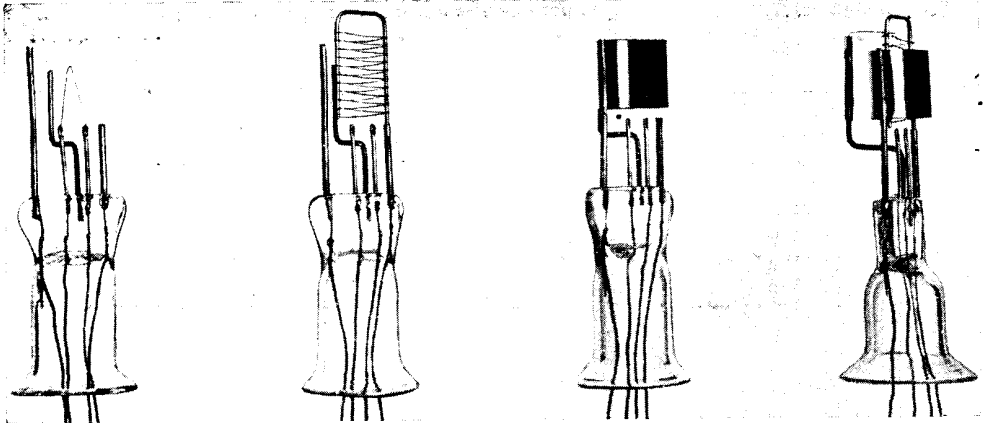

HOW THE MARCONI-OSRAM R5V VALVE IS CONSTRUCTED

Fig. 13. This type is of somewhat similar construction to the L.S.5 valve. The filament, although shorter, is supported in the same way. The anode, as shown in the third illustration, has a single support, which feature is also shared by the grid

three functions which valves may perform in a receiver are those of:

- (1) High-frequency amplifier
- (2) Rectifier
- and (3) Low-frequency amplifier.

Thus a typical receiver is one of three valves in which the three successive valves perform functions in the order specified. We now proceed to consider these functions in greater detail.

(1) **High-frequency Amplification.** The essential connexions of the high-frequency valves in three methods of high-frequency amplification are shown in Fig. 19. In each case the aerial circuit is connected to the grid and the filament of the valve responsible for the high-frequency amplification. In each case also a variometer is shown for tuning the aerial circuit. As the high-frequency valve is a potential-

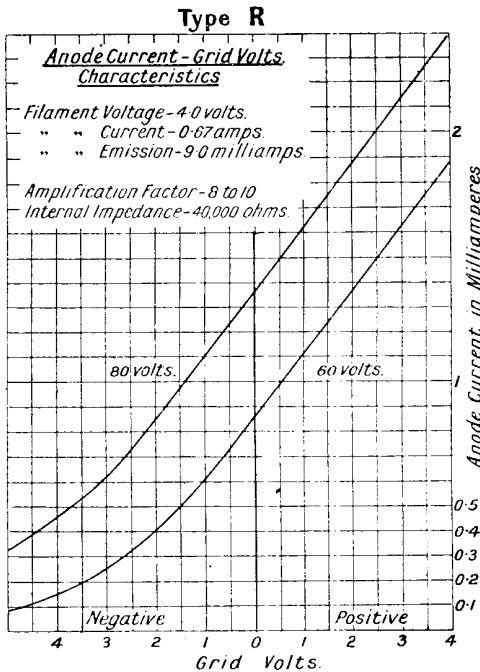

R TYPE MARCONI-OSRAM VALVE

Fig. 14. Characteristic curve of the R valve, showing the effects of 60 and 80 volts applied to the anode

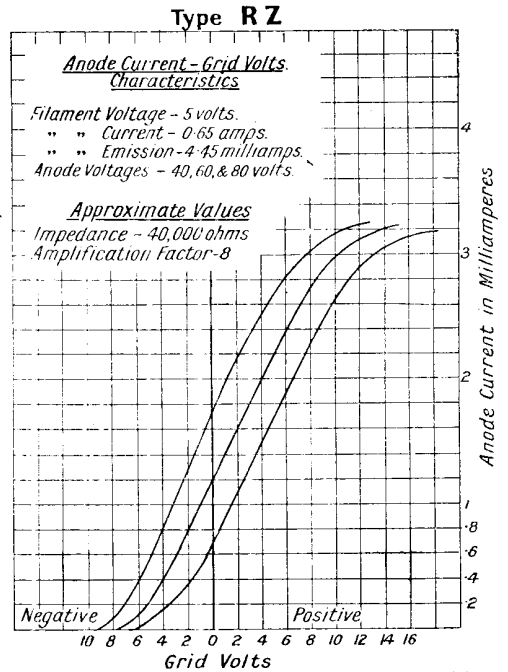

CHARACTERISTICS OF THE RZ VALVE

Fig. 15. The curves shown here are for anode voltages of 40, 60 and 80 and a filament voltage of 5

operated device, it is advisable to make the capacity of the circuit as small as possible, so that if a variometer is used no further tuning capacity is required. For example, the variometer made by the General Radio Co. has an inductance range of 100 to 1,230 microhenries, giving a range of 300 to 1,000 metres on a P.M.G. aerial.

In the tuned anode method (Fig. 19 a) the oscillatory circuit is tuned in the same way. The connexion from the first high-frequency amplifying valve to the second is made via the grid condenser and the anode battery. This method is very selective and satisfactory in every way. In the method (Fig. 19 b) using a high-frequency transformer, air-core coils are normally used. A given pair of coils is usually only efficient as a transformer over a short range of wave-lengths, but it is possible to design a transformer with a tapping switch having a greater range.

In the anode reactance method (Fig. 19 c) an air-core inductance is included in the anode circuit, and the potential changes across it are transferred to the grid and filament of the next valve stage via the grid condenser and the high-tension battery. For convenience a tapped coil may be used. Thus the H.F. reactance made by Radio Instruments, Ltd., is suitable for

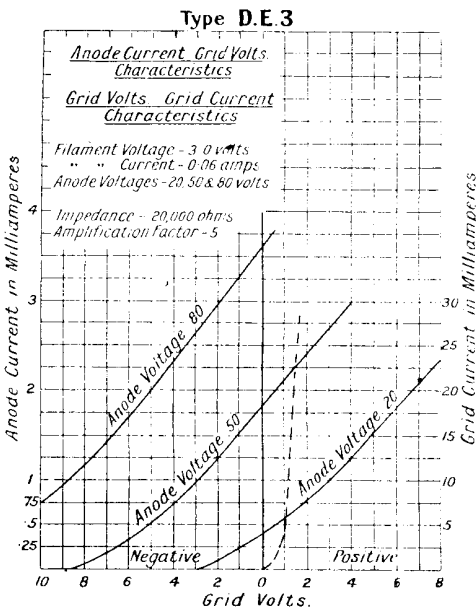

CHARACTERISTICS OF THE D.E.3 VALVE

Fig. 16. Curves of the D.E.3 dull emitter, requiring only 3 volts and '06 ampere in the filament and 25-45 volts on the anode

D 103

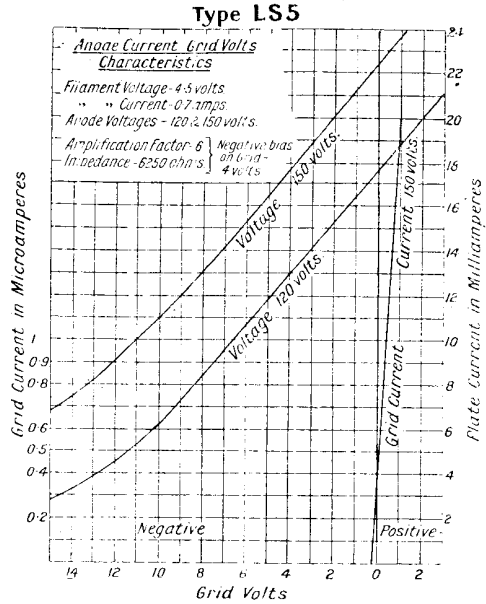

L.S.5 VALVE CURVES

Fig. 17. Characteristics of this loud-speaker valve. Anode voltages should be of the order of 120-150 for the best results, with a generous grid-bias voltage

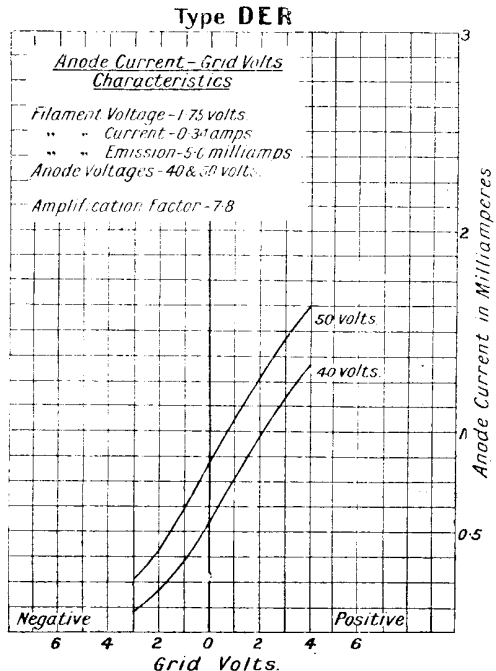

D.E.R VALVE CHARACTERISTICS

Fig. 18. Curves of the D.E.R type, which requires only a one-cell accumulator and a H.T. battery of 40-50 volts

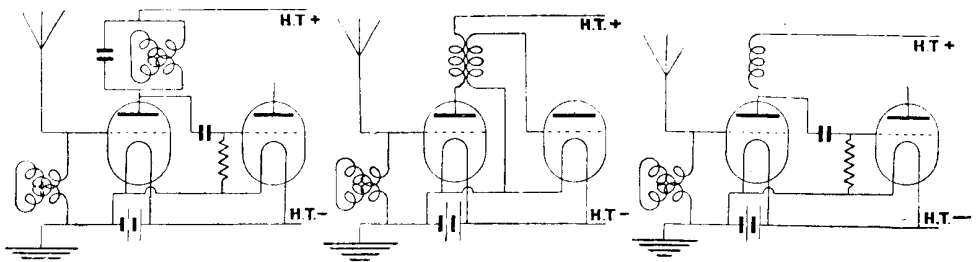

VALVE CONNEXIONS IN HIGH-FREQUENCY AMPLIFICATION

Fig. 19 *a* (left). Tuned anode method of H.F. amplification. *b* (centre). Transformer coupling H.F. amplification. *c* (right). Anode reactance method of H.F. amplification

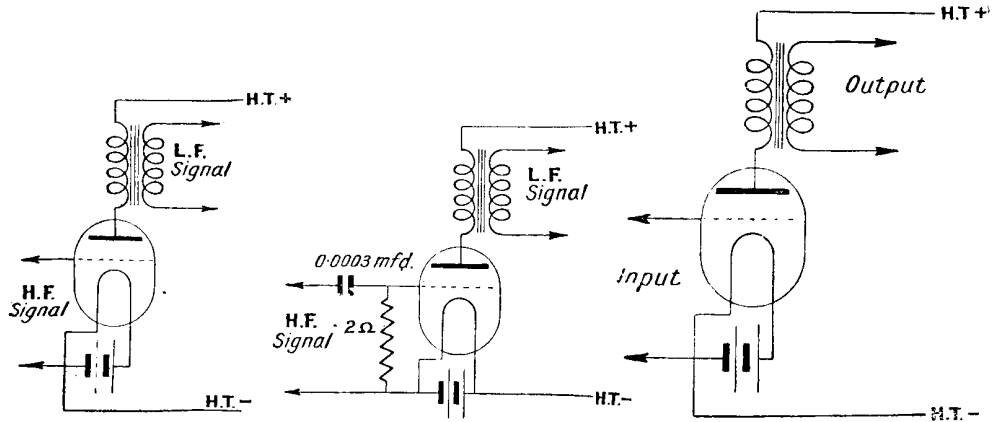

CONNEXIONS FOR DETECTING AND L.F. AMPLIFYING

Fig. 20. *a* (left). In this circuit the valve is used for reception and detection. *b* (centre). Here the valve receives, detects and rectifies. *c* (right). The valve and L.F. transformer method of reception

use in this way over a range of 200 to 20,000 metres.

(2) **Rectification.** There are two standard methods of rectification: (a) anode rectification; (b) cumulative grid rectification. The essential connexions of detector valves for both methods are shown in Fig. 20. In both cases the high-frequency signal to be amplified is applied to the grid and filament, while the resulting low-frequency signal is withdrawn from the anode circuit. Anode rectification (Fig. 20 *a*) depends on the non-uniform relation between the anode current and grid potential, and in choosing a valve for this function it is essential that the characteristic for normal operating anode voltage should be curved.

Cumulative grid rectification (Fig. 20 *b*), on the other hand, depends on the non-uniform relation between grid current and grid potential. Thus in choosing a valve for this purpose it is essential that the grid characteristic for the working grid and anode voltages should be curved. The grid current should also be of suitable magnitude.

(3) **Low-frequency Amplification.** The most efficient low-frequency amplifying circuit is the combination of a valve and a low-frequency transformer (see Fig. 20 *c*). The transformers used are of the step-up type. Examples of standard transformers with winding ratios are:

Radio Instruments inter-valve	
audio-frequency transformer	.. 4 : 1
Igranic inter-valve transformer,	
shrouded type 5 : 1
Forno inter-valve transformer	.. 5 : 1

With these transformers and a valve (R type) it is possible to obtain a low-frequency amplification of the order of 20, which is actually higher than the amplification factor of the valve. This amplification is not, however, usually maintained over a very large range of frequencies, so that for the amplification of speech and music the resistance-capacity method of amplification (Fig. 21) is sometimes used.

The amplification obtained by this method can never be greater than the value of the amplification factor of the valve, and is usually not more than 6 if R

type valves are used. Moreover, a high anode potential has to be used owing to the drop of potential across the high resistance R . The latter difficulty is to some extent obviated by using a choke inductance, L , of small ohmic resistance in place of the high resistance R (Fig. 22). But even in this case the amplification can never reach a value as high as that of the valve amplification factor, whereas, as mentioned above, the amplification factor can be exceeded if a step-up transformer is used.

We now consider the factors influencing our choice of valve in any given case. The main consideration is usually found to be the convenience the experimenter has for

supplying filament-heating current. If a 6 volt accumulator is available, and there is no difficulty about charging, valves of the R and RZ type may be recommended because of their cheapness. But in most cases this is not so, and the choice has to be made between the two types of dull emitter valves, of which the D.E.2 and D.E.3 valves may be said to be typical.

An accumulator is necessary if the former is used, but only .24 ampere per valve is taken from it, so that with a good accumulator of large capacity the charging need not be a very frequent matter. On the other hand, when the charging of accumulators is quite out of the question, as in country districts, valves of the D.E.3,

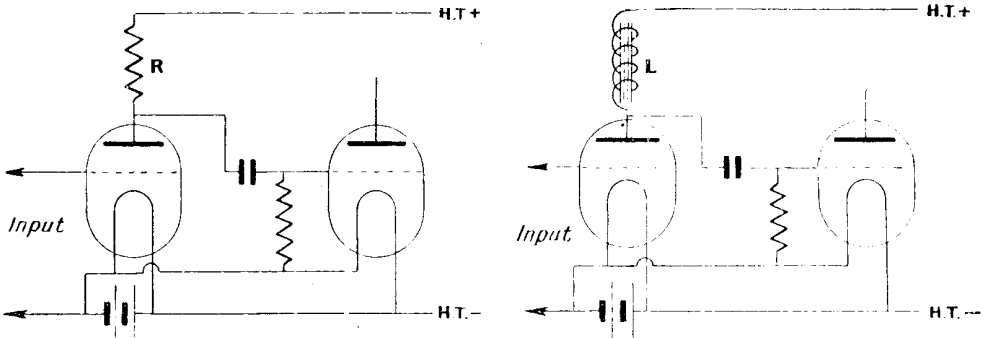

LOW-FREQUENCY AMPLIFICATION BY TWO METHODS

Fig. 21 (left). The valves here used obtain amplification by the resistance coupled method. Fig. 22 (right). Amplification is obtained here by the choke inductance method

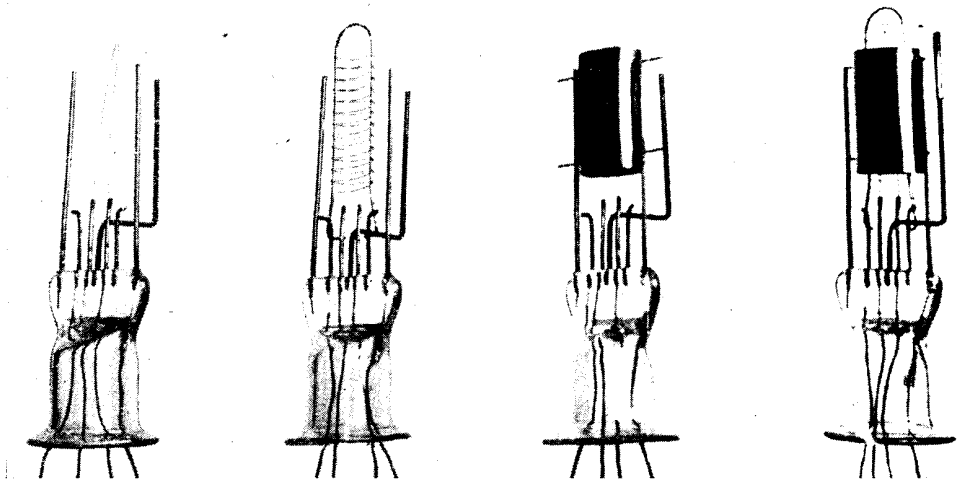

CONSTRUCTIONAL DETAILS OF THE L.S.5 VALVE

Fig. 23. Shown in the illustration to the left, the filament is supported as indicated in the right photograph by a rod with a spring-ended hook. The second illustration shows the grid construction, and the third the method employed for attaching the oval anode. The completed electrodes are seen on the right

B.5, and A.R. .06 types may be run on dry cells, as a current of only 60 milliamperes is required. All the valves mentioned above are of the general purpose type, and will act efficiently as high-frequency amplifier, detector or low-frequency amplifier.

For loud-speaker work a valve with a low internal resistance and high emission is most suitable (e.g. L.S.5 or B.4). The low internal resistance is usually provided at the expense of the amplification factor, which is low in loud-speaker valves. For high-frequency amplification a higher amplification factor is desirable.

The dull emitter valves mentioned above have a long life so far as filament burn-out is concerned. Useful life is therefore determined by the number of hours for which the initial emission is maintained, and is usually of the order of 1,000 hours.

Recently, valves with coated filaments have been made in England by the Mullard Radio Valve Co. and the Western Electric Co. The power for heating the filament is, for a given electron emission, very much less than that of the pure tungsten filament, and nearly as small as that of the thoriated tungsten filament. The Weco valve has a coated filament, and takes .25 ampere at .8 to 1.1 volt for normal operation. Its life is found to be several times that of a pure tungsten filament, and

to exceed that of the thoriated tungsten dull emitter filament.

A typical power-amplifying valve is the Marconi-Osram type L.S.5, illustrated in Fig. 23. This valve is a comparatively recent development in power amplifiers, for it is a dull emitter. The filament consumes approximately .8 ampere, at 4.5 volts, while the anode requires a potential of from 120 to 150 volts.

Reference to the illustration will show that the anode is oval in section, and that it is supported on either side by a very stout wire pillar. The grid, which is also oval, and which closely follows the interior of the anode, is supported on an inverted U-shaped framework of heavy wire. A double filament of an inverted U shape is fitted, the top of which is supported from a hook attached to another pillar situated at the rear of the anode.

The contacts fitted to this valve are worthy of note. It will be seen that they are not of the usual split wire type, but are made in two parts. There is a wire pillar of rather smaller diameter than usual, surrounded by a stamped metal thimble forced upon the central wire. It has been found that this construction eliminates the tendency of repeated removal and replacement of the valve in its socket to reduce the efficiency of the contact between the hollow socket and the valve pin.

VALVES FOR WIRELESS TRANSMISSION

By Professor W. H. Eccles, F.R.S.

During recent years the developments in the broadcasting of wireless transmissions have been phenomenally rapid: and no component has more quickly evolved to assist this advance than the three-electrode transmitting valve. Dr. Eccles contributes an excellent study of its principles and its practice in working. See also Broadcasting; Transmission; Valves for Reception

The rapid development of wireless telephony which has taken place during the past ten years has been made possible by the application of the three-electrode thermionic valve to the generation of electrical oscillations.

As soon as it was proved that oscillations so generated gave excellent wireless telephony, great attention was directed to the development of the three-electrode valve, and very soon the valve was being made of a size and quality that fitted it for Morse transmission over hundreds of miles as well as for telephony over tens of miles. As early as 1915 the American wireless engineers showed, however, that they had greater ambitions for telephony than merely to use it

for short-distance work; for in that year they succeeded by a special effort in transmitting speech across the Atlantic from Washington to Paris by means of a battery of 300 thermionic tubes operating in parallel. These tubes were of about 25 watts output each, and were then the largest made. Since that date the size of the three-electrode valves has been gradually increased, until to-day they have been built about four thousand times as powerful.

The valves used in transmitting stations are of two kinds, those with two electrodes and those with three electrodes. In either case one of the electrodes, called the cathode, is heated in order that it may emit electrons; the electrons are attracted

across the evacuated bulb from the cathode to the anode when the latter is raised to a high voltage. When they reach the anode they enter its substance and flow along the metal conductors leading to the outside, thus forming an ordinary electric current. The circuit is completed outside the valve by connexions of various kinds, including the source of high voltage, and thus the electrons enter the cathode again and constitute a negative current circulating continuously so long as the cathode is hot and the high voltage is applied to the anode.

The most convenient way of providing a hot cathode in an evacuated bulb is to make it in the form of a filament which is capable of being warmed by the passage of an auxiliary current through it. Another way is to make it in the form of a metal tube inside the bulb and then heat this tube by

A two-electrode thermionic valve may be called a diode valve for short, or a Fleming valve. The anode may in general be of any shape. An obviously convenient form of anode is a flat plate fixed parallel to the filament. Another obvious form is a cylinder surrounding the filament. Both forms were used by Fleming, and before him by experimenters on electrons.

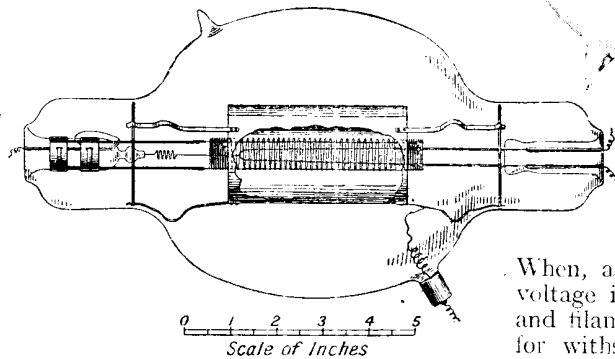

TRANSMITTING VALVE TYPE T.4.A

Fig. 2. This diagram illustrates an Admiralty type of glass valve for transmission. The sizes of its different components may be judged from the scale

Courtesy "Journal of the Institution of Electrical Engineers"

an incandesced filament inside it or by the process of electronic bombardment.

In transmitting valves, as in receiving valves, the most useful conductor for the filament is tungsten, which can be heated to very high temperatures without undue evaporation. At $2,000^{\circ}$ absolute, the emission is about 5 milliamperes per square centimetre of tungsten surface, at $2,500^{\circ}$ it is about 1 ampere per square centimetre, and at $3,000^{\circ}$ it is more than 30 amperes per square centimetre. The rate of emission can be increased by introducing thoria into the filament during the process of manufacture. Such a filament emits at $1,400^{\circ}$ the same electron current as would be emitted at $2,000^{\circ}$ by pure tungsten.

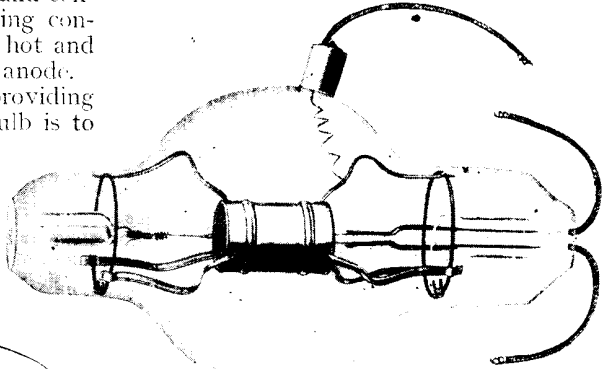

MARCONI-OSRAM 100 WATT POWER VALVE

Fig. 1. In this valve the circular anode is supported by metal tripods. The filament is kept tight by a helical spring fixed in the glass at the top end

When, as in large power valves, a high voltage is to be applied between anode and filament, the cylindrical form is best for withstanding the strong mechanical attraction that may arise between two conductors at very different potentials.

In fact, if the filament is a straight one and it is fixed accurately along the axis of the surrounding cylindrical anode, there is no attraction upon it at all, and even if it departs slightly from the ideal centre line the attraction is relatively small. The attraction can also be made very small when the anode is of plate form by making it of two plates, connected together electrically, one on each side of the filament. For medium power valves the plate form is therefore sometimes adopted, but for large power valves the cylindrical construction is almost necessary.

In most diodes the anode is situated within a glass or similar bulb, and is held in position round the filament by means of rigid supports resting on the glass. The variations of design are innumerable. One example is seen in Fig. 1, which shows a 100 watt power valve of Marconi-Osram

design. The cylindrical anode is here supported both above and below by metal tripods, which bear on the narrowed parts of the bulb. The lead from the anode is taken through a seal in the wide part of the bulb, in order to obtain between anode and cathode a long leakage path over the glass and thus secure excellent insulation between these conductors.

It will be noted that the filament is a hairpin filament kept taut by a helical spring anchored in the glass and attached to the bight. In mounting the electrodes inside the bulb the glass-blower must adjust the tension of this spring, and therefore the tension of the filament, by

at a speed of 11,000 miles per second when they strike, and the kinetic energy they possess is dissipated by heating the anode. This waste of energy during the use of a rectifying tube is inevitable until someone invents a way of landing the electrons on the anode without concussion.

This heating of the anode affects considerably the design and the manufacture of large valves. In the first place, the metal must be chosen to withstand easily the effects of high temperature. The metal ordinarily used in receiving valves is nickel; but in power valves the most suitable metal is molybdenum. A few years

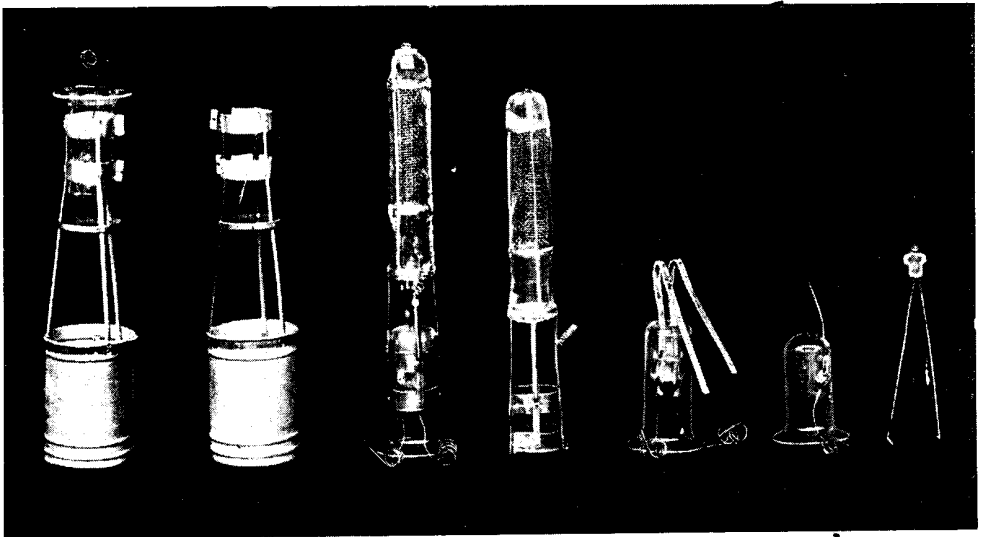

VARIOUS PARTS OF THE M.T.6 TRANSMITTING VALVE

Fig. 3. Here are portrayed the different stages of the construction of the M.T.6 valve. From left to right are shown: anode mounted; anode unmounted; grid mounted; grid unmounted; filament mounting and seals

Courtesy Marconi's Wireless Telegraph Co., Ltd.

pulling out or pushing in the glass part while it is being heated in the blow-pipe flame. The Mullard Company employ a small metal index which is also anchored in the glass, and which lies alongside the spring to serve as a gauge for helping the glass-blower to give a predetermined tension to the filament.

In the operation of these power rectifiers the anodes become very hot and are often worked at a red heat. The heat is produced by the impact of the electrons, which, after emission from the filament, attain high velocity and bombard the anode violently. For example, if the anode is 1,000 volts positive relative to the filament, the electrons will be moving

ago molybdenum anodes were made by weaving molybdenum tape into a basket-like cylinder, but nowadays they are simply rolled sheet metal. It is found that a molybdenum anode can dissipate four times as much heat as a nickel anode; so higher voltages can be employed with a molybdenum anode of the same size as the nickel anode, and there is less danger of damage by accidental overheating.

In the second place, in using power valves, provision must be made for getting rid of the heat. In a bank of rectifiers for a big transmitting station about 20 or 30 kilowatts must be disposed of. A certain amount of the heat is radiated to a distance; but if the bulb is of glass this

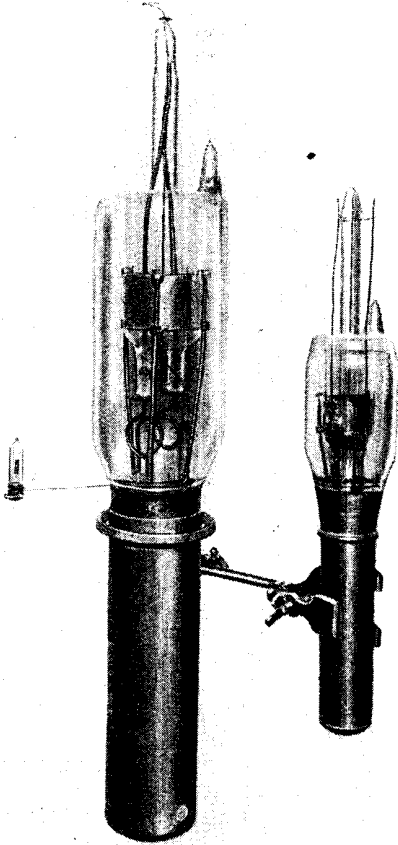

Fig. 4. An illustration of the Western Electric Co.'s latest type of water-cooled transmitting valve

Courtesy "Electrical Communication"

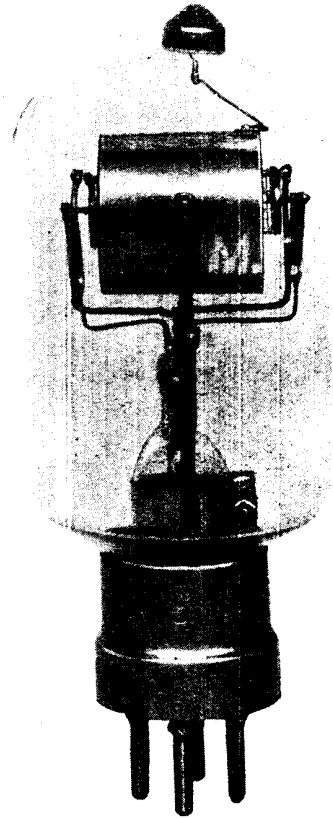

Fig 5. M.T.5 transmitting valve, which dissipates 25 watts at the anode, suitable for voltages up to 1500

Courtesy Marconi's Wireless Telegraph Co., Ltd.

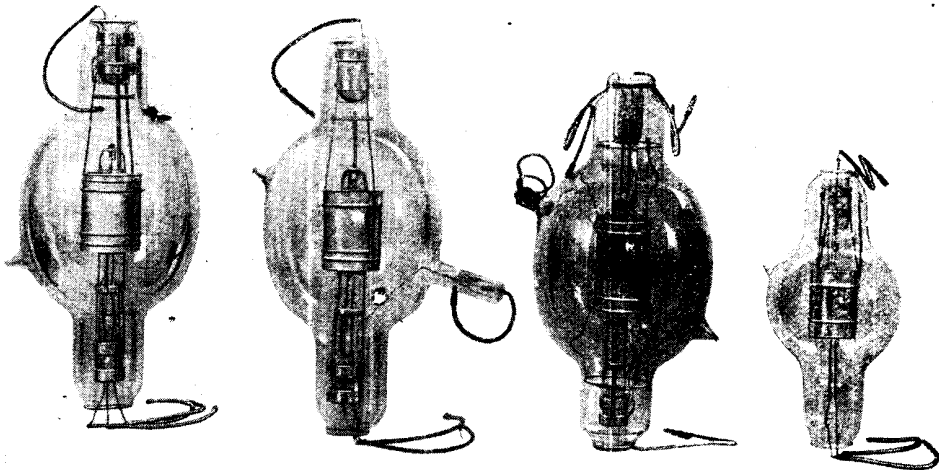
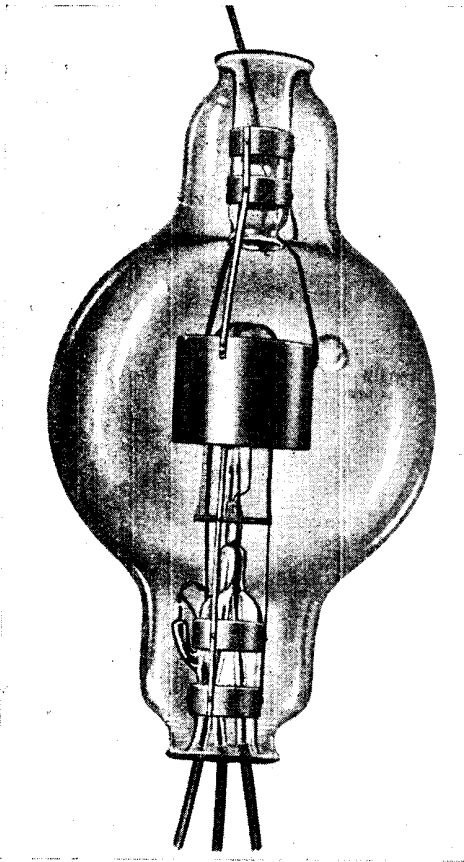

Fig. 6. Four types of transmitting valves. From left to right these are: M.R.6 rectifier; M.T.6; T.450 high-power valve; and M.R.4 medium-power rectifier

Courtesy Marconi's Wireless Telegraph Co., Ltd.

MODERN TYPES OF HIGH-POWER TRANSMITTING VALVES



M.T.4 VALVE FOR TRANSMISSION

Fig. 7. Tests of this valve have shown that it will dissipate 200 watts at the anode and is suitable for voltages from 7,500 to 10,000

Courtesy Marconi's Wireless Telegraph Co., Ltd.

absorbs some of the radiation and gets very hot. It then has to be cooled by the use of an air-blast furnished by a constantly running blowing engine or compressor.

In the third place, the manufacture of power valves is much more difficult than that of receiving valves. The fact that the anode becomes very hot in use compels the manufacturer to get rid of absorbed gas more thoroughly than is necessary in the manufacture of receiving valves. The process of exhaustion is pursued to extreme lengths, and the pumps are kept running some hours while the anode is bombarded by electrons from the filament in the same way as it will be bombarded in use.

Indeed, the bombardment during manufacture should be carried on at a higher voltage—that is to say, with even more

vigour—than will be experienced later. At the same time the glass must be heated by an external agency to a higher temperature than it is likely to experience in action, and this is best done in a furnace which can itself be partially evacuated to remove the pressure of the atmosphere from the bulb while it is heated almost until the glass softens.

While applying to the anode a voltage higher than will normally be applied to the finished article, the manufacturer meets a rather curious difficulty which causes a number of failures during the bombarding process. The high voltage on the anode accelerates the electrons from all parts of the filament and attracts most of them to itself; but some of the electrons from near the ends of the filament may, after getting up a high speed, shoot past the anode and strike the glass. When this happens to a sufficient extent the bombarded area of the glass may get so hot that the atmospheric pressure blows a hole in it and ruins the valve. This accident may be prevented by making the cylinder long enough to cover the ends of the filament.

The object of the elaborate manufacturing process indicated above is the complete removal of gas, whether free, or occluded in metal, or absorbed on glass. The free gas is easily removed by modern pumps, but gas in the solid parts is less easy to eliminate, and gradually comes out in working. This free gas is easily ionized by the high-speed electrons—that is to say, the gas molecules are broken into positive ions and negative electrons. The negative electrons join the main electron torrent and rush towards the anode. The positive ions are repelled from the anode, gain speed, and rush at the filament.

Doubtless most of the ions, in passing through the dense cloud of electrons just leaving the filament, are neutralized; but their momentum carries them right on to the filament, and they may heat portions of it so greatly as to cause actual evaporation of the metal. This is the beginning of the end of the filament. In the early days the endeavour to use high voltages in order to handle large powers resulted in rapid destruction because the art of evacuation was not systematized.

The life of a filament might then be one or two hundred hours. To-day many high-voltage valves live two or three thousand hours. It may indeed be said

that the life of a properly exhausted valve is a matter of filament thickness, and that the end comes because of unevenness in gauge or texture. The initially thin parts of a filament tend to become thinner still because the heat developed by the heating current is greater at the thin parts, and the evaporation of metal in the emission of electrons is therefore greater there. Obviously, thick filaments can be made of more uniform gauge and quality than thin ones, and on this account their life should be longer.

A thick filament requires a greater heating current than a thin one, and, other things being equal, costs more per hour in working. The designer or purchaser has therefore to balance shortness of life against running costs when deciding upon the thickness of filament he will specify in ordering a quantity of power valves.

Practically all that has been written above about the manufacture of valves with two electrodes applies also to valves with three electrodes, which may be called triodes. The triode differs from the diode only by having a grid interposed between the filament and the anode. The theory of the grid is the same in transmitting as in receiving valves. Because the grid is nearer the filament than the anode is, a small voltage applied to the grid is equivalent to a large voltage applied to the anode, and therefore small changes of grid voltage produce relatively large changes of anode current. The difference between transmitting and receiving triode valves lies solely in their size and design in detail.

The chief points in filament and anode design have already been explained for diode valves; the only additional feature in triode valves arises in the design of the grid, which must be supported to withstand great electrostatic pulls and must be thick enough to endure considerable bombardment.

During the war triode valves were made of gradually increasing size, until at last glass valves capable of dealing with half a kilowatt of input energy were standardized. The British navy meanwhile developed silica valves of even higher power. Silica has many advantages over glass; it allows of the anodes being worked at temperatures so high that glass would soften and collapse, and it is more translucent to heat rays, and therefore keeps cooler than glass.

The metal parts of both the glass and the silica valves are practically the same, but in silica valves the anode is made smaller than it could be made in glass valves of equal rating. A dimensioned sketch of an Admiralty glass valve is given in Fig. 2, which is taken from a paper read by Gossling before the Institution of Electrical Engineers. Recently Colonel Morris Airey, of the Admiralty, has exhibited a silica valve capable of dealing with over 50 kilowatts.

The latest development in valves, both diode and triode, consists in cooling the anode by flowing water or oil. Such a valve presents the appearance of a metal cylinder with a flat bottom, surmounted by a bulbous top of glass. The exposed metal cylinder is the anode, the grid and the

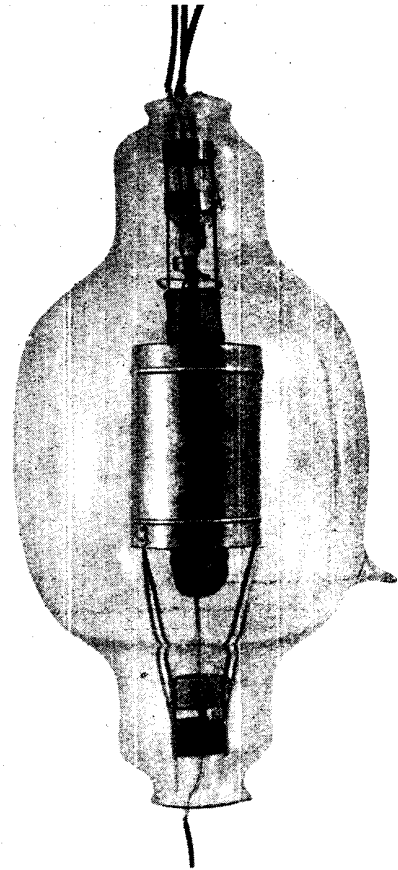

M.T.2 TRANSMITTING VALVE

Fig. 8. This, high-power transmitting valve dissipates 600 watts at the anode, and is suitable for voltages up to 1200

Courtesy Marconi Wireless Telegraph Co., Ltd.

filament being held in place within it by means of leads and supports sealed into the glass top. The glass top is itself sealed to the metal anode.

The water-cooled valve made by the Western Electric Company is illustrated in Fig. 4. This type of valve is also made by the General Electric Company of America and by Phillips of Holland. Some of these valves have been built of large size. The standard Western Electric valve is capable of dealing with an input of more than 15 kilowatts at 10,000 volts on the anode; but experimental valves have been built by the company to deal with more than 200 kilowatts.

As an example of a modern large valve equipment that at the Radio Corporation's station at Rocky Point, Long Island, may be cited. The valve equipment was supplied by the General Electric Company of America. It consists of a bank of three 50 kilowatt diode rectifiers and a bank of six 20 kilowatt triode oscillation generators. The primary supply of electric energy is 30,000 volts alternating current; this is rectified by the first bank and passed to the triode bank, which converts it to high-frequency current. A current of 350 amperes was maintained in the aerial during a test of sixteen hours.

VALVE SOCKET. Name given to a small brass component chiefly employed by the amateur constructor as a means of making

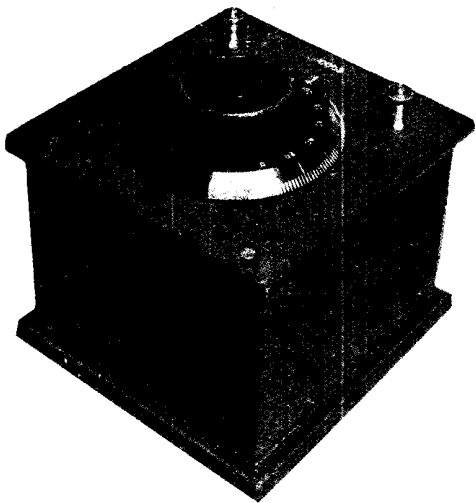

MOUNTED VANE CONDENSER

Fig. 1. It is best to mount vane condensers in a case as shown to prevent dust or dirt accumulating on the plates and altering the capacity

Courtesy Peto-Scott Co., Ltd.

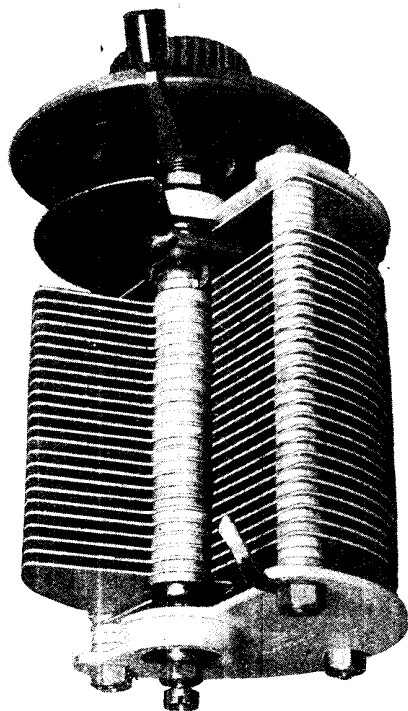

VERNIER VANE CONDENSER

Fig. 2. In this example a vernier adjustment is fitted for fine tuning. This instrument is of very accurate construction

Courtesy Peto-Scott Co., Ltd.

up a holder for an ordinary three-electrode valve. See Valve Leg.

VANE CONDENSER. Name applied to many patterns of variable condenser characterized by the use of a number of flat plates. One example is illustrated in Fig. 2, showing a Peto-Scott pattern with a vernier attachment. The condenser is composed of fixed plates arranged parallel to each other and secured to three tie rods, the plates being separated by small washers. The end plates are thicker than the others and act as the supports for the rods and the bearings for the centre spindle. Other and smaller plates are similarly mounted on the spindle, which is free to turn within the fixed plates, under the control of the dial and knob. A separate movable plate acts as a vernier, and is actuated by a small lever and knob. Vernier condensers are also dealt with under the heading Vernier in this Encyclopedia, and under the heading Condenser.

Vane condensers should be kept free from dust and dirt, and the method of mounting them in a small case with an

ebonite top is shown in Fig. 1. See Air Condenser ; Condenser.

VANNI, GIUSEPPE. Italian wireless authority. Born at Albano Laziale, Rome, 1862, where he was first educated, he continued his studies of electricity under Professor Kohlrausch at Strassburg. In 1894 he was appointed a lecturer in physics at the Collegio Romano, Rome, and professor and director of the physical

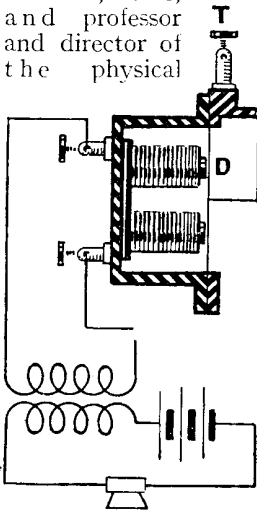

VANNI'S LIQUID MICROPHONE

This illustration portrays diagrammatically the liquid microphone of Giuseppe Vanni, and indicates clearly the principles of its action

laboratory of the Military Radio Telegraphic Institute in Rome, 1912. The same year he took part in the International Radiotelegraphic Conference in London, and also in those held in Paris in 1912 and 1913.

Professor Vanni is one of the most brilliant of the Italian wireless authorities. He is the inventor of an ingenious form of liquid microphone, separately described in this Encyclopedia, with which he carried out telephonic communication between Rome and Tripoli. He has written a number of standard books on electrical engineering and wireless, and in 1914 was awarded the Cagnola Prize of the Royal Lombard Institute of Science and Literature in Milan.

VANNI'S LIQUID MICROPHONE. Type of liquid microphone due to

G. Vanni. In the Vanni microphone a jet, J, of some conducting liquid, as acidulated water, is made to impinge on a sloping metal plate, F, which forms one terminal of the microphone. This sloping metal plate is fixed in position.

The other electrode of this microphone is also a metal plate, M, but it has a certain freedom of movement, so that one edge of it can just dip into the thin stream of conducting liquid that flows over the fixed electrode. The play of the moving electrode is controlled by means of a lever mechanism, A, attached to the diaphragm, D, of the microphone. The vibration of the diaphragm causes the moving electrode to dip in and out of the stream of liquid between the two electrodes, and this varies the resistance to any current which may be passing.

VARIABLE CONDENSER.

The expression variable condenser is chiefly applied to instruments of the moving-vane type, a development of which is illustrated in Fig. 1. This is known as the 3 E.V.C. condenser, and has many applications in conjunction with the elimination of interference and for many forms of bridged or balanced circuits. There are three variable elements in this condenser, the outer pair of moving plates and the inner or bridging plate, the plates of which are adjustable separately and relatively to each other.

Other forms of variable condenser are illustrated and described under the headings Air Condenser, Condenser, Tubular and Vernier Condensers (q.v.). A more compact

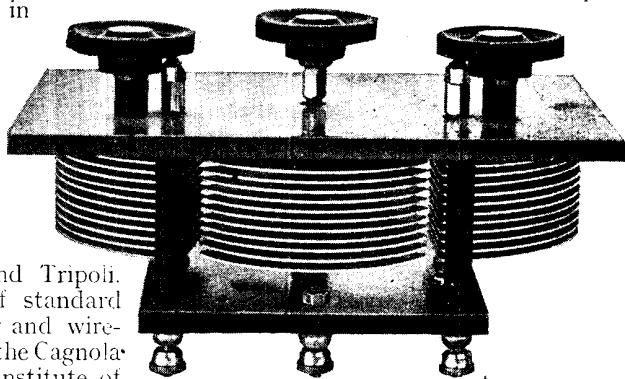

3 E.V.C. TYPE OF CONDENSER

Fig. 1. Here there are three variable condensers in one. This type of instrument is particularly valuable in interference-eliminating circuits

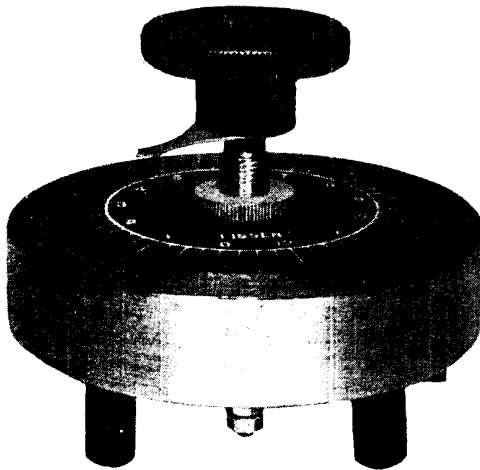

LISSEN VARIABLE CONDENSER

Fig. 2. Compactness is the striking feature of this instrument. In this type mica or some similar dielectric is employed instead of air

Courtesy Lissen, Ltd.

type of variable condenser is illustrated in Fig. 2, and is known as the Lissen. This, and others of other makes, incorporates the principle of two or more adjustable plates separated by a dielectric of mica or other material not air. One plate is usually fixed and the others adjustable, as regards their distance from it, by means of an ebonite knob. Such condensers have the merit of considerable range of capacity



LISSEN VARIABLE GRID LEAK

Suitable for panel mounting, this component has soldering tags attached for connecting the wires in position

Courtesy Lissen, Ltd.

while occupying small space. See Air Condenser; Condenser; Tubular Condenser.

VARIABLE GRID LEAK. Term used to describe all forms of grid leak with ready means for altering their value. One device, known as the Lissen, is shown in the illustration. It has an ebonite case with a centre hole fixing for panel mounting, the alteration of value being obtained by rotation of the ebonite knob. Soldering tags are fitted for the attachment of the connecting wires. See Grid Leak.

VARIABLE INDUCTANCE. Term applied to all forms of inductance which are so arranged that the effective value can be

altered at will. Among the methods that have been adopted are the sliding type of inductance, and the use of tappings and contact points of studs controlled by an inductance switch. See Coil; Inductance; Tapping, etc.

VARIABLE RESISTANCE. Strictly speaking, an expression covering all forms of adjustable resistance. In wireless work the term is more applied to those resistances of high value required in many circuits. There are many patterns, but these illustrated are characteristic, and known as the Lissen. The actual resistance is a compound of high resistivity and is varied by alteration of the pressure exerted by the screwed spindle rotated by the small ebonite knob. See Resistance; Rheostat.

VARIO-COUPLER. Name given to a tuning device. A vario-coupler consists of two elements, first a fixed portion which is virtually an inductance coil wound upon a tubular or spherical former, and often known as a stator, and a movable portion known as a rotor. The latter may take the form of a basket coil, spherical rotor ball, or other convenient form. In addition, a vario-coupler may actually consist of two plug-in type coils, suitably connected and tapped. In this Encyclopedia the application and construction of vario-couplers are fully dealt with, e.g. under Armstrong and Reflex Sets.

As regards the rotor ball type of

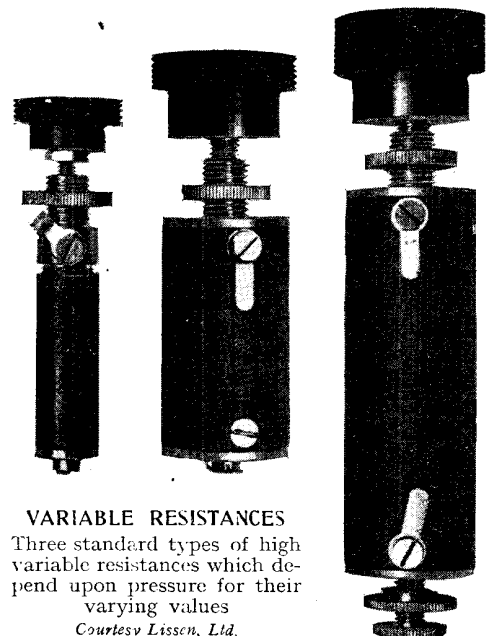

VARIABLE RESISTANCES

Three standard types of high variable resistances which depend upon pressure for their varying values

Courtesy Lissen, Ltd.

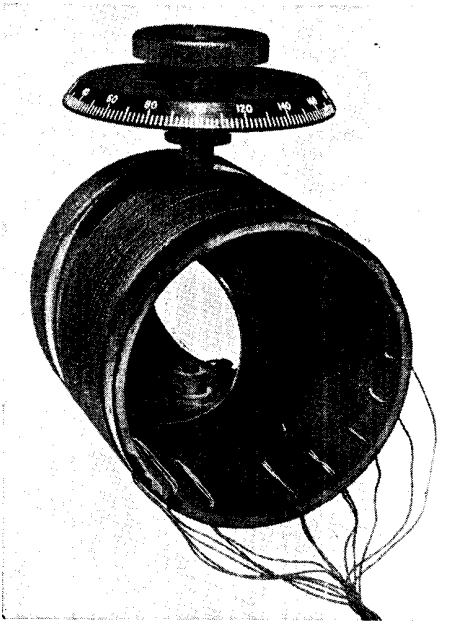

GECOPHONE VARIO-COUPLER

Fig. 1. In this type the rotor is mounted inside a tubular tapped inductance as the stator
Courtesy General Electric Co., Ltd.

instrument, such as that illustrated in Fig. 1, which is known as the Gecophone vario-coupler, this part of the device follows the same methods of construction and winding as that described in the article on rotor (*q.v.*). The Gecophone vario-coupler comprises a tapped stator in the form of an inductance on a tubular former, the rotor being mounted within the tube and controlled with an ebonite knob and dial.

In another pattern, illustrated in Fig. 2, a somewhat similar arrangement of a tapped inductance is used in the primary, while the rotor in this case consists of a lattice-wound basket-type coil mounted on two short spindles in a similar manner to a variometer, the movement of the rotor being controlled by an ebonite knob.

In instruments of this general type the wiring may be carried out in various ways. The tappings in the primary are usually carried to a stud switch controlled by a movable contact arm and connexions made in the usual way to aerial, earth and the detector. The rotor may be wired into the circuit either as a reaction coil or as a coupling coil to a secondary inductance of suitable value, in which case the primary is connected to aerial and earth and one side of the secondary taken to the detector. The vario-coupler is in this sense a

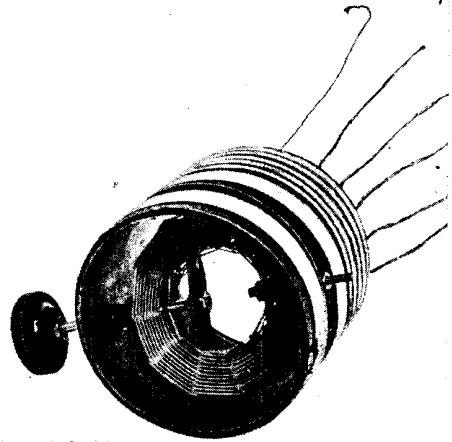

COMMON TYPE OF VARIO-COUPLER

Fig. 2. Here a lattice-wound basket coil is used as a rotor, movement being controlled by the knob

most adaptable instrument for tuning purposes. See Coil; Rotor; Stator; Variometer. See also under the names of various sets using vario-couplers.

VARIOMETER. A form of variable inductance in which the variation is made without alteration to the amount of conductor in the circuit. In practice, the

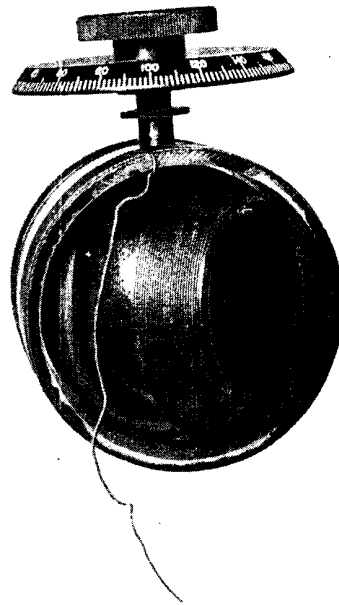

GECOPHONE VARIOMETER

Fig. 1. The rotor here is mounted on two half-spindles projecting through the stator walls
Courtesy General Electric Co., Ltd.



FOR HOME CONSTRUCTION

Fig. 2 (above). Four ebonite plates are cut to shape and drilled to form end supports of the home-made variometer. Fig. 3 (right). End plates of the rotor are now in position and the central spindle fitted

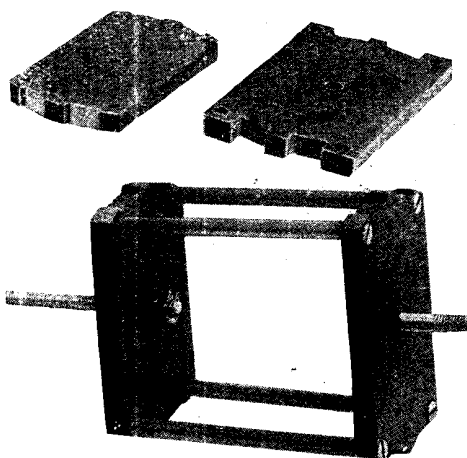

variometer usually comprises either a tubular or spherical exterior member or stator, with a spherical internal member known as the rotor. An example of this type is the Geophone variometer, illustrated in Fig. 1. The rotor is mounted on two half-spindles which project through lashed holes in the walls of the stator, movement of the rotor being controlled by means of a dial and knob.

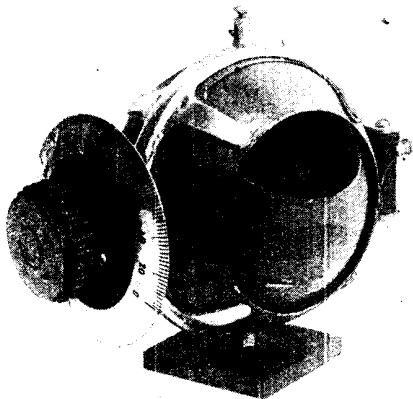

G.R.C. VARIOMETER

Fig. 4. Both stator and rotor in this example are wound without formers, an insulated outer cage carrying the spindle and ebonite blocks
Courtesy General Radio Co., Ltd.

A variometer is wired so that there are only two ultimate ends to the winding proper. The outer windings commence at one terminal, the requisite number of turns are made outside the stator former, and the end of this wire connected to the commencement of the rotor winding, such connexion being effected by means of bushing and half-spindle and by contact strips. Other methods include the use of flexible wire, contact brushes, and so forth. The end of the rotor winding is similarly

connected to the other half-spindle, and this is connected to the second terminal.

• A particularly good example of a variometer suitable for broadcast band of wave-lengths is that illustrated in Fig. 4, as supplied by the General Radio Co., Ltd. This is built up so that only the winding itself is needed to form the major portion of the stator and rotor, the latter having a small ring or flange which acts as a support to the spindle, the stator having an insulated outer cage of metal to carry ebonite blocks and supporting bushes for the rotor spindle.

The small ebonite plate is connected by means of a screw in the end of the stator framework and enables the frame to be fixed under any reasonable conditions. The modes of wiring and making variometers of the spherical type are described in the articles Stator and Rotor (*q.v.*).

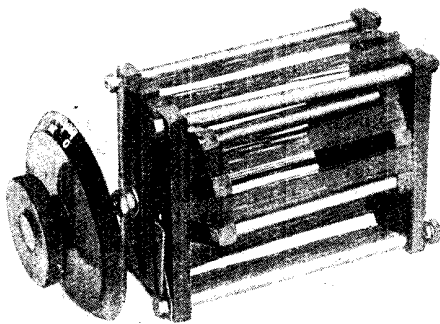

HOME-CONSTRUCTED VARIOMETER

Fig. 5. This simple variometer is easily made at home. Two rectangular formers are used in place of the more usual spherical ones

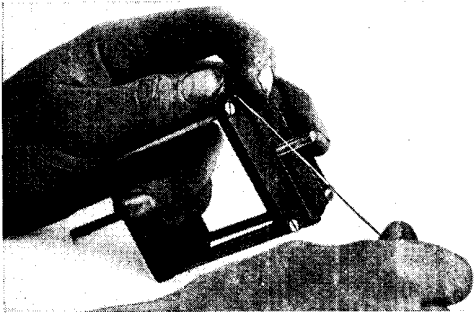

WIRING THE ROTOR

Fig. 6. To hold the wiring of the rotor firmly in place notches are cut in the end plates. Note the positions of the hands

A suitable simple and effective construction for amateur purposes is illustrated in Fig. 5, from which it will be seen that the spherical formation is substituted by the use of two rectangular windings supported by flat ebonite end plates. These are connected together by means of ebonite or brass rods to form two pairs, the smaller being arranged to rotate within the other.

For broadcast purposes, when used in conjunction with the average aerial and a low value series condenser, the variometer plates may measure 4 in. long, 3 in. wide and $1\frac{3}{8}$ in. deep for the stator, and $3\frac{3}{8}$ in. long, $2\frac{3}{4}$ in. wide and $1\frac{1}{2}$ in. deep for the rotor. These ebonite plates are then squared up and radial notches cut in the ends of them, as shown in Fig. 2. Central holes are drilled for the bush and spindles respectively. Other holes are drilled near the corners for the passage of the tie-rods. Two holes should also be drilled and tapped in one of the plates so that the variometer may be screwed to the panel.

After the plates have been prepared they should be tested by mounting them on a rod and rotating them to see that the radial slots are correctly cut, and that the ends of the pieces for the rotor are also cut to a radius. There should be a gap of about $\frac{1}{8}$ in. between the outside diameter of the rotor plates and the bottom of the radial walls on the fixed or stator plates. The rotor is then assembled, as shown in Fig. 3, by means of four equal-length rods of brass or ebonite

about $\frac{3}{16}$ in. in diameter. The ends of these rods are drilled and tapped, and No. 4 B.A. countersunk screws passed through the holes in the rotor end plates and screwed into the rods.

Two short lengths of screwed rod are then fixed in the centre holes and secured with lock nuts in the usual way, to act as spindles.

The next step is the wiring, which may be performed with ordinary No. 20 gauge enamelled copper wire. As many turns as possible should be made, commencing from one of the outside corners of the notches until the notches on one side of the spindle are completed. The wiring is then swept across to the next notch and continued as in Fig. 6.

After the wiring is finished, the two ends should be connected one to each of the spindles by means of lock nuts. The stator plates should then be assembled on the rotor by means of rods, which may be screwed into the holes in the end plates and secured with lock nuts. Two terminal nuts should be fitted on the outside end of the top pair of rods, each of these rods being connected to one of the half spindles of the rotor by means of a copper contact strip, the whole arrangement being clearly illustrated in Fig. 7.

To keep the rotor in place and keep the winding from rubbing against the end plates of the stator, one or two spring washers should be interposed between the two pairs of end plates, and the length of the stator rods, being rather longer than those

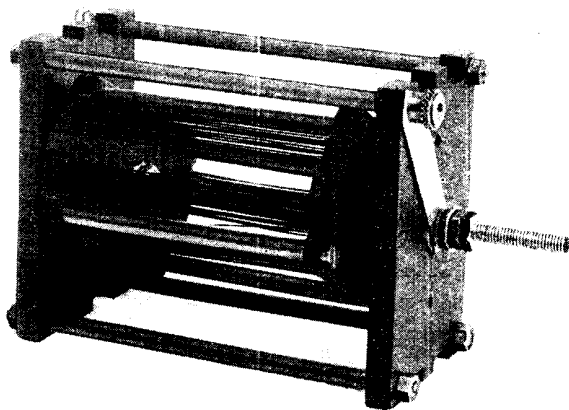

HOW THE ROTOR IS FITTED IN THE STATOR

Fig. 7. Here the variometer is nearing completion, and the rotor is fitted inside the stator. Note the connecting strip between the central spindle and the stator terminal!

for the rotor, gives sufficient clearance. These spring washers and other constructional details are shown in Fig. 8.

The stator is wound in a similar manner to the rotor, but it is necessary to interpose a thin strip of insulating material between the winding and the contact strips. The final stage in the wiring, as well as these contact strips, is illustrated in Fig. 9. The stator winding has to be carried out

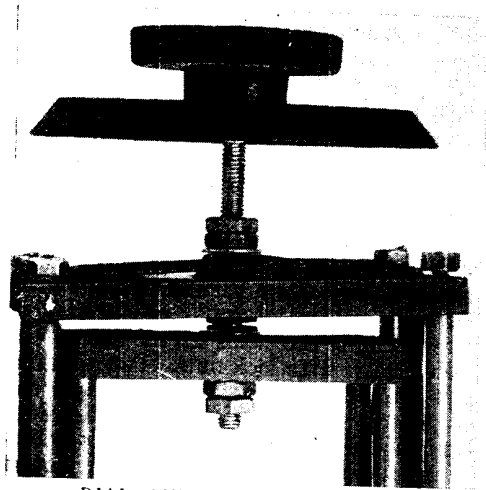

DIAL AND SPINDLE DETAILS

Fig. 8. Spring washers are employed to keep the rotor end plates from jamming against the stator end plates

after the rotor is assembled in its place, as it is otherwise difficult properly to connect the rotor to the spindles. The commencing end of the stator winding should be attached to one of the rods having a terminal on it.

The winding is then continued as in the case of the rotor, and should be in the same direction. The ultimate end of the rotor winding is connected to the other rod of the stator, which is also provided with a terminal. On making a battery test with telephones in the usual way, the circuit should now be completed through the terminal. The current should have an unbroken metallic path from the first terminal, around the stator winding to the second rod, which is connected to the variometer spindle by means of a contact strip, shown in Fig. 7.

The current then passes through this strip, through the rotor half-spindle, thence through the contact strip to the second terminal on the stator. In use, tuning is effected by varying the degree

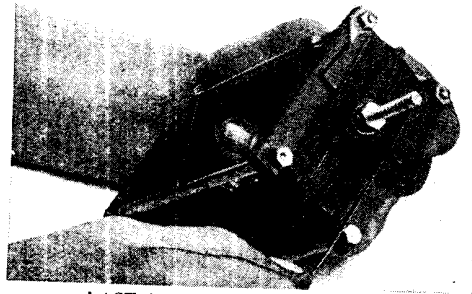

LAST STAGE IN THE WIRING

Fig. 9. The final stage of the wiring is shown here. The rotor winding is completed and the last stage of the stator winding is in progress

of coupling between the rotor and stator. Results may only be obtained when the rotor is turned through 180 degrees. This may arise should the winding be arranged in opposite directions. See Coil; Inductance.

VARIOMETER WAVE-METER. Form of wave-meter employing a variometer as the variable inductance. The best form of variometer wave-meter is that due to Professor J. S. Townsend and patented by him. This form of wave-meter, by means of a two-way switch, may be used for long or short wave-length ranges. See Wave-meter.

VERNIER CONDENSER. A condenser of low value used in a circuit for fine tuning purposes.

A vernier variable condenser of such construction is illustrated in Fig. 1, and in this three end plates are used, thus providing for adequate support of the vernier spindle, imparting to it an

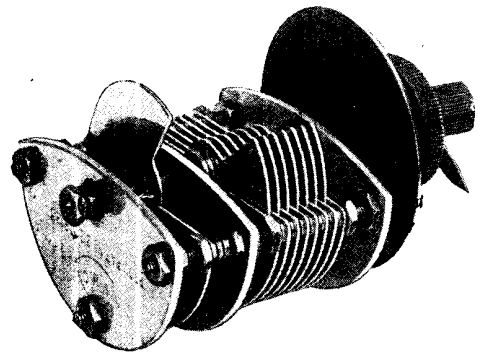

CONDENSER WITH VERNIER ADJUSTMENT

Fig. 1. Between the lower end plates an additional moving and fixed pair of plates, controlled separately, provide vernier or fine adjustment of capacity

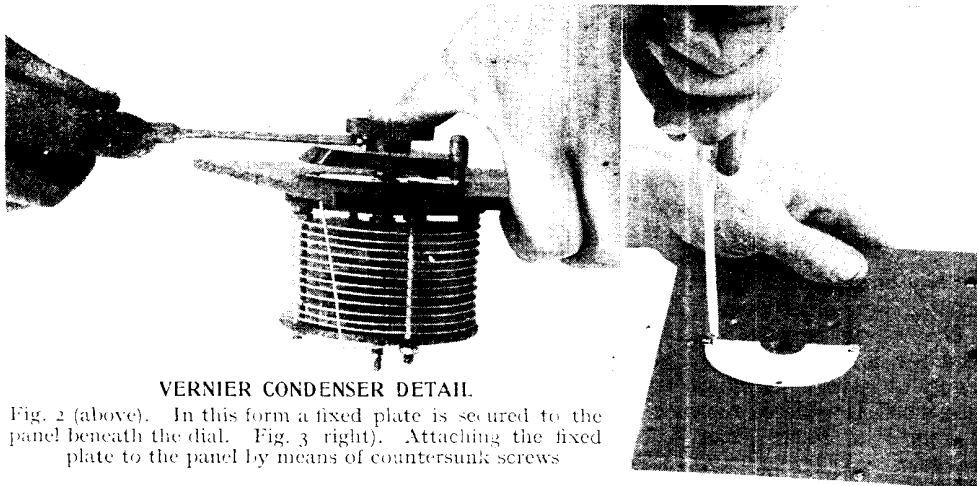

VERNIER CONDENSER DETAIL.

Fig. 2 (above). In this form a fixed plate is secured to the panel beneath the dial. Fig. 3 right). Attaching the fixed plate to the panel by means of countersunk screws

independent means of adjustment. Such condensers are usually reliable and robust in use and not easily deranged.

The experimenter will often be called upon to convert an ordinary variable condenser to a vernier condenser. One method by which an extensively used make of variable condenser can be adapted as a vernier is illustrated in Fig. 2. The method consists essentially of attaching a fixed plate to the outside of the panel, attaching to the underside of the dial another metal plate, and altering the dial knob so that the dial only may be rotated while the knob remains stationary.

The first step is to take an ordinary fixed condenser plate and screw it by means of countersunk brass screws to the outside of the panel, as is shown in Fig. 3. The

next operation is to part the knob from the dial, if necessary sawing them asunder. A special metal plate is then cut from brass or aluminium and should be similar in general shape to the ordinary moving plates, but should have an outwardly

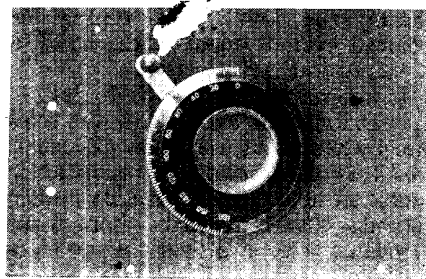

DIAL OF THE CONDENSER

Fig. 4. Plan view of the dial, showing the control knob for the vernier plate of the condenser

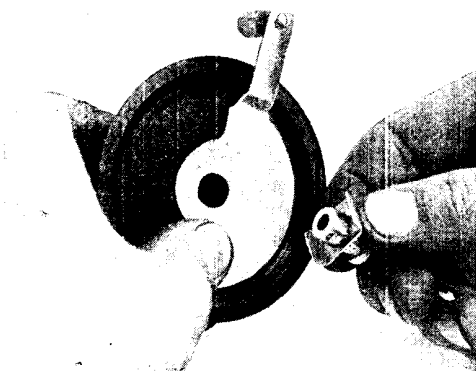

SPECIAL ADJUSTING PLATE

Fig. 5. Here the special metal plate is being fixed in position on the dial. This part of the construction calls for careful work

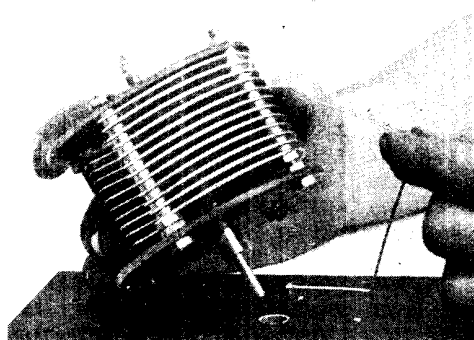

WIRING THE VERNIER CONDENSER

Fig. 6. In wiring the condenser one lead is brought through the panel to the fixed plate beneath the dial

projecting arm. The shape of this arm, as well as the small ebonite knob which is connected to it, is shown in Fig. 5.

The dial should be provided with a small bush and spring to keep it in its place, this detail being also visible in Fig. 5, where it is shown held between the operator's finger and thumb. The whole purpose of this little spring and bush is to provide a bearing for the dial to rotate upon. A plan view of the dial, knob and adjustable handle is shown in Fig. 4.

The wiring necessary for such a conversion is illustrated in Fig. 6, and consists merely of a single length of tinned copper wire, which is soldered to one of the screws securing the fixed plate to the panel, this wire being brought out to the opposite end plate of the main condenser and connected to one of the terminals in contact with the fixed plate. After assembling the dial, the knob proper is screwed on to the condenser spindle and secured with a set-screw, as illustrated in Fig. 2. In use the main part of the condenser is controlled in the ordinary way by rotating the knob, fine tuning being imparted by movement of the hand lever connected to the dial.

An alternative method is to leave the knob and dial in touch with the moving plate by means of the lever. Either plan gives very good results in practice. In a general sense any small variable condenser will act as a vernier if it be shunted across the ordinary type of variable condenser. See Billi Condenser; Condenser.

VERNIER DEVICES. This term embraces numerous mechanical arrangements for imparting slow motion to a control.

One of the simplest devices for the home constructor is illustrated in Fig. 1. It consists of an ebonite rod, about 9 in. long, with a tapered brass blade about 3 in. in length, attached to it. It is used as shown in Fig. 1, by resting the end of the blade on top of the panel and using the rod as a lever to move the pointer of a filament resistance. It will be found that if the lever is simply lifted, the movement imparted to the knob will be very small, thus providing fine tuning.

The most convenient method of making this lever consists of first cutting the blade to a taper shape and cleaning off the edges. An ebonite rod, $\frac{1}{2}$ in. in diameter and 9 in. in length, has a slot cut in the end with a hack-saw, as shown in Fig. 2. The blade is then inserted into the

slot, two holes drilled through the ebonite, and the blade secured by careful riveting. The method of using this vernier lever for the fine tuning of a condenser dial is shown in Fig. 3, the end of the blade being inserted between the dial and the panel and the lever twisted. Thus a very small motion is imparted to the condenser knob or dial, and fine tuning results.

Another type of detachable vernier arrangement, illustrated in Fig. 4, has a long ebonite rod provided with a rubber disk at the extremity. This is inserted into a bushed hole on the panel in such a way that the rubber disk bears against the rim of the condenser dial, so that



SIMPLE VERNIER DEVICE

Fig. 1. In this device a tapered brass blade is employed which enables a very fine adjustment to be made

by slowly rotating the vernier a very small amount of motion is imparted to the condenser.

The bushes are easily made up from terminal nuts, which may be shouldered and pressed firmly into holes drilled and counterbored in the panel, as shown in Fig. 5. These should be placed at such a distance from the rim of the dial that the rubber disk or wheel will press firmly against the latter. The components of the vernier handle consist of an ebonite rod about 9 in. in length, and one end should be drilled and tapped for a piece of screwed rod which is fitted into it. One end of this screwed rod is turned down so as to provide a smooth end. A solid disk of rubber about $\frac{1}{4}$ in. thick and $\frac{3}{4}$ in. in

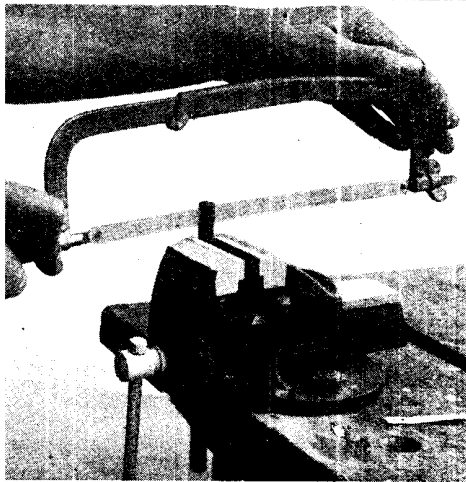

Fig. 2. An ebonite rod has a slot cut in it with a hack-saw to receive the metal blade for the vernier control

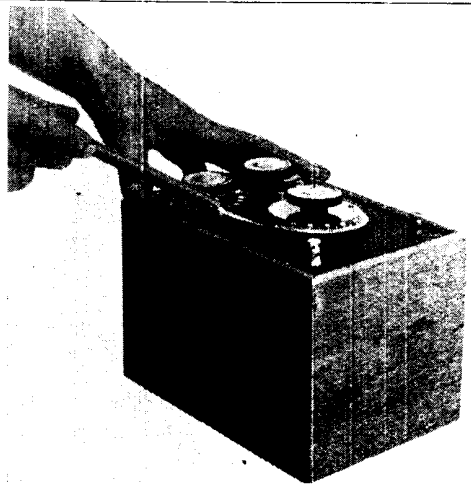

Fig. 3. How the vernier control lever is used to obtain fine adjustment of a condenser

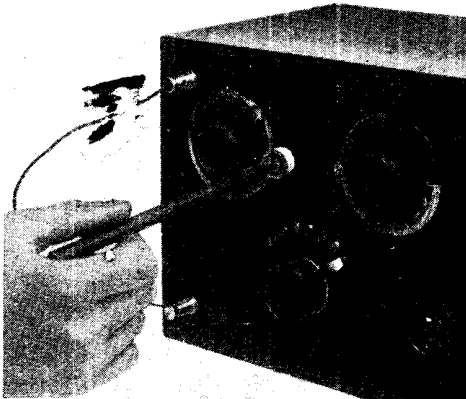

Fig. 4. In this control an ebonite rod with a rubber disk at one end provides fine movement of the dial



Fig. 5. Here the panel holes are drilled and counterbored to receive the vernier control shown in Fig. 4

FINE ADJUSTMENTS OBTAINED BY USING VERNIER CONTROLS

diameter is then grasped between washers and another nut placed on the end of the rod and the whole assembled.

A good example of an amateur-made worm-driven vernier device is illustrated in Fig. 6. This consists of a simple worm formed on the end of an ebonite rod. A little angle bracket of brass is attached to the ebonite panel on the set, and drilled to receive the end of the worm shaft. Teeth are then cut in the worm and the dial, so that when the worm is rotated the dial is moved a very small amount. The worm is detachable, and

can therefore be used to control several dials, providing they are cut with teeth. It will be found quite effective if the teeth are cut with a three-square file, as illustrated in Fig. 7. The notches should be uniformly spaced and of equal depth.

The spacing should be determined with the aid of a pair of dividers, which may be used to scratch the edge of the dial where it is to be notched.

The worm can be made from an ordinary wood screw by choosing one which is comparatively small in diameter, such as a No. 4, about 1½ in. in length. The

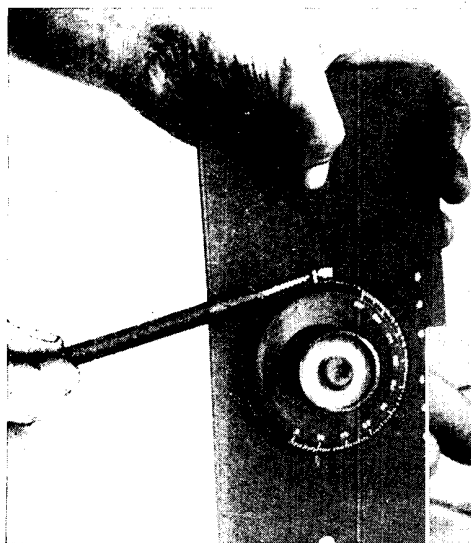

WORM-DRIVEN VERNIER CONTROL

Fig. 6 (above). Amateur-made worm-driven control which is simple and efficient in use. Fig. 7 (right). Cutting teeth on the dial for control with the worm-driven device



where they are provided with plates for attachment to the pole. See Aerial; Frame Aerial.

VIBRATION GALVANOMETER. Type of galvanometer in which the moving element is adjusted to work or vibrate in resonance with the alternating current which is being measured. Such galvanometers are the most sensitive means of detecting and measuring minute alternating currents, and, further, they are selective in the sense that they do not readily respond to any components of the current the frequencies of which are not of the resonance frequency.

One of the best-known types of vibration galvanometer is the Campbell pattern, illustrated in Fig. 1. This pattern is notable for possessing an inductance of a low order and a moderate effective resistance, while it is readily tuned to frequencies between forty and one thousand periods per second.

pointed end is cut off, and the thread filed away to form a peg to fit into the hole in the angle plate. The head of the screw is then cut off, and the shank inserted in the hole drilled in the end of the ebonite rod, and fixed thereto by means of set-screws.

The moving element consists of a very narrow coil having a low moment of inertia, held within the air gap of a permanent magnet by a system of double bifilar suspension. The upper portion of the suspension system is adjustable by rotating a pinion which moves a rack.

The notches in the rim of the dial are greatly improved if the dial be unscrewed from the condenser spindle and arranged to rotate on a simple peg. The worm is then brought into engagement with the notches on the rim of the dial, and rotated as rapidly and steadily as possible, either by hand or with the aid of a brace and bit. This has the effect of smoothing and more accurately shaping the teeth of the worm wheel, which will result in a much smoother action. See Condenser; Fine Tuning Devices.

VERTEX AERIAL. The name of a patented aerial consisting of a drum-like structure built up in sections and covered with mesh wire. The example illustrated shows the simple way in which this aerial may be erected on a pole set upright in the ground, or attached to the roof of a house. The framework of the aerial is of galvanized iron wire. The drum measures about 4 ft. across and 1 ft. deep.

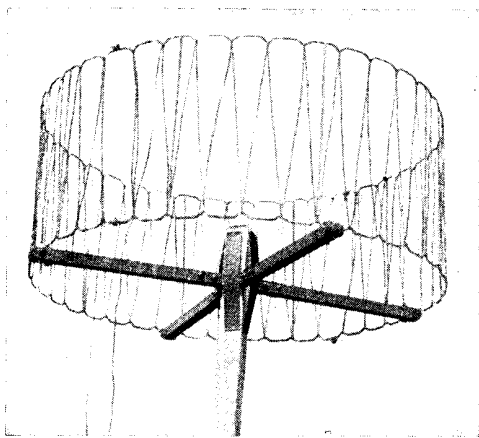

VERTEX AERIAL

This is a patent form of aerial which may be easily erected and has no directional effects

Four insulated cross-bars are connected to the frame and are united in the centre,

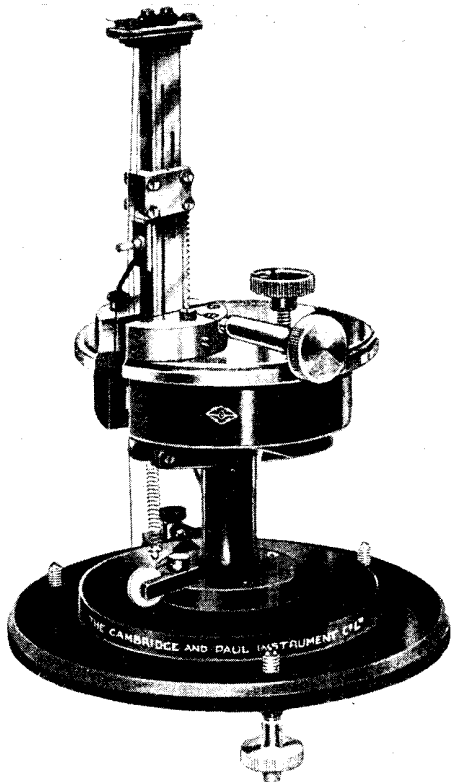

VIBRATION GALVANOMETER

Fig. 1 (above). In this instrument the moving element is adjusted to vibrate in resonance with the A.C. being measured. Fig. 2 (right). Resonance curve of vibration galvanometer

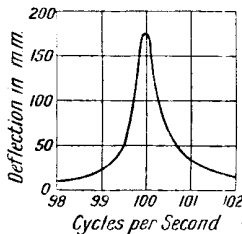

Fig. 1, Courtesy Cambridge and Paul Instrument Co., Ltd.

Attached to the rack is a slide-block upon which are mounted two phosphor-bronze wheels, between which the suspension rests. Thus the length of the suspension may be varied to any point within the limits imposed by the rack without fear of breakage.

Further suspension adjustment is provided by which the tension may be varied. The latter motion is applied to the lower suspension. By suitably carrying out these adjustments for different supply frequencies, it is possible to make the instrument vibrate in resonance with any of the frequencies before mentioned.

The moving coil itself has a resistance of 12 ohms, and the suspension has one of 12 ohms also. Attached to the coil is a

plane mirror which reflects the light through a lens having a focus of 100 centimetres. A movable cover is supplied with the instrument.

A curve showing the sharpness of the resonance obtained with these instruments appears in Fig. 2. The high sensitivity is due to reducing the damping to a very small amount, and if the full sensitivity is to be employed the frequency must be kept constant. In cases where this is impossible it will be found desirable to flatten the resonance curve by inserting a suitable shunt in the circuit. See Galvanometer; Moving-coil Instruments.

VIRTUAL VOLTS. Readings of alternating current values based on the root mean square of the average values of their electro-motive forces. See Root Mean Square.

VOLT. The unit of electro-motive force. The practical unit of E.M.F. or potential difference is the International volt. It is defined as being that electro-motive force which, when steadily applied to a conductor having a resistance of one International ohm, creates in it a current of one International ampere. The potential difference between two points on a conductor may be measured in terms of the work done in conveying a unit quantity of electricity from one point to the other. In general $E = W/Q$, where E is the potential difference in volts, W the work done in joules, and Q the quantity of electricity measured in coulombs. See Ampere; Electro-motive Force; Ohm; Resistance; Units.

VOLTAGE TESTING OF INSULATORS.

Method of testing insulators by which their breakdown strain may be ascertained. The materials of which insulators are made must necessarily be tested from time to time to ensure uniformity of their important electrical function. Apart from the actual material of which the insulator is composed, its shape and the conditions under which it is to be used are important factors upon which its efficiency depends. For instance, a porcelain cylinder with a perfectly smooth and plain exterior will, if exposed to damp or wet weather, allow current to leak around its surface, even though no current is actually passing through its body. For this reason insulators which are exposed to the atmosphere, or which have high voltages to contend with, are ribbed or grooved on their outer surface in order to prevent surface leakage.

When such insulators are under test, it is important that the test be made under the most adverse conditions that the insulator is ever likely to experience. To this end, high voltages are applied across the insulator under test and at the same time water is liberally sprayed upon its surface in order that no doubt may exist about its insulating properties under exceptionally bad conditions. See Insulation; Insulator.

VOLTAIC CELL. Primary cell in which chemical energy is converted into electrical energy. Most of the voltaic cells are separately described in this Encyclopedia under their own titles e.g. Clark Cell. See also Primary Cell.

VOLTMETER. An instrument for measuring the potential difference between two points of a conductor. There are many forms of voltmeter so far as external appearance is concerned. Those principally used by the amateur for wireless work are often of the watch type, so called because the mechanism is enclosed within a case similar in appearance to a watch. In others, such as that shown in Fig. 1, the mechanism is enclosed within a polished wood case.

As a fixed instrument, such as might be mounted upon a panel or charging-board, a pattern similar to that illustrated in Fig. 2 would be very serviceable, the case being made entirely of metal, having a glazed window for inspection of the pointer and dial. Apart from their size, however, voltmeters and ammeters are very much

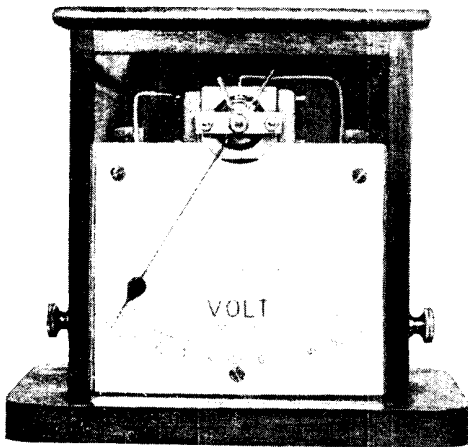

SMALL VOLTAGE VOLTMETER

Fig. 1. This instrument is used for registering small voltages, and is adjusted to show fractions up to one volt

Courtesy J. J. Griffin & Co., Ltd.

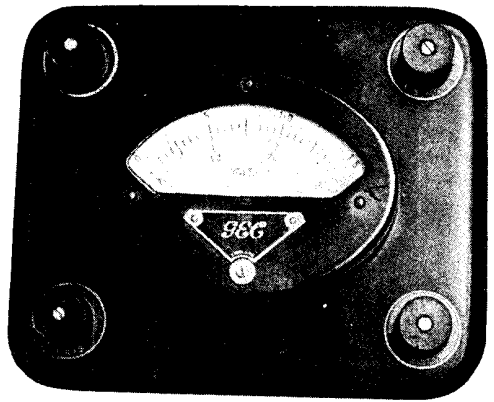

DOUBLE-RANGE VOLTMETER

Fig. 2. In this type of instrument voltages from 0 to 3 may be measured, or from 0 to 30, as may be required

Courtesy General Electric Co., Ltd.

alike, the internal construction of these instruments being described in this Encyclopedia under the headings Ammeter, Hot-wire Instrument and Moving-coil Instrument.

The essential difference between a voltmeter and an ammeter is that the voltmeter is a high-resistance instrument. This is because the voltmeter has to be connected in parallel with that part of the circuit where the potential difference is to be measured. The usual type of voltmeter is calibrated to cover a comparatively limited range of voltages. When, however, one instrument is to be used to cover considerably divergent voltages, such, for example, as the requirements of the low-tension battery, a commonly adopted plan is to provide an instrument with a series resistance. Means are provided, by the use of separate leads, by a small switch, or other convenient means, to enable one or other part of the circuit to be used at will. The one part would be proportioned to read for the lower-range voltages, and when the resistance is brought into play the higher voltages can be read.

A double-range instrument of this type is illustrated in Fig. 2.

It should be remembered that to function properly the voltmeter has to be very accurately made and well balanced, and should therefore be treated with every consideration and be preserved from mechanical or electrical shocks of any magnitude. See Ammeter; Galvanometer; Hot-wire Ammeter; Moving-coil Instrument; Wattmeter.

VREELAND ARC. Method of generating undamped oscillations from a direct current supply, due to F. Vreeland. A special mercury vapour tube is used, having one mercury cathode and two carbon anodes. The latter are arranged in parallel through choking inductances and resistances and an oscillation circuit is connected between them. The coils forming the inductance in the latter circuit are arranged that their magnetic fields cause a direct deflection of the stream of mercury vapour toward one or other of the carbon anodes. The oscillations are maintained in a steady state by the discharge of the condenser through the inductance coils.

VULCANIZED RUBBER. Name given to the hard rubber largely used for insulating purposes in wireless. See Ebonite; Vulcanite.

VULCANITE. Name given to hard vulcanized rubber, better known in wireless as ebonite or hard rubber. In the construction of the material pure rubber is mixed with about one-third of sulphur by weight and then heated up to 300° F. for a considerable time. For wireless purposes vulcanite is usually black and is supplied in sheets of convenient thickness. The outer skin often has poor insulating properties and in the construction of wireless instruments is best removed. This may be done by rubbing the surface on either side with glass or emery paper, as described under the heading Ebonite.

~~~~~ **W** ~~~~~

**W.** This is the chemical symbol for the metal tungsten, largely used in wireless for filaments of valves and for electrodes of spark gaps. See Tungsten.

**WANDERING.** The alteration of apparent direction of received signals due to changes not caused by either the trans-

mitting or the receiving station. See Fading.

**WANDER PLUG.** Name given to a small metallic plug usually fitted with an insulating handle or knob. Some types of wander plugs are illustrated in Fig. 2. The plug end is usually tapered and has a saw-cut along the tapered portion, thus assuring a good tight fit into its socket.

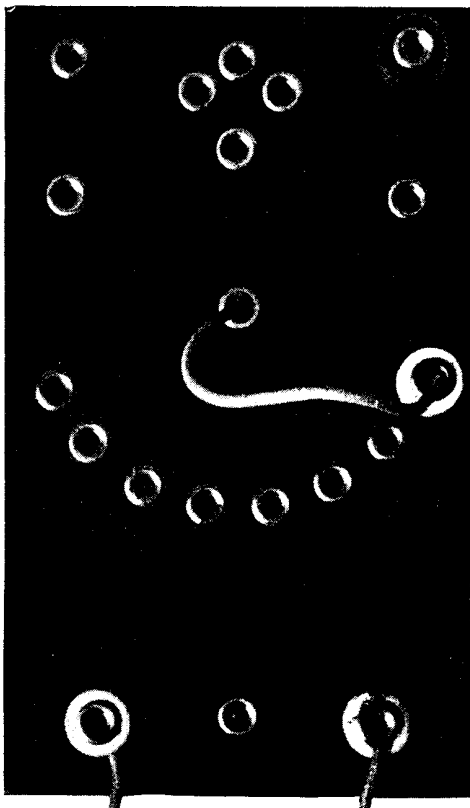

PANEL WITH PLUGS AND SOCKETS

Fig 1. Wander plugs and sockets are fitted to this panel for ease of alteration in circuit arrangements

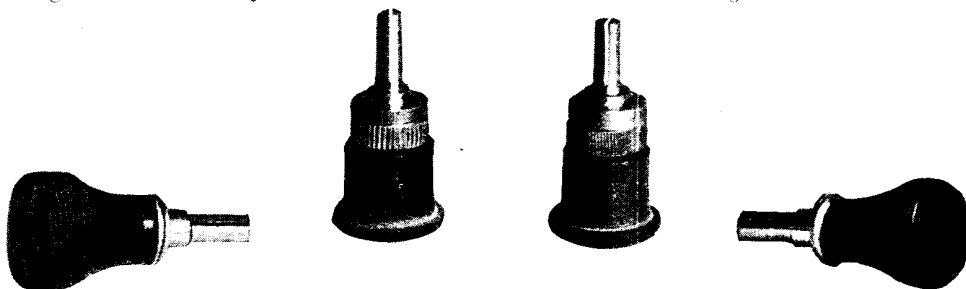

WANDER PLUGS FOR USE IN WIRELESS SETS

Fig. 2. Above is shown a group of wander plugs such as are largely used in wireless in connexion with tapped high-tension batteries. A black plug is used for the negative and red for the positive tappings

The plugs illustrated to the outside left and right have a solid knob having a screwed hole into which the plug portion screws. The connecting wire is twisted round between the pair of brass washers. In the central wander plugs in the illustration the knob in each case is hollow, and permits the connecting wire to pass through the hole.

The wander plug is largely used with the high-tension battery for rapidly selecting the required value of potential. Another and similar use allows the correct adjustment of grid bias to a valve. A convenient method of obtaining this is illustrated in Fig. 1, which shows a valve panel arranged for use with plugs and sockets. See Plug; Socket.

**WASHERS.** Name given in wireless to the flat ring, of metal, ebonite or other material placed between a nut and the surface against which the nut is tightened for obtaining a required effect. In wireless the washer is largely used, and in many different connexions and for various purposes. One important application is its use as an insulating washer between two electrical conductors. A common usage in this direction is with insulating terminals secured to a wood or other semi-conducting panel, where a washer of ebonite, celluloid or mica is placed between the terminal and its point of contact with the panel.

The spacer washer is extensively used in wireless in the construction of the variable condenser. In this case the washer is of a definite thickness, and spaces each adjacent pair of condenser plates.

The spring washer usually consists of a phosphor-bronze spring used on the spindles of moving parts such as filament resistances and variable condensers. See Air Condenser; Spacer Washer.

**WATT.** Unit of electrical power. It is the equivalent to the work done at the rate of one joule per second. A kilowatt is a thousand watts, and 746 watts equal one horsepower. The commercial unit of electric work is the watt-hour. It is the work done in one hour by a current of

one ampere flowing between two points of a conductor having a difference of potential of one volt. One watt-hour equals 3,600 joules = 2,654 foot-pounds. This unit is too small in practice usually, and the legal unit of electrical energy is the kilowatt-hour or Board of Trade (B.O.T.) unit, sometimes called the kelvin, equal to 1,000 watt-hours. See Joule; Units.

**WATTLess CURRENT.** When a circuit is so inductive that the A.C. current lags practically  $90^\circ$ , or when the circuit has such a capacity that the current leads practically  $90^\circ$  over the volts, the current is said to be a wattless current.

At any instant the power =  $E.C. \cos \phi$  watts, where  $E$  is the pressure in volts,  $C$  the current in amperes, and  $\phi$  the angle of lag or lead. If  $\phi$  is  $90^\circ$ ,  $\cos \phi$  is zero. The net work done in the circuit is zero except on account of the resistance. Wattless currents do no useful work, though the current still flows in the circuit.

**WATTMETER.** An instrument for indicating in watts the rate at which electrical energy is being consumed in any part of a circuit at any particular instant. In direct current work the wattmeter finds little application, for the measurement of power or watts becomes simply a matter of

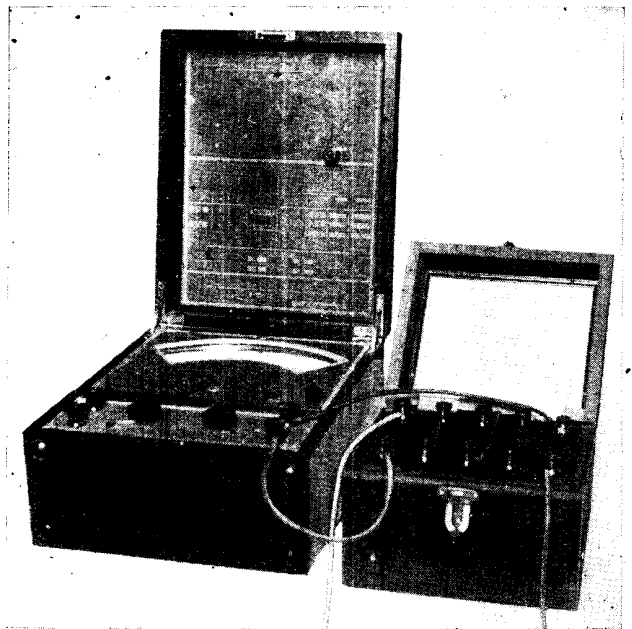

SUMPNER WATTMETER

Fig. 1. With the Sumpner wattmeter a quadrature transformer is always used. In the illustration the latter appears in the smaller cabinet on the right

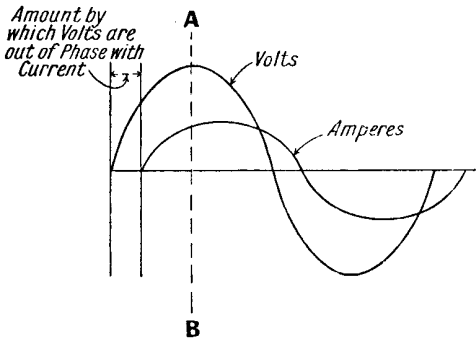

A.C. AND E.M.F. CURRENTS

Fig. 2. In this diagram the lag of the E.M.F. behind the alternating current is illustrated

multiplying the amperes by the volts, as shown on an ammeter and voltmeter. In alternating current work, however, this simplicity does not obtain, for it is very seldom that the pressure (volts) is in phase with the current (amperes), and the angle by which the current lags or leads with respect to the pressure must be taken into consideration.

This condition is illustrated in Fig. 2, where the curves of an alternating current

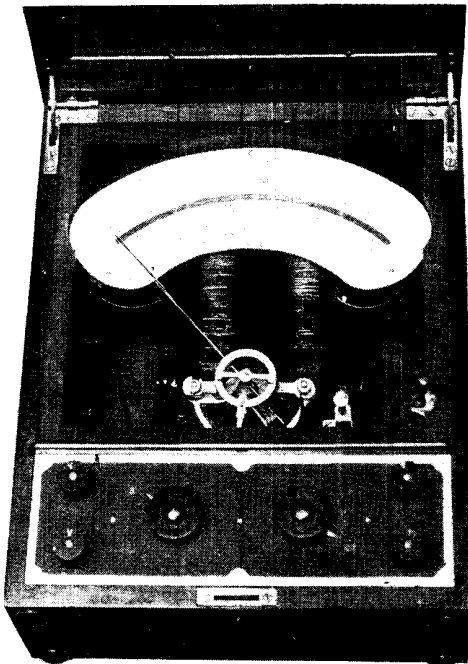

DETAILS OF THE WATTMETER

Fig. 4. This instrument is due to Dr. Sumpner, and is one of the best-known and most widely used wattmeters for measuring the rate at which energy is being consumed

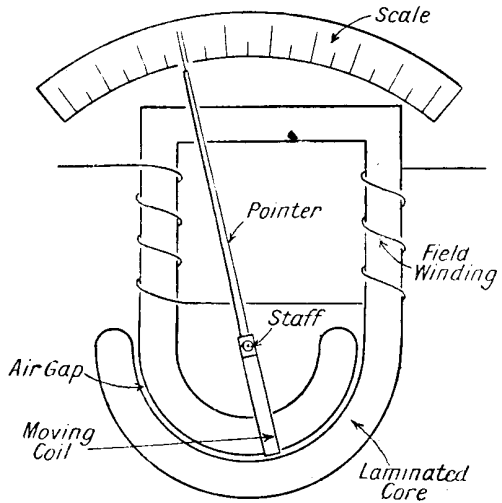

SUMPNER WATTMETER THEORY

Fig. 3. This illustration portrays the working parts and the principle of the action of the Sumpner wattmeter

and electro-motive force are plotted out together on a time base. They are shown with the current lagging behind the pressure, which is the condition generally found in normal A.C. circuits. Assuming that in the circuit which is here diagrammatically portrayed a voltmeter gave a reading of 100 and the ammeter 5, then the "apparent" watts are 500. This is the number of watts that are actually being generated by the alternator, but it is not the number that are actually being consumed by the load on that circuit. The latter value, which is the one desired, is shown in the diagram by the line A B, which is a line

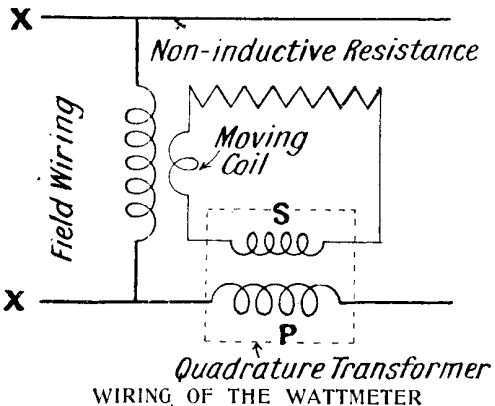

WIRING OF THE WATTMETER

Fig. 5. This diagram shows the wiring of the Sumpner wattmeter shown in Fig. 1, and is self-explanatory

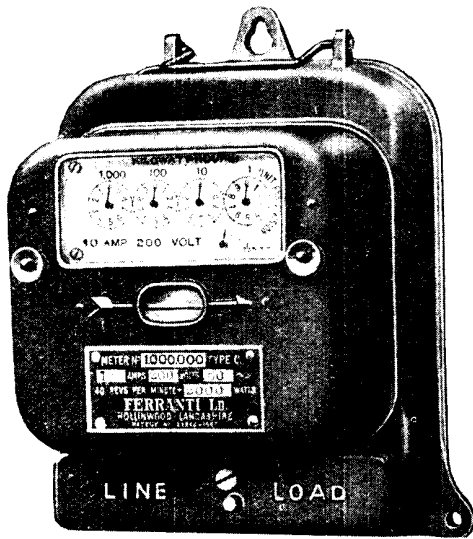

**FERRANTI INTEGRATING WATTMETER**

Fig. 6. This example registers up to 1000 kilowatt-hours at a maximum of 10 amperes and 200 volts

*\*Courtesy Ferranti, Ltd.*

drawn vertically through the ampere and volt curves, and crosses both, therefore, at the point where one is assisting the other.

If the true watts are to be ascertained, it is essential that an instrument be used

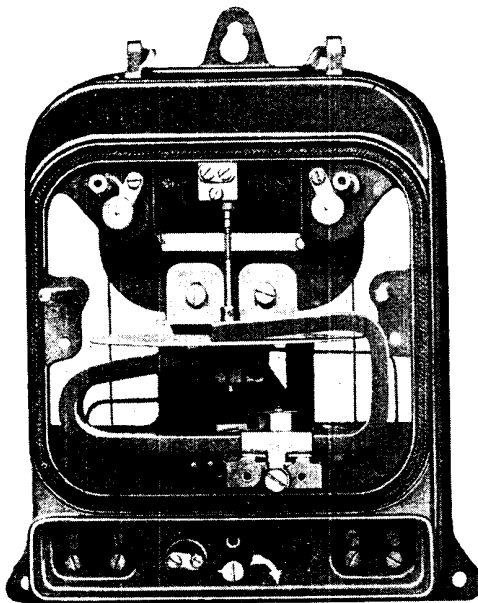

**INTERIOR VIEW**

Fig. 7. Front interior view of the Ferranti integrating wattmeter, showing the electro-magnet and control magnets

*Courtesy Ferranti, Ltd.*

which itself takes the power factor into consideration and indicates the "true" watts and not the "apparent" watts. The latter figure is always in excess of the former, and the power factor can never exceed the value of 1, and is usually .7 or .8.

An early form of instrument that functioned as a wattmeter was the Kelvin electrostatic balance. This was of practically no commercial importance as a measuring instrument, and required calculation after obtaining readings to ascertain the measurements required.

One of the best known and widely used commercial indicating wattmeters of today is that invented by Dr. Sumpner and manufactured by the General Electric

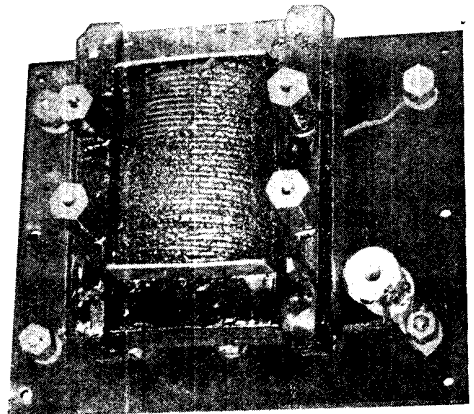

**QUADRATURE TRANSFORMER**

Fig. 8. Internal construction of the quadrature transformer as used with the Sumpner wattmeter is shown here

*Courtesy General Electric Co., Ltd.*

Company. This is illustrated in Fig. 1 in the form of a portable instrument, while a circuit diagram appears in Fig. 5. In Fig. 3 is given an explanatory diagram of the mechanism of this instrument, and this illustration and Fig. 4 should be studied together. Referring, now, to Fig. 3, it is clearly shown that between the poles of a peculiarly shaped electro-magnet a moving coil, wound upon a light rectangular former, swings. The core of the electro-magnet is laminated, and it carries at its upper ends two windings, one on each limb. A pointer is attached to the staff of the moving coil, and both swing together. Control is effected by the usual phosphor-bronze hair-springs, but these have not been shown in the diagram, Fig. 3, for the sake of clarity, although they appear in Fig. 4.

When this instrument is used as a wattmeter the field windings of the electro-magnet are connected directly across the mains, while the moving coil forms part of a closed circuit, which includes also a non-inductive resistance and the secondary of a quadrature transformer. These connexions are clearly indicated in Fig. 4.

The quadrature transformer forms part of the essential equipment of the Sumpner wattmeter, and is illustrated connected to the instrument in Fig. 1, a further illustration, showing its internal construction, appearing in Fig. 8. For the correct operation of the wattmeter it is essential that the current in the moving coil circuit be strictly proportional to that in the main circuit and in quadrature with it, and it is to satisfy these conditions that the quadrature transformer is used. In the design of this transformer a long air gap is introduced between the central limbs of the E-section iron laminations. The net result of this feature is to bring the magnetic flux to be practically co-phasal with exciting ampere-turns.

An air-cored transformer would, of course, fulfil this condition, but the iron core plays the important parts of reducing the magnetic reluctance of the circuit and thereby reducing the size of the instrument (important for portability), and also of shielding the windings from stray magnetic fields. The moving coil of the wattmeter has a resistance whose value is such that its self-inductance may be considered negligible, therefore the current in the secondary circuit of the transformer (to which the moving coil is connected) will be co-phasal with the electro-motive force, and therefore in quadrature with the main current.

There are actually four primary windings, each individually connected to the terminals on the upper panel, while there is only one secondary. The primary windings should be selected according to the different current values in the main circuit, directions for their coupling being given on the blue print inside the lid of the instrument.

With regard to the design of the wattmeter itself, there are three conditions which must be fulfilled. These are:

(1) The field of the magnet within the air gap must be uniform throughout the whole working range, and to this end very precise manufacturing methods must be used.

(2) The resistance drop in the field winding must be sufficiently small to allow the counter electro-motive force to be practically equal to the P.D.

(3) The field at any point within the gap must be strictly proportional to the total flux.

Wattmeters of the type described possess considerable advantages over other systems (such as the electro-dynamometer) in that they are substantially independent of frequency, wave-form and external magnetic fields. On the other hand, they are not adaptable to range-extensions by the application of external apparatus or by altering internal connexions.

The instrument illustrated may alternatively be used as a voltmeter by the simple expedient of using different connexions and rotating the knobs shown on the lower panel of the instrument to their other position. The latter adjustment causes an internal switch to move, and alters the connexions within the instrument to conform to the purpose indicated. Figs. 6 and 7 show the Ferranti integrating wattmeter. It registers up to 1000 kilowatt-hours, with maximum amperes of 10 and a voltage of 200. Fig. 6 shows the external view and Fig. 7 the view of the front with the case removed. See Ammeter; Electro-dynamometer; Power Factor; Voltmeter.

**WAVE-LENGTH.** The distance between corresponding phases of consecutive waves in a wave train measured in the direction of propagation at any instant.

The wave-lengths and frequencies of the most important other waves are given in the table below. See Frequency; Waves.

| Ray or Wave       | Frequency                 | Wave-length.                    |
|-------------------|---------------------------|---------------------------------|
| Gamma rays        | $3 \times 10^{16}$ cycles | '00000001 mm.                   |
| X-rays            | $4.7 \times 10^{15}$ "    | '0000638 mm.                    |
| Ultra-violet rays | $3 \times 10^{15}$ "      | '0001 mm.                       |
| Violet light rays | $8.33 \times 10^{14}$ "   | '00036 mm.                      |
| Blue              | $6.9 \times 10^{14}$ "    | '000451 mm.                     |
| Green             | $6.1 \times 10^{14}$ "    | '00049 mm.                      |
| Yellow            | $5.1 \times 10^{14}$ "    | '000588 mm.                     |
| Orange            | $4.9 \times 10^{14}$ "    | '000652 mm.                     |
| Orange-red        | $3.8 \times 10^{14}$ "    | '000789 mm.                     |
| Red               | $2.7 \times 10^{14}$ "    | '0008 mm.                       |
| Intra-red         |                           | Down to 1 mm.                   |
| W,T Waves         | $6 \times 10^3$ "         | 50 metres to                    |
|                   | to $2 \times 10^4$ "      | 30 kilometres<br>in common use. |

## WAVE-METER: ITS THEORY AND CONSTRUCTION

### How to Use and Make Instruments which Help Accurate Tuning

To the wireless experimenter the wave-meter is a most useful instrument and a knowledge of its principles is invaluable. Full details for the construction of a wave-meter are included. Reference should also be made to the heading Waves, and to such cognate headings as Broadcasting; Frequency; Transmission, etc.

A wave-meter is an instrument for measuring wave-lengths. Before passing to the construction of wave-meters and the methods used it is important that the relationships of velocity, frequency and wave-length should be fully understood. In the first place, electro-magnetic waves travel through the ether at the speed of light, which is  $3 \times 10^{10}$  centimetres per second, or approximately 186,000 miles per second. The field formed by these waves possesses a rhythmic character, having a certain definite frequency, the latter depending on the characteristics of the oscillator by which they are generated.

It is apparent that no useful purpose is served if the wave-length of the waves through any oscillatory circuit is ascertained, but on the other hand, if the frequency by which the waves are propagated at the place of transmission is found, the knowledge is of considerable utility, for by that means the wave-length may be ascertained with reference to a fixed known standard of velocity. The simplest method of effecting this is to utilize the inductive properties of the oscillatory circuit through which signals of unknown wave-length are passing to induce waves of a similar character in a wire whose length may be varied until a state of resonance exists between the two circuits.

Obviously this system has many practical limitations, chiefly on account of size, and this drawback has led to the development of other types.

Most forms of wave-meter, as the ex-Government Mark IV instrument illustrated in Fig. 1, have a buzzer to provide an audible signal. The particular wave-meter illustrated is a three-range instrument, and gives direct readings from 100 to 2,900 metres. These different ranges are obtained by switching in or out a series of fixed inductances arranged within the cabinet. The switch which operates these changes is shown to the left of the top of the panel. A carborundum detector is fitted, and operates without the use of a potentiometer. The detector is simple in construction, a steel strip making contact on the crystal, and adjustment being effected by screwing up or down a small knob.

On the extreme right of the panel, at the top, is the buzzer. This is of the high-frequency type, and emits a note of a very high pitch and pure character. It is designed to work for long periods without change of pitch and quality, and works well off a single dry cell. To the left of the buzzer is another switch, by which it is possible to arrange the instrument to work with a transmitting or receiving set.

The terminals below the buzzer connect that component to the battery, while those at the bottom of the panel connect to the telephones. A similar commercial buzzer wave-meter is shown in Fig. 2. This type of wave-meter is very simple to use, its operation, in conjunction with a receiver, being as follows.

First of all place the wave-meter in some position near to the tuner of the receiver and start the buzzer into action. Do not connect the telephones to the wave-meter, but keep them on the receiver. It is now possible that the buzzing will be heard faintly in the receiving telephones, but whether this occurs or not, rotate the wave-meter condenser until it is heard at a maximum. This point will be found to be very sharply defined and readily distinguishable.

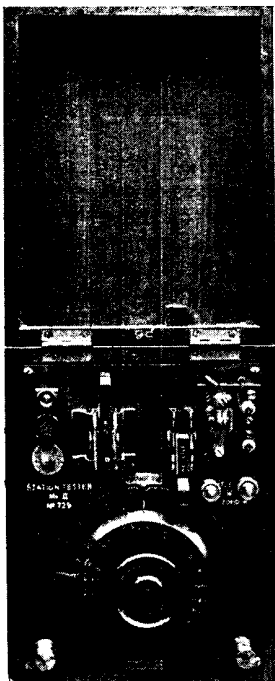

MARK IV WAVE-METER

Fig. 1. Panel view of the Government Mark IV wave-meter. It is a very useful experimental instrument



**DUBILIER TYPE WAVE-METER**

Fig. 2. This illustration shows a commercial type of wave-meter suitable for broadcast wave-lengths

Should no maximum occur at all, but the buzzing be heard at about the same intensity throughout the whole period of condenser rotation, it is an indication that the wrong scale is in use, and that the switch which controls the ranges must be moved to another position.

When the maximum buzzer note has been heard, the reading at which it occurs will indicate the wave-length to which the receiver is set, for it shows that the two circuits are in resonance. Greater accuracy will result if the meter is placed sufficiently far away from the receiver to give the faintest audible buzz, for by this means the maximum will be more sharply defined, and no doubt will occur at which division on the condenser the optimum point occurs.

A useful function of the wave-meter lies in tuning a receiver to any desired wave-length within the range of the receiver. This obviates

the process of searching for the station that it is required to receive, and makes only fine tuning necessary. The wave-meter is put into the "send" position, and connected to a suitable battery for operating the buzzer. The dial is then turned to the wave-length reading required and left with the buzzer in operation. The receiver is then tuned in the manner previously described until the transmitted oscillations of the buzzer are received at an optimum point.

With the wave-meter, the maximum and minimum wave-lengths of a receiver or inductance can be measured. Fig. 3 shows the lay-out required for obtaining the wave-length range of a variometer. The wave-meter is set into operation in the manner employed in the last test. The variometer is connected in series with a crystal detector and a pair of telephones to form a closed circuit. Having obtained a good spot on the crystal, the wave-meter dial is rotated until the buzzing is heard at an optimum point. By simultaneous adjustment of the variometer and wave-meter controls, the optimum buzzing point can be regulated to the maximum and minimum limits of the variometer.

To find the fundamental wave-length of an open outdoor aerial two operations are required. The first determines the natural



**WAVE-METER TEST**

Fig. 3. Here the experimenter is seen testing the wave-length range of an ordinary variometer with a wave-meter



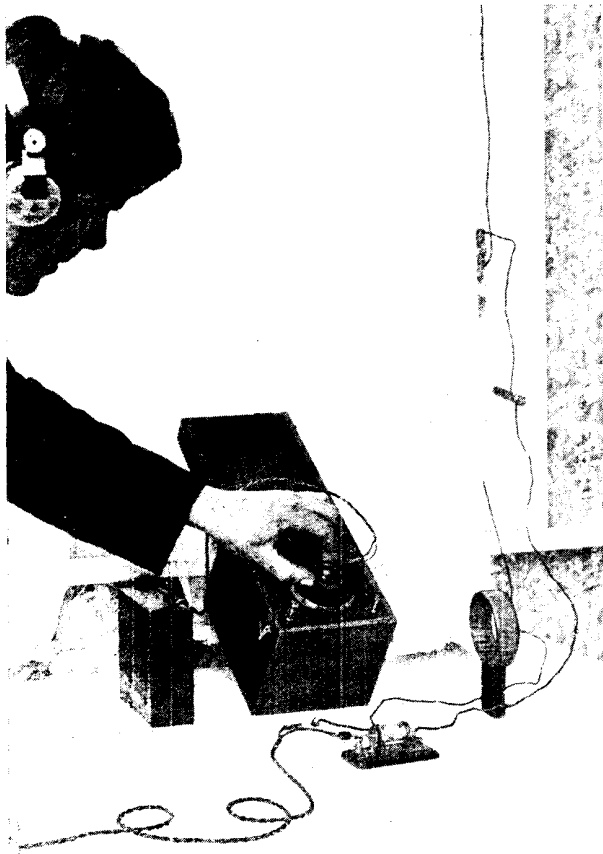

**WAVE-METER TEST FOR AERIAL**

Fig. 4. In this photograph is shown the method of ascertaining the wave-length of an outdoor aerial, using an inductance coil of known wave-length. Note the connexions

wave-length of an inductance coil, in the manner employed for the variometer. The aerial and earth are connected to either side of the inductance, as shown in Fig. 4, and a fresh reading with the wave-meter taken. The difference between this reading and that of the coil itself gives the fundamental wave-length of the aerial and earth system.

Another use for the wave-meter is as a wave trap, where advantage is taken of its tuning elements. The buzzer and crystal detector are not required, and are omitted from the circuit. One application is illustrated in Fig. 5. In this the aerial and earth terminals of the receiving apparatus are connected across the wave-meter to form a parallel circuit.

An essential feature with all wave-meters is that they should remain absolutely

constant and stable, as regards their amounts of inductance, after they are once calibrated. To this end the inductances must be wound on formers of considerable mechanical strength in order that the effects of heat and damp will not cause warping and shrinking. A slight variation in shape will cause serious alterations in values.

The heterodyne wave-meter consists essentially of a valve oscillator having variable inductive and condenser components. By adjusting these values it is possible to make the circuit oscillate at any desired frequency between the limits imposed by the inductive and capacitive quantities.

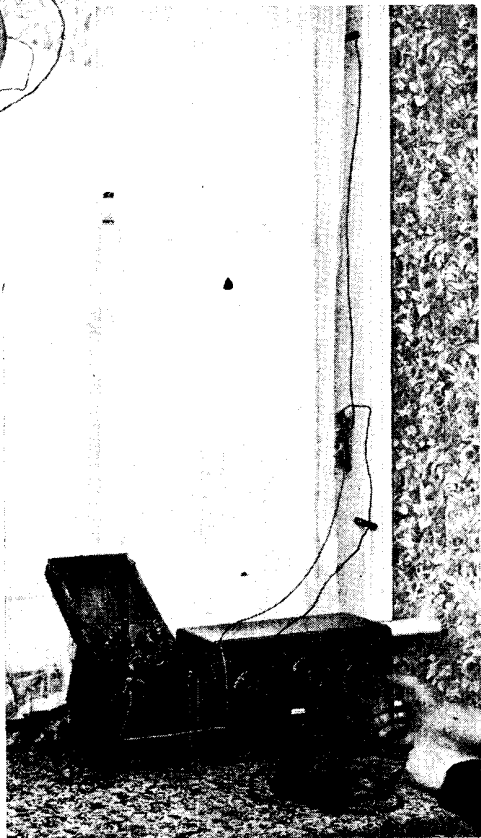

**USED AS A WAVE-TRAP**

Fig. 5. Where interference from an unwanted transmitter is experienced the wave-meter may often be used as a wave-trap



**EXPERIMENTAL LAY-OUT**

Fig. 6. Here is shown the lay-out required to tune a receiver to a definite wave-length of oscillation emitted from the wave-meter. Note the connexions here also

The wave-meter circuit is made to function and the condenser rotated until the well-known heterodyne whistle is heard in the telephones. The condition of resonance between the two circuits is indicated when the "nul" or silent point between descending and ascending whistles is obtained. An illustration of this form of wave-meter appears under the heading Heterodyne Wave-meter.

The main components required in the construction of a send and receive wave-meter include a duo-lateral coil, a crystal detector, a high-note buzzer, and a variable condenser of .001 mfd. capacity. The variable condenser should be of the best quality, as an inferior make may tend to change its capacity after it has seen considerable usage. The buzzer used should be selected for its high and constant note.

The completed wave-meter operating in conjunction with a receiving set is illustrated in Fig. 6. A substantial box fitted with a hinged lid, and with the right side of the box also hinged, is required. This

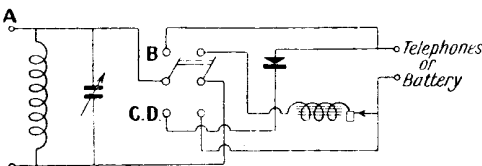

**CIRCUIT DIAGRAM**

Fig. 8. Wiring of the home-constructed wave-meter is carried out as here. This should be done in heavy-gauge wire

should be made from  $\frac{1}{2}$  in. prepared wood to the sizes given in Fig. 7. As shown in this illustration, the buzzer is secured to the inside of the hinged side, which is kept closed by means of a brass right-angle bracket screwed to the top of the front side of the box. A hole is drilled and tapped into the bracket on the side in contact with the hinged side. When the bracket is in position the hinged side is closed and a pencil mark is made corresponding to the hole in the bracket. A hole of clearance size is drilled over this mark, and permits a screw to pass through from the outside of the box. This screw may be made from a

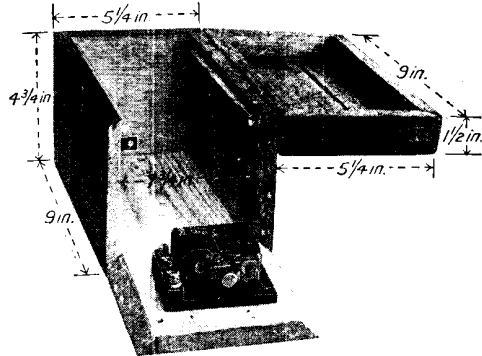

**CABINET FOR THE WAVE-METER**

Fig. 7. The experimenter who wishes to construct a wave-meter at home will find the leading dimensions of the case here

contact stud, through the head of which a short bar of stout brass wire is soldered. The position of the bracket and the screw used are also shown in Fig. 7.

A panel of  $\frac{3}{16}$  in. ebonite is cut and made a tight fit to the inside of the box. All joints should be as dust-proof as possible to obviate the possibility of alteration of the value of the components. To the extreme left of the panel as it fits into the box with the lid at the back an aerial and earth terminal are placed to the back and front of the panel respectively. At the opposite end two terminals are required for connexion of the battery operating the buzzer and also for telephone terminals when the instrument is determining the wave-length of a transmission. To the left

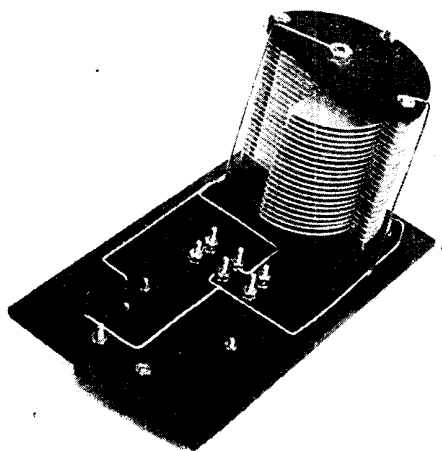

## WIRING COMMENCED

Fig. 9. Here the tuning components are connected to the centre contact of the switch and crystal detector

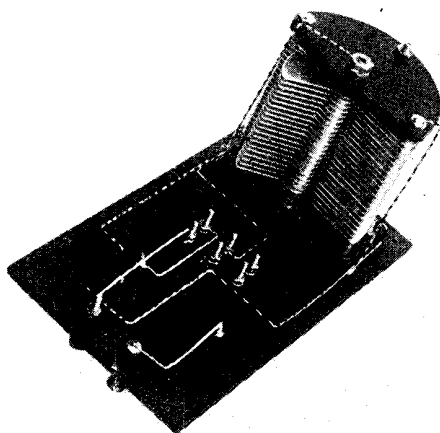

## SECOND STAGE IN WIRING

Fig. 10. At this stage the instrument is completed as a means of measuring transmitted wave-lengths.

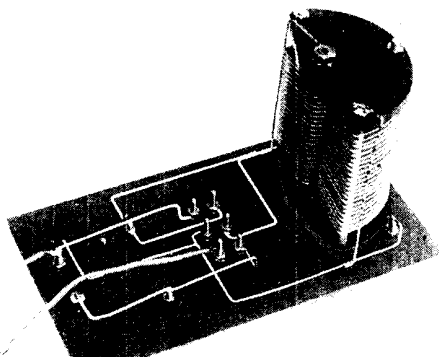

## WIRING COMPLETED

Fig. 11. In this illustration the wiring is finished, the flexible leads connecting to the buzzer on the hinged side of the case

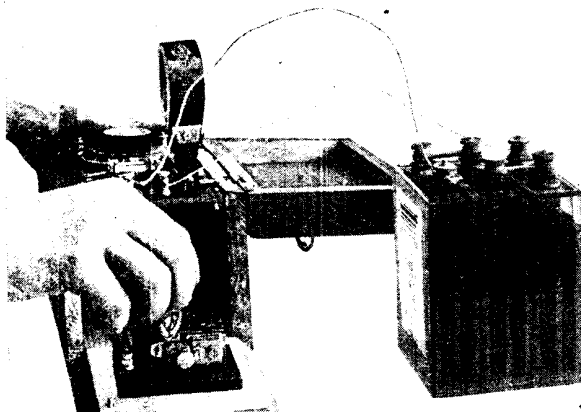

## AMATEUR-MADE WAVE-METER IN USE

Fig. 12. Owing to the hinged side, to which the buzzer is attached, adjustment is easily accomplished

of the panel the variable condenser is attached. A miniature double-pole double-throw switch is secured to the right of the condenser, which brings the switch about central to the panel. A good quality crystal detector is mounted to the right side of the switch, behind which the coil holder for the duo-lateral coil is placed.

The wiring, which is carried out to the circuit diagram given in Fig. 8, should be effected with thick gauge wire, care being taken to see that it is quite rigid and free from vibration. The first part of the wiring is shown in Fig. 9, where the aerial and earth terminals are connected to either side of the condenser, the coil holder and the centre studs of the switch.

The next wiring operation completes the wave-meter for determining the wave-length of a station transmitting. Used in this way the instrument is simply a crystal receiver in which the variable condenser is used for determining the wave-length of the station being received. The terminals to the right of the panel, as it normally fits inside the box, are used for attachment of the telephones. This stage of the wiring is shown in Fig. 10. When the wave-length of a receiving set at any particular point of its tuning range is required, the wave-

meter is converted by means of the switch into a small transmitter, the oscillations of the buzzer being heard in the receiving set when they are in resonance with it.

The buzzer circuit is shown completely wired in Fig. 11, the flexible leads being attached directly to the buzzer terminals.

It will be seen that the hinged side forms a convenient means for adjustment of the buzzer. In the buzzer illustrated the locking screw is provided with a wide, curved slot enabling the screw to be operated by a coin, as shown in Fig. 12.

The best way to calibrate the instrument is to use a wave-meter of known accuracy, but if such is not available, the constructed wave-meter must be calibrated by the reception of transmissions of known wave-length. The arbitrary graduations on the condenser dial may be removed if desired, and the dial recalibrated in terms of wave-lengths. An alternative plan is to prepare a chart to be pasted into the lid in which the existing dial calibrations correspond to certain wave-lengths.

## WAVES IN WIRELESS WORK AND THEORY

By Sir Oliver Lodge, F.R.S., D.Sc.

Here the well-known pioneer in the whole art and theory of wireless communication explains the fundamental theories and calculations underlying electro-magnetic waves and their radiation through the ether of space. Sir Oliver Lodge's introductory article on Waves (page iii) should be read in conjunction with this. See also Oscillation.

A wave is any disturbance which is periodic in both space and time. That is to say, the disturbance must repeat itself at regular intervals of space, which interval is called a wave-length; and must also repeat itself at regular intervals of time, which interval is called the period; while its reciprocal is called the frequency.

To take an example. The essential part of a corkscrew is periodic in space, the spires repeating at regular intervals. The distance separating the turns of the screw is called its pitch, which might be, say,  $\frac{1}{4}$  in., and corresponds to wave-length. But as long as the corkscrew is stationary there is no periodicity in time, and therefore nothing that corresponds to a wave. But now let the screw be steadily rotated with a certain frequency, say three times a second. The period is one-third of a second, and the turns of the screw will now be advancing with a given wave-length,  $\frac{1}{4}$  in., and a given period. The speed with which they advance will be the wave-length multiplied by the frequency, that is  $\frac{3}{4}$  in. per second. It is easy to generalize from this example, and to say

$$v = n\lambda; \text{ or, } \lambda = vT;$$

where  $v$  is the velocity of advance,  $n$  is the frequency, which is the same as  $1/T$ , the reciprocal of the time-period; while  $\lambda$  is the wave-length.

The simplest equation representing this kind of doubly periodic disturbance is

$$y = a \sin (qx - pt),$$

which means that the disturbance  $y$  is propagated along the axis of  $x$  with the

velocity  $v = p/q$ ; the wave-length being  $\lambda = 2\pi/q$ , and the period  $T = 2\pi/p$ . The frequency, of course, is  $p/2\pi$ ; while  $a$  is the amplitude or semi-diameter of the corkscrew, representing its departure from the straight, the square of which in real wave motion, such as sound or light, represents the loudness of the sound or the brightness of the light.

The wave equation may also be conveniently written thus

$$y = a \sin \frac{2\pi}{\lambda} (x - vt)$$

where the chief constants explicitly appear; and the frequency is  $v/\lambda$ .

The process of wave-propagation can be seen going on, in rather more complicated fashion, in the ripples on a pond or in the waves of the sea. The actual particles are heaving up and down, or revolving round and round, without locomotion. It is the wave form only which is progressive; there is no locomotion of anything material. And yet energy travels along a wave, being transmitted from source to receiver; as when sound produced at one place is heard or otherwise quenched at all places within hearing distance.

The fundamental equation to every kind of wave motion, travelling with the velocity  $v$  along the axis of  $x$ , is

$$\frac{d^2y}{dt^2} = v^2 \frac{d^2y}{dx^2}$$

And it was the splendid discovery that the equations representing electric and magnetic disturbances could be combined into an equation of that sort which constituted

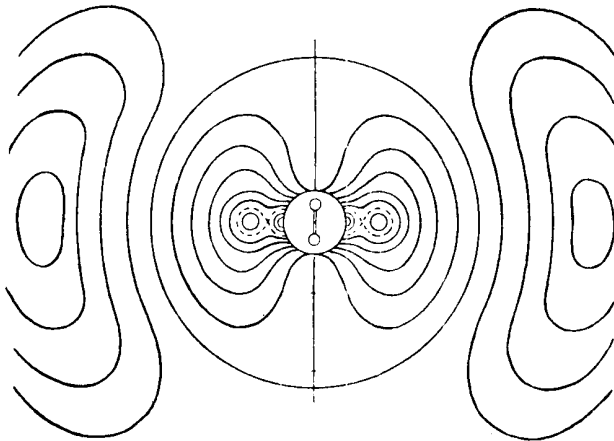

**HERTZ'S THEORY OF WAVE RADIATION**

Fig. 1. This figure represents one phase of the process of wave generation. A dumb-bell oscillator is seen at the centre and lines of force already flicked off are seen at the sides

product of the two ether constants—was the speed of light. That, then, is the equation of wireless waves, and of every other kind of wave which can exist in the ether of space—Hertz waves, radiant-heat, light, photographic rays, X-rays, gamma-rays, and all. They all go at exactly the same pace, whether they are several miles in length or only a million-millionth of an inch. They differ in intensity and frequency, and they differ in simplicity and complication; but they differ not at all in speed.

The way to generate such

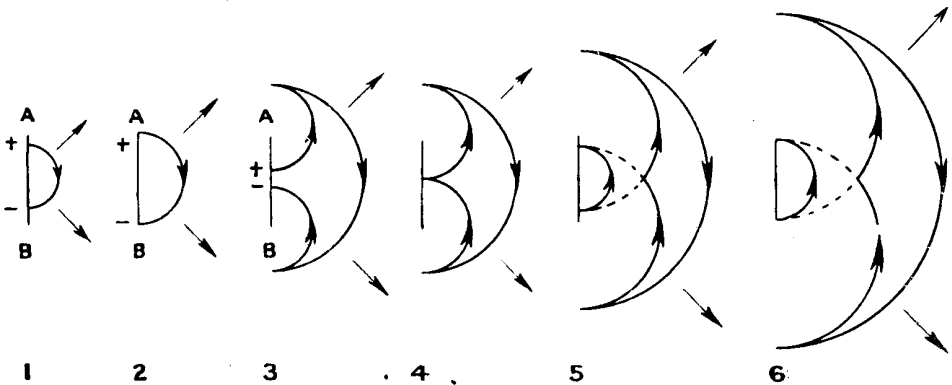

**DIFFERENT PHASES OF WAVE EMISSION BY AN OSCILLATING CHARGE**

Fig. 2. In these figures the charges are oscillating up and down the rod AB, and the results on electric lines of force connecting them are seen.

Clerk-Maxwell's Electro-magnetic Theory of Light. For by combining electric and magnetic known relations—expressing the facts discovered by Faraday in a most ingeniously comprehensive and abstract manner—he arrived at the following (here simplified) equation

$$\frac{d^2F}{dx^2} = \mu k \frac{d^2F}{dt^2}$$

where F is any relevant electric or magnetic vector; and this showed him at once that electro-magnetic wave propagation was possible, and that the waves must travel with the velocity  $1/\sqrt{\mu k}$ , where k was the electric constant of the ether and  $\mu$  its magnetic constant. Maxwell thereupon made experiment, and found that this speed of electric wave propagation—the speed corresponding to the

waves directly was unknown to Clerk-Maxwell, though he knew that from time immemorial mankind had ignorantly generated them indirectly by making bodies hot, and that even animals could detect some short waves from sun and moon by that remarkable instrument, the eye. But after Maxwell's death FitzGerald suggested that the oscillations known to be produced by a condenser discharging through an inductance might excite such waves, of calculable wave-length, directly. And about 1887 and '88 Lodge imperfectly, and Hertz much more thoroughly and completely, succeeded in generating and detecting such waves. These waves of Hertz were the wireless waves which, through the enterprise of Senatore Marconi and his co-workers, have now covered the world.

All that is really essential for their emission is two separated capacity areas, one charged positively, the other negatively, which are then allowed to spark into each other through connecting rods. The essential identity of these waves with light can be shown, and was shown, by repeating with them many optical experiments, some form of coherer being used for their detection, as expounded by Lodge in his book called "The Work of Hertz and his Successors," published first in "The Electrician" for June, 1894, the said waves having been foreshadowed by him near the end of a paper in the "Philosophical Magazine" for August, 1888.

#### Hertz's Application of Clerk-Maxwell's Theory

Hertz was not only an experimenter, he was able to apply Clerk-Maxwell's theory so as to work out the wave's mode of origin and to exhibit its manner of propagation. Hertz's theory of the emission of waves from a radiator or transmitter is usually depicted as in Fig. 1.

This figure represents only one stage or phase of the process of wave generation. A dumb-bell oscillator is seen at the centre, and the lines of force which have already been flicked off it are seen outside. They form closed loops round which an electric disturbance is circulating, and their magnetic concomitant (not shown) is in loops perpendicular to the paper.

The whole diagram is a mere section or slice of the three-dimensional propagation outwards all round the axis, the circle is really a sphere. Inside the circle lines emitted still more recently are shown, and these are inflected so that they are soon going to break into two portions, one portion expanding outwards, while the rest returns to the oscillator. The detached portion may be likened to a curious kind of expanding vortex ring in the ether. The place of breaking off is the crossing point of the dotted line. The number of receding or restored lines is the same as the number of expanding lines, but their energy is diminished by that of the detached portions. These detached and afterwards independent portions carry energy out into space, and accordingly the original disturbance subsides, unless it is supplied with fresh energy.

These detached and advancing portions constitute the electric waves which travel

with the speed of light, and affect coherers and valves when collected by receiving aeriols. A set of diagrams of all the different phases can be drawn, and if these are then mounted in a stroboscope, or projected in a kinematograph, the oscillations can be seen going on, and the waves can be seen flicked off at a certain distance from the centre and thereafter continually travelling outwards as electromagnetic waves.

Hertz's working out for the theory of the emission of waves from a linear or dumb-bell oscillator is very complete; but we can simplify it, in the light of Poynting's Theorem, somewhat as follows.

Poynting's Theorem states that when alternating electric and magnetic lines of force, in the same phase, cross or intersect at right angles, energy advances with the velocity of light in a direction perpendicular to both, and of an intensity proportional to their product. The sense in which this wave energy advances, whether in the positive or negative direction, depends on the phase relation between the electric and the magnetic oscillations; and if the phase of one of them is reversed, the direction of propagation is reversed, too.

#### Poynting's Illustration of Wave Emission

Now think of the earth or a terrestrial globe with a conducting rod right through it along its polar axis, and then think of an electric charge, or of a pair of opposite electric charges, oscillating up and down this rod. When the positive charge is at one pole and the negative charge at the other, the line of force joining them is something like a line of longitude. This is the condition at the end of a swing. When the charges are rushing past the middle of the rod, it will be surrounded by magnetic lines, which correspond with the lines of latitude. On a terrestrial globe the lines of longitude and latitude intersect at right angles, and therefore it would seem that we could apply Poynting's Theorem to them forthwith, and say that energy advances radially from the globe in all directions. Roughly speaking, this is true. But looking at the matter more closely we find that initially the electric and magnetic lines do not intersect, for they are not in phase; they start with a quarter-period difference, and they have to expand before they get into step.

The conditions near the oscillator are therefore somewhat complicated, and the energy pulsates to and fro, first advancing, then receding. But beyond a certain distance, which is approximately a quarter wave-length, the magnetic and electric oscillations have got into step. Thenceforward they will be in the same phase, the lines will properly intersect, and the energy will advance wholly in one direction, namely, outwards along every radius of the sphere. But though it advances in all directions, its energy is not equal in all directions. The radiation intensity will be a maximum in the direction of the equator and zero in the direction of the poles, because it depends on interaction of both electric and magnetic forces, and because the magnetic force is a maximum at the equator and zero at the poles. Consequently the intensity of radiation will vary with the cosine of the latitude. Hence, for effective transmission in all directions over the earth's surface, an aerial should be approximately vertical.

#### Why Short Waves are more Efficient

Initially the intensities of the electric and magnetic forces vary according to a complicated law of distance, involving the inverse cube and other powers of the distance. But beyond a certain range, comparable to a wave-length, they have settled down to the simple law of inverse square; and after that the strength of the radiation will follow the usual law of emission of light.

The same kind of complication, close to a source, is true for luminous and all other emitters. But whereas in optical cases the radiators are exceedingly small—indeed of atomic dimensions, so that only refined observation can detect what is happening in their immediate neighbourhood—a radiating oscillator or aerial is a big thing, and consequently we are able to study the pulsations in its immediate neighbourhood. And true waves, travelling altogether outward, do not begin until a quarter-wave distance has been exceeded. This is the reason why short-wave emission is more efficient than long-wave. A low-frequency oscillator, such as an alternating dynamo, pulsating, say, 300 times a second, emits waves 100 kilometres long. Consequently the place where true waves originate is about 15 miles away, where the strength of the

fields is insignificant; and accordingly its radiation is inappreciable.

#### Relation of Intensity to Wave-length

But if, instead of that, we consider an oscillator pulsating three million times a second, its waves are only 100 metres long, and the distance where waves originate is less than 30 yards. For a really small oscillator, such as Hertz used, the waves might be only 3 metres long, or, in extreme cases, 30 centimetres. The pulsations are then enormously rapid and the power of the radiation very great, so great that the energy is radiated away in the course of one or two swings, or most of it even in the fraction of a swing. That is why, other things being equal (which they never are), short-wave transmission is so effective.

But when obstacles and obstruction have to be encountered, long waves are able to ignore difficulties which would be fatal to short ones. Hence, in practice, there always has to be a compromise; and for really long distances long waves are usually best; in addition to the fact that a big oscillator has more energy at its disposal than a small one, though it does not get rid of it so quickly.

The way the intensity or power of the radiation depends on wave-length, from an oscillator of given size, was worked out by FitzGerald in 1883, long before even Hertz's discovery, though Hertz subsequently independently arrived at the same result, which may be expressed thus

$$\text{Energy radiated per second} = \frac{16 \pi^4 c Q^2 l^2}{3k\lambda^4}$$

where  $Q$  is the charge accumulated in the capacity area at the end of the straight vertical rod or wire of length  $l$ ;  $c$  is the velocity of light,  $k$  is the electrostatic constant of the ether, and  $\lambda$  is the wave-length. Here we see that the power of the radiation is proportional to the square of the height of the aerial, and inversely as the fourth power of the wave-length. This, applied to ordinary heat radiation, is equivalent to saying that the radiating power of a source is proportional to the fourth power of its absolute temperature.

I simplified this expression for radiating power in a paper in the "Phil. Mag." for July, 1889, as follows: Let the potential, in volts, to which the upper capacity-area is charged be  $V$ ; let the aerial conductor be a straight rod of length  $l$  and diameter  $d$ , and include the necessary spark gap whose width represents the potential  $V$ . Then

calculate  $\log_e \frac{4l}{d}$ , and call this  $n$ ; it is a mere number, usually in those days between 4 and 6, for the thick rod and dumb-bell shape then in vogue, and it is seldom more than 10 or 12 even now. Then the power of the radiation in watts is equal to

$$\frac{V^2}{360n^2 \text{ ohms}}$$

All simple emitters, large and small, radiate at approximately the same rate when supplied with the same spark gap; for the only difference between them is in the value of  $n$ , which changes but slightly. This simple expression for radiating power has not attracted attention, for it was published before the idea of using such radiation was mooted.

**Early Work on Wireless Waves**

A numerical example, given in my paper at the same time, is instructive. Let a dumb-bell oscillator consist of two spheres or plates joined by a stout rod and spark gap, such that  $l = 25d$ ; it will have the characteristic number  $\log_e \frac{4l}{d}$ , equal to 4.5.

Let its ends be charged to 26,400 volts when the spark occurs which starts the oscillations; then by the above simplified formula the dissipation resistance is 7,300 ohms, and the maximum power of the emitted waves will be 96,000 watts or 128 horse-power. At this rate the whole original stock of energy in the small oscillator contemplated would be gone in the two-hundred-millionth of a second, *i.e.* in the time of  $1\frac{1}{2}$  vibrations; but, of course, the energy really decreases logarithmically.

Nothing approaching continuous radiation could be maintained at this great intensity without the expenditure of great power; that is why, in 1897, I introduced additional self-induction in the joining rod, so as to diminish radiation intensity in order to prolong it and render exact tuning and selective reception possible.

Even for some of the ordinary single-wire aerials of to-day, apart from introduced self-induction, when the height is, say, 4,000 times the diameter of the conductor, the value of  $n$  or  $\log_e \frac{4l}{d}$  is only 9.67.

The capacity area at the top affects the amount of energy that can be stored, but does not directly affect the rate at which it is emitted.

Given a spark half a centimetre long, representing a potential of, say, 12,000 volts, and given an aerial with  $n = 10$ , energy is emitted at the rate of  $\frac{(12,000 \text{ volts})^2}{360n^2 \text{ ohms}} = 4,000 \text{ watts}$ , or about 5 horse-power.

If we want an expression for the radiating power of an aerial of height  $h$  in terms of a considerable introduced coil-inductance  $L$ , it is as follows

$$\frac{\mu V^2 h^2}{3cL^2} \quad \text{or} \quad \frac{V^2 h^2}{90(L/\mu)^2 \text{ ohms}}$$

If we express both  $h$  and  $L/\mu$  in the same units, say, in metres, and  $V$  in volts, the answer will come out in watts as before.

Thus suppose  $V = 12,000$  volts,  $h = 10$  metres, and  $L = 1\frac{1}{5}$  millihenry, so that  $L/\mu = 1,000$  metres; the radiation power is  $\frac{144 \times 10^6}{90 \times 10^4} = 160$  watts.

The expression for radiating power can be thrown into another form, and expressed in terms of the mean current flowing in the rod, without reference to sign; as measured, for instance, by a hot-wire instrument or an electro-dynamometer. The radiating power of a dumb-bell oscillator—during its period of spark excitation—through the rod of which an average circuit of  $A$  amperes is flowing, is

$$800 \frac{l^2}{\lambda^2} A^2 \text{ watts,}$$

where  $l$  is the mean distance between the terminal capacity areas and  $\lambda$  the wave-length.

For sustained oscillation of an effective current  $A$  amperes, in an aerial of height  $h$ , Dr. Eccles gives the radiating power as

$$640 \frac{h^2}{\lambda^2} A^2 \text{ watts,}$$

showing that, for given current, the rate of energy emission is directly as the square of the height and inversely as the square of the wave-length.

Those who wish to follow out the whole process more in detail will find a summary of Hertz's equations in one of the concluding chapters of Preston's "Theory of Light." They will also find some of the facts clearly stated in Dr. Eccles's well-informed article "Wireless Telegraphy," in Vol. II of Glazebrook's "Dictionary of Physics," where the diagrams in Fig. 2 (page 2226) are quoted from Mr. Oliver Heaviside's mode of presentation.

In these figures the charges are seen oscillating up and down the vertical rod



A B, and the results, on electric lines of force connecting them, are followed through half a swing. In No. 1 the charges are separating by reason of their momentum. In No. 2 the charges have reached the ends of the rod and are reflected down again, as in No. 3. In No. 4 they are crossing in the middle; and in No. 6 they are at the ends again, but inverted. The Faraday lines joining them are like lines of longitude, and envelop the axis A B, though only one is shown. They expand outwards with the velocity of light, but by No. 3 they have begun branches going back to the middle, and in No. 5 they have begun to form two loops. In No. 6 the outer crescent-shaped loop has broken away, and thereafter pursues its course independently: the inner curve being an upgoing electric surge and the outer a downgoing one, so that the two together appeal to any receiving station as a half-wave.

A succession of such loops, flicked off and flying along with the velocity of light, constitutes the Hertzian waves which convey the signals. They very soon become practically expanding equidistant spheres, and at great distances are practically travelling planes. If the oscillator is halved by earth connexion at the middle, only the upper halves of these diagrams need be attended to.

In these, and especially in the more complete diagrams, it is possible, with a little trouble, to visualize the flicking off of true waves at a certain distance from the oscillator, which subsequently expand in spheres, always advancing with the velocity of light; while near the oscillator it is possible to see the lines contorting themselves as the exciting charges move up and down, the energy for the most part pulsating and some of it returning to the oscillator, thereby tending to diminish the loss and prolong the swings.

When instead of a lower capacity area the earth is used as one end of the aerial, conditions become more indefinite and less amenable to calculation, and tuning cannot be quite so precise. For obviously the conducting power of the earth depends on the nature of the soil and on its state of moisture. If, however, it could be treated as a perfect conductor, the effect of the earth would be to reflect the aerial as a similar image, and to cut the field of radiation in half: so that only the upper half of the wave diagrams are effective. The half loops then travel with their roots on the perfectly

conducting surface. This may be approximated to on the sea; and it is again a question of compromise how far earth connexion is helpful and convenient in any given case. An earthed aerial seems more likely than an insulated one to collect stray disturbances—whether from natural causes or from heavy electrical engineering operations.

For early experiments on waves reference may be made to Proceedings of the Royal Society, vol. 50, page 1; and for further data about insulated aerials, to the same work, vol. 82, page 227.

**WAVE TRAP.** A device incorporated in a wireless receiving installation for eliminating interference from a transmitting station. The wave trap usually takes the form of a tunable inductance shunted across the aerial tuning inductance. In operation the wave-trap circuit is tuned to the exact wave-length of the interfering station, while the aerial tuning system of the receiver is carefully tuned to the wave-length of the station that it is required to receive. Many forms of wave traps of this description have two tunable circuits, so that interference from stations above and below the received wave-length may be eliminated.

A type of wave trap of commercial pattern is illustrated in Fig. 1, and requires a variable condenser for fine tuning. Of similar construction is the wave trap shown in Fig. 2. This instrument

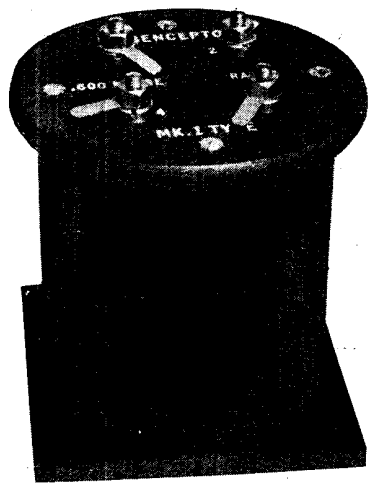

LISSEN WAVE TRAP

Fig. 1. Type of wave trap for use on 600 metre range reception. No tuning element is used other than a 0005 mfd. variable condenser

Courtesy Lissen, Ltd.

A B, and the results, on electric lines of force connecting them, are followed through half a swing. In No. 1 the charges are separating by reason of their momentum. In No. 2 the charges have reached the ends of the rod and are reflected down again, as in No. 3. In No. 4 they are crossing in the middle; and in No. 6 they are at the ends again, but inverted. The Faraday lines joining them are like lines of longitude, and envelop the axis A B, though only one is shown. They expand outwards with the velocity of light, but by No. 3 they have begun branches going back to the middle, and in No. 5 they have begun to form two loops. In No. 6 the outer crescent-shaped loop has broken away, and thereafter pursues its course independently: the inner curve being an upgoing electric surge and the outer a downgoing one, so that the two together appeal to any receiving station as a half-wave.

A succession of such loops, flicked off and flying along with the velocity of light, constitutes the Hertzian waves which convey the signals. They very soon become practically expanding equidistant spheres, and at great distances are practically travelling planes. If the oscillator is halved by earth connexion at the middle, only the upper halves of these diagrams need be attended to.

In these, and especially in the more complete diagrams, it is possible, with a little trouble, to visualize the flicking off of true waves at a certain distance from the oscillator, which subsequently expand in spheres, always advancing with the velocity of light; while near the oscillator it is possible to see the lines contorting themselves as the exciting charges move up and down, the energy for the most part pulsating and some of it returning to the oscillator, thereby tending to diminish the loss and prolong the swings.

When instead of a lower capacity area the earth is used as one end of the aerial, conditions become more indefinite and less amenable to calculation, and tuning cannot be quite so precise. For obviously the conducting power of the earth depends on the nature of the soil and on its state of moisture. If, however, it could be treated as a perfect conductor, the effect of the earth would be to reflect the aerial as a similar image, and to cut the field of radiation in half; so that only the upper half of the wave diagrams are effective. The half loops then travel with their roots on the perfectly

conducting surface. This may be approximated to on the sea; and it is again a question of compromise how far earth connexion is helpful and convenient in any given case. An earthed aerial seems more likely than an insulated one to collect stray disturbances—whether from natural causes or from heavy electrical engineering operations.

For early experiments on waves reference may be made to Proceedings of the Royal Society, vol. 50, page 1; and for further data about insulated aërials, to the same work, vol. 82, page 227.

**WAVE TRAP.** A device incorporated in a wireless receiving installation for eliminating interference from a transmitting station. The wave trap usually takes the form of a tunable inductance shunted across the aerial tuning inductance. In operation the wave-trap circuit is tuned to the exact wave-length of the interfering station, while the aerial tuning system of the receiver is carefully tuned to the wave-length of the station that it is required to receive. Many forms of wave traps of this description have two tunable circuits, so that interference from stations above and below the received wave-length may be eliminated.

A type of wave trap of commercial pattern is illustrated in Fig. 1, and requires a variable condenser for fine tuning. Of similar construction is the wave trap shown in Fig. 2. This instrument

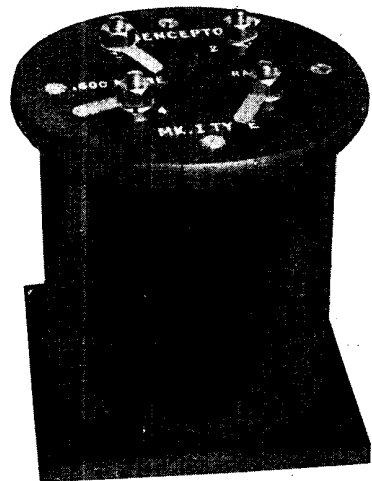

LISSEN WAVE TRAP

Fig. 1. Type of wave trap for use on 600 metre range reception. No tuning element is used other than a 0005 mfd. variable condenser

Courtesy Lissen, Ltd.

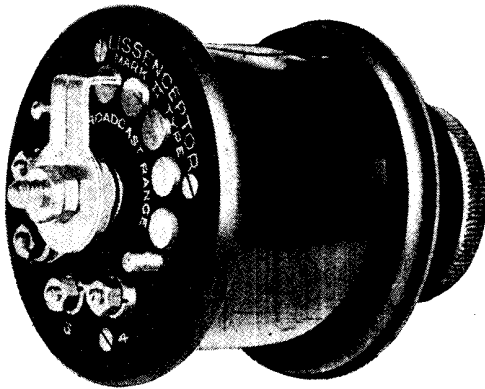

COMMERCIAL TYPE OF WAVE TRAP

Fig. 2. This type by the same manufacturers as the example in Fig. 1 is more closely regulated by the five-stud switch

*Courtesy Lissen, Ltd.*

incorporates a five-stud switch, and can be more closely regulated than the other type illustrated. See Interference Eliminator.

**WAX.** A semi-solid, paste-like material. Waxes used in wireless work are those

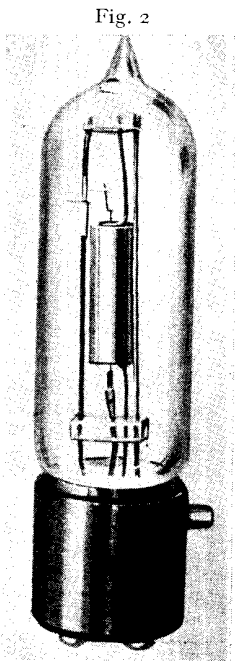

Fig. 2

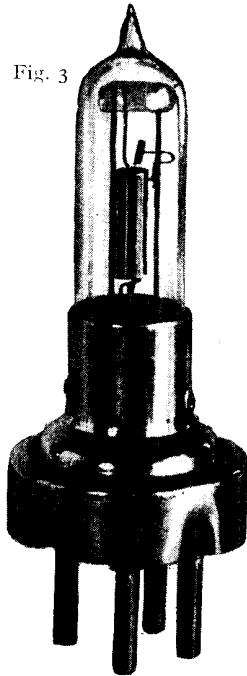

Fig. 3

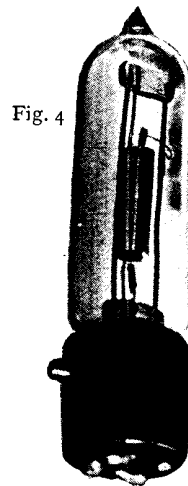

Fig. 4

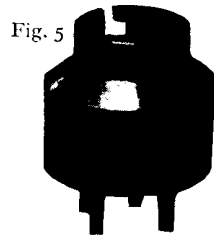

Fig. 5

WECO VALVES

Fig. 2. Western Electric Co.'s type, which operates on .8 to 1.1 volts and .25 ampere for the filament and 17-45 volts for the anode. Fig. 3. Mullard Weco valve. Fig. 4. "Peanut" type of Mullard Weco valve. Fig. 5. Four-prong adaptor for "Peanut" Weco valve

possessing good insulating properties, and the chief of these is perhaps paraffin wax. This is extensively used for impregnating paper and other materials in the construction of dielectrics for small condensers, and also for filling holes or channels containing conductors.

A variety of other wax-like compositions are made up, comprising resin, shellac, beeswax and the like, often with the addition of pitch, tar and bitumen,

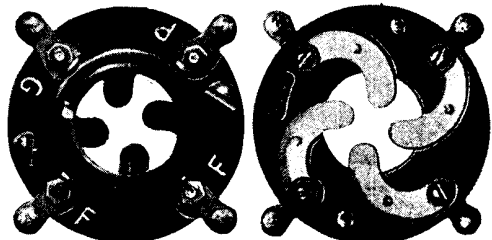

WECO VALVE HOLDERS

Fig. 1. This holder, used with Weco valves, is constructed to minimise inter-electrode capacity effects. Notice the marking of the electrodes, the two filament leads being together

these possessing insulating qualities, and also to a large extent being moisture-proof. They are prepared in various ways,

a typical example being the braided covering for an insulated conductor. See Basket Coil; Coil.

**WEBER.** Name given to the unit of magnetic flux. It is the flux produced by a current of one ampere flowing through a circuit with one henry inductance. The name Weber has been largely superseded by the term Maxwell (*q.v.*).

**WECO VALVE.** A special small thermionic valve introduced by the Western Electric Co. It is virtually an ordinary thermionic valve, but operates at .8 to 1.1 volts and .25 ampere for the filament, and 17 to 45 volts for the anode. It

measures about  $2\frac{1}{2}$  in. in length and  $\frac{5}{8}$  in. in diameter. It is admirably adapted for all classes of amateur wireless reception, particularly when the apparatus is required to occupy a small space, and has advantages when dry battery operation is desired. Several types of this well-known valve are illustrated in the previous page, and along with these are shown the adaptors specially made for use with them. See Valves for Reception.

**WEHNELT ELECTRODE.** Name generally given to a type of electrode in valves, due to A. Wehnelt. Wehnelt discovered that the current-carrying capacity of a wireless valve was increased by coating the filaments with calcium oxide. See Dull Emitter Valves.

**WELDING.** Method of uniting ferrous metals. Welding is adapted in wireless work chiefly in the fashioning of iron or steel parts for aerial masts and other constructive work.

**WESTERN ELECTRIC.** Abbreviated title of the Western Electric Company, Ltd., one of the leading manufacturers of electrical and wireless apparatus. An example of the thermionic valve manufactured by this firm is illustrated in Fig. 1, and is known as the L.S.2 valve. The arrangement of the plate and grid should be noted. Another well-known valve made by the same firm is the Weco (*q.v.*).

An adaptation of this small dry-battery valve, in the form of a two-stage amplifier for a crystal set is illustrated in Fig. 2. This amplifier is adapted to slip into the telephone compartment in the standard Western Electric Co.'s crystal receiving set. A three-valve two-stage amplifier is illustrated in Fig. 3. In this case three Weco valves are used, and connexions are made in such a way that the amplified current produced by one valve is collectively dealt with by the other two.

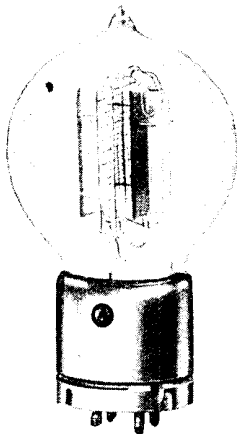

WESTERN ELECTRIC  
L.S.2 VALVE

Fig. 1. This valve is remarkable for the shape of the anode and grid and also the structure of the valve legs

**WESTON CELL.**  
Type of cell adopted

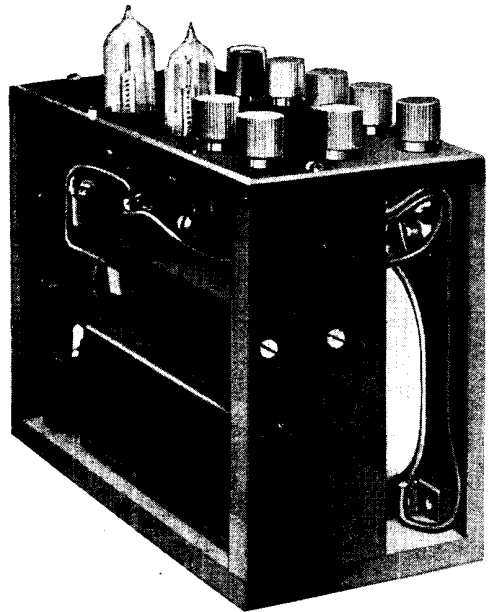

**TWO-STAGE L.F. AMPLIFIER FOR CRYSTAL SET**  
Fig. 2. In this amplifier Weco valves are used. The instrument fits the telephone compartment of the Western Electric Co.'s receiver

*Courtesy Western Electric Co., Ltd.*

by scientists as the standard of electromotive force, on the recommendation of the International Conference of Electrical Standards held in London in 1908.

Fig. 1 shows the external construction of a standard type of Weston cell. It will be seen that the whole instrument is totally enclosed within a cylindrical brass

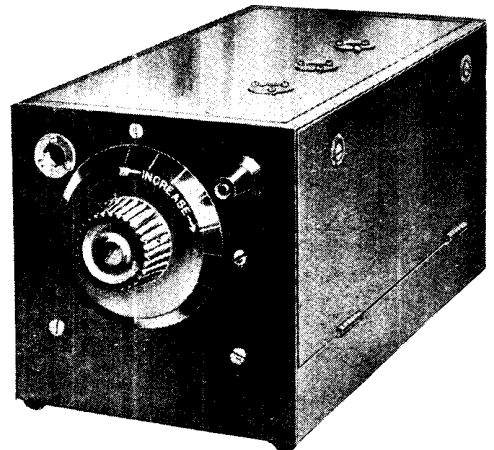

**TWO-STAGE AMPLIFIER FOR VALVE SET**  
Fig. 3. Three Weco valves are used in this set, which is a two-stage amplifier

*Courtesy Western Electric Co., Ltd.*

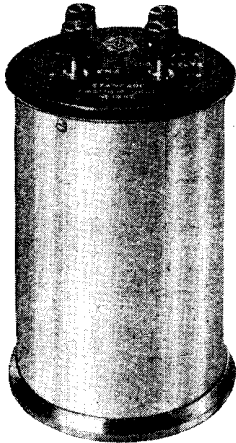

**WESTON STANDARD CELL**

Fig. 1. This cell has been adopted by scientists as the standard cell with which comparisons with other cells are made  
*Courtesy Cambridge and Paul Instrument Co., Ltd.*

casing having an ebonite top-plate. The latter is fitted, in this instance, with four terminals, as there are two cells enclosed, one being used as a check against the other. In the centre of the top, also, is a small hole through which a thermometer may be placed in order that an accurate check on the internal temperature may be taken. This is a most important point, for the voltage depends to some extent upon the temperature.

The interior of a single Weston cell may be seen by reference to Fig. 2. Upon a stamped metal framework attached to the underside of the ebonite top is a hermetically sealed glass vessel, the shape of which approximates to the letter H.

One of the vertical limbs of this tube contains in its lower portion a quantity of mercury. The latter is covered first by a layer of mercurous sulphate, and secondly by a layer of cadmium sulphate crystals. In the opposite limb is a small quantity of cadmium amalgam covered with cadmium sulphate crystals. Both of these tubes have a constriction formed at the level of the top of their solid contents, so that the upper layers of cadmium sulphate crystals form a kind of taper plug, which holds the contents in place.

The rest of the interior of the tube, up to the level of the horizontal limb, is filled with a saturated solution of cadmium sulphate. Silk cord lashing is used to secure the tube to the metal frame, and connexions to the terminals are taken from two leads of platinum sealed into the glass tubes near the bottom. The Weston cell gives an E.M.F. of 1.0184 volts at a temperature of 20° C. See Primary Cell.

**WET CELL.** General name given to those primary cells in which the electrolyte is a fluid, in contradistinction to the dry cell, in which the electrolyte is in the form of a paste. The figures show the component parts of two well-known forms of wet cell. Fig. 2 shows the positive

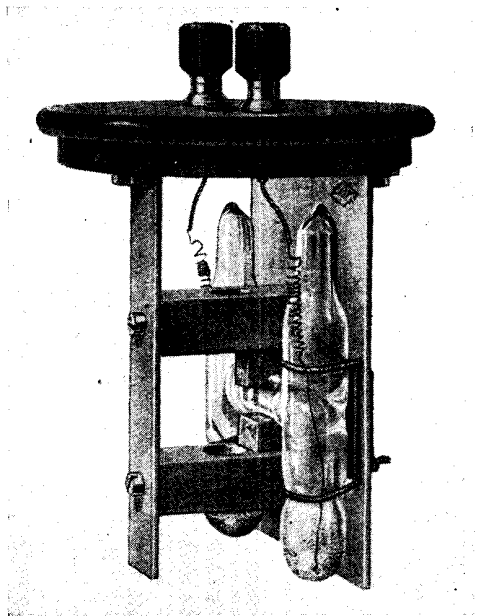

**INTERIOR OF WESTON CELL**

Fig. 2. Interior of the single cell, showing the curious H-shaped hermetically sealed glass vessel attached to the stamped metal framework  
*Courtesy Cambridge and Paul Instrument Co., Ltd.*

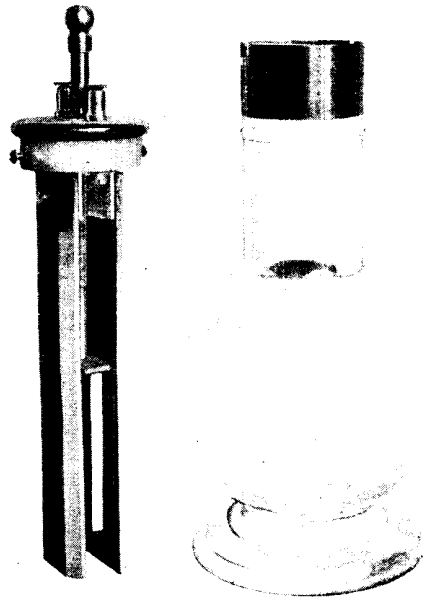

**ORDINARY WET CELL**

Fig. 1. Here is shown the glass containing vessel and the two elements of standard bichromate cell. This cell is economical in use provided the plate is withdrawn when not in use

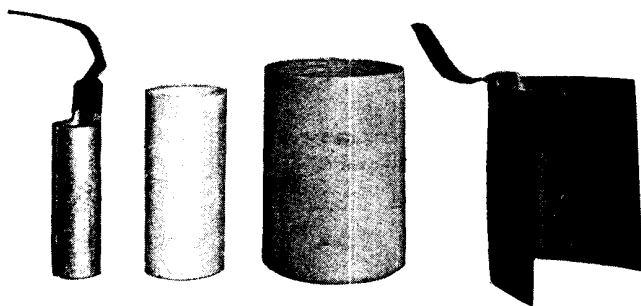

DANIELL CELL COMPONENTS

Fig. 2. On the outside are the two electrodes of the cell. The porous pot and the glass container shown in the centre complete the cell

and negative electrodes of an ordinary Daniell cell on the extreme right and left of the photograph, the glass containing jar and the porous pot which is a feature of this type of cell.

Fig. 1 shows the glass container and the two elements of a bichromate cell. This type of cell is fully described under the heading Bichromate Cell, and full particulars are given under the heading Bichromate Battery of how to make one. See Primary Cell; Dry Cell.

**WHEATSTONE, SIR CHARLES** (1802-75), British physicist. Born in February, 1802, at Gloucester, he was educated at private schools, and on leaving carried out privately many experiments in acoustics under the aegis of his father and uncle, a musical instrument maker. After some years' study of acoustics he devoted himself to experimental research of various kinds, and wrote a number of papers for scientific societies.

In 1834 he was appointed professor of experimental philosophy at King's College, London. Here he demonstrated a method of determining by means of a revolving mirror the speed of an electric current, a highly important investigation which led ultimately to the invention of the electric telegraph. Wheatstone obtained the co-operation of W. F. Cooke, and the two brought out in 1837 a patent for an electric telegraph. He invented the A B C instrument, the automatic transmitter and receivers, and many forms of electrical apparatus. He has rightly been called the father of modern telegraphy, and it is due to his genius and investigations that modern telegraphy has become the best-known method of communication throughout the world.

Wheatstone carried out many re-

searches in sound and light as well as electricity. He investigated the speed of sound through solids, gave an explanation of Chladni's figures of vibrating solids, and invented the concertina, stereoscope, the polar clock, electrical chronoscopes and a ciphering and deciphering machine, among other things.

Sir Charles Wheatstone has also been credited with the invention of the Wheatstone bridge, but the device

was actually invented by Christie, though Sir Charles made considerable use of the invention. He was made a fellow of the Royal Society in 1837, and knighted in 1868. He died in Paris on October 19th, 1875.

**WHEATSTONE BRIDGE.** Device for measuring an unknown resistance by means of a known resistance. It consists of a network of six conductors joining four points, and was invented by S. H. Christie, of the Royal Military Academy at Woolwich. Sir Charles Wheatstone pointed out the immense importance of the arrangement to electricians, and the device has come gradually to bear his name, though he gave the credit to Christie.

Fig. 1 shows the circuit diagram of the usual form of Wheatstone bridge.  $R_1$ ,  $R_2$ ,  $R_3$  and  $R_4$  are four resistances joined as shown at the points A, B, C, D. From B to D is a conducting path which can be opened or closed by a key,  $K_1$ , and which has a galvanometer in it. From A to C there is a conducting path with a battery key,  $K_2$ .

Suppose the key  $K_1$  is open and the key  $K_2$  is closed. Then a current from the battery will divide at A, part of it going along A B C and part of it along A D C. There will be a fall of potential from A to C, but since in the two branches A B C and A D C the fall is the same from A to the point C, there will be a point in A D C at which the potential is the same as that of a selected point in A B C. Suppose the point B is selected in A B C, and suppose the potential at some point D in A D C is the same as that at B. Then if the points B and D are joined by a conductor in which there is a galvanometer, no current flow will be indicated, the pointer of the galvanometer not deflecting.

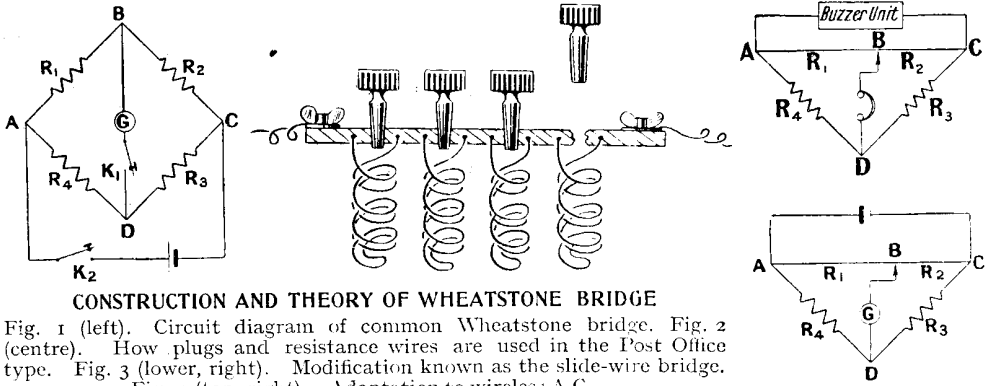

**CONSTRUCTION AND THEORY OF WHEATSTONE BRIDGE**

Fig. 1 (left). Circuit diagram of common Wheatstone bridge. Fig. 2 (centre). How plugs and resistance wires are used in the Post Office type. Fig. 3 (lower, right). Modification known as the slide-wire bridge. Fig. 4 (top, right). Adaptation to wireless A.C.

Now the differences of potential between A and B and between A and D are the same, since B and D are at the same potential; and the differences of potential between B and C and D and C are the same. So we can write down the following equations:—

P.D. between A and B = P.D. between A and D, and P.D. between B and C = P.D. between D and C.

If  $C_1, C_2, C_3, C_4$  are the currents in  $R_1, R_2, R_3, R_4$  respectively, we can write these two equations down as

$$C_1 R_1 = C_4 R_4$$

$$C_2 R_2 = C_3 R_3$$

or, dividing one equation by the other,

$$\frac{C_1 R_1}{C_2 R_2} = \frac{C_4 R_4}{C_3 R_3}$$

But the current in A B, i.e.  $C_1$ , is equal to the current in B C, i.e.  $C_2$ ; and the current in A D,  $C_4$ , equals that in D C,  $C_3$ , so that the equation becomes

$$\frac{R_1}{R_2} = \frac{R_4}{R_3}$$

From this equation it is clear that if the resistances of three of the arms of the bridge are known, the resistance of the fourth may easily be calculated, or if the resistance of one conductor adjacent to the unknown resistance is known, and the ratio of the other two resistances is known, the unknown resistance can be found. The resistances  $R_1, R_2, R_3, R_4$  are generally known as the arms of the bridge and D B as the bridge wire.

It is usual in practice to have the two resistances  $R_1, R_2$ , called the ratio arms, fixed and in a decimal ratio to one another, e.g. 1,000 ohms to one ohm, or 10,000 ohms to 100 ohms, and so on, while the resistance,  $R_3$ , the measuring arm, is variable, and  $R_4$  is the resistance to be measured.

The unknown resistance is inserted in the circuit, and  $R_3$  varied until the galvanometer reading is zero, when  $R_4$  can be calculated.

A common form of Wheatstone bridge is that known as the Post Office pattern, shown in Fig. 5. In this well-known pattern there are a number of coils of known resistance arranged so as to form three arms of the Wheatstone bridge. The ends of the coils are fastened to solid brass blocks separated from each other, a portion of each gap having a circular conical hole made in it, into which conical brass plugs can be inserted. Fig. 2 will make this internal construction clear.

When a plug is inserted it is clear that that particular resistance coil is cut out of the circuit, the current passing from one brass block to the next through the plug, so that the removal of a plug increases

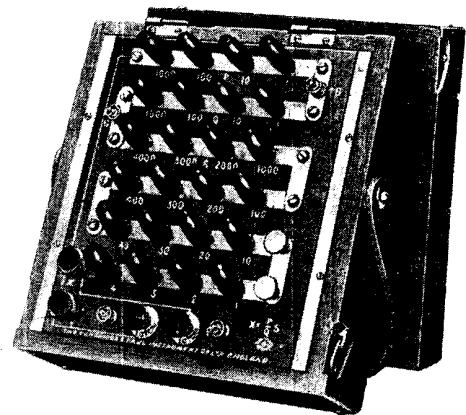

**POST OFFICE PATTERN**

Fig. 5. This is the most common type of Wheatstone bridge. The plugs when taken out increase the total resistance

Courtesy Cambridge and Paul Instrument Co., Ltd.

the resistance of the circuit. The coils, it will be noticed, are non-inductively wound. The top of the box is of ebonite and the brass plugs have ebonite tops. In Fig. 2 the ratio arms consist of eight coils having resistances of 1, 10, 100 and 1,000 ohms, while the measuring arm consists of sixteen coils with resistances of 1, 2, 3, 4; 10, 20, 30, 40; 100, 200 300, 400; 1,000, 2,000, 3,000 and 4,000 ohms, so that with all the plugs withdrawn there is a total resistance of 11,110 ohms in this series of coils. By withdrawing two plugs in the ratio arms any decimal ratio from 1,000 to 1 and 1 to 1,000 may be obtained.

On the left of where the ratio joins the measuring arm is the galvanometer terminal, on the right the battery terminal, and below the resistance terminals for the insertion of the unknown resistance.

Fig. 3 shows another arrangement of the Wheatstone bridge, often known as the slide-wire bridge. Here a uniform resistance wire A B C has a sliding contact, B, connected to the galvanometer. The circuit is identical with that shown in Fig. 1, and has been lettered in a corresponding way. By sliding the contact B along the wire we can obtain the balance when no current passes through G, and we get, as before,  $R_1/R_2 = R_4/R_3$ . The ratio  $R_1$  to  $R_2$  is the same as the ratio of the lengths of A B to A C, so that if A B has a divided scale attached to it and  $R_3$  is known,  $R_4$  may be found.

#### Wheatstone Bridge for Wireless

In wireless alternating currents are used and the forms of Wheatstone bridge already described could not be used, but the bridge is very easily adapted, as shown in Fig. 4. Here the battery is replaced by a buzzer, which gives an alternating current through the arms of the bridge and the galvanometer by a telephone. The sliding contact, B, is adjusted until a minimum sound is heard in the telephones, and the unknown resistance is found from the same equations as hold good for Fig. 3.

Instead of the resistances  $R_1$  and  $R_3$ , an inductance coil of unknown value, X, may replace  $R_1$  and a coil of known inductance, L, replace  $R_3$  in Fig. 4. When the slider is moved until there is a minimum sound in the telephones we have the equation

$$X/L = R_4/R_2$$

The unknown inductance should be of the same order of magnitude as that of the known, or otherwise it will not be possible

in practice to obtain a balance. This result is not precise, for the obvious reason that it neglects the resistances of the inductances, but it is sufficiently accurate for most amateur work. In page 1161 is described a more accurate form of the bridge, together with the necessary formulae for obtaining the inductance of a coil from bridge measurements. Fig. 6 shows a method which may be used by the amateur to take account of the resistances. In the arm in which are connected the inductance coils are inserted variable non-inductive resistances whose values are known.

#### Obtaining a Balance

By throwing the buzzer battery switch over to the right, the bridge may be balanced for resistances using the galvanometer to indicate the position of balance. By throwing both switches over to the left the circuit is used to balance for resistances for alternating current, the buzzer and telephones being used in the way already explained. The following is the actual method of procedure.

The throw-over switches are thrown to bring the telephones and buzzer into circuit and the sliding contact adjusted for minimum sound in the telephones.

The switches are now thrown to bring the galvanometer and battery into circuit and the resistances  $R_3$  and  $R_4$  varied, keeping the slider in the position already obtained until the galvanometer does not deflect. Throw over the two switches again and move the slider until minimum sound is heard in the telephones. Again switch the battery and galvanometer into circuit and vary  $R_3$  and  $R_4$  until a balance is obtained with the slider in the new position. This procedure should be carried out until there is no deflection in the galvanometer on switching it in and a minimum noise in the telephones when the buzzer is used. The equation

$$X/L = R_4/R_2$$

then applies.

Capacities may be measured by using the circuit shown in Fig. 4, the unknown capacity replacing  $R_4$  and a known capacity replacing  $R_3$ . If in place of  $R_3$  a variable air condenser is used and the slider is set at the mid point of A C, then the capacity of the condenser is varied until the minimum sound is heard in the telephones. The reading of the condenser gives that of the unknown capacity approximately.



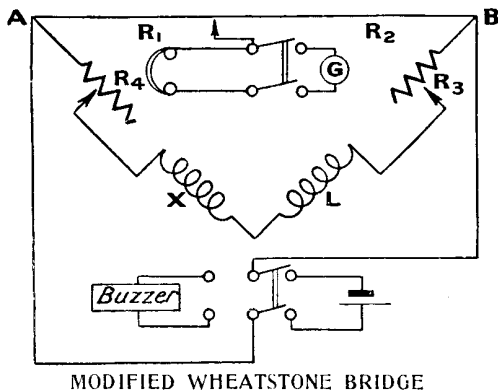

MODIFIED WHEATSTONE BRIDGE

Fig. 6. By means of this form of circuit the inductance value of a coil may be accurately determined

The construction of the Wheatstone bridge shown in Figs. 3, 4 and 6 is a simple matter, and will enable the amateur to get a close approximation to the values of the various components he may be using in his set. The uniform resistance wire may be of any standard material, as manganin. It should be connected to large terminals mounted on an ebonite panel. Underneath should be fixed a scale, preferably a centimetre scale. A convenient length for this scale and the wire is 100 centimetres, and the gauge of the wire may be about No. 20. The connexions to the terminals should be absolutely electrically sound, and the two connexion points should be on each terminal to connect up to the buzzer or battery. If the connexions are not sound there will be an increase in resistance of unknown amount, and the accuracy of the bridge will be lost.

The slider may be simply made with a small telephone clip to which has been soldered a length of flexible insulated wire. Before the wire is finally fixed in position the terminal should be clipped on to it. A firm connexion is made by screwing down the terminal screw in the usual way, releasing it when sliding the terminal along the wire. The ordinary dry cell will do for the battery, and small buzzer sets may be bought, or one made as described in this Encyclopedia under the heading Buzzer. An ordinary pair of headphones may be used. For a standard inductance a honeycomb coil may be used whose inductance is given by the makers. Precision condensers, such as those made by the Sterling Telephone Co., may be used when testing the capacities of unknown

condensers. See Anderson Bridge; Bolometer Bridge; Capacity; De Sauty Bridge; Foster Bridge; Inductance; Resistance; Resistance Box.

#### WHEATSTONE TRANSMITTER.

A mechanical automatic device operated by a punched tape for transmission at high speed. See High-speed Transmission.

#### WHIDDINGTON, RICHARD.

British physicist. Born in London, November 25th, 1885, he was educated at St. John's College, Cambridge, and carried out research work at the Cavendish laboratory under Sir J. J. Thomson. In 1911 he was elected a fellow of St. John's College, and during the Great War he designed a number of the standard R.A.F. wireless sets used on aeroplanes and in aircraft work generally. After the Great War he was appointed professor of physics at Leeds University, and a member of sub-committee D, on thermionic valves, of the Radio Research Board. Professor Whiddington has written many important papers on electrical subjects.

#### WHIPPING.

Word used in two senses in wireless work. In one application it refers to the bending or displacement of a rod or shaft while under load, an example being the bowing of an aerial mast or the bending of a rotating shaft such as that of an armature. In another sense, whipping consists of a kind of binding of twine, string or wire around a stranded wire or cable for the purpose of preventing the ends from fraying out. See Seizing.

#### WHISTLING.

Sound heard in the telephones of a receiving set. Whistling may be caused by the reaction coil being too tightly coupled, and this is one of the chief causes. The sound will generally cease if the coil is more loosely coupled. Whistling noises may also be caused through a receiving set in the neighbourhood oscillating, in which case there is no remedy until the offender stops. Bad connexions, too high a plate or filament voltage, body capacity, etc., are all also causes of whistling. See Howling.

#### WIEN, MAX.

German wireless authority. Born at Königsberg in 1866, he studied physics under the famous Helmholtz, and eagerly followed up the experiments of Hertz. In 1891 he worked with Röntgen, and then turned his attention to the study of wireless waves. In 1906 he published the results of his researches on the properties of short spark gaps, which resulted in a great advance in the

improvement of spark gaps for rapid discharges, since the discharge across such spark gaps is very rapidly quenched out after a few oscillations. Wien's discovery is generally known as the quenched spark gap.

Professor Wien studied how special forms of Geissler tubes could be used in series with an ordinary spark gap so that their resistance rapidly damps out the discharge. He designed several forms of these quenching tubes, capable of handling very heavy condenser discharges without overheating. Professor Wien has written many articles and published many papers on the theory and practice of quenched spark gaps.

#### WIMSHURST MACHINE.

Name given to a particular type of apparatus employed for experimental purposes in connexion with static electricity. Essentially, the instru-

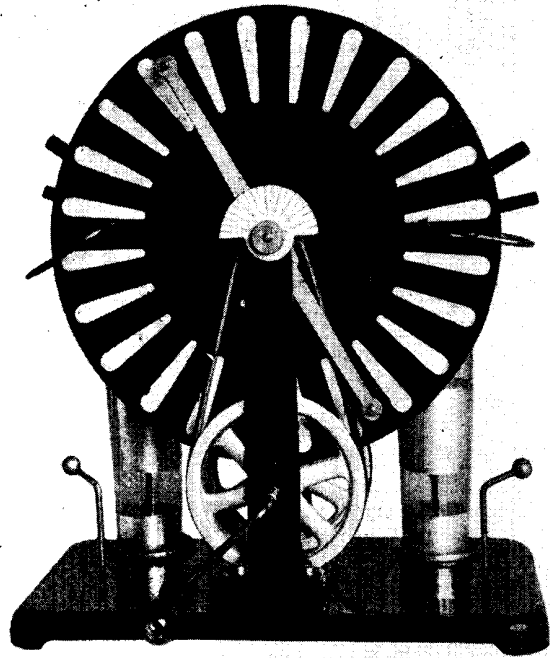

WIMSHURST MACHINE

Fig. 1. View of the machine from the driving side, showing clearly details of the collecting arms and the Leyden jars

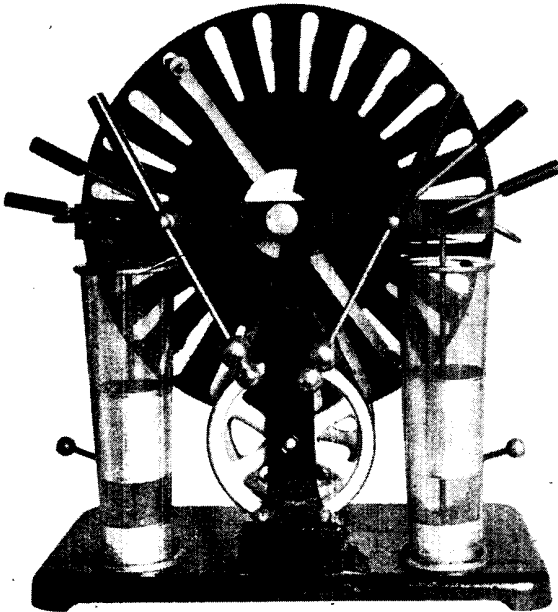

REAR VIEW OF THE MACHINE

Fig. 2. This photograph gives a clear view of the variable spark gap fitted with insulated handles, which enables the length of the spark to be regulated while the machine is being operated

ment consists of two insulated plates set on a common spindle and capable of revolving at high speeds in opposite directions. Around the circumference of the plates a number of segments of tinfoil are pasted. The current induced between the opposing sections in opposite segments is picked up by means of metallic arms fitted with soft brush contacts.

Two or more Leyden jars are usually incorporated to give intensity to the spark. A typical two-plate Wimshurst machine viewed from the driving side is illustrated in Fig. 1, this illustration clearly showing the collecting arm and the Leyden jars. A rear view of the same instrument is shown in Fig. 2, and this shows the variable spark gap fitted with insulated handles, so that the length of the spark may be regulated while the machine is in operation.

**WINDINGS.** General term for the turns of wire used on many forms of wireless apparatus. Thus the turns of wire round a transformer are often spoken of as primary and secondary windings; in a variometer as the rotor and stator windings; in an electro-magnet as pole windings, etc.

**WINDOW INSULATOR.** A particular form of lead-in insulator. In the Burndeft pattern illustrated the insulator is



**WINDOW INSULATOR**

Two ebonite rods, each having a disk bound with rubber, are used in this insulator, which is used to bring the lead-in wire through a window-pane

*Courtesy Burndeft, Ltd.*

composed of two ebonite rods, each having a disk attached, faced with rubber. A  $\frac{1}{4}$  in. diameter brass bar passes through the centre and terminates at either end with lock nuts and terminals. In use, a small hole is drilled through the glass of the window pane, the brass bar removed from the insulator, passed through this hole, and one of the ebonite rods placed at either side of the window, the whole being held tight by screwing up the lock nuts. See Aerial; Bradfield Insulator; Lead-In.

**WIRE.** In wireless work many forms of wire are employed. The aerial is usually made of multi-stranded wire consisting of several strands of copper, bronze, or sometimes steel. This is connected to the set by insulated wire, which may be single or multi-strand, and covered with an insulation consisting of cotton or similar material impregnated with an insulating compound. In the set much of the coil winding is carried out with cotton or silk-covered tinned copper wire. Alternatively enamelled copper wire may be used. The internal connexions are often made with bare tinned copper wire square in section. For other purposes a flexible wire is better, and is imperative for connexions between parts that are movable relatively to one another. Flexible wire is usually composed of a great number of thin strands of copper wire covered with insulation.

Several special forms of wire are utilized for specific purposes, such as Litzendraht. Wire used for the support of an aerial mast, or for other power purposes, is generally of stranded steel or galvanized iron. An example is illustrated.

Wire is generally sold by gauge numbers. The Imperial standard wire gauge is the legal gauge in Great Britain. Each size differs by a few thousandths of an inch in diameter only, thus offering wide choice of size. Details of the various sizes, numbers of turns per inch, and other information should be found from the regular wire tables, selections from which are to be found under their respective headings in this Encyclopedia.

The term wire is also applied to a number of variously sectioned strips of metal, such as half-round, oval, flats and pinion, all of which are available for amateur constructional purposes. See Gauge; Imperial Wire Gauge.

**WIRED WIRELESS.** Name applied to a system of transmitting telegraph signals or telephony over wires by using high-frequency currents and employing wireless methods in transmission and reception. Ordinary radio transmission uses oscillatory currents which may be allied to the usual single-phase currents used for power work, except that they are of a much higher frequency. Because of this high frequency, conditions obtaining in ordinary circuits which are of no importance in the lower frequencies assume definite importance and have effect on the currents travelling through them, and by suitably designing the circuits it is possible to radiate into free space a certain proportion of the current. It is due to this fact

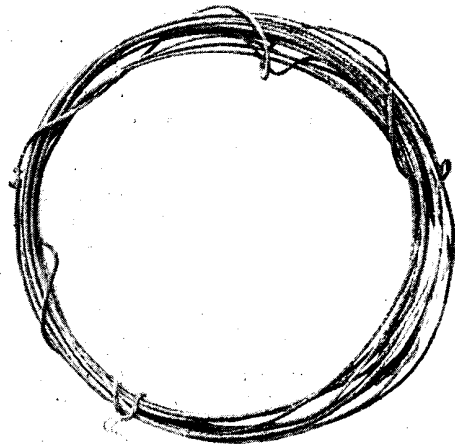

**GALVANIZED WIRE**

Galvanized wire is very useful to the wireless experimenter for the staying of aerial masts and such similar purposes

that wireless communication becomes a possibility. It is therefore conceivable that by arranging the circuit so that only the smallest possible radiation obtains, the transmission of high-frequency current over wires may be effected.

The simplest and best method of obtaining this effect is by connecting the output of the transmitting apparatus to two parallel conductors, and it has been proved that under these conditions the radiation will be very small, with resultant small losses in the transmitted currents. It is important to note that the actual conduction of the currents still takes place in the ether surrounding the wires, rather than in the wires themselves, the latter acting as a kind of guiding medium.

#### Duplex Wired Wireless

Experiment has proved that high-frequency currents may be transmitted over wires carrying either direct current or alternating currents of lower frequencies without one affecting the other, and, further, that more than one series of high frequencies may be carried along the same wires without interference, providing that they vary in frequency to a sufficiently large extent.

From the above it is apparent that wired wireless offers advantages over ordinary low-frequency line communication in that "duplexing" is possible by working both a high- and low-frequency conversation along it. Apart from that, owing to the aptitude of high-frequency currents for passing through conditions in a circuit which present an almost infinite impedance to currents of a low frequency, it is possible to convey them to the line through such mediums as a very weak magnetic coupling or a very small capacity. Thus such connexions may be made with safety even on lines through which enormous electrical powers are being conveyed, always providing that the insulation on the connecting medium is sufficient to oppose the voltage of the ordinary line current.

All types of line do not offer the same advantages to the carrying of high-frequency currents. For instance, iron wires present almost insuperable difficulties owing to the losses due to hysteresis, and underground cables are unsuitable owing to the large amount of capacity present. Obviously, therefore, copper conductors carried overhead offer the

greatest advantages, although the actual ohmic resistance is of little importance. As regards the power required, this is very small compared with radio working, and under favourable conditions, and with suitable lines, distances of several hundred miles may be traversed successfully with a power of only 20 watts.

Power lines are, on the whole, to be preferred to ordinary overhead telephone lines, because they are of low resistance, highly insulated, and do not as a rule vary in constants—as, for instance, by sudden changes from overhead to underground and vice versa.

Again, a disconnexion in a line carrying high-frequency currents does not always mean complete cutting of communication, for radiation and induction will sometimes bridge the gap and still allow communication, but with a lowered efficiency. In this connexion it is interesting to state that during the course of some tests in England over telephone lines running parallel to 10,000 and 20,000 volt power lines, continuity of conversation was obtained without any apparent loss of efficiency, despite the fact that one of the telephone lines was completely broken and lying on the ground for some 170 yards. So little difference did this make to the conversation that the experimenters did not notice the event until it was pointed out to them.

#### Interference not a Serious Matter

Referring again to the possibilities of transmitting more than one frequency of oscillations along the same wire, we must consider to what extent this may be done. In the first place all the advantages in wireless of tuning may be used as a means of providing selectivity; it is therefore easy to see that interference between frequencies is not a serious factor, but at the same time there are definite limits to the number of frequencies which may be simultaneously applied.

In the first place the human ear cannot generally hear sounds above 20,000 cycles per second, any sounds immediately below that frequency being heard as a very high squeak, so that the lowest limit of frequency which may be used is represented by that figure. Again, owing to the well-known beat or heterodyne principle, it is obvious that all frequencies above that of the lowest must be so far above that they do not combine and produce any beat

note of less than 20,000. Therefore the frequencies must be separated by at least 20,000 cycles per second, and thus if the first were 20,000 the next would be 40,000, and the next 60,000, etc. Unfortunately it is impossible to carry the frequency to too high an extent, for the use of very high frequencies results in serious losses through attenuation along the line.

So far, we have considered only that portion of the transmission which represents the carrier wave.

The impression of the modulated frequency upon this is to further complicate matters, for the effect of the speech and music frequencies is to produce others, and in the case of wired wireless the best conditions obtain for interference between these frequencies, for all are more or less similar in intensity. Again, harmonics of the carrier waves may easily become serious causes of interference.

Where simultaneous working between several stations is in progress, this interference may only be avoided by the use of filter circuits specially designed for the individual circumstance, and these may be applied either between transmitter and line or line and receiver.

As far as the design of the stations is concerned, these will be purely standard wireless sets of suitable power and employing valves, but they must be designed to work on the duplex system. The transmitter will consist of a small motor-generator for high-tension supply with suitable smoothing circuits, the usual valve oscillator and modulator circuits, batteries and a telephone attachment, for direct or remote control.

#### Calling-up Devices Employed

Before conversation may be effected the user must naturally start up his apparatus and generate the high-frequency oscillations. In order to obviate the necessity for the receiving valves to be always supplied with current ready for any call, it is necessary to use some form of calling-up device. For this purpose the Marconi Co. have developed an electro-capillary tube operating in conjunction with a carborundum crystal. This tube is mounted upon the beam of a most sensitive balance, which, when supplied with minute rectified high-frequency currents through the crystal detector, trips, and in so doing closes a pair of contacts connected in a local bell circuit.

The receiving operator then may lift his telephone receiver off the hook, and the two stations are in conversation.

Some complications ensue, however, on the system being extended to more than one station. For example, take a scheme employing four stations, A, B, C and D, where each must be capable of calling and speaking with any other. This installation might well apply to any power supply scheme, where, say, station A might belong to the chief engineer's office, and the others to assistant engineers in sub-stations any number of miles away.

#### Quadruplex Conversations

Under these conditions each station would be given a fixed receiving wave-length, say  $\lambda_a$ ,  $\lambda_b$ ,  $\lambda_c$ ,  $\lambda_d$ , but each station must be capable of transmitting on any of the wave-lengths, so that station B, for instance, may transmit on  $\lambda_a$ ,  $\lambda_c$  and  $\lambda_d$ .

Let us now assume that A wishes to speak to C. The first step A makes is to adjust his transmitter to  $\lambda_c$ , start up, and thus call C. Upon C hearing the call, he cannot immediately start up both transmitter and receiver, for he does not yet know with whom he is in communication. He therefore uses his receiver only until he knows who is calling him, and upon ascertaining that he adjusts his transmitter to  $\lambda_a$ . Both stations are then ready for conversation.

If during this conversation another station—B, for instance—wishes to speak to A (not knowing that the latter is engaged) and starts his transmitter, jamming would be caused. B must therefore first use his receiver, and adjusting it to  $\lambda_a$ , would hear C speaking on it.

On paper this system would appear to have many limitations and drawbacks, but in actual practice, on lines where privacy is not essential and all operators are conversant with the general outlines of wireless methods, inter-communication may be carried on with reasonable facility and greater certainty than with an ordinary telephone system.

So far, we have only discussed wired wireless as applied to small private systems, but it has a very much larger field of utility than this. In some countries, notably America, whole electric light and power installations for public supply have been impressed with high-frequency currents operated by powerful transmitters

and conveying speech and music in the form of entertainment. Under such a scheme any consumer of the company's electricity might at any time have the entertainment provided by merely attaching a wireless receiver to the mains by means of either a condenser such as the "Ducon" (*q.v.*) or a form of loose magnetic coupling.

In countries where power lines are carried overhead such a scheme is suitable, but in countries where practice specifies underground systems, the large difficulties obtaining through the capacity of lines renders the successful application of wired wireless for entertainment practically impossible.—*R. B. Hurton.*

See Broadcasting; Transmission.

## WIRING: THE BEST METHODS FOR SUCCESSFUL RESULTS

### How to Carry Out an Operation of Great Importance; Fully Illustrated

In the subjoined article is given a full description of the various methods of wiring a wireless set—an operation upon which depends the greater part of the success of amateur sets. The reader should refer also to the various headings dealing with set construction, and to such headings as Coils, Soldering, etc.

Wiring is an expression applied to the process involved in effecting the whole of the connexions in and to a wireless transmitting or receiving set. Provided the components are themselves of the correct value and correctly disposed on the panel and elsewhere, and should reasonably be expected to function in the proper manner, the whole of the success of the average amateur receiving set depends upon the care with which the wiring operations are performed.

In this Encyclopedia detailed instructions have been given for the construction of the various types of receiving and transmitting sets, and a large number of different circuit diagrams have been provided. The following notes apply in general to all classes of wireless apparatus. Naturally, some are more difficult to wire than others. This may not be due entirely to the complexity of the circuit itself, but is more generally the result of indifferent planning when arranging the rotation of the various components, or is necessarily the result of attempting to work the set into the minimum possible space.

An ideal arrangement for wiring is one in which the components are mounted on the back of an ebonite panel which is capable of being removed from its containing case so that the wiring can be performed on the work bench, and with these conditions every terminal is readily accessible and the wiring is robbed of much of its terrors. On the other

hand, if the set is so placed that some of the components are on an ebonite panel and others are located within the case, with perhaps the tuning coils mounted on the top or side of it, the wiring difficulties are necessarily enhanced.

All these points should therefore be borne in mind when designing or building a set. For the actual wiring, very few tools are really necessary. Fig. 1 illustrates a choice of these. They include two pairs of flat-nosed pliers, one at least of which should be of the side-cutting variety; a self-heating or other small soldering iron; some solder and fluxite or other soldering flux. A quantity of square tinned copper bus bar, flexible wire and tinned copper wire about No. 18 gauge are generally also necessary, and some systoflex or insulated sleeving for covering exposed parts of wires which might possibly be liable to short-circuit.

The initial preparation for wiring comprises the construction of a simple former for making the angle pieces, such as that

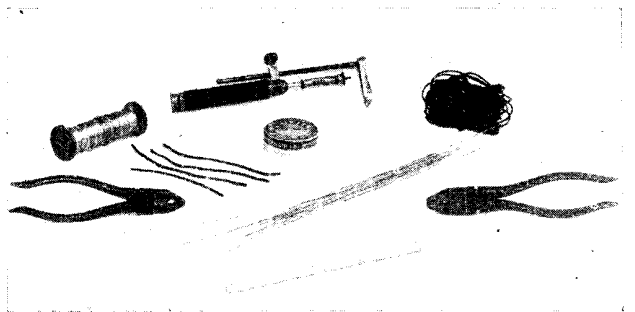

TOOLS USED IN WIRING

Fig. 1. Here are included two pairs of flat-nosed pliers, soldering iron and flux, square tinned copper bus bar, flexible wire, tinned copper wire and insulating sleeving

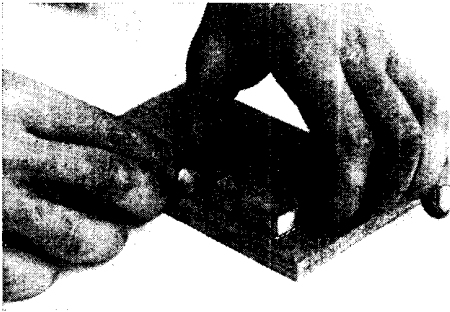

#### ANGLE FORMER IN USE

Fig. 2. For making neat square bends the angle former will save the constructor's time and make a very neat job

illustrated in Fig. 2. This is merely a flat wooden base to which a rectangular block of hardwood is screwed. All four corners should be right angles, and it is used to bend the wires at right angles by forcing the wires into close contact with the guide block.

The most important preparation is that illustrated in Fig. 3, which consists of grasping a suitable length of wire between two pairs of pliers held in the right and left hand, when the wire is stretched or pulled out to straighten it. The right-angle bends are primarily called for in most wiring arrangements, and if any number are required to be made, the bending block should undoubtedly be made up, but for only one or two bends the method illustrated in Fig. 4 should be suitable. The bend is made in this case by grasping the wire with a pair of flat-nosed pliers at the point where the bend is to be made. The other part of the wire is then pulled with the right hand while the pliers are twisted with the left, thus pulling and bending the wire to the required angle.

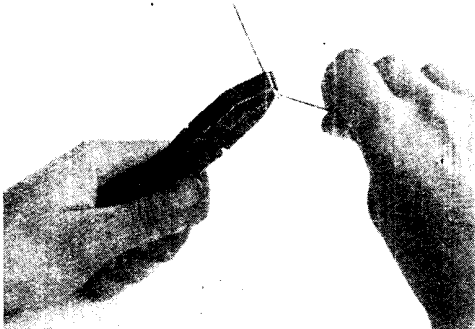

#### MAKING AN ANGLE BEND

Fig. 4. In this operation the wire is bent with the aid of a pair of flat-nosed pliers, as shown here. Note how the wire is held

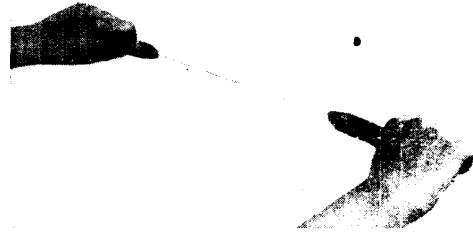

#### STRAIGHTENING WIRE

Fig. 3. This simple operation is at the same time one of the most important in the preparation for wiring

Most modern wiring is carried out by the system often known as the anti-capacity system. In its essentials each separate wire is so positioned on the set that it does not touch or come in close proximity to any other wire or metallic connexion. On the score of neatness and efficiency all the bends in the runs of the wires, when connected by this system, should be at right angles. The wires

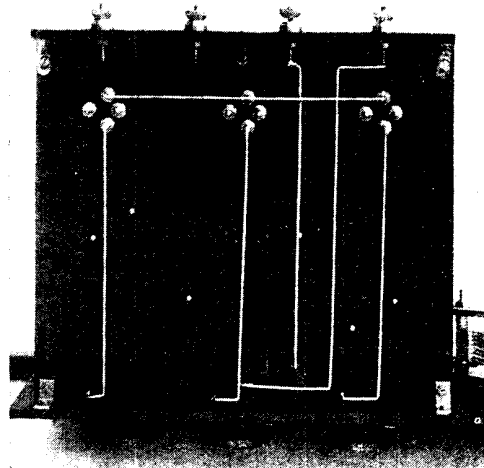

#### WIRING A VALVE PANEL

Fig. 5. This illustration presents an example of neat wiring beneath a valve panel. The filament circuit only is wired

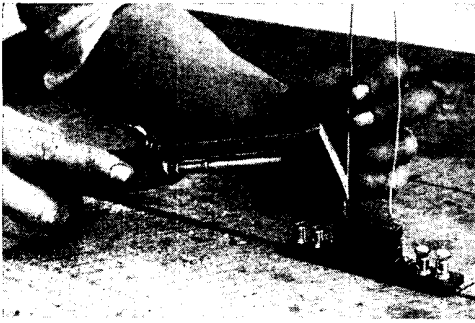

#### SOLDERING CONNEXIONS

Fig. 6. By soldering wires to the small components the resulting connexions on the panel are greatly simplified

themselves should run from point to point in straight paths. Ordinary tinned copper wire about No. 18 gauge can be used for this work, but it is preferable to use a smaller gauge of square-sectioned tinned copper wire. Not only is the sectional area of this wire greater, gauge for gauge, than the circular wire, but it is much stiffer, and therefore retains its position without much risk of its being accidentally moved, as should this happen, the wires may be liable to short circuit.

By the anti-capacity system of wiring the air is relied upon as the insulator, and it can usually be assumed that if a minimum gap of  $\frac{1}{4}$  in. be left between the conductors carrying the low-tension voltage and a clearance of  $\frac{1}{2}$  in. between the conductors carrying the high-tension voltage, ample insulation is provided. Those wires which carry the high-frequency current should as far as possible be kept remote from one another, and should cross each other at right angles. So far as the positioning in the set will allow, the wires carrying the high-frequency current should not run in parallel lines, as it is sometimes considered that such an arrangement tends to increase the self-capacity of the set as a whole.

Perhaps one of the most important features in good wiring is the neatness with which the wires are arranged on the set and the care with which the connexions are made. In Fig. 5 an example showing the low-tension connexions beneath the valve panel of a three-valve set are clearly shown, from which it will be seen that square tinned copper wire is employed, the connexions being carried out by soldering.

For good results it is imperative to

make metallic and electrically good connexions. This can only be accomplished by well-made soldered joints, in which the conductor and terminal, or other connecting points, are metallically connected by solder. In a poorly made joint considerable loss in efficiency will result from the presence of a film of flux or oxide between the two joint faces, although the exterior will appear sound by virtue of the presence of the film of solder.

If the amateur is in doubt as to his ability to make good soldered joints the joints can be made by means of nutted connexions, that is, an eye should be turned on the end of the wire and slipped over the screwed shank of the terminal or other connecting point and good contact effected by screwing a lock nut down firmly on to the connecting wire, particular care being taken to clean off any suggestion of grease or dirt and to make the connexions with mechanically clean nuts, wires and screws.

It will often be found to be desirable to solder connexions or connecting wires to various small components, such, for example, as the condenser illustrated in Fig. 6. The components of this type are generally provided with soldering lugs, usually having a small hole through them. The most effective method of making a connexion is to turn over the end of the wire to a right angle, slip it through the hole, and solder it firmly to the lug.

For this sort of work a small self-heating soldering iron is very useful, as it can be maintained at a uniform and correct working temperature, and is instantly ready for use.

In undertaking the wiring of a set it is highly desirable to adopt some regular plan and to divide the work into a series of sections, commencing, for example, by

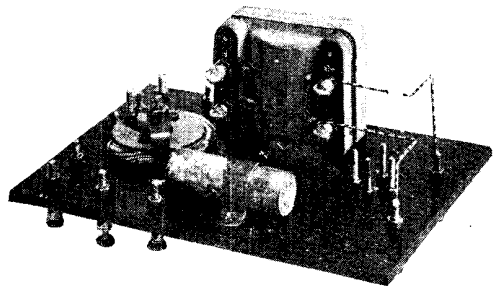

#### TRANSFORMER CONNEXIONS

Fig. 7. The input terminals are here shown connected to the primary windings of the transformer behind the panel



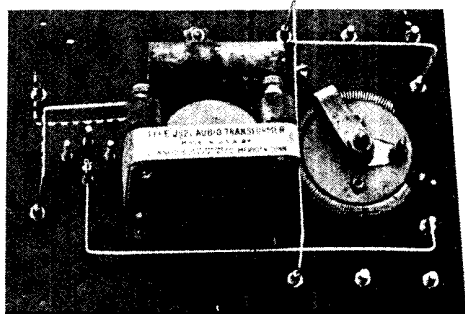

Fig. 8. Here the connexions to the telephone terminals are shown completed and in place

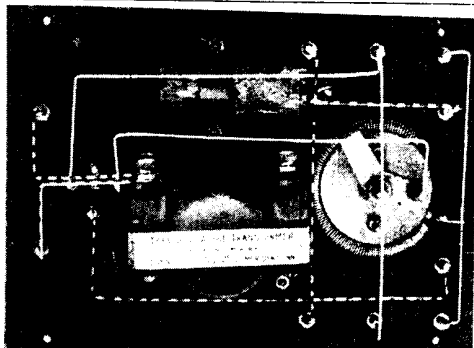

Fig. 9. In this view the filament connexions are indicated in bright wires, connexions previously made being shown dotted

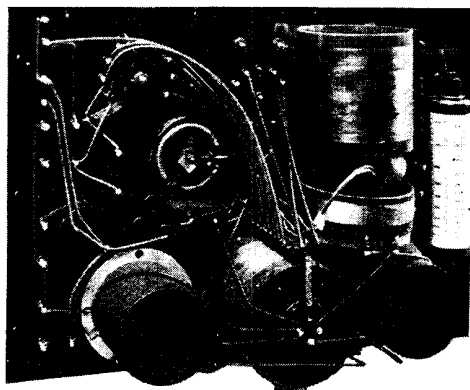

Fig. 10. Another panel is shown here with wiring carried out, using insulated sleeving

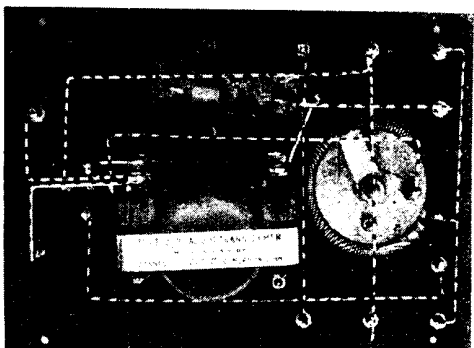

Fig. 11. This illustration shows the panel in Fig. 9 with the amplifier circuit almost complete

DIFFERENT STAGES IN WIRING A RECEIVER PANEL

wiring up the aerial circuit. Another section may include the whole of the low-tension connexions to the filaments of the valves and the other points in that circuit, and as each connexion is made it should be marked off on the circuit diagram, thus reducing the chances of error.

An example of wiring in this manner is illustrated in Fig. 7, which shows a standard low-frequency single-valve amplifier with grid-biasing battery, the whole of the components being mounted beneath an ebonite panel. The first step in this case is to connect the two "input" terminals with the primary winding of the transformer, these two wires being soldered respectively to the input terminals at one end, formed into eyes, and attached by means of terminal nuts to the primary side of the transformer at the other ends.

The next step will be to connect the plate or anode terminal of the valve holder to the telephone terminals, this wire being shown with others in Fig. 8. As this particular set was to be used as a

unit with others, three connecting terminals are fixed on opposite sides of the panel, and consequently they have to be connected by a bridging wire on the underside. One of these wires is seen in Fig. 8 connecting the upper pair of terminals, and a branch is taken from it to the second telephone terminal. This bridging wire connects to the high-tension positive side.

The branch from the bridging wire is a straight piece of wire, bent over near one end to a right angle, with one end soldered to the shank of the telephone terminal and the other overlapped and soldered to the bridging wire. A further stage in the progress of the wiring is illustrated in Fig. 9, which shows two other bridging wires similarly fitted to the foregoing example, with branch connexions to various points on the set. The wires that have previously been fixed are in this case shown by dot and dash lines, so as to isolate the other wires and render them clearer, a method which will be found of considerable advantage to the novice.

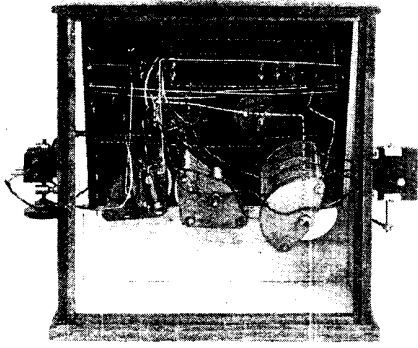

Fig. 12. In this set the various circuits in use are indicated by differently coloured wires

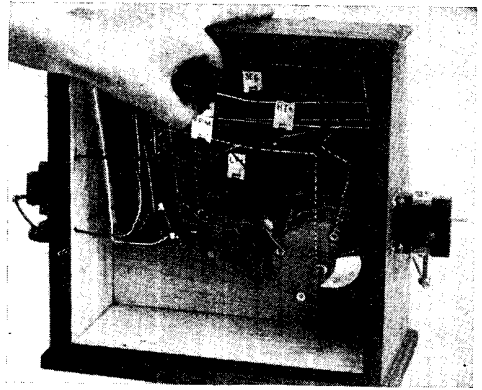

Fig. 13. How ordinary gummed paper tags may be employed to mark the different wires

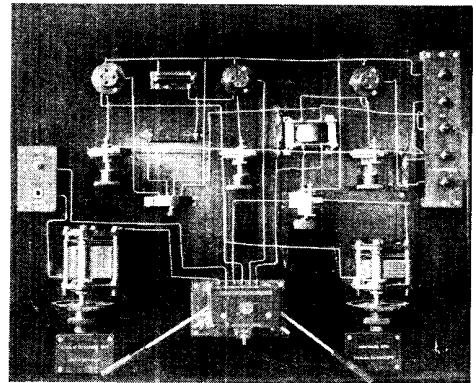
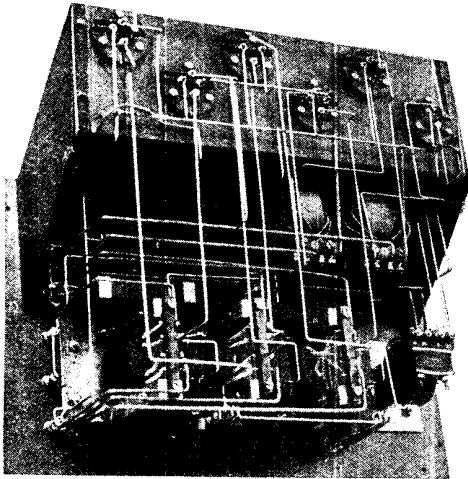

Fig. 14 (left). Very heavy wire is used in this neatly made set. Fig. 15 (above). This arrangement makes for easy tracing of wires

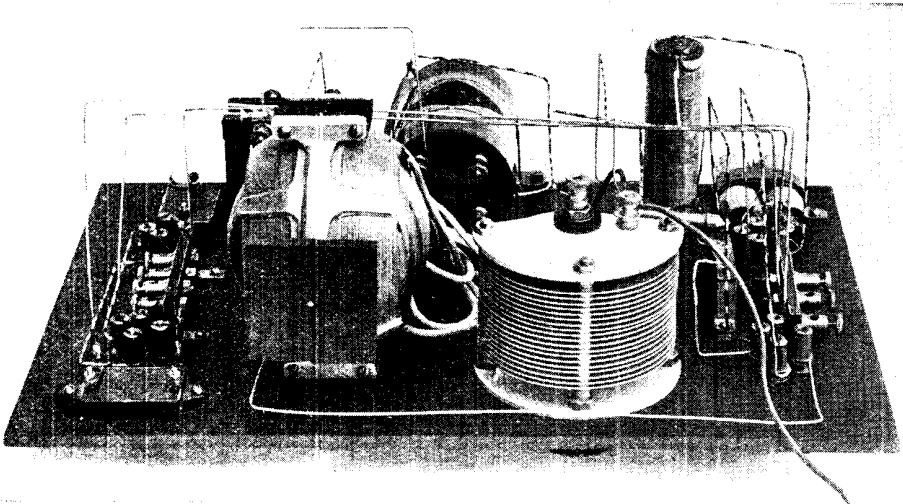

Fig. 16. When this set was wired connexions were made in flexible wire, sleeving and bare wire, as is clearly shown

VARIOUS WIRING ARRANGEMENTS IN LARGE-SIZE SETS

The wiring to the grid-biasing battery, which is shown in Fig. 11, is carried out by soldering one wire to the outer zinc case and connecting this by means of a soldered contact, or other convenient means, by another wire to one side of the secondary of the transformer. Connexion from the centre or carbon element of the battery is made by soldering a wire to it and connecting the other end to the low-tension negative wire.

By adopting the dot and dash system to indicate the various parts of the circuit, considerable saving of time results. A development of the same idea, as illustrated in Fig. 12, is to paint the various circuits in different colours, or to adopt different methods of dots and dashes. For example, the high-tension positive wires could all be painted bright red, the common negative wire green, and so on. This has the advantage that if the work is left until a later day to be completed and a note is made of the colours, it is much easier to carry on at the point where the work was discontinued.

A further device, which is pictured in Fig. 13, is to use small white cardboard tags, which can be clipped on to the principal wires, these tags being marked appropriately, as, for instance, H.T. positive, L.T. negative, and so on. An example showing the use of anti-capacity

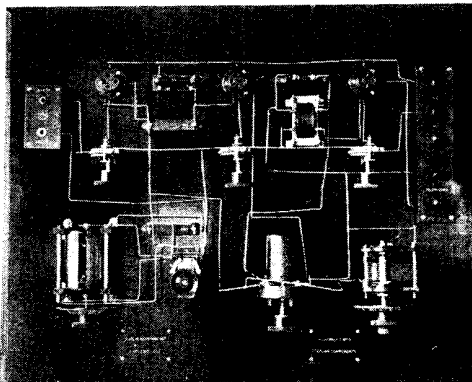

**STERLING THREE-VALVE SET**

Fig. 18. This set has a tuned-anode H.F. coupled valve followed by one stage of L.F. and a rectifier. The components are well spaced for wiring

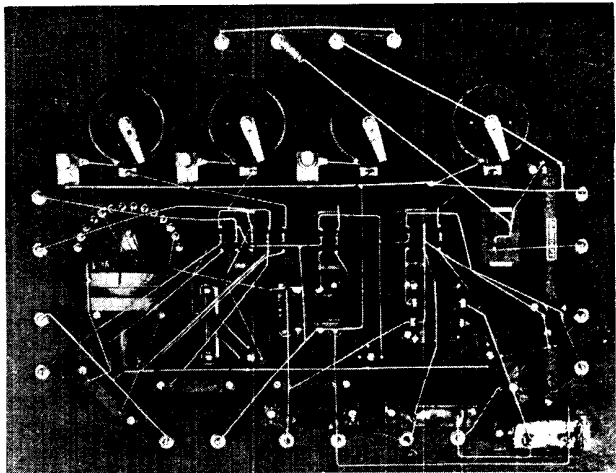

**WIRING OF BURNDEPT ULTRA IV SET**

Fig. 17. Each connexion here is made in as direct a line as possible. The L.T. circuit is carried out in heavy-sectioned wire to minimise resistance

*Courtesy Burndept, Ltd.*

wiring, and also flexible wires and those which are covered with sleeving, is given in Fig. 16.

In another example, illustrated in Fig. 10, the wiring is carried out in insulated sleeving. A point that should be noted is the neat manner in which the leads from the inductance tappings are taken to the stud switch at the top.

The rear of a marine type six-valve amplifier by the Radio Communication Co., Ltd. is shown in Fig. 14. A feature of this instrument is its compactness and the parallel arrangement of the leads. Very heavy wire is used throughout, for where wireless sets are put to marine usage they are subjected to very rough handling, and must accordingly be made very robust.

Bare wiring is used on the Burndept Ultra IV set, as shown in Fig. 17. In this instance each connexion is made from point to point in as direct a line as possible. The low-tension circuit is carried out in wire of very heavy section in order to minimise resistance. Every wire is bent on its own special former during manufacture. This process ensures each set being identical in internal capacity as far as the wiring is concerned, and also facilitates assembly.

An excellent way of connecting up components for experimental purposes is shown in Figs. 15 and 18. This consists of arranging the separate items on a base-

board well spaced out, and in convenient positions for handling, the actual wiring being done with stiff, bare, tinned copper wire. The set in Fig. 18 is a tuned-anode high-frequency coupled valve followed by rectifier and one stage of low frequency. Variometer aerial tuning is fitted and a special form of Sterling anode resistance unit. Fig. 15 shows a similar arrangement, except that a three-coil holder tuner is fitted with reaction on the secondary, while the high-frequency coupling is effected with a transformer having a tuning disk.

Arranged in this way the whole of the wiring is distinctly visible, and enables the circuit to be studied at will, and any alterations or additions made with the minimum of trouble. One small but important point is the use of the insulated panel for the battery and telephone connexions.

**WOLLASTON WIRE.** Name given to an exceedingly fine platinum wire coated with silver. An ordinary platinum wire is heavily coated with silver, and is then drawn out as fine as possible. The central core of platinum, by this means, can be made only a few ten-thousandths of an inch thick. Such fine wire is used in electrolytic detectors (*q.v.*).

**WOOD'S METAL.** Soft metallic alloy with a low melting-point. It consists of two parts of lead, one part of tin, four parts of bismuth, and one part of cadmium by weight. The alloy has the great advantage of melting at a low temperature, about 60° C., and is extremely useful for the fixing of crystal detectors in their cups and so ensuring a firm metallic contact. On page 561 appears a photograph showing this use of the metal, which is usually sold in the form of a rod.

**WORK.** Term used in physics. When a body is displaced by a force acting on it work is said to be done on the body, and the measure of that work is the product of the force and the distance the body is moved in the direction of the force. Power is the rate of doing work. The foot-pound-second unit of work is the work done by one poundal in moving its point of application one foot, and is called a foot-poundal. The C.G.S. unit of work is the work done by one dyne

in moving its point of application one centimetre, and is known as the erg. One foot-poundal equals 421,390 ergs.

The erg is too small a unit for practical purposes, and in electrical engineering three additional work or energy units are employed, namely, the joule, equal to ten million ergs; the watt-hour, equal to 3,600 joules, and the kilowatt-hour, the Board of Trade unit. See Erg; Joule; Power; Units; Watt; etc.



**X-RAYS.** Invisible rays derived from an electrical discharge in a highly evacuated tube which possess the property of being able to penetrate through many bodies which are opaque to light. X-rays are not used in wireless, but it was due to researches on these and other forms of discharge that the electronic theory of electricity was propounded, and the initial experiments in the propagation of electric waves through space started.

The apparatus for the generation of X-rays consists essentially of some form of high-voltage transformer, such as an induction coil (*q.v.*) and a Crookes' (*q.v.*) or Coolidge vacuum tube. An illustration of the latter form of tube appears in Fig. 1, from which it is clear that it is an elongated tube with a spherical portion near the centre. The electrodes are carried in the tubular portions and terminate opposite one another within the sphere. The ends of the electrodes are spaced some distance apart, one being inclined at an angle of 45 degrees. It is from this latter electrode that the rays are projected from the tube.

In Fig. 2 is shown typical high-tension apparatus for X-ray working. On the right, within the cabinet, is an oil-immersed transformer capable of giving a peak

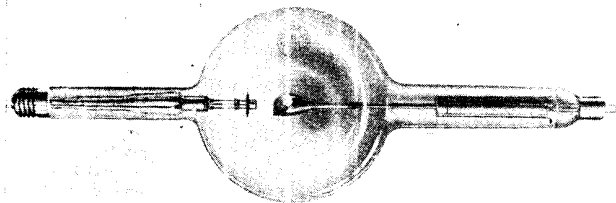

**COOLIDGE VACUUM TUBE**

Fig. 1. This type is one of the many vacuum tubes used in the generation of X-rays

Courtesy British Thomson-Houston Co., Ltd.

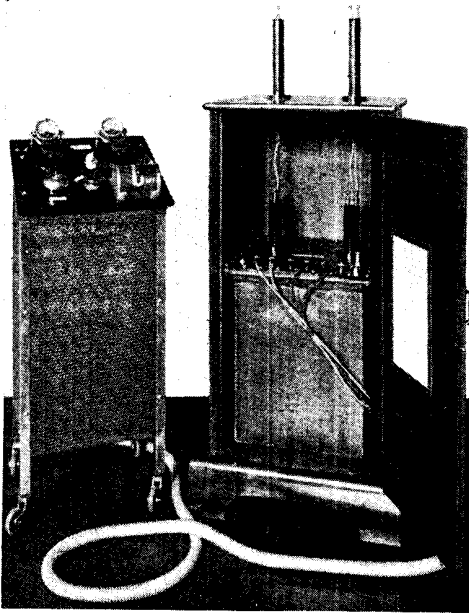

H.T. X-RAY APPARATUS

Fig. 2. On the right here is the oil-immersed transformer capable of giving a voltage of 90,000  
*Courtesy Watson & Sons, Ltd.*

voltage of 90,000. The panel on top of the left-hand stand is fitted with the necessary switch-gear and meters, the body within the expanded metal shields containing resistances, etc.

Fig. 3 shows a much larger X-ray outfit, capable of yielding a voltage of 150,000. A high-tension commutator type of rectifier is fitted. This apparatus may be used in conjunction with a vacuum or gas-filled type of tube, whichever is desired.

**X'S.** Erratic noises heard in the telephones which are not due to any inherent fault in the receiving set. They are usually produced by natural ether waves, as those due to a thunderstorm. X's are also called statics or atmospherics or strays. *See Atmospherics.*

**XTRAUDION VALVE.** Name given to a valve manufactured by the Economic Electric Co. The valve differs in construction from the standard valve in that the anode is a metal plate bent to form a channel section instead of the usual cylinder. The grid is of robust construction, and completely surrounds the straight filament wire.

The filament of the Xtraudion requires a voltage of 4, and at this maximum consumes 4 ampere. The valve is a hard one, the vacuum being of a very high

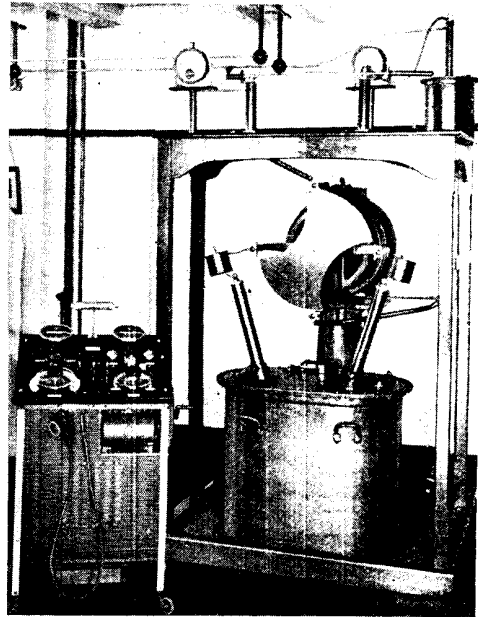

LARGE X-RAY OUTFIT

Fig. 3. With this X-ray apparatus a voltage of 150,000 may be obtained.  
*Courtesy Watson & Sons, Ltd.*

order. The anode voltage is 50. The valve will operate effectively in any circuit in which the standard R has been used, but for use as a rectifier a 5 megohm grid leak is required. A dull emitter form of this valve is the Dextraudion, which takes only 1 ampere at 1 volt and from 20 to 60 volts on the anode. It has a tough filament of special character and will operate on a current so low as 0.25 ampere at 3 to 5 volt, and thus makes a close approach to a "cold emitter." At these low values the filament cannot be seen to be alight. When supplied with the correct value of current the filament glows a dull red only. The saturation point is high, so that it will work a loud speaker effectively with 2 or 3 volts grid bias. *See Valves.*

**XYLONITE.** Trade name for a particular form of celluloid (*q.v.*).



**YAGI SPARK GAP.** Form of spark gap due to H. Yagi. This is a quenched spark gap, the electrodes of which are aluminium and brass. The gap functions in an atmosphere of coal gas. The properties and general functioning of the gap are similar to the Chaffee spark gap (*q.v.*).

**Y GROUPING.** System of connecting up three-phase windings. The circuits start from a common junction and their three ends go to the three lines. See Delta Connexions; Mesh Grouping.

**YOKOJAMA, EITARO.** Japanese wireless expert. Born in 1883, he was educated at the Engineering College of the Tokyo Imperial University, making a special study of wireless. He was appointed to the Electro-technical Laboratory of the Japanese Ministry of Communications to carry out research work in wireless telegraphy and telephony. He was one of the inventors of the T.Y.K. oscillation gaps for radio-telephony, for which he received many distinctions. In 1916 he was appointed head of the Radio Section of the Electro-technical Laboratory. Yokojama, who is one of the most brilliant Japanese wireless experts, is a member of the Institute of Radio Engineers, America, and other scientific societies.



**ZENNECK, J.** German wireless expert. Born April 15th, 1871, at Wurtemberg, he was educated at Tübingen. In 1895 he was appointed assistant in the Physical Institute in Strassburg, a post he held until 1899, when he carried out a series of tests in wireless telegraphy in the North Sea. In 1905 he was appointed assistant professor of physics at the Institute of Technology, Brunswick, 1906, and afterwards professor at Dantzie, 1911, and Munich, 1913.

Zenneck is one of the most brilliant of the German wireless experts. He has written a number of authoritative books on wireless and a very large number of articles on electro-magnetic oscillations.

**ZINC.** Metallic chemical element. The chemical symbol is Zn; melting point, 786° F. The specific gravity of cast zinc varies from 6.8 to 6.9, that of rolled zinc from 7.15 to 7.9. The heat conductivity is 36, compared with silver at 100; electrical conductivity 29.6, compared with silver at 100. The ultimate tensile strength is 5,000 lb. per square inch for cast zinc.

In colour zinc is bluish-grey, it is practically non-corrosive in the atmosphere, is capable of taking a high polish, is unaffected by water, but is soluble in nitric acid and in soda and potash solutions. Pure zinc is attacked very slowly by sulphuric acid, but this feature is one of

the greatest applications of zinc in wireless work and in electrical work generally.

Zinc is one of the most important components of most dry batteries. It forms the negative terminal in most small dry batteries, such as those composing the high-tension battery, and in those used for dull emitter valves. Zinc in rod form is used in most forms of wet cells, especially the Leclanché types (*q.v.*).

Another application of zinc is in the galvanizing process, in which iron or steel is immersed in molten zinc, which then forms a protective coating, preserving the ferrous metal from the effects of damp. An example is the galvanized wire ropes used in aerial mast construction. Zinc when overheated gives off poisonous fumes which should never be inhaled. The fumes are sometimes met when heating brass or other alloys containing zinc. Zinc is best soldered by the use of a flux composed of spirits of salts, which should be wiped from the surface of the zinc immediately the joint has been completed, or corrosion will follow.

**ZINCITE.** Native oxide of zinc. Zincite crystals are distinguished by their red colour, often broken up by orange-yellow streaks. The crystal is one of the best-known rectifiers in combination with certain other crystals. The combination zincite-chalcopyrites is the well-known perikon detector. Zincite may also be used with contacts of copper, bornite, galena, iron pyrites, silicon and tellurium.

With chalcopyrites the contact of the two crystals should be on the light side. With iron pyrites the pressure is not important, the unilateral conductivity remaining fairly constant for most pressures. The worst combination is zincite-galena, which has a poor unilateral conductivity. See Crystals.

**ZIRCONIUM.** One of the metallic elements. Its chemical symbol is Zr, and atomic weight 90.6. Zirconium is an iron-grey powder in one form, or it may be made to crystallize. The crystals look like antimony, are very brittle and extremely hard, being capable of scratching glass and rubies. Zirconium resembles thorium in many of its chemical properties, and for the control of the vacuum in high vacuum valves a small quantity of thorium or zirconium is included in the tube. These metals combine with hydrogen, oxygen, nitrogen, etc., to form compounds of very low vapour pressure.

# CLASSIFIED INDEX

This index is supplementary to the main alphabetical headings of the WIRELESS ENCYCLOPEDIA, and is designed to bring together references which, though having some relations in common, are necessarily scattered through the body of the work.

Thus amplifiers, condensers, valves and similar components are described under their specific names in the Encyclopedia in addition to the general articles on Amplifier, Condenser, Valves, etc. In this classified index they are all brought together under their general headings for the convenience of readers who are not familiar with the specific names. Similarly, such general headings in this index as Circuits, Coupling, Insulating Materials, etc., will be found of great assistance in the study of the various branches of wireless practice.

It is to be noted that the alphabetical headings of the WIRELESS ENCYCLOPEDIA itself are not, as a rule, repeated in this index, and when reference is required to a specific article the text matter of the work, and not this index, should be consulted.

## A

**A Battery**, functions, 1  
description and use, 214  
**Accumulators**. See also Batteries;  
Cells; Plates; Primary Cells;  
acid, strength of, 19, 1905, 1915  
—milky, 1432  
—testing strength of, 1868  
active material, 29  
blistering of plates, 248  
boiling in, 251  
buckling of plates, 20, 296  
capacity of lead, 11  
case for, 18  
celluloid case, 22  
central station lighting plates, 1907  
charging, 404  
—standard method, 15  
—from A.C. supply, 15  
—with chemical rectifier, 16  
—with Crypto rectifier, 553  
—from D.C. supply, 15  
—from mains, 1752  
—with mercury rectifier, 16  
—from primary batteries, 15  
charging board, 17, 403  
—how to make, 406  
—low voltage, 409  
—wiring, 409  
charging dynamo, 24  
charging set, 25  
—Homecharger, 1131  
—rotary converter for, 1752  
—Triumph, 25  
—Tungar, 2115  
choosing, 14  
collar, 26  
connector, 26  
container, 26  
current density, 12  
discharge rate, 1905  
—curve, 1904  
fanning of plates, 901  
Faure plates, 912  
forming in, 956  
forming of plates, 12  
furring of plates, 907  
gassing in, 1009  
glass separators for, 1039  
glass wool for, 1040  
Hart plates, 1902  
Homecharger for, 1131  
ignition rate, 12  
lugs, 1352  
making celluloid case for, 391  
negative plate, 1902  
perforated celluloid for, 1530  
pitch for, 1545  
plates, 1549  
plates, mending, 23  
repairing, 21  
reversible booster, 1742  
rotary transformer for, 1758  
sediment, 1787  
separators, 22, 1794  
splash board, 1874  
spraying, 1877  
stoppers, 23

**Accumulators**, sulphating, 19, 1913  
switchboard, 1939  
testing charging current, 18  
theory, 11  
time-capacity curve, 1904  
troubles, 20  
vents, 28  
voltage loss, 20  
volt-hours curve, 1903  
voltage S.G. curve, 1903  
**Accumulators**, Types  
C.A.V., 10  
chloride storage battery, 414, 1905  
D.P., 729  
D.P. construction, 1903  
Edison, 803  
Exide, 10, 13  
Fuller block, 10, 13  
glass cell open type, 1907  
Hart, 1088  
Lithanode, 1297  
Tudor, 1906, 2099  
**Acetone**, dielectric constant, 684  
properties, 28  
**Aerial**. See also Capacity; Frame  
Aerial; Inductance; Mast.  
at 6 R.J., 2076  
balancing, 187  
blocks, use of, 249  
capacity, 34, 860, 861, 862  
—of cage, 337  
—of fan, 898  
—of parallel wires, 357, 893  
—of single vertical wire, 357  
—of single wire, 357  
chimney stack, 42  
construction of, 39  
convective discharge, 531  
current, 50  
dimensions, 1290  
double-click method of measuring  
capacity, 721  
down haul, 729  
down lead, 729  
Ducon attachment for, 30, 759  
dumb, 766  
duplex, 34  
effect, 50  
fan antenna connector, 899  
frame, one-valve set, 1661  
—for reducing interference, 1197  
—how to make, 971  
—how to make, collapsible, 973  
—receiving set, 975  
—super-regenerative set, 1925  
—wave-length, 968  
guys, 1065  
hayard, 1070  
inductance, 38  
insulating, 36  
insulation, importance of, 1186  
insulators for, 199  
lattice mast for, 1275  
lead in, 1278  
—at Berne, 1279  
—through window frame, 1278  
length, correct, 33  
limiting voltage for, 1293  
loaded, 1360

**Aerial**, mast bands, 1412  
Marconiphone frame aerial set, 1505  
mast construction, 1410  
mast at Chelustord, 1409  
mast foundation, 40  
mast stays, 1893  
phantom, 1555  
pole mast, 41, 1410, 1575  
radio compass loop, 1626  
reaction on, regulations, 1299  
receiving, on "Royal Scot," 1809  
regulations for, 35  
resistance, 50  
short waves, for, 1808  
spreaders, 1877  
—for multi-wire, 1879  
strainer, adjustable, 31  
trap for guy-ropes, 952  
submarine, 1324  
switch, 50  
system, 51  
testing for faults in, 905  
transmitting, 189, 281, 283, 2071  
tuning condenser, 51  
tuning inductance, 51  
T.I. at 6 R.J., 2080  
T.I. at 5 L.S., 2071  
T.I. for long-wave receiver, 1318  
wave-length, 37  
wire for, 33, 1828  
**Aerials**, Types  
American broadcast, Biggin Hill, 1715  
Bellini-Post, 227  
cage, 32, 335  
cage at Bournemouth, 1953  
closed coil, 430  
Dieckmann cage, 682  
directive aerials, 1043  
duplex telephony, 31, 767  
Eiffel tower, 806  
fan, 32, 896  
flat top, 938  
frame, 32, 35  
frame, theory and types, 966  
Franklin aerial systems, 982  
ground, 34, 1064  
hexagonal loop, 1325  
horizontal, 1136  
Hoyt-Taylor, 152  
indoor, 48, 1152  
lattice, 44  
Levallois station, 1633  
L type, 32, 35, 1210, 1258  
loop, 1323  
loop, on door, 1325  
loop, outdoor, 1327  
loop, on submarine, 1324  
Marconi frame, 1325, 1505  
Robinson directional, 1746  
Rogers under-ground, 152  
roof, 39  
temporary, 46  
tree, 34  
T type, 1953  
T type, Bournemouth, 1933  
tubular, 2093  
twin-wire, 2157  
umbrella, 32, 692, 2114  
Vertex, 2212

**Air choke**, 52  
 condenser. *See* Condenser.  
 core choke for transmission, 2067  
 dielectric constant, 684  
 dielectric strength, 683  
 space coil, 56

**Alloys**, general description, 58  
 amalgam, 67  
 brass, 269  
 bronze, 289  
 constantan, 548  
 dutch metal, 773  
 german silver, 1033, 1739  
 Heussler, 1101  
 manganin, 1399, 1739  
 phosphor-bronze, 289, 1537  
 platinum, 1559  
 resistin, 1749  
 resistance wires, 1739  
 rheostan, 1742  
 thecostene, 1745  
 silicon-bronze, 289, 1817  
 solder, 1841  
 spelter, 1870  
 stalloy, 1883  
 Wood's metal, 561

**Alternating Current**. *See also* Current ;  
 Direct Current ; Generator ; Recti-  
 fier ;  
 in wireless, 59  
 cartridge fuse for, 379  
 charging accumulators, 15  
 converter for D.C., 532  
 Crypto rectifier for, 553  
 definition, 631  
 electrolytic rectifier, 836  
 Fleming valve for, 941  
 five, 985  
 frequency changers, 990  
 frequency meter for, 992  
 generators for, 1020  
 kick-back preventers, 1243  
 Korda frequency adder, 1252  
 Lenz law, 1285  
 measurement by wattmeter, 829  
 period, 1532  
 phase, 1535  
 phase angle, 1535  
 phase difference, 1535  
 phase synchronizing, 1536  
 polyphase, 1575  
 power factor, 1609  
 ripple reducing, 1421  
 root mean square, 1749  
 rotary converter, 1751  
 Siemens dynamometer, 1816  
 sine curve for, 1821  
 theory, 59  
 thermo-galvanometer, 2001

**Alternator**. *See also* Generator ; Trans-  
 mission.  
 Alexander, 60  
 definition, 60  
 Dolzalek, 721  
 Goldschmidt, 1041  
 Hartmann-Kampf, 1089  
 inductor, 632, 1180  
 laminations, 1259  
 output control, 1027  
 single-phase, 1822  
 slip rings, 1835  
 stator for, 1889  
 synchronized for tele-visual, 1985  
 synchronous motor, 1951  
 Tesla, 60  
 three-phase, 2005  
 three-phase winding for, 661  
 types, general, 60, 1027

**Aluminium**, brazing, 277  
 cutting sheet, 65  
 drilling, 65  
 expansion coefficient, 1712  
 melting point, 62  
 paint, 67  
 polishing, 867, 868  
 Ruhmer arc, use in, 1706  
 solder for, 1812  
 soldering, 66  
 specific gravity, 1869  
 turning, 61

**Ammeter**. *See also* Galvanometer ; Volt-  
 meter.  
 double-range, 724

**Ammeter**, galvanometer used as, 1000  
 G.P.O. detector, 665  
 hot-wire, 1137  
 milliammeter, 1432  
 principle of, 68, 823  
 shunt, 1813  
 testing charging, 18  
 thermo-electric, 1999  
 types, 68

**Ampere**, definition, 70  
 hour, 70  
 hour capacity, accumulator, 12  
 hour capacity, Leclanché cell, 1283  
 rule, 70  
 turn, 70  
 turns in generator armature, 1926  
 turns of magnetic circuit, 1359

**Amplification**. *See also* Circuits ; High-  
 frequency Amplification ; Low-  
 frequency Amplification.  
 cascade, 389  
 definition, 71  
 dual, 749, 1670  
 factor, 71  
 faults in H.F., 911  
 gramophone attachment for, 1046  
 H.F., 71, 422, 1101  
 H.F. reactance capacity, 1637  
 L.F., 71, 1345  
 L.F. faults, 912  
 Magnavox power, 1353  
 neotradux method, 1365  
 note, 1474  
 radio, 71  
 reflex, 1670  
 resistance-coupled, 423, 1738  
 Round circuits, 1763

**Amplifier**. *See* Circuits ; High-frequency  
 Amplification ; Low-frequency Am-  
 plification ; Valve Sets.  
 Aristophone, 73  
 broadcasting, 283  
 Burndept note magnifier, 1475  
 Burndept power, 72  
 capacity reactance, 363  
 for crystal receivers, 75, 559, 608  
 dual amplification, 750  
 dual, howling causes in, 1141  
 Elwell, 73  
 Felophone super two, 1475  
 Frenophone, 988  
 Geophone two-valve, 1347  
 Geophone power, 1601  
 general description, 72  
 H.F., 89, 1106  
 H.F., adding to crystal, 1109  
 H.F., how to use and make, 1105  
 London, 2 L.O., 1314  
 Marcomphone, 1398, 1399  
 Marecomphone, L.F., 1348  
 microphonic, 1430  
 neon lamp as, 1464  
 note magnifier, 1475  
 Oracle L.F., 1348  
 pliodynatron, 1552  
 Polar, 1348  
 power, 1353  
 power for loud speakers, 1601  
 relay at Wembley, 1718  
 resistance-coupled, 1733  
 short wave, 1810  
 speech, 1869  
 theory, 1345  
 Tingey L.F., 1347  
 two-valve dull emitter, 86  
 two-valve L.F., 80  
 types, 74, 1346  
 unit, 77  
 Western Electric power, 1601

**Angstrom unit**, definition, 97  
 measure of atoms, 153

**Annealing**, methods and processes, 98

**Anode**. *See also* Filament ; Grid ;  
 Valve.  
 battery, 102  
 circuit, 103  
 circuit, modified, 105  
 coil, 108  
 control, 109  
 converter, 109  
 current, 109  
 Fleming valve, 941

**Anode**, general, 101  
 magnetron, 1383  
 power valve, 1609  
 Poulsen arc, 102  
 reactance coil, 110  
 reactance unit, 1643, 2101  
 resistance, 112  
 reacted: unit, 1654  
 sheath, 1803  
 tapping point, 113  
 tuned, for H.F. amplification, 1103  
 tuned amplifier, how to make, 755  
 tuned, circuits, 363  
 tuned, receiving sets, 2101, 2105  
 voltage, 113

**Anti-capacity**, grid leak, 113  
 jacks, 1218  
 switches, 114  
 switches, how to make, 113

**Antidote**, for acid poisoning, 29

**Anti-spark Disk**, on Bradfield insulator  
 118, 267

**Arc**. *See also* Spark ; Spark Gap.  
 Chaffee, 395  
 characteristic curve, 120  
 Coffin-Jeance, 470  
 Dubilier, 126  
 Duddell musical, 760  
 Dwyer's, 774  
 Elwell-Poulsen, 126  
 flame, 937  
 Fleming, 126  
 general, 120  
 generator at Carnarvon, 1029  
 hissing, 1131  
 lamp, 120  
 lamp, carbous for, 366, 367  
 lamp circuit, 121  
 magnetic blow-out, 1355  
 magnetic blow-out theory, 1357  
 mercury vapour, 1419  
 Moretti, 126, 1445  
 multiple, 1454  
 mush explained, 1456  
 oscillator, 122  
 Poulsen, 129, 1598  
 Poulsen arc circuit, 1858  
 Ruhmer, 127, 1769  
 spacing coil, 1858  
 theory, 120, 1357  
 transmission, historical survey, 1573  
 transmitter, 123  
 transmitter for C.W., 525  
 transmitter at Carnarvon, 2062  
 transmitter at Eiffel Tower, 811  
 T.Y.K., 127  
 Vreeland, 2215

**Arcing**, base condenser preventer, 201  
 reduction of, 709  
 spark, 120

**Armature**. *See also* Dynamo.  
 bore, 130  
 core, 587  
 core and commutator of generator, 1024  
 E.M.F. in continuous current, 1025  
 general description, 128  
 gramme ring, 533, 1016  
 laminations, 1239  
 lap-wound, 1260  
 multipolar, 129  
 prevention of eddy currents in, 892  
 reaction, 130  
 ring, 1745  
 risers, 1745  
 rotating in magnetic field, 1021  
 series-wound, 1749  
 stampings, 130

**Armstrong Circuits**. *See also* Regeneration ;  
 Valve Sets.  
 theory, 133  
 how to make a receiver, 139

**Asbestos**, composition, 148  
 fuses covering, 168  
 on Bradfield insulator, 269  
 working in, 149

**Asphalte**, use in wireless, 148

**Atmospherics**. *See also* Earth ; Inter-  
 ference Preventers.  
 balanced crystal elimination of, 371  
 cause, 151  
 de Groot circuit to eliminate, 1888  
 Dieckmann cage to eliminate, 682  
 elimination of, 152, 1191



**Atmospherics**, filter circuits for elimin-  
ating, 933  
general notes on, 151  
Hoyt-Taylor method of elimination,  
153  
ionization, 1211  
Marconi X stoppers, 1887  
rejector circuits for, 1707  
Rogers eliminating circuit, 152  
static leak, 1887

**Atom**, arrangement, 847  
beryllium, 849  
boron, 849  
carbon, 847, 850  
electrical nature of, 817  
electrons in, 846  
general notes on, 153  
helium, 846, 848  
hydrogen, 848, 850  
lithium, 848  
oxygen, 847  
sodium, 847

**Audibility**. *See also* Reception; Trans-  
mission.  
definition, 154  
measuring, 155  
meter, 154  
meter circuit, 155  
range, 155

**Audio-frequency**. *See* Low Frequency.

**Auto Cut-out**. *See also* Fuse.  
adjustment, 169  
definition, 168  
overload release, 1542  
types, 169

**Autodyne**. *See also* Beat Reception;  
Heterodyne.  
circuits, 170, 171  
general principles, 170  
reception, 226

## B

**Back Coupling**, principle of, 105, 180

**Back E.M.F.** *See also* Electro-motive  
Force.  
definition, 180  
effect of inductance on, 1145  
effects in dynamos, 181  
mechanical analogy, 180

**Barretter**, liquid, 1296  
functions of, 200  
glass bulb, 200

**B.A. Screw Threads**. *See also* Screw  
Threads.  
table of sizes, 179

**Basket Coils**. *See also* Coils.  
for A.T.L., 1317  
A.T.L. for long-wave receiver, 1310  
construction, 202  
definition, 202  
former, 205  
functions, 202  
for H.F. transformer, 1121  
holder, 207  
holder, how to make, 207  
mount, 213  
plug in, 210  
T-shape holder, 211  
winding, 203, 1318, 1320

**Batteries**. *See also* Accumulators;  
Cell; Primary Cells.  
A battery, 1, 214  
accumulator, 11  
anode, 102  
B, 214, 220  
B battery circuit, 220  
B battery switch, 221  
bichromate, 235  
bichromate, how to make, 236  
box, 217  
C, 388  
charging panel, 218  
connectors, 218  
dry, 214  
dry, varieties and uses, 747  
E.P.S., 872  
Ever-ready dry, 748, 885, 937  
Exide, 214, 887  
filament-lighting, 14, 922  
flash-lamp, 937  
four-prong connector, 1642  
Fuller, 996  
general notes on, 213

**Batteries**, grid, 1052  
grid-biasing, 388  
Hellenes, 748  
high-tension, 214, 1131  
H.T. battery box, 1131  
H.T. dry, 748  
increasing amperage, 215  
increasing voltage, 215  
lead, 1278  
lead, 1302  
for multi-valve sets, 14  
parallel connexions, 215  
series connexions, 215  
short circuit, 1805  
for single-valve sets, 14  
Siemens dry, 215  
switch, 219  
tappings for, 1965  
testing for faults in H.T., 908  
three-wire system, 2015  
types, 213

**Beam**. *See also* Transmission; Waves.  
Marconi's wireless, 692, 1807

**Bearing**, adjustable, 223  
ball, 190  
plummer-block, 224

**Beat Reception**. *See also* Autodyne;  
Heterodyne.  
definition, 223  
frequency, 226  
heterodyne method, 1037  
local oscillator for, 1302  
silent point, 1816  
theory, 170, 225  
tone wheel, 2026

**Bench**, how to make, 232

**Bevelling**, use in wireless, 233

**Bifilar Winding**. *See* Non-inductive.

**Biographies**  
Alexanderson, Ernst Frederick Werner,  
56  
Appleton, Edward Victor, 119  
Arco, Graf George von, 122  
Armstrong, Edwin H., 132  
Bell, Alexander Graham, 227  
Bellini, Dr. Ettore, 227  
Blondel, Andre E., 252  
Blondlot, Professor Prosper Rene, 253  
Boutillon, Leon, 259  
Brady, Edouard, 267  
Braun, Ferdinand, 274  
Brown, Sidney George, 290  
Carpentier, Jules, 378  
Chaffee, E. L., 393  
Clerk-Maxwell, James, 425  
Cohen, Louis, 439  
Crookes, Sir William, 552  
de Forest, Dr. Lee, 659  
DeLinger, J. H., 660  
Dewar, Sir James, 676  
Debillier, William, 759  
Eccles, W. H., 801  
Edison, Thomas Alva, 803  
Faraday, Michael, 901  
Ferris, General Gustave, 915  
Fessenden, Reginald Aubrey, 916  
Fleming, John Ambrose, 939  
Goldschmidt, Rudolf, 1041  
Goldsmith, Alfred N., 1041  
Hammond, John Hays, 1074  
Hertz, Heinrich Rudolf, 1096  
Hogan, John V. L., 1131  
Hooper, Stanford, 1136  
Howe, George William Osborne, 1139  
Jackson, Admiral Sir Henry Brad-  
wardine, 1225  
Janet, Paul, 1226  
Kelvin, William Thom-son, 1233  
Kimura, Shunkichi, 1244  
Klein, Rene Henri, 1244  
Kolster, Frederick A., 1252  
Koomans, Nicholas, 1252  
Korn, Arthur, 1254  
Langmuir, Irving, 1269  
Latour, Marius, 1274  
Lodge, Sir Oliver, 1305  
Loftin, Edward Hill, 1309  
Makower, W., 1386  
Marchant, Edgar Walford, 1391  
Marconi, Guglielmo, 1391  
Marriott, Robert Henry, 1409  
McLachlan, Norman W., 1412  
McMichael, H. Leslie, 1414  
Meisner, Alexander, 1417

**Biographies**, Mullard, S. R., 1453  
Nally, Edward Julian, 1457  
Noble, Sir William, 1471  
Pannil, Charles Jackson, 1524  
Pedersen, P. O., 1530  
Peterson, Hermod, 1534  
Phillips, Raymond, 1536  
Pickard, Greenleaf Whittier, 1544  
Poulsen, Valdemar, 1597  
Prince, Charles Edward, 1613  
Pupin, Michael, 1619  
Rayleigh, John William Strutt, 1636  
Roberts, Joseph Harrison Thomson,  
1746  
Robinson James, 1746  
Rutherford, Sir Ernest, 1766  
Slee, Commander J. A., 1830  
Smith Rose, Reginald, 1836  
Solari, Marquis Luigi, 1841  
Squier, Major-general Sir George  
Owen, 1882  
Stanley, Rupert, 1884  
Steinmetz, Charles Proteus, 1899  
Stone, John Stone, 1901  
Tesla, Nikola, 1993  
Thornblad, Thor, 2003  
Thompson, Sylvanus Phillips, 2004  
Thomson, Sir Joseph John, 2004  
Torkate, Wiehl, 2027  
Tosi, Alessandro, 2027  
Vallauri, Giancarlo, 2178  
Vanni, Giuseppe, 2202  
Wheatstone, Sir Charles, 2234  
Whiddington, Richard, 2237  
Wien, Max, 2237  
Yokojama, Eitaro, 2250  
Zenneck, J., 2250

**Bits**. *See also* Drilling,  
centre, 266  
Jemming's patterns, 265  
nose, 266  
reamer, 266  
roshead countersink, 265  
screwdriver, 266  
taper, 266  
twist, 266

**Blacklead**, grid leak, 246

**Blow-lamp**, for brazing, 277  
for mending accumulator plates, 23

**Bobbin**, H.F. transformer, 253  
insulator, 254  
winding transformer, 166

**Bolts**, types used in wireless, 256

**Booster**, for accumulator charging, 258  
circuit diagram, 256  
functions, 256  
for generator set, 1027, 1030, 1031  
reversible, 1742

**Borax**, use in brazing, 276

**Brass**. *See also* Aluminium.  
alloys, 269  
angle, 95, 270  
bending, 273  
bushes, 305  
connectors, 274  
expansion coefficient, 1712  
flat strip, 937  
foil, 274  
general forms, 269  
plate, 270  
pulsing, 867, 868  
rod, 269  
rod, screw-cutting, 687  
solder for, 1842  
specific gravity, 1869  
tube, 269  
working in, 270

**Brazing**, aluminium, 277  
brass, 272  
compositions, 277  
general description, 275  
solders for, 1843  
spelter, 275  
steel, 275

**Bridge**. *See also* Wheatstone Bridge.  
Anderson, 94  
bolometer, 255  
calibrated resistance, 338  
Campbell's, 355  
— for measuring inductance, 1179  
capacity, 360  
de Sauty, 663  
Dyke and Fleming, 774  
Foster, 956

**Bridge**, inductance measurement by.  
 1161, 1179  
 megger, 1998  
 metre, 1123  
 resistance box, 1729  
 theory, 278

**Broadcasting.** *See also* Reception; Transmission.  
 American, 1470, 1715, 2152  
 Big Ben, 2019  
 Eiffel Tower time signals, 2019  
 engineering problems, 285  
 gramophone records, 1853  
 historical survey, 1982  
 microphones for, 287  
 principles of, 281  
 relaying, 1714  
 short-wave difficulties, 286  
 story of, xvii  
 time signals, 2019  
 Wembley relay, 1718

**Broadcasting Stations**  
 Birmingham, 244  
 Bourne-mouth, T aerial at, 1953  
 Cardiff, 376  
 Carnarvon, generators at, 1029  
 Edinburgh, 1721  
 Eiffel Tower, 805  
 Glasgow, 1035  
 London, 1311  
 Manchester, 1389  
 Newark, U.S.A., 1470  
 Plymouth relay, 1721  
 Radiola, 1633  
 Relay stations, 1721  
 Sheffield, 1721  
 United States, 2152

**Bronzing**, methods, 289

**Brush**, compound, 293  
 contacts for Crypto rectifier, 551  
 discharge, 291, 715  
 dynamo, 295  
 holders, 292, 294, 295  
 plunger, 291  
 single solid, 294  
 spring-loaded, 293

**Buckling**, of accumulator plates, 20, 296

**Burnetizing**, timber, 302

**Burnishing**, methods, 302

**Bushes**, types, 304

**Buzzer**, crystal sensitivity tests with, 311  
 definition, 306  
 flash lamp and buzzer, 310  
 high-frequency, 1114  
 how to make, 307  
 interrupter, 1203  
 Morse code, 1346  
 motor, 1451  
 Nairoh, 310  
 power, 1699  
 shunted, 1814  
 sparking, 1867  
 testing with, 311  
 —contacts with, 520  
 — for low resistance, 1996  
 test type of, 1995  
 theory, 307  
 tuning, 2131  
 twin note, 2137

C

**Cabinets.** *See also* Crystal Sets; Valve Sets.  
 crystal receiver, 601  
 crystal-valve self-contained, 613, 614  
 design of, 314  
 expanding, 320  
 flat-top, 331  
 hinged back, 318  
 hinged top, 318  
 joints for, 316, 1229  
 jacobean bureau, 326  
 Lyrian, 333  
 one-valve L.F. amplifier, 79  
 simple, one-valve, 314  
 sloping, 317  
 standing, 320

**Cables**, power, 334

**Capacity.** *See also* Condenser; Inductance.  
 accumulator, 11  
 aerial, 38, 357, 860, 861, 862  
 air condensers, 56

**Capacity**, Austin's formula, 357  
 balancing, 188  
 battery, 359  
 body, 254  
 bridge, 360  
 bridge filter circuit, 361  
 cage aerial, 337  
 calculations by Sir O. Lodge, 855  
 Campbell's bridge method of measuring, 355  
 carrying, of a conductor, 378  
 coils, 446  
 concentric spheres, 858  
 condensers, 358, 503  
 condensers in parallel, 359  
 condensers in series, 359  
 coupled resistance amplifier circuit, 1346  
 coupling, 361  
 coupling between valves, 1208  
 coupling formulae, 1361  
 cylinders, 358  
 gynamometer method of measuring, 638  
 definition, 855  
 de Sauty bridge method of measuring, 663  
 distributed, 720  
 distributed, of Igranic coils, 1144  
 double aerial, 862  
 double click method of measuring, 721  
 earth, 362, 785  
 electroscopic measurement of, 820  
 tan aerials, 898  
 farad, unit defined, 901  
 Faraday's apparatus for measuring, 855  
 horizontal wire, 357, 863  
 Howe's formulae, 357  
 how it changes, 856  
 inductive, 1177  
 Kelvin's measurement method, 359  
 Leyden jar capacity experiment, 857  
 magnetic inductive, 1364  
 minimizing capacity effect, 1777  
 multi-wire and aerial, 358  
 pair of flat plates, 859  
 parallel wires, 357  
 reactance, 363, 1637  
 resistance, 364  
 resistance coupling for L.F. amplifier, 1293  
 self— of coils, 446  
 self— of jacks, 1221  
 self— of lattice-wound coils, 1276  
 self— in switches, 114, 911  
 specific inductive, 857, 1889  
 sphere, 358, 857  
 switch, 365  
 theory, 356  
 units, 862  
 vertical wire, 357  
 wires, 357

**Carbon.** *See also* Electrodes.  
 arc lamp, 366  
 brushes, 293, 367  
 cell, 366  
 chams, 367  
 diaphragms, 368  
 Duddell musical arc, 761  
 general description, 365  
 granules, 368  
 graphite, 1048  
 graphite resistance, 1049  
 lamps for charging accumulators, 18  
 microphone, 1428  
 plate connector, 368

**Cardboard.** *See also* Coils.  
 materials, 371  
 tubes, 372  
 —cutting, 373  
 —drilling, 373  
 —fixing, 374, 375  
 —insulating, 372, 373  
 —sandpapering, 373

**Castor Oil**, dielectric constant, 684

**Cathode Ray**, Braun tube, 385  
 definition, 385  
 for sending pictures by wireless, 1985  
 oscillograph, 386  
 tube, 385  
 Western Electric Company's tube, 386

**Cat's-whisker**, ball bearings for, 190  
 nut grip, 387  
 spring contacts for, 387  
 types, 387

**Cell.** *See also* Accumulator; Battery;  
 Primary Cell.  
 agglomerate Leclanché, 51  
 bichromate, 239  
 Bunsen, 300  
 Clark, 424  
 Daniell, 645, 1051  
 double-fluid, 722  
 electrolytic, 834  
 Faraday's law of, 904  
 Fuller, 996  
 galvanic, 999  
 gravity, 1051  
 Grove, 1064  
 Hibbert, 1101  
 ironclad Exide, 1212  
 Leclanché, 1282  
 Lithanode, 1207  
 Menotti, 646, 1417  
 negative pole, 1460  
 polarization, 1572  
 positive pole, 1586  
 rectifying, 412  
 saturated solutions in, 1769  
 series, 1799  
 series-parallel, 1794  
 single-fluid, 1821  
 standard, 1884  
 Weston, 2232  
 wet, 2233

**Celluloid**, in accumulators, 21  
 accumulator case, 391  
 angle, 96  
 cement, composition of, 24  
 characteristics of, 389  
 cutting, 389  
 dielectric constant, 684  
 repairing with acetone, 28  
 solvent for, amyl acetate, 94

**Characteristic Curve**  
 boronite, 259  
 boronite-zincite, 400  
 carbon arcs, 120, 399  
 carborundum, 370, 556  
 carborundum steel, 400  
 current lag, 1259  
 definition, 399  
 dynatron, 782  
 filter circuits, 932  
 kenotron, 1235  
 neonatron, 1461  
 Q valve, 1624  
 QX valve, 1625  
 spherometer to measure, 1835  
 tellurium zincite, 400  
 three-electrode valve, 110, 381, 492  
 U 3 valve, 1669  
 valves, 634, 2192, 2193

**Charge**, definition, 403  
 electric, nature of, 818  
 electroscopic method of testing, 854  
 negative, 1460  
 residual, 1727  
 space, 1854

**Charging.** *See also* Accumulators.  
 accumulators, 14, 404  
 battery, machines at Carnarvon, 1031  
 board, 17, 405  
 board, functions, 404  
 board, low-voltage, 409  
 board, single-lamp, how to make, 406  
 booster for, 258  
 Crypto commutating rectifier for, 553  
 cut-out for, 636  
 generator suitable for, 1027  
 H-mecharger, 1131  
 home charging set, 25  
 lamps for, 405  
 panel, battery, 218  
 polarity test, 405  
 rate, 405  
 resistance lamps, 404  
 rotary converter, 1753  
 set cut-out, 169

**Chemical Rectifier.** *See also* Rectifier  
 circuit diagram, 412  
 description, 16, 411

**Choke.** *See also* Coil.  
 air-core choke coil, 52, 442, 2067  
 calibrating —coils, 701  
 coil, in tone filter, 2023  
 coil, for transmission, 2068  
 control in broadcasting, 288  
 control in transmission, 2053

**Choke**, Ford coil, use of, 2068  
 general theory of —coils, 415  
 high-frequency, 1115  
 how to make—coils, 416  
 iron-core chokes, 412  
 loud speaker improvement, 1342, 2022.  
**Circuits**. See also Crystal Sets; Valve Sets.  
 A battery, 1  
 acceptor, 9  
 amplifier, two-valve, 83  
 anode, 103, 104, 105  
 aperiodic, 119  
 arc transmission, 121, 122  
 Armstrong, evolution of, 135  
 Armstrong reactive, 137  
 Armstrong, simple, 423  
 Armstrong three-valve, 138  
 Armstrong single-valve super-regenerative, 146, 1379  
 Armstrong two-valve super-regenerative, 140, 1379  
 Armstrong's original, 133  
 autodyne, 170, 171, 1497  
 automatic transmitter, 178  
 B battery.  
 balanced crystal, 184  
 balanced valves, 1888  
 ball reactance, 194  
 beat reception, 226, 1303  
 Bolitho, 255  
 booster, 257  
 buzzer, 312  
 Campbell Swinton television, 1984  
 capacity bridge filter, 361  
 capacity-coupled, 1208  
 capacity reactance, 363  
 capacity resistance, 364  
 capacity-resistance coupled L.F., 1293  
 carborundum, 369, 604  
 cascade amplification, 380  
 Chaffee spark, 396  
 chemical rectifier, 412  
 closed, 429  
 Cockaday, 431  
 Cockaday\*fourth, 960  
 coherer, 440, 1394  
 condensers, function in, 498  
 conductively coupled, 420  
 control receiver, 529  
 coupled anode-grid two-valve, 1647  
 coupled grid reaction, 1647  
 coupled transmitter, 2051  
 coupling, 548  
 crystal, 557  
 crystal and valves, 559  
 crystal one-valve L.F., 71  
 C.W. transmission, 2067  
 de Groot, 1887  
 direction finder, 697, 700  
 disk discharger, 711  
 double-click capacity, 722  
 double magnification, 723  
 drain, 730  
 dual amplification, 749, 754, 1670, 1763  
 Duddell's arc oscillator, 123  
 dull emitter amplifier, 87, 765  
 dynatron, 781  
 earth arrester, 785  
 electrostatic coupling, 420  
 feed-back, 105, 913  
 filter, 932  
 filter at 6 R.J, 2078  
 five-valve frame aerial, 975  
 Fleming valve, 941  
 Flewelling, 918, 943  
 Franklin, 981  
 four-valve, 964  
 galvanometer calibration, 342  
 generator, 1019  
 grid detector, 421  
 hanging set, 1078  
 Hartley, 2074  
 Haynes regenerative, 1089  
 Hazeltine, 1091  
 Heising, 1093  
 heterodyne, 1097  
 H.F. amplifier, 91, 1105, 1628  
 H.F. and crystal, 1108, 1109, 1111, 1114  
 H.T., 220, 1131  
 inductive coupling, 421  
 intensifier, 1189  
 interference eliminator, 1193

**Circuits**, intermediate, 1199  
 interrupted C.W., 1201  
 kenotron, 1235  
 Lepel gap, 1285  
 liquid barretter, 1296  
 L.F. amplifier, 158  
 L.F. and crystal, 71  
 L.F. capacity-coupled resistance amplifier, 1346  
 L.F. transformer-coupled amplifier, 1346  
 long-wave receiver, 1231  
 loose coupler and crystal, 584  
 loud speaker and crystal, 597  
 magnetic blow-out, 1356  
 magnetic formulae, 1358  
 magnetron, 1382  
 Marconiphone, 1396  
 Marconi X-stopper, 1887  
 microphonic amplifier, 1431  
 multiple tuner, 1455  
 natural frequency of, 1457  
 negatron, 1461  
 neutrodyne, 1090, 1466  
 note magnifier, 1475  
 open, 1494  
 open oscillatory, 21, 1495  
 optimum heterodyne, 1497  
 oscillation, local, 1393  
 oscillatory, 1503  
 oscillatory closed, 1503  
 Peltier effect in, 1530  
 pilot lamp for, 1545  
 Popoff's coherer, 1576  
 portable amplified crystal, 627  
 portable set, 1580  
 power amplifier, 1602  
 power, at 6 R.J, 2078  
 push-pull transformer, 2037  
 quadrector, 185  
 reactance, 1638, 1640  
 reaction, 1646  
 reaction on anode, 104, 105  
 reaction on second valve, 1647  
 rectifier, 838  
 reflex one-valve, 1673  
 reflex three-valve, 1679  
 regenerative, 133, 1329  
 regenerative, one-valve, 1684, 1685  
 regenerative, one-valve plus two L.F., 1695  
 regenerative, tuned anode, 1686  
 Reinartz, 1701  
 rejector, 1707  
 remote control, 1724  
 resistance-capacity coupled H.F. amplifier, 1104  
 resistance-coupled amplifier, 423, 1736  
 resistance coupling, 1738  
 Round, 1763  
 secondary, 1786  
 selenium cell, 1544  
 short, 1805  
 short-circuiting device, 1805  
 short-wave amplifier, 1810  
 short-wave crystal receiver, 1813  
 shunt, 1815  
 Simon's selenium cell, 1792  
 single-valve, 1826  
 single-valve H.F. crystal, 71  
 slopometer, 1836  
 smoothing, 1837  
 spacing coil, 1838  
 sparking gap, 709  
 sparking buzzer, 1867  
 S.T. 100, 1894  
 super-regenerative, 136, 1379  
 super-regenerative, Flewelling, 1918  
 super-regenerative, oscillator single-valve, 1923  
 super-regenerative, three-valve, 1927  
 super-sonic heterodyne, 1930  
 switching systems, 1943  
 Telctunken, 1968  
 testing continuity with galvanometer, 1093  
 testing for correct, 909  
 theory, general, of, 413  
 three-slide tuner, 2009  
 three-valve long-range, 2013  
 three-wire, 2015  
 tone filter, 2024  
 tonic train, 1203  
 transformer-coupled, H.F., 1103

**Circuits**, transformer-coupled, L.F., 609, 613, 1208, 1294  
 transformer-coupled three-valve, 2046  
 transformer push-pull, 2038  
 transmitter, 420, 442, 2074  
 transmitter, Lepel, 1286  
 transmitting, 2067  
 transmitting at 6 R.J, 2080  
 tuned anode, 758, 1103  
 tuned-impedance amplification, 1105  
 two-valve, L.F., 83  
 ultra-audion, 2141  
 Unidyne, 2148  
 unit crystal, 622  
 voltmeter calibration, 344, 345  
**Coherer**. See also Decoherer.  
 Blondel, 253  
 Branly, 268  
 Castelli, 384  
 circuit, 440, 1394  
 Fleming, 940  
 Lodge, 1306, 1972  
 Lodge-Muirhead, 656  
 Marconi, 1313  
 Popoff, 1576  
 Stone, 1902  
 theory, 439  
 vertical type, 527  
**Coils**. See also Capacity; Inductance; Inductance Coil; Loose Coupler; Variometer.  
 aerial tuning coil, 51, 1274  
 A.T.I. at 5 I.S, 2071  
 air core, 52, 442  
 air space, 56  
 anode, 108  
 anode reactance, 110  
 astatic, 149  
 bank-wound, 196  
 basket, 202  
 basket, coupling of, 547  
 basket, for A.T.I., 757  
 basket, for crystal receivers, 589  
 basket, for H.F. transformer, 1121  
 basket, how to wind, 203, 1318, 1320  
 basket, testing faults in, 997  
 Burndep, 300, 444, 470  
 Burndep, inductance of, 301  
 capacity of, 446  
 capstan coil holder, 464  
 cardboard tubes for, 371  
 choke, 414  
 choke, for improving loud speakers, 1342  
 choke, for smoothing purposes, 1837  
 choke, in tone filter, 2023  
 choke, 426  
 condenser, 462  
 copper wire for, 535  
 coupling, 427  
 crystal sets, 574  
 crystal sets, how to make for, 582  
 de Forest, 659  
 double-slide tuning, 727  
 double-tapped, 442  
 duolateral, 548, 766, 907  
 effect of current in, 823  
 end checks for, 870  
 experimental, 449  
 exploring, 892  
 feed-back, 451  
 field, 229  
 flat coil, inductance, 416  
 flux density of, 947  
 Giblin-Remler, 1034  
 gimbal-mounted, 464, 1133, 2133  
 helical tapped, 1963  
 helix for transmission, 1095, 2131  
 H.F. slider inductance, 1116  
 holders, for basket coils, 207  
 holders, Bonds, 291  
 holders, how to make, 466  
 holders, jig for drilling, 1227  
 holders, Polar, 1669  
 holders, types, 462, 2133, 2135  
 honeycomb, 1133  
 honeycomb, how to make, 1131  
 honeycomb, Igranite, 1133  
 Igranite, 444, 1144  
 —capacity of, 1144  
 impedance, 1147  
 inductance, 447, 907, 1163  
 inductance of, 445  
 inductance coil unit, 1165

**Coils, inductance, types, 1163, 2131**  
 inductance, measurement of, 1158  
 inductance values of Igranic, 1144  
 induction, 1174  
 iron-core choke, 442, 1212  
 lap winding, 1261  
 lattice, winding on, 457  
 lattice-wound, 1276  
 lengthening, 1284  
 Lissen, 2133  
 loading, 1300  
 Lokap winder, 454  
 loose coupler, 443, 584  
 McMichael holder, 465  
 magnetic coupling, principles, 1376, 1378  
 magnetic field surrounding, 1370, 2124  
 magnum, 444  
 making, 447  
 micro-adjuster holder, 464  
 mounts, 469  
 multi-layer, inductance, 446  
 Oojah, 1493  
 pancake, 1619  
 pile winding, 1545  
 plug-in, 452, 466, 1555, 2132  
 plug-in reaction, 1560  
 primary, 1613  
 reactance, 1639  
 reaction rotor, how to make, 1651  
 rectangular inductance, 599  
 resistance, 458, 1733  
 Ruhmkloff, 1766  
 saddle for, 1767  
 search, 229, 892, 1042, 1785  
 secondary, 1786  
 sense, for direction finding, 697, 701  
 series, 4794  
 single-layer, inductance, 445  
 single-slider, 443, 1832  
 single-slider contact, 519  
 slab, 1829  
 sledge, 1830  
 slider for, 1832  
 slider bar for, 1832, 2007  
 sliding inductance, 1833  
 solenoid, 1849  
 space-winding, 1857  
 spacing, 1858  
 spark, 442  
 spark, principle of, 1372  
 spark, for transmission, 2069  
 spider web for crystal sets, 589  
 spider web inductance, 1870  
 stand for, 2134  
 switch-controlled, 1947  
 tapped, 442, 907, 1956, 2132  
 tapping, how to make, 460, 1966  
 testing continuity of winding, 461  
 theory, 443  
 three-slide tuning, 2006  
 tickler, 2019  
 toroidal, 446  
 triple, holder, 462  
 two-slider, 1833  
 types, 441  
 wave-length, 1144  
 wave-length of Oojah, 1494  
 winder, 454  
 winder, how to make, 458  
 winding, 451, 453  
 winding inductance, 2006  
 winding shell-type transformer, 2010

**Collar, accumulator, 26**

**Commutator, See also Dynamo.**  
 description, 472  
 disk, 473  
 eight-pole, 473  
 hand-lever, 472  
 lubrication, 474  
 mica in, 474  
 Swiss, 482  
 tone wheel, 2025

**Compass, radio, 1626**  
 Telefunken, 694

**Compasses, drawing, 471**  
 proportional, 736  
 various types, 732-733

**Condenser, See also Capacity.**  
 adjustment, 54  
 aerial tuning, 51  
 air, 52, 482, 489  
 air, how to make, 54  
 air, testing, 1995

**Condenser, anode circuit, 103**  
 anode-tuning, Baty, 2102  
 Autoveyors, 361, 479  
 balanced, 183  
 bank of, at Carnarvon, 2091  
 base for, 201  
 base-type, 201  
 Baty variable, 2102  
 bearing, 223, 224  
 billi, 241, 478, 1468  
 billi, how to make, 241  
 block, 249  
 blocking, 250  
 blocking how to make, 250-252  
 bracket, 478  
 bridge, for comparing capacities, 360  
 bridging, 278  
 buzzer, for charging, 312  
 by-pass, 140, 313  
 capacity, calculation, 359, 503  
 capacity measurement, 188  
 capacity measurement by electro-scope, 820  
 capacity of spherical, 358  
 capacity of tubular, 241  
 capacity, what it is, 476  
 coil, 462  
 copper foil for, 533  
 for crystal sets, 557  
 dead-beat discharge, 650  
 dial calibration, 349  
 dials, 505, 678  
 direction-finding tuning, 619  
 discharge, heat measurement, 857  
 disk, 481  
 disk, how to make, 705  
 disruptive discharge, 716  
 double anode, 1394  
 double click measurement, 721  
 dual tuning, 484  
 Dubilier, 481, 485  
 ebomite, 801  
 edge effect, 803  
 electric absorption of, 815  
 electrolyte, 834  
 essential characteristics, 477  
 3 E.V.C., 361, 479, 480  
 Fallon, 895  
 filter, 934  
 filtron, 934  
 fixed and blacklead grid leak, 247  
 fixed, general description, 485, 936  
 fixed, how to make, 486  
 functions of, in circuits, 499  
 Gernsback variable, 1034  
 glass plate, 1038  
 grid, how to make, 670  
 grid, testing correct value of, 912  
 half-plate, 1068  
 Hoffman's chart for capacity, 504  
 knobs for, 1247  
 leak in, 1281  
 Leyden jar, 1289  
 Lissen tubular, 2097  
 main, 1385  
 Mansbridge, 1390  
 Marconi, 481  
 Marconi double, 1394  
 mica, 486, 1572  
 microphone, 505  
 Moscicki, 1451  
 multiple, 1455  
 neutrodyne, 478, 1468  
 in neutrodyne circuits, 502  
 oscillatory discharge, 827, 1499, 1505  
 paper, 505, 1524  
 plates, 1349  
 pointers for, 1562  
 Polar, 707, 1568, 1572  
 Polar unit, 1572  
 Poldhu condenser bank, 482  
 power factor measurement, 355  
 precision, 1619  
 in parallel, 477  
 reaction, 1649  
 in regenerative circuits, 502  
 Scott air, 1787  
 semicircular, 493  
 in series, 477  
 short wave, 1811  
 spacer washers for, 854  
 spark-coil circuit, use in, 522  
 spark frequency, 1863  
 spindle, 1871

**Condenser, smoothing, 499**  
 switch, 505  
 synchronized, 484  
 telephone, 1974  
 testing for faults, 908  
 theory, 476  
 three-electrode, 361, 479  
 tinfoil for, 2021  
 with transformer, 503  
 for transmitter, 5 kw, 482  
 transmitter-system, 2089  
 transmitting, 477, 482, 2089  
 triple, 2092  
 tubular, 241  
 tubular, how to make, 493, 495, 2094  
 tuning by, 500, 2119  
 units, 503  
 vane, 2202  
 variable, 2203  
 variable condenser spindle, 1873  
 variable type, novel, 764  
 vernier, 489, 1873, 2203  
 vernier attachment, 491  
 vertical plate, 487

**Conductors, See also Alloys; Metals;**  
**Insulating Materials.**  
 aluminium, 62  
 anisotropic, 97  
 blacklead, 247  
 bismuth, 246  
 brass, 269  
 bronze, 289  
 burning out, 302  
 cadmium, 335  
 calcium, 338  
 carbon, 365  
 carrying capacity of, 379  
 connecting strips, 510  
 connectors, 513  
 constantan, 513  
 copper, 535  
 dutch metal, 773  
 flex, 343  
 general properties of, 508  
 german silver, 1033, 1739  
 hennessy metal, 1101  
 lead, 1277  
 lightning, 509  
 list of, 509  
 lithium, 1298  
 magnesium, 1355  
 manganese, 1390  
 manganin, 1390, 1739  
 mercury, 1417  
 nickel, 1470  
 omnibus bar, 1488  
 palladium, 1519  
 phosphor-bronze, 289, 1537  
 platinum, 1550  
 potassium, 1586  
 resists, 1740  
 resistance wires, 1739  
 rhodium, 1742  
 rhcostene, 1745  
 rubidium, 1765  
 selenium, 1791  
 silicon bronze, 289, 1817  
 silver, 1817  
 sodium, 1841  
 solder, 1841  
 spelt, 1870  
 stallo, 1883  
 thorium, 2005  
 tungsten, 2116  
 Wood's metal, 361  
 zinc, 2250  
 zirconium, 2250

**Connector, battery, 218**  
 binding posts, 242  
 brass, 274  
 bus bar, 302  
 carbon plate, 368  
 connecting strips, 510  
 plug-in, 513, 1556  
 stud, 1910  
 types of, 512

**Connexions, testing for wrong, 910**

**Contact Arm, types of, 521**

**Contacts, See also Switch; Tapping.**  
 brush, 554  
 plug-in, 1557  
 stud, 522, 1910  
 stud, fixing, 523

**Container.** See also Cabinet.  
 accumulator, 26  
**Continuous Waves.** See also Arc; Trans-  
 mission.  
 arc transmitters, 525  
 Austin ticker, 2018  
 beat reception, 225  
 control valves, use of, 525  
 crystal set receiver for, 312  
 definition, 523  
 heterodyne method, 1097, 1496  
 modulation of, 524  
 Morse by, 526  
 optimum heterodyne method, 1496  
 theory, 523  
 ticker for, 2018  
 timed spark system, 2052  
 transmission, 418  
 transmission circuit, 2067  
 transmitter, 526  
 transmitter, simple type, 2066  
**Control, battery, 616**  
 choke, 416  
 choke, in broadcasting, 288  
 Heising modulation, 1093  
 remote, 527, 1723  
 selector, 530  
 by wireless, 527  
**Converter.** See also Rectifier.  
 anode, 109  
 rotary, 532  
**Copper, cable, 535**  
 in Daniell cell, 645  
 expansion coefficient, 534, 1712  
 foil, 533  
 gauze, 533  
 good conductor, 818  
 pyrites, 534  
 resistance, 534  
 solder for, 1842  
 specific gravity, 534  
 strength, 534  
 sulphate, 534  
 tinned, 535  
 weight of wire, 535  
 wire, 534  
 wire resistances, 535, 1729  
 wire sizes, 534  
**Corona effect, description, 538, 703**  
 losses due to, 538  
**Countersinking, with brace and bit, 261**  
 how carried out, 542  
**Coupler, Loose.** See Coils; Loose  
 Coupler.  
**Coupling.** See also Loose Coupler;  
 Coil; Inductance Coil.  
 auto-inductive, 171  
 auto-transformer, 176  
 back, 180  
 ball reactance, 193  
 basket coil, 547  
 capacity, 361, 1208, 1360  
 capacity-reactance, 363  
 capacity-resistance, 364, 1293, 1732  
 close, 426  
 coefficient, 193, 544, 1360  
 conductive, 508  
 coupler panel, 543  
 direct, 544, 691, 1360  
 direct loose, 702  
 direct tight, 702  
 duo-lateral, 549  
 effects on howling, 1139  
 effect on oscillation, 1501  
 electrostatic, 420, 544  
 formulae, 1361  
 inductive, 421, 544, 547, 1160, 1177,  
 1360  
 inter-valve, 545, 1207  
 Lenz law, 1285  
 loose, 193  
 loose, analogy, 987  
 loose, explained, 1333  
 loose couplers, 442, 443, 577, 584,  
 1177, 1328, 1329  
 magnetic, principle of, 1359, 1376  
 ohmic, 1482  
 reactance, 1637, 1639  
 reactance-capacity, 546, 1637  
 reaction, 105, 1645  
 regenerative, 1688  
 resistance, 1208, 1733, 1738  
 resistance-capacity, 364, 1293, 1732  
 theory, 544

**Coupling, tight, 193, 987, 5019**  
 transformer, 1208, 1294  
**Crystal Detector.** See also Valves.  
 base for, 201  
 carborundum, 568  
 cat's-eye, 568  
 cat's-whiskers for, 387  
 double, 565  
 Everset, 568  
 four-crystal panel, 567  
 horizontal, 563  
 how to make, 565, 569  
 micrometer adjustment, 565  
 perikon, 562, 565  
 plug-in, 568  
 stationary cat's-whisker, 564  
 Sterling, 1909  
 Telefunken, 568, 1969  
 types, 562  
 unit, 569  
 vertical, 563, 564  
**Crystal Receivers.** See also Amplifica-  
 tion; High-frequency Amplifica-  
 tion; Low-frequency Amplifica-  
 tion; Valve Sets.  
 adding amplification to, 608  
 amplifiers for, 75  
 Aristophone, 127  
 balanced, 153, 184, 1816  
 basket coil, 589, 591  
 B.T.H., 296  
 cabinet set, 601  
 carborundum set, 602  
 choosing, 1657  
 cigar box, 587  
 circuits, 420, 421, 557  
 Cosmos, 574, 1424  
 double-slider, 581  
 dual amplification, 750  
 experimental, 605  
 Gecophone, 574, 1015  
 H.F. amplification, 623, 1199  
 H.F. and L.F., 627  
 H.F. one-valve, 610, 618, 619, 622, 627  
 H.F. transformer-coupled, 621  
 how to make, 579  
 increasing range of, 618, 622  
 increasing strength, 622  
 lattice-wound variometer, 600  
 loose coupler, 584  
 loud speaker set, 593  
 L.F. amplification, 623  
 L.F. one-valve, 609, 627  
 loading coil addition, 1300  
 McMichael, 1658  
 Marconiphone, 1396  
 Marconiphone and one-valve, 1396  
 Oracle, 574  
 portable, 623  
 Radio Instruments, 576, 1658  
 short-wave receiver, how to make, 1812  
 single slider, 589  
 spider-web coil, 591  
 Sterling, 574  
 testing for faults in, 905  
 tuning, 572, 629  
 twelve-circuit receiver, 605  
 types, 571  
 variometer, 585, 599  
 wide range, 576  
**Crystals.** See also Valves; Rectifiers.  
 anastase, 91  
 anglesite, 97  
 balanced, 153, 184, 1816  
 balanced carborundum, 370  
 black tellurium, 248  
 bornite, 259  
 brookite, 289  
 carborundum, 369  
 cat's-whiskers for, 388, 555  
 cerusite, 393  
 chalcopyrites, 396, 534  
 characteristic curves of, 109  
 combinations, 355  
 cups, 555  
 dead, 650  
 detectorite, 666  
 galena, 998  
 iron pyrites, 1215  
 molybdenite, 1445  
 mounting, 561  
 nagayazite, 1457  
 piezo electrical effect, 1544  
 properties, 555

**Crystals, radiocite, 1626**  
 resistance of, 400  
 sensitive spots, 573, 1794  
 sensitive spots, testing for, 311  
 silicon, 1816  
 zincite, 2250  
**Current.** See also Electromotive Force;  
 Electricity; Magnetism; Alternat-  
 ing Current; Direct Current.  
 anode, 109  
 alternating, 59, 631  
 A.C. measurement by wattmeter, 829  
 bichromate cell, 239  
 carrying capacity, 378  
 combination meter tester, 471  
 conduction, 508, 632  
 constant-modulation, 516  
 continuous, 523  
 convection, 532, 632  
 core losses due to stray, 537  
 current, resistance and E.M.F., 841  
 defined, 621  
 density, 632  
 density of accumulator, 12  
 direct, 631, 691  
 displacement, 715  
 earth, 788  
 eddy, 632, 802  
 effects, 821  
 effects on iron filings, 822  
 emission, 870  
 extra, 893  
 Foucault, 958  
 galvanoscope for measuring, 1007  
 G.P.O. detector, 665  
 high-tension, 631  
 hot-wire ammeter method of measuring,  
 1137  
 induced, 1154  
 induction, 1171  
 intermittent, 1199  
 Joule's law, 1232  
 Kirchhoff's laws, 1244  
 Korda frequency adder, 1252  
 lag curves, 1250  
 lag and lead, 830  
 leakage causes, 1281, 1282  
 left-hand rule for, 1284  
 Lenz law of, 1285  
 low-frequency, 1349  
 low-tension, 631  
 magnetic field from, in coil, 1370  
 Maxwell's corkscrew rule, 1412  
 measuring magnetic effect, 1007  
 measurement of, 69  
 Peltier effect, 1530  
 phase angle, 1535  
 phase difference, 1535  
 pole-finding paper, 1573  
 polyphase, 1575  
 potential, 1586  
 production of, 850  
 pulsating, 1616  
 returned, 1741  
 right-hand rule, 1745  
 rotary converter, 1751  
 rotary transformer, 1757  
 safe, for copper wire, 536  
 saturation, 1769  
 thermopile effects, 2002  
 three-wire system, 2015  
 thumb rule, 2018  
 transformation to sound, 1852  
 wattless, 830, 2216  
**Curve.** See also Characteristic Curve.  
 abscissa, 9  
 B.H. for iron, 1362  
 catenary, 384  
 foci of, 949  
 locus, 1305  
 permeability for iron, 1362  
 pure sine, 1148  
 sine, 1820  
 sine for potential in generator, 1022  
 squared paper, 1882  
**Cut-out, auto, 168**  
 automatic interrupters, 172  
 general description, 635  
 on charging board, 409  
**Cymometer, capacity measurement by, 638**  
 description, 637  
 Fleming, 637, 940  
 inductance measurement by, 638  
 wave-length measurement by, 638

**Cymoscope**, description, 639  
adjustable, 639  
early form, 639  
multiloop, 640  
Fleming's, 641

**D**

**Damping**, air, 644  
calculation, 657  
choke coils for, 415  
dead beat, 119  
decrement, 643, 656  
definition, 642  
factor, 643  
moment, 645  
of instruments, 119, 643  
oil, 644  
of waves, 642, 656  
**Daylight Effect**, fading, 894  
general, on reception, 648  
Heavyside layer, 284, 720  
sunrise and sunset effect, 648, 894  
**Dead Beat**. *See also* Damping.  
condenser discharge, 650  
defined, 649  
explanation, 119  
galvanometer, 647  
G.P.O. detector, 666  
Grassot dead-beat fluxmeter, 949  
instruments, 644

**Dead End**, effects, 651  
local oscillation effects, 1302  
switch, 651  
switch, how to make, 652  
**Deaf**, ossiphone for, 1510  
otophone for, 1510  
**Decoherer**. *See also* Coherer.  
Brown's, 656  
definition and types, 655  
electrical, 656  
Lodge, 655, 1307  
Lodge-Muirhead, 656

**Decrement**. *See also* Damping.  
damping, 643  
decimeter, 658  
logarithmic, 656  
measurement of, 658  
**Delta Connexions**, power measurement, 662  
three-phase transformer, 661, 1419  
reduction of ripple by, 1421  
wattmeter measurement, 662

**Depolarizer**. *See* Polarization.

**Detector**. *See also* Crystal; Coherer;  
Valves.  
barretter, 200, 1296  
crystal, 555  
coherer, 439  
cymoscope, 639  
Dennis, 662  
electrolytic, 664, 835  
G.P.O., 665  
liquid, 1296  
general types, 664  
magnetic, 664, 1363  
Marconi's magnetic, 1363  
panel, 666  
perikon, 1530  
Rubens and Ritter, 1999  
spark, 664, 1862  
Sterling crystal, 1900  
Telefunken, 568, 1969  
thermal, 665, 1999  
theory of magnetic, 1363  
unit, 569, 671  
valve, 675

**Dial**, condenser, 505  
condenser, calibrating, 340  
condenser, how to make, 678  
galvanometer, 1007

**Diaphragm**, microphone, 681  
Stalley telephone, 681

**Dielectric**, constant, definition, 684  
air, 684  
acetone, 28, 684  
castor oil, 684  
celluloid, 684  
ebonite, 683, 684, 792  
glass, 684, 1037  
glycerine, 684  
hysteresis, 684  
indiarubber, 684, 1151  
mica, 683, 684, 1425  
paper, 683  
paraffin wax, 684, 1526

**Dielectric**, shellac, 684  
turpentine, 684  
**Dielectrics**, Leyden jar experiment, 856  
—strength, testing, 703, 716  
**Dies and Taps**, adjustable, 686  
British Association, 685  
reversed, 687  
screw-thread cutting, 687  
tap, using small, 690  
varieties, 685

**Direct Current**. *See also* Alternating  
Current; Rectifier.  
accumulator charging, 15  
converter for changing to A.C., 532  
definition, 691  
generator, 691  
rotary converter, 1751  
rotary transformer, 1757

**Directional Wireless**. *See also* Direction  
Finder; Transmission.  
aerial at Brentwood, 693  
aerial at Cadiz, 693  
L'lini-Tosi aerial, 227  
Lown's, 692  
Franklin's circuits for, 682  
Marconi system, 692  
night effects on, 719  
radiogoniometer for, 1642  
search coil for, 229, 892, 1042, 1785  
short wave, 1807  
Telefunken, 692  
umbrella aerial for, 692

**Direction Finder**. *See also* Aerial.  
L'lini-Tosi, 228, 695  
loop aerial for, 1323  
Marconi, 696-697  
Marconi's at Brentwood, 692-693  
Marconi's at Cadiz, 693  
radio compass, 1626  
radiogoniometer, 1042  
Robinson, 702, 1746  
search coil, 229, 892, 1042, 1785  
sense indicator, 1794  
ships, 698  
Telefunken, 692  
transformer, 701  
tuning condenser, 699

**Discharge**, brush, 291, 715, 1282  
—Oudin resonator for, 1511  
conductive, 702  
convective, 531, 703  
corona, 538, 703  
dead beat, 649  
disruptive, 703, 715  
effects of points on, 1182  
glow, 1040  
oscillatory, 1505  
oscillatory, of a condenser, 827  
quenched gap, 1622  
rate of accumulator, 12  
spark, 708

**Discharger**. *See also* Spark Gap; Trans-  
mission.  
disk, 708, 1754  
—adjustment in transmission, 2052  
fixed, 704, 936  
Fleming, 704  
Lodge-Chambers, 704  
Peukert, 1534  
rotary, 714, 1753  
—on ship's transmitting set, 2056  
small power, 1951  
synchronous, 709, 1950  
transatlantic spark disk at Carnarvon,  
712  
trigger disk at Carnarvon, 713

**Distortion**, broadcasting, 284  
causes of, 717  
electro-magnetic waves, 719  
iron-cored transformer, 718  
neutrodyne method of eliminating, 1090  
night effects, 719  
Preece on, 718  
problems, 717  
reflection, 720  
refraction, 719

**Distribution Board**, functions of, 720  
**Dotting Pen**, how to use, 733  
**Drill**, brace shank twist, 738  
breast, 741  
centre pop. making, 1618  
cutting angles, 738  
diamond-point brace shank, 738  
fluted, 738

**Drill**, gauge, 739  
hand, 740  
level, in breast, 1288  
lubrication of, 744  
pistol grip, 740  
sharpening, 739  
straight shank twist, 738  
twist, 738, 2141  
use with brace, 264, 266  
varieties, 737  
**Drilling**, aluminium, 65  
brass, 272  
ebonite, 744, 793  
glass, 745  
jig, 320, 1227  
with lathe, 743-45  
machines, 742  
—choosing, 743  
nut, for split pin, 1481  
paper, 744  
processes, 740, 741  
square holes, 745  
template for valve, 1987

**Dry Cell**. *See also* Battery; Primary  
Cell.  
advantages, 214  
construction, 747  
Economic Electric Co., 746  
Ever-ready, 748, 885, 937  
flash-lamp, 937  
Helleseus, 748  
H.T., 748, 1130

**Dual Amplification**. *See also* Amplifica-  
tion; Regeneration.  
advantages, 749  
circuits, 754, 758  
circuits, howling in, 1141  
disadvantages, 749  
principles, 749, 1670  
Round circuits, 1763  
single-valve receiver, 750  
transformer for, 753  
tuned anode with, 755

**DuBilier arc**, description, 126  
**Ducon** electric light attachment, 30, 759  
methods of connecting, 760

**Dull Emitter**. *See also* Valves.  
Dextraudion, 2249  
for L.F. amplifiers, 87  
Marconi-Osram, 762  
receiver, 86, 762  
—at 6 R.F., 2074  
thorium in, 2005  
two-valve set with, 86, 762  
voltages for, 761  
Weco valve, 2231  
Wehnelt's discovery, 761

**Dynamo**. *See also* Generator.  
accumulator charging with, 24  
amateur wireless station, 778  
brushes, 294  
brush rocker, 1748  
commutator, 473  
compound, 475  
construction, 775  
exciter, 887  
field regulator, 918  
field rheostat, 919  
home charging, 776  
induction in, 1172  
interpoles of, 1200  
lap winding of, 1260  
load, 1299  
magnetic circuit of, 1358  
overtyping charging, 779  
saturation curve of, 920  
sectional diagram, 775  
self-excited, 1793  
series coil, 1795  
series-wound, 1799  
shunt-wound, 1815  
sparking, 1866  
speeds, correct, 778  
types, 775

**E**

**Earth**. *See also* Aerial.  
arrester, 785, 1291  
capacity, 362, 785  
clip, 785  
connexions, 786  
—for transmitting, 2070  
copper strap clip, 786  
counterpoise, 542

- Earth, current,** 788  
 dead, 651  
 lightning arrester, 785, 1291  
 importance of, 783  
 principles, 782  
 pipe as, 789  
 plate, 788  
 return, 789  
 resistance, 783, 789  
 substitutes for, 784  
 switch, how to make, 790  
 testing for faults in connexions, 906  
 —Resistances, 1998  
 transformers, 784  
 transmission, 283  
 varieties of, 782  
 water tap for, 787  
 wire, 789
- Ebonite.** *See also* Insulating Materials:  
 Insulators.  
 bushings, 305  
 condenser, 801  
 dielectric constant, 684  
 dielectric strength, 683  
 cutting, 794  
 drilling, 740, 744, 793  
 engraving, 798, 872  
 filing, 796  
 insulator, 338, 801  
 making, 792  
 matting, 796  
 matting with emery powder, 869  
 plugging holes in, 801  
 polishing, 799  
 qualities, 793  
 sawing, 172  
 screw cutting in, 800  
 shaping, 796  
 turning, 798
- Electricity.** *See also* Magnetism.  
 accumulators, 11  
 alternating current, 59  
 alternators, 60  
 back E.M.F., 180  
 batteries, 213  
 capacity, 356, 855  
 cell, 388  
 charge, 403  
 condenser, 476  
 conductors, 509  
 current, 630  
 dielectrics, 684  
 direct current, 691  
 dry cell, 746  
 dynamo, 775  
 electro-dynamics, 829  
 electrolines explained, 831  
 electro-motive force, 841  
 electrons, 845  
 ether, 876  
 Faraday's electro-chemical laws, 904  
 frictional, 850  
 generator, 1019  
 inductance, 1157  
 induction, 1170  
 insulating materials, 1184  
 insulation, 1185  
 Leyden jar, 1289  
 nature of, 878  
 Peltier effect, 1530  
 piezo, 1544  
 proton, 845, 1614  
 quantum theory, 1620  
 resins, 1727  
 Seebeck effect, 2002  
 theory of, 825  
 thermo, 2000  
 thermopile, 2002  
 three-wire system, 2015
- Electric Light,** Duccen attachment for, 30, 759
- Electrodes.** *See also* Battery: Arc:  
 Primary Cell.  
 Calland-Daniell cell, 1612  
 carbon, 366  
 Castner cell, 1417  
 cathode, 384  
 defined, 829  
 Daniell musical arc, 761  
 electrolytic rectifier, 837  
 grid, 1052  
 Grove cell, 1065  
 Leclanché cell, 1283-84  
 Moretti arc, 102
- Electrodes, Noden valve,** 1472  
 Poulsen arc, 102  
 quenched spark, 1623  
 Ruhmer arc, 102, 1766  
 spark gap, 1864  
 T.Y.K. arc, 102  
 Vreeland's arc, 102  
 water-cooled, 124  
 Wehnelt, 2232
- Electrolysis.** *See also* Primary Cell.  
 anion, 97  
 cation, 386  
 explained, 833  
 ion, 1211  
 ionization, 1211
- Electrolyte,** of bichromate cell, 236, 239  
 of Daniell cell, 645  
 density in accumulators, 19  
 double, 722  
 electro-chemical equivalent, 829  
 sal-ammonia, 1283, 1758  
 varieties, 834
- Electrolytic, Caldwell interrupter,** 856  
 cell, 844  
 condenser, 834  
 detector, 835  
 interrupters, characteristics of, -36, 1206  
 rectifier, 16, 836  
 rectifier circuit, 16, 837  
 Wehnelt interrupter, 836
- Electro-motive Force.** *See also* Current:  
 Electricity.  
 back, 180, 195  
 back, effect of inductance, 1145  
 current resistance relationships, 843  
 definition, 841, 950  
 electro-scope measurement of P.D., 855  
 explained, 841  
 generated in continuous current arma-  
 ture, 1025  
 in generators, 1021  
 induction relationships, 1156  
 induced, 1155  
 Kirchhoff's rule, 841  
 Korda frequency adder, 1252  
 measurement of, 841, 843  
 lag curves, 1259  
 related to current and resistance, 841
- Electrons.** *See also* Electricity; Mag-  
 netism.  
 atom, arrangement, 847  
 beryllium atom, 849  
 boron atom, 849  
 carbon atom, 847, 850  
 cells, 821  
 counting by spectrum method, 846  
 effect of friction on, 819  
 flowing through a conductor, 816  
 free, 985  
 helium atom, 848, 851  
 hydrogen atom, 848, 850  
 lithium atom, 848, 850  
 nature of, 817  
 oxygen atom, 847  
 proton, 845, 1614  
 relay, 852  
 size of, 849  
 sodium atom, 817  
 speed of, 849  
 theory of, 845  
 Thomson's discovery, 845  
 velocity of, how measured, 851
- Electroscopes, Bennet's,** 854  
 condensing, 855  
 measuring capacity, 820  
 measuring potential difference, 820
- Electrostatic, Bennet's electro-scope,** 854  
 capacity, 855  
 condensing electro-scope, 855  
 electro-scope, 854  
 electrophorus, 852  
 field, 864  
 induction, 865  
 units, 866
- Electro-technical Symbols,** list, 3
- Element, aluminium,** 62  
 argon, 127  
 beryllium, 849  
 bismuth, 246  
 boron, 259, 849  
 cadmium, 345  
 calcium, 338  
 carbon, 365, 847, 850
- Element, chlorine,** 411  
 cobalt, 431  
 copper, 533  
 electro-chemical equivalent of, 829  
 gold, 1040  
 helium, 848, 851, 1095  
 hydrogen, 848, 850, 1141  
 iron, 1212  
 lead, 1277  
 lithium, 848, 850, 1298  
 magnesium, 1355  
 manganese, 1390  
 mercury, 1417  
 nickel, 1470  
 nitrogen, 1470  
 oxygen, 847, 1511  
 palladium, 1549  
 phosphorus, 1537  
 platinum, 1559  
 potassium, 1586  
 rubidium, 1765  
 selenium, 1791  
 silicon, 1816  
 silver, 1817  
 sodium, 817, 1841  
 tantalum, 1956  
 tin, 2020  
 thorium, 2005  
 zinc, 2250  
 zirconium, 2250
- Emery,** cleaning off insulation with, 549  
 cloth, 867  
 cloth, how to fold, 867  
 paper, 868  
 polishing with emery paper, 868  
 powder, 869
- Energy, conservation of,** 950  
 definition, 871  
 kinetic, 871  
 potential, 871, 1590  
 quantum theory, 1620
- Engraving ebonite,** 798, 872  
 tools used, 872
- Ether.** *See also* Electron.  
 Clerk-Maxwell on, 877  
 and electrical theory, 825  
 free, 826  
 Lodge's experiments, 879  
 theories of, 876  
 waves, 877
- Eye, how to force,** 954  
 in strap plate, 891  
 double-ended, 262
- Eyebolt, forging,** 954  
 use on dynamo, 257  
 use on strainers, 894
- F**
- Fading, daylight effects on,** 648, 895  
 Heaviside layer effects, 284, 720  
 night effects, 719  
 sunrise and sunset effects, 648, 894
- Faraday's Laws of electricity,** 11, 904
- Faults.** *See also* Testing.  
 aerial, 905  
 basket coil, 907  
 condenser, 908  
 crystal sets, 905  
 double crystals, 905  
 duolateral coils, 906  
 earth, 906  
 H.F. amplifiers, 911  
 H.P. leakage, 910  
 high-tension batteries, 907  
 inductance slider, 907  
 lead-in wire, 905  
 loud speaker, 909  
 low-frequency amplifiers, 912  
 tapped coils, 907  
 telephones, 909  
 tuning connexions, 906  
 valves, 909  
 variometer, 907
- Faure Plates.** *See also* Accumulator:  
 Plates.  
 D.P. accumulator, 729  
 negative, 912  
 positive, 912
- Feed Back.** *See also* Regeneration.  
 capacity reactance circuits, 364  
 circuits, 913  
 coil, how to make, 450  
 definition, 913  
 principle, 105, 913

**Feed Back**, reaction coupling, 914  
**Field**, coil, 229  
 concentrated, 1373  
 electric, due to influence, 815, 1181  
 electrostatic, 864  
 Faraday's conception of magnetic, 1371  
 formula, 1380  
 magnet, 917  
 magnetic, 1364  
 magnetic, demonstration of, 1368  
 magnetic, flux density, 948  
 magnetic, measuring strength of, 1050, 1509  
 magnetic, representation of, 1156  
 magnetic, thumb rule, 2018  
 magnetometer, 1380  
 maintenance of magnetic, 1374  
 regulator, 919, 1700  
 regulator for charging board, 410  
 rheostat, 919  
 round current-carrying coil, 1370  
 round straight conductor, 1371  
 strength, how measured, 1380  
**Filament**. *See also* Anode; Grid; Valve.  
 argon, to lengthen life of, 127  
 battery, 922  
 construction, 921  
 dull emitters, 762  
 Fleming valve, 941  
 fuse, 922  
 magnetron, 1383  
 materials, 921  
**Filament Resistance**. *See also* Resistance.  
 Burned dual, 1743  
 Burned resistors, 1740  
 continuously variable, 925  
 formers for, 955  
 Fuller, 924  
 Holderstat, 1570, 1878  
 how to make, 76, 669, 926, 1743  
 Igranite, 925  
 knobs for, 1247  
 Marconi, 1395  
 microstat, 1432  
 plunger for Holderstat, 1561  
 Radio Instruments, 1743  
 vernier, 925  
**Filing**, brass, 271  
 cleaning files, 931  
 draw, 930  
 chonite, 796  
 flat, 929  
 round surfaces, 931  
 varieties of files, 928  
**Fleming**, biography, 939  
 circuits for Fleming valves, 942  
 coherer, 940  
 cymometer, 940  
 oil arc, 126  
 rule, 940  
 spark frequency recorder, 994  
 valve, 941  
 on wireless theory, xi  
**Flux**. *See also* Magnetism.  
 curves, 948, 1362  
 density, 948, 1361  
 direction, 946  
 fluxmeter, 949, 1050  
 leakage in transformers, 2029  
 magnetic, 1364  
 magnetic, direction of, 1021  
 magnetic, lag behind magnetizing  
 force, 1142  
 in transformer core, 1375  
**Flux**. *See also* Soldering.  
 borax, 1843  
 boron compo, 1843  
 brass, 948  
 copper, 948, 1819  
 easy, 1819  
 fluxite, 1843  
 killed spirit, 1843  
 silver soldering, 1818  
**Fly Nut**, use of, 257  
**Foil**, brass, 274  
 copper, 533  
 tin, 2021  
 —in condenser, 2021  
 —in Leyden jar, 2021  
 —in Wimshurst machine, 2021  
**Force**, centrifugal, 393  
 effect of, 949  
 electro-motive, 950  
 electro-motive explained, 841

**Force**, formulae, 1382  
 lines of, 1295  
 lines of, in coils, 1370, 1377, 1378, 2124  
 lines of, on magnet, 839  
 magnetic, 1364  
 magnetic, Fleming's rule for, 940  
 magnetizing —lead over magnetic flux,  
 1142  
 magnetizing of a solenoid, 947  
 magneto-motive theory, 1381  
 Maxwell's corkscrew rule for, 1412  
 in mechanics, 949  
 unbalanced, 949  
**Forging**, eyebolt, 954  
 hook, 955  
 methods, 951  
 right-angle bends, 953  
 steel, 951  
 strap for mast, 953  
 tracing up, 953  
**Formers**, for basket coils, 203, 205  
 coil, 451, 453, 457  
 filament resistance, 955  
 shell-type transformer, 2040  
 variometer, 956  
**Forming** of accumulator plates, 12, 956  
**Frame Aerial**. *See also* Aerial; Direction  
 Finding.  
 advantages, 968  
 Armstrong circuits with, 141  
 Bellini-Tosi, 227, 695  
 cabinet set with, 1327  
 Climax, 1661  
 collapsible, how to make, 969  
 five-valve set with, 975  
 hanging set, 1077  
 Hoyt-Taylor balanced, 152  
 how to make, 143, 971  
 interference, reducing with, 1197  
 Marconiphone, 1405  
 Marconiphone loop, 1325  
 one-valve set, 1661  
 Radio Instruments, 969  
 short-wave reception, 968  
 solenoid type, 969  
 super-regenerative set with, 1925  
 theory, 966  
 wave-length, 975  
 wire for, 970  
**Free alternating current**, 985  
 electrons, 985  
 magnetism, 966  
 oscillation in Armstrong circuits, 136  
 oscillations, application, 987  
 oscillations, definition, 986  
 oscillations, expression for, 988  
 oscillations in Leyden jar, 987  
**Frequency**. *See also* High Frequency;  
 Low Frequency.  
 audio, 155  
 beat, 226  
 changers, 990  
 changing by valve rectifiers, 991  
 Fleming spark frequency recorder, 994  
 group, 1064  
 Hartmann and Braun frequency meter,  
 993  
 high, 1101, 1627  
 Korda frequency adder, 1252  
 low-frequency limits, 1345  
 measurement with cymometer, 637  
 meter, 992  
 natural, 1437  
 photographic frequency recorder, 995  
 quantum theory, 1620  
 oscillation, 1502  
 radio, 1627  
 spark, 1863  
 spark, recording with dictaphone, 994  
 table, 990  
 Telefunken frequency changer, 991  
 triple, 1253  
 vibrating reed meter, 995  
 Westinghouse frequency meter, 993  
**Funnel**, acid, 29  
**Fuse**, bobbin, 997  
 burning out, 302  
 cartridge, 379, 997  
 filament, 922  
 types of, 997  
 uses, 168  
 wire in accumulator charging, 18  
**Fusible Alloys**, cadmium in, 335  
 Wood's metal, 561, 2248

## G

**Galvanometer**. *See also* Ammeter; Volt  
 meter.  
 A.C. measurement by, 2001  
 aperiodic, 1001  
 ammeter, use as, 1000  
 astatic, 149  
 ballistic, 191  
 ballistic for measuring permeability, 234  
 calibrating, 343  
 circuit continuity tests with, 1003  
 constant, 235, 1000  
 construction, 1000  
 damping moment, 645  
 d'Arsonval, 647, 1001  
 dead-beat, 1002  
 dial for, 1005, 1007  
 Duddell thermo-, 2001  
 Einthoven, 813  
 figure of merit, 1001  
 Grassot fluxmeter, 949, 1050  
 H.F. transformer tests with, 1003  
 how to make, 1004  
 measuring signals with, 1002  
 mirror, 1438  
 Moll, 1443  
 moving coil, 1452  
 needle, 1007  
 oscillograph application, 1506  
 precision, 1001  
 principle of, 823  
 sensitiveness, 1001  
 shunt, 1813  
 suspended coil, 1001  
 tangent, 1000, 1955  
 testing filament resistance with, 1003  
 theory of, 1000  
 thermo, 2000  
 thermopile for use with, 2003  
 varieties, 1000  
 vibration, 2212  
 Western Electrical Instrument Co.'s,  
 1002  
**Gap**. *See also* Spark Gap; Transmission;  
 Arc.  
 de-ionizing methods, 1357  
 micrometer spark, 1428  
 multiple, early form, 1008, 1504  
 Peukert discharger, 1534  
 quenched gap discharge, 1622  
 quenched gap transmitter, 1622  
 quenched spark, 1623  
 safety, 1768  
 spark, 1863  
 spark, electrodes, 1864  
**Gassing**, when charging accumulators, 18,  
 1009  
**Gauge**. *See also* Tools; Wire.  
 cutting, 1013  
 depth, 1011  
 drill, 1010  
 feeler, 1011  
 limit, 1011  
 screw thread, 1010  
 sizes, 1014  
 universal drill, 1011  
 vernier caliper, 1012  
 wire, 1010  
**Generator**. *See also* Dynamo.  
 A.C. in transmitting circuit, 1020  
 arc, 124  
 armature core, 1024, 1025  
 booster for, 258  
 Carnarvon, 1029  
 Crompton's, 1033  
 description, 1019  
 direct current, 691, 1024  
 duplex telephony, 769  
 Eiffel Tower, 808  
 electro-motive force in, 1021  
 English Electric A.C., 1027  
 field excitation, 1026  
 field regulator for, 918  
 field rheostat for, 919  
 half-kilowatt twin, 1032  
 hand, 1074  
 high-tension current, 1032  
 hunting of, 1141  
 low-tension current, 1032  
 output variation, 1027  
 parts, 1023  
 pole shoes, 1575  
 rotor spindle, 1761



- Generator, shunt-wound disk and booster,** 1030  
 three-kilowatt D.C., 1024  
 three-phase system for, 661  
 transmission circuit, 1019  
 two-kilowatt motor, 1028
- Glace Bay, fan aerias at,** 896
- Glass, crystal, dielectric strength,** 683  
 cutting, 1037  
 drilling, 745  
 flint, dielectric strength, 684  
 grinding, 1038  
 ground, 1038  
 paper, 1038  
 plate condenser, 1038  
 plate, dielectric constant, 684  
 separators, 1039  
 silencer, 1039  
 tube, 1039  
 uses in wireless, 1037  
 wool, 1040
- Glycerine, dielectric constant,** 684
- Grid. See also Anode; Filament; Valves.**  
 battery, position in circuit, 1052  
 battery, characteristic curve, 1053  
 biasing battery, function, 388, 1052  
 circuit, 1054  
 coil at 5 L.S., 2071  
 control, 1054  
 effects on regeneration control, 1687  
 function of, 401, 1052  
 function in tuned anode circuits, 363  
 in four-electrode valve, 2146  
 modulation grid control, 1442  
 reaction, 1647
- Grid Leak, anti-capacity,** 113  
 blacklead, 247  
 Bretwood, 1057  
 clips for, 426  
 connexions, 1055  
 Dubilier, 1056  
 Filtron, 934, 1056  
 formulae for, 1281  
 function, 1055  
 graphite, 1056  
 how to make, 1057  
 indian ink, 1056  
 Lissen variable, 2204  
 oscillation effect on condenser, 1499  
 pointer for, 1564  
 Polar Blok, 1569  
 scientific type, 1055  
 transmitting, 2068  
 Watmel, 1057
- Grinding. See also Tools.**  
 bench grinder, 1063  
 cold chisels, 1063  
 hand grindstone, 1061  
 lathe, 1063  
 stone used for, 1060  
 treadle, 1061  
 twist drill, 1063
- H**
- Hammer break on induction coil,** 1073, 1174  
 choice, 1071  
 interrupter, 1204
- Handles. See also Coil; Condenser.**  
 adaptable tool, 2026  
 control, 892  
 chisel, 2026  
 screwdriver, 2026
- Harmonics, circuit diagram for,** 1087  
 harmonic motion, 1086  
 in sound, 1087  
 sine curve, 1820
- Headphones. See Telephone.**
- Heavside Layer, action of,** 284, 1692  
 distortion effects of, 720  
 guiding theory, 1092  
 theory, 1092
- Heterodyne. See also Beat Reception; Oscillation.**  
 auto, 170  
 autodyne circuit, 1497  
 dissonance, use of in, 716  
 equal, 873  
 local oscillator, 1302  
 Marconi heterodyne unit, 1099  
 negatron valve for, 1462  
 opiumum, explained, 1495  
 oscillator, P.M.G.'s regulations, 1290  
 reception, 226
- Heterodyne, rectification,** 1097  
 rectifier, 1098  
 supersonic, 1929  
 theory of, 1097  
 wave-meter, 1100
- High Frequency. See also Amplification; Low Frequency.**  
 amplifiers, 89, 1106  
 bolometer measuring of, 255  
 definition, 1101  
 discharges, 1505  
 discharges, Oudin resonator for, 1511  
 explained, 71, 422, 1101  
 feed-back circuit, 913  
 Litzendraht cable for, 1298  
 Oajah plug-in H.F. transformer, 1431  
 resistance, 1828  
 resistance-capacity, 1637  
 skin effect, 1828  
 testing for H.F. leakage, 910  
 two-valve unit H.F. set, 1627
- High-frequency Amplification. See also Amplification; Low Frequency.**  
 circuits for, 422  
 crystal set, addition to, 559, 611, 618, 1109  
 dual-amplification receivers, 1670  
 general, 72  
 methods of, 1101  
 neutrodyne method, 1465  
 one-valve, 90  
 one-valve crystal, 71  
 reactance-capacity, 1637  
 Round circuits, 1763  
 tone wheel conversion to L.F., 2025  
 transformer-coupled, 621, 2045  
 transformer wave-length ranges, 2045  
 transformers for, 2036  
 tuned anode method, 361
- High Tension. See also Low Tension; Battery.**  
 battery for anode circuit, 102  
 battery box, 1131  
 battery, by-pass condenser for, 313  
 battery, doing without, 2146  
 battery, general description, 1130  
 battery, heavy type, 14  
 battery, Hellesen, 748  
 battery, how to make, 214  
 battery, Siemens, 215  
 battery, testing for faults, 908  
 B battery, 220  
 cable, 334  
 cartridge fuse, 380  
 circuit, 1131  
 dry battery, 748  
 neon lamp for transmitter, 1464  
 supply at 5 I.S., 2071  
 transmission supply, 2068  
 Unidyne set, 2146
- Honeycomb Coil. See also Coil.**  
 bobbin for, 1134  
 how to make, 1134  
 ferranic gimbal, 1133  
 plug-in, 1133  
 winding, 1135
- Hot-wire Ammeter. See also Ammeter.**  
 construction, 1137  
 principle of, 69, 1138  
 theory, 1137
- Howling. See also Reaction; Tuning.**  
 causes, 1139  
 tracing faults due to, 1140
- Hoyt-Taylor, system to reduce atmospheric** 152
- Hydrogen, atom,** 848, 850  
 dielectric constant, 684  
 Poulson's discovery, 1141  
 properties of, 1141  
 specific gravity, 1141
- Hydrometer, accumulator acid testing**  
 with, 1868  
 functions, 1141  
 Hicks, 1101
- Hysteresis. See also Iron; Magnetism.**  
 definition, 1142  
 dielectric, 684  
 loop, 1143  
 losses in iron, 1213
- I**
- Impedance, coil, 1147**  
 curves of, 1146  
 definition, 1145
- Impedance, filament-grid, 1683**  
 formulae, 1146-47  
 measurement of, 1147  
 tuned anode circuit, 363  
 tuned impedance amplifier, 1105  
 vector diagrams, 1146
- Indiarubber, belts, 1152**  
 description, 1151  
 dielectric constant, 684  
 packing, 1515  
 panel marking, 1152  
 puncturing voltage, 1151  
 solution, 1152  
 specific gravity, 1151  
 turning, 1151
- Inductance. See also Capacity.**  
 of aerial, 38  
 Atkinson bridge measurement, 95  
 astatic coils for measuring, 149  
 Burndept coils, 301  
 Campbell bridge for measuring, 1179  
 of choke coils, 114  
 Clerk-Maxwell's inductance formulae, 1169  
 of coils, 1158  
 cymometer measurement of, 638  
 definition, 1157  
 distortion effects of, 718  
 effect on back E.M.F., 1145  
 effect on tuning, 2119  
 experimental methods of measurement, 1160  
 formulae for, 1158  
 inductometer for measuring, 1179  
 Lodge's tuning, 1308  
 Maxwell Wheatstone bridge for measuring, 1161  
 measurement of, 1157  
 of multi-layer coils, 446  
 mutual—Campbell's bridge measurement, 455  
 mutual, formulae, 1456  
 mutual, measurement of, 1179  
 non-inductive resistance, 1473  
 of single-layer coils, 445  
 switch, 1167  
 of toroidal coils, 446  
 transmitting, 2090  
 tuning, 1169  
 values of de Forest coils, 660  
 values of Igranic coils, 1144
- Inductance Coil. See also Coil.**  
 aerial at 6 R.J., 2080  
 aerial tuning, 51  
 aerial tuning coupled, 1177  
 basket coils for A.T.I., 757  
 best shape for, 1159  
 Burndept, 301, 434  
 dead-end effects, 651  
 de Forest, 659  
 Eiffel tower, 811  
 former for, 1166  
 helical tapped, 1963  
 high-frequency slider, 1116  
 how to make, 1163  
 Igranic, 1144  
 iron-core, 1212  
 lap-winding, 1261  
 Lissen, 2133  
 loading, 1301  
 low-frequency iron-core, 1349  
 musical inductance, 1456  
 Oajah basket, 1491  
 Oajah slab, 1491  
 panel for inductance coil unit, 1165  
 single-slider, 1833  
 sliding, 1833  
 space-winding, 1857  
 spider-web, 1870  
 spiral, 1873  
 switch, 1166  
 switch arm, 1165  
 tapped, 442, 447, 1163, 1956  
 tappings, 1163  
 testing for faults, 907  
 theory of, 824  
 tuning, 1169  
 two-slider, 1833  
 varieties, 1163
- Induction, calculation of, 1172**  
 coupling formulae, 1361  
 current, 1171  
 dynamo, 1172  
 electric, 815

**Induction**, electro-magnetic explained, 840  
 electrophorus method of, 853  
 electrostatic, 865, 1170  
 formula, 1172  
 induced current, 1154  
 induced E.M.F., 1155  
 influence machine, 1180  
 magnetic, 1170, 1364  
 mutual, defined, 824  
 principle of electro magnetic, 1375  
 theory, 1170  
 zero value in iron, 1143  
**Induction Coil**, contact breaker for, 521  
 Grisson interrupter for, 1062  
 half-inch spark, 1175  
 hammer break for, 1073  
 mercury jet interrupter for, 1417  
 principles of, 1174  
 six-inch spark, 1176  
 types, 1173  
 voltage induced, 1174  
**Induction Motor**, three-phase circuit, 175  
**Inductor Alternator**. *See also* Alternator.  
 functions, 632, 1180  
**Insulated**, eyes, 1183  
 knobs, 1183  
 sleeving, 1831, 2049  
 screws, 1183  
 staple, 1184  
 wire, Systoflex, 1952  
**Insulating Materials**, adit, 30  
 ambroin, 68  
 asbestos, 148  
 asphalte, 148  
 bakelite, 182  
 black tape, 247  
 black wax, 248  
 celluloid, 389  
 Chatterton's compound, 411  
 condensite, 508  
 dielectric constants, 684  
 dielectric strengths, 683  
 ebonite, 1185  
 general description, 1184  
 glass, 1037  
 indiarubber, 1151  
 ivorine, 1216  
 isolit, 1216  
 list of, 1185  
 mica, 1425  
 micanite, 1425  
 micarta, 1426  
 micanite cloth, 1426  
 paraffin paper, 1525  
 paraffin wax, 1526  
 Paxolin, 1529  
 pitch, 1545  
 porcelain, 1185, 1576  
 presspahn, 1611  
 rubber, 1765  
 sealing wax, 1785  
 shellac, 1803  
 vulcanite, 2215  
 wax, 2231  
**Insulation**, aerial, 1186  
 breakdown effects, 1805  
 of cardboard tubes, 372  
 of copper wire, 535  
 insulating sleeving, 1831, 1952  
 materials for, 1184  
 megger for measuring, 1415  
 methods of, 1185  
 removing from coils, 519  
 removing from flex, 945  
 Systoflex, 1952  
 testing for, 1996  
 of wooden baseboard, 1185  
**Insulator**, barrel, 193, 1187  
 bobbin, 254  
 Bradfield, 266  
 Bradfield, anti-spark disks, 118  
 button, 306  
 corrugated, 538  
 cowl, 550  
 deck, 655  
 ebonite, 801  
 ebon, 803  
 eoz, 805, 1187  
 Eiffel Tower aerial, 806  
 fluted moulded, 1187  
 insulated eyes, 1183  
 insulated knobs, 1183  
 insulated screws, 1183  
 insulated staple, 1184  
 knobs, 1247

**Insulator**, lead in, 1280  
 partition, 1529  
 porcelain, 1187  
 porcelain cleat, 1577  
 reel, 1669  
 Rendahl, 1726  
 Silvertown, 1820  
 -strain rod, 1908  
 strop, 1909  
 stuffing box of Bradfield, 1917  
 switch, 200  
 umbrella, 1187  
 varieties used in wireless, 1187  
 voltage testing of, 2213  
 window, 2239  
 why poor conductor, 450  
**Interference Elimination**. *See also* Direction Finder; Frame Aerial.  
 balancing aerial method, 187  
 balancing method, 186, 1294  
 balanced carborundum crystals, 371  
 balanced crystal method, 181, 371  
 circuits for, 1193  
 de Groot circuit, 1888  
 Dieckmann cage, 683  
 drain circuit method, 730  
 eliminator, how to make, 1192  
 filter circuits, 932  
 frame aerial, 1197  
 Franklin circuits, 981  
 Hoyt-Taylor circuit, 153  
 jamming, 1225  
 limiting devices, 1292  
 Lissen wave-trap, 2230  
 Marconi X-stoppers, 1887  
 preventers, 1197  
 rejector circuits, 1707  
 Rogers circuit, 152  
 silicon, use in, 1816  
 theory, 1198  
 wave-trap, 2230  
**Interrupters**, automatic, 172  
 buzzer type, 1203  
 condenser, effect on, 1205  
 electrolytic, 836, 1206  
 Grisson electrolytic condenser, 1062  
 hammer, 1204  
 mercury type, 1206  
 motor driven, 1207  
 types, 1203  
**Iron**, annealed, 99  
 B.H. curve, 1362  
 concentrating effect on magnetic field, 1373  
 core inductance, 1212  
 expansion coefficient, 1712  
 filings, 1212  
 flux density and permeability curves, 948  
 galvanized, thimbles, 2003  
 hysteresis of, 1142  
 hysteresis loops, 1143-44  
 Lohys, 1214  
 losses, 1213  
 magnetization curve of, 990  
 malleable, 1386  
 mast fittings, 1386  
 permeability curve, 948, 1362  
 pyrites, 1215  
 solenoid effect, 1534  
 specific gravity, 1869  
 stalloy, 1214  
 uses in wireless, 1212  
 wire, 1215

J

**Jack**. *See also* Switch.  
 double closed, 1218  
 double filament, 1218  
 double telephone for use with, 1219  
 G.P.O. pattern, 1221  
 how to make, 1222  
 mounted, 1221  
 and plug, 514  
 and plug circuits, 1210  
 plugs, how to make, 1222  
 single closed, 1218  
 single open, 1218  
 telephone, 1219  
 varieties, 1218  
**Jar Unit**, value of, 31, 1226  
**Jig**, drilling, 320  
 coil holder, 1227  
 steel, 1227  
**Jigger**, auto, 171

**Jigger**, description, 1228  
 half-kilowatt, 1228  
**Joints**, dovetail, 315, 316, 1230  
 dowelled, 1228  
 housing, 316, 1230  
 keyed joggle halving, 1241  
 key mitre, 1241  
 metal plates, 1231  
 mitre, 1440  
 mitre board, 1439  
 mitre box, 1440  
 mitre template, 1988  
 mitred tenon, 977, 979  
 mortise and tenon, 1447  
 ropes, 1232  
 stub tenon, 1909  
 wire, 1231

K

**Key**. *See also* Switch.  
 base, 1238  
 essentials, 1236  
 feather, 1249  
 gib, 1240  
 mitre joint, 1241  
 Morse tapping, 1237  
 panel, 1238  
 switch, 1242  
 transmitting, 1237  
 transmitting with safety device, 1237  
 way, 1240  
 woodruff, 1240

L

**Lacquering**, brass, 273, 1254  
 cold, 1254  
 hot, 1254  
 methods, 1254  
**Ladder**, cat, 386  
 erection, 1257  
 extension, 1257  
 types, 1256  
**Laminations**, alternator, 1250  
 magnet armature, 1260  
 for transformers, 161, 165, 1259  
**Lathe**, C.A.V., 1262, 1263  
 change wheels, 1271  
 construction, 1262, 1264  
 face plate, 1266  
 grindstone, 1062  
 J.R., 1262-64  
 milling machines, 1433  
 packing lathe tool, 1516  
 parting tool, 1272  
 tools, 1265  
**Lathe Work**. *See also* Turning.  
 aluminium turning, 64  
 calibrating methods, 340  
 chuck, how used, 1266  
 coil winding, 457  
 collet chuck in use, 1267  
 countersinking with, 543  
 dial making, 679  
 drilling, 743-45, 1269  
 drilling ebonite with, 795  
 fixing work to face plate, 1268  
 hollowing cup for gramophone attachment, 1047  
 mandrel turning, 1272  
 milling, 1434  
 mounting block on screw chuck, 1267  
 screw thread cutting, 688, 1271, 1778  
 telephone earpiece making, 1270  
 truing up, 1268  
 turning control knobs, 1250  
 turning metal in, 1442  
 turning wooden bar, 1267  
 winding shell transformers, 2041  
**Lattice Mast**. *See also* Aerial; Mast.  
 construction, 44  
 Elwell triangular, 1275  
 self-supporting, 1276  
**Lead in**, at Berne station, 1279  
 cage at Bournemouth, 1953  
 fan antenna connector, 899  
 importance of insulation of, 1186  
 insulators for, 266, 1280  
 multiple-wire aerials, 899  
 testing for faults in, 905  
 through window frame, 1278  
**Lead Plate**. *See also* Battery  
 battery, 1278  
 cell, 12  
**Leak**. *See also* Grid Leak.  
 in condensers, 1281

**Leak, curve,** 1281  
formulae, 1281  
static, 1887

**Leakage, precautions against electrical,** 1282  
testing for H.F. leakage, 910

**Leyden Jar, charging,** 1289  
construction, 1289  
discharging, 1289  
experiments, 856-57  
glass plate condenser, 1038  
Lodge's experiments, 1303, 1952  
Lodge's form, 1289  
tinfoil for, 2021

**Licence, broadcast,** 1289  
constructor's, 1289  
experimental, 888, 1289  
wireless, conditions for, 1289

**Light, photography by,** 1537  
photophone transmission, 1541  
rubidium, sensitivity to, 1766  
selenium, sensitivity to, 1538, 1791  
velocity of, 826  
wave-length, 1291  
waves for transmission, 1541

**Lightning, arrester, magnetron circuit,** 1383  
arrester, 1291  
switch, 1292

**Linseed Oil, dielectric strength,** 683

**Lodge, Sir Oliver**  
biography, 1305  
coherer, 1307  
ether experiment, 882  
receiver, 1307  
syntonic jars, 1368  
tuning inductance, 1308  
—articles by  
alignment chart, 57  
alternating current, 59  
electron, 845  
electrostatic capacity, 855  
ether, 876  
force, 949  
Foster bridge, 957  
incommensurables, 1150  
index, 1159  
inductance, 1157  
induction, 1170  
leak, 1281  
logarithm, 1309  
Ohm's law, 1484  
oscillation, 1498  
potential, 1586  
units, 2160  
waves, 2225  
Wireless and Other Waves, iii

**Loop Aerial. See also Aerial; Frame Aerial.**  
for submarines, 1324  
how to make, 1326  
theory, 966, 1323  
transmitting, 1323

**Loops of Potential, antinodes,** 118

**Loose Coupler. See also Coil.**  
advantages, 1328  
coils, 442  
crystal receiver, 577  
crystal receiver, how to make, 584  
how to make, 1329  
Polar loose-coupled tuner, 1330  
principle of, 1328  
single slider, 1177  
stud switches, 1331  
types, 443, 1328  
vernier adjustment, 1329

**Losses, core,** 357  
corona, 538  
hysteresis losses in iron, 1213  
leakage flux in transformers, 2029

**Loud Speaker. See also Amplifier; Amplification.**  
adjusting mechanism, 1341  
amplification faults, 912  
Baldwin receiver for, 190  
by-pass condenser for, 313  
choke coil, use with, 415, 1342, 2023  
crystal set, 593  
diaphragms, 1336  
distortion in, 1341  
electro-magnetic, 1334  
electrostatic, 1335  
high-frequency amplification and tone, 1341

**Loud Speaker, Horn size,** 1336  
how to make, 1342  
how to pack, 1515  
pole-pieces, 1575  
power amplifiers for, 1691  
principle of, 1334  
relay of, 1335  
switch, 1946  
testing for faults in, 909  
tone filter, 2022  
tone improvement of, 1340  
types, Amplion, 93  
—Crystovox, 1338  
—Ethovox, 884  
—Erenophone, 989  
—Fuller, 1337  
—Geophone, 1337  
—Magnavox, 1352  
—Metropolitan-Vickers, 1424  
—Sterling, 1340  
—Western Electric, 1339

**Low Frequency. See also Amplification; High Frequency.**  
amplification faults, 912  
Burndept transformer, 1250  
capacity-coupled resistance circuit, 1346  
current, 1349  
definition, 1345  
feed-back circuit, 913  
frequency range, 1345  
general points on, 72, 156  
intensifier circuits, 1189  
iron-core inductance, 1349  
limiting voltage, 1293  
Round circuits, 1763  
tone wheel conversion from H.F., 2025  
transformer, 1349  
transformer-coupled circuit, 1346  
transformer formulae, 1350  
transformer principles, 160  
vector diagrams of L.F. transformer, 1349

**Low-frequency Amplifier. See also Amplifier; High-frequency Amplifier.**  
for crystal sets, 75, 559, 699  
crystal one-valve, 71  
dual-amplification receivers, 1670  
with dull emitters, 86  
Geophone L.F.A., 1347  
general notes on, 72, 156  
Marconiophone, 1398  
note magnification, 1474  
note magnifier, 1475  
Oracle, 1345  
Polar, 1348  
shell type transformer for, 2040  
Timex, 1347  
two-valve, 80, 157  
types, 1345  
Western Electric, 2232

**Low Tension. See also Accumulator; Battery.**  
A battery, 1  
C.A.V. battery, 10  
definition, 1351  
D.P. battery, 729  
Exide battery, 10  
filament circuit battery, 1  
Fuller block battery, 10

## M

**Magnet. See also Magnetism.**  
action on iron filings, 1369  
artificial, 148  
bar, 199  
compound, 475  
consequent poles of, 516  
D'Arsonval galvanometer magnet, 647  
electro, theory, 838  
electro, types, 839  
field, 917, 1368  
flux density of, 947  
horseshoe, 1137  
lodestone, 1305  
magnetic needle, 1460  
natural, 1457  
permanent, 1534  
permanent horseshoe, 1355  
polarized electro, 1573  
pole-pieces, 1574  
poles, 1573  
pole-shoes, 1575  
soft iron electro, 1355

**Magnet, south pole,** 1854  
testing strength of, 1051

**Magnetic attraction,** 1368, 1371  
blow out, 1355  
blow-out circuit, 1356  
blow-out theory, 1357  
concentration, 1373  
coupling, 1359  
coupling coefficient, 1361  
density, 1361  
density curve, 1362  
detector, 1363  
equator, 1361  
field, bismuth for measuring, 246  
—core losses, 537  
—defined, 1364  
—Faraday's conception, 1371  
—fling demonstration, 1369  
—Gauss unit, 1014  
—in coils, 1270-78, 1214  
—maintenance of, 1374  
—measuring strength of, 1050, 1589  
—representation of, 1156  
—in Poulsen arc, 124  
—reversed or coercive, 439  
flux, defined, 1364  
flux density, 948  
flux, direction of, 1021  
force defined, 1364  
force, Fleming's rule, 240  
induction, 1172, 1364  
inductive capacity, 1364  
key, 1365  
key connexions, 1365  
moment, 1366  
needle, 1366, 1459  
pitch, angle of dip, 97  
permeability, B.H. curves, 234, 918  
permeability, definition of, 947, 1531  
poles, 1366  
potential, 1589  
reluctance, 1363  
repulsion, 1368, 1371

**Magnetism. See also Electricity; Magnet; Magnetic, etc.**  
electro-magnetic effects, 822  
electro-magnetic induction, 1375  
electro-magnetism, 821  
field round coils, 1370, 2124  
field round conductors, 1371  
filings round magnet, 1368  
flux density, 947, 1361  
free, 986  
hysteresis theory, 1142  
induced, 1156  
induction, 1170  
isoclinic lines, 1216  
isodynamic lines, 1216  
isonegic lines, 1216  
isomagnetic lines, 1216  
lines of force, 1295  
magnetic attraction, 1368, 1371  
—circuit formulae, 1358  
—concentration, 1373  
—density, 1361  
—equator, 1364  
—field, 1364  
—flux, 1364  
—force, 1364  
—induction, 1172, 1364  
—inductive capacity, 1364  
—key, 1365  
—moment, 1366  
—needle, 1366, 1459  
—poles, 1366  
—potential, 1589  
—reluctance, 1366  
—repulsion, 1368, 1371  
magnetization cycles, 1143  
magnetometer, 1380  
magneto-motive force, 1381  
paramagnetic substances, 1527  
permeability, 1534  
permanence, 1534  
pictorially explained, 1369  
polar flux, 1572  
reluctance, 1722  
residual, 1727  
solenoid, 1849  
south pole, 1854  
of steel bar, 823  
theories, 1366  
unit magnetic pole, 1364

**Magnetizing Force, theory of,** 234

**Magneto-motive Force**  
 definition, 1381  
 flux density of a coil, 947  
 theory, 1381

**Marble**, drilling, 746

**Marconi**, biography, 1391  
 beam, 1393, 1807  
 coherer, 1393  
 double condenser, 1394  
 duplex sets, 769  
 filament resistance, 1394  
 heterodyne, 1099  
 Marconiphone, 1396  
 microphone, 287, 1430  
 wave-meter, 1406  
 wireless bell, 1407

**Mast**. *See also* Aerial.  
 aerial, 41-43  
 bands, 1412  
 bouchérising, 259  
 box, 260  
 box, how to make, 260  
 burnetizing, 302  
 butt of, 305  
 construction, 1410  
 Elwell triangular, 1275  
 guys for, 1065  
 lattice, 44, 1275  
 pole, 41, 1410, 1574  
 Radiola, 1633  
 self-supporting, 1276  
 stay for, 1893  
 steel, at Chelmsford, 1409  
 tubular, 2097  
 turret, 2137

**Matter**. *See also* Electricity; Electrons.  
 electrical nature of, 817

**Mercury**, amalgams of, 67  
 arc rectifier, 16  
 Castner cell electrode, 1417  
 interrupters, characteristics of, 1206  
 —on charging board, 409  
 —in cut-outs, 169, 636  
 —in Eiffel Tower, 808  
 let interrupters, principle of, 1417  
 Lieben-Reisz valve, use in, 1291  
 in liquid barretter, 1296  
 metal, 1417  
 specific gravity, 1869  
 valve rectifier, 1418  
 vapour arc, 1419

**Mesh**. *See also* Delta Connexions.  
 connexions, 1419  
 definition, 661  
 rectification for reducing ripple, 1421  
 three-phase connexions, 1419

**Metals**, aluminium, 62  
 bismuth, 246  
 brass, 269  
 cadmium, 335  
 calcium, 338  
 cobalt, 431  
 copper, 533  
 dutch, 773  
 gold, 1040  
 iron, 1212  
 lead, 1277  
 lithium, 1298  
 magnesium, 1355  
 malleable iron, 1386  
 manganese, 1390  
 mercury, 1417  
 nickel, 1470  
 palladium, 1519  
 phosphorus, 1537  
 platinum, 1550  
 potassium, 1586  
 rubidium, 1765  
 selenium, 1791  
 silicon, 1816  
 silver, 1817  
 sodium, 1841  
 tantalum, 1956  
 tellurium, 1987  
 thorium, 2005  
 tin, 2020  
 tungsten, 2116  
 Wood's, 2248  
 zinc, 2250  
 zirconium, 2250  
 expansion coefficients, 1712  
 specific gravity, 1869  
 —resistance, 1869  
 why good conductors, 850

**Metal Working**. *See also* Aluminium;  
 Brass; Brazing; Soldering, etc.  
 annealing, 98  
 brazing, 275  
 bronzing, 1512  
 cutting sheet, 1802  
 drilling, 740  
 engraving on, 872  
 forging, 951  
 lacquering, 1254  
 milling, 1433  
 oxidizing, 1512  
 principles of, 1421  
 sawing, 1772  
 screw thread cutting, 688, 1778  
 sheet metal working, 1421  
 silver soldering, 1817  
 soldering, 1844  
 turning, 64, 1442

**Mica**, in condensers, 707  
 dielectric constant, 684, 1425  
 —strength, 683, 1425  
 micaite, 1425  
 —cloth, 1426  
 properties of, 1425  
 specimens, 1425  
 use in accumulators, 474

**Microphone**. *See also* Transmission.  
 broadcasting, 282  
 carbon diaphragms for, 367, 368  
 —granules for, 368  
 condenser, 505  
 constant current modulation, 517  
 control, 286  
 Ericsson transmitter, 875  
 flame, 937  
 Goldschmidt's method, 1429  
 Jervis-Smith, 1226  
 liquid, 1297  
 Majorana's, 1386  
 micrometer flame, 1390  
 Marconi, 287  
 —broadcasting, 1430  
 microphonic amplifier, 1430  
 mouthpiece, 1452  
 principles of, 1428  
 skindervik, 1827  
 solid back, 1429  
 sound box, 1853  
 Sykes, 1948  
 transmitter, 1429  
 transmitting for amateurs, 2069  
 Vanni liquid, 2203  
 Western Electric, 287

**Modulation**, absorption, 9  
 Birmingham, room at, 246  
 carrier waves, 378  
 constant current, 516  
 control in broadcasting, 288  
 grid control, 1442  
 Heising, 1093  
 light method, 1542  
 London—control, 1316  
 modulated valve, 1443  
 modulator transformer, 1443  
 photophone means of, 1542  
 theory, 1441

**Moment**, displacement, 715

**Moretti Arc**, electrodes for, 102  
 atmosphere for, 126  
 principle of, 1445

**Morse**, automatic transmission, 1124  
 inker, 1182  
 code, omnigraph for practising, 1490  
 —omnigraph, how to make, 1490  
 —practising, 1445, 1490  
 key, 1446  
 international code, 1199  
 radiotelegraph abbreviations, 3  
 reception of C.W., 526  
 S.O.S. signal, 1849  
 sounder, 1447  
 tapper, 1964  
 tapping key, 1237  
 telegraph sounder, 1969

**Motor**, blowing, 253  
 buzzer, 1451  
 galvanometer for oscillographs, 1506  
 no-volt release, 1478  
 overload release for, 1512  
 squirrel cage, 1883  
 —rotor, 1883  
 starter, 1886  
 synchronous, 1951

**Moving-coil instruments**, 1452  
 —instruments and damping, 643  
 —G.P.O. detector, 666  
 relay, 1453

**Musical Arc**, Duddell's, 120

**N**

**Neon Tube** as amplifier, 1464  
 as cyroscope, 641  
 description, 1463  
 uses, 1464

**Neurodyne circuits**, 1466  
 condenser, 478, 502  
 principles of, 1465  
 receiver, how to make, 1467

**Nickel**, Fleming valve use in, 941  
 properties, 1470

**Night Effects** on distortion, 719

**Noises** in valve sets, 1527

**Non-inductive resistance**, 112, 1472  
 winding, bifilar, 240

**Note Magnifier**. *See* Low-frequency  
 Amplifier.

**Nuts** and bolts in wireless, 1478  
 lock, 1480  
 removing tight, 1481  
 types, 256, 1479

**O**

**Ohm's Law** explained, 842, 1484

**Oil key**, 1486  
 ring, 1487  
 stone, 1487  
 transformer, 2050  
 varieties and uses, 1352

**Olive Oil**, dielectric constant, 684  
 —strength, 683

**Oscillations**. *See also* Transmission  
 Valves; Waves.  
 aerial, how generated, 826  
 algebraic expression for, 988  
 back, 182  
 conditions for, 1504  
 constant, 1502  
 critical resistance for, 552  
 effect of negative resistance, 1460  
 explained, 1499  
 forced, 951, 1500  
 formulae, 1500  
 free, 986, 1500  
 free, natural frequency of, 1457  
 frequency, 1502  
 generation of local, 1302  
 impact excitation, 1145  
 local, 1302  
 logarithmic decrement, 1310  
 oscillatory discharge, 1505  
 oscillogram, 1506  
 oscillograph, 1506  
 Poulsen arc, 1599  
 resonator, 1741  
 Tesla transformer, 1994  
 testing valve for, 1140  
 theory of, 852  
 transformer, 1502  
 —description, 171, 1228  
 —half-kilowatt, 1228

**Oscillator**, formula, 1504  
 general principles, 1502  
 Hertz, 1097, 1505  
 local, 1302  
 magnetic blow-out for, 1355  
 master, 287  
 multi-gap, 1504  
 negatron, 1462  
 open-circuit, 421  
 at 6 R.J., 2079  
 rod, 1748

**Oscillograph**, cathode ray, 640  
 cathode-ray tube for, 385  
 Duddell, 1508  
 magnetic control, 1509, 1510  
 motor and mirror, 1508  
 principle of, 1507  
 transmission of photographs by, 1539

**P**

**Paint**, aluminium, 67  
 anti-sulphuric, 118  
 applying, 1517  
 brushes, 1517  
 fireproof, 1518  
 luminous, 1518  
 preservative, 1519

- Panel.** *See also* Ebonite. drilling, 1523 lay-out methods, 1521 mounting, 1523 pencil-marking leakages, 1282
- Paper, condenser,** 1524 dielectric constant, 684 dielectric strength, 683 drilling, 745 filter, 934 paraffin, 1525
- Paraffin, paper,** 1525 paper condenser, how to make, 1525 wax, dielectric constant, 684 wax for insulating baseboards, 1185
- Parallel.** *See also* Series. cell connexions, 215, 1526 resistance connexions, 1527
- Pen, dotting, how to use,** 733 drawing, how to use, 731
- Permeability.** *See also* Iron. curves, 943 definition, 1534 magnetic, 234, 947 measurement of, 234
- Petroleum,** dielectric constant, 684
- Photography,** Campbell Swinton's wireless method, 1985 Fournier d'Albe's method, 1537, 1986 Rosing's method, 1984 Ruhmer's method, 1984 theory, 1537, 1983
- Pitch, dielectric constant,** 684 properties, 1545
- Platè Plates, accumulator,** 1549 of D.P. accumulator, 729 original, 11
- Plates.** *See also* Accumulator; Battery. accumulator, 27 accumulator on Faure principle, 729 accumulator on Planté principle, 729 blistering of accumulator, 248 buckling of accumulator, 296 condenser, 1549 earth, 789 Edison cell, 804 Faure, 729, 912 forming of accumulator, 956 negative, 1460 Planté, 729, 1549 positive, 1586 sulphate removal, 1913
- Plug.** *See also* Jack; Terminal. battery, 1554 four-prong connecting, 1554, 1642 home-made, 1553 and jacks, 1218 short-circuiting, 1806 and sockets, 1838 temporary connecting, 1553 varieties, 1553 wander, for tapping, 1966, 2215
- Plug-in.** *See also* Coil; Inductance Coil. basket coils, 210 coil, 1555 coil holders, 466 coils, how to make, 452 connectors, 524, 1556 contacts, 513, 1557 crystal detectors, 568 high-frequency transformer, 1122 inter-valve transformer, 1209 reaction coil, 1560 transformers, 1558
- Plummer Block bearing,** 224
- Polarization, Daniell cell depolarizer,** 1373 definition, 1572 depolarizers, 663 ether waves, 720
- Pole.** *See also* Accumulator; Battery. definition, 1573 finding paper, 1573 mast, 1574 pieces, 1574 polarity test, 405 shoes, 1575
- Polishing, aluminium,** 66 brass, 272 ebonite, 799
- Porcelain, cleats,** 425, 1576 dielectric constant, 684 insulator, 1577 properties, 1576
- Post, binding,** 242
- Potential.** *See also* Electro-motive Force. difference, 843, 1589 electric, 819 electrical pressure explained, 1611 electroscopes method of measuring, 855 of electrostatic field, 865 energy defined, 871 equipotential surfaces, 873 magnetic, 1589 measurement of, 1588 rise and fall from generator, 1022 theory, 1586
- Potentiometer, analogy,** 1590 applications, 1596 Atlas, 1595 battery test with, 1591 in carborundum circuit, 369, 603 circuit position, 1596 Clark cell potentiometer test, 1591 Drysdale A.C. for impedance measurement, 1147 Fuller's, 1595 G.E.C., 1594 General Radio Co.'s, 1595 graphite rod, 1592 howling reduction with, 1140 how to make, 1591 Igranite, 1595 liquid, 1592 neutral point, 1465 rotary, 1595 theory, 1590
- Poulsen Arc, action,** 123 connexions, 1598, 1858 curve, 1498 electrodes, 1599
- Power, amplifiers,** 1601 apparent, 119 buzzer, 1609 factor, 1609 factor of condenser, 355 true, 2093 valve, 1609, 2189, 2195
- Preservation of wood by copper sulphate,** 534
- Preservatives, copper sulphate,** 534 creosote, 551
- Primary Cell.** *See also* Accumulator; Battery. agglomerate Leclanché, 51 balloon pattern Daniell, 1612 Barbier-Leclanche, 1284 bichromate, 239 Bunsen, 300 Calland-Daniell, 1612 Clark, 424 crowfoot, 646 Daniell, 645 Daniell depolarizer, 1573 double-fluid, 722 gravity, 1051 Grove, 1064 Leclanché, 51, 1282 Menotti-Daniell, 646 polarization, 1572 porous pot, 1577 Post-Office Leclanché, 1283 sack Leclanché, 1283 Siemen's sack Leclanché, 1284 single-fluid, 1821 types, 1611 Weston standard, 2233 wet, 2233
- Proton.** *See also* Electron. defined, 845, 1614 nature of, 817
- Pump, Gaede,** 998
- Punch.** *See also* Tools. centre, 393 various types, 1616
- Q**
- Quadrector circuit,** 185
- Quenched.** *See also* Spark Gap. gap discharge, 1622 gap transmitter, 1622 spark, 1623 spark gap, 1623
- R**
- Radiation.** *See also* Transmission; Waves. coefficient, 1626 electrolines, 831 electro-magnetic, defined, 840
- Radiation, electro-magnetic, explained,** 832-33 of electro-magnetic waves, 967 gliding theory, 1040 Heaviside layer, 1092 from loop aerial, 1324 resistance, 1626 theory of, 852
- Radiogoniometer, Bellini-Tosi,** 1044 coils in, 1042 description and use, 229, 1042, 1632 theory, 1043 triangular loop theory, 1043
- Radiophone arc lamp,** 121
- Radio-telegraph abbreviations,** 3
- Range.** *See also* Reception. blanketing effects, 1635 crystal set range, 1659 daylight effect, 648 fading effect, 894 Heaviside layer effect, 284, 720 limits of, 717 long-range three-valve receiver, 2009 receiving sets, map, 282 screening effects on, 1777 sunrise and sunset effects, 648 of transmitting sets, 649 valve sets range, 1659
- Reactance, anode—coil,** 110 anode—unit, 1643 ball, 193 Bardelet unit, 1644 capacity, 1637 capacity coupling, 546 circuit, 1638 coil, 1639 coupling, 1639 methods, 1638 set, how to make, 1639 Sterling unit, 1644 theory and formulae, 1637 units, 1644
- Reaction, on acrials,** 1617 anode circuit, 106 anode grid, 1647 armature, 130 circuits, 1646-47 coil, 1648 coil rotor, how to make, 1651 condenser, 1649 coupling coils, 548 coupling and feed-back circuits, 914 coupling, principle, 105 damper, 1649 Franklin circuits, 981 grid, 1647 howling, causes, 1139 plug-in reaction coil, 1560 P.M.G.'s regulations, 1290 principle, 107 on second valve, 1647 set, how to make, 1649 telephone circuit explaining, 1645 theory, 1645 wave motion with, 1647
- Reception.** *See also* Range, Transmission. automatic, 173 Creed modulator for, 1126 daylight effect, 648 duplex, 769 fading, 894 high speed, 1124 jamming, 1225 Lepel system, 1286 limits of, 717 loading inductance effect on, 1301 long-wave receiver, 1317 long-wave tuner, 1322 map of range, 282 Marconi beam receiver, 1307, 1809 Marconi multiple tuner, 1453 Marconi wireless bell, 1407 range of, 1635 range of crystal sets, 1659 range of valve sets, 1659 screening effects, 1777 short wave, 1807 soulder for, 1854 sunrise and sunset effects, 894 theory of, explained, 826
- Rectification of A.C. current,** 59, 532, 553, 836 crystal, 554 general, 1666

- Rectification**, valve, 1668  
**Rectifier**. *See also* Crystal: Valve, aluminium, 1667  
 circuits using Fleming valve, 943  
 chemical, 16, 411  
 Crypto commutating, 553  
 electrolytic, 836  
 electrolytic, how to make, 887  
 Fleming valve, 941  
 frequency changing by valve, 991  
 Grisson electrolytic interrupter, 1362  
 input for transmitter at 6 R.J., 2979  
 klenotron, 1235  
 mercury arc, 16  
 mercury valve, 1418  
 natural, 1457  
 neon lamp for, 1463  
 Noden valve, 16, 1471  
 potential, 1599  
 three-phase transformer method, 1429  
 Tunzar, 16, 2115  
 U-3 valve, 1668  
 valve, 1668  
 varieties, 1667
- Refraction**, definition, 1681  
 Eccles explanation, 1681  
 of ether waves and distortion, 719
- Regeneration**. *See also* Amplification:  
 Dual Amplification: Super-regeneration.  
 Armstrong circuit, 132, 123  
 Armstrong one-valve, 1379  
 Armstrong three-valve super-regenerative unit, 1379  
 coupling effects, 1685  
 curves, showing effects, 1683  
 function of condensers for, 502  
 Haynes circuit, 1089  
 one-valve circuit, 1684  
 principles, 1685  
 regenerative coupling, 1688  
 regenerator unit, 1699  
 Reinartz, 1700  
 super-regeneration explained, 1915  
 theory, 1682  
 tuned anode regeneration, 1686
- Regenerative Sets**, Cockaday, 431  
 Flewelling, 1916  
 Flewelling super-regenerative, 1916  
 frame aerial, 1925  
 how to make, 1688  
 single-valve, 1689, 1920  
 three-valve, 1696, 1915
- Relay**, Allstrom's, 1793  
 earthing, 701  
 electro-magnet suitable for, 839  
 electron, 852  
 high-speed, for transmission, 1129  
 hot-wire, 1712  
 jet, 1712  
 key, 1721  
 light, 1539  
 local battery, 1302  
 magnetic key, 1365  
 Marconi, 1713  
 moving-coil, 1453, 1711  
 moving-iron, 1711  
 non-inductive, 1712  
 for remote control, 526  
 selenium, 1792  
 short distance control, 528  
 stations, 1721  
 thermal, 1712  
 types, 1711
- Relaying**. *See also* Broadcasting: Transmission.  
 from America, 1715  
 Biggin Hill, 1716  
 from broadcasting stations, 1714  
 at 2 I.O., 1315  
 at Wembley, 1718
- Release**, electro-magnetic, defined, 840  
 no-volt, 1478, 1886  
 overload, 1512, 1886
- Reluctance**, definition, 1722  
 magnetic, 1366  
 of magnetic circuit, 1359  
 and magnetic flux-magneto-motive force relation, 947
- Remote Control**, aircraft, 1723  
 Bowden wire control, 1725  
 circuit diagram, 1724  
 coherer for, 527  
 Marconi at Radio House, 1722
- Remote Control**, relay, 528  
 at Sainte Assise, 179  
 of trains, 531
- Resistance**. *See also* Filament Resistance: Rheostat.  
 adjustable holder for, 112  
 aerial, 59  
 anode, 112  
 blacklead, 246  
 Blaxley variable rheostat, 523  
 bolometer method of measuring, 255  
 box, 1729  
 Burndept resist-a, 1749  
 calibrated, 338  
 Campbell's bridge method of measuring, 355  
 capacity, 364  
 capacity-coupled amplifier, 1104  
 capacity unit, 1732  
 coil, 1732  
 coil, how to wind, 458  
 continuously variable, 523  
 copper, 534  
 of copper wires, 535, 1729  
 coupled amplification, 423, 1199, 1293  
 coupled amplifier, 1733  
 coupled intensifier circuit, 1190  
 coupled valves, 1208  
 coupling, 1738  
 critical, 551  
 definition, 1727  
 earth, how to test, 1998  
 effect on back E.M.F., 145  
 of Eureka wire, 885, 1740  
 field regulator, 1700  
 filament types, 923  
 filament, how to make, 76, 926  
 formula, 1486  
 Foster bridge measurement of, 956  
 of German silver, 1739  
 graphite, 1049  
 high, 1123  
 high-frequency, 1116, 1828  
 high-frequency telephones, 1123  
 how to make filament, 76, 926  
 inter-valve coupling, 545  
 iron, 1740  
 laws of, 1728  
 Lissen variable, 2204  
 Litzendraht cable H.F., 1298  
 manganin, 1390  
 Maxwell Wheatstone bridge for measuring, 1161  
 measurement of, 1727-28  
 metre bridge measurement of, 1423  
 negative, 1460  
 non-inductive, how to wind, 1473  
 ohmmeter for measuring, 1482  
 Ohm's laws, 1484  
 in parallel, 1527  
 of platinum, 1740  
 radiation, 1626  
 relationship between current, E.M.F. and, 841  
 of resist-a, 1740  
 of rheostat, 1742  
 in series, 1794  
 specific resistance, 1869  
 variable, 2204  
 variable starter, 1886  
 wires, 1739
- Resonance**. *See also* Oscillator.  
 curve, 1741  
 Oudin resonator, 1511  
 photography by—method, 1541  
 resonator, 1741  
 theory of, 1740  
 transformer, 1741
- Resonator**. *See also* Oscillator.  
 Hertzian, 1741  
 Oudin, 1511  
 television, 1985
- Rheostat**. *See also* Filament Resistance: Resistance.  
 Burndept dual, 1743  
 definition, 1742  
 field, 918  
 filament, 923  
 how to make, 1743  
 Radio Instruments, 1743
- Rogers' Aerial**, for reducing atmospherics, 152
- Rope**, making bight in, 240  
 bridle, 279
- Rope**, cased cord, 384  
 catenary curve of, 384  
 cordage, 536  
 eye-splice in, 1874  
 fittings for, 537  
 splice strength, 1751  
 splicing, 1875  
 thimble for, 2003  
 wire, 1751
- Rotary**. *See also* Spark Gap.  
 converter, 1751  
 discharger, 1753  
 disk discharger, 714  
 spark gap, 1754, 1865  
 switch, 1755  
 transformer, 1757
- Rotor**, cardboard, 1759  
 drilling variometer, 745  
 ebonite, 1758  
 hardwood, 1759  
 spindle, 1751  
 variometer, drilling, 745
- Rubidium**, properties, 1765  
 for wireless picture transmission, 1985
- Ruhmer Arc**, description, 127, 1786  
 electrodes of, 102, 1766
- Ruling Pen**, use of, 731
- S**
- Sainte-Assise**, auto-transmission of, 179  
 induction coil at, 2134
- Saturation**, current, 1769  
 magnetic, 1142  
 solution, 1769
- Screw**, binding, 293  
 counter-bore for, 540  
 countersinking for, 542  
 cutting methods, 274, 685, 1777  
 driver, 1779  
 insulated, 1183  
 threads, B.A., 179  
 threads, cutting, 274, 685, 1777  
 threads, cutting on lathe, 1271, 1778  
 —gauge for measuring, 1010  
 threads, how to make, 180  
 threads, pitch, 1545  
 types, 1783
- Search Coil**. *See also* Direction Finder.  
 exploring coil, 892  
 function, 229, 697
- Sediment**, in accumulators, 29, 1787
- Selector**, Peto-Scott —switch, 1791  
 switch, 1789  
 for wireless control, 529
- Selenium**, cell, 1791  
 cell circuit, 1544, 1792  
 cells, for wireless photography, 1528  
 importance of, in wireless, 1791  
 properties, 1791  
 relay, 1792  
 sensitivity to light, 1538  
 for wireless transmission of pictures, 1884
- Separate Heterodyne**. *See also* Heterodyne: Beat Reception.  
 reception, 226
- Separators**. *See also* Accumulators.  
 accumulator plate, 729, 1794
- Series**. *See also* Parallel: Stunt.  
 cell connections, 215  
 cells in, 1794  
 coil, 1795  
 coil and condenser in, 1795  
 condensers in, 359  
 dynamo winding in, 1799  
 multiple, 1795  
 parallel, 1794-95  
 parallel for cells, 215  
 parallel switch, 1795  
 resistances in, 1794  
 short-wave condenser, 1811  
 wound, 1799
- Shellac**, dielectric constant, 684  
 properties, 1804  
 varnishing with, 1804
- Short Waves**. *See also* Transmission: Waves.  
 aerial and reflector, 1808  
 chart, 1803  
 circuit diagram for, 1810  
 condenser, 1811  
 difficulties of using, 286  
 Marconi beam receiver, 1393, 1809  
 Marconi's experiments, 1807

- Short Waves**, receiver, how to make, 1812  
receiving aerial, 1809  
transmission, 1807  
tuner for, 725
- Shunt**. *See also* Parallel; Series.  
for ammeters, 70, 1813  
circuit, 1815  
definition, 1813  
in galvanometer, 1813
- Shunt**, shunted connexions, 1814  
wound, 1814
- Sockets**. *See also* Jack; Plug; Terminal  
attachment, 1838  
plug, 1559  
valve, 1967  
various types, 1838
- Soldering**, aluminium, 66, 1842  
brass, 272  
connexions, 2244  
contact studs, 523  
copper, 533  
flux for, 948, 1842  
hard solder, 1842  
iron, 1844  
Lamb's torch, 1844  
lead solder, 1842  
methods, 1844  
silver, 1817  
silver, solder for, 1842  
soft solder, 1842  
solders, 1841  
tin solder, 1842  
wire, 2244  
wire terminals, 512
- Solenoid**. *See also* Magnetism.  
definition, 1849  
iron effect on, 1534  
magnetic field of, 1849  
magnetizing force of, 947  
rule, 1849
- Sound**, box microphone, 1853  
importance in wireless, 1850  
pitch in, 1545  
speed of, 1850  
theory, 1850  
transformation to varying current, 1852
- Spanner**, adjustable, 1859  
box, 263  
double-headed, 1859  
L-shaped, 1860  
varieties, 1859
- Spark**. *See also* Discharger; Trans-  
mission.  
coil, 1861  
coil for transmission, 2069  
coil interrupter, 172  
coupled circuit, transmitter for, 2051  
definition, 1861  
detector, 1862  
dictaphone recorder of frequency, 994  
discharge, 715  
Fleming spark-frequency recorder, 994  
frequency, 1863  
gap, 1863  
high-frequency spark system, 1116  
induction coil, 1174  
length, 1861  
photographic spark frequency recorder,  
995  
quenching, 1624  
shunted buzzer preventer, 1814  
systems surveyed, 2051  
timed, system, 2052  
timed—transmitter, 2019  
transformer, Marconi, 712  
in transmission, 1862  
transmitter, Eiffel Tower, 809.  
transmitter, Marconi, 712, 714
- Spark Gap**. *See also* Discharge; Trans-  
mission.  
anchor type, 94  
arcing, prevention of, 201  
asynchronous, 150  
back oscillation, 182  
Baldwin receiver, 189  
Chaffee, 395  
chopper, 417  
cooling, 1623  
eyemicroscope, 639  
defined, 1008  
discharge, 1863  
electrodes, 1864  
Fleming's silencer, 1816
- Spark Gap**, gaskets for, 1008  
glass silencer for, 1039  
Hertz oscillatory, 1863  
Lepel, 1285  
for low power, 1865  
micrometer, 1428  
multiple, 1008  
oscillatory discharge across, 1505  
Peukert discharger, 1534  
Poulsen, 1598  
quenched, 1623  
rotary, 710-714, 1754, 1865  
rotary discharger, 1753  
rotary  $\frac{1}{4}$  kw. twin generator, 1032  
safety on condenser, 481  
silencer, 1816  
synchronous disk discharger, 1950  
Telefunken, 1968  
transmitting, 1865  
wave propagation from, 832  
Yagi, 2249
- Sparkling**, buzzer, 1867  
dynamo, 1866
- Spelter**. *See also* Brazing.  
use in brazing, 275  
properties, 1870
- Spinning** aluminium, 66
- Spreader**. *See also* Aerial.  
bamboo, 195  
four-wire, how to make, 1879  
twin-wire aerial, 2140  
types, 1877
- Staining**, cabinets, 319
- Starter**, auto, 174  
motor, 1886
- Stoppers**, for accumulators, 28
- Strainer**. *See also* Aerial; Spreader.  
adjustable, 31  
aerial, 41
- Stud**. *See also* Contact.  
clip, 1919  
contact, 522  
switch, 1911
- Stuffing Box**, on Bradfield insulator, 267  
1912  
definition, 1912
- Sulphation**. *See also* Accumulator.  
in accumulators, 20, 1912  
prevention of, 1914  
removing from plates, 1913
- Sulphuric Acid**, for accumulators, 19  
anti-sulphuric paint, 118  
carboy for, 371  
use in Daniell cell, 645  
diluting, 1914  
strength for accumulators, 1915  
uses in wireless, 1914
- Super-regeneration**. *See also* Regener-  
ation.  
advantages, 1915  
Armstrong circuits, 140, 146  
Bolito circuit, 254  
circuit, 1918  
Flewelling circuits for, 943  
howling tendency of, 1140  
oscillator set, how to make, 1921  
principle, 1915  
receiver, how to make, 139  
set, how to make, 1916  
theory, 136  
three-valve set, how to make, 1925
- Switch**, aerial, 50  
anti-capacity, how to make, 114  
arm components, 1936  
barrel, 200  
battery, 219  
B battery, 221  
board, 1939  
brushes for, 292  
capacity, 365  
change over, 398  
condenser, 505  
coupled, 1933  
for crystal and amplifier, 1944  
for crystal to valve, 1945  
for cut-outs, 169  
dead end, 651  
dead end, how to make, 652  
Dewar, 677, 1936  
double-pole, 398, 1247  
double-pole, how to make, 723  
double-pole, double-throw, 1935  
double-throw, how to make, 727  
earth, how to make, 790
- Switch**, heavy current, 1931  
how to make, 1935  
inductance, 1167  
key, how to make, 1242  
knife, 1244, 1933  
lightning, 1292  
lightning arrester, 1291  
Lissen, 1936  
loud speaker, 1946  
over-load release, 1932  
plug switchboard, 1940  
range, 1635  
rocker type, 1938  
rotary, 1755  
selector, 1789  
series-parallel, 505  
series-parallel in crystal receivers, 558  
series-parallel, how to make, 1795  
single-pole, 398, 1244  
single-pole, how to make, 1245  
single-pole change-over, 1934  
sliding, 1936  
sparking at contacts, 1867  
stand by, 1884  
stud, 1911  
switching systems, 1943  
swivel, 1947  
swivel, how to make, 1948  
three-valve, 1945  
throw-over, 2015  
throw-over, how to make, 2016  
time, 2020  
tumbler, 1934  
tumbler, 2100  
two crystals, 1944  
two-valve, 1944  
types, 1931  
unsuitable, 911
- Symbols**, chemical and electrical, 2
- T**
- Tapper**, decoherer, 656  
double, contact 1965  
key, 1237, 1446  
key, how to make, 1970  
sounder, 1447  
sounder, electro-magnetically operated,  
1970
- Tapping**. *See also* Coil; Jack; Plug.  
batteries, 1965  
coils, 447, 460, 907, 1966  
inductance coils, 1163-64, 1956  
key, 1237  
sizes for B.A. screws, 179
- Taps**. *See also* Earth.  
for earths, 787
- Taps**. *See* Dies.
- Telefunken**, arc system of, 123, 1967  
circuits, 1968  
crystal detector, 568, 1969  
spark gap, 1968
- Telegraphy**. *See also* Broadcasting;  
Transmission.  
automatic high-speed, 1124  
duplex wireless, 187  
high-speed, 1973  
historical survey, 1972  
sounder, 1969
- Telegram**, wireless, how sent, 1124
- Telephone**. *See also* Loud Speaker;  
Microphone.  
amplifying, 91  
armature, 130  
condenser, 1974  
cord and connectors, 514  
for the deaf, 1980  
distribution board, 1974  
earpiece, how to make, 1270  
Geophone distribution box, 1974  
gramophone attachment, 1046  
high-resistance, 1123  
how to wear, 1092  
Lissen distribution board, 1975  
mouthpiece, 1452  
pneumatic earpads, 1562  
principles of, 1852  
receivers, 1976  
Sorbo earpads, 782  
testing for faults, 905, 909  
transformer, 1980  
types, Bell's original, 227  
—Brandes, 267  
—Brown, 291  
—Brown, Type A reed, 1977

**Telephone, types.** Brunet, 292  
 — Dynaphone, 781  
 — E.E.C., 1091  
 — Ericsson, 874  
 — Federal, 1976  
 — French type, 1979  
 — Geophone, 1123  
 — Landphones, 1075  
 — Ladies, 1980  
 — Sterling, 1091, 1977

**Telephony.** *See also* Telegraphy: Broadcasting.  
 duplex, 767  
 historical survey, 1981

**Television.** *See also* Photography.  
 Campbell Swinton's method, 1985  
 Fournier D'Albe's method, 1537, 1986  
 general principles, 1983  
 Rosings's method, 1984  
 Ruhmer's method, 1984  
 theory, 1537, 1983

**Terminals, duo,** 766  
 eye, 1954  
 flat connecting, 938  
 Gent and Co.'s, 1991  
 hook, 1954  
 plug-in, 1991  
 quick-grip, 1993  
 Refty, 1682  
 spade, 1954, 1990  
 split-pin, 1990  
 substitutes, 1993  
 telephones, 1954, 1992  
 valve-socket, 1990  
 varieties, 1989  
 War Office, 1990

**Testing, buzzer for,** 1995  
 air condenser, 1995  
 buzzer for low resistance, 1996  
 accumulator charging, 18  
 circuits with galvanometer, 1003  
 combination meter for, 471  
 condensers, 56  
 continuity of coils, 461  
 crystal sets with buzzers, 311  
 current polarity, 405  
 faults in receiving sets, 904, 909  
 filament circuit, 297  
 howling faults, 1140  
 insulation, 1415  
 megger for, 1415, 1996  
 Menotti cell for, 1417  
 resistance of earth leads, 1998  
 sliding contacts, 520  
 sparking buzzer for, 1867  
 valve efficiency, 1996  
 valve for oscillation, 1140  
 voltage of insulators, 2213  
 wire polarity, 1996

**Thermo-electric Ammeter.** *See also* Ammeter.  
 description, 1999  
 Marconi type, 2000  
 principle of, 69

**Thermopile, junctions,** 2002  
 Moll, 1444  
 principle, 2002  
 sensitive type, 2002-3

**Threads.** *See also* Screw.  
 how to cut, 685

**Three-phase System.** *See* Delta Connections.

**Three-wire System,** balancer on, 186  
 battery connections, 2015  
 protected, 2015

**Time Signals,** apparatus for broadcasting, 1314  
 Big Ben, 2019  
 Eiffel Tower, 2019

**Tools, hand saw,** 1770  
 bell-hanger's gimlet, 2070  
 bit, 246, 261  
 brace, 264  
 centre punch, 393  
 chisel, 413  
 circular saw, 1770  
 counterbore, 540  
 countersink bit, 542  
 cramp, 550  
 dies and taps, 685  
 drawing instruments, 731  
 drills, 737  
 files, 927  
 gauge, 1013  
 gimlet, 1034

**Tools, gouge,** 1045  
 grinding, 1060  
 hammers, 1071  
 hand saw, 1076, 1771  
 key-hole saw, 1771  
 lathe, 1265  
 level, 1287  
 mallet, 1387  
 marlinspike, 1408  
 mortise chisel, 1448  
 mortise gauge, 1450  
 oilstone for sharpening, 1487  
 paring chisel, 1528  
 parting tool, 1272  
 planes and planing, 1546  
 pliers, 1550  
 plough plane, 326  
 punches, 1616  
 saws, 1769  
 scraper, 1776  
 screwdriver, 1779  
 scriber, 1783  
 scribing block, 1784  
 shears, 1802  
 spanners, 1838  
 spokeshave, 1876  
 S.W.G. gauge, 1923  
 taps, 1967  
 union saw, 1771  
 wire gauge, 1069

**Transformer.** *See also* High Frequency;  
 Low Frequency.  
 aperiodic, 2034  
 auto, 175-76  
 closed core, 430, 1210  
 condenser with, 503  
 construction, 2028  
 cooling of, 2030  
 core construction, 2043  
 coupled amplifier circuit, 1346  
 coupled crystal set, 609  
 coupled intensifier circuit, 1190  
 coupled L.F. amplifier, 1294  
 coupled set, 2045  
 coupling, 176, 1208  
 direction finder, 701  
 earthed, why should be, 784  
 efficiency of, 2030  
 flux in core, 1375  
 formulae for construction, 1350  
 free magnetism of, 986  
 functions of, 2028  
 hedgehog, 1093  
 high-frequency, 1117, 1632  
 high-frequency, how to make, 752-53  
 1119, 2036  
 high-frequency, latitude of, 1274  
 high-frequency, wave-length table, 2045  
 howling, due to, 1140  
 how to make, 164  
 inter-valve, 1209  
 inter-valve coupling with, 545  
 iron-cored distortion, 718  
 laminations, 1259  
 leakage flux, 2020  
 losses, 2029  
 low-frequency, 160, 1349, 1476  
 low-frequency principles, 160  
 low-frequency shell type, 2040  
 modulator, 1443  
 modulator for transmission, 2068  
 oil, 2050  
 open-core, 163, 1495  
 open-core modulation, 2033  
 oscillator, 171  
 oscillation or jigger, 1228, 1502  
 pancake, 1519  
 plug-in, 1558  
 plug-in, how to make, 1122  
 Polar, 1571  
 principle of, 160, 824, 1374  
 push-pull, 2038  
 push-pull circuits, 2038  
 resonance, 1741  
 rotary, 1757  
 Round circuit, 1763  
 quadrature, 1619  
 reaction circuit, use in, 429  
 resistance loss, 2029  
 series winding, 2029  
 shell, 1804, 2040  
 shielded, 1804  
 short circuit of, 1805  
 shut winding, 2029

**Transformer, step-down,** 1899, 2028  
 step-up, 1899, 2028  
 tank, 1955  
 telephone, 1980  
 testing, 2044  
 three-phase, 661  
 three-phase, mesh connexions, 1419  
 transformation ratio, 2027  
 transmitting, 2030  
 types of, 162, 2028  
 variable type H.F. plug in, 2033  
 wave-length ranges, 2045  
 windings, 176, 2029

**Transformer, Types.** Burndept low frequency, 1350  
 Connecticut, 163, 2032  
 Elwell, 163  
 Eureka, 2033  
 Fuller's, 1981, 2031  
 G.E.C., 2032  
 G.R.C., 2034  
 Igranic, 162  
 Lissen T 2, 2034  
 Lissen T 3, 2034  
 McMichael plug-in, 1414  
 Marconi aperiodic, 2034  
 Marconi enclosed oil-filled, 2031  
 Marconi telephone, 1981  
 Maxvol, 2032  
 Oajah plug-in, 1494  
 Sterling, 2032  
 Sterling H.F., 1118, 1631  
 Sterling L.F., 1210  
 Tesla, 1994

**Transmission.** *See also* Broadcasting.  
 aircraft, 1723  
 amateur, by W. Le Queux, 2064  
 from America, 1715  
 arc lamp circuit for, 121  
 automatic, 177  
 automatic relay, 1365  
 Berengaria transmitting set, 2059  
 Berne lattice mast, 1276  
 Berne station lead in, 1279  
 blowing motor for, 253  
 breaking in, 279  
 Brentwood wireless telegraph station, 1128  
 broadcasting, 281, 1311  
 choke control, 416  
 circuits, 419  
 condensers for, 477, 482  
 constant current modulation, 516  
 continuous wave circuit, 2067  
 coupled-circuit transmitter, 2051  
 Creed keyboard perforator, 1125  
 Creed Wheatstone machine, 1125  
 directive aerials for, 1043  
 disk discharger adjustment, 2052  
 Eiffel tower, 805  
 Ericsson microphone transmitter, 875  
 fading, 894  
 fan aerials for, 896  
 Franklin circuits, 981  
 Gell keyboard, 1019  
 generating set for H.T. and L.T. current, 1032.  
 generators for, 1019  
 of gramophone records, 1853  
 half-plate condenser for, 1068  
 Hartley circuit, 2074  
 Heising modulation, 1093  
 helix for, 1095  
 high-speed, 253, 1124  
 high-speed relay, 1129  
 historical survey, 1972, 2051  
 H.T. generator at Carnarvon, 1629  
 H.T. supply, 2068  
 inductance coil at Sainte Assise, 2134  
 jamming, 1225  
 jigger, 2090  
 L aerial for, at Ongar, 1258  
 Lepel system, 1285  
 light method, 1541  
 London broadcasting station, 1311  
 McLachlan recorder, 1413  
 main condenser for, 1385  
 Manchester station, 1388  
 Marconi wireless bell, 1407  
 microphones for, 1428  
 modulation circuits, 1442  
 Morse tapping key, 1237  
 moving coil relay, 1453  
 multi-aerial system, 984



**Transmission** of photographs, 1986, 1537  
 portable sets for, 1581  
 power buzzer, 1609  
 quenched gap transmitter, 1622  
 from Radio house, 1124  
 Radiola, 1633  
 range of, 1635  
 relaying, 1714  
 relay key, 1721  
 relay stations, 1721  
 remote control, 1722  
 rotary discharger ship's et 2056  
 Round valve, 1764  
 screening effects on, 1777  
 seven-valve ship's transmitter, 2061  
 ships' transmitters, 2054  
 short wave, 1807  
 short wave condenser, 1811  
 short wave transmitting aerial at Inch-keith Island, 1808  
 Siemen's cabinet transmitting set, 2060  
 six arc circuit, 122  
 smoothing circuit, 1836  
 smoothing unit at 5 LS, 2072  
 spacing coil, 1858  
 spark, advantage, 2052  
 spark coil for, 2069  
 spark, explained, 1862  
 spark frequency, 1863  
 spark systems, 2051  
 spiral inductance, 1873  
 sunrise and sunset effects on, 894  
 Swiss commutator, 1930  
 synchronous disk discharger, 1950  
 T aerial at Bournemouth, 1953  
 tapped inductance for, 1964  
 tapper, 1964  
 Telefunken, 1967  
 telephony, historical survey, 1981  
 Tesla transformer, 1994  
 theory of, 826  
 thorium in transmitting valves, 2005  
 ticker, 2018  
 time signals, 2019  
 timed spark system, 2052  
 tone wheel, 2025  
 transformer for, 2030  
 transmitting condenser, 2080  
 transmitting inductance, 2090  
 transmitting key, 1237  
 transmitting key, how to make, 1238  
 trench transmitters, 1033  
 United States, 2152  
 valve systems for, 2052  
 Wembley relay, 1718  
 Wheatstone printing telegraph, 1613

**Transmitter**, aeroplane, 2064  
 aircraft communication,  $\frac{1}{2}$  kw., 2063  
 arc, 123  
 arc at Carnarvon, 2062  
 Berengaria apparatus, 2050  
 at Berne, Switzerland, 1095  
 2 BGM, 2073  
 at Birmingham, 244  
 broadcasting, 280  
 Bull, 298  
 at Cardiff station, 377  
 Chaffee spark, 395  
 chopper, 417  
 Colin-Jeanne, 470  
 condenser system, 2089  
 construction, 2071  
 Creed Wheatstone high-speed, 1125  
 half-kilowatt ship's, 2058  
 le Queux's set, 2070  
 5 LS, 2071  
 at Manchester station, 1388  
 quarter-kilowatt ship's, 2058  
 Rigi, 2065  
 6 R.J., 2073, 2082  
 seven-valve ship's, 2061  
 ship's rotary discharger type, 2056  
 Siemen's cabinet, 2060  
 timed spark, 2019  
 Tingey transmitting set, 2055  
 tuning lamp, 1260  
 unit system, 2054

**Trigger Disk**, description, 2092  
 300 kw. transmitter, 713

**Tuned Anode**. *See also* Amplification; Amplifier.  
 advantages, 2100  
 circuit diagrams, 106, 363, 758, 1686, 2103, 2104

**Tuned Anode**, coupling reaction coil, 128  
 example of, 108  
 method of H.F. amplification, 1103  
 set, how to make, 755  
 two-valve set, how to make, 2101  
 three-valve set, 2104

**Tuner**. *See also* Inductance Coil; Variometer.  
 double-range, 725  
 double-slide, 727  
 how to make, 2108  
 long-wave, 1322  
 Marconi multiple, 1455  
 panel at 6 R.J., 2080, 2085  
 three-slide, 2006  
 types, 2108  
 universal, 2166

**Tungar Rectifier**, description, 16, 2115  
 Tuning. *See also* Coil; Inductance Coil; Condenser.  
 of Armstrong receivers, 140, 145, 148  
 balanced crystals, 184  
 broad, 280, 1800  
 brush for, 295  
 buzzer, 2131  
 coil, 2131  
 coil stand, how to make, 2131  
 crystal receivers, 557-58, 572  
 crystal receivers with amplification, 629  
 detuning, 676  
 faults in, 906  
 filter circuits 932  
 flat, 939  
 inductance, 1169  
 inductive coupling for, 547  
 lamp, 2136  
 Lodge on, 1307  
 loose couplers for, 1328  
 note or tone, 1478  
 principles, 2117  
 reaction damper, 1649  
 rejector circuits, 1707  
 sharp, 1800  
 sharp lay-out for, 1801  
 single-slider coil, 1833  
 spade, 1396  
 spade for transformers, 1631  
 switch, 2137  
 syntony, 1952  
 tone, 2025  
 tone filter, 2022  
 three-slide tuner, 2006  
 two-slider coil, 1833

**Turning**. *See also* Lathe Work.  
 brass, 271  
 ebonite, 798  
 metal, 1266  
 wood, 1266 67

**Turpentine**, dielectric constant, 684

**T.Y.K. Arc**, use of boron in, 259  
 description, 2141  
 electrodes 102, 127

**U**

**Units**, absolute, 9  
 ampere, 70  
 ampere-hour, 70  
 ampere-turn, 70  
 Angstrom, 97  
 article by Sir O. Lodge, 2160  
 B.A., 220  
 B.A. ohm, 1729  
 Board of Trade, 253  
 Board of Trade ohm, 1729  
 British system, 280  
 British thermal, 296  
 calorie, 355  
 C.G.S., 393  
 coulomb, 540  
 of current, 70  
 dyne, 782  
 electric, 393  
 electro-magnetic, 840  
 electrostatic, 867  
 erg, 874  
 farad, 901  
 foot-pound system, 940  
 gauss, 1014  
 henry, 1096  
 horse-power, 1136  
 international, 1200  
 jar, 1226  
 joule, 1232

**Units**, kelvin, 1233  
 kilowatt, 1244  
 magneto-motive force, 70  
 metre, 1423  
 mho, 1425  
 orsted, 1482  
 ohm, 1482  
 poundal, 1600  
 power, 1600  
 quantity, 70  
 seohm, 1785  
 volt, 2213  
 watt, 2216  
 Weber, 2231

**Unit Sets**, anode reactance, 1643  
 cabinets for, 320  
 condenser for, 506  
 crystal detector unit, 569  
 detector, 671  
 H.F. amplifier, 89, 1627  
 induction coil, 1165  
 L.F. amplifier, 77  
 Peto-Scott single valve, 1823  
 Polar Blok system, 1564  
 reactode unit, 1654  
 regenerator, 1699  
 resistance capacity, 1732  
 Sterling, 2165  
 Sterling smoothing, 1847  
 Tingey, 2166  
 universal unit set, 2169  
 valve transmitter, 2054

**V**

**Vacuum**, Gaede pump for, 998  
 tubes, canal rays in, 356  
 —cathode rays in, 385  
 —Coolidge, 2248  
 —Crookes, 552  
 —Faraday dark space, 902  
 —Geissler, 1018  
 —X-ray, thorium control, 2005

**Valve**. *See also* Broadcasting; Transmission.  
 action in transmitting, 2052  
 amplifying, 92  
 balanced for reducing atmospherics, 1888  
 blue glow in, 253  
 characteristic curves of, 402, 2102-93  
 characteristics, measuring, 1835  
 control, 525  
 control in broadcasting, 283, 288  
 coupling between, 1207  
 detector, 675  
 dull emitters, 87, 761, 1405, 2231, 2249  
 Edison effect, 804  
 Eiffel Tower transmitting, 812  
 filament of, 921  
 Fleming's invention of, 1973  
 four-electrode, 959, 2146  
 four-electrode intensifier circuit, 1191  
 Gaede pump for, 998  
 general article, 2178  
 grid, 1052  
 hard, 1086  
 holder, 2178  
 holder, Holderstat, 1570  
 holder, rubber packing for, 1515  
 leg, 2179  
 modulator, 1443  
 oscillator, 2180  
 packing, 1514  
 panels, how to make, 666  
 power, 1609, 2189, 2195, 2232  
 principles of three-electrode, 401  
 reception, 2185  
 rectifying, 1668  
 regenerative circuits, use in, 141  
 Round, 1764  
 Round transmission, 1765  
 saturation current, 1769  
 saturation point, 1769  
 sheath of Cossor, 1803  
 sockets, 1838  
 soft, 1841  
 space charge, 1854, 2146  
 testing for faults in, 908  
 thorium in, 2005  
 transmission, 2052, 2196  
 transmitting, use of argon in, 127  
 two-electrode, 401

**Valve Types**. Audion, 168  
 B.T.H. B4, 2187, 2191

**Valve Types.** Cossor, 538, 2187, 2191  
 -D.E.B. Marconi-Osram, 761, 2186, 2191, 2193  
 -D.E.R., 2190, 2193  
 -Dextraudion, 2249  
 -dull emitter, 87, 761, 1405, 2231, 2249  
 -Dutch, 774, 1841  
 -dynatron, 781  
 -Ediswan A.R., 675, 2191  
 -Fleming two-electrode, 941  
 -French, 988  
 -kenotron, 1235  
 -Langmuir, 1260  
 -Lieben-Reisz, 1299  
 -L.S.2, 2232  
 -L.S.3, 2191  
 -L.S.5, 2191, 2193, 2195  
 -magnatron, 1382  
 -Marconi R., 2186, 2192  
 -Marconi R.2.A., 676  
 -M.O. 100 watt, 2197  
 -M.O. power, 2189  
 -M.O. R.5.V., 2189, 2192  
 -M.R.4, 2199  
 -M.R.5, 2195, 2199  
 -M.R.Z., 2192  
 -M.T.2, 2201  
 -M.T.4, 2200  
 -M.T.5, 2199  
 -M.T.6, 2199  
 -Mullard, 1453  
 -Myers, 2182  
 -Noden, 1471  
 -phiodynatron, 1552  
 -pliotron, 1552  
 -Q, 1624  
 -QX, 1625  
 -Round, 1764  
 -T.4.A., 2197  
 -U.3, 1668  
 -water-cooled, 2199  
 -Weco, 2231  
 -Xtraudion, 2249

**Valve Sets, choosing, 1657**  
 packing, 1515

**Valve Sets. How to make. See also Amplifier; High-frequency Amplifier; Low-frequency Amplifier.**  
 -Armstrong super-regenerative receivers, 133  
 -audio-frequency amplifier, 156  
 -Baty tuned anode, 2101  
 -Cockaday, 451  
 -detector unit, 671  
 -detector panel, 666  
 -dual amplification, 749  
 -experimenter's valve panel, 889  
 -Flöwelling, 1916  
 -four-valve set, 961  
 -frame aerial set, 975, 1925  
 -hanging set, 1077  
 -H.F. amplifiers, 611, 621, 1105  
 -H.F. amplifier units, 1627  
 -H.F. one-valve, 89  
 -H.F. and L.F. crystal amplifier, 2180  
 -home constructor's, 1132  
 -long-wave receiver, 1317  
 -low frequency to crystal, 609  
 -low frequency one-valve for crystal, 75  
 -Myers valve, 2182  
 -neutrodyne receiver, 1467  
 -note magnifier, 1475  
 -one-valve detector, 666-671  
 -one-valve dual amplifier, 749-755  
 -one-valve power amplifier, 1604  
 -Polar Blok set, 1564  
 -portable sets, 623, 1577  
 -reactance set, 1639  
 -reaction two-valve, 1649  
 -reflex one-valve, 1670  
 -reflex three-valve, 1673  
 -regenerative set, one-valve, 1689  
 -regenerative set, one-valve with L.F., 1695  
 -Reinartz, 1701  
 -resistance-coupled amplifier, 1733  
 -single-valve, 1824  
 -S.T. 100, 1894  
 -super-regenerative, 1916  
 -three-valve super-regenerative, 1925  
 -three-valve transformer-coupled, 2009

**Valve Sets, transformer-coupled, 2045**  
 -two-valve with dull emitters, 86, 762  
 -tuned anode sets, 2101  
 -two-valve L.F. amplifier, 80, 157  
 -Unidyne, 2146  
 -Universal tuner, 2166  
 -Universal unit set, 2169

**Valve Sets. Types. American broadcast reception at Biggio Hill, 1717**  
 -Aristocrat, 1664  
 -Aristophone, 127  
 -B.T.H., 297  
 -Burndopt H.F., 1106  
 -Climax, 1661  
 -Economic Electric, 1658  
 -Ethophone, 882  
 -frame aerial super-regenerative, 1925  
 -Fellophone, 914, 1639  
 -Ercnophone, 989  
 -Geophone, 1014, 1348  
 -H.F. amplifiers, 1106, 1112  
 -Lyrian cabinet, 333  
 -Magnavox, 1353  
 -Marconi H.F., 1106  
 -Marconi four-valve, 1663  
 -Marconi three-valve, 1663  
 -Marconiphone, 1396  
 -Marconi's resistance-coupled amplifier, 1734  
 -Metropolitan-Vickers, 1424  
 -Oracle L.F. amplifier, 1348  
 -Peto-Scott one-valve, 1823  
 -Polar L.F. amplifier, 1348  
 -Polar Radiophone, 1107  
 -Polar seven-valve, 1665  
 -Sterling four-valve, 1660  
 -Sterling H.F. 1106, 1631  
 -Sterling one-valve, 1823  
 -Sterling speech amplifier, 1870  
 -Sterling Threeflex, 661  
 -Tingey L.F. amplifier, 1347  
 -Tingey one-valve, 1823  
 -Tingey super-five, 2022  
 -Tingey transmitting, 2055  
 -Tingey two-valve, 1659  
 -unit system valve transmitter, 2054

**Valve Socket, drilling template, 1987**

**Vario-coupler, Baty, 2192**  
 how to make, 141  
 tuning unit, 2110  
 types, 2205

**Variometer, advantages of variometer tuning, 574**  
 basket type, how to make, 750-752  
 connecting strips for, 510  
 connexions for, 515  
 construction, 2206  
 in crystal receivers, 558  
 drilling rotor for, 745  
 formers for, 956  
 Geophone, 2205  
 G.R.C., 2206  
 how to make, 585, 2206  
 rotor winding, 2207  
 spindle, 1872  
 stator, 1890  
 stator from rubber ball, 1891  
 testing for faults in, 907  
 tuning, 574  
 types, 2205  
 winding stator, 1809

**Vents, for accumulators, 28**  
 adjustment on loose coupler, 1329

**Vernier, caliper gauge, 10, 2**  
 condenser, 2208  
 - spindle, 1873  
 condensers, how to make, 489  
 control for condensers, 484, 491  
 devices, various types, 335, 2210  
 fine adjustment knob, 1251  
 gauges, 1012  
 lever control, 2211  
 loose-coupler vernier device, 1329  
 rubber disk, 2211  
 sliding inductance, 1834  
 tubular condenser, 2094  
 worm-driven, 2212

**Voltage. See also Electro-motive Force.**  
 anode, 113  
 battery, 214, 221  
 bichromate cell, 238  
 breakdown, 278  
 Clark cell, 424

**Voltage, disruptive, 716**  
 drop, 237  
 Leclanché cell, 1283  
 limiting, 1293  
 loss in accumulators, 20  
 potential explained, 1587  
 securing, of various materials, 683  
 surges, 834  
 testing for insulators, 2213  
 virtual volts, 2213

**Voltaic Cell. See Primary Cell.**

**Voltmeter. See also Ammeter; Galvanometer.**  
 calibrating, 344  
 description, 2215  
 double range, 726, 2214  
 G.P.O. detector, 665  
 Kelvin's electrostatic, 1234  
 small voltage, 2214

**Vreeland's Arc, electrodes of, 102**

**W**

**Wattmeter, action explained, 820, 2216**  
 Ferranti integrating, 2218  
 integrating, 1188  
 Sumner, 2216

**Watts, apparent, 829**  
 definition, 2216  
 measurement of, 829  
 true, 829  
 wattless current, 2216

**Wave. See also Radiation.**  
 amplitude, 94  
 carrier, 378  
 continuous, 523  
 cycroscope to detect, 639  
 damped, 642  
 distortion of, 719  
 double-humped, 722  
 electro-magnetic, how propagated, 831  
 electro-magnetic, theory, 825  
 flat-top, 938  
 frequency table, 990  
 fundamental, 996  
 gamma, 1008  
 gliding theory, 1040  
 harmonics of, 1087  
 Heaviside layer, 1092  
 Hertzian, 1097  
 impure, 1158  
 infra-red, 1182  
 interrupted continuous, 1260  
 Lissen wave trap, 2230  
 Lodge on, 2225  
 logarithmic decrement, 1310  
 long-wave receiver, how to make, 1317  
 long-wave tuner, 1322  
 oscillograms, 1506  
 oscillograph, 1506  
 production of, 826  
 pure, 1619  
 radiation of, 967  
 reflection of, 1669  
 ranges for H.F. transformer windings, 2045  
 refraction, 1681  
 Röntgen rays, 1748  
 short, 1807  
 short-wave condenser, 1811  
 short-wave receiver, how to make, 1812  
 sound, 1850  
 theory, 2225  
 tuner for long and short, 725  
 ultra-violet, 2142  
 wave trap, 2230  
 wireless and other waves. Sir O. Lodge, iii, 2225  
 X-rays, 2248

**Wave-length, of aerial, 37**  
 alignment chart for, 58  
 of basket coils, 202  
 broadcasting, 251  
 Burndopt coil ranges, 301  
 cyrometer measurement of, 638  
 de Forest coil ranges, 660  
 formula for, 638  
 frame aerials, 968  
 heterodyne wave-meter, 1100  
 Igranic coil ranges, 1144  
 loading coil, 1300  
 measurement of, 851  
 natural, 1457  
 Oojah coil ranges, 1494

**Wave-length**, slab coils, 1830  
table, 2219  
**Wave-meter**, action, 2220  
construction, 2223  
Donitz, 721  
Fleming's, 637  
heterodyne, 1100  
Marconi, 1406  
Mark IV, 2220  
types, 2220  
variometer, 2208  
**Wax**, black, 248  
paraffin, dielectric constant, 684  
paraffin, for insulating cardboard tubes, 372  
**Wheatstone Bridge**. *See also* Bridge.  
applications, 2235  
barretter, 200  
bolometer type, 255  
calibrated resistance for, 338  
D'Arsonval galvanometer, use with, 643  
Maxwell for measuring inductance, 1161  
P.O. resistance box type, 1729  
theory, 2234  
**Willemite**, use in cathode ray tube, 385  
**Winding**, of coils. *See* Coils.  
**Wire**, annealed iron, 98  
armoured, 131  
bonding, 2243  
binding, 243

**Wire**, brass, 270  
B.W.G., 312  
cable, 334  
copper, 534  
copper, resistances, 1729  
cotton covered, 539  
double cotton covered, 722  
enamelled, 870  
flex and its uses, 845  
galvanized iron, 990, 2239  
gauges for, 1009, 1014  
general properties, 2239  
gold, 1040  
hard-drawn, 1086  
imperial wire gauge, 1148  
iron, 1215  
joints in, 1230  
lead-covered, 1278  
Litzendraht, 1298  
Litzendraht for minimizing capacity, 364  
low-frequency transformer, 161  
pliers for bending, 1551  
resistance, 1739  
—of Eureka, 885  
—of manganin, 1390  
rope, clipping and holding, 537  
sizes, cotton covered, 540  
sizes and weights, 535  
spool, 1877  
standard wire gauges, 1930  
straightening, 2243

**Wire**, Wollaston for barretters, 200, 2248  
**Wireless**, control, 527  
mechanics for wireless amateurs, by E. W. Hobbs, xxv  
pleasures of, by E. Blake, vi  
seeing by, 1983  
theory of, for amateurs, by Dr. J. A. Fleming, xi  
wired, 2239  
wonders of the future, by N. W. McLachlan, xxix  
**Wiring**, binding post, 242  
binding screw, 243  
general methods, 2242  
insulating sleeving for, 1831  
methods, 510, 2242  
soldering methods, 1847  
staves in, 2245  
systoflex, 1952  
testing for correct, 910  
tools for, 2242  
valve panels, 2243  
**Wollaston Wire**, for barretters, 200  
**Z**  
**Zinc**, for bichromate cell, 239  
expansion coefficient, 1712  
Daniell cell, 645  
plates of half-plate condenser, 1070  
properties, 2250  
specific gravity, 1860

Introductory Articles

PAGE

WIRELESS AND OTHER WAVES, by Sir Oliver Lodge, F.R.S. . . . . iii  
THE PLEASURES OF WIRELESS, by E. Blake, A.M.I.E.E. . . . . vi  
WIRELESS THEORY FOR AMATEURS, by Dr. J. A. Fleming, F.R.S. . . . . xi  
THE STORY OF BROADCASTING, by Rex F. Palmer, B.Sc. . . . . xvii  
MECHANICS FOR WIRELESS AMATEURS, by Edward W. Hobbs, A.I.N.A. . . . . xxv  
RADIO WONDERS OF THE FUTURE, by N. W. McLachlan, D.Sc., M.I.E.E. . . . . xxix

Special Articles by Leading Authorities

PAGE

BROADCASTING: (I) GENERAL PRINCIPLES AND METHODS  
By Richard Twelvetrees, A.M.I.Mech.E. 281  
BROADCASTING: (II) THE ENGINEERING PROBLEMS  
By Capt. P. P. Eckersley, of the B.B.C. 285  
CALL SIGNS: AMATEUR TRANSMITTING STATIONS  
Compiled by Leslie McMichael, M.Inst.R.E. . . . . 349  
CONTROL OF MACHINES BY WIRELESS WAVES  
By Major Raymond Phillips, I.O.M. . . 527  
ELECTRICITY: ITS CHARACTERISTICS AND MODES OF ACTION  
By J. H. T. Roberts, D.Sc., F.Inst.P. . . 816  
THE ELECTRON IN THEORY AND PRACTICE  
By Sir Oliver Lodge, F.R.S. . . . . 845  
ELECTROSTATIC CAPACITY AND HOW TO CALCULATE IT  
By Sir Oliver Lodge, F.R.S. . . . . 855

PAGE

THE ETHER: MODERN THEORIES  
By Sir Oliver Lodge, F.R.S. . . . . 876  
THE FLEMING VALVE: A PIONEER INVENTION  
By Prof. J. A. Fleming, F.R.S. . . . . 941  
GENERATORS FOR TRANSMISSION AND OTHER PURPOSES  
By A. H. Avery, A.M.I.E.E. . . . . 1019  
INDUCTANCE IN MAGNETIC CIRCUITS  
By Sir Oliver Lodge, F.R.S. . . . . 1157  
INDUCTION AND HOW TO CALCULATE IT  
By Sir Oliver Lodge, F.R.S. . . . . 1170  
LONDON B.B.C. STATION AND ITS WORK  
By Capt. P. P. Eckersley . . . . . 1131  
MAGNETISM: MODERN THEORIES & THEIR APPLICATIONS  
By J. H. T. Roberts, D.Sc., F.Inst.P. . . 1366  
OHM'S LAW: ITS MEANING & APPLICATION  
By Sir Oliver Lodge, F.R.S. . . . . 1484  
OSCILLATION: A WIRELESS FUNDAMENTAL  
By Sir Oliver Lodge, F.R.S. . . . . 1498

## *Special Articles by Leading Authorities (continued).*

|                                                                                                          | PAGE |                                                                                                | PAGE |
|----------------------------------------------------------------------------------------------------------|------|------------------------------------------------------------------------------------------------|------|
| PHOTOGRAPHY BY WIRELESS<br>By E. E. Fournier d'Albe, D.Sc. . . . .                                       | 1537 | TRANSMISSION: (II) THE AMATEUR AND<br>HIS PROBLEMS<br>By William Le Queux, M.Inst.R.E. . . . . | 2064 |
| POTENTIAL: ITS NATURE & MEASUREMENT<br>By Sir Oliver Lodge, F.R.S. . . . .                               | 1586 | UNITS: THEIR DETERMINATION AND<br>IMPORTANCE<br>By Sir Oliver Lodge, F.R.S. . . . .            | 2160 |
| QUANTUM THEORY OF ENERGY<br>By J. H. T. Roberts, D.Sc., F.Inst.P. . . . .                                | 1620 | VALVES FOR RECEPTION<br>By E. V. Appleton, M.A., D.Sc. . . . .                                 | 2185 |
| TELEVISION, OR ELECTRIC VISION AT A<br>DISTANCE<br>By E. E. Fournier d'Albe, D.Sc.,<br>F.Inst.P. . . . . | 1983 | VALVES FOR TRANSMISSION<br>By W. H. Eccles, F.R.S. . . . .                                     | 2196 |
|                                                                                                          |      | WAVES IN WIRELESS WORK AND THEORY<br>By Sir Oliver Lodge, F.R.S. . . . .                       | 2225 |

## *Plates in Photogravure and Colour*

|                                                                          | TO FACE PAGE |                                                                        | TO FACE PAGE |
|--------------------------------------------------------------------------|--------------|------------------------------------------------------------------------|--------------|
| AERIAL: Construction of Lattice Mast . . . . .                           | 44           | HANGING SET: Six-valve Suspended Set.. . . .                           | 1080         |
| AMPLIFIER: Construction of One-valve<br>Low-frequency Unit . . . . .     | 76           | HIGH-FREQUENCY AMPLIFIER: One-valve<br>Unit . . . . .                  | 1110         |
| BASKET COIL: Winding an Inductance . . . . .                             | 204          | INTERFERENCE ELIMINATOR: Construction<br>of Two-circuit Type . . . . . | 1194         |
| BROADCASTING: Radius Maps of the<br>British Isles . . . . .              | 282          | LOOSE COUPLER: Cabinet Type.. . . .                                    | 1332         |
| COIL WINDING: Construction of Two<br>Winding Machines . . . . .          | 458          | NEUTRODYNE RECEIVER with Two-stage<br>L.F. Amplifier . . . . .         | 1468         |
| CONDENSER: Two Fixed Types and One<br>Variable . . . . .                 | 488          | PORTABLE RECEIVING SET: Construction                                   | 1578         |
| CRYSTAL RECEIVER: Cabinet Set with<br>Amplifier . . . . .                | 616          | REFLEX SET: Construction of Three-valve<br>Receiver . . . . .          | 6167         |
| DETECTOR PANEL: Two Simply-made<br>Panels for Several Circuits . . . . . | 670          | REGENERATIVE SET: One-valve Set . . . . .                              | 1696         |
| DULL EMITTER VALVE SET: Two-valve<br>Receiver . . . . .                  | 762          | SHORT-WAVE RECEIVER: Amateur Set for<br>use at 200 Metres . . . . .    | 1812         |
| FAULTS AND FAULT FINDING: Leakages,<br>Bad Connexions, etc. . . . .      | 906          | SUPER-REGENERATIVE SET: Three-valve<br>Receiver . . . . .              | 1926         |
| FRAME AERIAL RECEIVER: Set with In-<br>ternal Batteries.. . . .          | 976          | TRANSMISSION FOR AMATEURS: Views of<br>6 RJ Station . . . . .          | 2076         |
|                                                                          |              | TUNED ANODE: Three-valve Set . . . . .                                 | 2106         |
|                                                                          |              | VALVE RECEIVER: Myers Valve Set . . . . .                              | 2182         |

END OF THIRD VOLUME

# Bind your Volumes in the **BEST** Way

## USE THE PUBLISHERS' BINDING CASES

Your set of the WIRELESS ENCYCLOPEDIA is now complete. If this work is to be of real, permanent value to you, it should be bound without delay before any of the parts become lost or damaged. Secure your binding cases now and buy those which have been specially prepared for this great work—those issued by the Publishers

## BLUE CLOTH CASE

(as illustrated overleaf)

# 2/-

Orders sent direct to the Publishers must be accompanied by 6d. extra for Postage and Packing.

## MISSING PARTS

Each volume comprises eight parts. If there are any missing, please enclose with your remittance cash for each missing part, stating at the same time the number of the part or parts required to complete the set. *This applies to readers only who wish the Publishers to undertake the binding.* Others may obtain back numbers through the newsagent or bookseller from whom they purchase their binding cases.

SOUTH AFRICAN readers should apply to Central News Agency Ltd. JOHANNESBURG (or branches).

AUSTRALASIAN readers to Messrs. Gordon & Gotch, Ltd., MELBOURNE (or branches).

CANADIAN readers to The Imperia News Co., Ltd. (Canada), TORONTO (or branches).

## TAKE ADVANTAGE OF THIS SPECIAL BINDING OFFER

The Publishers of the WIRELESS ENCYCLOPEDIA are prepared to undertake the actual work of binding the loose parts into volume form for those subscribers who are unable to get this done to their satisfaction locally.

### Conditions which must be observed:

Only fortnightly parts in good condition—free from stains, tears or other defacements—can be accepted for binding.

The parts to be bound must be packed securely in a parcel (eight parts constituting a volume) containing the name and postal address of the sender clearly written and posted direct to the Publishers' binding department or handed to a newsagent, the subscriber being liable for the cost of carriage in both cases.

If the Parcel is sent direct to the Publishers the cheque or postal order in payment should be enclosed in a separate envelope, together with a note mentioning how many parts have been despatched. The cheque or postal order should be sufficient to cover the full amount of the binding charges in respect of the actual number of parts sent in ONLY

The name and address of the sender should be given in the letter as well as in the parcel, and **the letter containing cheque or postal order must not be put in the parcel: post it separately.**

## ONE STYLE ONLY 5/6

*To bind eight parts in the Publishers' Dark Blue Cloth binding case, with full gilt back, top edges of the leaves "sprinkled," the inclusive charge will be 5/6 (2/- for the binding case and 3/6 for the actual binding and cost of packing and return carriage).*

All cheques or postal orders must be made payable to The Amalgamated Press (1922) Limited and crossed "Bank of England, Law Courts Branch." Address the letter and package to

"Wireless Encyclopædia," Binding Department,  
The Amalgamated Press (1922) Ltd.,  
Bear Alley, Farringdon Street, London, E.C. 4.

All prices apply to Great Britain and Irish Free State only

# Your Set is now Complete

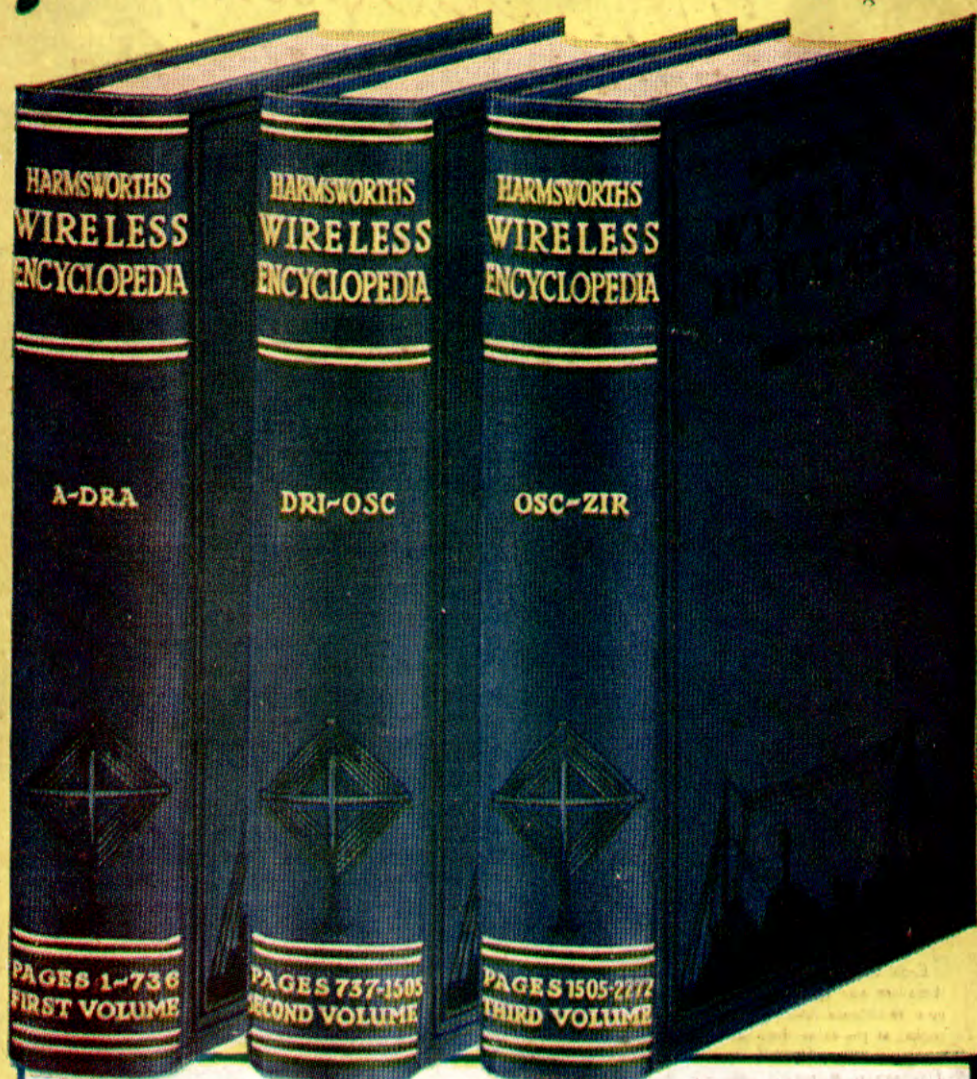

**BLUE  
CLOTH**  
Binding Case  
(as illustrated)

**2/-**

each from any news-  
agent or bookseller

## BIND YOUR PARTS LIKE THIS

This is the last opportunity to get your fortnightly parts bound up. You need these volumes in your workshop—ready for immediate reference whenever any knotty point has to be solved. The best binding cases to use are those which have been specially prepared by the publishers—authentic, artistic and very durable, calculated to stand any amount of hard wear. They are obtainable through any newsagent or bookseller for 2/- each. If ordered direct from the publishers 6d. extra must be sent for postage and packing in the British Isles. Overleaf you will find particulars of the publishers' special binding scheme for subscribers.