

REPRODUCING THE RECORDED ARTS

hi-fi+  
AWARDS  
ISSUE

## Watts Cooking!

### ▶ Close Harmony?

*Taking The Cure*  
*EMI's Golden Age*

### ▶ Togetherness

*Rowland Concentra 11*  
*Anatek Audio A50*  
*Euphya Alliance 270*  
*Rega Mira 3*  
*Hegel H1*

### ▶ New Arrivals

*Naim NAP 300*  
*Naim NAP 250*  
*ECS EA-2*



# 30 YEARS of performance classics

Throughout the history of Mark Levinson there have been many milestone products. Among this illustrious group are the JC-1 phono preamplifier (1972), LNP-2 preamplifier (1975), ML-1 preamplifier (1977), ML-2 mono power amplifier (1977), our first ever "Reference" component, the No.20 monaural power amplifier (1986), and the legendary No.30 Reference Digital Processor (1991) and No.32 Reference Preamplifier (1999). These products, even at the time of their introduction, were obviously destined to become classics. In many cases, these now classic components were considerably more expensive than virtually any other product in their class, and often offered fewer features (or less power) than competing products. Yet, they became classics. These and other now legendary Mark Levinson components shared one extraordinary trait: they outperform everything else in their product category. Performance, above all, is the primary motive for owning a Mark Levinson product – and exceptional performance is the most significant reason for owning a Mark Levinson No.40 Media Console. The No.40 is poised to establish new standards for connoisseurs of multi-channel audio and video.

We believe that the No.40 is perhaps the most remarkable product we have built in our 30 year history of innovation and market leading performance – it is surely destined to take its place among our classic designs.



**PATH**  
*Premier*

PATH Premier  
Dorner Road, Thame Industrial Estate, Thame, Oxfordshire OX9 3UD  
Tel: +44 (0) 1844 219000 Fax: +44 (0) 1844 219099  
Email: premier@path.co.uk

**mark  
levinson**  
MADRIGAL AUDIO LABORATORIES  
1972 - 2002

# Editorial

## Editor

Roy Gregory

## Contributors

David Ayers  
Chris Binns  
Mark Childs  
Martin Colloms  
Dave Davies  
Richard S Foster  
Simon Groome  
Jason Hector  
Jimmy Hughes  
Jason Kennedy  
Scot Markwell  
Paul Messenger  
Reuben Parry  
Alan Sircom  
Chris Thomas

## Photography

Simon Marsh

## Cartoonists

Dave Davies  
Thomas Divita

## Design

Creative Byte  
U12, Albany Business Park  
Cabot Lane, Poole, Dorset  
BH17 7BX

## Printed By

JPS Litho Ltd.  
Poole

Hi-Fi+ is published six times  
a year by: Hi-Fi+ Publishing Ltd

## The Editorial Office can be contacted at:

Hi-Fi+ Editorial  
Unit 12, Albany Business Park  
Cabot Lane  
Poole, Dorset  
BH17 7BX  
United Kingdom  
Tel. (44)(0)1202-659380  
Fax. (44)(0)1202-659540  
Net. [www.hifiplus.com](http://www.hifiplus.com)

## Advertising;

Rebecca Bird  
Tel/Fax. 0208 763-1277  
Email. [sales@hifiplus.com](mailto:sales@hifiplus.com)

## All Rights Reserved.

No one word of Hi-Fi+ may be reproduced without the written consent of the Editor. We are perfectly happy to co-operate, but we don't want quotations to appear out of context.

No sooner does the autumn show situation finally seem to be settling out, with the return of the Hi-Fi News show to its spiritual home at Heathrow, back from the outer wastes of the Hammersmith Novotel, than chaos looms again. Whilst we were stern critics of the Novotel shows, last year's Heathrow event was a major step in the right direction. Sure, there's still a way to go, but just when things are getting back to something like normality, Haymarket Exhibitions, whose sister title What Hi-Fi sponsor the Bristol show, announce a hotel based high-end event to run in parallel with their Live home entertainment event at Earls Court. That coincides precisely with Hi-Fi News' event at Heathrow. Of course, HFN chose their dates to coincide with Live in the first place, but that's hardly the point. With last year's Heathrow show spread across two adjacent venues it was already close to impossible to cover the whole thing in a single day. Split the attending exhibitors across Heathrow and a central London site and the impossibility of that proposition becomes a certainty. There is no way that this can be good: good for the industry, good for the exhibitors or good for the public. In fact, the only people who stand to profit are the organisers who plan to make a considerable sum of money out of their respective shows, if not this year, then next, when one of the shows will have fallen by the wayside.

At least, that's the plan. The problem is that both shows could fail. Exhibitors, worn out by the bad experiences of Novotel and previous conflicts could well vote with their feet and attend neither. Whilst that's an understandable response it would also be calamitous. Every company in the UK industry needs an internationally recognised national show in order to attract domestic and overseas customers. It's about time this industry grew up and behaved like a unified, adult whole. It needs leadership, it needs to make a decision as to which show it wants, and then it needs to stand by that decision. After all, without us there is no show!



# COPLAND

Copland Audio Products:  
**Scandinavian Cool.**

Copland's design team believes that its greatest challenge is to use a scientific approach to create a product which conveys art. Although music has its basis in mathematics, its *raison d'être* is to communicate emotion.. Soul. Spirit.

To achieve this end, Copland has chosen to blend the best of proven technologies - the valve - with the most sophisticated of modern methodologies. Because of this, you will find a compact disc player in a range which also reverses the vinyl LP. You will find stereo playback, which has served pure music for a half-century, alongside multi-channel amplification, designed to recreate the cinematic event in the home.

All of this reaches you, the music lover and cineaste, through components which reflect the most striking of Scandinavian virtues: minimalism, simplicity, clarity.



CDA822 - High resolution CD player



CTA305 - High Performance valve preamplifier



CTA520 - Power amplifier ( stereo or mono)



CVA306 - Multi Channel Valve preamplifier



CVA535 - 5 channel Audio Video amplifier



**absolutesounds ltd.**

58 Durham Road, London SW20 0TW T: +44 (0)20 89 71 3909 F: +44 (0)20 88 79 79 62  
info@absolutesounds.com www.absolutesounds.com

# Contents

## Equipment+

### Regulars

- 5 Columns
- 14 Letters
- 106 Las Vegas CES Show Report

### Awards

- 29 2002 Products of the Year

### Equipment Reviews

- 42 Wilson Audio System 7 Loudspeaker
- 48 Naim Audio NAP300 Power Amp
- 54 Naim Audio NAP250 Power Amp
- 148 Rowland Research Concentra 11 Integrated Amp
- 64 Hegel H1 Integrated Amp
- 70 Euphya Alliance 750 Integrated Amp
- 74 Anatek Audio A50 Integrated Amp
- 143 Rega Mira 3 Integrated Amp
- 84 Neat Acoustics Ultimatum MFS Loudspeaker
- 90 Graham Engineering Robin Tonearm
- 94 ECS EA-2 Power Amp

### The Real Deal

**- budget gear that works**

- 100 Monitor Audio B2 and Mordaunt-Short MS 912 Loudspeakers

### Audio Smorgasbord

- 107 Colloms on Crossovers and more on mains.

## Music+

### Music Reviews

- 122 Three Imaginary Boys – dark confessions and the early Cure
- 129 Popular and Contemporary Music
- 137 Classical Music
- 141 Jazz
- 145 Audiophile Music
- 149 The History Man does EMI's Golden Years

### Departments

- 122 Back Issues
- 143 Subscriptions
- 144 Binders
- 147 Advertisers Index

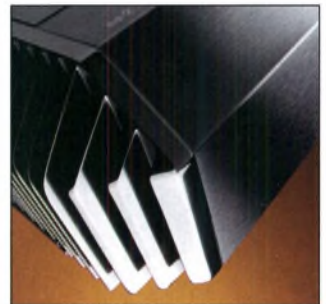

# the AUDIO CONSULTANTS

SOPHISTICATED SYSTEMS • ELEGANT SOUNDS

## 1. GamuT CD 1 player

This product has received universally stunning reviews in the US. A big, bold sound. £2400



1



4



5

## 2. Avalon Eidolon

We are now able to demonstrate this reference loudspeaker, along with the Diamond. Superlative transparency and resolution. Exceptionally musical with what appears to be an endless soundstage.



2

## 3. Shanling CD - T100 player

The amazing, highly flexible CD player with valve output and upsampling. Superb sound and certainly makes a statement with its appearance. £1650



3



7



8

## 4. GamuT D 200 dual mono power amplifier

An extremely lucid and controlled sound. £3250

## 5. Nottingham Analogue Horizon turntable

The new budget product from this respected manufacturer. Amazing value at £484; with Rega Arm £530. Tonearm shown is Nottingham Analogue Interspace at £434. Cartridge shown is Clearaudio Aurum Beta at £195

## 6. Unico integrated amplifier

80wpc integrated valve-mosfet amplifier. As you would expect, a remarkable sound from this valve amplifier manufacturer. £750 With phono stage £800. The new, matching Unico valve CD player produces a very big stage with rich tonality. Outstanding performance for its price. £1095

## 7. Rogue Audio valve amplification

Tremendous sound and build quality at this price point. The Model 66 pre-amplifier with phono stage costs £1295. The Model 88 stereo power amplifier 60wpc from matched 6550 valves. £1495

## 8. VPI Scout turntable with JMW Memorial 9" tonearm

Superb sound and value at £1350. Cartridge shown is Benz-Micro Ace at £395

Amplion • Avalon Acoustics • BCD Racks • Benz-Micro • Cardas • Clearaudio • Clearlight Audio RDC • conrad-johnson Diapason • EAR/Yoshino • Gamut • Gryphon Audio Designs • Heart • IsoTek • Kuzma • Lavardin • Living Voice • Lyra • Nordost • Nottingham Analogue • Opera • Pagode Equipment Supports • Pathos • Red Rose • Resolution Audio Rogue Audio • SME • Shanling • Shun Mook • Transfiguration • Triangle • Tri-Planar • Tube Technology • Unison Research • VPI • Wadia



Conveniently located between Reading and Basingstoke, we are approximately 15 minutes drive from either Junction 12 on the M4 or Junction 6 on the M3. Free and easy parking, outside the building. We have a home evaluation scheme for those who might find this method more convenient.

7 Comet House, Calleva Park, Aldermaston Reading, Berkshire RG7 8JA

T 0118 981 9891  
E info@audioconsultants.co.uk  
[www.audioconsultants.co.uk](http://www.audioconsultants.co.uk)

*Demonstrations by appointment,  
Mondays to Saturdays 10:00 to 18:00.  
It is advisable to call us before visiting.*

*Part exchange welcome. Ex-demonstration and previously owned equipment listed on our website.*

# Speakers Corner

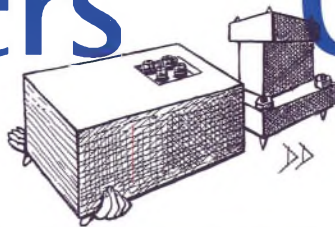

by Paul Messenger

After a winter that has alternated depressingly between wet and cold, the prospect of emigrating to somewhere drier and sunnier does have a strong appeal. However, the one factor that's kept me from entertaining such a possibility down the years has been the excellence of the BBC's (largely advertising-free) broadcast services.

The TV side might have deteriorated significantly following the arrival of multi-channel services (more means less). And I reckon George Entwistle did a better job as a hi-fi journalist than he's doing as editor of *Newsnight*. But the Radio services – especially Radios 3 and 4 – seem to be surviving the proliferation rather well. Indeed, I doubt there's another country in the world that can match the cultural breadth and depth that these two stations supply as a matter of course. I'm particularly impressed at the way Radio 3 is being evolved, and while its strong classical music orientation remains, the station does seem to be becoming much more broad-minded, while still maintaining a 'quality first' commitment.

Elsewhere in this magazine there are plenty of reviews of some of the best new music around. Here on this page, however, just in case you haven't already found it for yourself, I'm going to draw your attention to a radio programme to which a lot of people in the hi-fi industry are listening.

It's called *Late Junction*, is chaired by the estimable Verity Sharp, and provides a wonderfully eclectic mixture of top quality music in chunks of an hour and three-quarters four nights (Monday to Thursday) a week. And it's absolutely free if you've got an FM tuner. It usually starts at 10.15pm, providing the perfect excuse to miss *Newsnight* altogether, and is certainly a lot better for your soul. Accessing quality world music has always been difficult, but *Late Junction* saves all the effort and does an excellent job. I keep forgetting to tune into Bob Harris' Saturday night 10pm 'til Iam slot on Radio 2, but I'm told this show is worth a listen too.

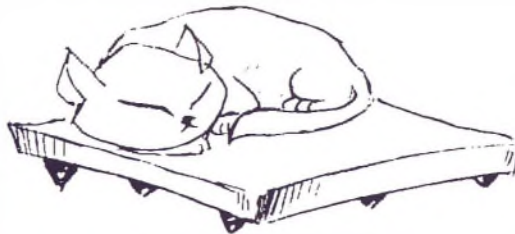

## Remotely Interesting

By and large the editor and I tend to agree on most things, but bring up the topic of remote control and we find ourselves poles apart. I might be an audiophile, but I'm not into hair-shirts, and not ashamed to admit that I find using an amplifier without remote control really difficult nowadays. Roy, on the other hand, couldn't give a fig whether his pre-amp comes with or without a handset.

To look at the wider picture, I guess it's all to do with our individual lifestyles, and the way each of us either embraces or rejects the various new technologies that impact our lives.

Remote control systems first emerged in the late 1970s, on video recorders and upmarket TV sets, but the technology took a little while to percolate through into our hi-fi systems. CD players had remote control from the start of course, but that wasn't until 1984 or thereabouts, and

I'm pretty sure I was remotely controlling my pre-amp from some time around the mid-1980s too. Around the same time I was also getting into cordless telephones, and, speaking personally, would find it very difficult to live without either of these technologies today.

At the same time I've managed to avoid having more than a very passing 'pay as you talk' relationship with mobile phones, which are hardly necessary to a 'working from home' lifestyle. And my involvement with computers remains strictly on a 'needs must' basis, purely as an essential tool for my working life.

But remote handsets and cordless phones have both proved very liberating in their different ways, and that in turn has made both of them quite addictive. Nowadays I find it quite irritating and constricting to talk on a hard-wired phone, and feel rather similar about operating a 'hands-on-only' pre-amp. On the odd occasion that one

► comes in for review, I'm very tempted to install it within reach of my chair – if only so I can reach the volume knob when the (cordless) phone rings.

One reason for my impatience with non-remote amps has to do with the fact that CD players invariably include the feature, and it's pretty common amongst tuners too. Indeed, the main reason I bought myself a Magnum Dynalab MD102 FM tuner a couple of years back was because of its (possibly unique) combination of remote control and genuine audiophile sound quality.

While I hardly expect to operate my vinyl remotely, controlling the pre-amplifier does provide the freedom to roam at will between at least three other sources (CD, radio and TV), and that alone increases – probably substantially – the amount of use my hi-fi system gets. And that has to be the bottom line: if a simple handset means I spend more time listening to my hi-fi, it surely has to be a plus.

That said, I do have some sympathy with the smallest amp makers. These provide much of the lifeblood of the specialist hi-fi sector, inevitably have limited resources, and features like remote control will often seem like unnecessary

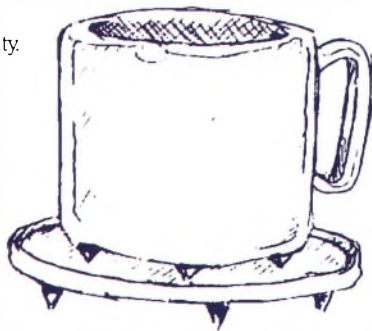

distractions from the main event. It's an understandable point of view perhaps, but still in my view wrongheaded.

While I'm pleased that so many specialist companies have now embraced remote control, applying it to hi-fi separates can throw up the odd snag. Although there's now a degree of conformity in the use of particular infra-red codes for specific operations, not everyone follows them, and my tuner often does unexpected things when

I'm trying to operate the pre-amp, for example. To that extent, remote control is a device that encourages the conformity of the one-make system, which is perhaps unfortunate. But the bigger complaint is simply that many hi-fi handsets are poorly designed. The Rega Solar I discuss in the Mira 3 review is one of the better examples.

All too often the handset is too wide for easy one-hand operation, with a forest of identical and indistinguishable buttons. Or the whole thing is unnecessarily heavy, bulky and downright pretentious. Today the components themselves tend to be refreshingly simple and easy to operate. Too bad the handsets don't always follow such a laudable example. ►+

# Playing The System

by Roy Gregory



A little over a year ago I hatched a plan to create a budget priced system, capable of delivering genuinely high-end musical performance. Of course, in this context, budget takes on a slightly more elastic quality than it might otherwise have, and note also the 'musical' qualifier. What prompted these musings was a mini flood of products that, whilst they might have lacked the qudos, finish, sheer weight and equally weighty price-tag of the high-end contenders that take themselves really (way too?) seriously, were more than a match for that overblown male jewelry in sheer musical terms. Sure, they didn't have the absolute resolution, focus and transparency of the expensive kit. Or its acres of milled from solid casework and fist-sized, gold plated binding posts: the sort of stuff that has reviewers

going all gooey and trying to outdo each other name-dropping obscure brands of wristwatch (about which they know even less than hi-fi, but in which they at least retain some degree of interest). But these beer-budget products were scoring exactly where all too much of the over-priced and over-hyped kit out there fails – in the simple communication of the musical event. It was the frustration of trying to squeeze music out of some of the industries' most highly touted products that got me started down this road. What I wanted was a plug and play system that delivered real musical results at real world prices, to act not as a reference, but more as a benchmark to keep my head on the functional straight and narrow (rather than being turned this way and that by OTT engineering quality and ►



# Walrus Systems

11 New Quebec St, London W1  
020 7724 7224



amazon  
amphion  
apollo furniture  
argento  
audible illusions  
audio note  
audio physic  
avantgarde  
breuer dynamic  
brinkmann  
carfrae  
cartridge man  
cawsey  
chord electronics  
clearaudio  
croft  
decca london  
dnm  
duevel  
dynavector  
ear yoshino  
es lab  
final lab  
gamut  
graham slee  
hadcock  
incognito  
klimo  
laverdin



loricraft  
lyra  
michell engineering  
morch  
musical fidelity  
nordost  
nottingham analogue  
origin live  
ortofon  
papworth  
phy cables  
pink triangle  
pluto  
rega turntables  
ringmat  
shun mook  
sme  
spendor  
stax  
sugden  
sumiko  
tannoy  
tci cables  
tivoli audio  
tom evans  
townshend audio  
transfiguration  
trichord  
van den hul  
verdir



fax: 020 7724 4347 email: mail@walrus.co.uk web: www.walrus.co.uk



## conrad-johnson

Valve and solid state technology applied in a manner others can only seek to achieve. The last of the big names to remain dedicated to pure valve circuits.



Acustica Applicata (DAAD)

**Avalon Acoustics**

Avalon Multichannel Systems

**Benz-Micro**

Cardas

conrad-johnson

Esopower

finite elemente

Harmonix

**Karan Acoustics**

Kuzma

**Magnum Dynalab**

McCormack

Muse Electronics

Phonomena

Sonographe

Tri-Planar

*Distributed*

*Exclusively by*

## finite elemente

For once, audio furniture does not stop short of being just that – instead, it is an excellent sounding creation of visual attraction, craftsmanship and fulfilled purpose.



Pagode HD03 MR

# AUDIOFREAKS

DISTRIBUTORS OF FINE AUDIO + HOME ENTERTAINMENT EQUIPMENT

*for the love of music*

► the hi-fi spectacular).

And a damned good plan it was too. Except that, like most such plans it was no sooner made than the various parts started to unravel. Even so, I got quite a way towards achieving my goal before the wheels came off and the sheer volume of work prevented me from bolting them back on. The first major hurdle came with the arrival of VPI's Aries Scout turntable, a model that neatly encapsulated my feelings and goals, thus promptly replacing the previous incumbent, the VPI HW19 Jr with the Hadcock GH228 on board. Of course, like all things VPI, the Scout took a while to settle down, designer Harry Weisfeld continually tweaking his new baby, so that each time I spoke to him there was some new mod that further improved the 'table. Still, the dust finally seems to have settled, and daylight offers a unit that is cross compatible with Rega tonearms (which the Hadcock isn't) as well as offering a more compact footprint, and a standalone motor, an expensive option with the 19. You get greater versatility as well as a better bearing, platter and clamp, in return for the Sorbothane suspension. Seems like a deal to me. The Cartridge Man's Music Maker cartridge also went through another evolution, further refining its performance, and further complicating matters. The latest version is ready to roll now, just waiting attachment to the JMW's headshell, whilst rumours of a dedicated mono version make the 9.0's interchangeable arm-wands an enticing proposition.

The other end of the system was looking far rosier. The Monarchy Audio SM70 amp continues to impress, as do the Living Voice Auditorium speakers. These at least are stable components in what at one time resembled a lake of hi-fi quicksand: No sooner did I lay my hands on something than it conspired to disappear into the liquid morass of uncertain availability or model replacement. Meanwhile, a couple of other contenders had actually firmed up, with both the Eichmann cables and the Chord Co. Signature interconnects finally reaching the marketplace.

Ironically, my digital plans remain unchanged, with Monarchy's Dip clock and 33DAC performing the digital honours as well as providing line switching and a volume control in the 'digital primary source' version of the set-up. All of which, along with the rest of the above, fit my £700 a box budget pretty darn well. It was the analogue

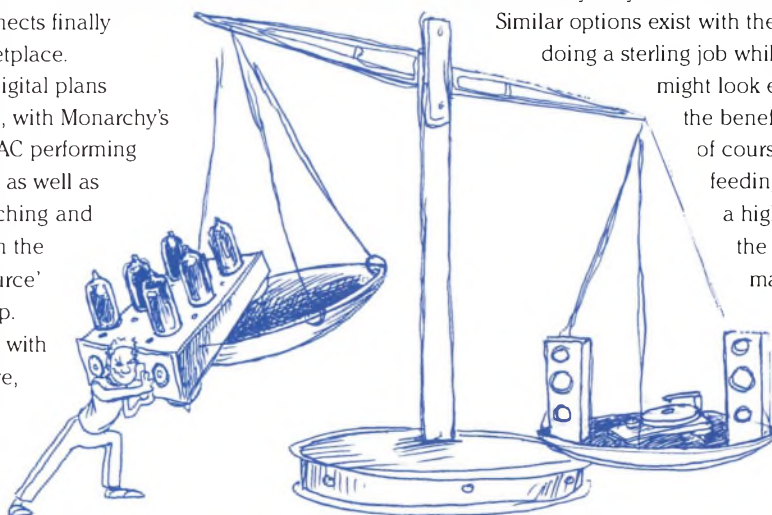

front-end, and more importantly the pre-amp and phono-stage that were causing all the anxiety. So let's re-cap where we're up to.

Front-ends:

Serious Analogue - VPI Aries Scout turntable with JMW 9.0 Tonearm - £1395

Cartridge Man Music Maker MM cartridge - £ 595

Basic Analogue - VPI Aries Scout turntable Rega RB250 Incognito tonearm

Digital - Existing CD player as transport Monarchy Audio DIP re-clocking unit Monarchy Audio 33 24/96kHz DAC/Line Stage

Rear End: Monarchy Audio SM70 power amp Living Voice Auditorium loudspeakers

Serious Cables: Chord Co. Signature interconnects and Odyssey loudspeaker cables

Basic Cables: Eichmann Express interconnects, loudspeaker and mains cables

Rack: RDC Aspect Rack

The way in which these building blocks can be combined should be pretty clear. So too should the gaps. Analogue die-hards can take the Serious Analogue route, whilst those on a tighter budget or wishing to balance analogue and digital sources can opt for the Basic solution.

Either way they won't lose too much music as a result.

Similar options exist with the cabling, the Eichmann's doing a sterling job whilst the Chord Signatures might look extravagant until you hear the benefits. Committed digiphiles of course have the option of feeding the Monarchy from a high quality transport, but the results off even a budget machine, fed via the DIP, are astonishingly good.

So back to those gaps. Well, the obvious one is the analogue pre-amp. The original scheme employed the Klimo Merlin, but its ►

► distribution is changing and so too will its price. If it stays within the £1400 mark (for phono and line stages) then all well and good, but I suspect it'll work out more expensive than that. The options then become a little more complex. At the upper end of the price range lies the Conrad-Johnson PV10B, while at the lower end, various Crofts certainly enter the reckoning. For basic analogue users combining the turntable with a digital source, then the Monarchy DAC's line stage used with a stand-alone phono stage would certainly be the most cost effective option, especially as the latter can be had for very

approachable prices indeed. The other gap is a good quality tone-arm lead for the Serious Analogue set-up: Incognito, Audioplan and Cardas all spring to mind.

It's these various options that I intend to investigate over the coming months, both in individual reviews and also working towards a system review(s) in the fullness of time. Who knows, the whole shebang might even see an outing at one of the autumn shows. But either way, this project will see completion, and once it does it should provide a whole new avenue for investigation. One that's transportable, which is when the fun really starts... 



# Big Boy's Toys

by Scot Markwell

Well, boys and girls, it is that time again. Time to wrack the 'ole noggin and try to decide what I consider the best audio "stuff" that I experienced this past year. Only it isn't. As a mere 'columnist' it seems I don't rate a vote. Well, I'm not taking that lying down, so it's my column and I'll just do my own awards! I've even bribed the graphics guys to give me my own little awards logo. So here they are, the ones that matter, the awards to win – Markwell's Magic Music Makers

First up are the lovely Reference 3A Royal Virtuoso loudspeakers ([www.reference3a.com/royalvirtuoso.htm](http://www.reference3a.com/royalvirtuoso.htm)). These lovely, Corian-encased 92 db/watt two-ways are the big brothers of the De Capos that RG reviewed several issues ago, and they have proved a real boon to me in my continuing perusal of SET amplifiers, in that they are both extremely easy to drive and particularly excellent-sounding. The only real limitation I sense from them is that in my room, where I pull them out much farther from the rear wall than one rightly should to get a good bass foundation, they seem a little mid-rangy and lightweight. If I make a point to shove them a bit farther back, however, they pick up a good bit of heft, but I really like the wide-open sense of space and dimensionality that I get in the forward position, and I have a couple of good subwoofers,

so what the heck. Overall, though, these speakers, at \$4000 US, are both a reasonable value and a top performer, yielding more music per cubic inch than most any other boxes out there. Superior transient response and smooth liquidity are hallmarks of the design, as well as a presence and directness (without any hardness) that are doubtless attributable to the lack of a conventional crossover in the speakers. With a directly-driven Kevlar woofer/midrange driver and a tweeter that uses only a capacitor to roll off the lower frequencies, the Master Virtuoso is a superb stand-mounter that is made wondrous with the addition of a GOOD subwoofer.

Speaking of good subs, the next item on my list is the Thunderbolt sub from Acarian Systems of New York. In an effort to bring the staggering bass performance of his Exotica Grand Reference (EGR) towers to a more practical size and price so that mere mortals can have a taste, Carl Marchisotto has put together a rather ordinary-looking powered box subwoofer that uses a driver similar to that in the EGR and a compact Class AB amplifier that is specifically tailored to the driver's operating parameters. The result is a unit that is scary powerful and capable of prodigious output, while at the same time tight and coherent and pitch-accurate in the extreme. I can 

# MAX

Midland Audio X-change

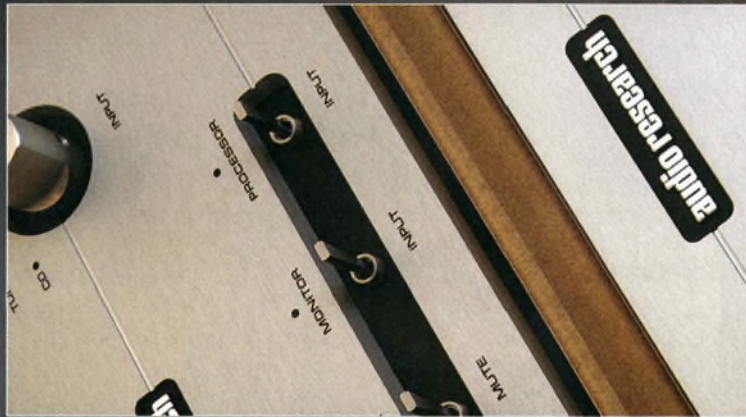

## Audio Research LS25 Mk 11

In performance, we believe the LS25 Mk 11 blows away the original in every respect. It's faster, more dynamic, more open-sounding and presents a more tightly focused soundstage. Bass response is cleaner, quicker, with more apparent impact, while higher frequencies are much purer sounding than the original. You will love the coherence of the new Mk.11 – vividly alive from top to bottom, with an immediacy that is stunning when driving really capable power amplifiers like the VTM200's. Once again, Audio Research brings new life and improved performance to an existing model, enhancing value for every owner.

## Nagra PL-L

One of the most respected names in the world of professional audio, Nagra has a forty year history of producing leading edge electronics for the recording industry. Their move into high end audio was a welcomed surprise, and their gear has met with rave reviews. Many listeners requested a line stage preamp, and Nagra listened. The PL-L will interest many, not only because of the great sound, but also for the new found convenience of full remote controllability. Balanced outputs are available as a option. As with all Nagra equipment, expect superb Swiss craftsmanship and meticulous attention to detail. Nagra takes great pride in introducing the ultimate preamp, the PL-L, line input cousin to the PL-P. The PL-L combines the unmistakable sonic excellence of the PL-P with the convenience of remote control for those whose source components do not include Phono. The features of the PL-L include four selectable inputs, one for balanced and three unbalanced, dual output zones, each with two unbalanced outputs. An optional balanced output is available as well.

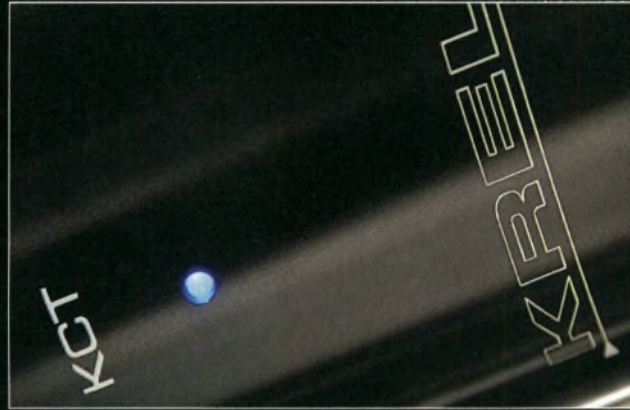

## Krell KCT Preamplifier

The Krell Current Tunnel (KCT) CAST stereo preamplifier holds the distinction of being the finest sounding, most technologically advanced, and most system friendly stereo preamplifier ever designed by Krell. It derives its name from the way the signal is routed from its input to its output. The signal is brought into the KCT in the current domain from a CAST source such as the Krell KPS 28c Compact Disc Player. The signal stays in the current domain as it travels through the KCT, protected from extraneous noise and unwanted signal interference as if it were in a tunnel. Using CAST technology and power supply regulation that is a direct result of the development of the Master Reference Amplifier, the KCT is able to deliver a usable bandwidth that extends to 1.5 MHz. The result is seamless, transparent musical reproduction of even the most dynamically demanding sources. Ease of operation is also accounted for in equal measure with features that include dual-zone operation, with independent volume controls, Theatre Throughput for integration into home theatre systems, and RS-232 controls for whole house automation. The KCT is a stereo preamplifier that delivers the ultimate stereo performance today and the opportunity for continued growth into the future.

## dCS Elgar Plus and Purcell

dCS Elgar Plus and Purcell with IEE 1394 interface are the cutting edge of digital technology. And at Midland Audio X-change you can now experience up sampling into the DSD data stream. That's right, take your normal CD collection and transform it into master tape quality, by using a dCS Verdi Transport and using the IEE 1394 "Fire wire" output into a dCS Purcell Up sampler IEE 1394 compatible. Up sample into DSD and then send the signal to a dCS Elgar Plus. The result is the closest to master tape quality we have heard. This system also plays SACD at a level, which is unsurpassed by any other player, or combination we have tried.

Phone John Roberts for an insight in what is achievable with any dCS product.



### Suppliers and installers of High Quality Audio Systems

47 Laboratory  
J.M.Labs  
Krell  
Kuning  
Audio Physic  
Mark Levinson  
Avalon Accoustics  
Marin Logan  
Michell  
Nagra  
bel canto  
Benz Micro  
Cardas  
Clearaudio  
Conrad Johnson  
dCS  
Densen  
Nadcast  
Electrocompaniet  
Finta Elements  
Verity Audio  
Gryphon  
Vesta

[www.midlandaudiox-change.co.uk](http://www.midlandaudiox-change.co.uk)

call John Roberts Tel 01562 822236

181 Franche Rd • Kidderminster • Worcs • DY11 5AD

e-mail [sales@midlandaudiox-change.co.uk](mailto:sales@midlandaudiox-change.co.uk)

Fax 01562 750246 Mobile 07721 605966

# EXPERIENCE THE CHORD EFFECT!



The first time you hear your sound system with Chord interconnecting cables will be the first time you've **really heard** it. Be warned - the effect can be shattering. Your eyes and ears will be opened. Your music will never sound the same again. Specify Chord cables - Hear the light!



SIGNATURE



CHORUS



ODYSSEY 4



ANTHEM



CLEARWAY



FOR SALES AND INFORMATION  
CALL: 01722 331674  
FAX: 01722 411388  
E-MAIL: [CHORD@CHORD.CO.UK](mailto:CHORD@CHORD.CO.UK)  
OR VISIT US AT  
[WWW.CHORD.CO.UK](http://WWW.CHORD.CO.UK)

► now hear bass detail and subtle tonalities that were heretofore lost in the quagmire through any number of other subs. It is a remarkably effective unit and one that seems to blend with various satellites much better than others I have used in the past. In particular, it goes really well with its intended partner, the Alon Napoleon mini-speaker, a two-way design that reminds me (fondly) of the late lamented Radio Shack Minimus 7, of which I had eight of at one time in a previous life, wherein I used double-sided tape to make them into a mini-line source (four per side with the metal boxes laid on their sides, tweeters inboard). Also, you might remember the ADS 200, a similar-looking but even better sounding mini-speaker that many folks on this side of the pond used to excellent effect with a variety of subwoofers.

In any event, the Napoleon satellite ([www.alonbyacarian.com](http://www.alonbyacarian.com)) is unique in my experience in that it sounds full and has a reasonable mid-bass foundation, never sounding thin or screechy like many mini-monitors can. One can play without the subwoofer in the system and almost not be aware that the bottom bass is missing till it comes along, so well-balanced is the Napoleon. Plus it seems to be able to take an intense drubbing from the amplifier without giving up its bones for dust. I have played it to rather insane levels (without any kind of high-pass filtering, mind you) with a VAC PA 100/100 equipped with KT-90 valves, and the buggers did not even flinch. (I have heard stories of 300 watt/channel VTLs played full-tilt with no ill effects, either). They just play big and bold, with a refined tonal balance and a simply huge, though not overblown, soundstage presentation. In fact, with the lights out and with some material, I could hardly tell that they were not the 3A Master Virtuosos. Damned impressive in anyone's book for \$2295 for two satellites and the Thunderbolt sub. This is a system to take very seriously, indeed, and may be had in both stereo and surround-sound packages: all the same speakers, just more or less of them.

Speaking of electronics, you might ask if I have heard any really outstanding kit in that category. Actually I have, and I will tell you here about two, as I do not wish to give away all of my writing fodder. First up is the remarkable NAT Se1 SET mono-blocks from NAT Audio of Yugoslavia ([www.nataudio.com](http://www.nataudio.com)). Mr. Petar Todorovic has been a busy fellow over there in central Europe designing and manufacturing amplifiers and pre-amplifiers that would seem to be on par with or ahead of, in terms of sound

quality, most anything I have seen from Western countries, especially in terms of price vs. performance. While I am not going to tell you that you can have a Lamm ML-2 for \$5900 instead of over 30 grand, but you can have a superb set of SET mono-blocs with 25 watts of feedback-less, Class-A power that use vintage 1942 VT-4-C output valves (this is very similar to a standard 845 type) for that price, assuming you can persuade Mr. Todorovic to send you a pair. As far as I know, they are not yet formally distributed in the UK or the USA. But make no mistake: These things are a serious attempt at SET glory, and in my room they have thus far succeeded admirably, driving the 3A

and Alon speakers above, as well as others, with exceptionally musical results. I will have a full review of these babies soon on the TAS/AMI web-site, but you folks here at Hi-Fi + are getting the first whiff of what I figure to be a new force in modern SET and line-stage development. Go and have a look at some of the stuff on the web-site and I wager that you, too,

will salivate as I did when I came across it.

Now the best for last. Once again, it is an Alon product. This has been a good year for that firm, at least in a design sense. Perhaps economics will someday catch up for them to the same level as in-house talent so that they can become rich and famous.

Well, rich, anyway... The product is their Lotus Elite loudspeaker, and it is a stunner. Available in the "normal" version at \$3995, and also in an upscale, Alnico magnet-equipped version at \$7995, the Lotus Elite is, pound for pound, the best speaker that Marchisotto has ever made, in this writer's opinion. I have heard it on a couple of occasions in Harry Pearson's room 2, as well as twice at different CESs (with totally different equipment each time), and each time the system has come off as if blessed with a magic touch for music and emotion. A medium-sized three-way design with an open-back midrange driver, twin eight-inch woofers and good sensitivity, the Lotus Elite gets my juices flowing in a way that I have not experienced since I fell in love with my Shahinian Hawks. Simply exploding with musical goodness and the ability to get the notes right and step out of the way of the music, the Lotii (is that a plural??) will, I predict, be a big hit and a boon to anyone who wants great sound on a reasonable budget in anything from a relatively tiny room to one that is almost baronial. And they go great with the Thunderbolt subs, as you may already suspect. Not to be missed, and I am getting a set of the regulars for full review, as is, methinks, your trusty editor. I hope I do not get in hot water for letting that slip...





# Incoming!

Please address letters to the Editor at Hi-Fi+, Unit 12 Albany Business Park, Cabot Lane, Poole, Dorset, BH17 7BX.  
or via the web-site at [www.hifiplus.com](http://www.hifiplus.com)

Dear CB,  
I am considering upgrading my amp to a Bryston and saw your review of the 14BST. To my surprise, you mentioned in your article Gale GS 401 speakers and how exciting that was to read.

Well, I am writing because I have a pair of GS 401's and love them. I am a product of the 70's and 80's and have had only Gales since 1981. They still are wonderful and they still sound great to me.

But in my search for an amp with more headroom, I have had a difficult time getting salespeople who have heard Gales let along even knowing what vintage they are. So, as you wrote about them, are you able to assist me in trying to match one of today's amps with 80's speakers? I have been considering Bryston 4BST, 14 BST and even considered the 7's. I have an Audio Research LS3 pre.

I hope that it is not too much to ask for you to share your thoughts with me regarding my components and what I might consider to power the Gales. If you have any thoughts on a CD player to use also I am listening. I feel it is time to upgrade that part of my system also.

I appreciate any and all information you can share. I was happy to read that you too enjoyed the Gales and as you have much more experience with audio equipment your input, wisdom and time spent answering the post will be greatly appreciated.

Thank you

**Scott Muramatsu**

*Hi Scott*

*The simple answer to your question is, get a 14B ST!*

*Being a little more practical, I guess it all depends on your room and required listening levels...*

*You must bear in mind that when I first started using Gales, listening to music required as much volume as possible, and my comments about the Naim 250 applied because of the unholy levels at which I listened to music. And of course, source material was only vinyl, the inherent rumble and LF rubbish which is what really caused the 250 to overheat. Bearing that in mind, if you have not heard Naim amps with the Gales, it is worth trying. A friend of mine uses an updated 250 with a pair and it does sound very good, and he never has any problems with cutting out as he only uses CD.*

*But I know that the Gales are a loudspeaker that do require a certain amount of volume before they wake up. In all seriousness, any of the Brystons will drive the Gales well. Second hand bargains are about, but if you can, go for an ST, as they are significantly better. The 3B will do the job nicely, provided you don't require massive listening levels, while I feel the 14B is the best they do so far - but I don't know if there is yet a 7BST. I think the circuitry is different anyway, as the 14 is a bridged design. It would have to be my first choice.*

*The situation should be far easier these days as there are many medium powered amps that will drive them, but if you do want something bigger, choice becomes limited, hence my enthusiasm for the Bryston. I should mention that I have used the Cyrus AFA 7.5's in the aforementioned friend's system to good effect - they do not have the ultimate slam or taughtness of a 14, but are dynamic with a good midrange and will drive well without distress.*

*A small word of warning - the surrounds on the original AR drivers becomes very frail, depending on the environment in which they have been used, I have come across ones which have disintegrated when touched, while others are quite OK. I guess if they are working okay with no farts or squeaks, leave them alone! I am not entirely convinced at the Wilmslow Audio replacements - Fearless I think - as they have quite different characteristics. Clean the fuses - or get someone to wire them out, as it also makes an improvement.*

*I hope this is helpful*

*Chris Binns*

Dear MC,

Keep up the excellent music reviews. Many thanks for bringing Six By Seven to my attention (definitely my favourite discs from the past few years).

Truly cooking.

If you get a chance, check out Jets to Brazil - *Perfecting Loneliness*, preferably on the double-LP (coloured vinyl). Different sound compared to Six By Seven, but another standout from the sea of conformity and mediocrity out there.

Cheers,

**Craig M. McDougall**







Copyright © South Pole 2002 Limited

**Caroline Hamilton**

Led first all women team to the South and North Poles in 2000/2002.



CP65 - Pre-amplifier



CA201 - Power Amplifier

# A different Classé

Outstanding achievement in any field is driven by enormous determination and energy. Just as Caroline Hamilton pushed herself to the limit in reaching the South and North Poles in 2000 and 2002, with her all women team, we at Classé have been totally committed in reaching our goal – to develop audio equipment that offers an unrivalled expression of music, irrespective of artist, genre or taste.

We believe that audio equipment should liberate your listening experience. And that belief is at the heart of every amplifier, source component and processor that we put our name to. The components we select, the systems we design and the processes we employ are driven by a passion for music and a desire to hear it as it was originally recorded.

To witness sound that's in a class of it's own, why not call Classé at B&W Loudspeakers UK on 01903 221500 for an audition?

Classé music and cinema systems from around £3,000 to over £50,000

*Classé*

[www.classeaudio.com](http://www.classeaudio.com)

## COUNTDOWN TO



**21 - 23 February 2003**

10am - 5pm every day  
at the Marriott Hotel,  
Lower Castle St., Bristol

#### GETTING TO THE SHOW

By train: Temple Meads Station is a short distance from the Marriott and is accessible by bus, foot or taxi.

By car: from the M4 take J19 (M32 - Bristol). Follow signs for City Centre and RAC signs to the Show.



Easy local parking in Broadmead and Bond Street NCPs.

# SOUND & VISION

## THE BRISTOL SHOW

**SEE & HEAR ALL THE LATEST PRODUCTS UNDER ONE ROOF, INCLUDING...**

- ACOUSTIC ENERGY:** the UK launch of the new AE1 MkIII loudspeaker
- ARCAM:** DV89 - witness the launch of Arcam's first DVD-Audio player
- CELESTION:** Soundstyle Electronics DVD player and Home Cinema Receiver
- CYRUS:** we've been promised some new CD players!
- DENON:** AVR3803 the state-of-the-art home cinema receiver and more
- DYNAUDIO:** First UK showing of the revised Contour Range and more
- KEF:** displaying the new XQ series and the brand new Reference Model 206DS dipole surround
- LOEWE:** new Aventos television, using the latest Loewe technology
- MERIDIAN:** 598 DVD-Audio player
- MISSION:** First public showing of the M7 sub and M3 sub/sat system
- NAD:** T752 - their first home cinema receiver with 7.1 surround decoding
- NAIM:** World Premiere of the much anticipated CDS3 CD player
- TEAC:** Legacy systems make an appearance
- WHAT HI-FI? SOUND & VISION:** there in person to answer all your questions

**GREAT DEALS AND SPECIAL OFFERS AVAILABLE ONLY AT THE SHOW - PLUS YOUR CHANCE TO WIN SOME SUPERB PRIZES IN THE SHOW COMPETITION**

#### Admission

Adults £7.00; Students/OAPs/UB40s £3.50; Accompanied children under 16 free

#### BRANDS ON SHOW INCLUDE:

Acoustic Energy, Acoustic Research, Aloia, Alphason, Anthony Gallo Acoustics, Apollo, ART, Arcam, Argento, Atacama, Audionet, Audioquest, AVID, B&W, B-Tech, Bandridge, Beyer Dynamic, Black Rhodium, Boston Acoustics, Bryston, Cabasse, Canton, Cable Talk, Castle Acoustics, Celestion, Chapter Audio, Cherished Record Company, Chord Company, Chord Electronics, Cinemax, Classe, Clearaudio, Clearlight Audio, Creek, Cyrus, Dagetti, Denon, Diverse Vinyl, Dream Vision, Dynaudio, ECS, Eclipse TD, Ecosse, Eichmann, Epos, Elac, Electrocompaniet, Emotive Excellence, Exposure, FDM Furniture, Fujitsu Plasmavision, Future Glass, Gamut, Goldring, Grado, Heco, Hi-Fi News, Hi-Fi Plus, Hi-Fi World, In Focus, Isotek, Ixos, Jamo, JM Lab, KEF, KM Acoustics, Leema Acoustics, Lehman, Lexicon, Living Voice, Loewe, Luxman, MJ Acoustics, Magnat, Marantz, Meadowlark, Meridian, Michell Engineering, Mission, Monitor Audio, Moon, Mordaunt Short, Music Works, Myryad, NAD, Naim Audio, Neat Acoustics, NEC Projectors, Niro, Nordost, O'Heocha Designs, One for All, Onkyo, Optimum International, Optoma/Themescene Projectors, Opus, Ortofon, Path Premier, Pioneer, PMC, Primare, Polk, Pro-Ac, Profigold, Project, Prowire, PSB, PURE Digital, Puresonic, QED, Quad, Quadraspire, Redline, Rega, REL, Revolver, Roksan, Rotel, Ruark, Russound, Sanyo, Sennheiser, Shun Mook, Sim 2, Sony, Sonus Systems, Soundstyle, Spondor, Stands Unique, Sugden, T+A, Tact Audio, TAG McLaren Audio, Target, Tannoy, Teac, Tech+Link, Tivoli Audio, Topodis Storage, Totem Acoustics, Trichord Research, Trinity Audio, True Colours Industries, Tube Technology, Velodyne, Vibe Technology, Vienna Acoustics, Videologic, Vivadi, Vivanco, Vivante, Vogel's, Voodoo Isolations, VPI, Waterfall, What Hi-Fi? Sound & Vision, Wharfedale, Wilson Benesch, Yamaha and many more

For the very latest information on new product launches check [www.bristolshow.co.uk](http://www.bristolshow.co.uk)

ORGANISED BY

**audio** X  
EXCELLENCE

**audio** T

in association with

**WHAT HI-FI?**  
SOUND AND VISION

# evolution

VISIT US AT  
**SOUND & VISION**  
THE BRISTOL SHOW  
21-23 FEBRUARY  
2003

## Cyrus' legendary amplifiers have evolved!

Back in 2001, Cyrus began a project to evolve our integrated amplifier designs to incorporate technologies researched over the last five years. Many months of electrical re-evaluation and detailed acoustic tuning have culminated in the fabulous new Cyrus 8. This extraordinarily accomplished amplifier sets new standards and strengthens Cyrus' position at the leading edge of what is possible in audio design today.

To discover how this major technical advance has evolved, please visit our website at [www.cyrusaudio.com](http://www.cyrusaudio.com).

**CYRUS**

Advanced Audio and Video Systems

Cyrus Electronics  
Huntingdon, Cambridgeshire, PE29 6XX

Tel: +44 (0)1480 435577  
Fax: +44 (0)1480 437715  
email: [info@cyrusaudio.com](mailto:info@cyrusaudio.com)

[www.cyrusaudio.com](http://www.cyrusaudio.com)

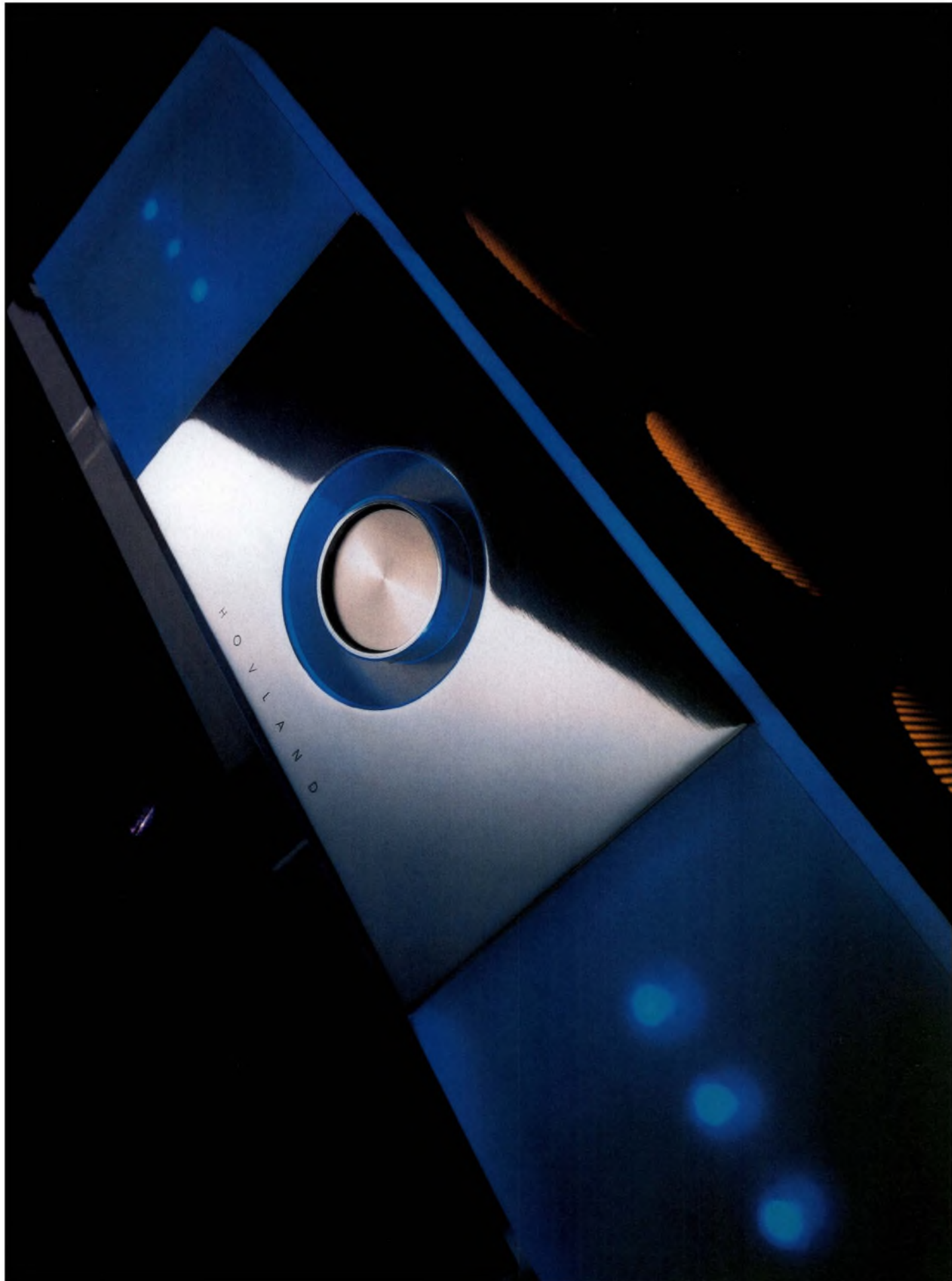

H  
O  
L  
L  
A  
N  
D

# Las Vegas CES 2003

## Elvis Has Left The Building... But it looks like he's on his way back!

by Roy Gregory

Who'd have thunk it? 2003, Vegas and a Convention Centre seemingly intent on doing digitally what George W has failed to achieve militarily, as well as being in total denial over the bursting of the Telecoms bubble. But out in the sticks, at the high-end audio ghettos of the Alexis Park and San Remo hotels, the abiding impression is of an analogue world. And impressions are what you'll get out of this show report. Given the vast sprawl that constitutes the Consumer Electronics Show comprehensive coverage would be space and time consuming in the extreme, as well as downright tedious. So I'm limiting this to my personal highlights, as well as saving much of the mainstream UK stuff for next issue and the Bristol Show. But the common theme that dominated this year's Vegas outing was the re-emergence of the turntable as a major source. Just about every room had one, and not just for show. For the first time in a decade it was actually worth taking records to hear at a hi-fi show, the trusty Nagaoka box pressed back into service.

Turntable of choice for many of the US high-end exhibitors seemed to be the new VPI TNT-HR-X, now in finalised (and significantly evolved) form after its initial outing at last year's New York show. Platter, bearing and drive remain largely unchanged, but the main chassis is now a laminated acrylic/aluminium sandwich (built on doorstep rather than Sunblest

proportions). I'll save the finer points for the review due in Issue 23, but initial impressions suggest that Harry Weisfeld has finally succeeded in banishing the velvety darkness that has always pervaded the TNT, whilst retaining its dynamic and musical strengths. ([www.vpiindustries.com](http://www.vpiindustries.com))

Elsewhere Lamm were using various vintage Micro Seikis, whilst my favourite Kuzma/Triplanar ([www.audiofreaks.co.uk](http://www.audiofreaks.co.uk)) combination was making sweet music via Sugden Bijou electronics and ProAc speakers, the 15 Class A Watts of the Music-master amp driving a pair of Tablette 8 Reference Signatures. The arm itself has now reached Mark 7 status, the change in designation simply indicating a further tightening of parts tolerances rather than any modification to the design. ([www.lammindustries.com](http://www.lammindustries.com))

The revised Air Tangent tonearm put in an appearance, while its partnering (triangular) turntable is close to completion. It was mounted here on the Nordic Concept Reference turntable, a substantial two chassis design finished in the same 'plywood' veneer as the Penn Audio speakers reviewed in the last issue. The two cabinets are of equal footprint, non-suspended and heavily damped using an innovative technique. The motor box also contains a battery power supply, used to drive the 'table and the onboard Vitus Audio phono stage.

The whole lot weighs in at around 60 lbs, costs \$14650 including an Origin Live tonearm. It certainly looks to be a thoughtful evolution on the classic non-suspended, thick acrylic platter approach, while its ceramic bearing and battery supply are reminiscent of the Amazons. ([www.dnaudio.com](http://www.dnaudio.com))

Those charming eccentrics at Sakura Systems, distributors of the 47 Labs equipment, showed the RS Laboratory RS-A1 tonearm, a fascinating unipivot design with a down-angled arm similar to the Grado arm, only this one's flat. You'll not be surprised to hear that it looks decidedly different, and you've got to love a company that still markets a headshell for detachable headshell arms, designated the RS-3 Rotary Headshell, and claiming to "eliminate the effect of the arm mass to the cartridge without hustle". ([www.sakurasystems.com](http://www.sakurasystems.com))

Talking of eccentrics (and what gets more eccentric than analogue, and not just the records either) the irrepressible Terry from Loricraft, aided and abetted by sidekick Martina Schoener, was showing a further evolution of the well-established Garrard 501 turntable, the Inspiration. Now boasting a stainless-steel chassis, which adds 7kg to the overall weight of the idler-drive assembly. The polished metalwork, plum coloured top-plate and walnut plinth were reputedly special ordered by a customer to match his Bently Corniche, a large photograph of which (supplied by ►

*So you think you've  
heard music?*

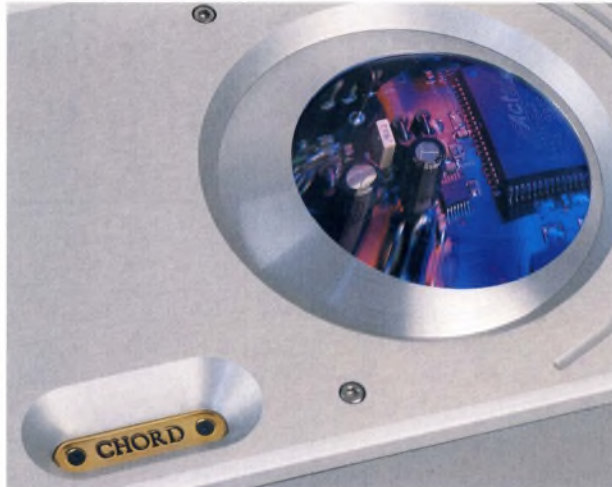

*Think again.*

The Chord DAC64. The world's first 64-bit digital-to-analogue converter.

Regarded by the press as 'stunning', the DAC64 is result of our innovation and engineering excellence, and will deliver new levels of sound quality from any digital source.

Each solid aluminium unit is hand-built to uncompromising standards to your specification.

So, to unlock the real potential of music, please contact us on 01622 721444, email [sales@chordsoftner.co.uk](mailto:sales@chordsoftner.co.uk), or visit [www.chordelectronics.co.uk](http://www.chordelectronics.co.uk)



Chord Electronics Limited

▶ the manufacturer) underlined the point. The new power supply helps justify the price rise of £1000 over the £5650 charged for the standard model. Meanwhile, the less-expensive 601 has also evolved, employing new materials technology in its open plinth construction. At £3850 this is fast becoming a serious contender in the serious analogue stakes, offering as it does, the mechanical elements of the 501 in a far more affordable (and some would say attractive) package. With another round of turntable reviews pending, I think the 601 needs looking at. (terry@garrard501.com)

Other UK companies showing new turntable models included Roksan, whose TMS 2 is finally in production. That's another one for the upcoming analogue issue, although a (very much) pre-production addition to the bottom of the range looked equally interesting. Aimed to sell for around £700, including an in-house uni-pivot arm with perspex bearing housing and headshell, this looks like it could offer outstanding value. The Rega compatible tonearm, at around \$350 on its own, could also upset a few apple carts. (www.henleydesigns.co.uk). Meanwhile, Avid were also showing a prototype 'table. A skeletal design that uses rods, splayed, spoke-like around the bearing hub. The unusual feature is that it's a modular design, so that by swapping out the standard rods for longer ones, 12" or even longer tonearms can be accommodated. Apparently, TEAC in Japan were the driving force behind the design, although I can see it appealing to many European audiophiles too. (www.avidhifi.co.uk).

Lyra rolled out production versions of the new Titan (\$4500) and Argo (\$1195) models, with the cheaper Dorian soon to follow. The Argo in particular, slotting into the range below the popular Helikon, should sell in large numbers, and it looks especially fetching in an electric blue anodised

## People

One of the great things about international shows is not just the chance to meet old friends from what is becoming an increasingly global industry, but also the opportunity to finally meet people you've admired from afar, sometimes for many years. This CES was no exception and I finally got to meet three analogue die-hards whose work has given me enormous hope or pleasure (or both) in this hobby and its future. First up was Bruce Thigpen, designer and manufacturer of my first passive linear tracker, a tonearm still close to my heart, the Eminent Technology ET2. That was getting on for 20 years ago now, and whilst the tall, urbane Mr Thigpen still services and supports those arms, along with the later 2.5s, his current fascination is the continued evolution of his LFT planar magnetic speakers. The results I heard from both the floorstanding, full-range hybrid LFT-VIII and the diminutive LFT-14Rs suggest that Eminent Technology's reputation for superb design solutions at bargain prices is well-deserved and remains intact.

Second on the list, historically at least, is the irrepressible Wally Malewicz, a man whose obsession with the minutiae of cartridge alignment and set-up has generated a whole kit of analogue set-up aids that take the black art out of optimising the sound of your turntable. With carefully created devices that make the whole process both deadly accurate and repeatable, immaculate set-up is put within the grasp of mere mortals, whilst the implications for reviewers are even more profound. With fewer and fewer dealers possessing this level of in-depth knowledge and experience, analogue aficionados are increasingly forced to fall back

finish remarkably reminiscent of the legendary Tsurugi. The flagship Titan employs a milled from solid titanium body, and, if memory serves, platinum magnets, which together help to explain its elevated price. But then, these days it looks like something of a bargain for a flagship model.

But the big news from Lyra was the imminent arrival of the Erodian phono-stage. Priced at around \$4000, the

on their own resources. Wally's tools mean you get it spot-on, every time – and boy can you hear the difference. Different tools allow you to optimise alignment, azimuth and anti-skating, achieve a neutral reference for VTA, and set downforce properly. The difference between good enough and absolutely right has to be heard to be believed, and if you're spending upwards of £600 on a cartridge then Wally's pretty much indispensable when it comes to maximising the return on your investment – sonically and in terms of cartridge life. His latest project? An attempt to bridge the schism between Harry Weisfeld of VPI and the self-appointed protector of all things analogue, Michael Fremer, righteously out-raged by HW's laissez-faire attitude to anti-skating on his JMW tonearms. The solution: a perfectly executed falling-weight compensator that attaches to the JMW's base, allowing the owner to adjust the angle and height of the roller so that it can't disturb the arm's azimuth. Of course, it also comes with a composite weight and precise instructions as to its composition for any given downforce. Simple and very, very effective – but then that sums up all of Wally's tools. (www.simplyblack.net – click on Wally's Vinyl Corner)

The final member of this trio, Dung Tri-Mai, is the man who bought the rights to the Triplanar tonearm when Herb Papier finally retired for good. Reworked and retooled, he rejuvenated this analogue legend, improving on the original and restoring it to the position of best ever fixed pivot tonearm. All those who profess affection, regard or an interest in the future of analogue replay owe Dung Tri-Mai a vote of thanks. His faith in the product has been repaid in orders at a level to make others sit up and take note. It was a pleasure to thank him personally.

▶ totally dual-mono design comes in a beautifully milled aluminium case, although the top-plate is plastic. It also comes from the same design team that brought you the all-conquering Connoisseur Definitions 4.0, although with its i/cs in place of the latter's complex "air dielectric" and discrete component construction, don't mistake it for a Connoisseur on the cheap. Its price pitches it head to head

▶ with The Groove, which will certainly provide stiff competition, a fact that the company is refreshingly aware of, so I look forward to hearing the finished version. ([www.path.co.uk](http://www.path.co.uk))

The other cartridge that seemed to be making a splash was the Shelter 501. Bearing an uncanny resemblance to the Crown Jewel, but costing a fraction of the price, it cropped up in the Lamm, Nearfield, and Rogue Audio rooms to mention just a few. As yet unavailable in the UK, I'm on the case, as the results I heard suggest that it could be very special indeed.

## Amplification

Talk of Rogue Audio conjures images of their new amp, a stereo monster dubbed (not inappropriately) Zeus. The massive, but attractively styled chassis delivers 250 Watts a side from its myriad output tubes, and weighs no less than 190lbs (or nearly as much as designer Mark O'Brien). Its sound, driven from an Avid/SME/Shelter front-end and out through Meadowlark Blue Heron II speakers was remarkably solid and stable, but also agile and quick enough to grab your interest and hold it. Best of all, the \$6000 price tag, whilst it hardly qualifies as pocket money, is distinctly affordable for a valve amp of this power, thus maintaining Rogue's reputation for solid engineering and value for money.

Perhaps the biggest surprise was Living Voice's entry into the world of electronics, in the shape of a pleasingly post-retro integrated amplifier, the "not-the-Shiva". Offering 25 Watts of Class A power from its solid-state circuitry, the amp received its unfortunate moniker before anybody stopped to consider its philosophical and multi-lingual implications. Ooops! I think you can assume that a rapid rethink is underway. Unfortunate appellation aside, the sound of the amp, targeted to sell for around \$1500 was extremely promising, although final spec and

details remain to be worked out. Looks interesting to me.

conrad-johnson limited themselves to a static display, but that didn't stop me slaving over two new power amp designs on show. Arriving in the spring will be the Premier 140 mono-blocks, delivering 140 Watts per channel from an octet of Svetlana 6550Cs and with a projected price, State-side, of \$6795. Bill Conrad feels confident in its superiority to the Premier 8, due in no small part to a new, low impedance driver circuit that he's developed around the 6N30Pi valve, and new polypropylene power-supply caps. But a bigger surprise came in the shape of the Premier 350, the companies' first solid-state Premier series power-amp. Further away from completion than the 140 details and price remain to be finalised, but it's a global feedback free circuit that delivers 350 Watts per side from the bulky, stereo chassis. Meanwhile, the mighty GAT, long awaited partner for the ART line-stage, still lurks in the wings, although progress is being made. Expect to see more about it before the end of the year. ([www.conradjohnson.com](http://www.conradjohnson.com))

It was a great pleasure to see the fabulously musical (and affordable) Monarchy Audio amps out in force, now joined by a prototype valve line-stage that uses a 300B output stage! Driven from their own Laserdisc transport, DIP and 33C DAC (\$1500), it was feeding a pair of SE160 mono-blocks (\$2000 ea.) into the Eminent Technology LFT VIII hybrid planar-magnetic speakers. I'll talk more about this system in the What Sounded Good? sidebar, so I'll confine my comments here to the observation that this was one of the cheaper systems at the show – as well as one of the better sounding! ([www.monarchyaudio.com](http://www.monarchyaudio.com))

Hovland, manufacturers of my favourite HP100 valve pre/Sapphire hybrid power combination, have gone the whole hog by producing

a solid-state power amp, the Radia. Aesthetically it's everything we've come to expect from Hovland, with stunning looks that form a natural extension to its function. Internally it's pretty impressive too, with totally dual-mono construction, down to separate power transformers for each channel. Each channel employs a bridged configuration, making it fully complementary when connected to a balanced input, while an active bias adjustment system helps keep the amp thermally stable. The chassis itself shows the companies' usual attention to structural integrity and rigidity, and contains the usual heavy sprinkling of Hovland's own-brand cabling and capacitors. Weighing in at 74lbs, the Radia delivers 125 Watts into eight Ohms and 200 into four, and will sell in the UK for \$7995.

([www.hovlandcompany.com](http://www.hovlandcompany.com))

Another familiar name (albeit one whose equipment I've never come across) was Herron Audio. Playing a VPI Aries Extended turntable, meaning one with the 12" JMW arm, through their own electronics and the well regarded Joseph Audio Pearl speakers, the sound was clean, clear and uncluttered, the great timing really allowing the music to breathe. In no way overly warm or romantic, there are those who might find the presentation too stark for their tastes, but I was impressed enough to organise review samples for US correspondent Richard Foster. Perhaps the most refreshing aspect of the Herron designs was the lack of pretence, musical or physical. Perfectly presentable but otherwise plain Jane boxes contain thoughtfully executed valve and solid-state circuits where the principal effort has clearly been expended on the insides. This keeps the cost/performance quotient extremely high, and whilst the metalwork might not impress your mates, the open, honest sound certainly should! Ahhh! Shades of jolly old England. ▶



# Model-One



We strongly believe that technical specifications are not the real key in sound reproduction. Our loudspeakers give real life and space to your music. Our first design is possibly the best example of this concept. The Model One has an extremely spatial sound image, it has rhythm, emotion and their frequency behaviour is incredibly coherent. Despite its size the Model One gives true and dynamic bass. These tones change easily to medium and higher frequencies: coherence is the key to a real music experience. Every principle of our design philosophy is used in the Model One in the most essential way: difficult simplicity. Maybe that's the reason why it has become our best-known speaker. The press have rewarded us repeatedly and are continually surprised by it. For many people, the Model One is a statement in hi-fi, a reference at any price. Many recording studios are using the Model One. Who knows if it will also be an important Totem in your life. We named this speaker "Model One" because, as a company, we wanted to choose something unpretentious. We also wanted to indicate that it was not only our first model, but our prime model!

To receive information on our full range of products, please send your address to [info@joenit.com](mailto:info@joenit.com) or call 003215 285585

London Area	Cornflake.co.uk, LONDON, Tel: 0207 6310472 Rayleigh Hi Fi, LAKESIDE, Tel: 01708 680551 Thomas Heinitz, BAYSWATER, London, Tel: 0207 2292077 Audio-T, READING, Berkshire Tel: 01189 585463
South East	Rayleigh Hi Fi, RAYLEIGH, Essex, Tel: 01268 779762 Rayleigh Hi Fi, CHELMSFORD, Essex, Tel: 01245 265245 Audio-T, TUNBRIDGE WELLS, Kent, Tel: 01892 525666 Rayleigh Hi Fi, SOUTHEND, Essex, Tel: 01702 435255 Visions, WESTERHAM, Kent, Tel: 01959 569977
The North	Audio Republic, Headingley, LEEDS, Tel: 07932 682440 Romers Hi Fi Great Harwood, Lancs Tel: 01254 887799 The Audio Room, Hedon, Hull Tel: 01482 891375
Scotland	Loud & Clear, EDINBURGH, Tel: 0131 5553963 Loud & Clear, GLASGOW, Tel: 0141 2210



## What sounded good

It's always nice to get excited by the sound of new products, or at least ones that are new to you. All shows have them and Vegas was no exception. But first, let's visit a few of the usual suspects, companies that can be relied on for good sound.

Holding up the British end, Canadian distributor Bluebird Music were undermining the local reliance on size and power with a small system that had more than a few visitors shaking their heads in astonished chagrin. Unfortunately, the prevalent comment seemed to be "I just need to find some speakers that sound like that – but bigger!" The system in question was fed by a SME 10/Kuzma KC Ref front-end, feeding Croft Charisma X and Twinstar amplification and the familiar Living Voice Avatar OBX-R, now with the revised and improved crossover as detailed in Audio Smorgasbord in this issue. Cabling was the new Chord Co. Signature, while the odd (and I do mean odd – in every sense of the word) CD was played on an AVI/Chord DAC 64 combination. Big, surprisingly powerful, very dynamic but above all coherent, this far from extravagant system put many of the really expensive set-ups on show to shame. But the best thing of all was that this was one room playing real music.

Vladimir Lamm was making his usual superb sound, his own Reference electronics (LP2, L2 Reference and ML2s) driving, of all things, a pair of Wilson System 7s. An unexpected combination to say the least, but you can't argue with the results. Front-end was a vintage Micro Seiki 5000 turntable with an original SME 3012-R and a Shelter cartridge, while signal wiring was supplied by Stereovox and mains distribution came from Shunyata. Refinement, delicacy and vivid tonal colour were combined with real dynamic authority and exquisite poise. A mono RCA disc (a mere Red Seal no less) of Horowitz playing Chopin was achingly beautiful, the mastery of the playing beautiful to behold. A lot of people have a problem with Chopin's piano music, mainly because they've been listening to it on systems that simply aren't up to the job, but

with the Lamm set-up LB, a sporadic classical listener got it at once, sitting spell bound through an entire side. Ironically, a second Lamm system using virtual identical electronics and turntable to drive a pair of huge 1962 Siemens full range horns, whilst definitely the most visually imposing demonstration, was musically rather less successful, especially on anything large scale and complex in character.

My love affair with the Nearfield Pipedreams continues, the monster line-sources being back on form after a disappointing outing in London. Driven here by a VPI TNT-HRX/JMW12.5 arm and Shelter cartridge, feeding VAC amplification, the sound was enormous yet tactile, with really impressive stereo separation. Dynamic range was huge, dynamic impact sudden and effective, but the music managed to remain intimate and communicative when required to. Later in the show, VAC's new budget mono-blocks driving the mid/treble towers were replaced with very much prettier, cubic, high-zoot models, which might have scored on delicacy but palpably lacked the grip required for the job, dynamic swings hardening dramatically, and at high frequencies, really quite painfully. In this case less (money) was definitely more (music). ([www.nearfieldacoustics.com](http://www.nearfieldacoustics.com)).

Two mentions already for the Kuzma Stabi Reference/Triplanar based system are probably enough, so I'll simply add them to this list. Cartridge was the notoriously finicky vdH Colibri which was sounding simply sublime, which sums up exactly what this arm and turntable are all about – bringing the best out of whichever pickup you choose. Of course, the Sugden Bijou electronics and ProAc speakers helped, creating a system that was a pleasure to share time with. Which brings us to the new boys on the block. I first heard the latest range of Alon speakers in the shape of a pair of four-cabinet monsters (and I mean monsters) hung on the end of Harry Pearson's legendary reference system at Sea Cliff. SM informed me that Alon designer Carl Marchisotto was intending to use similar electronics at the show to the ones I'd heard at HP's, but this time driving his \$8000 Lotus Elite Signature speakers. To this end, a Metronome CD player was feeding signal to a c-j ART line-stage and a pair of Antique Sound Lab Hurricane mono-

blocks. The Elite Signatures are compact floor-standers with separate crossovers and almost European dimensions, which nevertheless extend down to 28Hz. The somewhat unnecessary addition of a pair of Alon Thunderbolt subs (\$1695 ea.) provided additional underpinning, the extra space such a foundation provides making the most of the Elites open baffle mid and treble. Music really breathed on this system, backed up by impressive dynamics and an ultra stable presentation. The thunderous opening that prefaces Act Two of the Ghorgiou *Tosca* was scaled with aplomb, the cavernous acoustic combined with seemingly limitless power. But the really impressive part was the way in which the performance of the Elite Signatures mirrored that of the flagship version, offering more of the monsters' performance than they had any right to. With the Elite model starting at \$4495 (internal crossover, -3dB at 35Hz) and the Signature adding Alnico magnets throughout as well as the extra extension and external crossovers, these are speakers that demand an early review. ([www.alonbyacarian.com](http://www.alonbyacarian.com)). And finally, the Monarchy Audio/Eminent Technology system: Even playing material as familiar as *Belafonte Live At Carnegie Hall*, this marvel of affordable high-end minimalism managed to emanate freshness and enthusiasm. It perfectly captured the wry humour in Belafonte's spoken introductions to each song, whilst the sense of space and musical momentum were absolutely spot-on. Once again, this was a system that allowed music to breathe really convincingly, the easy rhythmic integrity I associate with the Monarchies gelling perfectly with the natural spaciousness of the di-polar Eminent Technologies. Even the warm, rounded bass on the Belafonte disc didn't cause discontinuity between the planar mid and treble panels and the moving-coil bass driver, perhaps helped by the lowish 180 Hz crossover, and the seamless mid-band soaring all the way up to 10K didn't hurt either. At \$1500 a pair these astonishing, near full-range di-poles represent the biggest bargain of the show, rivaled only by the electronics driving them. I'm astonished they're not more widely lauded in their homeland. Yet another case of too cheap to be taken seriously?

► It was also nice to reacquaint myself with the Stello electronics from April Music. I was really rather impressed by an early sample of their CDA200 up-sampling CD player, and it was displayed here alongside the matching AI300 integrated amp. But, in the intervening period the case-work has undergone a major revision, redesigned by none other than Oracle's main man, Jacques Reindeau. The results are mightily impressive, with the sleekly rounded and beveled fascias reminiscent of a more modern Burmester. The insides are equally impressive, beautifully laid out boards, neatly populated. The CDA200 retains its 192k up-sampling capability, backed up by modular construction of key elements, separate transformers for the digital and analogue stages and fully balanced outputs. The partnering amplifier offers a differential input stage, discrete components in its DC coupled signal path, modular construction and a bi-polar, push-pull, Class A output stage. US prices will be around \$2750 for the CD player and \$3250 for the amp. No UK importer as yet, but if the performance is as promising as the engineering and sound at the show suggests, that should be sorted out sooner rather than later. ([www.aprilmusic.com](http://www.aprilmusic.com))

### Speakers and Accessories

The two most immediately interesting speakers that I saw at the show were the Alon Lotus Elite Signatures and the Eminent Technology panels, both of which get discussed at some length in the What Sounded Good section. However, as the Eminent in particular are almost unknown over here, I'll give you a little background on the three model range. The core technology is a push-pull planar magnetic diaphragm which, unlike the Magneplanars, is driven from both sides. It's available in three

models. The hybrid, floorstanding LFT-VIII costs \$1500 a pair and offers a bandwidth from 33Hz on up. The specially developed 8" woofer crosses over at a low 180Hz to a midrange panel, which hands over to a planar tweeter panel at 10K. The frame carrying the panels is constructed from damped and welded steel and finished in Oak trim and black cloth, although other finishes are available for a small cost increment. The detailing is good too, with the superb Edison Price Music Posts being used on the bi-ampable crossover. Just as well, as the 84dB sensitivity will need all the help it can get. Having said that the sound was notably free of the softness and blurring that I remember from my Magneplanar days, offering superb clarity, transparency, warmth and focus. This much engineering and performance for \$1500? In a package that's slightly slimmer than the old MG1b! I'm surprised ET aren't calling home – 'cos their pricing clearly doesn't come from this planet. Get 'em while you can.

As well as the LFT-VIII, they also offer the LFT-II, a pair of tiny di-polar satellites about a foot high, supplied with an amplifier and sub-woofer for \$900. But perhaps the most interesting item of all is the LFT-14R, a flat panel that runs from -4dB at 45Hz. Di-pole throughout its range, and measuring just 28 x 16 inches, it arrives with stands to lift it a foot off the floor and costs \$3900. Efficiency is only 84dB but the 70 Watt GW Labs valve monoblocks were driving them with ease. First impressions were very impressive indeed, and whilst not the bargain represented by the LFT-VIII, they offer very similar qualities to a speaker like the Quad 63 in a package that's cheaper and half the size. Interesting stuff. ([bruce@eminent-tech.com](mailto:bruce@eminent-tech.com))

Penaudio showed a more affordable spin-off from the very impressive Charisma and Charm

sub-sat system. Named the Rebel 2, it consists of \$1695 satellites matched to a \$2000 sub, and whilst it lacked the phenomenal resolution and finesse of its more expensive brother, it displayed similarly superb integration, even with the sub sitting right next to the listening chair. The show pair were in a pale silk lacquer finish that I really liked, but wood veneers will also be available. ([www.penaudio.com](http://www.penaudio.com))

New to me were Murata, a Japanese company offering a fascinating omni-directional speaker and a range of super-tweeters, all employing hemispherical piezoelectric ceramic diaphragms. The tiny triangular cabinets employ a slot-loaded, flat diaphragm woofer and an upward facing dome driver of approximately 4" diameter. Fastened to the back and firing upwards was a small cylinder containing the super-tweeter, said to be good for 100K! The total system is extremely compact yet produces wonderfully spacious and tonally natural sound. Despite the diminutive dimensions the presentation supports the claim of a 50Hz cut-off, while the easy, open, airy sound was wonderfully beguiling. It's a system that demands closer inspection, but if you want to know more while we wait for review samples, then look up [www.murata.co.jp/speaker](http://www.murata.co.jp/speaker).

Finally, more than a few room were using the DiMarzio cables (yes, the same company that makes guitar strings). Refreshingly free of cable-induced-bullshit-syndrome, these Teflon insulated OFC Copper conductors' claim to fame is the careful choice of terminations, fixed with solder-less ultrasonic welds. My own experience suggests that this approach should reap real dividends and I look forward to trying them at home, especially as prices seem much more reasonable than the high-end norm. ([www.dimarzio.com](http://www.dimarzio.com))



# VALHALLA

*"Special. Very special indeed. .... I was genuinely impressed by the SPMs, feeling that they established new standards in many important areas. The Valhallas have just rendered them obsolete as any sort of reference. 'Tis ruined that I am."*

Roy Gregory Hi Fi + Issue 9

## NORDOST (UK) Ltd

Unit 7, Aber Park Industrial Estate,  
Aber Road, Flint, Flintshire CH6 5EX  
Tel: +44 (0) 1352 730251  
Fax: +44 (0) 1352 731273  
Email: sales@nordostuk.com

## NORDOST CORPORATION

200, Homer Avenue,  
Ashland, MA 01721, USA.  
Tel: (508) 881 1116  
Fax: (508) 881 6444  
Email: sales@nordost.com

Please visit our web site at:  
[www.nordost.com](http://www.nordost.com)

  
EDITOR'S  
CHOICE

  
EDITOR'S  
CHOICE  
Hi-Fi NEWS

  
AWARD  
WINNER  
Hi-Fi NEWS

  
PRODUCT  
OF THE  
YEAR

**clearaudio**

**THE HOME OF ANALOGUE**

NEW 50 page full colour Clearaudio catalogue

Call for your FREE copy NOW

Do not touch or press this surface

Stylus gauge EXACT

Tracking force

Leidenschaff und Kunst!

**Audio Reference**

For more information call:  
The UK Distributor on **01252 702705**  
or email: [info@audioreference.co.uk](mailto:info@audioreference.co.uk)  
or visit our web site:  
[www.audioreference.co.uk](http://www.audioreference.co.uk)

**'S' Series**

S9

S8

S6

S3

SR5 **New**

C3

SUB-3

**spendor**



Sendor S9



Sendor S8



Sendor S6

S9 "Great sense of timing and gorgeous bass" Jan 02

S8 "Stunning loudspeakers that deliver everything that their price demands"

S6 "Excellent all-rounders that demand an audition" Jul 02

Available now at your Sendor Dealer

For full information contact:

Sendor Audio Systems Ltd  
Station Road Industrial Estate  
Hailsham East Sussex  
BN27 2ER  
T+44 (0)1323 843474  
[info@spondoraudio.com](mailto:info@spondoraudio.com)

[www.spondoraudio.com](http://www.spondoraudio.com)





## ***BUYING HI-FI? THERE'S ONLY ONE WAY!!!***

I believe there is only one way to successfully buy hi-fi. You must try and test any item selected for evaluation in the comfort of your own home in the environment you know. No demonstration room can tell you how the sound will be in your own home. There are so many factors that contribute to different sounds even in rooms that are identical in size - carpets, furniture, wall paintings, even wall paper makes a difference.

Our unique extendable one months trial system has to be the best way of all. It will almost definitely cost you less in the long run. Couple this with the largest selection and choice of some of the worlds very best hi-fi products, the very best service and advice, many years of experience (since the 1960's) and the results have to be the best available anywhere.

### ***BUY WITH CONFIDENCE NOT REGRET***

Call me for our company brochure and product leaflet and full details of the best way to buy hi-fi. *John Jeffries\**

### **UPGRADE SCHEME**

Buy today and get a written guarantee that if you upgrade your system by 100% within two years, we will give you 75% of your original purchase price of any single item or complete system. Please ask for details and conditions of this amazing scheme.

**★ NEW SHOWROOMS NOW OPEN - 4 FLOORS OF THE WORLDS BEST HIFI ★**

**Sounds Of Music** 10-12 Chapel Place / 6 London Rd, Tunbridge Wells, Kent. TN1 1YQ / TN11DQ

**Tel:** 01892 545688 / 547003 **Fax:** 01892 616383

**[www.sounds-of-music.co.uk](http://www.sounds-of-music.co.uk)**

Acapella, Acoustic Zen, Avantgarde, Argento, Audio Synthesis, Advantage, Audience, Audio Physics, Apollo, Aloia, Audio Note, Audio Research, Audio Analogue, A.V.I., A.T.C., Acoustic Energy, Aremo, Atacama, Base, Balanced Audio Technologies, Black Rhodium, Boulder, Bow, Bose, Burmester, Cabasse, Convergent Audio Technology, Copland, Celestion, Copulare, Clear Audio, Clearlight Audio, Dunlavy, Echo-Busters, Eggleston Works, Electrocompanient, Gamut, Graham, Grado, Halcro, Harbeth, Hovland, Jamo, JM Labs, Kharma, Koetsu, Krell, KEF, Klipsch, Lumley, Lyra, Lamm, L.A.T., Lavardin, Meadowlark, Marantz, Martin Logan, Mitchell, Neat, Nordost, Opera, Optimum, Ortofon, Orchid, Parasound, Pipedreams, Plinius, Project, Passlabs, Pro-ac, Pink Triangle, Primare, QED, Quad, Rel, Renaissance, Rogue Audio, S.A.T, SME, Shure, Sennheiser, Spendor, Sound Lab, Soundstyle, Sumiko, Steinhart, Straight Wire, Sonus-Faber, Stands Unique, Teac, Theta, Tannoy, Townshend, Transparent, Transfiguration, Unison Research, Van Den Hull, Veritas, Wisdom, Wilson, Wadia.

# Product Of The Year Awards 2002



It's that time of year again, when we look back at the many products that have passed through our reviewers' hands and remember those that really impressed us, made us want to keep them, and in some cases, bought. These awards are, as ever, expressions of personal regard for the products honoured, rather than any attempt at absolute judgements. That's why there are no individual categories: a single "Amplifier Of The Year" is such an utterly meaningless concept as to be useless. These are just the products that blew our skirts up. We list them in the hope that they might do the same for you. And added to the awards this year is a new category to recognise outstanding software, be it individual recordings or the output of a label as a whole. These are about music first and the recordings that deliver it second. We hope you'll enjoy them as much as we did.



Inevitably, with passing time our industry loses some of its greatest and most respected pioneers. Two such are represented here, with 2002 seeing the passing of two of Japan's greatest analogue designers: Sugano-san, father of the Koetsu cartridges, and Noburo Tominari, founder of Dynavector. In both cases their legacy lives on in the hands of their sons. Our awards for their products are in no way sentimental. The strength and continued excellence of the companies' designs speak for themselves, and is a beacon amidst the gloom that others seem all too eager to embrace. If high-quality audio at home is a thing of the past then there's a refreshing number of both new and established manufacturers who haven't noticed. 2002 was a bumper year, with horizon broadening products at both ends of the price spectrum. 2003 is already looking just as interesting!



A handwritten signature in dark blue ink, appearing to read "R. G."



## ▶ Connoisseur Definitions 4.0 phono and line stages



Price: £26000

Reviewed in Issue 16

Distributor:

Scan-Tech Europa

Tel. (49)(0)561 4759 0266

Net. [www.lyraaudio.com](http://www.lyraaudio.com)

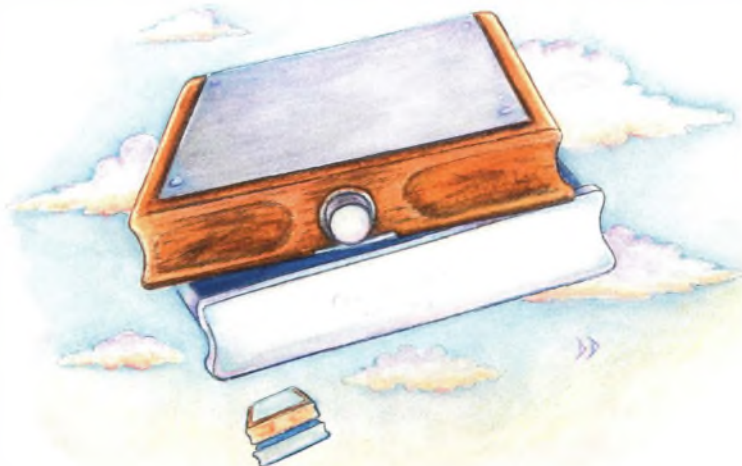

Quite simply the most impressive pieces of hi-fi equipment that I've ever used, the gorgeously constructed, resolutely minimalist but ruinously expensive Connoisseurs provoke involuntary outbursts of "How much?" That's until the stunned observer gets the double whammy that results from listening to the beasts. Then the "How much?" is delivered in quite a different tone. So far PR, CT and myself have all had our sensibilities rearranged. And we all want the Connoisseurs –

badly. Top of the wish list for anybody I've played them to, the Connoisseur Definitions 4.0s represent an object lesson in what's actually possible from a hi-fi system. CT concluded that any ancillaries with a Connoisseur would sound better than anything else without it, and I've a sneaking suspicion he might be right. The real shock is that this is Connoisseur's entry level line. What does the more expensive version do?

## Tom Evans Audio Design The Vibe Line Stage



Price: £2700

Reviewed in Issue 19

Manufacturer:

Tom Evans' Audio Design

Tel. (44)(0)1443 833570

Net. [www.besthifiintheworld.com](http://www.besthifiintheworld.com)

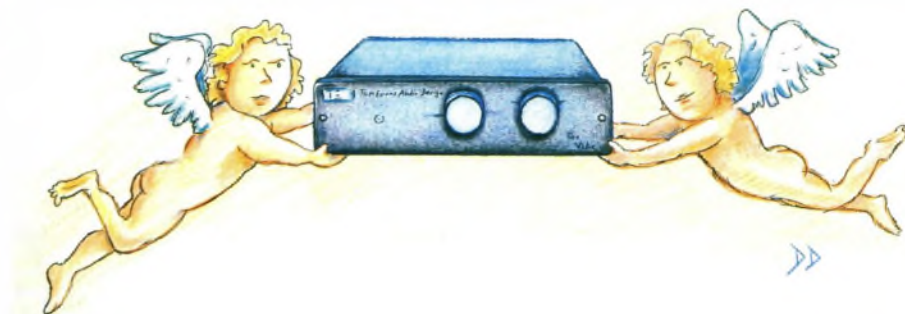

Following The Groove should have been the electronics design equivalent of that difficult second album, but the years are showing in a new maturity from designer Tom Evans. Rather than the fun but flaky product I was half expecting, what arrived was the finished article, a complete, even polished unit – and I'm not just talking about the plastic casework. The application of Lithos regulation and a stepped attenuator to the switching and volume

functions has harvested a rich reward. Impressive as a stand alone unit, used in tandem with The Groove you square the benefits, lifting the presence, dynamics, immediacy and resolution to new heights. Transparency to burn and focus to spare the "Toms" put you in the same acoustic space as the musicians, which is exactly where you want to be: And they do it at a price that's actually approachable! ▶



▶ **conrad-johnson MV60-SE**



Price: £2995

Reviewed in Issue 20

Distributor:  
 Audiofreaks  
 Tel. (44)(0)208 948 4153  
 Net. [www.conradjohnson.com](http://www.conradjohnson.com)



The single output pair, ultralinear valve amp is a long recognised recipe for high-end results on a real world budget, and conrad-johnson have been delivering on the promise for longer than most. The MV60 was already an excellent product but the decision to switch to 6550A output tubes for the SE version (largely as a result of persistent urging from the UK distributor) has transformed it into a caged

beast, augmenting the subtlety, focus and exquisite tonal palette with a healthy dose of dynamics and authority. Sensibly sized and sensibly powerful, it takes MV performance close to Premier levels, providing all the amp many of us will ever need. For those who want more than the Premiers beckon, but for now, this is the do it all amp of choice.

**Revel Salon Loudspeaker**



Price: £13495

Reviewed in Issue 17

Distributor:  
 Path Premier  
 Tel. (44)(0)1844 219000  
 Net. [www.madrigal.com](http://www.madrigal.com)



CB fell hot and hard for the curvaceous Salons, and continuing exposure has done nothing to dull the infatuation. Having lived with them at home I can see his point. Big and hungry (the looks do grow on you – honest) Revel's statement speakers have the bandwidth, quality and refinement, mixed with plenty of old style muscle, to trouble flagship speakers at many times their price. Astonishingly well behaved low frequencies delivered crushing weight, power and definition, even

in my smallish listening room, while genuinely awesome levels were served up with aplomb, the amps giving up way before the speakers showed any signs of distress. It's just as well for CB's neighbors that his evil plot to combine the Salons with the Briston 14B never reached fruition. They only live a short half mile away! Much, much more than just a LOUD speaker, the Salons have it all – as long as you have the power they need.



## ▶ Rega RB1000 Tonearm



Price: £1000

Reviewed in Issue 20

**Manufacturer:**  
Rega Research Ltd.  
Tel. (44)(0)1702 333071  
Fax. (44)(0)1702 432427

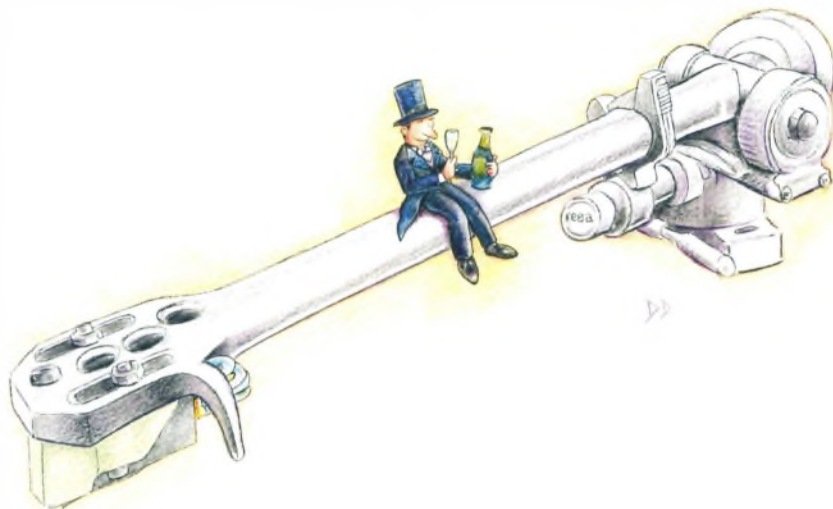

Take Rega's giant killing RB300 and address its weaknesses and you might not end up with a bargain, but you sure as hell get a serious tonearm. The RB1000 (which debuted on the P9 but is now just becoming available separately) replaces the moulded plastic cueing platform with stainless steel: the dodgy wiring with something an awful lot better; and selects

from Rega's vast stocks, the closest tolerated bearings if not known to man, then certainly ever seen on an arm at this price. PM and CB are both duly impressed, the P9 likewise. The only thing lacking now is proper VTA adjustment, but don't expect that unless Rega is acquired by Zurich Insurance.

## Reference 3A MM de Capo Loudspeaker



Price: £2200

Reviewed in Issue 16

**Distributor:**  
Absolute Analogue  
Tel. (44)(0)208 459 8115  
Net. [www.divertech.com](http://www.divertech.com)



A squat and not particularly pretty, eight inch two-way seems positively anachronistic in this day and age. Add in the cost and complication of stands and you might wonder why anybody would bother, but that would be a mistake. The de Capo runs its bass-mid unit wide open, and the absence of a power sapping crossover gives it a tactile vibrance and immediacy that is at once convincing and beguiling. Bass has surprising weight and impressive authority, while a recent tweeter change has

brought the high frequencies up to the same standard as the rest of the range. The sheer musical energy and gusto that emanates from behind and around these little boxes is astonishing. Some speakers just sound right, and this is one them. Few and far between they represent gold at any price. You should hear the Reference 3A de Capos. They'll surprise and delight you.

► **Kuzma Stabi Reference and Triplanar VI Tonearm**



**Price:** £3995 and £3350

**Reviewed in Issues 17 and 19**

**Distributor:**  
 Audiofreaks  
 Tel. (44)(0)208 948 4153  
 Net. [www.audiofreaks.co.uk](http://www.audiofreaks.co.uk)



The Stabi Reference is an utterly logical outgrowth of the thinking behind the original Stabi, Kuzma's original four point suspended deck. Laminated aluminium and acrylic replace the wooden structure of the original, while the damped suspension, heavy platter and external power supply make this an utterly consistent and stable performer. But combine it with the latest (and cosmetically much improved) version of the venerable

Triplanar and the whole is significantly greater than the sum of the parts: Powerful and dynamic, solid yet expressive, delicate and tactile. The combination of virtues will make the most of virtually any cartridge and extend virtually any system. If there's a bargain to be had in the financially ruinous arena of high-end analogue replay then this is it.

**VPI Aries Scout turntable**



**Price:** £1395

**Reviewed in Issue 16**

**Distributor:**  
 Cherished Record Co.  
 Tel. (44)(0)1579 363603  
 Net. [www.vpiindustries.com](http://www.vpiindustries.com)

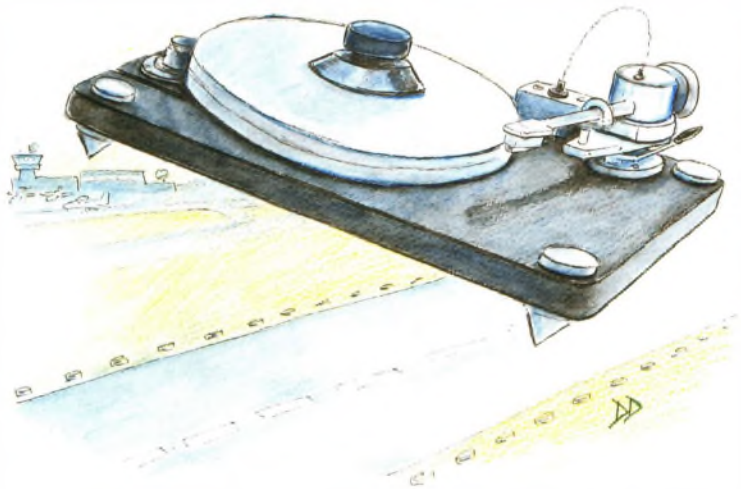

Harry Weisfeld has a long history of producing sane designs in a field where all too often insanity is the rule. His upgradeable HW19 model has been the value for money benchmark in its home market for more years than I care to remember, but it's finally been usurped – by its own younger sibling. Combining the separate motor/decoupled chassis structure of the Aries with a novel inverted bearing employing a Teflon thrust pad has produced a compact, stable and astonishingly quiet

drive system. Add a simplified nine inch version of the JMW tonearm (which dispenses with the on the fly VTA adjustment but retains the interchangeable arm tubes) and you've got a smaller, more affordable facsimile of a high-end record player that gives less away in performance than you might imagine, and little or nothing in the all important mid-band.



## ▶ Diverse Records



Reviewed in Issue 21

**Contact:**  
Diverse Records  
Tel. (44)(0)1633 259661  
Net. [www.diversevinyl.com](http://www.diversevinyl.com)  
E-mail. [sales@diverserecords.com](mailto:sales@diverserecords.com)

An audiophile label with a difference, delivering 180g pressings of quality contemporary pop recordings. Founder John Richards cut his teeth with Diverse Vinyl, suppliers of all things black, round and twelve inches across. It gave him a unique insight into the market, and more importantly, the gaps left by the traditional audiophile/re-issue merchants. People loved the quality but they were left cold by much of the repertoire. How about superior pressings of some of their current favourites?

That's exactly the goal of these records. Superb artwork and a performance led catalogue combined with top quality cuttings makes for musically rewarding listening. You might not be able to hear the second saxophonist adjusting his cod-piece, but that's not what these discs are about. Great music delivered just as well as the recordings allow – I'll take that every time.

## Dynavector ADP-2 Super Stereo Processor



Price: £795

Reviewed in Issue 18

**Distributor:**  
Dynavector (UK) Ltd.  
Tel. (44)(0)1202 767873  
Net. [www.Net\\_haputa.ne.jp/~dynavec/](http://www.Net_haputa.ne.jp/~dynavec/)



While the rest of the world seems intent on a dangerously uncritical acceptance of 5.1 multi-channel as the new de facto standard for music reproduction, the late, great Dr Tominari remained unconvinced, concerned that the new standard did nothing to attack digital's inherent flaws. His own investigations into the digital recording process and the measurements used to assess its accuracy yielded fascinating insights subsequently embodied into his Super Stereo technology. A hybrid

analogue/digital processor working in both the phase and time domains, the ADP-2 produces astonishing results from stereo recordings, with huge benefits in terms of rhythmic coherence, weight and harmonic correctness. You need to hear this to appreciate the magnitude of the improvement. Words do little justice to what is Tominari's crowning achievement.



▶ Hovland Sapphire power amp



Price: £6995

Reviewed in Issue 17

Distributor:  
Metropolis Music  
Tel. (44)(0)1892 539245  
Net. [www.hovlandcompany.com](http://www.hovlandcompany.com)

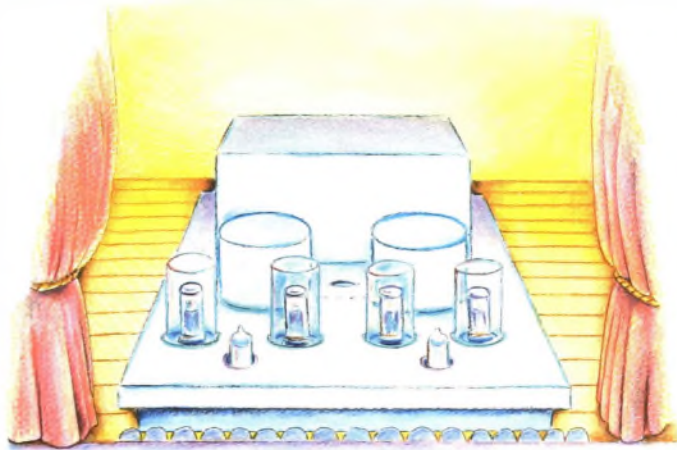

Exquisite construction and genuinely Bauhaus styling set the Sapphire apart from the 'fashionable' crowd. So too does its sound. Neutral in the best sense of the word, its innovative hybrid topology seems far more powerful than the 40 Watt rating would suggest. Clean and clear without ever being clinical it effortlessly treads that elusive line that bisects the best of solid-state and tube sound. Unfailingly musical but full of insight it has become an

invaluable reference chez Gregory, along with the HP100 pre-amp a unit which it might not match for value but which it exceeds in performance, presenting Hovland with an interesting challenge. Almost too sensible (and beautiful) to be true, the Hovland Sapphire demonstrates what can be done when talented and technically gifted designers follow the courage of their convictions rather than the latest band-wagon.

Coup d'Archet Recordings



Featured in Issue 18

Company:  
Net. [www.coupdarchet.com](http://www.coupdarchet.com)



If less really is more, then Glen Armstrong's Coup d'Archet records must be the most of all. Trolling Europe's radio stations for forgotten tapes of criminally underrated performers, all too often the victims of the oppressively patriarchal Classical recording industry, he transfers them to pristine 180g pressings, all in glorious living mono. Johanna Martzy has now been joined by Yvonne Lefebure and Michele Auclair, broadening

the repertoire and the appeal, delivering superb performances with the presence and immediacy that only mono can. For all those that assume that more channels must necessarily be better, incontrovertible proof that one is actually sufficient (and far more cost effective too – but we won't mention that).



## ▶ B&W N805 Signature



Price: £2250

Reviewed in Issue 20

Manufacturer:  
B&W Loudspeakers Ltd.  
Tel. (44) (0)1903 221500  
Net. [www.bwspeakers.com](http://www.bwspeakers.com)



If anyone ever subscribed to the theory that "a good biggun will always beat a good littlun" then it's JK, a man who values both headroom and bandwidth with equal fervor. Which makes his love affair with the beautifully crafted but inescapably diminutive Nautilus 805 Signature all the more impressive. A subtle and carefully considered refinement

of the successful (and still current) N805 model, it succeeds in extending that speaker's already impressive strengths, setting new standards for its size and emphatically underlining the virtues of properly extended high frequencies.

## Eleanor McEvoy – 'Yola'



Reviewed and Featured  
in Issues 18 and 21

Contact:  
Vivante  
Tel. 01293 822186  
Net. [www.vivante.co.uk](http://www.vivante.co.uk)



Beautiful songs, beautifully sung – and captured in a superb DSD recording that finally reveals the true potential of the SACD format. Ms McEvoy's emotive material, emphatic delivery and clear voice are the perfect ingredients for universal appeal, making this just the disc to expose hi-bit recordings to a wider, non-audiophile audience. But the ground-breaking nature of this disc goes further than that. Available

from day one as a hybrid SACD as well as a conventional CD, it is now available as a 180g LP too, at last making some sort of meaningful comparisons possible, whilst also demonstrating the potential available from DSD recordings transferred to black disc. All that, musical merit and a superb performance too, which is what makes everything else relevant. One disc that everyone should own (and take your pick of format). ▶

► **The Chord Co. Signature Interconnects**



Price: £500/1m pr.

Reviewed in Issue 21

Manufacturer:  
The Chord Co.  
Tel. (44) (0)1722 331674  
Net. [www.chord.co.uk](http://www.chord.co.uk)

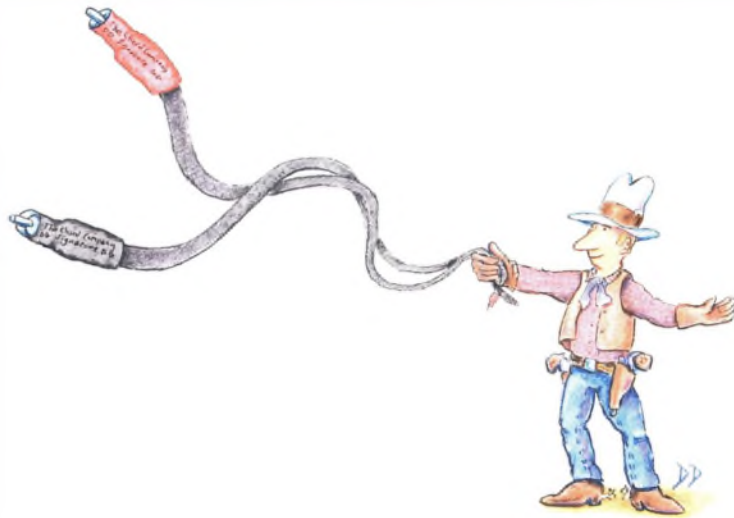

The Chord Co. built their reputation on solidly engineered cables that delivered value for money in a market area where that seems like a redundant concept. The company ethos has stayed firmly intact, supported by superb construction and a reluctance to follow expensive fashions simply for the sake of it. The Signature breaks new ground, cresting the £500 barrier for a meter pair, yet still manages to eclipse the performance of cables

costing two or three times the price. Transparent, detailed and seriously dynamic, it delivers genuinely high-end performance at a fraction of high-end prices. Which will of course have the audiophool community looking down their collective noses at it. Meanwhile, the rest of us can all enjoy the considerable benefits (and savings) it offers, unconcerned by issues of brand identity and what it says about the size of our woofers.

**Rotel RA-02 Integrated Amp**



Prices: £350

Reviewed in Issue 21

Manufacturer:  
B&W Loudspeakers Ltd.  
Tel. (44) (0)1903 221500  
Net. [www.rotel.com](http://www.rotel.com)



Convincing hi-fi is all about balance, and Rotel, past masters at producing budget gear that actually delivers music have hit pay-dirt with the RA-02. Taking a step away from the genuine budget sector has freed the design constraints and boy does it show. JMH was bowled over, and ever since the little Rotel arrived he's been comparing it to everything from exotic

single-ended triodes to audiophile integratseds, and is yet to find it wanting. A budget masterpiece with the perfect blend of f nctions and real power (not the limp and floppy paper variety) the RA-02 offers the promise of real music at real world prices which is rare indeed in this day and age. Underestimate it at the peril of your pay-cheque! ►

## ▶ Lamm ML2 Mono-blocks



Price: £27000

Reviewed in Issue 16

Distributor:  
Integrated Engineering  
Solutions  
Tel. (44) (0)23 8090 5020  
Net. [www.lammindustries.com](http://www.lammindustries.com)

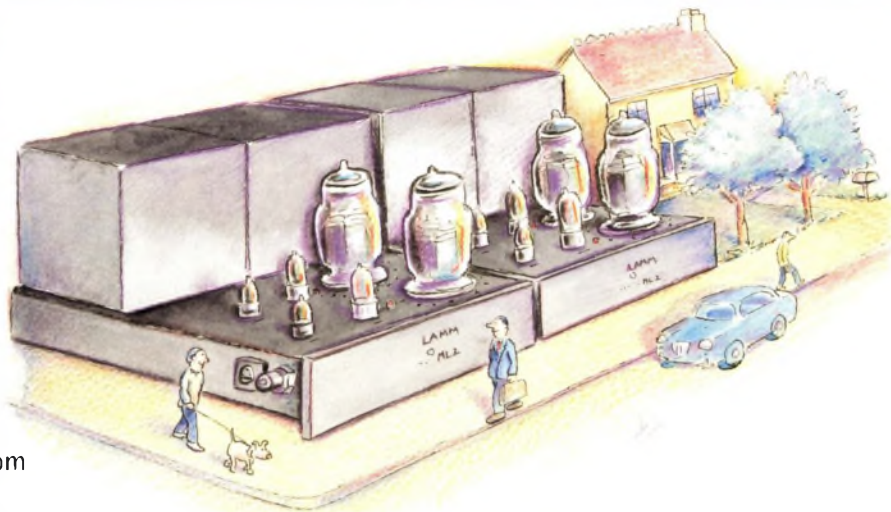

Hideously expensive with nothing on the outside to justify the price-tag, the Lamms take an almost perverse pleasure in destroying preconceptions. They deserve their place in this list by dint of demonstrating, once and for all, that it's not what you use but how you use it that counts. They don't succeed because they use a single-ended triode, tubes or because they're mono or class A. They succeed because

they're properly engineered, whilst driving a coach and horses through conventional notions of power output and drive capabilities. This sounds like no other 18 Watts I've ever heard, and laughs in the face of awkward loads. They're also the finest power amps I've ever had at home. All of which combines to ensure their presence here.

## Koetsu Red K Signature Moving-Coil Cartridge



Price: £2299

Reviewed in Issue 17

Distributor:  
Absolute Sounds  
Tel. (44) (0)208 971 3909  
Net. [www.absolutesounds.com](http://www.absolutesounds.com)



2002 has seen the passing of many audio legends, amongst them Sugano-san, creator of the legendary Koetsu cartridges. But don't assume that this is a sentimental award. As the designer of the Supex 900 and then his own Koetsu models, Yoshiaki Sugano was responsible to a greater extent than any other individual for the resurgence of interest in moving-coil designs. The Red K Signature is one of the latest designs from the famous marque and

displays all the power, spatial coherence and musical colour that it's famous for: seamlessly combined with increased transparency, resolution and neutrality. The result is both seductive and informative, musically communicative in a way that few high-end cartridges can match. Sugano's heritage lives on, not as nostalgia, but leading the way and showing us just what's missing from much more 'impressive' (and expensive) performers. ▶



▶ Shunyata Research Hydra and Power Snakes



Reviewed in Issue 17

**Distributor:**  
 Audio Atmosphere  
 Tel. (44) (0)1785 711232  
 Net. www.powersnakes.com

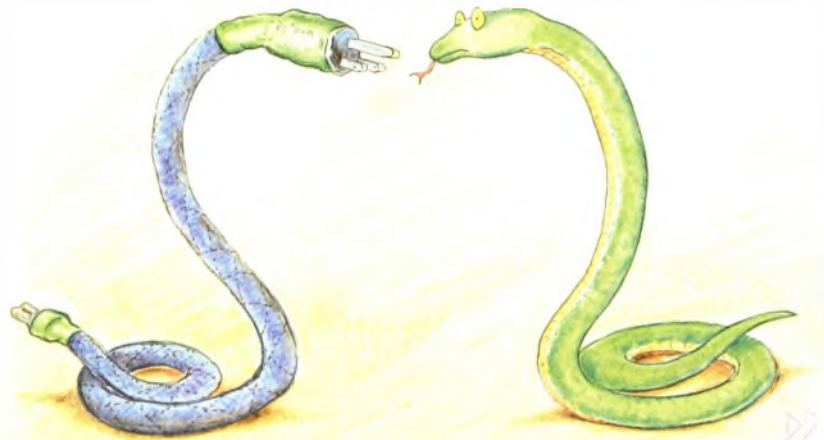

Mighty big and mighty expensive, Shunyata's massive mains cables and distribution block might seem like an archetypal case of cable company "more is better" overkill until you listen to them. Then the sonic benefits quickly quieten even the most vociferous of cable cynics. Anybody who still thinks mains cables can't make a difference (and lives in a cage,

and sends messages by pigeon) should experience the Shunyata effect: dramatic increases in weight and dynamic range are combined with a lower noise floor, greater spatial and detail resolution and much better tonal colours. All whilst actually increasing the music's sense of flow and rhythmic integrity. If there's a downside then we haven't found it yet.

JBL K2 Horn Hybrid Loudspeaker



Price: £20000

Reviewed in Issue 21

**Distributor:**  
 Harman Audio UK Ltd.  
 Tel. (44) (0)208 731 4670  
 Net. www.jbl.com

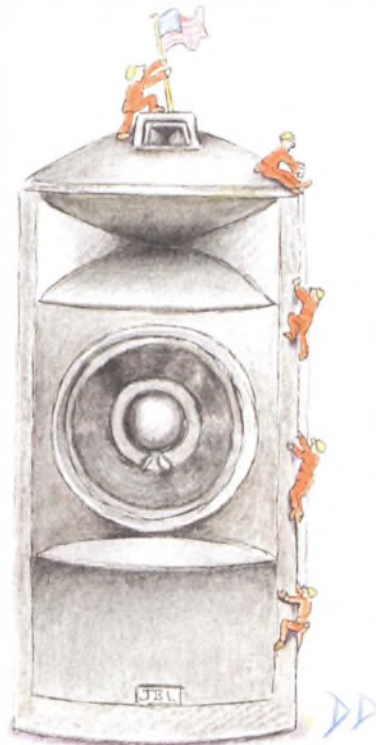

PM's in love. A long time high-efficiency fan as well as a self confessed bass-head, the conflicting requirements of these two apparently mutually exclusive goals were producing schizophrenic listening tendencies – Rhedeko on the one hand, B&W N800 Signatures on the other. Then came the big JBL. Its combination of horn loaded treble drivers with a massive, direct radiating pulp coned bass/mid unit provides the magic combination – real weight and scale along with a 94dB system sensitivity: Or, just enough life and immediacy, just enough wallop. It's a winning combination that's brought a beatific smile to the Messenger features. This one's here for the duration, if only because of the difficulty of hauling the 90kg cabinets out of his listening room. Writing the cheque seemed so much easier! ▶+

The Heathrow High Fidelity Show  
292 Aigburth Road  
Liverpool  
L17 9PW

Exhibition Organisers Tel: 01829 740650  
Fax: 0151 728 9343 Mobile: 07810 697123  
email: roy@chestergrp.fsnet.co.uk  
www.chestergroup.org



### The Renaissance Hotel - Heathrow

**"I've always held that it's the quality of show visitors that matters and not the number and so it proved here."**

**"There's been a tendency to try and recapture the glory days of the past, I think that's a mistake and this Heathrow event provides an important pointer for the future"**

**Roy Gregory** editor of HiFi+, reporting after last years show

There is a saying - why mend something when it's not broken, and we couldn't agree more. That's why we are keeping everything the same for this year. Same venue, same weekend, same generous rooms and an eclectic mix of quality hi-fi orientated exhibitors.

Oh, just one thing - we have added a few more exhibitors.

We've been overwhelmed by emails since last years show - encouraging us to maintain this event. We are very grateful for this vital support.

If you attended last years show - we will be sending you a special admission ticket which will also cover a companion. If you didn't attend and want to save some money, send us an email now asking for special ticket deals. For a full list of exhibitors log on to our website from the 3rd March

Yours sincerely

Roy Bird  
Organiser

*The Heathrow High Fidelity Show.  
29-30 March 2003.. Renaissance - Heathrow  
The Scottish Hi-fi & Home Cinema Show.  
18/19 October 2003.. Thistle Hotel - Glasgow  
The Manchester Hi-fi & Home Cinema Show.  
15/16 November 2003.. Hilton - Manchester Airport*

Stands for design



Want to hear more?

www.ifdesigns.co.uk Enquiries: 0870 744 1382

Introducing  
**the ea series**  
of amplifiers by ECS



Whether it's music or film the EA series will enhance your passion.

A range of amplifiers designed by enthusiasts for enthusiasts.

- Mono Bloc & Stereo versions
- 200w per channel
- Bespoke 1500va Power transformer
- Transformer balanced inputs
- Unbalanced audiophile gold phono connectors
- Ultra low impurity PCB copper track
- Zero inductance components used in critical paths
- Ultra low tolerance and inductance components used throughout
- Ultra short audio signal path
- Hand selected audio grade components
- 3 years parts and labour warranty

See & Hear us at the  
Bristol Show  
Room 416

Contact us for more info and  
for your nearest dealer.

ECS Ltd  
020 8743 8880  
020 8746 4315

www.ecsamplifiers.co.uk

## AUDIO ILLUSION

23 Langley Broom  
Langley, Berkshire, SL3 8NB  
2 mins, June 5 off the M4  
TEL: 01753 542761  
FAX: 01753 772532  
(Open: 10am – 8pm (Mon-Sat –  
By Appointment Only)  
www.audiillusion.co.uk  
audiillusion@btinternet.com

FINAL



FINAL

EVERYTHING MUST GO  
MASSIVE CLEARANCE SALE  
AT PRICES NEVER TO BE REPEATED  
\*\*ALL ITEMS SOLD WITH A WARRANTY\*\*  
\*\*ALL MAJOR CREDIT CARDS ACCEPTED\*\*  
\*\*MANY ITEMS HALF PRICE OR LESS!!!!\*\*  
STRAIGHT AUDIO / HOME THEATRE!!!!

## PREMIER BRANDS ON SALE!!!!

acurus: AVM: MONDIAL  
AERIAL ACOUSTICS  
CAIRN / EZO  
CHORD: CLASSÉ  
Enlightened Audio Designs  
MIRAGE  
Renaissance Audio Cables  
OWL PROJECTORS

### ACCESSORIES, ETC.

MONDIAL: # MAGIC BOX Improves your Picture!

RENAISSANCE AUDIO CABLES: Many... Price

ACURUS – Purchase the Pair for £1475!!!

A250: # 250W Stereo Amplifier (Black)

A200X.3: # 3-Channel (3x200w) Power Amp. (Black)

AERIAL ACOUSTICS (see picture below)

Model 5: Bookshelf Monitors-Pair (Maple) including

Special Stands

AVM – Purchase the Pre and Power together for £1450

V2: # Remote Pre-Amplifier (Black)

M2: # Mono Bloc Power Amplifiers – Pair (Black)

CAIRN / EZO

NANDA Face Nord: # Pre-amplifier, 2 Analog Chan.

Dual Mono, 3 Transformers, Bal In/Outputs (Silver)

CHORD (See Pictures below)

DAC64: # D to A Converter (Silver/Gold Badge)

AERIAL ACOUSTICS

MODEL 5



### OTHER CHORD PRODUCTS AVAILABLE



PLEASE CALL TO FIND OUT MORE!!!!

### RETAIL SALE

Ex. Demo/Mint £ 99 £ 49

Ex. Demo/Mint £ Call £ Call

Ex. Demo/Mint £1400 £ 750

Ex. Demo/Mint £1600 £ 850

Ex. Demo/Mint £2900 £1495

Ex. Demo/Mint £1175 £ 595

Ex. Demo/Mint £1975 £ 995pr

Ex. Demo/Mint £1000 £ 499

Ex. Demo/Mint £1980 £1350

### CLASSÉ (see picture below – CAV-150)

CAV-150: # Multi-Channel Amplifier (6 x 150w)

SSP-300: # 6.1 Processor (Silver/Black)

EAD RF DEMODULATOR # (Black)

MIRAGE – (see picture below)

FRX-9: # Flagship Loudspeakers (Cherr.)

M18: # Reference Bipolar Loudspeakers (Piano Blk)

M18: # Bipolar Floorstand Speakers (Piano Black)

MC-6: # Magneticaly Shielded Centre Speaker/Piano Blk

OM-6: # 3-Way 6-Driver Semi-Active Omnipolar

Loudspeakers (Piano Black)

M-129S: # Semi-Active Bipolar Loudspeakers (Piano Blk)

Unused/As New £1800 £ 899

### RETAIL SALE

Ex. Demo/Mint £3799 £2295

Ex. Demo/Mint £2899 £1795

Ex. Demo/Mint £ 600 £ 199

Ex. Demo/Mint £1100 £ 550

SHand/Mint £6000 £1995

SHand/Mint £400 £1395

Unused/As New £ 600 £ 299

Unused/As New £280 £1395

Unused/As New £1800 £ 899

### AWARD WINNERS/ 5 STAR BEST BUYS\*\*



\*\*AWARD WINNERS/ 5 STAR BEST BUYS\*\*

### OWL/SIM2 (see picture below)

SIM2 HT200-DMF Cinema DLP Proj\*\*

800 ANSI Lumens

Contrast Ratio 600:1

SVGA 848 X 480

Lamp life 6000 hours

Finished in Blue/Silver

Only 3 Months OK!

Ex. Demo/Mint

RETAIL: £6000

SALE: £4650

# Email for a picture

# Email for a picture





# Wilson Audio

by Alan Sircom

The WATT/Puppy is the most successful true high-end (i.e., costing more than \$10,000) speaker on record, and as such the basic design needs little introduction. It has changed quite a bit in its 17 year lifespan, but the changes to the System 7 are about the most dramatic to date.

Under the surface, practically everything about the WATT/Puppy has changed. The WATT 7 has an entirely new material used for the cabinet. Wilson Audio places great stead on materials science: using MLSSA software to determine a spectral delay signature of different materials, Wilson has rejected all the regular wood and wood-pulp materials commonly found in speaker designs, preferring to use ceramic/methacrylate-based cabinet material for mid-range and high frequency enclosures and two kinds of high-density acrylic/phenolic materials for the bass. Why? Because acrylic/phenolic compounds are remarkably non-resonant, making them ideal for deep bass settings, while the low resonant frequency and solidity of a ceramic/methacrylate compound makes for an ideal high frequency enclosure material. Wilson even spends time and energy researching the optimum kinds of adhesive used to bond one piece of material to another. The new materials used in the cabinet and bracing of the System 7 are all claimed to further reduce cabinet. As if these expensive materials were not

good enough, the WATT is cross-braced with a steel bar at the rear to further improve the stiffness of the standalone head unit.

The materials of the cabinet are not the only changes. The Puppy bass-bin of the System 7 has a raised rear and a chamfered edge. This is a largely cosmetic improvement; when uprated from System 5.1 to System 6, the WATT mid-treble unit was raised at the rear to better improve cabinet resonance and time alignment, but this often left a gap at the rear of the speaker. The

new-look Puppy makes the lines of the speaker considerably more elegant and integrates the top box with the bass unit better than before. It also means the WATT can be angled to suit the listener height and distance – as in the System 6 – but this time without making the back of the speaker look like it was hit by an axe.

The most minor change to the design is also one of the most obvious. The speaker can now be finished in any colour you care to name. The smooth inert surface means

the System 7 is a blank canvas just like the bodywork of a car. And Wilson has a paint shop that puts Rolls Royce to shame, with a clean-air filtration system that keeps anything larger than an amoeba out of the painting process. Aside from the usual four standard and eight premium 'Wilsongloss' domestic finishes (which means shades of silver, black, green, and of course red, white and blue), you can pick the colour of your dreams. Want a pair of speakers to match the finish of your Aston Martin? – no problem! If the only acceptable red is the one on your F50 or Testarossa, it is easy for Wilson to replicate the colour as the speaker uses exactly the same paint. The pair I tested came in a rich, vivid Ferrari yellow, which may not suit every taste but looks simply fantastic and actually works wonders in the sort of rooms that can comfortably accept a speaker like the System 7.

Although the Puppy features the same twin driver arrangement as before, the two 200mm Dynaudio-sourced bass units in the new System 7 Puppy have been changed, for the first time in its history. In contrast, the WATT retains the 175mm ScanSpeak carbon-fibre reinforced midrange cone and the specially customised 25mm Focal

inverted dome tweeter. Both the WATT and Puppy have a redesigned crossover network, though. Aside from being necessary to match the new drive





► unit and cabinetry, the revised cross-overs address time alignment (Phase Delay in Wilson terminology) and improve transient response, for faster leading edge attack and more accurate trailing edge decays.

There may be taller, wider and even deeper speakers, but the squat solid System 7 is the Hummer of hi-fi. I'd call it rock solid, except that you can get a landslide with rocks; this is practically earthquake proof in its solidity. Given that each System 7 speaker weighs 77kg yet is only 320mm wide, 490mm deep and stands 1130mm tall on its distinctive Puppy Paw feet, it's not hard to see where that solidity comes from.

Nothing about the Wilson System 7 is "just good enough". Instead, the ethos appears more like "if a job's worth doing, it is worth doing so well that nothing can possibly be left to chance. Ever". From the Puppy Paw feet to the milled alloy bolted in place rear ports of both WATT and Puppy,

this is overkill engineering on an Isambard Kingdom Brunel scale. It also means the specifications of the speaker make demands on the amplification system, but the System 7 is not as punishing a load as might be expected. The speaker has a suggested nominal impedance of four ohms, but a high sensitivity of 93dB and a minimum recommended amplifier power of around seven watts. This makes the speaker system theoretically triode-chummy, but don't be fooled; this is a red-blooded speaker that needs big solid red-blooded amplification to match it.

As an idea of the sort of power the System 7 revels in, the speakers were used with a pair of Krell 750Mcx monoblocs (which deliver a hefty 1.5kW into a four Ohm load). These small, handed mono transistorised amplifiers are only a notch down from the vast Master Reference Amplifier design they are based upon. The source was similarly Krellish; a KPS25sc CD player/digital pre-amplifier, the flagship of the Krell digital fleet. These were connected to one another using Krell's clever CAST (Current Audio Signal Technology) cables. This essentially transmits the signal along the inter-connect wire as current instead of voltage, making the whole amplifier combo act as one big circuit and virtually eliminates the characteristics of the interconnect cable in the process. Between



the 750Mcx power amps and the hefty single wired terminals of the System 7 lay the speaker cable of Doom: no less than 29 grand's worth of Transparent Opus MM (see box).

Throw out everything you know – or think you know – about Wilson WATT/Puppy speaker systems. And, while you are at it, sling out all your preconceptions about your CD collection too. This raises the bar.

You find the hidden gems within your discs, subtle nuances lost to most speaker systems yet presented here as if perfectly ordinary. One of the first CDs played through the System 7 was Leftfield's excellent debut *Leftism*, used because I have heard this particular recording hundreds of times through anything from a clock radio on up. It's more a warm-up for my ears than used for any critical listening. Or so I thought, until all this otherwise hidden detail came at me. Right from the start of disc, there are stealthy polyrhythms within the break beats. ►

## Opus MM Cables

The Wilson speaker deserves top-notch components, but the Transparent Audio Opus MM speaker cables transcend 'top-notch'. They make the Wilson kit look positively cheap by comparison.

Opus MM uses multiple strands of heavy gauge individually insulated oxygen-free copper, specially made terminations and a network box made to the sort of precision that a Netsuke carver would be proud of. Better still, the network pod – fully damped, isolated and sitting on its own spiked turtle shell table arrangement – is custom optimised for the output characteristics of your amplifier as well as the length of the cable.

This network is a key factor in the MM technology used in the Opus cables (and hopefully filtering down to more real-world levels). Transparent has set almost impossible tolerances in the selection of components within the network box itself. The levels of detail and lack of background from the cable itself means there is no margin for error. Final adjustments to optimise the network to the cable mean components need to be matched down to a single picofarad or 0.025 ohms. And the components within the network are matched

to have an identical copper structure as the cable where appropriate.

Most transistor amplifiers – at least the transistor amplifiers likely to be partnered with £29,006 worth of 8ft speaker cables – behave in a similar manner. But the current delivery and output impedance of valve amplifiers can vary dramatically depending on the output transformers used. So, Transparent Audio has amassed a library of valve power amplifier 'signatures' to match. This library often means Transparent has a sample of the valve amplifier in question to reference against. When buying a pair of Opus MM speaker cables, you tell the distributor not only the length of the cable, but the make and model of the amplifier used. Fortunately, there is a return to manufacturer update if you decide to change amplifiers, so you don't need a new set of Opus MM cables if you decide to switch from Conrad-Johnson to Audio Research, for example.

All of which makes a hand built cable, requiring two weeks to manufacture, burn in, tweak and test and it's a one-craftsman job. This must rank as one of the best cables around and perfectly suits the Krell/Wilson hegemony. It may sound like a bit of a Zen koan, but you have to pay a hell of a lot of money on cables to achieve the sound of no cable.

recordings: Count Basie's *The Atomic Count Basie* has this wonderful physicality about it; it presents a 3D space for mono sounds, albeit a small one between the speakers. This disc also highlights the absolute temporal and detail grip the speakers have. The second track in this classic big band mid-late 1950s recording – *Duet* – sounds like the carefully-timed bluesy swing between a muted horn and a piano that it is, with the rest of the orchestra keeping a low-profile beat in the background. On lesser speakers, the bluesy swing degenerates into incidental music for a Carry On film.

And then there's the almost religious experience of classical music played Wilson style. The Orchestra of the Sixteen's wonderful interpretation of Bach's *Mass in B Minor* is so precise, so accurate and so harmonious you can smell the incense burning. This Collins Classic recording – sponsored almost a decade ago by Quad – has a rich and natural acoustic which is portrayed with more accuracy here than even Quad could muster.

Naturally, you would expect audiophile recordings to take on a mastery above that of more prosaic recordings, but in a way the System 7 shows up what's bad about audiophile

▶ We talk about micro-dynamics; the System 7 can also resolve micro-rhythms. Subsequent tracks on the Leftfield disc highlight what a tightly controlled but extremely deep bass can do. Yes, bigger speakers like the X-1 will delve deeper into the sub-bass cave, but the System 7 produced bass of such clarity, volume and drive that after about 10 minutes, the undulating bottom end will leave you slack-jawed and open-bowelled.

On paper, these speakers can deliver up to 118dB in room sound pressure levels. In practice, this means they can play to the point where parts of you relax after each drum beat. Yet, for all that volume, it remains coherent and consistent; it doesn't shift tonally or shut down key parts of the music whether played at a whisper or a roar.

All Wilson's materials science pays off, as this is one of the least boxy boxes you can get.

This spells an imagery that is simply 'there', making many soundstages seem faux by comparison. It places music in a 3D space like the musicians were physically there, whereas most systems appear to produce a hologram of the musicians. This works even for monophonic



pressings as much as what's good about them.

These 'masterful' sounding discs are designed to make even the most humble hi-fi sound wonderful, but when the audio chain needs no such enhancements, all you are left with is a big bland acoustic with a big bland recording happening inside. The nearest I go to audiophile stuff is the mid ▶

## A brief history of Time (Wilson style)

Wilson Audio is the brain child of Dave Wilson, erstwhile, recording maven and all round audiophile-turned manufacturer. Right from the outset, he had a love of music and the recording process. As a budding audiophile, Dave spent the 1960s and early 1970s building his own Heathkit amplification, rubber sprung turntables and heavily customised Dahlquist DQ-10 speakers. From his Utah base, Dave Wilson's first audiophile company was the Wilson Recording label in 1977. Although this was the year of Disco and Punk Rock, Wilson's first record was of a concert by organist James Welch.

In the late 1970s, he started working on the massive, custom built Wilson Audio Modular Monitor, or WAMM which, in its V1A guise is still in production today. Well, sort of production – only four of these \$225,000 speakers are made every year.

But the WAMM is no use for a mobile studio; Dave and his wife Sheryl Lee (who was by now running the recording business) found monitor speakers used in recording studios were just not good enough. So, like any self-respecting audiophile, he designed his own speakers. From here, the Wilson Audio Tiny Tot was born. The first pair were for recording use, while the second pair were shown at the Summer Consumer Electronics Show in 1986. Despite costing \$4,500, and not being full-range designs, these speakers were among the very best a mid-80's audiophile could afford and entirely changed the received

thinking of the time. Wilson almost overnight made it possible to produce a true high-end speaker using regular pistonic 'cone and dome' drive units in an enclosure only slightly larger than normal bookshelf loudspeakers and without needing a tugboat of an amplifier to drive it. Originally supplied with an optional Gibraltar solid stand, the WATT became a full-range speaker design when the dedicated Puppy bass unit followed in 1988. This set the seal on the Wilson Audio success story. Products have come (such as the huge X-1 Grand SLAMM, first launched in 1993) and gone (like the coffee table sized POW-WHOW subwoofer), but the WATT/Puppy remains the mainstay of the Wilson fleet and more than 8,000 WATTS have been sold since their birth. Significant changes to the early WATT/Puppy include revised tweeter and midrange units, crossover networks, uprated Puppy Paws and Tails (feet and connection from WATT to Puppy, for those unused to Wilsonspeak) and a revised Puppy mounting plate. All of these modifications are still available for old WATT/Puppy owners to bring their speakers up to mid-1990s System 5 standards.

The most recent pre-System 7 change was the System 5.1 to System 6 upgrade in 1999 (sadly, this update is too substantial for retrofitting to older Wilson speakers). This involved a completely new cabinet design using new materials for the Puppy speaker. This raised the internal volume of the bass speaker, lowered cabinet resonance and provided a degree of adjustable rear tilt for the WATT cabinet. It also prepared the way for the latest changes to develop System 7.

special cream that can reduce the swelling). The WATT/Puppy was never satisfied; no matter how good the equipment used with it, or how wonderful the recording, it always managed to find fault. This made it ideal for someone who reviews hi-fi for a living, but too picky for just listening to the best possible music at home. Somehow, Wilson has managed to retain the insight into the system and recording of previous models, but has also made the speaker far easier to live with at the same time. On the recording side, it manages to be both an ideal

studio monitor and deftly un-monitor like. If this reads like a paradox, you should listen to it in action... this really is a Man (well, Speaker) for all Seasons, an honest sounding speaker but also a lively one.

The last Wilson speaker I spent any serious time in front of was the first Series X-1/Grand SLAMM. Although this has changed considerably since it was first launched, and although the bass response of even the first X-1 was considerably better, in so many respects the WATT/Puppy System 7 out-performs the first versions of the X-1. Fortunately, early X-1 owners can upgrade to newer and better things. But, think about that statement a bit more; a new \$20,000 speaker can out-class a \$70,000 speaker made just a few years ago. Wilson Audio is really on to something here. ➤+

### TECHNICAL SPECIFICATIONS

For complete WATT/Puppy system unless specified:

Nominal Impedance: 4 ohms  
 Drive units (WATT 7): 25mm inverted dome treble  
 175mm midrange  
 Drive units (Puppy 7): 2x 200mm bass  
 Sensitivity: 92dB (2.83V at 1 metre)  
 Frequency Response: 21Hz-21kHz +0, -3dB  
 Dimensions(WxHxD): 315 x 1130 x 490mm  
 Weight (WATT 7): 29.5kg  
 Weight (Puppy 7): 47.5kg  
 Prices:  
 WATT 7: £10,550  
 Puppy 7: £11,940

Distributor:  
 Absolute Sounds Ltd  
 Tel. (44)(0)20 8971 3909  
 Net. [www.absolutesounds.com](http://www.absolutesounds.com)

Manufacturer:  
 Wilson Audio Specialities Ltd.  
 Net. [www.wilsonaudio.com](http://www.wilsonaudio.com)

▶ 1990s soundtrack to the film *Dead Man Walking*, in particular the Tom Waits track *The Fall of Troy*. This sounded even more airy than usual, with Tom Waits' distinctive growl clearly defined centre stage. However, the System 7 also shows that he's over-mic'd and larger than life. It also articulates every word like Tom had taken a course in Shakespearean acting. It's still Tom, just the best of Tom.

One of my big issues about 'the Wilson sound' was that it made for a perfect Reviewer's Tool (a painful complaint, but fortunately there's a



# Illustrious - the new "world beater"

HI-FI WORLD FEB 2003

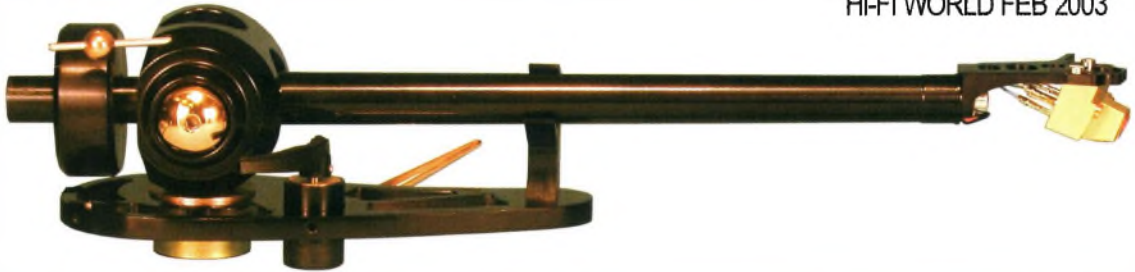

## Origin Live Tonearms

Silver - £599

Encounter - £970

Illustrious - £1570

"The Silver is the very best tonearm I've ever heard....the £599 price tag is laughably low....could probably charge five times this amount....words can't express how good this is - one of the designs of the decade" Hi-Fi World 2002

"There may be better value propositions around to upgrade your system but if there is I haven't heard them....A fantastic product then from Origin Live and this particular audiophiles dream review tool." TNT Audio 2002

Very occasionally new products appear that are so advanced as to render all previous benchmarks obsolete. People believe our new range of tonearms are just such products and we invite you to experience an unprecedented leap in your system performance - regardless of your current tonearm. Arrange for an audition now.

All products carry a full no risk money back guarantee and are available via your nearest Origin Live dealer or by direct mail order.

For more information visit our website or contact:  
Origin Live, Unit 5, 362b Spring Road, Sholing, Southampton, SO19 2PB, UK  
Tel/Fax: 02380 578877 e-mail: [originlive@originlive.com](mailto:originlive@originlive.com)  
[www.originlive.com](http://www.originlive.com)



## Bocchino Audio High-End Connectors

### Brenda" Phono Plugs



Gold and/or Silver-plated,  
High Conductivity Phono plugs

Visit our website:  
[www.bocchino-audio.co.uk](http://www.bocchino-audio.co.uk)  
and make your purchase online!

[www.supradirect.co.uk](http://www.supradirect.co.uk)  
The 1-stop website for discounted  
Supra cables and connectors.

Rewire your system NOW with these  
Award winning products

Featuring:  
Best Buy AV3 component video cable  
Best Buy AV6 RGB scart cable  
Best Buy X-ZAC fibre optic cable  
Best Buy Rondo 4x2.5T bi-wire cable

NOW AVAILABLE: CE-approved  
Supra LoRad Shielded Mains Cable  
in factory terminated lengths



Audiovector M3 Signature  
shown above.

Visit our website or  
photocopy/clip the coupon  
for details and prices to be  
sent to you. Some very  
special ex-demo prices  
available this New Year.



## AUDIOVECTOR

Call us to arrange a demo  
or visit our website at:  
[www.audiovector.co.uk](http://www.audiovector.co.uk)

Products now available:

Bookshelf models  
M1 Improved

Floorstanders  
M3 Improved  
M3 Signature improved

S6 Signature

And for AV systems:  
AV3C Centre channel  
MSub Active subwoofer

Post to: Audiovector UK, Unit 7, Wren Industrial Estate,  
Coldred Road, Maidstone, ME15 9YT Tel: 01622 201983  
Web: [www.audiovector.co.uk](http://www.audiovector.co.uk)

Name: .....

Address: .....

.....

.....

Post code: .....HFPO302



# Naim NAP 300 Power Amplifier

by Paul Messenger

Naim Audio usually manages to come up with a view of the world that is entirely its own, and that's certainly the case with this power amplifier, the top one of three in the company's new Classic series.

Let's start the ball rolling by trying to put the whole Naim amplifier line up into context – not as easy a task as it used to be, it must be said. All are now 'full width' components, and start off with the 'slimline' 5-series 'entry level' models, including the integrated NAIT 5, NAC 112 pre-amp and NAP 150 power amp. There's the odd AV-oriented model along the way, but then come the Classics – a trio of pre-amps (NAC 202, 282 and 252) plus the NAP 200, 250 and 300 power amps, all of which fit into casework the same size as the earlier 'full size' components (eg NAP 250), but have a significantly more solid 'feel' alongside the 'new look' triptych styling. Finally, at the top of the line there's the hideously expensive NAC 552/NAP 500 pre-/power combo.

According to the press release, this £4,750 NAP 300 is considered by Naim to be a replacement for the old NAP 135, a monoblock power amp which sat at the top of Naim's hierarchy for some 17 years. However, the 300 is not a monoblock, and the company website reveals that a new and relatively upmarket NAPV145 monoblock is about to appear. While the latter's V-type identification suggests it's primarily AV-oriented, it's also purportedly a mono version of the new 250, so in that respect might better be regarded as the spiritual successor to the 135 than this 300.

In contrast, the NAP 300 is much more of a scaled-down NAP 500, and certainly follows the 500's unique configuration in being a two-box stereo amp, with all the signal-carrying

amplification in one of the units, and all the power supplies in the other. Although Naim invariably uses non-ferrous alloy casework, it still believes in keeping the high voltage/current mains well away from the much lower signal voltages and currents.

The two units are connected together by two hawser-like cables, terminated in monstrous multi-pin Bumdry locking connectors borrowed from medical electronics. There are actually seven pins in each of these, though only four are actually used, delivering positive and negative voltage rails, a power supply earth, and an overall chassis earth.

Although we talk airily enough of power in the tens and sometimes even hundreds of watts, and voltage rails of 30V or more, in reality our hi-fi systems spend most of their time delivering delicate detail at rather less than a Watt, and the millivolts actually matter rather more than the volts. When I reviewed a massively powerful German power amplifier from Audionet equipped with electronic power metering recently, I was shocked to find how little power we actually need to achieve 'normal' listening levels with 'normal' sensitivity speakers. Things started getting quite uncomfortable, and it certainly wasn't possible to hold a normal conversation, once I started hitting peaks of only 10W. Which observation only serves to reinforce the aphorism that it's the first Watt that really matters.

NAP 300 actually uses the same type-007 transistors that were originally developed for the NAP 500, only here they're used in a conventional Class

A/B configuration, as distinct from the 500's internally bridged layout. That in turn means that it is bound to have a significantly lower power rating, but may well drive very low impedances rather better. Indeed, while the amplifier's power output is rated at a nominal 90W (8 Ohms), it's happy driving loads as low as 2 Ohms long term.

These output transistors are allegedly capable of up to 80 amps or 350 Watts, and the amplifier is capable of delivering a hefty 500VA on transients. There's

therefore no need to use several output devices in parallel in order to deliver copious current, and Naim can continue its long-standing philosophy of

using just one output pair per channel. Again echoing a practice originally adopted in the NAP 250 and 135, additional 007 transistors are used as part of the fully regulated power supply.

Special feet help protect the internals from externally generated vibrations, and the main circuit board is also designed to be resistant to microphony and vibration. A quiet, variable speed cooling fan is mounted on a large internal heat sink, so high powers can be maintained for long periods if desired, and you can be quite certain that you'll never be aware of the fan as long as the music's playing.

Naim tries very hard to avoid using RCA/phono type plugs and sockets, for at least one rather good reason that, if pulled out accidentally, they have the very unpleasant habit of breaking the earth before the signal, with potentially destructive side effects. Although the company has mellowed a little with its latest pre-amplifiers, that's a major



► reason why Naim much prefers to use DIN type connectors between its sources and pre-amps, and Pro-style 3-pin XLR/ Canons (of the type normally used for balanced working) for its power amp inputs.

Naim power amps tend to be used alongside Naim pre-amps, and one or other will supply the necessary special interconnect with a 4-pin DIN one end feeding a pair of leads terminated in XLRs at the other. Furthermore, Naim adopts its own connection protocol for the XLRs, using Pin 1 for the signal earth, and Pins 2 and 3 for the left and right channel signals respectively. It all works perfectly satisfactorily – provided you don't attempt to cross the species boundary by using someone else's pre-amp or connecting wires.

Being fully Naim-equipped myself, this wasn't going to be a problem for this review, though prior experience had suggested it was advisable to get the NAP 300 well run in and warmed up before attempting any listening. Having left it switched on for about a week, I brought it into the system, connecting it onto a NAC 552 pre-amp in place of the NAP 500 that I regularly use. The hope in the back of my mind, of course, was that the NAP 300 would deliver something close to the 500's performance at a little less than half the cost.

Sadly that wasn't the case – not at first, that is. Although the family resemblance between the 300 and the 500 is very obvious, there was no denying the dynamic superiority of the bigger brother, especially through the bass region. That said, the 300 does have a great deal in common with the 500, and seems to be getting more and more like it as time passes and the circuitry continues to 'free up' and 'settle down'.

Indeed, even six weeks after it was originally delivered and powered up, this amplifier's sound quality continues to improve, incrementally, day by day. When I first started using it, I was very conscious of some lack of 'get up and go', and found myself

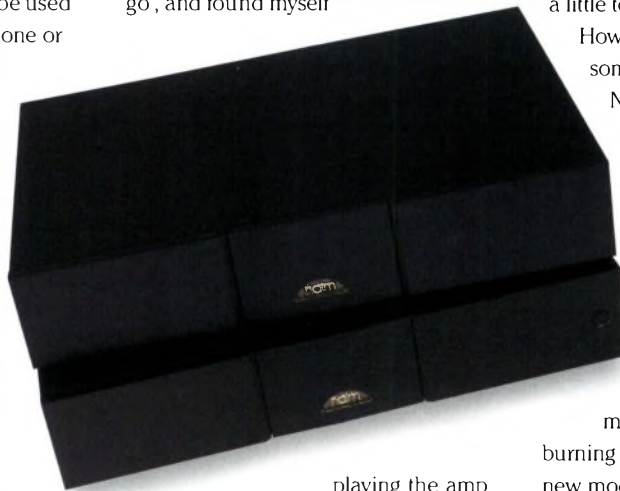

playing the amp louder than I would normally choose to, simply because it seemed to respond better that way. As time has passed, so the 300 has become steadily happier when playing at low levels: it still likes being played loud (though

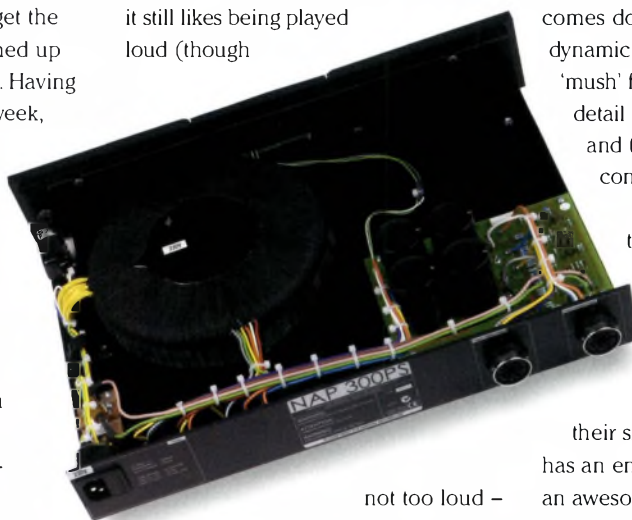

not too loud – it's not super-powerful!), but is now equally capable down amongst the microwatts.

Out of interest I also warmed up and connected a pair of NAP 135s for comparison purposes, and was quite surprised just how dramatically different from one another these successive generations of power amplification

sounded. Interestingly, my initial reaction favoured the earlier model, which definitely has a much 'punchier' and 'in yer face' sort of presentation. By comparison, the 300 seemed a little listless and underwhelming, and maybe a little too laid back for its own good.

However, I'd been there before, to some extent, when reviewing the NAP 500 back in Y2K. These new generation Naims do sound quite different from their predecessors, with much less 'front', so much so that I suspect a number of existing Naim owners might well start off disappointed. First impressions can be misleading, however, and more prolonged listening (and burning in!) allows the subtleties of the new models to shine through.

The 300 actually sounds 'quieter' than the 135s, and as such rather less dynamically dramatic, but that seems to be due mainly to its greater control and lower distortions. Its real advantage comes down at the bottom of the dynamic range, where the noise and 'mush' floor is obviously lower, the detail resolution obviously improved, and the overall dynamic 'window' consequently much wider.

The NAP 300 is therefore not the most dramatic sounding amp around, nor the most exciting. It doesn't have quite the hear-through transparency of the better valve designs either, or their sheer romanticism. But it has an enormous dynamic range, an awesome ability to carry a whole series of tunes simultaneously, and can lay bare the architectural intricacies of the most complex musical performance, with subtlety and delicacy. While it might not have the archetypal Naim 'sound', it falls firmly into the company's philosophy of making even the most difficult music all the more accessible. ►

## NAP 300 Part 2

# Seconds Out...

by Roy Gregory

► Time was when reviewing Naim kit used to be easy. It arrived with most of the imponderables answered: you knew how it was going to work best (ie. In a Naim system) and you had a pretty good idea of what it was going to do. The review process was reduced to discerning a simple question of degree. It's a Naim – how much of a Naim is it? The company had its own way of doing things, and as a result, very much its own sound. Dismissive of hi-fi artifice such as stereo imaging, focus, neutrality or transparency, it built its credo on what it chose to describe as musical attributes. It claimed to put the sense of the performance ahead of a simple impression of it, and it was a heady, addictive brew. As a doctrine in has the immediately appealing symmetry and common sense of all successful ideologies, but like them it's also much more complex beneath the surface. In seeking to project the key elements in a recording at the expense of others, the hi-fi system starts to flirt with the dangerous line that separates the reproducer from the interpreter. Naim are far from the only firm to have stepped this way (many single-ended triodes also flirt with reality). However, they are by far the most successful.

Their particular recipe places pitch, rhythm and timing at the head of the list of performance requirements, a flavour their many fans and dealers have grown to love and rely on. So imagine the consternation that ensued when the company, initially with the 5 Series electronics, started to stretch that

familiar performance envelope and step outside their cosy comfort zone. Yo, there was a wailing and a gnashing of teeth, at least in certain quarters. It wasn't so much that the complainants minded the new, more even balance or tonal sophistication, but these imposters stepping up to the plate left less room for the all important and familiar virtues they craved. At the same time, reviewers found themselves clutching at straws, the familiar suddenly rendered elusive and challenging. I can understand the

trepidation and difficulty experienced by both PM and CB

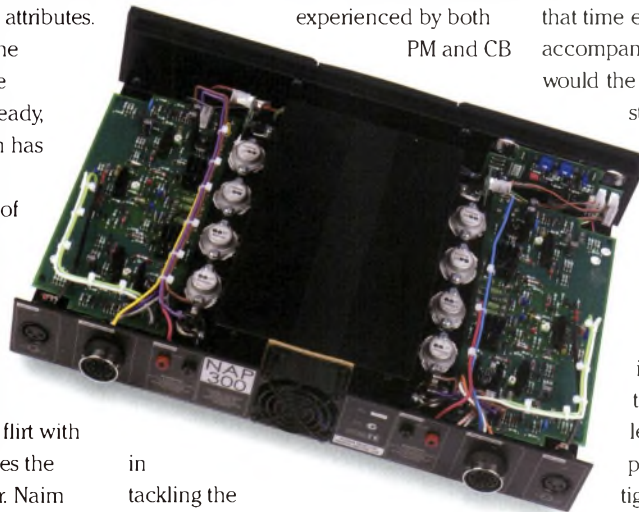

in tackling the NAP300 and 250 in this issue. Unlike them, I have an advantage – and not just the fact that I've read their copy already.

Now me, I've always been outside of this particular debate. I've always been aware of, and actually admired the considerable strengths of the traditional Naim approach. But I've also been aware of its costs, amongst them a set of values that leant themselves to the more robust end of the musical spectrum at the

expense of more delicate offerings, and a tendency to impose a rhythmic rigidity on proceedings whether it was on the recording or not. So, I for one have been fascinated and intrigued by Naim's progress towards mainstream, high-end respectability. That process started with the 5 Series, continued with the NAP500 and NAC552, but it's really reached its goal with the midrange electronics reviewed here. These are the bread and butter.

The NAC552 was the most impressive Naim product I'd ever had at home, at that time easily overshadowing its accompanying NAP500. How then would the next amp down in the range stack up? Well, the answer, at least initially, was none too well. I can certainly appreciate PM's strictures regarding the less than forthright delivery of the 300. Compared to Naims of old it lacks the directness and imposing rhythmic authority that set them apart. Altogether less obvious than its predecessors it's nonetheless a tight, driven sounding amp

when considered in the context of the opposition. It's also far more even and less exaggerated in its balance, but those benefits almost serve to highlight the blocky, mechanical, almost metronomic character of its bass. Add a general layer of grain and a graying of colours to the proceedings and it was a case of *déjà vu*. The NAP500 all over again – just worse. Not exactly auspicious, but then, as with the 500, I was following established doctrine and

▶ and relying on Naim's own NACA5 loudspeaker cable.

The NAC282 pre-amp I was feeding the 300 from is also from the latest range, and in another shocker for the old guard it actually includes a pair of phono socket equipped inputs. I was using these to hook up The Groove and a CD player via my usual Nordost Valhalla cables. What, I wondered, would be the effect of using the Nordost speaker cable? A quick check that it would provide the necessary impedance to keep the amp stable (the main reason to approach Naim amps and alternative cabling with care) and we had lift-off. And I do mean lift-off!

What a transformation: gone was the grain and dingy tonal shading, gone was the blocky, overbearing bass. Running the NAP300 with the Valhalla revealed the amp in an entirely new light. Suddenly, it offered an expansive and well-developed soundstage, solid and shapely vocals, ones that had real body and lungs behind them. Instruments extended beyond the limits of the speakers with real, honest to God discernable space between and behind them. But the real change comes in the timing and flow of the music. Now the rhythm is subtle, expressive, sinuous and insinuating. The beats that underpin the melody prompt and push it rather than pummeling it into place. The rigid, mechanical quality that imposed itself on proceedings with the NACA5 in use might have made your feet tap, but with the Valhalla you started to sing along. The music was at once more open, more communicative and more involving, full of low-level subtleties, properly arranged and properly integrated into an involving, convincing whole. Now all that information and the musical message it constitutes was there all along. It's just that via the NACA5 you'd never of known. Its rendition was crude and exaggerated in comparison, robbing the music of much of its depth and

complexity. Of course there's a small matter of the difference in price between these two cables, but that's not really the point.

So successful has Naim been in promulgating its doctrine over the years that many listeners won't even dream of using anything other than the companies' own cable. But NACA5 has been



around for a few years and this latest generation of electronics hasn't just outgrown it, it's left it way behind. In pushing the envelope Naim have disturbed the status quo. The old rules no longer apply, new ones need establishing, but there's a degree of unlearning to do first.

Given its druthers the 300 is an exceptionally articulate and engaging performer. Its elegant two box chassis and revised aesthetics have jumped Naim straight to the same level of presentation as the best of the competition, while the sound certainly justifies the price-tag. It offers stability and authority in the lower registers, coupled to a remarkably even distribution of dynamic range and musical energy from bass to extreme treble. It may not match the finesse, colour and delicacy of an amp like the Hovland Sapphire, but it compensates by retaining the wholeness, the organic qualities in the performance. It effortlessly unravels complex music, keeping individual strands distinct,

treating the various instruments even-handedly. The two words that spring to mind when I listen to the 300 are intelligible and engaging. It may not be the best amp that Naim make, but in terms of sheer performance it vies with the new 250 as best value. It may have moved away from Naim's traditional sound but it's moved much closer to their avowed intent. To experience what

it's capable of (and this with a relatively modest pre-amp) you'll need to follow its designers' lead and step outside the accepted envelope. But it really does deserve the best available ancillaries. Given Naim's forbearance I'd really enjoy the opportunity to give it just that. How good is the NAP300? Honestly, I don't know, but it sounds pretty damn good right now and I'm convinced there's a way to go yet. ▶+

#### TECHNICAL SPECIFICATIONS

Inputs:	2x XLR
Outputs:	1pr 4mm Sockets/Ch.
Power Output (continuous):	90 Watts, 8 Ohms
Transient Capability:	500 VA
Voltage Gain:	+ 29 dB
Input Impedance:	18 kOhm
Frequency Response:	-3dB @ 2Hz Et 70kHz
Mains Supply:	100V, 115V, 230V (50 or 60Hz)
Dimensions (300) (HxWxD):	87 x 432 x 314mm
Dimensions (PS) (HxWxD):	87 x 432 x 314mm
Finish:	Black, aluminium
Price:	£4,750

**Manufacturer:**  
Naim Audio,  
Southampton Road,  
Salisbury  
Tel. 01722 332266  
Net. www.naim-audio.com

# AUDIO AERO



32bit/192kHz

"the ultimate in CD playback..incredibly natural..something very special..."



*..a seriously great-sounding CD player...the musicality of analogue.. amazing liquidity...very high speed resampling...jitter-free" (Sound Stage)*

The Audiophile Club PO Box 6477 London N13 4AY  
Tel. 020 8882 2822 Fax. 020 8372 3772  
sales@audiophileclub.co.uk www.audiophileclub.co.uk

ARCICI - BC ACOUSTIQUE - CARY AUDIO  
EARMAX - HARMONIC TECHNOLOGY - MARSH  
SOTA - SOLILOQUY - TICE

## THE X SERIES



[www.leema-acoustics.com](http://www.leema-acoustics.com)



Distribution: Aspen Media Limited Tel: +44 (0)1442 255405 Fax: +44 (0)1442 399944

nom



# Naim Audio NAP 250 Power Amp

by Chris Binns

I'm almost embarrassed to recollect the first time I heard a Naim amplifier.

As a student in Salisbury, you will not be surprised to learn that like many others in my situation I used to frequent the local junk shops on the lookout for bargain clothing and of course, records. One in particular used to be a bit of a goldmine for music, although sometimes the purchase would be too embarrassing to risk exposure at the hands of my fellow students; to be seen with anything but material that was vaguely new wave was to risk ridicule for the rest of the day, if not the week. So I found myself outside the shop in Salt Lane clutching a second hand copy of *Solid Air* by John Martyn (25 pence complete with brown paper bag) seriously considering the option of going home via the pub. On the other side of the road were the premises of Naim Audio. It looked like a shop, although there was nothing in the window to support this theory; being a young and impetuous teenager I considered this for all of two seconds before marching in. After all, I had read about Naim Audio in various magazines – this was the company that made amplifiers without tone controls, a fact that earned them a certain amount of derision from some quarters. But there was one review that stuck in my mind, by Chris Rogers (I think) in a publication called *Hi-Fi for Pleasure*, where a group of amplifiers were assessed by the rather unusual (bear in mind that this was 1976) method of listening to them; pitted against the *crème de la crème* of Japanese and American monsters a fairly modest Naim combination came out smelling of roses, closely followed by an old Radford valve amp.

Once inside, I began to feel a bit stupid, but it was too late. I was approached by a large bearded figure.

“Yes?”

I mumbled something about wanting to look at some amplifiers, whereupon he replied rather abruptly that looking at them would tell me nothing, demonstrations were strictly by appointment and they didn't have the time to satisfy every curious idiot who came in off the street.

Three hours and two missed lectures later I tumbled out of the door having just had the full Julian Vereker treatment, with some of my more stupid questions were answered in the manner that I would later learn he reserved for small children. But I swear that John Martyn has never sounded quite as amazing as he did that winters day.

But one comment that J.V made stuck in my mind; “I could make my amplifiers a lot better, but there is no point at the moment.”

It took me several years to understand what he meant.

Naim Audio have always been quite open about their approach to producing hi-fi. It is no secret that the circuit of the power amplifiers originated from a transistor application manual, and that it was essentially the same throughout the range. What the company demonstrated was the importance of what I would call the housekeeping; power supplies, earthing, system topology and so on, to quite dramatic effect. Each product was finely balanced within itself, but more importantly to work as part of a system, with the higherarchy clearly set out.

At the time it was for good reason that Naim would not sell you an amplifier unless you had a Linn LP12, it was clearly demonstrated to me during that winter afternoon that playing loud music on another turntable caused the power amp to overheat and cut out far quicker than with the Linn, proof that there was

less low frequency rubbish coming from the LP12.

During the times that I have heard or owned Naim equipment, I have always had a soft spot for the NAP250. What distinguishes it from the other lesser models is the use of fully regulated power supplies, while the 135's are essentially a mono block derivative with just a little more grunt and better thermal capacity. This is an interesting and unusual approach, providing a very clean and stable supply for the amplification, but there are virtually no other solid state power amplifiers that I can think of (certainly sub £10,000) that can boast this, a fact that I find intriguing considering the present fascination with quality of mains. How much of this has to do with the fact that for a very long time I have regarded the '250 as a bit of a mainstay, an amplifier that I can always go back to, is to a degree irrelevant; the fact is, it works. I have used it with a wide range of loudspeakers, where it has earned considerable respect with its capability to drive everything from my then beloved Gales and Sara's through to the no less demanding electrostatics, while remaining great fun to listen to. For me, it fully encompassed the essential elements of the Naim 'sound', but with a degree more refinement and poise than the lesser models. Naim's refusal to compromise performance with multiple pairs of output devices for increased power delivery means that there has been a long wait for the NAP 500.

For the full history, I urge you to read Paul Messengers article in issue no. 4, where he has already expounded the virtues of the 250, comparing a very early sample to what was then the latest production model.

But, after what is approaching 30 years of production, the 250 has, in

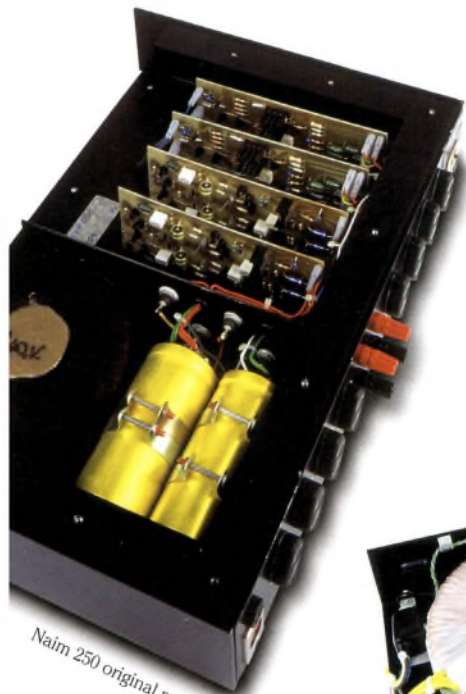

Naim 250 original model.

► common with all other Naim equipment had a makeover, both cosmetic and electronic. Long overdue, aesthetically at least, over the years small changes in casework have refined what can only be described as a fairly utilitarian look – functional black boxes. While this has established a definite visual identity for the Naim electronics, elegance has not been a word that would normally apply. The facelift applied to the new gear was much needed, and has succeeded in bringing it into line with both the competition and the 21st century. It now has an air of precision and class about it, while the basic construction still consists of a solid aluminium extrusion into which the electronics slide on a U shaped chassis. At first glance, it appears bigger than the original, due to the front panel no longer sitting inside the casework, but they are in fact exactly the same size.

Internally, there has also been considerable refinement. The space is dominated by a massive toroidal transformer (at a guess a good 30%

larger than the old one) which now has separate windings to feed individual rectification and reservoir capacitors for each channel. The four printed circuit boards of the original have merged into two by combining the power supply regulation with the amplifier circuitry; these are bolted to an internal heat sink as well as the base of the casework, to provide a higher thermal capacity, however if the temperature exceeds 70 degrees the mains power is shut

(to be used only with the supplied propriety plugs) are now better spaced to allow easier access when used within a Naim rack.

Naim were good enough to loan me a 282 pre amp and Hi-Cap power supply for the duration of the review. The company has always been dead against the use of their power amps with any other manufacturers pre-amp, mainly for the reason that the interface between a Naim pre and power amp provides a high pass filter that avoids wasting excessive power on amplifying rubbish. Perhaps this is less of an issue when using CD, but either way I believe it has contributed to the character of Naim amplification in the past.

In a similar vein, they strongly recommend the use of their own speaker cable, due to the absence of a series inductor within the amplifier a conductor with unsuitable electrical characteristics could result in instability.

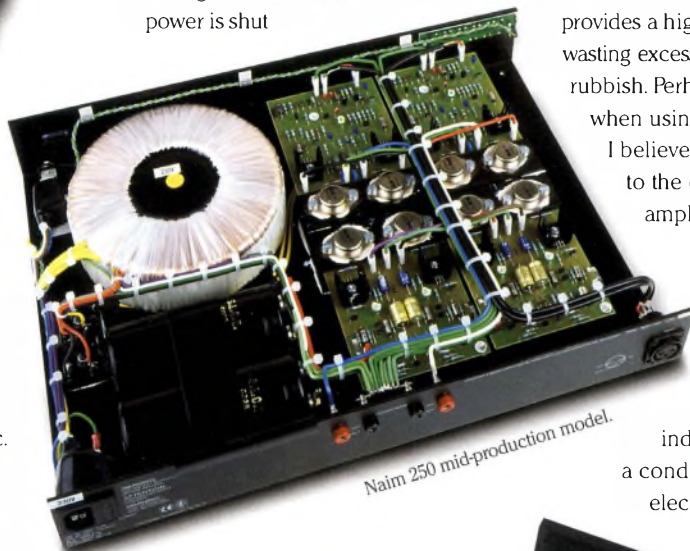

Naim 250 mid-production model.

off until the unit has cooled down. It goes without saying that construction is up to Naim Audio's usual high standard.

While not a bridged configuration like the NAP500 and 300, the '250 has benefited from the research bestowed on their flagship models. The old circuitry has been updated to utilise in particular the same output transistors of its bigger brothers, this presumably a contributing factor to a slightly more generous power output, now clocking in at eighty Watts per channel into 8 Ohms, as opposed to the originals seventy.

Connections on the rear panel remain the same, with a single XLR for input, but the 4mm loudspeaker sockets

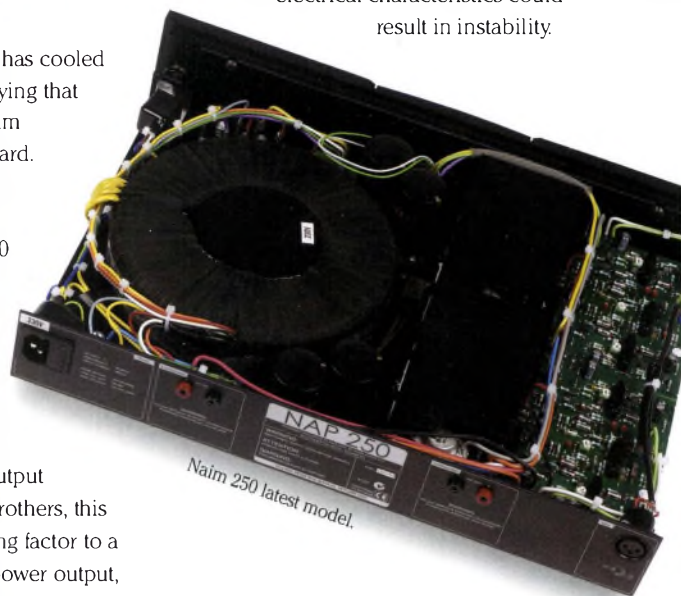

Naim 250 latest model.

I had on hand an old style NAP250 that I thought would make an interesting comparison, and together with the new equipment I left it powered up playing music for several days to let it settle down. Source equipment was ►

▶ the Densen 400XS CD player, with the Linn / Ekos / Helikon SL for vinyl, speakers were the Primary monitors and Quad ESL 63's.

Rather than jump straight into comparisons between the old and new, I spent a considerable amount of time listening to the system with the latest power amp. My immediate impression was that the new set up was far more even handed than I had expected it to be; Gone was the mildly mechanical, robotic quality that used to colour reproduction and make the violins sound as if they were made from plastic, while there was air and space around instruments that made orchestral recordings sound more fluid.

One of the reasons that I did not stick with a Naim system in the past was that while I found it to be eminently satisfying with rock and pop music, real instruments could sound a bit artificial and lacking in expression. Rather than rely on my memory I started to compare the two power amplifiers, with very interesting results, and after all, this is a review of the 250 power amp.

In many respects, the new version is a bigger amplifier. A couple of head banging evenings showed that it is capable of greater power delivery into awkward loads – and on the occasions where the mark one would dry up (signalling its distress at current limiting with a sharp crack) the mark two would develop significantly higher levels without trouble. It is also bigger in terms of its soundstage - while the mark one could present a good image between the loudspeakers, the mark two was more expansive, with better depth and greater ability to push the music away from the cabinets. Cleaner, and with less grain than its predecessor, the new 250 possessed better definition, which extended to the space between sounds -

as if the background was darker, or quieter, if that makes any sense. With greater resolution available, instruments and voices had more texture about them, allowing greater expression, particularly with something like a string quartet or a solo violin. It would seem that the latest version of the 250 is somehow 'wider open' than the original in terms of bandwidth, again contributing to the sense of a bigger amplifier,



and providing more information about the acoustic environment.

Because it sounds more open, musical delivery is less pressurised, a little more casual and laid back. While both amplifiers have identical gain characteristics, the original tended to sound fractionally louder, although this could have been psychological. What the new 250 lacks to a degree is some of the rudeness that the original version could supply. Given that Naim systems have traditionally always been highly competent at unravelling complex rhythmic structures, effectively keeping the beat going whatever, the new 250 is not as emphatic in this respect as its predecessor. The mark one had a certain aggressiveness that could keep the pace of music to the fore, regardless of how many layers were on top of it. The new version, possibly because it draws your attention away with other aspects of reproduction, lacks an element of bite that some music and systems rely on to generate excitement. In this situation it can be too polite.

The sound of the 250 has changed.

Ten years ago, I would not have traded that excitement for the extra refinement. But ten years ago, my listening tastes were somewhat narrow and naive. To be more specific, the performance has stepped outside the boundaries of the carefully sealed envelope that has traditionally been the Naim hallmark, and some will miss the purposeful,

urgent delivery that was never less than exciting to listen to. However, it is

a much better amplifier in other respects, with a delicacy and poise that makes it far more universal

in terms of the way it treats musical material. But stepping into the real world is not without its problems, and new areas of operation demand new rules regarding set-up and getting the best from equipment. The new 250 remains one hell of an amp, but realising the potential benefits over the old model may well take time and patience. But do it right and this latest version of Naim's old war horse starts to look and sound like a real bargain. ▶+

#### TECHNICAL SPECIFICATIONS

Power output:	80 Watts per channel, transient 400VA
Voltage gain:	+29dB
Input impedance:	18 K Ohms
Frequency response:	-3dB@ 2Hz and 65Hz
Dimensions (HxWxD):	87x432x314mm
Weight:	15.8 Kg
Price:	£2200

#### Manufacturer:

Naim Audio Ltd  
Tel. (44)(0)1722 332266  
Net. [www.naim-audio.com](http://www.naim-audio.com)

# THE EMPORIUM

Willow House, Rectory Road, Brome, Eye, Suffolk, IP23 8AH  
 www.emporium.dircon.co.uk email: [emporium@despammed.com](mailto:emporium@despammed.com) tel/fax: 01379 870873  
 mail order and export specialists

<b>CD &amp; DACD &amp; DACS</b>	£	CONRAD JOHNSON PREMIER 2	1000	<b>Turners, Cassette Decks, Real-to-Real</b>	£	TALK ELECTRONICS HURRICANE 3	800
ARCAM ALPHA 9 cd player	450	pre amp with phono	1000	AUDIO REFINEMENTS tuner	350	P/TORNADO 3P pre-power	500
AUDIO NOTE DAC 2	750	CONRAD JOHNSON PREMIER 10 line pre	1500	LEAK TROUGHLINE III STEREO	120	THRESHOLD CAS 2 100 watt	500
AUDIO RESEARCH DAC 1, 20 bit	1000	CONRAD JOHNSON PREMIER 11a power amp	2000	LEAK TROUGHLINE 3 with whiteley	300	YBA 2 pre/power with phono	1800
AUDIO SYNTHESIS DAX	900	CONRAD JOHNSON PREMIER 7B with	3500	valve decoder	1100		
AVI 20 bit dac	375	phono 2 box preamp	3500	NAKAMICHI TRITRACER 1000	450	<b>Turntables, Arms, Cartridges</b>	£
CEC TL1 CD TRANSPORT/black	2000	CONRAD JOHNSON PREMIER 6 mc	400	NAKAMICHI CR7E	1100	ALPHASON HR100S ARM	300
COUNTERPOINT CD 10 transport	800	step up novistors	400	PIONEER F91 tuner	250	AUDIO INNOVATIONS 1000 mc transformer	200
DENSEN BEAT 400 with gizmo	900	CROFT SUPERMICRO A mk2 black	300	QUAD FM3 excellent	110	FIDELITY RESEARCH FR66 12" arm	1000
KRELL Ks20T transport	3000	valve preamp	300	QUAD AM3 excellent	200	GARRARD 401 in APHELION PLINTH	450
RESEARCH REF 64 DAC,	4000	CROFT CHARISMA X phono preamp	1200	TEAC 6030S cassette	250	smc 3009 2 arm	250
LINN KARIK (not 3)	600	CROFT EPOCH ELITE pre, boxed	600			GOLDRING EXEL mc rebuilt by VdHull	450
LINN KARIK 3 excellent	800	CROFT SERIES IVS power amp	700	<b>Transistor Amps</b>	£	LFO MC 1 phono stage	150
MARANTZ CD94 mk1 cd player	350	CROFT APPARITION DTL	600	ALCHEMIST GENESIS monoblocks	800	LINN AK10 arm with upgraded arm lead	450
MARANTZ CD4 94 dac	350	CROFT ALEMIC inoode power amp	600	ALCHEMIST THE ALCHEMIST	2000	LINN LP12 #79000 valhalla, cirrus, I	1000
MICROMEGA DRIVE TWO transport	350	GAMMA SPACE REFERENCE, 300B,	1500	ARCAM ALPHA 10 integrated	425	TTOK LVII, IROKA	850
MUSICAL FIDELITY E624	350	LUMLEY LV1 valve preamp line level	1000	AUDIO ANALOGUE BELLINI/DONIZETTI	600	TROIKA	300
NAKAMICHI DRAGON CD AND DAC,	3333	LUXMAN amp much modified,	1500	AUDIO RESEARCH D130 transistor	1200	LINN TROIKA DECENT CONDITION	300
PINK TRIANGLE ORDINAL dac 18 bit	400	MELOS 333 two box pre line	1300	power amp, 2yyears	750	MICHEL GYRODECK OC psu silver wired	1000
RESOLUTION AUDIO CD50	1500	QUAD IS gold plated anniversary	3500	AUDION platinum hybrid ,	500	tadcock arm	
SHANLING T100	1650	TRILOGY 901 preamp with phono	350	BARTOLOMEO st140	300	MICHEL GYRODECK UP TO ORBE spec.	200/275
STAX TALENT DAC	400	UNISON RESEARCH SIMPLY TWO	600	BOSE power amp, 250 watts mega	500	& stub modded rega, tracer 3 mm	1500
TEAC VHD510 cd player 800	800	UNISON RESEARCH FEATHER ONE/POWER 35	1250	DNM preamp, metal cased line only	550	MICHEL ISO mc phono stage / hera	2000
TEAC T117-01 transport (clock 2) & dac	750	UNISON RESEARCH LABS APOLLO 2 20 watt SE	3000	ELECTROCOMPANIE 4.5 line	600	MICRO SEIKI ms5000 thread drive	2000
TRICHORD TRANSPORT AND	1000			ELECTROCOMPANIE 4.7 pre	1000	up to 4 arms	
PULSAR ONE DAC with psu and upgraded	1250	<b>LOUDSPEAKERS</b>	£	ELECTROCOMPANIE EWB 100	1350	NOTTINGHAM ANALOGUE CARBON	300
WADIA 64 DAC	600	AAD SOLSTICE ,	750	GRYPHON HEAD AMP,	750	FIBRE SPACE ARM latest	500
		ALIANTE LINEA,	1000	KRELL KRC-HR	3500	NOTTINGHAM ANALOGUE THE FOOT	500
<b>VALVEAMPS</b>	£	AUDIO NOTE AN-J-sp light oak,	900	LFO LS1 line preamp	400	ORIGIN LIVE THE SILVER ARM,	500
AIR TIGHT ATM2 80 watt amp,	3500	CASTLE HARLECHS,	500	LFO P2	750	ORIGIN LIVE all arms in stock ring for	
AUDIBLE ILLUSIONS MODULUS	1200	CELLO SERAPHIMS active	4000	LINN K100 boxed	700	good trade in price	
3 gold mc boards	600	DALI GRAND COUPE,	1000	LINN KAIRN with phono	1200	ORIGIN LIVE SILVER TAPER one of the last	30A
AUDIO RESEARCH LS1	900	HALES CONCEPT 5	2500	MARANTZ MA24 monoblocks,	500	ORTOFON MC2000 silver transformer	500
AUDIO RESEARCH LS8 mk1 line pre	1100	HEYBROOK SEXTETS	800	METAXAS CHARISMA PREAMP	500	PINK TRIANGLE EXPORT with rb300	500
AUDIO RESEARCH LS8 mk2 remote line pre	1100	LINN KABERS black passive	900	MICHEL ARGO HR line pre WITH HERA 1350	1500	PINK TRIANGLE LPT, rega arm no lid	250
AUDIO RESEARCH V 140 monoblocks boxed	3500	LOWTHER MAUHORN cabs PM6A	650	MUSICAL FIDELITY A1001 amp	350	ROCKPORT SIRIUS 2	17000
AUDIO RESEARCH REF PHONO	3750	LOWTHER dx3 dual pos acousta CABS	550	MUSICAL FIDELITY A1 final edition	750	ROKSAN XERXES with xps 2, alphason xenon	500
AUDIO RESEARCH LS7 boxed	825	LUMLEY 3.5 floors, ladders,	600	NAIM nac 32 8NAP 250 veryold style	500	SAEC WE 407, japanese arm,	600
AUDIO RESEARCH LS2 line level pre	1000	MISSION 754 Treedomis,	400	N.E.W. A201 power amp class A	3750	SIMON YORKE s7, with arm	4750
AUDIO RESEARCH LS15 remote pre	1750	NAMA INTROS boxed,	500	PASS LABS 0 monoblocks class A	500	SMC 10 turntable without arm	1750
AUDION STIRLING phono stage	300	PMC DB2 as new	700	PASS LABS 0 monoblocks class A	3750	TRON mc step up	200
AUDION PREMIER preamp with phono,	700	QUAD ESL 57 BLACK, SERVICED,	700pair	PINK TRIANGLE PIP preamp boxed	500	VAN DEN HULL MC2 high output( 2.5mv)	600
AUDION APOLLIS, single ended	3000	QUAD ESL57 bronze orig	500	PINK TRIANGLE PIP TWO preamp, mm and mc750	850	VOYD VALDI with helius orion	600
BEARD P50 power amp	500	REFERENCE 3A mm Da Capo ,	1250	PLINIUS 8100 integrated amp line level	350	(audionote wired)	600
BORDER PATROL 300B amp/mk1	1250	RJARK CRUSADERS	650	QUAD 33/FM3/AM3 in wooden steeve with 303	500	VPI HW16.5 RECORD cleaning machine	420
CONCORDANT EXCELSIOR pre with phono	600	SONUS FABER ELECTA AMATORS mk1	1400	ROTEL MICHI RHC 10 passive pre,	350	ex dem	
CONRAD JOHNSON PV8 preamp With phono	550	TOTEM ARRO	600	SIM AUDIO CELESTE amp, with phono	800		
		VIENNA ACOUSTICS BACH	600	SONY ESPRIT TAN 88 preamp,	300		

## audiocounsel

Firstly we love music. Then we select the best equipment to reproduce it.  
 For the best sounds and the best service; audiocounsel; where Customers and Music matter.



ARCAM, B & W, CHORD COMPANY, DENON, DENSEN, DYNAVECTOR, ISOBLUE, NAD, NAIM, PROJECT, REGA, ROTEL, SHAHINIAN, QUAD

12-14 Shaw Road Oldham Lanca. Phone:- 0161 633 2602  
 Plus NEW SHOP 26 High Street Cheadle SK8 1AL Phone:- 0161 491 6080

# "Besten Playern der Welt"

Best Player in the World - Stereo Magazine

## Lindemann D680 CD/SACD Player



Distributors for:  
Allaerts, Avantgarde Acoustic,  
DPS, Garrott, Lindemann,  
LYS, S.A.P., PHY-HP, Schroder,  
TRON and J.C. Verdier.

### G T AUDIO

5 Upper Road, Higher Denham,  
Buckinghamshire, UB9 5EJ.  
Telephone: 01895 833099  
email: sales@gtaudio.com

[www.gtaudio.com](http://www.gtaudio.com)

Demonstration by appointment only



# The Ultimate In Radio

- High quality FM/AM tuner
- DAB Digital Radio
- 192 kHz 24-bit DAC



digital radio

DRX-702ES



sales@pure-digital.com • [www.pure-digital.com](http://www.pure-digital.com) • 01923 277488

**PURE**  
DIGITAL



# Jeff Rowland Design Group Concentra 2 Integrated Amplifier

by Chris Thomas

There are more entries under the general heading of High End Integrated Amplifier than there used to be, but the results are patchy to say the least. Conventional wisdom dictates that spending several thousand pounds should always mandate separate pre and power amplification if sound quality is the deciding factor. This has made sense for years and continues to do so. But the idea of the single box amplifier is far from unattractive. I can well remember owning a Naim six-pack, comprising six NAP 135 mono amplifiers, plus a two box pre and another two boxes for the crossover electronics all sitting in ghastly looking black metal racks with a plethora of wires jutting from the back. It was a hell of a system but I would sometimes gaze at it, the most dominant object in the house and think "I love the sound of this, but wouldn't it be great if it could all be in one reasonably sized box?" Well, right now I am looking at the same space, but sitting there is a Concentra 2 integrated amplifier from the Jeff Rowland Design Group atop a light wood Naim Fraim, so has my wish come true? - Well, almost, but not quite.

Jeff Rowland equipment is not as well known in the country as it ought to be. This is probably because it is both very expensive and has a lower profile than Mark Levinson who manufacture the No.383 that so impressed RG some months back. There is no avoiding the fact that each and every piece of JR gear brings with it a premium price tag. But whereas, with some pieces of American equipment that carry such wallet-

emptying abilities, it's hard to see where the money goes, with Rowland you are left in no doubt. Pick any model in the range and before you have even plugged it in the casework alone lets you know immediately that this cannot be anything other than expensive and in some cases (no pun intended) ruinously so.

You can pop down the road to your local petrol station and spend £5.95 on a quartz watch or, at the other end of the scale (but by no means the extreme end) you can buy a mechanical Patek Philippe for £50,000. Over the course of the year el-cheapo will more than likely be more accurate than the Patek. It will remain a horrible object, but it will tell the time. So, if the job of a watch is only to tell the time why do some people aspire to such expensive items. I guess it is about such things as pride of ownership and the sheer joy of possessing something that is literally a beautifully built object.

What's more, as far as I can see, this is a peculiarly, though not exclusively, male trait. In fact a watch does a lot more that tell the time and if you have to ask what that is then you don't get it. And you probably won't get the Concentra 2 either.

This amplifier is a development of the Concentra, an integrated design that was first seen in the mid 90's. It was

a solid-state 100 watt that incorporated the electronics from the Synergy pre and the Model 2 power amplifiers into a shared case with all the usual compromises that that entailed. Ask any amplifier designer and he'll tell you that making such integrated devices really work requires great electronic cunning and thought. I was fortunate enough to have had some experience of both the Synergy and the Model 2, including the optional but horribly tempting battery power supply that bought about such startling improvements.

It was a terrific set-up.

Impeccably balanced, refined and musically involving it was, at the time, the closest American amplifier that I had heard to the Naim I had been using for many years.

I am not saying that it sounded like the Naim because it didn't. But it was fast to start and stop and had that lightness of musical touch when most of the US amplifiers I was hearing were all big, bloomed mid-bands with rather slow and ponderous rhythmic signatures.

Most amplifier manufacturers have their own brand of sound rather like top champagne houses have a house-style. Naim, for instance have always had an identifiable and unmistakable way of making music. You could hear a Nait 1 and it had that flavour of the biggest and priciest of their amplifiers. Spectral, Mark Levinson and several others all have a uniquely identifiable way that they go about their business. ▶

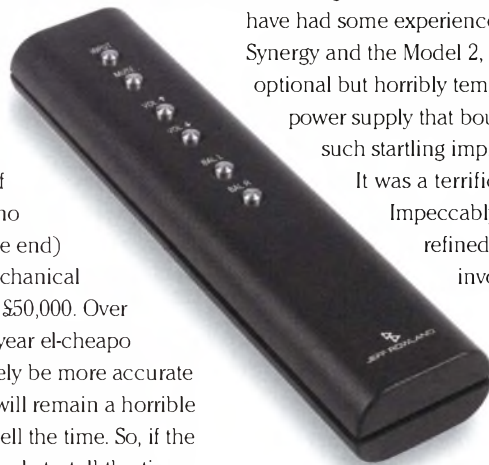

► And over the years this evolves and often becomes more refined, though in some cases this is not always met with universal approval. For every 10 people who believe that the new range of Naim equipment is better there will be at least one who bemoans the demise of the old.

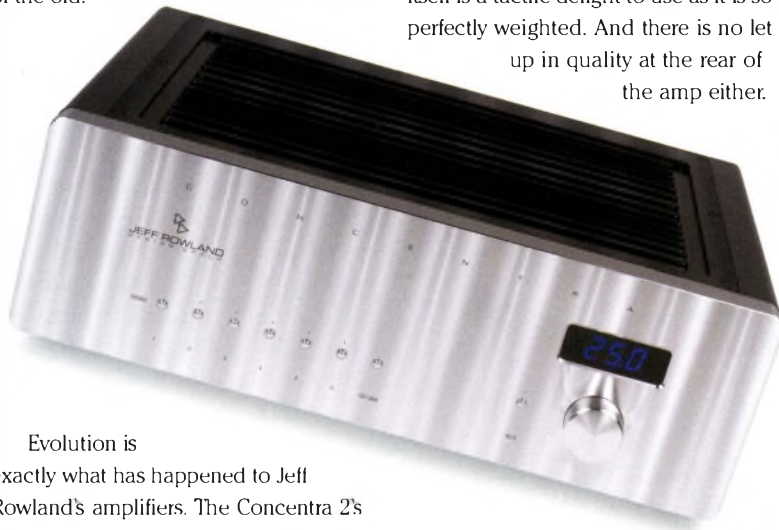

Evolution is exactly what has happened to Jeff Rowland's amplifiers. The Concentra 2's power has been upped from 100 to 150 watts per channel as the power amplifier from which the muscle section is derived is the newish Model 112, a smoother and rather creamier device than the Model 2. Build quality is as superb as ever and remains a significant part of the Concentra 2's appeal. Rowland have gone to great lengths to create a high-mass, non-resonant platform for the electronics. It is fashioned from substantial slabs of aluminium alloy so the case forms a total heat sink. Look along the cooling fins on the sides and the raised sections on the top and you will see that they are of varying thickness to avoid resonance issues. There are no sharp edges and every joint on the case is overlapped to prevent any ingress of dust. The front panel is a work of art in itself. Enormously thick, it is such a large piece of metal that it could end up giving the amplifier a rather ungainly slab-fronted look. But the quality of the vertical milling, the delicacy of the etched lettering and the tiny input selector buttons and illumination lighten

the effect considerably by giving the panel a texture that changes under different lighting conditions.

The digital readout of volume, now blue instead of red, is understated, yet can be read from anywhere in the room. The continuously rotating control itself is a tactile delight to use as it is so perfectly weighted. And there is no let up in quality at the rear of the amp either.

There are 6 line inputs, 3 balanced (XLR) and 3 single-ended (RCA) including a record loop though input 1 could be configured as a phono stage if required by the fitting of an internal



module. There are also pre-outs in both balanced and single-ended form for driving external amplifiers. And it's good to see that the speaker connections have now been made deep enough to accept the full length of a 4mm plug. The whole

substantial thing sits on four feet with compliant inserts supplied. I prefer them fitted but, as ever, the ear should be the judge.

The remote is a solid metal cased design of great simplicity. It allows you to flip through the inputs, which are numbered rather than labelled and has variable rate volume control. It is also the only way to access the channel balance as the Concentra has no control on its rather minimalist front panel. This, like all of Rowland's designs, particularly the current ones, is obviously an amplifier where aesthetic considerations are vitally important. This level of construction and finish has to be paid for obviously but this is what Mr Rowland's products are all about. But beauty here is not only skin deep. The internals are impressive enough to warrant a see-through top, if it didn't compromise performance.

Fed by my Naim CDS 11 and driving Revel Gems through a set of Nordost SPM speaker cables I had been preconditioned as to what to expect by my experiences with the original model. The extra power was immediately noticeable and it is the sort of power that

is less to do with volume than it is with musical energy. If you were expecting an American muscle amp, think again. The Concentra 2 is very refined, delicate even, though it has enough power to impose itself if the need arises. These attributes are evident in all aspects of its performance from the tonal to the rhythmic. I get the impression that the sound of the amplifier has been carefully shaped by Rowland who has made the necessary compromises in all the right places, leaving a neat and

concise feel to the music which is impressive. This is well illustrated in the low frequencies where pure bass extension is not its strong point. You will hear many an amplifier with more bass but if the last few hertz have been ►



► sacrificed for the sake of pitch coherence and fluidity then the trade-off is a successful one. Even driving a speaker as tricky as the Gem, through a cable as lean, taut and revealing as the Nordost SPM, bass instruments always remained understandable, progressive and in touch. It certainly never grows bloated or blurred even when it is being asked serious questions. Plectrum, bow, thumb, acoustic or electric, this Rowland always feels like it is in control of the music and not the other way round. It doesn't have the sheer iron grip, power and stop/start abilities of the Spectral or other pre/power combos I would admit, but it is not that far behind.

The feeling of delicacy and sensitivity to small aspects of musicianship is much more tangible through the mid and extremely silky top and is equally evident vocally or instrumentally. The subtler the musical message, the more the Concentra 2 seems to enjoy it. I was enormously impressed with the way it handled pianos, in my opinion one of the very hardest instruments to both record and reproduce at home. Ultimately it is down to note control and it certainly has that in abundance, with very little feeling of compression or artificiality to the leading edge and a natural sense of decay. I have enormous admiration for those musicians who can paint colourful pictures through subtlety and expression and who use their pure technique and relationship with their instruments with feeling and taste. A lingering note, a hanging chord or a delicate triplet where a single note would be the easy choice are all well within the resolution of this amplifier and the result is that the music seems understandable and feels that bit closer and more personal.

Though it is nearly a decade old now *Skip, Hop and Wobble* (Sugar Hill 3817) brings together what must be one of the ultimate acoustic trios in Russ Barenberg, Jerry Douglas and Edgar Meyer and I inevitably end up playing it through each and every piece of audio gear that passes through my hands. There's no place to hide in a 3-piece and the album is just packed with some really energetic virtuoso playing. But it's intense at times and presents



an amplifier with so many potential pitfalls that the interplay between the three can often sound confused, brittle and breathless. Not so with the Rowland. It locates each instrument solidly in time and space and is transparent enough to allow each the room and independence to really enjoy the extraordinary vibe of each of them playing off and around each other. The Concentra's *modus operandi* is so neat, focussed and concise that, even without a drummer to light the rhythmic path you are never in any doubt where the beat lies. As each player toys with time, the sheer compactness and tightness of the way the amplifier controls and resolves the music, from the big to the small, plus its fine midband shading and tonality leave you in no doubt that this is a very fine amplifier.

This is by no means the best amplifier I have heard, but, along with the equally impressive Mark Levinson No.383, it is certainly the finest and

most rewarding integrated model to have crossed my path. If you are looking for the most sound per pound then separates are still the way to go. And they offer greater flexibility for future upgrades. Some will call it overbuilt or suggest that it is a five grand amp in a two grand case. I couldn't argue with the second point of view, but the fact is that with Jeff Rowland products this level of construction and attention to detail, inside and out, is part of the deal and a major attraction to those who buy them. So if you are looking for a beautiful one-box amplifier, have a few bob and like Patek Philippe watches check it out. ►+

#### TECHNICAL SPECIFICATIONS

Type:	Integrated amplifier
Inputs:	3xbalanced line (XLR) 3xunbalanced line (RCA)
Phono Input:	Optional, can be retrofitted.
Outputs:	1xbalanced pre-out 1xunbalanced pre-out
Speakers:	1 pair binding posts per channel
Output power:	150 watts into 8ohms 250 watts into 4 ohms
Dimensions(WxHxD):	44.5x14.6x36.2cm
Weight:	57 lbs (26 kg)
Price:	£7200 as tested (line level)

#### UK Distributor:

HMF Audio.  
Tel. (44)(0)20 8771 7106  
Fax. (44)(0)20 8771 7106.

#### Manufacturer:

Jeff Rowland Design Group, Inc,  
P.O Box 7231  
Colorado Springs,  
Colorado 80933, USA.  
Net. [www.jeffrowland.com](http://www.jeffrowland.com)



HEGEL

Balanced •  
Dvd •  
CD •  
Tape •  
Tuner •  
Auxiliary •

# Hegel H1 Integrated Amplifier

by Roy Gregory

First came the CD player: well, actually there were plenty of line-level sources around before then, but the CD player was the first line-level primary source. That opened the door to passive control units and from there it was but a short step to the line-integrated amplifier and a new form of budget esoterica. Simply stick a few inputs and a volume control on a baby power amp et voila – a slice of the high-end on the cheap, or so the theory goes. There's more to it than that as not a few manufacturers discovered, but for every potential pitfall there was a corresponding benefit to be had. Pretty soon the high-end integrated was the fasted growing area in amplification and every company had to have one. However, some were more successful than others and many big names have quietly shuffled their integrated efforts off to the side lines. Instead it's proved to be a profitable arena for young companies looking to start up, making it one of the most competitive markets in hi-fi.

Get it right and there's no doubting that a line integrated can form the heart of an extremely impressive and impressively simple system. The reasons are far from difficult to fathom. The most expensive (and troublesome) component in any amplifier is the casework. Costly to create and difficult to keep looking pristine the wastage rate simply adds insult to injury. Just dispensing with

one set of casework offers a huge saving over a conventional pre-power set-up. After all, there are an awful lot of rack width line stages with not a lot inside them: Because line stages don't take a great deal of circuitry. But that doesn't mean you can simply dispense with them – a hard won lesson in some cases.

You need to properly isolate each input from the others and protect the power stage from over-work and poor impedance matching. Simply cranking up the gain doesn't really cut it.

The good news is that keeping the line-stage in the same box as the power-amp gives you control over the interface, meaning you can keep signal paths short (and dispense with the cost of an extra set of interconnects). The downside is protecting the relatively fragile source signals from the noise levels generated by the output stage and its hefty power-supply. This of course was the original rationale for separate control units in the first place. But with the average CD player chucking

out 2V and the average moving-coil generating something a lot closer to 0.2mV, the problem isn't quite as acute as it used to be.

So the ingredients for a successful line integrated amp are by now pretty well defined. For real audiophile credibility you need to add suitably minimal controls, balanced inputs, pre-outs (for later upgrades) and a remote control ('cos even sound quality takes a back seat sometimes, and staying seated is just so much more important). I do wish all you couch-audiophools would get a life – or at least some exercise.

If this industry is dying then it's heart disease that's doing the killing! Enter then the Hegel H1,

a rather beautiful integrated amplifier

from Norway. It comes from a complete line of products and shares its elegant styling with the rest of the range. I first came across them, looking fine and with sound to match, at the Frankfurt show a few years back. Imagine my pleasure when they finally reached these shores.

The H1's full width fascia is subtly curved and coated in an attractive and practical textured finish. The controls are limited to source select and volume, with a large, chamfered on-off button between them. ▶



▶ A tiny remote receiver lurks, almost unnoticed in the bottom left corner. So far so good and pretty much as expected. The shock comes when you look past the fascia. The casework extends way, way back. This is one deep amplifier. As deep as it is wide, allowing plenty of space inside to space things out and still pack in the beefy power supply for the healthy output stage and load tolerance that go hand in hand with a 120 Watt rating, audiophile aspirations and solid-state circuitry. The back panel is well equipped with



five single-ended inputs, one balanced and three single-ended outputs (one tape, and two pre-outs), but only a single set of 4mm binding posts for each channel. The obligatory remote is a generic plastic unit that will run a complete system's worth of Hegel electronics, although only the volume and mute functions are applicable to the H1. Those are the ones you actually want so I guess that's fine, and for once the acceptance angle is pretty good too, making this one of the more useful remotes I've had through the house. The fact that it's RC5 compatible also means that other remotes equipped with a volume and mute facility (from a CD player for instance) will also

operate it. Volume level indication is confined to a small dimple on the control itself, although muting the unit causes the large blue power LED to blink slowly, offering some protection against inadvertent switch on at ear and speaker rupturing levels.

I ran the Hegel with the Clearlight Audio Recovery turntable, carrying the Hadcock GH 242 SE (Incognito), Lyra Helikon and The Groove as a vinyl front-end and the

Rega Jupiter for CD replay. Cabling was the Chord Co. Signature interconnects with Nordost Valhalla speaker leads. Speakers alternated between the Audioplan Kontrast IIIi and the Living Voice OBX-R now with improved crossovers. After the mayhem of the multi-box Boulder and Connoisseur set-ups it was something of a relief to return to a single rack system. Ah yes, the rack. After the excellent results I've achieved recently with the finite elemente Ceraballs, I slipped them under the Hegel without even thinking about it, only to discover that this is one amplifier which takes exception to them, thus proving the rule. Initially I was plagued by an overly compact soundstage and a strange tang to the upper mid that leant brass a pale quality. Removing

the Ceraballs banished the problem, introducing a wider stage and much greater and more natural tonal development. Titanium Pulsar Points were no more successful, and goaded into action I ran the full gamut of other feet, cones and blobs. Nothing actually improved on the Hegel's own solid aluminium feet resting straight on the RDC rack. Which certainly suggests that the company know what they're about.

Once I'd convinced myself of that fact, things proceeded swimmingly. The H1's sound is solid and well rooted, with exceptional body and presence for a moderately priced solid-state unit. Its bass is mobile, tactile and tuneful, providing a stable rhythmic foundation for music, full of drive and momentum. James Leary's walking bass-line that underpins and sets up the structure for Basie's subtle prompts in 'Way Out Basie' (*Farmers Market Barbeque*, Analogue Productions APJ 023) is weighty, even and beautifully pitched. It undulates and evolves in perfectly pitched forward motion, never sounding leaden or plodding, but agile and dynamic. That sense of motion and energy is what characterises the Hegel's presentation.

In some respects it's a rather old fashioned sound, majoring on weight and motion, rhythm and impressive dynamic range, reminiscent in some ways of the flat-earth sound of yesteryear. Only here it's not shackled by the same obvious weaknesses. The Basie track delivers a compact sound that's full of life and presence, big on structure and line. You really get the sense of a tight band pushing the envelope. The brass tuttis are bold, brash and big – just the way they should be, delivering scale impact and contrast. The solos are never ▶

▶ allowed to meander off aimlessly but are always held in strict contrast to the backing band. It's impressively direct and musical. What's lacking is space. Not just the inter-instrumental space within the soundstage, but the space between notes that allows harmonics to develop properly. The result is that notes have a slightly blocky, chopped feel to them. Basie's piano is never quite as sonorous or complex as a box full of wood, wire and cast iron should be, the rhythm guitar likewise consists of more string than body.

his notes is sacrificed, and along with it some of the expression from this most expressive of players. However, add an extra player and some electronic instruments (Talking Heads' 77, Sire SR 6036) and the scene changes completely. Suddenly, the undulating shifts in rhythm are perfectly captured and pleasingly propulsive, while David Byrne's edgy, pointed lyrics take on real bite and attitude. There are none of the gross tonal liberties that used to be considered acceptable (even necessary) in 'real' hi-fi,

have PLAY LOUD engraved on its front panel. Totally un-phased by complex dynamic demands, it will play music with power, presence and impact, imbued with energy and purpose. Those opening chords of 'Psycho Killer' have real depth and menace, and the same holds true for the opening bars of Act Two of the Colin Davis *Tosca*. If you want scale, drama and impact then the H1 should definitely be on your shopping list. If you're a cuddly, warm, single-ended triode kind of guy then it'll leave you cold and possibly even affronted. But hey, it's hard not to like an amp that can sound this insulting when the music demands it. ➤

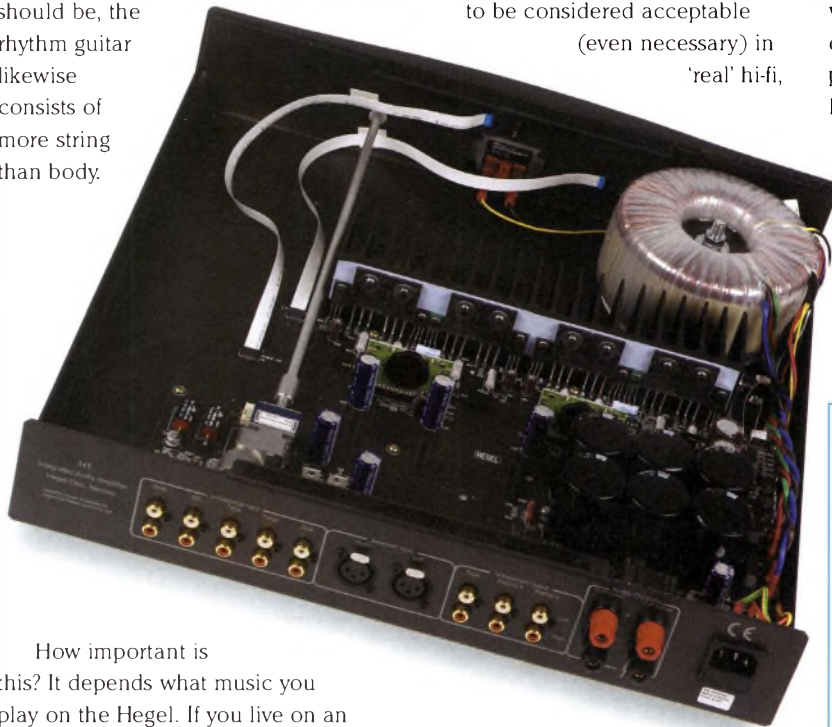

How important is this? It depends what music you play on the Hegel. If you live on an exclusive diet of acoustic chamber music then ultimately you'll want more delicacy and a defter harmonic touch, but as soon as the numbers (and volume) increase then the H1 starts to really come into its own. It's easy to demonstrate the point. Playing *Byrd At The Gate* (MFSL 1-515) the Hegel does a stellar job of rounding up this recordings flabby bass line and driving it along. But at the same time the lines of Charlie Byrd's guitar are robbed of subtlety by an emphasis on leading edge and attack. They have plenty of bustling purpose but the elongated shape of

nor the heavy-handed organisational imposition that made drummers sound almost metronomic. Rather it's a case of emphasising the leading edge and core of notes which in turn highlights the dramatic over the subtle, the message over the finer aspects of the medium. It's easy to over state this and don't get the idea that the Hegel is a complete washout when it comes to small-scale music because it isn't. It's just much, much happier once you open the throttle.

And that's the story in a nutshell. This is an amp that might as well

#### TECHNICAL SPECIFICATIONS

Type:	Line Integrated Amplifier
Rated Output:	120 Watts/8 Ohms
Inputs:	5 x single-ended line 1 x balanced line
Outputs:	1 x tape, 2 x pre-out
Speaker Outputs:	1 pr 5-way posts/ch.
Remote Control:	RC5 compatible
Dimensions (WxHxD):	430x80x450mm
Finish:	Blue/Gray
Price:	£1500

#### UK Distributor:

Audio Atmosphere  
Tel. (44)(0) 1785 711232  
Net. [www.audioatmosphere.com](http://www.audioatmosphere.com)

#### Manufacturer:

SoundEngine  
Malmogata 7C  
N-0566 Oslo, Norway  
Tel. (47) 2312 1760  
Net. [www.hegel.com](http://www.hegel.com)

# Doug Brady Hi-Fi



NAIM NAP 250



NAIM NAP 300



B&W Nautilus 805  
Signature Loudspeaker

The entire new range of Naim Audio is on demonstration and may be compared with models from other leading brands such as Musical Fidelity, Chord Electronics.

B&W Nautilus - a range of stylish high performance loudspeakers, with the Signature having a particularly beautiful finish.

Demonstrations by appointment plus home trials. 0% Credit available.

Kingsway Studios, Kingsway North, Warrington. WA1 3NU.

Tel: 01925 828 009 Fax: 01925 825 773

Email: doug.brady@dougbradyhifi.com Website: dougbradyhifi.com

## definitive audio

### CANARY AUDIO



#### CA608-LV

#### Integrated Amplifier

Hi-Fi Plus *Editor's Choice*  
Hi-Fi Plus *Product of the Year*

*The results are simply astonishing. The majestic sense of graceful power belies the modest rated output, bringing drive and purpose to music on demand and a palpable delicacy where required. The presence and substance of the music is independent of level, and for once the images and soundstage are consistent through dynamic shifts... The CA608 might start life as the baby in the Canary range, but get it modified and you turn it from a domestic pussy cat into a Bengal Tiger!*

Roy Gregory

### LIVING VOICE



#### Auditorium Avatar

Hi-Fi Plus *Editor's Choice*  
Hi-Fi Plus *Product of the Year*  
Hi-Fi Choice *Editor's Choice*

*"The Avatar is a near perfect balance of size, bandwidth, efficiency and tonal refinement. Its slim lines and small footprint deliver a genuine 94db sensitivity, and excel when it comes to delivering the scale, vibrance and colour of the music... Its unobtrusive quality allows it to cut straight to the heart of a performance, unlocking the music trapped in the recording, whilst its refinement makes it equally at home with both basic and surprisingly expensive amplification."*

Roy Gregory

See us at the  
**BRISTOL  
SHOW**  
ROOM 414

Tel 0115 973 3222 Fax 0115 973 3666  
internet: [www.definitiveaudio.co.uk](http://www.definitiveaudio.co.uk) email: [shout@definitiveaudio.co.uk](mailto:shout@definitiveaudio.co.uk)  
Living Voice · Vitavox · Electrofluidics · Art Audio · Border Patrol  
Canary · DNM · Sugden · Wavac · Lyra · Monarchy · Western Electric  
Wadia · Michell · Stax · Tom Evans · Nottingham Analogue · EMT  
Kuzma · Resolution · Benz Micro · Tri-planar · SME · Van den Hul

# See us at the Bristol Show

## in the Terrace and room 119



QCD150  
OAK CD  
CABINET



Q4 CHERRY  
TABLE



QK ROSENUOT  
CABINET

www.quadraspire.com



QUADRASPIRE



Q4 BLACK  
REFERENCE  
TABLE



Q4 CHERRY  
REFERENCE  
TABLE

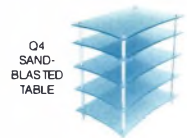

Q4 SAND-  
BLASTED  
TABLE



Q4V OAK TABLE



Q4V CHERRY  
CABINET

www.quadraspire.com

QUADRASPIRE LIMITED  
305 KELSTON ROAD, BATH, BA1 9AB, UNITED KINGDOM  
TEL: +44 (0)1225 333360, EMAIL: SALES@QUADRASPIRE.COM

## THE AFFORDABLE PHONO AMPLIFIER

FROM TRICHORD RESEARCH

only £299.00 inc VAT (COMPLETE WITH TOROIDAL PSU)

# Dino

Moving Coil  
Moving Magnet  
Switchable Gain  
Switchable Loading  
Super Regulators  
Discrete Output Stage  
Add a 'Dino+' PSU for true high end performance  
Dino complete with Dino+ combination - £498.00 inc VAT

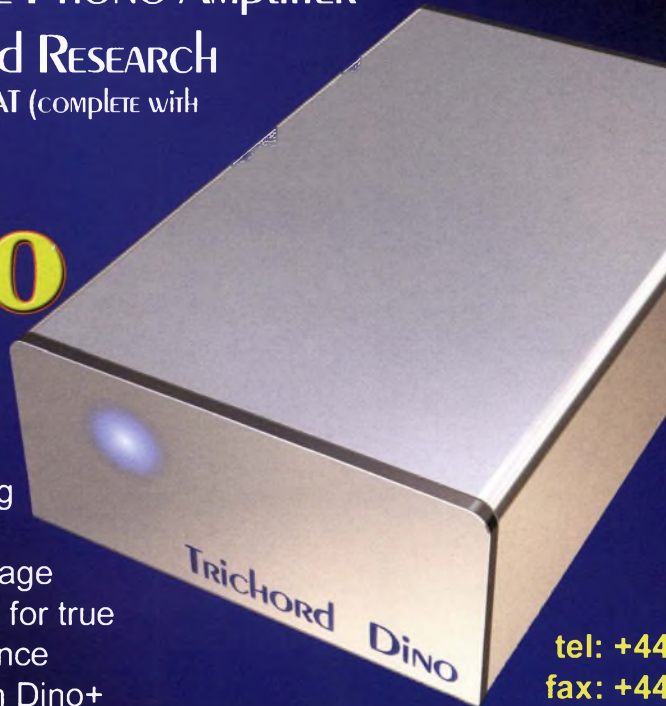

tel: +44(0)1684 573524  
fax: +44(0)1684 577380

www.trichordresearch.com

EUPHYA

Volume





# Euphya Alliance 270 Integrated Amplifier

by Jimmy Hughes

Specialist Audiophile products can often be a bit hair-shirt and impractical. We all know that. Performance is everything. Even if it means compromising ease of use. So it's nice to find something that offers excellent sonics while at the same time remaining simple to operate and install. That pretty much sums up my first impression of Euphya's Alliance 270 integrated amplifier; a good basic amplifier aimed at the serious enthusiast, yet offering conveniences like remote control.

Originating from France, it's the sort of product you can plug in and play without having to worry over-much about warm-up times and suchlike. Essentially it's a solid unflappable piece of kit that makes good music with a minimum of fuss and drama. Which isn't to say that care over installation won't pay dividends - it will. But fundamentally the Alliance 270 remains even-tempered and largely unfazed by its surroundings.

I was still using Rotel's truly excellent RA-02 integrated amplifier (see last month's review) when the Euphya arrived, so it was very much a case of going from one integrated to another. Mind you, there is a slight difference in price between the two: at £1749, the Euphya costs about £1400 more than the Rotel. A pretty big gap. Whether this extra cost is justified ultimately boils down to listening yourself and deciding. But I feel the Euphya shows definite benefits.

The main difference falls in the area of smoothness and refinement.

The Rotel has an attractive sense of attack and immediacy, making the music sound forward and lively. By comparison, the Euphya has a smoother more mellifluous musical presentation. There's a level of refinement that, good as it is, the Rotel doesn't quite aspire to. In this respect the Euphya sounds more natural, imparting a feeling of effortlessness that is both beguiling



and alluring. Yet at the same time there's no lack of immediacy or excitement. The Euphya may offer a beautifully refined presentation, but the music also has bite and dynamics. It's not a case of getting one at the expense of the other. In this respect, the Euphya's cultured sonics put me in mind of EAR's 869. There's a similar kind of mellifluous sweetness that gives massed violins or voices a pleasing warmth and roundness - yet with no loss of impact.

Agreed, the Euphya isn't quite as liquid as the EAR - transformer coupling the output, as with nearly all valve designs, helps give the 869 its distinct refined fluidity. But the transistor design isn't massively far behind. And of course you've no power constraints to consider - unlike the 869. With 40w output per

channel, the Alliance 270 has enough power for all but the most inefficient speakers, satisfying most musical tastes, in most situations, most of the time.

The Euphya is designed to be left in Standby mode when not in use. This keeps some low-level circuits constantly powered up, helping to minimise sound quality changes when the unit is first switched on. This certainly seems

to work as, once the amp has warmed up initially, I could hear no improvement in performance with extended use. In terms of sound quality, the Euphya seems to be at or near its best from the moment you press the Standby button. If there is an improvement, it's absolutely minimal.

During use, the Euphya generates virtually no heat - leastways it didn't at the sort of power levels I used it at. It's also pin-drop quiet in operation - for example there are no clicks or thumps when selecting different inputs, or switching the unit on and off. It's one of those amplifiers where you have to look at the lights on the front panel in order to ascertain its operating mode, and which input's currently selected.

There's virtually no audible noise from the mains transformer either. A fairly large toroidal is used, and sometimes these emit an audible buzz - depending on the quality of your mains. But I could only just detect the faintest buzz from the Euphya with my ear pressed close to the top panel. Unlike the Rotel (which went into self-destruct mode when provoked!) the Euphya seemed perfectly happy with my

► high-capacitance Goertz speaker cables, indicating a good stable bomb-proof design.

Looking inside, I was surprised to see so many components on the main circuit board. With ICs used extensively in so many modern amplifiers, it's common to find acres of empty space and plenty of distance between components. At a guess, I'd say the

appearance. So they're seriously considering fitting replacement hexagonal allen bolts. However, before doing this, they wanted to check with the makers just in case brass bolts had been chosen for sonic reasons. There may be something in this, as there are

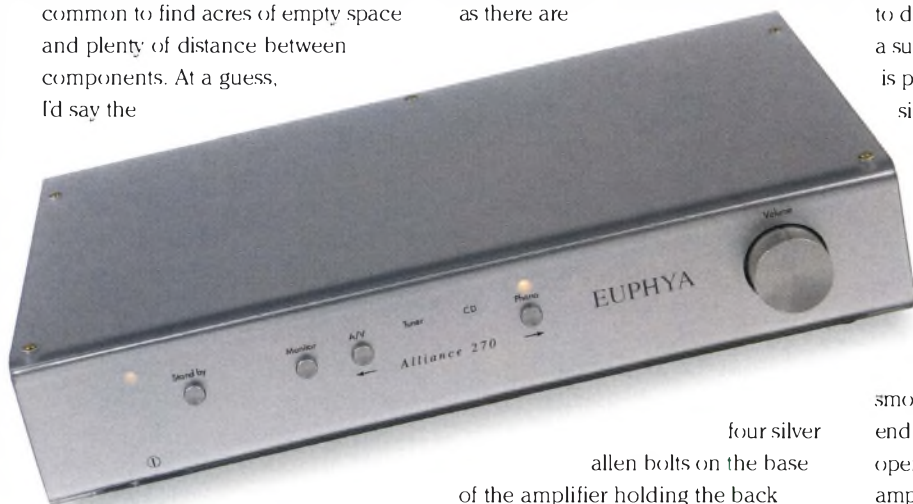

Rotel RA-02 could probably be reduced in size by 50% without too much difficulty. But this would not be possible with the Euphya Alliance 270. With a heavy compliment of discrete components, it's packed solid...

The one-piece top/front cover is made from plastic, and the main chassis seems to be alloy. Although its appearance suggests conventional plated steel, the chassis is non-magnetic. The top panel is held in place by slot-headed brass bolts, and being gold in colour, these clash visually with the silver colour of the amplifier. I checked with the UK importer in case cover studs had been fitted and perhaps accidentally lost or mislaid. But no, there aren't any studs...

The importers told me they too felt the use of gold-coloured slot-head screws rather spoiled the amp's

four silver allen bolts on the base of the amplifier holding the back panel in place. So it could be that the brass bolts are no accident.

A total of four line inputs (including Tape with monitor) are offered, plus a phono cartridge input. This is for 'magnetic' type pickups only, there being



no high-gain stage for low output moving-coil cartridges. With many modern amplifiers excluding any sort of phono stage, I suppose one should be grateful to Euphya for providing something. But it would've been better had the manufacturers gone the whole hog and catered for MC and

MM cartridges.

One set of speaker outputs are provided, using fully-recessed 4mm sockets. And there's an output for tape recording. An optional extra (at about £100) is an add-on circuit that provides a couple of pre-amp outputs - perhaps to drive a second power amp, or maybe a sub-woofer. A stereo balance control is provided, but this is a pre-set type situated on the rear panel, adjusted by a small screwdriver. The mains cable is captive and the amp sits on three feet.

As previously indicated, first impressions were of a clean, lively, and above all refined presentation. The sound was sharp and focussed, but very smooth and nicely integrated at the top-end. Tonally, the Euphya offers a neutral open sort of balance. Many transistor amplifiers sound slightly 'hard' in the upper mid-range, giving the music an impressive immediacy at the expense of sweetness and warmth. But the Euphya avoids this, sounding smooth, open, and neutral.

These qualities are very noticeable on massed violins and human voice. There's a welcome absence of that 'shouty' mid-band forwardness which obscures fine detail and subtle

ambience. Musically, the Euphya's presentation is very open and transparent.

Timing is good, and there's an attractive delicacy during quiet, subtle passages.

Put differently, there's nothing coarse or vulgar about the Alliance 270; it's cultured rather than bellicose.

Perhaps as a result, the Euphya is a shade more demanding of its sources; because it's not colouring the sound with its own false additives, you're more in touch with the quality of your

► source material. If the source is good, the benefits in terms of fine detail, subtle tone colour, and dynamics are very noticeable. The music will sound warm, vibrant, colourful, and focussed. If the source is undistinguished, the result may be disappointing - somewhat bland and featureless.

By saying that, I'm not implying the amplifier holds a magnifying glass to its sources, exposing weaknesses and limitations mercilessly. Actually, if anything, the opposite is true. The Euphya is very forgiving in many ways - it certainly doesn't scream at you when things aren't 100%. It's just that its honesty and neutrality won't hide losses of quality in the early parts of the chain. It won't add false spices to disguise a fundamental lack of flavour elsewhere.

In a listening period that spanned four or five weeks, I tried all kinds of music with equal success. But perhaps best of all were recordings of simply-miked acoustic music where the aim had been to create a natural unexaggerated tonal balance and a realistic truthful stereo soundstage. On this sort of material, the intrinsic 'rightness' of the amplifier's sonic presentation was fully apparent: The sound was not only attractive and likeable, it was believable too.

For example - acoustic guitar with steel strings: You not only got plenty of twang; there was a woody mellowness too that's very characteristic of a good instrument heard live and unamplified. Not only that, you could also hear the subtle breathy overtones apparent when the strings are absolutely brand-new. There's a lovely 'softness' despite the necessary tonal brilliance and attack. Not everyone looks for such characteristics. But for me it's the hallmark of

quality hi-fi.

Selling for £1749, the Euphya Alliance 270 is not exactly inexpensive. And perhaps at first glance it's not good perceived value. If you compare it to something like Rotel's RA-02 (which offers a similar specification), you might well ask if the extra cost is justified. Certainly, in terms of component count, there's a lot more inside the Euphya - a massive amount more. The question is whether or not it all adds up to a better sound.

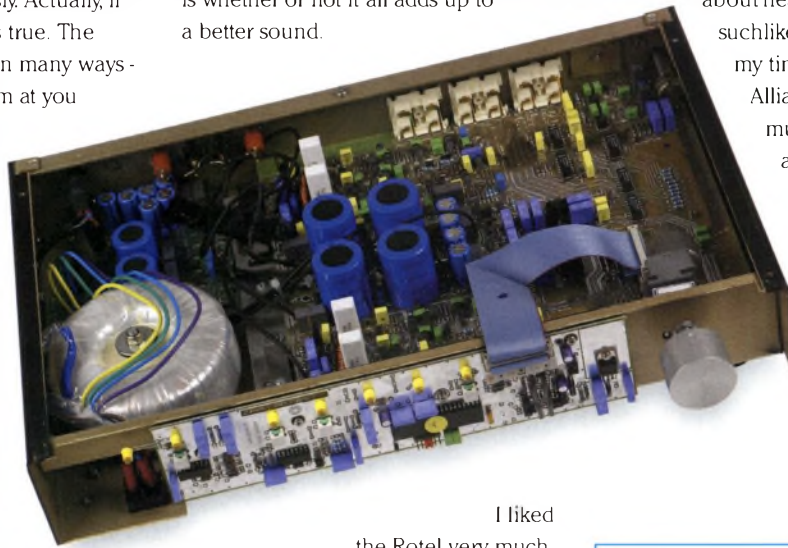

I liked the Rotel very much indeed. But nonetheless feel that an amplifier like the Euphya represents the next stage up. Although I was unable to make a direct comparison to the EAR-869 (I got a call just before Christmas from EAR asking for it back), I'd say the Euphya offers a sonic performance that approaches the more expensive valve design - with the added benefits of greater power, remote control, and built-in phono stage. So looked at like that, the Euphya actually offers good value.

The EAR-869, by dint of its limited power output, is unavoidably something of a niche product - outstanding given the right circumstances, but not a universal choice able to successfully slot into a wide range of systems playing a broad range of music. In this context, the Euphya Alliance 270 is a much more versatile beast; one able to satisfy the demands of a wider range of speakers and music types because of its extra

power output and excellent stability.

It's quite stylish-looking too - though some may feel the plastic top and front creates a less expensive impression than a nice brushed aluminum fascia. And those brass fixing bolts - they definitely need sorting out! After all, we expect a bit of style from the French... The Euphya is delightfully user-friendly and easy and simple to operate; you don't have to fuss over it, or worry about heat dissipation and suchlike. I really enjoyed my time with the Euphya Alliance 270, finding it musically rewarding and agreeable to live with. Worth the asking price?

I think that's a yes, then. ►+

#### TECHNICAL SPECIFICATIONS

Type:	Remote Control Integrated
Inputs:	
Line	4x Line
Phono	1x MM
Line Outputs:	1x Tape
	2x Pre-out (optional)
Speaker Outputs:	1pr 4mm Sockets/Ch
Power Output:	40 Watts/Ch
Dimensions(WxHxD):	430x100x310mm
Weight:	6.5 Kg
Price:	£1749

#### UK Distributor:

Integrated Engineering Solutions  
Tel. (44)(0)23 8090 5020  
E-mail. Info@highendaudio.co.uk

#### International Distributor:

Acoustic Precision

# Anatek A50 Integrated Amplifier

Source

Aux1  
DAB  
CD  
DVD  
AV

Monitor

Source  
Recorder

Volume

Class A Stereo

# Anatek Audio A50 Integrated Amp

by Paul Messenger

I don't suppose many people reading this will have heard of Anatek Audio. I hadn't myself, until this little amplifier turned up, entirely unannounced, unexpected - and packed in an Arcam carton! It turned out that my friend Martyn Hook had sent it down for me to try, 'cos he thought I'd like it - and he was right!

Martyn is manager of the Brighton branch of Sevenoaks Hi-Fi, a true hi-fi enthusiast of vast experience, and with a personal taste for hi-fi that's much more exotic than Sevenoaks' normal stock in trade. The Anatek amp - neat name, I reckon - actually comes from the Brighton area, because that's where designer Clive Read lives, and Martyn has been involved, giving advice, feedback, encouragement, and is hoping to make a few local sales too through the Sevenoaks shop.

The amp is actually manufactured by Keith Audio Ltd, based in Ditchling, just to the north of Brighton, a small scale OEM electronics supplier that has been making bespoke electronics such as language lab equipment for over twenty years. Marketing and sales, however, are operating out of Luton, which is much better placed to cover the country.

Although the £1,000 A50 represents his first foray into the hi-fi scene, Clive has had plenty of experience, having been involved in amplifier and other analogue electronic design projects on the industrial side for a great many years. But having come up with some

entirely original - indeed patentable - ideas for circuit topologies, he decided to take the plunge. This A50 integrated amplifier is just the first fruit: a radical phono stage has also recently been prototyped, and is allegedly giving very promising results.

I couldn't describe this as the most attractive amplifier I've encountered - to be honest it's a bit bland and boring to look at, and very black too, the word 'anonymous' tending to spring to mind. And I searched in vain for a remote handset when I was extracting it from the carton. However, the style police can take heart from the news that a smarter-looking remote control version is already in the planning stage. The A50 might be all about performance, but at least Anatek is aware of its limitations.

What we have here then is not the most exciting looking piece of hi-fi on the planet, nor one that offers anything in the way of ergonomic sophistication either. It comes from a brand new start-up company that has no track record of any kind, and costs a not inconsiderable £1,000, so in truth if it hadn't sounded so promising at first listen I'd have simply put it straight back into the carton and that would have been the end of the matter.

A row of four knobs plus three LEDs decorate a chunky black brushed alloy fascia that's a little over-size and rather sharp-cornered. The volume control is larger than the other three, which are used to select

between the six line inputs, to monitor a seventh 'recorder' line in, and to switch the unit on. The blue LED confirms that the unit is on, and the red ones advise if protection is actuated on either channel.

There's no sign of either a mono/stereo switch, or indeed a balance control here, and I regard their omission as regrettable. I reckon there ought to be a pair of 'pre-out' sockets too, for those who might want to experiment with bi-amping or subwoofers. But as a performance-led package, no frills are permitted to interfere with its attempts to deliver the very best possible sound quality.

Part of the front panel writing mentions: "Class A Sonics", referring to the patented output configuration which apparently combines the advantages of a relatively cool-running Class A/B output stage alongside the extra sonic purity and complete freedom from crossover distortion of a proper Class A design. According to Clive, every 1°C rise in temperature halves the life of a semiconductor.

The circuitry is direct coupled, to avoid electrolytic capacitors in the audio path, and is also designed to have low DC drift to minimise thermal memory effects - the momentary distortions caused by loud transients. A single input coupling capacitor helps ensure fast bass. To maximise sonic purity, the A50 uses radio frequency (RF) filters on the signal inputs, outputs and mains input, ►

▶ while all amplifying stages have minimal gain at RF

Designed to preserve audio quality, the classy (and effective!) protection system avoids the normal current limiting approach. Instead, to ensure the amp can withstand a permanent short circuit, it uses a unique non-invasive electronic switching system that shuts down the output stage electronically when the output current reaches 12 amps.

The A50 might not look all that exciting, but the proof of any amplification lies solely in the listening. It was time to connect up the A50 and give it a whirl. It certainly gets warm to the touch, but gets nowhere near as hot as a true class A design would.

The good news is that this unprepossessing looking little amplifier sounds rather wonderful and altogether special. Indeed, if it hadn't, there would have

Indeed, if anything I should feel guilty about reviewing something that readers are likely to have considerable difficulty finding.

Part of the problem lies in the way this industry operates, and in particular



how it deals with 'start up' companies. Frankly, we reviewers have far too much power, because many retailers rely heavily on our reviews to 'sell' products -



do we take flak for it! Ed.)

The strength of this little amp lies in a level of transparency and an ability to build dynamic tension that's rare at any price, and rarer still amongst solid state amplifiers. Which is not to suggest that the A50 sounds like a valve amp; rather it shows a slight similarity in character through its sheer

directness, and the distinct impression that there's very little processing blocking the path between source and speakers.

This amplifier has an immediacy that's very seductive and beguiling, though in spectral balance terms it certainly sounds more like a solid state than a thermionic design. Where valve amps seem to

focus the attention on the upper midband and presence zone, bringing an immediacy to voices that simply doesn't seem to be part of the normal solid state repertoire. The Anatek seems to capture something of the same, but does so further down the band, more in the upper bass and lower midband, bringing a combination of drive, tension and richness to proceedings which is very unusual.

The real reason is this ▶

been little point in reviewing it at all. It's not as though the shelves of your local hi-fi shop are likely to be groaning under the weight of unsold Anateks.

especially new products from new brands with no track record. The bottom line is the chicken'n'egg scenario where the dealer won't stock a product unless it has had a favourable review, but magazines (understandably) tend to be reluctant to review a product with minimalist availability. (Not this one - and boy

► amplifier's remarkable freedom from time-smear and textural thickening through the broad bass and mid-band. It's the sort of amplifier that really gets your feet tapping – as I noticed when my partner spontaneously broke into a little dance the other day! Timing is simply impeccable, and that fact alone sets this amp well apart from the pack.

The down side (there always seems to be a down side!) is that the sound does lack some top end 'sparkle' and 'air'. Exactly how important this is might be partly a matter of personal taste, and partly a function of the character of the rest of the system. I wouldn't therefore suggest partnering it with some of the duller speaker models around, but it seemed a perfectly good match with some very serious stuff like the JBL K2s and B&W Nautilus 800s that I had around at the time. Yes, it does smooth off a little of the fine detail, and suppress vocal consonants a tad, but not sufficiently so as to be irritating to these ears.

One of my long term favourite discs is the Grateful Dead's *Reckoning* – arguably the original 'unplugged' album, and a substantially acoustic live recording that always shows up system inadequacies. This sounded particularly effective via the Anatek, which delivered the music with great authority and an impressive propulsive drive, especially through the bass region. Yet it also showed

great dynamic delicacy and expressiveness, accurately reproducing the subtle tonal colours, convincingly portraying the audience's applause, and communicating the vocals with real intimacy.

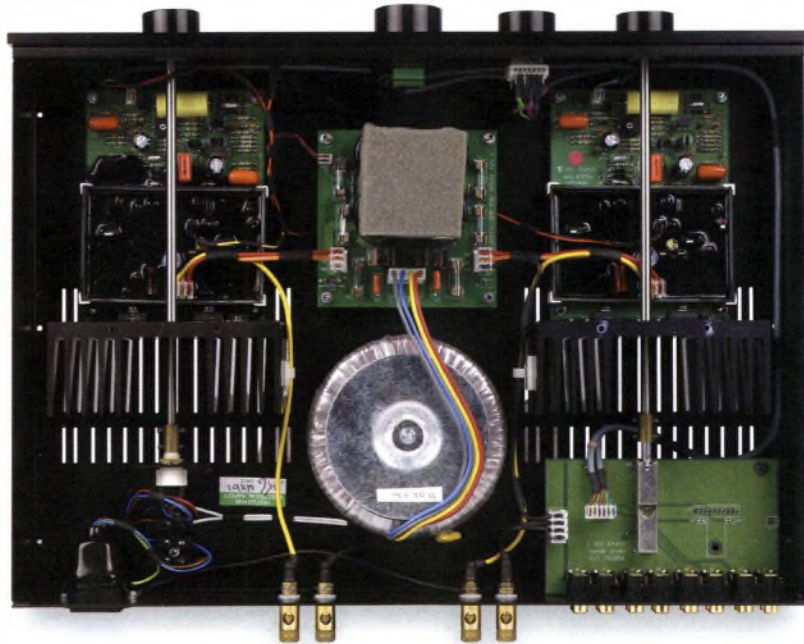

I deliberately conducted some high level tests, and the A50 again acquitted itself particularly well. The sound hung together with considerably integrity and impressive loudness, right up until the point where the protection came in, on cue. I turned it off, left it for 30 seconds or so, then powered it up again, and it was as though nothing had happened.

Superficially at least there would seem to be plenty of reasons to pass by this amplifier and leave it sitting on the shelf. You've never heard of it, it doesn't look all that pretty, the feature list is parsimonious and it's not exactly cheap either. But spare half an hour of your valuable time, to give it a listen, and that just might turn out to be one of your more significant decisions.

It's unquestionably the most interesting new solid state amp I've heard since the Lavardin some five years ago, and at a relatively affordable £1,000, this Anatek looks like a real audiophile's bargain. But don't take my word for it. Hunt it down and listen for yourself – I'd be very surprised if you're disappointed. As for the review sample, that's staying here as a reference point – and will, I suspect, soon form the heart of my partner's system in the next room! ➤+

#### TECHNICAL SPECIFICATIONS

Line inputs:	6 + recorder
Line outputs:	recorder
Power outputs:	loudspeakers L & R
Output power:	50 watts into 8 ohms 70 watts into 4 ohms
Output current:	12 amps maximum
Quiescent power:	15 watts per channel
Frequency response (-3dB):	1.5Hz and 100kHz
Protection:	short circuit-proof thermal
Dimensions (WxHxD):	430 x 80 x 300 mm
Weight:	8.0 Kg
Price:	£1000

**Manufacturer:**  
Anatek Audio  
76A Summer Street  
Slip End, Luton LU1 4BN  
Tel. (44)(0)7817 681402  
Net. [www.anatek-audio.co.uk](http://www.anatek-audio.co.uk)

At Sound & Vision - the Bristol Show 2003. Room 416

"..Neat's  
ULTIMATUM  
deserves  
recognition  
as amongst  
the very best  
there is.."

Hi Fi + April 2002

*Ultimum*

neat acoustics + 44 1833 631021

music to the *n*<sup>TH</sup> degree

[www.neat.co.uk](http://www.neat.co.uk)

Hovland

*The Music Makers*

PRODUCT  
of the  
YEAR



Hovland HP 100

PRODUCT  
of the  
YEAR



Hovland Sapphire

Metropolis Music  
6 London Road, Tunbridge Wells,  
Kent TN2 1DQ  
Tel: 01892 539245  
Fax: 01892 616383  
[www.Metropolis-music.co.uk](http://www.Metropolis-music.co.uk)



If you want only one.....

*Final*

www.finallab.com

mail@finallab.com

FINAL LABORATORY tel / fax : +81 (0)564 63 3279 ● JAPAN

hi-fi+  
PRODUCT  
of the  
YEAR

hi-fi+  
PRODUCT  
of the  
YEAR

Great  
products,  
*just rewards...*

Distributed by:

WOLLATON  
A-U-D-I-O

▲ Klyne Model 7  
Line and  
Phono stage

Telephone: 0115 852 3858

e.mail: audio@wollaton.demon.co.uk

▲ Monarchy Audio SM70  
Power Amp

Monarchy Amps, Transports and DIPs • Klyne Pre-Amplifiers • Aliante Loudspeakers  
Audio Valve Amplifiers • Solidsteel Hi-Fi Furniture  
Kochel Horn Loudspeakers • Wavac Amplifiers • XLO Cables & Interconnects



Phono

CD

Tuner

Line1

Line2

Tape

Mute

# Rega Mira 3 Integrated Amplifier

by Paul Messenger

I've long been a Rega fan. This Southend based company started out way back in the 1970s, initially just making turntables, but gradually adding other bits of the hi-fi chain as the years passed, so that it now does the complete system from start to finish.

The company is very much a hi-fi specialist, always following its own path with creativity and individuality, and taking little note of the competition. Sometimes it sets a trend that others subsequently follow; sometimes it remains out on its own limb. Whichever, the company's products have always been a little further upmarket than the budget sector, and well below the 'high end', but invariably provide fine value for money.

That would seem a pretty fair description of this brand new Mira 3, which is a simple-feature integrated amplifier priced at £548. As the name implies, it's the third variation on the Mira theme, though it looks almost identical to its immediate predecessor, called just Mira; that in turn replaced a very different looking amp which was also just called Mira, in 2000. The only difference between Mira '2000' and the Mira 3 lies in the volume control, the former using a motorised potentiometer (variable resistor or rheostat), while the new model uses a system based on a Wolfson chip (see Boxout).

When the original Mira with its tough alloy 'clamshell' casework appeared, dealers allegedly complained that: "only Rega could

produce an amp in a cast metal case that looked like plastic". When the second generation Mira first appeared the tune had changed to: "only Rega could produce an amp in a plastic case that looks like metal"! In fact most of the Mira 3 casework is cast alloy, with a finned heatsink, cunningly contrived as part of the base, though the front panel is indeed a plastic

moulding, cunningly painted to look like metal (like the bumpers on today's new cars).

Whether you opt for the black or the metallic silver finish, there's no denying that this is a good looking amp. The fascia is divided into three unequal sections, the much larger central one carrying all the important bits, and featuring a scalloped top edge, reflected in the top surface of the case itself. Very chic, very designer, yet also attractively understated – until you turn it on, that is.

There's just a single knob on this fascia – but what a knob! First, it's a dual-function affair, not only adjusting the volume but also selecting between

five of the inputs. Depressing the knob actuates a switch that changes between the two modes, subsequently sensibly defaulting to volume mode if left for a few seconds. Furthermore, around the edge of this knob is an array of 20 red LEDs, corresponding to a total volume range of 80dB, which light up progressively at calibrated 4dB intervals as the volume is raised. Play it loud and you're looking at a ring of fire!

One might perhaps niggle that the knob's shaft-encoding microprocessor control lacks the positive 'feel' of a regular potentiometer, but that of course is entirely academic if you're using the remote control. There are also three buttons alongside the

master control knob, each with a red LED to show if it is engaged: one switches the whole thing on; another provides muting; the third selects record monitoring.

Add the archaically labelled 'tape' input to the other five and there are six inputs all told here – five at line level plus an equalised phono (vinyl) input for high output (moving magnet) cartridges. There are also two record output pairs, plus pre-out and power-in pairs, the latter requiring a very minor internal dealer mod. Another interesting and unusual dealer-adjustable feature, which arguably improves the overall flexibility, is the ability to set alternative input



▶ sensitivities (or pre-amp gains) to settings either side of the 'default' setting supplied.

Sadly, there's no sign of either a mono/stereo switch, or indeed a balance control, and I regard the omission of both



as rather regrettable. Furthermore, I was also surprised not to find a separate earth terminal for the vinyl input. Rega wires its turntables arms and cartridges in such a way as to render this unnecessary, but many other vinyl spinners still carry a separate earth, including the Linn I used (alongside a Rega cartridge) to check out the phono stage. I didn't encounter any hum problems I must admit, though I'd have liked to have had the option to connect an earth.

Mira 3 is fully remote controllable, although the handset itself is actually an optional extra. This makes some sense, as someone purchasing, say, a complete Rega system would have no need to receive a handset with each component, since only one is needed to cover amplifier, CD player and tuner. Rega therefore makes its Solar system handset optional, but charges only a very modest £25, so you're not going to feel ripped off. Especially as it's also one of the nicest handsets around, ergonomically speaking.

Since I reviewed literally dozens of TV sets during the 1990s, I've had lots of experience of all manner of remote handsets. As a result I have developed a rather poor opinion of those that come from the specialist hi-fi sector, few of which show adequate thought and attention to detail.

Rega's Solar handset is one of the exceptions that prove the rule

– while it's not perfect, it gets a lot closer than most. It's nice and light, and slim enough to operate one-handed too, with some sensible button differentiation by both colour and shape – all features that other brands would do well to follow. My only criticism is that the



button layout prioritises the CD player and tuner over the amplifier, and that finding and reading the latter's input switching could, with advantage, have been made a lot easier. That said, I can't think of another example that does it better.

Out of interest, and in order to provide a worthwhile context for the

Mira 3, I arranged for Rega to lend me an example of the earlier Y2K version of the Mira too. Just as well, as it turned out, because it highlighted and drew attention to a problem with the 3 that would otherwise have probably gone undetected.

I started off by listening to the Mira 3, which sounded decent enough but didn't get me particularly excited – something which caused no great surprise, since my normal amplification is considerably more costly. However, when I connected up the earlier Mira I was rather nonplussed to find it sounded rather better, in my opinion, than the new model. Although the Mk 3 seemed to have a slightly bigger sound with a greater sense of scale, it was also less dynamic and interesting, with rather more obvious time-smear in evidence.

Now it's true that I was using vastly more costly sources and speakers either side of the amps, making for rather unlikely and unrepresentative partnerships, that just highlights one of the difficulties in reviewing individual components in isolation. I always feel happier using top quality

ancillaries, because they make differences much more obvious, and (most importantly) help me avoid making mistakes.

One can certainly make a case for using more 'representative' systems, but it's much harder to come up with reliable 'absolute' judgements. That said, I swapped the £20k JBL K2s for a pair of £200 Rega Aras, put a Jupiter on the front of the system, and repeated the listening. It was harder to hear the differences, but they were still audible, and I still wasn't happy. ▶

## The Volume Chip

For decades, volume controls have been implemented by a potentiometer – simple mechanical devices, in which a contact point wipes around a resistor track – and the Mira 3's predecessor did indeed use such a 'pot', albeit motorised to enable remote control. However, some form of solid state alternative is attractive, on both cost, convenience and long term reliability grounds, so for this new Mira 3 Rega has replaced the pot with a 'resistor matrix' approach from Scottish chipmaker Wolfson. The WM8816 chip comprises a selection of literally hundreds of resistors, available via

an analogue switched network that's controlled via a microprocessor driven either by a digital encoding front panel knob, or the remote handset buttons.

The implementation provides 80 steps of 1dB each, and left and right channels are matched within 0.2dB. The resistive networks are placed in the feedback and input circuits of the pre-amp's line amplifier, to optimise the gain for best signal-to-noise ratio. Perhaps most significantly, combinations of resistors are selected in such a way as to ensure a constant input impedance at all volume settings, so source components always see the same load at different volume settings, avoiding possible changes in sound quality.

I telephoned Rega, and Scott immediately brought over a new sample. We listened to both, realised the original one did have a problem, and he took it back for checking. It turned out that the quiescent current had been set way too low, a production teething problem that probably arose because it – indeed both examples – came from the very first production batch.

a little 'bigger' than its predecessor. But I couldn't put hand on heart and categorically state that it represented an overall improvement, as it still seemed slightly less 'au point' in timing coherence and dynamic expression.

To be honest, in my judgement there's little to choose between the two, the Mira 3 sounding larger and more relaxed, while its predecessor sounds

a little smaller but livelier.

I couldn't call the Mira 3 the last word in tension or transparency; it must be said, but it shows a finely judged balance, with accurate tonality and a good dynamic range.

The bass goes impressively deep, with

good power and propulsion, and the treble is open, sweet and delicate too. It's the midband that slightly lets the side down here, the mild time-smear sacrificing some dynamic expression and making voices sound just a tad 'shut in'.

If transient attack sometimes seems a little 'soft', the tonality proved very

satisfying, especially with acoustic material. Although this amp knows how to rock'n'roll when called upon to do so, its real forte seems to lie with the sort of subtle and delicate material that fits well with its innate subtlety and delicacy.

Though nearly all my listening was done via the various line inputs, I did take time to check out the vinyl input, using one of Rega's fine Exact cartridges. Results were very much as expected, indicating that the vinyl stage is well up to speed with the rest of the amplifier.

Although the Mira 3 isn't the last word in sound quality, it's not the last word in price either, and on balance seems to represent very good value at £573 (inc remote). Chuck in the excellent ergonomics, sexy styling and sensibly chosen feature set and it looks like being one of the amplifiers to beat in the less expensive sector of the hi-fi separates scene. ➤

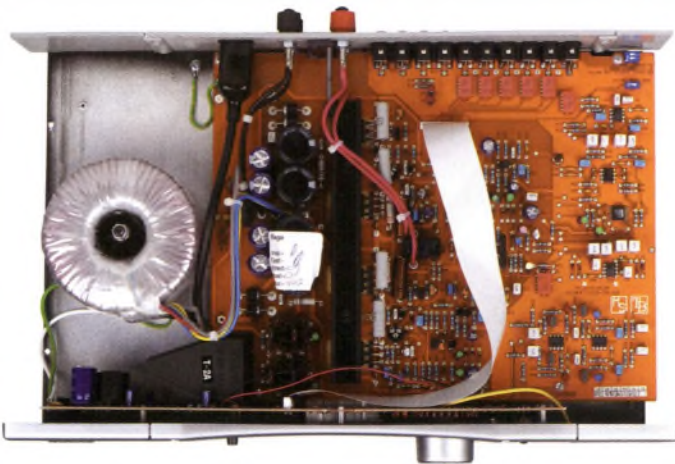

That problem sorted I was able to get on with some proper listening, going back to my costly reference speakers though still making good use of Rega's excellent Jupiter CD player. There was no doubt that the two generations of Miras were now a lot closer to each other in sound quality, and once again I noticed that the Mira 3 sounds just

### TECHNICAL SPECIFICATIONS

Type:	Full facilities integrated
Inputs:	MM phono + 5 line
Input sensitivity (line):	220mV/10kOhm
Input sensitivity (MM phono):	2.1mV/47kOhm/100pF
Power amp input sensitivity:	818mV/24kOhm
Tape output:	215mV/560 Ohms
Pre-amp output:	818mV/470 Ohms
Power output:	61W both ch 8 Ohms
Power output:	91W both ch 4 Ohms
Dimensions (WxHxD):	430x85x270mm
Weight:	6.9 Kg
Price:	£548

#### Manufacturer:

Rega Research Ltd.  
119 Park Street  
Westcliffe on Sea  
Essex SS0 7PD.  
Tel. (44)(0)1702 333071  
Net. www.rega.co.uk



# Neat Acoustics Ultimatum MFS Loudspeakers

by Jason Hector

When it comes to speakers I'm a fussy listener. Far too many transducers simply do not cut the mustard with me. I listen and frankly cannot see what the fuss is about. Loads of speakers lack any sort of musicality and if they manage to get the musical message across, some other part of their performance is severely lacking. It was a good day when I heard Shahinian Arcs for the first time and I just had to have a pair to replace the Linn Kans, my speakers at the time. At last here was a speaker that was as fast and musically engaging as the Kans, that could integrate the musical themes into a cohesive whole, was not too coloured and (horror of horrors) could do real bass. It took me a few years but I finally bought a pair and they gave me great service. When I came to replace them there was only one option; Shahinian Obelisks. These followed the Arcs into my listening room and were reviewed in issue 16. The Obelisks offer a similar mix of strengths to the Arcs, only more so and to be honest I thought I would be hard pressed to ever find another speaker that I could live with near the Arcs' price. Well, enter the Neat Ultimatum MFS, one of the very few speaker solutions at this price point that can get close to the Shahinians for sheer musical enjoyment.

It's this musical enjoyment criterion

that is all-important. There are speakers out there at up to twice the price that beat the Obelisks in one or maybe two areas but very few get close when it comes to delivering a musical thrill into a domestic setting. Let me explain: the Obelisks always manage to deliver the emotion in a piece of music. When a band is playing, the interplay between the performers and the way they play the rhythms off of each other is key to the delivery of emotion. Take something

seemingly simple like a vocalist accompanied by a guitar (Roddy Frame – *Surf* is a good example). The placement (in time) of the accompanying notes relative to the vocal performance is more critical to me than the imaging or the last ounce of detail or tonality. The Neat MFS, like the Shahinians, manages to place the two elements almost perfectly in time. This results in the performance of a song rather than a man playing a guitar and singing.

Some of the success of the MFS is due to a design process that is unique to Neat speakers; the speakers are never measured during the design phase. Talking to Bob Surgeoner (MD at Neat) the design process is iterative and any changes are incorporated only if they sound better. Based on this outing Bob's and fellow designer Derek Gilligan's ears are to be trusted. The MFS is the baby of Neat's new Ultimatum

series, a range that has been 8 years in development. PM was suitably impressed when he reviewed the top of the range MF9 in Issue 16. The MFS is the baby in the range and tries to bring Ultimatum performance to a lower price point and smaller listening environments.

The MFS is a large (for the modern market) and at first glance expensive stand mounted speaker. It is heavy and we might expect that weight to result in a strong and non-intrusive cabinet for

the speakers. In the MFS' case the carcass of the speaker is made from birch plywood and consists of discrete internal chambers with good bracing. It is essentially a two-way speaker but this description is stretched by the inclusion on the top surface of two "area-drive" ribbon super-tweeters similar to the main tweeters in other Neat speakers. The super-tweeters, like the main drivers, are mounted into a baffle which is a 45mm thick MDF, birch plywood and polyethylene

sandwich construction so that the drive units have a rigid but non-resonant foundation to work off. The two baffles are separate from each other and decoupled from the main speaker structure by a polyethylene membrane. The super tweeters do not add a "way" to the speaker: instead they augment the treble available from the main front mounted tweeter making its life a little easier. The main tweeter is a serious



▶ device; an inverted titanium oxide coated titanium dome. It is mounted into a large circular indent in the baffle and is surrounded by some foam material, I guess to control dispersion of the high frequencies. Neat modify the tweeter for their Ultimatum range.

Below the tweeter sits the main driver, a reworked Neat 168mm bass mid driver. This driver uses a treated paper cone and soft rubber surround. It also features a machined metal phase plug at the centre which should help with heat dissipation and one thing I can confirm is that these speakers will handle bucket loads of clean power. What is hidden from observation is that this unit is not alone in providing the bass frequencies. Inside the cabinet there is a second 168mm driver which acts to isobarically load the front device. So, to reiterate the driver count, we have two ribbon super tweeters, one top drawer inverted dome tweeter and two purpose designed bass mid drivers, one isobarically loading the other. Suddenly they don't look half as expensive! The whole system is loaded by a port that is found round the back of the speaker. It's a two inch, heavily flared construction, and was undetectable in action, except through the amount of bass energising the room from these compact speakers.

So where to start with the sound? Perhaps its best to start where I found these speakers at their weakest and get that out of the way - the bass. Its not that the speakers have poor bass: it's just that in my listening environment and compared to the rest of the frequency

range the bass is the weakest link. Onto the players went various Dreadzone and Merz discs. These albums feature and propel the music along with copious amounts of deep, synthesized bass. First impression is of a satisfying powerful sound across the frequency band. The bass from the MFS is deep, but maybe it is a little too deep as the upper bass down to the mid-bass can be a little one note at times. There seemed to be

a suck-out in the output in this region as well, and both of these bass effects may be due to extending the output down so far in frequency. The very deepest bass was more impressive, with plenty of authority, but it loses some texture compared to my reference Obelisks. The Obelisks are class leaders in this regard and this is a mild effect in the MFS, which only became obvious in direct comparison. It's also significantly influenced by toe-in (I preferred about 20 degrees of inward slant) which suggests that this is at least partly a room and speaker interaction.

Other than this toeing in, I found the speakers were very easy-going with respect to position and worked well just nine inches from the solid rear wall. With the Merz and Dreadzone albums the port is obviously passing large amounts of air as the drive units fly in and out on the bass heavy material. With a lesser design this can often mean the speaker sounds slow, with notes running into each other, but the bass from the MFS is articulate, stopping and starting quickly with little overhang. Providing the rest of the system is up to the task the MFSs will remain in control. The rest of the speaker's sound is completely unaffected by these seismic events in the low frequencies. The vocals in particular stay well focused and

detailed. The nuances of the voices clear to hear over and timed with the rest of the music. The less than stellar Dreadzone and other recordings were surprisingly well treated by the MFSs, and considering the resolving power on offer, the speakers did not work miracles but they did not rip the music to shreds through over analysis either.

The crossover is a simple affair kept to as few elements as possible. All of the



components are high quality items with air cored inductors and Neats newly developed

capacitors creating first order filter slopes. The speaker also makes use of mechanical frequency roll off as well as the electronic filter which Neat, like Epos, claim gives a more natural result. The natural organic sound is apparent with any acoustic piece like Dolly Vardens' *Forgiven Now* or the other Diverse Records vinyl reissues featuring Alison Krauss. The various instruments are presented in all of their tonal glory with harmonics intact and again the shape of the notes adds yet more realism and creates a believable, convincing sound. With this sort of quality recording vocals can be truly haunting, an in-room experience which holds you spell- ▶



► bound for track after track. What really strikes you on listening to these speakers all day is their low distortion which leads to zero fatigue from an extended and powerful treble response. In the treble and upper-mid these speakers really are outstanding. They have an ease and clarity usually only found at much higher prices. Cymbals and snare drums and the energy they contain are particularly well handled. This really is one of the best results I have heard in my room.

Speaker connection is via some hefty WBT sockets and the speakers are bi-ampable (Neats preferred configuration). At the London show last September the benefits of the bi-amping were comprehensively demonstrated with two Dynavector HX1.2 amplifiers. Remember folks, bi-amping works, bi-wiring is a pain. Neat would be happy to make a single wired version if requested and speakers suitable for active operation are also available on request.

During the review period I was driving the Neats with my usual Naim pre-amp and Dynavector power amplifier. Sources were the Dynavector TeKaitora and Naim Aro shod LP12 and the Micromega Duo CD player. The MFS thrives on fast power and the inclusion of the Dynavector L100 pre-amp for an evening opened this system up even more. The L100's speed and clarity was welcome and further revealed a speaker that has super fast rise-times but that also allows notes to decay naturally as well. Take Dexy's Midnight Runners' *Tbo-Rye Ay* and the vigorous instrumentation so beloved by Kevin Rowland. Blasts of brass rip into the room with exactly the right harshness and harmonic power, string tone is spot on. The speakers showed very low compression and were

linear with loudness so they were still interesting to listen to at low volumes. They also get the subtlety of tonal changes right when driven more forcefully, whether it be a Johnny Cash vocal, a Dexy's instrumental or an Orange Can guitar riff. But best of all they are fun speakers to listen to, always connecting you to and drawing you into the music by successfully integrating the musical strands. It was hard to turn this system off.

Imaging is (after my earlier dismissal) good and stable in space with vocals often forward from the speakers while the rest of the image extends behind. Whether it is the effect of the upward firing super-tweeter or not the MFSs filled the room with ease and were still enjoyable off axis, making the possibility of sociable listening very real.

The MFS speakers were supplied with Neats own purpose designed stands. These heavy-weight affairs of slate and steel were the ideal solid support for the speaker and a great aesthetic match. The overall fit and finish standard of these speakers and their stands is high indeed. The stands consist of a black slate base which accepts the good size spikes, four large silver grey tubular uprights which were sand filled in the review pair and a multi-layer top. Neat recommend that the speaker is secured to the stand using blobs of blu-tack, I find this solution out of keeping with the price of the speaker and would have preferred to see a more repeatable and solid connection scheme, but blu-tack does work. The whole assembly is very heavy and stable and looks very purposeful.

The speakers are available finished in a variety of veneers and as an extra cost option can be piano lacquered to a deep, lustrous finish. In black or lacquered veneer this finish is worth every penny lending the speaker real class.

The Neat MFS speaker shows that you can have your cake and eat it, at a price. The speaker is capable of a very musical, rhythmic and emotional result, achieving this with a detailed, wide bandwidth and very low distortion character no matter what the material played on them. Hell, they even image well. What more could you ask? Get a listen as soon as possible, but ideally at home where you can check out the bass. 

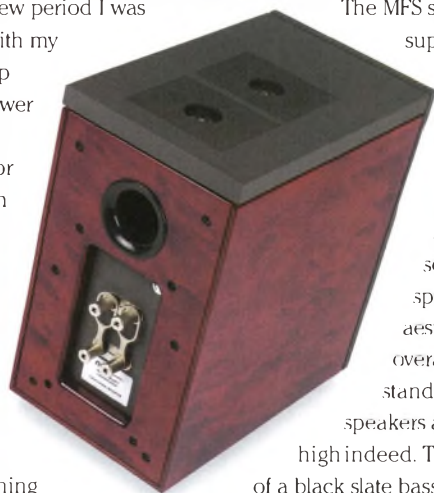

#### TECHNICAL SPECIFICATIONS

Type:	Two-way reflex loaded
Drivers:	2x 168mm paper cone bass/mid 1x 25mm titanium oxide inverted dome 2x Area drive ribbon supertweeters
Enclosure type:	Multi chamber, multi driver array, incorporating iso-baric internal cavity plus upward firing super-tweeters.
Sensitivity:	88db/1 watt
Recommended amplifier power:	25 - 200watts.
Impedance:	6 Ohms average 4 Ohms minimum
Dimensions (WxHxD):	22x 38x37cm
Weight:	15kg each.
Finish:	To order
Price:	MFS: from £2995 Stands: £495

#### Manufacturer:

Neat Acoustics Ltd  
Tel. (44)(0)1833 631021  
Net. [www.neat.co.uk](http://www.neat.co.uk)



## Reference Audio

An honest high quality range of loudspeakers available in any finish.

- True Hard Wired Crossover
- Full Frequency Spectrum
- High Quality WBT Connectors

### The Loudspeaker Manufacturing Company Ltd.

181 Robin Hood Lane, Chatham  
Kent. ME5 9NJ

Tel: 01474 854208

Fax: 01474 854902

[www.referenceaudio.co.uk](http://www.referenceaudio.co.uk)

*your perfect partner*

## KORATO GROUP

Hand built in Belgrade Serbia using the finest of components from around the world (hoveland, Audionote, Vanden Hul and spectra dynamics)



**KVP10/PHONO**- Valve preamp  
Two box construction with valve regulated dual mono power supplies stunning sound and value for money £1420.  
This one has been a real winner with customers so far.



**KTA 100**- Class 'A' transistor power amplifier  
100w/8 ohm 200w/4 ohm. 23Kg of musical muscle.  
(You can only imagine what this would cost if it came from the U.S.A) Price £1600-yes you could even purchase three for the ultimate home cinema (dare i say that)?  
Larger 160w/8 ohms 320w/4 ohms Anniversary model available (As used at Manchester)



**RENAISSANCE MONOBLOCKS**  
Valve power amplifiers using 4x EL34 triode connected in push pull parallel class 'A' producing 45w Audionote output transformers. 380mmx310mmx170mmH 11kg each. Stunning sound and value for money £1950 pair.

Product range includes 15w valve integrated £750, 20w valve power amplifier £1080 Anniversary Phono stage & Anniversary Pre £3750 (out of this world specification including dual mono power supplies per stage)

*Audiosolutions*

See our website [www.a-audiosolutions.co.uk](http://www.a-audiosolutions.co.uk) TEL 01977 798844

DEALER ENQUIRIES WELCOME 'A' Audiosolutions UK DISTRIBUTORS OF KORATO AND OPUS3 (Continuo turntable) Also dealers for THE CARTRIDGEMAN, HADCOCK and GRAHAM SLEE PROJECTS

# Audio Reflections

## NEW PRODUCTS ON DEM

**TOM EVANS** - Groove . Vibe  
**PS AUDIO** - P300 Powerplant  
- HCA2 Power Amp  
**SME** - 10/SME4/LYRA Helikon  
**GAMUT** - D200 Power Amp  
**CHORD** - New Choral system  
**WILSON BENESCH** - New Act  
**BRYSTON** - 14B SST  
**PMC** - IB2  
**REVEL and AYRE**



NEW AVI INTEGRATED AMP



AUDIONET . ATC . AVI  
AYRE . BRYSTON . CHORD  
GAMUT . LEXICON . LYRA  
NORDOST . PRIMARE  
PS AUDIO . PMC . REL  
RED ROSE . REVEL . SME  
STAX . TOM EVANS  
WADIA . WILSON BENESCH

TEL: JOHN BLEAKLEY (LEEDS) 0113 2049458 : SIMON TRICKETT 0113 3873609

E-MAIL: [info@audioreflections.co.uk](mailto:info@audioreflections.co.uk)

FAX: 0113 2533098

# Enjoy music more

Euphya



L A M M



METRONOME  
TECHNOLOGIE



Renaissance  
Amplification



## High End Audio Roadshow

A series of demonstrations in comfortable venues throughout the UK.

Convincing musical re-performances by PLAYBACK systems featuring Lamm, Metronome Technologie, Reference Audio, Renaissance Amplification and other PLAYBACK partnership recommended components.

March 15<sup>th</sup> and 16<sup>th</sup> - Holiday Inn, Oxford

Watch this space for more UK venues.

Free admission to all music lovers. For full information please contact:

Integrated Engineering Solutions Ltd - 023 8090 5020 audio solutions - 07787 543031

Audiocraft - 01895 253340 Hazlemere Audio - 01494 865829

[www.highendaudio.co.uk](http://www.highendaudio.co.uk)

### NOW, FOR THE FIRST TIME, HEAR SOUND REPRODUCED AS IT WAS MEANT TO BE

#### VINYL IMPERATIVE

Correct alignment and support of the LP on the platter is the most important aspect of vinyl reproduction. The new *Anniversary Ringmat*, at £70, is THE pre-eminent record mat for virtually all turntables.

Further improvements can then be achieved by using:

- LP Blue *Statmat* and *Statcap*, at £45, to remove static;
- *Ringcap MkII*, at £15, to remove vibrations emanating from the centre of the record;
- *Ringmat Spacers* to provide an improved interface between platter and record, to remove resonance from your turntable and platter and to fine tune stylus rake angle/VTA.

All these, incl. the *Anniversary*, can be purchased as the *Ringmat Support System* for £210.

#### DRAMATICALLY IMPROVE YOUR CD, SACD and DVD SOUND

For digital sources, the *CDi Blue Statmat*, at £37.50, will totally transform playback.

#### FROM ILLUSION TO REALITY WITH RINGMAT AUDIOPHILE CABLES SIMPLY, THE FINEST CABLES FOR LINKING-UP YOUR HI-FI SYSTEM

Our *Pure Signal Interconnects* from £105 per stereo pair and *Pure Power Speaker Cable* from £25 per mono metre are the finest, most affordable cables available to you.

"So dropping them straight in... immediately after the Valhallas probably wasn't the kindest thing I could have done! Surprisingly, the Ringmat leads stood up remarkably well, which speaks volumes for their musical balance, evenness and coherence. ... and that's quite a feat when you consider the extent to which the Valhallas embarrass the vast majority of even the most expensive competition."

Roy Gregory HI-FI+ Issue 19 Sept-Oct 2002

#### PLUS, THE BEST ISOLATION PRODUCTS AVAILABLE

Protect all your equipment, including your TV and speakers, from static, by using a *Statfoot*, from £10, underneath each one. *Ringmat Feet* and/or *Ringmat Domes*, our isolation "soft feet" approach from £17.45, must also be used if you want the best sound (and picture).

#### NEW PRODUCT LINE-UP, PRICE LIST and MONEY-BACK GUARANTEE

Call us for details or visit our Website: [www.ringmat.com](http://www.ringmat.com).

#### RINGMAT DEVELOPMENTS

PO Box 200 Brentwood Essex CM15 9FB GB

Call: 01277 200 210 Visit: [www.ringmat.com](http://www.ringmat.com) or Email: [enqhf+@ringmat.com](mailto:enqhf+@ringmat.com)

## PUTTING SOUND INTO FOCUS

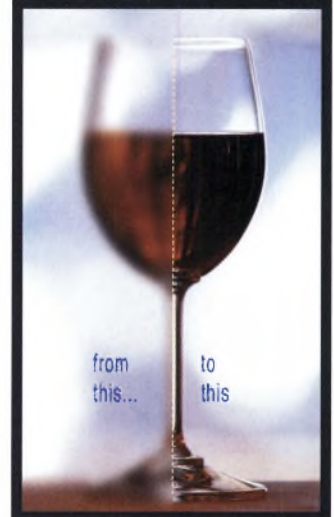

 RINGMAT



# Graham Engineering Robin Tonearm

by Roy Gregory

As analogue becomes increasingly refined and rarified the market has followed suit. Where, once, myriad different products jostled for attention, the Darwinian influence of shrinking sales has slowly but surely honed the competition into survivors (with attributes to offer) and those that have fallen by the wayside. Much of the fluff and artifice that used to provide individuality has been discarded as manufacturers have resorted to the further evolution of a few proven approaches. It's a savage and unforgiving environment, but just like nature itself, evolution has thrown up a few anomalies. When Rega launched its first RB series tonearm few of us would have predicted just how comprehensively it would decimate the budget opposition. But market pressure has seen the demise of all but Linn's Akito, clinging on by its fingernails by dint of the Regas' incompatibility with the LP12. These days, if you want a cheap arm then chances are it will be a Rega or a variation on that theme.

The problem is that the RB300 slaughtered most of the middle market competitors as well. They might have been better, but not enough to justify the difference in price. Suddenly we were left with a market populated by the Rega at the bottom and any number of expensive and exotic offerings at the top. Between £150 and £1500 was a gaping void through which the Morch trod a lonely path. Real arms started with the Ekos and rewired SME 5 and went on from there. But nature abhors a vacuum and slowly but surely, new

mid-priced challengers have appeared: the revitalised Hadcock, VPI's JMW 9.0, the Kuzma Stogi S and Clearaudio's new Unify. This is, all of a sudden, a hyper competitive market sector once again, with every month delivering new offerings to catch the prospective purchaser's eye.

Graham Engineering have built an enviable reputation for their 2 series uni-pivots. Exquisitely finished and with a suite of clever set-up aids they've become the friendly face of high-end analogue. But they've always been on the pricey side, and regular evolutions along with their associated cost increases have kept the 2.0 and its siblings firmly in the exotic/expensive category. So long standing rumours of a new, more affordable tonearm from Graham were the cause of considerable interest. Well, it's finally arrived, dubbed the Robin, and to say that it surprised me is an understatement.

For a start, the Robin isn't a uni-pivot. Open the box and inside you'll find a shiny, silver arm, its gimbal bearings enclosed in a horizontal circular housing that is deeply reminiscent of the Jelco arms of old (badged by companies such as Mission in the UK and Audioquest in the US). Look closer and you'll find an angular, cast headshell that carries further genetic markers of the arm's lineage, and sure enough, intimate inspection confirms that the whole shebang is made in Japan, although whether by Jelco I can't be sure.

Indeed, the appearance of the Robin is so different to the slim, black elegance of a 2 series arm that I'd never have guessed the source of the review sample if it wasn't written on the box. So what we actually have here is a combination of Graham design input and Japanese manufacturing. Nothing wrong with that of course – just as long as the design is sound and the

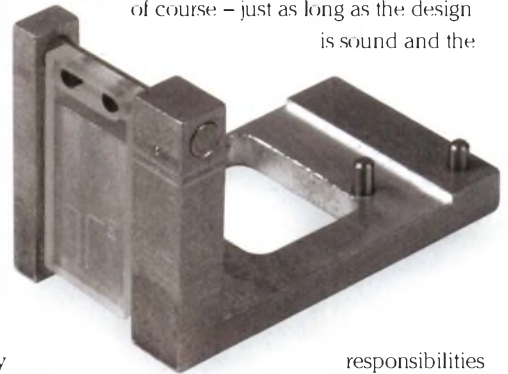

responsibilities sensibly divided. Unfortunately, in this instance I'm not sure that's the case.

Let's look at the reasoning behind that concern. Any tonearm manufacturer looking to create a mid-price model is faced with a simple truth. If they expect to cash in on the valuable upgrade market then the product's geometry and mounting hardware had better be Rega compatible so that it can be sold as a simple drop-in replacement for the ubiquitous budget champ. No problem – unless of course you manufacture an expensive top-end model too. Then you want the mid-price arm to act as a stepping stone, leading owners up into the audio firmament and, inevitably, to the door of your flagship product. So the perfect mid-price arm needs to fulfil the dual

► role of aftermarket upgrade to budget arms as well as original equipment fitted to top-flight decks (hopefully) for later upgrade. The problem that faces designer Bob Graham is that his 2 series arms aren't Rega compatible, so the Robin needs to be available with two different effective lengths, and two separate mounting arrangements.

In typical Graham fashion his solution is conceptually elegant. By providing the arm with a narrow vertical shaft, it's easy to manufacture different mounting collars to comply with the demands of a Rega or Graham cut deck. But what about the effective length? Well, that's the clever bit. By the simple expedient of offering two alternative headshells, a Rega compatible arm can be changed to Graham geometry or vice versa, cutting down

on the parts count and inventory required to meet both requirements.

Indeed, headshell and mounting collar aside the two arms will be identical: Simplicity itself, especially from a manufacturing and marketing point of view. Unfortunately, there's no such thing as a free lunch, and whilst the mounting collar is essentially no different from those employed by most other arms (apart from the nicely executed sprung loaded studs that stop the arm plummeting to the bottom of its travel each time you loosen the set screw to adjust VTA) the detachable headshell was abandoned long ago by serious designers. To make matters worse this is a simple one-pin screw in job, standard fitting on 1970's tonearms. It doesn't even use a fancy collar and allen bolt arrangement like Linn's Basik LVX. At least Fidelity Research added an extra pin to clearly audible effect. Indeed, the last serious offering that used this system was the Grado tonearm, back in the mid-eighties, and it was an



anachronism then.

Other blasts from the past include the plastic dial on the front of the counterweight (which could have been heavier) used to set tracking force, and the nasty, detachable arm cable with its standard, JLS type 5-pin din connector. The mounting and set-up instructions are confined to a single type-written sheet devoid of any technical specifications, and while the overhang stud is simplicity itself, the CR-2 cartridge alignment gauge that arrived with the arm demands further explanation for the uninitiated. The instructions suggest that these two items are actually optional extras,

so maybe the instructions arrive along with the extra bill. Tools are confined to a single allen key, and you don't even get cartridge mounting hardware. Compare that to the ball drivers, cartridge screws, dedicated protractor and multi sheet instructions, loaded with diagrams that accompany the JMW and you begin to wonder what's up. Of course, I can appreciate the effort to keep the price as low as possible, but some things are more than just luxuries. Besides, and this is what really does the damage, the Robin is actually far from cheap. By the time it's crossed the Atlantic (as well as the Pacific and the intervening continental landmass) it arrives in the UK with a direct to the public price tag of £625. Which might not seem like much for a genuine Graham arm, but then that's not what you're getting. Besides which, that price translates to around a £1000 if it was sold through dealers so that's the qualitative yardstick against which it must be measured, and the lack of support when it comes to set-up and installation must also be considered. It's glitzy finish and

appearance is all too reminiscent of Japanese direct drive decks of the kind that got analogue a bad name, and altogether, even at £625, the package looks awfully expensive for what you're actually getting.

All of which wouldn't matter nearly so much if the Robin sounded out of this world. Unfortunately that simply isn't so. Listening to this arm served as a timely reminder as to



why Jelco arms and detachable headshells are pretty much a thing of the past. The sound of this arm, irrespective of the deck on which it was mounted (and believe me when I say that I tried to find a deck, any deck, that helped its cause) was soft, coloured and muddled. I worked at it, with turntables that varied from the Scout, through the Clearlight Recovery to the Gyrodeck, and with cables from Hovland and Nordost as well as the nasty one supplied: All to no avail. The basic character of the arm dominated, whatever I tried.

Playing the musically inviting and engaging *Empathy* (Bill Evans, Shelly Manne and Monty Budwig, Verve V6-8497 re-issued on 180g vinyl by Speakers Corner) it was astonishing how the music was robbed of its incisive life and vitality. Granted, this isn't the greatest stereo recording ever, with hard left and right separation, only Budwig's bass troubling the centre fill: But what a performance. Only, playing it back via the Robin you'd never know. I can pick apart the aberrations, from Manne's ►

► exposed and separated cymbal work to Evan's clumsy, jangly piano. The midrange is robbed of colour, having a gray, papery and hollow quality, while the bass was appallingly muffled and indistinct. Indeed, in the bass solo that graces the superb rendition of Irving Berlin's 'Washington Twist' it's actually hard to follow the path of the melody, so blurred are the edges of the notes, so indistinct their individual pitch. But it's the overall effect that's the real problem. Dynavector's DV-507 arm uses a detachable headshell in a complex and unlikely design that dates from the late 70's. It too lacks the separation and definition that we take for granted with modern arms. But, and it's a huge but, it gets the individual elements of the music in the right place and in proportion to each other. It's true to the essence of the music in a way that the Robin simply isn't. Indeed, it's hard to believe just how congested and muddled this arm can make something as simple and direct as a jazz trio sound.

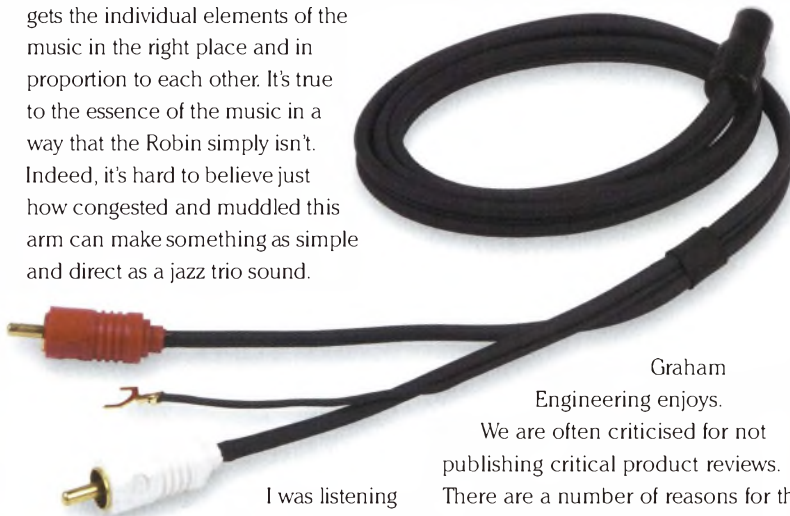

I was listening to the Cure albums featured in this issue while I was using the Robin. The superbly recorded and vitally tuneful bass lines that underpin so much of the band's music were rendered soft, dull and disjointed, devoid of weight, texture or attack, detached from proceedings and ultimately meaningless. Robert Smith sounded as if he was suffering from emphysema, so hollow, colourless and lacking in expression were his normally immediately recognisable vocals. And once again, the music was robbed of power, drama and atmosphere. The dense, often claustrophobic textures of the music collapsed in on themselves, bringing a same-y, compressed quality

to the music.

I could go on, but I'm not sure it would serve any useful purpose. Graham are to be commended for their serious attempt to make their product line more widely applicable and attainable. Such efforts are essential to the continuing health of analogue replay. However, sadly, despite all the good intentions the Robin will do nothing to further that goal. Indeed, it's likely to do completely the opposite. Whilst reviewing the arm I was shocked to find myself choosing CD over LP when it came to listening for pleasure – and that's a first! It's especially disappointing in a product that comes from a company with the deservedly fine reputation that

Graham Engineering enjoys. We are often criticised for not publishing critical product reviews. There are a number of reasons for this (mainly that we tend to concentrate our time on products that impress us and fire our imaginations) but the most important is that when a product doesn't perform for us that doesn't mean it won't perform for someone else in a different system context. This is especially true of amps and speakers. However, in this case I'm confident that the inherent flaws in the Robin disbar it from serious consideration. Add to that the power and appeal of the Graham name and it becomes important to point out to people that it bears no relationship to the products on which the company built its reputation.

The dated appearance, poor sound quality and basic nature of the overall

package simply can't begin to justify the price being asked for this product. The conceptual cleverness doesn't survive translation to the real world and the odd neat touches like the non-slip collar, whilst elegant, are insufficient to divert attention from the obvious flaws. It's hard even to know how it might be salvaged without destroying its whole *raison d'être*. I'm afraid that if you want the quality that made Graham famous, then you're still going to have to pay for it (£1420 for a Graham Basic to be precise). I get no pleasure from writing this review, but unfortunately I think it's necessary, partly because of that fame. I think the Robin is best considered an aberration, and best treated as such. I shan't be sorry to see it go. ►+

*On the point of going to press, Bob Graham contacted me with the news that the alignment tool supplied with our arm could well be wildly inaccurate. With this in mind, and worried also about sample variation, he is dispatching a second arm for me to listen to. The review stands – for now, but watch this space. RG*

#### TECHNICAL SPECIFICATIONS

Type:	Closed bearing, detachable headshell tonearm
Headshell Socket:	Single pin screw
Effective Lengths	
– Rega:	239mm
– Graham:	235mm
Effective Mass:	11g
Arm Cable:	Detachable with JLS connection
Weight:	570g
Finish:	Silver
Price:	£625

**UK Distributor:**  
Audio Reference  
Tel. (44)(0)  
Net.

**Manufacturer:**  
Graham Engineering  
Net. [www.cvis.com/~tnu2001](http://www.cvis.com/~tnu2001)



ea-2

stereo amplifier



# ECS EA-2

## Stereo Power Amplifier

by Roy Gregory

ECS: It probably doesn't ring too many bells. But take another look at the amp itself. Hardened industry watchers could be forgiven a nagging sense of familiarity, an almost *deja-vu*, because you will have seen it before, because this product originally saw the light of day under quite another banner, that of Mana Acoustics. This is indeed, the legendary Stealth amplifier. Legendary because for all the rumours and hype, we never seemed to see one; stealthy because no one ever got to hear one, so perhaps a degree of explanation is required.

The EA-2 amplifier was designed, is built, and always has been by ECS, or European Circuit Solutions, a high-tech electronic design consultancy. However, lacking specific knowledge of the hi-fi industry, they agreed to allow marketing and branding to be handled by Mana Acoustics, an arrangement that, for whatever reasons proved less than successful. Older now and wiser, ECS have decided to stand on their own two feet, hence the change of product name. Unfortunately, that doesn't alter the fact that they know precious little about the hi-fi industry, and the industry knows precious little about them. But all that seems likely to change, with new alliances forming and some pretty influential people quietly lining up behind the new product line.

At first glance, the EA-2 might not seem particularly impressive. At £4000 it's not inexpensive and it's not very big. However, look a little closer and you'll start to appreciate what sets this amp apart from the crowd. The fit and finish

of the otherwise plain casework is exceptionally good, whilst execution of the finer detail is full of neat touches and a precision, quality feel.

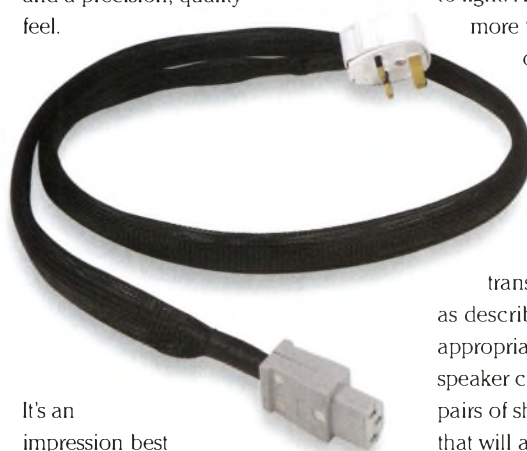

It's an impression best summed up by the small toggle switches that allow the user to switch between the amp's balanced and single-ended inputs. There are any number of micro-toggles on offer, but rather than taking the easy (and cheap) route, ECS chose beautifully presented, beefy, latched versions where you must lift the switch's lever before you can rock it over. It's a sensible arrangement, especially given the amount of groping around that the average amplifier's back-panel has to endure: Good, solid engineering sense that's redolent of the companies' instrumentation background, and all too rare in the world of hi-fi.

Don't let the svelte profile deceive you either. The EA-2 succeeds in looking a lot smaller than it actually is, due in no small part to the stealthily beveled heatsinks and front-panel. But pick it

up and you'll soon realise that its neat exterior conceals a substantial beast, weighing in at around 22kgs, stripped to fight. And the sophistication runs more than skin deep too. This is one power amp where you definitely need to read the manual.

Connections, made with the amplifier off, are straightforward: Simply select single-ended or transformer balanced inputs as described above - connect the appropriate cables. Then connect the speaker cables. Each channel offers two pairs of shrouded WBT binding posts that will accept bare-wire, spades or 4mm plugs. The company states that the inner pairs should only be used for bi-wiring (in a case where the amplifier end of the cable has four connectors) so presumably the outer ones get the signal first. Plug in the IEC lead (ECS offer their own lead as an upgrade option), press the switch on the front-panel and away you go. A small blue LED comes on to let you know the amp's alive, in case your ears aren't working. But this is definitely an amp to leave on, because once it's off, you need to leave it off for 15 (!) minutes before you even power it up again, to allow the protection circuit to reset. Wade straight in with wires flying and you'll do damage to your equilibrium as well as possibly damaging the amplifier. This should be made much more clear, ideally with a transit warning on the mains input socket and a

► modification to make the LED blink to indicate the amp's muted status.

Inside the EA-2 you'll find neatly laid out circuit boards, ECS's speciality. They make great claims for both the purity of the conductor material used and the layout and grounding arrangements, designed to produce vanishingly small noise levels. To that end, the amp also employs multiple regulated supplies, fed from a massively over-specced 1500 VA transformer, and pays particular care to thermal stability. The input stage runs on FETs, while the output stage employs two pairs of bi-polar output transistors a side. Such is the confidence of the company in their engineering that they offer a standard three-year warranty on their products.

ECS rate the EA-2 at 180 watts into 8 Ohms, and whilst they don't supply a 4 Ohm rating, the weight of the beast (mainly down to its enormous transformer) suggests that it should be pretty load tolerant. If you want to drive really difficult loads to high levels then the company also offers the visually identical EA-1 mono-block, rated at 200 Watts into 8 Ohms. I used both the Amphon Xenons reviewed in this issue, and the awkward and demanding NHT 2.9s with the EA-2, without ever feeling the need for more power or greater levels, so the EA-1s need to offer qualitative improvements too. Anecdotal evidence suggests they do, but I'm getting way, way ahead of myself here.

Which brings us to how the EA-2

sounds, and my first discovery. This amp is extremely sensitive to what it sits on. Placing it on the standard RDC damped shelf that comes with my aspect rack produced a sound so congealed and smoothed off, so devoid of edge or bite as to be soporific.



The rapid insertion (well, as rapid as the weight and external smoothness of the amplifier allowed) of four finite element Ceraballs wrought a dramatic improvement, encouraging a spate of further experimentation. In fact, none of the various cones



(or their various metals, ceramic or carbon compositions) or platforms tried was to prove nearly as effective as the Ceraballs, but boy were the differences between them obvious. Which is when it dawned on me that the Ceraballs are probably the nearest thing I've got to a glass shelf in my

Mana and Fraim free house. Is a glass-shelved table essential? Given the performance achieved with the Ceraballs I'd have to say no, but don't even think about putting this amp straight onto MDF!

Listening to the EA-2 was never less than a pleasure, but it does bring a specific quality to music, partly revealed by its consistently enjoyable presentation. It delivers a big, solid, stable and powerful sound, full of substance and presence. Admirable qualities and distressingly rare in the world of hi-fi. The problem is that it delivers them a little too consistently, which is a swings and roundabouts situation. On the one hand it does tremendous favours for less than wonderful recordings, especially those that tend to the thin, edgy or brittle: On the other, it can rob better recordings of nuance, texture and expression. The question is, what's it doing to produce this result?

Playing the MoFi pressing of *Byrd At The Gate* (MFSL 1-515) there's much to enjoy and admire in the EA-2's presentation. The drum kit is absolutely solid, locked on the left side of the stage, while Keiter Betts' bass is similarly substantial on the right margin. But whilst it's the precision, pace and timing of the underplayed drumming that catches the ear, the transformation in the bass is even more remarkable. Normally plummy and rather woolly, it has depth, weight, power and a better than fair stab at pitch! With the nether regions nailed down, Byrd's guitar is given space ►

▶ and a solid foundation on which to dance, allowing his flights of melodic and rhythmic fancy to remain firmly anchored to the musical whole. Add in the explosive applause and it adds up to an enjoyable and engaging experience, especially given the unusual solidity and presence enjoyed by the guitar.

So what's the beef? Well, along with that deep, deep and deeply defined bass, comes a warmth, a rounding and smoothness that robs Byrd of a little expressive fluidity, his guitar of some texture and harmonic detail. Likewise the soundstage, is well enough separated but at the expense of dimensionality and space. It's a compact and solid picture, impressive for its presence rather than its depth or spaciousness. Playing with alternative pre-amps underlined the amp's influence on proceedings, as it collapsed the gap in transparency between The Vibe and the Hovland. Indeed, the HP100, with its powerful bass, was the preferred partner, playing to the EA-2's strengths whilst the additional immediacy and transparency of The Vibe failed to really make an impact.

The Byrd disc is both a best and a worst case scenario; the benefits in the bass are stupendously effective, the front and center exposure of the guitar highlights the slight loss of nimbleness and delicacy. Other examples are far more flattering. Whilst 'Andy's Chest' lose a little bite and aggression, many a listener will prefer the refined and sumptuous delivery of 'Perfect Day' (Lou Reed *Transformer* RCA NL 83806). It makes for far more relaxed listening, and gives the song a real sense of ebb and flow. Tonally it's spot-on through the midband (the treble being a little overly sweet and rounded) with Reed's voice immediately identifiable, although you might stop to wonder where the elocution lessons suddenly arrived from.

The Heifetz/Brahms *Violin Concerto* (RCA LSC-1903) might lack the characteristic space of its Living Stereo heritage, and the last degree of textural nuance from the maestro's bow, but it's hard not to be swept away by the sheer power and majesty that the ECS amp delivers. Its timing and rhythmic integrity keeps the drama building while



its unburstable headroom relieves the system of any sense of strain. Indeed, the surging power available on tap might well endanger your speakers, it arrives with so little fuss or bother. Running into the 90dB Audioplan Kontrast III is that I eventually settled on, the crack of a bottomed bass driver in the *Symphonie Fantastique* was a timely warning!

The ECS EA-2 is an engaging and impressive first product. It is big, bold, refined and genuinely unflappable, laughs in the face of loudspeaker bullies, is the life and soul of the party. Its failings are entirely in the hi-fi rather than the musical domain, and I've probably made much more of them than many a listener would simply because they're highlighted by my own preference for small, ultra agile amplification. Where it deviates from the real it does so to the kinder side

of neutrality, which is why it's so forgiving of poor recordings and less than subtle application of the volume control. If you like it loud and varied, a system that's got to take on all comers then you could do an awful lot worse than buy an EA-2, especially considering the superb engineering, finish and the price-tag. It does what hi-fi systems always used to – before we developed an unhealthy obsession

with the likes of imaging and the resolution of inner detail (like how many fillings the backing singers have).

If you want all the above, but in a single package (well, two to be precise) then the £5995 a pair mono-blocks look like a mighty enticing prospect. I certainly intend to find out, and sooner rather than later.



#### TECHNICAL SPECIFICATIONS

Type:	Solid-state stereo power-amp
Inputs:	1x single-ended RCA 1x balanced XLR
Input Impedance:	47 kHz
Rated Output:	180 W into 8 Ohms
Output Connections:	2 pairs 4-way binding posts per channel
Dimensions (WxHxD):	438 x 112 x 428mm
Weight:	22 kg
Finish:	Black
Price:	£3995

#### Manufacturer:

European Circuit Solutions  
Tel. (44)(0)20 8746 4315  
Fax. (44)(0)20 8740 4200  
E-mail. Sales@euro-circuit-solutions.com  
Net. www.ecsamplifiers.co.uk

**STOCKISTS OF  
LEADING HI-FI**

- A careful selection of the best Hi-Fi to suit most budgets.
- Two comprehensive listening rooms.
- Expert advice on building a system.
- Expert advice on improving existing systems.
- Home installation service.
- Call in for more information or a demonstration.
- 0% Finance Available on request.

# Basically Sound

**NORWICH · NORFOLK**

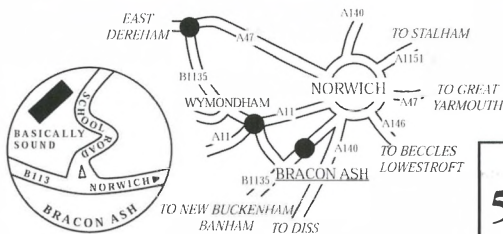

**01508  
570829**  
CLOSED MONDAYS  
AND SUNDAYS

Basically Sound of Norfolk, The Old School, Bracon Ash, Nr. Norwich, Norfolk NR14 8HG  
[www.falcon-acoustics.co.uk](http://www.falcon-acoustics.co.uk)

NOW ON  
PERMANENT  
DEMONSTRATION  
THE COMPLETE  
RANGE OF  
NAIM AUDIO  
EQUIPMENT,  
INCLUDING TH  
E 552 AND 500



**hificables.co.uk** online shop for cables & accessories



**Expert advice**  
**Exceptional prices**  
**Excellent Service**

**FREE UK Delivery**

Providers of high quality Hi-Fi and AV cables from: Audience, Black Rhodium, Chord, Clearlight, DNM, Hificables, Nordost, QED, Van Den Hul, IXOS

Also suppliers for:  
Aallsop, AudioPlan, Densen, Graham Slee, Grado, RDC, Ringmat, Shure, Vibrapod



[www.hificables.co.uk](http://www.hificables.co.uk)

# Hazlemere Audio

If you *value the best*  
(rather than just the most expensive)

Spectral



Cables  
Siltech  
Spectral

Speakers  
ART  
Reference 3A  
Verity Audio

Digital  
dCS  
Opus 21 (new from  
Resolution Audio)  
Oracle  
Metronome

Amplification  
Chapter Audio  
DNM  
Nagra  
Plinius  
Renaissance  
Spectral



Supports  
Avid  
Clearlight  
Kinabalu

Avid Acutus  
Turntable

Power supply  
Accuphase  
Isotek  
Jaya  
Loricraft

Audio Analogue  
Creek  
Ecosse  
Epos  
Fanfare  
Gamut  
Harmonic Technology  
Ortofon  
Piega  
SME  
Sugden  
Triangle

For an appointment (day or evening) call High Wycombe

**(01494)  
865829**

There are well-known amplifiers. There are highly-regarded amplifiers. Then there is Spectral – recognised throughout the world as the leader.

## Spectral – the “Reference”

The keys to the Spectral sound – fine detail, startling immediacy, dancing rhythms and amazing clarity – stem from their **ULTRA-FAST RESPONSE**.

Spectral amplifiers **RISE** and **SETTLE** in 10 millionths of a second after the **FAST TRANSIENTS** and **COMPLEX HARMONICS** of a violin or trumpet, or the 1,000,000 to one ratio of loudest to quietest signals. Imagine the complexity of a full orchestra.

We hear this astonishing nimbleness as natural “**PRESENCE**”, increased **DYNAMICS** and a wider palette of **TONE COLOURS**. We also hear more of the musicians’ technique – bowing, plucking, breathing – and so more of the emotion. Here, speed does **not** equal aggression.

Spectral products evolve from the **LIVE EVENT**. Designer Prof Keith Johnson is the driving force behind **REFERENCE RECORDINGS**, and also the inventor of HDCD recording.

Spectral draw on techniques from hi-tech fields like microwave engineering and adapt them as **REVOLUTIONARY AUDIO** solutions.

Visit [www.spectralaudio.com](http://www.spectralaudio.com) for more.

Customers say we make some of the **BEST SOUNDS** they have ever heard, so you know we can do the same in your home. Our advice will take account of your best components and guide you where change is needed, in stages you can afford. You **AVOID EXPENSIVE MISTAKES**, enjoy music along the way and save money in the long run.

**JUST LISTEN AND YOU’LL KNOW.**

The  
Right  
Note

*Music in the home*



**BATH**  
01225 874728

**CD:** ACCUPHASE, ADVANTAGE, AUDIO SYNTHESIS, BALANCED AUDIO TECHNOLOGY, dCS (ELGAR, DELIUS, PURCELL AND VERDI), RESOLUTION AUDIO, SUGDEN, WADIA. **VINYL:** AUDIO SYNTHESIS, BASIS, CLEARAUDIO, DNM, (THE) GROOVE, GRAHAM, LEHMANN, MICHELL, STRATOSPHERE, SUMIKO, TRANSFIGURATION. **AMPLIFIERS:** ACCUPHASE, ADVANTAGE, BALANCED AUDIO TECHNOLOGY, BEL CANTO, CAT, DNM, GAMUT, HOVLAND, NAGRA, SONNETEER, SPECTRAL, SUGDEN. **LOUDSPEAKERS:** AUDIO PHYSIC, BKS, ETHOS, NEAT, TOTEM, VERITY AUDIO. **TUNERS:** ACCUPHASE, MAGNUM DYNALAB. **CABLES:** ACOUSTIC ZEN, CHORD CO., DNM, HOVLAND, NORDOST, SILTECH, YAMAMURA CHURCHILL ETC

# Boulder

**THE BEST NEEDS FEW WORDS**  
**METROPOLIS MUSIC, TUNBRIDGE WELLS, KENT T:01892 539245 F: 01892 616383**  
[www.metropolis-music.co.uk](http://www.metropolis-music.co.uk)



# The Real Deal

## Mordaunt-Short's MS912 and Monitor Audio's B2

by Jason Kennedy

Budget loudspeakers offer tremendous value for money. Speaker makers have to invest at least as much in research and development with a £200 speaker as they do with a £1,000 one. If you look at B&W's 600 Series speakers they benefit from technologies developed for the Nautilus project, the first fruit of which was, and still is, a £35,000 active loudspeaker supplied without amplification.

It is also much harder to make a good inexpensive loudspeaker than a good expensive one. (There's a serious debate just waiting to happen... Ed.) Almost any Tom, Dick or Harry can cobble together components and build an expensive loudspeaker that makes a decent noise. The parts aren't inherently that expensive and the only reason you don't see more one man band speakers is the finite resources of the retail sector and the marketing power of the big brands. You won't find any one man bands in the budget speaker sector; it takes big production runs to keep the price down and pretty serious R&D budgets to keep the quality up.

Competition in the budget sector is incredibly fierce. Back in the day when I was Paul Messenger's blind test roadie, swapping speakers behind the silk curtain while the listening panellists strove, usually in vain, to identify their own progeny, I heard an awful lot of affordable loudspeakers. Then as now the standards were high. Most had even responses and similar levels of bass extension, and most could provide good quality entertainment, especially when

driven by Paul's distinctly non-budget Linn/Naim rig. It was an educational experience and I learnt not to underestimate the potential of the budget box.

For a start small speakers have a psychological advantage. You don't expect a big sound to come out of a small box, even if you've experienced it before. And if it's a cheap small box your preconceptions are even easier to fool. It's the reason why Bose can sell so many sub/sat systems even though their sound rarely matches the asking price. And, at the other end of the scale, why the notorious white van men selling large (and very, very cheap) loudspeakers in car parks manage to con unwitting punters out of their money. We listen with our eyes. So don't dismiss compact budget speakers because they don't look like they can do the job: they can, and surprisingly well.

Obviously they have limitations. The most immediate one is bass extension. Affordable boxes with compact drive units will not produce anything of note below about 50Hz. In fact decent bass just cannot be produced on the cheap, subwoofer or no. Controlled low frequency air movement remains the domain of the larger loudspeaker. The other area in which they struggle is absolute level. You can play a budget speaker loud but it won't be a very comfortable experience. Mind you most of us have been through a phase of playing our budget systems as loud as we could manage, so this is a relative consideration. If you've not been spoiled by high-class speakers budget designs

are pretty damn entertaining at most levels. And their behaviour at high level is one of the clearer means of distinguishing between them, as is the case with the budget beauties gathered here.

The Mordaunt-Short MS912 is a substantial box for anyone's £200. The eight kilo, vinyl wrapped carcass is beautifully finished with rounded leading edges and a silver front baffle that hides the driver fixings to give a very classy effect. It's constructed from 15mm MDF with wood composite bracing. The bi-wire cable terminals would not look out of place on designs costing two or three times as much.

The driver array consists of a 12cm mid-bass cone in a 16.5cm chassis. Though it has been finished to look like a metal driver it is in fact a composite which includes an aluminium layer. The magnet is shielded to be TV friendly and incorporates what's described as a "large voice coil". The cone is one of M-S's CPC (continuous profile cone) designs, not so far from Robot Wars' CPZ (corner patrol zone) but somewhat more useful when it comes to sound propulsion due to its smooth and relatively rigid form. High frequencies are handled by a 25mm aluminium dome of Mordaunt-Short's commissioning, which employs a neodymium magnet.

More compact in scale is Monitor Audio's latest £200 contender, the B2 from its revised Bronze series. It weighs in at six kilos a channel. This is a slightly more conventional looking design with driver chassis inset into the front baffle, so revealing the mounting hardware. ►

▶ But it's no less professional in its execution with the vinyl wrap extending over the front for good contrast with the black driver surrounds and front port. Construction is of braced 18mm MDF with profiled baffle edges at the front only, the theory being that this forming should reduce diffraction. Nevertheless, the edge that remains is still pretty definite. Cable connections are via four terminals mounted horizontally, using plastic nuts on gold plated binding posts. These are functionally the same as those on the M-S, just less sexy. However their in-line nature does make them more spade friendly than conventional arrangements. The front mounted reflex port's tube is rubberised which is said to reduce air turbulence and unwanted noise, though one might imagine that it's main effect would be to damp any resonance in the material itself.

The drive unit complement is remarkably similar to that of the Mordaunt-Short. The main mid/bass driver uses a 12cm composite cone consisting of polypropylene loaded with metallic particles, a combination that is said to aid low level resolution whilst damping unwanted resonance. The metal matrix polymer (MMP) cone is an injection moulding with varying thickness in an attempt to increase stiffness without overly increasing weight. The magnet assembly has a vented rear section to reduce thermal compression.

Treble is delivered by another 25mm metal dome; where would the speaker industry be without them? This one, apparently, is a C-CAM (ceramic coated aluminium/magnesium) with gold finish as promoted by MA's former owner Mohammed Iqbal with his favourite "gold domes matey" catch phrase.

The Monitor Audios were first to take the stage, ousting a pair of ATC SCM50s by dint of sheer audacity. Blu-tacked to

Atacama stands they did look a bit odd in a system more used to boxes at ten times the price but the noises produced, though in a different league, were by no means embarrassing. I did bring in a more realistic amplifier than the usual

Gamut 200 watter for the job, in the form of Pioneer's classic A300R Precision.

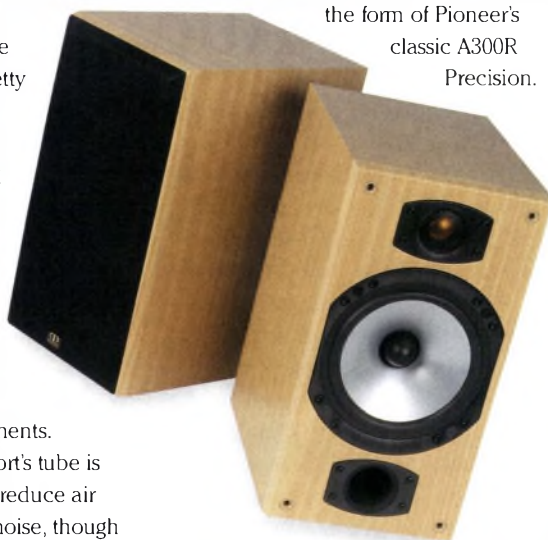

A Tom Evans tuned machine that has endured additional, subsequent tweakery, it represents a pretty refined 35 watt integrated, albeit one that is no longer manufactured. Source was courtesy of another Evans/ Pioneer project, the Eikos CD player. The Townshend Deep Cryogenic cables cost more than speakers and amp together but provide a remarkable and familiar conduit for the signal.

Firing up the B2s one is immediately struck by their ability to project voices. Initially this was David Thomas' voice accompanied by the Two Pale Boys on the album *Surf's Up*, the speakers doing a pretty good job of throwing the voice out and up with little sense that it was coming from the boxes. The cabinets seem to be pretty 'quiet' considering the price. Bass extension is inevitably limited even when you push the speakers quite close

to the wall but if one were feeling generous this could be described as tight or even fast! And you do get to hear the upper harmonics of bass notes, which on this occasion sound appealingly open, with the reverb well preserved. Low level detail seems pretty well served as well, which is impressive, adding depth and presence to the voice and subtlety to instruments.

Missy Elliott's latest album *Under Construction* is a bit more poppy and self assured than previous one but this doesn't stop it containing two decent tracks, one of which, 'Gossip Folks', revealed the dynamic limitations of the Monitor Audios. Never mind that, it was still pumped out at a healthy volume and kept strictly on time as far as the slightly undernourished beats were concerned.

On Anouar Brahem's *Thimar* Dave Holland's double bass comes over slightly smaller than life and John Surman's horn doesn't have the shine and colour you get with dearer speakers. Yet the lyrical intonations of the playing come across loud and clear, and by the standards of its peers this was a decent

rendition of tremendously subtle material. Tori Amos' 'God (Under the Pink)' is a lively, slightly angular track that stretches a budget speaker's cool pretty tight. The B2s coped but you wouldn't want to listen too long or too loud to more challenging material.

Coming back to the

B2s after the 912s you notice a distinct forwardness to their balance. They sound louder at ostensibly the same volume level, the midrange protruding but the bass not really coming across any lighter. It has the sort of balance that offers an open sound with pronounced midrange detail, so you get to hear plenty of what really counts in the music: leading edges, intonations and emotions. ▶





▶ With the more powerful Moon I5 integrated (70watts) in the driving seat, the B2s delivered firmer bass with a more disciplined sense of beat, though it was not exactly loose before. Tight and engaging sums up the enhanced results conjured up by this upgrade and while it's unlikely

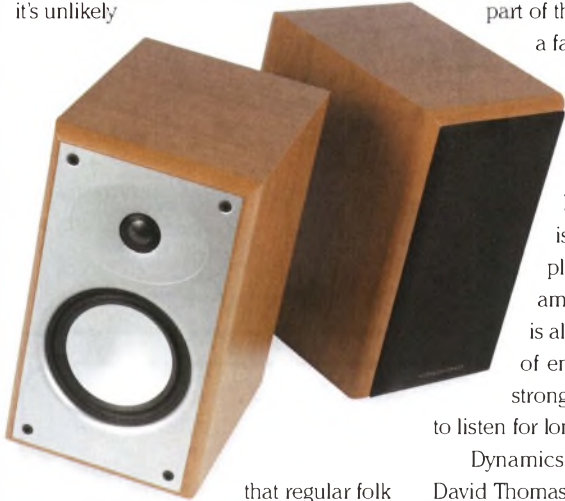

that regular folk will combine a £2k amp with £200 speakers it's good to know that the speaker is sensible to upgrading potential. Judging by the quality of mid and treble with the I5 in tow, available power is an issue. I was quite impressed by the rendition of a choral piece that can challenge even high-end speakers on occasion. Coherence also improved suggesting that the extra grip and transparency being delivered was not going to waste.

This new B2 is a lively and entertaining speaker with tight, controlled bass, agile and enthusiastic midrange and remarkably smooth treble. It is definitely a strong new contender in the budget box stakes.

Mordaunt-Short's MS912 has a relatively relaxed and smooth balance that encourages a little more tweaking of the volume control. It seems to offer deeper bass but in fact has fuller upper bass and slightly less pronounced mid-

range that produces rich instrumental tone but doesn't project voices quite so effectively. It seems a little odd that it renders the tone of a saxophone with considerable success but is less adept at projecting voices and deciphering lyrics as the two fall into broadly the same part of the range. It's probably just a factor of balance and while the B2s sound better at low to middling levels the MS 912s deliver their best result at slightly higher gain settings. There is a sense that they will play louder for a given amount of distortion which is always nice, and the sense of engagement is also very strong so you are encouraged to listen for longer.

Dynamics are still limited, but with David Thomas for instance, the sense of surreality in the music is rendered most effectively, the haunting trumpet of Andy Diagram describing ever more distorted scenes. Eminem's aggressive yet entertaining scansion came across rather well too, the bass sounding nice

and fat and the beats driving along at a healthy tempo without losing their place in time and space. Here again the extra power handling helps the overall effect. The Gaudeamus choral piece could have been reproduced with more height and depth, the

singers don't quite fulfil their potential for room fillability in quite the way the B2s managed. Denser material also proved a bit of a challenge, the Chilli Peppers' latest offering causing the speakers to lose a little of their composure. But then again, without factors like this what would be the point of more expensive speakers - you've got to have a reason to upgrade apart from that we tell you so!



The Mordaunt-Short MS912 is a very impressive box for the money. If you want to play loud and can give them the extra space that their rear ports prefer they'll thank you with some highly engaging music making.

This was an intriguing review, to compare two full flavoured loudspeaker designs from the sharp end of the market is not something I usually get to do. To be frank I was impressed, probably more so than the review reads. Both proved able conduits for musical transmission and it was not difficult to appreciate their output. Both have shortcomings but at the price the quality on offer is stunning. ▶+

#### TECHNICAL SPECIFICATIONS

##### Monitor Audio B2

Frequency Response: 42Hz-22KHz

Sensitivity: 90dB

Nominal Impedance: 6 Ohms

Power Handling: 100W

Dimensions (HxWxD): 350 x 185 x 250mm

Weight: 6kg

Finishes: Black ash or beech vinyl

Price: £200

##### Manufacturer:

Monitor Audio

Tel: (44)(0)1268 740580

Email: [info@monitoraudio.co.uk](mailto:info@monitoraudio.co.uk)

Web: [www.monitoraudio.co.uk](http://www.monitoraudio.co.uk)

##### Mordaunt-Short MS912

Frequency response: 55Hz-22kHz

Sensitivity: 89dB

Nominal Impedance: 4-8 Ohms

Power Handling: 15-150W

Dimensions (HxWxD): 355 x 205 x 295mm

Weight: 8kg

Finishes: Cherry or black ash vinyl wrap

Price: £200

##### UK Distributor:

Marantz UK

Tel: (44)(0)845 128 3951

E-mail: [info@mordaunt-short.co.uk](mailto:info@mordaunt-short.co.uk)

Web site: [www.mordaunt-short.co.uk](http://www.mordaunt-short.co.uk)

# Heatherdale

audio limited

202, Findon Road,  
Worthing, BN14 0EJ

**Now Open**  
Brand New Mark Levinson Listening Room

### SPEAKERS

Three SCS 2 Speakers (Walnut Finish) (Brand New)  
Normal Price £2395 £1595  
Mission 762 (Stand Mount Model) (Black Ash)  
Just Reduced From £250 £150  
Tanney Kingdom 12 x Demo speakers £3495  
Pro-ac studio 1 speakers mk 2 £395  
Audio Physics tempo speaker £395  
Revel Ultima sub 15 with LE1 sub amp £90A  
Epos ES30 Speakers £1495  
Atak Symphony floor standing speakers £99  
Thiel 1.5 Speakers £395  
Pro-ac studio towers (alc. @live) speakers £395  
Orchid PL11 Speakers x demo £3995

### PRE-AMPS

Exposure 11 & 12 Pre Amp & Power Supply  
Just Reduced from £900 £650  
Nakamichi CA-7E Pre Amp Cost New  
£2550  
Toll Pre Amp (fully balanced) £595  
Adcom GTP 450 Tuner/Pre-Amp £350  
Oakley Image 6 High-end Valve Pre Amp  
(similar to Conrad Johnson) £295  
Naim Nac 42.5 Pre Amp £150

Exposure 21 Pre-Amp (Femote) (Ex Stock)  
Just Reduced From £690 £750  
Music Fidelity MV7 pre amp £395  
Mark Levinson ML32 reference pre amp full  
4 year warranty £90A  
Counterpoint SAS Pre amp £475  
Mark Levinson ML 380s Pre amp £90A  
Mark Levinson M 26 Pre amp and  
power supply £90A

### AMPLIFIERS

Krell KST 100 Power Amp £1695  
Nakamichi PA 5 Stereo Power Amp  
Cost New £1150 £695  
Adcom GFA 5300 Power Amp £350  
Naim audio NAP 90 power amp £395  
Mark Levinson 436 Mono amps £90A  
Audionote Neo Mono Amps £7500  
Audionote P3 Power Amp £925  
Nakamichi CA-7E Pre and 2x FAS Stats  
Stereo Power Amps (to audio system)  
for Dabek 3X int. amp with X pak PSU £2500  
AM 2000Mi integrated amp £395  
Arcam xelia one integrated amp (pro logic) £750  
Audio Lab 8000A inter amp £595  
£225

### CD PLAYERS & TRANSPORTS

Marantz CD 72 mk2 SE CD Player (mini) £295  
Marantz CD 63 SE CD Player £195

### Pre-owned Equipment Available with Guarantee

Export Facilities Available. Visit our Web Page [www.hifi-stereo.com](http://www.hifi-stereo.com)

Main dealer for Mark Levinson Reference products

Marantz CD 16 £600  
Pioneer PD91 reference CD player £250  
Trichord Genesis CD player £250  
Mark Levinson No 37 CD transport £90A

### DACS

Sonic Frontiers SFD1 Digital Processor £695  
Mark Levinson 360S Dec £90A  
California Audio Lab Sigma 2 tube dac  
Mint and boxed £595

### MISCELLANEOUS

Zuechschne D4 Oak wall Shelf £120  
Stereographic Research Coax Resolution  
Reference digital (with active shielding) £250  
Stax SR007 omega ref  
(SR117 head phone & SRM007 dual triode)  
Normal Retail £2995 £1750  
Shun Mook Record Clamp £995  
Normal Retail £1660  
Audio Note ANS7 MC Transformer with  
Phono Stage £8495  
Audio Note (Kondo KSL AC2 mains cable  
fresh and boxed) £650  
Audionote (Kondo) 3mtr par SP2  
speaker cable £2500  
Audio Note (Kondo) ksl-LP Silver litz  
interconnect 1 mtr pair £995  
Audio Synthesis DAX Decade variable output £1795

Audio Research BLI balanced converter  
(single ended to balanced) £295  
Revox B16D Tuner £395  
Lumman K331 W Double Cassette Deck  
Pioneer CT S630S cassette deck £150  
Nakamichi Dragon Cassette Deck  
(Just serviced) £125  
£995

### TURNABLES, CARTRIDGES & TONEARMS

Eminent Technology air bearing arm with  
magnesium wand c/w pump £1695  
Verder Ebony Wood arm board Normal Retail  
£800 £425  
Helius Silver Wred Tonearm £545  
Ortofon Jubilee Cartridge £995

We now offer 0% finance (subject to status).  
Please phone to arrange an audition.  
Main Dealers for Mark Levinson, Thiel,  
and Absolute sounds.  
We accept Switch - Mastercard - Visa One's Club -  
American Express

Tel...01903-872288 or  
Evenings...07860-660001  
Fax...01903-872234  
E Mail address;  
[heatherdale@hifi-stereo.com](mailto:heatherdale@hifi-stereo.com)

# mike manning

audio

the home-entertainment specialists

## For the Best in Hi-Fi & Home Cinema

**DENON-PIONEER-YAMAHA-NAD**  
**ROTEL-NAIM AUDIO-M&K**  
**REGA-DENSEN-DEF'TECH**  
**B&W-LOEWE (TV/VIDEO)**  
**PROJECTORS, PLASMA etc**

Demonstration Lounges  
Home Installations  
Service Facilities

Yeovil

01935-479361

110, Middle Street, Yeovil  
Closed Mondays

Taunton

01823-326688

54, Bridge St, Taunton  
Closed Tuesdays

# pear audio

presents

Shahinian

DYNAVECTOR  
Well Tempered

Stockists and Information  
from:

Pear Audio Ltd.

7 Prospect Place, Alnmouth,  
Northumberland, NE66 2RL

Telephone: 01665 830862

Fax: 01665 830051

# WORTHING AUDIO

Worthing Audio, 20 Telville Gate, Worthing,  
West Sussex, BN11 1UA  
Tel: 01903 212133 Mob: 07900 918882

Worthing Audio wish to introduce an exclusive new product in the UK.  
The **H-CAT P12** preamplifier (Holographic Cloning Amplifier Technology)

Manufactured by NAP, the H-CAT is the only amplifier of it's kind. This zero feedback design, is virtually distortion free, has no sound of its own and allows even the faintest sounds picked by the microphone to retain their pitch and tonality. The cloning creates an exact albeit larger replica of the incoming signal at the output, eliminating the minutest signal-speed variation caused by conventional circuit instability. The result being a preamp that transmits signals unfettered as if 'through air' as you hear it live!

In our opinion the H-CAT produces harmonic accuracy, outperforms any other preamplifier on the market and takes pre-amplification to a new plateau.

**THE SOUND IS SIMPLY SUPERB!**

Worthing Audio is the **ONLY** importer of this product and by cutting out the middleman can offer this outstanding preamp at the advantageous price of £3,395.00.

It can be demonstrated at our premises in Worthing or in London.

( We can offer a 15-day money back guarantee for those who unfortunately cannot get to these venues )

For further information on this product see [www.h-cat.com](http://www.h-cat.com)

## SILVER ARROW CABLES

Our **4N pure silver foil flat air interconnects** and speaker cables outmatch every other cable they have been compared with, which is just about everything on the market.

**SILVER ARROW CABLES** are not really heard of (only 4 UK dealers), but in the USA they are more than highly regarded.

Comments like "**stunning**", "**so organic**", "**I don't believe the sound of these cables - superb**", we get that all the time.

Any person thinking of spending £2,000.00 + on 1metre interconnects, should listen to these cables. At **£1,000.00**, we feel they surpass all cables at any cost.

**Painstakingly made in the UK**

**AGENCIES: NAP - H-CAT . KORA . OMEGA SPEAKER SYSTEMS . SILVER ARROW CABLES . AUDIONOTE  
VOODOO ISOLATION . EXPERIENCE FILTRATION "MAINS" . CLEARLIGHT AUDIO ASPEKT RACKS ...AND MANY MORE**

## new audio

# FRONTIERS

hi - fi - retail



The Isoblu stand  
a new reference



Now on demonstration  
the amazing Naim NAP 500



Dynavector moving coil  
cartridges, the best there is

43 GRANBY STREET  
LOUGHBOROUGH  
LEICESTERSHIRE  
LE11 3DU

TEL: (01509) 264002  
FAX: (01509) 219900  
E-mail:  
[naf@replate.freemove.co.uk](mailto:naf@replate.freemove.co.uk)



**PowerSnakes™ PYTHON**

**2008 PRODUCT YEAR**

### SHUNYATA RESEARCH

Power cables  
Power Distribution  
Signal & Speaker Cables

[www.shunyata.com](http://www.shunyata.com)

available in the UK  
from

**AUDIO ATMOSPHERE**

[www.audioatmosphere.com](http://www.audioatmosphere.com)

[stuart@audioatmosphere.com](mailto:stuart@audioatmosphere.com)  
01785 711232



**PowerSnakes™ HYDRA**

Re-defines the term state-of-the-art  
in high-end power distribution.

**2008 PRODUCT YEAR**

# Divide and Conquer...

## Everything you wanted to know about crossovers but were afraid to ask!

by Martin Colloms

The crossover network might be a superficially simple concept, but it actually embraces a wealth of ideas that extend into many different aspects of loudspeaker system design.

In basic terms it's a frequency sensitive filter that needs to operate at amplifier power levels. It has to be suitably specified, and built with electronic components that are particularly selected for performance, sound quality and power handling.

Indeed, some audiophile crossovers are built on a truly heroic scale, with huge low-loss components, like weighty polypropylene capacitors and air-cored inductors wound in thick wire. Nevertheless all electronic components are imperfect to some degree, particularly at high power levels, and each type and size will have its own unique sound quality signature. The skilled designer makes value and performance choices based on measurements and listening tests, so that the choice and use of crossover components is consonant with price, and complements the rest of the speaker's build quality.

Good speakers generally use two or more drivers of various sizes, in part because achieving a wide frequency range alongside a consistent and wide angle of radiation is physically and acoustically impossible with a single moving coil piston driver.

The role of the filter network is to separate the full range of sound

frequencies into chosen bands or sub-ranges to feed these two or more drivers with appropriate segments of the spectrum.

For the ubiquitous two-way speaker with woofer and tweeter, the powerful low notes need to be kept out of the delicate tweeter, while the high notes (which are little use to the slow responding woofer) are directed towards the tweeter with its much lighter moving parts. A crossover network is generally an integral part of a complete speaker system, which also includes an enclosure to support and acoustically load the various drive units

If each driver had a perfect frequency response and sound output characteristics, the crossover could theoretically be relatively simple. It could be regarded as 'short' because very few components would need to be connected up to apportion the respective intended frequency controlled power to the drivers.

However, in practice this is hardly ever the case. Even where the designer has total control over drive unit design and build, further adjustment is invariably required to 'voice' the system. Voicing involves the fine tuning of all available variables to blend and balance the sound output. The intention is to create an optimised harmonious unity – or one which is as good as can be achieved with the parts and time available.

Designers know well that the

crossover network can play an important, or even the dominant role in voicing. Taken to extremes it can become quite complex, as a designer tries to compensate for or equalise all the remaining errors detected in the sound of the prototype speaker.

This is where crossover 'order' comes in. Speaker designers often talk about the 'order' of a crossover networks – eg first order, second order etc. – even sometimes claiming advantage for one kind over another.

The simplest form of filter requires just one electrical component, for example the series connection of a capacitor or an inductor. An inductor passes lower frequencies but progressively impedes higher frequencies – it has a rising impedance with increasing frequency. Contrarily, a capacitor progressively impedes lower frequencies, but freely passes higher frequencies – it has a reducing impedance with rising frequency.

The simplest two-way filter for a two-way speaker (ie with separated bass and treble ranges) may be represented by the electrical circuit diagram shown in Fig. 1. The combination is called a crossover network, because the resulting power level versus frequency for each driver has an intended crossover point where in theory both drivers are working together at half power to blend smoothly at the crossover transition. (see Figs 2a, 2b)

If the inductor and/or capacitor ►

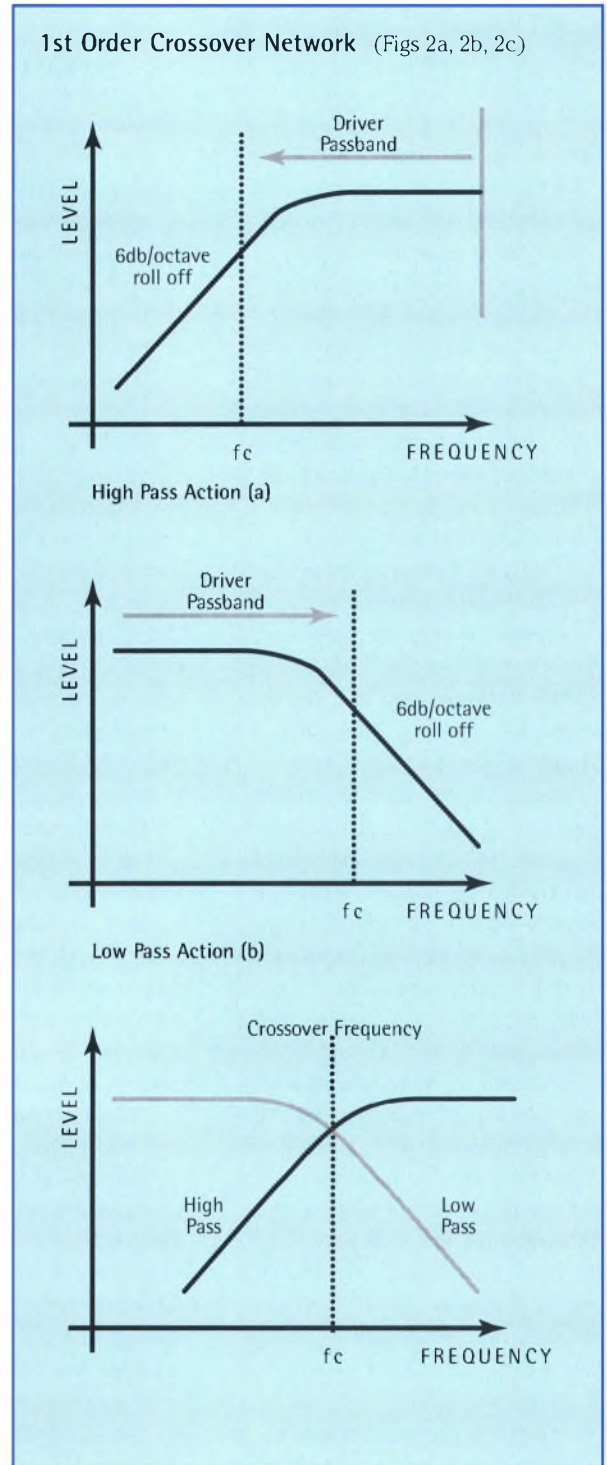
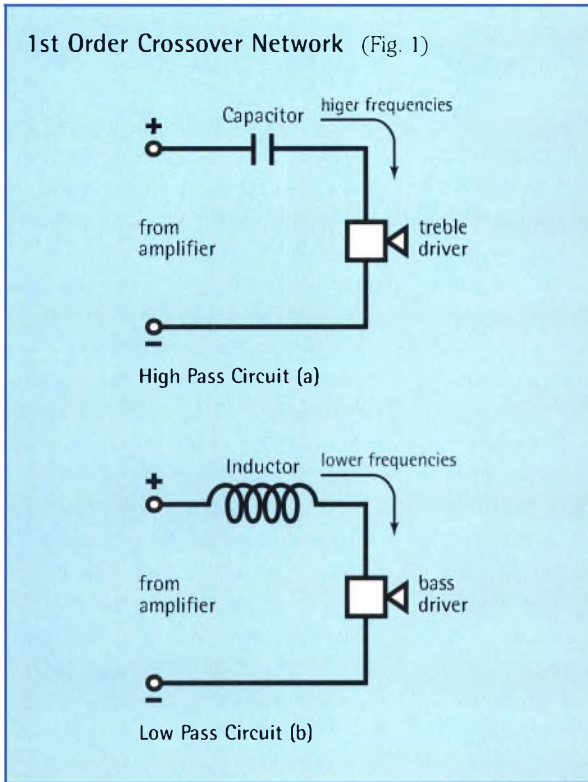

► has the wrong value or size, the idealised power sharing at the crossover frequency may not be realised. For example, if the inductor is too small, and/or the capacitor is too large, then the respective power will overlap too much and the sound level will peak up at the crossover frequency. Conversely if the inductor is too large and or the capacitor too small, then the output from the driver may not overlap at all, leaving a gap or 'dip' in the system power at crossover.

Another issue is relative level, or variations in driver sensitivities, with obvious potential consequences for tonal balance. If the woofer and tweeter sensitivity – or relative loudness – are not matched, then a simple crossover network can result in a 'step' in the frequency response, as the signal is transferred from one driver at low frequencies to another at high frequencies.

Where a designer has total control, the sensitivities of the drivers may be

adjusted in manufacture, for example by varying the strength of the magnet and associated pole system. If not (and more commonly), level mismatches are dealt with by using another kind of component called a resistor. This can control the flow of power without any regard to frequency, so a whole frequency range may be adjusted using an appropriate level-matching resistor for voicing.

A basic network, essentially comprising single components, is conveniently called 'first order' in filter

terminology (it has single 'poles' in network theory terminology), and has the oft-stated 'advantage' that it is short, simple, and therefore has the least chance of damaging the quality of ►

► the audio power being transferred to the drive units themselves.

Idealised simple filters work best with idealised near perfect drive units, working in acoustically perfect cabinets. And even the best of these still have technical parameters that prevent a first order filter from performing as we, or theory, would like. On paper, a first order filter supplements simplicity and potential clarity with an idealised summation of the output from the drivers – idealised in that such low order filters cannot ‘ring’ or resonate. On the face of it they show exemplary behaviour in the transient or time domain.

This is a hugely complex field, so much so that this examination can merely skate over its surface. Note, however, that for a first order filter to work well, neither drive unit can have a significant variation in level nor sound radiation with angle, over a much wider frequency range than the choice of crossover frequency suggests. If a crossover point of 2.5kHz is chosen, for example, the bass/mid drive unit ought to work beautifully up to say 9kHz, while the high frequency unit should remain happy down to, say, 500Hz. Such acoustic paragons simply do not exist.

Furthermore this exploration of first order has hitherto overlooked the need for time alignment between the drivers. Without this the expected phase relationships of such a simple filter network will not be seen in the net sound output, and can result in uneven response, on and/or off axis. Any gaps or inconsistencies of this kind will be clearly audible in the sound of the system.

If belief in first order crossovers is taken to the extreme, some interesting contradictions can emerge. Their fine speaker designs are typically ‘first order’ and proud of it, but that by no means guarantees that its crossovers have single, simple components for each network arm. In fact a myriad

of speaker system design skills are deployed to help achieve a ‘resultant’ first order acoustical response from the installed drivers. Inside many cross-over components may be working as level adjusters, or as equalisers for frequency response and phase, all designed to work cooperatively with the natural properties of the drivers to achieve that target characteristic.

We have therefore circled around the question of crossover ‘order’ to arrive at one possible definition: the effective, real world characteristic of the ‘acoustic’ crossover, measured and heard from the front of the speaker (specifically on the all important designed listening axis). This is clearly different from a theoretical ‘first order’ crossover network, whose ultimate behaviour will inevitably be modified by the frequency and phase characteristics of the drivers.

Crossover network theory is fine on paper, but those idealised electrical characteristics must be substantially adjusted to take account of the drive units. Indeed, in the real world, networks of significant complexity are used in a highly creative fashion to smooth out imperfections in drivers and cabinets, and helping to achieve the best possible sound from the system.

Each designer finds his own way of adjusting and interpreting the possibilities, and this helps explain why every design will have its own signature. That signature is the distillation of the designer’s best available view on how to create, using the parts available, the illusion of a musical performance from a recording. However, customers will not always agree with a designer’s interpretation, and variations in sound perception and musical taste will continue to provide an ever fascinating divergence of opinion for years to come.

## Why do we need crossover networks?

Crossover networks are a necessary evil, only invoked to solve major problems present in the design of speaker systems. For a natural sound the speaker ought to have a uniform acoustic output with frequency, and this should be the primary requirement amongst many other parameters.

Because humans can hear over a very wide frequency range, generally stated as almost 10 octaves or doublings, from a deep ‘pressure’ wave at 20Hz (below which you can’t count the beats, and sound is no longer a ‘tone’) up to a delicate ‘tingle’ at 20,000Hz (where it is more a sound than a pitch), the difficulties presented for a loudspeaker are immense. Sight covers a much narrower range of wavelengths than this. A speaker has to reproduce sound waves which, in air, range in size from a colossal 17 metres at 20 Hz to just 1.7mm at the highest frequencies.

To achieve uniform output from standard to-and-fro piston-type sound radiating diaphragms, the piston diameter ought to be somewhat smaller than the wavelength of the frequency it is reproducing. Ideally then a tiny 10mm piston will give best treble radiation, whereas for good power in the deepest bass a speaker at least as big as a sideboard would be perfect!

While a few full range exceptions exist and will be examined in a later article, the usual way of coping with this contradiction is to divide and conquer. We split the frequency range using some form of filter/crossover dividing network, and direct these narrower frequency ranges to drive units of different sizes, each optimised to radiate sound in its respective range.

As a fair compromise, a general purpose high frequency unit or tweeter is considered effective up to 25 or 30mm in radiating diameter, and these are often built as a dome, generally convex but occasionally ►

### 2nd Order Crossover Network (Fig 3) 2 Way System

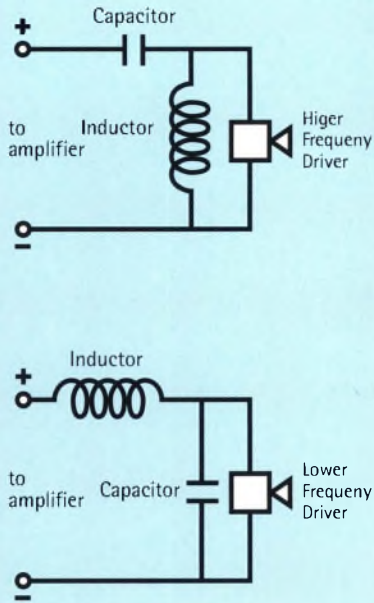

### 2½ Way Crossover Network (Fig 4) Showing use of matching resistors and with typical values for a 2nd Order Design

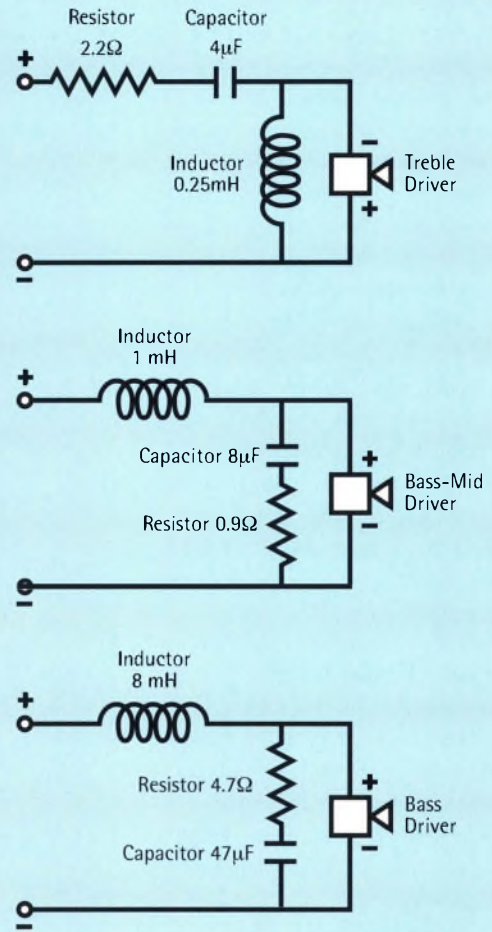

► concave. Good ones work quite well to as low as 1kHz, allowing the crossover division to be set between 2kHz and 4kHz. Useful bass can be obtained from drivers sized from 125mm upwards. A unit with a typical 165mm diameter chassis and careful cone design can be made to work well acoustically up to 3 or 4kHz, blending with the tweeter. At the bass end of its range, such a 165mm bass/mid drive unit can deliver quite substantial cone movement – perhaps 12mm overall – which is enough to generate satisfying pressure levels in the bass. Putting the two together provides the basic recipe for the ubiquitous two-way loudspeaker system.

### DEFINING ORDERS

#### 1st order crossovers

A near impossible blend of two or more drivers, working in a speaker system where the resultant acoustic energy follows a first order single pole characteristic, with gentle 6dB/octave rolloff slopes outside the crossover

point, and good phase and power summation. Because it uses the least electrical components, it may provide superior sound quality. [See fig 1 a, b fig 2 a, b, c]

#### 2nd order crossovers

The most common type, which at its most basic comprises two components – an inductor and a capacitor – per arm or section. A two-way crossover will therefore have four components in total plus the odd resistor or so for matching. With two network ‘poles’ it is termed second order from the defining equations.

[See fig 3]

#### Two-and-a-half-way crossovers

Two-and-a-half-way (2.5-way) is an invented term for what is often a full range, compact two-way speaker system

design which has been augmented by adding an additional bass driver. The latter’s output blends with and augments the system, enhancing and extending the low frequency performance. Because a normal frequency-band-dividing three-way crossover is not present, the compromise term ‘2.5-way’ is used. For a given budget the floor standing 2.5-way can often deliver the biggest bang for the buck. Another way of looking at it is to consider this type as a forward sounding compact 2-way augmented and filled out by adding an on board passive sub-woofer.

[See fig 4]



► **Higher order crossovers**

There is no theoretical limit on crossover order, but problems of cost, power loss and the need for increasingly accurate parts progressively rule out going beyond fourth order. Fourth order itself has some interesting properties for advanced speaker systems, however.

One of its many variations, named after its creator Siegfried Linkwitz, offers superior alignment with time delay adjusted drivers, allowing drivers to be wired in-phase, and providing a time coherent output with fine power integration between the drivers and superior system impulse response. Quite widely used, this type of network provides neat contradiction to those who take a simplistic view of the subject, and claim that only low order can give a good quality and pulse response free from 'ringing' (unwanted continuing electrical resonances which may colour the sound).

**D'Appolito Configuration**

Sometimes called MTM (mid-treble-mid), this uses a vertical-in-line driver configuration with two bass/mid (or mid-only) drivers flank the treble unit – an arrangement first seen in the active, full range compact Meridian M2 of the 1970s.

US designer Joseph D'Appolito helped popularise the arrangement with a subsequent theoretical analysis, leading to a preferred crossover alignment which achieves tolerably good sound radiation in the vertical plane from a desirably symmetric yet acoustically awkward arrangement – awkward because the patterns for sound radiation are very different in the vertical and the horizontal planes. The inevitably wide separation of the mid sections at the crossover frequency presents the designer with difficulties particularly where the enclosure is horizontal – like most centre-channel dialogue speakers, which then fail to serve an arc of listeners adequately. ►+

**BI-WIRING/-AMPING**

**Bi-Wiring**

Opinion is divided over bi-wiring. Originally patented in Japan by Toshiba, this seemingly trivial option for connecting a multi-way loud-speaker (specifically one with separate connections to each driver and its associated crossover network sections) to an amplifier merely suggests using separate speaker cable runs for each 'way'.

Sets of terminals on the back of the speaker may be connected in parallel by bridging straps if just one standard cable is in use. If a two-way speaker is involved, a bi-wire connection needs one additional set of cables, ideally matched in length type and quality to the first; the bridging straps on the back of the speaker should be removed.

Each speaker cable serves a specific frequency band and driver, potentially with greater clarity. There may also be some benefit to the crossover network, where the internal separation of the frequency-limited 'ways' depends on a good electrical circuit 'ground'. The baseline 'ground' is established by the amplifier, and must inevitably be extended to the speaker via the speaker cable. Bi-wiring provides an individual link between the amplifier ground and the specific crossover section, potentially enhancing performance.

Bi-wiring has become widespread with moderate cost speakers, and no doubt dealers are more than happy to double their sales of high margin speaker cables! Nevertheless many audiophile speakers are single

wired, on the assumption that the highest quality speaker cable will be used. Designers of such models agree that injudicious use of bi-wiring, badly matched cable, or even incorrect wiring could compromise performance and lose any possible benefit. They also argue that making provision for bi-wiring can be self-defeating, because if it isn't adopted then the bridging straps add unnecessary extra electrical contacts that impair sound quality. (These should always be kept clean and tight to avoid loss of performance.)

**Multi-Amping**

Providing a bi-wire (or even multi-wire) facility opens up a further upgrade option, namely multi-amping. Multiple power amplifiers, fed in parallel via their inputs, provide independent power outputs to drive each 'way' – ie drive unit plus associated crossover network – of a speaker system.

Amplifiers generally deliver improved dynamics when the power demands made by a speaker are reduced – as they inevitably will be when feeding the more limited frequency bands defined by the respective crossover sections. Although the amplifiers still reproduce their full bandwidth, they only deliver power across restricted frequency ranges. It is this principle that allows them to perform to a higher standard.



# State Of The Mains...

by Roy Gregory

We've devoted a fair amount of space to the subject of the mains and its effect on the sound of your system. Rightly so, because it's critical to getting the best out of your equipment. But whilst things used to be pretty straight forward, with the Russ Andrews and Ben Duncan approaches setting the established benchmark, since then a host of competitors and imitators have appeared. And whilst we've looked at the most interesting of these, I feel it's about time we tried to establish what exactly these contrasting approaches deliver, and how they stack up relative to each other.

With this in mind I assembled a cast of what seemed like thousands – at least it did when it was all spread across the listening room floor. In reality it consisted of a systems worth of Russ Andrews kit, an Isotek Substation, the ruinously expensive Shunyata Hydra distribution block and Power Snakes from America, and a filter, distribution block and mains lead from new guys on the block Experience Filtration.

For listening purposes I set up a simple four-box system (well, six if you include the crossovers) consisting of the Rega Jupiter CD player, Hegel H1 integrated amp and Living Voice Avatar OBX loudspeakers, wired with Nordost Valhalla. Keeping things as simple as possible serves two purposes: firstly it makes chopping and changing the power loom feeding the entire system reasonably quick and manageable. Secondly, it provides a worst case scenario for mains treatment. The more boxes in the system, especially digital boxes, the greater the problems of mutual interference and the more potential there is for filtering.

By keeping things minimal we are working with a situation which theoretically needs the minimum of help. Bigger and more complex systems should actually accentuate any benefits heard here.

For the purposes of direct comparison I relied on two specific recordings. First was the Eleanor McEvoy track 'Did I Hurt You' (*Yola* EMCD1), the second the Arturo Delmoni / David Burgess performance of the Handel *Sonata in E Major*, arranged for violin and guitar (Sonora SACC 102). Basically acoustic they might seem like odd choices when so much of what mains cabling and filtering does is expressed in terms of weight and dynamic range. But what I want to concentrate on is the impact of the mains loom on the intricate relationships within the musical performance. The simpler and more natural the performance the more obvious these effects become.

There are other considerations, one of which is long-term charging effects within the power supply components themselves. This means that quick comparisons have to be backed up by much more protracted listening with uninterrupted connection, preferably over a period of days. The conclusions here are drawn from a combination of the two approaches, with all these systems exhibiting changing behaviour over time, normally exhibited as a drawing together of musical strands and an increase in musical coherence. The control for the listening was a pair of standard, decent quality mains

leads, plugged into unswitched sockets on a separate ring.

## Listening to the mains...

The first and most important thing about these listening tests is that each and every one of these set-ups represented a dramatic improvement over the control. Without exception they all offered major benefits in terms



of dynamic range, transparency and the range of tonal colours on show, this in turn translating into a more dramatic and engaging musical performance. Singers were far more expressive and immediate, the lyrics far more communicative. Bass was deeper and more tactile, the top to bottom timing and coherence of the playing much improved.

The bottom line here is simple: investing in a good quality mains loom is money well spent. By doing so you release the latent potential that you've already paid for in buying the components that make up your replay chain. After all, in a very real sense, when you are listening to music, you're actually hearing the mains. ►



audio rapture

01359 240687  
www.aanvilaudio.com



2 Star Lane, Ringwood, Hants, BH24 1AL  
Tel: 01425 461230 Fax: 01425 472054



...Join the dots!

phonography

Arcam, Rega, Rotel, Naim, Densen, Royd, Shahinian,  
Dynaecor, Ortofon, Cura, Dynaudio, Chord, Quadraspire

hi-fi+

REPRODUCING THE RECORDED ARTS

Back issues

If you missed out on earlier issues of HiFi+, and want to complete your collection, you can order them by calling

+44 (0) 1202 659380

or by visiting our website:

www.hifiplus.com

Issue 1,6,9 and 14 - Sold Out, Issue 2 - \$4.75

Issues 3-11 - £3.95.

Postage & packing: UK - Free. Europe - £1/magazine.

Rest of World - £1.50/magazine.

UK orders are sent by Parcel Post,  
please allow 2 weeks for delivery.

Overseas orders are sent by surface mail.



► Electricity is the building blocks on which your system operates. But not all mains leads and distribution blocks are created equal. Here we have the best we've come across (along with the Audioplan which was absent from the equation, standing in for the Shunyata at the publisher's home!) but each has its own specific character and strengths. To that end the specific comparisons will concentrate on the differences between these products: we've already established that they're worthwhile in themselves.

**The Russ Andrews Purifier Block, Super Purifier and Kimber Power Kords**

These components represent a very real benchmark, not least because they're the ones I've been relying on at home for a couple of years. That familiarity, and the hard won trust that goes with it make these the standard for

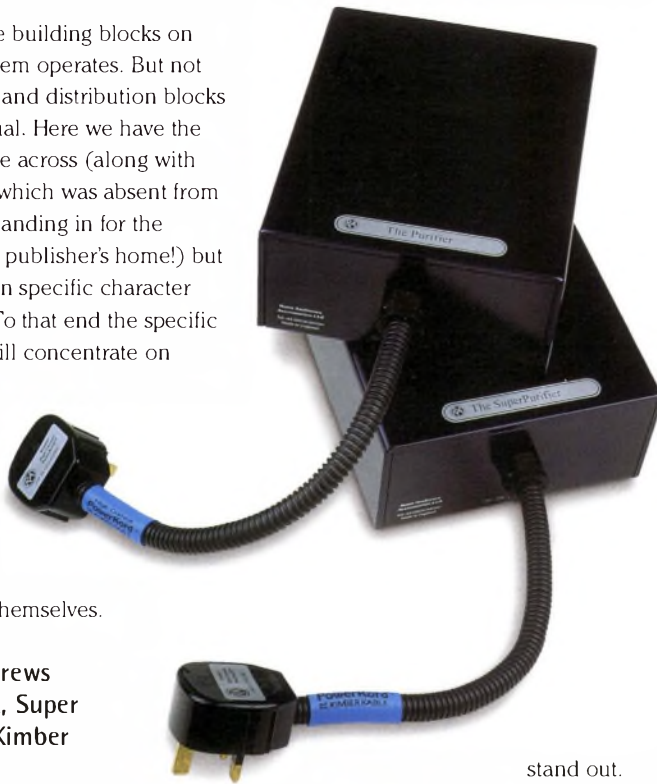

in the best Linn / Naim tradition, the Russ Andrews leads engage you with the performance, but without the tonal and spatial costs that attended the systems on which that approach was first established. It's a system that is outstandingly natural because of the organisation it brings to the detail it delivers. It simply makes sense of proceedings, and it does so so effortlessly that you don't notice it working, making it easier to enjoy the music.

**The Shunyata Research Hydra mains distribution block, and Sidewinder, Mojave and Python Power Snakes mains leads.**

The Shunyata components are far and away the most expensive here, with the Hydra distribution block alone costing \$2595! They are also the most impressive. How impressive? Originally reviewed by DA he dug deep and bought a set – and his system has no fewer than nine discrete components. You'd better believe he was impressed. The look of pain as I prised them from his grasp for this little exercise would haunt my dying day, if I only had a conscience.

Outwardly beautifully finished if straightforward, the Shunyata products are far more sophisticated than they appear. Pick up the monster Python mains lead and it rattles as loose grains tip from one end to the other. It's a granular chemical compound specifically developed to absorb and dissipate RFI and other forms of mains interference. Shunyata call it Stardust, but there's plenty of solid empirical physics behind the fanciful name. The cheaper leads (cheaper being a relative term you understand) don't benefit from a dose of Stardust but the Hydra is packed with it. Indeed, it's so effective that even simply plugging the Hydra in to the same ring, in parallel to your normal system produces an audibly significant benefit. ►

stand out. The naturalness of Eleanor McEvoy's vocal, the inflections and emphasis of her delivery, the sense and power of the lyric are served up clean, clear and effective. Those who hang on the shape and



comparison now that we've established that the control has been left, trampled in the dust. Music via the Russ Andrews is blacker, crisper, more detailed, much more coherent and much more natural. But it's the communicative qualities that really

phrasing of a lyric or instrumental line will love this set-up. It manages to effortlessly unravel the various strands in a track, the structure of the music, letting you hear each one without destroying the relationship between them. Indeed,

► So what do the Shunyatas deliver? Big, solid, dynamic sound with outstanding tonal shading, separation and presence. They also remove any hint of strain or stress from the music, allowing your system to scale dynamic heights previously undrempt of. The sheer solidity of performers and instruments, the depth, weight, texture and stability of the low frequencies delivers astonishing authority from even modest

The Delmoni track offers a richer, more substantive violin whilst the scale and perspective of the soundstage is impressively natural, the relationship between the placing and height of the two instruments convincingly stable and clearly defined.

That sense of shape extends down into the lower reaches, giving the bass drum a little extra kick and texture. There's more centre to its contribution, critical to the overall pace and progress of the track.

But it's the ruinously expensive Python that really tells you what the Shunyata system is capable of. (There's actually an even more expensive lead – the Anaconda – that I've only seen, but it's certainly got an appropriate name!) For a lead that's so massive

the Python is surprisingly flexible, which is a good analogy

for its sound. Anybody who thinks that mains leads don't make a difference should listen to this one.

It's big, present and immediate,

but at the same time

it's supple and capable of enormous subtlety. It's not often that

I'd suggest that a snare drum is a particularly expressive instrument, but the Python, catches its combination of skin and body, snap and weight perfectly.



Replacing the Sidewinders with the more expensive Mojaves adds further scale and power, but it's the increased dynamic range and discrimination that you're paying the extra for. It adds life and definition to the opening percussion of the Eleanor McEvoy track, and

systems, making their music powerful and direct. If scale, presence and substance are what you crave then you'd better start saving know.

The Sidewinder cables deliver the family character with a big, solid presentation, although the bass, whilst impressively weighty lacks some of the shape, texture and rhythmic precision of the Russ Andrews system. However, the sheer presence and immediacy is both engaging and appealing.

shape and purpose to the piano melody, with its halting, stabbed sprays of notes underpinning and punctuating the vocal. It adds up to a more intimately musical delivery than the Sidewinders are capable of.

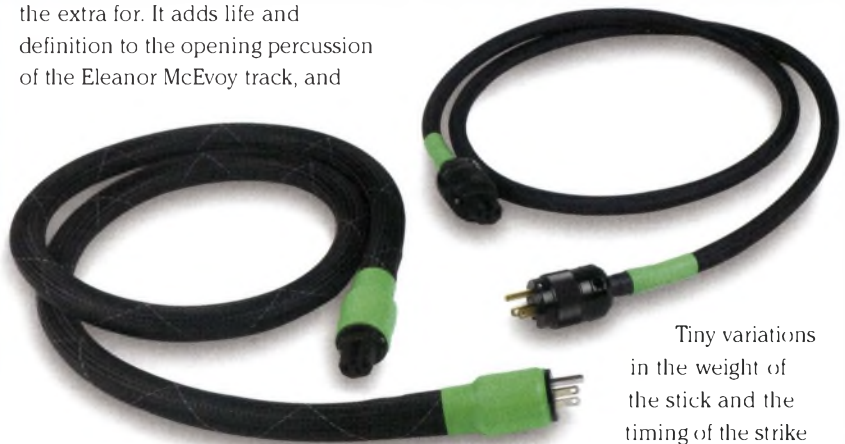

Tiny variations in the weight of the stick and the timing of the strike are laid bare, giving

the drumming shape and purpose beyond any of the other set-ups here. That subtlety extends to the separation of instruments and space within the soundstage. The control and definition on the vocal is superb, not least ►

# FREE Hi-Fi Upgrade

hififorsale.com Ltd's AudiophileCandy  
2003 accessories catalogue

2003

## Our NEW Edition Features:

- A massive selection of class leading audio accessories from manufacturers throughout the world
- Overviews and advice from leading industry experts
- The Latest Industry News
- "Your Views" letters page
- Over 65 full colour pages featuring over 350 products



AudiophileCandy 2003 is your **FREE** essential guide to the very best in audio accessories

## Grab Your Copy NOW

For your **FREE** copy of our latest catalogue visit [www.audiophilecandy.com](http://www.audiophilecandy.com) and fill in our contact form or call;

**0870 241 246 9**

Advertise your old Hi-Fi for **FREE** on-line at [www.hififorsale.com](http://www.hififorsale.com), or pick up an audio bargain. Every month we have over **50,000** visits and **2.5 million hits!** - What are you waiting for?

# DON'T RACK YOUR BRAINS



# RACK YOUR HI-FI



"But how does it sound? Wonderful... The absence of resonant smearing allows the music to flow in an open, communicative and unforced manner." - **Hi-Fi+**



"A top performer with matching price tag. Sleening neutrality and laid back with it, detail and control were always in abundance." - **Hi-Fi Choice**



"It simply clarified music heard from equipment sited on it. The definition of an acoustic guitar's plucked harmonics was perceptibly, and repeatedly, improved, and there was less smearing of instruments in the soundstage." - **Hi-Fi News**



"The Aspekt works well with a wide range of equipment from Rega's £300 Brio amp through to our reference Krell set-up." **Verdict:** One of the best equipment supports around. If your system justifies the outlay give it a go. - **What Hi-Fi?**



**TRY AN ASPEKT RACK TODAY**  
SIMPLY CALL: 0870 241 246 9

Audible errors are as obvious as poor spelling

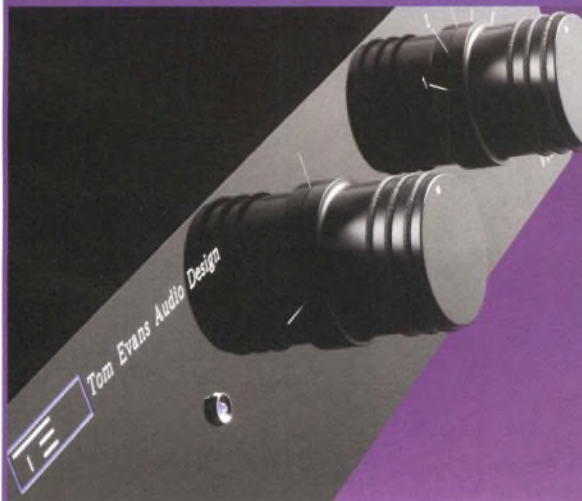

**Tom Evans Audio Design**  
tel/fax: 01443 833570

## Introducing the ea series of amplifiers by ECS



Whether it's music or film the EA series will enhance your passion.

A range of amplifiers designed by enthusiasts for enthusiasts.

- Mono Bloc & Stereo versions
- 200w per channel
- Bespoke 1500va Power Transformer
- Transformer balanced inputs
- Unbalanced audiophile gold phono connectors
- Ultra low impurity PCB copper track
- Zero inductance components used in critical paths
- Ultra low tolerance and inductance components used throughout
- Ultra short audio signal path
- Hand selected audio grade components
- 3 years parts and labour warranty

See & Hear us at the Bristol Show Room 416

Contact us for more info and for your nearest dealer.

ECS Ltd  
020 8743 8880  
020 8746 4315

[www.ecsamplifiers.co.uk](http://www.ecsamplifiers.co.uk)

'Superb amplifier with bags of power and genuine resolution, one of the best music appreciation devices available.'  
 BorderPatrol P20, Jason Kennedy Hi-Fi Choice Summer 2002.

'.....for the first time in my experience, I'm listening to an amplifier with the linearity and directness that are supposed to be single-ended's great virtues'  
 BorderPatrol SE300B  
 Roy Gregory Hi-Fi+ issue 8.



**BorderPatrol**

Tel/Fax 00 44 (0)1273 276716

e-mail bp@borderpatrol.net

www.borderpatrol.net

**UNIQUE!**

# ClearCover™

Protect Your Sound Investment

## HANDCRAFTED ACRYLIC DUST COVERS FOR CLEARAUDIO CHAMPION TURNTABLES

- Attractive and substantial handmade dustcover, formed from 5mm acrylic.
- Small rubber feet make locating easy and prevent slipping.
- Rear cable aperture for arm leads that exit above the deck.
- Standard 90mm height clears most tonearm installations.
- 140mm high option available for deep platter models.
- Smoked Grey version suits black chassis decks.

**From just £125.00**

**Covers and protects the whole deck top area when not in use.**

**NEW! UniCover™**

Universal covers that fit over most open chassis style decks, e.g. Gyro SE, SME 10, Wilson Benesch Circle, Pro-ject RPM9 etc.

**Specific ClearCovers also in development for other popular decks not offering lids as standard or as an option. Call for details.**

**Bespoke service available for one-offs, call for quote.**

ClearCover UK Limited  
 117a New Rd, Croxley Green  
 Herts, WD3 3EN, UK

If you sell or own any of these decks, then you may well need a ClearCover:

- Acoustic Signature
- Amazon
- Audio Note
- AVID
- Basis
- ClearAudio
- Croft
- Kuzma
- Michell Engineering
- Nottingham Analog
- Oracle
- Pink Triangle
- Pro-ject
- Reson
- Roksan
- Simon Yorke
- SME
- Sound by Design
- Sota
- Thorens
- Verdier
- VPI
- Well Tempered
- Wilson Benesch

Mail Order & Dealer Enquiries: 01923 351512 Email: chris@clearcover.co.uk [www.clearcover.co.uk](http://www.clearcover.co.uk)

# The Cartridge Man

We sell our own MusicMaker cartridge, digital stylus force gauge and digital turntable level. We also carry a limited range of valve equipment - Croft, E.A.R. - and pick up arms - Hadcock, S.M.E. Ortofon, Graham Slee Projects and a few other high quality products.

We also rebuild classic valve equipment, giving you a choice as the level of specification. We have in stock a range of original Mullard valves, including the sought after EL 34's. Also available is a turntable setting up service, this is free when you purchase one of our cartridges as is our Test Record.

We don't believe that quality is necessarily synonymous with massive amounts of 'dosh', we encourage customers to purchase second-hand items where appropriate. Sound quality come before cosmetics. Remember' it doesn't have to cost an arm and a leg... And don't forget our cartridge rebuild service.

88, Southbridge Road, Croydon, CRO 1AF. tel/fax; 020 8688 6565. [www.thecartridgeman.com](http://www.thecartridgeman.com)

► because it's the sort of velvet grip that manages to define without crushing the life and expression out of the music.

Whether it's the tension in the skin on a drum or the dramatic tension in a vocal, the Hydra / Python set-up delivers it in a big, bold and incredibly direct fashion. The weight, solidity and stability are impressive indeed, even on (or should that be especially on) small scale music, while the life, immediacy and directness allows immediate contact with the music. If the Shunyata's have a weakness it's that they lack the effortless sense of shape and rhythmic agility that the Russ Andrews system delivers. But in every other respect they are clearly and dramatically both more expensive and sonically superior to the other options here.

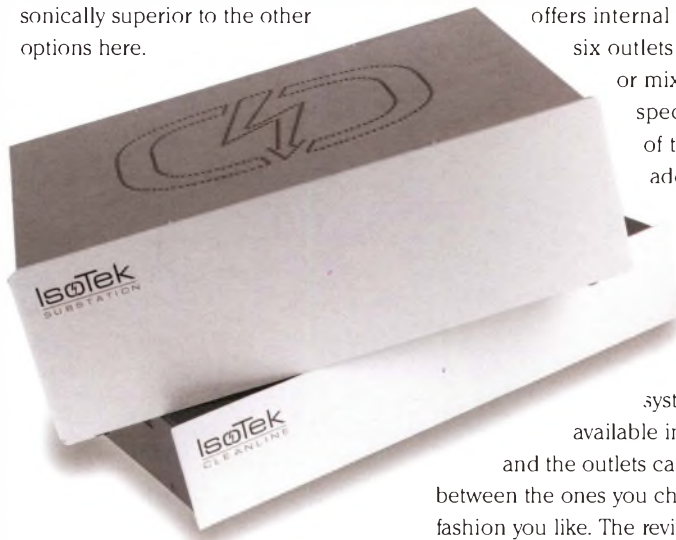

### The Isotek Substation and 2 kVA Qube

The Isotek units were reviewed Issue 19 so I'll skip the in depth description of what is the most versatile piece of kit here. Indeed, there are so many options that just explaining them all in detail would add another page to this article! However, the short version is as follows. The Substation is



a chassis that can be built up to contain a variety of modules. In its simplest form it offers internal filtering and six outlets of any type or mix you care to specify. On top of that you can add isolation transformers designed to separate different elements in the system. These are available in three sizes,

and the outlets can be split between the ones you choose in any fashion you like. The review unit has three 300 VA modules, each connected to two UK style sockets, but as each chassis is built to order, you can specify exactly what you need. Although Isotek now have a mains cable of their own it wasn't available in time for this listening, so the Kimber leads were used both

sides of the Substation, feeding it and the system.

The sound of the Isotek Substation majors on transparency and definition. It delivers the music with less inter-instrumental grain and greater layering in the depth dimension than the other set-ups here. Only the Shunyata's match the transparency and separation of the Isotek, although the greater dimensionality of their individual images reduces the overall impression

of space. In contrast, the Isotek offers smaller and less substantial images that make more of the space and depth it delivers. The only real downside was that the bass from the Hegel integrated amp sounded deeper than with the Russ Andrews set-up but also rather leaden. What I'd call an extra sandbag in the bass drum syndrome. That was with the H1 running from its own 300 VA isolation module, which might be asking a little much of the Substation which is really designed for source components and pre-amps.

Sure enough, substituting the 2 kVA Qube rectified things pretty dramatically. The bass actually gained weight, but also pitch and drive. The increased sense of shape banished the dragging quality ►

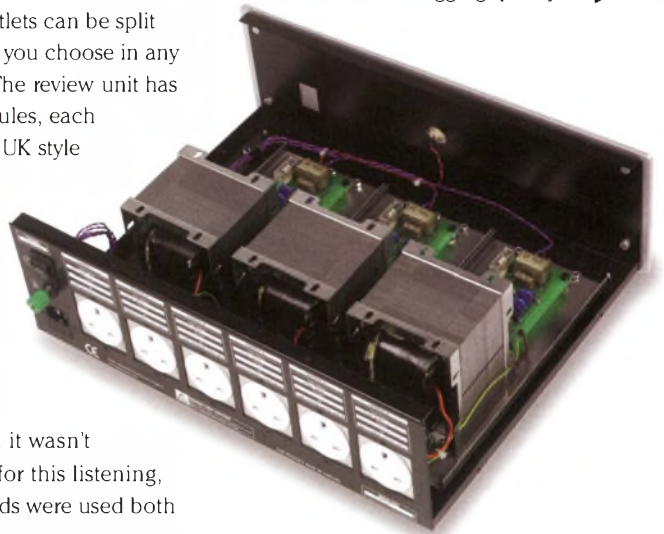

► and replaced it with a welcome sense of power. I can't say that it was the most subtle or textured bass, but it gets full marks for enthusiasm. The other quality that the Qube brought with it was a more rooted and stable quality to the sound-stage.



and lower current 20 Amp version, while the extension block can be ordered with pretty much as many or as few sockets as you require. I've only listed the common options, but anything is, as they say, possible. These are beautifully finished and presented products, the white webbed finish on the power leads being especially handsome (although I do worry what it might look like a couple of years down the road!). Although outwardly simple as far as I can gather these units employ a similar approach to the Shunyata ones, their materials and construction ensuring incredibly high levels of noise rejection.

Whether it's coincidence or not, they also sound most like the Shunyatas in overall character, with a confident solidity and presence to their music. Their range of tonal colours and harmonic definition are especially impressive, whilst they also demonstrate an attractive delicacy. Their sound-staging is extremely coherent, their good tonal and spatial separation delivering clarity rather than pulling the music apart. They separate the snare and plastic strung guitar better than any of the other set-ups here short of the Hydra / Python combination, and do it with a wonderful, natural warmth. It's a stark contrast to the slight tonal compression of the Russ Andrews system or the hint of coldness to the Isotek.

I'd started the listening using a couple of the Kimber leads to ensure consistency. Swapping out the one feeding the CD player for the

delivering a more coherent acoustic, one that enclosed Delmoni and Burgess much more obviously in the same space.

One final thing: Isotek make much of the benefits of mutual isolation within the system, something that I have experienced in the past with the Audioplan modular mains system. Sure enough, adding the Sonifex Red Box DAC into the overall scheme of things brought with it an infusion of grain and greyness to proceedings in each and every case. But the effect was significantly less noticeable with it connected via its own Isotek isolation transformer, and that in

the system which offers the lowest overall grain as it is, making it the one in which any increase would be most apparent.

### **The Experience Filtration V250 F 30 Amp mains filter, Distribution Block and SCI 1.5M mains lead**

Experience Filtration are the one newcomer in this overview. They supplied their V250 F mains filter, a cylindrical design that looks like it would be more at home in the Turbine Room at Tate Modern than a hi-fi system, along with a distribution block and a mains lead. The filter is also available in a slightly cheaper



► Experience SCI 1.5M lead brought a further improvement in tonal range and focus, underlining the importance of creating a coherent mains loom, just like your interconnect and speaker leads.

### A Conclusion Of Sorts

If you think that spending upwards of a thousand pounds simply connecting your system to the wall is extravagant then you

and he parted with a considerable sum in order to retain its benefits.

But if the Shunyata is a little rich for your wallet, the more affordable options are also well worth investigating. Qualitatively pretty much on a par with each other, they offer subtly different balances. The Russ Andrews system can certainly lay claim to being the first, and in terms of rhythmic and musical communication is still the best. The



Isotek is the most transparent and offers the best spatial definition. It would also be my choice for any system with a host of clashing digital devices or laden with DSP. The Experience Filtration products offer the greatest presence, weight and solidity. You pays your money and takes your choice.

need to hear the considerable benefits delivered by all of the mains looms featured here. Having said that, they're not all created equal and each has its own character and weaknesses. Nothing, after all, is perfect.

By far the best in most individual respects, and certainly overall, is the expensive Shunyata rig. This offers an almost incredible improvement in terms of colour, solidity, presence and dynamic range, making listening to recorded music a dramatically more palpable experience, but boy do you pay for the pleasure. The really crazy thing is that it's worth it. Remember, this set came from the publisher's system

However, what is abundantly clear is that that money will be well spent.

How much of your budget should you devote to the mains feeding your system? Well, the rule of thumb regarding interconnecting leads used to be around 10%. That's inadequate for your signal leads and it's probably inadequate for your mains leads too. Am I really suggesting you devote something like 30% of your total expenditure to hooking the boxes that actually do the work together? Oh yes, and the proof is in the listening. Don't knock it until you've tried it. ►+

### Prices And Availability

Russ Andrews Accessories Ltd  
Tel. (44)(0)1539-825500  
Fax. (44)(0)1539-825540  
Net. www.russandrews.com

Kimber High Current Powerkords (5')  
£156 ea  
Purifier Block £500  
Super Purifier £350

Audio Atmosphere (Shunyata)  
Tel. (44)(0)1785-711232  
E-mail. stuart@audioatmosphere.com  
Net. www.powersnakes.com

Hydra £2595  
Sidewinder Gold £329  
Mojave £599  
Python £998

Aktiv Distribution (Isotek)  
Tel. (44)(0)1635-291357  
E-mail. isotek@aktivdistribution.co  
Net. www.isoteksystems.com

Isotek Substation From £405  
Transformer Modules  
150 VA £175  
300 VA £205  
600 VA £285

Isotek 2kVA Qube £1495

Experience Filtration  
Tel. (44)(0)1332-757068  
E-mail. info@experiencefiltration.com  
Net. www.experiencefiltration.com

V250F 30 Amp Filter £1190  
V250F 20 Amp Filter £990  
Distribution Block -  
4 Way £315  
6 Way £350  
8 Way £385  
SCI 1.5M Mains Lead £155

# SELECTED PRE-OWNED & EX-DEMONSTRATION ITEMS

## All Fully Warranted with Extended Trade-Back Guarantee

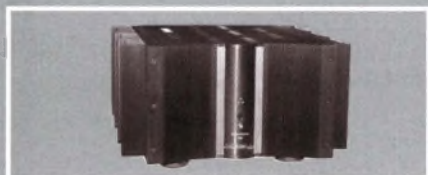

**KRELL FPB300 EX-DEM AS NEW** £9998 **£6998**



**MARK LEVINSON 380** £4495 **£2990**



**PATHOS Twin Towers Ex-dem** £3250 **£2495**



**WADIA 8 Tran+DDE12 DAC** £7500 **£3600**



**REVOX B710 Mk2** £548



**MICHELL Gyro SE EX-DEM AS NEW** £740

### VINYL REPLAY

<b>DUNLOP</b> Systemdeck 3 / Basik LVX / KS	£750	<b>£379</b>
<b>DYNAVECTOR</b> Dactor cartridge	£2500	<b>£1625</b>
<b>MICHELL ISO HR</b> Phono Stage Ex-dem	£895	<b>£696</b>
<b>MICHELL Gyro SE EX-DEM AS NEW</b>		<b>£740</b>
<b>MICHELL</b> Delphini Phono LPSU EX-DEM AS NEW	£895	<b>£738</b>
<b>MICHELL</b> Delphini Phono SPSU EX-DEM AS NEW	£998	<b>£798</b>
<b>MICHELL ISO/HERA</b> Phono Stage	£895	<b>£448</b>
<b>MICHELL ISO HR/HERA</b> Phono Stage	£895	<b>£480</b>
<b>REVOLVER</b> Turntable + Linn LVX arm	£380	<b>£148</b>
<b>SME 10A</b> with 309 Tone Arm Ex-dem	£3410	<b>£2896</b>
<b>VOYD</b> Reference inc arm	£14,995	<b>£5000</b>
<b>WELL TEMPERED</b> Reference turntable	£5500	<b>£3575</b>
<b>WILSON BENESCH</b> Full Circle (Mint)	£1995	<b>£1495</b>

### CD • DVD

<b>ARCAM</b> Alpha CD	£300	<b>£96</b>
<b>ARCAM</b> Alpha 6 CD + Clock 3	£850	<b>£458</b>
<b>AUDIO ALCHEMY V1</b> + PSU	£489	<b>£169</b>
<b>AUDIO ALCHEMY V3</b> DAC + PSU	£900	<b>£549</b>
<b>AUDIO ANALOGUE</b> Maestro EX-DEM	£1500	<b>£1298</b>
<b>AUDIOLAB</b> 8000 DAC	£1000	<b>£496</b>
<b>AUDIO MECHA</b> Kreatura Trans	£1500	<b>£648</b>
<b>AUDIO MECHA</b> Damnation + Upgrade	£1250	<b>£599</b>
<b>CALIFORNIA AUDIO LABS</b> CD Trans	£600	<b>£298</b>
<b>CYRUS</b> daD 3Q	£900	<b>£498</b>
<b>DPA</b> PDM 1 DAC	£1000	<b>£438</b>
<b>KRELL KPS 25</b> CD/Pre	£24,998	<b>£14,996</b>
<b>KRELL 250</b> CD Player	£3798	<b>£2000</b>
<b>KRELL 250</b> CD Player AS NEW	£3798	<b>£2298</b>
<b>KRELL KPS28</b> CD Player EX-DEM	£8998	<b>£7496</b>
<b>LINN</b> Karik CD	£1850	<b>£1098</b>
<b>MARK LEVINSON</b> 31.5 Ref transport	£10500	<b>£6500</b>
<b>MARK LEVINSON</b> 360S DAC	£7500	<b>£4875</b>
<b>McINTOSH</b> MCD751 CD Trans EX-DEM	£2549	<b>£1996</b>
<b>McINTOSH</b> MVPB42 DVD Player EX-DEM	£3390	<b>£2896</b>
<b>MERIDIAN</b> 203 DAC	£499	<b>£228</b>
<b>MERIDIAN</b> 563 DAC	£705	<b>£398</b>
<b>MERIDIAN</b> 500 Trans	£1400	<b>£798</b>
<b>MERIDIAN</b> 596 DVD Player EX-DEM	£2549	<b>£1996</b>
<b>MICROMEGA</b> DAC1	£750	<b>£320</b>
<b>MONRIO</b> Asty CD Plyr NEW IN BOX	£750	<b>£495</b>
<b>MONRIO</b> 18B2 DAC EX-DEM	£600	<b>£295</b>
<b>NAIM</b> CD3		<b>£595</b>
<b>NAIM</b> CD3/XPS Mk2 EX-DEM	£6265	<b>£4994</b>

<b>NAIM</b> CDX Ex-dem	£2470	<b>£1974</b>
<b>NVA</b> Emotive Statement (Must be seen!)	£2200	<b>£998</b>
<b>ORELLE</b> DA10T Trans	£900	<b>£450</b>
<b>PIERRE LURNE</b> Elixir DAC	£500	<b>£348</b>
<b>PIERRE LURNE</b> Audio Mecca Kreatura Trans	£950	<b>£598</b>
<b>PINK TRIANGLE</b> Cardinal (Trans)	£1250	<b>£550</b>
<b>PRIMARE</b> V20 DVD Plr EX-DEM AS NEW	£998	<b>£848</b>
<b>RADFORD</b> WS1 CD Player	£999	<b>£358</b>
<b>REGA</b> Planet	£500	<b>£350</b>
<b>REGA</b> Jupiter Ex-dem	£1000	<b>£658</b>
<b>REVOX</b> 8225	£1000	<b>£348</b>
<b>TAG</b> CD120R (Trans)	£2200	<b>£1100</b>
<b>TEAC</b> VRDS 10 (CD Player)		<b>£450</b>
<b>TEAC</b> P500 (Trans)	£850	<b>£400</b>
<b>THETA</b> Gen Pro IV	£4500	<b>£2400</b>
<b>THETA</b> DATA Basic	£2400	<b>£1100</b>
<b>THETA</b> Pro Basic IIIA (DAC)	£4000	<b>£1990</b>
<b>THETA</b> Pro Time II	£2000	<b>£995</b>
<b>THORENS</b> TDC2000(Trans) + TDA2000(DAC)	£2000	<b>£1198</b>
<b>THORENS</b> TDA2000 Integrated CD Player	£995	<b>£796</b>
<b>TRICHORD</b> Pulsar 1 DAC + PSU	£1800	<b>£1298</b>
<b>WADIA</b> 8 Tran+DDE12 DAC	£7500	<b>£3600</b>

### AMPLIFIERS • TRANS

<b>AUDIO ANALOGUE</b> Maestro EX-DEM AS NEW	£2600	<b>£2098</b>
<b>AUDIOLAB</b> 8000A Integrated	£700	<b>£300</b>
<b>AUDIOLAB</b> 8000Q Pre	£1200	<b>£596</b>
<b>AUDIOLAB</b> 8000M X 2 Power amps	£1600	<b>£796</b>
<b>BAT</b> VK40	£4950	<b>£2600</b>
<b>CYRUS</b> Pre	£700	<b>£358</b>
<b>CYRUS</b> Power	£700	<b>£358</b>
<b>CYRUS</b> III	£600	<b>£358</b>
<b>CYRUS</b> PSXR	£498	<b>£228</b>
<b>CYRUS</b> Monoblocks	£1800	<b>£700</b>
<b>DENON</b> AVP-A1D Digital Pre-amp	£2500	<b>£1299</b>
<b>DENON</b> ADV 700 Ex-demo	£750	<b>£644</b>
<b>DEVA</b> 250 Integrated + Matching Power	£1000	<b>£450</b>
<b>ELECTROCOMPANET</b> EC3 MC	£2200	<b>£1188</b>
<b>EXPOSURE</b> 7/8 pre & Power	£1100	<b>£400</b>
<b>HARMON KARDON</b> AVR85 AV Rec	£1000	<b>£498</b>
<b>JEFF ROWLAND</b> C.3 (pre-amp)	£4990	<b>£2490</b>
<b>KRELL</b> KAV300i	£3965	<b>£2500</b>
<b>KRELL</b> KSA 80 Power amp	£3000	<b>£1600</b>
<b>KRELL</b> KAV300i EX-DEM AS NEW	£3965	<b>£3168</b>
<b>KRELL</b> FPB300 EX-DEM AS NEW	£9998	<b>£6998</b>
<b>KRELL</b> KCT Pre-amp EX-DEM	£9998	<b>£6998</b>

<b>KRELL</b> KAV250P Pre	£2995	<b>£1850</b>
<b>KRELL</b> KAV250A Pwr (Choice of two from £2350)	£3698	<b>£2350</b>
<b>KRELL</b> FPB650 Mono's. 5 available, price each	£14,000	<b>£8000</b>
<b>LFD</b> LS1 Pre-amp	£1900	<b>£500</b>
<b>LFD</b> LS2 Pre-amp	£950	<b>£250</b>
<b>LINN</b> LK1	£450	<b>£194</b>
<b>LINN</b> LK2	£550	<b>£299</b>
<b>LINN</b> Kairn Pre	£1700	<b>£1098</b>
<b>MARK LEVINSON</b> 32 Pre inc phono	£17500	<b>£11380</b>
<b>MARK LEVINSON</b> 33H Power amps	£20000	<b>£13000</b>
<b>MARK LEVINSON</b> 27.5 Power	£6000	<b>£3998</b>
<b>MARK LEVINSON</b> 380	£4495	<b>£2990</b>
<b>McINTOSH</b> MX 132 Pre/Processor Ex-dem	£7990	<b>£4996</b>
<b>McINTOSH</b> MC7108 8 Channel Ex-dem	£2549	<b>£1996</b>
<b>McINTOSH</b> MC122 EX-DEM AS NEW	£1249	<b>£998</b>
<b>McINTOSH</b> MC35L EX-DEM AS NEW	£5095	<b>£3998</b>
<b>McINTOSH</b> MC7108 8 Channel power Amplifier EX-DEM AS NEW	£2549	<b>£1998</b>
<b>McINTOSH</b> MX1 32 AV contr EX-DEM AS NEW	£7990	<b>£5498</b>
<b>MERIDIAN</b> 201 Pre	£760	<b>£329</b>
<b>MERIDIAN</b> 557 ex demo	£1625	<b>£1294</b>
<b>MERIDIAN</b> 563 Ex-dem	£700	<b>£446</b>
<b>MICHELL</b> Argo + Hero		<b>£598</b>
<b>MONRIO</b> MPI 135w EX-DEM	£600	<b>£395</b>
<b>MONRIO</b> MP2 135w X 2 NEW	£950	<b>£595</b>
<b>MONRIO</b> MP3 135w X 3 NEW	£1225	<b>£795</b>
<b>MONRIO</b> MP2 135w X 5 NEW	£1500	<b>£895</b>
<b>MUSICAL FIDELITY</b> The Pre-Amp 3a	£1300	<b>£240</b>
<b>MUSICAL FIDELITY</b> P270	£2000	<b>£578</b>
<b>NAD</b> C160 Pre	£420	<b>£278</b>
<b>NAGRA</b> VPA Monoblocks EX-DEM AS NEW	£9350	<b>£7748</b>
<b>NAIM</b> NAIT 3 Choice of two	£700	<b>£498</b>
<b>NAIM</b> NAP90 (Power)	£600	<b>£378</b>
<b>NAIM</b> NAP90 (Power)	£600	<b>£400</b>
<b>NAIM</b> Hi-Cop (New style)	£780	<b>£498</b>
<b>NAIM</b> NAC 102 Pre (Ex-dem)	£1210	<b>£964</b>
<b>NAIM</b> NAC 82 Pre (Ex-dem)	£2500	<b>£1994</b>
<b>REGA</b> Elicit	£750	<b>£498</b>
<b>REGA</b> Cursa (Pre) Ex-dem	£1000	<b>£638</b>
<b>REGA</b> Exons (Monoblocks) Ex-demo	£750	<b>£498</b>
<b>ROTEL</b> RC971 (Pre)	£450	<b>£248</b>
<b>ROGERS</b> A100 Integrated	£400	<b>£154</b>
<b>SONY</b> SDPEPES (Digital)		<b>£298</b>
<b>TALK ELECTRONICS</b> Storm (Intgrd)	£650	<b>£370</b>
<b>TESSERA</b> Pre	£1500	<b>£798</b>
<b>THETA</b> Gasanova Pre Ex-dem	£4478	<b>£3596</b>
<b>VERITAS</b> P400 Power	£3000	<b>£2496</b>

## WANTED

TOP QUALITY, MINT CONDITION  
HI-FI EQUIPMENT & SYSTEMS  
CASH, COMMISSION SALES AND  
GREAT PART-EXCHANGE OFFERS  
AGAINST NEW EQUIPMENT

## NEW, NEW, NEW

WE CAN SUPPLY MANY TOP  
HI-FI & HOME-CINEMA BRANDS  
AND YOU'LL GET THE BEST TRADE-IN  
ALLOWANCES FOR YOUR UNWANTED  
HI-FI EQUIPMENT & SYSTEMS

## GUARANTEE

THREE MONTHS PARTS & LABOUR  
WARRANTY ON ALL SALES  
GENEROUS TRADE-BACK OFFERS  
IF YOU DECIDE TO UPGRADE  
AGAIN WITHIN TWELVE MONTHS

# NOW YOU CAN TRADE-UP TO NEW Top Brands - Top Part-Exchange Prices

## High-End Cables Make Fabulous Savings on Some Serious Connections



CONRAD JOHNSON PV11 Pre £1600 ~~£999~~



CARY CAD300SE monoblocks (As new) £5000 ~~£3998~~



BAT VK40 £4950 ~~£2600~~



NAGRA PL-L (Line Level Pre) Ex-dem - Mint £5395 ~~£4395~~



AUDIO INNOVATIONS Alto Integrated Amplifier £208



PATHOS Classic One EX-DEM AS NEW £995 ~~£848~~

### AMPLIFIERS • VALVE

ARION Electro Integrated	£1200	<del>£598</del>
AUDIO INNOVATIONS	£1500	<del>£748</del>
AUDIO INNOVATIONS L2	£700	<del>£448</del>
AUDIO INNOVATIONS Monoblocks	£2999	<del>£1948</del>
AUDION Silver Knight 300B Mono's	£2250	<del>£1390</del>
AUDION Silver Knight 300B Intgrld EX-DEM	£1125	<del>£876</del>
AUDIONOTE M2 Pre	£1000	<del>£600</del>
AUDIO PRISM Debut (Red Rose)	£2800	<del>£1700</del>
AUDIO PRISM Mantissa (Red Rose)	£3000	<del>£1800</del>
AUDIO RESEARCH LS2 Pre	£2800	<del>£1798</del>
AUDIO RESEARCH LS15 Pre	£2995	<del>£1996</del>
AUDIO RESEARCH BL1	£699	<del>£496</del>
AUDIO RESEARCH LS8 Pre-amp	£1800	<del>£1196</del>
AUDIO RESEARCH LS16 Pre-amp EX-DEM	£2999	<del>£2398</del>
AUDIO RESEARCH VT100/3 Pwr EX-DEM	£6400	<del>£5198</del>
AUDIO RESEARCH VT50 Power Amp	£3499	<del>£2496</del>
AUDIO RESEARCH VT100 Mk1 Power Amp	£5500	<del>£3498</del>
CARY Pre-amp	£3500	<del>£1490</del>
CARY CAD300SE monoblocks (As new)	£5000	<del>£3998</del>
CLASSE CA200 + DR6	£7700	<del>£3500</del>
CLASSE CA100 Power	£2000	<del>£1128</del>
CONRAD JOHNSON PV11 Pre	£1600	<del>£999</del>
CONRAD JOHNSON PV12V Pre	£2000	<del>£1128</del>
CONRAD JOHNSON PV14L Pre (3hrs use!)	£2200	<del>£1590</del>
CONRAD JOHNSON Premier 17 Pre	£4750	<del>£2750</del>
CONRAD JOHNSON Premier B Monoblocks	£16,000	<del>£9750</del>
COPLAND CTA 301 Pre	£1299	<del>£899</del>
CR DEVELOPMENTS Carmeto (Pre)	£900	<del>£428</del>
GOLDMUND Mimesis 6 Amp Ex-dem	£2900	<del>£1726</del>
GOLDMUND Mimesis 4 Tuner Ex-dem	£6100	<del>£2996</del>
GRAAF 13.5 Bil Pre Ex-dem	£3950	<del>£2996</del>
JADIS DA30 Integrated	£3500	<del>£2246</del>
MICHAELSON Odysseus 40w Int	£1150	<del>£699</del>
NAGRA PL-L (Line Level Pre) (Mint)	£5395	<del>£4395</del>
PAPWORTH TVAS0	£2000	<del>£1198</del>
PATHOS Classic One EX-DEM AS NEW	£995	<del>£848</del>
PATHOS Twin Towers	£3250	<del>£2495</del>
PM COMPONENTS Monoblocks	£3000	<del>£1498</del>
QUAD 22 + 2 monoblocks	£450	
UNISON RESEARCH Feather 1 EX-DEM	£795	<del>£495</del>
UNISON RESEARCH Power 35 EX-DEM	£1500	<del>£895</del>

### LOUDSPEAKERS

ACOUSTAT Model 2 Electrostatics	£2500	<del>£674</del>
ARIEL ACOUSTICS Model B's (stands) Ex-dem	£5679	<del>£3996</del>
AUDIONOTE AN/E (Inc stands)	£2900	<del>£1748</del>
B&W DMB01 (Rosewood)	£1500	<del>£749</del>

B&W THX System EX-DEM	£4975	<del>£2498</del>
CASTLE Chester (Blk)	£900	<del>£475</del>
CASTLE Howard S2	£1400	<del>£848</del>
DALI 400	£800	<del>£400</del>
DYNAUDIO SDA 2.4	£650	<del>£348</del>
ENSEMBLE Primadonna VERY RARE	£10,000	<del>£4,000</del>
EPOS ES1.4 Inc stands	£950	<del>£394</del>
GAMMA ACOUSTICS Epoch 5	£3000	<del>£998</del>
GERSHMAN X1	£2500	<del>£1298</del>
HALES Signature System 2	£4000	<del>£1848</del>
HARBETH Compact 7ES EX-DEM	£1299	<del>£996</del>
HARBETH HLP-3ES EX-DEM	£799	<del>£596</del>
HEYBROOK Heystack (Rosewood)	£500	<del>£297</del>
IMPULSE H7 (Black)	£1000	<del>£480</del>
INFINITY Modulux (Inc stands)	£600	<del>£390</del>
KEF Cube (EQ Box)	£700	<del>£246</del>
KEF Coda 80 Centre Speaker Maple As new	£150	<del>£124</del>
KEF Ref 4.2 (Rosewood)	£3650	<del>£2300</del>
KEF Kober (Black)	£2000	<del>£780</del>
LINN Kober (Rosewood) ACTIVE	£2500	<del>£1350</del>
M&K VX100 Sub EX-DEM	£754	<del>£634</del>
M&K VX7 Mk2 Sub EX-DEM	£474	<del>£384</del>
MAGNA PLANAR 1a Imp	£1400	<del>£850</del>
MAGNA PLANAR MG111A	£3500	<del>£1195</del>
MARTIN LOGAN Aerius i	£2295	<del>£1595</del>
MARTIN LOGAN SL3	£3399	<del>£1995</del>
McINTOSH CS350 (Centre speaker) EX-DEM	£2295	<del>£1896</del>
McINTOSH LS320 EX-DEM	£1790	<del>£1296</del>
McINTOSH LS340 EX-DEM	£4590	<del>£3598</del>
McINTOSH LS360 EX-DEM	£6389	<del>£4998</del>
McINTOSH PS112 Active Sub EX-DEM	£2290	<del>£1798</del>
MEADOWLARK Shearwater	£2990	<del>£1990</del>
MERIDIAN AS00	£800	<del>£478</del>
MERIDIAN DSP33 Stereo Pair EX-DEM	£2475	<del>£2146</del>
MERIDIAN DSP33C Centre EX-DEM	£1355	<del>£1146</del>
MERIDIAN DSP500 (20 bit) EX-DEM	£6995	<del>£4998</del>
MERIDIAN DSP500C (Dig Centre) EX-DEM	£1995	<del>£1594</del>
MERLIN TSM-SE (Mint)	£1600	<del>£1148</del>
MISSION 754P (Rosewood)	£1200	<del>£698</del>
MISSION 783 (Beech) EX-DEM AS NEW	£999	<del>£794</del>
MISSION 78C (Centre) EX-DEM AS NEW	£350	<del>£274</del>
MISSION MCL (Block) EX-DEM AS NEW	£100	<del>£74</del>
MONITOR AUDIO Studio 14	£900	<del>£400</del>
MORREL Bass Master (Oak)	£1600	<del>£728</del>
NAIM Credo Ex-dem	£1425	<del>£994</del>
NAIME PERFECT Virtuosa Ex-dem	£1395	<del>£698</del>
OPERA SPI (Cherry) EX-DEM AS NEW	£525	<del>£428</del>

PINK TRIANGLE Ventrical	£1500	<del>£950</del>
PROAC Studio 1 Mk2	£1000	<del>£350</del>
PROAC Response 1.5 (Rosewood) EX-DEM	£1970	<del>£1596</del>
PROAC Response 2.5 (Lt Oak) EX-DEM	£2700	<del>£2148</del>
QUAD ESL63 (Block)	£3500	<del>£1400</del>
REGA Naos (Cherry) EX-DEM AS NEW	£998	<del>£794</del>
REGA ARA (Cherry) EX-DEM AS NEW	£255	<del>£214</del>
REGA ELA Ex-dem	£750	<del>£418</del>
REGA XEL (Block)	£990	<del>£640</del>
REL Q100 Sub	£750	<del>£448</del>
REL Strata 3 Sub	£800	<del>£548</del>
ROGERS Studio 9	£3000	<del>£1598</del>
ROKSAN Ojan (Ex-dem - Mint)	£1000	<del>£590</del>
SUARK Equinox (Block)	£2200	<del>£1400</del>
SUARK Sceptre	£700	<del>£348</del>
SUARK Logrhythm (Sub)	£900	<del>£498</del>
SNELL J3 High Sensitivity Monitors	£770	<del>£449</del>
SNELL Type E2	£2000	<del>£698</del>
SONUS FABER Grand Piano (Ex-dem)	£1699	<del>£1399</del>
SONUS FABER Gravis Sub EX-DEM	£999	<del>£798</del>
SONUS FABER Amati Homage EX-DEM	£11850	<del>£9996</del>
SONUS FABER Cremona Homage EX-DEM	£4995	<del>£4196</del>
SONUS FABER Concertino EX-DEM	£599	<del>£529</del>
SONUS FABER Electro EX-DEM	£1789	<del>£1349</del>
SOUNDLAB Dynastats	£3200	<del>£1400</del>
SYSTEM 165 (Mahogany)	£500	<del>£244</del>
THIEL CS2.3	£3500	<del>£2298</del>
TRIANGLE Icare	£1500	<del>£748</del>
TRIANGLE Zephyr XS EX-DEM AS NEW	£595	<del>£395</del>
TRIANGLE Lyrr XS EX-DEM AS NEW	£1600	<del>£895</del>
TRIANGLE Titus XS EX-DEM AS NEW	£335	<del>£225</del>
TRIANGLE Comete XS EX-DEM AS NEW	£395	<del>£275</del>
TRIANGLE Antal XS EX-DEM AS NEW	£875	<del>£595</del>
WILSON Cub (Block Laminated) Ex-dem	£5495	<del>£3496</del>
WILSON Cub (Gloss) Ex-dem	£6890	<del>£3996</del>
WILSON 6 (Block) Ex-dem	£1999	<del>£13998</del>
WILSON 6 - still in their crates!	£18500	<del>£12030</del>
WILSON BENESCH Orator EX-DEM AS NEW	£2900	<del>£2524</del>
WILSON BENESCH Actor EX-DEM AS NEW	£3999	<del>£2998</del>
WILSON BENESCH Act-1 EX-DEM AS NEW	£6999	<del>£4499</del>
WILSON BENESCH Act-2 EX-DEM AS NEW	£8999	<del>£5999</del>

### TUNERS / TAPE

LUXMAN ST50 (Rare)	£900	<del>£550</del>
MERIDIAN 204	£580	<del>£350</del>
SONY ST770ES	£440	<del>£250</del>
NAKAMICHI CR2E Cassette	£600	<del>£300</del>
REVOX D36 Reel to Reel	£348	
REVOX E36 (Reel to reel)	£298	
REVOX B710 Mk2	£548	

Much More Always Available  
Please Check Our Web Site  
[hifitradingstation.com](http://hifitradingstation.com)

ALL ABOVE ITEMS IN STOCK  
AT TIME OF GOING TO PRESS

The Hi-Fi Company's

# Trading Station

35 Cowgate  
Peterborough PE1 1JZ

PHONE:

**0870 608 8211**

OPEN: Tues - Sat: 10am - 5.30pm

NEXT DAY DELIVERY  
WITH CREDIT CARD PURCHASES

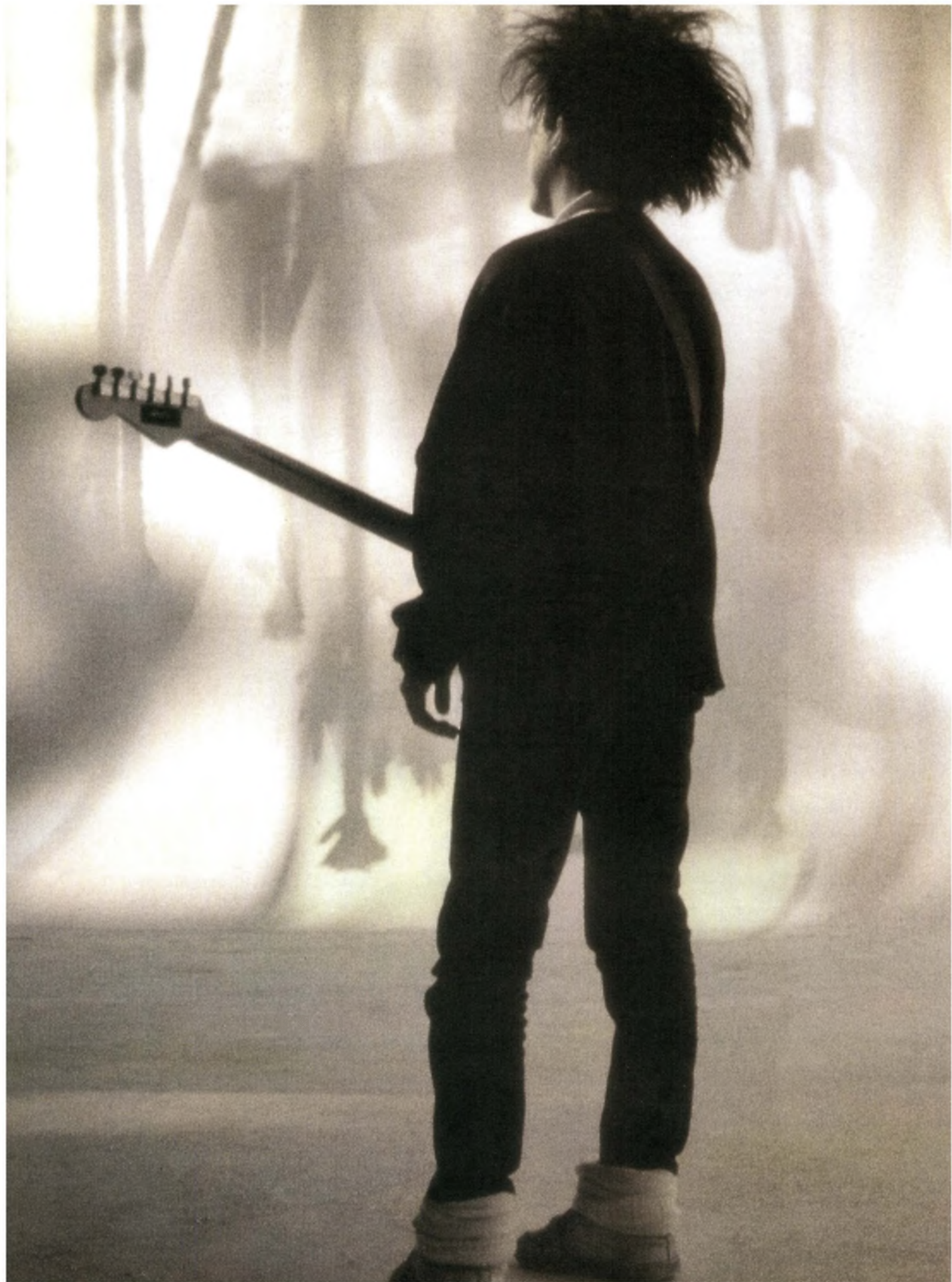

# Three Imaginary Boys...

## An everyday tale of hair-gel, eye-liner and the New Wave

by Roy Gregory

I guess that each and every one of us has one band that we hold dear: one band that can do no wrong: one band that's accompanied us along our path to audio enlightenment. For yours truly it's The Cure, an association that it's fair to say, got me started on hi-fi, and that remains strong enough that RP, another devotee, declined my invitation to write this piece on the basis that it was more appropriate coming from me.

It was those mobile, tuneful bass-lines that first convinced me that hi-fi was more than a luxury, and they remain just as demanding of system performance today as they did back in the early '80s. Indeed, by now it's probably just about safe to admit that it was indeed me (aided and abetted by an elder brother) who subjected every room at a Brighton hi-fi show to 'A Forest'. By the time we were half way round the first floor people were scattering and rooms emptying at our approach. But whilst it was certainly anti-social it was also a productive exercise, convincing me that the LP12 was superior to the early Pink Triangle, but more importantly, that the Syrinx PU3 knocked spots off the Ittok. This ran contrary to all received wisdom and I've been questioning reviews and magazines ever since. So, The Cure were there at the start of this particular odyssey, and even if they aren't, their music will be there at the end. There's comfort in travelling with familiar companions.

As with any band 15 or so albums into their career (depending on what or how you count such things) there have been myriad personnel changes and various solo projects. But also like most consistently successful bands,



there's been a hard core membership and an undisputed leader. In the case of The Cure the man is Robert Smith, accompanied by the twin shadows of Simon Gallup and Lol Tolhurst. Indeed, the band has never been without at least two of this central triumvirate, a kernel established as early as their second album. And which dominated the band's early years, establishing the sound of 'classic' Cure. It's those early album's I intend to concentrate on here, and they start,

somewhat confusingly with not one but two different releases!

The Cure arrived on the coattails of punk, releasing their first album in May 1979. This untitled offering featured a lurid pink sleeve and a trio of domestic appliances, leading fans to speculate as to which band member was represented by which. The general consensus has it that the intellectually voracious Smith was the vacuum cleaner, lanky bass player Dempsey the standard lamp, which leaves the hapless (and less than skeletal) Tolhurst as the fridge. True to the spirit of obscurity the tracks remained unnamed, represented on the label simply by icons, although history and subsequent releases have filled in the gaps and supplied the album with a name: *Three Imaginary Boys*. 12 tracks long (not including the unlisted instrumental that closes side two, 'The Weedy Burton'\*) it wears its heart

\*Named for Dempsey's fascination with the Bert Weedon penned Play In A Day guide to guitar - an entirely apposite proposition in the aftermath of Punk!

► and its background firmly on its sleeve. These were the darkest days of Thatcher's Britain, a society with three and a half million unemployed, inner city riots and incipient racism. Life in the concrete new-town of Crawley must have seemed pretty bleak, an atmosphere and attitude that transfers to the music, desolate in the opening '10.15 Saturday Night', chilling in 'Subway Song' and underlined by the sparse, three-piece line-up. Everything here is written by the band, save a single cover, the Hendrix 'Foxy Lady', and the echoes of the musical context are clear in the clashing chords and air of nihilism that pervade songs like 'Grinding Halt', 'Object' and 'So What'. The post-punk environment is clear in the jaunty irreverence and freedom from the constraints of conventional musical form. You hear it throughout the album, most obviously on the studio gabble intro to 'Foxy Lady' or spoken sneer of 'So What' and most effectively at the conclusion of 'Subway Song' and 'Grinding Halt'. But lurking in amongst these tracks are the seeds of what the band will become, a pair of perfectly formed and structured pop-songs, 'Fire In Cairo' and the title track 'Three Imaginary Boys'.

The first of these is an upbeat slice of pure party pop, carrying an almost uncanny resonance of the band's first single (released in December '78), the darkly challenging 'Killing An Arab' (b/w '10.15 Saturday Night'). Who else could have got away with quoting Camus against a background of insistently biting and jagged guitar chords, the teeth of a Doberman chained just short of overt threat? But that controlled menace made the song a cult classic and paved the way for the first album, containing as it did, the seeds of both the stark and confrontational alongside the poised and perfectly pitched. It's the latter that closes out the album, the beautifully spaced chords and off-beat descending bass-lines of 'Three Imaginary Boys' rekindled the love of structure and form, pace and line insinuated into my brain by a more formal musical education. Here we have the effortless grasp of space and time that was to emerge later, combined with the lyrical intelligence of Smith, affectingly candid in this early incarnation. It leads perfectly into the second album, *Seventeen Seconds*, but there's a little detour along the way.

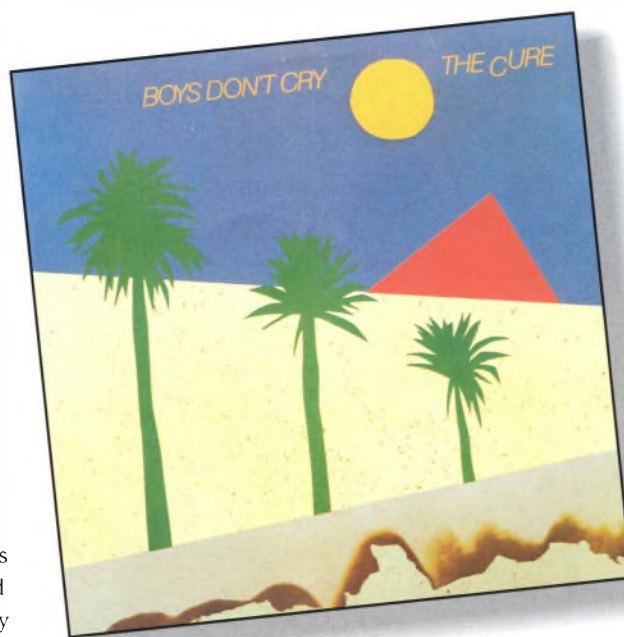

Strangely for a band that's enjoyed fleeting chart success (at best) The Cure have a history of single releases that intersperse and don't appear on album releases. In June '79 they released 'Boys Don't Cry' (b/w 'Plastic Passion'), following that in November with 'Jumping Someone Else's Train' (musically a reworking of 'It's Not You' from the first album and b/w 'I'm Cold' an early collaboration with Siouxsie Sioux, who provided the vocals). However, in this

instance, the A sides from these singles, along with 'Killing An Arab' and 'Plastic Passion', were rolled together with eight tracks from *Three Imaginary Boys* and 'World War' (a reject from the original album sessions) to create the LP *Boys Don't Cry*, released onto the US market in February '80. This reveals just how quickly things were moving, the 'hits' album being much smoother and musically more rounded than the original. The shades of punk are whittled away, replaced with a more complete and polished presentation,

a process that took another step with the eventual CD release (September '86) which saw the replacement of 'World War' and the possibly misogynistic 'Object' with 'So What'. The latter, with its end of the relationship message a single line amidst the ranting reading of the back of an icing sugar packet, is typical of Smith's love of the oblique, the important or painful submerged amidst the mundane.

*Boys Don't Cry* was only available in the UK as an import until September '83 when Fiction finally released it, but meanwhile, *Seventeen Seconds* had appeared in April 1980. It signaled the departure of Michael Dempsey, replaced on bass by Simon Gallup, drafted in from the Crawley contemporaries The Magypsies. The three-piece format was augmented by Matthieu Hartley on keyboards, bringing depth and texture to the slow sumptuous swirl and enigmatic atmosphere that characterised the album. The measured tempo of 'Three Imaginary Boys' was the order of the day and even the faster pace of the single, 'A Forest' (b/w 'Another Journey By Train') is ameliorated by its repetitive patterns that evolve far more slowly in a style now familiar since the advent of sequencers. But back ►

► then they played it, and it was new, depending on the careful, clever structure to keep its shape through the rapid repetitions and slow evolutions that gave the track an almost hypnotic appeal. Relieved of the need to fill, Smith's guitar becomes leaner and more etched, picking out its lines against the undulating landscape provided by bass and keyboards. Highpoints are 'Play For Today', following hard on the almost-overture of 'A Reflection', and the enigmatic 'M', where even deployed in rhythm mode, the guitar retains a smallness and separation from proceedings that manages to stand apart from yet dictate events. This delicacy of touch was the first flowering of Smith's emerging talents as a guitarist. Often overlooked in his role as singer and frontman, his deft playing perhaps reached its apogee on his sabbatical with the Banshees, but more of that later. Here it established the heart of what I've come to think of as the classic Cure sound, single instruments placing a melody against the soundscape behind. It was a quality that pervaded the whole album, from the short introductory mood pieces that open each side, to the fragile poise of 'At Night' and 'In Your House', balanced over the solid beat of Tolhurst's bass drum. This was a much more introverted and reflective world-view, underlined by a new detachment in the lyrics. Gone are the harsh edges, cocky, almost overt cleverness and shock value, replaced by a seductive drive that is fascinated by order in the abstract, refining and generalising the emotions that were so raw and personal in the original. It's powerful stuff, surpassed only by the album it foreshadowed – *Faith*.

With the arrival of their third album in April '81, Smith distilled the essence of *Seventeen Seconds* into

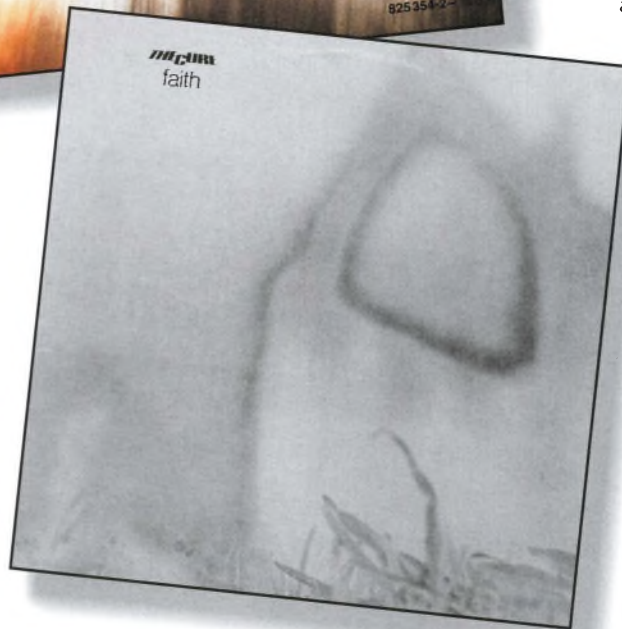

a more intense and even more self-consciously restrained (some would say depressed) performance. Taking over the task of keyboards himself, he dispensed with Hartley, a move that created more space in the music, his more hesitant contributions adding to the overall sense of fragility.

With titles like 'The Holy Hour', 'The Funeral Party', 'Doubt', 'The Drowning Man' and 'Faith', combined with a monochrome sleeve suggestive of the vaulted remains of a ruined church, it's not hard to see where the album gets its 'descent into depression' reputation, but that comes from people who've only dipped into its surface textures. Gallup's bass is well to the fore, establishing both pace and melody, and with the return to the three-piece line-up, now in its definitive form, the space around and interplay between the instruments weave complex patterns redolent with

atmosphere. Just listen to 'Other Voices', propelled by the repetitive bass riff, with its recessed and echo-y vocal. Then compare it to the drum-pattern driven 'All Cats Are Grey' with its stately chord changes and metronomic snare to appreciate the shifting balance and shared responsibilities between the three players, each revolving to the centre of proceedings on demand.

*Faith* also revealed a new willingness to experiment, with sonorous piano chords adding to the atmosphere, their prolonged decay beautifully rendered by the excellent Robert Smith/Mike Hedges recording that characterises both this album and *Seventeen Seconds*. Bass is deep and tactile, the

► pelucid notes full of shape and purpose, while the all important drum sound is crisp, solid and full of tone and impact. Smith's jangly guitar is urgent when required ('Doubt') subtle and understated where appropriate. The end result is a recording that is at once dense and beautifully defined, ponderous but purposeful and above all powerful. *Faith* was never a little light listening or music to wash up by ("too many sharp knives around" the critics would say) but an intense and musically demanding masterpiece. Followed by the single only release 'Charlotte Sometimes' (October '81 b/w 'Splintered In Her Head), another literary off-shoot, based on the book by Penelope Farmer, these recordings mark the end of the band's investigation of slowing tempi and the patterns of repetition. After *Faith* there was nowhere left to go.

Released in May 1982, *Pornography* represents both an evolution and a major change of direction. Building on the driving intensity of 'Doubt' it elevates the art to new levels, swathes of sound becoming slabs, space compressed by urgency. But most important, the guitar is off the leash, losing none of its deft placement and timing of notes, but tumbling them into slashing attacks, fractured runs and unsettling, off-beat riffs that never quite go where you expect them too or end where you think they should. The pounding momentum and ringing guitar chords of 'The Hanging Garden' (released as a single in July '82 b/w a live version of 'Killing An Arab') encapsulate the new, abrasive sound of *Pornography*, although tracks like 'Siamese Twins' look back to the ordered grace and

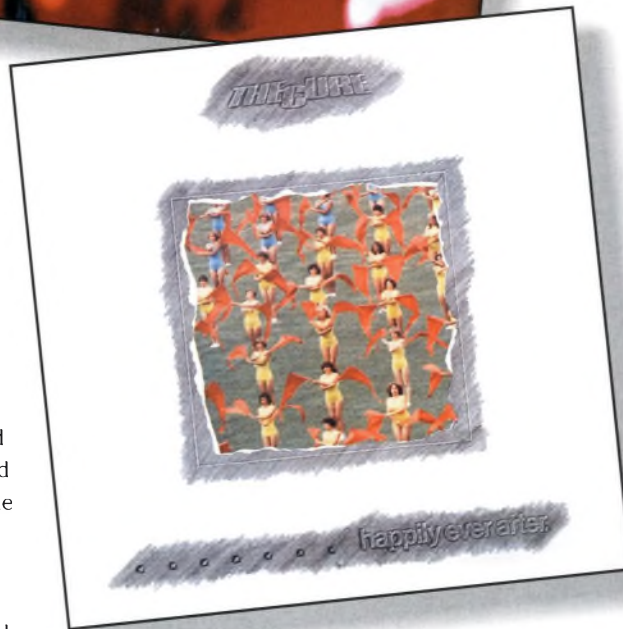

latent power of *Faith*, but introducing a new edge to proceedings. The central vocal and the directness of its expression is in sharp contrast to the distant abstraction of the earlier album.

*Pornography* was produced by Phil Thornalley who delivers a dense, almost claustrophobic sound which, whilst it lacks the hi-fi quality of the previous discs, is entirely appropriate to the intensely introverted music. It also represented a watershed for the band, the closing of its first period and first major evolution. Simon Gallup left and for a while The Cure were in suspension, eventually reforming as a five-piece to record *Japanese Whispers*, released in December '83, and the three 'fantasy' singles culminating in the jaunty, almost jokey 'Lovecats' (b/w 'Speak My Language'). So this is where we will leave the path of history. However, recorded history is another matter.

In keeping with the chaotic release patterns and independent singles issues, other albums and options exist when it comes to owning The Cure on record. *Happily Ever After* was a September '81 US release combining *Seventeen Seconds* and *Faith* into a slip-sleeve budget double album.

Pressed by A&M it doesn't have quite the transparency and impact of the excellent originals, but it still lets you hear the quality of the recordings. Rare in the UK where it was only available as an import, it adds nothing to the recorded body, but is there for completists.

Those looking for a taster or overview could consider *Standing On A Beach*, a singles collection (released in May '86 and accompanied by the rare



► video collection *Staring At The Sea*) but with 13 tracks crammed onto only two sides, recording quality inevitably suffers. Nor does it penetrate the deeper reaches of the albums where many of the golden moments lie. In fact, its sole virtue is the presence of the otherwise hard to find (but very worth-while) 'Charlotte Sometimes' a long held holy grail amongst the *Faith-ful*.

In 1988, Strange Fruit released a Cure title in their Peel Sessions series. The Cure played many live sets for both Peel and David Jensen, but only this one has surfaced (a pity, as the tracks stored include such gems as alternate versions of Primary and the otherwise unreleased 'Ariel'). Recorded by the original three-piece line-up in December '78, it's a 12" 45 RPM disc containing 'Killing An Arab', '10.15 Saturday Night', 'Fire In Cairo' and 'Boys Don't Cry'. Sound quality is really rather good, perfectly capturing the edgy energy of the early material, even if it lacks the solid underpinnings so vital to the quality and appeal of the studio tracks taped by Chris Parry. This is a different experience and one that's well worth seeking out.

As previously noted, there existed close ties between Robert Smith and The Banshees. Siouxsie was notoriously hard on guitarists, and when the latest incumbent succumbed scant weeks before the band's 1983 tour, who better to step in than the otherwise idle Smith? The tour garnered a live album, *Nocturne*, which captures this brief collaboration before it too ended in a typically bloodied Banshee fashion (although how much of that was for show is hard to gauge, as Smith had already released an album, *Blue Sunshine*, with Banshee's bass player Steve Severin under the banner of The Glove). Taped at the Albert Hall gig late in '83 it offers the opportunity to hear

Smith's guitar freed from the rigid responsibility of leadership. The jagged, stacked power chords of 'Israel' are perfectly spaced, the delicately picked lines of 'Dear Prudence' deft and just far enough off kilter to lend an air of disturbed fragility to the track. There's a contrived almost clumsiness to the playing, derived from the precise placement of the notes. It displays a supreme confidence and at the same time a deep understanding of the power of musical order, and the implicit threat in its disturbance. *Nocturne* catches the Banshees live and at the height of their powers. It does the same for Robert Smith as an individual and should be embraced by all Cure fans, offering a microcosm of the bands' genius.

For beginners and newcomers *Seventeen Seconds* is probably the place to start. The mainstream releases are all available on CD, but the early digital transfers do the recordings no favours and it really is worth seeking them out on vinyl. Just don't buy mine. Even if they were for sale they've been played to death, and having kept pace with my system's development, then on early occasions "ploughed" might be nearer the

mark. But I wouldn't be without them and the music has worn much better than the records. In fact, the person snatching that pristine copy of *Faith* from beneath your hovering fingers could well be me. The Cure just seem to provoke my anti-social tendencies...

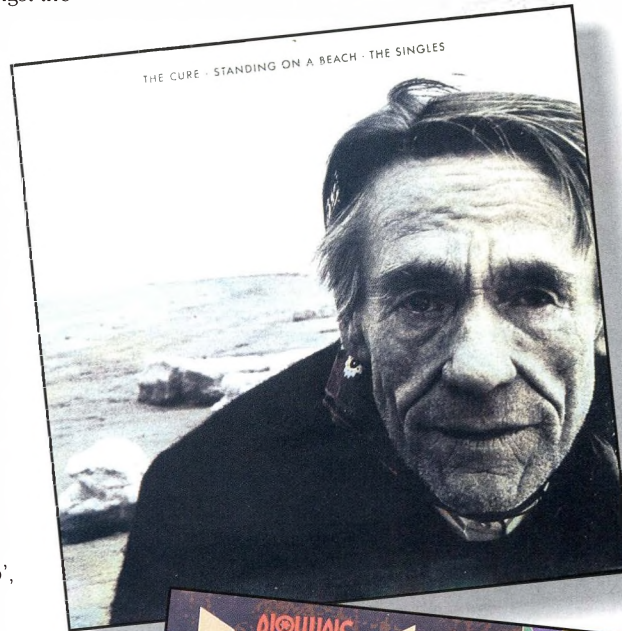

*When five stars just aren't enough...*

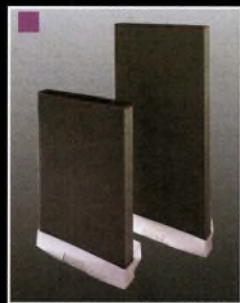
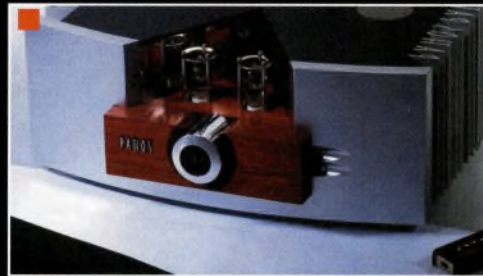

- ARCAM ■ AUDIO ANALOGUE ■ AUDIONET ■ AUDIO RESEARCH ■ BOSE ■ COPLAND ■ CYRUS ■ DCS  
 ■ DENON ■ GRAAF ■ GRADO ■ HARBETH ■ JADIS ■ JBL ■ KEF ■ KRELL ■ KONTAK ■ LINN ■ MARTIN LOGAN  
 ■ McINTOSH ■ MERIDIAN ■ MICHELL ■ MISSION ■ NAGRA ■ NORDOST ■ OPERA ■ PATHOS  
 ■ PINK TRIANGLE ■ PIONEER ■ PRIMARE ■ PROAC ■ QUAD ■ ROTEL ■ SME ■ SONUS FABER ■ SPENDOR  
 ■ TRIANGLE ■ UNISON RESEARCH ■ VAN DEN HUL ■ VERITAS ■ WILSON AUDIO ■ WILSON BENESCH

*The World's Finest Hi-Fi  
& Home-Cinema Systems*

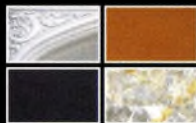

*Nationwide Delivery  
& Expert Installation*

**West *kj* One**

KJ WEST ONE

26 New Cavendish Street London W1G 8TY Phone: 020 7486 8262/3

BRANCHES IN NORTHAMPTON (01604) 637871 & PETERBOROUGH (01733) 341755

[www.kjwestone.com](http://www.kjwestone.com)

**NEW 2003  
HOME-CINEMA  
BROCHURE  
Call For Your  
FREE COPY**

# Record Reviews

## How To Read Them













The information contained in the record reviews is presented in the following way. Albums are identified by label and serial number. Beneath this you will find one or more icons which denote the available formats for the recording. The first icon refers to the format reviewed.

The ratings at the bottom of each review reflect the reviewer's opinion of the recording quality, and musical merits of the album. You'll soon realise that a great many musically significant albums offer less than wonderful sound. Don't let it put you off! For your information the scale rates a standard, good quality pop recording as slightly below average.

The reviewers are identified by their initials.

They are:- Chris Binns, Pete Christie, Dave Davies, Roy Gregory, Jason Hector, James Michael Hughes, Jon Maple, Reuben Parry, Dave Ayers, Andrew Hobbs, Chris Thomas, Mark Childs, Simon Groome, Michael Mercer.

### Key to Icons

-  CD
-  Gold CD
-  HDCD
-  XRC D
-  Double Disc
-  SACD
-  Hybrid SACD
-  MultiChannel SACD
-  120g 120g LP
-  150g 150g LP
-  180g 180g LP
-  Availability As S/H LP
-  Vinyl Double Album



Andy Partridge

### Fuzzy Warbles The Demo Archives Volume 1

Ape House Ape CD01 

The first release on Partridge's own label this with its 'Volume 2' sibling mark the start of what will become a 10 CD trawl through the off-cuts archive and a serious attempt by Partridge to outdo the bootleggers at their own game. He has succeeded splendidly. This CD is packed with great material, from the puzzlingly unreleased category like the gorgeous 'Born Out of Your Mouth' originally recorded for an interactive website, or 'Wonder Album' Partridge's hymn to female masturbation, to lighter weight stuff like 'Don't Let Us Bug Ya' written before Randy Newman usurped Partridge as the composer for Disney's *James and the Giant Peach*. There are several numbers that didn't quite make it to formal XTC releases, such as 'Everything' originally bound for 'Oranges and Lemons', and 'Goosey Goosey' (for *Nonesuch*) which are still highly enjoyable also-rans. Add in a rich mix of early demo's, sonic doodling and part formed versions of more familiar material and you have a delightful smorgasbord (or should that be side-board) of English pop at its eccentric best. Sound quality of course is variable, but Partridge has done a fine job here too. Better yet, Volume 2 is at least as good which bodes well for the rest of the series (to be released in batches of two), making this the XTC equivalent of the Fabs 'Remastered' sets. Highly recommended.

DD

RECORDING  VARIABLE  
MUSIC 



Martin Stephenson

Collective Force

Force CD001

This is a strong and musically diverse Martin Stephenson album that embraces the kind of material one would not usually associate with Invergordon's adopted son. Catchy Caribbean rhythms for 'Every Little Step Of The Way': Gospel harmonies on a spiritual, 'Time For Jesus': And some cool Latin beats can be heard in the 'Highland Bossa Nova'. There is even time for African styled vocals on the title track and 'Baba Num Sana'. *Collective Force*, with twenty tracks and over Seventy minutes of music, divides into two disproportionate sections entitled "Thru The Gate" and "In The Garden". Both contain some reworked but familiar tunes. There's sweet female backing vocals added throughout an opening, 'Orange Is The Colour Of Joy', while near the end of the disc there is a cut of the rootsy, 'Rowan Berries', that is given a layered, Clannad-like, treatment. In between these musical excursions, one can pick out a typical Stephenson sound with those comforting and subtle guitar licks that have underpinned his folk songs since the early Eighties. The Redwood Studios production, where Martin shares credits with long-time collaborator, Pete Rawson, is bathed in warmth, and offers a nicely balanced reproduction of these varied vocal and instrumental textures.

RP

Supplier: Cherished Record Co. 01579 363603



Maria Solheim

Barefoot

KKV FXCD 234

Do you ever have a dream where you find yourself naked in a public place hopelessly exposed and completely vulnerable? Well, this is the visible degree of emotional nakedness that Maria Solheim shows in a thirteen-track debut album. Should we allow her to indulge in this desire for public exhibition? The answer is a resounding "yes". In 'Suspicion', lyrics dealing with commonplace themes like untrustworthiness come at you from a tangent. Here, her perspective and the narrative about the underlying doubts of a newly married woman are developed through the use of a simple but effective lyrical device. From the outset the husband is referred to in a detached and abstract way; "I run along with my suspicion...I married my suspicion. We have been very happy ever since. If you want to talk to me, talk to my suspicion first." A wry, mischievous delivery of these lines undermines the institution of marriage and continues to raise some awkward and quite searching questions about the basis on which we form relationships in general. Inevitably, this particular vignette ends in pain and separation. Elsewhere in songs like, 'I once heard a boy', 'The last waltz', 'Lady of my life' and 'Before she goes to bed' Solheim proves that her rare and refreshing observational talent is no fluke.

RP

Supplier: hotrecords@pavilion.co.uk



Laura Cantrell

When The Roses Bloom Again

Shoeshine Records SPIT 014

Laura Cantrell's weakness for the "Big Apple" is well documented. Here, on a much anticipated follow up to *Not The Tremblin' Kind*, this is demonstrated through her fondness for the current dynamic crop of New York songwriters like Dave Schramm's 'Conqueror's Song', Amy Rigby's 'Don't Break The Heart', Dan Prater's 'Vaguest Idea' and Jay Sherman-Godfrey's 'Wait'. These, together with four Cantrell-penned originals, make up two thirds of another reputation-enhancing album. A lot of this success is of course down to her crystalline voice, which seems to combine the sweetness of Emmylou and the twang of Nanci, with it's own measure of porcelain-like fragility thrown into a lyrical approach that literally ravishes the ears. The canny choice of other vintage country music covers in, 'Yonder Comes A Freight Train' and the closing, 'Oh So Many Years', shows a finely drawn appreciation of those traditions which are likely to appeal to a more conservative section of the audience. The fact that they sit so comfortably alongside Cantrell's own, 'Too Late For Tonight', 'Early Years', 'Broken Again', and a ballad on the life of hillbilly singer Molly O'Day, 'Mountain Fern', is testimony to the quality of her vision and the strength of this genre as a whole.

RP

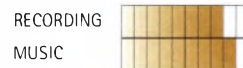



Jane Weaver

## Like An Aspen Leaf

Bright Star Recordings BSR16V 

Local Catholic girl Jane Weaver is one of the better-kept secrets of the Manchester music scene and this, her debut seven-track mini-album, is a gently pitched showcase for those smooth alternative folk songs that she pens. While her early influences include Kate Bush and Echo & The Bunnymen, it's more the shadow-like presence of a Neil Young or, perhaps even the youthful Tracey Thorn, who lurks behind these dreamy and softly textured melodies. The title track, with its analogous idea of an aspen tree, whose leaves are noted for their trembling in the breeze, beautifully encapsulates (in a fleeting moment) those pensive and intelligent qualities that can marry the swaying rhythms within the music to a delicate and vulnerable image. The deliberately wobbly instrumentation, and Weaver's stretched vocal, compounds this sense of frailty, which is a theme that is repeated in later songs such as 'The heart that buckled you', 'Ridiculous' and 'Why don't you smile'. A brightly polished production would have been a mistake here. This recording offers simple, yet nicely framed presentations of acoustic guitar, cello, piano, drums and Jane's lightweight (but perfectly pitched) voice. To that end they reinforce the tender naivety of a musician I will be keeping an eye for the future.

RP

Supplier: Cherished Record Co. 01579 363603



Nora Jones

## Come Away With Me

Blue Note/Classic Records JP5004 

Like a good chunk of the nation, I was swayed by Jones's appearance on Jools Holland's show: sultry vocals, a jazz vibe and gorgeous looks, and like that same chunk of the nation, I rushed out to buy the CD. My infatuation proved temporary though and it was but a short time 'til the CD had winged its way to my local second hand record store. Now Classic have released the whole thing on gorgeously pressed 200gram vinyl, winged with deep affection to me by the Editor for my even greater enjoyment.

To be fair, it's not a bad album. Jones' has a lovely voice, is a very adept pianist, and is very sensitively backed by some fine musicians including the great Bill Frissell. The whole thing is beautifully produced by Arif Mardin, Jay Newland and by Jones herself and the CD, no sonic slouch, is eclipsed by this LP which gives real weight and presence to the performers, opening out the soundstage and making the whole thing that much more real. It's just that for me at least, it seems that all this lavish attention has come too early in Jones' career. The songs feel too lightweight, the lyrics not justifying the attention merited them here. Take 'Come Away With Me' or 'Don't Know Why' as the two most prominent

examples, or better yet Jones' treatment of the standard 'The Nearness of You'. Here her relative inexperience really shows, the words are all there, the vocal inflections, but somehow the feeling, the sense of convincing experience that's essential to bringing a song like this alive just isn't present.

Nora Jones is clearly very talented and may well have a great future, but for me this record is a case of too much too soon. If you love the CD however, you owe yourself this album since it trounces the CD in every way.

DD

Supplier: [www.vivante.co.uk](http://www.vivante.co.uk)

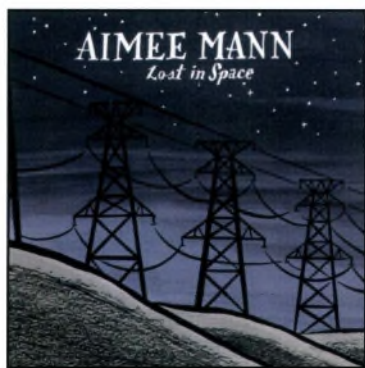

Aimee Mann

### Lost In Space

Superego Records VVR 1020882

Occasionally, despite the tightening jeans and dark roots, yesterday's rock chicks gracefully mature into an "Aimee Mann". Live, Aimee's intelligence is revealed through a wry and self-deprecating stage persona. In the studio, her sweetly worded, witty, probing and frequently ironic lyrics shelter behind a refined musical pigment that's distinctive to all the solo albums. *Lost In Space* continues this rewardingly familiar trend. The "space" in question is a personal and contemplative one which is sometimes reawakened by a half-remembered tune heard softly late at night. Here, these eleven pensive songs rake through a number of concerns ranging from everyday breakdowns in communication that threaten to pull any relationship apart, 'Invisible Ink', to that outward façade constructed by many of us to disguise the mundane and increasingly treadmill lives we lead, 'It's Not!'. Then there are those irresistibly brief and destructively passionate love affairs where 'The Moth' provides a suitably hypnotic metaphor. Some are prompts; other songs are instructive, or even cathartic in tone, but all are fleshed out with appropriately crafted and melodic solutions. Musically, whether it's a multi-layered string and horn arrangement, or through songs pared back to little more than acoustic and electric guitars, this is another undeniably strong release.

RP

Supplier: Cherished Record Co. 01579 363603



Audioslave

### We are your friends

5101302 Epic / Interscope

Audioslave are three parts Rage Against The Machine, one part Soundgarden and all rock. And if that didn't sound clichéd to you, then you'll love them. When Audioslave formed they managed to keep the best aspects of each of their previous bands. There's no tricks here, this isn't a concept album, or an experiment in electronica, this is heavy, all American rock. The album is so polished it almost shines: every riff, every hook is timed to the split second, and the whole thing is recorded with particularly warm tones. After the surge of garage bands flooding onto the British music scene it's all a bit of shock. But *Audioslave* is great. Chris Cornell's vocals are absolutely massive, and Tom Morello's guitar makes a welcome return, seemingly more easily paired with a more traditional singer. And its this relaxed atmosphere that makes the album excellent, with each song sounding natural, as if the whole thing were just some extended jam session. Huge American rock, done by an alliance of the best in the business. Every track could be a single. It's every clichéd in the book, but it's good.

MC

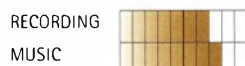

Simian

### We are your friends

Source CDSOUR 065

Last years *Chemistry is what we are* was a sinister affair, full of medieval superstition, electronica and strange harmonies. With that album, and a series of gigs set in churches, Simian forged their reputation for originality. In short, Simian are weird. *We are your friends* is, in many ways, a lot easier to get into, and then again, not. The album is very different from their debut: where *Chemistry...* was dark and bare, this album is bold, this album swaggers. Simian have blended their electronica with Beach Boys harmonies and Californian sunshine to create something that is, on the face of it, much more friendly: friendly, like a stalker. Because when all is said and done, Simian are still deeply unsettling. The drum samples are still just as crisp, the analogue samplers still go squelch in a thoroughly satisfying manner, and the vocals still fill the room. But now the four-piece have backed this up with well paced musical direction. Simian continue to push music forward, sounding like no-one else, but this album marks a distinct attempt at mainstream acceptance. The songs are much more traditional in structure and sound, giving an easy introduction for first time listeners. But as before, the deeper you go into Simian's music, the more is revealed.

MC





Sigur Ros

Fatcat Records FATCD 22



Sigur Ros come from Iceland, the land of the musically strange, home to Björk. I don't know what it is about the Icelandic culture that produces artists whose music is set at an oblique angle to the rest of the Western world, but long may it continue if this album is the result. I'm led to believe that, like the Cocteau Twins, Sigur Ros sing in a made-up language, but frankly it could be Icelandic for all I know. What I do know is that the high pitched, somewhat ethereal wailing of the singer fits hand in glove with the vast bleak soundscapes issuing forth from the band. Sigur Ros are a band that eschews obvious melody for stark tone textures, not unlike some of the 1970s avante garde German bands such as Faust and Amon Düül II. The end result is surprisingly effective and captivating, despite the lack of obvious hooks. That's not to say there is no melody to be found, it just doesn't jump out at you; this is not an album that sticks in the memory on first hearing, rather it piques the interest enough to persuade you to have a second listen. Make the effort, it's worth it.

DA

RECORDING  
MUSIC



Beth Gibbons and Rustin' Man

Go Beat 066574-1



### Out of Season

*Out of Season* is the first Solo LP from the Portishead front-woman and has garnered some amazingly rave reviews from other publications, Mojo going as far as to say "it's among the best albums ever made". A quick glance at the bottom of this review will tell you that I don't agree with that conclusion.

This album marks a change of direction for Beth in many ways and is an opportunity for her to demonstrate her singing talents in a more varied way. This album only sounds Portishead-like on one track, the rest of the time it is far less bleak and more acoustic. Beth does have an excellent voice and she tests its flexibility throughout the album, wielding it like a range of instruments. Each song reveals a different facet to her abilities and in many ways she is like an actor stepping into a role. The music behind the voice is also varied. From simple small-scale accompaniment to orchestral big-band backing it further expands the range of the album. I don't think it is a truly great album because the range of emotion seems muted, lacking an up-lifting quality compared to the very best.

Sinatra and Drake are cited as influences and are in evidence but it is a female fragility all its own that makes this album a very good buy. Just don't expect miracles.

JH

RECORDING  
MUSIC



Peter Hammill

FIE 9127



### Clutch

Although Peter Hammill has now been recording music for thirty-five years, both as a solo artist and as a member of Van Der Graaf Generator, he has rarely achieved critical acclaim or commercial success. Fortunately there are enough people switched on to his intense and lyrical music to enable him to continue working as an artist and putting out CDs at regular intervals. On *Clutch* we find him returning to a simpler song writing and performing style. All were written and performed on acoustic guitar, with the only additional instruments being violin, viola, saxes, and flutes used sparingly on certain tracks, plus that voice. The effect of this decision is that Hammill has produced one of his most intimate and intense albums in years. Along with this, on certain songs he has gone for a more direct lyrical style than normal: This is more than merely wrong, as sin on sin's grotesquely piled. Don't look so surprised when you find yourself reviled. Don't look to me for comfort in your trial – the girl was just a child' from 'Just A Child'. Elsewhere we find a paean to the inevitable growing up and distancing of his daughter, and plea to understand the pains of the anorexic. This isn't light listening, but in my opinion when Hammill is on this form he cannot be bettered.

DA

RECORDING  
MUSIC





JJ72

I To Sky

Laketa Records LAK5095292 

Just as I was wondering what had happened to JJ72, along came 'Formulae', their incendiary returning single. And *I To Sky* proves that this was no one-off.

Two years away and the frighteningly young band have grown not just in stature. Mark Greaney's vocals are still stunningly agile, but now come attached to a bona-fide rock god, rather than a sultry teenager. Hilary's bass riffs have grown into accomplished sexual rumblings and Fergal still hits things, just harder. And with age comes sophistication, so whereas before they just wished it would snow, now they build towering anthems fit to fill a stadium near you.

With enough range of material, this album doesn't linger too long on any one level, wisely switching between lumbering rock beasts and more fragile ballads. JJ72 retain some of the naivety that made *Snow* so compelling, but the solid production has proved to be the death of their glass-like brittleness, a particular natural strength of a three piece band. And so instead there are walls of guitars, the touring second guitarist becoming a reality in the studio as well.

An inspiring follow up, *I To Sky* is, in almost every way, superior to their debut. Another band, doing what they do best, just better.

MC



Beck

Sea Change

Geffen Records

Beck could very well be the most diverse musical talent we've seen in many, many years. He has tackled numerous genres throughout his career. Cruising from slack pop single 'Loser' to the tricked out funk of *Odelay*, and then onto his haunting *Mutations*, he has covered a vast amount of musical real estate for his audience. Capping it of course with his last disco-infused soiree *Midnight Vultures*. This time around it seems he wanted to get back to basics. Beck back to singer/songwriter? It's a journey you can not afford to miss. Choosing to work with Nigel Godrich again as producer was certainly his smartest move to date from a creative standpoint. If you're a RadioHead fan, you already know the depths of Godrich's gift. A man capable of squeezing every last drop of soul from each note in the chain, he brings a warmth and texture to his projects that rivals some of the most revolutionary LPs ever released. This tag team spawned one of the best albums of the year by far. While depressing at its core, the music is inviting and vulnerable. The album opens up with a beautifully melodic track 'The Golden Age'. Its floaty guitar rhythms make for fantastic road tripping music. It's easy to imagine yourself behind the wheel of a convertible, sun glaring off the hood, trying to forget all the drama

surrounding your life. 'Lost Cause' is an addictive tale of estrangement and frustration. Hovering synths surround the plucks of Beck's guitar, while his despairing vocals expose the core of his seeming depression. This album is orchestrated magnificently. It's full bodied, yet the focus is certainly Beck and his trusty writing tool, the guitar. You just don't get much better than this sonically these days, especially in the world of pop (snap crackle) world. I was doing some work for a record label executive recently, and he was listening to one of his labels releases on a system I had just finished tweaking. I was worried he was going to complain, as the system sounded a bit anemic to my ears. He didn't say a word, but when I through *Sea Change* in the player the soundstage exploded! He was blown away, and frankly, so was I. The topic of the discussion that followed was; how can he get the same sound from the albums on his release schedule! The depth of this recording is freakin' sublime. The sound is airy and spacious. Subtle musical nuances decay naturally, as they would if the instruments were being plucked in a small hall. There is an organicness (that should be a word) to this CD that enables the listener to experience both the musical and emotional content of this album, though it's not very uplifting (quite the contrary actually). The low end is wildly precise, not overly muddy or washy. Congrats to the both of them for this effort. Do yourself a favor, especially if you seem to be having trouble finding a good album in the rock/pop section these days, buy this record.

MM







**Northwood Audio**

*Now on demonstration*

- AudioMeca Mephisto II CD
- Audio Note Dac2.1 Signature
- Isotek mains products
- JM Labs Micro Utopia
- Marantz 8300 SACD/DVDA
- Merlin Mains & Audio Cables
- Michell Gyrodek & SME309
- PMC DB1 loudspeakers
- Proac Tablette 8
- Pure DAB Digital radio
- Quad ES1.1 & ES21 speakers
- Rega turntables & electronics
- Shanling CDT-100
- Talk Electronics Thunder 3.1 and many more...

98 Cambridge St,  
Aylesbury, Bucks  
Tel: 01296 428790  
[www.northwoodaudio.co.uk](http://www.northwoodaudio.co.uk)



**Experience Filtration**

Experience Filtration Ltd · PO Box 6155 · Derby · DE24 0ZZ · ENGLAND  
Tel: +44 (0)1332 757 068 · Fax: +44 (0)1332 572 713  
[info@experiencefiltration.com](mailto:info@experiencefiltration.com) · [www.experiencefiltration.com](http://www.experiencefiltration.com)

# Audio Images



With the best choice, advice & service. For all that is Real Hi-Fi and Home Cinema

*The future of Hi-Fi will never be the same - the new amplifier from Tom Evans*

Audio Images is The shop. Call now on 01502 582853  
128 London Road North, Lowestoft, Suffolk NR32 1HB.

## the sound sanctuary



The only choice for music lovers looking for the highest quality sound.

Naim. Linn. Rega. Musical Fidelity. Chord Electronics and Wilson Benesch plus esoteric audiophile brands such as Wavac. Klyne and Monarchy.

Castle Sound & Vision, the region's leading hifi, home cinema and multi room specialists

48 - 50 Maid Marian Way Nottingham NG1 6GF Tel: 0115 958 4404  
[www.castlesoundvision.com](http://www.castlesoundvision.com)

## Great sound starts with a solid foundation.



CERIMAX PRESENTS THE FINEST SPIKE-FLOOR INTERFACE EVER DEVELOPED

Spike Spotters™ were not designed to protect your floor from damage, although they will certainly do that. They were developed from the floor up, to improve acoustic performance through ceramic dampening and isolation of your speakers and audio components.

**SPIKE SPOTTERS™**  
[www.spikespotters.com](http://www.spikespotters.com)

audio republic

QUALITY HIFI FROM ALL OVER THE WORLD  
America, Japan, Canada, New Zealand, Germany, England.....  
NOW IN LEEDS

78 Otley Road  
Headingley  
Leeds, LS6 4BA

0113 2177294

stockists of



**Shahinian Dynavector**



and others...

[www.audio-republic.co.uk](http://www.audio-republic.co.uk)

# Reminders

## MUSN'T MISS

The Heathrow High Fidelity Show.  
29-30 March 2003..  
Renaissance - Heathrow

The Scottish Hi-fi & Home Cinema Show.  
18/19 October 2003..  
Thistle Hotel - Glasgow

The Manchester Hi-fi & Home Cinema Show.  
15/16 November 2003..  
Hilton - Manchester Airport

### UK Hi-Fi and Home Cinema Shows

292 Aigburth Road, Liverpool, L17 9PW

Exhibition Organisers Tel: 01829 740650

Fax: 0151 728 9343 Mobile: 07810 697123

email: roy@chestergroup.fsnet.co.uk [www.chestergroup.org](http://www.chestergroup.org)



**Vivaldi**  
**I Concerti di Dresda**  
**Freiburger**  
**Barockorchester/Gottfried**  
**von der Goltz**

Opus 111 OP 30283 (CD)

This is the latest edition in Opus 111's ongoing undertaking to record all 450 of the Vivaldi scores held in Turin's National Library, and like the previous releases it is of the highest quality. Vivaldi composed these concertos for the Dresden Hofkapelle, one of the finest and largest orchestras of the period. With the exception of one *sinfonia*, all feature an abundance of obbligato instruments, representing an innovative style and generating a diversity of vibrant arrangements, with the best known being the *Concerto RV577 in G minor*, whose obbligato consists of a violin, two oboes and two recorders, which convey a delightfully dated quality to proceedings. All are inclusive of good-humoured spectacle and discriminating splendour, with each solo instrument weaving a tightly knit interplay of textures and colours, and feature some prominently original themes, especially in the *Sinfonia RV192 in C major* that is the real treasure of this collection. The Freiburg players bring wonderful atmosphere and personality to the phrasing with their intuitive expertise, and establish a measure of musical fascination to the recording – their sympathetic ornamentation in the slow movement of *RV577*, which can lack expression and texture, is admirable. The clear and vibrant recording is simply the icing on the cake.

SG

RECORDING   
 MUSIC 



**Ralph Vaughan Williams**  
**The Early Chamber Music**

**Nash Ensemble**

Hyperion CDA67381/2 (CD)

While some may say that Ralph Vaughan Williams did not arrive at an established style until *A Sea Symphony* of 1909, the works on this release reveal much of genuine note among his early chamber compositions. Some are previously unpublished or unknown pieces, often alluding to his later style. Others are evocative of other composers, such as the *String Quartet in C minor* (1898) that hints, after opening in a distinctive RVW fashion, at both Dvorak and Tchaikovsky, and the *Piano Quintet in C minor* which, along with the *Quintet in D major*, may embrace the French tradition, but reveals touches of Brahms. To these works are added three later, even posthumously published duos with piano and, from 1941, *Three Preludes on Welsh Hymn Tunes (Household Music)* which was composed to be played by any combination of instruments available during wartime, but is performed here by Vaughan Williams' favoured ensemble, a string quartet. The Nash Ensemble play throughout with their usual panache, and with sound that is very good without actually approaching demonstration quality, this release should reopen the debate on the merits of Vaughan Williams' earlier compositions and the reasoning behind the composer's withdrawing them.

SG

RECORDING   
 MUSIC 



**JS Bach**  
**The Art of Fugue**

**Fretwork**

Harmonia Mundi HMU 907296 (CD)

Although Johann Sebastian Bach specified no express instrument for his culminating achievement, *The Art of Fugue* is typically presented on a solo keyboard instrument. While there are performances by ensembles as varied as saxophone quartet and full orchestra, the use of an unaccompanied harpsichord or organ remains a powerful and often convincing argument. But this recital by the prominent viol consort, Fretwork, is a truly enthralling example among ensemble recordings of this collection of sixteen fugues and four canons. The playing is entirely discerning, liberating sporadic tensions with the musicians' tender shaping of the vibrant rise and fall throughout each piece – a kind of gentle ebb and flow that is completely enthralling in its tranquillity. While many ensemble performances conceal the beauty of the music, creating a purely technical expression of counterpoint, here each player's total commitment shines through – helped by a superb recording – illuminating each musical gesture and allowing the driving forces to form and flow. The overall structure of the work is superbly portrayed and the composer's expressive writing is revealed with colourful, yet refreshingly simple forms of uncorrupted counterpoint and distinct characters, demonstrating that these pieces can be truly exceptional works for the right ensemble.

SG

RECORDING   
 MUSIC 

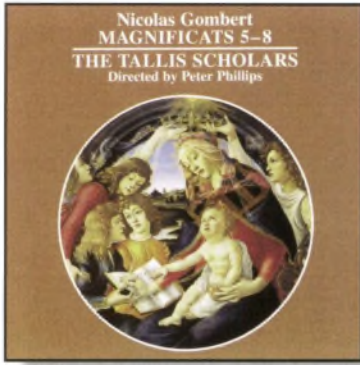

**Gombert  
Magnificats 5-8**

The Tallis Scholars/Phillips

Gimell CDGIM 038

Nicholas Gombert's glorious mid 16th Century Magnificat settings are some of the finest works of the period. Gimell released the first four around a year ago (CDGIM 037) and this second disc concludes the series. With no comprehensive recording prior to this, these two issues are obviously of great importance to lovers of Renaissance religious music.

Peter Phillips and the Tallis Scholars are, as usual, creatively assured, harmoniously aware and inventive – not only in the selection of repertoire, but in the bold addition of a number of accidentals which generate delightful moments in *Magnificats 6 and 8*. They manage to add a touch of excitement, especially in the plainsong segments where the melodies are allowed to sway under the emotion of human affection, especially in the intensely beautiful antiphon for Mary Magdalene, *In diebus illis*. But they still adhere to the ardently detached side of these works, with their coherent, precise and supremely balanced tones. There is a relentless impetus to each piece, an inescapable melodic tide that allows each to rise in dramatic intensity, to end in a magnificently thrilling climax.

With delightfully atmospheric, reverberant sound, this important release is musically expressive and totally exquisite.

SG

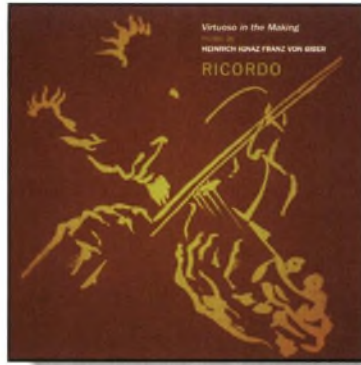

**Virtuoso in the Making  
Music by Heinrich Ignaz Franz  
von Biber  
Ricordo**

Linn CKD 195

**Biber  
Unam Ceylum  
Holloway/Assenbaum/Mortensen**

ECM New Series 1791 472 084-2

Virtuoso violinist and composer Heinrich Ignaz Franz von Biber's music is admired by musicians, but divides listener's opinions. Many find his numerous stylistic idiosyncrasies and sense of humour too extreme, too ornate and self-indulgent, while others view this same diversity as audacious, groundbreaking creativity. Ricordo's debut recording for Linn features several of his seldom recorded earlier works, with the majority indebted to Biber's early mentors Bertali and Schmelzer, with the opening *Pastorella* paying reverence to Schmelzer's own work - included later on the disc for comparison. They frequently anticipate Biber's later compositions, with the *Sonata in E major*, highlighting the extravagant runs, vibrant contrasts and impressions so prominent in his *Sonata Representativa in A* and *Battalia*, and while the *Sonata in C minor* may be conceptionally less inspired, it is more than indicative of his popular *Mystery Sonatas*. Many excellent ensembles have approached Biber's work, but Ricordo are certainly not eclipsed. They manage to extract every nuance of his fertile imagination, performing with flair and plenty of skill. Above all they exhibit a certain sense of gratification. Violinists Kati Debretzeni and Penelope Spencer stand out as exceptionally

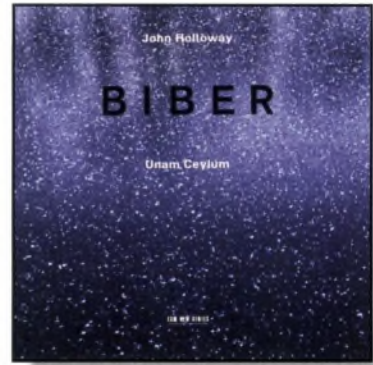

fine performers, and Linn's engineering is superlative, resulting in an outstanding debut release.

Having already recorded a penetrating set of Biber's *Mystery Sonatas* (reissued on Virgin VBD 5 62062 2), John Holloway's new recording of four sonatas from the *Sonatae a Violino Solo*, Salzburg 1681 and two unpublished sonatas is no less persuasive, translating the composer's breathtaking, experimental and striking work with his elegant and brilliant gestures. While Biber used normal tuning, he also asked for scordatura or altered tunings (*Sonatas IV and VI*) that are more informal and characteristic, and it is these pieces that come across as the most compelling. Holloway handles the change in *Sonata VI* particularly beautifully. His bowing demonstrates a specific lightness and freedom, producing a degree of resonance that is consistent with an appreciation for 17th Century tones and textures. He is accompanied with assurance by Aloyisa Assenbaum (organ) and Lars Ulrik Mortensen (harpsichord), and while ECM's sound is not quite as detailed or realistic as Linn's, it is still very good.

For those wanting just one recording of Biber's wonderful music, I recommend Romanesca's fantastic release of the complete *Sonatae a Violino Solo* (Harmonia Mundi HMU 907134.35), but I would not want to do without any of the above-mentioned discs.

SG



**Award winning**  
 turntables & record cleaning machines from

**THE PRODUCT YEAR** **THE EDITOR'S CHOICE**



**01579 363603**

[www.cherished-record-company.co.uk](http://www.cherished-record-company.co.uk)

**Vynoodle**  
 Classical Music on Vinyl



Catalogue  
 01332 760587

List online at [www.vynoodle.co.uk](http://www.vynoodle.co.uk)

**THE NATURAL CHOICE FOR HI-FI UPGRADES**

**GARRICK**<sup>®</sup>  
 FOR THAT NATURAL SOUND



Hand crafted stone products to your exact requirements

- Speaker Stands
- Hi-fi Racks
- Plinths
- Top Weights
- AV Racks

Tel: 01202 591922  
[www.garrickstone.com](http://www.garrickstone.com)

SEE OUR NEW RANGE AT THE BRISTOL SHOW - STAND BAY 2

**Infidelity**  
 INDECENTLY GOOD HI-FI

**Buying hi-fi should be a delight.**

If choosing your new hi-fi in a civilised and relaxed atmosphere from a well-chosen selection of genuine performance equipment appeals, then we are for you. Bring along your own records or CDs, we'll provide the coffee, and hear the difference we can make.

9 High Street, Hampton Wick,  
 Kingston upon Thames, Surrey KT1 4DA

**Telephone: 0208-943 3530**

Open: Tues - Fri 10.30am - 7pm  
 Saturday 10am - 6pm.



   
 the symbol of security

**Music Matters**

The finest hi-fi, Home Cinema and Multi-room systems - from a selected range of suppliers

*Including*

Arcam, Base, Bowers & Wilkins, Chord, Cyrus, Dynaudio  
 Epos, KEF, Living Control, Marantz, Meridian,  
 Musical Fidelity, Project, Rel, Sonus Faber,  
 Wilson Benesch

*And much, much more.....*

Demonstrations available by appointment  
 020 8420 1925

344 Uxbridge Road, Hatch End, Pinner, Middlesex HA5 4HR  
 Open Tuesday - Saturday 10am - 5:30pm



**For people who love music**

Griffin Audio Ltd, 94 Bristol Street, Birmingham  
 Tel: 0121 622 2230 Email: [griffinaudio@fsbdial.co.uk](mailto:griffinaudio@fsbdial.co.uk)  
 Web: [www.griffinaudio.co.uk](http://www.griffinaudio.co.uk)



**Dynavector** presents SuperStereo.

Once you've heard it, you will never be content with ordinary stereo.

"...the whole (listening) experience is dramatically lifted, with a huge increase in instrumental weight and overall space ..."

*Ray Gregory, Hi-Fi +*

"...extraordinarily convincing .....

...simply sounds more natural ..."

*Paul Messenger, Hi-Fi Choice*

Hear SuperStereo at the London Hi-Fi Show, Heathrow Renaissance Hotel, 29/30 March 2003.

The Adp-2 processor costs £795 and is available from:



**Dynavector** (SuperStereo)

Tel/Fax. 01202-767873

E-mail. [dynavector@onetel.net](mailto:dynavector@onetel.net) uk

Net. <http://web.onetel.net.uk/~dynavector>



THE INNOVATIVE  
HI-FI, HOME CINEMA  
AND MULTI-ROOM  
RETAILER/INSTALLER

**ORANGES & LEMONS**

Friendly and efficient service 0% Finance available

JUICY FRUIT FROM LONDON'S FRESHEST RETAILER

ARCAM B&W CABLE TALK CASTLE CHORD CREEK  
DENON EPOS LINN MARANTZ NAD NAIM NEAT PMC  
QED REGA ROKSAN ROTEL RUARK STANDS UNIQUE  
SOUNDSTYLE YAMAHA XANTECH and many others

**020 7924 2040**

61/63 WEBBS ROAD, SW11

website: [www.oandlhifi.co.uk](http://www.oandlhifi.co.uk)



## Paul Hynes amplification

Exceptional designs, exceptional power supplies,  
exceptional components, truly exceptional performance.  
01931 712822 or [paulhynes@freezone.co.uk](mailto:paulhynes@freezone.co.uk) for details.



50W mono otocl balanced SE bridge amplifier  
100W valve/fet hybrid version now available.

# Radlett Audio

EST. 1978

CONSULTANTS

## THE HIGH-END SPECIALIST SINCE 1978

ATC, Audio Analogue, Avantgarde, Bow,  
Bryston, Copland, EAR, Lyra, Mark Levinson,  
Naim Audio, Notts Analogue, PMC, ProAc,  
Proceed, Rega, Revel, Roksan, Isotek,  
Sonus Faber, Stax, Spondor, Sumiko,  
Wadia and lots more.

9 Holywell Hill, St. Albans, Herts, AL1 1EU

**Tel: 01727 855577**

Fax: 01727 858727



the stunning new  
**ATC SCM 20 active  
loudspeakers**

get close to them, together with  
some other fine products, at

signals

High End Audio World

>cartridges  
lyra  
ortofon  
sumiko  
>cables  
chord company  
nordost  
van den hul  
>headphones  
grado  
stax  
>hardware  
atc  
densen  
epos  
harbeth  
imerge  
in focus  
lexicon  
michell  
naim audio  
primare  
red rose  
sme  
trichord

i p s w i c h ( 0 1 4 7 3 ) 6 5 5 1 7 1  
f a x ( 0 1 4 7 3 ) 6 5 5 1 7 2  
w w w . s i g n a l s . u k . c o m

SECOND/HAND - EX DEM OR  
SPECIAL CLEARANCE LINES

## YOU'LL ALWAYS GET THE BEST DEALS

FROM

[www.sounds-of-music.co.uk](http://www.sounds-of-music.co.uk)

**LOG IN NOW**

**OR CALL 01892 545688**



### Vince Guaraldi Trio

#### Jazz Impressions of Black Orpheus (Cast Your Fate To The Wind)

Fantasy/ Acoustic Sounds OJC-347

180g

*Black Orpheus* the Grand Prize Winner of the 1959 Cannes Film Festival is a wonderful retelling of the Orpheus legend set against the backdrop of Mardis Gras in Rio de Janeiro. It's a great film (available on Criterion Collection DVD), with a fabulous and highly evocative soundtrack available on Verve.

Guaraldi, joined here by bassist Monty Budwig and drummer Colin Bailey, recorded this album in '65 riding on the back of the still powerful bossa nova wave launched by Getz/ Byrd's *Jazz Samba* in 1962. The album contains a smash hit in 'Cast Your Fate to the Wind' (so much so that the album became re-titled as this), it's a strong number but no more so than the equally good surrounding tracks. The album which contains four numbers based on the film's music and four additional tracks, is filled with melodic grooves: check out Jobim's 'Samba De Orpheus' which provides with the lovely 'Manha de Carnaval' the leading themes of the film, or their cool-blues version of 'Since I Fell For You'. Maybe it's all a bit 'jazz-lite' but it's a very long way from muzak and as a beautifully played evocation of great film, is a recording to treasure. The Acoustic Sounds pressing is immaculate and the recording is a little 'hard left, centre and right' but otherwise fine.

DD

Supplier: Vivante - [www.vivante.co.uk](http://www.vivante.co.uk)

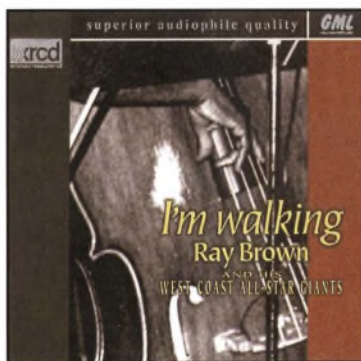

### Ray Brown and his West Coast All Stars

#### I'm Walking

GML-XRCD-30331

XR

Taped across two days in 1990 for the GML label, this album brought together the talents of Ray Brown and a team of stellar American players with Japan's premier vibraphone player, Ichiro Masuda. The recording itself is too recent to benefit from minimal miking and the overall stereo coherence that brings, but in its place you get full value in terms of impact and energy, perhaps better suited to this upbeat, swinging set. Brown, of course, needs no introduction, and as well as sharing rhythm duties with drummers Billy Higgins and John Guerin, he contributes seven of the ten compositions as well as helping out with the arrangements. Backed by the likes of Cedar Walton and Jeff Clayton, the results are a tight, cohesive sound full of life and punch, making for an almost big-band dynamic range and impact. Amidst all the energetic blowing, Masuda's subtle vibe playing adds a touch of easy grace, especially on a standout rendition of 'Time After Time', a performance that carries the instrument blessedly clear of my recurring *Jazz At The Pawnshop* nightmare. Its inventive strands and lines help weave together a superb ensemble performance. With close to 50 minutes of highly enjoyable music making, this is both artistically compelling and great value.

RG

Supplier: Vivante - Tel. 01293 822186



### Johnny Griffin

#### Introducing Johnny Griffin - Chicago Calling

Blue Note / Classic Records 1533

200g

Nicknamed the 'Little Giant', a little man with a very big sound, this was his debut for Blue Note. After playing with Lionel Hampton's Big Band and a time in the forces, Griffin left his native Chicago for New York, where he really came into his own in 1957 with this album and the even better follow-ups *A Blowing Session* and *The Congregation*. Mixing originals with a selection of standards, this is an extraordinarily strong set. Leading a quartet comprising Wynton Kelly, Curley Russell and Max Roach, Griffin has the best possible launching pad and he flies: From the up-tempo self-penned opener 'Mil Dew' propelled by great drumming from Roach, his power is evident from the start. The lighter title track 'Chicago Calling' is a showcase for Griffin's fluidity wringing some great choruses from his horn, with Kelly contributing some particularly lovely piano. The standard 'These Foolish Things' demonstrates a fuller, almost Webster like tone, showcasing Griffin's ability to bring the best from a ballad. Kelly's lyrical contribution here is also a standout. And so it goes, not a weak track on the album, a very fine band on peak form, having what sounds on this evidence like the time of their lives. The pressing is immaculate and the mono recording full bodied and dynamic.

DD

Supplier: Vivante - [www.vivante.co.uk](http://www.vivante.co.uk)





**Jimmy Scott**

**Falling In Love Is Wonderful**

Rhino 8122736432 

Denied a proper release for 40 years since it was briefly issued by Tangerine and then withdrawn over label wrangles with Savoy, this 1962 recording is undeniably one of the jazz vocal classics, rated by many as amongst the top three vocal albums ever (with Holiday and Sinatra since you ask). Scott's voice to the uninitiated can seem very strange, a hormonal disorder rendered his adult voice more like a woman's, but once you're used to it he has few peers in wringing emotion from a song. His experience tells from song to song. Just listen to 'If I Should Lose You', or 'They Say It's Wonderful' for two great examples, or indeed to any of the 10 tracks here.

Produced by Joe Adams and Ray Charles, with arrangements by Marty Paich and Gerald Wilson, Charles's touch is evident throughout, maintaining consistently slow tempo's he allows Scott to dig deep into the soul of each number.

For once the pundits are right and I rate this album up there with Sinatra's *Wee Small Hours* and Holiday's *Lady in Satin* (but let's not forget Ella and Sarah). If you like this you should also check out some of Scott's underrated recent releases such as *Dream* (Warner), or *Over The Rainbow* (Milestone).

DD



**Bill Evans, Shelly Manne and Monty Budwig**

**Empathy**

Speakers Corner/Verve V6-8497 

A rare recording and an unusual line-up, the three musicians each contracted to a separate label. But Verve producer Creed Taylor pulled the strings and pulled them together for this August '62 session. The results may not rank as one of Verve's greatest recordings in terms of quality, but the music is simply sublime. Sonically speaking, the spread is too left-right to be really convincing. Evans' piano hard in the left-hand speaker with Manne's drum-kit hard right, Budwig's bass just inside the speaker and behind. But that's as far as the criticism goes. The spatial anomalies do nothing to disturb the musical chemistry between the players. Evans is all sparse chords and counterpoint, leaving plenty of space for Manne's tasteful fills, and when he takes a back seat, Budwig steps forward with fluid, mobile, agile bass lines that walk away before integrating seamlessly back into Evans' melodic framework. There's an easy respect and balance between the players that even Manne's characteristic exuberance can't disturb. The weight, colour and relationship between the instruments is beautifully captured, and such is the skill of the players that even a hacknied standard like 'Danny Boy' comes up anew. This is one of those rare recordings that captures true musical giants at the top of their game. The ghostly quiet surfaces just add to the magic of the experience.

RG

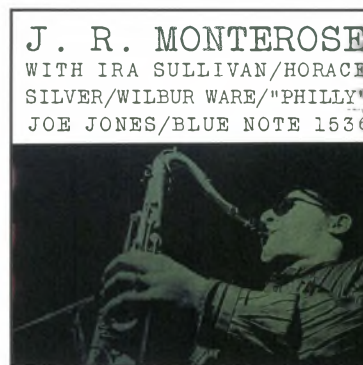

**J.R. Monterose**

Blue Note / Classic Records 1536 

J.R. Who? You might ask. Well, this was the tenor players first album under his own name, but just look at the band that Alfred Lion assembled around him for this release: Horace Silver, Wilbur Ware, 'Philly' Joe Jones & Ira Sullivan. What a start. Monterose, having moved at an early age from Detroit to New York, had initially studied the clarinet but ultimately moved to tenor sax. He'd worked with Buddy Rich, Teddy Charles and Charles Mingus picking up influences from them and from Charlie Parker and Sonny Rollins along the way. The album mixes a number of Monterose's own compositions with a couple of numbers by Donald Byrd and Paul Chambers brought in by Silver at Monterose's request since he didn't want the album to be dominated by his own stuff. Stand out numbers are the Donald Byrd composed 'The Third' where Monterose's Sonny Rollins influence is particularly evident. 'Bobbie Pin' features some great bass soloing from Wilbur Ware, and the frenetically paced 'Marc V' really catches fire with the best ensemble playing of the set. This is another very strong Classic/ Blue Note mono re-issue bringing the best from a great recording proving once again that sometimes mono is best!

DD

Supplier: Vivante - [www.vivante.co.uk](http://www.vivante.co.uk)





*isolation systems*  
**Voodoo**  
**AIRTEK** Pneumatic Isolation Platforms

for electronics, turntables & Speakers (excellent reviews)  
NATURAL RHYTHMS Equipment Rack System with unique  
cable isolation System, all hand crafted in our workshops in a  
variety of real wood veneers. Custom service available.

The **Voodoo** 99.999% solid silver power cord,  
Interconnect cables, solid silver, & copper fitted with bullet plugs  
Quality Mains Power Cords £49.95 Credit Cards Taken,  
Tel, **Voodoo** on +44 (0) 1643 841244, voodootek@hotmail.com

**SOUTH WEST ANALOG E**

Have all **Voodoo** equipment on demonstration along  
with **SME-TUBE TECHNOLOGY- MICHELL**  
**NOTTINGHAM ANALOGUE - LORICRAFT/GARRARD**  
**CROFT - various cartridges, ORTOFON , VDH**  
Second hand equipment, Record cleaners/cleaning service.  
Perspex lift off covers, Major credit cards.  
Tel +44 (0) 1643 851351,  
graham@southwestanalogue.fsnet.co.uk

**tom tom audio**

**THE NAIM AUDIO SPECIALISTS**

We buy and sell top condition, second user, ex-demo  
and new naim equipment and associated brands.

From individual components, through to full systems, tom  
tom audio is your cost effective key to naim audio with  
complete peace of mind.

We offer full demonstration facilities and home trials plus  
considered help and advice.

Cash waiting, plus all products are tested and carry  
a full, no quibble 12 month money back guarantee.

**WE COLLECT AND DELIVER**  
**CALL 07971 202742 ANYTIME**  
tunes@tomtomaudio.com



## Subscription Form

In order to ensure prompt arrival of your copy of hi-fi+, it is safest to take out a subscription. This lasts for a year, or 8 copies, and means that your magazine is delivered to your doorstep immediately it is published. No more fruitless journeys in search of audio enlightenment, and no more worries about missing an issue.

In order to apply, simply fill in the form, legibly (!), and drop it in the post. Oh, and we won't supply your details to double glazing or insurance industries. You can rest safe in the knowledge that the only junk mail you'll receive has been sent by us!

And the cost of all this peace of mind?

### One Year Subscription / 8 Issues

Within the Uk, \$28.50 For the rest of Europe, £37.25  
For the rest of the world, \$46.00

### Two Year Subscription / 16 Issues

Within the Uk, \$48.00 For the rest of Europe, \$65.00  
For the rest of the world, £80.00

### Contact:

hi-fi+ Subscriptions, Unit 12 Albany Business Park  
Cabot Lane, Poole, Dorset BH17 7BX

### Or call:

Andrea Chick on Tel: 44 (0) 1202-659380  
or Fax: 44 (0) 1202-659540

### Via the web:

[www.hifiplus.com](http://www.hifiplus.com)

### ABOUT YOU:

Title -----  
Forename -----  
Surname -----  
Address -----  
-----  
-----  
Postcode -----  
Daytime Tel -----

I would like my subscription to start from issue: -----

### PAYMENT:

UK  Europe  Rest of World

One Year  Two Years

Cheques to be made payable to Hi-fi+ Publishing limited.  
(drawn on a UK bank)

Visa  Access/Mastercard

Card No -----

Expiry Date -----

Switch

Card No ----- Issue No -----

Expiry Date -----

Signed ----- Date -----

## ■ NEW VINYL RELEASE FROM VIVANTE PRODUCTIONS LTD



### Eleanor McEvoy: *Yola*

***"Yola slips on like a favourite jumper. It should become a classic..." Roy Gregory - Hi Fi +***

Now forgive a little bias here but we think that the album sounds extremely good in its vinyl incarnation. *Yola* is a modern day folky/pop album, in the classic tradition of Suzanne Vega, Tracy Chapman and Mary Black. So if you want to hear some beautifully crafted songs (like you thought they didn't write anymore!), played by musicians (acoustic guitars, drum, bass and piano) whose understated and totally sympathetic musicianship is a pleasure to hear, then *Yola* is an excellent album to spend time with. But it's Eleanor's voice that has centre stage and deservedly so, because she is a wonderful singer. Eleanor's music is deeply personal (i.e.: love, it's perils, uncertainties and occasional bright spots) and requires that she approach her lyrics with real commitment and feeling, which she does of course, in spades. Tracks include *I Got You See Me Through*, *Leaves Me Wondering*, and *The Rain Falls*.

vivante

Vivante publishes a monthly newsletter, *On The Record*, which highlights new releases on all audiophile formats, includes special offers and features columns written by top Hi-Fi and music critics.

Please ask to receive your free copy when you order *Yola*.

We are very glad that we at Vivante in association with Alto, our partners in this project, have had the chance to bring this stunning album out on vinyl.

**Vivante Alto Labs VA01 180g £19.95**

Unit 6, Fontigarry Business Park, Reigate Road, Sidlow, Nr Reigate, Surrey RH2 8QH. UK.  
**tel:** +44 (0)1293 822 186 **fax:** +44 (0)1293 821 965  
**email:** sales@vivante.co.uk **web:** www.vivante.co.uk

## Keep your hi-fi+ magazines in immaculate condition with these specially designed protective binders.

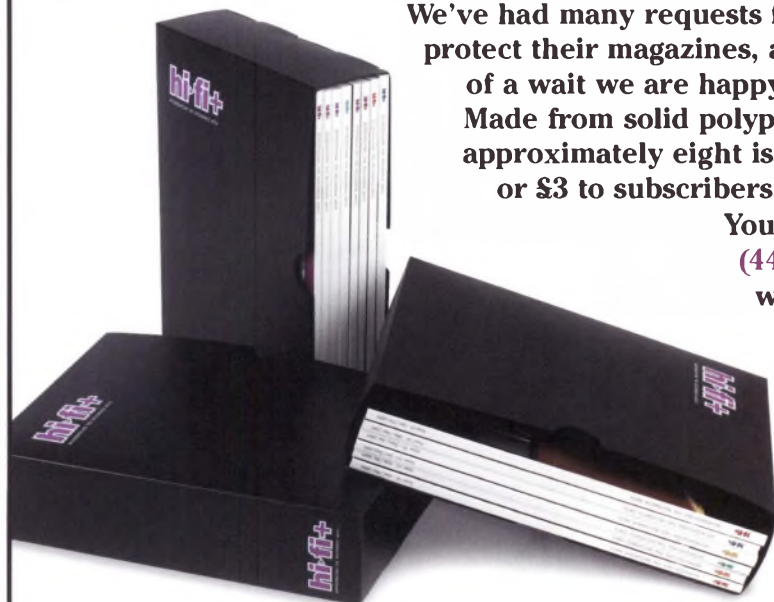

We've had many requests from readers for binders to protect their magazines, and finally, after something of a wait we are happy to announce their arrival. Made from solid polypropylene each one will hold approximately eight issues and they cost **£5 each, or £3 to subscribers, with £1.50 p&p per order.**

You can order yours by calling **(44)(0)1202- 659380** or via the website at **www.hifiplus.com**

# hi-fi+

Hi-Fi+, Unit 12,  
Albany Business Park,  
Cabot Lane, Poole, Dorset  
BH17 7BX,  
United Kingdom



## Beethoven

### Symphony No. 9 Solti, CSO and Chorus

Speakers Corner / Decca 6 BB 121/2

180g

2

It is only fitting that Beethoven's final symphony should also be (arguably) his greatest. The *9th* is a monumental work and Solti rises to the occasion. Fitting too that he leads the perfectly drilled forces of the Chicago Symphony Orchestra and Chorus with whom he enjoyed such an artistic-ally productive relationship, and soloists of the caliber of Lorengar, Minton, Burrows and Talvela, who collectively put in a storming performance in the final movement. They're egged on by an uncharacteristically flamboyant Sir Georg, whose sweeping reading and sudden dynamics suit the score, while still managing to provide the deft delicacy so necessary for the music's texture and contrast. There are of course, other great performances of the *9th*, but what sets this one apart is sound good enough to have made it a fixture on the TAS list. The open, deep, beautifully layered and focussed soundstage is wonderfully warm, the legendary Wilkinson again delivering the goods. Indeed, this recording offers all the best aspects of the Decca label, with none of the pinched tonality or second-rate performers it sometimes suffered. The Speakers Corner pressing loses a little of the vivid immediacy of the original, but its perfectly quiet and flat surfaces are ample compensation, especially given the price of secondhand copies. A very welcome release.

RG

RECORDING 

MUSIC



## Beethoven

### Symphony No.3 "Eroica" Munch BSO

JVC RCA Living Stereo JMCXR-0019

XR

2

### Symphony No.6 "Pastoral" Reiner CSO

JVC RCA Living Stereo JMCXR-0020

XR

4

The performance of these truly great Symphonies, despite a natural presence and authority brought to each concert hall by the huge egos stood at the podiums, still falls short of what one would expect of readings by a Charles Munch and Fritz Reiner at their best. Of course the brilliantly written music – its heroism in the "*Eroica*" and those evocative and idealised recollections of country life in the "*Pastoral*" – shines through, but there is a palpable feeling that more of Beethoven's grand visions could and should have been revealed. In this sharing process the recordings are both open, transparent and detailed enough, the orchestral playing within the parameters allowed under the direction is polished, but the conductors are perhaps too tight-lipped. Too focused upon imposing a particular design upon this music, although that is not to say these interpretations are without merit. Munch's approach to the *Third Symphony* has a likeable ponderous majesty about it, which fills out the whole width and breadth of Symphony Hall, Boston. This recording is panoramic, closely-miked and possesses fine clarity right across the midrange, and it is the sparkling and lifelike reproduction of the tone, timbres and drier string textures that makes up for the baton's overall lack of incisiveness and urgency. The execution of the *Funeral March*, however, is quite striking: the appropriately slow tempo here is stoic and darkly intense without



becoming slack. Munch remains stately throughout, even if elsewhere the revolutionary Napoleonic themes demand a little more cut and thrust to them.

Dr. Reiner's version of the "*Pastoral*" *Symphony*, with its surging speeds and efficient execution, too much neglects the affectionate, warm-hearted and contemplative side that Beethoven envisaged for it. His brisk *Finale* is, however, a sympathetically handled section, but the rigid tempo taken as a whole removes some of the obvious delight and spontaneity from those scenes by the brook or at the peasant's merry-making. Even here the Chicago Symphony players are excellent.

The recording is an interesting adjunct to this album. Richard Mohr and Lewis Layton taped this performance over two days in April 1961, but it wasn't released until October 1963 when it appeared as the first RCA Living Stereo to feature the notorious Dynagroove computerised frequency modulation process. Whilst this has no effect upon the XRCD sonics, it may interest some to know that the sound of an original U.S. cut LP is pretty disappointing. As an alternative on record, look out for the English pressing by Decca. Even though they probably got a second-generation master tape from RCA America, the Dynagroove equipment used for cutting the lacquers stayed on the other side of the Atlantic.

RP

Supplier: [www.vivante.co.uk](http://www.vivante.co.uk)

**Eroica**  
RECORDING 

MUSIC

**Pastoral**  
RECORDING 

MUSIC



**Berio**  
**Voci**  
 Kashkashian/Schulkowsky/Radio  
 Symphonieorchester Wien/Davies

ECM New Series 1735 – 461 808-2

Luciano Berio used the folk music of his native Sicily in the construction of both works featured on this CD – *Voci* and *Naturale*. But also included here are historical tapes of authentic Sicilian music to demonstrate the fact.

Violist Kim Kashkashian takes the technical minefield of *Voci* and tears through its complex exterior to reveal its expressive core. Accompanied by the Radio Symphonieorchester Wien, directed by Dennis Russell Davies, her instrument leaps from crescendo to fiercely resonant passage and back again, exposing Berio's very personal style. On *Naturale* she is joined by the excellent percussionist Robyn Schulkowsky, and a "taped" folk singer, recorded by the composer. The result is an intensely raw set of opposing factions that create great vibrancy. Between the two are the six, almost African sounding, Sicilian songs, that are sung and recorded in a rather amateur manner, but will be of great importance, and ultimately rewarding, to those who wish to fully understand Berio's work.

Ignoring the historical tapes, the recordings are vividly dynamic and up to ECM's usual standard. While Berio's compositions will not appeal to everyone, this disc represents a superb demonstration of how he incorporates conventional ethnicity into his music.

SG



**Shostakovich**  
**Symphony No. 11 (The Year 1905)**  
 LSO/Rostropovich

LSO Live LSO 0030

With live recordings, such as this, you can feel the tension. The audience sit in stunned silence throughout, as Mstislav Rostropovich leads the LSO through a most deeply considered Barbican performance. He wrings every emotion from both the music and the orchestra, generating a most chilling representation of Russian history. Rostropovich takes his time to establish this intensity, weaving his own creativity into the work's musical structures, but we are rewarded by a vivid interpretation of Shostakovich's reflection on the St. Petersburg massacre; from his depiction of the bleak and desolate *Palace Square*, to the final climax of rising defiance. You can feel the crunch of the freezing ground beneath your feet, sense the rise in hostility, and picture the ruthless slaughter before the period of reflection. The composer's linking of all four movements only adds to the tension. Only with the final movement's early energy and drive do these feelings of bitterness and despair relent. Tony Faulkner's engineering is up to his usual high standards, and with the help of the Barbican Hall's improved acoustics, creates a vivid picture that only adds to the atmosphere. This is an intensely harrowing listening experience that will leave you spellbound.

SG



**Ravel**  
**Daphnis & Chloe**  
 Munch BSO

JVC RCA Living Stereo JVCXR-0222-2

This XRCD transfer taken from the original dual-track, 30 ips master tapes is a luminous and lifelike experience where the various musical threads including the singing by New England and Alumni chorus members are all delivered with a remarkable degree of clarity. Thematically, a ballet about dancing shepherdesses, cowardly pirates, satyrs and the bacchanalian rites of Pan in pursuit of his Syrinx paints a highly theatrical scene. An equally elaborate reading is needed to do this score and those motifs justice and Charles Munch gives us one that's full of pepper. At the root of his gripping and emotional interpretation is the beautifully incandescent Boston string tone that magically washes its rich palette throughout the midrange of the recording. All that is good stems from here. That sparkle, presence and warmth in the violin, viola and cello playing extends into the horn and wind section dynamics as well, while a solid reproduction of the percussion and low horn notes down in the engine room knits these two key areas together rather nicely. Our conductor, his musicians and the technical team of John Pfeiffer and Leslie Chase are then left to balance out the varying demands of this frivolous, animated and thoroughly good-natured music.

RP

Supplier: [www.vivante.co.uk](http://www.vivante.co.uk)





# WILMSLOW AUDIO

Loudspeaker specialists for over 40 years

- Range of replacement drive units from Vifa-Scanspeak, Peerless, Morel, Seas etc, for use in AR, Gale, Heybrook, IMF, KEF, Mission, ProAc, Rogers, TDL plus many others.
- Comprehensive stock of components, capacitors (SCR & Hovland), QED cable, damping and grille materials.
- UK's largest supplier of kit loudspeakers - all on demonstration

**Phone today for your FREE catalogue or check out our Website.**

## WILMSLOW AUDIO

50 Main Street, Broughton Astley, Leicester

Tel: 01455 286603 Fax: 01455 286605

Website: [www.wilmslowaudio.com](http://www.wilmslowaudio.com)

### AS SEEN ON T.V.

Wilmslow Audio is currently being featured on 'John's Workshop' on Discovery Home and Leisure



## ADVERTISERS INDEX

A' Audio Solutions	88	Dynavector	140	Paul Hynes	140
Aanvil Audio	112	European Circuit Solutions	41/115	Pear Audio	104
Absolute Sounds	2	Experience Filtration	135	Phonography	112
Audio Atmosphere	105	Final Lab	79	Pure Digital	59
Audio Consultants	4	Garrick	139	Quadraspire Ltd	69
Audio Counsel	58	Griffin Audio	139	Radlett Audio	140
Audiofreaks	8	GT Audio	59	Reference Audio	88
Audio Illusion	41	Hazlemere	98	Ringmat	89
Audio Images	135	Heatherdale Audio	104	Signals	140
Audiophile Club	53	Hificables.com	98	Sounds of Music	28/140
Audio Republic	135	Hififorsale.com	115	Sounds of Music - Boulder	99
Audio Reference	27	IF Design	41	Sounds of Music - Hovland	78
Audio Reflection	88	Infidelity	139	Sponsor Audio Systems Ltd	27
Audio T	16	Intergrated		The Cartridge Man	116
Audiovector/		Engineering Solutions	89	The Chord Company	12
Bocchino Audio	47	Joenit	23	The Emporium	58
Basically Sound	98	KJ West One	128	The Right Note	99
Border Control	116	Leema	53	Tom Evans Audio Design	115
Castle Sound & Vision	135	Mike Manning	104	Tom Tom Audio	143
Cerimax	135	Midland Audio Exchange	11	Trading Station	120/121
Cherished Records	139	Music Matters	139	Trichord Research	69
Chestergate	40/136	Naim	IBC	Vivante	144
Chord Electronics	20	Neat Acoustics	78	Voodoo Isolation	143
Classe	15	New Audio Frontiers	105	Vynoodle	139
Clear Cover Ltd	116	Northwood Audio	135	Walrus	7
Cyrus	17	Nordost	26	Wilmslow	147
Definitive Audio	68	Oranges & Lemons	140	Wollaton Audio	79
Densen	OBC	Origin Live	47	Worthing Audio	105
Doug Brady	68	Path Premier	IFC		

# A Masterly Voice...

## A great classical catalogue that's readily available on record and doesn't cost the earth!

by Richard S Foster

Would you believe that one of the greatest catalogues of classical music is available for your listening pleasure at less than the price of a newly re-issued recording? There is a wealth of wonderful records available containing not only excellent performances but also offering great sound. That's right... original records made less than 30 years ago with not only those qualities, but one more great benefit: they are ALL available from the major UK classical record dealers for under £10 each! And that's before you start rooting through your local Oxfam store.

While there are many mid-priced and budget issues from this company at lower prices, the full-priced EMI catalogue of the 1970's is ripe with a wealth of wonderful issues by world-class artists and orchestras available for a very small investment. The reality is that most of these records remain 'undiscovered'. They have not been written about by any of the dedicated audio magazines since the day they were released. But these records were reviewed by the critics of the day: The Penguin Stereo Record Guides, The Art of Record Buying (the annual publication of the monthly EMG newsletters) and Gramophone Magazine to name but a few. Today of course, we read about them being re-issued in CD or on specialist 180g LPs, but still the significance of the originals seems to have escaped us.

But before we get too far, here are my three golden rules for buying records second-hand:

### Buy only what you like.

The only way you're going to learn about this music if you have no previous knowledge is to dive right in. Start with the 3 Bs – Bach, Beethoven, Brahms – and go from there. You're going to be in for a treat. Twenty-five years ago I couldn't spell Tchaikovsky, let alone know what works he'd written.

**If you are not sure about the music or the performance, try and obtain the least expensive pressing of the record first.**

Earlier pressings are almost always guaranteed to sound better than later pressings. An example of this might be buying a later pressing of the famous Effrem Kurtz/ Philharmonia

Orchestra recording of Prokofiev's *Peter and the Wolf* and Saint Saëns' *Carnival of the Animals*.

This is a wonderful sounding record that also contains great performances. Original white/gold (EW1) \* pressings of this record are routinely offered in excess of £150. There are so many performances of these works available. Would you spend that kind of money before you heard the performance? I shouldn't think so. Because this record was so popular, it stayed in the catalogue for many years. Later, 1970's issues of this record (black and white postage

stamp dog on red background - ER3) are available for less than £10. Makes sense to me to try the later issue first to see if you like this recording.

This was advice given to me in the early 1980's when I started collecting the Mercury Living Presence records. There was so much music by American Composers that was unfamiliar to me. At that time the Mercury's were very expensive and I just felt very intimidated by the scope of their catalogue and lack of my knowledge. US Mercury's are very label and stamper-number dependent. There are many variables that separate good sounding from awful ▶



\* Designation according to the Mikrokosmos Labelography designations. The Mikrokosmos Labelography is an on-going reference work that identifies and categorizes classical record company labels by country and in chronological order of their release; A very important work for the collector. Please go to: <http://www.Mikrokosmos.com> for further information.

▶ sounding pressings in this catalogue. My friend David Nemzer advised me to buy the latest label issues of these records to see if I enjoyed the music. He also advised me that earlier would always sound better. He was so right.

### Always do your homework whenever possible.

Earlier I mentioned some of the written reference sources that were available when these old records were first published. When I began collecting I quickly realized that knowledge was power - as well as saving me money. It's so important to know more than the dealer you buy from. I found out about these publications and bought copies of all of them. (This was before the Internet and e-mail lists like *phonogram* were available\*).

For those readers interested in the great guides and magazines available about these records, I suggest you consult with your the local reference. You will be surprised as to what is available.

My collection of EMI ASD series records contains approximately 900 individual titles. There are more individual titles available but, based upon my own likes and dislikes, I've made the decision not to be a completist.

While many people consider the true 'golden-age' of recordings to be that 1959-1963 period, I'm not so sure. Of course some of the artists available in the earlier catalogues would either not be recording (in the case of Maria Callas) or still with us (Sir Thomas Beecham [d.1959], Otto Klemperer [d.1973]) for the early to mid 1970's recordings. I am fortunate enough to own 100's of the early ASD series as well as the great EMI Columbia issues from the SAX catalogue. While there are sonic blockbusters available in these series, the lion's share of these issues contain only mediocre sound.

While the Decca Record Company, in my opinion, won the 'sound wars' at the dawn of stereo in the early 1960's, EMI really came into their own in the sound department in the mid

1960's through to the 1980's. Almost EVERY record issued by EMI from ASD 2251 - the first true stereo 4 digit

catalogue number - Sir John Barbirolli's great interpretation of Schubert's *9th Symphony* (The Great C Major) in February of 1966, through to EMI ASD 4221, Norman del Mar/ Bournemouth Sinfonietta's collaboration on Stanford's *Irish Symphony* released in August of 1982, contains excellent analogue sound. That is quite an accomplishment. So what am I telling you? I'm saying that your own tastes will dictate what you will be happy with and also that you can purchase some stunning recordings from the last century at fairly modest prices. All you need to do is look at the catalogues of some of the more reliable UK dealers and take a plunge. \*\*

The records I am going to briefly mention were made from about 1970 through to 1976; there are literary 100's of titles available at modest prices. These are all easily identified as first issues by their label (black and white postage stamp dog on red background (ER3)). This particular label was in use by EMI as the first label for issues from approximately ASD 2804 (May 1972) through to ASD 3807 (November 1979). Of course there are always exceptions so remember I'm speaking generally and this does not at all reference the collaboration for the EMI/ Melodiya labels which we may discuss at another time. Two recordings listed below contain earlier labels as first issued. They are so noted.

EMI ASD 2989: *Ibert: Divertissement; Honegger: Pacific 231; Satie: Gymnopédies; Poulenc: Les Biches. City of Birmingham Symphony Orchestra conducted by Louis Frémaux. Recording producer: David C. Mottley; recording engineer: Neville Boyling. Recording first published April, 1974.* ▶

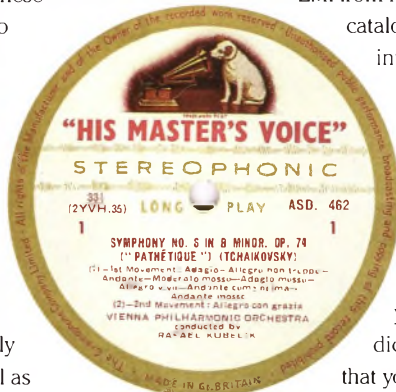

\* Phonogram is the largest e-mail list on the internet dealing with vinyl records. For further information, send an e-mail to: majordomo@phonogram.net. In the first line of your email type: 'info phonogram'. There is also an equipment list available. You should add the line: 'info equipment' for further information. Do not include the quotation marks please.

\*\* Two of my personal favorite dealers for this material are Jonathan Kustow of Classic Choice (<http://www.classic-choice.co.uk/mainframeset.html>)[[jjk@classic-choice.co.uk](mailto:jjk@classic-choice.co.uk)] and Chris Orchard of LP Classics (<http://www.lpclassics.co.uk>)[[chris.orchard@ukonline.co.uk](mailto:chris.orchard@ukonline.co.uk)]. Both these dealers provide extensive catalogues of English classical records. More importantly, they both pack their items well and provide a generous no hassle return policy. I've used them for years and can unequivocally recommend them. There are plenty of others, but these are just two that I've had great service from.

▶ EMI ASD 3008: *Ravel: Bolero; Chabrier: España; Saint Saëns: Danse Macabre; Dukas: L'Apprenti Sorcier; Debussy: L'Après-midi d'un Faune. City of Birmingham Symphony Orchestra conducted by Louis Frémaux. Another Mottley/Boyling collaboration. Recording first published July, 1974.*

EMI ASD 3176: *Ibert: Symphonie Marine; Bacchanale, Louisville Concert. City of Birmingham Symphony Orchestra conducted by Louis Frémaux. Recording producer: David Mottley; recording engineer: Stuart Eltham. Recording first published April, 1976.*

Let me assure you in the mid 1970's, almost any record made by Louis Frémaux and his City of Birmingham Symphony Orchestra was your guarantee of a fine performance as well as an introduction into great sound quality. While the critics of the day were not all that kind regarding the 'music' contained on ASD 3176, they did enjoy the performances and the sound quality. ASD 2989 contains a high quality production of the great 'Divertissement' composition (second only to the great Jean Martinon's legendary early Decca recording on a very expensive SXL 2252). This lp contains a very good performance of Honegger's incredible 'Pacific 231' and a beautiful performance of Satie's *Gymnopédies*. EMI ASD 3008 is an absolute barn-burner of a recording. The entire record offers great performances of each and every work contained on it and the record is a guaranteed five-star demonstration quality disc that will have your mouth wide open in astonishment.

EMI ASD 3190: *Frank Bridge: The Sea Suite (Seascape, Sea Foam, Moonlight, Storm); Summer Tone Poem; Cherry Ripe; Enter Spring Rhapsody; Lament. Royal Liverpool Philharmonic Orchestra conducted by Sir Charles Groves. Recording producer: John Willan; recording engineer: John Kurlander. Recording first published May, 1976.*

Frank Bridge is a fine English composer and this record spans the range of his orchestral output from early to late. Sir Charles Groves offers warm, sensitive readings of these romantic works and the engineers have provided first-class sound through-out. A record that sells for almost nothing on the used market and one that you will enjoy for years to come.

EMI ASD 3017: *The Academy in Concert. Albinoni arr. Giacomini: Adagio in G minor; Mendelssohn: Scherzo in G minor (from Octet in E flat major, Op. 26); Handel:*

*Minuet (from 'Berenice'); Mozart: March in D major, K.335, No. 1; J.S. Bach: Sinfonia (from 'Christmas Oratorio'); Fachelbel: Canon à 3 on a ground in D major; Beethoven: Twelve Contradances; Haendel: Pastoral Symphony (from 'Messiah'); J.S. Bach: Air (from Suite No. 3 in D major) Mozart: Die Schlittenfahrt (German Dance No. 3, k.605). The Academy of St. Martin-in-the-Fields conducted by Neville Marriner. Recording producer: Christopher Bishop; balance engineer: Stuart Eltham. Recording first published October, 1974.*



These works are all well suited for the marvelous Academy of St. Martin-in-the-Fields. Each one of these bon-bons is more delicious than its predecessor and you will turn to this recording often. Eltham has provided an excellent balance and the orchestra's tone is rich and lush without being over reverberant. Great sound effects can be found in the Mozart work. Highest recommendation for performances and sound.

EMI ASD 3154: *Britten: Four Sea Interludes. Op. 33a (Dawn, Sunday Morning, Moonlight, Storm); Passacaglia, Op. 33b from Peter Grimes; Sinfonia da Requiem, Op. 20. The London Symphony Orchestra conducted by André Previn. Recording producer: Christopher Bishop; recording engineer: Christopher Parker. Recording first published February, 1976.*

This record was given a rosette by the authors of the Penguin Stereo Record Guide, their highest recommendation. Bishop/Parker deliver another recording that offers the highest qualities to its listener: an exceptional performance containing exquisite sound. Previn and the orchestra are very comfortable in these works and their love for the music comes through loud and clear. The *Passacaglia* alone will tax the worth of all but the largest of systems. This recording brings new meaning to the words, 'deep bass'. Highest recommendation.

EMI ASD 2822: *Elgar Overtures: Cockaigne Op. 40; Froissart Op. 19; Overture in D minor (Handel arr. Elgar); In the South (Alassic) Op. 50. London Philharmonic Orchestra conducted by Sir Adrian Boult. Recording engineer: Christopher Bishop; balance engineer: Robert Gooch. Recording first published September, 1972.* ▶



► EMI ASD 3050: *Elgar Orchestral Music: Triumphal March from Caractacus, Op.35; Carillon, Op. 75; Chopin Funeral March-orchestrated by Elgar; Dream Children, Op. 43; Elegy, Op. 58; Incidental music and Funeral March from Grania and Diarmid, Op. 42; Polonia, Op. 76; Meditation from The Light of Life, Op. 29. The London Philharmonic Orchestra conducted by Sir Adrian Boult. Recording producer: Christopher Bishop; balance engineer: Christopher Parker. Recording first published February, 1975.*



These are all marvelous performances from some of Sir Edward Elgar's finest and most popular works. They are all rather grandiose overtures and tone poems-like works I've come to love very much. There is something very magisterial in his compositions and I think Sir Adrian does an excellent job in interpreting them. Boult delivers a more dramatic and noble presentation of the overtures and doesn't move into the world of the romantic. Both records once again offer demonstration quality sound and you will be dumbfounded when you hear the 'Triumphal March' from *Caractacus*. This orchestra is in its own element with these works and Boult is the perfect leader. Another top recommendation.

EMI ASD 2660: *Brahms: Symphony No. 3 in F major, Op. 90; Tragic Overture, Op. 81. The London Symphony Orchestra conducted by Sir Adrian Boult. Recording producer: Christopher Bishop; balance engineer: Michael Gray. Recording first published March 1971 (first label: colour postage stamp dog (no white ring) on red background(ER2).*

EMI ASD 2746: *Brahms: Symphony No. 2 in D major, Op. 73; Alto Rhapsody, Op. 53. Janet Baker: Mezzo-Soprano. Male voices of the John Alldis Choir led by John Alldis, Chorus Master. The London Philharmonic Orchestra conducted by Sir Adrian Boult. Recording producer: Christopher Bishop; Balance engineer: Christopher Parker. Recording first published October, 1971. (ER2, first label)*

EMI ASD 2871: *Brahms: Symphony No. 1 in C minor, Op. 68. The London Philharmonic Orchestra conducted by Sir Adrian Boult. A Bishop/Parker collaboration. Recording first published April, 1973.*

EMI ASD 2901: *Brahms: Symphony No. 4 in E minor, Op. 98; Academic Festival Overture, Op. 80. The London Philharmonic Orchestra conducted by Sir Adrian Boult. A Bishop/Parker collaboration. Recording first published June, 1973.*

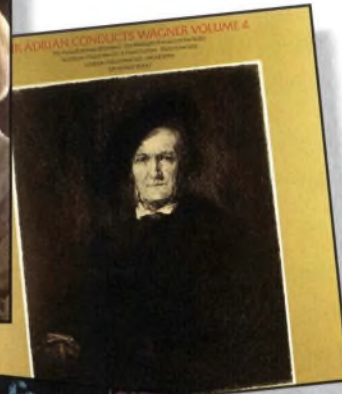

Well here come some surprises. Sir Adrian Boult conducting Brahms? You betcha'; and he is fantastic.

His control of the orchestras is impressive to the point he's rated higher than the lofty Otto Klemperer in two of these performances. These are warm, expansive readings offering refinement and great dignity that in my mind tell me that Sir Adrian is a superb Brahmsian interpreter. I believe it important for collectors to try and explore works that they might not associate with a particular conductor. I think if you looked carefully in the used marketplace (and I hate all the readers living in the UK who can find these records for almost nothing at their local stores, not to mention charity shops) you would probably be able to buy all four of these records for under £20. There is also a box set of these performances available as EMI SLS 5009, but I can

guarantee the individual issues will offer superior sound. Possibly one of the finest Brahms *Seconds* on record is here coupled with a very memorable account by the great Janet Baker of the *Alto Rhapsody*. Highest recommendations.

EMI ASD 2812: *Richard Wagner: Die Meistersinger von Nürnberg (Overture, Prelude to Act III); Tristan und Isolde (Prelude); Tannhäuser (Overture); Lohengrin (Prelude)*

to Act I; Prelude to Act II). *The New Philharmonia Orchestra* conducted by Sir Adrian Boult. Recording producer: Christopher Bishop; balance engineer: Robert Gooch. Recording first published July, 1972. (ERZ)

EMI ASD 2934: Richard Wagner: *Die Walküre (The Ride of the Valkyries)*; *Siegfried (Forest Murmurs)*; *Götterdämmerung (Dawn and Rhine Journey, Siegfried's Funeral March)*; *Tannhäuser (Prelude to Act II)*; *Tristan und Isolde (Prelude to Act III)*. *The London Philharmonic Orchestra* conducted by Sir Adrian Boult. Recording first published October, 1973. A Bishop/Gooch collaboration.

EMI ASD 3000: Richard Wagner: *Siegfried Idyll*; *Parsifal (Prelude Act I, Transformation Music Act I, Prelude Act III, Good Friday Music Act III, Transformation Music Act III)*. *The London Symphony Orchestra* conducted by Sir Adrian Boult. Recording first published July, 1974. A Bishop/Gooch collaboration.

EMI ASD 3071: Richard Wagner: *The Flying Dutchman (Overture)*; *Rheingold (The Entrance of the Gods into Valhalla)*; *Tannhäuser (Grand March Act II)*; *A Faust Overture*; *Overture: Reinzi*. *The London Philharmonic Orchestra* conducted by Sir Adrian Boult. A Bishop/Gooch collaboration. Recording first published April, 1975.

These four records offer a very interesting and entertaining look into some of the wonderful excerpts from the music of Richard Wagner. The orchestral playing is always at least good and there are some fine moments captured by the engineers. While I don't consider Boult in the class of say Karajan, Klemperer, Dorati, Szell or Walter in these works, he does have something to say about Wagner and I think it very worthwhile. You are guaranteed excellent sound, good readings of works everyone has heard at one time or another all at very moderate prices. Recommended.

EMI ASD 3081: Shostakovich: *Concerto for piano, trumpet and strings, Op.35*; *Piano Concerto No. 2, Op. 192*; *Three Fantastic Dances*. Christina Ortiz, piano. Solo Trumpet: Rodney Senior. *Bournemouth Symphony Orchestra* conducted by Paavo Berglund. Recording producer: John Willan; balance engineer: Stuart Eltham. Recording first published June, 1975.

EMI ASD 3197: Rachmaninov: *Rhapsody on a theme of Paganini, Op. 43*; *Dohnányi: Variations of a Nursery Song, Op. 25*. Christina Ortiz piano. *The New Philharmonia Orchestra* conducted by Kazuhiro Koizumi. Recording producer: John Willan; recording engineer: Robert Gooch. Recording first published April, 1976.



I'm a big fan of Christina Ortiz in these performances. Born in Brazil in 1950, Ortiz first studied in Rio and then in Paris. She studied under one of my all-time favorite pianists, the very great Magda Tagliaferro. She has a fine way of molding these works and offers great refinement in the *Three Fantastic Dances*. The orchestral accompaniment under Berglund is of the highest order and this record offers demonstration quality sound.

Berglund was born in Helsinki in 1929 and has a fine legacy of recordings with EMI and this orchestra. Look especially for his performances of the Sibelius symphonies as well as a very fine reading of the Nielsen *5th symphony*. (Available for no more than £3 as EMI ASD 3063)

Kazuhiro Koizumi was born in Kyoto, Japan in 1949. In 1973 he won first prize at the third Karajan

International Conductors Competition. His leadership of the New Philharmonia in the works of Rachmaninov and Dohnányi are absolutely first rate. The performances by Ortiz are powerful and exciting. While you may have your favorites for these works, you'll not find finer readings offering demonstration quality sound for the price of this disc. Although there was a fine performance offering excellent sound of this very same material available for many years on Decca (SXL 2176) with Boult and Katchen I think the HMV recording offers not only a superior performance, but a finer, more modern sound. The Dohnányi recording is stunning. The performance is sensitive, controlled and exciting. Highest recommendation for both records.

As you can see there is much to like in this EMI catalogue. Enjoy your exploration.



SEE WHERE IT TAKES YOU

"You can see how people become Naim addicts can't you"

**Gramophone**

"AWARDS WINNER 2002, PROCESSOR OF THE YEAR"

**Hi-fi News**

"Naim's Magical Movie machine"

**What Hi-fi**

"The belle of my particular home theatre ball"

**Perfect Vision**

"Makes any film a delight to watch"

**Stereoplay**

"Completely convincing"

**Prestige Audio Video**

"Naim's first multi channel system is a joy"

**Hi-fi World**

"Cost no object dedicated av system, you won't find better than this"

**Essential Home Cinema**



SERIES  
**5**

Introducing the latest addition to the Series 5, the Naim AV2 (Audio Video) processor. It not only enhances anything you listen to, it makes everything you watch come to life. People talk about 'Surround Sound', at Naim we immerse you.

  
WORLD CLASS HI FI

For your nearest stockist call +44 (0)1722 332266. Or visit [www.naim-audio.com](http://www.naim-audio.com)

THE ULTIMATE ENTERTAINMENT SYSTEM

# Densen

Densen ● Audio ● Technologies

Acoustic Arts  
Watford  
Tel. 01923 245250

Audio Counsel  
Cheadle  
Tel. 01614 916090

Audio Counsel  
Oldham  
Tel. 01616 332602

Hi-Fi Studios  
Doncaster  
Tel. 01302 725550

Kevin Galloway  
Audio  
Kilmarnock  
Tel. 01563 574185

Midland Audio  
Exchange  
Kidderminster  
Tel. 01562 822236

Mike Manning  
Taunton  
Tel. 01823 326688

Mike Manning  
Yeovil  
Tel. 01935 479361

New Audio Frontiers  
Loughborough  
Tel. 01509 264002

Phonography  
Ringwood  
Tel. 01425 461230

Progressive Audio  
Gillingham  
Tel. 01634 389004

Radfords  
Bath  
Tel. 01225 446245

Radfords  
Bristol  
Tel. 01179 441010

Signals  
Ipswich  
Tel. 01473 655171

Zen Audio  
Hull  
Tel. 01482 587397

"I absolutely loved the Densen. I can confidently state that the Densen gave me more of everything that I treasured, not in the sense that it emphasized any aspect of the music but rather that it brought me closer (as far as I could tell) to it. I bought the review unit, and it is now part of my reference system."

*Secrets of home theater 1999*

"The B-200 and B-300 are like a Zeiss lens bringing everything into focus. It seems to transmit more musical clues which passes many other amplifiers by. One can analyse hi-fi specifics till the cows come home but it's something intangible, difficult to put into words, but to which the ear and brain subliminally react. So, do I like this Densen set? No, I love it."

*Hi-Fi News august 2000*

LIFE IS TOO SHORT FOR BORING HI-FI

Densen ● Randersvej 28 ● 6700 Esbjerg ● Denmark  
Phone: (+45) 75 18 12 14 ● [www.densen.dk](http://www.densen.dk)