

hi-fi+

REPRODUCING THE RECORDED ARTS

American Beauty

▶ The Retro Issue

Living Voice
ART ST-ONE
Hovland HP100
Koetsu Black Urushi
ClearAudio Discovery
Border Patrol 300B-WE
Dynavector DV507, 13D & Dr. T
VPI Aries Turntable & JMW Tone-arm

▶ New Naim

The NAP 500 Power Amp

▶ Music

DVD Audio
Opus 3
Everything But The Girl

▶ Show Report

Novotel 2000 - fear and loathing in West London?



9 771465 595011

08

INTEGRITY

Among the extensive list of superlatives commonly showered upon high-end music systems, the word "integrity" is seldom used.

The new N°383 Integrated Amplifier highlights the spirit and integrity of Mark Levinson®, defining its essential elements. It carefully integrates both power and preamplifier circuits into a single, elegant chassis. Every detail expected of a Mark Levinson® component is executed with precision. Dual mono power supplies, balanced circuitry, world-class construction standards and sophisticated user interface are all there, joined in the service of performance. The N°383 simplifies and unifies your system, while staying true to the music.

When the Madrigal® design team set out to create the first integrated amplifier worthy of the Mark Levinson® badge, there were no shades of gray — it would either live up to the standard, or it would not exist. Audition the N°383 at your Mark Levinson® dealer soon and hear for yourself the integrity of our integration.



mark
levinson®

For full details on Mark Levinson components please contact:-

Path Premier
Dormer Road, Thame Industrial Estate, Thame,
Oxfordshire OX9 3UD

Tel: 01844 219000 Fax: 01844 219099
email: premier@path.co.uk

PATH
Premier

Editor

Roy Gregory

Contributors

Dave Ayers
Chris Binns
Pete Christie
Dave Davies
Jason Hector
Jimmy Hughes
Mike Mercer
Paul Messenger
Reuben Parry
Chris Thomas
Phil Ward

Photography

Simon Marsh

Cartoonist

Dave Davies

Design

Creative Byte
Unit 12, Albany Business Park
Cabot Lane, Poole, Dorset
BH17 7BX

Printed By

Stones The Printers, Ltd.
Banbury

Hi-Fi+ is published six times
a year by; Hi-Fi+ Publishing Ltd

The Editorial Office & Subscriptions

Dept. can be contacted at;

Hi-Fi+ Editorial
Unit 12, Albany Business Park
Cabot Lane, Poole, Dorset
BH17 7BX
Tel. (44)(0) 1202-659380
Fax. (44)(0) 1202-659540
Net. www.hifiplus.com

All Rights Reserved.

Not one word of Hi-Fi+ may be reproduced without the written consent of the Editor. We are perfectly happy to co-operate, but we don't want quotations to appear out of context.

Editorial

What future two-channel? It's an increasingly pressing question, and one that nobody seems in too much of a hurry to answer. The problem is that in the current market environment, unless someone actually sorts out a response and gets around to organising its presentation, two channel's relevance will simply wither and die, squeezed out of existence by marketing budgets and technological "advances". Of course, there are those who would be only too happy to see that happen. Just think of all that extra hardware that people will need to purchase to support the new formats, not to mention re-buying their existing music collections in glorious surround sound.

Then there are those who feel that two-channel still has a lot to offer. The simple fact that you can achieve the same level of amplification and speakers for a third of the price is kind of attractive. (Anybody who believes that multi-channel music needs anything other than identical amplification and speakers for all five channels, or that you can skimp on the sub-woofer, is irretrievably set on the route to no-fi; you know, loads of TV and no music.) That leaves a lot of budget for a better front-end or loads of extra software. And domestic impact, already an issue for many two-channel devotees, simply precludes expansion to six speakers and all the extra boxes that go with them.

And that ignores the huge existing treasury of stereo recordings: classical, pop and jazz. Does anybody seriously believe that these great performances are going to be enhanced by reprocessing for multi-channel playback? Think "electronically reprocessed for stereo". And there's no way that stereo playback through a six-channel set-up can compare to the performance of dedicated stereo system. (I don't think I'll even mention the mono XRCDs that DD reviewed this month!)

So there are compelling reasons to maintain our interest in two-channel music replay, even to the extent of choosing it over six-channel for the replay of multi-channel software in an either/or situation. It's about time we got our act together if we want to have the option.



Ry Gregory

A lot of changes - and still rather a lot of money.



Speakers as universally revered as our Reference Series are a tough act to follow. After all, what can you do to improve on excellence?

Rather a lot, as it happens. Take the high order crossovers, for example. They've been completely redesigned, using advanced polypropylene capacitors for even greater lucidity. And every crossover is further fine-tuned to match the parameters of each individual drive unit. We even found ways of making the drivers themselves with greater precision to iron out the slightest sonic imbalance.

Having perfected the acoustics, we turned to aesthetics. Hence the choice of five stunning contemporary finishes - exquisitely book-matched veneers, now including Cherry and the highly figured pale Albina Burr, with corners carefully radiused to eliminate residual edge diffractions. In all, literally hundreds of painstaking improvements were made.

So many small improvements can make a big difference to sound quality - and these do. You'll find the Reference Series~Two vastly more accomplished than its illustrious predecessors. Sweeter. Purer. Even more lavishly detailed.

Like all the best things in life, they still don't come cheap - but to anyone who really appreciates sound, they're better value than ever.



REFERENCE SERIES 

Contents

Equipment+

Regulars

- 5 News
- 15 Novotel Show Report
- 28 Letters to the Editor
- 32 Columns

Feature

- 40 A history of innovation...
Interview with Dr. Noburu Tominari
of Dynavector Systems
- 44 Dynavector DV507 Tone-arm and
DV13D Cartridge
- 47 Dynavector Dr. T XVI Cartridge

Equipment Reviews

- 50 Hovland HP100 Vacuum Tube
Pre-amplifier
- 58 Naim NAP 500 Power Amp
- 64 Border Patrol 300B-WE Single-
ended Valve Amplifier
- 68 VPI Aries Turntable and JMW
Memorial Tone-arm
- 74 Koetsu Black Urushi Cartridge
- 76 ClearAudio Discovery Cartridge
- 78 Living Voice Avatar Loudspeaker
- 84 Myriad MP100 Pre-amplifier and
MA240 Power Amplifier
- 88 Ruark Solus Loudspeaker
- 94 ART ST-One Loudspeaker

The Real Deal - budget gear that works

- 98 Tom Evans' Audio Design Micro-Groove
and Micro-Groove Plus Phono Stages

Audio Smorgasbord

- 104 Non-Ferrous Furniture and
SME Upgrades

Music+

Feature

- 110 DVD – sorting out the confusion

Music Reviews

- 114 Popular and Contemporary Music
- 121 Ben and Tracy
- 124 Jazz
- 128 Classical Music
- 132 Audiophile Discs from XRCD
- 136 Audiophile Recordings
- 139 Opus 3 – Swedish recordings...
done naturally

Departments

- 14 Subscriptions
- 120 Back Issues

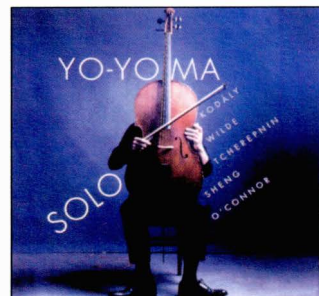
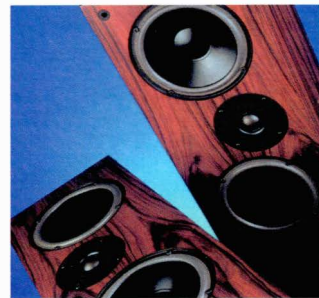

System 'La Musica' - the shape of things to come?

Stereo has always been a quality based technology; you buy it because it sounds good, you upgrade because it sounds better. Which is fine all the time the quality is actually present and demonstrable. Unfortunately, over the last decade, an increasing number of manufacturers (and dealers) have lost sight of that fact, choosing to rely on marketing rather than performance to sell their wares. The result has been a lot of very expensive and very disappointing systems which have been embarrassed in the face of competition from multi-channel alternatives dependent on sheer quantity instead. After all, why endure a mediocre two-channel set-up when for the same or less, you could have a complete set of bells and whistles with a gizmo count to make the mind spin and the eyes boggle? In a world where the simple solution is the one people choose, and value for money is king, that's a no-brainer.

Faced with, and far from happy with this situation, three established German high-end manufacturers adopted an unusual response. They decided to pool their knowledge in a project designed to exploit every last ounce of potential from a basic stereo set-up, creating a system which should provide not just ear-opening performance, but which should do so consistently in a wide range of different rooms and environments. Two years later, they are at last ready to show the fruits of their labours, although this is, almost by definition, an on-going saga which seems destined to run and run. In the process, the goalposts have moved, and if the target price has increased then so too has the performance on offer. And how!

The manufacturers in question are Peter Suchy of Clearaudio, Rolf Gemein of Symphonic Line and Alfred Rudolf of Acapella. Interestingly enough, their own product lines

overlap and compete, but in this instance ego has taken a back seat with strict delineation of responsibilities. The basic components in the system consist of a modified Clearaudio vinyl source and cabling, Symphonic Line one box CD player and integrated amp, and speakers and supports from Acapella. The whole lot is combined under the 'La Musica' banner, and is sold as a complete system only. The three companies involved continue to operate completely separately with their own product ranges.

One of the first things that became obvious at the start of the project was that in order to achieve the desired consistency, the entire system would have to offer a coherent solution to the problem of isolation from the outside world, both physical and electrical. As such a sophisticated range of supports and mechanical grounds ►

► has been developed, along with a dedicated set of mains cabling. Now this is music to my ears (literally), as readers will know that we have been running a series of complete system reviews in which we encourage manufacturers to supply every last element of the set-up. The System 'La Musica' takes the whole process to a new level. This system arrives complete with a full suite of tweaks and instructions on everything down to record cleaning.

I think we'd better start at the beginning.

The heart of the System 'La Musica' is a four shelf Acapella rack. This employs sand filled acrylic tubes for uprights, but it is the shelves which set it apart. These are based on a high-quality plywood, but bonded to the top surface are compressed layers of cork and lead, finished off with a sheet of aluminium, the top surface of which has been ground smooth to the extent that similarly ground pucks fit so closely that the join is airtight, resulting in slight suction when you lift them. This level of mating is critical to good energy transfer, and using a similar platform under my Clearaudio Reference record player, I can vouch for its effectiveness. In the 'La Musica' system the top plate supports another platform, isolated by five Clearaudio Magix opposed-magnetic feet, each with a ground aluminium base. The top plate itself is split, so as to break the direct path from the turntable's free-standing motor back to its chassis and platter.

The record player itself is a heavily modified Clearaudio Solution

turntable. Normally the baby of the range, the 'La Musica' turntable has been on a course of growth hormones that would make a hardened member of the *peleton blanche*. The platter has been replaced with Lexan, while there is now a peripheral record clamp (*à la* Mapleknoll) and a central record weight. The RB300 arm has had a Clearaudio Sixstream rewire which provides a single cable run from the cartridge pins to the inputs on the phono-stage, and up front

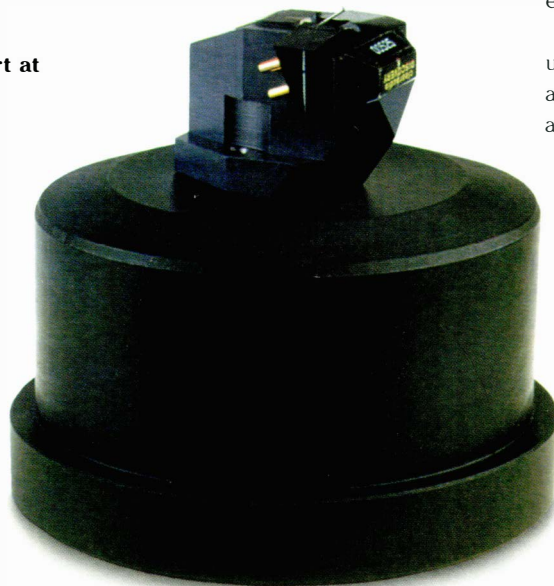

you'll find a specially badged version of the new £1920 Clearaudio Discovery cartridge (reviewed elsewhere in this issue). The armboard is threaded to allow for the fine adjustment of arm height critical with such an exotic pick-up.

Given the emphasis on mechanical grounding, it is hardly surprising that the 'La Musica' turntable relies on something a little more complex than the Solution's combination of acrylic and stainless steel cones. Reasoning that the two main energy sinks in the system are the arm base and the main bearing, these are directly supported

on special blocks or rods made of a special "high-speed" material, which transmits energy at three times the speed of stainless-steel.

The remaining perspex cones simply stabilise the chassis, preventing energy passing back into it from the aluminium top-plate. The motor, on its separate section of support, is located against a horizontal thrust rod, again mounted into a "high-speed" tower, itself bolted to the top-plate and designed to sink its energy more efficiently.

Unfortunately, Rolf Geheim was unable to attend the demonstration, and details of the electronics remain a mystery. However, given the enhanced power-supply and physical integrity lavished on the Clearaudio phono-stage, it doesn't take a genius to work out what to expect. All the electronics were coupled to their platforms using "high-speed" pucks, whilst their casework was damped using a ceramic coupler and a substantial lump of lead. And by all I mean all. Even the small external PSU for the phono-stage received the treatment.

Visually the most interesting components were the speakers. A two-way design, the 140mm bass/mid unit was mounted on a massive, sculpted baffle, connected to a surprisingly large and very solidly braced, plywood enclosure. The dedicated stands are a three leg version of the uprights and platforms employed in the Acapella rack, complete with "high-speed" pucks beneath the cabinet. But it is the tweeter mount that makes the visual statement. The soft dome tweeter is eccentrically mounted on a circular, acrylic flying baffle, itself machined to an amorphous, organic shape to minimise diffraction.

The overall effect of the system is visually rather impressive, in an ►

understated way, and once the CD player receives its full 'La Musica' livery (the one we saw was still in a black Symphonic Line box) it will enjoy the sort of coherent styling, finish and use of materials that only complete projects like this can ever have. Despite its comparatively compact dimensions and outwardly conventional appearance, there is definitely something that sets it apart, even to the uninformed.

The demonstration, conducted by Alfred Rudolph and Peter Suchy, was a fascinating insight into the development process. The basic elements of the system, once explained, were left in place, the approaches adopted being justified by their application in peripheral ways. Thus we started by listening to the system as described, then lead blocks were placed against a coupling rod let into the tweeters' magnet assemblies. The improved mechanical grounding produced a massive improvement in top-end focus, clarity and the scale of the sound-stage. A further 25 kilos of mass added to each speaker produced mixed results, until it too was coupled, via a ceramic rod, to the tweeter sink, demonstrating that mass alone is insufficient, and that it is the provision of proper energy paths that allows its proper application.

Similar effects were demonstrated by suspending the speaker cables on Magix feet to isolate them from structure borne vibration, and inserting the dedicated mains cables in place of standard items. Again, the explanation comes down to either preventing or sinking unwanted vibrational energy. After all, any component or wire that passes an electrical signal vibrates, and one of the key effects of poor mains is increased mechanical vibration.

The lesson here is clear.

Developing the System 'La Musica' has not only shown the benefits of a single, coherent approach to system design, it has also forced a reappraisal of how far you need to extend that approach. It has clearly revealed the absolute importance of apparently peripheral elements, cabling, support and power source being just as vital to the final performance as the core components themselves.

All of which would be some-what academic if the system was anything less than impressive. In fact, its performance is extraordinary. In its fully tweaked guise it is capable of exactly the kind of musical integrity and coherence whose lack normally separates hi-fi from the real thing. The sheer scale, bass power and depth, and naturalness of both soundstaging and acoustic are astonishing given the modest dimensions of the speakers. The rhythmic integrity and attack would astonish most Naim users, whilst the dynamic discrimination, at both ends of the scale is exceptional. The end result is one of the most effortlessly engaging systems I've ever listened to. PM got it right when, following a piece of Weber he remarked "Well, that was worth a round of applause!". And it was. Exactly as if the musicians had been playing before you, building together to the piece's final climax, full of their energy and creative tension. It wasn't that you really thought they were there, but it was so easy to suspend your disbelief that you found yourself listening in exactly the same way, with the same attention and excitement, that you would at a live performance. Whilst it is easy to criticise the system for its lack of real extension at both frequency extremes, that is to miss the point. It is the completeness of what it does do that sets it apart.

A long way apart.

The system we heard is close to a final prototype; the effects demonstrated will be incorporated into the final products, so that the cables will have internal damping rather than having to be floated, and the speakers won't be heaped up with lead weights. There are also plans to increase the bandwidth of the speaker, possibly using a 200mm driver. In that form, the whole shebang will cost £14000, which seems like a lot of money until you compare it to the opposition. After all, this is a two source system delivering seriously real musical enjoyment for less than the cost of most "state-of-the-art" power amps. And in recognition of its status as a work in progress, purchasers will receive any upgrades free of charge for a period of three years.

But for most of us, the importance of the System 'La Musica' is in its role as a much needed benchmark. It serves as a timely, and extraordinarily powerful reminder of just how good simple stereo can, and more importantly should, sound. There's more than one way to build a hi-fi system, and 'La Musica' isn't the only way to go. But currently, it promises to be one of the most cost effective, throwing down a serious challenge to the competition. We've been banging on about systems as a whole, the importance of peripherals and set-up, since page one of issue one. Go and listen to the System 'La Musica' at a show (where everything sounds bad, doesn't it!?) and maybe you'll believe us.

For further information, contact:
Audio Reference
Tel. (44)(0)1252-702705
Fax. (44)(0)1252-301412



A NEW DAWN

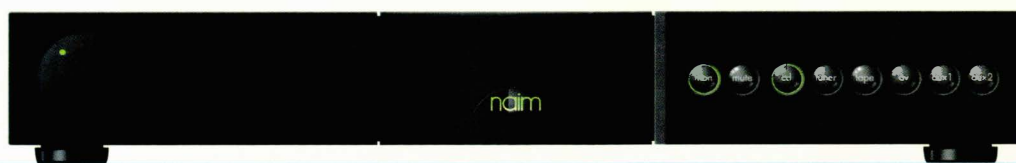

SERIES
5

In search of a new musical experience? Naim's Series 5 range of audio equipment is exceptional. Even by Naim's exceptional standards. Expect no frills or gratuitous gadgetry. Our business is sound. Pure and simple. Just sit back, listen and believe.

THE ULTIMATE MUSIC SYSTEM

WORLD CLASS HI FI

For your nearest stockist call +44 (0)1722 332266. Or visit www.naim-audio.com



L I G N E

Utopia

JM lab

STANDING OVATION

"For me, this is truly the ultimate desert island loudspeaker..."

Jack English, *Stereophile*, volume 19 no. 5.

"I am comfortable in saying that, to this point, these are the best speakers I have ever heard.

I love them..."

Jonathan Scull, *Stereophile*, volume 21 no. 4.

Sound Image UK Ltd ■ 52 Milton Road ■ East sheen ■ London ■ SW14 8JR
 Tel 0181 255 6868 ■ Fax 0181 255 6869 ■ <http://www.focal.tm.fr>



The finest electronics from France have suddenly become more approachable. YBA introduce the new Audio Refinement Complete system. Products which embody the knowledge and philosophy of Yves-Bernard André at surprisingly affordable prices.

Audio Refinement

Sound Image UK Ltd ■ 52 Milton Road ■ East sheen ■ London ■ SW14 8JR
 Tel 0181 255 6868 ■ Fax 0181 255 6869 ■ <http://www.focal.tm.fr>



F
R
E
E
T
H
E
C
I
S
I
O
N
M
U
S
I
C

Sterling Reference

intensive care by Ruark

To find out how Ruark can improve your soundness, please contact us at the address below or visit our web site at www.ruark.net
Ruark Acoustics Ltd., 59 Tailors Court, Temple Farm Industrial Estate, Southend-on-Sea, Essex SS2 5TH • Tel: 01702 601410 • Fax: 01702 601414

B&W update CDMs and install extranet

B&W's popular CDM range has finally received its own application of Nautilus technology, bringing it into line with the flagship 800 and starter 600 Series 2 models that flank it in terms of price and quality. This latest incarnation is the third, and the new line-up is distinctly different to the old. Gone is the old CDM 2, the CDM 7 has been totally revised, there's a new slimline surround speaker, the CDM SNT, and a new top model, the CDM 9NT. The CDM 1NT and CDM CNT compact and centre speakers remain, albeit with totally new tweeter assemblies and revised cabinets.

In fact, the new tweeter is common to all models except the SNT. Derived from the unit used in the Nautilus 800 series, it is virtually identical (edge-wound voice-coil aside) to the one found on the 803, 804 and 805, complete with its distinctive onion shaped rear enclosure. Altogether more elegant than the HF 'wart' of the previous models, it is sited on an even more radically sloped top baffle, which further improves dispersion (but means that updating older models is, unfortunately, impossible). The CDM 7NT not only sports the new tweeter, but has been redesigned to incorporate a new Paper/Kevlar coned bass unit, housed in

a separate reflex enclosure to the woven Kevlar mid/bass driver, also port loaded. The result is a real Miss Jones (you know, "My don't you look lovely without your glasses!"), and whereas the old CDM 7SE was rather embarrassed by the performance of the much cheaper model 1SE, tripping over its clumsy bass, slurring its awkward and muddled midrange, it has blossomed into a confident and accomplished performer, easily bettering the impressive performance of the 1NT with a dramatic increase in scale, weight and dynamic range without any loss of subtlety. The top-end on both speakers was exemplary, again removing one of the criticisms levelled at the previous versions (although this had more to do with proper running-in than any real problem).

But far and away the most interesting model is the new CDM 9NT, launched at the September Novotel Hi-Fi Show. This design is, to all intents and purposes, the driver line-up from the Nautilus 804, including the surroundless woven Kevlar mid-range unit, installed in a conventional (ie non matrix) cabinet. A true three-way design, with the separate mid and treble rear chambers developed for the Nautilus series, the

CDM 9NT has a pair of the mushroom design paper/Kevlar bass units used in the 7NT mounted in their own reflex enclosure. Intended to sell for around £1800 this could offer outstanding bandwidth, tonal neutrality and linearity at the asking price, so watch out for the review in the next issue.

These changes create a far more homogeneous feel to B&W's range, creating a common balance or voice which embraces the range as a whole, and making for greater versatility and coherence should you want to mix and match speakers in a multi-channel or multi-room set-up. I've always had a soft spot for the CDM 1 and 2. It looks like the rest of the range is catching up.

The other big news from B&W has less obvious relevance to the end user, but should in reality offer a huge improvement in the speed and level of support and information available from B&W dealers and distributors. Dubbed Clarity, the new system acts as an extranet extension to the company's recently revised web site, performing as an e-business platform for the 62 distributors and over 3000 dealers worldwide. Access to the site is strictly controlled, and each registered



► user is allowed into the various gated information zones appropriate to their function. This means that whilst Clarity provides information and services in five main subject areas (Distributor resources, Service, Marketing, Press and Casa home installation) access can be tailored to individual requirements. Thus, a retailer can allow one member of staff to access marketing and service information, whilst another might have the additional capability to order spare parts or photo CDs on-line. The result is that a customer contacting a dealer or distributor regarding availability of a new model can expect far more accurate information on availability, as well as more rapid, round the clock ordering, which might not be that important if you are living in Hounslow, but matters a lot more if you are in Hong Kong. It also means that as I write this article I can order the appropriate up to date images from the Clarity system, rather than grubbing around for a picture of the

tells the retailer or distributor exactly which models from B&W's long history still enjoy parts availability, as well as providing comprehensive listings for the parts themselves, as well as exploded diagrams of each sub assembly, ensuring that you

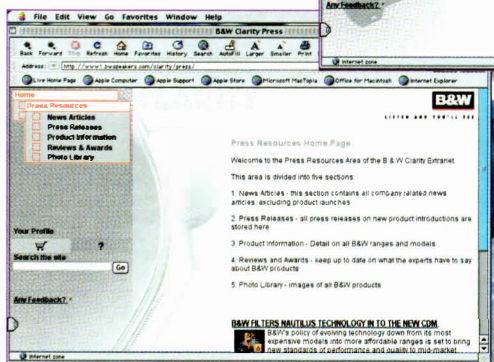
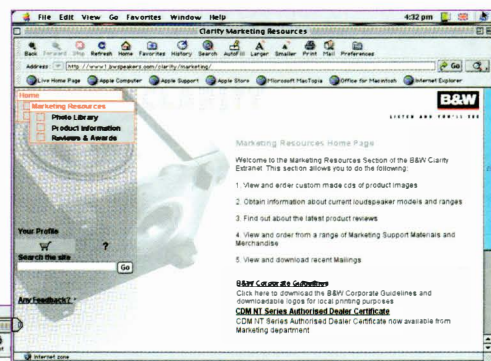
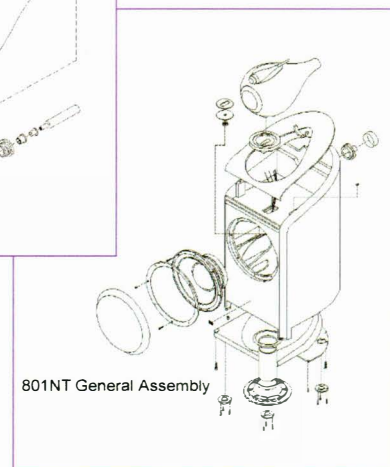
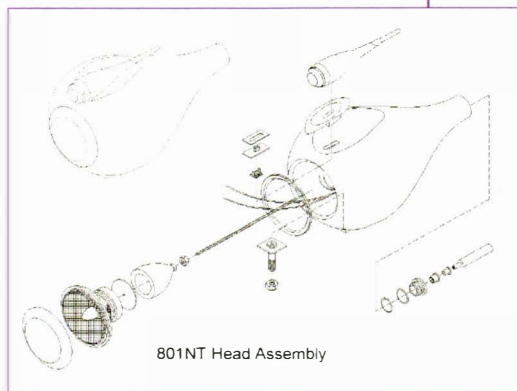

actually end up with exactly what you need. Ordering is as simple as highlighting the appropriate component on the diagram and giving the appropriate command. This means that even the most technically challenged customer can

channel and multi-room installations has created vastly more complex systems, with a whole variety of new problems to go with them. The Casa zone provides an information forum allowing Casa installers to share experiences and solutions, as well as order or support products. This is exactly the kind of use to which the internet should be put, and it is perhaps not surprising that B&W should be one of the first company's to instigate the system, given their reliance on high technology in product development. Hopefully, this is the first of many such systems, all of which should improve the customer's lot significantly.

previous model. I know exactly what's available, and which image will suit best. Which means that you get a more accurate and informative magazine.

But the really impressive part is the on-line service information. This

simply point to the problem on his or her dealer's computer, and believe me, that is going to prevent an awful lot of mistakes and confusion, and the frustrating delays that go with it.

Likewise, the move into multi-

B&W Loudspeakers Ltd
Tel.(44)(0)1903 524801
Net. www.bwspeakers.com



Sounds of Music

first rate reasons for coming to
our launch!

Call 01892 547003 Now
for your advance ticket



Lumley Monarch 2000

For the slightly less deep pockets - the 2000's are a superb alternative

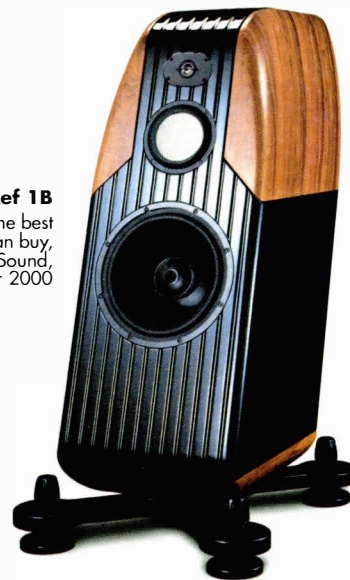

Kharma Ref 1B

Rated one of the best loudspeakers money can buy, by The Absolute Sound, August/September 2000

Come and listen to these two stunning loudspeakers alongside Advantage, Pass Labs, Balanced Audio Technology, Hovland, Meadowlark, Copulare, Eggleston and Wisdom at our special UK **Kharma / Lumley Monarch** launch.

28 & 29 October 2000
at **Kempton Park Race Course**

only 2 minutes from junction 1 of the M3 motorway

In conjunction with:

**Audio
Reference**

Import & Distribution

Argento, Convergent Audio Technology, Cabasse, Clearaudio,
Graham, Marsh Sound Design, Robertson,
Thule, Transfiguration

Win
a set of **Clearaudio Magix**
(by entry ticket number)

Dealer Shows On The Increase

When you combine an industry that is increasingly discontented with the venue and cost of the only real national show, with rumours that this year at Novotel will be the last independent event before hi-fi is consumed into a 'high-end' ghetto at the Live, Earls Court show, then it is hardly surprising that the more enterprising dealers and manufacturers are increasingly organising public events of their own. Given the success that such shows enjoyed last year, many organisers have increased the scope of their activities, making them even more worthwhile attending. Add to that the more relaxed atmosphere that goes with smaller events, and the opportunity to hold them in more appropriate buildings than modern hotels, and you've actually got a much better chance of hearing the equipment on show actually performing to something approaching a representative level.

So, here're a few dates for your autumn diary:

Saturday 28th and Sunday 29th of October - Sounds of Music at Kempton

Sounds of Music have hired the executive conference facilities at Kempton Park to host the UK debuts of the Lumley Monarch 2000 and Kharma Reference 1B loudspeaker systems. These prestige products will be supported by the requisite cast of thousands (of pounds, that is) drawn from the extensive Zentec and Audio

Reference port folios. Entry is by ticket only at the princely price of £1 a head, but you do get entered into a draw to win a set of ClearAudio Maggix magnetic de-couplers. If that doesn't ring any bells then you'll want to attend the system set-up seminars which are planned to show the benefits of correct cabling and isolation in a system. The Cherished Record Co. will be on hand with a selection of rare and wonderful vinyl as well as record cleaning machines, whilst hififorsale.com will be trying to entice you with their extensive range of hi-fi accessories and audio gizmos, as well as publicising their free online forum for advertising second-hand equipment.

For further information or tickets, contact Sounds of Music on 01892-547003.

Saturday 18th and Sunday 19th November - Hi-Fi 2000, Dublin

Irish shows have a unique feel to them that always makes them a high point in the hi-fi calendar. Following the success of last year's event, Cloney Audio have decided to repeat the experience, which is welcome news indeed. Irish debuts for the Sony SACD1, Lavardin electronics and Arcams new Diva DVD player and AV receiver are headliners, but there will plenty of other exhibitors, including Cyrus, Krell, Nordost, UKD and Marantz. The excellent live music from last year will be repeated, and a good time will be had by all.

Missing this one is the audio

equivalent of intimate contact between your left thumb and a very large hammer. Weekend away in Dublin anyone? You can contact Cloney Audio on 00353-1-288-8477 or at www.cloneyaudio.com

Saturday 18th and Sunday 19th November - Hi-Fi 2000, Manchester Airport Hilton Hotel

And for those of you who consider Dublin a bit of a trek, that same weekend sees an alternative in the shape of another Hi-Fi 2000, this time being held at the Manchester Airport Hilton Hotel and organised by Chester Gate exhibitions. Exhibitors include Arcam, Naim and Rega (all showing totally restyled electronics), The Chord Co. and Music Works with cables, and exotica from the likes of Lavardin, Rogue Audio, Gryphon and GT audio's extensive stable. And there are plenty of others too, including Definitive Audio (so you can hear the Avatars which we reviewed in this issue!), Densen, Ringmat and software peddlers Diverse Vinyl and The Cherished Record Co.

Entry costs £5, but you can save yourself a pound by clipping the coupon from the advertisement on page 30, and you can get further details from Bob Dennis on 0151 645 1075 or at www.btinternet.com/~chestergate/

hi-fi+ will be attending all these events so if you fancy meeting up for a chat, you know where to find us. ➤+

SUBSCRIPTION FORM

In order to ensure prompt arrival of your copy of hi-fi+, it is safest to take out a subscription. This lasts for a year, or six copies (plus the summer and winter 'specials'), and means that your magazine is delivered to your doorstep immediately it is published. No more fruitless journeys in search of audio enlightenment, and no more worries about missing an issue.

In order to apply, simply fill in the form, legibly(!), and drop it in the post. Oh, and we won't supply your details to the double glazing or insurance industries. You can rest safe in the knowledge that the only junk mail you'll receive has been sent by us!

And the cost of all this peace of mind?

One Year Subscription / 8 Issues

Within the UK, £28.50 For the rest of Europe, £37.25
For the rest of the world, £46.00

Two Year Subscription / 16 Issues

Within the UK, £48.00 For the rest of Europe, £65.00
For the rest of the world, £80.00

ABOUT YOU;

Title _____

Forename _____

Surname _____

Address _____

_____ Postcode _____

Daytime Tel _____

PAYMENT;

UK Europe Rest Of World

One year Two year

Please start my subscription from Issue No: _____

Cheques to be made payable to Hi-fi+ Publishing Limited.
(drawn on a UK bank)

Visa Access/Mastercard

Card No _____

Expiry Date _____

Switch

Card No _____ Issue No _____

Expiry Date _____

Signed _____ Date _____

Contact:

hi-fi+ Subscriptions, Unit 12, Albany Business Park, Cabot Lane,
Poole, Dorset, BH17 7BX United Kingdom

Or call;

Tel. +44 (0) 1202-659380

hi-fi+

Musical Realities

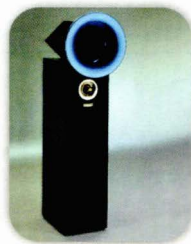

Acapella

Nothing comes close to this amazing 3 way plasma horn.

Covering 20 - 40000 kHz



Graham

A match made in heaven, hear the Nightingale tonearm and experience the synergy of Graham and Transfiguration technology together as one.



Clearaudio

"Immediately after a short break-in period, the Aurum Beta was exhibiting characteristics I'd never heard from any cartridge costing less than \$1000." *Stereophile Magazine*



Thule

"I would certainly put the PR250B up against any solid state stereo preamplifier in the \$3000 range, and of course the PR250B does so much more." *Stereophile HTG*

Distributors of:

Acapella, Argento Audio Cable, Cabasse,
Clearaudio, C.A.T., Marsh Sound Design, Robertson,
Graham, Thule, Transfiguration

Audio Reference
IMPORT & DISTRIBUTION

Unit 8, Enterprise Park, Slyfield Industrial Estate,
Guildford, Surrey GU1 1RB
Tel: (01252) 702705
email: info@audioreference.co.uk

Novotel Show Report

by Roy Gregory

It's September and that means show-time, at least in England. Time was when the entire industry made its annual pilgrimage to Heathrow and the Penta Hotel, soon to become the Ramada and ultimately the Renaissance. But no more. For the second year running we've all been jostling for space at the Hammersmith Novotel, a cramped and claustrophobic venue notable mainly for the extremely limited number of large rooms, the narrowness of its bedrooms and the sonic unsuitability of all of them. And don't even start on the access. Who ever thought that we'd look back at Heathrow with nostalgia?

The depressing surroundings only served to emphasise the poor exhibitor turnout. Live 2000, the home entertainment show occurring on the same weekend was blamed in some quarters, but having attended both I'm not so sure. Whilst there are a few exceptions, those choosing Live over the Novotel were promoting AV or Lifestyle product (let's remember that Novotel is supposed to be a Hi-Fi show), and many, such as Marantz, Sony, Tannoy, Kef, Mission, Monitor Audio, Henley and Acoustic Energy actually appeared at both. Other reasons that cropped up regularly in my straw poll of non attendees were increasing costs, the dreadful environment and facilities at the Novotel and the difficulty of obtaining anything other than a bedroom to work in (Spare a thought for Avant-Garde who brought a special version of their monster Trios, complete with four active subwoofers, and who paid \$8000 for what turned out to be a prefabricated 'sound booth'! The

only thing not moving was the stony expression on Holgar's face.) Whatever the reason, it's impossible to escape the depressing fact that exhibitor levels have fallen to something around one third of the last Heathrow show. Which is ironic, as Renaissance would have been a good sobriquet for this year's gathering.

A whole host of companies made welcome returns, if not from the dead, then in some cases from deep coma, at least as far as the UK is concerned. Perhaps the most impressive was the revitalised Trilogy, who showed not only the stylish and affordable VTi integrated (\$2500) but surprised everyone with near production samples of the reference series Finale Line Stage (\$8000) and the truly gargantuan, matching Mono Blocks (4 x 211 triodes, 250 watts and \$17500 a side!). These are a long way from the manufacturer's pipe dreams and 'concept products' that tend to crop up at shows, never to be seen again, and signal a repositioning of the under-rated Trilogy brand at a far more appropriate level. Both systems were sounding good, the VTi delicate and open through a pair of ProAc Response 1 SEs, the Finales spacious and authoritative through my favourite Ars Acoustica System Max. I look forward to longer exposure in the near future. (Trilogy: Tel. (44)(0)207 251 2640; Net. www.trilogyaudio.com)

Another welcome reappearance was Audiostatic, exhibiting in their own right after a period of distribution with Audiofreaks. They were playing

their Wing full range electrostatic (\$4200) with some intriguing and diminutive Swiss electronics from Neukomm Audio Systems. Appearance was everything we've come to expect from Audiostatic, the graceful and beautifully finished narrow panels looking elegant and statuesque. The speakers were fitted with optional Fin rear baffle extenders designed to counteract the 100 - 200 Hz cancel-

lation suck-out which leaves so many 'statics sounding thin and ethereal. Not surprisingly, chamber music sounded wonderful, but so too did Neil Young ('Trans-Am' from *Sleeps With Angels*), with real presence and substance. Perhaps it was the Fins, perhaps it was the 8mm panel excursion, or perhaps it was those dinky little amps, but it sure sounded fine to me. Also on static display was the phi, a small hybrid with a round electrostatic element and a pair price of £3290. Interesting in itself, phi also opens up possibilities for multi-channel music applications, relevant to SACD and DVD-A. And AV as well, if you must! (Geschka High Fidelity: Tel. (49)(0)221 976 2316; Net. www.geschka-hifi.de)

And whilst we're on the subject of things electrostatic, the Cadence hybrids were at the show, now represented by Audio Freaks. Along with the baby Anina speaker, (\$2695) they also showed a pair of the massive Canasya mono blocks, running four 845s a side for 200 push-pull watts (\$10000). These distinctive amps are styled with the panache that this

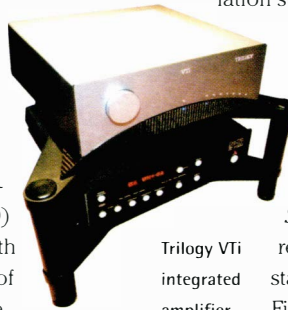

Trilogi VTi
integrated
amplifier





Cadence: Canasya monoblocks.

► company always brings to electronics, but which somehow seems to evade all but their most expensive speakers. (Audiofreaks: Tel. (44)(0)208 948 4153; Net. www.audiofreaks.co.uk)

Wharfdale marked the show with the release of their first, serious hi-fi speakers for quite a while. The Pacific product line consists of four models and a centre channel, the most expensive Pi-40 floorstander costing £500. The entire range employs time aligned tweeter pods which gives them something of a B&W look, and flies in the face of fashion by trading efficiency for bandwidth, meaning they go deeper than the current norm for their compact dimensions. How they stack up in the current marketplace remains to be seen, but they're attractive enough and it's nice to see Wharfdale returning to their roots. (Wharfdale: Tel. (44)(0)845 458 0011; Net. www.wharfdale.co.uk)

Monster Cable also reared their mighty head. Mighty? You'd better believe it. Monster's turnover probably exceeds that of every other specialist audio cable manufacturer put together. Monster by name.... Their initial push seems to be aimed at the lower reaches of the market, but that probably reflects the logistics of trying to deal with such an extensive product range rather than anything else. We're promised some of their more exotic offerings shortly, and if distributors Lenbrook get behind the whole line, we could be in for a major shake-up in the UK cable market. (Lenbrook: Tel. (44)(0)1908 319360; E-mail. info@lenbrook.co.uk)

My best two moments at the show...

The Thursday morning power cut which plunged the third floor into darkness. It all went dark. It all went silent – except for one room. Final Music were running on batteries!

The shared room in which a degree of friendly rivalry between LP and CD proponents resulted in a 'shootout'. About 10 seconds into the first track came the dreaded hop, skip and jump of stylus and groove parting company. The digital supporters club dissolved in laughter – until the DJ pointed out that it was the CD that was skipping!

Last of the Lazarus brigade were Creek, who not content with making their first appearance at a UK hi-fi show in recent years, also brought along the first models from the relaunched Epos range. Now I've always had a high regard for Mike Creek's electronics, feeling that they offer exceptional sound quality at a modest price. In fact, for several years running they have made one of the most enjoyable sounds at the Frankfurt show, driving the demanding Shahinian speakers, so it's nice to see them making a greater effort in their home market. (Creek: Tel. (44)(0)208 361 4133; Net. www.creekaudio.co.uk)

And finally, hard rumours are circulating of a Pink Triangle system. Pitched at around £4K a unit, it promises the kind of engineering that PT's inventiveness has always cried out for.

Leaving the returnees aside, I guess it's time to look at the other exhibitors, and in the interests of some sort of order, we'll take them by product categories.

Analogue

Possibly the most significant analogue news was the announcement of an all new Roksan TMS, embodying a further refinement of the original Xerxes design, and in the process chipping away at those final niggles. The new deck uses a complex machined Corian plinth system, outwardly similar to the original TMS design. However this version significantly reduces the transmission of

vibrational energy from the motor to the platter. The top plinth now has an MDF sub-plinth that is supported on both sides, finally eliminating the dreaded platter sag. It also has a separate armboard, making swapping arms significantly easier. A single Caspian style case can accommodate a host of power supply and phono stage options, finally eliminating the stack of boxes that always seemed to be a part of Roksan ownership. Corian promises to be a far more stable material than the previous MDF, and rather more in keeping with the ultra precision engineering that has always typified the metal elements of the design. All in all it presents a fairly mouth-watering proposition, even if it will cost £5250. (Roksan: Tel. (44)(0)208 900 6801)

No show would be complete without the analogue fringe products from the likes of V.Y.GER and Silvernote, but the most interesting product on view had to be the Schroeder tonearm (accompanied by the Linus cartridge..... only kidding!). This looked like a hybrid development of the Well tempered arm, the tube assembly hanging from a pair of threads. However, in this instance the threads meet below the gallows. Damping is provided by two disc magnets, one fixed to the arm base, the other to the tube. These resist deflection and the degree of damping can be varied with their spacing. The arm tube itself is available in a variety of materials, including Carbon Fibre, Ebony, Rosewood and Bamboo, ►

▶ and both 12" and 9" lengths. The various options mean that almost any effective mass can be provided to order. Azimuth, VTA and overhang are all adjustable, the VTA using a fine screw to provide repeatable increments. A single piece cable loom is provided, and cable choice is yet another option. Prices start at c\$800 for the entry-level version, while a Model 1 costs c\$1500 and the Reference c\$2500. The arm has been in limited production for some years and has a cult following amongst Berlin audiophiles. Now that the designer has decided to widen his distribution we'll provide more details as they become available.

Digital Products

The digital debate seems to have gone quiet. CD manufacturers are licking their wounds, SACD's proponents are happy to consolidate their position while DVD-A has suffered yet another delay (software in March looks like the current best bet, although there are also rumours of a raft of Warner titles much sooner). Meanwhile, Marantz debuted their first SACD player. It sounded well in the UKD room where they were playing Fone's first four releases, but was suffering from an excruciatingly bright treble when I heard it in the Marantz set-up. I suspect that the brand new Tannoy speakers weren't run in, but it's only a suspicion.

(Marantz:

Tel.(44)(0)1753 680868:

UKD Tel.(44)(0)1753 652669)

Sugden were ploughing the CD furrow with two new machines, the elegant little CD Master, based on a double height Head Master case, and the Masterclass CD. The CD Master costs £1250 and uses a hybrid 18bit chipset. The Masterclass unit is resolutely retro, and uses Crown Grade TDA 1541 16bit chips! It runs out at £2500. Both units sounded excellent, underlining CDs continuing relevance. (Audio Synergy:

Tel. (44)(0)1924 406016)

Other than that, most of the action was with new DVD-V players from the likes of Arcam and Theta, which has rather more to do with AV than hi-fi.

Amplification

Chapter Audio is a new name but an old face, being a new venture from ex Chord Electronics sales manager Mike Gregory. The Chapter Two amplifier is (surprise, surprise) a compact high power unit running from a switch mode power supply. Compared to the Chord amps the Chapter Two has a rather more organic and altogether less butch styling which I have to admit I markedly prefer. There are also significant internal differences between the two, especially as regards the power supply itself. Sonic judge-



Chapter Two amplifier

ments will have to wait, although one retailer was talking in terms of all his Christmases arriving at once. Priced at \$5000 it will be up against serious competition, not least from Mr Gregory's erstwhile employers, who are, understandably, none too chuffed. (Chapter Audio: Tel. (44)(0)1392 686797; Net. www.chapteraudio.com)

Talking of Chord they had their massive SPM12000 Reference amplifier up and running, and it really is an imposing beast. But I have to say that for me, the new CPM3300 integrated amplifier was rather more interesting. Adjustable sensitivity balanced and single-ended inputs and the new illuminated top-plate make for a flexible and stylish product. At 280 watts a side and \$5500, this all remote unit



Chord Electronics and the new Wilson Benesch Discovery speaker - 3 way with an integrated stand.

looks right on the money. (There will also be a slightly less versatile and less powerful sibling at \$3500.) The new amp was driving a fascinating new speaker from Wilson-Benesch, the stand mounted, three-way Discovery. Derived from the Bishop, this employs a combined stand and cabinet construction, built from aluminium alloy and carbon fibre elements. There is a forward firing Scan tweeter, paired on the baffle with a conventional mid-range driver. Situated in the bottom of the cabinet is one of W-B's Tactic isobarically loaded tandem bass units, ensuring a 45Hz -3dB point from the compact enclosure. The system is single wired from sockets on the bottom rear face of the stand, and finishes include various wood veneers for the front cheeks. Whilst the sloping top doesn't sit as comfortably on the small design as it does on the Bishop, the overall effect is still elegant enough for domestic use (even with the visible bass driver basket). Wired together with Chord Co cables (yes, the other one) the system produced some of the best sound I've heard from the many combined Chord/W-B demos I've attended. It was open, neutral and stable, but still retained plenty of life and jump to keep things interesting. This pairing might cost the wrong side of \$11K, but it's compact, versatile and it definitely delivers. (Chord



NORDOST

MAKING THE CONNECTION

Loudspeaker Cable

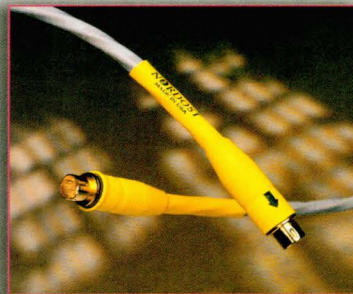

Visual



Power Cords

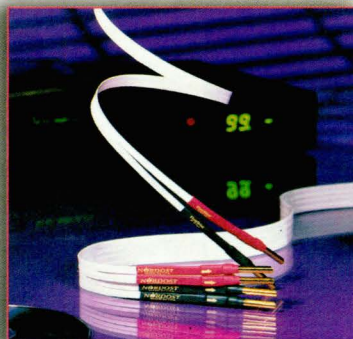

Installation



Maintenance



Resonance Control

Digital



Interconnect

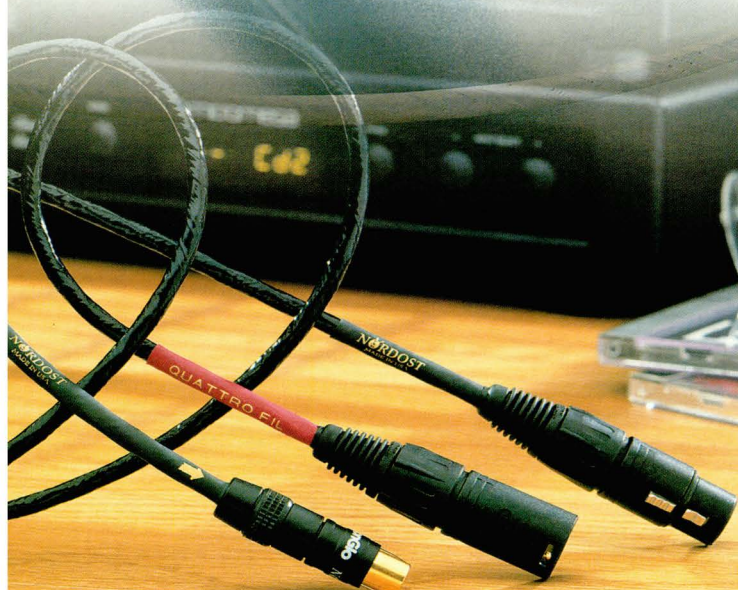

► Electronics: Tel. (44)(0)1622 721444; Net. www.chordelectronics.co.uk. Wilson-Benesch: Tel. (44)(0)1142 852656)

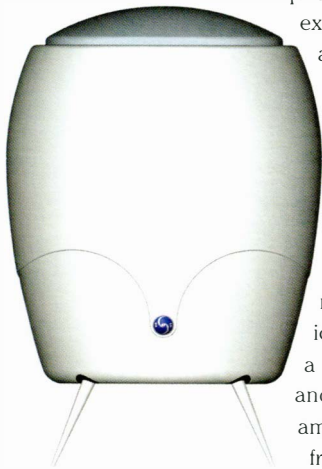

A quick sojourn in the extremely unpleasant environment at Live 2000 revealed two serious light-weight contenders. Arcam were showing their new Deva range of electronics, including a DVD-V player and matching AV amp (CD players from £400, integrated

amps from £370, matching power amps from £300). What makes these new metal fasciaed products interesting is that, although the successful Alpha series continues in the catalogue, I can't see the general public passing up the superior finish and styling of the Devas. And they're available in a choice of black or silver finishes. Looks like a bloodless coup in Huntingdon then. That is unless the new Myriad Cameo products have anything to say about it – very pretty

indeed! Myriad's fast growing reputation and the excellent performance of their T Series products suggests that the home grown electronics market might be about to heat up. And there's always Roksan's Kandy range. Crowded or what? (Arcam: Tel. (44)(0)1223 203203; Net. www.arcam.co.uk. Myriad: Tel. (44)(0)800 652 5002; Net. www.sennheiser.co.uk)

Also over at live and worth a mention just for their display, were Blureoom and their multi-coloured Pods. They also had a fabulous new sub-woofer, the Bass Station, which somehow seemed vaguely reminiscent of Thunderbirds, but that was probably sub-conscious association with the excellent B&W AV demo of said digitally enhanced plastic puppets. Mind you, I'm sure that Lady Penelope never looked like that when I was young! (Blureoom: Tel.(44)(0)1903 260033; Net. www.minipod.com)



Iso Pods meet the Bass Station: Bew might have been demoing Thunderbirds, but Blureoom had the models.

Back at the Novotel, Naim were making a cracking sound with their new 5 Series slim-line electronics. CD player, pre, power

and Flatcap were driving a pair of Credos in a system that had all the Naim hallmarks but seemed more relaxed and better balanced than previous offerings. Also on view was a mock-up tuner, set to Spire FM of course, and the whole set of electronics in a single stack really brought home the dramatically improved aesthetics of the new range. What next? A re-styled NAP250. Could the company survive such sacrilege? Meanwhile the future looks bright, the future looks black and green.



Naim 5 Series electronics: First sight of the 112 pre-amp 150 power amp, Flatcap 2 and NATO 5 tuner

(Naim Audio: Tel (44)(0)1722 332266; Net. www.naimaudio.com)

Final Music, manufacturers of eclectic but fascinating and wonderful battery powered amplification made a rare and very welcome appearance at the show. They brought with them the long awaited mains supplies for their amplifier modules. Roughly 12" cubes, these are output transformerless units with no fewer than 46 power pentodes each. Not surprisingly they are fan-cooled, but still run pretty hot, and you need one per unit! They don't supply quite the luscious, languid fluidity of the battery option, which is still unsurpassed in terms

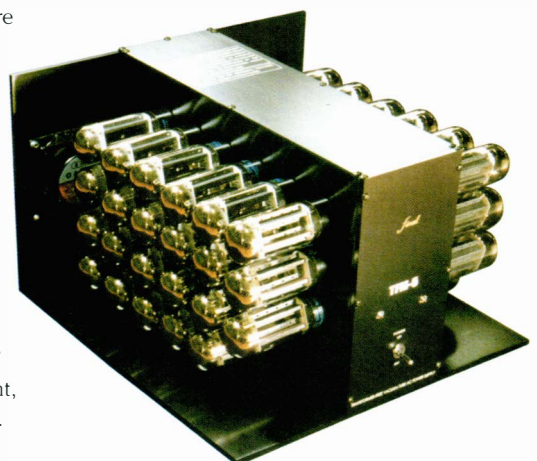

Walrus Systems

11 New Quebec St, London W1

allaerts
amazon
ars acoustica
art
audible illusions
audio note
audio physic
audio synthesis
avantgarde
canary audio
clearaudio
croft
decca london
dnm
ear yoshino
ergo
final
graham
helios
living voice
morch
musical fidelity
mvl

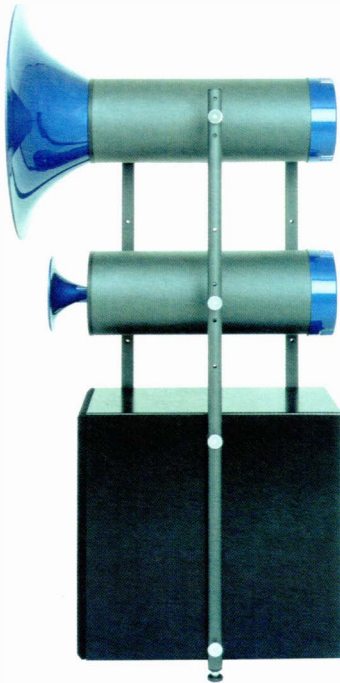

Avantgarde Uno, from £5300 (white)

We intended to put some text here, you know, the sort of trite caption we normally put in our ads. But Pete ran out of ideas, and anyway, the captions always paled after seeing them a few times. So these products have been left to speak for themselves. And this space has been left intentionally blank

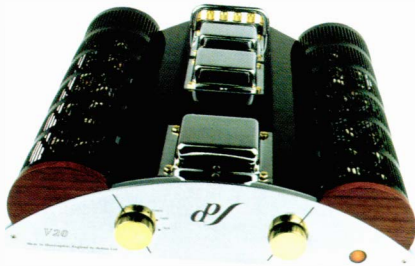
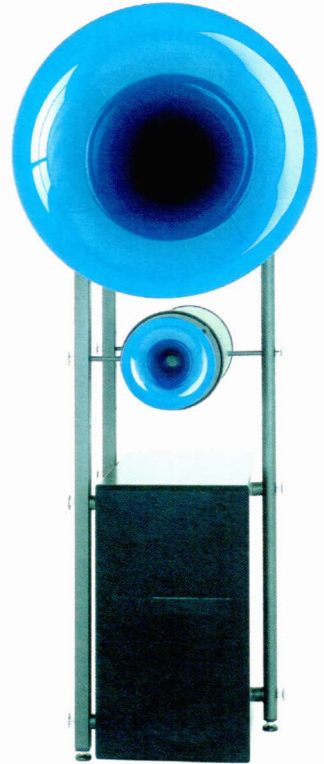

EAR Yoshino V20 £2699



Audio Physic Virgo 2, from £2999

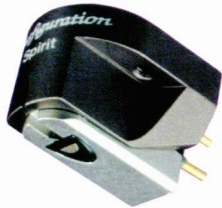

Transfiguration Spirit £950



Amazon Audio Model 1 £2500
Morch DP6 Gold £800

noteperfect
nordost
ortofon
phy cables
plinius
pro-ject
rega turntables
strumenti acustici-
-di precisione
simon yorke
stax
sugden
tci cables
tom evans
totem
townshend audio
transfiguration
trilogy
tron
van den hul
verdier
vienna acoustics
yamamura-
-churchill



tel: 020 7724 7224

fax: 020 7724 4347

email: mail@walrus.co.uk

web: www.walrus.co.uk

* interest free credit available on most items, subject to status *

▶ of musical expression, but they do bring greater grip and bandwidth. Sonically they are close enough to make the choice of supply programme dependent, mains for Meatloaf, but definitely batteries for late night Ella and Louis. Expect a full review soon, including the fascinating prospect of the battery phono stage, but those who can't wait should contact: (Walrus Systems: Tel.(44)(0)207 724 7224; Net. www.walrus.co.uk)

I was also pleased to note the arrival of Rogue Audio on these shores. This is a brand of sensibly specced and sensibly priced valve products from the USA, and for once, great value isn't incompatible with serious style. These are some of the nicest looking valve amps, in a simple, uncluttered way, that I've ever come across. Offering a complete range of products that enjoy an excellent state-side reputation, they brought their top pre-power and a brand new integrated to the show. And value? How about £3000 for the sweetest pair of 120 watt mono-blocks you've ever seen. Internally switchable from ultra-linear to push-pull triode (an arrangement that I've never been too happy with), the M-120 amps use four KT88s a side and feature mechanically decoupled mains and output transformers. There's also a 60 watt stereo model and three pre-amps. (Audiocraft: Tel. (44)(0)1895 253340; E-mail. kevinwalker@genie.co.uk)

Past Audio, based in Sweden showed a pair of extremely intriguing valve monos, along with a matching pre-amp. Parallel single-ended 300B output tubes were encased in a massive clear acrylic and aluminium chassis that shows careful attention to this often overlooked aspect of product design. Similar care has

been lavished on component and build quality, and the end results are impressive to say the least. At c\$3600 for the pre-amp and c\$3900 for a pair of power amps, they represent good value too. Playing through speakers from Finnish company Amphion (their \$1600 Krypton flagship) the sound was impressively open and dynamic, with excellent phrasing and structural integrity. Even more impressive when you



Amphion Krypton.

consider that the speakers boast (or should that be suffer) an 86dB sensitivity. A promising start that indicates that both these products are worthy of further attention. (Past Audio: Tel.(46)(0)8508 64080; Net. www.pastaudio.com Amphion: Tel. (35)(0)817 2882 100; Net. www.amphion.fi)

Loudspeakers

Back at Live, Elac launched two new serious floorstanders using the Jet tweeter and sandwich bass/mid drivers from the CL330 model. The two-way 512 JET sells for £1300, whilst the three-way 516 JET is £1700 and adds a purpose built 115mm sandwich mid unit. Given the rapturous reception that the CL310 received from PC, these should be well worth investigating.

Elac's other big news was the



Past Audio M7B mono power amp: Parallel single ended 300 B's and zero feedback.

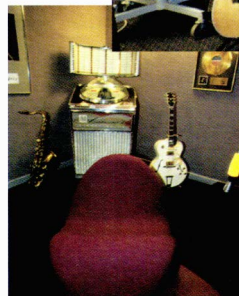

The real stuff: Absolute Sounds might have abandoned their legendary demo's, but they brought along some tasty instruments instead.

launch of their first NXT flat panel speaker. 60cm by 40cm the panels extend down to 150Hz and up to a -3dB point of 20KHz, and come with a matching sub-woofer. Due partly to the development of their own exciters Elac claim far higher performance standards than other NXT product, and demonstrations tend to bear this out. With power handling of 120 watts real hi-fi performance from NXT technology is definitely coming closer. Combine this with their work on a combined centre channel/projection screen and their panels look set to be



Sonus Faber's new surround package, slinky in black leather finish.

And another thing...

by Jason Hector

This year, like last year, the London Hi-Fi show was held at the Novotel in Hammersmith, and once again this proved less than ideal. Presumably I'm not alone in this view

as attendance seemed to be down in terms of both exhibitors and the public. Still, at least it alleviated the chronic over crowding of last year. There were also a better proportion of good sounding rooms, although whether that reflects the lower number of visitors, weaker companies dropping by the wayside, or exhibitors getting to grips with the lousy environment, who knows?

So who was making a good sound? Well Mirage were giving a decent DTS demonstration using their bipolar speakers and Path Premier electronics, although being a little backward I still can't really see the point of multi-channel in the average music system. Helping to make the point (although perhaps accidentally) were KEF, who had the Reference 4-2 and Reference 3-2 loudspeakers in a five channel AV set-up, but reverted to two channel for music demos. The fine sound quality extended the precedent set at last year's Novotel and Bristol shows, where KEF offered some of the best sound.

The Reference speakers really demonstrate the qualities of the uni-Q driver, with a fantastically wide and deep sound-

stage, allied to a delicate touch that allowed the music to flow into the room in a very persuasive way. These products were some of the many that I'd like to spend some real

Acoustics speakers via Nordost cables. Still, I guess it's only taken ten years for someone else to realise how attractive the Rega 'tables are. (Henley Designs: Tel. (44)(0)1491 834700;

E-mail. henleydesigns@aol.com)

Talking of Lavardin, they were demonstrating just how coherent their amps sound, using Avid Acutus and Sony SACD-1 front ends with Sonus Faber Amati Homage speakers: very impressive and musical indeed.

Meanwhile, over in the Nordost room the inimitable Lars was doing his thang, demonstrating very real differences from cables and supports. The fully tweaked system was

impressive, but even I didn't expect it to hold together under

the unrestrained assault of high level Ramstein! Those little System Audio floorstanders should have buckled at the knees, which just goes to show how important it is to get excess energy out of the system.

(Audiocraft: Tel. (44)(0)1895 253340; E-mail. kevinwalker@genie.co.uk) PMC and Bryston, the pro-audio bunch, continue their assault on the home audio brigade showing some great little active monitors: Tom Baron again managing to squeeze excellent sound out of lousy ambient conditions.

(PMC: Tel. (44)(0)1707 393002; E-mail. sales@promonitor.co.uk)



Project debut turntables: "any colour you want as long as..."

time with. (KEF: Tel. (44)(0)1622 672261; Net. www.kef.com)

General analogue distributors and all round good guys Henley Designs were playing music from two turntables: the Project Debut (very cheap indeed at £130 including £22 worth of cartridge, and now available in a host of very Rega like colours), and the gorgeous clear acrylic Perspective (at £1250 including an Ortofon Rohmann cartridge, which has to make it bargain of the century). Both sounded excellent through The Groove phono stage and Lavardin IT integrated amp driving Vienna



PMC's TB2

Italian valve amp manufacturers Synthesis were at the show again, with some of the best looking HiFi available. I mean, who else offers valve amplifiers and speakers in tangerine? They've added a CD player to their Barbie style separates, and their systems sounded very sweet and relaxed. i-Mac users should form an orderly queue.

Music tools showed a system of Norma amps, Relco speakers and the ludicrous V.y.ger turntable. This must be the biggest (and heaviest) turntable I have ever seen; think Gothic Rockport! Air bearing platter and arm, the sound was very explicit with great control and power through some ribbon hybrids. Meanwhile, those other masters of excess GT Audio had two rooms. Downstairs were the magnificent trio horns from Avant Garde; moments of excellence were evident but the 'room' really let them down, moving with the music like a trailer home in a twister. Upstairs Tron amps were driving the very unusual Ocellia loud speakers, from a Verdier front end; wonderfully open sound, although a tad restrained compared to what I'm used to.

Star of the show? Well in absolute quality terms it had to be the Path Premier demonstration. Simply stunning CD replay with a range of styles and recordings, not just the usual audiophile tosh but real music. Video was provided through the new Madrigal projector and a massive screen, and that too was pretty stunning. There again, it should have been considering the £60000 all in price tag! I guess at this level price becomes almost irrelevant, but if you can't justify the money but are in the market for a Ferrari, I can only recommend buying a Fiat and this system! For what its worth, the new Revel sub-woofer (15" metal driver and 1.4kW of power) looks like a bargain at £2500.

Chord and Wilson Benesch were demonstrating how good the UK high end can be, with the Bishops being driven by the new monster Chord SPM12000 power amp (at a cool £31000). Neutrality was the order of the day but not, thankfully at the expense of the music. This was one system that really did work very well, especially from the vinyl source.

Back at more realistic prices (at least for me) was the Sugden room. They have now come up with a complete range of components in the same case style as the headphone amplifier. Stunning solidity of construction was the order of the day, and the sound through Totem speak-

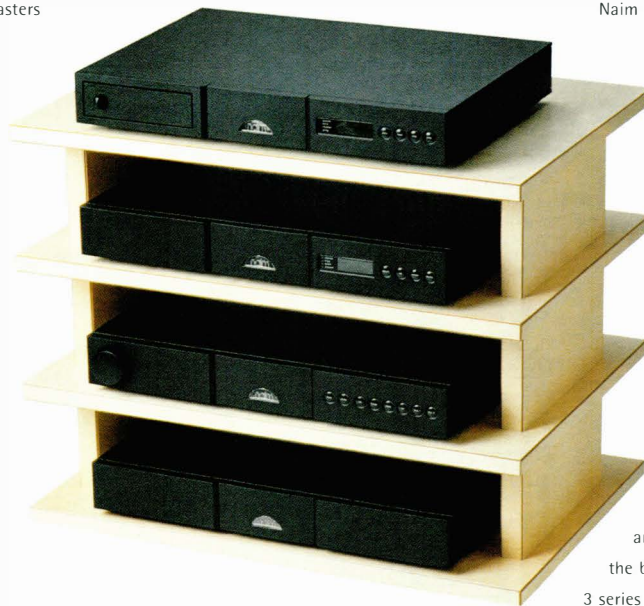

ers seemed to be built on an equally solid footing. Very easy to listen to, these components simply sounded "RIGHT", along with the small system reviewed in Issue 7 which also sounded pretty impressive. Sugden get my vote for best sound per pound at the show.

Sugden were also supplying the electronics for the ART room, where Derek and Ramsey Dunlop were showing off the prototype of a £15K reference grade loudspeaker. The design was extremely interesting, with three separate

enclosures, one for each driver, and each time aligned and spaced from the others with shaped wooden braces (very von Schweikert!). Music was there aplenty, and ART were very pleased with the positive response they received.

Redgum Audio were a major surprise. They offered an eclectic looking set of boxes each with a wood front panel. The CD player used a standard off the shelf CD-Rom to drive with their own DAC. And the sound? Pretty darn good; musically complete with plenty of rhythm and drive, and pretty detailed too. These guys deserve success in their search for dealer support. (Redgum: Net. www.redgumaudio.com)

Naim were very proud of their new 5 series components. The CD5 was to be found driving the new 112 pre and 170 power into Credos, with a new Flatcap 2 doing power supply duty. The music was really flowing, the new components showing the usual Naim strengths, but also the influence of the new 500 technology, whose sound has filtered down to these products. Most obvious was a poise and balance to the presentation which used to only be available further up the Naim range. The aesthetics are also starting to grow on me, and the build quality is far superior to the 3 series components they have replaced.

Look out for a review soon. In comparison, the big 500 DBL system seemed to suffer far more from the square room, whose poor ceiling and walls all seemed to be motion at some points.

All in all, I really enjoyed myself, but then when hi-fi is concerned, this much in one place can't fail with me. My only gripe, and one that applies to most shows, is the reluctance of most exhibitors to play real music. Stuff chosen from a very narrow range of audiophile recordings just doesn't cut it with me. Which is why none of their systems feature in the above.

BRITAIN'S LEADING HI-FI RETAILERS PRESENT

Beauty

SPM 1200C Power Amplifier



and the best

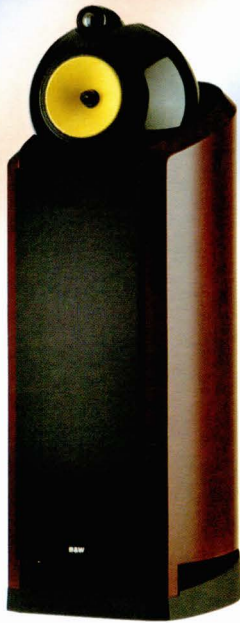

Nautilus 802

B&W



CPA 3200 Pre-Amplifier

The finest names in British audio - Chord Electronics amplification and B&W loudspeakers - together and on permanent demonstration.

Come and discover the perfect audio pairing in beautiful harmony.

CHORD

L I S T E N A N D Y O U ' L L S E E

Doug Brady Hi-Fi,
Phase 3 Hi-Fi,
Music Matters,
Robert Ritchie Hi-Fi,
Leicester Hi-Fi,
Audio Excellence
Sound Academy

Kingsway Studios, Kingsway North, Warrington WA1 3NU
213-215 Tarring Rd, Worthing W. Sussex BN11 4HW
363 Hagley Rd, Edgebaston, Birmingham B17 8DL
102 Murrey St, Montrose, Angus, Scotland DD10 8SG
6 Silver Walk, St Martins Square, Leicester LE1 5EW
134-136 Crwys Rd, Cardiff, S. Wales CF24 4NR
152a High St, Bloxwich, Walsall WS3 3JT

Tel.01925 828 009
Tel.01903 245 577
Tel.0121 429 2811
Tel.01674 673 765
Tel.0116 253 9753
Tel.02920 228 565
Tel.01922 493 499

BADA
BRITISH AUDIO DEALERS ASSOCIATION
the symbol of security

GEDIA

Timbre Stage all aluminium rack: if you have to ask...



▶ important players in the home theatre install market. (Elac: Tel. (44)(0)800 652 5002; Net: www.sennheiser.co.uk)

Absolute Sounds showed a new surround sound package from Sonus Faber in a new black leather finish. The demise of Absolute Sounds' legendary dems, so central to any visit to the Heathrow shows, is another result of the move to Novotel. Instead the company rely on static demonstration of hi-fi products and a continual AV demonstration. As if missing his roots Ricardo decorated his room this year with classic guitars, a vintage jukebox and other musical instruments, but most of his new products were AV orientated. I for one sadly miss the good old days. (Absolute Sounds:

Tel. (44)(0)208 971 3909; Net. www.absolute-sounds.com)

Gradient were at the show for the second year running, and their demonstration last year with the interesting Cymbol electronics was one of the better sounding rooms at an otherwise dismal event. They didn't disappoint this year either, the same team coming up with one of the few rooms that actually managed to generate a semblance of controlled bass. It's about time to discover whether they can do it at home, so expect a review shortly.

(Restek UK: Tel.(44)(0)1903 207634; Net: www.restek.co.uk)



Avalon Symbol

Ancillaries

Accessories and furniture were too numerous to cover in any real detail, but Timbre Stage had their stands all over the place, which is pretty impressive for such a young company.

You can read more about these new racks elsewhere in this issue, so

I won't bother to repeat myself. The Chord Co. had cables here, there and everywhere too, but their big news, sexy new packaging and display racks aside, was the launch of a new interconnect, the Calypso. This cable was designed by the company and is hand terminated at their Salisbury factory. Nothing unusual in that, except for the price - £30 for a meter pair, which brings the price of

hand finished cables to a new low. There is also a new version of the Siren inter-connect, now a teflon insulated twisted pair at £75. Nigel Finn was looking suitably beatific, but I think that was simply his relief that the petrol crisis hadn't completely scuppered is masterplan.

(Chord:

Tel. (44)(0)1722 331674; Net. www.chord.co.uk)

Elsewhere, Russ Andrews was doing a roaring trade in mains accessories, underlined by the number of Issue 3 and Issue 4 back numbers we sold.

Perhaps the mains message

is finally getting through. If so, it's high time! (RATA: Tel:(44)(0)1539 825500; Net. www.russandrews.com)

Best at Show

Which brings us to the best sounds at the show. Following last year's precedent I'll list five in no particular order.

Audiofreaks can normally be relied on to provide an oasis of musical calm amidst the most torrid show, and this year was no exception. What was exceptional was that Branko was slumming it with a mere £3000 worth of speakers



Unique two arm version of the STABI-S: Choose your weapon.

(for half the time anyway). The Symbol is a slim new floorstander from Avalon, and he was driving it with a brand new £1500 phono stage, Premier 17 line stage and MF2500 solid-state power amp from conrad-johnson. Analogue source was a special version of the Kuzma Stabi-S, mounting both the Stogi and uni-pivot tonearms, with Benz Glider and Ruby Reference cartridges. The sound was impressive - deep open sound stage, tonally natural and rhythmically coherent, the Hungaratron Vivaldi Lute disc sounding vivid and engaging. Thelma Houston wasn't too bad either, and this is one of the few

EXPERIENCE THE CHORD EFFECT!

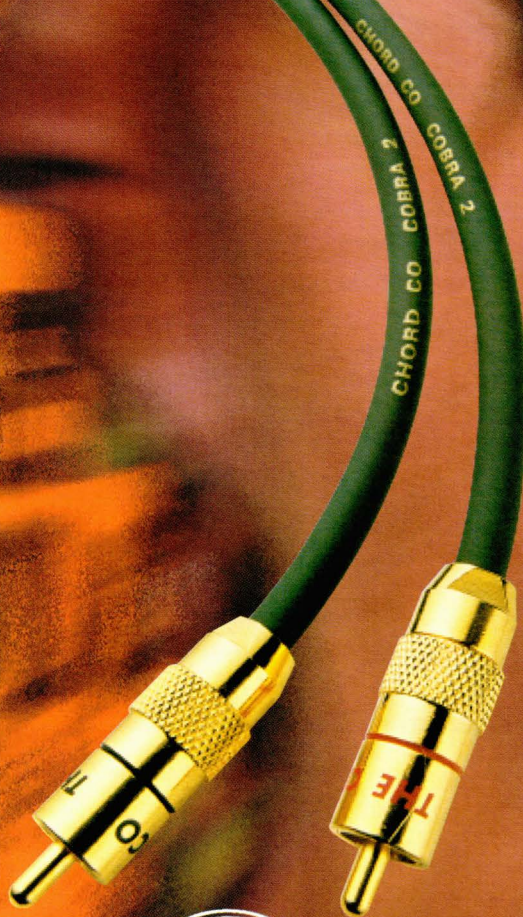

The first time you hear your sound system with Chord interconnecting cables will be the first time you've **really heard** it.

Be warned - the effect can be shattering.

Your eyes and ears will be opened. Your music will never sound the same again.

Specify Chord cables -
Hear the light!

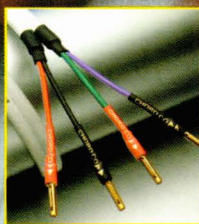

FOR SALES AND INFORMATION CALL: 01722 331674
FAX: 01722 411388 E-MAIL: CHORD@CHORD.CO.UK OR VISIT US AT WWW.CHORD.CO.UK

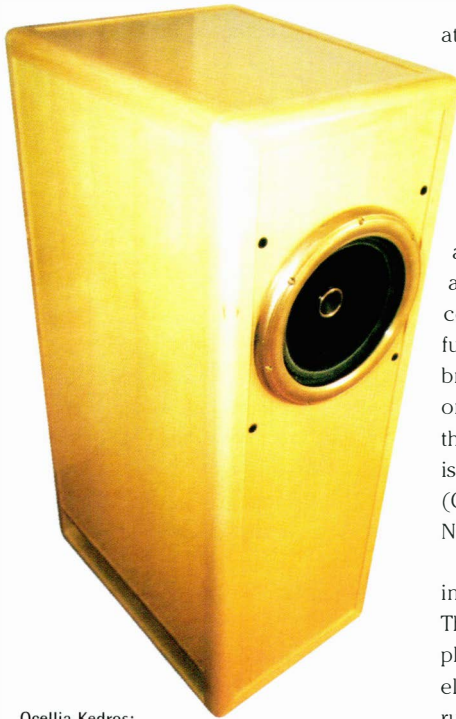

Ocellia Kedros:
Very large, very strange
but very engaging

► rooms I regretted leaving.
(Audiofreaks: Tel. (44)(0)208 948 4153;
Net. www.audiofreaks.co.uk)

Ocellia is an unusual French speaker brand distributed in the UK by GT Audio. They use an extremely unusual driver, also built in France by Phy-HP Based on a massive cast bronze chassis, a nine inch paper cone is driven by an Alnico magnet assembly, and operates up to around 12KHz! At this point a concentrically mounted and time aligned surroundless paper cone piezo tweeter takes over. The crossover is incorporated into the drive unit. The whole thing is then mounted in a semi-open baffle enclosure, using 5mm plywood walls and a solid Beech framework. The base is open and a sliding rear panel allows tuning to the room. Efficiency is high

at 98dB and the entire speaker employs only natural materials in its construction and finishing, including violin lacquer on its carcass. The top of the line Kedros costs \$5000, but cheaper, non concentric versions are also available. Driven by Tron amps and a Verdier/12" SME 3012/SPU-GM combination, the sound was wonderfully coherent and the music really breathed. This is another that goes on the review shortlist, and the thought of an Ocellia/Final system is simply mouth-watering.
(GT Audio: Tel. (44)(0)1895 833099;
Net. www.gtaudio.com)

RT Services matched Audiofreaks in the relaxed musicality stakes. Their system comprised an Accuphase transport driving dCS decoder electronics and Spectral amps, all running from an Accuphase PS1200 power supply. Cabling came from Spectral for signal and Siltech for mains and the speakers were the unobtrusive and seriously underrated Verity Audio Fidelios. Given an amp/speaker/cable budget of under £20K, the sound was exceptionally open, coherent and unforced. Yes, I know that's not cheap, but it pales into insignificance compared to a lot of the equipment on show. The Spectrals drove the compact Fidelios effortlessly in the large

room, and I really enjoyed the music they played. (RT Services: Tel. (44)(0)1235 810455;
E-mail. info@rtsaudio.co.uk)

Audio Reference unleashed the System La Musica maestros (see the news story in this issue) on an unsuspecting public. Mssrs. Suchy and Rudolph (ClearAudio and Acapella respectively) are still finalising the La Musica system, so they went to the other extreme. Here they employed the £10K ClearAudio Master Reference turntable, £6K Insider Reference cartridge, dedicated stand, CAT pre and power amps, and the £20K Acapella Violon speakers, complete with horn loaded plasma tweeter. This they set up in a hotel bedroom, with no attempt at acoustic treatment of any kind, and proceeded to wow whoever wandered in. This was seriously impressive stuff, but the nicest thing was seeing how much fun these two elder statesmen of the German audio industry were having. That, after all, is what this is supposed to be about. (Audio Reference: Tel. (44)(0)1483 575344)

And final mention goes to Path Premier whose predominantly AV dem was built around Levinson electronics (including the new 434 and 436 mono amplifiers, designed to provide the odd channel for existing users moving up to five channel systems). A new Madrigal projector provided superb pictures and the very clear and professional presentation managed to cover a lot of ground and introduce topics of genuine interest (examples of HDTV for instance). Impressive, informative and professional, a few more companies could do themselves a serious favour by taking a leaf out of the Path Premier book. (Path Premier: (44)(0)1844 219000; E-mail. premier@path.co.uk)



Levinson's new 434 and 436 mono-blocks:
styled to match the No. 32 pre-amp.





Incoming!

Please address letters to the Editor at Hi-Fi+, Unit 12 Albany Business Park, Cabot Lane, Poole, Dorset, BH17 7BX.
or via the web-site at www.hifiplus.com

Dear Sir,

I have only just purchased a copy of your Aug 2000 issue, even though I have seen your magazine on the newsstand previously. It really is a sad reality that there are in fact only a few quality mags in the UK that cater for the serious and dedicated audiophile.

I am a longtime reader of Hi-Fi News and Stereophile, I can now add Hi-Fi+ to this list. Is there a reason why you do not back up your subjective reviews with a technical review? Since you do review expensive kit, which I like, I for one would like to see if the subjective views correlate with the objective (technical) ones.

Jane Spurgeon, e-mail

PS. I do like the quality feel to the new look print format.

An excellent question, and one that requires a serious answer as its implications cast a wide shadow. The history of measurement in the development of hi-fi is a chequered one, and over the years it has been used to undermine such heretical suggestions as "amplifiers sound different", "turntables sound different" and "cables sound different". In these instances, measurement has been used to retard rather than encourage our understanding, and the fact that it can be used in this way reveals much. In practice, what we can hear does not correlate with what we can measure. In fact it is generally the opposite, with the products that measure the best often sounding the

worst. As yet there are no measurements that can adequately reflect the character and nuance of a component's performance. Does that mean that measurements are a waste of time? That depends on what you expect them to tell you.

Measuring hi-fi is just like measuring anything else. The validity of the results is determined by the methodology of the measurer and how rigorously he/she applies it. Their interpretation is similarly limited. In other words, if I want to measure a paving slab with a ruler, the results will depend on the quality of the ruler I use, how carefully I place it and how carefully I read off the measurement, whether I write it down correctly and whether I note how the measurement was made. For instance, I might have measured one side and the diagonal, which would still provide me with all the information that measuring two adjacent sides would, but only if I note that this was how the measurement was made.

Once I try to transfer that information to somebody else, the situation becomes even worse. Not only do they have to have a ruler that matches mine, they have to know what the figures mean and how I generated them. And all that just to measure a paving slab! You begin to see the problem. There is an abiding fascination with numbers and what people see as "science". Both are seen as dealing in irreducible truth. However the scientific validity of any process is based on how it's done – the method-ology. Simply producing

numbers isn't enough, we need to know what they mean, and that is the nub of the problem.

Measurement can be extremely useful to a product designer, working in a limited context. Trying to use it as a generalised descriptive system is pretty pointless. Not only is there little or no consistency in the way measurements are made (often, even by a single person) but there is no agreement as to what they mean, and once again, little correlation to what we hear. Once they've been simplified to the point where a layman can understand them you've probably destroyed whatever information they contained.

Where does that leave the magazine? I'm quite happy to look at measurements and see if they can explain what we hear. They don't even get close most of the time, which means that we'll only be writing about it when we come across a situation where they do, and that then it'll be done by someone who knows a lot more about them than me.

Finally, let's return to the point that the scientific validity of results is defined by the way that they are generated. Absolutely nothing to do with numbers, you'll note. In fact, what is generally referred to as "subjective" reviewing can be just as scientific as measuring things, depending on how carefully it is carried out. That's why I prefer the term "observational". And let's face it the results are generally much more informative, and hence, valid. In fact, as a generalisation, those

▶ *commentators who rely most on numbers are often the least willing to rely on their ears.*

So the short answer to your question is, yes, we will be comparing what we hear with measurements, but only in the context of specific articles, or where the benefits are clear (the frequency balance of a transducer, for example). I'll use anything to further my understanding, just so long as it is actually useful. Ed.

Dear Sir,

Firstly, thanks for an excellent magazine. I've been reading Hi-Fi magazines for more than 10 years now but yours is the first I've decided to subscribe to, so that must tell you something.

I'm particularly impressed with the way you seem as interested in 'peripheral' stuff (which of course isn't) e.g. mains cables and 'tweaks', as you are in the various Hi-Fi components. And therein lies a particular frustration (and I'm sure I'm not on my own on this). It's taken me a long time to realise how very important the tweaks and peripherals are. I've recently placed Stands Unique Isolators (after reading about them in Hi-Fi+) between my Spondor SP2/3 speakers and MAF stands and they've made, I think, a huge difference, by I guess, better isolating the speakers from a suspended wooden floor. I think I now know what smear is. The problem lies somewhere between (as it generally does) on the one hand Russ Andrews pretty much telling his customers (who include me) not to buy any new gear until they've bought all his products, or local dealers, who in my experience know little about such products and seem to care even less (presumably because they don't make much money out of them) or are just sceptical as they haven't bothered to do any serious listening to them. So whilst I do understand why you constantly urge readers to trust a local dealer I have to say that the ones I have experience of seem generally to be much more interested in taking my

money than helping with any problems I may have. The difficulty is highlighted by yourselves in the article "Listening to Mains Cables" in Issue 3 when you state that Phonography, a company you seem to have a good relationship with, know little about mains cables.

Trying to sort out a system with a local dealer becomes very difficult, if not impossible, as it may well be that all that is needed is a tweak/peripheral rather than a new CD player, so trust breaks down.

Finally I have a great idea for a regular feature. I think you should offer the system set-up you did with Reuben Parry in the first issue to one of your readers every month. This would be an excellent opportunity to work with different products and rooms etc and would I'm sure help a lot of us to better understand these important issues. And guess what? I have just the person in mind for the first 'makeover'. So when you're next in Newcastle upon Tyne....

Yours sincerely

Geoff Weston

Newcastle upon Tyne

How much you get out of your system depends on the care that goes into putting it together. Back in the distant past, the best person to do that for you was an experienced dealer, but times have changed, as you rightly observe. However, some old school dealers survive, and some of their newer brethren are coming to realise that unless they do something to justify their existence, then they're living on borrowed time. Yes, you'll have to look, but the search is worthwhile. There are dealers out there who can do just what I did for RP and believe me, you'll know when you find one. Ed.

Dear Sir,

Thank you for your efforts to look for real hifi. Here is my two cents to expand on that subject. In reference to issue 6, Paul Messenger's comments on the next wave of digital hifi.

We may already have the next version of digital nirvana right at our fingertips without us, or the big companies, even realizing it. With the introduction of the Audio Note Dac Kit 1.1, we would appear to have the closest digital representation of vinyl yet. And this triumph comes from a small, specialist company. So while the big companies fight it out on DVD, SACD etc, we can sit back and very much enjoy our current software, all over again, and keep adding to it. Will DVD-Audio improve on this new Dac unit? Probably not right away. The big companies have marketing deadlines (which they've already passed) and they want your hard earned money now. This will create shortcuts which, in turn, could lessen our musical enjoyment.

I believe that to find the future of "real" hifi, we are going to have to seriously look at the small obscure companies and the do-it-yourselfers. If not, the hobby and passion of "real" hifi is toast.

Take the Babb Company of Dallas, Texas as another example. They have been building second to none, single diaphragm speakers for 20 years now. No one, until recently, has taken this small company seriously for home hifi. Instead, most applications of their unique technology have been for marine use. Big company advertising has left this company in the shadows, and hi-fi has paid a dear price as a result. As music lovers, we've been royally had.

Our hobby is coming full circle, back to the basements and attics of Fleming, Armstrong and Leak. The single ended tube amps are a current example.

To get great hifi, we should look inward, look to the small companies who have a real passion and yes, we must do-it-ourselves, just like Marconi, Paul Klipsch, and Burt Babb did.

Yours sincerely

Scott Guthrie

Ontario Canada



AVOID THE QUEUES AND SAVE MONEY!

ADVANCE TICKETS FOR THE LEADING HI-FI SHOW IN THE NORTH ARE NOW AVAILABLE

FOR ONLY £5.00!

PLUS THE FIRST 200 APPLICANTS WILL ALSO RECEIVE A FREE SHOW PROGRAMME WORTH £2.00

OVER 40 EXHIBITORS FROM MANUFACTURERS TO RETAILERS

FREE PRIZE DRAW FOR A NAIM CD5 CD PLAYER WORTH £1125.00

FREE TO ENTER COMPETITION TO WIN A MUSIC WORKS BLOCK & LEADS

DON'T DELAY - SIMPLY FILL IN THE COUPON BELOW & POST IT BACK

TO US



Manchester Airport

18/19 NOVEMBER 2000

web site: www.btinternet.com/~chestergate/

Please send me Advance tickets at £5.00 each I enclose my cheque/postal order for (Please make cheques payable to the hi-fi show)
Complete this form and return it to: Dept HF+ Chestergate Exhibitions & Events Ltd, 1/2 Bowmere House, Birch Heath Road, Tarporley, Cheshire, CW6 9UR (Tel: 01829 733268)

Name

Address

Post Code

Tel: Fax:

Experience a New Dimension of Sound

RINGMAT – CHANGING AND IMPROVING YOUR PERCEPTION OF SOUND

Ringmat Developments is at the leading edge of sound technology. It creates products designed specifically to improve the sound quality produced by domestic hi-fi's, from the kitchen CD player to the hi-fi in the lounge. Our philosophy is aimed at bringing the understanding of sound reproduction out of the dark ages and helping hi-fi users to escape the flat and rather uninteresting sound quality produced by most domestic stereo equipment. We want to help our customers to enter a new dimension of sound that will bring the magic and spontaneity of live music into their homes.

Sounds grand and expensive? Certainly the conception is grand, but expensive? - No, definitely not. Why? - Because this grand vision can be achieved without the purchase of expensive new equipment but by using our very economically priced products as a complement to your existing hi-fi. The results will amaze you, we promise.



RINGMAT DEVELOPMENTS

Bringing music to life

www.ringmat.com

www.statmat.net

E-mail: enqhifi+@ringmat.com

RINGMAT SUPPORT SYSTEM

"... has to be one of the best ever turntable enhancements ..."

Deon Schoeman

Audio Video - South Africa

"Already I'm wondering how I ever listened to music without it."

Jimmy Hughes

Hi-Fi Choice

RINGMAT FEET

"... the effect on the music was magical."

Jimmy Hughes

Hi-Fi Choice

"Much more important... is that the music, all the way through, sounds warmer and more like reality, as if you have taken an electronic veil away from your system. ... you are now able to close your eyes and feel that the performers are in your room ..."

Bjarne Jensen

High Fidelity

"... the music itself seems to change, becoming rhythmically more cohesive, and altogether more purposeful and coherent. Statmat increases the sense of depth and space around voices and instruments, expanding dynamic range to give more light and shade ..."

Jimmy Hughes

Hi-Fi Choice

MONEY-BACK GUARANTEE

For more information, including reviews and brochures, or to order with a money-back guarantee, contact

RINGMAT DEVELOPMENTS

PO Box 200 Brentwood
Essex CM15 9FB GB

T: (0) 1277 200 210

F: (0) 1277 201 225

E-mail:

enqhifi+@ringmat.com

Web: www.ringmat.com

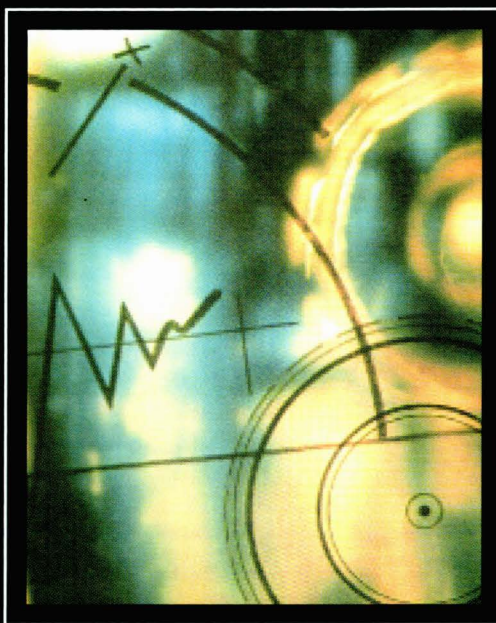

RINGMAT SUPPORT SYSTEM

Playing The System

by Roy Gregory

Not so long ago, young Reuben, of audiophile record review fame, treated himself to a new bike. He's already got one of course: a rather nice Santa Cruz Heckler, XTR, four inches of travel and disc brakes all round. In fact, it's such a nice bike, tricked out to the nth degree, that it's the only steed he's been able to afford for quite a while. Besides, the one thing the Heckler isn't is light, as even Roob will admit after a few beers (or at the top of an especially long and steep hill) - and it needs a lot of servicing - and he's suffering new toy deprivation withdrawal. All of which explains his decision to avail himself of an end of season 'hard tail' bargain. Altogether, lighter, simpler and a lot, lot cheaper. Only it didn't quite work out like that.

What Roob brought home was a spangly new Cannondale Raven, all carbon fibre and Lefty single stanchion suspension fork. Yes, it's a four inch travel full suspension bike, and yes, it's got discs front and rear. It hasn't got any XTR transmission bits, but believe me, that's only a matter of time. Oh, and at \$2700 it's guaranteed to turn heads. In fact, the only thing it's got over the Cruz is a fatter downtube that paradoxically means a lower weight. Functional duplication? Well, one of them isn't going to get ridden. Mind you, Roob's no fool. At the same time he stuck a pair of Marzocchi forks on the Heckler, thus adding a lump of weight, and substance to the Landrover and Lotus Elise argument

he'd prepared as a defence. Unfortunately that one would have held a bit more water if he hadn't told everyone the original 'hard tail' scheme.

By now, the non cyclists amongst you could be forgiven for thinking that a publishing error had dumped a load of out takes from Mountain Bike Action into your hi-fi mag, but consider this. In this very issue, JMH reviews the Koetsu Black Urushi. It's about an inch long, comes in a plain wooden box without instructions or even an indication of recommended tracking force, and also costs £2700. Roob's bike on the other hand, is six feet long, all high tech materials and aerospace engineering, flash as you like and a guaranteed totty magnet (he says). More to the point, it seduced him. It persuaded to go the extra financial mile for the promise of better performance (and extra pulling power).

Yes, I know it's not a fair comparison. I'm comparing a hand made, ultra rare work of art with a mass market, mass produced and globally advertised product. But the point is that in the real world they both compete for the same pounds in the same pockets. Roob's already got a great cartridge, but then he's already got a great bike too. It's all about presentation, and whilst the Koetsu can (probably) afford to adopt its "if you have to ask..." attitude, it's about the only piece of hi-fi that can. Unfortunately the argument that performance is all

that matters no longer cuts any ice. Real products in the real world come with proper packaging, service back-up and an advertising campaign to make you feel good when you buy them (sorry, need them...).

The problem of course is that presentation costs money, putting up the price of your products. However, in practise, if you are careful it doesn't cost a lot more to present a product well than it does to do so badly. And it also adds real value to the purchaser in the shape of confidence and pride of ownership.

Now before you rubbish that suggestion allow me to present a little evidence. Twelve miles up the road is Salisbury, where two hi-fi companies renowned for offering solid, long term value for money are based. Indeed, they've both built successful businesses on exactly that basis. They've also both gone through a major change in presentation. The Chord Co. have all new packaging for their entire range, and sexy new display stands. More to the point, they've done it without putting up their prices, and at the same time as introducing the cheapest hand terminated in the UK, 'real' interconnect on the market. As Nigel Finn says, it's all a case of finding a way of doing it properly without impacting on the customers. (Well, he actually used the term "ripping-off", but I'm sure you get the point.)

Meanwhile Naim have thrown off their 'plain and proud of it' image ►

► with the NBL and NAP500, and are in the process of launching the svelte new 5 Series slim-line products. The finish and styling of these doesn't just leave the 3 Series products for dead, it is actually more cost effective as well, helping to counteract creeping price rises. But what makes this shift in style so important is what it reveals. The fact is that even Naim have realised the limitations on what people are prepared to accept. If someone buys an expensive hi-fi (and remember that for most people anything over £500 for a system is

importantly, he's actually interested in hi-fi. The result is photographs that make products look as interesting and attractive as possible. This speaker costs £6K, you'd better hope it looks good in the pictures! As a magazine, we depend entirely on peoples' continued interest in hi-fi for our survival. An essential part of what we do is to present products properly, maintaining a level of interest over and above the simply 'buy/not buy' decision level. We don't pretend they're something they're not, and we criticise as we find, but the last

As such, a major promotional event like Novotel is something we should all want to see succeed. Unfortunately, that seems unlikely all the time things stay as they are, and specifically all the time we remain at this venue. It is simply too confined, too dingy and sounds too bad. Large companies who want big rooms to put on serious demonstrations can't get them because there aren't enough to go around. Small companies can't afford a bedroom because they're too expensive.

Imagine for a moment, taking a friend who has expressed a possible interest in hi-fi along to the Novotel. Do you reckon he or she would be impressed? Lousy sound in poky little rooms, dark and claustrophobic corridors and no attempt to provide reasonably priced refreshments other than the over priced offerings from the hotel itself. It all adds up to an expensive and disappointing day out, especially by the time you've schlepped all the way

into central London and out again.

Great hi-fi should seduce the listener, not batter them over the head, but we persist in creating an environment and scenario in which it is virtually impossible to appreciate any level of sonic subtlety. As I write this the dust is settling on the Hammer-smith experience, and I've not heard a single positive word about it, from exhibitors or customers. Surely it's time to think again. This is one instance where a healthy dose of negative feedback could just save the patient.

And yes, I do want a go on Roob's bike!

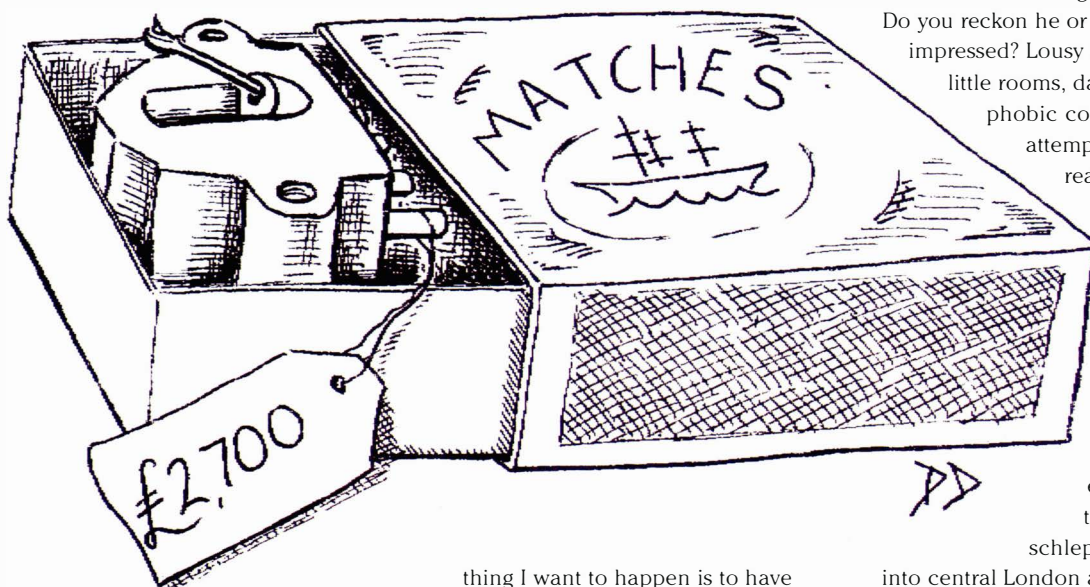

expensive) then why should they have to keep apologising for the way it looks? This is not about selling someone something they don't want. It's about making the good stuff appear as attractive as the junk, junk which is often backed up by up to the minute styling, racy packaging and a whole slew of point of sale and promotional literature.

Closer to home, why do you think we take so much care over the photography in Hi-Fi+? Simon is a great photographer, but just as

thing I want to happen is to have someone turn the page, maybe missing a product ideal for their purposes (or a little set-up tip they could apply to their own system) just because there's a lousy picture that makes the product look drab and boring.

All of which brings us to the thorny topic of the Novotel show. Everybody involved in hi-fi, whether as a manufacturer, reviewer or customer, has a vested interest in maintaining a healthy industry. The professionals want to keep their jobs, the buyers want a wider range of better products to choose from.



Home Truths



by Jimmy Hughes

A friend recently asked me what reviewers mean when they write about timing. It's a good question. As I understand it, timing refers to the subjective portrayal of rhythm and tempo. It concerns the apparent speed at which a piece is played, and whether phrasing is heavy or light. It's well known that hi-fi equipment can subjectively alter the perceived speed (or tempo) of a piece of music, making it seem 'fast' on one system and 'slow' on another. This has nothing to do with actual speed - ie a turntable running fast or slow - but is something purely subjective.

Tempo and phrasing are perhaps the most important constituents of music - the lifeblood of a performance. Although playing the right notes is vital too, it's tempo and phrasing that gives shape to the music, conveying emotion, personality, mood, atmosphere, feelings and passion. What was it the great pianist Schnabel said? "The notes I play no better than anyone else. But the silences between the notes; those I do better than anyone!". I guess it all stems from speech, and our sensitivity to fine nuances of articulation and dynamics that colour meaning.

We don't just listen to what people say, we listen to how they

speak. Of course, the actual words spoken are important. But when we listen we listen for meaning. And meaning is conveyed by subtleties of phrasing, inflection, intonation, and dynamics. It's the same in music. Great players and singers express meaning in music through the supreme command of timing. Which places an enormous burden on the equipment used to recreate a performance.

The question is - what exactly is it that makes one piece of hi-fi good in terms of tempo/timing, and another bad? I find that very hard to answer. Ultimately, I think it's a system/room thing, rather than something intrinsic to a particular component. Some systems in a particular location seem to produce snappy engaging rhythms that get your toes tapping. Yet the same equipment, set it up in another room, can sound deadly dull and leaden. Why this occurs is a great mystery.

For this reason, I feel uneasy when products are described as having great timing. It may be that a certain CD player or amplifier displays coherent timing in one particular system. But will it necessarily do the same when partnered with different equipment in another room? Not necessarily. Since what you stand individual

components on can radically alter timing, it's hard to say it's purely an equipment thing.

When it comes to tempo, there's a general consensus that Fast equals Good and Slow equals Bad. If someone listens to your system and says it sounds slow, they're (usually) not being complimentary. By 'slow' they're implying that rhythms sag and the effect is heavy and leaden. Fast means lively pepped-up rhythms and plenty of forward momentum. In a word - excitement.

Yet I often find that if a system articulates the notes cleanly and precisely, and recreates the proper rise and fall of attack and decay, it creates an impression of music moving more slowly because (subjectively) the notes seem to last longer - you can savour the decay of a note even though there's a new one to replace it. The balance between bass and treble is also extremely important.

If the tonal balance is slanted towards the lower frequencies, the subjective effect is one of weight and reduced agility leading to impressions of slowness. Conversely, a bright/thin sounding system sounds forward and immediate, reproducing a welter of fast leading edges that give the (false?) impression of pace and speed. However, while such systems may sound exciting and

► impressive for a while, the sense of pace and speed quickly evaporates.

It's like driving at high speed in a fast car; the impression of speed is soon lost. What the body registers is not absolute levels of speed, but relative levels of acceleration and deceleration. In hi-fi terms, what's important is contrast - the ability of a system to sound both sharp and mellow, assertive and beguiling, or warm and brilliant, as the music demands - rather than simply superimposing its own uniform character on whatever's being played.

Something that goes beyond simplistic notions of Fast and Slow is Coherence. A friend of mine liked to play a recording of a rather skeletal percussion piece to determine the timing coherence of

a system. Playing his disc, sound could be judged in simplistic hi-fi terms - how deep the bass, how high the treble, how much impact transients had - but of far more importance was whether or not the piece hung together rhythmically. The idea was to listen and see if the various sounds made musical sense.

On some systems the recording sounded great sonically, but seemed like a collection of random noises that bore little or no relationship to one-another. Yet the same track heard on another system seemed

totally different; suddenly there was a relationship between the beats - they were no longer random - as though the piece had a definite intelligible pattern or shape. Noise had become Music. This is something far more important than whether or not a system sounds fast or slow.

The whole timing thing is fascinating. Yet I still can't put my finger on the mysterious factor X that makes one system sound musically coherent and the other disjointed. Probably, it is no one single thing, but a combination of several rights (or wrongs) that ultimately create a result that's greater than the sum of the parts. When it's there, it's unmistakable; when it's absent, it can be very difficult to find the reason why. ►+

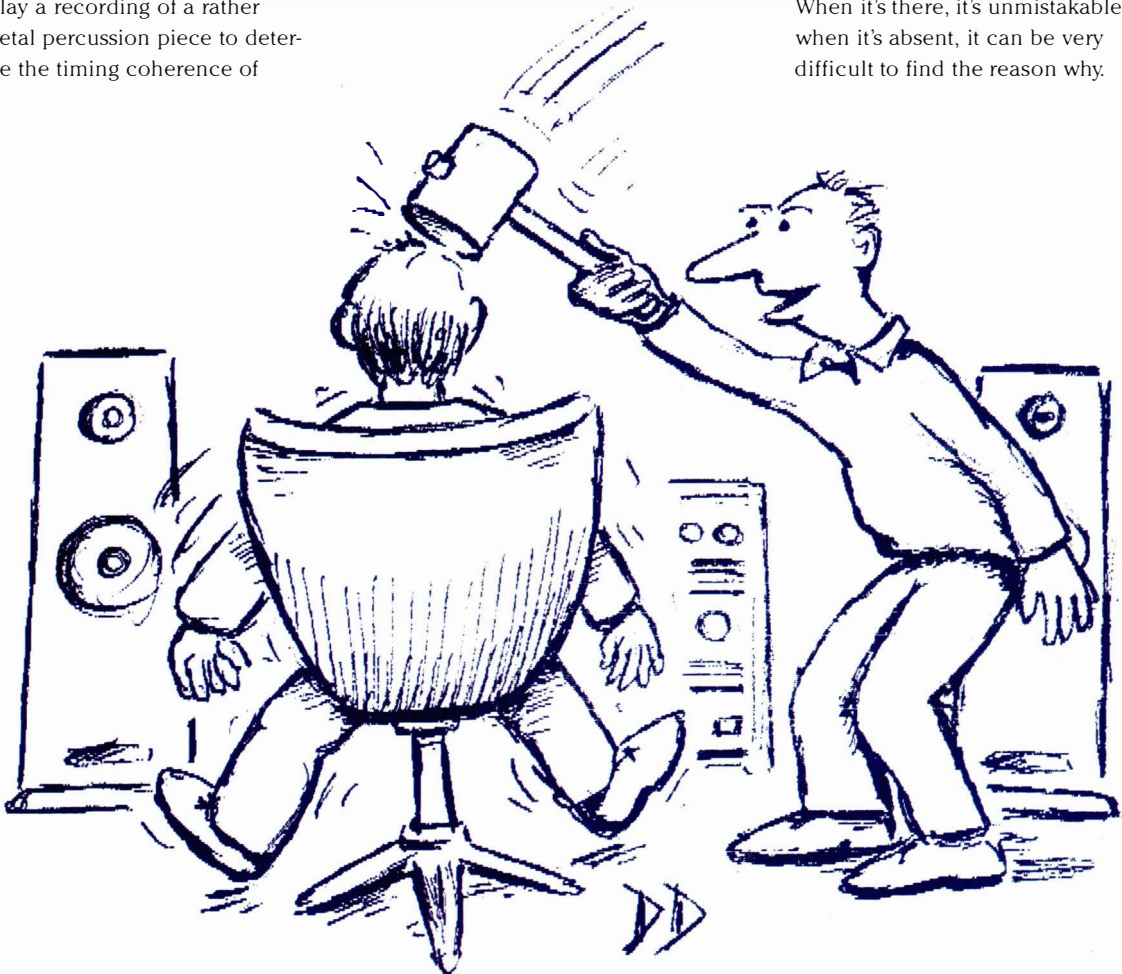

See! Now you can really feel that jack hammer beat.

Speakers Corner

Rooms – the Final Frontier

by Paul Messenger

Loudspeakers are often regarded as the final components in the hi-fi chain, which is simply not correct. It ignores the fact that the ultimate component, which 'couples' the loudspeakers to the ears, is the air trapped in the confines of the listening room. I've long believed that this is a vitally important factor, yet it's one that has often, in the past at least, been overlooked by speaker designers.

Happily, this is much less of a problem than it used to be, especially back in the early days of transistor amplification, when designers were lowering sensitivity to gain more bass extension. There was a tendency to create designs to give a flat, deep bass when measured in free-field anechoic conditions. Put two such speakers into a typical domestic lounge and the bass is boosted twice over: first by the presence of two rather than one speaker; and secondly by the 'room gain' effect, where major standing waves within the room become excited and provide irregular 'acoustic amplification' through the bass region.

These mechanisms are now sufficiently well understood that 'boomy' speakers are much less common than they used to be, though I still feel that leading speaker brands ought to do more to help their customers choose the right loudspeaker in any given range from a 'room matching' point of view.

However, that's a whole topic in itself, which I'll maybe tackle in a future column. The trigger that got me onto this thorny topic was a European conference to launch three

new ranges of Infinity loudspeakers. Ironically this took place a week after Infinity had parted company with its UK distributor Gamepath, so it may be a little while before I get the chance to try the products themselves.

But there was much more to the conference than product. The keynote technical lecture was from Dr Floyd Toole, whom I'd met many years previously, when he was working in an academic role for the Canadian NRC. He recently moved to Harman, as Vice President of Acoustic Engineering, where he's been putting much of his work into commercial practice, notably his objective approach to subjective testing.

In many senses Floyd and I live on opposite sides of Planet Hi-Fi. I'm a romantic, stereophonic vinyl-spinning analogiste, whereas Floyd loves his Lexicon 7.1 system, and looks forward to an all-digital future. These differences in perspective might add a certain spice to our discussions, but I have enormous respect for the guy and his achievements, and found myself nodding vigorously in agreement when his lecture got onto the whole topic of loudspeaker/room interaction, 'room gain' and the effect of room modes on bass performance.

I also learned a great deal. Having spent more than a decade reviewing hundreds of speakers, I'm very aware that my particular room works pretty well through the bass region, but has obvious reinforcement modes at 30Hz and 55Hz. I'd attributed these main modes to the width and height of the room respectively (ie the shorter two of the three main room dimensions),

but that turns out to have been a misleading over-simplification of the mechanisms involved.

Harman International's resources in brainpower and test equipment are rather greater than mine, and their work across a large number of rooms has shown that this business of room modes is actually a much more complex problem than I had appreciated, though not beyond more sophisticated powers of analysis than mine.

Although the modes present in any room are related to the main dimensions, the key mechanism at work lies not so much in those prime modes themselves but in their interaction with one another. Essentially (if still somewhat simplistically), the problem modes tend to be created when a harmonic of a length mode coincides with a harmonic of a height or width mode.

That of course ties in with received wisdom that the better rooms are those with nicely irregular, non-harmonic relationships between the main room dimensions. A perfect cube is of course well known as the worst case scenario, but a room with length twice the width - say 24ft x 12ft - is also asking for trouble, especially if it has a not untypical eight foot ceiling.

In the real world not everybody has simple rectangular rooms, and the construction methods and furnishing all play their parts in defining the ultimate performance of this ultimate component in the chain. You can make a few educated guesses from the room dimensions, and from taking into account whether the walls, floor and ceiling are solid brick or concrete. ►

► or of joist/stud/board construction. But the real world is very complex, so predicting the behaviour of any given room with any given speaker and listening positioning is inevitably a rather hit and miss affair.

What Infinity has done is come up with a novel and very interesting technology, which first analyses the specific listening conditions, and then gives the user the opportunity to do something about it. It's called RABOS (for Room Adaptive Bass Optimisation System); it comes as an integral feature of two of the three new Infinity ranges (the Prelude MTS, and the Intermezzos); and it represents the most

times before, one can fairly argue, usually with less than successful results. Indeed, the fad for 1/3-octave equalisers back in the 1970s soon died out as people realised that the cure was usually worse than the disease. Those banks of sliders were a crude tool - something of the 'sledgehammer to crack a nut' syndrome - that more often than not completely missed the target.

Infinity's RABOS approach is altogether more subtle and rapier like in its conception and application. It's able only to suck out a peak, not boost a null, as attempting the latter simply doesn't work (because it's the result of

There may well be more than one unwelcome room mode of course, but Infinity reckons that getting rid of the worst one usually takes you about eighty per cent along the road, and there are comprehensive instructions to help identify the biggest troublemaker. The size and Q of a peak is important of course, but often less so than the frequency: a peak above 60Hz is likely to be much more troublesome than one down around 30Hz, simply because it's much more likely to be excited by the musical instruments. Having specified the precise nature of the mode, presets on the speaker are adjusted to set the parametric notch filter to cancel it out.

I don't make judgements on hi-fi systems operating in foreign hotel bedrooms, but can't deny that the bass end of the Prelude MTS did sound exceptionally deep, clean even and boom-free, so I'm really rather looking forward to trying them out at home. I don't think there's much doubt that RABOS is going to work pretty much as advertised. What is rather more open to question whether its benefits will outweigh the extra 'gubbins' involved in the EQ and bass amplification.

Infinity's approach might be contrary to much accepted audiophile thinking about simple, direct signal paths, but it definitely deserves to be given a fair hearing, as it's by far the most likely technique I can recall which seriously attempts to tackle the intransigent problems of room modes. If you've already got a pretty good room in mode behaviour terms, RABOS might be an unnecessary complication, but if you and your system are struggling in the confines of a small concrete box, it could well prove the solution to figuring what's really going on down in those bottom octaves. ➤



I think we should pull them out another 1/2 inch.

serious and well thought through attempt I've yet encountered in tackling the problem of bass room modes.

The speakers involved have integral powered/active bass drivers, which allows the Optimisation circuitry to be incorporated. This consists of just a single adjustable parametric equaliser, operating conventionally enough in the analogue domain prior to the power amplification, which provides the ability to 'tune out' just the single most troublesome room mode.

Equalisers have been tried many

cancellation). And the whole package comes with a test CD and an accurate measuring microphone/meter, so that the room modes can be precisely identified, both in frequency and Q (a measure of 'sharpness' or severity).

Having set the speaker system up the room, the customer/dealer uses said disc, the mike/meter and supplied graph paper to plot the true 'real world' low frequency behaviour of the speaker/room combination across the main listening zone, with considerable precision.

The Best Mains Solution For Audiophiles

Why bandage the problem with power conditioners when you could be generating clean power?

The Power Plant takes the AC from your wall socket, converts it to DC then back to AC. The result is pure mains power, and a major upgrade to the sound of your system.

For more details please check our website.

P300 with 4 outlets - £1200

P600 with 8 outlets - £2200



Moon High-Performance Amplification By SimAudio



Innovative circuitry, attention to detail and outstanding mechanical integrity set the Moon electronics apart. Unconditionally stable output stages and large power supplies are combined with feedback free design for outstanding tonal and rhythmic performance. Surprisingly affordable high-end, designed for long term listening pleasure.



Perpetual Technologies New In The UK

Upgrade your entire CD collection with the P-1A up-sampler from Perpetual Technologies for £800. The PIA is future proof and will support all current and future digital formats including home theatre applications. Also available - P-3A DAC; 44.1, 48, 96 & 192 KHz compatible. £585

Other brands: Forsell, Synergistic Research, Alon Loudspeakers, Jolida Valve Equipment, Silverline Audio Loudspeakers, Z Systems.



Ultimate Sonics

DISTRIBUTORS OF AFFORDABLE HIGH END HI-FI

36 Hurstbourne Road Forest Hill London SE23 2AB

Email: info@ultimate-sonics.com

Web: www.ultimate-sonics.com

Tel: 020 8699 2446

Fax: 020 8699 4232

Mob: 07956 805 572

Check out our Pre-Owned pages on the web for bargains

PREMIUM HI-FI FOR
THE MIDLANDS

A real treat
in store
at



Chord 2200
& 1200C



The finest names in audio and Home Cinema
Electronics, including Projection Equipment,
Home Cinema and Multi room installations.

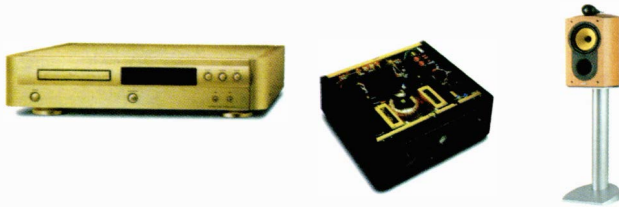

Marantz Premier cd7



*For more information on the world of hi fi and home
cinema, to fit everyones requirements
contact us at.*



20 years experience in the art of audio

WALSALL 01922 493499

Sharing ASDA Car Park off High Street, Bloxwich
Email:sales@soundacademy.co.uk

or
call **David**
at



SUTTON COLDFIELD 0121 321 2445

The Parade, Sutton Coldfield
Email:sales@soundacademy.co.uk

Nautilus 800

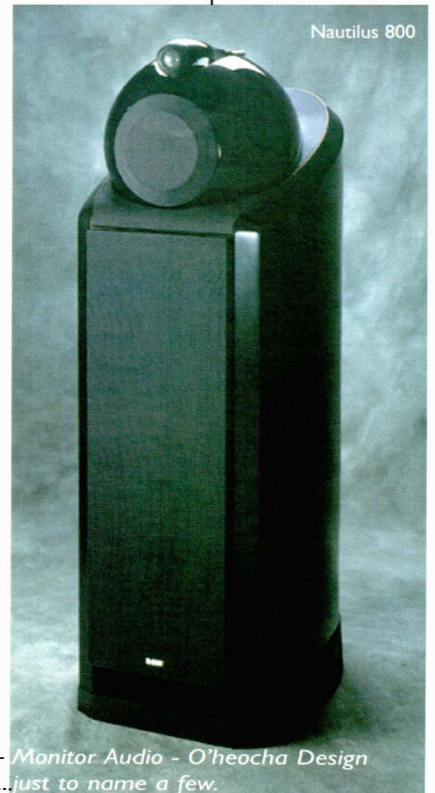

*Naim - Meridian - Chord Electronics - B&W - Marantz Premier - Arcam - Monitor Audio - O'heocha Design
Crestron - Living Control - System Line - TAG McLaren.....just to name a few.*



Dynavector

30
20
10
0
10
20
30
B C A

COLUMBIA
RECORDS
MADE IN U.S.A.

Unsung Hero

Dr Tominari of Dynavector Systems

Interviewed by Roy Gregory

For most people Japanese hi-fi is limited to midi-systems and massive corporations, whereas in fact Japan has a vibrant and inventive high-end market which we in the West know little or nothing about. But whether we are aware of it or not, it's a market which has had profound effects on our own. The single-ended amplifier / high efficiency speaker movement started many years ago in Japan, reaching us through the likes of Be Yamamura in Italy and Jean Hiraga in France. Likewise, there have always been exclusive Japanese high-end products which have enjoyed near legendary status amongst the gai-jin. Koetsu and Audio Note are the two that spring to mind, and it's no coincidence that Sugano-san and Kondo-san are about the only Japanese high-end designers that most of us know by name.

However, there is another, tiny, specialist company which has a track record of consistent innovation and excellence. It too has enjoyed a long and successful association with Western audiophile markets. It too has kept the faith with what many see as redundant technology. And typically, it's done it at lower price levels than the other companies I've mentioned. That company is Dynavector, and its guiding light is Doctor Noburu Tominari.

RG. How long have you been making pick-up cartridges, and why do you continue when so many others have stopped?

Dr T. More than 23 years now. It started

as a hobby when I retired from the University. I was always fascinated by cartridges as I feel they have a huge influence over the reproduction of recorded sound. Ten years ago surround sound appeared and although it impressed many people, especially for movie sound, it made no impression on me when it came to reproducing music. On the other hand, many people in Japan have huge collections of CDs and vinyl records at home. Many people listen to music at home but when you come back from the concert you find that the sound is not good - not realistic. I was really worried about this, and the way that the major Japanese companies were ignoring high quality music reproduction for most people. Despite the existence of large stereo music collections they were pouring all their resources into the development of surround sound media. Now music will have to be re-recorded for the new formats, losing the wonderful performances that we already have, making music a poor relation to the technology.

Most audiophiles already have several sources and software to go with them. They don't want to start again with yet another new format, so the marketing effort behind DVD has gone into the home cinema market, concentrating on selling people the extra equipment they need for this, and films rather than music. That is why listening to music is a declining hobby. People buy the new equipment but their old recordings don't sound good on it, and they can't afford to

replace them with new ones. I became convinced that what was required was a system to get better sound from their existing music collections.

So this is why I continue to make better cartridges and also developed Super Stereo (a fascinating variation on surround sound which we will be returning to shortly). For high end listeners who already have good amplifiers and speakers, there is

Many people listen to music at home but when you come back from the concert you find that the sound is not good - not realistic

a whole legacy of great performances, great conductors, pianists or singers, stretching back nearly one hundred years and just waiting to be enjoyed. We should apply the best technology to their reproduction, but it should be analogue technology because these are analogue recordings. They were recorded in mono or stereo, so why try to replay them with a multi-channel digital system?

But to get the best from these records you need a very high quality cartridge. Working with prototypes ►

▶ of my latest design I was astonished how good these old records could sound. Much better than a modern CD. Unfortunately, this new cartridge is not as simple as something like an Ortofon. Most high quality cartridges are based on extremely simple structures

time I asked them about constructing one they couldn't understand what I wanted such a large stylus for! But I was convinced that you should use as short and stiff a cantilever as possible. This was quite widely recognised but no one believed that the technology



gemstone cantilevers there is no space, so the armature must be much smaller than normal. Unless we use the fine wire for the coils there will be insufficient windings for a working output level. We did this twenty years ago, and are still the only company who can use such fine wire. Eric Rohmann, who was president of Ortofon until some years ago, even tried to buy one of our machines. Incidentally, you are aware that Ortofon and Grado hold all the patents on moving-coil cartridge designs. Dynavector was the only Japanese company that ever paid the licence fees. (Laughs)

RG. The first Karat cartridge had a 2.5mm cantilever, but over the years that has shrunk down to 1.7mm.

Dr T. At first when I tried short cantilevers I worked in sapphire or ruby and their resonance dictates a length of 2.5mm. But in Diamond, it is possible to use 1.7mm. We even made a very special product for the US high end market with a cantilever only 1.3mm long, and called the Karat 13D. It was our flagship model and sold nearly 60 pieces in America. The 17D was the first diamond cantilevered cartridge that we made, and the 13D was a very special development of it, using a special body and headshell arrangement.

RG. The next major development that you produced was the Flux Dumper, which first appeared on the XX1. What does it do?

Dr T. It first appeared on the XX1, but now it is incorporated into all our cartridges. It involves winding a wire around the front yoke of the cartridge. Experiments showed that movement of the coils was generating a voltage in the yoke which in turn effects ▶

developed fifty years ago, and very old fashioned in their use of magnetic materials. Instead I use eight Alnico magnets to create a much more uniform magnetic field. The results of experiments were so impressive to me that I immediately incorporated this technique into a new cartridge, the XV1. One dealer in Japan, as soon as he heard this cartridge immediately said it sounds superior to any DVD or SACD. This cartridge reproduces the air and atmosphere of a recording, even from a very old record, which is absent from digital sources.

RG. The first Dynavector product I became aware of was the original Karat cartridge, with its solid ruby cantilever. Were you the first person to employ gemstone cantilevers?

Dr T. Absolutely. I get my gemstone cantilevers from Namiki, and the first

They thought it was impossible but I dared to try it.

existed to create such a short gemstone cantilever. They thought it was impossible but I dared to try it. It was a very unusual solution at that time. In order to achieve it we had to develop a parallel technique that enabled us to wind incredibly fine wire for the coil. Our wires are only 11 microns in diameter. Every other cartridge uses at least 20 microns.

RG. Why do the fine wires help you use in using a short cantilever?

Dr T. At the end of the cantilever is the armature. On the very short

► the linearity of the magnetic flux. It is this that makes many poor moving-coil designs sound thin and irritating. By short circuiting the yoke we prevent this happening, which leads to a much smoother and more natural high frequency balance. The effect is quite noticeable, which is why we put a switch on the XX1, so that people could hear the effect.

RG. What is the relationship between the Te-Kaitora and the XX1?

Dr T. The Te-Kaitora is really just a special version of the XX1 made for Mr Denson who distributes Dynavector products in Japan and also builds the Dynavector electronics. It has no body, and uses better magnets and selected parts. And also better quality wires as well.

RG. I notice that neither the XX1, the Te-Kaitora nor the XV1 use gemstone cantilevers. Why is that?

Dr T. At the moment, the construction of this magnetic assembly used in these cartridges requires a long cantilever.

Our wires are only 11 microns in diameter. Every other cartridge uses at least 20 microns.

It would be very difficult to engineer this for a short cantilever, and also very, very expensive.

RG. I also notice that the output on the XV1 is slightly higher than previous models.

Dr T. Yes. That is to make it easier to use with conventional phono electronics. We have also created

a moving-coil head amp to go with our cartridges, and those from other manufacturers. It is an updated version of a circuit that I first used 20 years ago, but it is improved with modern components from the United States and Japan. The quality of the parts used has a huge influence on the sound quality of phono electronics. 20 years ago I started with the idea of basing the amplification of low output

Experiments showed that movement of the coils was generating a voltage in the yoke which in turn effects the linearity of the magnetic flux. It is this that makes many poor moving-coil designs sound thin and irritating.

moving-coil cartridges on current rather than voltage. Theoretically current amplification is far better than existing hi-fi head amplifiers, which are based on voltage amplification. Unfortunately, 20 years ago the components available were not as

advanced or capable of low noise performance. The development of analogue IC chips has really improved things, especially in terms of signal to noise ratio. So last year I built a new version of the circuit and was amazed by the

improvement in performance. The current version uses only the very best components that I can find.

RG. And the unit amplifies from low output moving-coil up to moving magnet level?

Dr T. That is correct. You must connect it to an existing moving magnet stage, along with its associated

equalisation. Currently of course, many audiophiles are using line stage pre-amplifiers with no equalisation built in, so I am working on an equalisation circuit which once incorporated into the unit will mean that I can then increase the gain all the way to line level.

Using the PHA-100 the sound of all moving coils is fuller and more natural. Because it presents the cartridge

generator with a dead short it maxi-mises the output current, which in turn leads to a smoother sound with more body. It also works better with very low output cartridges for this reason.

As mentioned, Dr Tominari has been a source of constant innovation. His use of gemstone cantilevers and the development of the Flux Damper, PHA-100 head amp and the new magnetic structure for the XV1 are only part of the story. We will be reviewing one of his Super Stereo units in the next issue, but by way of an introduction here are two reviews, one of his latest cartridge, the XV1, the other of his long running and eclectic tonearm, the DV 507, along with the ultra rare DV 13D cartridge. You only have to look at these products to appreciate that Dr Tominari is not one to simply accept the status quo. As you will see, it's an attitude that has led him to develop some fascinating and technologically challenging products.



The Dynavector DV 507 Tonearm and DV13D Moving-Coil Cartridge

by Roy Gregory

When it comes to hi-fi, weird and wonderful products are nothing new. In fact, hi-fi could have been invented as an outlet to prevent frustrated designers from doing any real damage. (But that was before they discovered massive triodes with driver voltages in excess of 1000 Volts. The best laid plans of mice and men...) Leaving

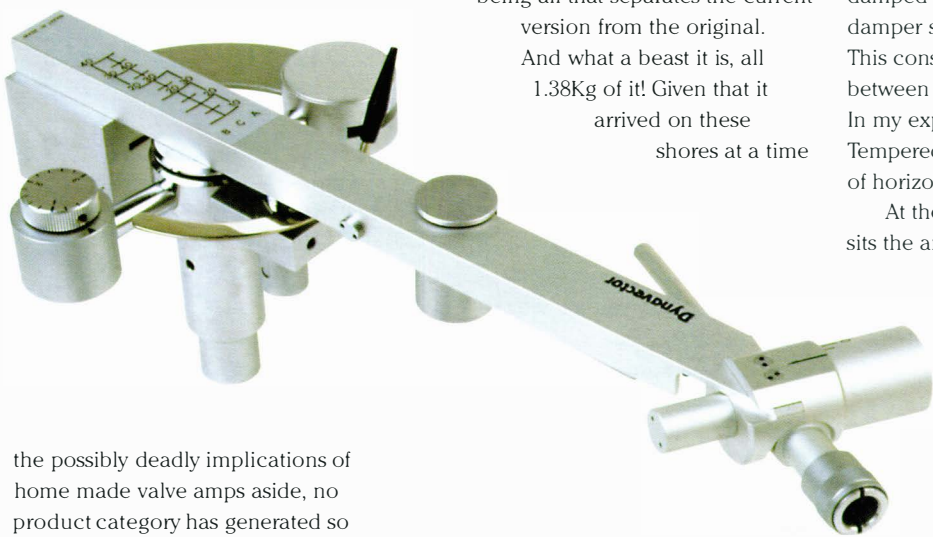

the possibly deadly implications of home made valve amps aside, no product category has generated so many bizarre designs as the tonearm. From the stationary Transcriptor (the platter moved under it!) to the pivoted head-shell on the ultra lightweight Vestigial, the simple act of dragging a rock through a spiral groove seems to have fascinated and exercised some of mankind's more inventive (or just plain wacky) minds. But you know, the really odd thing is that some of the strangest designs have also been some of the best sounding. I should know, I've owned or own most of them: the Eminent Technology and Forcell air-bearing passive linear trackers, the

Souther Tri-Quartz, the original Mission 774 and the wooden Grace G714. All were strange, and all of them worked. But the one arm I always hankered after getting my hands on was the monster Dynavector DV505.

Well, I never did, but here's the next best thing, the DV507. In fact, it's damned nearly the same thing, a few refinements and a change of finish being all that separates the current version from the original. And what a beast it is, all 1.38Kg of it! Given that it arrived on these shores at a time

when the light-weight suspended sub-chassis turntable ruled the roost (the LP12 was the incumbent champ, the even lighter Pink Triangle its nearest challenger), it is perhaps hardly surprising that the massive Dynavector struggled for acceptance. Take its eclectic approach into account and it was only ever destined for cult status.

The guiding principle of the Dynavector arms (there have been three different versions) is the separation of the horizontal and vertical pivots. The DV507 is almost two arms in one.

Lateral motion is handled by a massive horizontal I-beam, at the end of which sits a short, vertically pivoted section. The theory is that the much slower lateral excitation of off centre records allows a higher horizontal inertia than the much faster vertical deflections. Taking advantage of this allows a more massive and rigid overall structure. The horizontal resonance is further damped by the massive magnetic damper situated behind the bearing. This consists of a steel arc passing between a pair of powerful magnets. In my experience, only the Well Tempered arms offer more in terms of horizontal damping.

At the business end of the beam sits the angled and dynamically balanced stub assembly, complete with a detachable headshell and its own counterweight. The entire forward assembly is counter-balanced by a large weight which slides on the beam, preventing excessive side loading of the lateral bearings and a corresponding increase in friction.

Whichever way you look at it, the DV507 is an imposing creation. It is also a horrendously (and critics would argue unnecessarily) complex structure. But for me, the attraction lies in the engineering. The vertical bearings are silky smooth, the dial-up tracking force is spot-on. The headshell is milled from solid, when other people were using bits of bent metal. You get three different counterweights for the stub arm so that you can

► optimise it for different cartridges, which along with the general arrangement of headshell and down force makes running multiple cartridges a real possibility. Early arms suffered from a dreadful falling weight bias arrangement, but the 507 has a rotating spring set-up which is easy and repeatable to set. And of course the whole thing would be a waste of time if you couldn't adjust the VTA. The 507 has a simple horizontal bar rotating around the vertical shaft that allows you to crank the arm up and down: unscrew, adjust and retighten. Simplicity itself, and once again, the length of the bar makes repeatable settings a doddle, even if there isn't a scale. This is one completely thought through product.

But the bits that really get me are the incidentals: the tiny magnetic clamp that holds the arm at rest, the simple overhang gauge that works with the headshell to provide perfect alignment (an idea which **didn't** originate with the Graham arm) and the minute, chromed, pin spanner bolts that hold everything together. It's an attention to detail that extends to the DV13D and its integral headshell. The modified cartridge generator with its diminutive 1.3mm cantilever is built into a solid block of aluminium. It's tapped on the sides for the four screws that fasten it to the prongs of the machined headshell, which is massive by today's standards, but must have looked like something from a shipyard back in the mid-eighties. The separate finger lift is bolted in place using the half inch fixings provided for mounting the cartridge into fixed headshells, while flying leads carry the signal to the arm pins. A massive stylus guard is clamped in place with a knurled screw. The whole thing has the kind of mechanical integrity which you'd normally associate with an armoured

vehicle rather than a piece of hi-fi.

Mounting the DV507 was simplicity itself, once you've found a suitable deck (somewhat easier these days, with the resurgence of interest in higher mass and

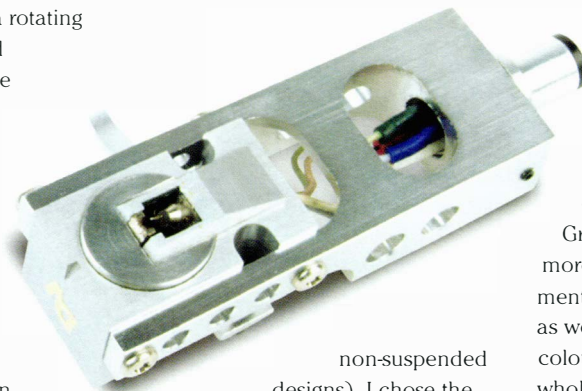

non-suspended designs). I chose the Clearlight Recovery, and given

that few people are likely to have a pre-cut armboard in stock, the excellent mounting instructions and template supplied were a real bonus. The actual arm collar is similar to a Linn arrangement, but screwed down from above rather than bolted up from below. Once installed, and only fixing the arm cable presented any problem at all, the combination of DVs 507 and 13D were impressive indeed.

The superb finish and imposing bulk make an impressive contrast to the shiny black top-plate of the Recovery, whose stable foundation was reassuring once it came time to check the alignment and actually cue a record. The sheer bulk of the arm, and the proximity of the beam to the record surface are disconcerting at first, but you soon get used to them. In fact, the only operational blemish

was a persistent drift on the cueing caused by the polished surface of the arm's cueing arc, but you get used to that too.

Now, if you've read this far, you probably want to know how the whole shebang sounds. In a word - solid. The DV 507 brings tremendous solidity and substance to music.

Compared to modern arms it is easy to criticise it for a lack of focus and clarity. The various Gramms and SMEs are obviously more transparent and define instruments in space far more precisely, as well as offering lower levels of colouration. But that is far from the whole story. The DV 507 may not have the clarity and separation of those arms (and make no mistake, if you want to buy one in the UK it will cost around £2000) but it has something else; coherence. Music flows from the big Dynavector all as a piece. The Corelli *Concerto Grosso* on the fabulous Tacet recording The Tube is played with complete poise and confidence. And as you listen, it dawns on you that although the instruments aren't separated in



space the way they are with the Graham or ClearAudio TQI, their individual contributions are just as readily recognised.

It's almost as if the arm (and cartridge) are separating them tonally rather than spatially, an effect that's underlined by the clearly audible harpsichord continuo. Indeed, with ►

▶ the 13D mounted, the harpsichord's contribution has never been so obvious, or made as much sense.

The coherence and stability extend to the soundstage, which is totally divorced from the speakers, increasing the sense of a complete performance in front of you. Overall, the sound has a tangy shade that

tonearms, at least not in hi-fi terms. However, its relaxed musicality can teach more than a few of them a thing or two. In this respect it reminds me rather of the VPI JMW Memorial arms, with their natural pace and unobstructive view of the performance.

shock or something of a revelation, depending on your point of view. The fact that it still makes a valid musical statement today suggests which it should have been. I for one have thoroughly enjoyed our long awaited introduction. 



adds an almost orangy warmth to the acoustic, adding to the sense of intimacy, especially on female vocals, like the Classic reissue of Billie Holiday's *Lady In Satin* (CS8048). Audiophile spectaculars like the Kari Bremnes album *Norwegian Mood* (ARS EXLP221) reveal the Dynavector combination's limited transparency and slightly constricted dynamic range, but playing real music and mainstream recordings their east confidence and natural expression really came into their own. I also used the arm with the ClearAudio Accurate, but whilst it improved the dynamic range and built on the already impressive bass performance, it lacked the seamless grace of the 13D, and it was Dynavector's cartridge which spent most of the time on duty.

Strictly speaking, the DV507 no longer competes with state of the art

In part that is probably down to the excellent geometric accuracy of the 507 (you'd expect nothing else from such an obviously engineered product), but it also suggests a deep and abiding understanding of the flaws in so much reproduced music. Listening with the Dynavectors went a long way to removing the system from the equation. It wasn't that they were invisible, more that they didn't intrude. It's a trick that the current products haven't forgotten. Twenty years ago, when the accepted benchmark was an SME 111 with a V15-1V, the combination of the 505 and the 13D must have been either a culture

TECHNICAL SPECIFICATIONS

Type:	Bi-Axis inertia controlled Dynamic and Magnetically damped tonearm.
Total Length:	306mm
Effective Length:	241mm
Effective Mass:	17g
Cartridge Weight Range:	<20g
Tracking Force:	0 - 3g
Weight:	1380g

Available from - Pear Audio (see page 48)

Manufacturer:

Dynavector Systems Ltd
16-15 Iwamoto-cho
2-chome
Chiyoda-ku
Tokyo 101
Japan
Tel. 0081 3861 4341
Fax. 0081 3862 1650
Net. www.dynavector.co.jp

Dynavector DRT XV-1

by Paul Messenger

I introduced this splendid cartridge in the last edition of Hi-Fi+, after just a short time with the device, and as part of a combination with the very unusual Well Tempered Reference turntable/ tonearm combination. A couple of months on, now mounted in my familiar Linn LP12/Naim Armageddon/ARO combination, I feel ready to write a proper review.

The DRT XV-1 is Dynavector's latest 'top-of-the-line' model, a low-output moving-coil design costing a considerable sum. The DRT presumably refers to main man Dr Tominari, who's been guiding the company for the past thirty odd years, but this cartridge's main claim to fame is that it uses Alnico magnets, which is relatively unusual (though not unknown) in this day and age.

Alnico is highly regarded by Far East audiophiles, and is the 'original' permanent magnet material, made from an alloy of Aluminium, Nickel and Cobalt (or similar recipe).

I've long suspected that it refreshes the parts other magnetic materials don't even know about, and this is borne out by my loudspeaker experience. I have two speaker systems based on Alnicos which are in occasional intermittent use: a pair of Spendor BC1s, and a pair of Tannoy Westminster Royal drivers (which I flush-mount into an "infinite baffle" wall). Both these systems have an extraordinary naturalness in the midband which regular ferrite-energised drivers just don't seem to

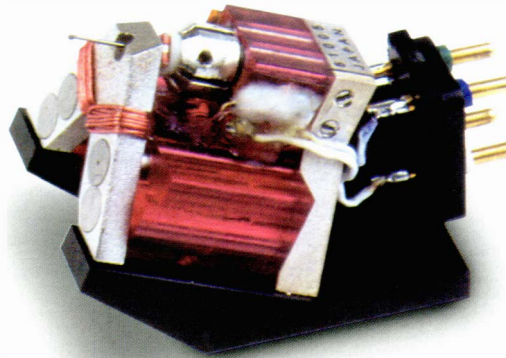

possess. Would the same X-factor apply to Dynavector's XV-1 cartridge?

Once upon a time, of course, Alnico was the norm, but its 'power-to-weight' ratio isn't that great, and both power and weight are important factors in cartridge design. The XV-1 therefore has a rather modest specific output (0.3mV at 1kHz for 5cm/s) and a distinctly above average weight of 12.5g.

It's a very handsome looking device, with the highly polished and precision built V-shaped micro metalwork clearly on view, including the eight tiny Alnico magnets that set up the fields, with translucent red plastic filling in the gaps. The magnet/yoke/coil structure is much too complex for any simple analysis, but everything on Ser No 51001 looked beautifully put together. Tracking weight is specified as an intelligently conservative 1.8-2.2g, and the stylus profile also avoids extremism.

There's plenty to grab hold of

here, and in that respect the XV-1 is marginally less scary to install than Dynavector's Te-Kaitora, but that totally non-reflective boron rod cantilever still pokes out unprotected into free space, just begging to be carelessly knocked off. Fixing screws also need to be carefully chosen, as they grip into blind tapped holes in the body (not my favourite

approach). Once installed, the shape and exposed stylus makes alignment very easy, the fixing hole-to-stylus distance slightly longer than average here. And I actually got to quite like the exposed cantilever, because dust build-up was easily spotted and equally easily removed.

I gave the test discs a quick spin, which is always interesting. The XV-1's basic frequency balance is impeccably smooth and neutral, even through the most difficult top octaves. Although compliance is quoted at a quite low 10cu, this cartridge's fundamental resonance is down around a lowish 7/8Hz in the medium mass ARO arm, presumably due in no small part to the high mass of the cartridge itself. This fundamental resonance has only light damping, which in turn would seem to confirm its particular suitability to a well damped tonearm like the Well Tempered.

Dynavector is promoting its own approach to cartridge head amplification, the DV-PHA-100, operating on current rather than voltage and presumably also



▶ providing a measure of electrical damping, whilst merely providing a boost for connection to a regular moving magnet phono stage. I didn't get hold of it in time for this review, so maybe a follow up is on the cards.

Before getting onto the actual sound, it's worth mentioning that I ran the XV-1 over some of my torture tracks, and it sailed through without any suggestion of mistracking, despite the low stated compliance.

Conventional wisdom has that the turntable has the most effect on the sound, followed by the tonearm, and finally the cartridge. The XV-1 turns conventional wisdom on its head. When I first tried it, in the Well Tempered combination, I was bowled over by the wonderful mid-band transparency and delicacy. Now I've spent time with it in my regular Linn/ARO combo, and once again I'm gobsmacked by that gorgeous midband, and again aware of its rather reticent extreme top and bottom.

The XV-1's character simply dominated, despite the huge differences between the turntable/arms. It's that sort of cartridge, quite unique in character, and utterly beguiling in its way, yet also distinctively different from the norm. On swept sinewave tones, there's almost no difference at all between the measured frequency balance of the XV-1 and my regular Linn Arkiv B, which is quite difficult to believe since these two cartridges have such totally different sonic characters.

The Arkiv is all about slam, drive and drama (not unlike the Clearaudio Discovery), but change over to the Dynavector and all the perspectives shift quite dramatically. Percussive drama immediately seems rather understated, but instead you find yourself caressed by the subtle delicacy, texture and tonality, of a midrange that's beautifully sweet, devoid of harshness or 'glare', and

simply sounds 'more natural' in the way it layers the contributions of different musical strands - not unlike those Alnico speakers I mentioned a few paragraphs back.

Human voice is invariably one of the toughest tests, and here the XV-1 is a real star, sounding comfortably more coherent and transparent, and significantly less coloured than other cartridges I've auditioned recently. Brass is another tough test, which again the XV-1 passes with flying colours. It's particularly 'kind' and strain-free with this sort of presence-rich material, so I regularly found myself playing and enjoying discs at a higher level than usual. I also found myself digging around amongst my classical orchestral - and even operatic - discs, because of the believable textures and lack of congestion on strings and choirs.

The bottom and top end are both rather restrained. You won't get the slam and authority of an Arkiv, or the top end sparkle of a Discovery, and under direct comparison to the latter, the Dynavector's soundstage is perceptibly a little smaller in scale. Does that really matter? I'm honestly not sure. The top end sounds open enough, yet reacts kindly to surface defects, so surface noise isn't a problem. The bottom end sounds weighty enough, but somehow I lack a little drive, which becomes more obvious when dealing with modern synthesised material. The XV-1 is great with Gotterdammerung; rather less so with Exit Planet Dust.

Taken overall, Dynavector's 'retro-vatory' XV-1 is a conspicuous success. Its particular strength-and-weakness profile flies in the face of my normal preferences, and I made no concessions in terms of partnering ancillaries, yet its very real charm and 'natural musicality' completely won me over. It might well be better

served by some tonearm damping, but I haven't encountered any problems with the ARO.

To these ears it sounds quite 'valve-like', with that seductively mellifluous midband, against the crisper but harder 'transistor' type sound, and I suspect that those who already favour thermionics might well be even more enthusiastic over the goodies the XV-1 brings to the party. I guess it must go down as a rather 'extreme' design, inasmuch as it gives results which are quite different from the modern stereo-type, yet at the same time it's entirely practical, easygoing and so nice to listen to that I'm not looking forward to giving it back. Not one little bit. ▶+

TECHNICAL SPECIFICATIONS

Type:	Low Output Moving-Coil
Cantilever:	Boron Rod
Output:	0.3mV
Compliance:	10cu
Weight:	12.5g
Price:	£2500.00

Distributor:

Pear Audio
7 Prospect Place
Alnmouth
Northumberland
NE66-2RL
Tel. (44)(0)1665 830862
Fax. (44)(0)1665 830051

Manufacturer:

Dynavector Systems Ltd
Tel. 0081 3861 4341
E-mail. 0081 3862 1650
Net. www.dynavector.co.jp

Sounds of Music

1 MONTH
home trial exchange
scheme

KNOWLEDGABLE
helpful staff

MOST
credit cards
accepted

INTEREST
free credit

FREE
delivery &
installation

GENEROUS
part exchange

**Where to
Find Us**

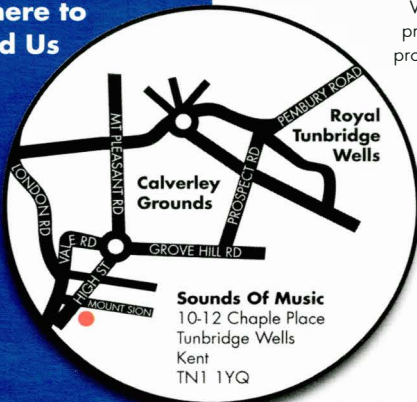

Carfrae Horns

The fastest loudspeaker around



B.A.T.

One of the top U.S. valve ranges

Advantage

Most definitely the best Advantage
around



Krell

The reference yesterday, today and
tomorrow

Passlabs

Refined performance and as solid as
a rock

A.V.I.

Miniture size - mammoth performance



Welcome to Sounds Of Music

We carry one of the largest ranges of specialist products in the UK, covering all price ranges from quality modest systems to the very best money can buy. All the products we stock are also available on our special trial exchange system, so you can make your audio decisions in the comfort of your own home. Where else can you try a range as extensive as ours?

We specialise in room tuning advice and matching and balancing a complete system for your own particular taste. Our knowledgeable and confident staff are more than qualified to help you through the 'hi-fi maze'. If you are connected, look up our web page for monthly updates, special offers and second hand bargains.

Our aim at Sounds Of Music is to provide you with all the best and latest products and all the best news and technology, as well as giving the very best sound you can get for your pound. Buying hi-fi from Sounds Of Music could not be more simple or successful.

www.sounds-of-music.co.uk

**Call: 01892 547003 now to book an appointment
fax: 01892 547004**

**Where else can
you compare all
these products:**

Avantgarde, Argento, Audio Synthesis, Advantage, Audio Physics, Audio Refinement, Apollo, Audion, Audio Note, Audio Research, Audio Analogue, Anthem, A.V.I., A.T.C., Acoustic Energy, Atacama, Base, Balanced Audio Technologies, Beyerdynamic, Boulder, Bow, Bose, Burmester, Cabasse, Carfrae Horns, Covergent Audio Technology, Chord, Copland, Cadence, Cable-Talk, Celestion, Copulare, Clear Audio, Dunlavy, Echo-Busters, Eggleston-Works, Electrocompanient, Graham, Goertz, Goldring, Grado, Hales, Harbeth, Hovland, Jamo, JM Labs, Karma, Koetsu, Krell, KEF, Klipsch, Lumley, Lyra, L.A.T., Lavardin, Meadowlark, Musical Technology, Magnum Dynalab, Marsh Sound Design, Marantz, Martin Logan, Mitchell, Musical Fidelity, Neat, Nordost, Opera, Optimum, Ortofon, Orchid, Parasound, Plinius, Pathos, Project, Passlabs, Pro-ac, Piega, Pink Triangle, Primare, QED, Quad, Rel, SME, Shure, Sennheiser, Sonic Link, Soundstyle, Sound Organisation, Sumiko, Straight Wire, Sonic Frontiers, Sonus-Faber, Stands Unique, Target, Trilogy, Teac, Theta, Tannoy, Totem, Talk Electronics, Thule, Townshend, Transparent, Transfiguration, Triangle, Unison Research, Van Den Hull, Wisdom, Wilson, Wilson-Benesch, Wadia, XTC, XLO, YBA, Zingali.



POWER

LEVEL

MODE

OVLAND

PH/AUX
AUX1
AUX2
CD1
CD2
TUNING
TAPE
INPUT

BALANCE
1
0
3
4

Hovland HP100 Pre-Amp

by Roy Gregory

Have you ever noticed how certain categories of product come and go, top of everybody's wish list one moment, forgotten the next? Time was that a full facilities valve pre-amp was the crowning glory of high-end credibility. In fact, their performance was considered so quintessentially magical that one London dealer recommended (and sold a fair few) systems based around the £2000 Audio Research SP8 and the £750 Meridian M2 active speakers. Why? Because it was the cheapest way to get that all important valve pre-amp into a system. Indeed, in their heyday, customers could choose from the likes of Audio Research's SP8, 10 or 11 (the 9 never really made it), the Conrad-Johnson Premier 3, the CAT SL1, the Matisse and various MFAs or Audible Illusions. All, with the exception of the Matisse, American, and all expensive. And mostly now long gone.

Many of those manufacturers have gone on to produce valve or hybrid line stages, but with the advent of multiple digital sources and multi-channel, not to mention remote control and ease of use, they bear

little or no relation to their forebears in terms of facilities or sonic signature, and it was the latter that used to be all important. Reviewers waxed lyrical about air and warmth and what soon became known as valve sound (rather like we now have triode sound). The CAT is still out there, having gone through five of its nine available incarnations, and the Audible Illusions Modulus 3a



soldiers on, virtually unchanged, but these are very much the last of the old guard.

All of which makes the appearance of a new kid on this particular block all the more amazing. I'd love to tell you that the Hovland HP100 has been 20 years in development and is really just a late starter, but it hasn't and isn't, at least not in the simple sense. What it is, is a bona fide full facilities valve pre-amp replete with volume, balance and no fewer than eight

inputs; mute, mono and tape switching, a medium gain phono input and no remote control. In fact it's so downright old fashioned it's just plain ornery - and I love it. From its three large, chrome rotary controls and bright black nickel fascia to its solid construction; from its discrete logos and lettering to its piece de resistance blue backlit front panel, here is a product which understands

both form following function and pride of ownership. The

Hovland looks classy and you'd better believe that it sounds classy too, although that's where it parts company

with tradition. You see,

the Hovland doesn't sound like a valve pre-amp at all. Mind you, it certainly doesn't sound solid state either, and once it's warmed up it seems at first, almost devoid of character and the grosser aberrations that marred its spiritual ancestors. Of course it has a signature, and I'll come back to that, but for the moment let's just note that appearances can be deceptive.

If the HP100 hasn't been twenty years in development, then the philosophies and thinking behind it certainly have. The sidebar spells out the background, but for now ▶

The who and why of Hovland



Left to right: Robert Hovland, Chief Engineer,
Jeffrey Tonkin, Director, Industrial Design
Michael Gorges, Co-Engineer/Director, Production
Alex Crespi, Director, Sales & Marketing

Hovland is probably a new name to many of you, at least as far as electronics goes, and it's not often that a product this classy springs from virgin ground, so you won't be surprised to hear that the company (and its accumulated expertise) actually stretches back a fair distance. In fact, designer Bob Hovland actually branched out on his own when Saul Marantz, for whom he was working, sold his company to the Japanese. The Hovland Company was founded in 1976, and has been in business ever since.

Twenty-four years on, how come you've only just heard of them? Because much of their initial work

was research into materials and passive components, which put them well ahead of the field.

By the very early '80s they were selling some of the first ever purpose built audio cables, and soon followed those with their 'MusiCap' film and foil capacitors. Audiophile components may be familiar these days, but Hovland were one of the genuine pioneers of what is now accepted wisdom. Along the way they also produced small runs of both solid state and valve electronics, achieving something of a cult following in their native California. The current HP100 is the culmination of all this work, itself soon to be joined by a 50 watt push pull stereo amplifier.

Given its background, it's hardly surprising to find that the pre-amp is the physical realisation of many of the company's theories. It also embodies their belief in balanced design, each aspect of the product receiving equal attention, so that it's built and looks as good as it sounds. At its heart lies an impressive, hand built, precision stepped attenuator. This 31 step device uses coined silver contacts and matched Holco resistors, and is the result of extensive research into all kinds of variable potentiometers. If the volume control is 90% of any line stage, Hovland have gone to enormous lengths to get their right.

Other aspects of their research are less obvious, but bear an uncanny similarity to many of my own conclusions. They like to stress the benefit of low mass components and socketry, a philosophy for which I have considerable sympathy. Experience shows that this has a seriously underestimated effect on sound quality. The mechanical design of the product is intended to provide maximum physical isolation of the various individual stages and the pre-amp as a whole. Given both its unusual indifference to a whole host of supports, and that I tended to prefer its own unadorned feet to the various alternatives I tried, I think we can conclude that these guys know what they're about. They also use their own (expensive) cabling throughout, and are careful to keep the circuit non-inverting in nature.

These exotic solutions are not chosen simply for effect. Each one is the result of exhaustive research and listening tests, to ensure not just the sonic benefits but also their repeatability and longevity. Hovland are keen to produce a product which offers a long and consistent working life. Given the maturity of the circuit design, most refinements come in the area of materials and components. In fact, you could almost look on the pre-amp as a framework, arranged so that elements can be removed and replaced as improved parts become available. To this end, the various models also have upgradeable phono stages, so that if you own the line only version, an extra £995 will add the medium gain phono stage, whilst MC transformers will set you back another £550 (£1450 if you do the two together). The black powder coat of the review samples' casework has also recently been replaced with polished and anodised panels, perforated metal discs taking the place of the grilles in the top-plate. Even cosmetic changes are retrofitable, and existing owners can purchase a new set of panels at a preferential price. As you can literally see, the HP100 continues to evolve, inside and out.

► what you really need to know is that Bob Hovland started his design career at Marantz when it was still an American company. That gives the HP100 some fairly serious heritage, and probably helps account for the vintage feel and build quality. Indeed, the sumptuous elegance and deco styling of the Hovland left me anticipating a wallow in the luxurious warmth and cosy friendliness of a classic valve pre-amp. Boy, was I ever wrong.

Listen to the Hovland and what you'll hear is music with clarity, poise and vitality; it's seamless from bass to apex, coherent and consistent. It is holistic. It is direct. It has the natural immediacy of the real thing. Assuming of course that the rest of the system is up to it - you can't listen to a pre-amp on its own. It is wonderfully free of hi-fi artifice and devoid of the spectacular. Its open soundstage is natural rather than etched, its bass floats, with none of the earthbound thunder that seems to get 'audiophiles' so excited. It simply puts the music first, without adding any touches or shape of its own, which makes it remarkably faithful to the original performance.

But don't expect that sound straight out of the box. I was lucky enough to have the Hovland around for considerably longer than most review products. In fact, I was so busy enjoying it that it wasn't until the importer needed it back that I realised that I hadn't spent any time 'reviewing' it. That required a second bite at a brand new cherry, and I'm now in a position to tell you that the HP100 takes a good three weeks to burn in, and will go on getting better for several months. It doesn't like being unplugged either, and takes two to three days to really hit its stride after being powered up. Cold, it lacks any sense of drama or authority, and sounds altogether rather mean and pinched. Likewise, ►

▶ straight from the box it has a hard plastic taint to the upper mid and treble which takes weeks rather than days to disappear.

Because of their extended stay, the two different HP100s got to play with a whole host of other equipment, including Wadia 860x and Rega Jupiter/Io CD players; turntables from ClearAudio, Clearlight, Amazon and DNM; power amps from Jadis, Copland, Border Patrol, Lavardin and Densen; and speakers too numerous to mention, but including the usual suspects. The Hovland is simplicity itself to use, proving

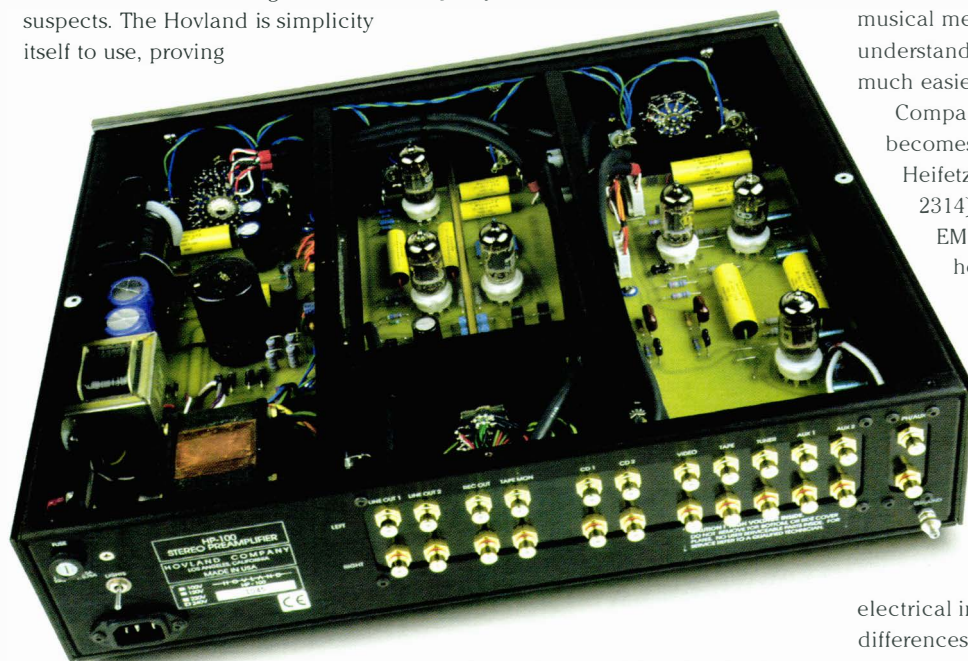

remarkably immune to siting and perfectly at home on my RDC rack (although it may prove too wide for some!). Experiments with Pulsar Points and other supports tended to change the sound rather than improve it, and I preferred the HP100 au naturelle with most systems. Oh yes, the blue back-lights. Turn them off using the switch on the back panel and you get a worthwhile improvement in transparency and slightly better focus. Everything becomes a bit crisper and clearer, and you can hear further into the recording. So lights

off for listening, on for leisure. Fortunately the switch can be easily reached from the front, but why not slave it to the mute?

One visitor remarked that discussing the Hovland in hi-fi terms doesn't make a great deal of sense. You have to think in musical terms. I couldn't agree more. Listen to the HP100 and you listen to music. It is so un-obstructive, so absent from the sound that the natural shape and chemistry of the recording simply pull you in. Small and

intimate, huge and bombastic, the Hovland brings out the best in whatever you play. Take something complex with superb ensemble playing, like the Frankfurt Philharmonia Ensemble recording of the Dvorak *G Major String Quintet* (Edition Pheonix EPH02), and the character, colour and clarity of each instrumental voice is immediately recognisable and locked in space. Each player's contribution, his placement of notes and the way he shapes his phrases, the way they interlock with the other player's parts, becomes clarity itself. The music makes sense, just like it does when you hear it live.

The Analogue Audio Association recording is, of course, outstanding. The playing is full of purpose and sophistication, the sound has outstanding life and presence, but it's incredible how easy it is to mess it up. The Hovland passes the signal intact and on time. Notes happen when and where they should, in a single coherent space, and with impressive life and vitality, which is most of what I want from a pre-amp. The correctness of its portrayal, tonal, temporal and physical, make the musical message so much easier to understand and enjoy, the system so much easier to forget.

Comparing performances becomes exactly that. Listen to the Heifetz Mendelssohn (RCA LSC-2314) and then try the Ferras on EMI (ASD 278). What you'll hear is the contrast between the sweeping grace and power of the American recording and the poise and understated control of the British. The yawning chasm between the two approaches is just as wide as it should be, undiminished by

electrical intrusion. Likewise, differences in partnering equipment seem more obvious. The upper mid/lower treble dip in the Nordost SPM cables was more than normally apparent, possibly mirroring a similar tendency in the pre-amp itself, and I tended to prefer the Clearlight cables instead, with their greater sense of presence and purpose. Indeed it's here that the HP100s character starts to show, a character which has little to do with colouration or deviation from the real, but more to do with the unit's particular perspective. This is slightly set back, introducing a sense of distance between the listener and the performers. Distance as in feet ▶

▶ rather than detachment. The players are right there, but not reach out and touch close.

It's difficult to be too emphatic about this (and arguably it is actually a more realistic rendition of the concert experience) but it seems to be related to the degree of energy in that all important mid/treble transition. There is no variation in texture or the degree of detail, rather a subtle suppression of the sudden dynamics that characterise the rest of the range. This creates a slightly studied, almost academic air to

already displayed a marked preference for the company's own arm cable, the only piece I had available.

Which brings us to the thorny question of phono stages, and what if anything you actually need. Like most pre-amps, the HP100 is available as a line only unit for those who've kicked the vinyl habit. (If you never acquired it in the first place then a pre-amp like this is

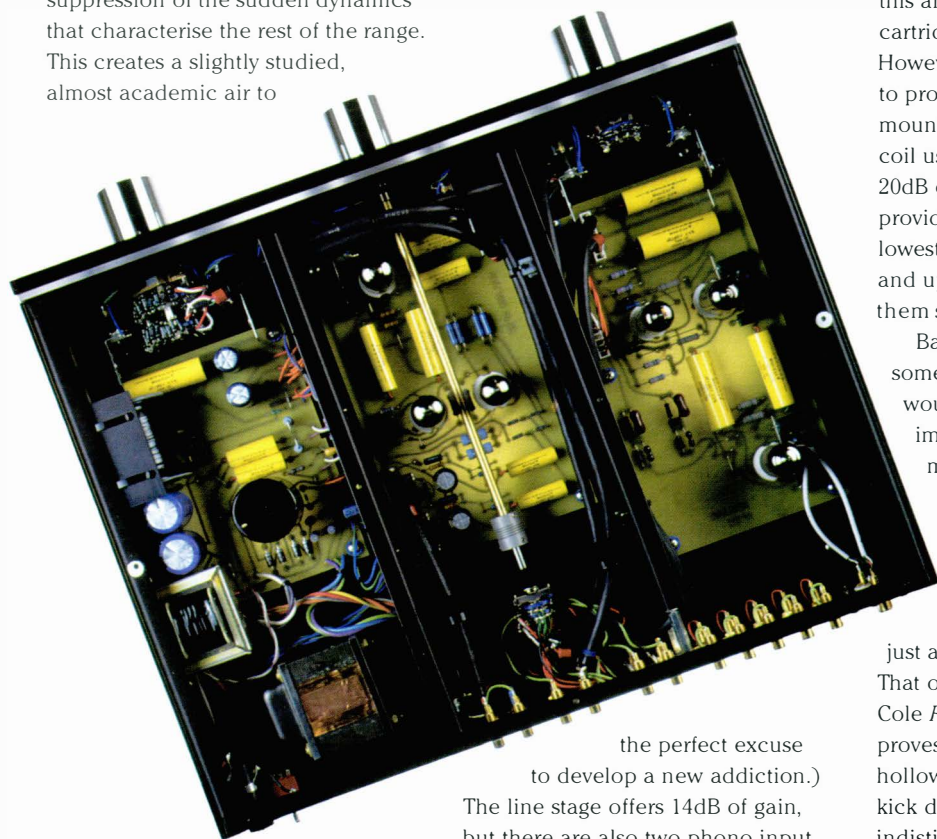

the pre-amp's performance, not at all at odds with enjoying the music, and a natural extension of the overall stability it brings to proceedings. And if this is in stark contrast to the fiery and emphatic CAT or the ultra precise DNM, then it's a diffidence which lets the music speak for itself, which is what makes it so difficult to pin down. Given the alacrity with which it exposes the shortcomings in ancillaries, I'd love to hear the HP100 with Hovland's own cables. It has

the perfect excuse to develop a new addiction.) The line stage offers 14dB of gain, but there are also two phono input options available. The review units both had a medium sensitivity, 46dB gain, valve phono stage. This needs a minimum of 1mV from a cartridge in order to achieve decent noise levels, which makes it ideal with a whole host of moving-magnets or high output moving-coils. I used the variable reluctance Cartridge Man Music Maker for much of my listening, and that was fine, but the second unit suffered slightly higher noise than the first, so valve quality may be an issue.

It wasn't a problem with the Franken-Grado, but I reckon it might have been with around half the output.

For running the ClearAudio moving-coils I used either 'The Groove' or the Pass Aleph-Ono, the line stage providing ample gain for either. Incidentally, I had a moving-magnet version of 'The Groove' for a short while, and the HP100's mm input was musically superior to both this and the Pass with higher output cartridges - impressive indeed. However, Hovland have now started to produce their own internally mounted transformers for moving-coil users. These offer an additional 20dB of amplification and should provide sufficient gain for even the lowest output cartridges (0.1mV and up!). Hopefully I'll get to try them soon.

Back to the music and a little something energetic. After all I wouldn't want you getting the impression that a hint of reticence makes the HP100 slow in coming forward. Quite the opposite.

The pre-amp's overall coherence, and dynamic and rhythmic integrity mean that it can kick up its heels just as soon as the music demands. That old favourite 'Forest Fire' (Lloyd Cole *Rattlesnakes* Polydor LCLP1) proves the point. That's a real live, hollow kick drum, with real live kick drum texture, rather than an indistinct thud. And when the drum reinforces the point at the end of the first verse, the Hovland effortlessly encompasses the double snare crash without so much as a ruffle. It cruises just as effortlessly through the hitch kick that picks up the beat after the first chorus, and the bass guitar is a thing of beauty. Each note is precisely pitched and paced, the fingering absolutely clear. The sound is right where it should be, level with the mix rather than stumbling along below it, and the tactile, ▶

▶ mobile notes drive the song along rather than holding it back. Even in the climax the separation holds, the HP100 delineating and scaling each stage as the band ramp up the volume and the density. And that nice, real kick drum's still there...

'The Real Life' from the John Cougar Mellancamp album *Lonesome Jubilee* (MFSL 1-222, and one case where the Mo-Fi is definitely worth the extra) fair gallops along, but once again the Hovland shifts effortlessly between the high density choruses and the lower key verses, without any loss of presence or shift in the sound-stage. It waltzes through the stutter drum break at the end of the second chorus and then ramps things back up for the final fling. Altogether something of a tour de force when it comes to dynamic coherence and rhythmic agility. But that's not the point. I put this track on to illustrate the argument, but as soon as I finished the review notes I was straight back down-

stairs to listen to the whole album. That's what I love about the Hovland. There is power and there is subtlety, but most of all there is music. Nothing I've used communicates quite like it, or has its total lack of fluster. I hesitate to use the term control because that implies 'grip' or constraint. The HP100 is more like an open sluice which is so wide that it can accommodate the fiercest torrent without things getting messy or confused. The music simply flows, the pre-amp never intrudes, even when the going gets tough. So no problem with music with attitude. In fact, musical attitude is what this pre-amp is all about.

As I write this there's a faint blue glow washing over my waiting system. Fuss free and fabulous, and with style to burn, this is a product to enjoy; enjoy its feel and looks, but most of all enjoy its music. Any pre-amp has a choke hold on its system, and the Hovland is no exception, it's just that here we're talking silk scarves and velvet gloves. In a world of compromises (and believe me when I say

that pre-amps are compromised) the HP100 is one of the best balancing acts I've heard. It's heart is definitely in the right place, and so is its head. I'm not saying it's the best pre-amp out there. I'm not saying it's the one you should buy. But I am saying it's the one I prefer to listen through. ▶✚

TECHNICAL SPECIFICATIONS

Product Type:	Stereo Valve Pre-Amplifier
Valve Complement:	
Line;	2 x ECC83, 1 x ECC82
Phono;	2 x ECC83, 1 x ECC81
Inputs:	8 x Single-Ended (Phono Optional)
Outputs:	2 x Single-Ended Main 1 x Single-Ended Tape
Input Impedance:	
Line;	100 kOhms
Phono;	1 MOhm (others optional)
MC;	User variable
Output Impedance:	2500 Ohms
Dimensions (WxHxD):	464 x 134 x 370mm
Weight:	12.3 kg
Price:	
Line;	£4450-00
Phono;	£4950-00
MC;	£5550-00

Distributor:

Zentek Music Ltd
Tel. (44)(0)1892-539595
Fax. (44)(0)1892-616517

Manufacturer:

Hovland Company
1545A Pontius Ave
Los Angeles
California 90025
USA
Tel. 001-209-966-4377
Fax. 001-209-966-4632
Net. www.hovlandcompany.com

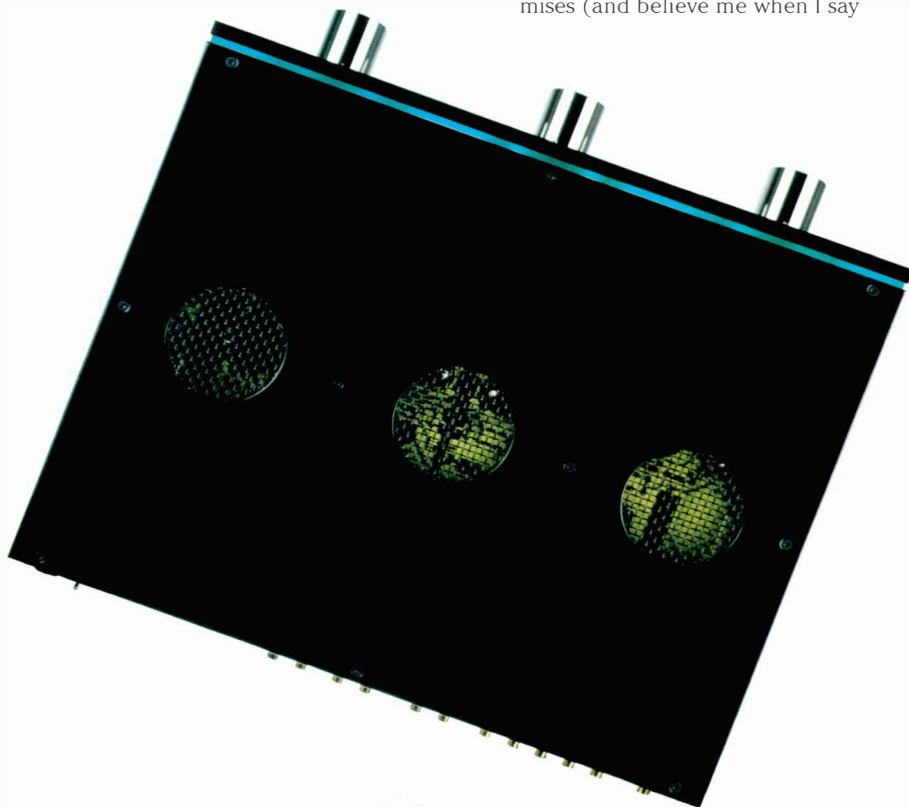

mike manning

the hi-fi specialists **audio**

**Naim Audio - Rega Research - Densen - Dynavector
Well Tempered - Roksan - Shahinian - Rotel - JM Lab
B&W - Mission - Heybrook - Marantz - Denon - NAD
Definitive Audio - M&K - Pioneer - Ortofon - Yamaha
Stands Unique - Chord Company - Nordost - QED**

Believe what you hear!!

YEOVIL
(Mike & Lee)
110, Middle Street
01935-479361
Closed Mondays

TAUNTON
(Andy and Neil)
54, Bridge Street
01823-326688
Closed Tuesdays



JEFFRIES

hi-fi



Naim NAP 500

When Jeffries Hi-Fi was founded in 1935 your Gramophone had to be wound up by hand and the needle had to be changed after three minutes, The transistor was 20 years away. Today the amplifier (left) can look like this.



Now, with shops in Eastbourne, Brighton and Portsmouth, we are the South Coast's leading specialist for HiFi, DVD, Home Cinema and Custom Installations.

We Make the buying experience simple and pleasurable, coupled to our promise of "Quality, Value and Service"

EASTBOURNE
4 Albert Parade
Green Street
Eastbourne
East Sussex BN21 1SD
01323 731336
Fax: 01323 416005

BRIGHTON
69 London Road
Brighton
East Sussex
BN1 4JE
01273 609431

PORTSMOUTH
29 London Road
Portsmouth
Hampshire
PO2 0BH
023 92 663604

<http://www.jeffries.co.uk> Email: sales@jeffries.co.uk



audio **X**
EXCELLENCE

audio **T**

WE SELL THE FINEST PRODUCTS

and we bring you the benefits and security of buying from a larger dealer, yet each of our stores is run as an individual specialist shop. We are enthusiastic and friendly, with the knowledge and experience to satisfy your expectations.

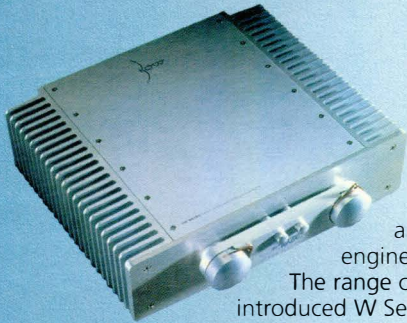

BOW
TECH
NOLOGIES

BOW Technologies was founded in 1994 by Bo Christensen and since its inception has pursued the holy grail of combining wonderful aesthetics and good sound quality. BOW Technologies is a master of the art. It's electronics have won many awards around the world and much praise for their stunning looks and superb engineering.

The range consists of the ZZ Reference Series and newly introduced W Series.

Available at OXFORD, WEST HAMPSTEAD, HIGH WYCOMBE, EPSOM



Wilson Benesch has, in less than ten years, earned a world wide reputation for producing innovative, elegantly designed audio equipment. From turntables to tone-arms and in 1995 – the A.C.T. One – the

World's first curved floor-standing loudspeaker. With its multi alloy baffles and advanced carbon fibre composite structures, it remains as contemporary and successful today as it was five years ago.

Available at BRENTWOOD, BRISTOL, CARDIFF, EPSOM, READING, SOUTHAMPTON, SWINDON, WEST HAMPSTEAD

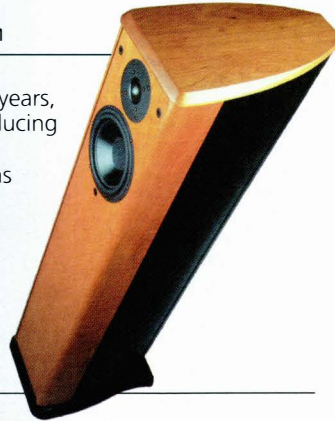

CHORD

Chord Electronics has become synonymous with outstanding performance. The company's range of products fulfils every stereo or multi-channel system requirement. Continual dedication to research and innovation, combined with excellence of build

and sterling reliability have been rewarded by continued growth. Chord users include many of the most demanding customers in the audio world, both from professional and high-end customer domains.

Available at BASINGSTOKE, BRENTWOOD, BRISTOL, CARDIFF, CHELTENHAM, EPSOM, EXETER, READING, SOUTHAMPTON, SWANSEA, SWINDON, TUNBRIDGE WELLS, WEST HAMPSTEAD

- 53 YEARS JOINT EXPERIENCE • 3 YEAR GUARANTEE ON HI-FI SEPARATES
- FULL DEMONSTRATION FACILITIES • PRICE PROMISE • 10 DAY EXCHANGES
- 30 DAY NO COST PENALTY UPGRADES • PART EXCHANGES
- INTEREST FREE OPTION Subject to status. Written details on request
- HOME LOANS AND HOME DEMONSTRATIONS
- EVENING DEMONSTRATIONS BY APPOINTMENT

BASINGSTOKE 4 Feathers Lane
01256 324311

BRENTWOOD 30 Crown Street
01277 264730 Open late Thursday

BRISTOL 65 Park Street
0117 926 4975 Open late Thursday

CARDIFF 134/136 Crwys Road
029 2022 8565 Open late Thursday

CHELTENHAM
38 Winchcombe Street
01242 583960

EPSOM 15 Upper High Street
01372 748888 Open late Thursday

EXETER 156 Sidwell Street
01392 491194

HIGH WYCOMBE
30-32 Castle Street
01494 558585 Open late Thursday

LONDON: W. HAMPSTEAD
190 West End Lane
020 7794 7848 Open late Thursday

OXFORD 19 Old High Street
Headington
01865 765961 Open late Thursday

READING 4 Queens Walk
Broad Street Mall
0118 958 5463

SOUTHAMPTON 10 -12 Hursley
Road, Chandlers Ford
023 8025 2827 Open late Thursday

SWINDON 60 Fleet Street
01793 538222 Open late Thursday

SWANSEA 9 High Street
01792 474608

TUNBRIDGE WELLS
6 High Street 01892 525666

All shops are closed on Mondays

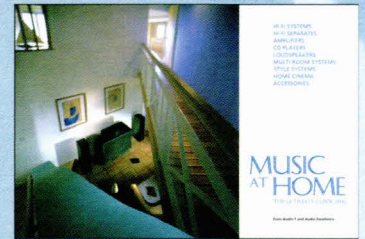

FREEPHONE 0500 101501
(quoting HFP)

and ask for a **FREE** copy of
our **MUSIC AT HOME** Guide



For the very latest information
please check our web sites:
www.audio-t.co.uk
www.audio-excellence.co.uk



INPUT CH1

LEFT

140W 4x 6500 POWER SOCKET

DESIGNED AND MADE IN ENGLAND BY PIONEER AUDIO LTD. SOUTHAMPTON RD. SALISBURY

Pioneer

NAIM NAP 500 Power Amplifier

by Chris Thomas

I recently became very popular among my Naim-owning friends as word got out that I was listening to a NAP 500, Naim's newest, most powerful and most expensive amplifier to date. Never, in my experience, has any product created so much interest as the 500 and I have just about lost count of the number of people who "just dropped by" to have a listen. It is undoubtedly a very important product for Naim Audio. The venerable and classic NAP 250 has been with us now for 25 years and the mono NAP 135 for several years less than that, but the 500 is a product that Naim have wanted to build for some time. It was however only after a 6-year collaboration with a semi-conductor manufacturer that an output transistor emerged that fitted their special requirements and allowed the design work to proceed. The brief was for an amplifier that could drive loads down to 2 ohms for long periods without distress and be capable of delivering more than 100 watts into an 8-ohm load. It should also sound better than a pair of 135s. This is a new amplifier with new circuitry and not, by any stretch of the imagination, a beefed-up 250. It also looks strikingly different from any previous Naim product with a new illuminated logo and complex casework featuring rather sculptural heat sinking. It's a more modern appearance, and one that's echoed in the new slimline 5 Series. But don't worry, whilst the styling will (presumably) carry over to a whole range of products designed to match the 500, there are no plans to graft it onto the existing line.

While they have always been keen to separate the power supplies of their preamplifiers and CD players from the other circuitry this is the first time that Naim have incorporated this thinking

into a power amplifier. The NAPS 500 power supply carries the transformer and the initial supply stages and this connects to the NAP 500 with two enormous leads (much bigger than those found on the NAC 52 and the CDS 11) terminated with large Burndy connectors. These provide 12 raw

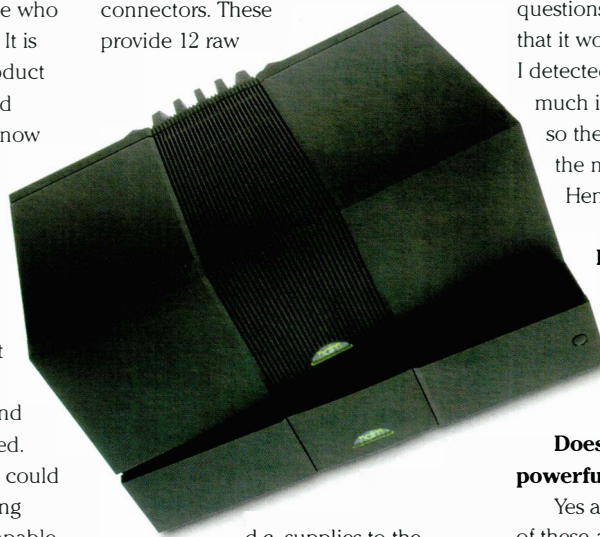

d.c. supplies to the power amplifier which itself has 10 stages of local regulation per channel. Cooling by internal and external heat sinks is considerable and Naim are obviously expecting the amplifier to get some serious use. I reckon you could safely use it in a recording studio as even after a hard listening session I was unable to raise the case temperature more than couple of degrees above ambient. There is also an "intelligent" fan for extra cooling though I never managed to get it running.

As I mentioned before, this amplifier has created enormous interest and expectations. Naim Audio have better brand loyalty than most Hi-Fi companies and fans of their equipment tend to stick with it. After all, there is always a genuine upgrade option available with

low redundancy, the equipment is super reliable, easily re-saleable and offers a view of music that, I believe, appeals on a very fundamental level. Naim fans who came to listen, and those who merely rang for a chat about the 500 were amazingly consistent in the questions they asked. They all suspected that it would be good, but deep down I detected that they would not mind so much if it was just a little disappointing so they wouldn't have to find the money to buy one. Hence their first question.

Does it sound like a Naim amp?

Yes is the unequivocal answer. It has all the hallmarks of the Naim sound.

Does it sound like a more powerful 250 or a pair of 135's?

Yes and no. If you are used to either of these amplifiers the 500 will sound immediately familiar. It builds on their performance rather like the CDS11 did when it superseded the CDS. But it is cleaner and quieter and its power advantages are impossible to ignore. It is always in greater control, has a formidably strong low-end that seems to go down forever and this is backed up by a feeling that the amplifier has a seemingly never-ending stream of power available on tap. I believe it is slightly more forward in its presentation though this could be a by-product of blacker backgrounds and more vigorous dynamics. But one of the things that takes it beyond the 135 experience is its overall level of resolution which allows you further into the note and closer to the music. The envelope of each and every note is easier to hear and understand and this makes musical

► phrasing a thing of even greater beauty and importance. The ability to phrase and to use the instrument as a medium for emotional communication lies at the heart of great musicianship. It's what separates the men from the boys. To understand and come to terms with the sheer mechanics of playing an instrument is one of the greatest gifts any musician can be blessed with because only then can you really explore the possibilities of nuance. Naim products have always excelled at illuminating this and the 500 simply takes it new levels. The dynamic strength, tone and weight of note are superb, but it is the

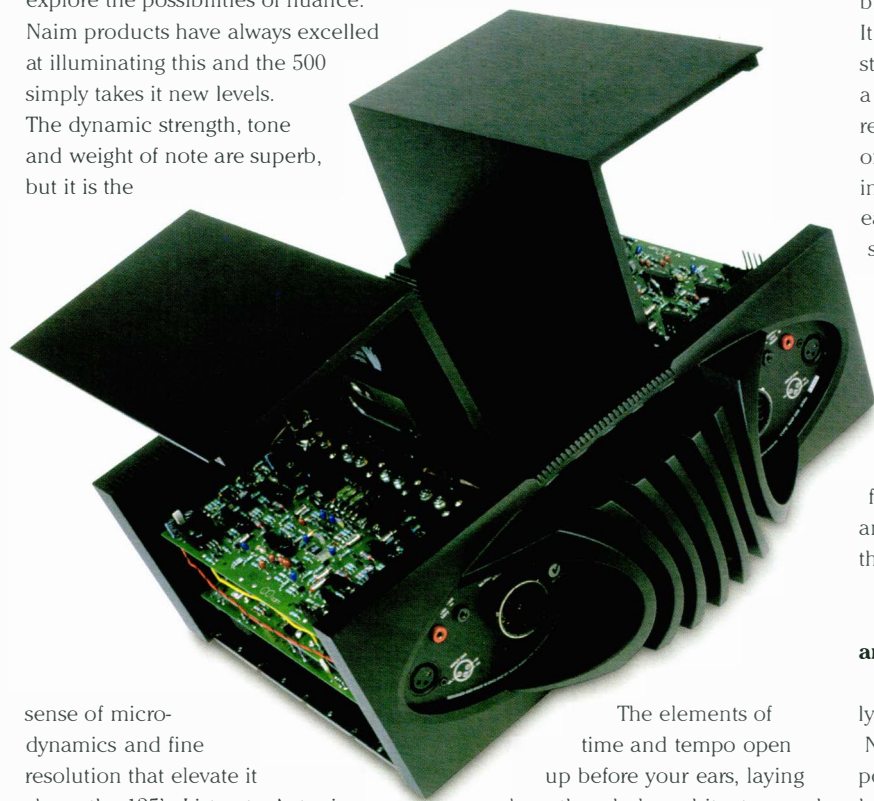

sense of micro-dynamics and fine resolution that elevate it above the 135's. Listen to Antonio Forcione's recordings on the Naim label and you will hear a musician who is essentially a quiet player. He brings the level down to suit the dynamic and textural range of his acoustic guitar and draws you into the piece using the voice of his guitar like a vocal. He is manipulating the shape and tone of each note with his fingers, using the dynamics of the instrument as a means of expression and this is where the NAP 500's abilities at resolving small musical statements is so good. Power is not only about volume.

Is it a fast amplifier and does it have that sense of rhythmic coherence that all Naim amplifiers have?

This was one of the aspects of its performance that most interested me and the answer is a resounding yes on both counts. Play a piece of music on the 500 and it puts you straight in touch with the rhythmic heart of the song. You feel immediately connected to both the flow and pace of the music.

The elements of time and tempo open up before your ears, laying bare the whole architecture and structure of the piece. But it does not tear the music into shreds by sounding over elaborate or fussy. Rhythmically the 500 is very together and totally integrated. Speed-wise it is simply superb for such a powerful device. Any amplifier that is truly fast must exercise control over the whole of the note. There are many amplifiers that grab the leading edge of the transient in an explosive and exciting way only to let it go when the next one comes along, but the Naim is far more focused in this area. It settles as quickly

as it rises, making it easy to hear the decay and tone without the brashness and confusion of lesser amplifiers. Listen to the music of Charlie Parker or John McLaughlin to understand just how critical this is. Both of these formidable musicians have speed at the heart of their expression. Parker's whole sense of flow and pace can seem impressive but confusing on most amplifiers, as he seems to be able to blow several thousand notes a minute. It all seems breathless and somewhat staggering technique –wise, but take a listen on the NAP 500 and it is revealed in all its beauty, as dozens of phrases strung together by almost invisible “rests”, which tumble against each other sometimes answering and sometimes just say. Likewise McLaughlin who I once heard state that he tried to arpeggiate a chord as fast as others could strum it. Musicianship at this level is not about speed for speeds sake. It is about the phrase. Where it begins, how it ends and how it feels. You need a fast amplifier to get anywhere near understanding music of this intensity and beauty.

Should it be used exclusively in an all Naim system?

Although the NAP 500 was obviously designed to be a partner to the NAC 52, preamplifier there are other possibilities. I have, over the years, had some success with other power amplifiers being driven by a 52, but have never been over impressed by Naim power amplifiers when fronted with alien preamplifiers. But I rather enjoyed my Spectral DMC 12 pre driving the 500 through a pair of modified Naim interconnects. The Spectral is about speed, dynamics and resolution so, with these attributes in common it should perhaps not have been such a surprise that these two worked so well together. Without the NAC 52 the 500 showed another, slightly lighter side to its character. It was ►

▶ a little leaner, brighter and more transparent with a slightly glossier top end. Often when you mate two unrelated pieces of amplification you end up in a no-mans-land where neither piece gives its best but this was different and really rather enjoyable. But, I have to say, hand-on-heart, that the NAC 52 is still a better match. Music just sounds that bit more together, as if the two are working as one, with more cohesion and slightly better focus. Loudspeakers though are a different matter. Again I would say that a pair of Naim NBLs are the natural partners for the 500, but I had superb results with my Revel Gems as they really appreciated the bandwidth and grip of the Naim. The tremendous weight and presence of the 52/500 and its balance between delicacy and strength showed me a side of the amplifiers nature that I found compelling. The Gems are just about the fastest speaker I have heard and the Naim thrives on this. They are also truly remarkable at presenting you with a true sense of the soundstage. Get them positioned just right and the music seems to appear in space between, to the side of and way behind the speakers. Holographic is a much-abused Hi-Fi term but the Gems really do disappear and leave you with the impression that you are looking deep into the performance. The Naim is not as good at this as the best American amplifiers. It just does not have the sheer depth of three-dimensional image though it does spread the sound across the room in height and width with wonderful precision and stability. The Naim is thicker and weightier in the midband but just lacks that sense of transparency that the American amplifiers excel at. But, as Naim loudspeakers are designed to be mounted close to a rear wall and do not have great depth themselves this is perhaps unlikely to be too much of an issue.

Can the NAP 500 be used with cabling other than Naim's own?

I am a little at odds with Naim Audio over this as I have been using Nordost Quattro-Fil between my CDS 11 and preamplifier for some time via a phono block which takes the place of the 5-pin din plug at the CD players output. But speaker cables can threaten the



stability of the power amplifier if not properly specified and the recommended cable is still Naim's own NACA5 which I have to say does a remarkably good job when you consider that it is just a few pounds per metre. Compare this with Nordost SPM at just under £3000 for a 3.5 metre pair and you might think it would and should be no contest. With Naim speakers I marginally preferred the SPM for its clean open quality, especially at the top end where it was cleaner and subtler but there was no way it was worth the extra investment. With the Gems I had a clearer preference for the Nordost's uncanny imaging abilities and see-through quality. But I have to say that the NACA5 is a truly remarkable cable for the money though I would not be at all surprised if Naim were working on a better cable to compliment the 500. Watch this space.

I shall be coming back to this Naim

combination in the near future for an aural update but I have to say I am very impressed. In many ways it is exactly the amp I was hoping it would be. It is unmistakably a Naim product through and through though you are going to need a NAC 52 and a really top quality source to get the best out of it. It is an excellent upgrade from a pair of NAP 135 mono amplifiers and I would probably prefer a NAP 500 driving a pair of passive NBLs rather than the 3 x NAP250 active option. At a whisker under £10,000 it finds itself in competition with some quality American amplification but I suspect that most will find their way into Naim systems that have been evolving for many years. It is expensive, but look at it this way – if you buy it you will only really be converting a cash asset into a musical one. No contest. 

TECHNICAL SPECIFICATIONS

NAP 500	
Rated Output	140 watts per channel into 8ohms
Input Impedance	18Kohms
Frequency Response	1.5Hz – 100Khz
Size (HxWxD)	160x430x374 mm
Weight	25Kg
NAPS 500 Power Supply	
Size (HxWxD)	76x430x300mm
Weight	15.4 Kg
Price	£9995

Manufacturer:

Naim Audio
Tel. 01722 332266
Fax. 01722 412034
Website. www.naim-audio.com

See overleaf for your local Naim dealer

NAIM LISTINGS

LONDON	
The Cornflake Shop,37 Windmill Street, W1	020 7631 0472
Thomas Heinitz, 35 Moscow Road, Queensway, W2	020 7229 2077
Oranges and Lemons, 61-63 Webbs Road, SW11	020 7924 2040
NEAR LONDON	
Audio T, 173-175 London Road, Camberley, Surrey	01276 685597
Audio T, 159a Chase Side, Enfield, Middlesex	020 8367 3132
Audio T, 15 Upper High Street, Epsom, Surrey	01372 748888
Infidelity, 9 High Street,Hampton Wick,Kingston upon Thames, Surrey	020 8943 3530
Radlett Audio, 9 Holywell Hill, St Albans, Herts	01727 855577
SOUTH	
Audio T, 4 Feathers Lane, Basingstoke, Hants	01256 324311
Audio T, 2-12 Hursley Road, Chandlers Ford, Hants	023 8025 2827
Audio T, 4 Queens Walk, Broad Street Mall, Reading, Berkshire	0118 958 5463
Audio T, 6 High Street, Tunbridge Wells, Kent	01892 525666
Jeffries Hi- Fi, 69 London Road, Brighton, E Sussex	01273 609431
Jeffries Hi- Fi, 4 Albert Parade, Green Street, Eastbourne, E Sussex	01323 731336
Jeffries Hi- Fi, 29 London Road, Portsmouth, Hants	02392 663604
Phase 3 Hi- Fi, 213-215 Tarring Road, Worthing, W Sussex	01903 245577
EAST	
Audio T, 30 Crown Street, Brentwood, Essex	01277 264730
Basically Sound, The Old School, School Road, Bracon Ash, Norwich, Norfolk	01508 570829
WEST	
Audio Excellence, 65 Park Street, Bristol	0117 9264975
Audio Excellence, 156 Sidwell Street, Exeter, Devon	01392 491194
Audio Excellence, 58 Bristol Road, Gloucester	01452 300046
Audio T, 40-42 Albion Street, Cheltenham, Gloucestershire	01242 583960
Audio T, 60 Fleet Street, Swindon, Wiltshire	01793 538222
Mike Manning Audio, 54 Bridge Street, Taunton, Somerset	01823 326688
Mike Manning Audio, 110 Middle Street, Yeovil, Somerset	01935 479361
MIDLANDS	
Audio Excellence, Independence House,The Trinity, Worcester	01905 619059
Audio T,19 Old High Street, Headington, Oxford	01865 765961
Castle Sound & Vision, 48-50 Maid Marian Way, Nottingham	0115 958 4404
Creative Audio, 9 Dogpole, Shrewsbury, Shropshire	01743 241924
New Audio Frontiers, 43 Granby Street, Loughborough, Leicestershire	01509 264002
Oxford Audio Consultants, Cantay House, Park End Street, Oxford	01865 790879
NORTH	
Acoustica, 17 Hoole Road, Chester, Cheshire	01244 344227
Acoustica, 114 Wolverhampton Road, Stafford	01785 258216
Audio Counsel, 14 Stockport Road, Cheadle, Cheshire	0161 428 7887
Audio Counsel, 12 Shaw Road, Oldham, Lancashire	0161 633 2602
Audio Excellence, 86-90 Boughton, Chester, Cheshire	01244 345576
Audio Images, 284 Glossop Road, Sheffield, S Yorkshire	114 273 7893
Doug Brady Hi-Fi, Kingsway Studios, Kingsway North, Warrington, Cheshire	01925 828009
Fortissimo, 237 Deansgate, Manchester	0161 834 2545
Fortissimo, 2 Bold Street, Hale Road, Altrincham, Cheshire	0161 929 0834
Zen Audio, 35 George Street,Hull, N Humberside	01482 587397
WALES	
Audio Excellence, 134 Crwys Road, Cardiff, S Glamorgan	029 2022 8565
Audio Excellence, 9 High Street, Swansea, W Glamorgan	01792 474608
SCOTLAND	
Robert Ritchie, 102-106 Murray Street, Montrose, Tayside	01674 673765



THOMAS HEINITZ LTD
EST: 1956

Londons Premier Dealer
35, Moscow Road,
London W2

Tel: 0207 229 2077

Fax: 0207 727 9348

Email: rufus@thomasheinitz.com

Stockist of the full range



Dynaudio
Naim
ATC

Mark Levinson
JA Michell
Rega

Saturn

Jupiter

Mars

Venus

Mercury

Sun

The Cornflake Shop
37 Windmill Street
London W1P 1HH

AVI
Bryston
Pro Monitor Co

t: 0207 631472/3234554 f: 0207 4367165
email: sales@cornflake.co.uk
web: www.cornflake.co.uk

Vision
Multiroom
Home Cinema

The Leading

naim in the

East Midlands

CASTLE
SOUND
& VISION

complete design & installation

HIFI • HOME CINEMA • MULTI ROOM

48 - 50 Maid Marian Way, Nottingham NG1 6DQ
tel: 0115 958 4404

Infidelity
INDECENTLY GOOD HI-FI

Buying hi-fi should be a delight.

If choosing your new hi-fi in a civilised and relaxed atmosphere from a well-chosen selection of genuine performance equipment appeals, then we are for you. Bring along your own records or CDs, we'll provide the coffee, and hear the difference we can make.

9 High Street, Hampton Wick,
Kingston upon Thames, Surrey KT1 4DA

Telephone: 0181-943 3530

Open: Tues - Fri 10.30am - 7pm
Saturday 10am - 6pm.

ORANGES & LEMONS
JUICY FRUIT FROM LONDON'S FRESHEST
HI-FI & AUDIO/VISUAL RETAILER

Friendly and efficient service
Free home demonstrations • 0% finance available

ARCAM • B&W • CABLE TALK • CASTLE ACOUSTICS
CREEK • DENON • EPOS • LINN • MARANTZ • NAD • NAIM
REGA • ROKSAN • RUARK • YAMAHA and many others

020-7924 2040
61/63 WEBBS ROAD, SW11

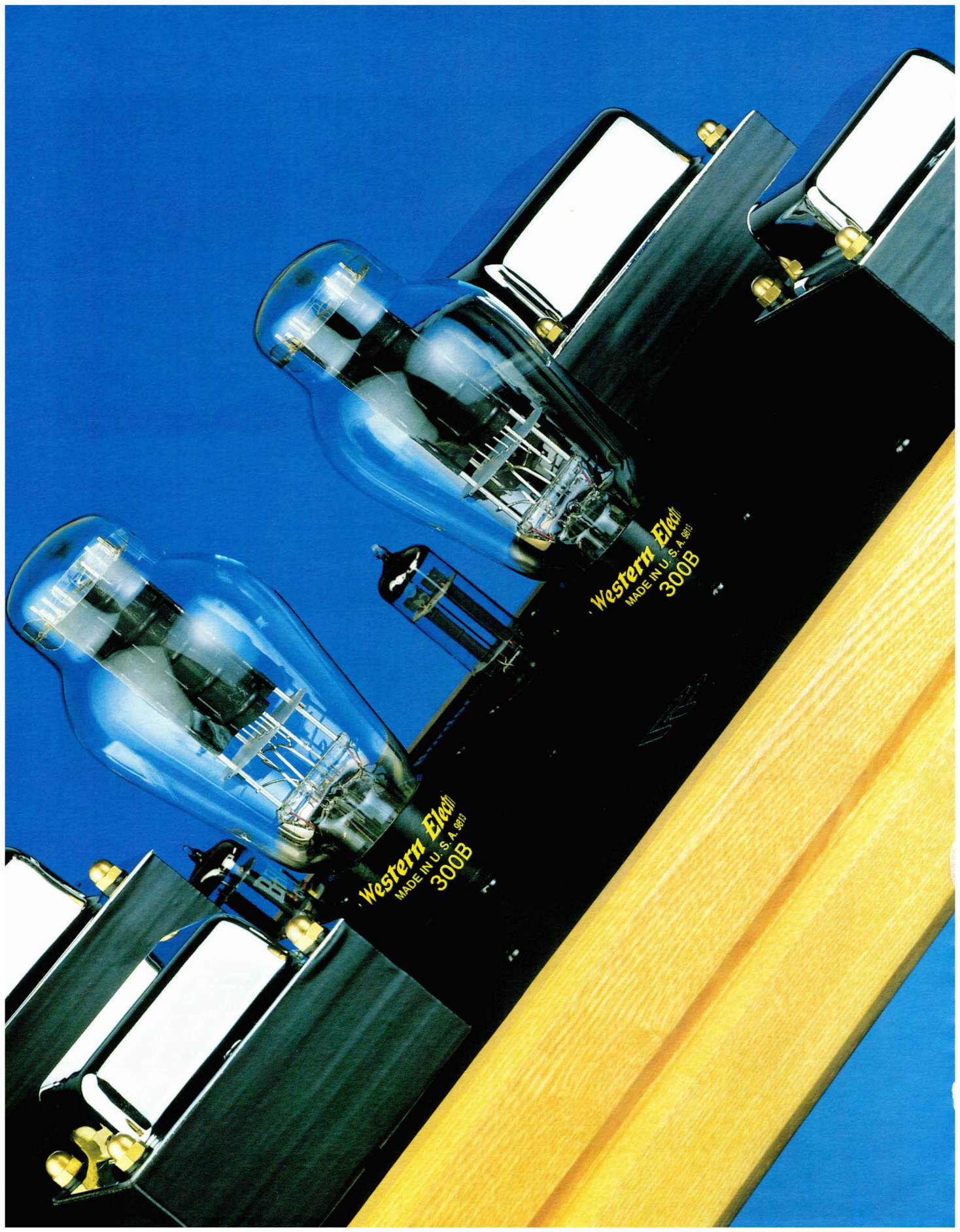

Western Electric
MADE IN U.S.A. 8812
300B

Western Electric
MADE IN U.S.A. 8812
300B

The Border Patrol 300B SE(WE) Power Amplifier

by Roy Gregory

Listen to some audio commentators and you could be forgiven for feeling that single-ended amplifiers are the truth, the light and the only way. Indeed, the quasi-religious fervour which this technology attracts brooks no dissent - bizarre when you consider that it was last current over sixty years ago. This topology, and only this topology, delivers sound so natural that it renders all else false, music so powerful that mere Watts become irrelevant. Are we to assume that the development of all intervening technology was just a string of gigantic mistakes? Apparently so.

In fact, so universal has this crusade become (they'll be burning old copies of *Wireless World* soon, swiftly followed by a few reviewers and editors) that the odd voice of moderation has risked being swept away by the flood. But, unfortunately, our experiences with a number of highly regarded single-ended designs have left us cold. Yes, as far as it's fair to generalise, they are warm and snuggly, and they breath across the midrange, but their lack of grip at frequency extremes, and an almost generic incapability to time bass notes robs music of drama and its sense of performance.

So, are we anti single-ended? Far from it. We call it the way we hear it.

But we're not prepared to write off an entire technology on the basis of a few bad experiences. One of the big problems that has emerged in hi-fi in the last twenty years, in direct proportion to the influence of marketing on product development, is the concept of the 'magic ingredient' and the label that goes with it. The first really obvious example of this was the metal dome tweeter. First there was the SL6, then the 600; all those lovely diagrams drawn with lasers and soon you couldn't sell a speaker without a metal dome. So much so that established speaker designs were hastily re-jigged to accept some new wonder tweeter and a ti designation. Next came bi-wiring, and since then there's been similar stupidity over everything from chipsets in CD players to materials in cables. With the benefit of 20x20 hindsight how many of you would buy any speaker today just because it uses a metal dome tweeter? In fact, there's something of a backlash now, with soft domes making a real comeback. The problem with single-ended amplifiers is that in too many cases it really is just a label. A lot of manufacturers are producing them because they feel that they have to,

rather than because they believe in the technology. The simple fact is that there's no such thing as a universal panacea, and an amplifier, properly used, is either good, bad or somewhere in between. Just because it contains single-ended circuitry and direct heated triodes is no guarantee of quality. In hi-fi it's not what you use but how you use it that matters, and buyers forget that at their peril.

Which brings us to the Border Patrol 300B SE(WE), an excellent and distinctive amplifier that also happens to be single-ended. Originally intended to partner the huge and extremely efficient Air Partners, single-ended circuitry was chosen as the most appropriate topology, and back in 1991, this was probably the first use of single-ended 300Bs in the UK. It was the limitations at the frequency extremes of that original design that led to the development of the sophisticated external power supply, a simplified version of which soon became popular as a modification for other valve amps. But it's the full on three stage supply that remains at the heart of this amp.

Which explains why the Border Patrol is a two box design, the non magnetic, wood framed chassis being linked by a heavy umbilical to the large external power supply. The amplifier proper is sparsely populated, with just four valves and four transformers. The socketry is all mounted vertically on the back of the top-plate, and whilst that may

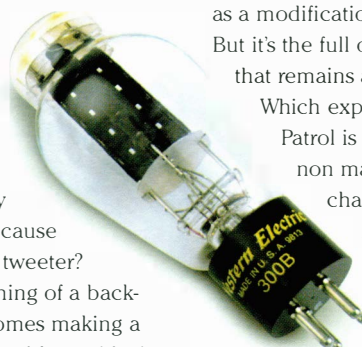

"...eye of toad and leg of newt?"

There's nothing magical about the insides of the Border Patrol amp and supply, just meticulous engineering taken to a logical extreme.

The amplifier is, by its very nature, extremely simple; a 13D3 input valve is capacitor coupled to the E182CC, which uses an interstage transformer to drive the 300B output tube. But it is the attention to detail that sets the Border Patrol apart. The interstage transformers are bi-filar wound, the coupling cap is a Hovland. The main HT caps are from Elna/Cerafine, and elsewhere you'll find a scattering of Black Gates and Os-cons. The bespoke output transformer uses a double bobbin and no less than 22 sections. With so few components each and every one can be critically assessed, as can be heard in the final results. There's no assumptions here.

And so to the power supply. The large aluminium case contains three separate valve rectified choke input supplies. A GZ37 is used to supply HT to the output stage, while two EZ80s provide HT to the input driver and negative bias to the output stage (the latter via the secondary winding of the interstage transformer). This shouldn't be confused with the after-market add-on Border Patrol PSU which is a single stage device supplying HT only. Despite its less sophisticated nature this is an extremely impressive device, available for £595, or in more powerful form at £995. Having heard the difference that this (relatively) simple device makes to the likes of Audio Innovations, Leak, Audio Note, Art Audio and Croft amplifiers, the impact of its much bigger brother on the performance of the 300B SE(WE) can be nothing less than fundamental. Is it this that separates the Border patrol from the vast majority of single-ended designs? Without a doubt it's the major influence.

▶ not make for the tidiest cable dressing, hook-up is an absolute doddle. I definitely approve. Inputs are phono sockets, whilst single sets of 4mm binding posts are provided for each channel, with separate taps for 4 and 8 ohm loads. The amplifier sits on large cones, so be careful dragging it around, although thankfully the external power supply keeps its weight nice and manageable (I wouldn't want to pick this up if it was all in one box).

The only complication with set-up involved earthing, so hum free operation may demand a little care, but your dealer should sort this out for you anyway. I ended up running the Border Patrol from a floating earth. Otherwise, operation was completely fuss free throughout the review period. Incidentally, the WE in the amp's designation refers to the Western Electric valves with which it arrived. A £500 option, I didn't hear the amp in standard trim, but independent observers reckon that they're worth the £250 a valve premium, so who am I to argue? Otherwise you get a pair of JJ 300Bs from Slovakia, built on ex-Tesla machinery which Border Patrol reckon represent the best of the rest.

And the Border Patrol doesn't just look different. As you've probably already guessed the sound isn't exactly



run of the mill either. Taut, crisp and solid are not words that apply to the vast majority of single-ended triode amps, but that's exactly how the 300B SE(WE) sounds. Lovers of the lush, blowy and indistinct character that so many single-ended advocates seem to like are going to be



sorely disappointed.

There are no rose tinted specs, slurred and rolled off frequency extremes or over stuffed harmonics here. In fact, for

the first time in my experience (the SAP Anniversary excepted), I'm listening to an amplifier with the linearity and directness that are supposed to be single-ended's great virtues. Indeed, the Border Patrol might have dipped out on the syrupy sweetness part of the single-ended deal, but it delivers the "real sense of power" with consummate ease, another area in which most of its compatriots fail to live up to their billing.

Instead of lush and overblown, the 300B SE(WE) is wonderfully (and correctly) rich. Instruments have a natural weight and colour, and voices, especially tenors, have tremendous authority and a real sense of substance. Bjoerling's tone and power were awesomely barrel chested (*Cavalleria Rusticana* RCA VIC6044), while Milanov's magical poise and control (*La Forza Del Destino* RCA SER 4516/7/8/9) forced you to question just why she is so consistently overlooked when people discuss great sopranos. There is absolutely no doubt that this amp is outstandingly natural in tonal and harmonic terms, giving the performer, be it instrumental or vocal, a tangible presence in the room.

All of which is useless if the whole thing doesn't hang together, so often a single-ended Achilles heel. Thankfully, the Border Patrol has plenty of grip ▶

► in the nether regions, and keeps things moving purposefully along. Take the high energy drive of 'Look Down, Look Down' (Martin Stephenson and the Daintees *Boat to Bolivia* KWLP5); from the jaunty opening phrase to the layer on layer of guitar and drum rolls as the song builds to its climax, the amp never fails to step up a gear and never loses control. The chopped guitar is tactile and full of direction, the twinned bass and bass drum notes are easily separated. And the voice? I think the word is direct. Unmistakably Martin Stephenson, the singer is never drowned no matter how frantic the band, never submerged in the (beautifully separated) backing vocals; the lyrics never lose that connection straight to you. In fact, the whole thing is a musical tour de force, belying the modest power rating of the amp, an impression that's reinforced by the complete change in the size, shape and acoustic character of the sound stage (not to mention the drum sound) on the next track, 'Slow Lovin' ', a trick one more normally associates with the kind of muscle amps we reviewed in Issue 6.

Of course, with around the same number of Watts output as I have fingers, the Border Patrol's performance is going to depend to a critical degree on the speakers it's asked to drive. Much of my listening was done with the Living Voice Avatars, a speaker which often appears with the 300B SE(WE) at shows and in dealers demonstration rooms. With its 94dB sensitivity and benign load it's an obvious match, although its far from either an

automatic choice or the only option. I used the Audioplan Kontrast Illis to good effect, as well as the Ars Acoustica Devas (89.5dB and on the 4 ohm tap!). Both were fine but the Devas did underline the point that there's a real difference between sounding powerful (which

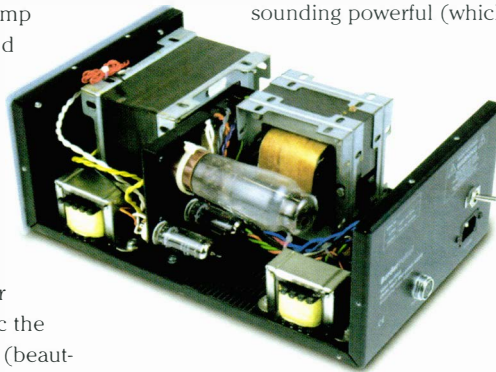

the Border Patrol does) and actually being powerful (which it isn't). Regardless of all the fond beliefs to the contrary a Watt is a fixed unit, not a sliding scale.

Pre-amp wise I used both the SP1.5 and the Hovland, whose capacitors feature in both the amp and the Living Voice speakers. I also ran the pre-amps and source components from the excellent PS Audio Power Plant 300, with the expected sonic benefits.

Throughout the various changes the 300B SE(WE) proved remarkably unconcerned, simply letting each amp's essential character straight through, be it the musical coherence of the 1.5, the clarity and colour of the Hovland or the rhythmic, tonal and information benefits of the PS Audio.

Is that the same as saying that the Border Patrol has no character? No, but the character it has is musically unobstructive. Comparisons with the JA30 are fascinating. The Jadis can't match the phenomenal tonal and harmonic accuracy of the Border Patrol (which is what lets it separate the simultaneous

bass notes and the various voices on the Daintee's track), but they do inject an extra element of snap and coherence to the overall sound. These are distinct trade-offs, defined by personal taste and musical repertoire, but what the 300B SE(WE) loses in terms of absolute focus and leading edge definition, it makes up for in terms of substance, and like the JA30, it gets the musical energy in the right place. Both are superb musical performers, they simply tilt their emphasis in slightly different directions. Listen to either in isolation and you soon forget the shortcomings, which is another way of saying that they both put the musical event first. Ultimately the Jadis offer the more dramatic performance, but combine the Border Patrol's sheer presence with its large and capacious sound stage, and the result is a performance which retains its musical directness and purpose without shoving them down your throat, ideal for long term musical enjoyment. I could happily live with either, which places the Border Patrol 300B SE(WE) in very select company indeed.



TECHNICAL SPECIFICATIONS

Type:	Two box stereo valve amp
Valve Complement:	
Amplifier;	1 x 13D3 1 x E182CC 2 x 300B
Power Supply;	1 x GZ37 2 x EZ80
Rated Output:	8 Watts
Dimensions (WxHxD):	Amp. 430x220x330mm PSU. 220x145x345mm
Weight:	Amp. 17Kg PSU. 16Kg
Price:	300B SE(WE) £4495.00 300B SE £3995.00

Manufacturer:

Border Patrol
Tel/Fax. (44)(0)1273-276716
E-mail. bp@borderpatrol.net
Net. www.borderpatrol.net

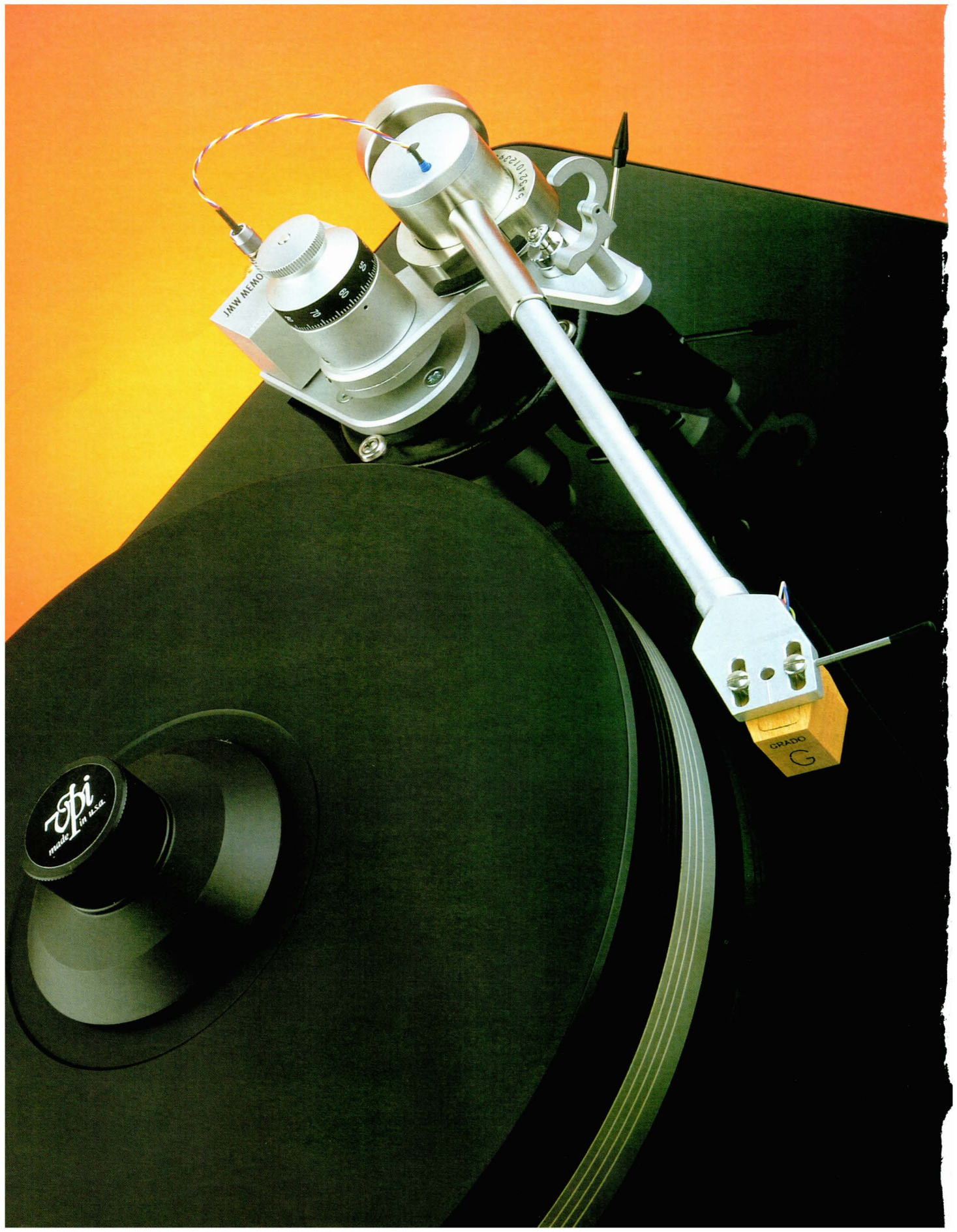

JMW MEMO

Sbi
made in U.S.A.

GRADO
G

VPI Aries turntable and JMW Memorial tonearm

by Jimmy Hughes

There are two kinds of High End turntable. The first is hyper-critical over setting up, needing careful adjustment and continual fine-tuning to maintain peak performance. Great if you want a full-time hobby. The second is far less picky, needing very little beyond basic setting-up. The VPI Aries sits in the latter camp, and should prove very dependable once installed - an important plus factor for those unable or unwilling to go through the rites and rituals of constant fine-tuning.

Paradoxically, given what I've just said, the Aries fitted with VPI's JMW Memorial tonearm (the combination supplied for this review) is actually a tweeker's delight, allowing incredibly fine vta adjustment. It enables you to set stylus vertical tracking angle (VTA) to suit each LP individually, thereby optimising reproduction.

The main chassis of the Aries is made from 5cm thick MDF with a ten gauge steel plate bonded to its underside for improved damping and stability. Finished in an attractive high-gloss black polyester, the whole assembly sits on four widely-spaced adjustable neoprene isolated Tip Toe cones, while the motor is housed in its own separate assembly weighing a substantial 7.7 kilos. The motor simply needs positioning in a recess to the left. After that, you fit the belt, level the top, plug in - and that's it.

Well, not quite. The tonearm still

needs careful setting up to suit the needs of the cartridge. But that's true of all turntables. As previously mentioned, the review Aries was supplied with VPI's JMW Memorial tonearm; a 10" (There's also a 12" version for \$1350) damped uni-pivot model dedicated to the memory of the designer's son Jonathan who was killed in a road accident in 1995. Its principle attraction is easily adjustable vta via a calibrated



turret to the left of the bearing housing, allowing increments of 0.00035". That and the fact that the entire arm tube can be easily removed, complete with counterweight. Combined with the simple and repeatable VTA adjustment, running more than one cartridge is as simple as buying an extra arm tube assembly, but I'll come back to that.

The turntable came supplied with a special VPI commissioned version of the Grado Reference Sonata cartridge - a reasonably priced, and in this case very low-output moving iron design that has low-impedance coil windings suitable for most MC phono inputs. Later I fitted the Koetsu Black Urushi,

with predictably superb results. But the much cheaper Grado sounded excellent too - though alas it proved a little over-sensitive to the stray hum field produced by the mains transformer of a nearby EAR-859 integrated valve amp.

First impressions of the Aries were of a smooth, solid, very stable presentation. Using the Grado, background noise (hiss and LP surface ticks) sounded low, despite a wealth of detail at middle and upper frequencies. The impression of rock-steady stability was aided by the substantial 38mm thick, 7.5kg heavy two-piece turntable platter, made from acrylic, stainless steel and lead, and inherited, along with the bearing, from

VPI's top of the line TNT 5.

Bass was firm and tight, yet warm and voluminous, with excellent power and control.

The main bearing is a 12.5mm diameter steel shaft tipped with a hardened steel ball. It runs on a tungsten-carbide thrust plate, and the bearing bushes are made of Delrin. The bearing shaft fits tightly enough, with only a trace of free play (side to side rock) discernible. Being so heavy, the complete chassis/platter system is reasonably immune to feedback and transmitted noise despite the lack of any real suspension. However, there may be situations where the turntable benefits from being sat on an isolation platform - a big, big one - able to take its 50cm x 40cm footprint.

► VPI intend you use the Aries without a mat, employing the supplied record clamp and rubber washer to 'bond' the LP to the acrylic platter.

Doing this gives a firm tightly defined presentation that's very tidy and precise. However, I preferred to forgo the services of the clamp for my regular Shun Mook Mpingo record weight. And I also added a QR Developments Ringmat. This gave the sound increased ease and space without losing focus or precision, and subjectively (I felt) improved naturalness.

Indeed, the Aries/JMW combination is nothing if not natural. The presentation was crisply defined and articulate, yet without any sense of the music being straitjacketed or 'tight' in the pejorative sense. The mid-band felt beautifully fluid and open, with a nice mix of precision and relaxation. The music had a CD-like focus and firmness, but without the sterile tonal hardness/forwardness that tends to mar silver disc. Detail was precisely honed and sharply defined, yet beautifully open and (that word again) natural.

Initially I used the JMW Memorial arm minus damping fluid - I just wanted to check everything was working okay before going the final mile. The fluid - a heavy viscous silicone - goes in a dashpot into which the uni-pivot sits, and serves two main purposes. Because the whole arm assembly is effectively suspended on a single point, there can be problems with spurious torsional motion. Also, the unipivot bearing may 'chatter' in sympathy with vibration produced by the pickup.

Adding damping fluid usually firms-up the sound, improving stability and pin-point stereo imagery, making the musical presentation more solid.

However, with the JMW, I found the differences pre and post damping to be smaller than usual - only a marginal increase in security was noticeable

- a good thing, I think, as it points to the JMW's inherent stability and lack of bearing noise.

The makers claim the long distance between unipivot bearing and stylus, coupled with reduced headshell offset angle, improves tracing accuracy leading to

lower distortion. Indeed, other reviewers have claimed for this tonearm the best features of pivoted bearing arms (stability, solidity, security) with the low distortion, 'air', and sound-staging of linear trackers. I'd agree with this assessment; the

JMW does combine these seemingly contradictory attributes.

Going on memory, I'd say the VPI/JMW doesn't quite equal the fantastic detail and precision of the Avid Acutus/SME combination I reviewed in these pages some months back. It's generally looser and more

relaxed (though not ill-focussed or sloppy), with a beguiling charm that's extremely likeable and engaging. Music is, after all, something to be enjoyed! But it's no slouch when it comes to detail; you hear everything that's on the record, it's just that the presentation is friendly and relaxed rather than steely and forced.

Having adjustable VTA is certainly useful. Indeed, for many US audiophiles it's said to be an absolute must. And of course they're right. However, speaking personally, I'm not sure I could always be bothered to reset VTA for each and every LP played! 20 years ago, perhaps, today... The need to adopt different cartridge VTA settings arises because of differences between LPs.

In the '60s the disc cutting stylus angle was typically around 15°, whereas in the '70s it was altered to 20°. Nowadays there's also the issue of different record pressing weight (and hence thickness).

Raising the back of the arm, so the cartridge points down slightly when viewed from the side, gives a positive VTA and a slightly sharper brighter sound. However, beyond a certain point, there may be an increase in high-frequency edge, giving the top-end a thin metallic quality. A negative VTA, where the pivot assembly is lowered so that the arm tube slopes down slightly to the back, has the opposite effect, reducing high

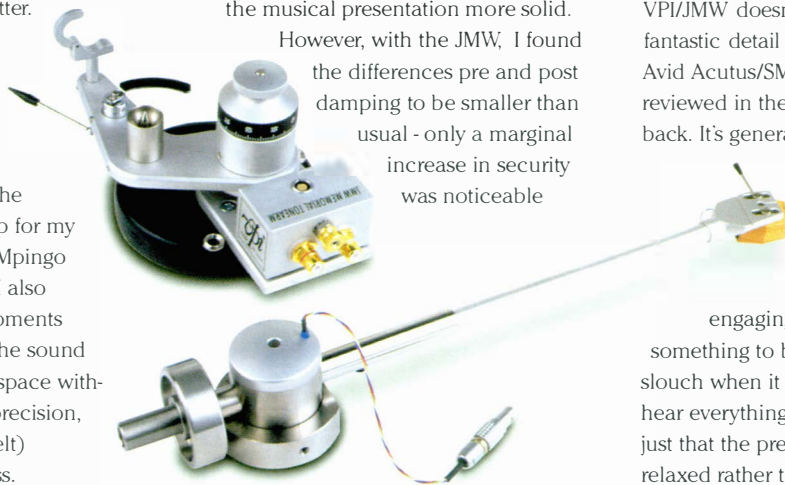

▶ treble and bringing up the bass.

But taken too far, a negative VTA leads to thick dull sound devoid of sparkle and life. Less predictably, changes in vta can subjectively alter timing, making rhythms sound snappy or leaden. With most tonearms, altering arm height to adjust cartridge VTA is a tricky job; often it's virtually impossible to accurately and repeatably set a particularly height. You can get pretty close, but you're never sure the arm is exactly where it was before.

The beauty of the JMW's adjustment system is its simplicity and consistency; you can go from one extreme to another quickly and precisely. And (if need be)

return to your original setting



that particular LP sounds best at such and such a setting. You can then quickly reset the arm for optimum vta each time the record is played.

For the Koetsu Black Urushi, I adopted a slightly negative VTA with good results. The JMW's supplied counterweight coped with this heavyweight pickup, and the minimal anti-skating force (Harry Weisfeld uses a twist in the arm's leadout wires to provide the modicum of side force he prefers) did not seem to cause problems. Although I filled the pivot dashpot with as much fluid as it would take, I felt the damping effect was lower than is often the case with arms of this type - not a criticism, just an observation!

As I mentioned earlier, for the well-heeled with more than one cartridge, it's possible to buy complete tonearm assemblies that allow one to interchange pickups quickly. Just remove the multi-pin plug from its socket, lift the arm off its unipivot, and that's it - though you'll need to take care not to spill

damping fluid from the arm bearing.

One other thing about the arm; it's the first

damped unipivot

just as painlessly - useful for instance if you have a collection that contains a fair number of 180g pressings alongside your standard records. After all, that's only a case of two, easily remembered settings. Even then, for some listeners, life will doubtless seem too short to indulge in such hair-shirt pursuits. But the JMW makes adjustment so easy, it's almost a crime not to experiment.

As a front for my laziness, I'm still a believer in a single 'optimum' VTA for most LPs. But if you've a disc that sounds excessively bright (or the reverse) it's worth trying different arm heights to see if an improvement occurs. If it does, make a note to the effect that

I've tried which doesn't rely on some kind of adjustable outrigger weight system or an eccentric counterweight to balance the arm laterally. The main centre housing is very substantial and quite heavy, while cartridge offset is minimal. These things, coupled with a low centre of gravity for the bearing itself, mean that a twist of the eccentric ring round the bearing base is sufficient to achieve correct azimuth. It also perhaps explains why fluid damping makes less difference than usual...

All in all then, a very potent turntable/arm combination - stylish, solidly engineered, beautifully finished, plus easy to operate and set-up. The sound is clean, open and natural,

without being the least bit 'hi-fi' in terms of presentation. Yet there's all the detail and clarity one could wish for. Moreover, VPI offer a range of upgrades and improvements (such as a heavy flywheel for the motor) that can be added later for those wishing to further enhance performance.

The VPI Aries fitted with the JMW Memorial arm offers real analogue naturalness, allied to the focus and stability one expects from CD. It's a precision instrument, yet doesn't need cossetting, and it should provide consistent quality sound over a long working life span. I'm impressed - I think you will be too!



TECHNICAL SPECIFICATIONS

VPI Aries turntable

Speeds change:	33/45 Manual
Armboard:	Separate, pre-cut for all common arms.
Clamp:	One piece, screw down.
Lid:	Optional extra (61x23x46cm)
External Flywheel:	Optional extra (€895)
SDS Electronic	
Speed Control:	Optional extra (€895)
Dimensions (WxHxD):	56x15.25x40.6cm
Weight:	29.55Kg
Finish:	Piano Black
Price:	£1995.00

JMW Memorial 10" Tonearm

Bearing Type:	Fluid damped uni-pivot
Effective Length:	250mm
Effective Mass:	10.2g
Price:	£1095.00

Distributor:

Cherished Record Co.
Tel. (44)(0)1579 363603
Fax. 944(0)1579 363604
Net. www.cherished-record-company.co.uk

Manufacturer:

VPI Industries Inc. New York
Tel. (001) 908 946 8606
Fax. (001) 908 946 8578

hhf Quality
Audio
Video
holburnHIFI Multi-room
MAKE A NOTE OF OUR NAME

01224 585713 Open 7 days

www.holburnhifi.co.uk

Holburn HiFi 441 Holburn Street Aberdeen AB10 7GU

Audio Images

For a refreshingly different selection as well as established brands. From budget to high end.

With the best choice, advice & service.
For all that is Real Hi-Fi and Home Cinema



Audio Images is The shop. Call now on 01502 582853
128 London Road North. Lowestoft, Suffolk NR32 1HB.

www

AUDIO
ATMOSPHERE.

com

SOUNDS PERFECTION

For the best in Home Theatre

Mail Order throughout the UK
Visa Access Switch

Stockists of:-
Audio Analogue • Audio Note • Avid • Boston Acoustics • Electrocompaniet • Border Patrol Canary • Einstein • GRAAF • Henley Designs J.M. Labs • Lexicon • Michell Eng. • Monitor Audio Musical Fidelity • Nakamichi • Ortofon • Parasound Philosophy Cables • Project Turntables • Primare Rel Acoustics • SME • Sonic Frontiers • Sonic Link Stands Unique • Straight Wire • Sugden • Tara Labs Target • Teac • Totem • Triangle • Tsunami Unison Research • Vienna Acoustics • Yamaha

Available 7 days a week friendly service and advice.

Tel/Fax:
01326 221372

Mobile:
0498554357



Email: nigel@soundsperection.co.uk
Web site: www.soundsperection.co.uk

Radlett Audio EST. 1978 CONSULTANTS

It's the **naim** of the game

9 Holywell Hill, St. Albans, Herts, AL1EU

Tel: 01727 855577
Fax: 01727 858727

FORTISSIMO 



On permanent demonstration: the complete Naim audio range featuring the new 5 series and the incredible NAP 500 power amp.

237 Deansgate, Manchester M3 4EN
Tel: 0161 834 2545 Fax: 0161 834 2535
2 Bold Street, Hale, Cheshire WA14 2ER
Tel: 0161 929 0834 Fax: 0161 929 0834

The Cartridge Man

We sell our own MusicMaker cartridge, digital stylus force gauge and digital turntable level. We also carry a limited range of valve equipment - Croft, E.A.R. - and pick up arms - Hadock, S.M.E. - and a few other high quality products from Ortofon and Audio Technica.

We also rebuild classic valve equipment, giving you a choice as the level of specification. We have in stock a range of original Mullard valves, including the sought after EL 34's. Also available is a turntable setting up service, this is free when you purchase one of our cartridges as is our Test Record.

We don't believe that quality is necessarily synonymous with massive amounts of 'dosh', we encourage customers to purchase second-hand items where appropriate. Sound quality come before cosmetics. Remember' it doesn't have to cost an arm and a leg...
And don't forget our cartridge rebuild service.

88, Southbridge Road, Croydon, CRO 1AF. tel/fax; 020 8688 6565. www.thecartridgeman.com

pear audio

presents

Shahinian DYNAVECTOR Well Tempered

Stockists and Information
from:

Pear Audio Ltd.
7 Prospect Place, Alnmouth,
Northumberland, NE66 2RL
Telephone: 01665 830862
Fax: 01665 830051

www.midlandaudiox-change.co.uk

MAX

Midland Audio X-change



The Border Patrol 300b SET amplifier

Hi-fi Choice Five-Star & Editors Best Buy, and quite simply the best amplifier of it's kind on the market today. I know because I have them! Please phone for a demonstration of this truly wonderful amplifier

Suppliers and installers of
High Quality Audio Systems

Audio Note	Nagra
Audio Research	Primare
Avid	ProAc
Basis	Rega
Clearaudio	Revel
Copland	Roksan
Dcs	Sonus Faber
Densen	Spectral
Electrocompaniet	SPM
Mark Levinson	Sugden
Martin Logan	UKD
Michell	Wadia

call John Roberts Tel / Fax: 01562 822236

181 Franche Rd • Kidderminster • Worcs • DY11 5AD

e-mail: sales@midlandaudiox-change.co.uk

Mobile: 07721 605966

MAX

Midland Audio X-change

Koetsu Black Urushi

by Jimmy Hughes

Expectations. Great Expectations. How could it be otherwise? Faced with the \$2800 Koetsu Black Urushi one is bound to expect much. Can any pickup cartridge, however good, justify such a high price tag? Perhaps not, but how do you quantify perfection? What was it Oscar Wilde said about knowing the price of everything and the value of nothing?

So it was with a mixture of excitement and dread that I sat down to sample the Urushi. Excitement, because of the sonic wonders anticipated; dread in case the result was a terrible disappointment. What musical delights might a cartridge of such pedigree draw from the grooves? Would one sit there transfixed, hearing details never noticed before? Or would it all be a massive let down?

In the event the Urushi proved every bit as remarkable as I might've hoped - but not in the manner expected! I was anticipating a big bold larger-than-life presentation full of power and dynamics, just like the original Koetsu designs of years gone by. But, although the sound had plenty of presence and body, the first impression was one of unexaggerated naturalness. Tonal balance was smooth and wide-ranging; full and solid, yet not overly rich or warm.

There was a sense of the music being delivered whole; nothing added, nothing taken away. The presentation was highly cultured and refined, as though the whole tortuous process of dragging a diamond tip through a constantly undulating groove was the easiest thing in the world. Tracking was excellent, and rarely did the pickup sound strained or in difficulty.

Going back to LPs after enjoying the security of CD can be a frustrating experience; even those who still harbour concerns about CD sound quality often find their reservations



calmed by CD's sheer consistency. You can relax with CD, certain that nothing will interrupt your listening pleasure. LP isn't nearly so reliable, alas. But it can scale sonic heights CD only aspires to.

In this context what first struck me about the Urushi was its superb poise and control; nothing seemed to faze it. The music sounded detailed and articulate, but natural and unexaggerated; no false drama, no added colour - just beautiful subtly-shaded sound, displaying excellent contrast and gradation of dynamics and tone colour. In a word, it sounded right.

Surface noise was low, giving the impression of voices and instruments projecting out cleanly from an inky-black silent background. Naturally, no LP (however quiet) can match the truly silent background of CD. But a mere comparison of signal-to-noise-ratios between the two mediums misses the point. Quality of sound needs to be considered too.

CD (for all its intrinsic quietness) can often be brutally unforgiving, disproportionately highlighting tape hiss and other kinds of background noise where these exist in the original recording. Why is hard to say - but I think it's because CD encourages higher than average playback levels to achieve a sense of presence. You have to play CD loud to get the music to project, and this emphasises background noise.

Good analogue works differently, creating a gap between loud and soft that subjectively suggests great dynamic swings. Measurably, these swings may actually not be that great, but they sound it. This is the crux of the matter. It's not enough for sound to get louder; it must grow and expand to recreate the subjective impression of a real crescendo. It's as much to do with quality of sound as quantity...

Something very noticeable with the Urushi Black is its ability to produce strongly projected full-bodied sound at comparatively low volume levels. You don't have to play music loudly to suggest power and presence - it's achieved naturally; the by-product of exceptional resolution and tactile immediacy rather than sheer brute force. The music sounds solid and focussed, and seems to envelope you without being excessively loud in real terms.

Like all past Koetsu pickups, the Urushi Black has a generously high output. This is a definite plus factor in the creation of a big powerful sound. Yet there's no lack of subtlety or finesse - you don't sacrifice delicacy on the altar of immediacy. Doubtless there are some ultra-low output cartridges that sound even more delicate and refined. But such models don't quite cut it when power and drive are called for. The Urushi Black has the balance just right.

Further insight into the Urushi's remarkable reproductive qualities came unexpectedly one night when some friends of my wife called over. They're not especially musical, and Hi-Fi was definitely not on the agenda; we were eating as it happens. So I just put on some nice *Musique de Table* to play in the background during the meal.

I chose a beautiful 1959 Mantovani LP called *Songs to Remember* - a lush ▶

▶ and delicately romantic farewell to the '50s. I always thought Decca's recording was great, but I'd never previously heard it sound so incredibly vivid and holographic. Soundstaging was amazing, with an almost three-dimensional width, depth, and space one could almost step into.

Did I say Hi-Fi wasn't on the agenda? Well, it soon was. My non hi-fi friends were totally won over. It was almost like they'd never heard stereo before! We were sitting quite close to the speakers, and one guest starting looking behind the speaker (remember I have my speakers back-to-front) almost as though she half expected to see a few musicians there!

As a boy growing up in the 1950s, I recall being similarly fascinated with my parents' table radio - I kept trying to look in the back to see where all the voices were coming from. But all I could see were these funny glass bottles that glowed a dull orange. It didn't make any sense. Indeed, it still doesn't...

Inevitably, the conversation switched to Mantovani and other similar 'Easy Listening' LPs of that era. The dated LP covers were a source of merriment and also nostalgia. It's sad to think that albums that were probably dead cool when released now seem ridiculously kitsch. Sad - but funny too! And don't forget - the music was still being played quietly to create a pleasant background ambience.

Even with the volume set to a whisper the experience was engaging. But let me correct myself. When I said hi-fi was suddenly on the agenda, actually it wasn't. It was the beautiful music and sensitive arrangements that caught everyone's imagination - not how high the treble or how deep the bass. It was, in short, the best kind of sound - sound that didn't draw attention to itself, but simply showcased the music.

The Urushi is a big cartridge; long, deep, and quite weighty - you'll need a tonearm with good play-free bearings equipped with a heavy counterweight to

balance it. Such characteristics make the Urushi demanding. However, it's my feeling that stylus needletalk is lower than with earlier Koetsu cartridges. Consequently, there's less mechanical energy being fed into the tonearm.

I used my review sample in a Kuzma Stogi arm mounted on a Stabi turntable, and had to beef-up the counterweight to get the tracking weight right. I opted for about 2g downforce with very little bias, and a slightly negative vta. The familiar Koetsu stylus guard is nice; protective, but easy (and safe) to fit. And the tapped mounting lugs made fixing the cartridge to the headshell simple and painless. Later I fitted the Urushi to the VPI Aries/JMW Memorial combination, again with superb results.

As I write this in August 2000, it's almost twenty years to the day that I heard my first Koetsu. A friend loaned me his Linn fitted with a Breuer type 7 tonearm and Koetsu Rosewood for a couple of weeks in August 1980 while he was on holiday. The experience was nothing short of overwhelming - a total and utter revelation. My own Linn Ittok/Asak was immediately living on borrowed time!

I'd never previously experienced a cartridge that could get so much out of a record - and do so without emphasising background noise. It was a revelation, and I mention it now because it's so easy to forget how remarkable such qualities are - it's easy to be blasé about something that's a minor miracle.

Of course, times have changed since then; the competition has undoubtedly got better; standards have inevitably risen. Yet the Black Urushi is nonetheless capable of producing a magic that defies attempts to explain or quantify. I'm not saying the magic's there on every record - some LPs simply sound good rather than exquisite or ravishing - but

when this pickup is at or near it's best, the results are quietly unobtrusively jaw-droppingly awesome.

It's the ability to create three-dimensional holographic soundstaging that's so impressive - on the right disc you almost feel you could walk between and around the musicians. That's what so impressed my friends that evening - and they know nothing about Soundstaging. Yes the price is high. But you're buying the modern equivalent of alchemy, black art, and voodoo as much as science and engineering with a cartridge of this calibre. Some things are beyond price...

I'll tell you something else that's interesting; no one's ever made a

Koetsu style Great Cartridge at a bargain price. No one.

You're playing for expertise and know-how that goes beyond engineering. It's what the thing does, rather than what it is that counts.

But that's just my view - only you can say if the price is justified by the end result.

Fortunately, barring accidents and mishaps, Koetsu cartridges have a remarkably long working life - usually three to five years (possibly more) depending on usage and the condition of your records. So think of it as a long-term investment - a final great analogue purchase that should last a very long time. Isn't it about time you heard your LP records in all their glory? ▶+

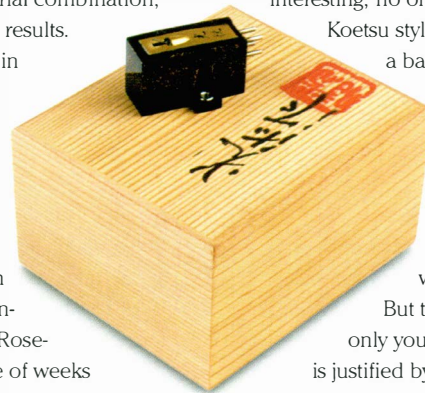

TECHNICAL SPECIFICATIONS

No technical specifications supplied.

Price: £2799-00

Distributor:

Absolute Sounds

Tel. (44)(0)208 971 3909

Fax. (44)(0)208 879 7962

E-mail. info@absolutesounds.com

Net. www.absolutesounds.com

ClearAudio Discovery Moving-Coil Cartridge

by Paul Messenger

I first encountered a ClearAudio cartridge some fifteen years ago, and was rather impressed by the sheer individuality of these unusual looking devices. Pronounced ClearAudio, the company is German, and was started and has been run very successfully by an ebullient and enthusiastic Peter Suchy, who came over to the UK during the summer.

The main purpose of this visit was to introduce a joint venture by three German companies (ClearAudio, Symphonic Line and Acapella), to create a complete and harmonious end-to-end system dubbed La Musica (reported on in greater detail in the news pages). And I have to say the demons they put on were intriguing and persuasive. The big dilemma of high end hi-fi is that the very best components have always tended to come from the smallest and most specialist suppliers, but putting them all together into a system can result in a measure of disappointment. Creating the complete high end system is therefore usually down to the individual dealer, but there's also a tradition of manufacturers working closely together to a common aim - notably the Linn/Naim collaboration through the 1970s - and La Musica treads a broadly similar path, in creating a complete package in which all the elements, including cables and supports, are working in the same direction.

Right at the front of this system was a new cartridge, the ClearAudio

Discovery, and the only element available separately. Peter mentioned that he'd brought over a couple of samples of this new 'mid-price' moving-coil cartridge, and wondered whether anyone would like to review one. Seeing my obvious enthusiasm, RG gave me the nod and I got to take a Discovery home.

I say 'mid-price', but that's only when viewed from ClearAudio's rather elevated perspective. It forms a new 'middle rung', in a ClearAudio moving-coil ladder which starts with the £810.00 Gamma 2000 and reaches all the way up to the Insider Reference at a mere £6715.00. The Discovery sells for the considerable sum of £1920.00, which puts it up there with some of the most expensive cartridges I've ever tried.

In hierarchical terms, however, it actually represents a new and more upmarket partner to the Victory, these two models comprising the start of a new series which is quite distinct from the original range. The main change seems to be in the bodywork, which is different in both shape and material to the earlier models. It is, according to the press release, "aerodynamically shaped", which of course is monumentally irrelevant to something which hardly moves, but I guess it looks rather smart in a 'stealth fighter' sort of way, and the avoidance of parallel faces and their associated resonances is a positive feature in any transducer. Where the earlier ClearAudios use a lead-based

alloy body, these two new models are fashioned from a Mg/Al/Si (magnesium, aluminium, silicon) alloy, which sounds suitably tough and inert. It also results in a slightly lighter cartridge, which is always good news, though the Discovery is still a pretty substantial 8g.

In other respects, there's still plenty of ClearAudio tradition here, most obviously in the 'hammerhead' front which houses the wide-spaced terminal pins, set either side of the cantilever and stylus. The hidden bits sound pretty familiar, with ClearAudio's 'symmetrical/balanced' gold coils, a boron cantilever and Trigon II (6x40um) stylus.

Measurements might be unfashionable these days, but they can yield useful and meaningful findings when applied to transducers (ie cartridges and loudspeakers). They confirm, for example, that the compliance and mass together give a very sensible fundamental arm/cartridge resonance at around 10Hz, when mounted in my medium-mass Naim ARO tonearm. Said resonance has about average damping (ie less than a Linn Arkiv B, and more than a Dynavector DR T XV-1). The Discovery has a very healthy output, comfortably above average for low-output M-Cs, but the test records also reveal that the extreme top end is a little strong and unruly, with some indication of resonance at around 12kHz.

Installation posed few problems, the bodywork providing plenty of protection for the cantilever if not

▶ exactly facilitating alignment. Having said that, you shouldn't rely on the cartridge body anyway. The new body-work has threaded holes (so no need for fiddly nuts), and at least there's some form of stylus guard (if not a very good one). The fixing-hole-to-stylus distance is longer than average, which could possibly lead to alignment problems, especially if your tonearm has holes rather than slots (like the standard ARO), and the forward positioned pins mean that it can be a stretch for the headshell wiring. Fortunately ClearAudio supply a set of extended cartridge tags which should provide a solution, as well as being excellent items in themselves.

Having aligned everything properly, I was looking forward to finding out what the Discovery could do when I noticed the temporary leaflet advised a 30 hour running-in period before commencing serious listening. That's 100 sides, or maybe a couple of weeks of regular play (unless you make use of the modulated run-out grooves on, say, The Beatles *White Album*, or the Chemical Brothers *Surrender*). The latest leaflet talks about 50 hours run-in, but in practice I found the Discovery had pretty well settled down after about ten hours, and I had plenty of time to put another couple of hundred on the clock.

Even before the run-in period was finished, I was well impressed by this cartridge. Once I'd got into its groove, I felt little inclination to go back to my regular Arkiv B. The Discovery certainly has the sweeter, more open and transparent sound through the midband and treble, though the bass end did seem a little softer and less authoritative (something which might be 'tuneable' with different input loading).

However, under my conditions at least (Linn Sondek/Naim ARO), it also sounds just a little nervous and edgy, and definitely prefers the sort of virgin quality vinyl that doesn't seem to

feature too strongly in my well used collection. Damage and dirt on discs tends to be more obvious than I'm used to, at least partly no doubt because of the cartridge's conspicuous top end.

That said, what it might lack in terms of ultimate smoothness, it makes up for with its immediacy, liveliness and convincing reproduction of dynamics. This was the quality that



originally attracted me to that first ClearAudio cartridge many years ago, and for these ears at least it's the key advantage that ClearAudio has over its rivals.

It's a character which reminds me a little of those unique Decca moving-iron cartridges, that have always left low-output moving-coils for dead in terms of immediacy and dynamic expression, but which also always suffer from edgy nervousness. (The Decca design never really made the transition from mono to stereo all that satisfactorily.) ClearAudio cartridges sound and behave much more like conventional MCs than Deccas, but they do have a hint of those rather special qualities.

In the final analysis, the Discovery does most things exceptionally well. It tracked my favourite 'problem' discs

without drama, and delivers a fine combination of transparency, dynamics and tonal neutrality through the midband. But it also has enough 'character' of its own, notably the lift in its top end, to mean that careful system matching is vitally important to a good overall result. Halfway through the review period I changed my regular NAP135 power amps for Naim's new NAP500, and the latter's stronger top end was a less happy match for the Discovery, almost irrespective of the speaker system in use at the time. Given the fine balance through the bass and mid-range,

I wonder whether the top-end of this early sample might be less than representative. A rematch with another unit would certainly be interesting, given the design's considerable strengths.

As it stands, zestful and invigorating are two good adjectives to describe the Discovery's performance. If your system could do with a wake-up call, this cartridge could be the perfect solution, though I'd also urge some caution if you're not prepared to make the effort to keep your vinyl in top condition. ▶+

TECHNICAL SPECIFICATIONS

Cartridge Type:	Low Output Moving-Coil
Cantilever:	Boron Rod
Stylus:	Trigon
Compliance:	15cu
Weight:	8g
Output Level:	0.6mV
Tracking Force:	2.4g
Price:	£1920.00

Distributor:

Audio Reference
Tel. (44)(0)1252-702705
Fax. (44)(0)1252-301412

Manufacturer:

Clearaudio Electronic GmbH
E-mail. Clearaudio@t-online.de



Living Voice Avatar Loudspeaker

by Roy Gregory

Hi-fi systems, despite the assumption in the high-fidelity moniker, wreak havoc on the signals that they pass. Is that a little harsh? I don't think so, and furthermore, I reckon it's pretty easy to demonstrate. All you need to do is compare the sound of live acoustic music to what comes out of your speakers.

Or if you are lucky enough to have access, compare master tape playback in a studio or cutting room to the final product of that tape (LP or CD) played at home. In some ways that is even more shocking, given that you can't lay any of the blame at the door of the recording engineer. I'm afraid the conclusion is unavoidable; even supposedly high-fidelity systems shed information like a tree sheds leaves in an autumn wind.

When it comes to system losses, my own personal bug-bear has tended to be pre-amps (and even worse, phono stages). They get their grubby hands on the signal while it's weak and especially fragile, allowing them the scope for the most vicious kind of damage. I've lost count of the number of pre-amps I've heard that eject a shrunken, shivering, stripped naked facsimile of the signal at their outputs, and let's face it, it's all downhill from there. But once I set my prejudices aside, even I have to admit that when it comes to doing major league damage then transducers, and speakers in particular, are in a class of their own. They don't just lose information, they also bend it out of shape.

The most obvious evidence of this not so poetic licence can be seen in the shape of all those speaker ranges where the cheaper models outperform the more expensive ones (Flagship models? You really don't want to go there...). The sad truth is



that all too often, the smaller, simpler speakers are musically more coherent and plain make more sense of the signal you feed into them. Built to a straitjacket budget, there simply isn't the room to try anything too clever, but give the designer a bit of financial leeway, and between him and the marketing department they've got the chance to really screw things up!

Having said that, there are always

exceptions to the rule, and one of the more surprising examples comes from Living Voice, the Nottingham company best known for the kind of horn loaded excess that most Japanese audiophiles would be happy to live in, let alone listen to. The Air Partners, and their (slightly) smaller siblings the Air Scouts, with or without horn loaded bass bins, are of a size and price that render them beyond fantasy for most of us, a fact that even their designer Kevin Scott has to acknowledge. His response was, the Living Voice Auditorium, a speaker so damed sensible that it's hard to imagine it emerging from the same Strangelove mind that created the Scouts and Partners. What is even spookier is that the Auditorium isn't just one design, but has evolved into a three model range, spread from £1500 for the original, through to \$4000 for the Avatar OBX, yet the various models are visually virtually indistinguishable from one another. Now, give most designers something close to triple the budget to work with and they'll come back with a bigger box(definitely), more drivers (definitely) and more exotic materials (probably). After all, that's what justifies the extra price on the shop floor. But not our Kevin; oh no, nothing so simple. Not content with creating this rather excellent, universally well reviewed and respected £1500 floor-stander (a speaker from a small independent manufacturer which has carved a substantial niche in a seriously competitive market sector), he developed further refinements on the original theme, with little or no external differences to justify the



In case you were wondering...

The £4000 Avatar OBX adds a much heavier cabinet and Scanspeak's top of the line D2905/99 Revelator tweeter. It also has a massively over-specced crossover mounted in separate, external cabinets. Rest assured that we'll be visiting it soon.

► considerable increases in price. But what makes the Auditorium/Avatars so fascinating to me is the way that they give us the chance to evaluate the effects of the extra expenditure (as well as the way it has been made) on the sound of what is essentially a single design. Oh yes. Kevin's got the shotgun out, and unless he's extremely careful then his feet could be in serious danger!

As I mentioned earlier, the whole saga started with the Auditorium, a sensibly sized floor-stander, combining sensible efficiency with a sensible bandwidth at the sensible price of £1500. And it's a cracker. So much so that we used it for a lot of the listening to the low powered amplification in Issue 2. What we have here is the next model up, the \$2500 Avatar, an Auditorium with a thousand pounds worth of refinement added. What does the extra expenditure buy you in material terms?

Well you get a far more rigid cabinet for starters, courtesy of the thicker, inset back panel and three unevenly spaced internal braces. The Vifa bass/mid drivers use the same cone assembly but the

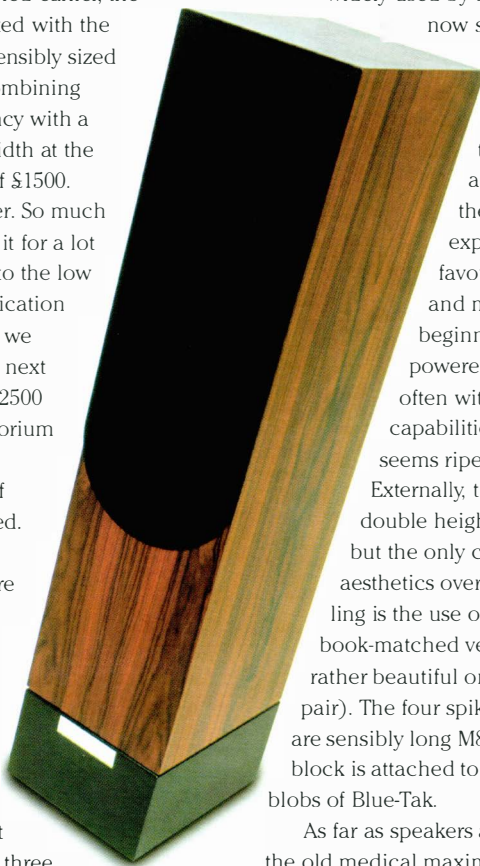

magnet is around twice the size in the Avatar. The Auditorium's Vifa high-frequency unit gets replaced by the excellent Scanspeak D2905/95 (unusual in a speaker at this comparatively modest price) and this allows a slightly lower crossover frequency. But a lot of the extra money has gone into the crossover itself. This uses several expensive Hovland MusiCaps a side, along with Clarastat resistors, which join Living Voice's own in-house inductors. The hard-wired boards are physically separate for each leg, employ bi-wiring and star-earthing, and considerable care has gone into the placement and orientation of the components. Interestingly, the crossover also employs a conjugate load to ease the overall drive characteristic, a technique once widely used by KEF but which is now sadly neglected.

Kevin feels that component quality is critical to a successful application of the theory, which might explain its fall from favour, but with more and more people beginning to use low powered amplification, often with limited drive capabilities, the time seems ripe for a comeback. Externally, the Avatar gets a double height block/stand but the only concession to aesthetics over its cheaper sibling is the use of a higher quality book-matched veneer (which was rather beautiful on the review pair). The four spikes on the stand are sensibly long M8 type, and the block is attached to the speaker with blobs of Blue-Tak.

As far as speakers are concerned, the old medical maxim "First do no harm" is a good place to start. The problem is that a £1500 speaker is so inherently compromised that you end



up having to decide which aspects of performance to protect and which to sacrifice. In the Auditorium, the lifebelt gets slung to the essential structural elements, dynamic range and rhythmic integrity, the onus being on getting the shape and sense of the music out unimpeded. The result is a musically satisfying if occasionally excitable performer, and one whose sales success suggests that it's got its priorities right. What the Avatar adds to the equation is a major dollop of sophistication, as well as an extra dB or so of sensitivity.

Listening with the more expensive speaker you can hear much farther into the timbral identity of the instruments. The music is richer and weightier, with greater substance and presence. It also displays much more impressive dynamic discrimination and sophistication. The superb control of vocalists from Ella to Zinka Milanov comes to life. Just listen to 'All Through The Night' and 'Anything Goes' from the superb (and very welcome) Speakers Corner re-issue of *The Cole Porter Song Book* (Verve MGV 4001-2). Ella's instantly recognisable tones switch effortlessly from the stretched, descending phrases of the opening number to the chopped syncopated pushes of the second. And if Miss Fitzgerald's versatility ►

▶ doesn't exactly come as a surprise, then the ease with which the Avatars match it is welcome indeed. Indeed, versatility could be their middle name. With the tonal refinement required for acoustic recordings, they still retain the dynamic and rhythmic qualities so vital to rock, pop and jazz (as a brief and painfully memorable exposure to German metal-meisters Ramstein at concert levels served to demonstrate).

In fact, the Avatar is a supremely skilful balancing act. Bear in mind that Living Voice don't have the investment levels and engineering facilities of a B&W. Tailor made drivers are something they can only dream of. And if that puts them in the somewhat disparaging category of "box-stuffers" then the Avatar (and Auditorium) are physical proof that there's more than one way to stuff a box.

This balancing act starts with, and is perhaps best understood in terms of, the low frequencies. Despite its dimensions and the weight it gains over the Auditorium, the Avatar could never be described as a bass fiend. It trades too much bandwidth in return for efficiency for that. But whilst there are plenty of speakers this size that go lower, they don't do it with the Avatar's overall coherence or impact. The bottom line here is that you've got a pair of 6" drivers in a pretty big box. Better to go for speed and definition than risk things getting out of shape by pushing them too hard. And it works. The legendary crescendo that opens the Fremaux/BSO *Le Cid* arrives with real

shock factor, even if it lacks the sheer wallop that happens, normally some time later, on really big systems. But it's once the echoes die away that the Avatar's strong suit reveals itself, shifting density to the soft pizzicato of the Cello underpinning the castanets and back again to the next crescendo without missing a beat, taking a tour through the woodwinds in between times. And the whole sequence occurs in a single acoustic space and texture, whose quality is stable under even the most extreme assault. No rents appear in the musical fabric to let the system intrude.

Coaxing this level of bass integration and the maximum available weight from the Avatar requires considerable care over placement. They need room behind them for the best results, and it helps that they are refined enough for near field listening. They also thrive on a wider than average stance which creates the huge sound stage that is so in keeping with the open generosity of their midrange. And if they lack the pinpoint spatial precision of an Audio Physic Virgo or Ars Acoustica Diva, then look at what else they offer (£1500 on the one hand, significantly wider dynamic range on the other). And if I haven't mentioned the treble it's because it is a natural and unobtrusive extension of the midrange. Nothing to get excited about, in the best possible sense of those words.

In fact, that could be the Avatar's Achilles' heel. Its imperturbable and unobstructive nature is so far from the norm that it's easy to miss the extent

of its considerable accomplishment. It does the job so evenhandedly and with so little fuss that other, superficially more impressive speakers might seem more attractive. It's an old mistake, but that doesn't make it any less painful if you happen to fall into it.

In a world of loudspeakers voiced for crossover AV use, the Avatar is at once a specialist and an all-rounder. It may be designed primarily to play music, but then it plays all types of music equally well. I've been listening long and hard. Spend some time and do the same. The Avatar doesn't do tricks - it's far too good to have to! ▶+



TECHNICAL SPECIFICATIONS

Drive Units -

Tweeter:	29mm Fabric Dome
Bass/Mid:	2 x 150mm Doped Paper
Bass Loading:	Rear Reflex Port
Impedance:	6 Ohms
Sensitivity:	94dB
Bandwidth:	-3db at 35 Hz
Dimensions (WxHxD):	220 x 280 x 1035mm
Weight:	17 Kg
Finishes:	Santos Rosewood European Maple Cherry
Price:	£2500.00

Manufacturer:

Living Voice
Stanhope House
Harrington Mills
Leopold St
Long Eaton
NG10 4QE
United Kingdom

Tel. (44)(0)1159 733222

Fax. (44)(0)1159 733666

E-mail. shout@livingvoice.co.uk

Net. www.livingvoice.co.uk

definitive audio



...land of opportunity and adventure...

We could tell you that Definitive Audio is the most highly acclaimed audio specialist in the country. Thankfully we don't have to, other people have been doing it for us.

We are regularly featured in specialist journals, underground fanzines, high circulation glossies and even the odd radio programme. The interest is flattering.

Paul Messenger described us as having *"The crucial X factor that makes a good system great"*.

Jason Kennedy said, *"Every time I visit Definitive Audio the systems sound better and better"*.

Alan Sircom said our £3.5k system *"...breaks almost all the rules...I have encountered few systems that sound as good as this one - at any price"*.

We could go on - but enough of the trumpet blowing. Our real success lies in providing an open-minded environment that is free from hype, a quality of relationship with our customers that is second to none, and an experience that is as reassuring as it is refreshing.

Our showrooms are situated in a roomy Victorian mill 1 mile from Junction25, M1.

Please ring for appointments, general enquiries or for more information.

LIVING VOICE



Auditorium Avatar OBX-R
Hi-Fi Choice *Editor's Choice*
£4000

"If you really want to hear what's going on in your music collection... get a great valve amp, a superb source and a pair of these loudspeakers. ...they'll turn you into the raving music nut that got you started in the first place."

Jason Kennedy

AMEX • VISA • MASTERCARD

Tel 0115 973 3222 Fax 0115 973 3666

internet: www.definitiveaudio.co.uk email: shout@definitiveaudio.co.uk
Living Voice • Helios • Border Patrol • Art Audio • SJS Electroacoustics • Wadia
Vitavox • Lowther • MF • Nott'm Analogue • Western Electric • SME • Canary



GROOVY
BABY

SUGDEN AUDIO
PRODUCTS

MADE IN ENGLAND

HeadMaster
versatile class A
pre-amplifier



Tel 01924 406016

www.audiosynergy.co.uk/head.htm

KEVIN GALLOWAY audio

a fresh musical perspective

The Tabu CDP I compact disc player marks the introduction of the very first Gryphon source component, a rethinking of integrated single-chassis CD transport/DAC design to complement both the performance and the appearance of the highly praised Callisto amplifiers. In addition to decoding for HDCD CD's, the CDP I includes true differential 24-bit, 96kHz digital-to-analogue converters and a revolutionary upsampling circuit.

equipment by

DCS, GRYPHON, SUGDEN, LAVARDIN, BORDER PATROL, CANARY AUDIO, NAGRA, LFD, AVID, LYRA, ACCUPHASE

loudspeakers by

AUDIO PHYSIC, LIVING VOICE, TOTEM, ART, AVANTGARDE ACOUSTIC, HARBETH, VIENNA ACOUSTICS



Scotland's leader in High Performance Audio Systems and Installation.

telephone 01563 574185 fax 01563 573207 email kevingalloway@btinternet.com

UNISON RESEARCH

for a lifetime
of musical
enjoyment



S6

- Single-ended integrated amplifier.
 - 33 watts of pure Class-A
- Beautifully styled and impeccably built by master craftsmen in the art of fine valve amplifiers.
- Enchanting, natural sound.
S6, £1600



SR1

For more
information
on the
range of
Unison
Research
products
please contact:



23 Richings Way, Iver,
Bucks, SL0 9DA, England

Tel: 01753-652669 Tel: 07000-853443 Fax: 01753-654531

www.ukd.co.uk e-mail: nick@ukd.co.uk

- The grace of triode tubes, with the power and control of solid state.
 - Complete with radio wave remote control.
 - Integrated amplifier.
 - 80 watts dynamic Class-A.
 - Fully protected self-regulating circuit.
- SR1, £1250*

MYRYAD

PHONES

TAPE 1

TAPE 2

CD

VIDEO

TUNER

AUX

MYRYAD

MP 100 Stereo Preamp



Myryad MP100 Pre-amp and MA240 Power Amp

by Pete Christie

Power is a funny thing. Too little, and things tend not to work properly, too much, and there's always the danger of nasty bangy noises, usually accompanied by the strange aroma of burning.

A friend of mine once decided that 850cc wasn't quite enough, and he managed to equip his ageing Austin Mini with an over-bored 1500cc engine. A truly remarkable feat of automotive engineering which resulted in a genuinely astonishing rate of acceleration right up to 115 mph, followed by an equally astonishing explosion as various bits of gearbox randomly scattered themselves across the thoroughfare.

"Too much torque" was the considered opinion at the time (dodgy stuff, torque).

Then there's my garden pond. Basically a hole in the ground which I expertly filled with water. It was decided that as ponds went, it did the job fairly well, but it could use a bit of a boost (as garden features go!). A fountain - now there's a thought. I could quite easily have nipped down to the local garden centre and bought an off-the-shelf "namby-pamby" pump, but I decided to use my imagination and put a bit of power into it. I modified an old pump I had lying around the place, and after several enjoyable days spent with various plumbing bits and pieces, I switched it on. It worked all right! I sent a jet of water 50 feet into the

air, over the garden wall and all over next-doors washing. Within 15 seconds, the pond had reverted back to being just a hole in the ground with nothing more than a couple of tadpoles pathetically flapping about in a small muddy puddle to give any clue as to its former aquatic identity.

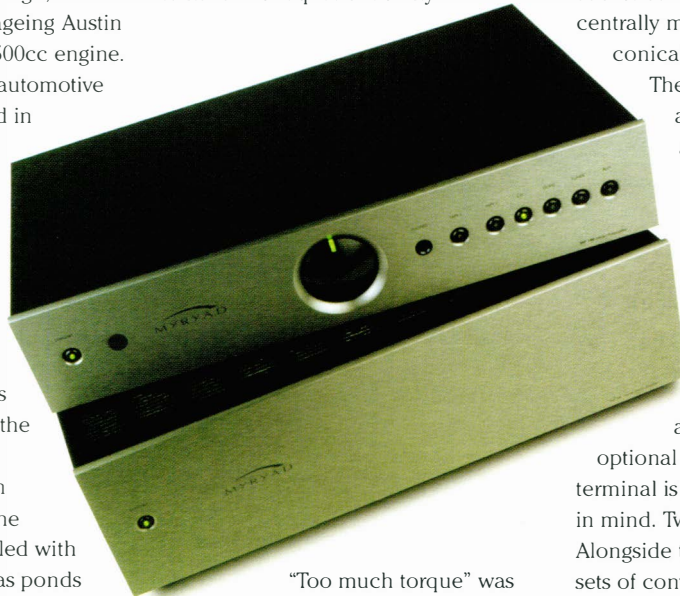

"Too much torque" was the considered opinion at the time (dodgy stuff, torque).

The conclusion is therefore that power is best used sensibly, and to achieve this requires careful planning and application. Like the MP100 preamp and MA240 power amp - two members of the current Myryad stable.

Based in Waterlooville, Hampshire, Myryad were formed in 1995 with a philosophy of producing high quality audio separates which would give (and I quote) "outstanding performance, graceful aesthetics,

first-class reliability and exceptional value for money". Well, the aesthetics certainly come up to expectations. Finished in satin anodised silver-grey, the MP100 remote controllable pre-amp is certainly stylish. Simply laid out control buttons and a headphone socket contrasted by the enormous, centrally mounted and countersunk, conical volume control knob.

The rear panel is no less attractive - all the inputs are situated on the left hand side and are typical gold-plated phono sockets. Four line inputs are supplied - Aux, Tuner, Video and CD. There is a module available which can turn the auxiliary input into a turntable input as an optional extra, and a "ground" terminal is fitted as standard with this in mind. Two tape loops are supplied. Alongside the input sockets are two sets of conventional, unbalanced, RCA phono line level outputs. Next to these are an impressive pair of balanced, XLR line outputs. Another pair of phono sockets for the integral "My-Link" communication system, and an IEC power socket and switch complete a thoroughly business-like rear panel.

The MA240 power amp is just as stylish, and even more simply adorned. Just a small power button/light and the Myryad logo. It don't come much more simple than that. The rear panel is as minimalist, and just as

▶ attractive. Both balanced and non-balanced inputs are provided, along with the choice of a switch selected bridged mode should you want to use a pair of power amps as mono-blocs (8 Ohm loads only please!).

I feel that now would be a suitable time to mention the physical proportions of this stuff. The power amp is very heavy. Weighing in at 15 kg (that's 33lbs in old money), it definitely needs to be mounted on a suitably solid hi-fi equipment rack. Mind you, the custom-designed mains transformer itself weighs in at 3kg! The amplifiers' outer casing is fairly heavy-duty, and the front panel is a 6mm thick (1/4") slab of aluminium. It's a good job they didn't use steel or I wouldn't have been able to pick the thing up! Put the power and preamp together and you get an assembled lump of equipment, which measures about 9"(230mm) high, and 14 1/2"(368mm) deep. It certainly looks as if it's got a bit of "torque". In fact, according to the information on the Myryad web-site, the amplifiers provide:

"limitless power and effortless control", "the custom-designed transformer is complemented by a discrete, low noise, regulated power supply. This is why Myryad's amplifiers never show any sign of strain, however hard you drive them".

It also added that: "Engineered simplicity is the key to Myryad's refined performance. Designed with the audiophile in mind Myryad products use a minimum of sound-degrading controls. The straightforward signal path reduces hum and noise while Myryad's DC5 advanced circuit configuration

increases speed and lowers distortion, while controlling speaker drive units with unrivalled ease" (make a mental note of that final phrase).

This, I felt, was going to be interesting!

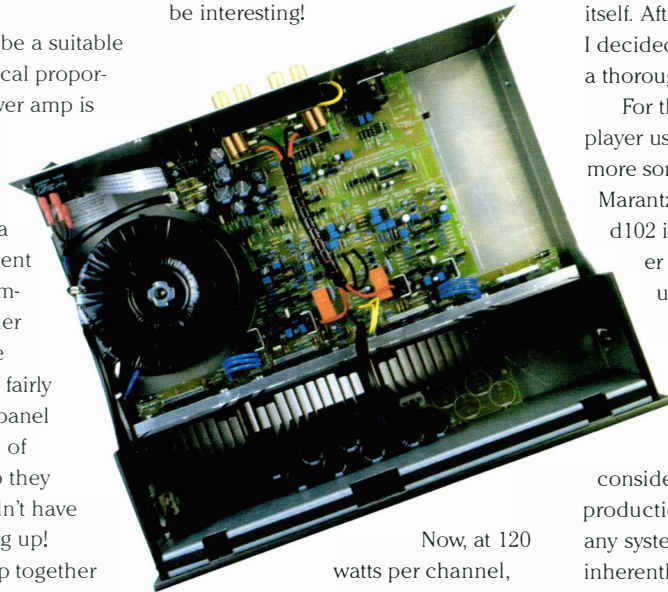

Now, at 120 watts per channel, there was absolutely no way that I was going to get a true and accurate test within my home system. Face it. If I were to put this amount of power into my ageing Rogers LS3/5A.s, it was likely that I would very possibly turn the drivers inside out and totally melt the

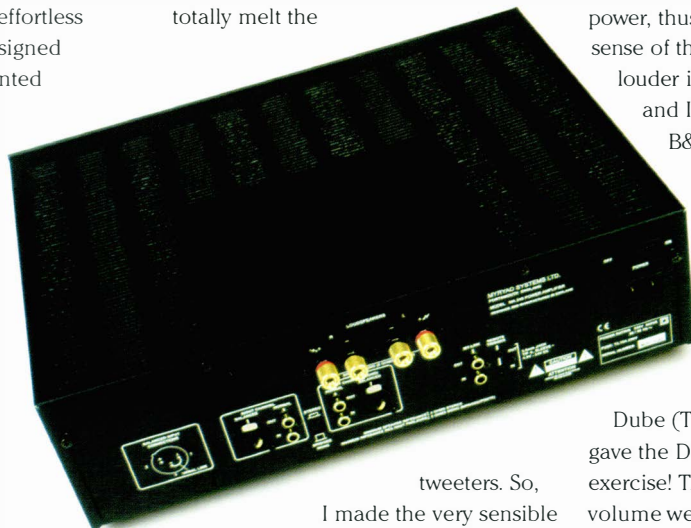

tweeters. So, I made the very sensible decision to carry out the listening tests at the hi-fi emporium where I spend my days. The units I was supplied with were new, so a

running-in period was an absolute necessity. I connected a fairly inexpensive CD player at the front end, and a pair of B&W DM603's to the back end, turned it on and left it playing to itself. After a couple of weeks of this, I decided the time was right to give it a thorough audition.

For the test I replaced the CD player used for running in with a more sonically suitable machine - the Marantz CD17 KI, using van den Hul d102 interconnects and CS122 speaker cable. I left it all connected up to the DM603's for starters and put on a CD that would suitably "move some air" - 'Sledgehammer' from the Peter Gabriel CD *So* (Virgin PGCD5). I have always

considered this to be an awkward production, and one that can pinpoint any system shortcomings, as it is inherently bright and stabby. There is no denying that the sibilance of the horns and vocal line is apt to produce a certain wince-factor when played at a reasonably high volume. This was still apparent using the Myryads, though the superbly driving bass and drum lines seemed to have grown in intensity and power, thus making a great deal more sense of the recording. In fact, the louder it got, the more it "grooved", and I couldn't remember the B&W's sounding better.

What about a bit of reggae? Now if you want to move a bit of air, there's nothing quite like a thundering good bass guitar line. So I turned to 'Serious Reggae Business' from the 1995 CD *Trinity* by Lucky Dube (Tabu 530479-2). This really gave the DM603's bass drivers a bit of exercise! Thumping good stuff, and the volume went up a bit more, and the entire album ended up being played! It was noticeable that the amps were completely happy, and that the coherence between soundstage ▶

▶ and timing was rock-steady. They were fast without seeming spiky, and they appeared “big” without ever giving any hint of sluggishness. The only down side was that by maintaining this volume level, the bottom-end vibrations were quite possibly going to liquefy my larger internal organs. So I tried a change of music.

Having proved themselves to be totally comfortable with powerful recordings, I decided to try and trip up the Myryads with something a tad more subtle. Having rocked the joint with reggae, I replaced Lucky Dube with Ravel: the recently re-issued *Piano Concerto* in G by the Berlin Philharmonic conducted by Claudio Abbado and featuring Martha Argerich as soloist

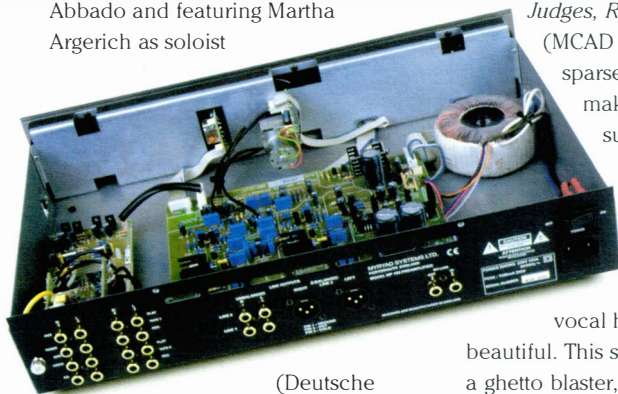

(Deutsche Grammophon 447438-2). Originally recorded in 1967, this performance is one of my particular favourites and I selected track 2, the *Adagio Assai*, and sat back to see how the Myryads would handle subtlety and lightness of touch.

I needn't have worried - no problem here. Dare I say it? After proving that power and dynamism came as easily as the 120 Watts/Channel rating suggested, this Myryad stuff can also charm with its delicacy. Each trickling note of the piano dripped out of the speakers with exquisite detail. The imaging was precise and natural, and the depth was more realistic than

I had expected it would be. In fact, it was difficult to criticise the sound quality given the possible mismatch of loudspeakers. So I changed them.

I dragged in a pair of Audiovector M3's, and connected them to the Myryads in bi-wire mode (M3's being tri-wirable). The ensuing image improvement was quite literally amazing! All the clout and control I had previously experienced was still very much in evidence, only now, the performance had become noticeably more real and “in the room”. I reviewed the same pieces of music to get a datum, and with each piece, my opinion was confirmed. Here was a cast-iron case of power being apportioned carefully and thoughtfully.

The last example I'll use is a perennial favourite of mine, 'North Dakota' from the 1992 album *Joshua, Judges, Ruth* by Lyle Lovett (MCAD 10475). The very sparseness of the piece makes it an excellent subject for review. The production is excellent and literally drags your attention into the song. The lyrics are spare and the

vocal harmonies surprisingly beautiful. This song sounds good on a ghetto blaster, but on a hi-fi system such as this, it can really knock your socks off! So I listened - carefully. I tried to find fault, being as picky as I could. I must say that I was impressed.

The Myryad pre/power combination works. It's like a ride in a big BMW. It is smooth, it is powerful, and it has enough power to provide all the necessary excitement you might require. Visually, it is well designed, though I'm not too sure about the size of the lamp on the volume control - to my mind, it is a bit too bright, but that is purely personal. The boxes themselves were of a suitable high quality, and though large, would grace any living room. I liked them.

The people at Myryad should congratulate themselves on producing a good-looking, great sounding, exciting combination. I haven't seen the

rest of the range, but if it is as good as the MP100/MA240 combination, I should think that I could have quite a bit of fun with it.

I wonder what would happen if I added another power amp and doubled the power? - probably give it too much torque!



TECHNICAL SPECIFICATIONS

Myryad MP100 Preamp

Inputs:	4 Single-ended line 2 Single-ended tape
Input Sensitivity:	200mV
Outputs;	2 Single-ended 1 Balanced 2 Single-ended tape
Max Output Level:	>20V (0.1% THD)
Dimensions (WxHxD):	436x95x303mm
Weight (net):	6.3 kg
Finish:	silver grey or black
Price:	Line only: £600.00 Phono MM: £80.00 Phono MC: £100.00

Myryad MA240 Stereo Power Amp

Inputs:	1 Single-ended 1 Balanced
Input Sensitivity:	1.1V (ref 120W)
Outputs:	1 Single-ended
Power Output Stereo:	120 W (8 Ohms)
Power Output	
Bridged Mono:	400 W (80hms)
Dimensions (WxHxD):	436x135x368mm
Weight:	15kg
Price:	£1000.00

Manufacturer:

Myryad Systems Ltd
2 Pipers Wood
Waterberry Drive
Waterlooville
PO7 7XU
United Kingdom
Tel. (44)(0)2392 265508
Fax. (44)(0)2392 231407
Net. Info@myryad.co.uk
Web. www.myryad.co.uk



RUARK

Ruark Solus

by Chris Thomas

The Managing Director of a prominent British audio company recently told me that their market research indicates that you, the Hi-Fi buying public, are resistant to spending more than a few hundred pounds on small stand mounted speakers. Apparently when it comes to models from about one thousand pounds upwards you want floor standers with bass – lots of bass. Without that low-end wallop you just do not feel as if you are getting value for money. And if you look around at the market you will see that it is true. There are just not that many quality small loudspeakers on the market so perhaps the market research boys are right. There also seems to be predominant feeling that small speakers belong in small rooms while larger rooms need a bigger speaker and this sits neatly alongside the other misconception that the bigger model will always require a meatier amplifier. But to me there is nothing in Audio quite as exciting as a super quality source feeding a powerful yet transparent amplifier driving a small but musically eloquent stand mounted speaker designed by someone who has capitalised on all the advantages that small boxes potentially have.

When it comes to loudspeakers, bass is the problem and it always has been. As a designer, once you have decided that you want real low frequency extension then you need a bigger box and possibly more drivers. But if you do not want the bass to sound as if it is coming from a box you need to go to drastic but necessary lengths to stop that enclosure flapping around and generally joining in with the music. Ideally you would want a smaller cabinet with greater inherent

rigidity but there is the trade-off with extension so, as we have seen, ingenious solutions aimed at maintaining the precious relationship between bandwidth and control have abounded over the years. Cute cabinet design, advances in driver technology and loading, ports and crossovers have all played important roles in improving things but the fact remains that I have very rarely heard a really, really convincing extended and articulate bass performance coming from any large loudspeaker, regardless of price. Even friends of mine who have spent more than ten thousand pounds in search of this goal still have nagging doubts about the bass and spend obscene amounts on cables, racks and room treatments trying to get it right.

Relieved of the need to rattle chest cavities the designer of the Ruark Solus has focussed his efforts by taking advantage of the inherent good things small loudspeakers traditionally possess and concentrating on getting the all-important mid-range just right. Two drivers make life a lot easier than three or four and greatly simplify the crossover. Smaller cabinets mean greater rigidity with more easily controlled resonance and less energy storage, which should mean a faster response. Smaller baffle boards bring the same advantages plus a far smaller

surface for the drive units to interact with. This can create greater clarity and precision of image by reducing the potential for early reflections from the baffle edges to confuse matters. But there are pitfalls. One of the stranger things that I have found about reviewing loud-speakers is that, in the same way that I want a big speaker

to have several small speaker characteristics, I want a small speaker to mimic certain aspects of big speaker behavior. You see a good small speaker must not sound small. It must always sound bigger and have a far

greater dynamic range and scale than its humble size would suggest.

The Solus is the entry-level model for Ruark's Sterling Reference range and is an attractive looking, compact two-way design. Oh okay, let's call it a mini-monitor.

The bass/mid driver, manufactured by Scanspeak for Ruark is a 150mm paper coned type made from long

fibres and treated to avoid inner reflections. This is achieved by cutting spiraling slits in the cone itself from the dust cap to the roll surround and then filling them with a damping material prior to the final coating of dope. Ruark and other designers who are using variations on this method claim that this



► dissipates and controls vibrations around the cone instead of reflecting them back towards the centre. The analogy used is that of a stone being lobbed into a pond and the action of the ripples spreading out and, with no obstacles in the way, hitting the bank and reflecting back towards the source. Imagine that a loudspeaker cone is dealing with thousands of these stones every second and you realise that the ability to in some way control the resultant reflections would be extremely advantageous in both evening driver response and reducing colourations.

The 28mm tweeter is an open-weave fabric dome type; Ferro-fluid cooled and closely mounted above the bass/mid driver and both offset and mirror imaged on the other cabinet. It is manufactured by Morel, which slightly surprises me given Ruark's obvious close relationship with Scan-speak who, themselves manufacture superb tweeters. The front baffle is inclined to give time alignment and has a Grey slate-like texture though this is offset by the side cheeks, which are available in a number of real wood veneers. You would expect a company like Ruark with their history of cabinet making to have thought long and hard about the enclosure for the Solus. They themselves draw an interesting comparison with a violin, quite rightly claiming that it is the body and not the quality of the strings which determines the ultimate tone of the instrument. So the cabinets for the Solus are fairly complex affairs with varying wall thickness and strategically placed bracing throughout. It is ported to

the rear and can be single or bi-wired through two sets of WBT terminals. A clip in grill is supplied but I thought they sounded a lot more open without it in place.

The right stand can make or break a loudspeaker's performance and it is a good sign when a designer creates a speaker to include the stand as an integral part of its concept. Ruark's Solus stand is a high-mass tubular fabrication. It is sand-filled, including the base, and is enormously heavy. But it holds the speaker at just about the right height for the majority of installations and supports it without the aid of spikes. I would say that, after trying them with some other stands, they are probably mandatory, unless your dealer can recommend an alternative.

Before I tell you how the Solus performs let me deal with the question of amplification. Now, I don't know how loud you like to listen to your music but I can tell you that low-powered amplifiers, regardless of quality should be avoided. The speaker's efficiency of only 86dB/watt at 1M suggests that an amplifier of around 50 good watts per channel should be the minimum requirement. But the Solus drinks power like a sponge and reacts to volume in such an unflustered

way that it would be hard to imagine an amplifier too powerful to drive them. I hooked them up for a few days to a Mark Levinson No.335 power amplifier. This lovely device produces 250 watts into 8 ohms and 1000 watts into 2ohms. Already impressed with the way that the little Solus retained its composure under fire I decided to see how loud they would go before showing signs of stress. As I began slowly cranking the level up they just got progressively louder but the music remained intact. Up and up the volume went until, at about three quarters on the readout

I could hear a bit of compression building up and the weird thing was that, even with that sort of power running through them, they did not sound obviously "loud". Far more importantly, they maintained the same perspective and view of the music that they had at more normal levels, whereas other small speakers seem to suddenly come alive at a certain volume setting, only to slumber back into the cabinets when it is retarded again.

Wouldn't it be great if all loudspeakers could do their stuff tucked away into a corner out of the way and not taking up acres of floor space? The unfortunate fact is that speakers like the Solus need just about the same amount of room as those tall slim floor-standers you've been thinking of buying. They will tolerate close sidewall placement a lot better than being pushed too near to a rear wall. That large rear-facing port plus their impressive extension and weight see to that and, if you have a good ►

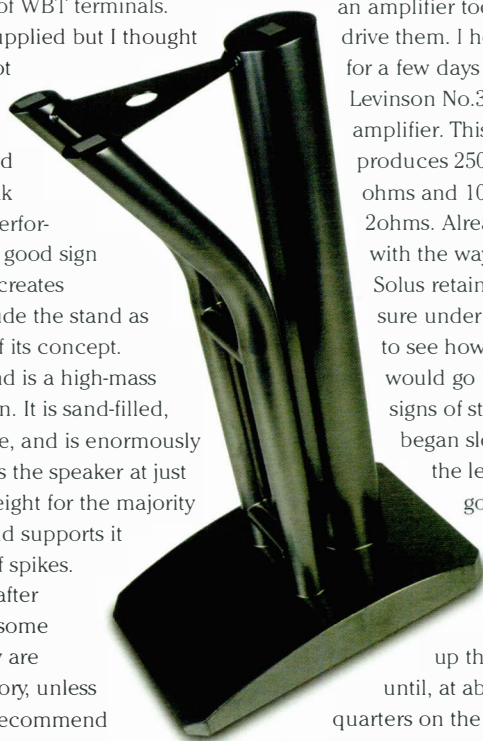

► enough amplifier, you definitely will not feel the need for any room boundary enhancement. Allowing the Ruarks plenty of air is a must. Do this and you will be surprised at the both the size of the soundstage they produce and the weight and depth of the bass on offer. I certainly have not heard a comparably sized speaker do any better in this respect and if you add a vivid sense of tone and control to the equation you have something a little special.

Lee Ritenour's Wes Montgomery tribute *Wes-bound* (GRP 97052) and the track '4 on 6' shows what I mean. The title will give you a notion of the time signature but the whole track is constructed over a very straightforward four-note riff, which subliminally runs beneath the music throughout. The Solus did a great job holding this in sharp relief to the other instrumentation as the tune progressed. The way that drummer Harvey Mason shows you what is possible time-wise over such a straightforward musical line is fascinating.

The contrast of the tonally warm, fat-bodied jazz guitar with the very precise cymbal work both locked tightly into the same "feel" was foot-tappingly irresistible. But when the horn stabs come they come with speed, weight, wonderful precision and a real honkiness that, on a good system simply cannot be confused with a programmed keyboard. This is a real horn section and they are as tight as you will hear. I really liked the Solus on this kind of recording, where their overall neatness of presentation opened the music up rhythmically and

harmonically. Their sense of "a place for everything and everything in its place" and their refusal to grow confused, shrill or remotely pushy are good attributes for a small speaker to have. They even managed to make parts of Steely Dan's ultimately disappointing *Two Against Nature* (Giant 62190 2) sound good which, given the abysmal studio sound that runs through much of this album, is no mean feat. But it did highlight a flaw

in the Solus in that they can sound a little thin and lacking body at high frequencies, not hard or ever nasty, just a little lightweight and occasionally splashy. This is at its most obvious on percussion, especially cymbals, and in particular close-miced high hats. Now the snare drum sound on the Steely Dan disc is,

I believe, one of the worst I have ever heard. It's thin and nasty with no body and is unerringly and mechanically irksome, but that on Larry Carlton's *Fingerprints* (WB 47338-2) is not. There are some superb bits of studio multi-track recording on this album if you exclude the opening track.

It has density and unexpected complexity, with all manner of reverberation types thrown into the mix.

But the drums, and in particular the top of the kit are all recorded very cleanly, and close. This was where the Solus felt less than secure in the treble. It is nothing to get too worked up about but it should be mentioned.

The Solus are a welcome addition to the ranks of small speakers. They have a smart capacity for unraveling the complexity of rhythm and though

not quite as fast and crisp as I was expecting they do bring a sense of relaxation to music that is quite rare from such a small design. They are harmonically and tonally rich though at times can sound a mite overdamped, depending on the quality of the associated equipment. Many small speakers run into a brick wall as you up the ante with better source components and amplifiers but the Solus respond better to these improvements than anything else I've heard at the price. If you are looking for a sub \$2K speaker system I recommend you put aside any preconceptions you might have about the potential for such a small box and take a long hard listen to them.



TECHNICAL SPECIFICATIONS

Type:	Two way, rear ported.
Drive Units:	150mm Bass/Mid – 28mm tweeter
Efficiency:	86dB/watt @ 1M
Bandwidth:	50Hz – 20KHz +/- 3dB (in free space conditions)
Connections:	Bi-wire WBT terminals
Dimensions (HxWxD):	330x206x330mm
Weight each:	10Kg
Finishes:	Slate textured centre with optional coloured cheeks Finished in Natural Oak, Black Oak and Natural Cherry
Extra cost finishes;	Yew, Natural Beech, Santos Rosewood and Black Piano Lacquer
Price:	£1250
Stands:	Filled tubular.
Price:	£350

Manufacturer:

Ruark Acoustics Ltd
Tel: +44 (0) 1702 601410
Fax: +44 (0) 1702 601414

Some of the *best* kept secrets in HiFi

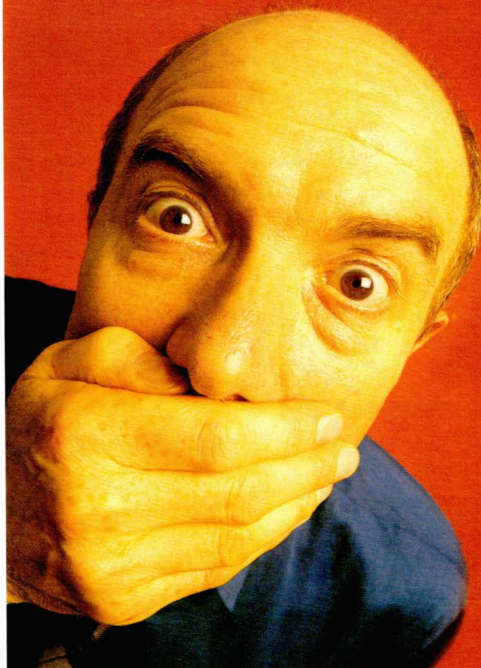

- **Aliante Loudspeakers**
Superb sound quality combined with Italian style from Pinninfarina
- **Audio Valve Amplifiers**
Valves get easy to use with automatic valve adjustment
- **Monarchy Amps, Transports and DIPS**
High end at low cost
- **Klyne Pre-Amplifiers**
Sonic perfection in pre-amps
- **Kochel Horn Loudspeakers**
The speakers Mozart would have used and loved
- **Wavac Amplifiers**
The single ended legend (100wpc!)
- **XLO Cables & Interconnects**
Simply the Best in the World

Distributed by:

W O L L A T O N
A - U - D - I - O

Wollaton Audio, 134 Parkside, Wollaton, Nottingham NG8 2NP

Telephone: 0115 928 4147

Fax: 0115 928 0625 e.mail: audio@wollaton.demon.co.uk

it sounds better **neat**



neat acoustics

tel: 01833 631021 fax: 01833 630022

e-mail: bob@neat.co.uk

<http://www.neat.co.uk>

neat ELITE

music to the **n**TH degree

THE EQUALISER...

...WITHOUT EQUAL

Introducing PASSION Phono, an entirely new state-of-the-art phono stage from the makers of ADEQ, DAX and PASSION. Featuring an RIAA equaliser created exclusively out of Vishay Bulk Foil resistors and hand-selected, precision polypropylene capacitors. Designed to guarantee the most accurate RIAA decoding imaginable and, of course, a sound quality to die for.



AUDIO
synthesis

P.O. Box 50, Nottingham NG9 1DZ, U.K.

Tel. +44 (0)115 922 4138 Fax. +44(0)115 922 9701

Website: www.audiosynthesis.co.uk

Email: salesinfo@audiosynthesis.co.uk

The **Dog'sBlocks**



*Experience the ultimate clean power source for your Hi-Fi, and we think you'll agree that they're the **Dog'sBlocks!** Once you've got the block, we've got just the lead to go with it!*

Jason Hector, Hi-Fi+ magazine said...

"...for the money, they are the biggest upgrade I have ever made."

**Music
Works**

14 Stockport Road, Cheadle,
Stockport, Cheshire SK8 2AA
Telephone: 0161 491 2932
Facsimile: 0161 428 3633



The ART-ST One Loudspeaker

by Chris Binns

Loudspeaker technology has not fundamentally changed in the last 50 years. A bold statement I know, but we are still doing much the same things that Gilbert Briggs was doing when he wrote his first book on loudspeakers in 1952. That is, stuffing drive units into cabinets. The laws of physics are still behaving themselves as far as I am aware, and the moving coil transducer reigns supreme - maybe with different cone materials, although paper is still predominant. The real advancements have taken place with our ability to swiftly and accurately calculate, simulate and measure loudspeaker parameters, largely due to messers Thiele and Small, and of course the rapid development of the computer.

But if that all sounds a bit scathing, bear in mind that there has been plenty of time for refinement, and by chipping away at the moving coil driver we have achieved some major steps forward in terms of, say, distortion. I think it is fair to say that the general standard of loudspeaker components is much improved, and with sophisticated measuring facilities available at reasonable cost, that is no longer exclusively the domain of large companies. Most commercial loudspeaker designs get what we now consider to be the fundamental parameters for hi fi reproduction in place, for example, a flat frequency response.

Perhaps there is no longer such a thing as a truly bad loudspeaker. So, if most designs are getting the basics right, what constitutes a good loudspeaker? And perhaps more importantly, is good necessarily enjoyable?

The ART STOne is a tall, but slim floor stander. There is nothing to separate it from the crowd in terms of technical innovation, and nor does it promise hitherto unreachable heights of sonic bliss. Designed and manufactured in Scotland by the same Dunlops who were responsible for the Systemdek, the approach would seem to be a combination of tried and tested technology and no compromise to the construction. With not a hint of wood or veneer in sight, the whole enclosure is covered in a black sock, capped at either end with a slab of polished slate. The visual effect is a little austere, but elegant none the less. I would imagine that in normal domestic surroundings and placed near a wall they would look quite discrete.

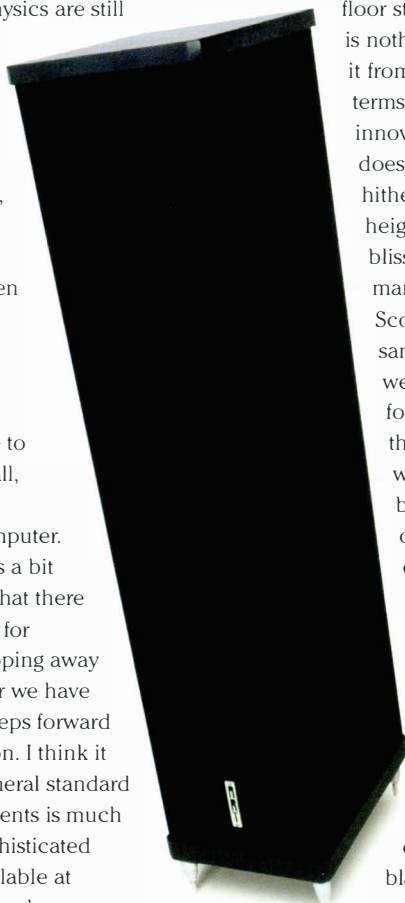

They are extremely solid. The enclosure is constructed entirely of 30mm mdf with plenty of internal bracing to render it virtually inert. There has in the last decade, been an argument against small stand mount loudspeakers based on the reasoning that you may as well utilise the volume where the stand is to have more cabinet whilst not taking up any more floor space. It also offers an opportunity for manufacturers to offer 'more speaker for the money'. That's fine, but the penalty you pay is that larger panels are far more likely to vibrate and resonate and hence colour the sound. I make this point because there are a large number of slim, floor standing loudspeakers at the budget end of the market offering lots of cabinet for your money, but in reality the structure is probably less rigid than the packaging that they came in. Not so with the ART's. The sheer fact that they are extremely heavy tells you something, whilst rapping them with your knuckles is both painful and unrewarding.

Because I am interested in this sort of thing, and I happened to have a stethoscope in the house (don't ask...)* I played some fairly lively music through the ST ones while running the stethoscope over the

* Much as I would like to tell you that the stethoscope was in the house for a grown up game of doctors and nurses, the sad truth is that it is a very useful tool for evaluating systems. Want to know how effective the coupling between your speakers and stands is? Listen to the energy in the stand, with the music playing of course. Vibration through your turntable? The list is endless.

▶ side panels.... to reveal almost nothing – which, of course is the way it should be. The less the cabinet contributes to the sound the better, and with large panels it only takes a tiny amount of vibration over the surface to swamp the output of the main drivers with all sorts of coloration.

So, one very dead cabinet, containing three drive units. Bass and mid are handled by two 5" units built by SEAS in Norway to a specification for ART. Fitted with a phase plug and a polycarbonate cone, a lot of time and effort has been spent in getting this diaphragm to behave itself without the aid of too much equalisation. In other words, only a relatively simple filter network is required to cross it over to the tweeter, which sits in between the bass mid units in a classic D'apollito arrangement.

Up until the mid sixties (or thereabouts), high frequencies were usually handled by small cone type units, with the odd innovative, and usually expensive alternative, such as electrostatics and the legendary ionic designs. As an aside, if you have ever heard one of the Fane Ionophone units it is quite an experience; there are no moving parts at all, except the air.

The introduction of the dome as a diaphragm offered many advantages over the cone in terms of performance, and the last 30 years have seen countless variations on the theme. From rigid types such as the ubiquitous KEF T27 which used a hard plastic called Melinex, through to the 'soft dome' types which reigned supreme in the seventies, there have been distinct trends or fashions in the type of materials used. When, in 1982 Celestion introduced the SL-6 loudspeaker with a metal dome tweeter, within months most manufacturers were advocating the use of metal as a diaphragm material, for better or for worse.

At about the same time, a little

known French company called Focal started producing a rather interesting high frequency unit with a fibreglass diaphragm, which in itself was nothing new, but the fact that it was concave as opposed to convex, was. A return to the cone? Well, not quite, although the dispersion pattern was quite similar – more directional than the standard dome. Nobody seemed to really notice these units until fairly recently, where variations on the design have become de rigeur in high-end designs such as the Wilson Audio loudspeakers. The reason I am telling you all of this is of course because



the ART uses a Focal tweeter. The diaphragm is made of Titanium oxide, which is rigid but light in weight, and has a degree of useful inherent damping. The tiny, and again very light voice coil drives the diaphragm about half way down its radius, ensuring good piston movement over a wide bandwidth. The only area which has been subject to some criticism is the mounting plate, which in this particular model is plastic. ART actually dispense with this and machine their own plate from aluminium, giving greater rigidity and thus better coupling to the cabinet.

The two bass units are reflex loaded by a substantial port which fires downward, and the well-machined steel feet and cones ensure that the right distance is maintained between cabinet and floor for correct operation. It should also make them relatively immune to placement near a wall, traditionally a problem with ported enclosures. The crossover is constructed from high quality components, providing second order slopes for the bass-mid and third order for the treble.

The theory on placement was borne out in practice. Installing the ART's in my living room I opted for the most popular position, which is toward the middle of the room with plenty of space behind and around them. With a loudspeaker of these dimensions I would think that a lot of domestic situations would dictate that they would have to be sited against, or at least near a wall, so I also spent a certain amount of time using them in that configuration, as I will report later. Meanwhile, I had one major problem, cats. Normally

Fat Bastard and his sister show a healthy lack of interest in loudspeakers, due in no small part to learning at an early age the perils of open electrostatics – and before you call the RSPCA, we avoided any fireworks, but only just.

But obviously the fully cloth covered ST One proved too much of a temptation for FB, and I came in one evening to find him performing acrobatic stunts, presumably under the misapprehension that what he was clinging on to was a scratching post. Which left me with the embarrassing problem of explaining to the manufacturers why there were lots of tiny holes in the cloth.

The units I had for review had done most of the required running in, but I still left them running unattended for a day or so before listening. ▶

► When the time came, the first thing that struck me was a certain familiarity to their character, which I suppose is hardly suprising as the loudspeakers that I normally use also employ a variation of the Focal tweeter. As a result, I found it very easy to absorb them in to the system with little adjustment.

And there they stayed for many weeks, partnered mainly by the Primary valve amps and connected with either Nordost SPM or Chord Odyssey cable.

Much to their credit, the ART's did not really draw attention to themselves, and I just got on with listening to music, as I would normally do. If that seems slightly negative, let me back that up by suggesting that the prime function of any audio equipment must surely be to reproduce music without getting in the way, and the ST-Ones singularly failed to get me into reviewer mode.

Bass response was well defined and even, with good extension, while the rhythmic content of music was conveyed with integrity. In my room there was no discernible emphasis on any bass notes, suggesting a very effective port arrangement. The midrange was fast and highly detailed, with excellent integration to the top end, which was again detailed and very open. There was no hint of the slight zing that can sometimes accompany the Focal tweeter. But dissecting the performance of the ART's is difficult. Their greatest strength lies in their ability to present music in a coherent manner; a feat which many more sophisticated designs fail to pull off successfully.

I'm still avidly listening to a Chandos recording of Dyson's Violin Concerto, and with the ART's in place all the textural subtleties of the music were gloriously intact. From the surreal opening of the first movement to the entrance of the violin, the sense of unease and drama was conveyed to great effect, with a good spacious soundstage and plenty of depth. The lack of cabinet coloration made

listening to small scale string music very satisfying, the sound of each instrument was quite distinct with no sense of blurring or hollowness apparent, but with a very definite sense of the musicians playing together as a unit. At the other extreme, rock music came across with plenty of energy and plenty of detail, and nice percussive transients. The only short-coming I found was that in my admittedly large living room, bass heavy music (recordings from Real World studios being a good example) caused some distress at high volumes. There is only so much air that two five inch units can move, and playing an album by Dark Star - *Twenty Twenty Sound*, at the kind of levels that I wanted to, the (heavy) Steve Lillywhite production was causing the bass units to work very hard.

Moving the speakers to a wall position had suprisingly little effect my room. The upper bass thickened up a touch, and some of the midrange projection was masked by this, but I suspect that in a smaller room the overall balance will still be maintained and there will be no shortage of available level. Perhaps more importantly, the ST Ones do not require

masses of power to do this, and they also present a relatively benign load to the amplifier. As they are not too demanding, they should work with a wide range of amplification that can be selected on sonic attributes, rather than driving capability.

And of course, a kind impedance curve means that the use of single ended triodes is a distinct possibility for a change.

I had to hand the Densen Beat pre-power amps and pressed them into service with the ART's. It was a great combination, maximising on the dynamic control that the Densen has, and sounding highly engaging and musical.

The ART ST-One is a fine loudspeaker. It manages to reproduce music in an essentially non hi-fi fashion, which puts it in something of a minority regardless of price. For this kind of money there are other designs that are technologically more advanced, and no doubt can offer better performance in certain areas. Hey – that's hi-fi. But the ART's are music. The biggest compliment I can pay them is that once they were in my system, I forgot about them. ►+



TECHNICAL SPECIFICATIONS

Frequency response:	45Hz - 20KHz +/- 2dB
Sensitivity:	89dB/2.84v 1 /1M
Impedance:	8 ohms
Dimensions (HxWxD):	1090 x 227 x 327
Weight:	70Kg
Finish:	Black Fabric / Slate
Price:	£2000.00

Manufacturer:

Acoustic Reproduction Technology Ltd.
 Tel. (44) (0)1292 319416
 Fax. (44) (0)1292 319416
 E-mail. into@loudspeaker-art.com
 Net. www.loudspeaker-art.com



Tom Evans Audio Design



Tom Evans Audio Design



The Real Deal

Tom Evans' Audio Design 'Micro-Groove' Phono Stages

by Roy Gregory

The emergence of the original Michell Iso some ten years ago was the audio equivalent of the 'shot that rang around the world' at the start of the American War of Independence. Not many people actually heard that lone discharge, nor did it actually cause the war, but it marked the culmination of a series of events, and we're all still living with the consequences.

The Iso was the first generally available, stand alone, moving-coil to line level phono amplifier. It marked both a point of no return, and the dawning of a bright new era. On the one hand, from this point on we all accepted that vinyl was marginalised as a mainstream source. From this point on you were going to have to pay extra if you wanted it. On the other, the elevation of phono stages to the "specialist" realm removed them from the status of electronic after thought and brought a welcome leap in performance. Like I said, the Iso didn't cause any of this, nor was it an overnight occurrence, but this unassuming little plastic box certainly gave the whole sequence of events a very healthy shove simply by recognising this situation and establishing a new status quo.

The reasons for the Iso's staggering success were two-fold; it was the right product at the right time, and it offered sensational performance for the money. It may not have looked like much (in an industry which is notoriously guilty of equating quality with physical mass),

but for \$400 it granted access to the hallowed halls of serious phono performance, previously the exclusive reserve of high-end heavy hitters like Audio Research, Vendetta Research and Spectral. Indeed, in terms of phase coherence and transparency, it set new standards.



The Iso was Tom Evans' first product as an independent designer, and both it and he have travelled a convoluted path in the intervening years. Yet fittingly, just as the original Iso bows out, Tom has launched his crowning glory, 'The Groove', a no holds barred phono stage which sells for £1500. And just as the original Iso upset the high-end apple cart, 'The Groove' has ruffled more than a few feathers, as well as fixing its fair share of inane grins on previously morose mugs. The problem of course is, not everyone can afford £1500 for a phono stage, so with that in mind, let

me introduce its little brother, the 'Micro-Groove'.

At this point, Iso owners could be forgiven for doing a double take. Yes, it does look similar to say the least, but closer inspection will reveal a number of important developments. The familiar perspex case work is larger than before, by ten percent or so, but more importantly, so's the socketry. Gone are the nasty PCB mounted phono sockets, the push in three pin from the power supply, and thankfully, the fiddly little earth post on the underside. Instead you get solidly mounted and well spaced phonos, a screw home power plug and a nice big earth post, all arranged on the back panel, along with a power LED to tell you that it's on. The plug top power supply has been improved and very slightly enlarged too (I was never a fan of the massive Hera transformer when used with the Iso, feeling that it lost more on the swings than you gained on the roundabouts). Decoration is limited to the same sticky labelling that graces (or should that be defaces) original models of 'The Groove', although the big version now comes with the option of an engraved front plate. Inside, the circuit has more than a little in common with its illustrious forebear, although higher performance silicon is used throughout. Otherwise, consider this as an evolution rather than a revolution. Gain and cartridge loading are still individually matched ►

▶ to the purchaser's cartridge, a system which seems limiting at first but which actually maximises performance whilst dispensing with a set and forget adjustment that most owners will rarely if ever use. The phono stage comes in three basic versions to suit cartridges with outputs between 0.1mV and 0.6mV, greater than 0.6mV and moving magnets. The manufacturer simply selects the appropriate model for your cartridge and then trims the gain and impedance accordingly.

But the best news I've kept 'til last. The Micro-Groove costs £400, which is the same price that the Iso started at! What's more, it's upgradeable, another £300 buying you Lithos regulation of the type used in 'The Groove' proper, effectively turning the starter unit into half of its dual-mono big brother. Scary. (There's also a switchable equalisation version available to special order and called the 'Shellac'.... Okay, I'm only joking!)

The 'Micro-Groove' is simplicity itself to set-up. The nicely spaced sockets provide solid connections,

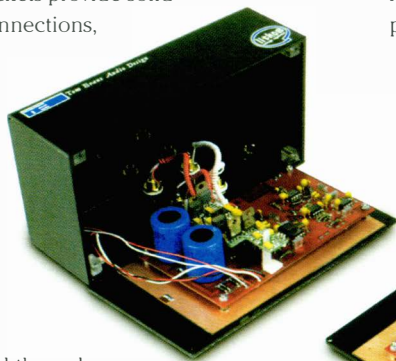

and the only real concern is positioning, which wants to be relatively distant from large transformers and other hi-fi equipment. It likes a light-weight support, and wood is better than glass or metal (especially steel). Otherwise it's just a case of plug and play. Burn-in takes about a week, and the unit should be left powered at all times. Unfortunately, simply leaving it cooking isn't enough, and the 'Micro-groove' needs to pass a good few hours of

signal before its tonality settles down. From the off it sounds pinched and bright, but the more you use it the more its harmonics will round out and fill the sound with some much needed substance and body.

The obvious place to start is with a comparison to the original Iso. The one I had to hand was a late production model, but running from a better power supply than the plugtop normally supplied. A smaller transformer than the Hera, it seems to carry all the latter's benefits, without its muscle bound downside. Inserting it into the system produced that same warm sense of comfortable familiarity that you get arriving home from a long holiday. The winning combination of transparency, organisation and musical coherence was instantly recognisable, and just as musically valid as when I first heard it ten years ago. With the normal attention paid to siting, and amplifying the healthy output of my ClearAudio Accurate, noise levels were low and performance completely trouble free.

With both units connected and warmed through for

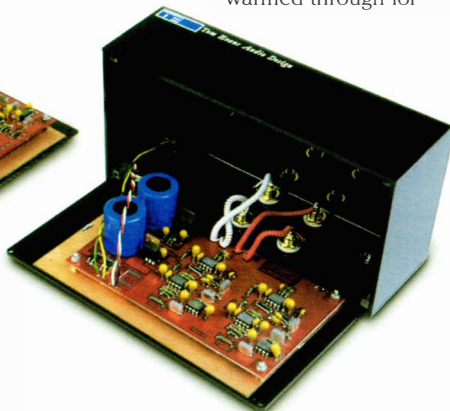

several days, I played half a dozen tracks on the Iso, just to re-familiarise myself before switching to the 'Micro-Groove', and very nice they were too. But swapping to the newer incarnation revealed a far more resolute performance. Greater top to bottom transparency

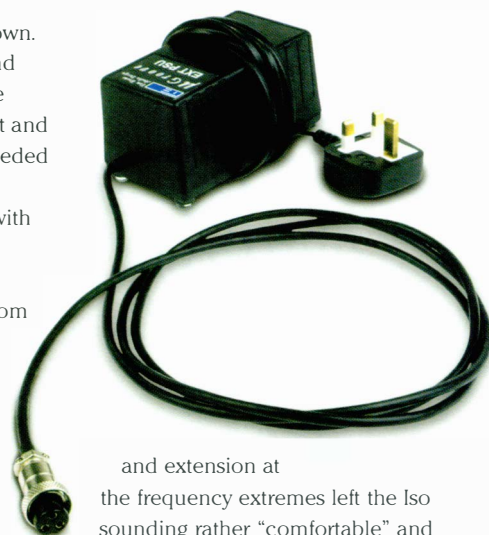

and extension at the frequency extremes left the Iso sounding rather "comfortable" and rounded off, lacking its offspring's clarity and bite. In fact, the 'Micro-Groove' sounds exactly like what it is: a cleaned up and altogether more solid evolution of the Iso, retaining the older unit's musical integrity, but offering greater insight and overall clarity. Which begs the question, should owners of the Iso chop it in for the new model?

Well, that depends. If you are running the Iso as a way of enjoying an existing record collection while your main musical focus has switched to CD then the answer is probably no. Assuming you'd get around £200 for your old unit, the £200 cost of replacement could be better spent elsewhere. However, if you've recently rediscovered vinyl and see yourself as a candidate for future upgrades then a change is well worth considering, for one reason and one alone; Lithos. There is of course, nothing stopping you having the Lithos regulator fitted to your Iso, but to really get the full benefits of the improved noise performance the increased transparency of the 'Micro-Groove' is essential.

Comparisons between the standard 'Micro-Groove' and the 'Plus' version are little short of astonishing, considering that the signal circuitry is identical. The Iso established itself as the benchmark for acceptable phono performance, a position that was ▶

▶ never seriously challenged. The 'Micro-Groove' comfortably inherits that mantle, but the 'Plus' is something else entirely. Compare the two and you'll see what I mean; get used to the 'Plus' and you'll wonder how you ever found the cheaper models acceptable.

So what does the Lithos regulator bring to the party, apart from a blue LED rather than the standard green one? In a word, clarity, but clarity in every sense. There's an obvious gain in transparency and solidity of the images, and the whole sound stage becomes far more defined and stable. But these are merely the most obvious symptoms. That improved definition applies to the leading edge of notes, their harmonic envelope and decay. In other words, the 'Plus' has far greater low-level accuracy, and here's the interesting bit; unlike most "accurate" hi-fi which generally sounds as dull as dish-water, the Lithos-ed 'Micro-Groove' sound altogether more musical and involving. The dramatic increase in low-level resolution produces music that is full of immediacy, presence and sophistication.

Now the immediacy and presence are easy enough to understand, given the increased transparency and harmonic definition, but what's this sophistication? The increased definition of individual notes has clear temporal as well as spatial implications. Because we can now tell so much more clearly where individual notes start and how long they are sustained, the relationship between notes, and precisely where and how the musicians place them becomes much more apparent. This provides a direct insight into the chemistry of the performance, the interplay of the musicians, bringing the whole thing to life. Forget rhythmic

integrity as an issue, here's the entire musical skeleton, clear to see. (For more on this see the reviews of the Final Music amplifiers in Issue 2, and 'The Groove' in Issue 4.) The 'Micro-Groove Plus' might not match the astonishing, almost master-tape solidity, presence and authority of its more expensive brother, but it gets you a fair way along the same road. In order to



understand why that should be, it's necessary to appreciate exactly what the Lithos regulation achieves.

Built from fifty discrete components onto a small pcb, the Lithos circuit is around a thousand times quieter and fifty times faster than the high quality Linear Technology 317AT/337AT ICs used in the standard 'Micro-Groove', and those are amongst the best conventional regulators available. The result of this is that not only does the circuit running from the Lithos regulator get power devoid of the overlaid ripples and distortion that the vast majority of signal circuits have to tolerate, but the circuit can react faster and to smaller signals, retaining their contribution and correct position in the overall picture. It's this that makes the 'Micro-Groove Plus' sound so stable and immediate, and makes it communicate the musical message so directly. It's this which

moves you so much closer to the original performance.

If the 'Micro-Groove' establishes a new benchmark, then the 'Plus' sets the standard for others to aspire to. No it doesn't match the astonishing performance of 'The Groove', but then it doesn't cost £1500 either. What you get at £700 is enough of 'The Groove's' attributes to seriously embarrass the (much) more expensive competition.

You also get an immediate improvement in the performance of every record you own. Remember, the Lithos technology means that the 'Plus' provides performance potential that simply isn't possible from phono-stages using conventional regulation. This isn't just an upgrade, it's a new set of rules. The standard 'Micro-Groove' extends the Iso's reputation and is a very worthwhile evolution. The 'Micro-Groove Plus' is a far more radical beast. It brings the revolutionary technology of

'The Groove' down to a far more affordable level, and lets you get there by stages too! Believe me, you really haven't heard what's on your records. ➤+

TECHNICAL SPECIFICATIONS

Input:	1 pr RCA phono
Output:	1 pr RCA phono
Sensitivity:	>0.1mV
Loading:	User Specified
Bandwidth:	DC -80KHz
Output Impedance:	12 Ohms
Dimensions (WxHxD):	200 x 70 x 125mm
Weight:	0.5Kg
Prices:	
Micro-Groove;	£400
Micro-Groove Plus;	£700

Manufacturer:

Tom Evans Audio Design
Tel/Fax. +44 (0) 1443-833570
E-mail. bill.pilcher@ex-cell.co.uk
Net. www.besthifintheworld.com

Imagine the London Philharmonic playing
Mozart in your living room.
Ella Fitzgerald giving you a personal
performance. **The Rolling Stones**
entertaining at your party

Choice Hi Fi can arrange all this. Our Hi Fi systems take you right inside the concert hall, the club the recording studio recreating the atmosphere, emotion and pleasure of the original performance.

At **Choice** Hi Fi we make the process of acquiring the ultimate system simple and straightforward. With prices ranging from £1,500 to £150,000 each system is uniquely tailored to suit your decor, lifestyle, budget and of course musical taste.

We provide a complete consultation, installation and after sales service, leaving you to enjoy your system to the full, with complete peace of mind. Once on the road to Hi Fi Nirvana, the temptation to upgrade can be strong.

So **Choice** Hi Fi offer a generous part exchange or trade in policy. We therefore also have a wide range of perfect previously owned equipment from which to choose, which further increases your buying power (see our classified ad).

Visit our London Showroom by calling us on

020 8392 1963

STOCKIST OF

Acoustic Energy, Advantage, Alon, ATC, Audible Illusion, Audio Physics, Boulder, Bryston, Cary, CAT., Chord, Clear Audio, Denon, DNM, Dynavector, Eggleston Works, Graham, Michell, Musical Fidelity, Oracle Analogue and Digital, PMC, Plinius, Rockport, Shahinian, SME, Stax, Tara Labs, Target, Teac, Totem, Transfiguration, Trichord, Trilogy, Van den Hul, VPI, Wilson Benesch, XLO, Zingali

DVD Players now available from Sony, Panasonic and Pioneer

People who love music choose Choice.

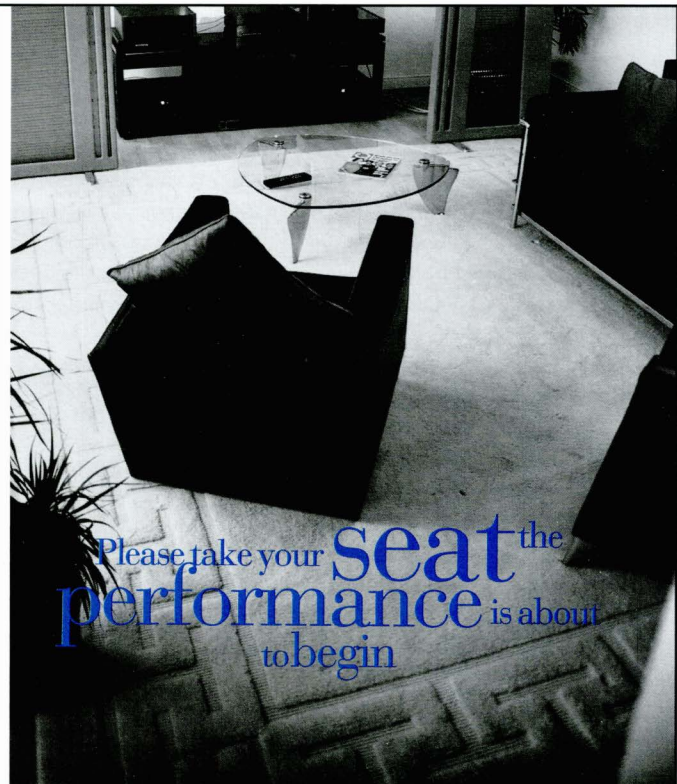

Please take your seat the
performance is about
to begin

*record cleaning machines: record cleaning fluid: tonearms:
turntables: incognito arm cables: arm rewire: pearl coolers:
sovtek tubes: thirty series amplifiers: phono stages: power con-
ditioners: spur installations: cables: headphone amplifiers: dis-
tribution boards: ben duncan projects: distribution boxes:
amplifiers: cartridgeman products: test lp: test cds: stylus bal-
ances: leyline cable systems: mains cables: accessories: ringmat:
statmat: decca cartridges: audiophile vinyl: audiophile cds: car-
das: densen: michell:
hfn accessories: record/cd care:
books, books & more books!*

moth
GROUP 

Moth Group. 10 Dane Lane, Wilstead, Bedford, England. MK45 3HT
Telephone ++44(0)1234 741152 Fax ++44(0)1234 742028
e-mail: moth@britishaudio.co.uk www.britishaudio.co.uk

3 reasons why...

www.
hifisale
.com

Our brochure

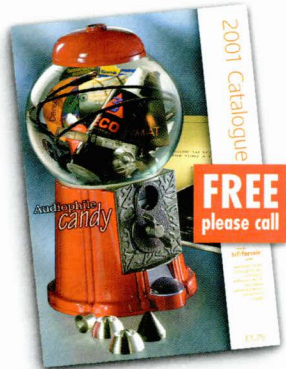

Our web site



Our selection



...you should call 0870 2412469



www.hne.co.uk

*dedicated support and loudspeaker systems
handcrafted from exotic natural granites and solid
hardwoods for extreme stability and balance of
low and high mass damping*

visit our website, e mail info@hne.co.uk or
tel/fax 01777 708673 for further details



our new 'nonpareil' 16.03 loudspeakers ▶

▶ over 130 dedicated Cableway® loudspeaker stands

▼ modular racks, upto 1200mm wide, 600mm deep in custom heights ▶

over 120 dedicated Isolation plinths® ▶



also turntables plinths
amp plinths
new Krell range



Furniture Wars

by Roy Gregory

More and more companies seem to be catching onto the non-ferrous school of furniture thought, as well as beginning to appreciate that domestic acceptability demands more than coloured paint and glass shelves. The latest products to cross our path are again indicative of the changes afoot in what used to be one of hi-fi's more stable markets.

First up is the latest design to spring fully formed from the creative imagination of Derek Whittington, the man who brought you the original SoundStyle Tripods, a stacking system that was amongst the first to break the angle iron aesthetics that dominated early equipment supports (remember the original Audiotech and Sound Organisation tables?). Actually, this time around it's more of a cooperative venture with Chris Bampton of Isoblu. Well, whoever's responsible the Isoblu racking system shares all the good points of its spiritual predecessor and throws in a couple of extras too.

Another stacking system, this one is based on massive MDF shelves and solid wood uprights, standing on a separate, spiked baseboard, rather like the Hutter system that so impressed Jason. In fact, outwardly at least, the Isoblu and Hutter are superficially similar, but in this case appearances are deceptive. Rather than the Hutter's multi layer construction supported on aluminium spacers, the Isoblu employs MDF for its shelves and solid wood for its

uprights. The uprights are triangular in section, cut to a knife-edge that simply locates in a groove in the top of the baseboard or shelf below. You can vary the spacing of the shelves by fitting full-depth hardwood spacers between the uprights and the shelf they support. The whole thing is held together with dowels, and whilst, once loaded the inherent stability of the design makes those unnecessary, they don't half make it easy to build. All you do is choose sections of an appropriate height and then stack them up in whatever order suits. The baseboard is equipped with either nice heavy M8 spikes or threaded 'skate' feet to allow for levelling, and that's



the sum total of the metal in the system.

In use, it's difficult to exaggerate the practical elegance of the Isoblu rack. Any stacking system means that you can build from the bottom, wiring things up a layer at a time as you go, but the Isoblu shelves can be slid forwards and backwards once the stack is complete, making access to

your equipments' rear panels an absolute doddle, regardless of depth (or lack of it). Being totally modular also means that shelves and uprights can be interchanged so that if you damage the surface of the top shelf you can always replace it with one from lower down the stack. Likewise, spacers can be added or removed in order to accommodate changes in equipment. The end result is compact and extremely stable in a 'confidence inspiring' sort of way.

None of which would really matter if it didn't do the business sonically. Fortunately (and not surprisingly, given its pedigree) the sonic benefits are both obvious and substantial. To date, I've only heard it for a short time, and in the context of a Naim set-up, but I'm already a convert. The improvements in bass depth, texture and tunefulness, as well as midrange separation and overall tonal palette, compared to a (admittedly much cheaper) Quadraspire rack weren't just worth the difference in price, they produced a fundamentally more balanced and rounded musical result. Rhythmically there was greater expression and variation, the increase in space around notes making the musician's placing and pacing both more apparent and more relevant. In fact, the influence was entirely positive, to the point where I'm positively looking forward to trying the Isoblu rack with other systems and equipment. If first impressions are anything to go by then this could represent just as big a change in ►



► the status quo as the original tripods, way back when.

The Isoblue rack is very much a work in progress, with a single pale ash finish, and one shelf size that comes with 100mm uprights as standard. Spacers are available in 35mm and 65mm options, allowing for a maximum shelf space of 200mm. However, the beauty of the system lies in its ability to grow and evolve according to demand, and I expect the options to expand pretty quickly. There are already plans for a darker wood finish, probably available before Christmas. Current prices are around £100 for a base or shelf and uprights, with the spacers costing an extra £30 a pair.

For further information, contact:

Isoblue Ltd
Tel. (44)(0)1332-875700
Fax. (44)(0)845-3020150
E-mail. design@isoblue.com
Net. www.isoblue.com

The Timbre Stage stands are a completely different kettle of fish. They come from a company that earns its living in the highly competitive world of office furniture, and believe

me, it shows. This really is furniture.

The uprights are solid aluminium, and yes, they are as thick as they look; the glass shelves are rebated into the sculpted MDF frames, and supported on small plastic feet that serve as dampers. But these stands are more than a simple exercise in conspicuous consumption. Considerable thought has gone into their design. The tripod layout is inherently stable, while the adjustable feet finish the uprights aesthetically as well as mechanically. Curved plywood sheets form a flying shield at the back, drilled to allow access for cabling whilst hiding the excess from view. The shelves themselves are available initially in two sizes and two shapes, and despite appearances, each size employs the same footprint whether the chosen shelves are round or oval. The spacing and number of shelves can be

varied through the use of different sized uprights, the top layer being finished with beautifully turned aluminium caps.

There's no doubting that the finished effect is striking to say the least, however, the aesthetic dictates do have some serious practical implications. The smaller stands are far and away the most acceptable from the point of view of size. The larger ones are enormous, especially in terms of depth, and anything other than corner siting is unlikely to be practical in the majority of households, which whilst it provides a perfectly concealed cable 'duct' is of course, far from ideal in acoustic terms. In practice, even the oval shelves in the smaller size have trouble accommodating the footprint of conventional separates. This is less of a problem than it might at first seem, as the racks are supplied with the option of small aluminium pucks, which are used to space the equipment from the shelves and their



surrounds, similar in concept to the isolation blocks used by A Cappella in the System La Musica featured elsewhere in the news pages. The round rack is to my eyes the most appealing, but unless you have narrower than standard equipment from the likes of Linn, Meridian or Michell, then size will be a problem. If however you do own products from those companies then the results are superb, to the extent that Michell are now actively recommending the Timbre Stage supports. And if you want to really go to town you can always go for the solid polished aluminium shelf frames – at a price.

So far, listening tests have been extremely promising, but with so many variables to consider (equipment on pucks or sitting directly on the shelves, the number of damping blobs, the shape of the shelves) the results are

also pretty variable. Expect a full review in the next issue.

The Timbre Stage racks are available directly from the company themselves in a variety of finishes: black, silver or natural MDF for the frames, black or Beech for the plywood cable shields. The uprights are

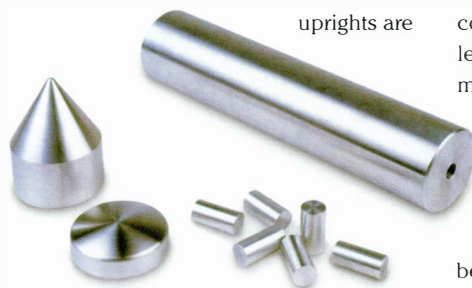

only available in brushed aluminium. Prices depend on the shape and number of shelves, but as an example, the small oval shelf (Evolution Annexe) rack shown would cost

£880, or £220 a shelf. The larger version would cost £980 or £245 a shelf, whilst the one with solid aluminium frames is a cool £3500 (a whopping £875 a shelf) in the large size. That puts it on a par with the Aavik titanium rack reviewed in Issue 6. Hopefully we'll be able to find out whether it compares sonically as well! However, leaving such extravagance aside for a moment, the MDF versions represent pretty good value when the engineering and finish are taken into account. The Timbre Stage products may not be cheap, but then they are beautifully designed and built.

For further information:
Timbre Stage
Tel. (44)(0)118 974 2333
Fax. (44)(0)118 979 7105
Net. www.Timbrestage.co.uk



On-Line Accessories

www.

hifi**for**sale

.com

Many of the more interesting accessories that have featured in the pages of Hi-Fi+ aren't exactly easy to get hold of. We receive an awful lot of phone calls from interested readers wondering where they can actually get to hear some of these cost-effective upgrades, and unfortunately it's not always as easy as a visit to their local dealer. One of the most consistent enquiries has been for the Clearlight Audio RDC products which we hold in such high regard. As a result it's something of a relief to be able to tell you that a new, on-line accessory company, hifi**for**sale.com, now has stock of all the RDC product.



Hi-Fi+ supporting an internet retailer? Shocking I know, but in this instance it does make sense. As well as the Clearlight products, hifi**for**sale.com also offer a whole host of other hard to get accessories, such as the Audio Prism CD Stoptlight, the ART Q Dampers and Allsop's manual record cleaning system, the Orbitrac.

The benefit of the mail-order set-up (use of the net being a simple extension

of the marketing status quo, despite the current media/political hysteria) is that it offers customers the opportunity to try products at home with a straight money back guarantee, all for the cost of return postage. Given that many of these accessories are unobtainable from conventional dealers, are system and situation dependent, but can make a very worthwhile difference to the sound of your system, it looks like a win-win situation to us. You can find [www.hifi**for**sale.com](http://www.hififorsale.com) at their web address, or you can contact them more conventionally on:

Tel. (44)(0)870 241 2469
Fax. (44)(0)1256 851486
E-mail. [theteam@hifi**for**sale.com](mailto:theteam@hififorsale.com)



Calling all SME owners...

by Roy Gregory

There are no better hi-fi tweaks than the free and reversible kind.

Try it: if you like the results then great, and if not, simply put it back the way it was. I love 'em, mainly because it's a way for people to get into, and quite possibly improve their system without it costing them a bean. So I was especially chuffed when the inimitable Kevin from Definitive Audio (the fact that the shop's name can readily be shortened to "Def Audio" should in no way undermine your confidence!!) recently demonstrated the following simple upgrade for current SME tonearms.

Of course, you need to actually own an SME arm to benefit, but with the shrinking number of tonearm options on offer, there are a lot of analogue fans that do. Yet for every person who marvels at the engineering, consistency and finish of the SME products, there is another with reservations about the sound: heavy, rhythmically slurred and shut-in, or so the detractors would have it. And I'll admit to some sympathy with their view, although mechanical termination and turntable matching certainly have their part to play. Regular readers will know that I constantly recommend SME owners to invest in the superior internal wiring from the Gold version, along with a better quality lead out cable or termination box, and these changes go a long way to creating a more balanced sound - at a price. Indeed, the improvements are noticeable enough for SME to offer a very worthwhile silver hybrid version of the vDH D102 arm cable as an optional upgrade (£148.10 as a separate item,

£45.54 if ordered with the SME 5). Not cheap then, but a substantial improvement.

Kevin elicited a similar level of improvement for free!

One thing that all the current SME arms have in common is the small bridge that links the two sides of the bearing cradle. What most people don't realise is that this part is purely cosmetic, held in place by a pair of allen bolts. Its purpose is to hide a screwhead



that disfigures the otherwise pristine armtube. Removing it takes seconds. Replacing it can be similarly rapid, but involves considerable care, as the fitting of the bridge is part and parcel of the original bearing set-up. Over-tightening the bolts could place torque on the bearing cradle and ruin the tolerance of, or even seize the vertical pivots. If you are going to replace the bridge do so with the utmost caution, don't over-tighten it and don't expect any sympathy from SME if you do. You are after all, tinkering with their baby. This is a case of nipping up snug, and definitely not torquing down

a la Linn. You have been warned.

I've spoken with SME about this, and they are aware of the mod but prefer the arm as delivered, underlining the caution required in refitting the bridge. So, if you proceed, bear in mind that you do so in direct contravention of the manufacturer's advice.

However, for me what makes the whole exercise worthwhile is the improvement in sound that results. The music gains air, life and dynamic freedom, leaving the old, slightly sat-on quality way behind. It also becomes rhythmically more agile and dynamically more purposeful, lending performances more drama and spontaneity. How big a difference are we talking here? I've done the demonstration for a fair few people now and all agree that if this were presented as the difference between the resident 309 and a much more expensive arm, then they'd be opting for the pricier product every time. And no they didn't know what had been done.

The thing I like about this tweak is that it attacks exactly those areas where the SME arms are traditionally criticised. It does nothing to dilute their strengths (other than the aesthetic results of removing the bridge) and can be reversed with care. Because of that, you are gaining performance in areas that a simple upgrade from a 309 to a 5 won't address. Having used the 309 'naked' I'll not be returning it to stock form. Once you've heard the benefits I doubt you will either.



Joe Jackson

- A Cure For Gravity

by Phil Ward

I suspect I'm about to give our esteemed editor apoplexy. See, I'm going to start this review with my conclusion and, worse, go completely over the top - thereby breaking the two most important rules of writing reviews. But what the hell, I've always wanted to rebel a little so here we go.

This is a terrific book and everybody should read it. See, I've done it, and it wasn't too painful. Now comes the qualification. When I say everybody I mean, well, anybody that's ever played an instrument or fooled around in a band; certainly anybody for whom music is at, or near the soul; definitely anybody who felt isolated as a kid or was bullied at school; without a doubt anybody who grew up in the 60s and 70s, and, of course, anybody who's enjoyed Joe Jackson's music over the past twenty-two years. I guess that covers pretty much everybody who's likely to be reading Hi-Fi Plus.

And "terrific"? Yes it really is that good. Joe Jackson turns out not only to be a great writer with a touching, funny (often hilarious), and heart-warming story, but one of the most eloquent and passionate advocates for the deeper power and importance of music I've ever read. Jackson grew up a shy, sickly and awkward kid in 60s and 70s Portsmouth and only a prodigious talent for music - one that he alone discovered and developed with little help from his parents or his school - saved him, as he writes, from

ending up like "the sad bastards who mill around outside pubs at closing time looking for a fight". Long before he found the niche for those near perfect, jazz tinged, ironic pop songs that we all know and love, his talent took him all the way through a classical music education to a degree in percussion from the Royal Academy of Music. Of all the songwriters that found fame on the crest of new-wave, Jackson was undoubtedly one of the very few genuine, piano playing, multi-stave sight reading, thinking, analysing musicians - he just never really let on.

A Cure For Gravity takes us up to 1978 when A&M's David Kershbaum did the World a favour and took a punt on Joe Jackson. The long dreamed of record deal was finally signed and Look Sharp was recorded at Eden Studios in West London. I suspect it will never happen, but knowing, through the later recordings, a little of how Jackson's career and music developed, I'd love to read the following twenty-two years worth,

but I guess we'll have to make do. Some "make do"! For anyone that came to hi-fi primarily through a love of music, A Cure For Gravity is, for my money, as close to required reading as makes no difference. Highly recommended.

A small postscript for UK based loudspeaker engineers: The Dave Barfield who gets many a mention in Jackson's book is indeed the same Dave Barfield who works as Sales Manager at one of the well known component suppliers. I already checked. Small world huh? 

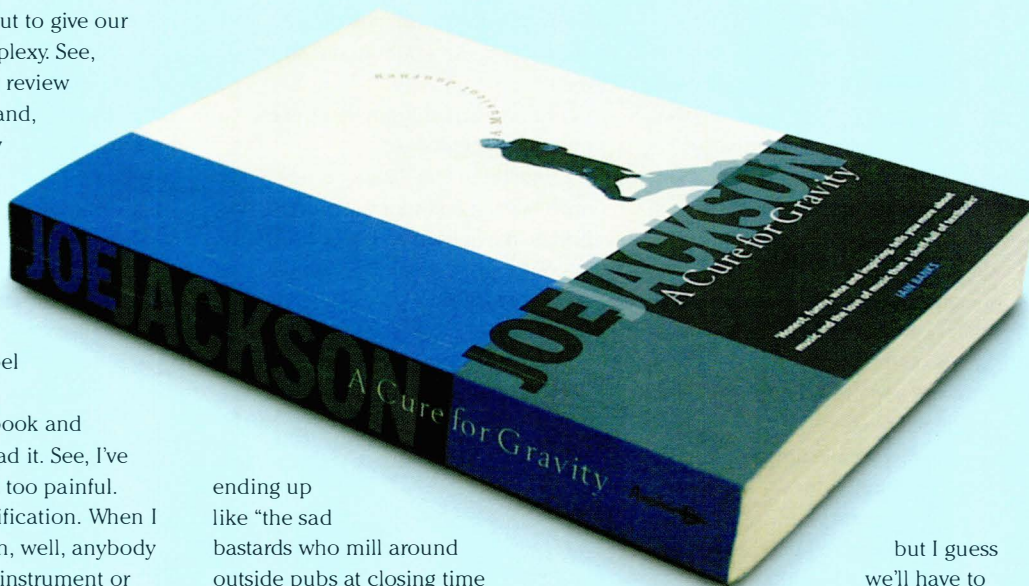

Joe Jackson
A Cure For Gravity

Published by Anchor
ISBN 1862 30083 6

AND NOW...

for something
completely different



London
Hi-Fi Show
Rooms
3037 & 3038

A New Age of Fresh Thinking

*For further information
please contact us:*



2 ANVIL COURT, 50 DENMARK STREET
WOKINGHAM, BERKSHIRE RG40 2BB

tel: (44) (0)118 974 2333
fax: (44) (0)118 979 7105
http: www.Timbrestage.co.uk
e-mail: info@Timbrestage.co.uk

MONITOR AUDIO

WHAT HI-FI?



The Monitor Audio Bronze 2

This design combines warmth
and detail in equal measure,
and does so to stirring effect.
Plenty of detail and bags of
bass, the Monitor Audios put
the music first. A great buy!



MONITOR AUDIO

As close as it gets

Cambridge, England.
t: 01223 242898
e: info@monitoraudio.co.uk
w: www.monitoraudio.co.uk

DVD Standards, "versatility" and the shifting digital landscape

by Roy Gregory

The total hegemony achieved by digital music storage systems since the widespread acceptance of CD has been so complete that the term 'Digital' is now the best friend of any marketing man trying to talk up a new product. You want it to seem like a step forward in quality, find some way of using the D word and the adoring public will just lap it up. Of course, things have never been that simple, but the one universally accepted truth, at least amongst the people on the street, is the notional perfection of CD. The silver disc has stood like a colossus above the technological revolution, maintaining public confidence in things digital in the face of such embarrassing fiascos as DCC and CD-I. Until now.

With new, high-bit digital formats jostling for position, and a small but real resurgence in vinyl records, the once monolithic dominance of CD is starting to crumble, and with it the absolute certainty that went with it. The most seasoned observers have little or no idea

which way the looming format wars will go, whilst the poor end-user is deluged with competing claims and a barrage of confusing and all too repetitive acronyms. And ironically, much of that confusion stems from within a single camp. Just what is DVD, and how many different forms can it take? The answer is lots, and with that in mind we thought it might be a good idea to indulge in a short potted history of the versatile disc, establishing once and for all just how it relates to CD*.

The Red Book Standard

The heart of this discussion actually lies in the physical structure of the various discs involved, and the way in which data is stored on these discs. And, as far as CD-DA (Compact Disc-

Digital Audio) is concerned, this is enshrined in the legendary Red Book. The bits that matter for this comparison are the data storage capacity and data rates of the medium, and these are cast in stone. A Compact Disc consists of a single sided, optically read disc, twelve centimetres (or 8cm) in diameter and 1.2 millimetres thick. It will hold 650-680 Mega-bytes of information, which are read at a constant rate of 1.5 Mega-bits per second. Doing the sums (and remembering that eight bits make a byte) that gives you enough data storage for just over an hour of music, using 16-bit quantisation sampled at the prescribed rate of 44.1kHz.

There are no ifs, buts or maybes with a CD. That's what you get. And although CDs exist in various forms such as ►

* As we go to press Warner Music Group have just announced their first raft of ten DVD-Audio releases for the 7th of November 2000. But what is most interesting is the sub-text in which they announce that all Warner DVD-A discs will be playable in three different ways: high-resolution multi-channel, high-resolution stereo and "Dolby Digital in the video title set". Which broadly translated means that you'll be able to play the DVD-A discs (at lower resolution) in DVD-V machines! Smart move on the part of Warners, as not only does this grant them access to the huge existing market of DVD-V player owners with future proofed product, but it neatly sidesteps the dual inventory issue with the retailers.

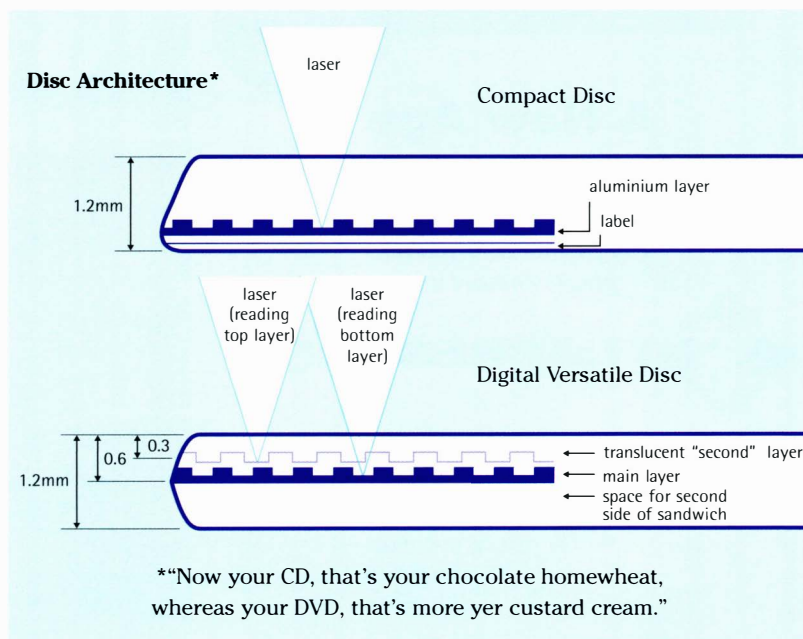

► CD-ROM, CD-R and CD-RW, they are all hampered by maximum storage capacity. Problems arise when you want to start putting more information onto the disc, such as pictures, and maybe a five or six channel sound track. You quickly run out of available space and data flow. You can't get enough information onto a CD, and you can't get it off fast enough for decent quality either. Let's face it, CD has enough trouble with two channels of PCM digital audio, let alone six, which even if you could lift sufficient data would cut the playing time to around twenty minutes. And that's without any pictures.

The answer in the search for greater data handling capability is twofold. On the one hand you can devise a better storage and retrieval system, on the other you can employ data compression, making the data easier to handle in the first place (for example DTS 5.1 surround sound on CDs, which exists outside the official CD 'standard'). The problem of course is that to date, compression systems have always proved audible, which is unacceptable to a critical audience. It is this conundrum that lies behind the plethora of DVD related formats. The acceptability of compression is central to the difference between the DVD-Video and DVD-Audio standards. But perhaps we'd better start at the beginning...

The Digital Versatile Disc

As most of you will already know, a DVD is the same size and thickness as a CD. However, internally its structure is completely different. Whereas the 1.2mm thick CD is a slab of plastic with a metal reflective layer on the back, a DVD is a two part sandwich constructed from a pair of 0.6mm halves. Just to make things even more complicated - but to increase data storage capacity even further - each half has a dual layer capability, so that a double-sided disc can have up to four discrete layers of information stored in it.

The different possible structures that

Disc Name	No. of Sides	No. of Layers	Data Capacity per Side
DVD-5	1	1	4.7GB
DVD-9	1	2	8.5GB
DVD-10	2	1	9.4GB
DVD-18	2	2	17GB

this construction allows a DVD are defined as follows:-

In practice, the double sided, double layered DVD-18 isn't yet reliable in manufacture, but that is only a matter of time. The thing to realise is that even a single layer, single side "DVD-5" can still hold nearly 7 times as much information as a CD, and that gives you a lot more space to work with.

DVD technology has been applied in a number of ways. Perhaps not surprisingly, it first emerged in ROM form for the computer market, a significant development when we come to consider not so much the merits, as the sheer muscle behind the competing high-bit formats. When you need a pinch hitter then Microsoft are handy guys to have around, but we'll get to that later. There are also DVD-Rs (for professional use in authoring studios) and, in Japan, DVD-RWs for consumer use in 'DVD video recorders'.

DVD-Video

The first Audio/Home Entertainment application of DVD has been the DVD-Video standard, now familiar as the primary format for home cinema. Like the Red Book for CD-DA, the DVD-V standard defines a set of operating parameters that the system will accept. Unlike CD, these are many and various. If we think back, you'll remember that it wasn't just storage that was an issue with CD, but the retrieval rate for the data as well. In comparison with CD's 1.5Mbit/s data rate, DVD offers a variable rate of between 1.5 and 10 Mbits per second (9.6 Mbits in practice, as the remainder is used for control and machine codes). An engineer configuring the audio

track(s) on a DVD-V has a whole menu of options to choose from, including: mono, stereo, Dolby Surround and 5.1 discrete surround sound using perceptually coded compression such as MPEG2, Dolby Digital and DTS. Also the engineer can choose two-channel uncompressed linear PCM. He can choose 16-bit stereo sound coded at a 48kHz sampling rate or, if he's quality conscious, he can increase both the bit and sampling rates to 20 or 24, and 96kHz respectively. It's all a question of real estate.

Putting the video images and sound-track for a movie onto DVD is an exercise in space and 'bit budget' management. In a 'perfect' world you'd run with high quality video and six-channels of 24/96 uncompressed PCM sound. Unfortunately, even DVD doesn't allow for that sort of data storage and retrieval, so this option is not a part of the DVD-V standard. The engineer has to juggle the data rate and quality of the stored MPEG2 video depending on the demands of what is happening on the screen. Overall running time of the video is a major factor too, of course. Has the client allowed for the manufacturing of a dual-layer disc, or does everything have to fit within 4.7GB? Compressed movie sound formats such as Dolby Digital are all about the efficient use of storage space. Even six channel surround sound (5.1) in Dolby Digital takes just one-quarter the data rate of two channel 16/48 linear PCM.

All of which is interesting, but doesn't have a lot to do with advances in digital audio. In fact, it explains exactly why movie sound off DVD-V **isn't** hi-fi. However, the DVD-Video ►

Comparison of format options for Digital Audio Coding on CDs and DVDs

Format	Coding	Compression (* Perceptual Coding)	Channels	Sampling Rate (kHz)	Quantisation (bits)	Data rate
CD-DA	PCM	None	1 or 2	44.1	16	1.5 Mb/s
DVD-Video	PCM	None	1 or 2	48 or 96	16, 20 or 24	1.5 to 6.114 Mb/s
	MPEG	Yes *	1 to 6			128 to 640 Kb/s
	Dolby Digital	Yes *	1 to 6			384 or 448 Kb/s
	DTS	Yes *	1 to 6			768 Kb/s or 1.5 Mb/s
DVD-Audio	PCM	MLP	1 to 6	44.1, 88.2, 48 or 96	16, 20 or 24	1.5 to 9.6 Mb/s
	PCM	MLP	2	176.4 or 192		Up to 9.6 Mb/s

Notes

MLP is optional for disc authoring in studios. But MLP **decoding** is mandatory in DVD-Audio players (in case a player is loaded with a disc that contains "MLP'd" audio tracks!).

In the DVD-Audio specification, an authoring engineer has to work within a maximum data rate of 9.6 Mb/s for the audio content.

This means that MLP **must** be applied for multi-channel audio running five channels at 20bit/96kHz or above.

MLP can be applied to any audio content, of course, if the engineer wants to save space on the disc, increase playing time, or manage his bit budget to incorporate additional pictures/slides/ audio tracks.

On a DVD-Audio disc any 'full motion video' content corresponds directly to the DVD-Video standard and, to maintain compatibility with today's existing DVD-V players, must contain accompanying audio coded in 2-channel PCM or multi-channel Dolby Digital. This portion of the disc could only be replayed in a DVD-V or multi-standard player.

► format did present an opportunity for high quality sound that has led to some confusion. If you compromise the picture quality severely (or ditch the pictures altogether) and use the disc for stereo sound, you can store up to two hours of uncompressed 24bit/96kHz PCM sound on a single DVD-5, and that's a hell of an advance over CD. So much so that some small US audiophile record labels, notably Classic Records, Acoustic Sounds and Chesky, started issuing discs in this format, erroneously dubbing them DADs (for Digital Audio Disc). Being the darlings of the audiophile community they received a disproportionate degree of attention in the hi-fi press, who, being none too swift **and** carried away with the very audible sonic benefits over CD, happily added to the confusion over the new discs' actual identity. They are, and always were, DVD-Video discs, whatever the labels choose to call them. Indeed,

what hasn't been widely reported in the audiophile press is that Pioneer Corporation in Japan (the same people that brought you double speed 96kHz DAT) released half a dozen such discs as long ago as winter 1996 when DVD-Video was first launched over there. The people driving the DVD-V standard were always aware of the option, and Japanese audiophiles have been listening to 24/96 audio for four years!

With a little forethought, DVD-V could have become a viable replacement for CD. Unfortunately, two things stand in its way. In adopting a 48kHz sampling rate and sandwich construction, the designers deliberately excluded the existing 44.1kHz Red Book standard, and the royalties associated with it. Whilst this makes excellent financial sense if you own a major corporation, it also ensures that you lose backward compatibility with CD players, meaning

that software retailers would have to hold double inventory. Secondly, because DVD-V was always envisaged as a storage medium for images, disc engineers have tended to assume that the machine playing the disc will be linked to a TV. Thus it has become standard practice to provide the disc navigation information in the form of menus on the screen. In other words, you often can't even access tracks without fist turning on your TV monitor!

DVD-Audio

Which brings us finally to the DVD-Audio standard, the high quality audio format based on DVD disc architecture. The disc itself is identical to all other DVDs in its physical structure. However, the way in which data is stored, and the form of the file directories that the player must recognise and read in order to find it, is quite distinct.

DVD-A will support data recorded at 16, 20 or 24-bit resolution, and sampling rates based on multiples of 44.1 and 48kHz, up to a maximum of 192kHz. That means that you can run two channels of 24/192 uncompressed linear PCM for around an hour or so, which is sufficient length for high quality audio applications. As long as you only want two channels. However, there are various other options available, and the one that the music industry sees as the future of recorded music is a discrete six channel system based on uncompressed 24/96 signals. There's only one problem. Although DVDs offer sufficient storage to support such a standard, the 9.6 Mb/s maximum data rate is insufficient to read them all simultaneously.

Which brings us back to the thorny subject of compression, and perhaps the most surprising element in this whole story. The requirement for a truly transparent compression system, analogous to the PDF standard developed for computers, led to yet another round of technological competition as various companies sought to have their 'lossless' compression system incorporated into ►

the DVD-A standard. The contest was won by Meridian Audio. Yes, the same Meridian that is based in Huntingdon and build multi-channel digital music and movie systems. The same Meridian that makes the popular 506 and 508 CD players. Given their product line, the company's interest in the debate is hardly surprising. Their participation and eventual success most certainly is, but the story of Meridian Lossless Packing, or MLP must wait for the next part of this article.

In the meantime, I'll leave you with something to consider. How much of CD's outstanding market dominance is

down to the fact that it is a single monolithic entity? The rigidity of the Red Book standard means that when you buy a CD you know exactly what you are paying for: around an hour or so of 16bit 44.1kHz sampled, uncompressed stereo sound. Back that up with a snappy marketing campaign, something like "Pure, perfect sound forever!" and you quickly develop a high level of market penetration and consumer confidence.

The problem facing DVD is that its very versatility makes for a confused and confusing situation. The fact is, that even within the standards themselves, each disc could contain any one from

a whole host of data storage options, and more importantly, standards of data integrity. Something legitimately labelled as a DVD-Audio disc could contain anything from an hour of high definition 24/192 stereo, to a discrete multi-channel 24/96 recording, to hours of somebody reading The Lord Of The Rings at the old 16/44 CD standard. In mono! And you can bet your bottom dollar that no matter how carefully the discs are identified, Joe public will be buying the wrong thing. And I haven't even included the DVD-Video options. Perhaps it's just as well that DVD-Audio is seen as an audiophile standard... ➤+

There are well-known amplifiers. There are highly-regarded amplifiers. Then there is Spectral – recognised worldwide as simply “the best”.

Spectral... what else?

The keys to the Spectral sound are ultra-fast response and **MEGAHERTZ BANDWIDTH**. The result? – the clearest, cleanest and most **NATURAL** music you have ever heard.

Spectral research shows that the human ear is very sensitive to timing and **PHASE ACCURACY**. Music signals normally leave a heat "trail" in a circuit which then smears following signals.

Their answer is **ULTRA-FAST CIRCUITS** which use expertise from instrumentation and microwave.

CD: ACCUPHASE, ADVANTAGE, AUDIO SYNTHESIS, dCS ELGAR, DELIUS AND PURCELL, MERACUS, PASS, SUGDEN, WADIA. **VINYL:** BASIS, CLEARAUDIO, DNM, (THE) GROOVE, GRAHAM, LEHMANN, MICHELL, STRATOSPHERE, SUMIKO BLUE POINT SPECIAL, TRANSGURATION. **AMPLIFIERS:** ACCUPHASE, ADVANTAGE, BALANCED AUDIO TECHNOLOGY, CAT, DNM, GAMUT, NAGRA, PASS, SONNETEER, SPECTRAL, SUGDEN. **LOUDSPEAKERS:** AUDIO PHYSIC, BKS, ETHOS, LUMLEY, MAGNEPLANAR, NEAT, TOTEM, VERITY AUDIO. **TUNERS:** ACCUPHASE, MAGNUM DYNALAB. **CABLES:** ARGENTO, CHORD CO., DNM, HOVLAND, NORDOST, SILTECH, SPECTRAL, YAMAMURA CHURCHILL ETC

Spectral's perfectionism means that products typically remain in production for 8-10 years.

Visit www.spectralaudio.com for more.

Customers say we make some of the best sounds they have ever heard. Our advice takes account of your best components and guides you where change is needed, in stages you can afford. You **AVOID EXPENSIVE MISTAKES**, enjoy music along the way and save money in the long run. **JUST LISTEN AND YOU'LL KNOW.**

The Right Note
Music in the home

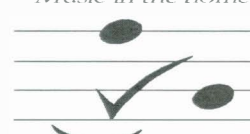

BATH
01225 874728

STOCKISTS OF LEADING HI-FI

- A careful selection of the best Hi-Fi to suit most budgets.
- Two comprehensive listening rooms.
- Expert advice on building a system.
- Expert advice on improving existing systems.
- Home installation service.
- Call in for more information or a demonstration.
- 0% Finance Available on request.

Basically Sound
NORWICH • NORFOLK

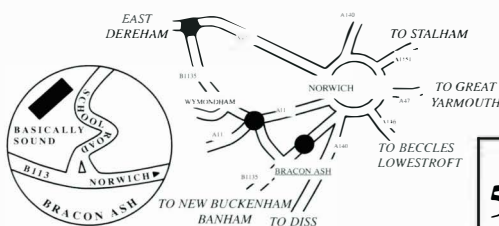

01508 570829
CLOSED MONDAYS AND SUNDAYS

Basically Sound of Norfolk, The Old School, Bracon Ash, Nr. Norwich, Norfolk NR14 8HG
www.basicallysound.co.uk

- AUDIONOTE**
AUDIO ANALOGUE • BEYER
BRYSTON • CABLE TALK
DENON • EPOS • FINAL
GRADO • NAIM AUDIO • OPERA
PMC • PROAC • QED • REGA
ROYD • SENNHEISER
SOUNDSTYLE • STAX
TALK ELECTRONICS
TEAC • TARGET XLO
AND MANY MORE



Record Reviews

How To Read Them

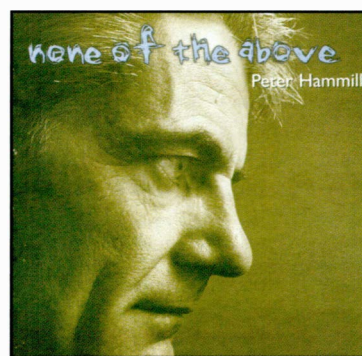

Peter Hammill

None Of The Above

FIE9122 

Intimacy is the watchword for PH's latest offering, and whilst some musicians choose to lay their music out in front of the listener like some epic film, this CD is more like a BBC play, complete with small sets and a sense of eavesdropping on the characters found within. In part this feeling is helped by Hammill's technique of aiming the lyric directly at the subject of the song, either by referring to the narrator in the singular, or more frequently by use of the word 'you'. With the smallest of contributions from other musicians, Hammill uses sparse instrumentation as an adjunct to the lyric, punctuating with a single guitar phrase here or emphasising with a subtle time change there. In doing so, the lyric, the singing, and the music are in three-way symbiosis. When he sings 'It's always me, me, me, with you' on my favourite track: 'Tango For One', I feel like we've shared some mutual 'friends'. There are times in my life when I really wish I'd had the courage to express the sentiments contained within many of these tracks. Hammill succinctly and poetically says it for all of us.

DA

www.sofasound.com



The information contained in the record reviews is presented in the following way. Albums are identified by label and serial number. Beneath this you will find one or more icons which denote the available formats for the recording. The first icon refers to the format reviewed.

The ratings at the bottom of each review reflect the reviewer's opinion of the recording quality, and musical merits of the album. You'll soon realise that a great many musically significant albums offer less than wonderful sound. Don't let it put you off! For your information the scale rates a standard, good quality pop recording as slightly below average.

The reviewers are identified by their initials.

They are:- Chris Binns, Pete Christie, Dave Davies, Roy Gregory, Jason Hector, James Michael Hughes, Jon Maple, Reuben Parry, Dave Ayers, Andrew Hobbs, Chris Thomas.

Key to Icons

-  CD
-  Gold CD
-  HDCD
-  XRCD
-  Double Disc
-  MD
-  120g LP
-  150g LP
-  180g LP
-  Availability As S/H LP
-  Vinyl Double Album

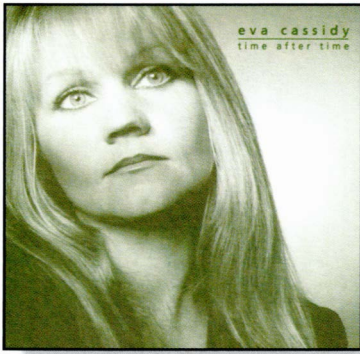

Eva Cassidy

Time After Time

BLIX STREET RECORDS G2-10073 

Distasteful and often hastily compiled posthumous albums are inevitable. Yet it is only now, some four years after her death, that I feel an Eva Cassidy CD could be accused of lacking a certain amount of integrity. Obviously, with a devoted following and a finite body of work, there is the temptation to exhume each and every single track she cut. But this post-mortem, an exercise in live and studio mixes, clearly places commercial motives ahead of artistic ones. Ironic, if you consider that when alive, Eva was very much an unspoiled talent free from industry hype. Some of the pop material chosen here simply doesn't always do her justice, including Paul Simon's 'Kathy's Song' and the Cyndi Lauper title track. Where the range and beauty of this powerful and crystalline voice truly excels is in the gospel-flavoured 'Way Beyond The Blue' and Bill Withers standard, 'Ain't No Sunshine', which exude class. The best of Cassidy is heard in these soulful blues numbers, and with the emotional embrace of a traditional plaintive folk song like 'I Wandered By A Brookside', where her intonation, phrasing and vocal modulation rhythmically mimics flowing water.

RP



Elliot Smith

Figure 8

Dreamworks BL48  

ELLIOT SMITH GOES ELECTRIC! Not perhaps the same impact as when Dylan did it, but still, to me and other Smith aficionados this album is a big step away from the purely acoustic past, and into something new. Personally I like it. In fact I like it a lot. The harder more powerful presentation allowed by the electric instrumentation has really paid dividends here, largely because, as with Dylan, it has been added to an already successful performer.

This is the fifth album by Elliot Smith and way back in Issue 1 I reviewed his last album *XO* very positively. This new offering is even better. Still retaining the quiet vocal delivery with excellent tunes, this album is, in places, more upbeat than the previous offerings, and even has you humming along (horribly out of tune if you're me) after a few bars of each track. I have always felt that Smith is trying to make sense of the world through his song writing, and I think with *Figure 8* he is getting closer, with even more acute observations than before.

Figure 8 is a very fine album, one that builds on the past but also adds new elements which open this artist to a wider audience. It should ensure even more well deserved success for Elliot Smith.

JH



Jimmy Page & The Black Crowes

Live At The Greek

TVT2140-2 

'Celebration Day' is the opening track on this double CD, and it couldn't be a more appropriate choice. The gig was a party in honour of Led Zeppelin, and Jimmy Page is the guest of honour. This is no black tie affair though, the booze is in and everyone's getting down. Celebrating not only Zep but also their influences, Page and the band storm through the set list with abandon. Zeppelin analog retentions are going to hate this album, as the material is enjoyed, not revered. In my opinion this approach is preferable to the recent slew of po-faced tribute albums. Led Zeppelin 2 and Physical Graffiti are the favoured material, but songs are drawn from elsewhere in the Zeppelin catalogue, and there are even additional non-Zeppelin songs, including a powerful version of Fleetwood Mac's 'Oh Well'. As The Black Crowes are a six-piece band, the extra musicians allow the live experience to be much more fleshed out than the power trio + vocals of the original band. Comparing the album to the recent *BBC Sessions* is interesting, the latter being sparse but intense, whereas *Live At The Greek* is lighter but richer. The recording quality isn't the best, but the music shines through, and that's what counts in the end.

DA



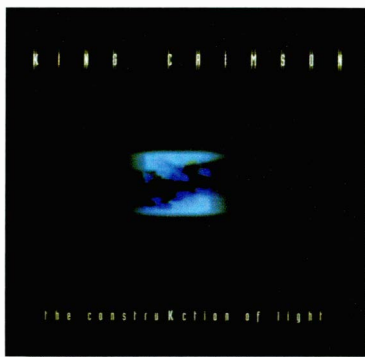

King Crimson

the construKction of light

Virgin KCCDX2 7243 8 4926120 LC03098 PM527

Robert Fripp, guitarist and mainstay of King Crimson can appear obtuse in the extreme to the casual observer, and with this album he is musically charting a parallel course. If you thought the previous studio outing *Thrak* was hard work, then this one is the London Marathon. In fact I believe a better title would have been 'the de-construKction of music'. Making no compromises towards the listener, the band break down familiar Crimson themes and structures and reconstitute the fragments into a format that frequently has little discernible tune or melody. The 'rhythm section' rarely operates as you would expect from a rock album, and the guitar patterns that were used so successfully on the three 80's albums are turned inside out, making them spiky and uncomfortable. Embracing the tenet that an artist can choose to challenge his audience carries with it the risk that many will not wish to take up said challenge. As I've long been an acolyte in the court of the crimson king, I made the effort and found it a satisfying, but uncomfortable, experience. If you are thinking of picking up the gauntlet, be warned. This is a slaving Rottweiller of an album. It can be trained, but approach with extreme caution.

DA

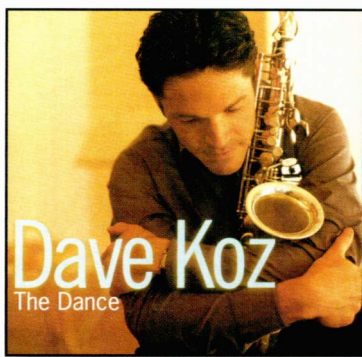

Dave Koz

The Dance

CAPITOL CDP 7243 49945821

Dave Koz reminds me of the mainstream activities perpetrated by Dave Grusin during the 1980s, when a fusion of MOR, Jazz and Pop produced soundtracks like that for *Tequila Sunrise*. *The Dance* shares those very same candy floss qualities – sickly-sweet and synthetic to the taste. This ephemeral contemporary jazz confectionary is eminently accessible, makes best use of its protagonist's talent on sax (he'll never be a Colossus) and notably distinguishes itself in the technical department where Pete Mokran's mix at the Conway Studio, Hollywood has that sparkling hypnotic blandness one expects from Tinseltown. Alongside Koz's own songs is a suitably sugary arrangement of 'Careless Whisper' – backing vocals and all – it cuts a fierce contrast with LA's seedier underbelly on which George Michael will forever now be judged. But I seriously question whether this juxtaposition was intentionally delivered, Koz is too diplomatic to have consciously gone to that place. However, beefing up any production does take a good deal of thought. Spanish guitar, trombone, vibes, trumpet and flugelhorn raise the temperature in strictly musical terms and their finely etched HDCCD resolution greatly compensates for an absence of compositional inspiration.

RP



Calexico

Hot Rail

City Slang 20153-1

Calexico is a town on the Californian – Mexican (get it? Cal – exico) border.

No, Calexico are really two guys who seem to be able to play a wide range of instruments, and even manage to make good use of the accordion, a rare occurrence.

Well which is it to be? Actually its both and the two blokes that make up Calexico the band have recently released this album which seems to be a description of Calexico the town, or the soundtrack to an ambitious border hopping road movie.

It all starts out with some Mexican trumpeteering which follows through into many of the subsequent tracks, producing a Spaghetti Western feel. Think *The Good the Bad and the Ugly* and you'll be spot on. So there is more than a hint of Moricone influence. But don't get the wrong idea, although the Mexican Tijuana influence is always present, it is often subtly applied as the album covers a very broad range of styles, from pure Spanish guitar instrumentals to some harsher modern urban music, accompanied by the leadsinger's modern indie / LoFi style vocals.

Having bought this album, I am extremely pleased. It is nicely varied, but with that underlying influence to hold it together into a single coherent whole. A good effort.

JH



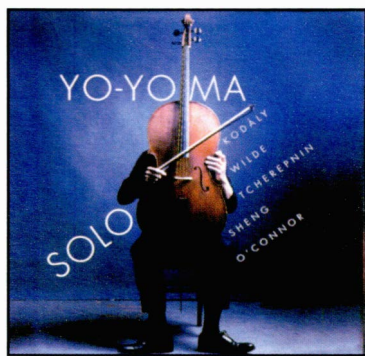

Yo-Yo Ma

Solo

Sony SK 61739

Solo is a disc of unaccompanied, 20th-century, cello works that draw from musical traditions from around the globe. Ma's playing is always impressive. These far-flung pieces are played with profound feeling – especially Wilde's 'The Cellist of Sarajevo' – written to acknowledge the heroism of a cellist who, each day would play on the spot where twenty-two people had been killed by a grenade. Ma is superb at balancing innovation and tradition. He is convincing, whether dealing with O'Connor's 'Appalachia Waltz', or lifting heavenly tones from the ancient east, in Sheng's Seven Tunes Heard in China. In all, Ma shows that the greatest influence on a composer's music can be the feelings, sounds, and styles from his/her roots.

The music is backed by a totally appropriate sound, whereby the cello is staged in the centre, with plenty of warm reverberation from the hall. Tones are spot-on, and the size of the instrument is correct – this is definitely not a violin being played! Whether bowing or plucking, there is always enough detail in the sound to support the emotion and flow of the music.

This is an intensely expressive album, which can stir feelings inside that have stayed dormant for years. It is a truly moving experience.

SG

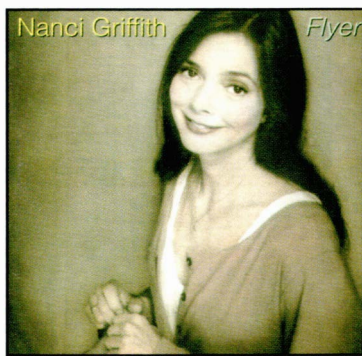

Nanci Griffith

Flyer

MCA 11155

Inexplicably this is one of those albums that somehow has, until very recently, simply passed me by. Fifteen beautifully crafted songs, as ever with Nanci, effortlessly traverse a fragile boundary in taste between pop music and the country scene. Its folk and Irish resonances (particularly heard through lucid arrangements for fiddle and mandolin) are the irresistible sweetmeats which make such a striking contrast to a deep seam of loneliness in 'Goodnight To A Mother's Dream' or those lukewarm lovers of 'Say It Isn't So'. Yet, these instrumental and harmonic textures appear almost as an adjunct to a skilful lyricist's vision. The art is to take possession of mundane or even inconsequential images and use them to probe and pick over emotional bones until a human condition is exposed to view. This remains true of both Griffith's own contributions and her instinctively strong choice in covers. Here, it's Julie Gold's gentle, melancholic observations of 'Southbound Train', where lines like "My heart is on the baggage rack / It's heavy as can be / I wish that I could find someone / Who would carry it for me / Just to pay it some attention / And handle it with care / Because it has been dropped / And is in need of some repair" perfectly complement Nanci's impeccable ear for a brilliant turn of phrase.

RP

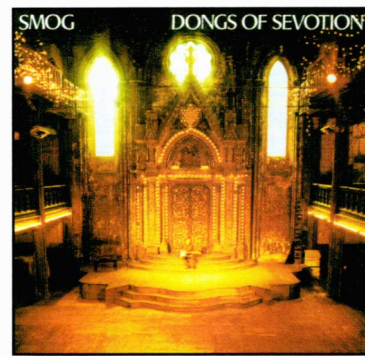

Smog

Dongs of Sevotion

DC169

This album was bought on the basis of a short listen to the amazing second track, 'Dress sexy for my funeral'. The songs sentiment and topic is described by the title and it intrigued me. So was the rest of this LP of equally high quality? Fortunately it was.

Lyricaly clever and deep, sounding like Transformer man Lou Reed together with plenty of Leonard Cohen influence, it's also reminiscent of another favourite of mine, the Tindersticks. There is plenty of emotion, although the slightly deadpan largely spoken vocal delivery will never over emphasise this. The songs can seem almost depressing, although like Cohen at his best, the feeling of triumph over adversity and the need to keep fighting is also present, and that can make the songs uplifting.

The music behind the words is generally slow paced and sparse, with musical yearnings from country through blues and rock. It is all so much more varied than I expected with pianos, synths, drums and guitars featuring across the album, although with such sparse instrumentation, each track is allowed to develop it's own individuality.

Overall this is an unusual but very good album that is well worth checking out.

JH



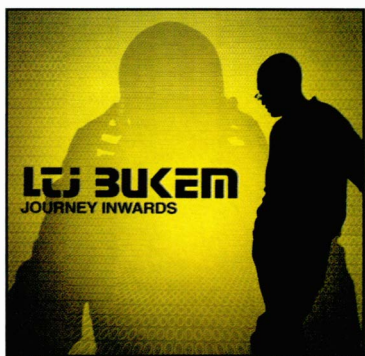

LTJ Bukem

Journey Inwards

Kinetic-Reprise  

LTJ Bukem has been an architect of the drum-n-bass movement since its birth in the late 80's. Now he cuts all of his skills into the grooves on *Journey Inwards*, his first full-length album. The two CD set works as a compilation, seamlessly blending disparate dance sounds, yet staying true to Bukem's singular vision. 'Sunrain' is a splendid fusion of classic 80's synthesizer riffs, tight bass lines and Chaka Khan-like vocal styling. 'Watercolours' opens up with ethereal voice synths and shakers panning across the soundstage, then the sonic landscape is slammed with rickety drum clicks, driving bass grooves and incredibly airy saxophone chords. 'Point Of View' consists of nothing more than a few simple string arrangements, yet manages to evoke strong musical emotion and energy. This CD is what the always-evolving electronic scene deserves. A well crafted record of pure sonic excellence. Actual instruments are solidly mixed with artificial loops and samples. The midrange is rich and full, with no techno-induced congestion. The highs articulate great detail and possess true organic textures. But be prepared, this album's bottom end necessitates a to fully appreciate it's magnificence. *Journey Inwards* is just that, a journey. If you want a crash course in the finer elements of electronic music this is it. Bravo LTJ, bravo.

MM



Badly Drawn Boy

The Hour of Bewilderbeast

Twisted Nerve TNXL LP133  

This review was going to be a piece of the proverbial, right up to the point that Badly Drawn Boy was nominated for the Mercury prize. Now the whole tenor has to change. Suddenly this will be seen as an "important" album (whatever that means) and Mr. Boy, hat and all, is right there in the limelight. So is this album the best of 2000? Should it have won the Mercury? Well to be honest I don't know, and I don't care. And that's because I think this album is really good, regardless of how many prizes it wins.

Filled with lots of short masterpieces, many of which are instrumentals and acoustic at that, this long player demonstrates real skill and depth. A LoFi, stripped bare recording and very simple under-produced sound match the initially simple songs, whose careful tunes and rhythms are actually mixed together in an easy to appreciate yet complex manner. This acoustic work frames the boy as he delivers some well thought out, straight from the heart lyrics (and this wouldn't be LoFi if the vocal delivery wasn't a tad flat and slightly lifeless).

Badly drawn boy, the prat in the hat? No not at all. A modern day Nick Drake? Probably not, but excellent all the same.

JH

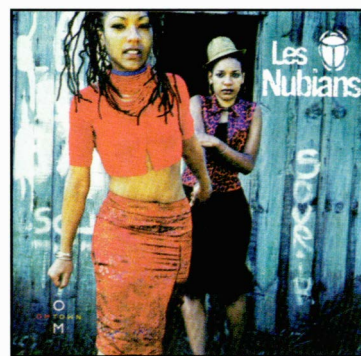

Les Nubians

Princesses Nubiennes

Omtown OMCD-45997 

Princesses Nubiennes is a luscious combination of French hip-hop, r&tb, jazz and wholesome lyrics. 'Demain' is a smooth r&tb tune, full of sultry choruses and riveting bass lines. 'Taboo' is a rendition of Sade's hit single 'Sweetest Taboo.' Though completely in French (along with 98% of the album) this version possesses a fully bodied texture, both melodically and lyrically that clearly surpasses it's UK predecessor. The track also includes a few French rap verses. 'Makeda' is full of lyrical complexity which, thanks to my former co-worker Rustem Ertegun, son of the legendary Nesuhi Ertegun (co-founder of Atlantic Records) I was able to have translated into English. The words speak of society distorting facts in order to make us forget the atrocities that occur. How historical figures gave up their lives in order to expose the truth to the masses. The song pleads for us to grasp knowledge and virtue, and in turn re-write the wrongs. Thumbs up to all co-producers on *Princesses Nubiennes*. This CD's sound is seductive and tasteful. The spaciousness between instruments is sublime. Bass lines exert great punchiness, yet are focused and clear. The vocals are sweet and centered, not to mention downright sexy. Les Nubians have created a unique sound that exemplifies music as a universal language.

MM





Pasion Canyengue

Los Primeros Pasos

PC 2000

Tango has suffered in this country from a ludicrous nudge-nudge reputation and the giggles that go with it, an unfortunate state of affairs that has consigned it to a walk-on part in bad comedies and silent movies. Not so in its native Brazil, where Tango isn't just a culture, it's a way of life. And with Flamenco finally gaining some artistic ground, it's high time that we started to take Tango seriously too. Pasion Canyengue is a five piece Anglo/Brazilian band that plays in the traditional Canyengue style, even down to their insistence on a bandoneon rather than the more familiar accordion. The recording consists of a dozen 'standards' and serves as the ideal introduction to this music, whilst its lack of technical trickery and rather basic technique is an absolute boon. The result is a rendition that might want for balance and perspective (the violin is rather over voiced) but which lacks none of the passion, vitality or rhythmic drive that's so important to this music. Standout track is 'Oblivion', whose haunting melody is arranged here for violin. The playing is beautiful, both technically and stylistically, with no stiffness or intruding classicism. In fact, the whole disc has an authenticity that brings the music to life. Latin dance: why bother with Ricky martin when you can have the real thing?

RG

e-mail: jonytango@bigfoot.com

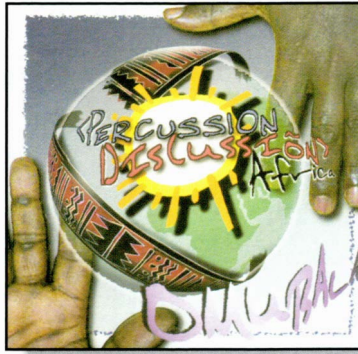

Percussion Discussion Africa

Omubala – The Story

FAR & WIDE MUSIC

Out of Uganda's recent turbulent past comes a joyous celebration of its folklore, animistic beliefs, ceremonies and wise teaching that revives a flagging oral tradition of storytelling in an age where the pervasive tendrils of a Western multi-media threaten cultural emasculation across the globe. This atmospheric album (evocatively sung by Michael Musoke in the tribal dialects of Luganda, Lukonjo, Lugosa, Runyoro and Teso) goes on to explore an indigenous heritage through its fusion of Latin-jazz rhythms and an inspired African slapped-skin beat at the hands of Uganda's very own conga-master, Omwana We Nsenene Ssewanyana (Sewi). From the colourful tribal greeting, 'Twabalumusa', and a symbolic 'Saalu', (Hyena), with its underlying message about exploitation; to an instructive marriage folk tale, 'Layaye', that emphasises the value of forgiveness, or simple praise offered up by a tribe in appreciation of their favourite food in 'Elooke', (Green Banana), there are frequent moments of wonderful clear-sightedness which we would do well to heed before assimilation of another vibrant culture occurs.

RP

FAR & WIDE MUSIC TEL: 0161 477 2761

e-mail: Sewanyana@aol.com

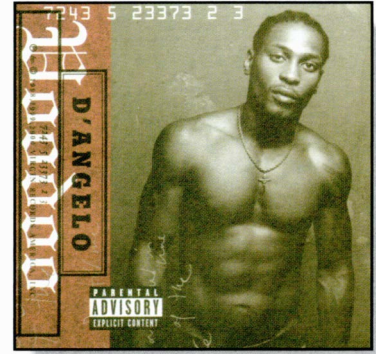

D'Angelo

Voodoo

Virgin 7243-8-48499-24

Well known for his contributions to soundtracks, his collaboration with Clapton and his well received debut album *Brown Sugar* (1995), D'Angelo has been keeping a pretty low profile. His earlier work encapsulated the grand r&tb sounds of years past, and was a huge hit amongst gen-Xers and old skool r&tb fans alike. On that first album he was the performer, producer, arranger, and composer, and five years after that break into the mainstream, D'Angelo delivers an urban tour de force with *Voodoo*. In an era where r&tb and hip hop are inundated with 'booty' and 'gangbanging' *Voodoo* harks back to the roots of Black pop, while incorporating a fresh ruff sound, again manufactured by D'Angelo himself. The musical landscape is a culmination of pounding bass lines, electric piano riffs, and rickety drum clicks. There's plenty of horns, and layers upon layers of slippery vocals. The album is well produced. There is a great sense of space between singers and musicians (though it sounds like the studio's live room was a small one). The bottom end can be a bit murky at times, but for the most part it is well articulated. On most tracks the vocals almost overlap, simultaneously evoking congestion and intimacy. This record could very well spark a new wave within the pop industry as it thumps through your listening room.

MM



hi-fi+

REPRODUCING THE RECORDED ARTS



Back issues

Issue 1 - Sold Out Issue 2 - \$4.75

Issue 3 - 7 £3.95 each

Prices include P&P in the UK

If you missed out on earlier issues of HiFi+, and want to complete your collection, you can order them by calling

+44 (0) 1202-659380



B&W Nautilus Speakers

When B&W built the best speakers
- they selected the very best stockists
- sole dealers for all Ireland

CLONEY AUDIO

55 Main Street, Blackrock, Dublin.

Tel: (01) 288 8477 / 288 9449 Fax: (01) 283 4887

www.cloneyaudio.com

Audiophile Amplification
www.rothwell.omnia.co.uk

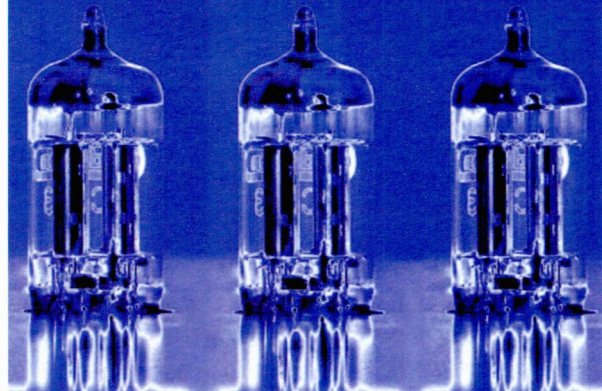

VPI Turntables & Record Cleaning Machines

Arguably the **Best** ★

For more information on these and other VPI products
+ our huge selection of Audiophile CD's and Records
please contact us at

Cherished Record Company

PO BOX 21 LISKEARD PL14 5YP TEL 01579 363603 FAX 01579 363604

VISIT OUR WEBSITE www.cherished-record-company.co.uk

Ben and Tracey

by Reuben Parry

Well, it could be a car sun visor seen in any town. “Ben / Tracey” is an immediate head-turner of one sort or another. Do you continue to stare out of some secret curiosity, or is the sense of embarrassment for them so acute that you have to hurriedly glance away? In some ways, too, Watt and Thorn’s early careers mirror this adolescent badge. Back then their music conveyed a blend of freshness, honesty and fragility, one only expressed during the kind of short lived spell of youthful naivety that causes such sentimental statements to be made.

Two decades later and it’s possible to detect in Tracey Thorn’s rich and sensual vocal delivery, or through Ben Watt’s more subtle arrangements, those moments when an acoustic sounding simplicity from the past resurfaces. Of course, over the years, it’s been their eye-brow-raising recuperative powers and constant sense of reinvention that have ensured unlikely longevity and considerable popularity. As *Everything But The Girl*, (the name coined during student days was taken from the Beverley Road retro furniture store in Hull, which proudly claimed above its doors “For your bedroom needs, we sell everything but the girl”), they safely negotiated the Indie scene

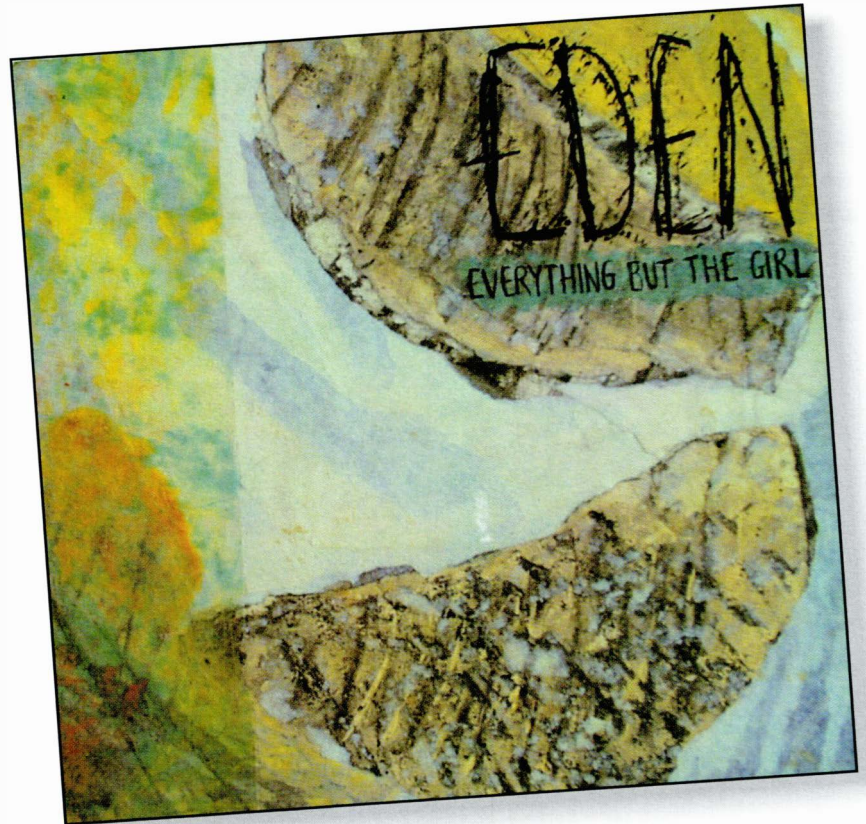

through a series of bold and diverse switches in musical direction.

Their discography is extensive and convoluted to say the least, and just keeping track is a feat in itself. A jazzy-pop album debut, *Eden* (1984), was quickly followed by the rockier textures of 1985’s, *Love Not Money*, before the gentle counterpoint of a highly orchestrated *Baby The Stars Shine* (1986) took yet another departure in its stride.

After a two-year hiatus this propensity for disappearing off on dramatic tangents provided a successful single, ‘I Don’t Want To Talk About It’, which peaked at No. 3 in the U.K. Charts. This sparse, bittersweet cover version of a song by the late Crazy Horse guitarist Danny Whitten is typical of the tracks like ‘Tears All Over Town’ and ‘Lonesome For A Place I Know’ that carefully balance emotional intensity with the lean, sinuous

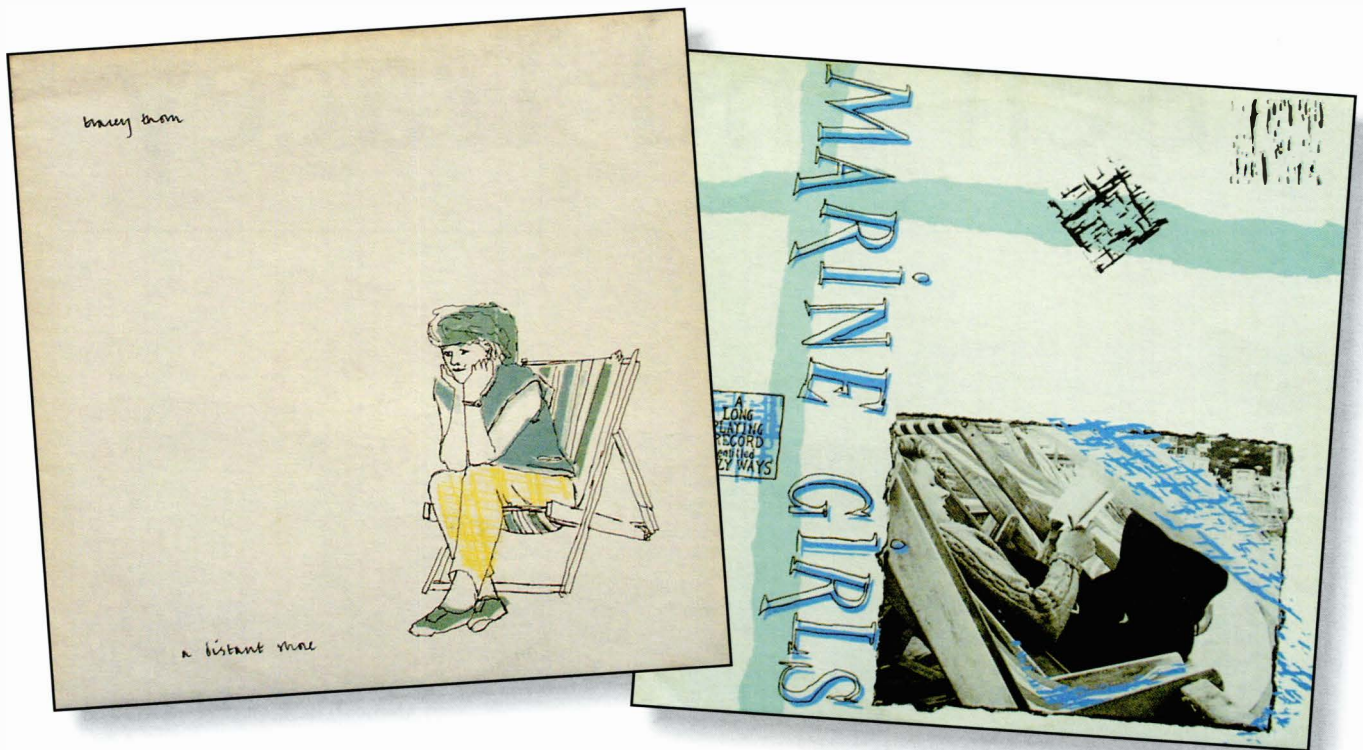

► backing found on this their 1988 release, *Idlewild*.

The streetwise *Language of Life* appeared once the duo decided that Los Angeles was an appropriate recording location for a smart, showy disc. Tommy LiPuma's 1990 production did the slick commercial business here – while a guest appearance by the legendary Stan Getz obviously stroked egos and buttressed the EBTG reputation. “Pop. Pop. Pop.” Was the message inscribed in to their next album, the suitably titled, *Worldwide* (1991). It's broad thematic brushwork, despite worthy songs such as ‘Old friends’ and ‘Twin Cities’, never really caught fire – other groups just did straight pop better.

There then followed a series of albums that concentrated on covers, compilations and remixes: *Acoustic* (1992), *Essence And Rare* (1992) and *Home Movies* (1993) spanned that most difficult and unfortunate period when the rare anti-immune system disease, Chung-

Strauss Syndrome, took Ben Watt uncomfortably close to death. In recovery he penned several new numbers including ‘The Only Living Boy In New York’ which was superglued on to *Home Movies* as something of an afterthought. Not until the release in 1994 of the sensational *Amplified Heart* CD did EBTG return to their strong and decidedly individual songwriting style. Later issues of this album contain the excellent Todd Terry remix of ‘Missing’. Beefed up for the club scene, it heralded the brilliant electric fusion of 1996's *Walking Wounded*, which was in itself a sophisticated departure into clubland trip-hop and drum'n'bass. The metamorphosis of Tracey Thorn from mellow pop-singer into simmering disco-diva was complete with the issue of last year's *Temperamental* CD. From light jazzy numbers to updated house in under twenty years is some diametric shift for those pallid, post-punk teenagers who'd independently

signed up to the small London-based Cherry Red Label, prior to heading off for University in 1981. Listening now, today, to *Temperamental*'s tireless beat (it gets plenty of airplay in the car) with those mixed splinters from Thorn's voice, piercing and playing across her sensuous lead vocals, these ears can still catch more than a passing hint of an old tune or wistful chord change, a nuance which carries me back to Tracey's first band proper, the Marine Girls, and Ben's haunting individual work, *North Marine Drive*.

While all the EBTG records and CDs are readily available, tracking down the solo singles, LPs and those grooves with other groups, is less straightforward. Ben's 12 inch *Summer Into Winter* EP (12 CHERRY 36) recorded back in December 1981, for example, is something of a rarity. He's joined by Robert Wyatt on piano for five cuts that find Watt at his most melancholic. The opening track, ‘Walter And John’ sets a tone

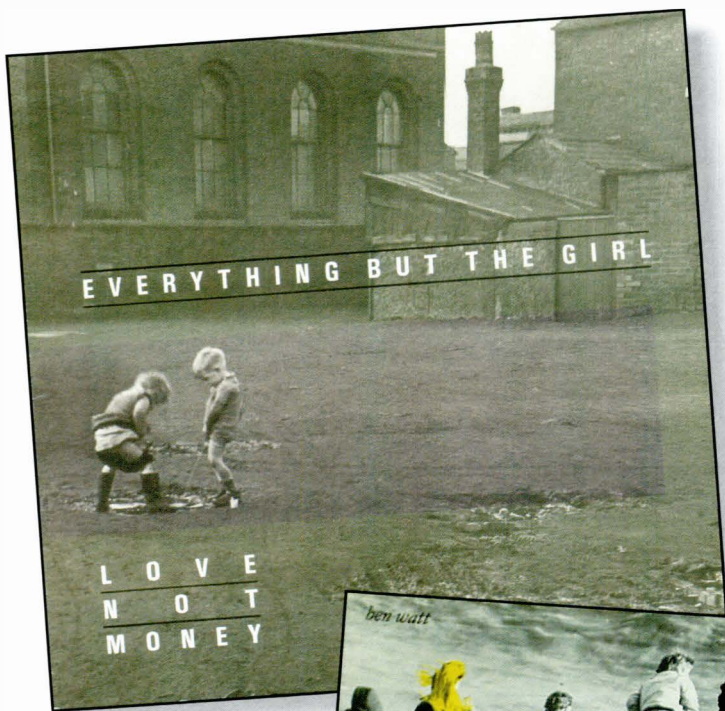

► through its minimalist approach and intensely sad sentiments, that was to permeate his and Thorn's lyricism for several years. There was joyless beauty and early resonant anguish, too, with 'Some Things Don't Matter' (originally a 7 inch single) that can still be heard on the definitive Cherry Red compilation CD, *Pillows And Prayers* (MRED 41). Here, too, Tracey's 'Plain Sailing' (taken from the solo album, *A Distant Shore*) can be found dripping with honesty and innocence. It, along with the Marine Girls' 'Lazy Ways' and a 1982 EBTG single release, 'On My Mind', are all crucial, hard to find, cuts on vinyl. The critically acclaimed, *North Marine Drive* (B RED 40), mentioned previously, continued the mournful motif. Published in 1983 it's still available on CD and was even



recently spotted by yours truly in my local record shop as a second-hand LP – which proves it's not impossible to find.

Tracey Thorn's own excursions at this time with the Marine Girls – a Young Marble Giants influenced girl band – are equally difficult to locate, especially on LP. Songwriting duties, here, were shared with Jane

Fox and their first record, the whimsical *Beach Party*, is certainly as sparsely structured as *Colossal Youth*. No surprise then to find their second and final LP on Cherry Red, *Lazy Ways* (B RED 44), was produced by Stuart Moxham of the Giants. This intelligent, girlie music, shaved back to little more than guitars and breathless female vocals, even had enough spunk to audaciously cover 'Fever'. But Thorn better described this period in her career than I ever could when she said, "I listen to the stuff we recorded,... It sounds extraordinary. A complete collision of naivety and sophistication, timidity and defiance, shallowness and depth.

It sounds original although I can hear where every component part was stolen from!" Somehow, out of this "collision", there comes a satisfying sense of integrity and cheek that is wholly acceptable. The demise of the Marine Girls (following a truly dreadful Glasgow gig in the summer of 1983) hastened the formal convergence of Thorn and Watt as EBTG.

The previously casual working relationship blossomed. Mike Alway, who first signed the pair to Cherry Red, split for WEA Records, taking Ben and Tracey along for the ride. Within a year the beguiling *Eden* was issued on his new, Blanco Y Negro label – all solo bets were off and the ceaseless EBTG evolution was now underway.





Barb Jungtr

Chanson – The Space In Between

Linn AKD 129

Hands up if you've heard of Barb Jungtr before? Me neither, but there's nothing I like more than finding something new to love. The set is geared around songs that are heavily European (rather than American) in influence, and includes numbers by Jacques Brel, Jacques Prevert, Leo Ferre, even Elvis Costello ('New Amsterdam'). A couple of honorary Americans creep in by way of Cole Porters 'I Love Paris' and Yip Harburg's 'April in Paris' but given the themes, that's fine.

Jungtr wrings every drop of emotion from each song, her slightly husky voice lending itself beautifully to this music. Backed by a fine band, notably Russell Churney and Simon Wallace on piano, Julie Walkington on bass and Kim Burton on accordion.

The recording is excellent. Jungtr's voice is perfectly captured with real presence, the bass, piano and particularly accordion are very much 'in the room', and the whole thing has a warm, natural glow that is so right for the material although I thought the bells, in 'Sunday Morning Saint Denis' sounded more like struck bedpans.

Many of the songs are pretty powerful and theatrically presented in a way that won't appeal to everybody, but as Julian Clary says in the sleeve notes: 'Barb Jungtr is a one woman emotional enema and not for the faint hearted'. I say, light that Galloise, sip a Ricard and go for it!

Supplier: Vivante

DD

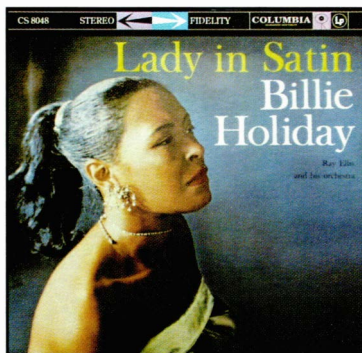

Billie Holiday

Lady In Satin

Classic Records/Columbia CS8048

Regarded as something of a lightweight album when it was released (rather like Ella's *Cole Porter Song Book* reviewed in the audiophile section), this marked something of a departure for Holliday, and if it's not exactly upbeat, then neither does it plumb the depths of despair so often associated with this singer. Of course, since those days the notion of what constitutes "jazz singing" has broadened considerably (in no small part because of albums exactly like this), and songs like 'Violets for Your Furs' and 'I Get Along Without You Very Well' are now considered standards. So whilst this isn't a classic Holiday album, it's more accessible than most and constitutes an excellent starting point if you're new to this most distinctive of voices. The pressing is up to Classic's normal excellent standards, and if the recording doesn't match the warmth, detail and presence of Verve's best, then it's not too far behind. Her familiar gravelly rasp is slightly smoothed and distant, stepped back into a coherent soundstage, along with the orchestra. I like the arrangements, and the slightly contrived instrumental solos actually work rather well. Not strictly an album for purists then, but if you're so much of a purist that it prevents you enjoying this, then you need to lay off the scourge and ice-cold showers. Me, I'm perfectly happy thanks.

Supplier: Vivante

RG



Lew Del Gatto

Katewalk

Naxos Jazz 86058-2

The liner notes read "music is not a verbal art, and Lew Del Gatto's music is not an intellectual exercise. This set is for your heart and soul..." Which is pretty apt. Del Gatto had been very much a sideman over the years but Naxos have finally persuaded him to step out front. Backed by a sterling band including Randy Brecker, Victor Lewis and noticeably Chip Jackson on bass, Del Gatto's tenor soars above it all with a breathy, warm, vibrant tone.

The opening number and title track, inspired by the loping walk of Del Gatto's wife, draws you into the set straight away. From this number and throughout the set, which benefits from a very 'live' feel due I suspect to Del Gatto's insistence on no overdubs, Chip Jackson's bass lines are key to driving the set ahead. Melodic, solid and expressive and at the 'right' playback level satisfyingly room shaking, he holds the set together. But this isn't to criticise any other band member – the playing is really tight throughout.

Equally strong in both the faster paced numbers like the title track or gentler ballads like 'Autumn Nocturne' this is one of those sets that whilst it doesn't challenge you, draws you in from the first notes. It's relaxing, involving and over too soon. The recording is fine, a little loose at the bottom end maybe, but at the price a stone bargain!

DD



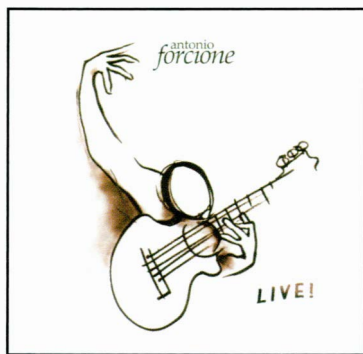

Antonio Forcione

Live!

Naim cd054 

And about time too! Much as I admire Forcione's studio recordings, this is the first time I feel the 'whole man' has been captured. Recorded at The Vortex, London between the 16th and 18th of March this year, you are there, in the best seat in the house (third row, centre?).

Ranging from choppy, dynamic numbers like 'Acoustic Revenge' to lyrical delicate pieces like the emotive 'Serenio' every note (and whether Forcione is using nylon, or steel strings), every nuance of his playing is crisp and clear. And whilst this is technically a fine recording, most importantly, the emotion of his playing is captured. And it's clear he's having a great time, the set includes an outrageous – try and imagine this if you can – version of 'I Heard It Through The Grapevine' where since overdubs are not an option, Forcione seems to have sprouted an extra pair of hands.

Forcione is joined by Rony Barrak on tabla for another stand-out number 'African Dawn', a real smile maker if ever I heard one.

As the sleeve note says "There is a special magic, an intimate vibrancy which is impossible to recreate in the studio...Here is some food for thought without any additives, sugar or preservatives. Enjoy."

Supplier: Naim

DD

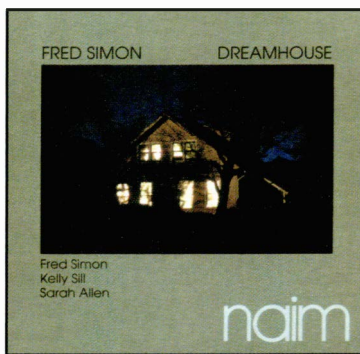

Fred Simon

Dreamhouse

Naim cd044 

His name was vaguely familiar, but only when prompted by the sleeve notes did I recall that I'd seen it on the Windham Hill release *Usually/Always*. It turns out that Simon's been around the scene for almost thirty years performing live, recording and writing for film and TV and has over 8 releases in his name. Sometimes I feel so remote in Winchester! Simon fronts a trio that also comprises Kelly Sill (who's worked with Art Blakey, Hank Jones and Joe Henderson amongst many others) on bass, and Sarah Allen (a wide ranging musical career including spells with jazz, folk, pop, theatrical and classical ensembles) on drums.

The set chiefly comprises Simon's own compositions plus Hill Et Robinson's standard 'Old Folks'. This is a delightfully cool, laid-back album. It's not about breaking barriers or challenging pre-conceptions, it's simply about highly enjoyable music making. It's the perfect late night chill-out. Even the faster paced numbers have a gentleness about them that I find very soothing.

The recording is up there with Naim's very best, and the sense of the recorded environment is very well captured – the album was recorded in Union Church, Hillsdale, Illinois – with the drums set well back in a spacious environment.

Supplier: Naim Audio

DD



Ugetsu

Cape Town Blues

Naxos Jazz 86052-2 

Inspired by Art Blakey's Jazz Messengers (the bands' name comes from a Jazz Messengers album title) and was formed by bassist Martin Zenker in '96. Four years and four CD's on, their music has developed considerably and the band is now well established on the jazz scene, playing festivals and concerts around the globe.

The set is entirely self-penned with contributions from trumpeter Valerie Ponomarev, Tim Armacost (tenor sax), Adrian Mears (trombone), and Rick Hollander (drums).

The standout track for me is Mears 'Down the Back of the Garden' which opens with some great brass ensemble work before breaking into some fine soloing, in particular from the composer. This number does demonstrate the Blakey influence but still shows development, sounding entirely contemporary in its propulsive style.

Another highly enjoyable number is the title track 'Cape Town Blues' where the bands enjoyment clearly comes across as they race through a series of solos, including some great tenor work from composer Tim Armacost.

The recording is a bit lightweight in the percussion and bass, lacking a little in weight and drive, although the rasp, spit and breathiness of the horn section is well caught.

DD



You've heard the concert live...

**Wilmslow Audio –
Loudspeaker specialists
for 30 years.**



**Now hear it again & again
on Wilmslow speakers...**

Tel: 01455 286603

www.wilmslow-audio.co.uk

Heatherdale Audio Ltd 202, Findon Road, Worthing, BN14 0EJ

FOR THE CONNOISSEUR

WILSON MAXX in FERRARI GREY £24995
MARK LEVINSON 33 REFERENCE
MONO AMPLIFIERS £19995
MARK LEVINSON 30.6 DAC 24/96
plus HDCD. £11995
Cello Reference Standard DAC £2995

NOW DEMONSTRATING THE MARK LEVINSON 383 INTEGRATED AMP.

SPEAKERS

Wilson Maxx in Ferrari Grey
(less than 4 months old) £24995
B & W Matrix 3 speakers. Ex cond. boxed £695
Linn Isobariks. With Stands £895
ATC Towers 7's £795
Audionote ANE/SE (Rosewood) F. Veneer £3995
Kef 101/2 speakers £475
Mission 782 Loud Speakers
(Stand mount model) £250
Monitor Audio Subwoofer Rosewood £195
Solstice AAD speakers with stands £495
TANNOY 15" Dual concentric speakers
in superb oak cabinets. £2995
Selection of Thiel ex. Demo. Speakers.
All with 10 year guarantee. £phone

PRE-AMPS

Cello Encore Anniversary Pre-amp £4495
Audio Research phono 1 phono stage MM & MC £895

Audio Research SP 14 Pre-amp.
(with phono stage) boxed £1495
Exposure 21 Pre-amp NEW with remote £890
Passlabs Aleph P Pre-amp £2799
Graaf WFS two Pre-amp £1195
Quad 44/405 Mk 2 £395

AMPLIFIERS

Mark Levinson 27.5 amplifier (100wpc) £2695
YBA Passion mono amplifiers
(less than 4 months old) £6500
Cello Performance 11 Mono amplifiers £9995
Audionote P4 Monoblocks £3395
Exposure 18 Stereo Amplifier £495
Exposure 18 Stereo Power amplifier NEW £720
Adcom GFA 5300 Power amp £295
Restek Challenger integrated amplifier £595
Quad 405 Mk 2 with 44 pre-amp £395
Quad 405 Mk 1 with 44 pre-amp £350
Pioneer precision integrated amplifier £295
Arcam Alpha 6 amplifier £165
Exposure 11/12 and super 8 £995

CD PLAYERS & TRANSPORTS

Mark Levinson ML 39 CD Player £3695
Mark Levinson ML37 transport £2695
Linn Karik CD player £895
Sony 552/702 transport and DAC
(cost new £2500) £995
Audio Research CDT1 CD transport £1295
Proceed PCD 3 CD player £1595

Pre-owned Equipment Available with Guarantee

Export Facilities Available. Visit our Web Page www.hifi-stereo.com

Main dealer for Mark Levinson Reference products

Roksan ROK-DP1/ROK-DA1
transport and DAC £895
Pioneer precision PD-S 505 CD player £295
Arcam Alpha 7 CD player £165

DACS

Mark Levinson 30.6 Reference DAC
(HDCD-24/96khz) £11995
Cello Reference DAC £2995
LFD DAC 3 £1595
Sonic Frontiers SFD1 DAC £1195
Vac Dac Valve Dac £895

MISCELLANEOUS

Roksan Artaxerxes X phono stage with
DSU power supply £395
Sony TK7 700ES cassette deck (boxed) £195
Quad FM4 Tuner £250
Nakamichi BX2 cassette deck (just serviced) £295
Audio Research 2metre set Litzline
speaker cable (£765) ex. Demo £495
Nakamichi RX 505 3 head auto reverse
cassette deck £695
Revox PR99 MK2 tape deck trolley mounted
Sonic Frontiers Jitta Bug £1495 £295

Vanden Hul CS122 Hybrid speaker cable
2.5 meter sets £50/set
Teac A-33405 Tape recorder £595
Stax Lamda Nova Electrostatic headphones
and energizer £795
Demon TU-260L Tuner £95

TURNTABLES, CARTRIDGES & TONEARMS

Michell Gyrodeck with RB 300 arm
and OC power supply (boxed) £1095
Basis 1400 turntable with RB 300 arm £695
SME series IV Tone-arm £695
CEC Turntable & PSU £495
Helius Silver wired tonearm £995
Roksan Xerxes The mechanic pick-up
arm Linn Trioka cartridge £795
VPI TNT Turntable £3495
Roksan turntable with SME 1V tonearm
Ortofon MC 7500. Full guarantee.(new) £995
Duel CS 500 Turntable (boxed) £1495
Beogram 4002 Turntable £150
Lumman PD 282 Turntable £100
Technics SLD2 Turntable £75

We now offer 0% finance* (*subject to status). Please phone to arrange an audition
Main Dealers for Mark Levinson, Thiel, and Absolute sounds

We accept Switch - Mastercard - Visa - Diners Club - American Express

Tel...01903-872288 or Evenings...07860-660001

Fax...01903-872234 E Mail address; heatherdale@hifi-stereo.com

Garrard
80th
anniversary



Garrard™

Loricraft Audio

As well as the renowned 501 turntable and PRC 11/111 Silent Record Cleaning Machine, Loricraft Audio offer completely re-manufactured Garrard 301 and 401 turntables, mounted in stylish new plinths. We can also service your existing 301/401s and Thorens TD 124s using genuine parts, and RDC pieces. Upgrade with our purpose built electronic power supply.

Genuine Garrard accessories and parts as used in our servicing:

- Garrard strobe-disc
- Garrard hand held electronic strobe-light
- Garrard 301 knobs
- Garrard 301 suppressors
- Garrard 301 platters
- Garrard 501 turntable mat
- Garrard 301 rubber mat (as per original)
- Garrard 301 trim plates, on/off etc.

Loricraft Audio,
4 Big Lane, Lambourn,
Berkshire RG17 8XQ UK
Answerphone/fax: 01488 72267
Works: 01488 71307
Email: terry@garrard501.com
Web: <http://garrard501.com>

Germany and other
European countries:
0049 761 292 4168

Choosing your dealer is as important as the equipment you choose

The performance you get from top quality Hi-Fi has as much to do with the way the system is set up as the quality of the equipment. If you live in the Manchester area give us a call to find out what we're on about.

South Manchester, 14 Stockport Road
Cheadle, Cheshire SK8 2AA
Tel: 0161 428 7887

Manchester, 12 - 14 Shaw Road
Oldham, Lancs OL1 3LQ
Tel: 0161 633 2602



TRICHORD RESEARCH

www.trichordresearch.com

tel: 01684 573524 fax: 01684 577380



Vivaldi
The Four Seasons

Academy of St Martin in the Fields
Sir Neville Marriner

Decca Legends 466 232-2 **CD** **6**

I knew vinyl was doomed when Decca deleted their famous Argo recording of Vivaldi's *Seasons* in the late '80s. It was the LP equivalent of the Ravens leaving the Tower of London. Released in 1970, the Academy's *Seasons* was quite simply 'the' version of Vivaldi's masterpiece. No other came close; not for sound, not for performance. That it spent the best part of 20 years in the LP catalogue at full price is a testimony to its popularity. Agreed, by today's standards it sounds a shade lush and over polished; the strings have a lovely burnished sheen and there's a glossy quality to the playing that no longer strikes the ear as authentic. But, for all that, there's nonetheless something beautifully stylish and (dare I say it?) classic about the whole performance. Like a '50s Dior suit, Marriner's account has an effortless unselfconscious elegance that is both dated and timeless. There's a freshness and innocence about this *Seasons* that makes it unique. Though they recorded the *Seasons* twice more their pioneering Argo set remains the best; a classic account, beautifully recorded. Three solo concertos, from the mid '70s, have been added to fill the disc up. By now the Academy were Big Business, and it shows; the playing is effortlessly polished and slick, but a certain freshness and innocence has gone.

JMH



Virtuosa Valentina!

Valentina Lisitsa

Audiofon CD 72055 **CD**

This CD contains a quite remarkable solo piano performance from this young Russian. It will tell you if your system is up to producing a full size concert grand within your listening room, and will also leave you breathless. It is packed full of delights that will thrill and astonish. On the cover are the words "Unedited Performance". This means there are occasional slips and mistakes, including one that startled me so much I laughed - after a minute or so of Liszt's *Hungarian Rhapsody No. 2* - but these do not really interfere with the wonderful flow of music from the pianist's fingers - and what flow. The speed of her playing can leave you aghast.

Peter McGrath made the recording in Miami, using a Schoeps spherical stereo microphone and Nagra-D, producing possibly the best piano sound from CD that I have heard on my system. It is a stunningly dynamic recording, set in a large hall, with just enough character. Obviously the use of top grade equipment, minimal micing, no signal processing, and a lack of editing is the formula for an exceptional recording.

Another wonderfully, sparkling, recording from the Audiofon label. It is just a pity they're no longer with us.

SG

Available from APR - Tel: 01434 220627

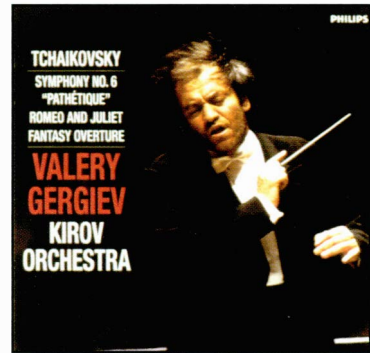

Tchaikovsky
Symphony No. 6, "Pathétique"/
Romeo And Juliet Overture

Kirov Orchestra/Gergiev

Philips 456 580-2 **CD**

Following Gergiev's disappointing Tchaikovsky *5th* with the VPO, this recording, with the Kirov, is an improvement, but still misses the mark. He employs a slow tempo, but manages to produce tension in the right places. He utilises a palate of dark, ominous tones to paint a picture of corrupt passion rather than tragic romance. This is a large and powerful reading, and the *Romeo And Juliet* is played in the same fashion, making you think that there is some sinister background to the tragedy that finally befalls the two young lovers.

Philips' recording is big and dark, to match the performance, and they have used valve equipment to give the recording vinyl-like warmth. The pizzicato strings have a nice tone and feeling. There is a deep, resounding bass, and the sound is full of detail, without being brittle or etched. The whole CD is a little too up-front, although the lower strings and brass, which has plenty of bite, do have some depth.

This disc has all the hallmarks of an outstanding recording, but misses the mark. It is just too highly coloured to be regarded as a benchmark performance. For that, look towards Mravinsky or Pletnev.

SG

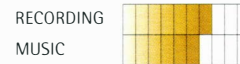



Shostakovich
Cello Concerto No. 1, Op. 107*
Piano Concerto No.1, Op. 35**
 De Rosa*, Lisitsa**, Caldwell,
 Ekaterinburg P.O.

Audiofon CD 72060

These are two dazzling performances of two of Shostakovich's most contrasting concertos.

William De Rosa is probably the best known performer here – he was once proclaimed "... one of the most brilliant cello talents in the world", and you can hear why in this performance of Op. 107. The playing is commanding, with real perception, and glorious tone. Valentina Lisitsa is less well known but produces an exhilarating and dynamic *Op. 35*, which ranks with the best, while special mention must go to the solo trumpet, played by Viatcheslav Chtchennikov. The conducting of Sarah Caldwell (an opera specialist) is expressive, drawing the Ekaterinburg (formerly Sverdlovsk) Philharmonic to produce soulful and committed playing throughout.

Audiofon recordings are designed to give the feeling of a spontaneous, live musical performance, so editing is reduced to a minimum to maintain the musical flow. The idea certainly works here, with no thought going to the occasional wrong notes. There is a good sense of the acoustic, with the soloists placed front centre.

A wonderful disc of two marvellous pieces of music, superbly recorded. But if you want this CD move quickly, as Audiofon are, sadly, no more, and supply is limited.

SG

Available from APR – Tel: 01434 220627



Schubert
String Quartet G major D887
Quartet Movement C minor D703

Aurnyn Quartet

TACET 5

Completed in 1826, a couple of years before his untimely death, Schubert's final string quartet *D887* inhabits an intense, shadowy, tortured world. Knowing he hadn't long to live, it's tempting to think Schubert poured all his pain and suffering into the piece; perhaps the bleakest of all his instrumental works. Maybe – maybe not. Just the same, it's a powerful piece of remarkable originality. The long first movement is racked with the deepest melancholy and anguish, while the slow movement (a kind of dead march) veers between bitterness and anger before finally resolving in calm acceptance. The shadowy skittish Scherzo anticipates Mendelssohn, while the finale is simply one of the greatest Schubert wrote; tremendous impetus and power, driving the work to a demonic conclusion. Demons also inhabit the strange Quartet Movement – with it's wildly contrasted themes. The Aurnyn quartet have all the technique needed to play this difficult music, and they attack it with great determination and the right kind of controlled passion. Comfortable it isn't – but then this isn't comfortable music. Tacet's recording, made using old valve microphones, sounds clear, focussed, and detailed, with excellent attack and dynamic range. Good sound then, but buy this disc for the music – it's some of Schubert's greatest.

JMH.

Supplier Vivante



Sainte Colombe
Concerts à deux violes esgales
 tome II

Savall/Kuijken

Astree Auvidis ES 9933

Sainte Colombe, a French composer of the late 17th-century, was virtually unknown until the Alain Corneau film *Tous les matins du monde*. He was a bass violist virtuoso, being credited with adding the seventh string to the bass viol of the French baroque, and also the teacher of the greatest French violist of them all, Marin Marais.

The music is simple but moving, being suggestive of a Gaelic Vivaldi, and although the two players should not be too taxed they show great harmony with Sainte Colombe's work. Savall and Kuijken are evenly matched in both tone and ability, giving the music a beautiful flow. These are pieces of contrast, of light and shade, often being lively yet at other times melancholy and mysterious.

Recorded in 1992, this CD is a good representation of what all recorded, authentic, chamber music should sound like. The two instruments are realistically captured in the recording environment. Microphones seem to have been kept at a reasonable distance, capturing both the lovely acoustics of the room, and the beautiful tone and details in the wooden resonance of the instruments.

Heartily recommended to all with even the slightest interest in the music of the baroque.

SG





Mahler / Berg
Symphony No. 4/Seven Early Songs

Bonney/Chailly
Royal Concertgebouw Orchestra

Decca 466 720-2

Chailly is a great Mahlerian. I have heard him performing Mahler, both on CD and live, and, at the present, I know of no better conductor of this exalted music. From the opening notes one knows that this is a skilful reading of one of Mahler's most accessible symphonies. Having said that there are some weaknesses.

With Chailly, every sound is animated. It is a brilliant performance with impressive playing by the Concertgebouw, but the problem lies with Barbara Bonney's singing. Let me first say that she has a beautiful voice, it is just that she does not sound entirely at ease singing *Das Himmlische Leben*, making the music sound constricted. Listening to the Berg pieces seems to confirm this, as Bonney captures every note perfectly, and is altogether more comfortable.

The production is very good, with nice hall atmosphere, but is not perfect. The sound is a fraction bright. Every detail is there, but it does not sound real. A live orchestra has more body, power, and depth.

Probably not a first choice, but if you have already got a recording of Mahler's 4th, or if you want the Berg Songs, do not let me put you off purchasing a very admirable CD.

SG

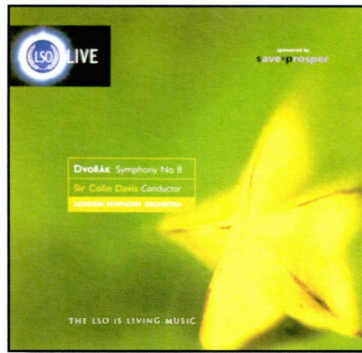

Dvorak
Symphony No. 8 in G

LSO/Davis

LSO 0002

This is a compelling performance of Dvorak's 8th! Recorded live in October 1999, in the Barbican Hall, this is not the kind of performance that comes along everyday. Davis is an intelligent conductor, and here he gives an articulate reading. The first movement can sometimes sound a little disconnected, but not here, with the melodies being cleverly integrated. But it is the slow movement, which stands out, capturing a darkness that gives it the kind of emotion rarely found. This impression is extended into the third before an excellent finale. Performance wise, this is the Dvorak 8th to have – even better than Kertesz's.

I have heard the wonderful LSO in the Barbican Hall on a number of occasions, and so I know their sound pretty well. Here Tony Faulkner captures it beautifully. The hall and orchestra are laid out before you, slightly behind the speakers. There is just enough warmth, but with plenty of the orchestral details which bring the recording of a live performance to life.

This CD contains a truly great performance, well recorded, and even though it contains fewer than 40 minutes of music, it is priced low enough to be a bargain.

SG

Available from the Barbican
Tel: 020 7638 8891

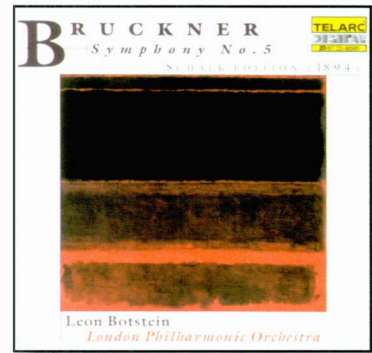

Bruckner
Symphony No 5 (Shalk edition)

Leon Botstein, LPO

Telarc CD-8059

Bruckner's symphonies were misunderstood by most of his contemporaries, so friends and colleagues sought to make his music acceptable and 'popular' by re-orchestrating it and introducing cuts. In today's respectful times, where the composer's original intentions are deemed sacrosanct, such meddling now seems barbarous. So what a surprise to see a new recording of a Bruckner symphony in one of these 'corrupt' editions! Franz Shalk was an important late 19th century conductor, but history has judged him harshly because of his wholesale reworking of Bruckner's 5th symphony. It was his version that was published ahead of Bruckner's own, and recorded by Hans Knappertsbusch for Decca.

Yet far from being apologetic, Telarc's copious liner notes make out a positive case for Shalk. And on the evidence of this highly committed and exciting performance from Leon Botstein and the LPO, they've got a point. Bruckner's deep spirituality and heavenly spaciousness are replaced by something altogether more cogent and gripping; Bruckner, steetwise with attitude! In modern terms, this is Shalk's remix, and it works brilliantly. The extra brass in the coda of the finale sound thrilling – really lifting the listener emotionally with a glorious blaze of sound. Clean, powerful, dynamic sound. A fascinating disc, especially for collectors.

JMH



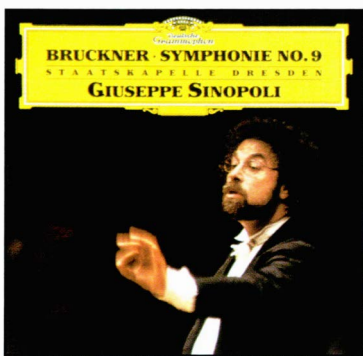

Bruckner
Symphony No 9

Dresden Staatskapelle
Giuseppe Sinopoli

DG 457 587-2

Opinions divide regarding Sinopoli's Bruckner. He was to record all 9 symphonies for DG, but record company cuts mean the cycle will not be completed. This account of the *9th symphony*, recorded during live performances, is powerful and highly intelligent. As so often with Sinopoli, you hear things obscured in other recordings, such is the clarity and balancing of forces. It's an interpretation based solely on what's in the score - by turns thrilling and challenging - with a broad muscular line that gives the music a secular modern feel. The *9th* is Bruckner's most anguished score. He looks into the abyss (like Mahler in his *9th symphony*), but without resolving the uncertainties and doubts he sees there. That the work remained unfinished at Bruckner's death (the finale was never completed) is partly to blame for the work's ambivalence. Given this, Sinopoli plays the work with remarkable clarity of vision, bringing a keen far-sighted objectivity to music that can sound unbearably fraught and painful. Not that the performance lacks passion or fire; on the contrary, the Staatskapelle play with gripping intensity throughout. Rather, Sinopoli's eyes are set to a distant horizon as he makes us aware time and again of how remarkable the music is, and how modern too. DG's recording sounds sonorous, full, and highly detailed, with some bone-crunching climaxes, and forward balances.

JMH

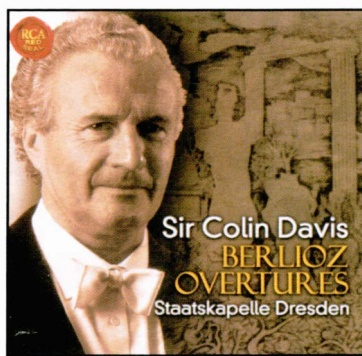

Berlioz
7 Overtures

Dresden Staatskapelle
Sir Colin Davis

RCA 09026 68790-2

One suspects that the Staatskapelle rarely get much opportunity to perform Berlioz, but under the watchful and experienced Colin Davis they play with incredible vigour and panache, bringing to the music all the thrill and excitement of a new discovery. Moreover, the atmosphere of each piece is captured well - from the mysterious forboding of *Les Francs Juges*, to the extrovert upbeat brilliance of *Le Corsaire*, with its almost jazzy wind writing. Nor do the tricky cross rhythms in *Benvenuto Cellini* faze the players, who phrase the music with great relish and the utmost panache. Listening, one gets the sense of a great conductor and orchestra revelling in the music and enjoying every minute. There's always been an aristocratic noble quality to the sound of this orchestra; the brass in particular have a special warmth and sonority that creates a unique ambience. This suits Berlioz, ensuring that the brass do not blare even in the loudest climaxes. It lends dignity to music that could otherwise sound vulgar and forced. RCA's recording sounds beautifully spacious and open, without being too distant. The top-end sounds very sweet, ensuring that brass and strings never harden tonally, even during the most vigorous climaxes. Perspectives are natural too, with a nice terracing of dynamics and a proper sense of distance between the front and back of the orchestra.

JMH

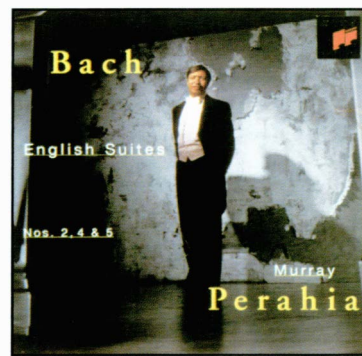

Bach
English suites 2, 4 and 5

Murray Perahia (piano)

Sony Classical SK 60277

This disc completes Perahia's set of the English suites for Sony, and if anything, both playing and recording surpass those of the earlier disc. From the first note you know you're in the presence of a master musician: one of supreme technical command who has scrutinised every detail of the music, yet is able to play with freedom and imagination. Tempi remain steady, but rhythms are subtly inflected to keep the pulse of the music flowing and alive. Above all, it's Perahia's balancing of Bach's sometimes complex part writing, his ability to clarify textures and maintain clarity, that one marvels at. It's as though each finger leads a life of its own. Yet perhaps even more wonderful is the fact that technique soon falls into place behind the music and its interpretation. After a while one simply takes the excellence of the playing for granted; all that's left is the music. As with the earlier disc, the recordings were made at La Chaux-de-Fonds in Switzerland, albeit exactly one year later, but the sound is slightly fuller and more present - as though one were slightly closer to the instrument - giving marginally greater clarity. The piano sounds warm-toned but clear, incisive, and detailed, with a very natural tonal balance and excellent tonal depth. Without being spectacularly 'hi-fi' it's one of the finest piano recordings I've ever heard.

JMH



An Embarrassment of Riches... the Latest XRCD2 Crop

by Dave Davies

A growing section of my jazz CD library is occupied by XRCD's, even though in many cases they duplicate standard CD's of the same material. There's a simple reason for this as far as I'm concerned, and that's that XRCD's generally deliver the real musical goods, digging much deeper into a performance and wringing that much more satisfaction from every disk. This coupled with the added merit of good to excellent packaging (when oh when will mainstream manufacturers get rid of the awful jewel box?), makes owning an XRCD a far closer experience to the sense of satisfaction I get from a great LP, which makes these discs well worth the premium price. More to the point, once they'd got beyond the "doesn't this sound good" obligatory sonic blockbusters that featured amongst the early releases, JVC have been pursuing a very welcome policy of selecting material on musical merit rather than the quality of the original recording. In fact the majority of the releases reviewed here are mono. This in my view doesn't matter a fig. A great performance is a great performance and if the storage medium releases that much more of the essence of the music, stereo or mono just 'aint important. The following reviews are a selection of the latest batch of musically meretricious gems from Japan, many of which I haven't spotted in standard issues.

First up a great favourite: *Art Tatum, Red Calender and Joe Jones* from the Tatum Group Masterpieces series

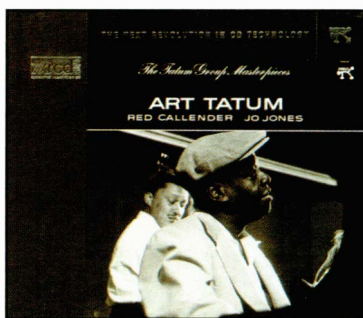

(VICJ-60375). I have this '56 recording in the original Pablo LP version, and also in the standard CD issue. When compared to the latter, the XRCD sounds at first a little harder and brighter, but then it's quickly apparent that each note of Tatum's lightning fast runs across the keyboard is much more distinct. Jones' brushwork is much crisper too and the whole thing is simply more engaging and thus more enjoyable. The LP has bags of detail too plus a warmth that means in this recording at least that the LP gets my vote, but the XRCD comes awful close. I'd love to see more of the Tatum Group Masterpieces appear on XRCD, particularly his set with Ben Webster, and let's not forget the Tatum Solo Masterpieces series!

RECORDING
MUSIC



Another mono masterpiece and another of my all time favourite recordings is Sonny Rollins' triumphant *Saxophone Colossus*. Although it's a '56 mono recording it's a gem, with a solidity, presence and attack that makes the lack of stereo insignificant. The standard format CD sounds pretty good to me, maybe a bit brittle at the top end but, from the first notes of the opening track 'St Thomas', doing a pretty

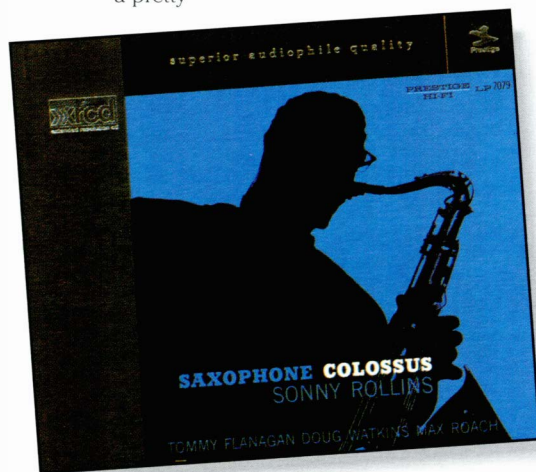

good job of conveying the excitement of the performance. Moving from this to the XRCD version of the same track first impressions are that, like the Tatum, it's a little brighter, but again it's quickly obvious that this is actually about much more detail coming across. To really sort the men from the boys in this number, just wait 'til you hear Max Roach's solo. It explodes from the speakers without there being the shadow of a doubt which part ▶

► of the kit he's attacking at any given moment. My absolute favourite version of this album remains the DCC LP re-issue (what chance of finding an original pressing after all), which does all the XRCD does without a very slight touch of hardness that's sometimes apparent in the digital version, but the JVC disc runs it a close second.



Moving to a less familiar release, *The Ray Bryant Trio* (VICJ-60212), recorded in '57, this was Bryant's first recording as a leader. Bryant, bassist Ike Isaacs, and drummer Specs Wright had been working as Carmen McRae's rhythm section and their cohesion is apparent from the first note of this

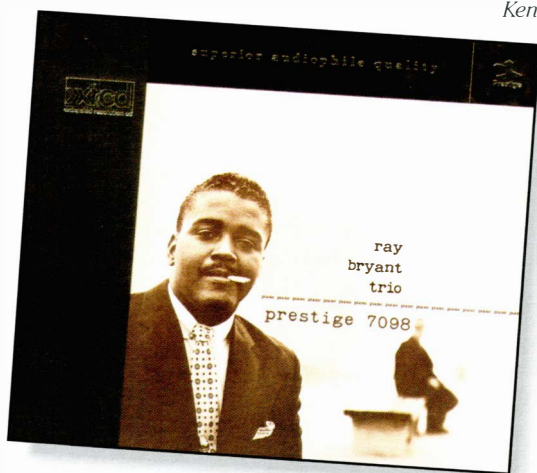

great set. From standards like 'Django' and 'The Thrill is Gone' to Bryant originals like 'Blues Changes' and 'Splittin' this recording is a real find that I'd treasure in almost any format. To have it in XRCD is a real bonus. The mono recording has real solidity and presence, with a very natural and very un-digital warmth. The band swing like hell from start to finish of this great disc; one that I can't recommend too strongly.



The pianist Kenny Drew was one of the leading sidemen of the be-bop era, with a fine technique and sense of swing. He recorded with many of the greats including Sonny Rollins, John Coltrane and Dexter Gordon. *The Kenny Drew Trio*

(VICJ-60213) recorded in '56 was his first album as a leader and is an enjoyable if fairly typical example of a piano trio album of the period. Backed by Paul Chambers and Philly Joe Jones, Drew powers through a series of standards, including 'Caravan' and Monk's 'Ruby My Dear', but the set lacks a really distinctive character.

The Monk tune is a good example, where the pauses which in the original Monk version make the tune really distinctive and leave you holding your breathe waiting for the next note, here merge into the music making it at once more flowing but much less distinctive. The recording, whilst dynamic with plenty of detail, is a little hard.



Explorations (VICJ-60140), is a studio session by Bill Evan's finest trio: Paul Motion (drums), and Scott La Faro (bass). Recorded (in stereo) in '61, it is one of Evan's best albums and thus one of the finest albums in the jazz idiom. Opening with the bands take on the opening track 'Israel', which was originally recorded for Miles Davis'



Birth of the Cool sessions, the sheer quality of the music making is unsurpassed. From the fast paced opener, to delicate ballads like 'Haunted Heart' this is a fine, emotionally involving set. The recording gives due prominence to Evans' piano, backed by nicely weighty bass from La Faro. Paul Motions drumming is well captured too, sounding particularly natural.

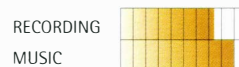

Another stereo release from this batch, and from a musician previously unknown to me, is Don Friedman's *Circle Waltz* (VICJ-60258). Classically trained, Friedman worked both in the modern jazz idiom and in avant-garde, recording with Ornette Coleman, Dexter Gordon and Chet Baker. He also recorded regularly as

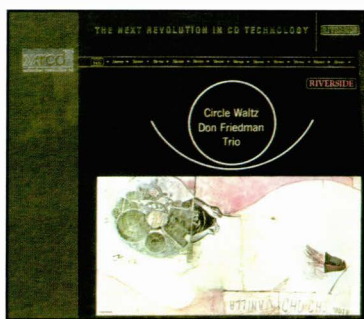

► Clark Terry's pianist. In this '62 session, recorded in New York, Friedman fronts a trio including Chuck Israels on bass, and Pete La Roca on drums. It's a gentle album, even the faster numbers lack any real aggression, but that's no bad thing. No numbers would give a clue to Friedman's avant-garde experience, though the melodic feel to his playing hints at his classical background. The stand-out track for me is the closing number 'Modes Pivoting'. This has the most range, showing a number of variations in timing and features some great playing from Friedman. It's only let down by the fact that it fades out at 6.44m, just when it's getting most interesting. A good spacious recording complements this set.



Red Garland was no ordinary pianist having started his career on clarinet, moved to sax, spent some time as a boxer and finally moved to piano. He worked with many of the

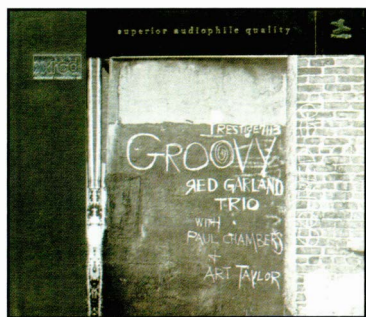

great names including Charlie Parker, Lester Young and Coleman Hawkins, but he didn't enjoy real fame 'til he joined Miles Davis' great quintet in '55, where he proved highly influential. He began leading his own bands at around the same period, the time from which this recording (*Groovy* VICJ-60161) stems, where he joins Paul Chambers on bass and Art Taylor on drums. Opening with Ellington's 'C Jam Blues' this is an enjoyable set, with hints of Ahmed Jamal and Errol Garner in his playing. I feel he's stronger in the faster paced numbers like the opener than in ballads where things can slow down just a little too much. 'Gone Again' is a good example of this where it all gets a bit too sleepy to hold my involvement. Things pick up again immediately on the next track 'Will You Still Be Mine', with fast runs that echo some of Tatum's style. This track also benefits from some fine, rasping, bowed bass from Chambers. A crisp, clear recording in living mono, who needs stereo?



Dating from '55, *The Hampton Hawes Trio* (VICJ-60215), has Hawes leading the great Red Mitchell (bass) and Chuck Thompson (drums), in a set from '55, that in a series of up-tempo numbers just oozes funky vitality. Influenced by Bud Powell, Hawes was

one of the '50's best pianists, bringing a bluesy, gospelly feel to be-bop, and this is evident throughout this solid set. From the opening 'I got Rhythm' to the closing 'Carioca', the pace barely lets up. Even the slower numbers like 'So In Love' have a life to them that keep the involvement absolute. The recording although in mono, barely shows a hint of its age. This is a great set that I'm delighted to have been introduced to. It has a great cover too, which I'd love to see in its original LP format.



Another great cover adorns *Piano – Wynton Kelly* (VICJ-60259). Dating from '58, this set was Kelly's second recording as a leader and features a band including Kenny Burrell (guitar), Paul Chambers (bass), and on four of the eight album tracks, Philly Joe Jones (drums). As great a drummer as Jones is, the strongest tracks are those featuring simply the trio. Maybe it's because there's just a bit more room for the music to breathe, each individual contribution is a little clearer and the subtleties of their playing more obvious. 'Strong Man' includes



Jones (drums). Newborn was a highly gifted pianist but never really gained widespread recognition as a result of his many absences from the scene due to personal and medical problems. He began playing in Memphis whilst still in his teens and in '56 moved

Even ballads like 'Stella by Starlight' take on a fresh aspect, with Newborn at his most Tatumesque in the opening bars, seemingly having added a foot or two to his keyboard. His technical mastery is stunning but is never allowed to overwhelm the feeling. Brown and Jones play superbly but this is Newborn's album from start to finish, laden with his trademark high-speed runs and sheer poetry. The recording, whilst not stunning is very capable, with Newborn's speed of light keyboard traversals well captured.

RECORDING	
MUSIC	

to New York working for a time with Charlie Mingus and recording for a gamut of labels. In the early sixties he moved to Los Angeles where he met Lester Koenig who was to produce his best work, including this album.

To those in the know, Newborn is considered to be in the same league as Art Tatum, Bud Powell and Oscar Peterson, and on the evidence of the set I wouldn't disagree. It opens with a storming gospel influenced title track, and soulful blues and gospel permeate the rest of the album.

For me the point of these latest XRCD2 releases is not so much the sound quality, but the music. I've been introduced to some great stuff I hadn't had the chance to hear before – Phineas Newborn, Wynton Kelly and Hampton Hawes' solo work, and Ray Bryant. Equally, through the enhanced resolution of XRCD2, I've been given new perspectives on old favourites like the Sonny Rollins and Bill Evans albums. Sure, XRCD's are expensive, but when weighed against the musical enjoyment I've got from the

▶ some lovely, sensitive playing from Burrell, as does the following track 'Ill Wind' where he's much more to the fore. Kelly plays beautifully throughout. The mono recording (what else?!), does great justice to each musician, with perhaps the exception of Paul Chambers, since the bass is just a little muffled when set against the clarity of the others. Kelly never really had great success as a band leader, making his name primarily as a sideman for artists including Dinah Washington, Charlie Mingus, Dizzy Gillespie and of course Miles Davis. On the evidence of this album, it's difficult to see why he didn't enjoy more attention in his own right. He deserved it.

RECORDING	
MUSIC	

Now here's a name I definitely hadn't heard before: Phineas Newborn Jr. His album *Harlem Blues* (VICJ-60374) was recorded in '69 (yes, it's stereo), with Ray Brown (bass) and Elvin



lengthy sessions listening to these albums, and to the lifetimes pleasure I'll get from old and now new favourites in this medium, I have to say they're worth every penny. ▶+

Supplier:
Vivante.
(44)(0)208 977 6600



**Shostakovich
Symphony No. 5**

**Stokowski
Stadium Symphony Orchestra**

DCC EVEREST LPZ-2016 **180g** **2**

Unquestionably one of the great Twentieth Century compositions, Dmitri Shostakovich's *Fifth Symphony* (scored for a full romantic orchestra with piano and celesta) continues to win favour through its lyrical pattern and dynamic contrapuntal style, which culminates in a series of stunning climaxes and that stirring Allegro non troppo fanfare. Stokowski handles this work magnificently. Under his baton the strings (drenched in emotion) dovetail with those soaring brassy moments to heighten a sense of that successful struggle against adversity which remains such a broad thematic preoccupation. The SSO musicianship, too, is of a high standard although there is a certain lack of spit'n'polish, that occasionally allows it to be eclipsed by the spontaneity of the LSO playing for Previn (RCA SB 6651) or intuitive warmth found for Maxim Shostakovich by the USSR SO (EMI ASD 2668) – both mid 1960s recordings which have as yet only reappeared as standard CDs. Here, on vinyl, the DCC cut taken from Harry Belock's 1958 original three-track master tapes and the RTI pressing are a revelation. Tape hiss (formerly the blight of Everest LPs) is suppressed and the smallest instrumental details (including extraneous hall noises) are exposed, giving a real "you are there" feeling to proceedings.

RP



Eric Bibb and Needed Time

Spirit and the Blues

Opus 3 LP 19401 **180g**

Those who read the last issue of Hi-Fi+ will know that I rate the CD of this album high enough to include it as one of my Desert Island Discs. It is a tour de force in the art of this wonderful performer. A mixture of blues, ballads, country, and gospel, all performed to the highest of standards. Every track is compelling and moving.

I thought I knew the sound of this album. The CD is good, but this is something else. Everything now seems bigger and more real. I was shocked to hear how much more power there is in Eric's voice on 'I Want Jesus To Walk With Me'. Bass is deeper and more natural. Nuances I could not hear before – such as the slap of bass strings – all add to my appreciation of each musician's individual contribution to the music, and those performers play, or sing, between, behind, and around the speakers – a wonderful, in your room, experience.

The only negatives concern the cover, which is thin and flimsy. Apparently Opus 3 know, saying that it is down to cost, but if plans on future vinyl releases go ahead, quality should improve.

I urge you to buy a copy so that others may follow. You will not be disappointed. The perfect album? Very nearly.

Supplied by Pentacone
Tel/Fax: 01924 445039

SG



Another side...

With a famous folk revivalist father, Leon, and an enviable procession of influential musicians including Joan Baez, Bob Dylan and Odetta passing through the family home, one could be forgiven for believing that Bibb's entry into the business was a formality. But, like many children in the shadow of high profile parents, Eric needed to discover an individual voice – finally establishing himself as an uncommonly talented blues guitarist.

Years spent busking, travelling and then touring around Europe eventually lead to a permanent move from his native New York to Stockholm, where an association with slide man Goran Wennerbrandt culminated in two albums cut for the Swedish Opus 3 label. *Spirit & The Blues* (the first of these LPs) is distinctive. A richly attractive and effortless delivery, consciously gentler than those gnarled and often whiskey-soaked voices of great blues men from the past, brings a new perspective to adaptations of classic material like 'Tell Ol' Bill', 'Lonsome Valley' and 'Meetin' At The Buildin'. It also obviously suits Bibb's own style of songwriting.

An impressive "live" studio recording (cut at 45rpm into four short sides) it is pleasingly free from overdubs and post-production mixing. Consequently, these tracks, whether it's a fingerpicking 'When Shall I Be' or negro-spiritual 'Woke Up This Mornin', reveal the inner most instrumental workings as well as those emotional resonances present in Bibb's phrasing. An excellent and deeply honest debut.

RP



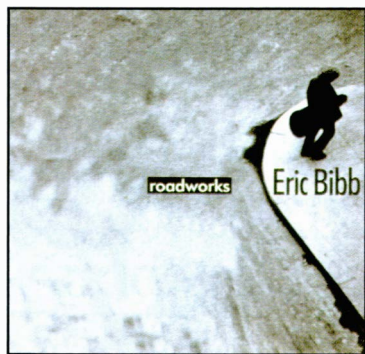

Eric Bibb

Roadworks

Hatman 2003

This is an album of live recordings made during Eric's 1999 world tour, both in concert and studio. Many tracks will be familiar to fans, including 'I Want Jesus To Walk With Me' and the beautiful 'For You', but some may not. Eric sings and plays guitar backed by a selection of acoustic instruments. The final track, 'Lazy Afternoon', is a duet with his father, Leon. As usual with Eric's work the music is excellent. The album opens with the traditional 'Tell Ol' Bill', which has appeared on previous Bibb recordings, with other tracks mainly consisting of traditionals and those penned by Eric himself. Highlights include 'Panama Hat', and the traditional blues of 'Goin' Down Slow'. The recording of 'Shavin' Talk' in producer and bass player Dave Bronze's bathroom is a nice idea. Sound quality is a bit of a mixed bag - not surprising when the disc was recorded in nine different venues. Natural tones, some good ambience and intimacy, but some instruments sound a little too close and I don't like the unnatural panning of the guitar, in the background on 'Saucer 'n' Cup'. For Eric Bibb fans out there this album is a must. But, if you want an introduction to this talented musician, buy his Opus 3 material first.

Supplied by Pentacone

Tel/Fax: 01924 445039

SG

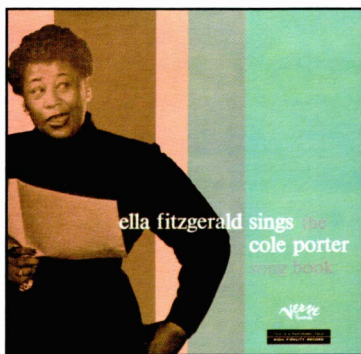
Ella Fitzgerald
Sings The Cole Porter Song Book

Speakers Corner Verve

MGV4001/2

When Ella recorded this, and the rest of her popular song books, she got the kind of flack from the "jazz establishment" that Dylan was to get for going electric. And yet, looking back, these albums are amongst her best loved, and in many ways, most respected. Free from the stylistic demands of jazz, with its emphasis on technique, she was able to concentrate on, and blossom as an interpreter of lyrics.

Cole Porter, dismissed as a lightweight by "serious" musicians has, none the less, provided us with a canon of song, remarkable for its timeless appeal. What maybe wasn't so obvious at the time was the multi-level nature of his work, at once simple on the surface but with a knack for fastening on the essential heart of a matter. Add Ella's stellar interpretation and the results are musically sublime.

Four sides containing such gems as 'Anything Goes', 'Night And Day', 'I've Got You Under My Skin' and 'Let's Do It', all in glorious Verve sound. It sold in droves, but precisely because of its popularity, decent, non-dancetted discs are hard to come by these days, which makes Speakers Corner's re-issue especially welcome. Cleaner, and a little cooler than the original, the sound is excellent. Wonderful. Essential. Brilliant!

RG

Beethoven
Symphony No. 7

Cantelli, Philharmonia Orchestra

Testament EMI ASD 254

Guido Cantelli's interpretation of a brilliantly scored and frequently recorded work has both style and substance enough to recommend it. Flowing and richly textured performances like these sometimes struggle to extract that very last ounce of excitement present within Beethoven's exultant finale but they do, instead, offer a compensatory abundance of warmth, imagination and even-handedness which will have you returning to this particular LP again and again. Moreover, thematically, an element of control does paradoxically seem to galvanise those long-held and loosely ascribed Dionysian motifs which have surrounded the *Seventh* since its inception in 1812. The recording, though, is not quite your typical early EMI and, while I don't possess an original for direct comparison, I am familiar enough with both its peers and a Seventies re-issue, CFP 103, to know that this re-cut is the likely superior. A warm and full-sounding disc whose ambience (minus the usual opacity heard on "white labels" like Cluyten's rendition of the *Fifth Symphony* ASD 267) allows for a far better separation of instruments. As a postscript for all you secondhand enthusiasts, the compelling Colin Davis / RPO release on the bargain EMI HMV label (SXL20038) should not be overlooked. It's also outstanding.

RP

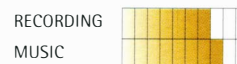

Hear the difference...

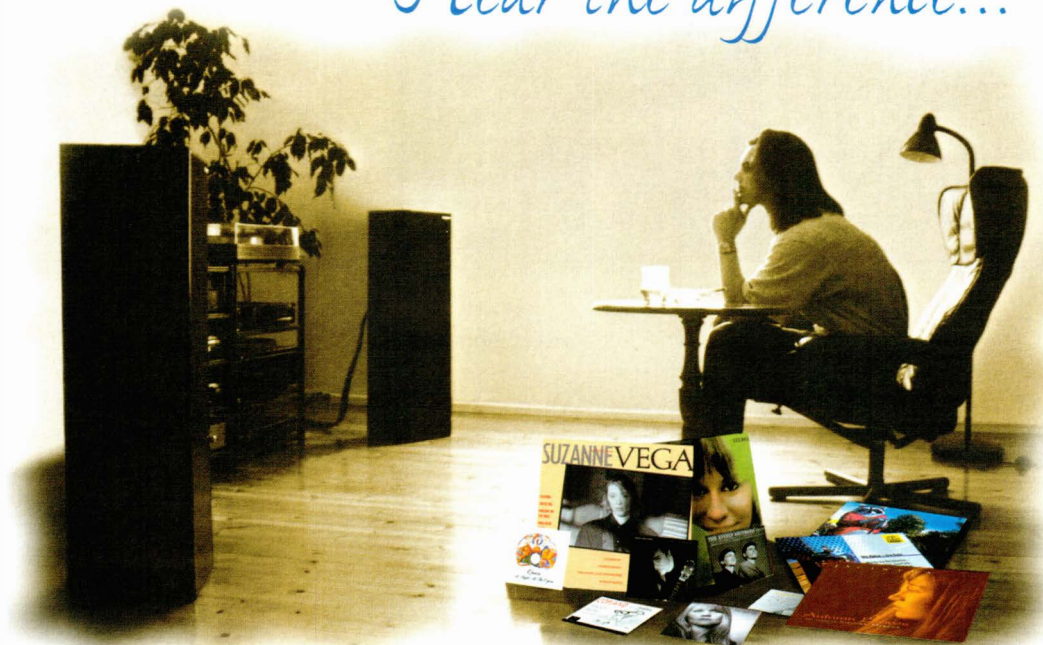

• Vivante • Unit 4 • 60 High Street • Hampton Wick • Surrey • KT1 4DB •
• tel: 020 8977 6600 • fax: 020 8977 4445 •
• web: www.vivante.co.uk • email: sales@vivante.co.uk •

...Audiophile recordings - the ultimate Hi-Fi upgrade

MICHELL GYRODEC SE AND QC POWER SUPPLY

A SYMBOL
OF PRECISION

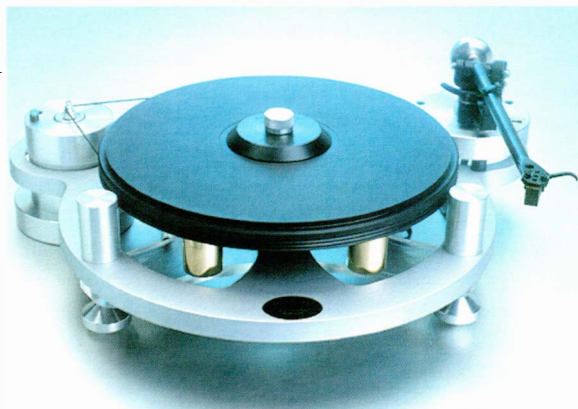
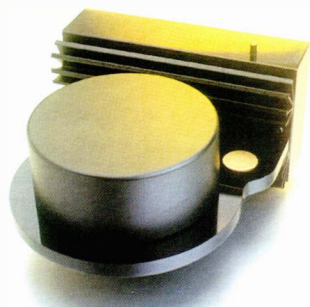

WHAT HI-FI?
June 1999

Michell Engineering, 2 Theobald Street, Borehamwood, Herts WD6 4SE
Tel: 0208 953 0771

OPUS 3

– Swedish recordings...naturally

by Simon Groome

Ever since I started listening to music through a quality hi-fi, I have been hooked by the excellence of sound on one label above all others. My love affair with Opus 3's recordings dates back to when I auditioned the system that, although much modified, I still own. I can still remember, all those years ago, hearing, for the first time, the wonderful voice of Afro-American gospel/spiritual singer Cyndee Peters, and her gripping interpretation of House of the Rising Sun. The musicians were laid out before me and I could hear every nuance of the music. But it was the naturalness of the presentation that captivated me. I immediately ordered a copy of the LP (now available as part of CD 7706/03 – *A Collection of Cyndee Peters and Eric Bibb*) and still use the track today to evaluate any alteration to the set up of my system.

My experiences were far from unique, and in the late eighties, Opus 3 discs were considered as essential demonstration material at a whole host of shops and hi-fi shows. Today that has changed, with the need to impress pushing manufacturers towards the spectacular, at the expense of the beautiful simplicity embodied by these Scandinavian recordings. But just because you don't hear them so often doesn't



mean that they have gone away. The voice of Cyndee, the playing of Eric, as well as the other performers on the label, are just as wonderful as they always were.

Opus 3 – as it points out on all their LP and CD covers – is an independent, Swedish, record company, dedicated to recording timeless, acoustic music, such as jazz, classical – chamber, choral, orchestral, and organ - blues and folk/world music. Their aim is to reproduce voices and instruments as naturally, and accurately, as possible, and to recreate the feeling and atmosphere felt at the moment of recording.

Opus 3's roots can be traced back to the late 1950's, when a young Jan-Eric Persson lay in his sick bed.

His father, who worked for Philips, brought home a bare speaker driver and wired it up for him, so he could listen to music. Jan-Eric was so fascinated by the small vibrating object he became hooked. By the end of the 1960's he, and a friend, were designing loudspeakers. After a couple of years the pair felt happy with the sound of their driver and crossover configuration, but only on certain LPs. The decision was made to produce their own recordings - ones that could be trusted for their sound. Eventually

the recording process would take over and Jan-Eric was to give up speaker design to concentrate on recording in the Stockholm jazz clubs.

The company Opus 3 started at the end of 1976. In the beginning there were three members of the team, but by 1977 just the partnership of Jan-Eric and Bo Hansson, who would become the LP side of the company, would remain. Vital to the Opus 3 sound is the equipment used in the recording chain. When the company started they bought a couple of Swedish Pearl condenser tube microphones, but lately, C-24 AKG tube microphones, Beyerdynamic M-160 double-ribbons, or Neumann U-89 microphones have been used. They also employ a custom-built

▶ tube mixer, designed by Jan-Eric with Kjell Malmberg of AV Research Ltd. This mixer is important because, used in conjunction with the company's Telefunken Magnetophon M-28C tape recorder, run at 15ips with either Agfa or BASF tape and no Dolby, it reduces the number of gain stages in the recording chain to five. This is opposed to the fifty or so in a standard multi-channel and multi-track studio. However, as Jan-Eric points out, if you don't get the right sound at the microphone capsule, it doesn't matter what equipment is used.

Today, when people talk about recording methods, the choice of digital converters and oversampling are often their main concerns. But when Opus 3 started, discussions were more to do with recording techniques or philosophy – how many microphones should be employed? - or the recording environment – studio versus concert hall. Opus 3's method of recording concentrates on three areas of the sound – depth of image, timbre, and dynamics. To understand the company and its recording methods it's necessary to look at the background to this philosophy.

Opus 3 uses the analogy that stereo sound is like three-dimensional sight - just shut one eye to see how it affects your judgement of distance. In the same way, the human auditory system requires sound waves reaching each ear, with regard to sound level, direction, time and frequency. This information tells the brain the differences between the two signals received by the two ears. We can then tell the relative position and character of any sound source, such as the placement of the different instruments within an orchestra, and the size and acoustics of the concert hall.

In 1931 Alan Dower Blumlein

first solved the problems of dual-microphone techniques. What became known as the "Blumlein method" consists of two bi-directional microphones, at right angles to each other, and placed as close together as possible. This eliminated any time-of-arrival differences, which cause phase problems when one microphone receives sound prior to the other, but managed to produce intensity differences, as each microphone had a maximum sensitivity in a different direction, allowing a good stereo spread to be achieved. The result



of Blumlein's work meant that the auditory system could gather the right information, from the recording, so the listener could build up the illusion of a real concert hall, church, or jazz club, while a given instrument would appear situated naturally within that space.

For these reasons, Opus 3 uses a variation of the Blumlein method - recording at a single point with a stereo microphone - in nearly all its recordings. The result is a discernible air around the musicians, which gives a wonderful "you are there", feel to the performance. Instruments are naturally spaced in a coherent

acoustic, and soundstages are spacious, with real depth, layering and perspective. The distance of the microphone from the band ensures that it "hears" whole instruments, their sound combining with the reflected energy of the recorded environment exactly as it does at a live concert, rather than relying on electronic reverb. With jazz recordings a second microphone is often used for the acoustic bass, while the acoustics of some environments may require an occasional break from the rule. Jan-Eric recognises

that there are other ways of recording music, and has described the old Kenneth Wilkinson recordings, on Decca and RCA, as "wonderful", but feels that his experience with the above technique, as well as the tools at hand, are the key elements in Opus 3's sound. Another important aspect of the company's philosophy is that, with the exception of the Hammond B-3 organ, used on Kjell Öhman's *The Hammond Connection* – CD 19402, all Opus 3's recordings feature entirely acoustic

instruments. (Even the Hammond behaves like an acoustic instrument in the sense that it must be recorded with a microphone.) Designed before electricity and PA systems, these instruments were designed for a live acoustic environment, such as a church or concert hall. Opus 3 believes it is important to record them in the same kind of environment, and not in a studio, so that the natural timbre, or character, of the instrument is preserved. The recording location is always chosen to suit the programme, rather than imposing a single acoustic environment on different styles of music. Jan-Eric also prefers to be isolated from the players whilst

▶ recording. That way he receives no visual clues, just like the listener at home, which makes it easier to ensure a natural, stereo, perspective on the tape.

The dynamic range of an instrument, or the human voice, is the difference between the loudest and softest sound levels it is capable of producing. Like timbre, the dynamics not only depend on how the instrument was built, but also on the way a composer or performer utilises it. It is the dynamics that create much of the emotion, mood, and expression in music,



and not just the pyrotechnics often used to demonstrate hi-fi. When hearing many recordings produced today, I feel the true understanding of the term "dynamics" may have been lost, or confused with energy and power. Just listen to Celine Dion! Close miking exaggerates the recorded dynamics, and in the same way that reverb is added to restore the sound of an instrument's body or sound board, multi-track recordings need to be re-balanced to achieve anything approaching a natural effect. As a general rule Jan-Eric states that you should always record at a distance that is at least twice the length of the radiating body of the instrument. Watching a musician such as Eric Bibb playing live, I am astonished

how far away from the microphone he performs.

Having captured the sound on analogue tape, editing is done the old way, with a razor blade and tape, thus avoiding the problems of transferring the music onto a digital-editing suite. Once again, this approach is designed to reduce the number of electronic stages in the process. Likewise, Jan-Eric always takes care of the record cutting and CD mastering himself, rather than leaving it to others. That way he can bypass as much equipment as possible and keep the chain as short as practical. In fact Jan-Eric is a very "hands-on" producer, and is involved in every aspect of the production of any new release, from selecting the artists, to designing the cover and photo-graphing the performers. For CDs the analogue sound is converted to digital using a DCS 900. Recent CDs have also employed Sony Super Bit Mapping, which helps with low-level signals, and HDCD - both of which Jan-Eric refers to as "a step in the right direction".

Future releases will also be issued on SACD, with the first master already having been produced in London. Sony are so delighted with the result, they have requested that four other Opus 3 releases are to be reissued on this format.

Jan-Eric's monitoring system comprises Totem Model 1 speakers - for their ease of use when moving around recording locations - and AKG K-1000 headphones. He also used Quad ESL-63 electrostatics with Gradient subwoofers,

but has recently started to employ a pair of the new Quad ESLs - not that surprising, as he is the Swedish distributor of this British equipment. For amplification he uses modified Dynaco Mk.111s or a Quad 606, while LP's are played on Opus 3's own Continuo turntable, with a Well-Tempered tone arm, and Ortofon SPU cartridge, with Van Den Hul type II stylus and boron cantilever. A newly acquired Sony 777 SACD player caters for digital discs.

In the autumn of 1990, Jan-Eric and Bo Hansson parted, effectively splitting the old company in two. Since that time Jan-Eric has concentrated on producing CDs, although he has started to release one or two recordings on LP once more (see my review of Eric Bibb and Needed Time's album *Spirit and the Blues* - LP 19401 elsewhere in this issue). Jan-Eric knows that today's LP market is small, but the issuing of new vinyl has come about because one of Opus 3's distributors wanted it enough to guarantee a certain volume. Jan-Eric believes that SACD is closer to the sound on the master tape, but agrees that a well-set-up turntable, with a good cartridge, ▶

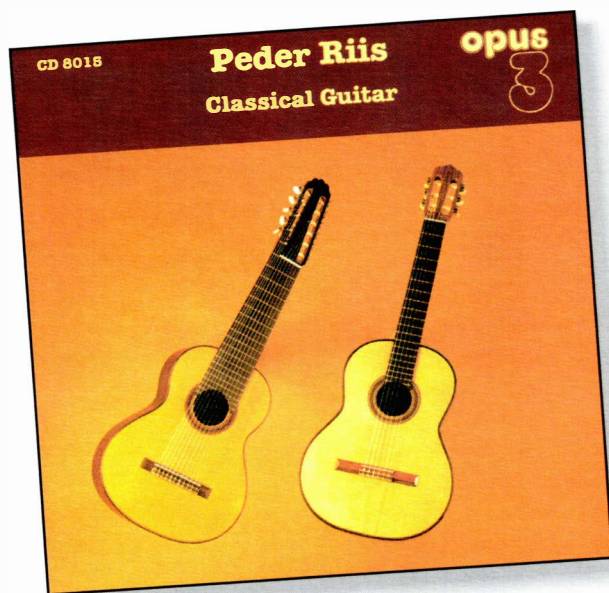

▶ can also sound superb.

Artists recording with the Opus 3 label understand the significance of the sound and its impact on their performances. Some have actually asked to be recorded on Opus 3 for this reason (and because their music is never placed second to sonic excellence, as with some other “audiophile” labels that I could mention). Artists such as Eric-Bibb and Tomas Örnberg continue to rely on Jan-Eric for sound quality that can accurately communicate their music.

The Opus 3 catalogue has always contained a very personal selection of music, but each and every musician has been chosen because they display some unique qualities. These performers range from internationally acclaimed instrumentalists to young musicians with a promising career ahead of them. Initially they were discovered very much by word of mouth, but as the label became better known, performers started to send in tapes. Likewise, the chosen programme is drawn from a wide and eclectic range of genres, but always trying to offer something special.

One example of this is the recording of Mozart's *Clarinet Concerto* – CD 8801, performed by Kjell Fagéus, a basset clarinet specialist, and the Royal Orchestra of Stockholm conducted by Eri Klas. Mozart actually wrote a special version of this piece (as with his *Clarinet Quintet* – CD 19301) for the basset clarinet, an instrument producing a range that extends four semitones below that of an ordinary clarinet. This is the version that Opus 3 chose to record, and whilst other labels have since followed suit, theirs was the first.

Chamber music is well

represented, with two outstanding ensembles. The Zetterqvist String Quartet's outstanding performance, *Stenhammer – Sandström – Edlund* – CD 19702 (HDCD), is a little intense for many listeners, although those who like the string quartets of Bartók, Shostakovich, and Smetana should certainly try to hear this album. For those looking for a more relaxing time, there is the Stockholm Arts Trio's performance of work by *Franz Schubert* – CD 19601 (HDCD). When listening to this recording I feel that I am attending a live performance, seated in the front row of the Wigmore Hall. This has got to be the most realistic recording of chamber music on CD. The playing is sublime, with beautiful tones from the instruments.

There have been other notable performances on Opus 3. Peder Riis and the Stockholm Guitar Quartet have released some wonderful recordings. I have always been a sucker for the sound of the acoustic guitar, and these performers play some of the best – produced by Swedish instrument builders, Georg Bolin

and Lars Jönsson. The quartet was formed in 1975 and recorded for the first time, with Opus 3, in 1978. They are the only guitar quartet to play four differently tuned instruments,



producing sound spanning almost six full octaves – about double that of a conventional 6-stringed guitar. This has allowed the group to extend the repertoire for the instrument, into areas of chamber and orchestral music usually beyond the scope of the guitar community. Rather than start with one of the Quartet's recordings, I would recommend Peder Riis' solo work, *Classical Guitar* – CD 8015.

The pieces by Bach and Weiss were originally written for the lute, but are played here on 11 string instruments, which have the same sound register. I have not heard these works played better, and the recording is excellent. There is a tonal beauty to the CD that is rarely found in recorded music - the guitar seems to hang in the natural acoustics of the stone church, in which the recording was made.

Another superb album of guitar music is Manolo Yglesias' CD, *Destino Flamenco* – CD 19505. This is the best ▶





those composed by Mozart and Rossini. The performances are light and humorous, with luxurious tones and a beautifully balanced sound. Much of Opus 3's best work has featured jazz music performed by musicians from around the world, yet usually incorporating a homebrewed Swedish core. Sweden has a jazz community that includes some excellent musicians specialising in traditional

jazz recording. My favourite of their releases is *It's Right Here For You* – CD 19404 (HDCD), under their Swedish Jazz Kings designation. When listening to this CD, I am suddenly swept to a 1920's club, in Chicago – I can almost smell the cigarettes and taste the bourbon! The realism is outstanding, with instruments and soundstage clearly defined. I have never heard a clarinet or soprano sax recorded as well as they are here – you can hear the reeds vibrating - and the brass sounds crisp and metallic. This is some of the greatest swing that you are likely to hear, with magical playing by, guest artist, English trombonist Roy Williams. The Blue Five have also featured as a backing group to Kenneth Arnström, an amazing clarinet player and saxophonist with a style all of his own, on *Rhythm King* – CD 19502. As the title suggests, this performance centres more around rhythm, being slightly light-hearted, and more dance orientated.

▶ flamenco recording I have heard – full of proud and spirited music. Manolo's playing is magnificent, with intricate finger-work, and he is even able to produce drum like sounds from the strings. The recording enables the listener to hear and feel the impact of his performance, with vibrations from the body and strings permeating the listening room. A "must buy" for all guitar lovers.

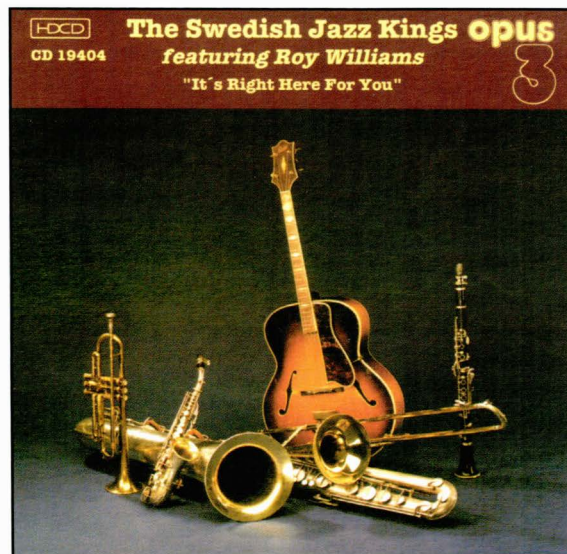

The Omnibus Wind Ensemble has a global reputation for its wide repertoire and virtuoso playing. It has formed a deep and knowledgeable interest in the controversial classical compositions of Frank Zappa. Their recording of his work started with the CD *From Mozart to Zappa* – CD 9203, and was followed up with *Music by Frank Zappa* – CD 19403. The group comprises twelve performers playing an unusual, yet colourful, array of instruments. This gives them a style and sound all of their own, performing music from genres as varied as classical, Swedish jazz, Latin and rock. My favourite of their releases is *Opera Pearls* – CD 19602 (HDCD). This is a delightful album of orchestrated music from the opera, with my preferred works being

jazz. Tomas Örnberg's Blue Five, also known as the Swedish Jazz Kings, have featured on a number of Opus 3 recordings. They play music of the twenties and thirties, specialising in Louis Armstrong, and have been joined by American clarinetist Kenny Davern, Australian trumpeter Bob Barnard, and one of the world's leading Armstrong interpreters, the unfortunately named to English speaking ears, Bent Persson. Their second recording (CD 8003) won the 1982 Swedish Gramophone Prize and was named by Jazz Journal International as that year's best new



While excellent, the sound does not quite produce the atmosphere of the Swedish Jazz Kings CD.

There are also five recordings featuring the superb talents of Lars Erstrand, who, in 1981, was



discovered his work in the 1980's – I listed two of his albums in my desert island discs in issue 7. His blend of vocal and instrumental folk music, inspired by jazz, afro blues, gospel, Latin American, and classical, always brings a smile to my face – whether its through humour, or his songs that inspire and uplift the soul. He has

performed his work around the globe and won awards for his recordings: best album of the year (1997) in its category (Sunday Times), for *Good Stuff* (CD 19603 [HDCD]), while *Spirit and the Blues* (CD 19401) won the

be available on general release in the UK, Ireland, and USA, due to a decision by Eric's management, but will be available to audiophiles and hi-fi enthusiasts directly from the importer and supplier of all things Opus 3, Pentacone.

Possibly the best way to get to know the Opus 3 recordings, is to get hold of one of their Test Records/CDs. Although Jan-Eric was involved in producing the Ortofon Test LPs, which do include pink noise, channel checks, and tone bursts, as well as the hard to find Quad Test CD, these do not. Instead the Opus 3 Test Records are a selection of tracks taken from their albums, including both out-takes and alternative takes. Their value comes in the fact they also contain instructions on what to listen for when playing them. I have always preferred to listen to the music I am familiar with to set up a hi-fi, rather than specialist test noises, and these recordings

certainly help, giving an engineer's insight into what would have been heard at the recording session.

They, of course, also act as a great set of samplers, and, therefore, a great introduction to the Opus 3 philosophy.

Opus 3 recordings are a mixture of eclectic musical taste, and possibly the most natural sounds outside a concert hall or jazz club. Performance wise, there is something for everyone and certainly some hidden treasures for the more adventurous music-lover. Their recording philosophy brings life to recorded music,

enabling the music and its interpretation to be appreciated and understood, naturally. I only wish more recordings were produced this way.



Available in the UK from:
Pentacone
Tel/Fax: 01924 445039
www.pentacone.freeserve.co.uk

▶ named as one of the world's top vibe players, only losing out to his two mentors, Lionel Hampton and Milt Jackson. Lars also employs many top international soloists on his recordings, including, the above-mentioned Bob Barnard and Roy Williams, as well as Danny Moss, from Britain, on tenor sax.

Other recordings have featured music as diverse as Beethoven – *Symphonies Nos. 1 and 2* (CD 19504), performed by the Stockholm Sinfonietta – an orchestra of a size familiar to Beethoven – conducted by Okko Kamu, and *Music for Organ, Marimba, Vibraphone, and Percussion* (CD 19802 [HDCD]). Music reminiscent of the best ECM jazz recordings, *Lands End* (CD 19803 [HDCD]) has been released, as well as *Concertos for Double Bass* (CD 8502).

The best known of the artists who have recorded with Opus 3 is Eric Bibb, whose association with the label dates back to its earliest releases. This wonderfully talented and very personable artist has always been a favourite of mine, since I first



“Benchmark” award (Australia), and “Record to Die For” (Stereophile magazine). I am delighted to hear that there is now a vinyl issue of *Good Stuff* (LP 19603), and a brand new recording, *Just Like Love* (CD 20002 [HDCD]), which is also the first release to have an SACD version (CD 21002). I will be reviewing these releases shortly. Apparently the latter may not

CYRUS



CLS 70 is the first of three striking new loudspeakers Cyrus will launch this year. Each CLS design follows our philosophy of incorporating advanced technologies within fabulous cabinets using the finest materials.

The CLS 70 illustrated is finished in Maple at £800 a pair. The new *Tripod* speaker stands are recommended for optimum performance, at £200 a pair.

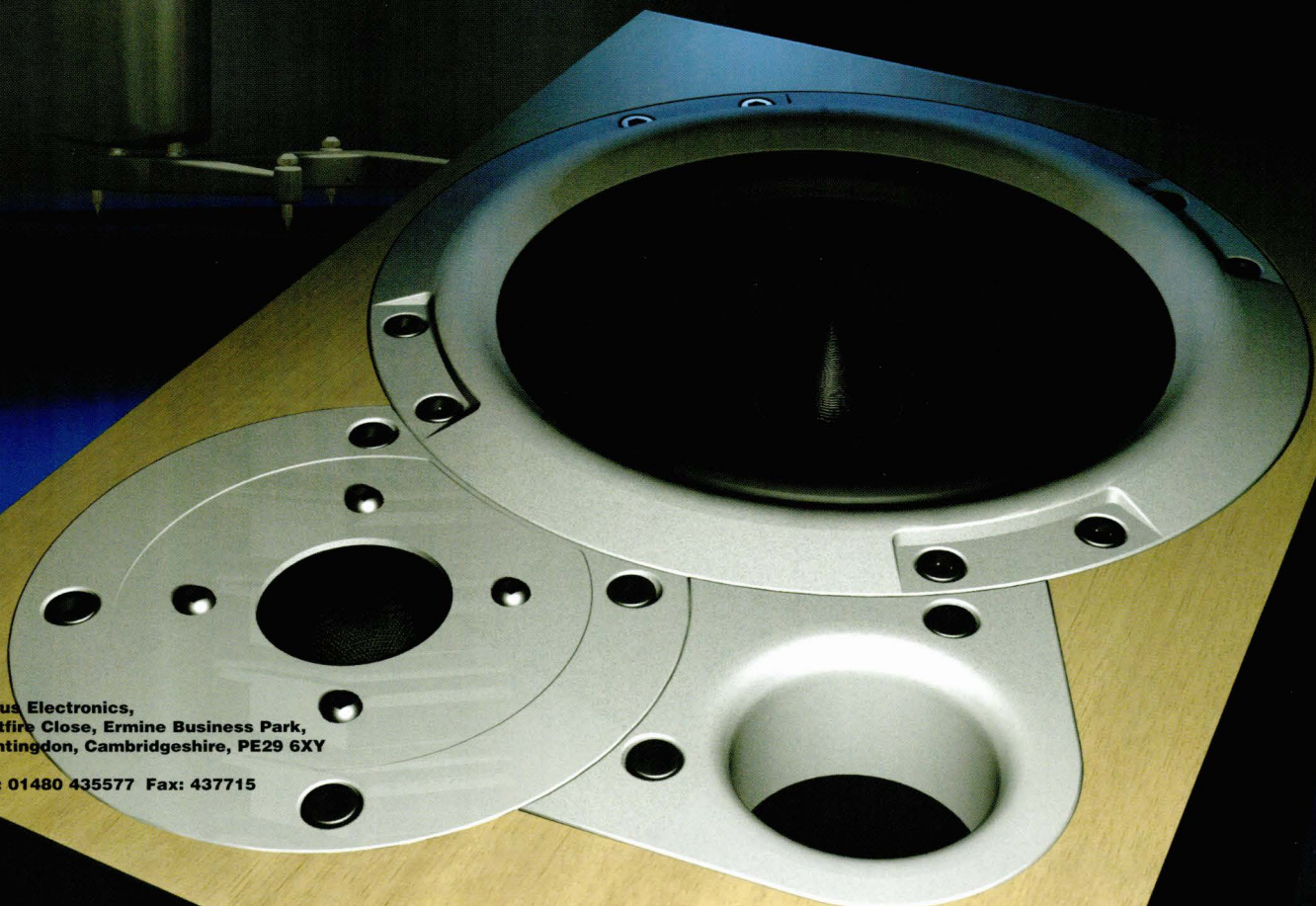

**Cyrus Electronics,
Spitfire Close, Ermine Business Park,
Huntingdon, Cambridgeshire, PE29 6XY**

Tel: 01480 435577 Fax: 437715

www.cyrusaudio.com
email: info@cyrusaudio.com

CYRUS

bwspeakers.com

Explore the Nautilus™ 800 Series



Sir John Eliot Gardiner is one of today's most versatile conductors. Famed for his work with ensembles from the Monteverdi Choir to the Vienna Philharmonic Orchestra, and classical recording labels from Deutsche Grammophon to Philips, Sir John Eliot chooses for his home listening pleasure B&W's superb Nautilus™802.



B&W

LISTEN AND YOU'LL SEE

For further Information contact UK Sales on: 01903 750750