

TIPS FOR AMATEUR PHOTOGRAPHERS  
(See page 56)

VOL. 116 NUMBER 2999

READ BY THOUSANDS EVERY WEEK FOR PLEASURE AND PROFIT

# WOODWORKING JOINTS

ANOTHER ARTICLE OF A POPULAR SERIES

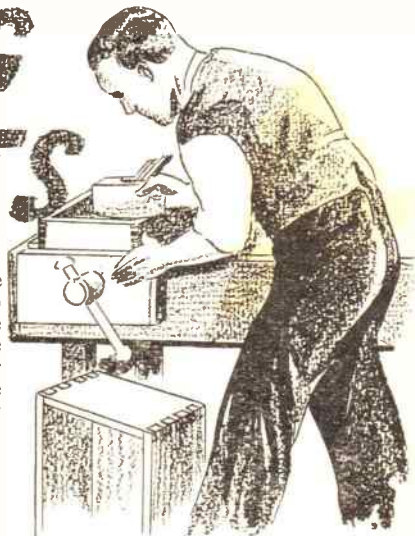

**I**N this article we describe the dovetail joint, and by the help of illustrations, give suggestions for cutting the joint. Each dovetail is shaped somewhat like a fan, as you will see by the sketches. Where a number of dovetails come together in a joint, as at Fig. 1, they are known as box dovetails.

Dovetails are the strongest and best joints you can use for tool boxes, handkerchief boxes, etc. They hold the sides firmly together and tend to prevent the wood from warping. We often show butt joints for these purposes, because dovetails are apt to frighten the beginner, but when you have mastered the dovetail joint you will be able to use it in place of many butt joints.

Suppose you wish to make a box about 10ins. by 6ins. by 5ins. You will need two pieces 10ins. by 5ins. and two pieces 6ins. by 5ins. They should be planed true to about  $\frac{1}{16}$ in. thick, making sure that the ends are square.

**Marking Out**

A good joint depends largely upon the accuracy of marking out. If you

study the diagrams 1 and 2 you will see the joint assembled and drawn apart to show the construction. Four joints have to be made to complete the box. Notice that the dovetails are cut in the longer pieces of wood, and the pins, as the other shapes are called, in the shorter pieces. Fig. 3 shows a side view of the dovetails.

Commence marking out by squaring a line round the ends of the longer sides as shown at Fig. 4. The depth of the line will be the thickness of the shorter end. The shorter ends will be similarly marked.

The dovetails have to be marked on the longer sides. In this case the wood is 5ins. wide and we suggest the arrangement shown in Fig. 3. The actual number of dovetails differs with the width and thickness of wood. (When you have marked the measurements along the line shown in Fig. 4, you prepare the bevel for marking the slope.

**The Bevel Square**

The ordinary try-square, with which you will, no doubt, be familiar, is set permanently at 90 degrees, but the bevel square can be moved, by means of

IN THIS ISSUE	
	Page
Woodworking Joints	49
A Semi-Rustic Summer House	51
Make a Useful Fireside Curb	52
A Breeding Cage for Birds	53
A Few Ideas for Cyclists	54
Modern Table Bookcase	55
Can You Produce a 'Pictorial' Photograph?	56
A Fretwork Money Box	58
The Handyman's 'Treasure Chest'	58
Experiments with Potassium Carbonate	59
Replies of Interest	60
Patterns for The Money Box	63

All correspondence should be addressed to The Editor, Hobbies Weekly, Dereham, Norfolk.



THE MAGAZINE FOR MODELLERS, FRETWORKERS & HOME CRAFTSMEN

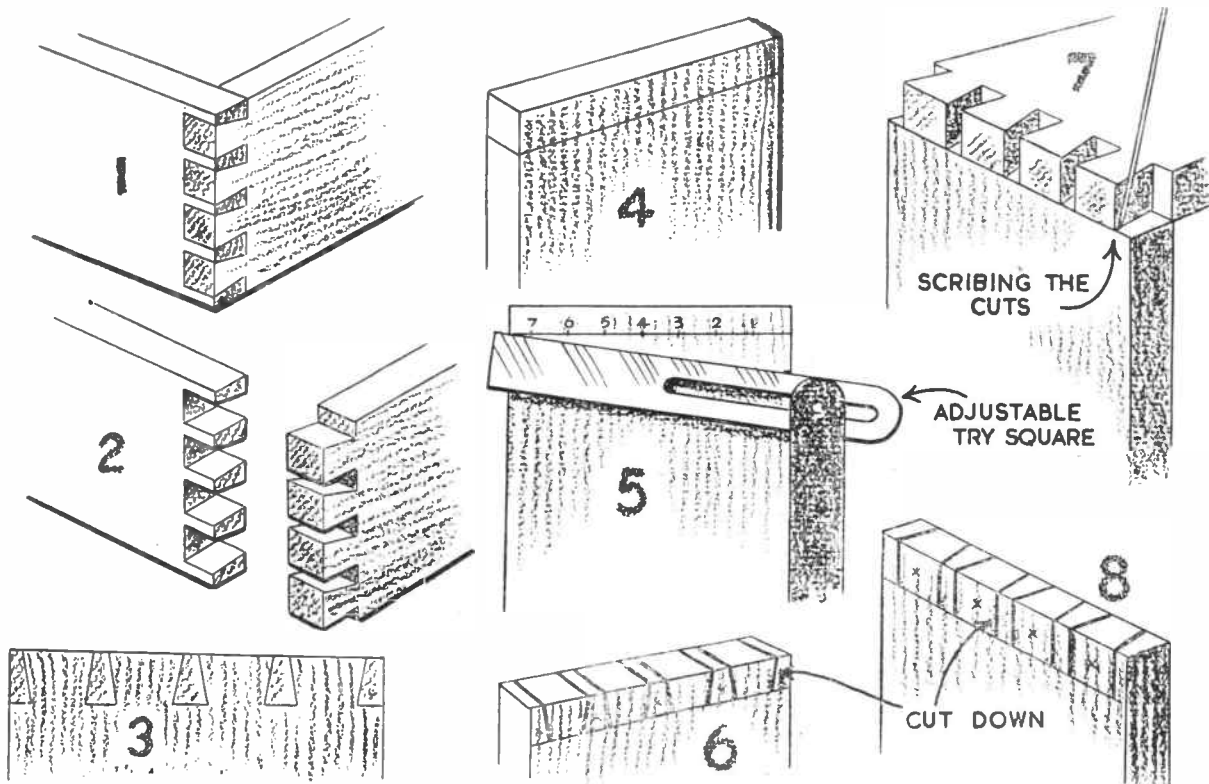

a tightening screw, to any angle required.

The slope varies a little according to the wood in use, but for our purpose 1:7 is satisfactory.

Square a line across a piece of card or waste wood and mark along this line seven units of equal length. Now mark one of these units along the edge of the wood and join these two points with a pencil line. Loosen the screw of the bevel and adjust the blade to the slope of this line as shown in Fig. 5. Tighten the screw and you are ready to mark out the dovetails.

Place the bevel along the end of the wood and from the previously made marks draw cut lines down to the pencil line. Square the cut marks across the end of the wood and then complete the bevels on the other side. Fig. 6 shows the marks completed. The waste wood is denoted by the small crosses.

Before marking out the shorter ends you must cut out these dovetails. Fix the wood in the vice and saw down the cut lines as far as the pencil line. Saw away some of the waste wood with a bow-saw or fretsaw. Now with a narrow chisel tap out the waste pieces so that the four dovetails are left. It is possible to cut away the waste completely with a fretsaw if the thickness of the wood is not greater than  $\frac{1}{4}$  in. You should be careful to hold the saw perfectly

upright if you are using a handframe.

The next step is to mark the size and positions of the dovetails on the ends of the other pieces of wood. Fix the unmarked piece in the bench vice and lay the dovetails on top as shown in Fig. 7. Scribe round the dovetails and continue the lines down to the pencil line by means of the try-square. Fig. 8 shows the completed marking out on the end. The crosses denote the waste wood as before.

Fix the end in the vice and saw down to the pencil line, keeping on the waste-wood side of the line. Cut away as much as possible with the bow-saw or fretsaw

and follow this up by chiselling down to the line.

If the joint has been cut accurately the two parts should slide into each other without too much forcing. The parts can be gently tapped together to form a strong joint. A little glue should be smeared on the joints before assembly. Finally, do not complete each joint in turn, but make the four sets of dovetails and then mark and cut the pins before assembly.

In the next article of this series we shall describe the construction of the stopped dovetail, which is used in the construction of drawers. (M.p.)

### Fireproofing Clothes

*IS it possible to render fireproof to any extent, cloth such as overalls, by means of soaking in a chemical solution after cleaning? I am a welder by trade and my working clothes have a very short life due to flying red hot sparks continually setting my overalls smouldering. (D.W.G.—Tenby).*

**A**FTER the ordinary washing and drying of your overalls you should immerse them in the following solution: borax, 10ozs.; boracic powder, 8ozs.; water, 1 gallon. When thoroughly impregnated (i.e., uniformly wetted by

the solution), remove, wring out and dry without rinsing. The borax and boracic powder should be completely dissolved in the water, of course. The treatment must be renewed each time the overalls have been washed. There are wash-proof treatments, but as these call for the use of hydrometers and not-so-common chemicals, we do not quote them. The solution mentioned above can be kept and used again and again until finished. To avoid evaporation, it is best kept in glass or pot jars, suitably closed.



# A Semi-Rustic Summer House

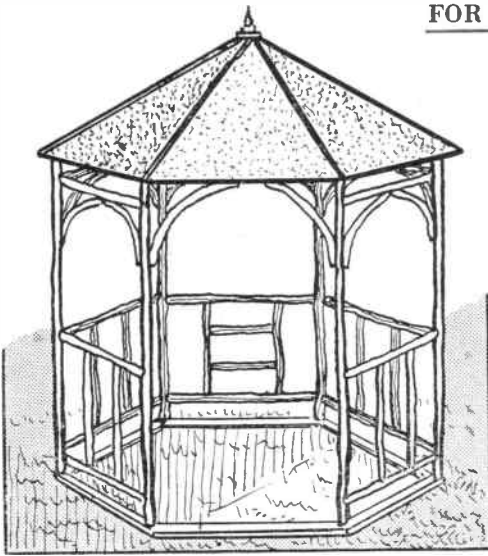

A SUMMER house is always a welcome addition to the garden, and the design illustrated has some attraction of its own, being more pleasing to look at than a more formal building. It is mostly built of such rustic wood as can generally be obtained at little expense, especially in country districts, and need cost little to construct.

Make up two hexagonal frames by cutting six pieces of each of the two

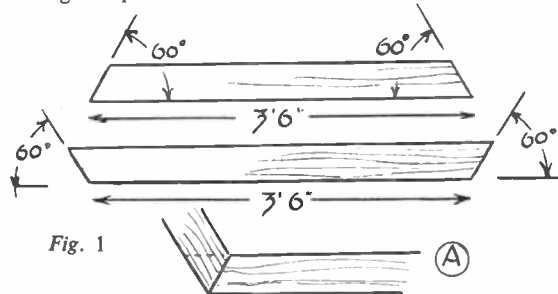

Fig. 1

parts of the frame shown in Fig. 1. Each frame is composed of three of each, nailed and glued together. The corner joints are made of the simple halved variety, and are easily cut by laying two together, as at (A) (a long piece over a short one) and pencilling the corner angles across, the overlapping portions being then sawn to half their thickness to make the joint. Employ good deal 1½ ins. by 4 ins. substance, and glue with casein glue, then securely nail through the joint. Leave the centre of the joint free of nails to facilitate subsequent fixing of the vertical posts.

These posts are of rustic wood, about 2½ ins. diameter, as straight as possible, and 6 ft. long. Be careful to saw across the ends squarely, to better ensure a

symmetrical structure. Now nail the posts to each corner of the ground frame, then nail the top frame to the posts. Use good long nails, and hammer well home. Preliminary holes for the nails had better be bored to lessen the danger of splitting the wood.

The detail sketch, Fig. 2, will now be helpful. Between the vertical posts nail three horizontal rails, cut from 1½ in. rustic wood. Top and bottom rails are positioned 6 ins. up or 6 ins. down, the intermediate rails some 3 ft. above ground level. No rails are fitted between the two posts intended for the entrance to the summer house, of course. The rails are straight nailed through the posts as at (B) or skew nailed to the posts as at (C), according to circumstances. Fit each separate rail across and cut it a little longer than the distance, to enable the ends by being sawn and chiselled to a

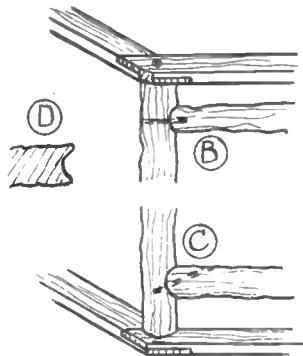

Fig. 2

concave surface, as at (D), to fit the round posts more neatly.

Before proceeding further with the rustic wood, it will be wise now to make up and fit the roof in position. For the centre piece of the roof (E in Fig. 3) cut a piece of wood 4 ins. square and 5 ins. long to hexagon shape. This can be easiest done by describing a 4 in. circle on to stiff paper, and dividing the circumference into six parts by stepping off the radius round the circle, and joining the points by straight lines. Pin this to the top of (E) and transfer the hexagon shape to the wood. Saw accurately to the shape, making the sides of truly hexagon figure.

Cut six rafters of 1 in. by 2 in. timber, and saw one end of each to an angle of 60 degrees. Nail two of the rafters to part (E), to opposite sides, and lay the whole on the top frame of the summer house, as in detail, Fig. 3. See the ends of the rafters extend beyond the frame by an equal amount, and where they contact the frame, saw out a right-angled notch 1 in. each way. It may be

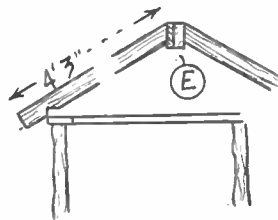

Fig. 3

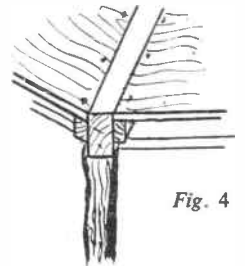

Fig. 4

added here that to ensure a neat fit at the angles of the frame it would be as well to saw off the extreme corners to leave a 1 in. flat across, on which the rafters can fit. Now nail the rafters to the frame, then similarly fit the remaining four rafters in position.

The spaces between the rafters must now be filled in with pieces of boarding. Any kind of wood will do here, even common box wood, as it only serves as a support for the roofing felt to be fitted over later. To the inner faces of the rafters nail ½ in. square strips of wood, at the correct distance down to enable the boards, nailed to them, to lie level with the top edges of the rafters, as in roof detail, Fig. 4. It may be necessary here

(Continued on page 52)

# Make a Useful Fireside Curb

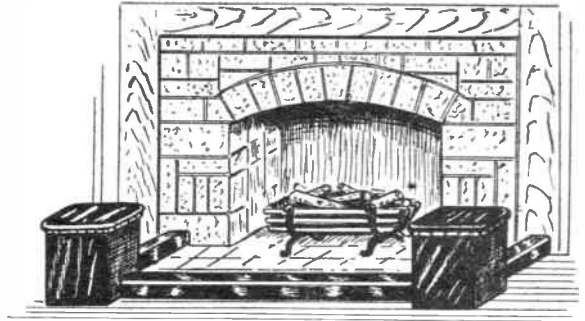

Easy for  
the young  
Carpenter

A FIREPLACE without a curb is like a window without drapes. The curb shown in this article not only sets the room off, having corner seats with storage space inside, but it becomes an article of beauty and utility.

## The Seats

The corner seats are made from  $\frac{3}{4}$  in. plywood with  $\frac{1}{2}$  in. square fillets at the corners. The fillets are glued to the plywood and fixed with finishing nails. These are driven just below the surface, using a suitable punch. For a more sturdy job, screws can be used. Before assembling the seats, holes are cut in

two of the sides to take the curb pieces.

The seat tops are  $\frac{3}{4}$  in. plywood with the top edge rounded off and four strips of  $\frac{1}{2}$  in. fillet nailed to the underside. These are to position the tops on to the sides. The tops are then padded with cotton padding or any other suitable material and covered with upholstering plastic. The plastic is first secured at one side and stretched across, securing the

other sides in turn. Special round-headed upholstering nails can be bought for this purpose.

The curb pieces should be made from a selected piece of 3 ins. by  $2\frac{1}{2}$  ins. timber. See that it is straight and free from knots. Bevel the front edge and saw into lengths for the front and two side pieces, allowing for 2 ins. or 3 ins. to protrude into the corner seats.

If the fireplace is likely to be used, the inside edge of the curb should be metal lined. Strip metal can be bought for this purpose, or, if expenses are to be kept down, strips can be cut from used cans and nailed on in sections. A coat of gold paint on the metal will set it off.

## Finishing

The finish of the woodwork will depend on the style of the room. In any case the nail holes will require filling with plastic wood and all the surfaces glasspapered down. For a simple and easily applied finish, brush on two or three coats of shellac thinned down with denatured alcohol. Each coat should be lightly rubbed down with steel wool or glasspaper. A filler should then be applied, brushed across the grain and coloured to suit. The excess filler is removed by wiping off after 15 to 30 minutes, left for a day, and then lightly glasspapered. Finally, apply a coat of good varnish to a dust free surface and leave to dry in a place where no dust can settle before the varnish is dry. (J.W.T.)

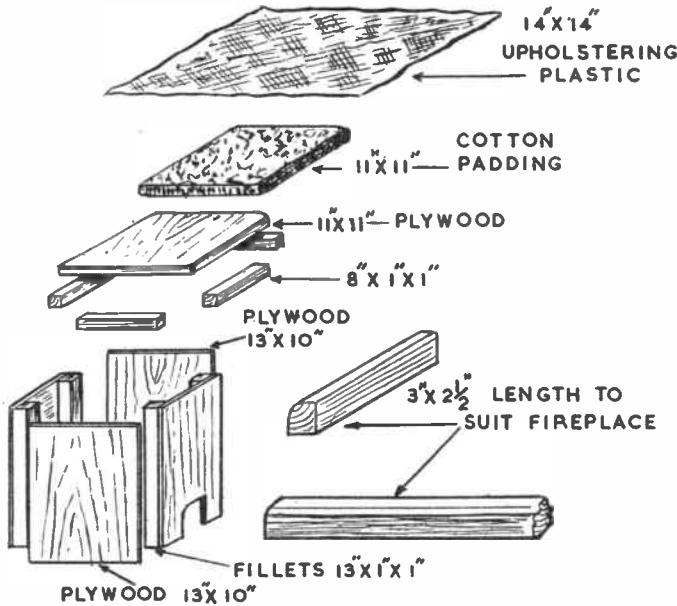

# Semi-Rustic Summer House

(Continued from page 51)

to notch the strips over the top frame, they must extend to the ends of each rafter.

Nail the covering wood over, then creosote the lot. Rubberoid or other roofing material is then cut into suitably sized pieces and nailed to the rafters, and over the front edges of covering boards. Each piece should cover boards and the edges of the adjoining rafters as well, so the edges of one piece of felt

will cover that of its neighbour. A neat finish will result here if the edges of the felts are hidden by nailing strips of wood over them. Over the roof centre piece (E) nail a round or hexagonal piece of wood about 6 ins. across to hide the ends of felt, etc. It would also help to neaten the general effect if a finial were glued to the centre of the top to crown all.

The rustic vertical rails of the sides of the summer house can now be fitted and

skew nailed in place. In the upper angles curved spandrils, also of rustic wood, are to be added, both to improve the structure, and generally stiffen it. These can be natural curves, carefully chosen to match in pairs, as far as possible. Bevel off the ends to fit up snugly against posts and rails, and screw in place.

The bottom surface of the ground frame should be well creosoted, the remainder, and all exposed woodwork, not of the rustic kind, can then be painted white or green, as preferred.

(W.J.E.)

# A Breeding Cage for Birds

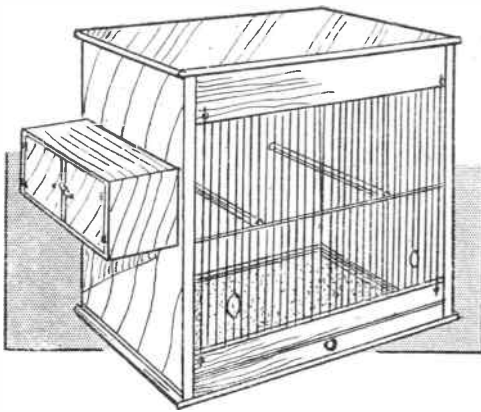

**R**EADERS who may be interested in the breeding of birds can quite easily and cheaply make their own cages for the purpose. A good design of such a cage, suitable for most of the smaller birds at least, is depicted in Fig. 1, with a sectional view, Fig. 2. Any decent quality wood will do for the job, even some varieties of box wood would serve quite well, if made smooth, of course. A thickness of  $\frac{1}{2}$  in. is suggested for the ends, and  $\frac{3}{4}$  in. for front cross pieces, and the remainder, except the parts which can well be cut from plywood, mentioned in the text.

First cut the ends, and in the left side one, to which the nest boxes are affixed, bore out the two holes shown by the dotted circles in Fig. 2. Cut the top crossbar (A) and lower one (B) and note the latter is positioned to leave a 1 in. space below it for the sand tray. Nail these across, then the back can be fixed in place, followed by the top and bottom of the cage. To the left side glue and nail a 1 in. by 6 in. shelf, a little below the nest box holes, shown at (D) in Fig. 1, for the birds to alight on entry to, or exit from, the nests. At about spot (C), a perch should be fixed along at a convenient height for the birds to reach the food and water vessels outside.

All joints should be well nailed and glued to make a strong and rigid structure, and the wood, it is almost needless to mention, perhaps, should be planed or glasspapered smooth. Owing to the width of boards necessary, much time can be saved if tongued and grooved matchboarding is employed, glued together, and as new wood is not imperative, a few lengths of second-hand stuff, if clean and in good condition, would serve nicely.

A pair of nest boxes are illustrated in Fig. 3. Sides and division are cut from  $\frac{1}{2}$  in. wood, top and bottom from plywood, glued and nailed firmly together. No back is needed, of course, the end of the cage forming that part. A couple of plywood doors are cut

and hinged with lin. brass butt hinges, as shown. A wood or metal button, fitted to the division will hold both doors shut, and a knob or just a wire loop threaded through a hole in each door, will serve to open the doors at need. This is fixed to the left end of the cage, over the holes already bored, with screws from the inside of the cage.

### The Sand Tray

For the sand tray, cut a sheet of plywood to the bottom full dimensions inside length and deep enough to reach the front edge of the cage. Along the front of this glue a strip of wood, the same thickness as bar (B) and wide enough to fill the gap below. Also glue narrow strips of wood to the remaining edges to make the tray. The addition of a small knob at front will complete this part. Finish the structural work of the cage by screwing to the back a pair of

they are quite cheap, and even now are not too expensive it is believed. The stock size required for the cage is 16 ins. by 10 ins. It might be as well to get this part before commencing the work of constructing the cage, as if a front of the size given is not available at the time of asking, one a few inches larger would probably suit and the dimensions to suit the opening could be increased to suit the size front available without delay.

Readers wishing to make their own wire fronts should purchase 16 S.W.G. steel wire for the purpose. The fronts are easily fixed in place, wire extensions at each end being provided and small staples or screw eyes fitted to the front of the cage to hold all in position. One or more wood perches, made from dowel rod, can be fixed across the cage, one end of each perch being notched to fit over the wire, and the other end simply held in place with a nail or screw, driven through the back of the cage.

(W.J.E.)

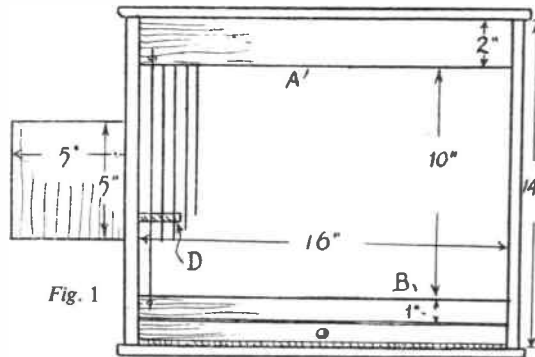

Fig. 1

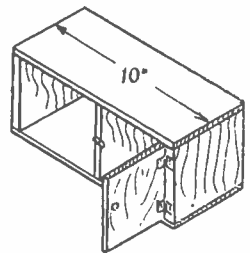

Fig. 3

brass wall plates for suspension purposes.

The completed work can now be lime washed inside or painted; in the latter case use a non-poisonous paint for the purpose. The outside can be painted any colour preferred or given a coat of black varnish. The varnish seems to frame the interior of the cage somehow, and render the occupants more conspicuous, and is a popular choice.

The wire front is far better purchased ready made. The complete front is provided with feeding holes and a sliding door, and can be bought in a range of sizes to suit all cages, at most pet shops or from advertisers in journals devoted to birds and aquaria. Normally

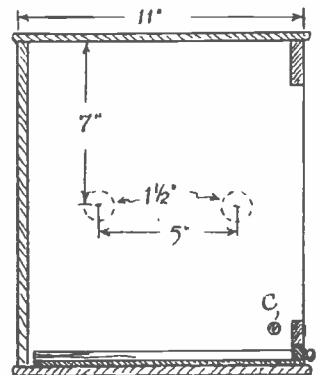

Fig. 2



# A Few Ideas for Cyclists

**M**OST people have been troubled at one time or another with rubber handle-bar grips coming loose and, perhaps, like myself, thought fixing them really tightly again an impossible job. I certainly considered that attempts at refixing were work in vain till I heard of the wonders that could be performed with insulating tape. Since then I have locked numerous loose grips with the hold of a vice and they have never come slack again.

## How It's Done

To work the oracle obtain some narrow insulating tape and tucking the end in the open end of the bar, start to wrap round in a spiral so that the tape just and only just overlaps at its edges (Fig. 1). Continue to a length greater than that of the rubber. Here cut the

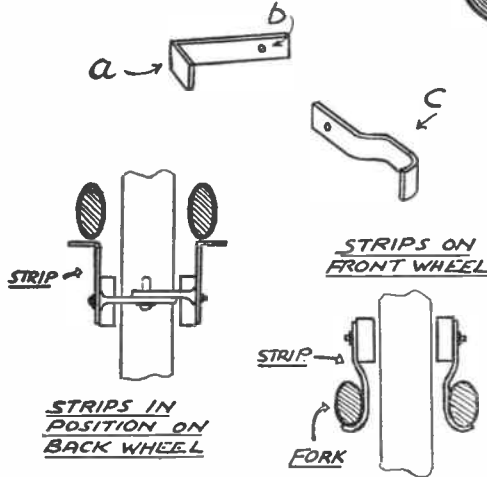

Fig. 2—A simple method of preventing caliper brakes jumping

tape. Now soak the grip in soapy water (this is important) and when the surface is slimy, ease the end over the taped bar and force it forward by rotating in the direction of the spiral. Work quickly, as if the grip 'seizes' half way along it is difficult to get it started again.

Once in position trim away any unwanted tape at the front and the job is done. The grip, it will be found, is now solidly fastened in position, and seemingly gets tighter still (if that is possible), as time goes on.

A trouble that sometimes develops in less nicely set or assembled caliper brakes is 'jumping'. It can be caused by the wheel being a trifle out of the true, or by not too well designed or pivoted calipers. The fault can be remedied by

fastening thin strips of metal to the shoe bolts as indicated in Fig. 2. In the case of the rear wheel the strips are bent at the ends to a rightangle as (a) and are of such a length that when being held in position by passing the shoe bolt through the hole (b), the angled ends just touch the stays. Back wheel calipers

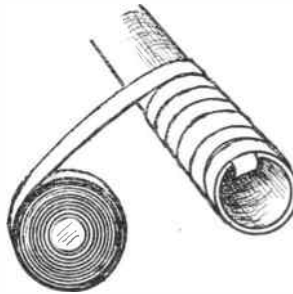

Fig. 1—Winding on the insulating tape to fix loose handlebar grips

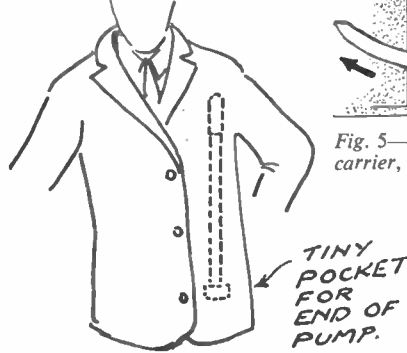

Fig. 3—Storing the pump

tend to jump inward towards the stays but with the strips in position the movement is arrested. When fitted it will be found that the strips turn the brake into a very positively acting arrangement. The strips are easy to make from scrap.

At the front wheel troublesome blocks tend to jump forward and away from the frame so the strips here have to be taken round behind the forks. This needs very little extra bending as (c) and if nicely fitted make the front brake as positive as the back.

## Idea for The Pump

And here is an idea with regard to your pump. Sometimes it is safe to leave the machine locked at a location but not too good to leave the pump on

it. Pumps are, however, quite a nuisance to cart about, but they can be put out of the way in a sports coat if a little pocket is made at the bottom corner as shown to take the end. Secured thus so as to prevent falling out and the coat buttoned a pump can be carried unnoticed. A second loop can be put in higher up if desired, but it is optional.

## A Dry Saddle

Keeping one's saddle dry in really wet weather is always difficult and here is where a piece of thin plastic can be very useful. This is made into a saddle

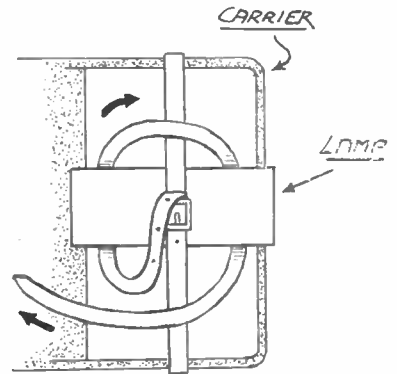

Fig. 5—To fasten a rear lamp firmly on a carrier, take a strap over and round, as shown, and pull tight

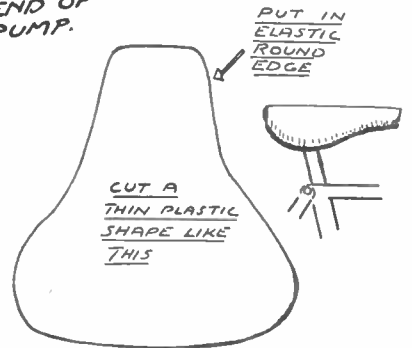

Fig. 4—Making a plastic saddle cover

cover by the simple expedient of shaping as Fig. 4 and running elastic round the outer edge through a turned-down seam. This plastic can be stitched

(Continued on page 57)

# Modern Table Bookcase

**M**AGAZINES and books can be stored with equal ease on this modern combined table, while it can, if necessary, serve also as a coffee table. All parts are cut from  $\frac{3}{8}$ in. thick stock, preferably not plywood, choosing the best grain for pieces (A), (B), (D) and (E). Seven separate pieces in all go to make the assembly.

Leading dimensions of the assembly are shown in Fig. 1. Fig. 2 dimensions the separate pieces. Mark out all parts very accurately and cut exactly.

Parts (B), (D) and (E) have semi-circular ends of 6 $\frac{1}{2}$ in. radius. Each is cut from a panel 15ins. by 13ins. A blind groove,  $\frac{1}{2}$ in. wide,  $\frac{1}{8}$ in. deep and 12 $\frac{1}{2}$ ins. long is cut in the underside of (B) along the exact centre. Parts (D) and (E) are tongued, as shown. When assembled, one is reversed, i.e. inverted, with respect to the layout shown, so remember this

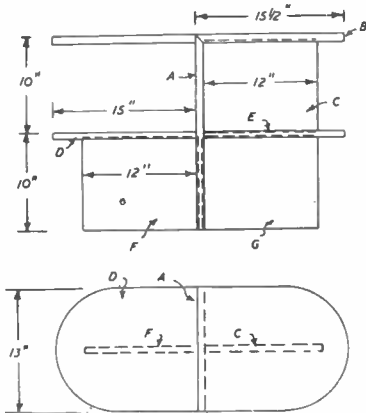

Fig. 1

when adding the grooves. Part (D) is grooved on the underside only whilst part (E) is grooved both top and bottom. Otherwise (D) and (E) are identical.

## Main Upright

The main vertical member (A) is a panel 20ins. by 13 ins. Chamfer off the top edge at 45 degrees since this is mitred to part (B) (also chamfered) in the assembly. Mark and cut the slot accurately in the centre of part (A) and also cut the  $\frac{1}{2}$ in. wide,  $\frac{1}{8}$ in. deep grooves either side. Note that there is no groove above the line of the slot on either side.

Two of the remaining parts are also identical—(F) and (G). Take care to get these truly square otherwise the final assembly will be thrown out of line. Part (C) is similar, but with slightly different overall dimensions.

Three stages in assembly are shown in Fig. 3. This is quite a straightforward process, but accuracy depends on the correct size and shape of the individual parts. Where one part fits into a corresponding groove, this fit should be reasonably tight. Glue is used to hold the assembly, pinning or screwing being unnecessary.

## Assembly

Start by standing part (A) upright and gluing in parts (F) and (G). Provided the grooves have been cut accurately and the parts are square this should automatically align part (A) in a vertical position. Parts (D) and (E) are then slid in place, in turn, after applying glue to the mating surfaces. Note how the tongues locate and fit side by side in the slot in part (A). Any inaccuracy here and

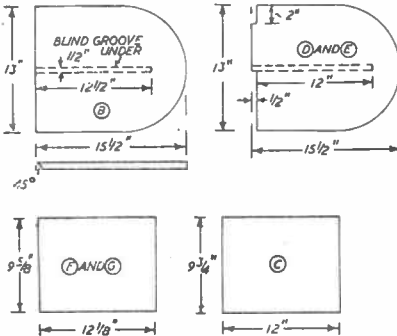

Fig. 2

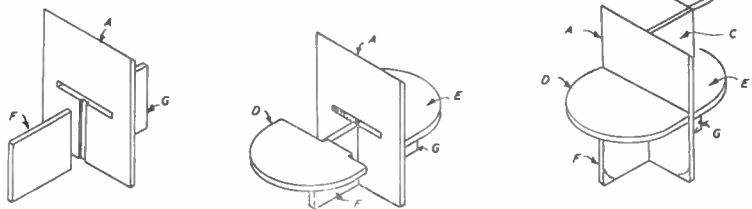
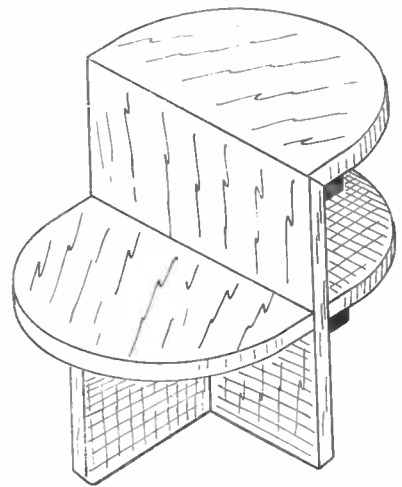

Fig. 3

the shelves (D) and (E) will not lie flush against (A).

The final stage in assembly consists of gluing parts (B) and (C) in place. Part (C) locates in the slot on top of part (E) and simply butts against the side of part (A), both joints being glued, of course. The addition of part (B) locates (C) in a vertical position since the upper edge of part (C) fits in the groove on the underside of part (B). Take especial care to get the mitred joint between (A) and (B) a good one.



Once all the glue joints have set, little remains but to clean up the assembly, fill the grain of the wood and sand down perfectly smooth prior to staining and polishing. Staining and polishing is preferable to lacquering unless the wood itself is not particularly attractive. If you like, you can round off the corners of the

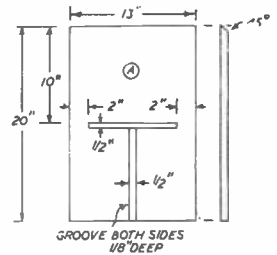

GROOVE BOTH SIDES 1/8" DEEP

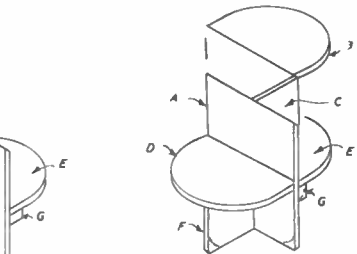

'legs' as giving the assembly a rather smoother appearance. Taking off wood equivalent to a 1 $\frac{1}{2}$ in. radius would be about right and not unduly reduce the base length. Another idea you might like to adopt is to fit parts (D) and (B) with glass tops, getting the glass cut to exact shape and then fastening in the usual manner with small metal fittings

(R.H.W.)

Tell your friends about the good things in 'Hobbies Weekly'

# Produce a 'Pictorial' Photograph ?

**W**ILL you please note that special emphasis is put on the word 'pictorial' in the title, and also that the title is in the form of a query. Probably before you answer it you will want to know what is really meant by pictorial.

Some time ago a well-known photographer asked this question of the readers of a journal: 'What is a "good" photograph?' But his description was concerned mainly with the technique of the negative, exposure, lighting, developing, etc. In this article it is the intention to deal mostly with the commonplace subjects with which we amateurs are chiefly interested, and as the season is now about to commence, there is no reason why we should not endeavour to tackle our hobby in what may seem to the beginner as a more serious way than hitherto. And by the time you have finished reading you should be able to answer the query of the title with a decided: "Yes, I can!"

## A Definition

Perhaps it will be best at this stage to try to get some sort of definition of the word pictorial. The dictionary is not too clear, and in order to help you to start thinking out a meaning of your own, it might help if I attempt to give one which has helped me a lot in the past.

If you visited a picture gallery and studied the works of some of our masters of the art of painting you would possibly be struck with two or three outstanding examples. You would spend rather more time looking at these than at the majority; and, if you were to ask yourself quite seriously why they had this special appeal, you would find that it was because there was a complete harmony, not only of colour, but also of the details in the scene. No one colour or item dominated the whole. If there was one figure which by the title of the picture demanded more attraction, then the other figures although treated by the artist as subsidiary, were, nevertheless, used in such positions as to lead your eye to the main figure. So the whole ensemble became a perfect harmony.

Turn your attention to a beautiful landscape and you will find that the artist has followed the same theme. He may have included a pathway or an open five-barred gate to lead your eye to his principal object. In other words those artists have followed certain definite rules of composition which have characterised picture-making from the

very earliest ages and will continue to do so in all branches of art. It is only by following those rules can we hope to produce pictorial photographs.

## Rules

To enable this perfect harmony to be achieved, the artist, and the photographer, must also use certain rules in the 'build-up' of his picture and, broadly speaking, these concern the

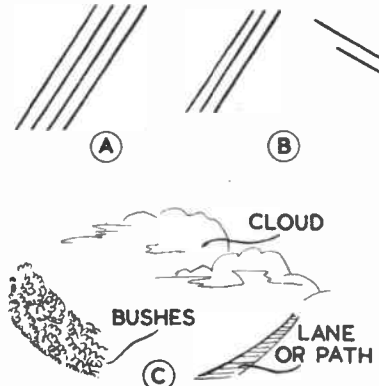

**HOW THE 'SPHERICAL' OR 'SERPENTINE' CAN BE INTRODUCED BY CURVES OR ROUND MASSES**



**'ROUGH EXAMPLE OF THE PYRAMIDAL' IN LANDSCAPE**

lines or masses. For instance, if you will examine illustration (A) you will get the impression that the lines might be falling over, but when other lines are added as in (B) then the effect is put right and we get 'balance'. The same impression occurs where a mass of trees or a group of dark bushes appears on one side of our subject without a compensating mass on the other side. The whole lacks balance. If the lines in our first illustration represent trees, and there are no other lines such as those of a cottage or haystack, you will feel that you want to lift up the view on to one of its corners so as to straighten the trees.

But then the remainder of the picture would be out of the level, and it is obvious that the trees would demand all or most of your attention. The same would apply to a dark mass of bushes on the one side, but if you could insert a nice cloud on the other, then immediately a balance is struck and the build-up has started.

Any reader can teach himself some most valuable lessons by taking a black crayon and a piece of plain paper and trying to sketch, quite roughly, a few examples as suggested. Not necessarily straight diagonals; curves or both will demonstrate the theme.

Two of the most common rules which the pictorial artist has to cultivate are the pyramidal or triangular and the circular. If it is not easy for you to make a sketch, take any good illustration in a magazine and, with your ruler and pencil, go over the principal objects and see how many triangles you can make. Some will have their bases at the bottom edge, others may be at some other angle and almost lying on their sides. With another picture it will be possible to trace the circular or serpentine rule.

## Further Factor

Having got a grip of what we will call the first lesson in composing a 'pictorial', let us proceed to another important factor, that of light and shade, technically known by the awkward name of *chiaroscuro*, derived from the Italian and actually meaning light-dark. Now we all should know that any result which gives us simply a mass of bright well lighted detail and no shadow cannot be termed a picture. We must, again, seek to introduce balance and not only just black and white, but as many intermediate tones as possible. There must be gradation, i.e., as many depths of grey as the subject offers.

Here it is as well to point out that the weakest part of a picture is usually the centre, and this applies particularly when light and shade are being considered. So the strongest highlight or deepest shadow should be at a position somewhat nearer the side than the centre or middle, and, somewhere on the opposite side, though not exactly the same distance in from the side or base, there should be a highlight or shadow to provide the balance and harmony.

While on this important question of light, remember that we must not allow light patches to be scattered



about our picture. Unfortunately, this effect is frequent when an exposure is being made on a scene that is well covered with sunlight, such as a landscape with trees in the foreground. The result of the patches of sunlight is very often not so noticeable in the natural surroundings as when we view a print from the negative. Our eyes become disturbed by and attracted to the spots, and the remainder of the so-called picture is completely lost or ignored.

In a similar manner we must also resist the temptation to expose on a scene which, because of the strong lighting, is merely a fight between light and shade. Really, the qualities of a 'pictorial' photograph are the half-tones between the blacks and whites and, as already suggested, the more gradations of greys appearing, the better the picture. The opposite of such an effect is the so-called 'soot and whitewash', or hard, contrasty picture.

Having learned some of the elementary rules, take a piece of white card or paper and rule a rectangular block about 3ins. by 2ins., the longest measurements to be the top and bottom lines. Divide these into three equal spaces and do the same with the sides. Fill in with upright and horizontal rulings. You should now have a block of nine equal spaces. Try to imagine that this is the focusing screen or a large view-finder on your camera. The bottom row and a small portion of the middle row represents the foreground, the middle row and a small portion of the top the middle distance and the top row the distance and sky. All is ready for the build-up of your landscape picture.

### Complete a Picture

Try now to complete a scene by inserting some roughly drawn details common in landscape and country scenes, placing them in what you consider to be their correct positions for obtaining balance and harmony, with lines, curves and masses of light and shade. It is a splendid plan to sketch

these details on separate pieces of paper, some rather larger than the squares, others smaller. The larger ones are for use in the foreground and the small sketches occupy the middle distance and the distance. The details should include such subjects as trees (both single and clumps), cottage, church, gate, horses, hayrick, and a suggestion of one or two men. A few minutes spent with such a collection will prove invaluable to you in the future.

### How?

Many will be wondering, perhaps, how all this placing of details can possibly be utilised in the taking of photographs, for you will argue that the camera can only take what it sees through its lens and cannot shift details to other parts of the scene.

Of course, you are right, but it is your eye that first catches sight of a possible picture on your rambles. You are suddenly pulled up to have a closer

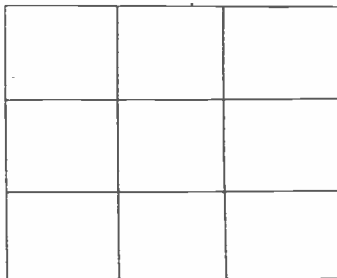

*How to prepare an imaginary 'focusing screen'*

look at a bend in the river, an interesting piece of cliff work as seen from the beach, a group of men at work in the field, or an old couple busy in their cottage garden. Something that appeals to your mind as being beautiful and shows possibilities of a charming study, or is, at any rate, worth an exposure.

You look at it through the view-

finder. It may be that you are then not quite so enthusiastic about it, for there happens to be something that is rather obstructive. It may be a bush or a shed which seems to spoil the general setting of the other items. Yet you hesitate, because you feel more or less convinced that there is a picture to be had.

Do not be in a hurry either to make the exposure or to pass on, but scrutinise the scene carefully and move a pace or two to the right or left, backward or forward and it may be that the obstructive piece will simply walk out of the scene so far as your view-finder is concerned. Perhaps the trouble is not due to any object at all, but rather to the light, and it would be better if the sunlight were coming from another direction. If so, it will pay you to make another visit to the spot in the morning or evening.

You can be assured that you have learned something from these few hints, otherwise that scene would not have appealed to you, or you might have shot it without giving much thought to it and it would have proved to be just another of those haphazard chances which fail to claim much merit as pictures.

Always keep this in your mind when out with the camera. Nature will always provide the material if you have the ability to make use of it, and it is only by knowing and practising the fundamentals of picture-making that you will succeed.

### Last Word

Perhaps the following piece of advice ought to have been mentioned before, but it has been purposely left to the last. Never let a straight path or similar strong feature cut the scene in two either as an upright or horizontal dividing line. It is always better to have such a line entering from one of the bottom corners and this can usually be achieved by moving a few yards in one direction or another.

(J.J.C.)

## Ideas for Cyclists

(Continued from page 54)

by a machine or just tacking will do and the job does not take long or call for much effort.

### Saddle Cover

If having to be out on a wet day paying calls, the cover can be used in two ways. Either it can be put on the seat when you get off and removed when you start to ride again, or it can be

used to put over a wet saddle.

The cover, if desired, can be left on permanently, for plastic never gets sodden and is easily wiped over before mounting. The taking off and putting on gives the more perfectly dry seat, however.

Finally here is a rear lamp idea. If you ever have to fasten on a loose rear lamp never attempt to lash it to a stay

but put it on the carrier. Run a strap over it, pull tight, and then take the end round as shown (Fig. 5). The lamp is now locked firmly in position and will not come loose. The whole process takes but a moment.

(H.A.R.)

### Next Week

Free Design for a Doll's Dressing Table, and lots of other interesting features

# A Fretwork Money Box

With full-size patterns on page 63

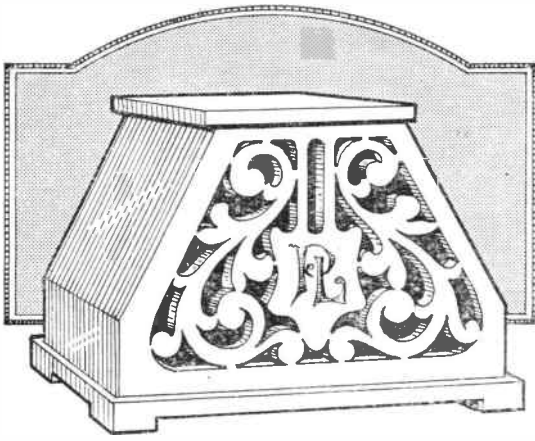

**A** FEW pieces of  $\frac{3}{8}$  in. and  $\frac{1}{4}$  in. wood go to make the attractive money box shown here. The box measures 6 ins. long,  $1\frac{7}{8}$  ins. wide and 4 ins. high, and it is intended to take coins up to  $1\frac{1}{4}$  ins. in diameter. The front of the box is decorated with a simple fretwork pattern which should suit the beginner, and the rest of the work is just a matter of cutting round to outline and gluing the parts together.

The manner of removing the coins from the box is explained in the diagram of the base. Here, the circle shown at one end must be cut round with the

fretsaw held at a slight angle so that the disc of wood removed may be easily replaced. A piece of stout paper is stuck over to seal the opening; this may be cut with the tip of a knife when required.

Cut the mortises (A) in the base and note where the two small sides (B) come between the front and back of the box. Note also how the feet (F) are glued on underneath. Trace the pattern of the fretted front to  $\frac{3}{8}$  in. wood and cut the frets before cutting round the outline. Note the dotted lines which show the positions of the sides (B) and (C). Clean up the finished front and use it as a

template for marking round in pencil to get the back of the box, also of  $\frac{3}{8}$  in. wood.

Patterns for the sides (B) and (C) are given full size. Cut two of each of these  $\frac{1}{4}$  in. thick and then chamfer one edge of pieces (C) as shown in the section on the pattern. This chamfered edge fits down on to top of sides (B).

In assembling the box, glue tenons (A) into the base, then apply glue to the edges of sides (B) and (C) and ease them gently in place between the uprights. See that the outer edges all come flush with the front and back. Form the top of the box from the pattern shown and glue it in place on the uprights, putting in a few fret pins as indicated. Finally, cut the four feet from the spare wood and glue them on.

A piece of thin wood or stout coloured card should be stuck behind the fretted front before the parts of the box are assembled.

The initials of the owner may be suitably drawn on the shield. (S.W.C.)

## BE PREPARED

# The Handyman's 'Treasure Chest'

**W**HETHER you live in a house or a flat, large or small, the odd repair job will invariably crop up at some time or another. With present-day prices soaring and incomes unable to keep up to them, sending for the local builder or the plumber or the electrician, is often quite out of the question. The man in the house—and sometimes the woman—has to set to and execute the best job possible.

The achievement of success in these sundry tasks can prove quite enjoyable, and it is just as well to get some pleasure out of any job, be it large or small, important or trivial.

### The Right Equipment

The essential thing, however, to ensure that it does become a pleasure, is to ensure that the right equipment is available for the particular repair.

If the right tools are used with poor materials, or good materials with the wrong tools, it is hopeless to expect a first-rate piece of work.

Even more important still is that sure knowledge of ways and means is

obtained before the repair is attempted. Handyman books and text books of all kinds are expensive and possibly out of reach of many a household, but this does not prevent the ambitious one from securing the necessary details. Practically every type of book required for household repair work can be referred to or obtained on loan for a period in the local library.

### Tool Kit a Necessity

A tidy tool kit kept either in the garage or in a generally acceptable place inside the house should be recognized as an important a feature of the home as all the other sections for which couples save, such as all the articles of the kitchen outfit, the items of bed linen, and suchlike. After 'moving in', probably the first things required are those from the tool box, the hammer and tacks or nails.

The average handyman is well aware of all the items he wants to complete his tool chest but for those who are beginning to accumulate their tackle, and, perhaps, buy as and when they

spot a bargain, here is a helpful list.

Blowlamp; bradawl; brace and bits; brushes (paint—3, and distemper—1); chisel; chopper; claw-hammer; files (half-round and flat); fuse wire; hand-saw (24ins.); iron-plane; linseed oil for keeping paint brushes in good order; oilstone; pipe-grips (1 pair); pliers (with insulated handles); putty knife; rag and oil for greasing tools; rule (2ft.—steel); scraper; screwdrivers (large and small); soldering iron, solder, and soldering paste; spanner (adjustable); square; tenon-saw; trowel; vice (steel); wood saw.

Although tap washers are easily procurable from any good ironmonger's shop, it is worthwhile keeping a supply in the tool kit for emergencies.

### No Need to Wait

If a washer goes west after the shops are closed on a Saturday, it is far better to be able to do the job right away than wait until Monday. It saves water from being wasted, and—far more important—it avoids jangled nerves if

(Continued on page 60)

# Experiments with Potassium Carbonate

**W**HENEVER a gardener burns leaves and twigs for the ash he is, unconsciously, making a crude form of potassium carbonate. Indeed, potassium carbonate was once made in this way, and purified by extracting the ash by boiling it with water in iron pots. After filtering and evaporating, the carbonate was obtained in the solid state and was known as 'pot-ash'. Hence the names potash and potassium.

Potassium carbonate is a close relative of sodium carbonate (washing soda), and behaves similarly in many of its reactions. There are, however, several tests by which we can differentiate the two.

Leave a little potassium carbonate on a watch glass for a few hours. On another watch glass place a few washing soda crystals. The potassium carbonate will deliquesce. The washing soda will not.

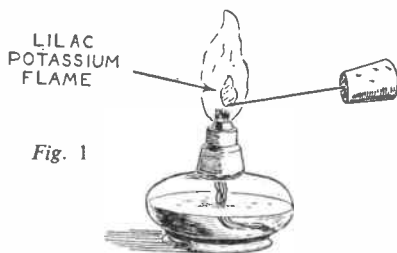

Fig. 1

For the other tests it is better to convert potassium carbonate into potassium chloride, which is very similar to sodium chloride (common salt). Dissolve about 10 grams of potassium carbonate in 25 c.c. of water. Gradually add dilute hydrochloric acid until no further effervescence occurs. The liquid should then be neutral or only slightly acid to blue litmus paper. Evaporate the solution to half its bulk.

Straighten out an iron paper clip and push one end into a cork. Hold the other end of the wire in a spirit lamp flame or non-luminous bunsen flame until it is red hot and does not colour the flame. Then dip it in the potassium chloride solution you prepared and hold it in the flame again. The flame will be coloured lilac near the wire. If you repeat this test with sodium chloride solution, the flame will be coloured yellow.

A further test is to make a few c.c. of a strong solution of tartaric acid and to add this to a little of the potassium chloride solution. On shaking well and letting the mixture stand a few minutes a white crystalline precipitate of

potassium hydrogen tartrate (cream of tartar) will form. Repeat the test, using sodium chloride solution; in this case, no precipitate forms.

Another reliable test is the cobalt-nitrite reaction. To about 1 c.c. of the potassium chloride solution add a few drops each of sodium nitrite solution, cobalt chloride solution and acetic acid. In a few moments, a bright yellow precipitate of potassium cobaltinitrite will appear. Here again, if you replace the potassium chloride by sodium chloride, nothing happens.

Evaporate the remainder of the potassium chloride solution to dryness and you will have a specimen of the solid salt for your laboratory stock.

## Other Potassium Compounds

Potassium carbonate is a good starting point for the preparation of other potassium compounds. Potassium hydroxide (caustic potash) is often needed in the laboratory, and it is as well to know how to prepare an emergency supply in case you run out of it at an awkward time.

Dissolve 10 grams of potassium carbonate in 120 c.c. of boiling water in a beaker. Keeping the liquid boiling, stir in a little at a time 9 grams of slaked lime which has been ground to a cream with water. Between each addition cover the beaker with an evaporating dish and let the liquid boil a few moments. If the volume of the liquid evaporates below 120 c.c., make up the difference by adding water.

When nearly all the lime has been added, occasionally filter a few c.c. of the liquid into a test tube containing

dilute hydrochloric acid. When a filtered test portion does not effervesce, the whole of the liquid in the beaker can be filtered. The filtrate is a solution of potassium hydroxide. As it attacks cork, keep it in a rubber-stoppered bottle.

Another useful potassium compound to have in stock is potassium thiocyanate. To make it, first drive off the water of crystallisation of potassium ferrocyanide. This is quickly and easily done by heating the powdered salt on a deep clean tin-rod over a low flame, which is about 1 in. below the lid (Fig. 2). Stir continuously to prevent charring. Use about 12 grams of potassium ferrocyanide. To find out when all the water of crystallisation has been driven off, hold a watch glass close to the powder. When the glass does not mist over, the salt is dry.

Let it cool. Thoroughly mix 9 grams of it with 3.4 grams of potassium carbonate and 6.4 grams of sulphur. Heat the mixture gently in a large crucible until the effervescence stops. Let the mass cool. Place it in a flask with 50 c.c. of methylated spirit. Attach an upright condenser and boil the mixture under reflux on the water bath, in the usual way.

After ten minutes, filter the hot liquid into a distillation flask, attach a condenser and distil off the meths. on the water bath. Scrape out the dry mass of potassium thiocyanate left in the distillation flask and bottle it at once, for it is deliquescent.

This salt is used as a test for ferric iron. Dissolve a little in water and add a drop of ferric chloride solution. An intense red colour appears.

If we leave out the potassium ferrocyanide, and just heat potassium carbonate with sulphur we will obtain a different product. This is the pharmaceutical preparation known as 'liver of sulphur' on account of its liver-brown colour. It is used in treating some skin troubles.

First dry 9 grams of potassium carbonate by heating it to redness. Then grind it with 5.2 grams of sulphur. Heat the mixture in a crucible until all effervescence stops. Pour out the molten mass on to a slate to solidify. When it is cool enough to handle, break it up and bottle it at once, for this, too, is deliquescent.

Liver of sulphur contains higher sulphides of potassium. If you want to make a new and potent stink bomb, just dissolve some in methylated spirit. A few drops of this solution give a room a powerful odour of a tom cat! (L.A.F.)



Fig. 2



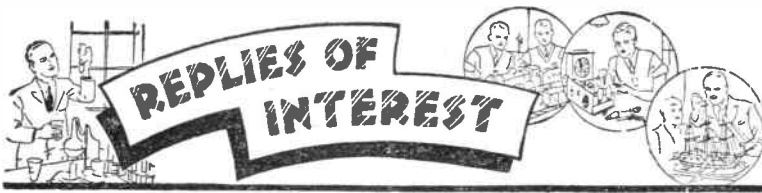

### Re-Covering a Billiards Table

**C**OULD you give me information dealing with the making and re-covering of billiards tables, or are there any books on this matter? (J.W.—Blackheath).

**T**O re-cover a billiards table, remove the side bars holding the cushions, unpick the old cloth and take particular note of the way the cloth is snipped to go round the pocket holes, also the position of spots and baulk lines. Lay the new cloth over and tack to the battens under the bed; do not tack one side at a time, but a part of each in succession until the corners are reached. Then snip and draw over the pocket holes to finish. We are not aware of any book dealing with construction of a billiards table, but articles on the subject occasionally appear, and a search among the household constructional books in your public library, or, perhaps, a reference to a good encyclopaedia may produce the information.

### The Right Dye

**I** AM desirous of colouring some paraffin wax and cannot find a suitable dye. I have made some white paper flowers and want to dye them in colour by dipping them into paraffin wax, but find that all the dyes I have tried turn black when dipped into the hot wax. Can you please advise me what type of dye I can use? Some of the colours I require are blue, mauve and red. (H.M.—Chadwell Heath).

**A**NILINE dye stirred into molten paraffin wax will generally produce a dye suitable for colouring waxed paper flowers. The dye is obtainable in powder form, and is a pure staining

agent. Supplies can generally be had from any good artist's colour shop.

### Dripping Conservatory Roof

**I**S there a way to stop a glass conservatory roof from dripping? I have painted it many times with lead paint, inside and out, and have even removed all the glass, repainted and re-putted the wood spars and replaced the glass, finishing with further coats of paint inside and out. It still drips in places, not badly, but enough to make it uncomfortable. The woodwork is in good condition. (R.D.—Norwich).

**T**HE condensation can be reduced by painting the woodwork with an anti-condensation paint, 'Zat', for example. The glass is a more difficult proposition, but you could make up the following and would probably find it fairly satisfactory. Dissolve 20ozs. coconut oil soap (or palm olive, perhaps) in boiling water to a jelly consistency, and add, stirring continuously, 2ozs. tripoli, 1oz. white alum, 1oz. cream of tartar, and 1oz. white lead, all previously pulverised. Pour while hot into a shallow tin and let solidify. Apply to glass with a rag dipped in warm water, and then polish with a soft cloth.

### Renovated Violin

**I** HAVE a violin from which I have taken off all the old varnish and got down to the bare wood. I have given it a water stain and after allowing it to dry, have given it at different intervals two coats of linseed oil and turpentine. It has stood for about 18 months and is now ready for varnishing. Could you advise me how to proceed? I would like an oil varnish finish in preference to spirit. (J.B.—Bolton).

**O**IL varnishes are rather difficult to prepare, but if you wish to try your own make, here is a good recipe. Melt together 3ozs. copal and 1oz. mastic. Also mix together in a separate vessel (after heating)  $\frac{1}{4}$  pint oil of turpentine and  $\frac{1}{4}$  of a pint of pale drying oil. Now well mix the whole, stirring all the while. You could colour part with gamboge or dragon's blood, according to tint required. Apply two coats of the tinted varnish and when quite dry lightly smooth the surface with powdered pumice on a felt pad. Dust off, and if the tint is right, apply a third coat of the untinted varnish as a finish, or even more coats if a harder gloss is desired. Polish up with a soft silk cloth.

### Sharp-Edged Glass

**I** HAVE some photo frames of the type where the glass slides into a stand. I have had to replace the glass but would like to know of a way I can remedy the sharp edges? (E.H.—Lee).

**T**HE sharp edges of the glass can be smoothed by rubbing them with a paste composed of powdered carborundum and water applied with a hardwood rubber. Follow this by using a fine grade emery powder and follow by polishing with rottenstone and water.

### Repairing Torn Plastic

**C**AN you please tell me how I can repair a torn plastic waterproof cape? (R.D.—Inverness).

**A**TEMPORARY repair can be made to a plastic cape with Sellotape or one of the similar self-adhesive tapes. Most of the plastic cape materials can be welded as follows:—lay the two edges together with a slight overlap and cover with a cloth. Press with the edge of a hot soldering iron or flat iron. Experiment with a scrap piece or an unimportant corner to get the right heat. The correct heat will soften the two surfaces so that they join together. Most of the common adhesives will not join plastics. Welding is best, but as an alternative you could use Surridge's Titebond.

can be seen quickly.

When the 'man of the house' is out and an emergency arises, the housewife frequently has to use her ingenuity in carrying out small household repairs. It is always advisable, therefore, to keep a small set of simple tools handy for her, such as a hammer, pair of pliers, pair of pincers, screwdriver, small bradawl, a half-round file, and an adjustable file, in addition to a couple of tins of small nails and tacks.

This might save the tired worker a job on his return! (E.M.B.)

## The Handyman's 'Treasure Chest'

(Continued from page 58)

that tap can be immediately prevented from constantly dripping.

Oil-treated, compressed leather washers are the best for cold water taps, and vulcanized rubber washers for hot water taps.

Usually, two or three  $\frac{1}{4}$ in. washers for ordinary taps, and  $\frac{3}{4}$ in. washers for bath taps are sufficient to have on hand.

A word about nails and screws.

Never mix them up with all the oddments in an old box. It is asking for a frayed temper in an emergency, just when you specially need to be cool, calm and collected.

Discarded cocoa or mustard tins prove very useful receptacles for nails and screws to be kept separately in their respective sizes. Even better still are small glass jars, so that the contents

**PLYWOOD** offcuts. Approx. 10 sq. ft. 5/6, post free.—Mayco, 1 Nadin Rd., Sutton Coldfield.

**CRAFTWORKERS!** (Either sex), soft toy assembling. Interesting and instructional hobby. The ideal pastime. No registration fees, etc. Details, S.A.E.—Cuddlycraft Supplies, East Rd., London, N.1.

**CASTING** moulds for lead soldiers, animals, etc. Complete illustrated catalogue, 6d. Sample mould, 5/.—G. F. Rhead, Hartest, Suffolk.

**MINIATURE** album, perforation gauge, watermark detector, hinges, 100 stamps, 1/3. 250 different in album, 2/6, post free.—D. Thomson, 46 Beil Dr., Glasgow, W.3.

**STAMPS**—world assortment on paper. 1 lb. (3,000), 18/6; ½ lb., 9/9; 4ozs., 5/3.—A. Davies, 111 Holmelay Road, Hereford.

**STAMPS FREE!!** Twenty unused (2½d.).—G. H. Barnett, Limington, Somerset.

**THEMATICS.** Animals, Birds, Transport, Q.V. to Q.E.II approx. Discount, postage.—Bishop, 40 Marine Parade, Hythe, Kent

**FREE** set to applicants sending for my discount approvals. Send 5/- for giant bargain parcel.—Collins, 6 High St., Dalmellington, Ayrshire.

**WALL** plaques and novelties. Beautiful designs. Ready to paint. Offer for limited period. Sample box, 5/—, including P/P.—Box No. 6, Hobbies Weekly, Dereham, Norfolk.

**MODELS.** You can make lasting stone-hard models with Sankey's Pyrama Plastic Cement. Supplied in tins by Ironmongers, Hardwaremen and Builders' Merchants. Ask for instruction leaflet.

**DUTTONS SHORTHAND.** Shorthand in 1 week. Test lesson, 2½d. stamp.—Dutton's (HB/SV), 93 Gt. Russell St., London, W.C.1.

**DUPLEX** Self-adhesive Transfers for decorating fancy goods, trays, plastics, etc. List and samples, 3d.—H. Axon Harrison, Jersey.

**PLYWOOD OFFCUTS.** Gaboon in various thicknesses. Handy sized parcels for the cabinet, toy, model maker, and all handicrafts. Parcels made up in £1 and 10/- lots. Carriage paid. Send P.O. to—Reeves, Plywood and Timber Merchant, 33 Front Street, Monkseaton, Whitley Bay. Tel.: W.B. 4677. Parcels are now dispatched on day of receiving order.

## HOBBIES BRANCHES

### LONDON

78a New Oxford St., W.C.1  
(Phone MUSEUM 2975)

87 Old Broad Street, E.C.2  
(LONDON Wall 4375)

117 Watworth Road, S.E.17  
(RODney 5509)

GLASGOW—326 Argyle Street  
(Phone CENTral 5042)

MANCHESTER—10 Piccadilly  
(Phone CENTral 1787)

BIRMINGHAM—14 Bull Ring

SHEFFIELD—4 St. Paul's Parade  
(Phone 26071)

LEEDS—10 Queen Victoria Street  
(Phone 28639)

HULL—10 Paragon Square

SOUTHAMPTON — 25 Bernard St.

BRISTOL—30 Narrow Wine Street  
(Phone 23744)

## GROW MONEY!

### MAKE BIG PROFITS REARING LIVING MINIATURE TREES



Comprehensive 5,000 word illustrated guide, plus six packets of various seeds, yours for only 8/6. Fascinating Hobby—Profitable Business. No experience necessary. **Miniature Trees (Dept. 20/8), Room Two, 3, Bloomsbury St. London, W.C.1.**

**ZIMPLAN** Doll's House fittings and papers; send S.A.E. for list. Doll's House plan—special; send 2/6. Trade supplied.—Zimplan, 88 Ware Road, Hoddesdon.

**AMERICAN MAGAZINES.** America's famous hobby magazines. One year's supply Popular Mechanics, 32/-; Popular Science, 28/6; Homecraftsman, 16/6; Popular Homecraft, 18/-. Free booklet listing all others sent on request.—Willen Ltd. (Dept. 57), 101 Fleet Street, London, E.C.4.

**WHEELS** for Toys, etc., in Hardwood, Plastic and Rubber Tyred Metal. Doll's House fittings and papers. Doll's Cot and Pram fittings. Decorative Transfers. Beads for Counting Frames and other Toy accessories. Fine Art Pictures for Jig-Saws, etc. Stamp for lists. Trade supplied.—Joyden Toy Co., 193 Chase Side, London, N.14.

**1,000 FOREIGN** stamps, 4/9; 1,000 Colonials, 6/9; Special Offer, Liberia 1919 10c. SG. R23 (cat. £7/10/-) 12/6.—L. Burns, 194 Seacliffe Road, Bangor, Ulster.

**HANDICRAFTS,** 399A Seven Sisters Road, London, N.15. Plywood offcuts from 1½d. Aeromodelling Keil Kraft kits. Balsa wood. Large mixed parcel plywood. Send 10/- P.O.

**MARQUETRY**—special offer of selected veneers:—(A) One envelope containing four varieties, 20 pieces 12ins. x 6ins., 3/- envelope. (B) One envelope containing 13 varieties exotic veneers, 29 pieces mixed sizes 12ins. x 4ins., 5/- per envelope. Either or both lots sent carriage paid on receipt of P.O. Satisfaction guaranteed.—Millgate Service Station, 16 Millgate, Stockport.

**INDIA** Saints and Poets Set. Outstanding free gift for all approval applicants enclosing postage.—Yulwontmor Stamps, P.T.S. (Dept. H2), 175 Priory Road, St. Denys, Southampton.

**RUBBER** moulds from exquisite models. Four for 7/6; single mould, 2/6.—Goodwin's (Dept. G.V.), 26 Bird St., Bolton.

**MILLIGANS** 100,000 Government Surplus Bargains. Transformers, 230v/12v A.C., 1A.P., brand new, 7/6, post 1/-. Automatic counters, 0-999, 1/6, post 6d. Gear units, containing numerous useful gear wheels, 2/6, post 6d. 230v A.C./D.C. motors (approx. 1/20th h.p.), 20/-, post 1/8. Switches, cables, resistances, buzzers, indicator lights, telephones, etc., etc. Send 3d. Stamps for list. Money Back Guarantee.—Milligan's, 24 Harford Street, Liverpool, 3.

**PERSPEX.** Clear, coloured. Sizes cut; also corrugated. Plastics, Aluminium, Asbestos, Mouldings.—Henry Moat & Son, Ltd., Atom Works, Newcastle, 1.

**KUKLOS ANNUAL.** Indispensable cyclist's handbook. Tours, resthouses, money-saving hints. 2/10, post free.—Burrow, Publishers, 2 Imperial House, Cheltenham.

**STAMPS.** 12 Austrian Views, free to approval applicants. Send 2½d.—Willett & Carville, 69 St. Vincent Crescent, Glasgow, C.3.

**STAMPS FREE.** Empire Packet including SPictorials and Victorians free to approval applicants.—Robert J. Peck, 7A Kemp Road, Bournemouth.

**TOY CASTING MOULDS.** Soldiers, sailors, fairmen, etc. 1,000 varieties from 3/- each. Catalogue, 9d. Moulds for Plasterwork, plaques, ornaments, brooches and Coronation souvenirs. Moulds from 3/6 each. Catalogue, 9d. S.A.E. for list. Rubber moulds, four for 7/6.—J. W. Nuthall, 69 St. Marks Road, Hanwell, London, W.7.

**FREE GIFT** given to all who request my 25% discount stamp approvals. (Send 2½d. stamp) to—P. G. Hott, 27 Camden Dwelling, York Way, London, N.7.

## MARINE ENGINEER OFFICERS

**AMBITIOUS** youths leaving school between the ages of 16-18 years with proficiency in Mathematics and Physics to General Certificate of Education (Ordinary Level) standard or its equivalent, can now be considered for **ENGINEERING APPRENTICESHIPS** comprising 4½ years' training ashore and afloat with a view to becoming fully qualified Marine Engineers. For details of such Apprenticeships in the Shell Tanker Fleet, offering excellent opportunities for advancement, apply to—

**The Anglo-Saxon Petroleum Co. Ltd.**  
St. Helen's Court, Great St. Helen's,  
LONDON, E.C.3

**MAGIC CIRCLE** for Boys. Send 6d. for Wonderful Coronation Conjuring Catalogue.—363 Sandycombe, Kew Gardens, Surrey.

**THE ONLY FULL LIST OF CAR INDEX NUMBERS** alphabetically arranged is in **WHERE'S THAT CAR FROM?** Of all Book-sellers, 9d., or from the Publishers, Raleigh Press, Exmouth (1½d. postage).

## THE MODEL MAKER'S SPRAY GUN

FOR CELLULOSE, LACQUER, ETC.

COMPLETE WITH  
AIR BULB, VALVES  
CONNECTOR,  
CONTAINER AND

The Special  
SPRAY UNIT  
WITH 5 YEAR  
GUARANTEE

### 8/6

P. & P. Free.

For a perfect finish using cellulose or any paint. Narrow angle spray keeps masking to minimum and is ideal for models, toys, etc. Made by the makers of the famous Carspray Kits.

Order direct from

**CARSPRAY**, 102 Deaconsfield Road,  
Hemel Hempstead, Herts. Tel. Boxmoro 644

# MAKE LARGER PRINTS WITH THE JOHNSON POSTCARD ENLARGER

Expense need no longer deter you from buying an enlarger. With the Johnson Exactum Postcard Enlarger you can make postcard-size prints from 2½ in. x 3½ in. (box camera size) negatives. It is as simple to use as a contact printing frame. No focusing is required and there are no adjustments to make. Full instructions are enclosed with each Enlarger.



Price 55/2d.

## MAKE BETTER PRINTS WITH JOHNSONS UNIVERSAL DEVELOPER

Johnson Universal Developer is highly concentrated and contains Johnson '142' for preventing fog and stains, and '326' wetting agent to promote even development. Universal is excellent for developing both contact and bromide papers, producing a rich image colour with a full range of tones. Full instructions accompany every bottle.

225 c.c. (8 oz.) size 2/9 each

570 c.c. (20 oz.) size 4/6 each

<b>JOHNSONS</b> <b>HENDON</b>	OF	<b>THE WORLD FAMOUS MANUFACTURERS</b> <b>OF PHOTOGRAPHIC CHEMICALS,</b> <b>APPARATUS AND ACCESSORIES</b>
	LTD	

LONDON, N.W.4. ESTABLISHED 1743



## HOME CABINET-MAKER

Ideal for Amateur and Professional

**SUPER UNIVERSAL LATHE AND COMBINATION WOODWORKING MACHINE**

UNSURPASSED FOR VERSATILITY, PERFORMANCE, PRICE AND CAPACITY . . . with the Super Swivel Platform you can build up this machine into a complete workshop for Turning at any angle, Sawing, Sanding, Polishing, Planing, Rebating and Bandsawing.

From £12 . 12 . 6

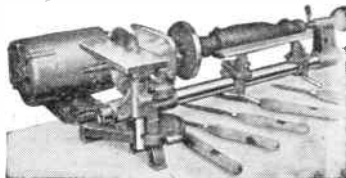

Showing arrangement for turning centres and sawing.

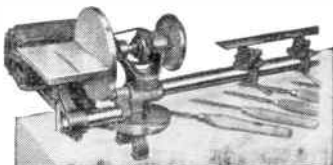

Showing Sanding attachment replacing Saw. Left: Super Swivel Platform positioned for turning at any angle (front, rear or end).

Send for illustrated leaflet to Department H.W.1

**CORONET TOOL CO., DERBY**  
Daily Demonstrations Stand No. A.327/226 B.I.F. Castle Bromwich

LOOK FOR THE NAME  
**BROOK "GRYPHON"**  
ON YOUR MOTOR

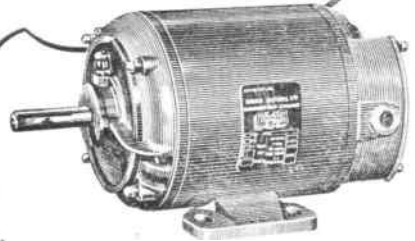

When I want a fractional horse-power motor for my workshop, that's the one I choose!

Why? It's a well built machine with a good bit of power to spare. Its made by BROOK the electric motor specialists . . . that's why I can always rely on it.

Single or three phase in various enclosures from 1/8th to 1 h.p.



1.MH. 276

## BE TALLER

in 12 days or money back. New discovery increases height 2 to 5 inches. Gained 4½ inches. My weight increased from 9 stone 4 lb. to 10 stone 8½ lb.—P.D. 'I have increased 3 inches.'—H.C. Guaranteed harmless. Full course, 10/-. Air Mail, 16/3. Details 1½d. stamp. Sent under plain cover.

## Be a Master of JU-JITSU



Amazing new methods show you how to 'get tough' and make any attacker helpless with lightning speed — or money back. The Morley Rapid Ju-Jitsu Course teaches you all the knock-out blows, shows you how to throw a stronger man helpless to the ground, gives absolute mastery. Develops body, gives self-confidence. You can acquire this devastating weapon in a few weeks. Both sexes. Complete system 10/- (\$1.50). Details, 1½d. Powerful arms course 2/9. 114 WAYS TO BE YOUR OWN BOSS. 114 tested ways of earning a second income at home with little or no capital 5/6.

J. J. MORLEY (H/96), 28, Dean Road, London, N.W. 2

## Is This Saw in Your Kit?

You can cut almost anything in wood with this Coping Saw. The blade is 6½ ins. long and can be turned to cut at any angle. No tool-kit is complete without one. Get yours NOW.

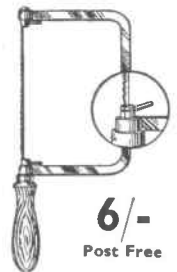

6/-  
Post Free

Buy from any Hobbies Branch or post free from Hobbies Ltd., Dept 99, Dereham, Norfolk



# PATTERNS FOR THE MONEY BOX

F

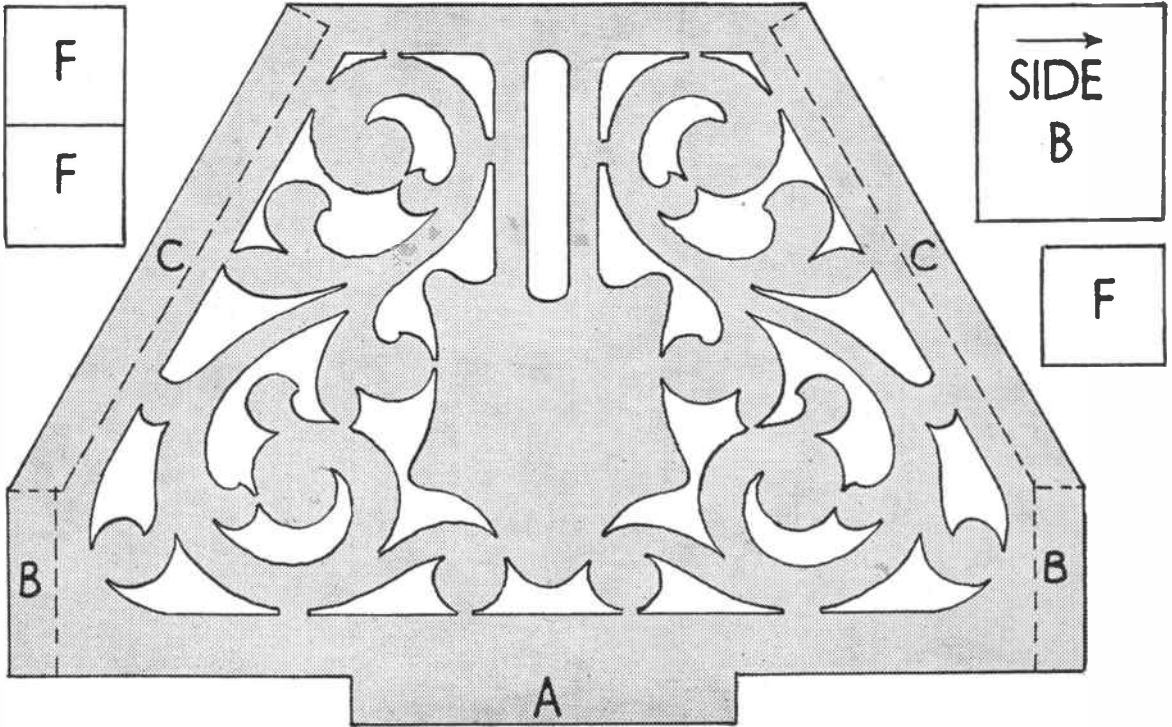
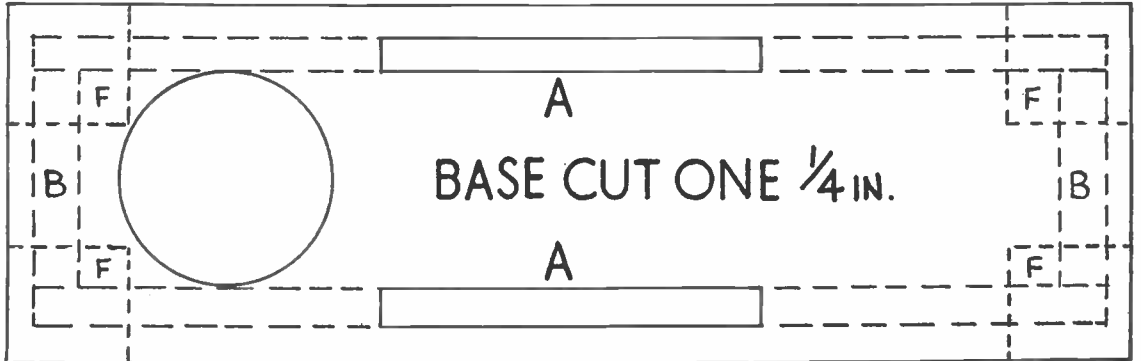
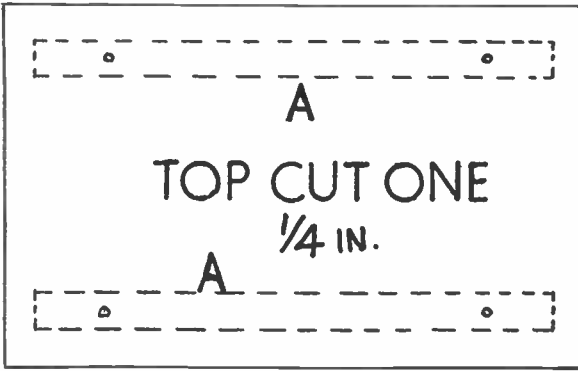

# ILFORD FILMS

## for faces & places

You can't go wrong with any of these famous roll films **SELOCHROME**, **HP3** or **FP3**. You'll get a good picture every time.

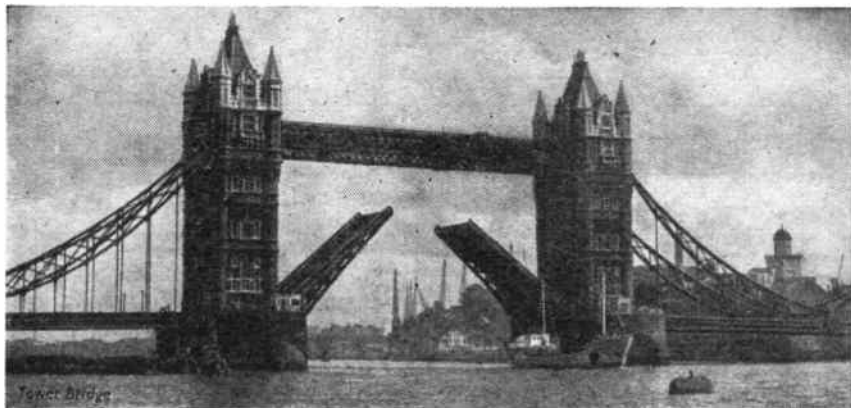

Tower Bridge



### GET YOUR WORK MOVING!

You've carefully planned your job—you've given it every attention in construction and finish—now add the final touch of genius and make it *move*. As a craftsman you know the value of smooth running home routine. That is why you should fit Flexello castors to your work—and to all your furniture too! They are engineered to give effortless running and are specially designed to protect carpets and floors.

There's a better castor for your every need in the Flexello range at your local handicrafts shop or high-class ironmongers. Ask to see them. *Feel* how efficient they are, and remember to fit Flexello.

# Flexello

CASTORS & WHEELS LTD · SLOUGH · BUCKS  
Obtainable from all good ironmongers



Ball-bearing socket, wide plastic wheel.  
Code No. FF46

Shock absorbing wagon castor, 3" wheel.  
Code No. FS33

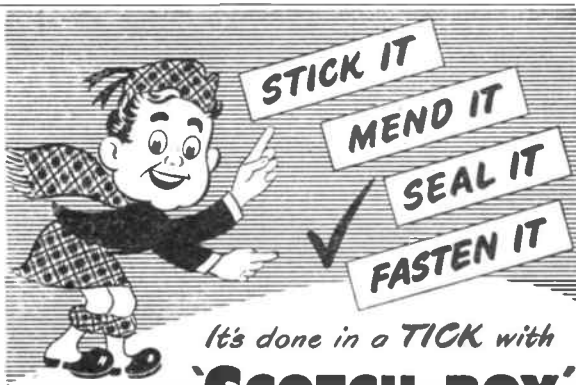

It's done in a *TICK* with  
**'SCOTCH BOY'**  
THE ORIGINAL  
*Cellulose* **TAPE**

Just the thing for hundreds of sealing and mending jobs. Invaluable to the modelmaker and handyman—a miracle of usefulness.

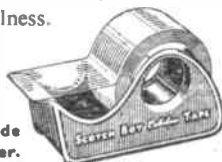

When buying, look for the Scotch Boy Trade Mark and the handy red plastic Dispenser.