

EVERYDAY ELECTRONICS

INCORPORATING ELECTRONICS MONTHLY

ABC

VOL 17 No 11 NOVEMBER '88

The Magazine for Electronic & Computer Projects

ISSN 0262-3617

PROJECTS... THEORY... NEWS...
COMMENT... POPULAR FEATURES...

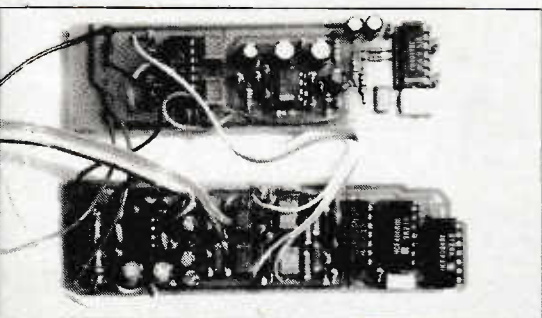
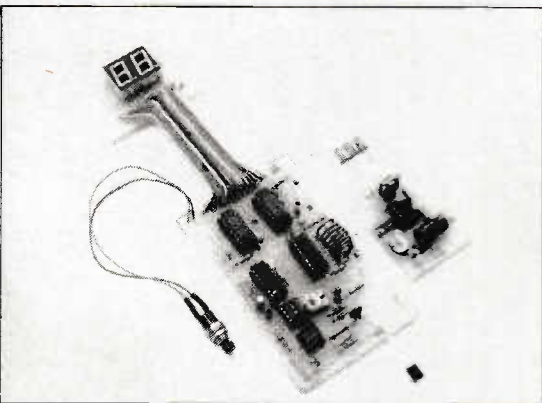
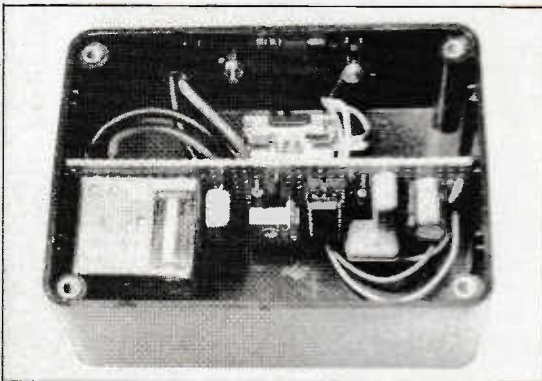
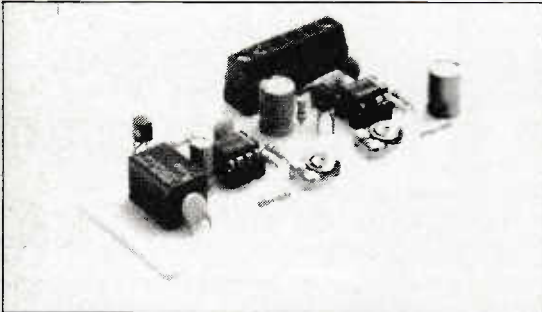

© Wimborne Publishing Ltd 1988. Copyright in all drawings, photographs and articles published in EVERYDAY ELECTRONICS is fully protected, and reproduction or imitations in whole or in part are expressly forbidden.

Our December '88 issue will be published on Friday, 4 November 1988. See page 623 for details.

Everyday Electronics, November 1988

Projects

- DOORBELL DELAY** by Steven Holland 630
Prevent misuse of the doorbell. Can also be used as a "doorbell" for the deaf
- REAR SCREEN ONE-SHOT** by T. R. de Vaux-Balbirnie 632
Keep a clear view, without overtaxing your battery
- INFRA-RED OBJECT COUNTER** by Roger Parsell 635
Programmable counter with digital readout
- SEASHELL SEA SYNTHESISER** by Andy Flind 651
Relax to the soothing sounds of the sea
- ECG MONITORING INTERFACE** 658
Use your BBC Micro to monitor the electrical activity in the body
- MICRO ALARM** by John Lewis 662
Electronic "guard-dog" for your micro computer

Series

- INTRODUCING DIGITAL ELECTRONICS** 640
by Michael Cockcroft
City and Guilds 726/301 Certificate Course
Part Two: Component Identification and Coding
- ROBOT ROUNDUP** by Nigel Clark 648
Investigating the world of robotics
- BBC MICRO** by R. A. & J. W. Penfold 658
Regular spot for BEEB fanatics
- ACTUALLY DOING IT** by Robert Penfold 664
Mounting control panel components
- AMATEUR RADIO** by Tony Smith G4FA1 666
New UK Amateur Licence; Voice of the Andes
- ON SPEC** by Mike Tooley BA 680
Readers' Sinclair Spectrum page

Features

- EDITORIAL** 629
- FOR YOUR ENTERTAINMENT** by Barry Fox 650
Satellite D-Day; Technical K.O.
- CONSUMER ELECTRONICS** by Ian Graham 656
A brief report on the UK home entertainment market
- SHOPTALK** by David Barrington 660
Product news and component buying
- CROSSWORD No. 7** 665
Some light-hearted brain teasers
- SPECIAL REPORT** by Mike Tooley 668
Basic Electronics review
- BOOK REVIEWS** 670
A selection of recent releases
- DOWN TO EARTH** by George Hylton 672
Active Filters; Phase Shift Oscillator
- DIRECT BOOK SERVICE** 674
Special service to EE readers
- PRINTED CIRCUIT BOARD SERVICE** 678
- ADVERTISER'S INDEX** 684

FREE
GREENWELD 100-page
COMPONENTS CATALOGUE (banded with magazine)

Readers' Services • Editorial and Advertisement Departments 629

621

Introducing DIGITAL ELECTRONICS



This exciting new series can lead to a worthwhile qualification—and we can supply all the components you need! The first six parts: Everything as listed in the booklet given free last month with EE
Just **£12.95!**

Low cost tool kit:

25 Watt mains soldering iron, screwdriver, cutters, snipe nose pliers, wire strippers.
All for **£9.95**

NOTICE TO RETAILERS

Greenweld Electronics Ltd. have been appointed Official Wholesalers of Verobloc, Veroboard, Easiwire & Accessories by Vero. We will be only too happy to supply all your Veroboard requirements at Trade Price. Ring, write or fax us for full information and prices.

1989 CATALOGUE FREE with this issue!

However, if someone's beaten you to it, send £1 straight away for your copy!

- * 100 pages of components and equipment
- * Low, low prices
- * Fast 'by return' service
- * Discount Vouchers
- * 28 pages of Surplus Bargains
- * Only £1—send for your now!



All prices include VAT; just add £1.00 P&P; Min Access £5. No CWD min. Official orders from schools welcome—min. invoice charge £10.00. our shop has enormous stocks of components and is open 9-5 Mon-Sat. Come and see us!

By post using the address below; by phone (0703)772501 or 783740 (ansaphone out of business hours); by FAX (0703)787555; by EMail Telecom Gold 72:MAG36026; by Telex 265871 MONREF G quoting 72:MAG36026.

443D MILLBROOK ROAD, SOUTHAMPTON SO1 0HX.



The UK Distributor for the Standard Toroidal Transformers

- * 106 types available from stock
- * Sizes from 15VA to 625VA
- * Dual 120v primaries allowing 110/120v or 220/240v operation

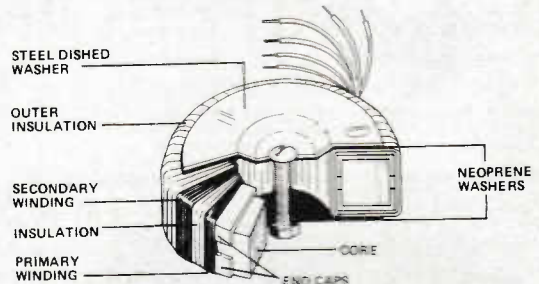

TYPE	SERIES NO.	SEC VOLTS	RMS CURRENT	TYPE	SERIES NO.	SEC VOLTS	RMS CURRENT
15VA £9.15	03010	6+6	1.25	150VA £16.10	83011	9-9	8.89
	03011	9+9	0.83		83012	12+12	6.66
	03012	12+12	0.63		83013	15+15	5.33
	03013	15+15	0.50		83014	18+18	4.44
	03014	18+18	0.42		83015	22+22	3.63
	03015	22+22	0.34		83016	25+25	3.20
	03016	25+25	0.30		83017	30+30	2.66
	03017	30+30	0.25		83018	35+35	2.28
30VA £10.35	13010	6+6	2.50	83019	40+40	2.00	
	13011	9+9	1.66	83020	110	1.45	
	13012	12+12	1.25	83021	220	0.72	
	13013	15+15	1.00	83022	240	0.66	
	13014	18+18	0.83	225VA £17.60	83012	12+12	9.38
	13015	22+22	0.68		83013	15+15	7.50
	13016	25+25	0.60		83014	18+18	6.25
13017	30+30	0.50	83015	22+22	5.11		
50VA £11.55	23010	6+6	4.16	83016	25+25	4.50	
	23011	9+9	2.77	83017	30+30	3.75	
	23012	12+12	2.08	83018	35+35	3.21	
	23013	15+15	1.66	83019	40+40	2.81	
	23014	18+18	1.38	83020	45+45	2.50	
	23015	22+22	1.13	83021	50+50	2.25	
	23016	25+25	1.00	83022	110	2.04	
	23017	30+30	0.83	83023	220	1.02	
	23028	110	0.45	83024	240	0.93	
	23029	220	0.22	300VA £19.20	73013	15-15	10.0
23030	240	0.20	73014		18-18	8.33	
80VA £12.90	33010	6+6	6.66		73015	22-22	6.82
	33011	9+9	4.44		73016	25-25	6.00
	33012	12+12	3.33		73017	30+30	5.00
	33013	15+15	2.66		73018	35+35	4.28
	33014	18+18	2.22	73019	40+40	3.75	
	33015	22+22	1.81	73020	45+45	3.33	
	33016	25+25	1.60	73021	50+50	3.00	
	33017	30+30	1.33	73022	110	2.72	
	33028	110	0.72	73023	220	1.36	
	33029	220	0.36	73024	240	1.25	
33030	240	0.33	500VA £25.35	83016	25+25	10.0	
120VA £13.70	43010	6+6		10.0	83017	30+30	8.33
	43011	9+9		6.66	83018	35+35	7.14
	43012	12+12		5.00	83019	40+40	6.25
	43013	15+15		4.00	83020	45+45	5.55
	43014	18+18		3.33	83021	50+50	5.00
	43015	22+22	2.72	83022	55+55	4.54	
	43016	25+25	2.40	83023	110	4.54	
	43017	30+30	2.00	83024	220	2.27	
	43018	35+35	1.71	83025	240	2.08	
	43028	110	1.00	625VA £27.95	93017	30+30	10.41
43029	220	0.54	93018		35+35	8.92	
43030	240	0.50	93019		40+40	7.81	
			93020		45+45	6.94	
			93021		50+50	6.25	
			93022		55+55	5.68	
			93023	110	5.68		
			93024	220	2.84		
			93025	240	2.60		

Prices include VAT and carriage

Quantity prices available on request
Write or phone for free Data Pack

Jaytee Electronic Services

143 Reculver Road, Beltinge, Herne Bay, Kent CT6 6PL
Telephone: (0227) 375254 Fax: 0227 365104

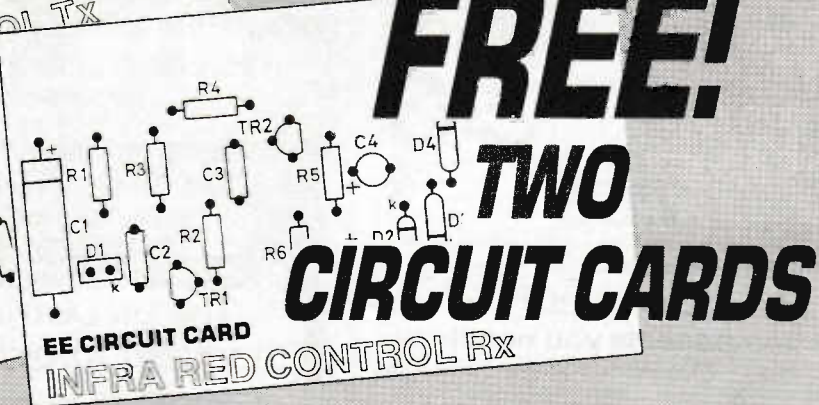
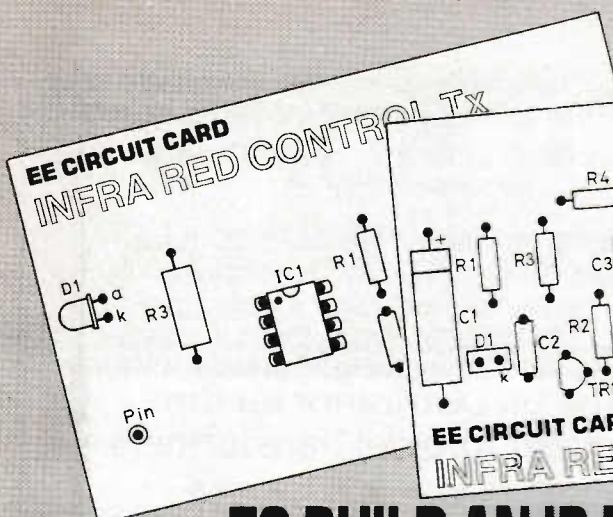

FREE!

**TWO
CIRCUIT CARDS**

TO BUILD AN IR REMOTE CONTROL TRANSMITTER AND RECEIVER

Two circuit cards will be given away free with next month's issue. On them you can build an infra-red Transmitter and a matching Receiver for remote control or infra-red beam systems. Full circuits and constructional details will be given in the issue.

PERSONAL CASSETTE AMPLIFIER

Use your personal cassette player as an in-car stereo system with the addition of this low cost amplifier. Using just twelve components this amp should appeal to both novice and experienced constructors and can be used for a variety of applications.

METRONOME

All budding musicians eventually face a common problem; learning to keep time. A metronome provides a cheap and effective solution to this difficulty. Better still is an "accented" metronome, with a "ping" every few beats to indicate the start of each bar. These are rather expensive to buy, but one may be built very cheaply from readily obtainable components. This one is also pocket-sized, so if your instrument is portable you can take it with you and practice anywhere.

**SPECIAL
'SCOPE
OFFER**

Two oscilloscopes at very special prices for EE readers. The Hameg HM205-2 Digital Storage 'scope and the HM203-6 two channel 20MHz 'scope. Both have built-in component testers. Don't miss this offer.

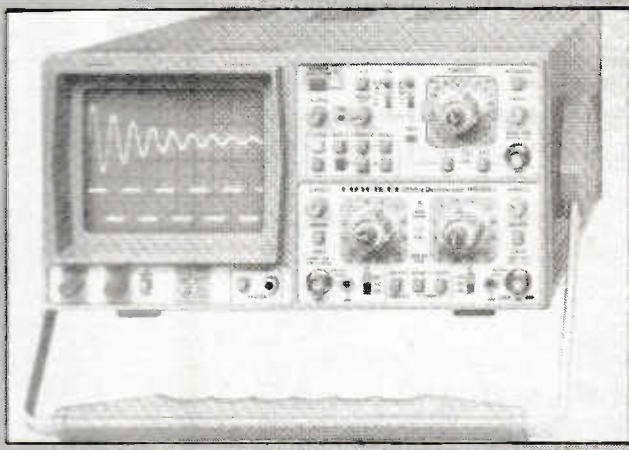

COMPLETE INDEX FOR '88

**EVERYDAY
ELECTRONICS**

DECEMBER ISSUE ON SALE NOVEMBER 4

NEXT MONTH

ZENITH KITS - FOR THE ELECTRONICS ENTHUSIAST

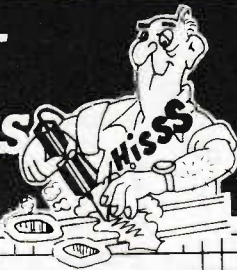

The following is a selection from our catalogue:

- Black Ice Alarm (for Winter Motors).....Kit £17.53
- Negative Ion Machine, complete with case.....Kit £24.11
- Miniature F.M. 'BUG' transmitter 60-145MHz.....Kit £6.95
- 3-Watt F.M. transmitter 80-108MHz 12-Volt.....Kit £13.99
- Running light sequencer 10-channel, varispeed.....Kit £15.89
- Audio Power Meter 10-LED indication.....Kit £12.94
- VU-Meter 10-LED indication P.P.M. display.....Kit £13.63
- Electronic Door chime 3-note - variable freq.....Kit £9.85
- Infrared transmitter/receiver system.....Kit £33.09
- Light Activated Relay, 9-12Volt opp.....Kit £8.91
- Metal and Voltage Detector.....R/Built £11.00
- Tone Generator - Pulse or Warble tones.....Kit £5.50
- Loudspeaker Protector 5-100Watts.....Kit £11.40

■ All Kits are available READY BUILT please see latest Catalogue.

■ All Kits contain full instructions PCBs and components ■ All prices include VAT and postage and packing ■ Overseas orders add 10% to above prices ■ Please send Cheque or Postal Order with Order.



ZENITH ELECTRONICS Dept. 2
Cortlandt Business Centre
Hailsham, East Sussex, UK BN27 1AE
Telephone (0323) 847973
Telex 878334 Fax 647204



Access & Barclaycard Orders
Telephone (0323) 847973

S.A.E.
(A4 + 26p)
for
FREE
Catalogue

CIRCUIT BOARD ASSEMBLY/REPAIR JIG

*It May Be A Little 'Lo-Tech'—But It's
Incredibly Handy*

Adjustable, rotating heads hold p.c.b.'s firmly but safely for easy assembly or repair. Insert components and simply flip over to solder leaves both hands free for a better job. Supplied with earthing lead for use with CMOS.

Interchangeable heads for holding many other items available.

Each jig hand
made for a
lifetime
of use.

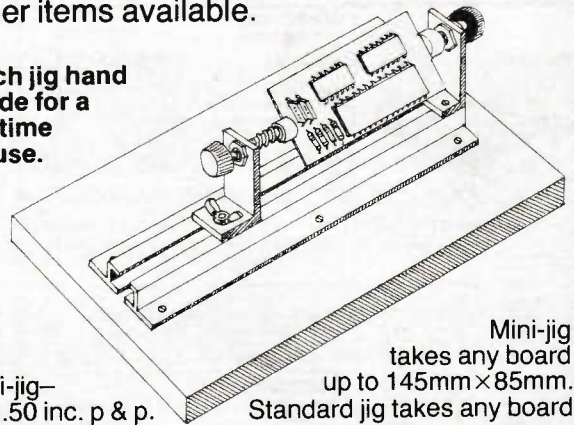

Mini-jig—
£21.50 inc. p & p.
Standard jig—

Mini-jig
takes any board
up to 145mm x 85mm.
Standard jig takes any board
up to 310mm x 145mm.

£24.50 inc. p & p. Cheque or P.O. only please:

EVERETT WORKSHOP ACCESSORIES
5 Railway Terrace, Henllan, Llandyssul,
Dyfed, SA44 5TH, Wales

TWO GREAT HOBBIES

ONLY
£124.50
INC VAT



...IN ONE GREAT KIT!

The K5000 Metal Detector Kit combines the challenge of DIY Electronics assembly with the reward and excitement of discovering Britain's buried past.

THE KIT — simplified assembly techniques require little technical knowledge and no complex electronic test equipment. All stages of assembly covered in a detailed 36 page manual.

THE DETECTOR — features Analytical Discrimination & Ground Exclusion, backed by the proven pedigree of C-Scope, Europe's leading detector manufacturer.

A comprehensive instruction book is available @ £5 (deductable from order).

Ask at your local Hobby/Electronics shop or contact C-Scope for a copy of a published Field Test Report.

CSCOPE

C-Scope International Ltd., Dept. EE86,
Wotton Road, Ashford, Kent TN23 2LN.
Telephone: 0233 29181.

C
A
T
A
L
O
G
U
E

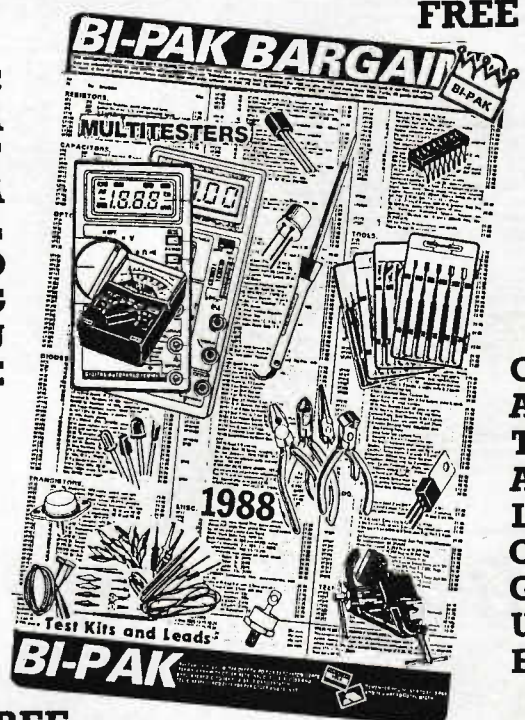

FREE

Send a stamped addressed envelope or
up to 50p in coins to cover handling to:
BI-PAK CATALOGUE,
P.O. BOX 33, ROYSTON, HERTS. SG8 5DF
Please do not send cheques

MAGENTA ELECTRONICS Ltd

PROJECT KITS

Magenta supply Full Kits: Including PCB's (or Stripboard), Hardware, Components, and Cases (unless stated). Please state Kit Reference Number, Kit Title, and Price, when ordering.
REPRINTS: If you do not have the issue of E.E. which includes the project, you will need to order the instruction reprint as an extra: 80p each. Reprints are also available separately—Send £1 in stamps.

REF NO.	KIT-TITLE	PRICE	REF NO.	KIT-TITLE	PRICE
792	SOLDERING IRON TEMPERATURE CONTROLLER Oct 88	£9.50	540	ELECTRONIC SCARECROW July 86	£8.87
790	EPROM ERASER Oct 88	£24.95	540	PERCUSSION SYNTH June 86	£30.43
791	BREAKING GLASS ALARM Sept 88	£17.51	542	PERSONAL RADIO June 86	£11.53
789	AMSTRAD P10 Sept 88	£19.90	543	WATCHDOG June 86	£8.24
788	TIME SWITCH Aug 88	£17.61	529	MINI STROBE May 86	£13.86
787	SPIKEATER July 88	£3.99	526	PA AMPLIFIER May 86	£26.95
786	UNIVERSAL NICAD CHARGER July 88	£6.99	523	STEREO REVERB Apr 86	£26.44
785	ISOLINK July 88	£24.51	524	VERSATILE PSU Apr 86	£24.69
784	VIDEO WIPER July 88	£33.59	526	FREELoader Apr 86	£8.48
783	HEADLIGHT REMINDER June 88	£7.99	513	BBC MID INTERFACE Mar 86	£27.94
782	DOOR SENTINEL May 88	£12.81	514	INTERVAL TIMER Mar 86	£18.87
781	SUPER SOUND EFFECTS GENERATOR May 88	£12.99	515	STEREO HI-FI PRE-AMP	£49.19
780	CABLE & PIPE LOCATOR April 88	£15.35	512	MAINS TESTER & FUSE FINDER Mar 86	£8.82
779	STEREO NOISE GATE April 88	£26.90	503	FUNCTION GENERATOR Feb 86	£24.84
778	INDUCTIVE PROXIMITY DET. April 88	£8.63	504	POWER SUPPLY FOR ABOVE	£7.62
777	LOW FUEL ALERT April 88	£6.43	497	MUSICAL DOOR BELL Jan 86	£18.72
772	SEMICONDUCTOR TESTER Mar 88	£23.51	493	DIGITAL CAPACITANCE METER Dec 85	£41.55
776	LIE DETECTOR Mar 88	£11.80	481	SOLDERING IRON CONTROLLER Oct 85	£5.47
775	ENVELOPE SHAPER Mar 88	£14.99	473	R.I.A. PRE-AMP Sept 85	£16.74
774	SOS ALERT Mar 88	£9.36	464	STEPPER MOTOR INTERFACE FOR THE BBC COMPUTER less case Aug 85	£11.68
769	VARIABLE 25V-2A BENCH POWER SUPPLY Feb 88	£49.73	461	1035 STEPPER MOTOR EXTRA OPTIONAL POWER SUPPLY PARTS	£14.50
770	CAR LAMP CHECKING SYST. Feb 88	£7.10	461	CONTINUITY TESTER July 85	£5.20
765	GAME TIMER Feb 88	£14.32	459	AMSTRAD USER PORT July 85	£17.67
765	QUIZMASTER Jan 88	£18.96	455	ELECTRONIC DOORBELL June 85	£7.56
767	TRANSISTOR CURVE TRACER (BBC)	£14.98	453	GRAPHIC EQUALISER June 85	£26.94
763	AUDIO SIGNAL GENERATOR Dec 87	£13.64	444	INSULATION TESTER Apr 85	£19.58
764	DUAL MAINS LIGHTS FLASHER Dec 87	£20.98	432	GAMES TIMER Jan 85	£9.11
739	ACCENTED BEAT METRONOME Nov 87	£20.95	430	SPECTRUM AMPLIFIER Jan 85	£6.91
740	ACOUSTIC PROBE Nov 87 (less bolt & probe)	£16.26	417	DOOR CHIME Dec 84	£18.78
741	BBC SIDWAYS RAM/ROM Nov 87	£27.53	392	BBC MICRO AUDIO STORAGE SCOPE INTERFACE Nov 84	£36.25
744	VIDEO CONTROLLER Oct 87	£29.14	394	PROXIMITY ALARM Nov 84	£22.66
745	TRANSTEST Oct 87	£9.70	387	MAINS CABLE DETECTOR Oct 84	£5.53
734	AUTOMATIC PORCH LIGHT Oct 87	£17.17	386	DRILL SPEED CONTROLLER Oct 84	£8.68
735	CARAVAN FRIDGE ALERT Oct 87	£5.44	381	GUITAR HEAD PHONE AMPLIFIER Sept 84	£7.99
736	STATIC MONITOR Oct 87	£8.66	362	VARIAP AM RADIO May 84	£13.15
723	ELECTRONIC MULTIMETER Sept 87	£46.96	363	EXPERIMENTAL POWER SUPPLY May 84	£23.58
729	NOISE GATE Sept 87	£23.25	364	SIMPLE LOOP BURGLAR ALARM May 84	£17.16
728	PERSONAL STEREO AMP Sept 87	£14.31	358	FUSE/DIODE CHECKER Apr 84	£4.35
730	BURST-FIRE MAINS CONTROLLER Sept 87	£13.57	356	SIGNAL STEREO ADAPTOR Apr 84	£13.73
724	SUPER SOUND ADAPTOR Aug 87	£38.39	344	QUASI TRACER Feb 84	£18.77
718	3 BAND 1.5-30MHz RADIO Aug 87	£26.53	337	BIOLOGICAL AMPLIFIER Jan 84	£24.14
719	BUCCANEER I.B. METAL DETECTOR inc. coils and case, less handle and hardware July 87	£26.45	334	CONTINUITY TESTER Dec 83	£12.59
720	DIGITAL COUNTER/FREQ METER (10MHz) inc. case July 87	£67.87	332	CHILDREN'S DISCO LIGHTS Dec 83	£10.48
721	MONOMIX July 87	£21.00	333	NOVEL EGG TIMER Dec 83 inc. case	£12.90
722	FERMOSTAT July 87	£12.14	301	STORAGE SCOPE INTERFACE FOR BBC MICRO Aug 83 less software	£19.34
711	VISUAL GUITAR TUNER Jun 87	£22.99	299	HIGH POWER INTERFACE BOARD Aug 83 no case	£12.99
715	MINI DISCO LIGHT Jun 87	£12.59	292	USER PORT I/O BOARD less cable + plug	£13.22
709	WINDSCREEN WASHER WARNING May 87	£5.12	293	USER PORT CONTROL BOARD July 83 less cable + plug + case	£31.67
708	FRIDGE ALARM May 87	£9.88	277	NW PERSONAL RADIO less case, May 83	£9.60
707	EQUALIZER (IONISER) May 87	£15.53	278	MOISTURE DETECTOR May 83	£6.88
705	BULB LIFE EXTENDER April 87 (less case)	£5.24	270	NOVELTY EGG TIMER April 83 less case	£6.91
703	EXP. SPEECH RECOGNITION April 87	£20.98	263	BUZZ OFF March 83	£5.68
700	ACTIVE VR BURGLAR ALARM Mar 87	£35.85	262	PUSH BIKE ALARM Feb 83	£14.77
561	VIDEO GUARD Feb 87	£9.39	255	ZX TAPE CONTROL Nov 82	£8.98
563	CAR VOLTAGE MONITOR Feb 87	£12.58	242	2X WAY INTERCOM July 82 no case	£5.68
584	SPECTRUM SPEECH SYNTH. (no ca) Feb 87	£20.92	243	REFLEX TESTER July 82	£9.79
578	SPECTRUM I/O PORT less case, Feb 87	£9.44	240	EGG TIMER June 82	£6.86
579	STEPPING MOTOR BOOSTER (for above) Feb 87	£5.45	237	CAR LED VOLTMETER less case, May 82	£4.00
575	STEPPING MOTOR MD200 Feb 87	£16.80	225	CAMERA OR FLASH GUN TRIGGER Mar 82 less tripod bushes	£17.20
589	HANDS-OFF INTERCOM (per station) inc. case Jan 87	£10.49	205	SUSTAIN UNIT Oct 81	£17.63
588	CAR ALARM Dec 86	£12.47	206	TAPE NOISE LIMITER Oct 81	£5.976.27
571	RANDOM NUMBER GENERATOR Dec 86	£15.72	207	HEADS AND TAILS GAME Oct 81	£3.47
568	BBC 16K SIDWAYS RAM Dec 86	£12.97	209	PHOTO FLASH SLAVE Oct 81	£4.79
564	CAR FLASHER WARNING Nov 86	£9.37	211	FUZZ BOX Oct 81	£10.05
563	200MHz OIG. FREQUENCY METER Nov 86	£62.98	197	0-12V POWER SUPPLY Sept 81	£24.55
562	10 WATT AUDIO AMPLIFIER Oct 86	£36.70	181	SOIL MOISTURE INDICATOR E.E. May 81	£5.66
561	LIGHT RIDER LAPEL BADGE Oct 86	£10.20	149	GUITAR PRACTICE AMPLIFIER Nov 80	£22.95
560	LIGHT RIDER DISCO VERSION	£19.62	124	SOUND TO LIGHT Nov 80 3 channel	£29.38
559	LIGHT RIDER 16 LED VERSION	£13.64	118	SPRING LINE REVERB UNIT Jan 80	£34.27
558	SCRATCH BLANKER Sept 86	£55.83	118	UNIBOARD BURGLAR ALARM Dec 79	£8.38
556	INFRA-RED BEAM ALARM Sept 86	£28.35	113	DARKROOM TIMER July 79	£4.03
555	FREEZER FAILURE ALARM Sept 86	£15.90	111	MICROCHIME DOORBELL Feb 79	£21.99
554	CAR TIMER Sept 86	£8.72	113	SOUND TO LIGHT Sept 78	£10.98
553	BATTERY TESTER Aug 86	£7.19	108	IN SITU TRANSISTOR TESTOR Jun 78	£9.42
544	TILT ALARM July 86	£7.82	106	WEIRD SOUND EFFECTS GEN Mar 78	£7.82
546	CARAVAN BATTERY MONITOR July 86	£17.17	101	ELECTRONIC DICE Mar 77	£6.26
547	SQUEEKIE CONTINUITY TESTER July 86	£3.52			

MAGENTA ELECTRONICS LTD. SHOP NOW OPEN—CALLERS WELCOME



EE70, 135 HUNTER STREET,
 BURTON-ON-TRENT,
 STAFFS. DE14 2ST.
 0283 65435, Mon-Fri 9-5
 Access/Barclaycard (Visa) by
 phone or post.
 24 hr Answerphone for credit
 card orders.
 Our prices include VAT

ADD £1 P&P TO ALL ORDERS.
 PRICES INCLUDE VAT.
 SAE ALL ENQUIRIES.
 OFFICIAL ORDERS WELCOME
 OVERSEAS: Payment must be
 sterling.
 IRISH REPUBLIC and BFPO. UK
 PRICES.
 EUROPE: UK PRICES plus 10%.
 ELSEWHERE: write for quote
 SHOP HOURS: 9-5 MON-FRI.

TOP KITS

MOSFET VARIABLE BENCH 25V 2.5A POWER SUPPLY



A superb design giving 0-25V and 0-2.5A. Twin panel meters indicate Voltage and Current. Voltage is variable from zero to 25V.
 Current-Limit control allows Constant Current charging of NICAD batteries, and protects circuits from overload. A Toroidal transformer MOSFET power output device, and Quad op-amp IC design give excellent performance.

OUR KIT REF. 769 £49.73

COMPONENTS, KITS, BOOKS, TOOLS,
 MOTORS, GEARS, PULLEYS, OPTICAL
 FIBRES, ROBOTICS, AND MUCH MUCH
 MORE—IN OUR
NEW CATALOGUE £1.00

INTRODUCING DIGITAL ELECTRONICS
 COMPONENT PACK £13.99
 INCLUDES BREADBOARD AND BATTERY

MOTOR-GEARBOX ASSEMBLIES

Miniature gearboxes complete with quality electric motor. Variable ratios by fitting 1 to 6 gears. 1.5-4.5v, 3-2200 rpm. Long 3mm shaft. Ideal for robots and buggies.

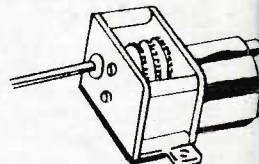

SMALL (MGS) £3.49 LARGE (MGL) £3.98

ADVENTURES WITH ELECTRONICS

An easy to follow book suitable for all ages. No soldering, uses an S DEC breadboard. Lots of clear diagrams and instructions to build 16 projects. Component pack includes S DEC and all components for the projects.

OPTICAL
 FIBRES
 TRIAL
 PACK OF
 10
 METRES.
 Nine
 assorted
 types
 & data.

£1.99

STEPPING MOTORS 12 VOLT

48 STEPS 0335 £14.50
 200 STEPS MD200 £16.80

0283 65435

FROM MAGENTA

A SELECTION OF OUR BEST PROJECT KITS

As usual these kits come complete with printed circuit boards, cases, all components, nuts, screws, wire etc. All have been tested by our engineers (many of them are our own designs) to ensure that you get excellent results.

INSULATION TESTER

An electronic High Voltage tester for mains appliances and wiring. An inverter circuit produces 500 volts from a PP3 battery and applies it to the circuit under test. Reads insulation up to 100 Megohms. Completely safe in use.



OUR KIT REF 444 £19.58

DIGITAL CAPACITANCE METER

Simple and accurate (1%) measurements of capacitors from a few pF up to 1,000 uF. Clear 5 digit LED display indicates exact value. Three ranges - pF, nF, and uF. Just connect the capacitor, press the button and read the value.

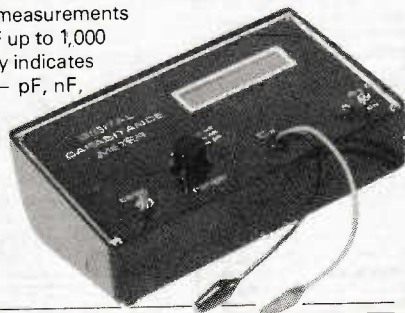

**£41.55
OUR KIT
REF 493**

3 BAND SHORTWAVE RADIO

Covers 1.6-30 MHz in 3 bands using modern miniature coils. Audio output is via a built-in loudspeaker. Advanced design gives excellent stability, sensitivity and selectivity. Simple to build.



OUR KIT REF 718 £25.27

DIGITAL FREQUENCY METER 200 MHz

An 8 digit meter reading from A.F. up to 200 MHz in two ranges. Large 0.5" Red LED display. Ideal for AF and RF measurements, Amateur and C.B. frequencies.

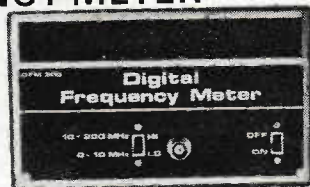

KIT REF 563 £62.98

'EQUALISER' IONISER



A mains powered Ioniser that produces a breeze of negative ions in the air. A compact, safe, simple unit that uses a negligible amount of electricity.

KIT REF 707 £15.53

SUPER SOUND-EFFECTS GENERATOR

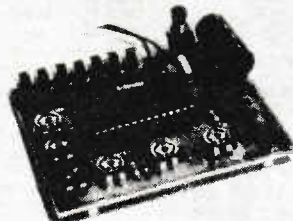

A wide range SN76477 sound effects board giving: Bird Chirps, Sirens, Helicopters, Explosions, Phaser Guns, Steam Train sounds, and more. Supplied without a case.

KIT REF 781 £12.99

ELECTRONICS TEACH-IN 88/89

£2.45

From the
Publishers of
EVERYDAY
ELECTRONICS

A Complete



City and Guilds
Certificate Course

INTRODUCING MICROPROCESSORS

TEACH-IN 88/89 BOOK £2.45

PRIORITY ORDER FORM A complete City and Guilds Certificate Course for 726/303 Introductory Microprocessors

Written by Mike Tooley B.A. this course can lead successful readers to a City and Guilds Certificate. Everything you need to know is included—even Pre-test papers, etc. Make sure of your copy, send in the priority order form with your payment now.

Send to Direct Book Service, 33 Gravel Hill, Merley, Wimborne, Dorset BH21 1RW.

TEACH-IN 88/89—INTRODUCING MICROPROCESSORS, PRIORITY ORDER FORM

NAME _____

ADDRESS _____

Please send me a copy of Teach-In 88/89—Introducing Microprocessors as soon as it is published (Oct. 28 1988). I enclose cheque/PO £ sterling only for £..... (overseas readers add £1 postage).

For KITS & COMPONENTS - Choose the easy way - with

Send 50p* & SAE for CATALOGUE

ORDERS: RING (01) 567 8910 - 24 HRS.

NEW GIANT SOLAR CELLS

NOW IN STOCK these giant size solar panels 12 x 12in will deliver 12 volts 200mA in bright sunlight and 11.5 volts 60mA on a typical British summer day (dull and overcast). **HUNDREDS OF USES** in the car or caravan, e.g. Charging NICads, powering low voltage circuits where mains or battery supplies are inconvenient or coupled to a lead acid battery and a simple inverter you could build yourself a self contained mains supply for low power appliances. Stock No. 303 145. **£14.50** (plus £1.75 for p&p on total order).

SOLID STATE RELAY BARGAIN

*Zero Voltage Switching: No radio interference problems *2.5KV Input to Output Isolation: No risk of damage to your computer or driver circuits. *4KV Terminals to Heat-sink Isolation: Simply bolt onto a heatsink *3V to 32V Input Voltage: easily interfaced to TTL or CMOS Logic. *24V to 240V rms Load Voltage: Allowing mains loads to be switched. *Built in Snubber Network: Enabling switching of inductive loads. *10A Maximum Current: 4A with no heatsink fitted at 40 deg C. **£2.25**

ELECTRONIC GUARD DOG KIT



One of the best deterrents to a burglar is a guard dog and this new kit provides the barking without the bite! The kit when assembled can be connected to a doorbell, pressure mat or any other intruder detector and will produce a random series of threatening barks making the would be intruder think again and try his luck elsewhere. The kit is supplied complete with high quality PCB, transformer, all components and instructions. All you need is a mains supply, intruder detector and a little time. The kit even includes a horn speaker which is essential to produce the loud sound required. The "dog" can be adjusted to produce barks ranging from a Tarter to an Alsatian and contains circuitry to produce a random series of barks giving a more realistic effect.

XX125 Complete kit of parts £24.00

DISCO LIGHTING KITS

DL1000K - This value-for-money 4-way chaser features bi-directional sequence and dimming. 1kW per channel. **£19.25**
DL21000K - A lower cost uni-directional version of the above. Zero switching to reduce interference. **£10.80**
DLA/1 (for DL & DL21000K) Optional opto input allowing audio 'beat'/light response. **77p**
DL3000K - 3-channel sound to light kit features zero voltage switching, automatic level control and built-in microphone. 1kW per channel **£15.60**

The DL8000K is an 8-way sequencer kit built in opto-isolated sound to light input which comes complete with a pre-programmed EPROM containing EIGHTY - YES 80! different sequences including standard flashing and chase routines. The KIT includes full instructions and all components (even the PCB connectors) and requires only a box and a control knob to complete. Other features include manual sequence speed adjustment, zero voltage switching, LED mimic lamps and sound to light LED and a 300 W output per channel. And the best thing about it is the price.

ONLY £31.50



TEN EXCITING PROJECTS FOR BEGINNERS

This Kit has been specially designed for the beginner and contains a **SOLDERLESS BREADBOARD, COMPONENTS, and a BOOKLET** with instructions to enable the absolute novice to build TEN fascinating projects including a light operated switch, intercom, burglar alarm, and electronic lock. Each project includes a circuit diagram, description of operation and an easy to follow layout diagram. A section on component identification and function is included, enabling the beginner to build the circuits with confidence. **ORDER NO. XK118 £15.00**

VERSATILE REMOTE CONTROL KIT

This kit includes all components (+ transformer) to make a sensitive IR receiver with 16 logic outputs (0-15V) which with suitable interface circuitry (relays, triacs, etc - details supplied) can be used to switch up to 16 items of equipment on or off remotely. The outputs may be latched (to the last received code) or momentary (on during transmission) by specifying the decoder IC and a 15V stabilised supply is available to power external circuits. Supply: 240V AC or 15-24V DC at 10mA. Size (excluding transformer) 9 x 4 x 2 cms. The companion trans is the MK1B which operates from a 9V PP3 battery and gives a range of up to 60ft. Two keyboards are available—MK9 (4-way) and MK10 (16-way), depending on the number of outputs to be used.
MK12 IR Receiver (incl. transformer) £16.30
MK18 Transmitter..... £7.50
MK9 4-Way Keyboard..... £2.20
MK10 16-Way Keyboard..... £6.55
601 133 Box for Transmitter..... £2.60

HOME LIGHTING KITS

These kits contain all necessary components and full instructions and are designed to replace a standard wall switch and control up to 300W of lighting.

TD300K Touchdimmer £9.30
TS300K Touchswitch £9.30
TDE/K Extension kit for 2-way switching for TD300K £2.95
LD 300K Light Dimmer £4.75

NEW POWER STROBE KIT

Designed to produce a high intensity light pulse at a variable frequency of 1 to 15Hz this kit also includes circuitry to trigger the light from an external voltage source (eg. a loudspeaker) via an opto isolator. Instructions are also supplied on modifying the unit for manual triggering, as a slave flash in photographic applications or as a warning beacon in security applications. The kit includes a high quality pcb, components, connectors, 5V strobe tube and full assembly instructions. Supply: 240V ac. Size: 80 x 50 x 45.
XX124 STROBOSCOPE KIT £13.75

NEW HIGH SECURITY LOCK KIT

Designed for use with our lock mechanism (701 150) this kit will operate from a 9V to 15V supply drawing a standby current of only 50µA. There are over 5000 possible 4-digit combinations and the sequence can be easily changed. To make things even more difficult for an unauthorised user an alarm can be sounded after 3 to 9 incorrect entries—selectable by means of a link. The alarm can sound for a few seconds to over 3 minutes during which time the keyboard is disabled preventing further entries. A latched or momentary output is available making the unit ideal for door locks, burglar alarms, car immobilisers, etc. A membrane keyboard or pushbutton switches may be used and a beep sounds when a key is depressed. Kit includes high quality PCB, all components, connectors, high power piezo buzzer and full assembly and user instructions.
XX121 LOCK KIT £15.95
350 118 Set of Keyboard Switches £4.00
701 150 Electric Lock Mechanism 12 volt £16.50

PROPORTIONAL TEMPERATURE CONTROLLER KIT



Uses "burst fire" technique to maintain temperature to within 0.5°C. Ideal for photography, incubators, wine-making, etc. Max. load 3kw (240V ac) Temp. range up to 90°C. Size: 7x4x2.5cms.
MK4 £7.80

BARGAIN COMPONENT PACKS

Refill those empty component drawers at a fraction of the normal price and don't be caught without that odd resistor or capacitor to complete your project. All components supplied are full specification and not seconds or surplus stock.

PACK A: 650x0.25W resistors 47R to 10M £4.25
PACK B: 60xElectrolytics 1uF-1000uF £3.25
PACK C: 30xPolyester Capacitors 0.01-1uF £4.50
PACK D: 36xHorizontal presets 1k-1M £3.00
PACK E: 30xIC sockets 8, 14 & 16 Pin £2.00
PACK F: 25xRed LEDs 5mm £1.75
PACK G: 25xGreen LEDs 5mm £2.00
PACK H: 30x5mm LEDs - red, green, yellow £2.50
PACK J: 50x1N4148 Si. diodes £1.00
PACK K: 40xNPN/PNP transistors BC182/212 General Purpose £2.25

10% OFF when you buy ALL 10 PACKS

Components for the new EE INTRODUCING DIGITAL ELECTRONICS COURSE (1st 6 parts) only £11.95

Good quality tools selected to offer outstanding value for money

650 004 6in mini. Snipe Nose Pliers. Serrated jaws and return spring. **£2.10**
650 005 6in lap jointed side cutters. Insulated handles and return spring. **£2.10**
650 006 Light duty cutters. Cutting capacity 0.22-1.2mm copper wire. **£1.60**
TOOL KIT - Contains: side cutters, snipe nose pliers, wire strippers, flat blade screwdriver, Phillips screwdriver in black textured, reinforced and padded case which when opened out measures 240x205mm **£6.80**
650 007 Self-adjustable automatic wire stripper with built-in cable cutter. **£3.95**
650 018 Wire Stripper **£1.50**
650 013 Screwdriver **£0.15**

Soldering Irons
650 018 Economy 15W Iron **£2.99**
650 100 15W ANTEX Iron **£6.80**
650 103 18W ANTEX Iron **£6.95**
650 104 25W ANTEX Iron **£7.10**

LOGIC PROBE

A MUST for working with TTL & CMOS devices. Displays logic levels and pulses down to 25ns with LEDs and sound. Comprehensive instruction booklet supplied.
 Working voltage 4-16V dc
 Input impedance 1M
 Max. i/p frequency 20MHz
ONLY £9.50

RECHARGEABLE SOLDERING IRON

Powerful cordless iron complete with table-top/wall-mounting charging bracket. Reaches soldering temperature in 10 seconds. Includes lamp which lights when soldering. Comes with mains charging unit and 12V car battery adaptor.
Special offer £15.95

HELPING HANDS

Magnifier and crocodile clips on ball and socket joints mounted on a heavy base. Ideal for holding and inspecting PCBs during soldering, fault finding, etc.
(650 035) £3.95

NEW SUPER-SENSITIVE FM MICROBUG

Highly sensitive FM transmitter measuring only 45x25x15mm, including the built-in microphone. Frequency 88-100MHz enabling reception on a standard domestic FM radio. Range approximately 300m depending on terrain. Powered by 9V PP3 (7mA). Its small size and highly sensitive electret microphone makes it ideal for surveillance, baby alarm, etc.
INTRODUCTORY PRICE £5.50

LOW COST MULTIMETER

A versatile meter with 19 ranges including 10A DC & BATTERY TEST. Case is tilted for easy reading. Supplied complete with batteries, test leads and a manual. Ideal meter for the beginner. Input impedance 20K ohm per volt. AC Volts: 0-10-25-1000V 5%. DC Volts: 0-2.5-20-25-250-1000V + 5%. DC Current: 0-2.5-25m 250mA-10A + 4%. Resistance: 0-10K-100K-10M
 Battery test: 9V-1.5V AA-1.5V C & D
 Protection: Fuse
 Dimensions: 154 x 77 x 43mm
£8.62

SOLAR POWERED NICAD CHARGER

Takes up to 4 x AA size. Charges 2 batteries in 4-6 hrs. depending on strength of sunlight. Ideal for boating, caravaning, modellers, etc. **£6.50**

ELECTRONIC WEIGHING SCALES

This kit contains a Single Chip Microprocessor, PCB, displays and all electronics to produce a digital readout of weight in Kgs. or Sts. and Lbs. in normal use a toothed wheel (pattern provided) is made to rotate when a weight is placed onto the scales, interrupting two infra-red beams. The processor counts the number of teeth passing the sensor (up or down, depending on which beam is broken first), and shows the reading on the LED display in Sts. and Lbs., Lbs or Kgs. A PCB link selects the scale for bathroom or two types of Kitchen Scales. A linear version of the toothed wheel could also be used. Other uses include up/down counters. A low cost digital ruler could be made by using a wheel with the correct tooth to diameter ratio. **£6.50**

TH ELECTRONICS 13 BOSTON RD LONDON W7 3SJ Tel: 01-567 8910

SEND 9"x 6" S.A.E. & 50p FOR CATALOGUE OR CALL AT SHOP MON-FRI 9-5pm SATURDAY 10-4pm

ORDERING INFORMATION: ALL PRICES EXCLUDE VAT

FREE P&P on orders over £20 (UK only), otherwise add 75p + VAT. Overseas P&P: Europe £2.75. Elsewhere £6.50. Send cheque/PO/Barclaycard/Access No. with order. Giro No. 5293 14002.

LOCAL AUTHORITY AND EXPORT ORDERS WELCOME GOODS BY RETURN SUBJECT TO AVAILABILITY

EVERYDAY ELECTRONICS

INCORPORATING ELECTRONICS MONTHLY

The Magazine for Electronic & Computer Projects
VOL. 17 No. 11 November '88

MAIL ORDER

As I write this we are in the middle of a postal strike—hopefully by the time you read it the strike will be over! It does, however, serve to remind us just how much we rely on the post as part of our general lives and also for our hobby/business.

The strike has had a tremendous effect on the mail order companies that supply components—our own p.c.b., back numbers, binders and book service has ground to a halt and we are also unable to get copy to some authors and advertisers for checking. The office FAX is working overtime and so is the 'phone but they do not solve all the problems.

RIGHTS

The mail order supply of almost anything has become a way of life and this method of supply is usually quick and efficient. A recent incident at home made me realise that for younger readers a few pointers might be helpful.

My son had ordered some parts for his skateboard—when they came he was not happy with the quality and felt he had wasted his money. I pointed out that if he sent them back quickly, undamaged, he could get a full refund of his money. He had not realised that he was entitled by law to such a refund if he was not happy with the goods. Your rights as a consumer are well protected by the law in the U.K. and you should have no hesitation in ordering by mail—postmen permitting.

BE PATIENT

The aftermath of a postal strike gives the mail order companies even more problems, with an unprecedented amount of mail being delivered. Following a period of little or even no work they then have more than they can cope with. Please be patient if you are waiting for goods—there is no way of knowing when a particular letter will eventually find its destination and, therefore, how quickly the company can despatch the goods.

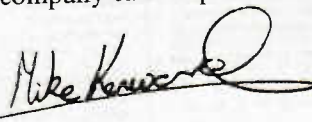

SUBSCRIPTIONS

Annual subscriptions for delivery direct to any address in the UK: £14.50. Overseas: £17.50 (£34 airmail). Cheques or bank drafts (in

£ sterling only) payable to Everyday Electronics and sent to EE Subscriptions Dept., 6 Church Street, Wimborne, Dorset BH21 1JH. **Subscriptions can only start with the next available issue.** For back numbers see below.

BACK ISSUES AND BINDERS

Certain back issues of EVERYDAY ELECTRONICS are available price £1.50 (£2.00 overseas surface mail) inclusive of postage and packing per copy. Enquiries with remittance, made payable to Everyday Electronics, should be sent to Post Sales Department, Everyday Electronics, 6 Church Street, Wimborne, Dorset BH21 1JH. In the event of non-availability remittance will be returned. **Please allow 28 days for delivery. (We have sold out of Sept., Oct., & Nov. 85, April, May & Dec. 86, Jan., Feb., April, May, Nov. 87, Jan., March & April 88.)**

Binders to hold one volume (12 issues) are available from the above address for £4.95 (£9.00 overseas surface mail) inclusive of p&p. **Please allow 28 days for delivery. Payment in £ sterling only please.**

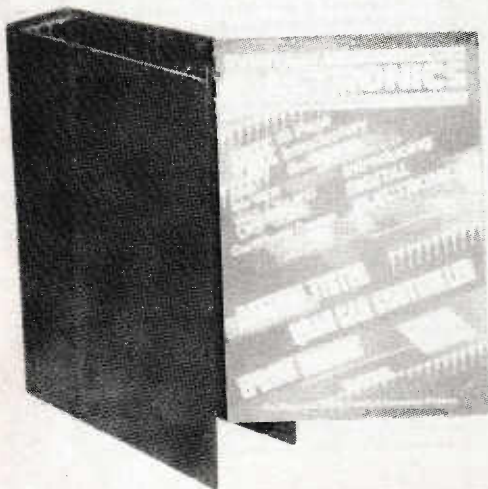

Editorial Offices
EVERYDAY ELECTRONICS EDITORIAL,
6 CHURCH STREET, WIMBORNE,
DORSET BH21 1JH
Phone: Wimborne (0202) 881749
FAX: (0202) 841692

See notes on **Readers' Enquiries** below—we regret that lengthy technical enquiries cannot be answered over the telephone

Advertisement Offices
EVERYDAY ELECTRONICS ADVERTISEMENTS
HOLLAND WOOD HOUSE, CHURCH LANE,
GREAT HOLLAND, ESSEX CO13 0JS. Clacton
(0255) 850596

Editor MIKE KENWARD
Secretary PAMELA BROWN
Deputy Editor
DAVID BARRINGTON
Editorial Assistant
COLETTE MCKENZIE

Editorial: WIMBORNE (0202) 881749
Advertisement Manager
PETER J. MEW Clacton (0255) 850596

Classified Advertisements
Wimborne (0202) 881749

READERS' ENQUIRIES

We are unable to offer any advice on the use, purchase, repair or modification of commercial equipment or the incorporation or modification of designs published in the magazine. We regret that we cannot provide data or answer queries on articles or projects that are more than five years old. Letters requiring a personal reply must be accompanied by a **stamped self-addressed envelope** or a **self-addressed envelope and international reply coupons**.

All reasonable precautions are taken to ensure that the advice and data given to readers is reliable. We cannot, however, guarantee it and we cannot accept legal responsibility for it.

COMPONENT SUPPLIES

We do not supply electronic components or kits for building the projects featured, these can be supplied by advertisers.

OLD PROJECTS

We advise readers to check that all parts are still available before commencing any project in a back-dated issue.

We regret that **we cannot provide data or answer queries on projects that are more than five years old.**

ADVERTISEMENTS

Although the proprietors and staff of EVERYDAY ELECTRONICS take reasonable precautions to protect the interests of readers by ensuring as far as practicable that advertisements are *bona fide*, the magazine and its Publishers cannot give any undertakings in respect of statements or claims made by advertisers, whether these advertisements are printed as part of the magazine, or are in the form of inserts.

The Publishers regret that under no circumstances will the magazine accept liability for non-receipt of goods ordered, or for late delivery, or for faults in manufacture. Legal remedies are available in respect of some of these circumstances, and readers who have complaints should address them to the advertiser or should consult a local trading standards office, or a Citizen's Advice Bureau, or a solicitor.

TRANSMITTERS

We would like to advise readers that certain items of radio transmitting equipment which may be advertised in our pages cannot be legally used in the U.K. Readers should check the law before using any transmitting equipment as a fine, confiscation of equipment and/or imprisonment can result from illegal use.

The law relating to this subject varies from country to country; overseas readers should check local laws.