

# THE POST OFFICE ELECTRICAL ENGINEERS' JOURNAL

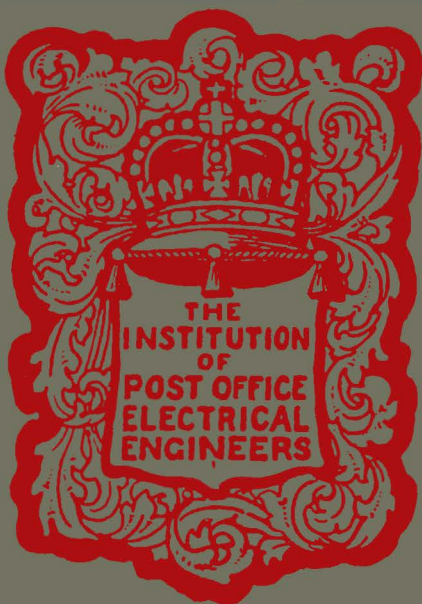

**VOL. 17**  
**PART 3**

*Price 2/- net.*



**OCT:**  
**1924**

ADVERTISEMENT INDEX

THE  
**LONDON ELECTRIC WIRE CO.**  
**AND SMITHS, LTD.**

**Playhouse Yard, Golden Lane, London, E.C.1.**

Telegrams:  
"Electric, London."

Telephone:  
Clerkenwell 1388, 1389, 1390, 1391.

MANUFACTURERS OF

**Every Description of Cables and  
Wires for Electrical Purposes.**

Cotton-Covered and Braided Wires.  
Cotton-Covered Strips and Cables.  
Silk-Covered and Enamel Insulated Wires.  
Multiple Cables.  
Flexible Cords.  
Cables and Flexibles for Wireless Work.



"Eureka," Nickelchrome and other High Resistance Wires.

**PITMAN'S BOOKS**  
FOR POST OFFICE ENGINEERS AND STUDENTS.

## AUTOMATIC TELEPHONES

By F. A. ELLSON, B.Sc., (Hons.) A.M.I.E.E., Engineer, G.P.O.

This is an introductory treatise dealing in simple manner with the fundamental principles, methods, and advantages of automatic telephony, with descriptions of apparatus, circuits and operation. Attention has been confined to the chief established systems in use to-day. Price 5/- net.

## TELEPHONY

By T. E. HERBERT, M.I.E.E.

This important work from the pen of the well-known technical expert and writer is intended for the use of all engaged in the work of construction and maintenance of telephones and students preparing for the examinations of the City and Guilds of London Institute.

893 pages. 618 illustrations. Price 18/- net.

*The Electrician* says:—"The treatment is very full and clear. It may be very confidently recommended as being a sound and adequate treatment of the subject. Whenever a knotty point arises, the author, where possible, provides an explanatory sketch. . . . The construction of aerial and underground routes is very thoroughly handled, and here, again, the illustrations are praiseworthy."

FROM THE SAME  
PUBLISHERS

TELEGRAPHY (Herbert) 18/- net.  
MODERN RADIO COMMUNICATION (Reyner) 5/- net.  
ARITHMETIC OF TELEGRAPHY AND TELEPHONY  
(Herbert and DeWardt) 5/- net.

*Complete List post free from*

**PITMAN'S, Parker St., Kingsway, W.C.2**

iii.

R 300.

HEIGHT 5½ INS.

WEIGHT:  
8 LBS. 8 OZS.

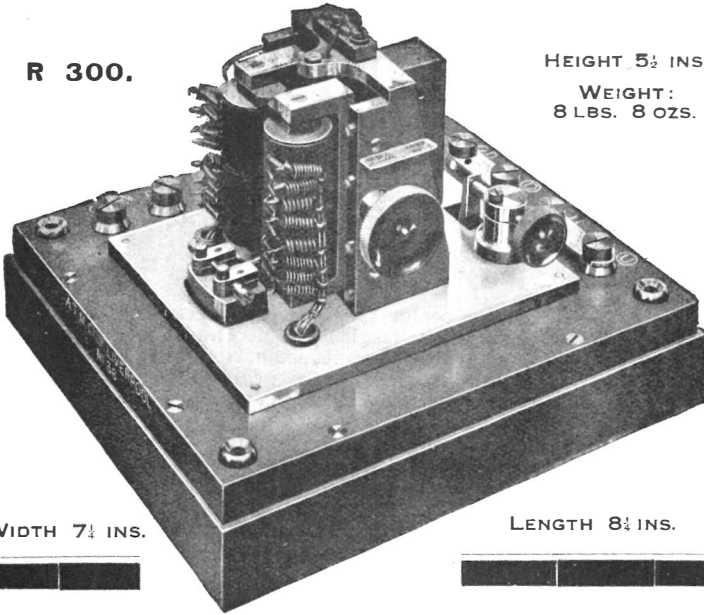

WIDTH 7¼ INS.

LENGTH 8½ INS.



A.T.M.

# GULSTAD RELAY CABLE PATTERN.

THIS pattern relay has been developed for specially difficult lines and submarine cables.

The adjustment of the contact carriage and the relation of the electro magnet cores to the armature system is of wide range and can be made in minute steps.

The frame in which the coils slide is very rigid and the relay is not susceptible to extraneous vibrations.

SEND TO-DAY  
FOR  
CATALOGUE  
No. 39.

**AUTOMATIC TELEPHONE**  
MANUFACTURING CO., LTD.

*Head Office and Works.*

MILTON ROAD,  
EDGE LANE,  
LIVERPOOL.



*London Office:*

NORFOLK HOUSE,  
NORFOLK STREET  
STRAND, W.C.2

# The Post Office Electrical Engineers' Journal.

A QUARTERLY JOURNAL.

## CONTENTS FOR OCTOBER, 1924.

COPYRIGHT.—The entire contents of this Journal are covered by general copyright, and special permission is necessary for reprinting long extracts, but Editors are welcome to use not more than one third of any article, provided credit is given at the beginning or end thus: "From the 'Post Office Electrical Engineers' Journal.'"

	PAGE
THE ROMANCE AND HISTORY OF THE ELECTRIC TELEGRAPH— A. H. ROBERTS ... ..	171
TELEGRAPH CODES AND KEYBOARD TAPE PERFORATORS ... ..	181
TELEGRAPH AND TELEPHONE PLANT IN THE UNITED KINGDOM ... ..	184
P.O. TELEPHONE EXHIBIT AT THE BRITISH EMPIRE EXHIBITION. THE A.T.M. CO.'S CODER CALL INDICATOR—F. I. RAY ... ..	185
THE DIRECTOR—W. E. HUDSON ... ..	197
EUROPEAN LONG-DISTANCE TELEPHONY ... ..	198
THE MEASUREMENT OF HIGH FREQUENCIES—F. E. NANCARROW ... ..	209
LEAFIELD RADIO STATION ... ..	217
OVERDAMPED CONDENSER OSCILLATIONS—CHARLES P. STEINMETZ ... ..	223
HEADQUARTERS NOTES ... ..	233
LONDON DISTRICT NOTES ... ..	235
RETIREMENT OF MR. RICHARD WARING ... ..	238
MR. F. McMORROUGH ... ..	240
LOCAL CENTRE NOTES ... ..	243
BOOK REVIEWS ... ..	245
STAFF CHANGES ... ..	251
COMMUNICATIONS ... ..	252
THE INSTITUTION OF POST OFFICE ELECTRICAL ENGINEERS ... ..	253

All communications with regard to advertisements to be addressed to:

The Advertisement Manager,  
Post Office Electrical Engineers' Journal,  
4, Ludgate Hill, London, E.C.4.

PUBLISHERS:

THE ELECTRICAL REVIEW, LTD., 4, LUDGATE HILL, E.C.

Price 2/- net, post free, 2/3.

Annual Subscription, postage  
inclusive, 9/6, payable in advance.

# Hindrance or Help —which?

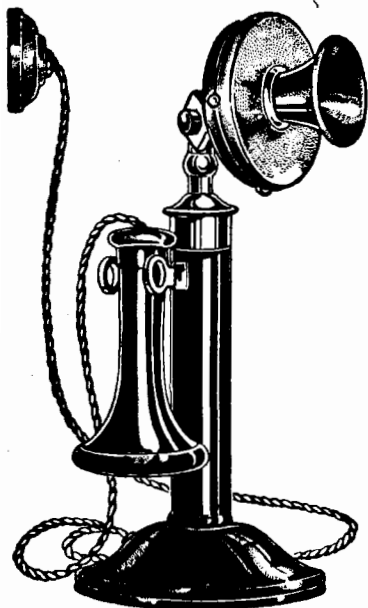

IS the 'phone system you instal a blessing—or otherwise. Does *your* 'phone mumble its messages, connect wrong departments . . . occasionally go on strike altogether?

Better instal an **Ericsson** Telephone System. Its clear-speech, working-all-the-time efficiency, tiny repair bill—all will repay in repeat orders and goodwill.

We can help in your telephone problems Write us to-night for free illustrated list.

---

THE BRITISH  
L. M. ERICSSON MFG. CO., LTD.  
*International Buildings,*  
67/73, Kingsway, London, W.C.2.

SCOTLAND.—Malcolm Breingan  
57, Robertson Street, Glasgow.

AUSTRALIA.—J. Paton & Co.,  
Macquarie Place, Sydney, N.S.W.  
J. Bartram & Son, Pty Ltd.,  
586, Bourke St., Melbourne.

NEW ZEALAND.—B. L. Donne,  
Australasia Bank Chambers  
Custom House Quay, Wellington.

N.E. ENGLAND.—North British  
Eng. Equipment Co., Milburn  
House, Newcastle-on-Tyne.

LEEDS.—North British Engineering  
Equipment Co., Excelsior Build-  
ings, Lands Lane.

**Ericsson**  
Telephones

# SIEMENS BROTHERS & CO<sup>LD</sup> MANUFACTURERS OF ELECTRIC CABLES

OVERHEAD, UNDERGROUND, SUBMARINE and SUBFLUVIAL  
for Telephony, Telegraphy and Transmissior Power.

## TELEPHONE APPARATUS

MANUAL AND AUTOMATIC  
Siemens "Autophone" System of Automatic Telephone Exchanges.

## TELEGRAPH APPARATUS

MORSE, WHEATSTONE, and BAUDOT.

WIRELESS TELEGRAPHY.

STANNOS WIRES.

OVERHEAD TELEGRAPH, TELEPHONE  
& POWER TRANSMISSION LINES.

## DISTANCE THERMOMETERS

for Cold Storage and Other Purposes.

## PYROMETERS

for Internal Combustion Engines.

ELECTRICAL MEASURING, TESTING  
AND RECORDING INSTRUMENTS.

## SIGNALLING APPARATUS

for Ships, Railways, Mines, Power Stations, Etc.

## PRIMARY CELLS & BATTERIES

FLUID and DRY.

## ELECTRIC LAMPS

Etc., Etc.

*Full Particulars from the manufacturers*

**SIEMENS BROTHERS & CO., LTD.**

TELEGRAMS:  
SIEMENS  
WOOLWICH

WOOLWICH,  
LONDON, S.E. 18.

TELEPHONE:  
CITY 6400  
(7 LINES.)

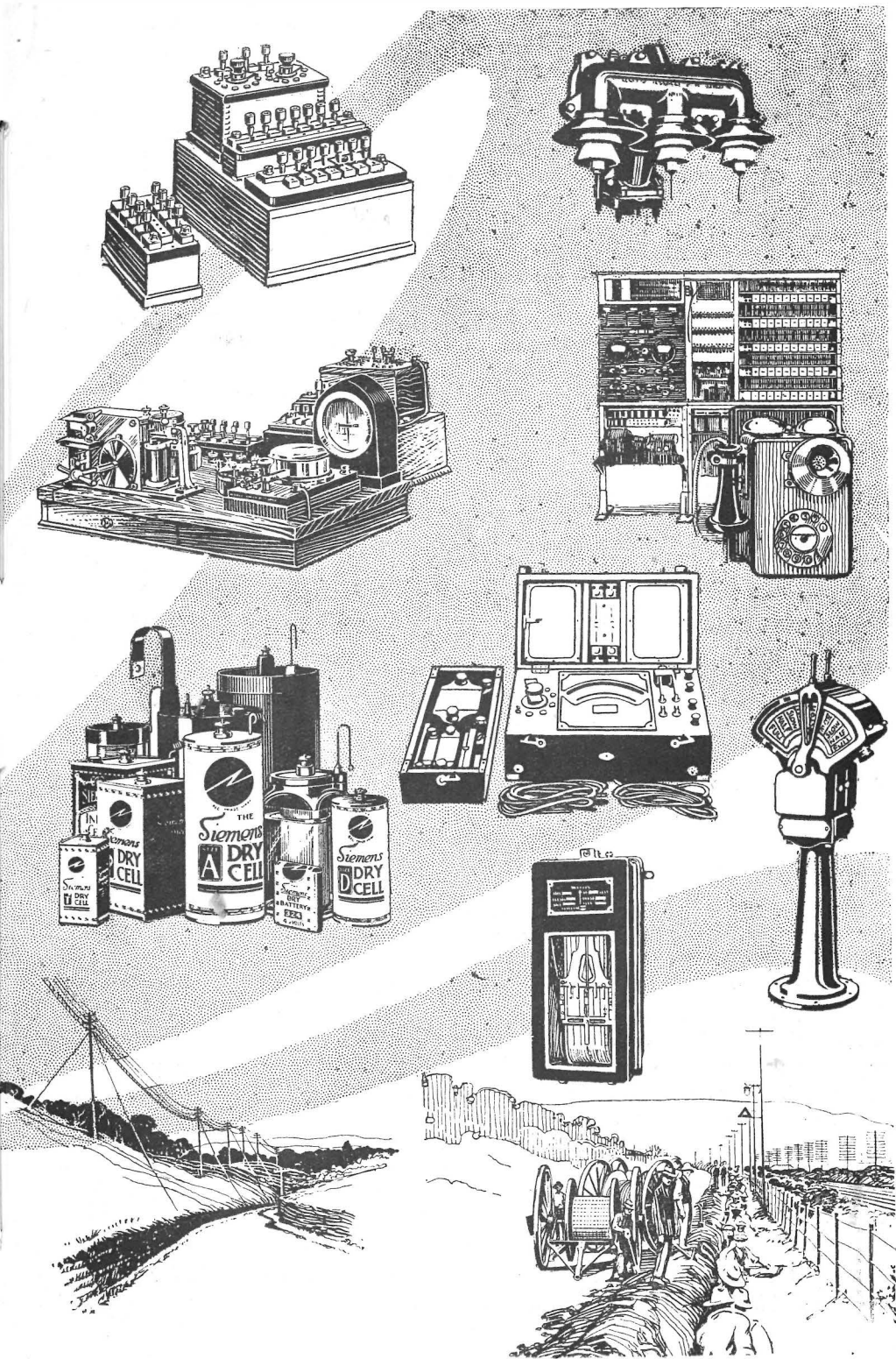

# **FREDERICK SMITH & CO.,**

Incorporated in

The London Electric Wire Co. & Smiths, Ltd.,

**ANACONDA WORKS, SALFORD, MANCHESTER.**

---

**HARD DRAWN H.C. COPPER LINE WIRE.**

**Special Tinned H.C. Copper Wire.**

**COPPER TAPES AND BINDERS FOR LINE WIRE.**

**COPPER TROLLEY WIRE**

**SPECIAL NON-FOULING SECTIONS.**

**SILICIUM BRONZE WIRE**

**"C" Quality for Telephone Lines, &c.**

---

## **Annales des Postes, Telegraphes et Telephones.**

---

The French Administration of Posts and Telegraphs publishes a technical journal entitled "Annales des Postes, Telegraphes et Telephones."

This publication, which appears every two months, is edited under the control of a commission nominated by the Ministry; it includes amongst its contributors writers of the highest authority; it publishes regularly also extracts from the current technical literature on telegraphy and telephony from all countries.

The *Annales des Postes, Telegraphs and Telephones* forms per year a volume running to about 1,200 pages, which constitutes a technical record of the first order on all progress in the realm of telegraphs, telephones and postal work and also current work and research in French laboratories and those abroad.

The magazine is published by the *Librairie de l'Enseignement Technique*, 3, Rue Thénard, Paris. The annual subscription is 24 francs for France and her colonies, and 27 francs abroad.



**GRAPH SERIES.**

By EDWARD RAYMOND-BARKER, M.I.E.E.

**Handbook in Cable-Break Localisation****Graphic Methods. The Calculator Board in Practice.**

Demy 8vo, 66 pages. 38 Illustrations.

Paper covers, 1s. 6d. : post free, 1s. 8d. Cloth covers, 2s. 6d. : post free, 2s. 8d.

ALSO

**Cable-Fault Localisation Graphs in Practice.**

Demy 8vo, 68 pages. 24 Illustrations.

Paper covers, 1s. 6d. : post free, 1s. 8d. : Cloth covers, 2s. 6d. : post free, 2s. 8d.

ALSO

**Graphs in a Cable-Ship Drum-Room :  
NOTES FOR JUNIOR ASSISTANTS.**Limp Cloth, cut flush. 48 pages. 25 Illustrations, including 10 Photo-engravings.  
4 Tables. Super Royal 8vo.

Price 1s. 6d. net. Post Free 1s. 8d.

The ELECTRICAL REVIEW, Ltd.,  
4, Ludgate Hill, London, E.C.4.**TECHNICAL BOOKS.**Have been our speciality for over THIRTY YEARS. Post us  
your orders. We send them all over the World.**TELEPHONE TROUBLES AND HOW TO FIND THEM.** On both the  
magneto and C.B. systems. Thousands of copies in use all over the world. 19th edition.  
10d. post free.**THE WESTERN ELECTRIC AUTOMATIC TELEPHONE SYSTEM.**  
By Anson. Should be studied by all telephone engineers. Cr. 8vo, 1s. 2d. post free.**HANDY ELECTRICAL DICTIONARY.** By Weber. Thoroughly up-to-date.  
Contains definitions of over 4,800 distinct words, terms and phrases.  
Cloth, 1s. 8d. ; leatherette, 2s. 0d.**QUESTIONS AND SOLUTIONS IN TELEGRAPHY AND TELEPHONY  
FINAL EXAMINATIONS.** By FEW. Set by the C. & G. Inst. in the  
Final Exams in T. and T. for the ten years 1906-1915, with full solutions to the last papers.  
Cr. 8vo., illustrated. 2s. 3d. post free.**THE HUGHES AND BAUDOT TELEGRAPHS.** By ARTHUR CROTCH.  
Invaluable to students, as a knowledge of both systems is now demanded by the examiners.  
2s. 0d. post free.**QUESTIONS AND SOLUTIONS IN MAGNETISM AND ELECTRICITY.** By  
W. J. WHITE. Contains solutions to all questions in M. and E. (Grade I.), set by the Board  
of Educ. and the C. and G. Inst., for 1907-1921. Fully illustrated. New and enlarged  
edition. Cl. 8vo. 2s. 0d. post free.**THE TELEGRAPHERS' GUIDE.** By BELL & WILSON. The standard  
for Grade I. The new (8th) edition has been revised and brought up to date by a well-known  
C.T.O. teacher of high standing, and is recommended by all the electrical journals. 20th  
thousand. Cr. 8vo., profusely illustrated. 4s. post free.**TELEPHONE ERECTION AND MAINTENANCE.** A handbook for the con-  
tractor and wireman. By H. G. WHITE. Officially recommended by the C. and G. examiners.  
Cloth, 8vo. 3s. 10d. post free.**S. RENTELL & Co., Ltd., 36, Maiden Lane, London, W.C.2.**

Write for Catalogue No. 3A.

---

---

# *The Good Service* **VACUUM SWEEPER**

What the mark "sterling" is to silver so is the mark "Western Electric" to the electrically-operated Sweeper. Where you buy a Vacuum Sweeper bearing that mark, you are buying one that is truly serviceable—one that will afford its user, either in the home or in the office, a feeling that its use means absolute efficiency with a minimum of effort and expense and a maximum of hygienic thoroughness.

The unprecedented demand for Western Electric Vacuum Sweepers is a pleasing indication that the public have been quick to appreciate their salient features and sterling qualities.

**12 MONTHS  
GUARANTEE**

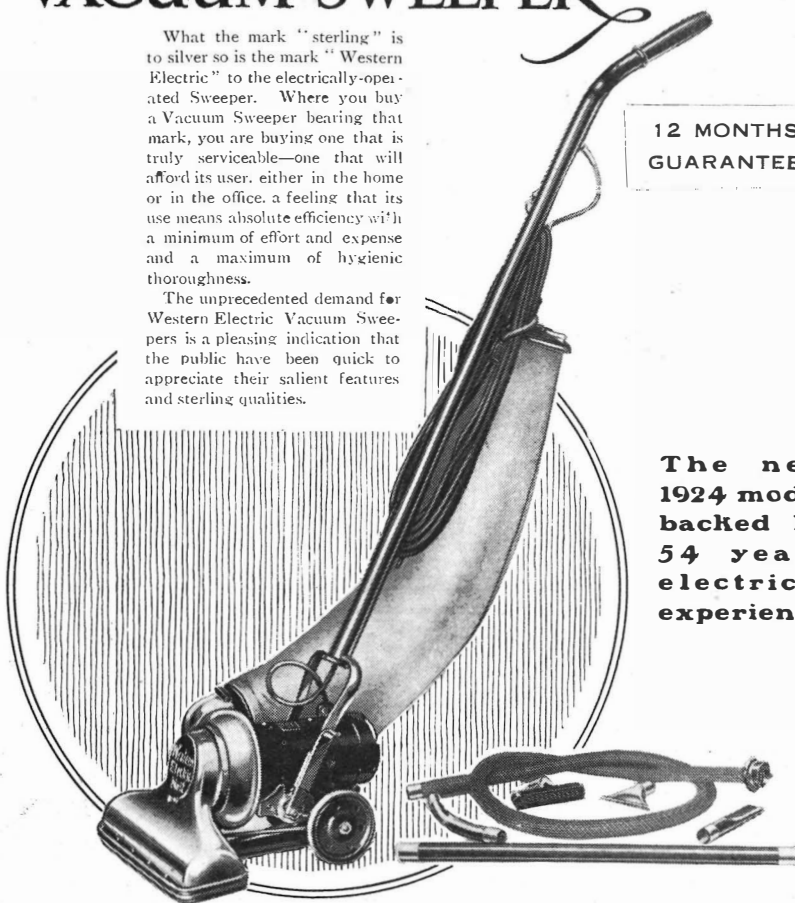

**The new  
1924 model  
backed by  
54 years  
electrical  
experience**

***Western Electric Company Limited.***

**Connaught House, Aldwych, London, W.C. 2.**

Central 7345 (9 lines.)

*Branches:—Birmingham, Leeds, Manchester, Newcastle, Liverpool, Glasgow, Cardiff, Southampton, Dublin, etc.*

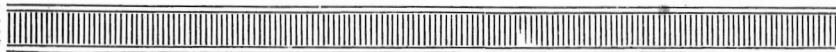

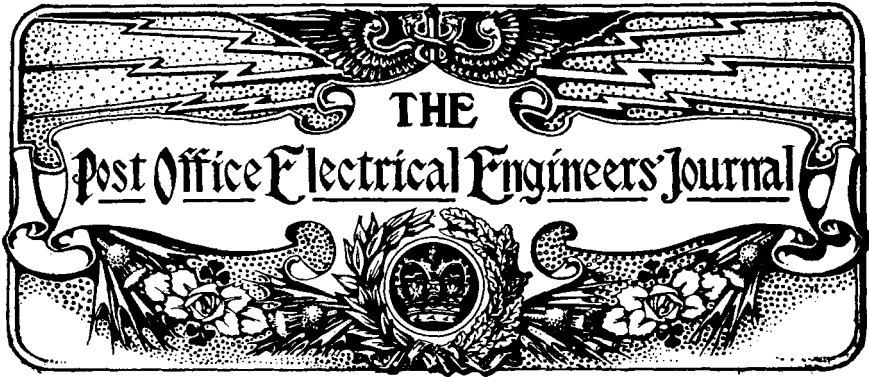

## THE ROMANCE AND HISTORY OF THE ELECTRIC TELEGRAPH.

A. H. ROBERTS.

### PART VI.

IN chapter IV., the story of multiplex telegraphy was commenced by a reference to Newton's patent "Electrepode." In point of time, this was followed by M. G. Farmer's multiplex, which was patented in America in 1853, and by Burnett's multiplex, a specification of which was filed in this country in 1860, as related by Mr. H. H. Harrison in his lecture on "The historical basis of modern printing telegraphy."

These inventors were rather in advance of the times, as the requirements of the public could be satisfied by less complicated installations, but a few years later traffic increased to such an extent that there was a natural demand for increased output on long-distance circuits. There were two ways of meeting this demand: (a) By fast speed automatic transmission, and (b) by the adoption of multiplex methods. At this juncture, M. Meyer introduced his well-known quadruple multiplex, which was exhibited at the Vienna Exposition in 1873.

Several circuits on the Continent were worked on the Meyer system with a fair measure of success, but it was evident that in many ways improvement was essential before multiplex working could be regarded as a reliable and accurate method of communication. Engineers of many nationalities were keenly interested and applied their energies to the solution of the many mechanical and electrical problems which this tentative trial disclosed.

THE BAUDOT SYSTEM OF MULTIPLEX.

The most brilliant work in this direction was performed by M. Baudot, a Frenchman, who in 1874-5 produced a type-printing multiplex of remarkably ingenious construction. Baudot wisely adopted a code in which the signals for each printed character consisted of an invariable number of line current impulses.

It has already been stated that Messrs. Gauss and Weber, by omitting certain letters of the alphabet, constructed a code made up of four such units, but for the purpose of handling public telegrams the complete alphabet was necessary and Baudot used a fifth unit which provided the extra number of permutations required.

The following short biographical sketch of M. Baudot is mainly taken from an introduction to a lecture delivered by Mr. A. C. Booth to the Metropolitan Centre of the Institution of Post Office Electrical Engineers, in 1907:—

Jean Maurice Emile Baudot was born at Magneux (Haute-Marne) France, on September 11th, 1845. After receiving a rudimentary education, he spent his youth on his father's farm, attending to agricultural affairs until he entered the French Telegraphic Service on July 16th, 1870. There was at that time nothing to indicate his possession of the inventive genius which he subsequently developed, and it was only later on and concurrently with his study of telegraphic apparatus that he undertook to perfect his scientific education. In 1872, two years after he had joined the Telegraph Service, Baudot first interested himself in the improvement of the telegraphs, his endeavour being to combine the advantages of a printing system, such as the Hughes, with those of a multiplex of the Meyer type. To this end, he adapted the code of Gauss and Weber to his requirements.

In the latter part of 1874, Baudot produced his first Receiver, but not having the means to fully realise his ideas he offered his invention to the French Administration, giving them the right to use it if they would adopt the system. Meanwhile, Baudot continued to perform his operating duties and to devote his time, after office hours, to research work.

In June, 1875, the French Administration accepted the offer and provided a limited supply of funds to enable the inventor to proceed with his investigations. At the same time, Baudot was relieved of operating duties and transferred to the Factory for the purpose of assembling an experimental set of his apparatus. The first trial took place during the same year and was sufficiently encouraging to justify the construction of a five-channel equipment. In 1877, it was definitely decided to adopt the system for use in the national service.

From that time, Baudot devoted his entire energies to the task

of perfecting his instruments. When the Government grant was exhausted the enthusiastic inventor did not hesitate to draw on his own modest resources, even to the extent of pledging the gold medal awarded to him at the International Exposition in 1878. It is gratifying to recollect that when these facts became known to the authorities further financial assistance was immediately placed at Baudot's disposal.

About 1887, Baudot designed a keyboard perforator and cadence transmitter for the purpose of introducing automatic signalling and thereby relieving the sending operator from constant attention to the cadence tap. There was no immediate demand for these appliances, but in 1903 it was decided that automatic transmission should be given a trial on a French circuit and M. Carpentier, by effecting some modification of Baudot's plan, constructed instruments which were used experimentally in Paris in 1906.

M. Baudot was promoted to the Legion d'Honneur in 1879, gained a diploma of honour at the Electrical Exposition in 1881, and in the following year was appointed to the position of Inspecting Engineer in the French telegraph service.

Personally, M. Baudot was a modest, unassuming gentleman, who sought his pleasure in hard work and avoided the bright light of publicity which is sometimes regarded as one of the rewards due to the possession of unusual talent. Content to labour simply and honestly in that particular branch of electrical engineering with which his name will ever be honourably associated, M. Baudot unfortunately overtaxed his strength and contracted an illness from which he never recovered. To the great regret of his many friends this illustrious genius of the telegraphic world passed away on 28th March, 1903, at the comparatively early age of 58.

In this country, the first set of Baudot apparatus was installed on an Anglo-French cable in 1897. The result was entirely satisfactory, and other circuits to the Continent were soon equipped with similar instruments, but it was not until 1905, when Mr. A. C. Booth, of the P.O. Engineering Department, succeeded in duplexing the system, that the Baudot was regarded as a prospective competitor against the Wheatstone and other automatic fast speed methods on inland circuits.

Notable advances had been made in speeding up the Wheatstone system by reducing manual operation to a low limit through the introduction of keyboard perforators, receiving perforators and printers, which will be more fully referred to later. Trials of these instruments had reached an interesting stage at the time the Baudot was duplexed, so it is not surprising that the latter had to await its opportunity. This came in 1910, when the first inland

quadruple duplex Baudot was established between London and Birmingham. Later on, the installation was converted to sextuple duplex, thus providing 12 working channels on a single circuit. The effect of this premier essay was so convincing that, year after year, the system was steadily extended to other centres until, by the development of forked circuits, it became the leading feature of the British telegraph service.

Further development in the direction of automatic transmission at an increased speed has already been inaugurated, as in the case of the Murray multiplex and the Western Electric, both of which may be regarded as ingenious applications and extensions of the fundamental processes evolved by M. Baudot and developed from the duplex Baudot as used in this country, which embodies permanent duplex conditions of working as distinct from the French method of permanent simplex operation.

Before passing to other subjects, mention must be made of the

#### DELANY MULTIPLEX.

This was one of the few combinations in which the Morse code had been successfully adopted for multiplex working. Invented by an American engineer, the Delany was installed for use on several busy, long-distance circuits in this country about 1886.

The system comprised many admirable devices; for example, the distributor brush, which revolved at a moderate speed, was operated by means of an electrically vibrated reed and La Cour phonic wheel to secure smooth and constant running. This proved so satisfactory that the same principle, applied in an improved form, is extensively used for a similar purpose to-day.

The Delany was worked by key and sounder at a speed of 20 to 25 words a minute on each arm. The number of channels varied from three to six, according to the length and electrical characteristics of the line on which it was used. Originally it was a simplex system, but in 1901 Mr. S. A. Pollock, of the Post Office Engineering Department, developed a duplex tetrode set, which gave good service on a London-Liverpool circuit, and incidentally established a new record for this country in the volume of traffic transmitted by hand over a single line, 180 miles in length, during a period of eight hours.

The abandonment of the use of the Delany multiplex by the Post Office in 1904 was not due to any inherent defect in the apparatus but may be ascribed to the necessity of providing conductors of sufficiently heavy gauge to keep the time required for the propagation of the signals within limits which would render the service profitable. In addition, the opinion is generally held that the Morse alphabet, with its long and short signals, is fundamentally unsuited to multiplex conditions. The progress of

direct printing instruments has now rendered hand transcription a story of the past, so far as heavily loaded circuits are concerned, and future development is likely to proceed further in the direction of machine telegraphy for all but minor circuits.

#### MODERN WHEATSTONE METHODS.

The Wheatstone fast speed automatic system owes much of its modern popularity to the ingenuity of Mr. F. G. Creed, who was successful in a field of research which had baffled many of his predecessors.

The problem which presented itself to acute minds was: "By what means can the received Wheatstone signals be rendered capable of producing a slip perforated exactly as the original which is run through the transmitter at the sending station?" It was confidently anticipated that such an instrument would be of very great value and many endeavours were made, both in this country and abroad, to attain the desired result, but the difficulties were found to be almost insuperable as far as fast speed working was concerned. More than one inventor produced an instrument which would operate at 30 to 40 words a minute, but at higher rates the prospect seemed hopeless. At this juncture, Mr. Creed took the matter in hand and by using compressed air to operate the mechanism, he was able to introduce a machine capable of working at 150 words a minute. This apparatus was taken up by the British Post Office in 1902. Six years later, Mr. Creed still further increased the speed to over 200 words a minute.

Not content with this notable achievement in labour-saving, Mr. Creed set himself the task of evolving a machine telegraph which would translate the received Wheatstone perforated tape into printed Roman characters. In spite of many difficulties this was successfully accomplished and by means of ingenious selecting mechanism any symbol represented in the Morse code automatically printed the required sign in clear type. The combination of receiving perforator and printer, therefore, rendered it possible to convert any circuit worked on the Wheatstone fast speed principle into a complete type-printing machine telegraph, without in any way interfering with the ordinary line signalling arrangements.

The Creed printer, like the Creed receiving perforator, was dependent on compressed air for its operation. In a later form of the instrument, a small air compressor was fitted to the base of the printer, thus rendering the instrument self-contained and independent of an external pneumatic supply. A considerable number of sets of Creed equipment are still in daily use at large telegraph centres, where they are principally utilised in receiving and printing news for delivery to the daily press. In a minor

degree, the system is also employed to dispose of any sudden influx of ordinary commercial traffic.

The latest development in connection with Creed receivers and printers consists in dispensing altogether with pneumatic plant and running the newly-designed instruments by small electric motors. A set of this type is working on a Wheatstone circuit in the P.O. Court at the British Empire Exhibition.

As concrete examples of what patient industry allied to mechanical genius can accomplish, the Creed instruments are unsurpassed. To the practical telegraphist, who is aware of the difficulties that had to be surmounted in the construction of these machines, the result must appear to be little short of marvellous.

Another adjunct which gave an impetus to the Wheatstone automatic fast speed system was the keyboard perforator, which by the depression of a selected key punched the whole of the dots, dashes, and spaces to form the letter or other symbol required. The keys were arranged in order similar to that of a typewriter, allowing a typist, after a little elementary tuition but without any actual knowledge of the Morse code, to work the machine and produce slip ready for running through a transmitter. The earliest of Mr. Creed's inventions was a Wheatstone keyboard perforator of this type, worked by pneumatic pressure. This was adopted by the Post Office authorities about the year 1900 and performed good service for the Wheatstone system until 1905, when other inventors brought forward new pattern instruments in which various improvements were embodied.

The Creed keyboard perforator did excellent spade work by familiarising operators with new methods of working and preparing the ground for the production of other time-saving instruments.

Quite recently Mr. Creed has added another pattern of keyboard perforator to his long list of telegraphic inventions. In this instrument, the perforating mechanism is operated by a small external motor, which obviates the difficulty due to overheating of the coils and consequent gradual reduction of speed which has been the chief cause of trouble experienced with many of the perforators worked by solenoids or electro-magnets.

Mr. F. G. Creed commenced his telegraphic career, at the early age of 14, by joining the Western Union Cable Co. at Canso, Nova Scotia, as a Learner. Ten years later, he was employed by the Central and South American Telegraph Co., and continued in that service until 1896, when he decided to relinquish his post as a telegraphist and embark on the development of his inventions. Carrying this purpose into effect, Mr. Creed patented his first keyboard perforator in this country and thus paved the way to the more ambitious achievements which have already been briefly described.



Mr. Creed now presides over the extensive Telegraph Works at Croydon which bear his name. The specialised products of this factory include Creed motor-driven Wheatstone transmitters, keyboard printers, repeaters, undulators, relays, high and low power radio apparatus and numerous other instruments which are known and appreciated throughout the civilised world. In whatever branch of telegraphic industry one may be interested, be it land line, subterranean cable, submarine cable, or radio transmission and reception, Messrs. Creed and Company's instruments will be found performing excellent service.

The idea of using a keyboard perforator to prepare the transmitter tape is not a modern conception, for, according to Mr. H. H. Harrison, as early as 1855 an American Civil Engineer, named Humaston, patented an instrument in this country for that purpose, but Allan, of Westminster, in 1859, was the first to adopt the now familiar typewriter form of key. Most of the earlier machines were fitted with keys more or less resembling those of a piano. Dr. Werner Siemens, in 1868, patented the first completely automatic Morse keyboard perforator in this country. Other well-known types were introduced by Mr. John Gell, M. Kotyra, Capt. Soldatenkow, Mr. Kleinschmidt, M. Pollak and Messrs. Booth and Willmot.

Another inventor, whose name will ever be honourably associated with the development of the Wheatstone automatic telegraph, is Mr. John Gell, whose electrical keyboard perforator did much to extend the use of the system in the direction of continuous working on important commercial circuits. Gell perforators are still popular instruments where the class of work can best be met by fast speed automatic transmission.

Mr. Gell is also the inventor of a system of Wheatstone working which caused much interest at the time of its trial by the British Post Office. The special feature of the arrangement was that each operator of a series of Gell perforators had a motor-driven transmitter placed adjacent to the keyboard. By the action of an automatic switch, transmitter No. 1 would be stopped after a certain number of messages had passed through it. Transmitter No. 2 would then run a series of telegrams, and so on, the control of the starting and stopping mechanism being effected by means of a predetermined signal punched on the tape. Extensive trial was made on two long and important P.O. circuits and but for the fact that multiplex type-printing methods were coming into general use there is not much doubt that more would have been heard of the Gell Wheatstone system. The stopping of one transmitter when a predetermined point of the perforated slip was reached and the simultaneous starting of another instrument, without the intervention of manually operated switches, was the most surprising

feature of the whole system and the certainty with which these functions were performed appeared almost uncanny to the uninitiated observer.

Mr. John Gell formerly occupied a Supervisor's position in the New Zealand telegraphs and came to this country to develop his telegraphic inventions.

#### MODERN TYPE-PRINTING SYSTEMS.

In 1901, Mr. Donald Murray, whose reputation as a prolific inventor of telegraph apparatus has long since been established in the engineering world, introduced his fast-speed automatic type-printing apparatus to the British Post Office authorities. By this system, a punched paper strip, prepared on a special keyboard perforator, was passed through a transmitter connected to the line, and a similar perforated slip issued, letter by letter, at high speed, from the receiving instrument at the distant station. This slip was fed into a high speed printer which produced a typed copy of the message in page form.

Among the many novel devices incorporated in these machines were three which call for special mention. The first was a method which, in the case of wrongly perforated signals, enabled the operator to correct the mistake without any indication of the amendment appearing on the printed form. The second was the use of phonic wheel motors driven by vibrating reeds, and the third was correction of synchronism from the message signals. All three of these features were new in high speed telegraphy and have since then been extensively employed in automatic and multiplex systems. The Murray automatic system was worked on a London-Edinburgh circuit from 1902 to 1906. During that time many improvements were embodied in the instruments and in the latter year a London-Dublin line was equipped and successfully operated for two years. London-Berlin and London-Leeds circuits were also fitted with Murray automatic type-printing apparatus between 1909 and 1912. In the meantime, Mr. Murray was working on a scheme which would combine the advantages of an automatic system with those of a multiplex; the result was the invention of the Murray multiplex page-printing telegraph, a masterly production which comprises most of the virtues and few of the weaknesses of either system. The advantages of the Murray Multiplex were so decisive that it completely superseded the Murray automatic system.

Between the years 1904 and 1909, Mr. Murray was employed by the Postmaster-General for the purpose of developing his numerous inventions then in use for the public service, and many notable improvements were conceived and applied during that period.

Mr. Donald Murray, M.A., of Sydney University, who was trained for a farming career at the Agricultural College, Lincoln, Canterbury, New Zealand, went into journalism and took up the study of telegraphic transmission as a hobby; but eventually the interests of electrical and mechanical science became so strong that Mr. Murray decided to make it his life's work. Having worked out a crude model of his first fast-speed type-printing telegraph (now in South Kensington Museum), Mr. Murray went with his invention to New York, in 1899, and his system was taken up by the Postal Telegraph Company (MacKay-Bennett Commercial Cable interests), who assisted him to develop it into the Murray Automatic Printing Telegraph. It was when this system was completed, after two years' work, that Mr. Murray came to London, in 1901, and interested the British Post Office in his machinery.

Not only Mr. Murray's machines, but also his papers on telegraphic subjects have admittedly served as guides to other workers in the same field. This was particularly the case with his I.E.E. paper on "Setting Type by Telegraph," which focussed the attention of telegraph engineers on the fundamental importance of the 5-unit alphabet for machine telegraphy. His second I.E.E. paper, on "Practical Aspects of Printing Telegraphy," led to the adoption of the Multiplex with the Murray automatic improvements by the Western Union, and this in its turn has led to the remarkable modern developments of printing telegraphy in the United States, including the start-stop printing telegraphs, which are beginning to attract so much attention in the telegraph world.

The war unfortunately interrupted the manufacture of the Murray Multiplex in Europe for four years, with the result that America has gone far ahead and various multiplex systems have sprung up, all more or less based on the combination of ideas of the Murray automatic-multiplex system.

That this state of affairs is not to remain unchallenged may be gathered from the fact that the General Electric Company and the British Post Office have severally extended their facilities for research and development work in this country and the study of progressive methods of transmission is receiving constant expert attention.

It will be noticed, as an interesting coincidence, that Messrs. Creed, Gell and Murray all received their early training in British Colonies.

This brief summary of the history of the electric telegraph can, perhaps, be fittingly closed with a reference to a beautiful and simple piece of apparatus known as the vibrating relay. Invented by Mr. K. Gulstad, who for some time was Chief Engineer of the Great Northern Telegraph Company, of Copenhagen, the instru-

ment was described in the *Electrical Review* of June, 1898. Mr. Gulstad with commendable public spirit declined to patent the device on the ground that his work in that direction had not been undertaken in order to reap a personal financial advantage, but from a desire to benefit mankind in that sphere of science with which he was most familiar.

The principal advantages secured by using a vibrating relay are increased sensitiveness, greater stability of working and freedom from disturbances due to induction from neighbouring lines.

Several Telegraph Administrations, including the British Post Office, as well as telegraph instrument makers, have freely availed themselves of the generous gift of the inventor, by constructing vibrating relays based on the Gulstad principle, but varying in type according to the requirements of the circuits on which they are intended to operate.

Telegraphy is sometimes spoken of as a dying industry, which is being extinguished by the telephone and by new discoveries in radio transmission, but such a pessimistic view receives no confirmation from the Telegraph Engineer, who believes that his profession will, in the future as in the past, prove equal to all the demands that civilisation and progress may make upon it.

THE END.

---

BIBLIOGRAPHY,

In addition to the authorities already mentioned in the text, the following published works have been consulted in compiling these notes:—

*The Electric Telegraph, its History and Progress.* By Edwd. Highton, C.E.

*History of the Invention of the Electric Telegraph.* By Turnbull and Highton.

*The Electric Telegraph.* By Dr. Lardner and E. B. Bright, F.R.A.S.

*Galvanism.* By Sir W. Snow Harris.

*The Electric Telegraph.* By R. Sabine.

*Railways, Steamers and Telegraphs.* By Geo. Dodd.

*History, Theory and Practice of the Electric Telegraph.* By Geo. B. Prescott.

*The Electro-Magnetic Telegraph.* By Lawrence Turnbull, M.D.

*Electric Science.* By Bakewell.

*Description of an Electric Telegraph.* By F. Ronalds.

*The Electric Telegraph, Etc.* By W. F. Cooke.

*The London Anecdotes. The Electric Telegraph.*

TELEGRAPH CODES AND KEYBOARD TAPE PERFORATORS.

*Electricity, Galvanism, Magnetism and Electro-Magnetism.*

Dr. Roget.

*Handbook of Natural Philosophy.* By Dr. Lardner.

*Electricity and Magnetism Specifications.*

*Elementary Lessons in Electricity and Magnetism.* By Dr. S. Thompson.

*Electricity and Magnetism.* By Fleeming Jenkin.

*Historical Account of the Introduction of the Telegraph into England.* Dr. Hamel.

*Traité de Télégraphie électrique.* Abbe Moigno.

*Traité de Electricite.* Cavallo.

*American Electro-Magnetic Telegraph.* Vail.

*Remarkable Applications of the Electric Fluid.* Bain.

*A Century of Electricity.* Mendenhall.

*Museum of Science and Art.* Dr. Lardner.

---

**TELEGRAPH CODES AND KEYBOARD TAPE PERFORATORS.**

IN his very interesting article in *La Technique Moderne*, reprinted in the *P.O.E.E. Journal* for July, 1924, M. Jacob has rendered valuable service by excavating a mass of useful facts and arguments of a novel character about telegraph keyboards and signalling codes. It is also very interesting to note that there is a leaning on the part of the advanced school of telegraph thought in France towards paper printing.

Before dealing with that subject, I should like to correct a slight misapprehension on M. Jacob's part. He says it is not advisable to use excessive speed with keyboard perforators, and that having to perforate on slip instead of printing characters diminishes the speed. I take this to mean that in M. Jacob's opinion keyboard perforators are slower than typewriters. This is certainly a mistake. Keyboard perforators are much more rapid than typewriters. Good modern perforators, such as the Murray, the Morkrum and the Western Electric machines, are much easier to operate than a typewriter and much faster, and there is no carriage to run back and there are no sheets of paper to bother about.

By means of a vibrator I have tested the Murray Multiplex keyboard perforator and I have succeeded in getting it to work faultlessly up to 410 words a minute (41 letters per second). I have also tested a Morkrum keyboard perforator in the same way successfully up to nearly the same speed, and I have no doubt that the Western Electric perforator, being of a similar design, would

give equally good results. Typewriters do not work successfully at more than about 120 words a minute (12 letters per second), and though they can be forced to work up to 150 words a minute they soon wear out at such a speed.

M. Jacob is on firmer ground in saying that the speed of the perforator should not greatly exceed the speed of transmission. That is true, but the speed of transmission should be raised to correspond with the average speeds easily achieved by typists on keyboard perforators. A speed of 60 words a minute presents no difficulty at all to a good keyboard operator. Typists on the Murray Multiplex keyboard perforators in newspaper offices in Fleet Street work with extreme accuracy for six and eight hours every night at 50 to 70 words a minute. The following information from America is also significant. Mr. George M. Yorke, Vice-President in Charge of Engineering, Western Union Telegraph Company, New York, writing to me on the 1st May, 1924, says:—

“Now as to speed of transmission. Our experience here is that operators of their own volition get up to 70, 80 and even 120 words per minute on the free keyboard perforators and we believe that with suitable arrangements of apparatus and staff it is undesirable to provide printer equipment which does not operate satisfactorily at 60 words per minute. We have made some observations which indicate that under average conditions in an operating room here in this country we would be throwing away about 50% of the operators' capacity if we provided printers which would operate at a maximum speed of 40 words per minute instead of 60. It is true that not many of our circuits are working at this speed, but the trouble is not with the operators.”

M. Jacob says that not more than five or six telegrams should be perforated ahead of transmission. The Western Union objects even to one telegram being perforated ahead of transmission. Quick handling of traffic would be impossible if the number extended to five or six telegrams. The proper course is to raise the speed of the Multiplex channels to not less than 60 words a minute. There is no difficulty in this, and also there is no difficulty in securing accuracy at this speed. The Western Union cannot afford to make mistakes and the Western Union insists on high speeds.

Turning now to the subject of page printing, it is a curious fact that the Western Union, after about eight years' experience of page printing (or, to be strictly accurate, column printing) is turning back to tape printing, and has placed orders with the manufacturers for many hundreds of tape printers to replace page printers. There are various reasons for this decision which do

not apply in other countries. The Western Union has to face sharp competition from the Postal Telegraph Company, and business men in America easily and frequently transfer their patronage from one telegraph company to another. It is, therefore, important that Western Union telegrams shall be free not only from errors, but also from visible corrections. Hence it is the practice of the Western Union to re-run or re-punch telegrams containing corrections so as to obtain faultless telegrams. This results in a very material reduction in output. With tape printing the difficulty does not arise because corrections can be cut out of the tape. Also, the Western Union, by careful study and training, has succeeded in getting operators to paste up message tape on to telegraph forms and check them at speeds well over 50 words a minute. In other countries the telegraph service is a Government monopoly and the necessity of issuing telegrams free from corrections does not exist. Also it has not been possible hitherto, outside of America, to get operators to paste up message tape on to telegraph forms and check them and get corrections at a speed of more than 40 words a minute. Hence it may happen that page printing Telegraphy may come into vogue outside of America while it is ceasing to be the mode in the United States.

In any case also, there is no real page printing up to the present. It is column printing and there are many problems involved in achieving real page printing or its equivalent. The British Post Office has dabbled in column printing for years, and has recently decided to make trials of the Morkrum column printer, which has proved itself to be a very strong and reliable machine. The Australian Government has also given an order for 104 of these Morkrum printers. In America many hundreds of them are in use.

DONALD MURRAY.

# TELEGRAPH AND TELEPHONE PLANT IN THE UNITED KINGDOM.

TELEPHONES AND WIRE MILEAGES MAINTAINED BY THE POST OFFICE IN EACH  
ENGINEERING DISTRICT AS AT 30TH JUNE, 1924.

Telephone Stations.	Overhead Wire Mileage.				Engineering District.	Underground Wire Mileage.			
	Telegraph.	Trunk.	Exchange.	Spare.		Telegraph.	Trunk.	Exchange.	Spare.
421,334	582	4,053	59,429	557	London	21,937	42,633	1,437,349	49,629
46,136	1,931	18,931	48,154	1,732	S. East	3,625	16,568	79,349	14,113
51,046	4,421	22,728	39,436	1,480	S. West	13,480	2,683	76,696	2,091
38,688	8,980	27,745	35,814	3,809	Eastern	13,391	18,025	40,285	25,007
70,161	9,001	39,849	47,532	3,254	N. Mid.	14,784	25,779	113,547	81,350
47,826	4,845	24,714	49,756	4,675	S. Mid.	9,398	11,350	94,210	90,826
44,580	5,365	26,767	40,713	1,750	S. Wales	5,116	12,314	69,383	19,211
69,035	8,329	23,037	38,909	4,907	N. Wales	11,511	22,616	124,566	27,361
116,914	3,009	16,563	46,989	3,451	S. Lancs.	12,072	50,036	274,154	41,404
69,084	6,427	28,458	43,736	2,777	N. East	7,609	20,124	134,702	22,548
45,298	3,823	22,669	36,940	2,351	N. West	7,325	22,356	81,064	23,965
36,771	2,608	14,914	22,587	2,099	North	2,439	7,979	57,692	8,454
15,997	4,834	5,661	10,819	214	Ireland N.	140	57	27,898	101
47,497	5,660	20,353	30,991	1,424	Scot. East	1,484	5,520	76,953	11,512
68,893	7,544	22,139	39,413	1,064	Scot. West	12,240	16,864	175,051	27,218
*1,189,260	77,359	318,581	591,218	35,544	Totals.	136,551	274,904	2,862,899	444,790
*1,158,492	76,810	315,084	582,857	35,650	Figures on 31st March, 1924.	133,203	264,293	2,813,587	446,110

\* The above Telephone figures now include Exchange, Private, Call Office and Service, but exclude Subscribers' property maintained by the Department. Hence there is slight difference in the figures given here from those quoted in last issue as existing on 31st March last.





**POST OFFICE EXHIBIT.**  
**BRITISH EMPIRE EXHIBITION, WEMBLEY (2).**

THE A.T.M. CO.'S CODER CALL INDICATOR.

F. I. RAY, B.Sc., F.H.D., and  
W. E. HUDSON, Wh.Sc., B.Sc. (Hons.), A.C.G.I.

WHEN a multi-office area is being changed from manual to automatic operation, arrangements must be made for dealing with calls between converted and unconverted exchanges. In the previous article it was shown how traffic from manual exchanges can be handled by key-sending positions situated at a central office (the Mechanical Tandem Exchange). In this article the converse problem of dealing with calls to manual exchanges is considered.

There are several ways of catering for this traffic :—

- (1) At manual exchanges, junctions from automatic exchanges may be terminated on line jacks or cords and plugs at an operator's position, only the code portion of the call being dialled by the calling subscriber.
- (2) At manual exchanges these junctions may be terminated on selectors, and a sufficient number of selectors and connectors provided to enable calls to be completed automatically. The banks of the connectors could be multiplied with the exchange multiple. When the exchange is finally converted, these switches can still be used, either there or at some other fully automatic exchange.
- (3) A central junction switchboard may be provided and arrangements made for all calls to manual exchanges

being received there. This could be effected either in the translator or by providing a special code for manual exchanges, such as "O."

(4) Call Indicator Equipment may be used.

Numbers 1 and 3 suffer from the disadvantage that the subscriber would have to know which exchanges were automatic and which manually operated. Of these systems the fourth has been developed by the A.T.M. Co. for use in the largest areas, and their Coder Call Indicator is shown at the P.O. exhibit. One advant-

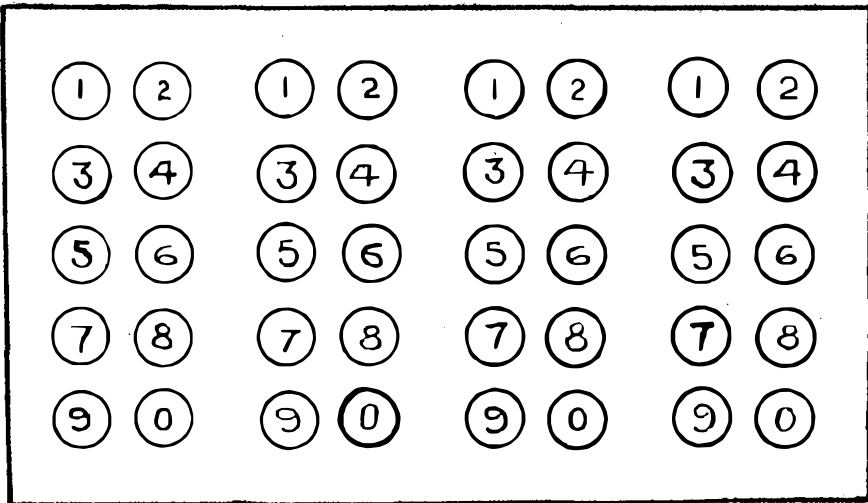

DECODER  
RELEASE



BUSY

PRESS KEYS.

FIG. 1.—C.C.I. POSITION LAMP FIELD.

age of the call indicator system is that the automatic subscriber dials in exactly the same manner for manual and automatic calls, there being no necessity at any time to speak to an operator. In addition, economy of operators at the manual end is obtained by the rapidity with which calls can be completed.

A Call Indicator consists essentially of a lamp field by means of which the required subscriber's number appears visually. This

is done by arranging on the keyboard a screen bearing four groups of figures, 0—9, in front of four sets of ten lamps so that when one lamp of each group is illuminated a four digit number is made visible. One such lamp field would be fitted per position. The arrangement is shown in Fig. 1.

On the Coder Call Indicator single cords and plugs are used, each having one clearing lamp, and any disengaged cord can be used to complete a call. Another important feature is that storage facilities are provided, so that although only one call can be displayed at a time, four others may be stored to await their turn.

#### OPERATION OF THE POSITION.

When a call is received, a “ marker ” lamp and “ marker pilot ” lamp light immediately. The latter is situated behind the lamp field as shown in Fig. 1. After the digits have been received they appear on the lamp field and the marker lamp goes out. At this stage should another call be received its presence will be shown by the lighting of another “ marker ” lamp and the marker pilot. The operator takes any plug and tests the correct jack in the usual manner. If it be free she will insert the plug, when ringing current will be fed to the line automatically ; if it be busy she will depress the busy key, shown in Fig. 1 in front of the lamp field, which will send busy tone back to the calling subscriber. In either case the displayed digits will disappear and should other calls be stored the earliest in order of arrival will be shown. The clearing lamp lights when the calling (automatic) subscriber hangs up his receiver. Should the cord not be withdrawn and the manual subscriber wish to make a call himself, he has only to depress his switchhook once and an automatic “ busy recall ” is put into operation, causing the supervisory lamp to flash. The attention of the operator is attracted and she withdraws the plugs, thus allowing the subscriber to reach his “ A ” operator.

It will be observed that the C.C.I. operator needs no transmitter as she does not speak to the subscribers. Her work consists merely of testing jacks and inserting and withdrawing plugs, and so she can complete calls at a very high rate.

#### GENERAL DESCRIPTION OF C.C.I. CIRCUITS.

At the Mechanical Tandem, calls to a manual exchange are passed through a C.C.I. repeater. This in turn seizes a coder in which the numerical portion of the call is stored in order to be converted into C.C.I. pulses.

The use of this code, from which the system takes its name, is designed to decrease the time taken to send the four digits through to the manual exchange.

Three kinds of pulses are used, “ positive,” “ light negative ”

and "heavy negative," and different combinations of pulses are used for each digit, as is shown in the accompanying table:—

DIGIT.	Relays operated.	Code impulses sent out.	
1	A	+ - -	
2	B	■ - -	
3	A B	+ ■ -	
4	C	- + -	- represents a light negative pulse.
5	D	- - ■	■ represents a heavy negative pulse.
6	A D	+ - ■	
7	B D	■ - ■	+ represents a positive pulse.
8	A B D	+ ■ - ■	
9	C D	- + ■	
0	None	None	

A "negative" pulse is sent by connecting the negative of the battery to the negative line through a resistance, the positive line being earthed. If the resistance be high a "light negative" is sent, but if low a "heavy negative" results. For a positive impulse the positive line is connected to the battery through a high resistance and the negative line is earthed. The pulses are sent out in quick succession, one digit being completed every four steps of a sending switch of the rotary line switch type. One complete travel over the banks transmits the whole number.

These pulses, however, are not sent out at once, but are held up in the coder until the C.C.I. apparatus at the manual exchange is ready to receive them.

Referring to Fig. 2, the call has been extended through the C.C.I. repeater and a selector to a junction leading to the required manual exchange. The seizure of the junction causes a rotary switch associated with it at the manual exchange to hunt for a free "Position Trunk Relay Set." This in turn seizes a free marker and lights a marker lamp. The call is held in this position until the "Decoder" is free, when the Decoder Control Switch is released and by working in conjunction with the marker completes the circuit through the position trunk relay set to the Decoder. The coder now sends out its pulses and releases itself. The pulses are decoded by means of two polarised and one marginal relay, and are stored in the "Digit Relay Group" until the Storage Relay Group is free. This occurs when there is no display in the lamp field. The call is then transferred to the storage relay group

and appears on the call indicator. The decoder control switch and the marker are now released. When the operator inserts the plug the cord rotary line switch searches back and connects the cord to the junction *via* the trunk relay group.

After the termination of the call, the subscriber hangs up his receiver and releases the apparatus at the automatic and tandem exchanges, the junction and the trunk relay set. The only apparatus remaining engaged is the cord circuit, which is held until the plug is withdrawn.

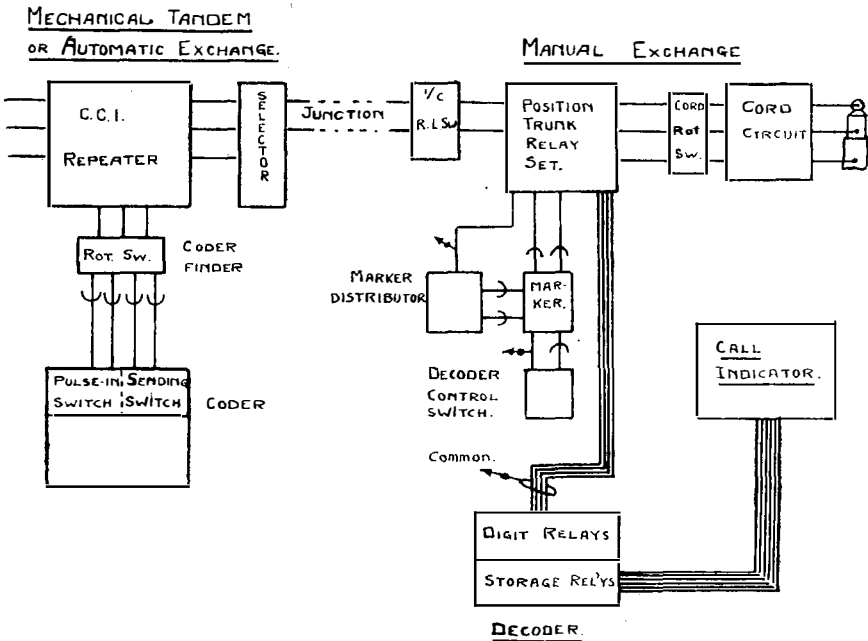

FIG. 2.—SCHEMATIC THROUGH CIRCUIT.

DETAILED DESCRIPTION.

*Symbols.*—In the circuit diagram, Fig. 3, contacts are shown dissociated from their relays. A bracket near a three-spring contact means that it has a “make-before-break” action. Relay windings are shown in the usual manner used by the A.T.M. Co. “Cross hatching” at the end means that the relay is rendered slow to release by a copper slug at the heel end of the core. If the end of the relay be completely blackened instead of being cross-hatched, the symbol indicates that the slug is at the armature end. When it has been necessary to separate the two windings of a double wound relay the core is drawn in both cases, but a space is left to show one winding is absent. In addition, an index is used, thus F<sup>1</sup> and F<sup>2</sup> are the two windings of relay F of the coder. All rotary switches have 25 point banks, but owing to the necessity of

condensing the diagram only sufficient of the bank is shown to explain its action.

*C.C.I. Repeater.*—When the three first letters of the required exchange are dialled the director translates them into an office code. This translation is such that the call reaches the C.C.I. repeater with two sets of office code impulses yet to come. The first is used to select a junction to the manual exchange and the second is a compensating digit for that junction, the necessity for which will be explained later.

The loop across the two lines incoming to the repeater operates the A relay. A energises the line relay of the outgoing selector over the circuit, negative battery and 100 ohms non-inductive resistance, J3 contact, made A2 contacts, J5 and H4 contacts over the the positive trunk to earth, *via* one side of the selector line relay. A also completes the circuit of B relay, which pulls up and energises the polarising winding of the Shunt-Field Relay, puts an earth on the release Trunk to hold the selectors through which the call has already passed and completes a circuit from earth at the release trunk, B1 make contact, E1 contact to relay G and battery, also to H3 contact, B2 contact of rotary switch to A relay.

The A relay pulling up causes the rotary switch to hunt in the usual way for a free coder.

When the first impulse train arrives at the C.C.I. repeater it is merely repeated by the A relay over the +ve Trunk to the selector, the circuit being that already described for holding the selector. During the impulses, however, C relay pulls up and energises the first winding of the J relay. This is of the "two-step" type, the first winding being able to close only the "X" contact. The second winding is shunted by earth at both ends, but after the impulse train, when the C relay falls back, the shunt is removed and both windings now being energised in series, J operates completely. This, at contact J5, breaks the circuit over which the first impulse train was repeated to the selector. The latter, however, is maintained in its operated position by the earth on the release trunk through G1. It will be seen that there is a pulsing circuit from a pulse wiper back through J5 made contact to an A2 contact. Normally, this goes to battery through H, but if A releases it goes through J4 and B3 made contacts to earth. Hence other impulse trains will send earth down the pulse wire during the break period.

*Coder.*—The pulse wire is led through a J series relay to battery through the motor of a "pulse-in" switch. This switch will step round in synchronism with the impulses as they are received. To describe its action it will be best to consider a definite call, such as 33481. Of these numbers, 3481 is the subscriber required and 3 is the junction compensating digit. On the reception of the com-

compensating digit, the pulsing-in switch will step round to its fourth position. At the same time relay J will be energised by the earth impulses over the pulse-in wire. J removes the earth from the private bank and energises K. After the impulse train J and K will release, but owing to its slow-releasing properties relay K will remain energised for a brief period. During this period an earth is placed on the second, third and fourth wipers. A circuit is also completed for the first winding of the two-step relay E of the No. 5 or compensating group. It will be seen from the figure that the earth on the second wiper (which will be resting on its fourth contact) will energise relay A *via* E<sub>1</sub> normal contact. Similarly relay B of this group will be operated through the third wiper. These two relays lock up *via* their own contacts on to the earth on the release trunk. When the K relay releases, the shunting earth across the first winding of the group 5 E relay is removed and it is pulled up completely by both windings in series. The falling-back of the K contact also replaces the earth on the private bank and so rotates the pulsing-in switch to its home position. The same procedure occurs when the next digit, a 3, is received. The pulse-in switch wipers will be standing on the No. 4 set of tags, and during the releasing period of K an earth will be sent over No. 2 wiper, No. 4 tag, E<sub>1</sub> made contact of compensating group, E<sub>1</sub> normal contact and A relay of No. 1 group to battery and over No. 3 wiper, No. 4 tag, to B relay No. 1 group. These relays pull up and lock on to the release trunk.

No. 1 group E relay is a two-step relay, and on receiving earth through J contact, made contacts of K and No. 5 E<sub>5</sub> and its own contact, closes only its " X " contact. When the shunting earth on its second winding is removed it operates completely, giving the pulsing-in switch access to the next group of A, B, C and D relays.

In this way all the remaining digits are stored; 4 pulling up the C relay of the second digit group; 8 the A, B and D relays of the third group, and 1 the A relay of the fourth group.

After the third group has been energised No. 3 E<sub>6</sub> contact gives access to E relay of No. 4 group and F relay in parallel, so that during the release of K from the final impulse train F pulls up and locks across the line by means of its second winding and its own contacts. It will be held in this position by battery and earth from the manual exchange until the latter is free to receive it. When this is the case the F relay will be released and will place an earth *via* the release, G<sub>1</sub> normal and No. 4 E<sub>9</sub> made contact to No. 1 tag of the private bank of the sending switch. The driving magnet will be energised and will free the relay H from its short-circuit. H opens the circuit of the driving motor which releases, stepping the wipers round to No. 2 tag and short-circuiting the H

relay. Earth is again picked up on the second tag and the same interaction of the H relay and the driving motor occurs, and the wipers are moved on to No. 3 tag. In this way the switch rotates over the whole bank.

H is a micrometer adjusted relay; that is, it has a screwed knob by means of which the spring tension can be altered and hence the speed of rotation of the wipers can be adjusted.

When the wipers reach No. 3 position an earth will be placed on the negative trunk by No. 2 bank and the negative battery will be connected to the positive trunk through the high resistance and the operated contact A<sub>1</sub>. This constitutes a positive pulse.

Since relay B of No. 1 group is also energised, on the next step earth will be connected to the positive trunk and battery through a low resistance and operated contacts B<sub>1</sub> to the negative trunk, so sending out a heavy negative pulse. On the next step, since No. 1 group C relay is not energised, the battery will be connected to neither of the trunks, and so no pulse results. On the sixth set of tags, since D is not operated, the battery is connected to the negative trunk, *via* the high resistance and the normally made D<sub>1</sub> contact, so sending out a light negative pulse.

Hence from No. 1 group, which corresponds to the first digit, we have sent out a positive, a heavy and a light negative pulse, forming the digit 3.

The second digit was a 4, which pulled up the No. 2 group C relay, and it will be seen that the wipers, in passing from No. 7 to No. 10 set of tags, send out successively, a light negative, a positive and another light negative, which from the table corresponds to 4.

In the same way the remaining groups of relays are tested and the correct pulses sent out. From the No. 3 group, of which A, B and D are operated, positive, and two heavy negative impulses would come, and from the No. 4 group, of which only the A relay to locked up, come a positive and two light negatives.

During rotation an earth is held on the release trunk by E<sub>8</sub> No. 4 group operated contact and F normal contact. This is to prevent the transmission of a mutilated call if the calling subscriber hang up during this period.

Towards the end of rotation, on the twenty-third contact, relay G is pulled up, which releases the digit relays (A, B, etc.) and removes the earth from No. 1 tag of the sending switch private bank, so permitting the switch to stop in its home position. Relay G also places an earth on the pulse lead, which, passing back to the C.C.I. repeater through made J<sub>5</sub>, made A<sub>2</sub>, and made J<sub>3</sub> contacts, pulls up the H relay. H locks up, completes the talking circuit through the repeater and releases the rotary coder finding switch and the coder.



## MANUAL EXCHANGE APPARATUS.

The junction lines incoming from the automatic exchange are terminated on rotary line switches, to the banks of which are connected the trunk relay sets, and when relay F of the coder operates and connects a loop across the junction lines the rotary line switch searches for a disengaged trunk set.

Rotary line switch A relay operates by battery through relay A to earth round the loop. Contact A<sub>2</sub> connects the rotary magnet to the private wiper and if the first contact be engaged the rotary magnet operates on the "engaging earth" and steps the switch to a disengaged position, in which the shunt is removed from relay B which operates and switches the lines through to the trunk set.

The trunk set relay A operates by battery through resistance, contact G<sub>6</sub>, relay A, contacts C<sub>3</sub>, F<sub>1</sub>, E<sub>1</sub>, round the loop, contacts E<sub>5</sub>, F<sub>6</sub>, C<sub>4</sub>, H<sub>1</sub> to earth. Contact A<sub>1</sub> closes the circuit of relay B which operates. Contact A<sub>4</sub> closes a circuit *via* earth, back contact of D<sub>5</sub>, A<sub>4</sub> contact, No. 1 wiper of the marker distributor, marker relay MB<sub>6</sub> contact, marker MA relay to battery. Relay MA therefore operates and connects the rotary magnet of the marker to the marker wiper and release trunk. Now in the position trunk set in use for this call, the marker release trunk is disconnected from earth at contact A<sub>3</sub>, and the marker will therefore step round until this disconnected position is found, when the shunt will be removed from relay MB which then operates. Contact MB<sub>1</sub> completes a circuit for the marker lamp and pilot relay which operates and lights the pilot lamp. Contact MB<sub>3</sub> connects earth to the Decoder Control Switch start wire, and contact MB<sub>2</sub> disconnects the Decoder Control Switch release trunk from earth. Contact MB<sub>4</sub> connects earth to the marker distributor magnet, causing the wipers to step to the next contact. The marker release trunk is connected to earth during the release period of relay MA and this causes relays D and J of the trunk set to operate and lock *via* contact D<sub>4</sub>.

When the Decoder relay group is disengaged, the Decoder Control Switch, DB and DC relays release and the Decoder DA relay is connected to the start wire. Earth *via* contact MB<sub>2</sub> operates relay DA and connects the rotary magnet to the Control Switch wiper, thus causing the switch to step round until the position at which the earth is disconnected by the operation of contact MB<sub>2</sub>. The control switch DB relay now operates and connects earth *via* contacts DA<sub>1</sub> and DB<sub>2</sub>, control switch wiper, contact MB<sub>2</sub>, marker wiper, relay F, contact A<sub>2</sub> to battery through the second coil of relay A. Relay F operates and locks, together with relay A to earth *via* contacts F<sub>3</sub>, D<sub>6</sub> and G<sub>5</sub>.

The +ve and -ve lines are now disconnected from earth and battery respectively and joined to a loop formed of relays H, O and J.

## DECODING.

When relay F operated, contacts F<sub>1</sub> and F<sub>6</sub> disconnected the +ve and -ve lines from earth and battery respectively and connected them to a loop formed by relays H, O and J. Relays H and J are polarised, relay H operating only with positive impulses, while J operates with either light or heavy negative impulses. Relay O operates only with heavy impulses.

The object of the junction compensating resistance, the amount of which is adjusted by the special digit which precedes the numerical part of the number, can now be seen.

In order to fix an adjustment for the heavy impulse relay O, a standard junction line resistance must be taken. All junction line resistances must therefore be approximately adjusted to this standard and this is done by the compensating resistance.

Contact F<sub>4</sub> connects earth to relay K which operates, and which at contact K<sub>1</sub> connects earth to the Decoder group.

The first digit is 3, the impulses for which are (+ ■ -.) On the receipt of the +ve impulse relay H operates and closes the circuit of group 1 relay A by earth through contacts K<sub>1</sub>, H<sub>1</sub>, back contacts of F<sub>3</sub>, and E<sub>5</sub> to battery through relay A. Relay A operates and locks up, *via* A<sub>1</sub> contact. The heavy negative impulse operates both the O and J relays and two circuits are closed to operate the group 1 B and F relays—earth through contacts K<sub>1</sub> and O<sub>1</sub>, back contacts of F<sub>4</sub> and E<sub>3</sub> to battery through relay B and earth through contacts K<sub>1</sub> and J<sub>1</sub>, back contact of F<sub>5</sub> to battery through the first coil of relay F. Contact FX closes, but the main coil is shunted by earth through J<sub>1</sub> and the relay F does not fully operate until relay J releases.

Relay J releases and relay F can now operate completely, so that when the light negative impulse is received relays G and group 1 E will be operated.

Relay G releases relay F, which falls back and releases G ready for the next digit.

Thus group 1 relays A, B and E are operated. Group 1 relay E switches the operating circuits to the next digit group, while group 1 relays A and B store the digit, which in this case is 3.

The next digit (4) consists of - + - impulses.

The negative operates relay J which operates relay F. The positive operates relay H, which operates group 2 relay C, and the second negative operates relay J, which operates relay G and group 2 relay E. Relays F and G release, leaving group 2 relays C and E operated.

The last two digits are registered in a similar manner and finally group 4 relay E operates and at contact E<sub>1</sub> releases relay P. Relay P releases and earth through back contacts of L<sub>1</sub> and M<sub>1</sub>, contacts E<sub>2</sub>, P<sub>2</sub> is connected to the operating windings of the

storage relays and also relay G of the Trunk relay set. The storage relays now operate and lock up to earth, *via* back contacts of N<sub>1</sub> and L<sub>3</sub> and front contact of K<sub>1</sub>.

*Call displayed.*—Relay G of the trunk set locks up by earth through contact E<sub>3</sub>, relay G, contacts G<sub>2</sub>, C<sub>2</sub>, D<sub>2</sub> to battery through relay L. Relay L operates.

Contact L<sub>2</sub> connects earth through the storage relay contacts to the display lamps and the number is displayed. Contact L<sub>3</sub> changes over to make the holding circuit of the storage group independent of relay K.

*Release of Decoder group.*—When relay G of the Trunk set operates, contact G<sub>5</sub> changes over and holds relay D, but removes earth from relays A, F, J, DB and MB. All relays in the Marker and Decoder control switch release.

Relay F releases and at contact F<sub>4</sub> disconnects relay K, which releases all relays in the Decoder group. The call is now displayed and the Decoder is ready to deal with another call.

*Operation when Called Subscriber is Free.*—The operator will now take any of the plugs and test the called subscriber's multiple jack in the usual manner. On finding the number free the plug is inserted in the jack and cord circuit relay E will operate by battery, relay E, to earth on the sleeve of the jack. Contact E<sub>2</sub> connects earth to the cord circuit line switch A relay, which operates and connects the magnet to the private wiper *via* contact A<sub>2</sub>.

Now private bank contacts of all trunk sets, except the set from which the call is displayed, are connected to earth *via* the back contacts of their G and E relays. On the set in use, however, relay G is operated, so that this private contact is disconnected from earth and the cord circuit line switch will therefore rotate until this point is found, when the line switch B relay will operate.

The cord circuit A relay is now operated round the loop in the C.C.I. repeater. Contact A<sub>1</sub> closes the circuit of relays B and C, which operate. Contact B<sub>1</sub> connects earth through A<sub>1</sub> to the release trunk to hold the line switch B relay and also the Trunk set E relay. The latter was operated (after the line switch B relay had been energised) by earth through contacts A<sub>1</sub>, B<sub>2</sub> and B<sub>3</sub> in the line switch circuit, contact G<sub>3</sub>, to battery through relay E, which holds through contact E<sub>4</sub> when relay G releases.

Contact E<sub>3</sub> releases relays G and L. Relay G releases and disconnects relay D, which also releases.

Thus earth through contact A<sub>1</sub> in the cord circuit is holding the following relays:—B and C of the cord circuit, B of the line switch, E and B of the trunk set and relay B of the incoming line switch.

Relay L releases and at contact L<sub>1</sub> operates relay N during the

release period of relay M. Contact N<sub>1</sub> opens and the storage relays are released.

*Ringing the Subscriber.*—When the cord circuit A relay operates, ringing current is connected to the subscriber's instrument by battery, ringer, contact A<sub>3</sub>, relay D, contact D<sub>3</sub>, through subscriber's instrument, contacts E<sub>1</sub>, D<sub>1</sub> and B<sub>3</sub> to earth.

When the subscriber answers, contact D<sub>2</sub> closes and the relay operates completely, cutting off the ringing current and connecting the lines through for speech.

Relay F is now operated and at contacts F<sub>1</sub> and F<sub>4</sub> reverses the potential on the lines so that the call is metered against the calling subscriber.

*Calling Subscriber Hangs Up.*—Cord circuit relay A releases and at contact A<sub>1</sub> releases the Incoming rotary line switch, Trunk set and Cord circuit rotary line switch. The clearing lamp now lights by battery through the lamp, front contact of E<sub>3</sub>, back contact of A<sub>2</sub> to earth through the front contacts of F<sub>2</sub> and C<sub>1</sub>.

The operator then removes the plug and all operated relays release.

*Called Subscriber Desires Another Call (Flashing Recall).*—If before the plug is removed the called subscriber hangs up and then calls again relay F will be released for a short period and at contact F<sub>3</sub> opens the circuit of relay C, which has been locked up *via* F<sub>3</sub> and C<sub>2</sub>. Relay C releases and when F re-operates the clearing lamp is made to flash by interrupted earth through the back contact of C<sub>1</sub>. This also induces a click in the operator's head-set.

*Called Subscriber Busy.*—When the operator tests the line and finds it busy, she depresses the "Busy" key. This connects earth to relays C and L. Relay C is retained by battery relay C, contacts C<sub>3</sub>, F<sub>1</sub>, E<sub>1</sub>, loop through C.C.I. repeater, contact E<sub>5</sub>, F<sub>6</sub>, C<sub>4</sub>, relay C to earth.

Contact C<sub>5</sub> connects busy flash to the +ve line. Contact C<sub>2</sub> releases relays G and L, thus releasing the storage group. Contact C<sub>1</sub> holds relay B and also keeps the release trunk engaged.

When the subscriber clears, relay C releases, thus freeing all apparatus at the Manual exchange.

#### DECODER RELEASE KEY.

Should a marker lamp light, and the call not be displayed in a reasonable time, the Decoder release key is pressed.

This connects earth to relays L, G and Decoder D, and also to the storage group *via* the Decoder relay contacts. Relay C also operates.

Relay G operates and releases F as before. Relay L connects earth to the display lead and displays any digits received.



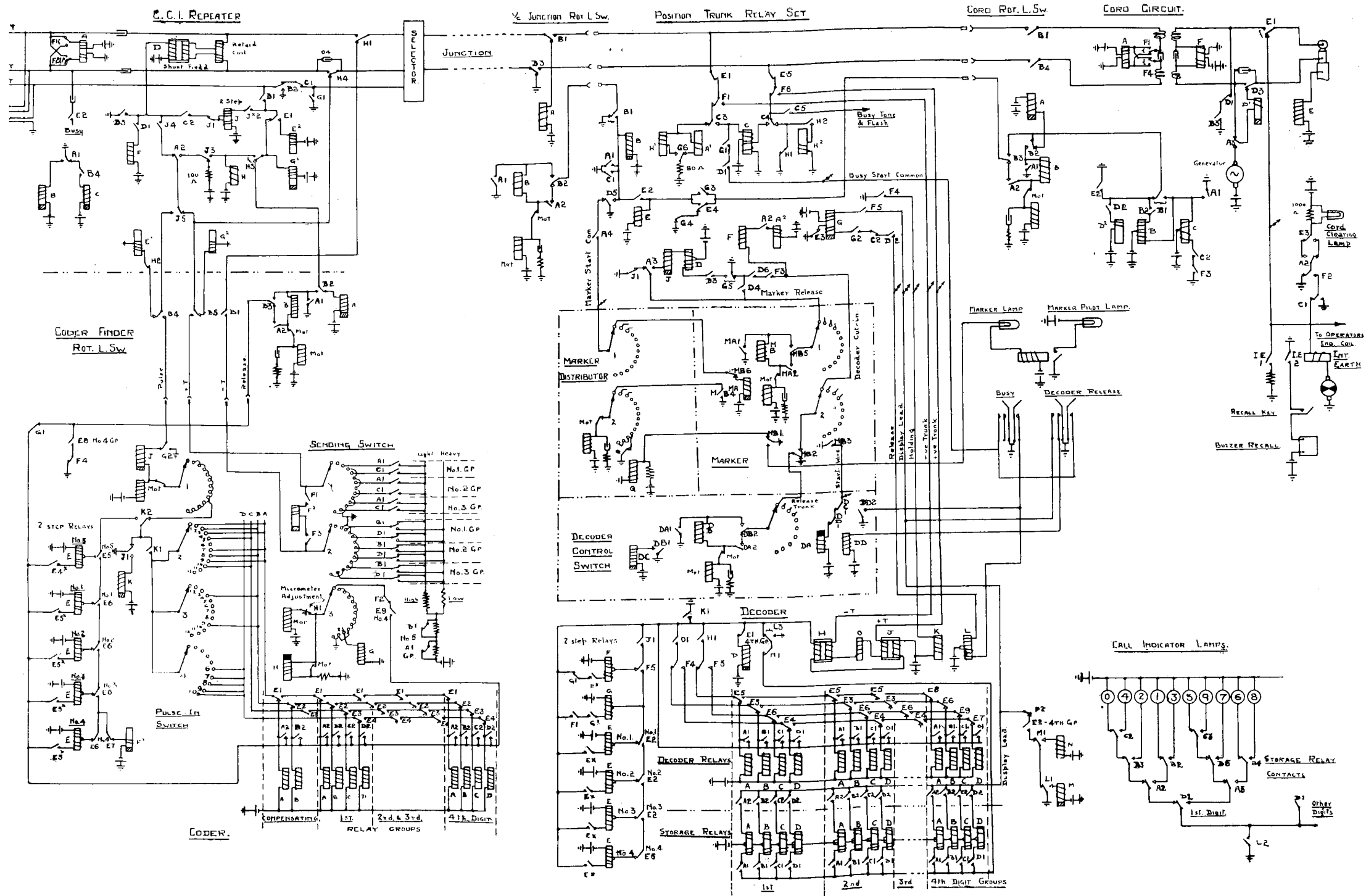

FIG. 3.—CIRCUIT DIAGRAM. A.T.M. CO.'S CODER CALL INDICATOR SYSTEM.  
 (Note.—The F<sub>1</sub> and F<sub>4</sub> contacts in the Cord Circuit are shown in the operated position.)

On the release of the key relays G, L and D release, and the call releases when the subscriber hangs up.

THE DIRECTOR—(continued).

W. E. HUDSON, Wh.Sc., B.Sc. (Hons. Lond.), A.C.G.I.

[In the article on the A.T.M. Co.'s system in our last issue, Mr. Hudson, in discussing the difficulties of dialling through in multi-office areas, said that with the advent of the W.E. Co.'s Panel system sender and translator and later of the A.T.M. Co.'s and Siemens Director schemes, many of these difficulties were removed. This should have read "the A.T.M. Co.'s Director and Siemens Translator schemes . . ." It should be mentioned that the term "Director" is applicable only to the A.T.M. Co.'s system. The term was intended to be read in the foregoing article in a general sense as a method of operating a multi-office area.—EDS., P.O.E.E. Journal.]

THE only point of interest remaining to be dealt with is the time cut-over. This is to prevent a subscriber holding a Director, which from the traffic point is a valuable piece of apparatus, for an amount of time greater than is considered necessary.

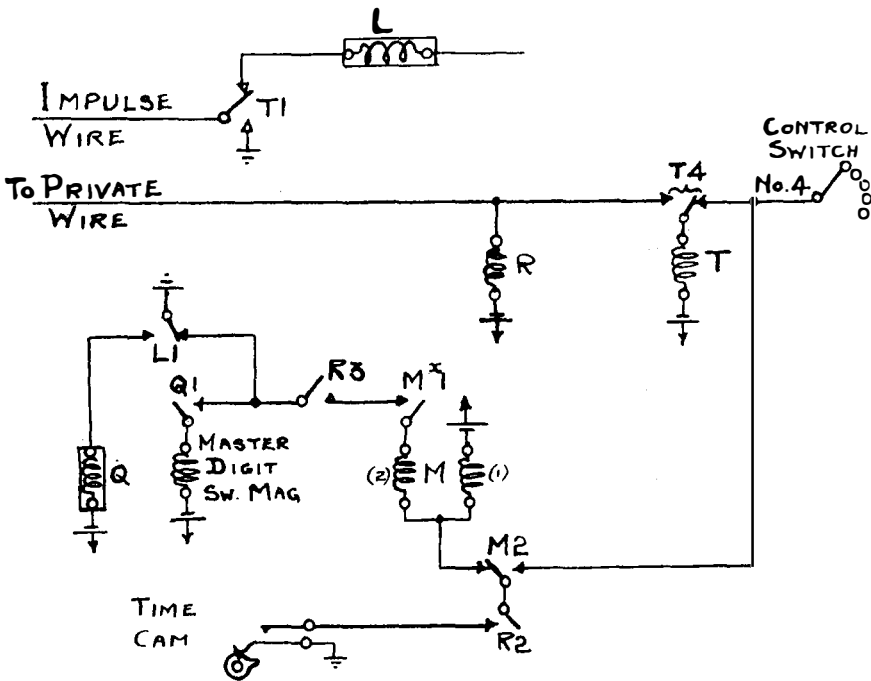

THE DIRECTOR TIME LIMIT CIRCUIT.

The holding time between digits is governed by a cam which gives an earth impulse at definite intervals so that if a subscriber fails to dial the next digit within a prescribed time (some eight seconds) the Director is released.

The circuit operation is as follows:—

As soon as the Director is picked up relay R is operated, and contact R<sub>2</sub> prepares a circuit for energising the first coil of relay M. As soon as earth is connected by the cam the first coil is energised and contact M<sup>x</sup><sub>1</sub> operates, but the main coil is shunted out until the cam contact opens, when relay M operates completely, closing M<sub>2</sub>.

Assuming that no dialling takes place, the next earth impulse operates relay T which connects earth to the impulse wire and releases the Director as explained in last issue.

Should the subscriber dial before this "switch-out" occurs relay L operates and at contact L<sub>1</sub> releases relay M, so that the cycle can be repeated.

---

## EUROPEAN LONG-DISTANCE TELEPHONY.

THE limited development of the long-distance telephone system of the Continent of Europe compared with that of the United States of America is due primarily, of course, to the radical difference in the political conditions of the two areas—the conditions in Europe not only increase greatly the normal difficulties of providing an efficient service but also, it may reasonably be assumed, render far less articulate any demand there may be for a given channel of intercourse. It needs to be borne in mind, however, that the disparity between the two systems, although obvious before the recent war, has been very strongly accentuated during the past five years by the rapidity with which, in the United States, advances in technical knowledge (stimulated by the war) have been given practical shape in the form of actual speaking channels.

It would not have been surprising—particularly as "everybody's business is nobody's business"—if the question of improving European communications by means of some concerted action had remained unvoiced for many years; and it is very pleasant, therefore, to know that the necessary inspiration came as early as November, 1922, when Mr. Frank Gill, in his Presidential Address to the (British) Institution of Electrical Engineers, dealt with the subject under the heading of "Electrical Communication—Telephony over Considerable Distances"; it is equally pleasant to feel that the Address stands as a monument alike to Mr. Gill's vision of the need and to his courage in assuming that the need, having been indicated, could be met. (Mr. Gill has



## EUROPEAN LONG-DISTANCE TELEPHONY.

since drawn attention to the fact that in *Annales des Postes, Télégraphes et Téléphones*, of June, 1921, there appeared an article by Mons. M. G. Martin, entitled "Long Distance Telephony in Europe," in which the suggestion is made that an association be set up by the European Administrations for the purpose of constructing, maintaining and operating long international telephone circuits; and that he would have referred to the proposal in his Address had he then been aware of it.)

The immediate outcome of this presentation of the subject was that the French Government, through M. Paul Laffont, Under-Secretary of State for Posts and Telegraphs, convened a meeting at Paris of telephone experts, representing Belgium, France, Great Britain, Italy, Spain and Switzerland, for the purpose of acting as a Preliminary Technical Committee and, in that capacity, making a general, though primarily a technical, survey of the whole question.

The British delegates were :—

Major (now Col.) T. F. Purves, Engineer-in-Chief, G.P.O.  
Mr. J. G. Hill } Assistant Staff Engineers, Engineer-in-  
Mr. A. B. Hart } Chief's Office, G.P.O.  
Mr. H. G. Trayfoot, Traffic Inspector, Secretary's Office,  
G.P.O.

The conference opened on 12th March, 1923 (and closed on the 20th id.), under the presidency of Monsieur A. Dennerly, Inspector-General of Posts and Telegraphs (whose sudden death a few months later was the cause of great regret both in his own country and abroad). The result of the deliberations was that a large number of recommendations, covering the whole ground of the problem, were adopted unanimously and unreservedly; and, subsequently, these recommendations were approved by the Administrations of the six countries represented on the Preliminary Technical Committee, thus paving the way to practical progress.

The recommendations may be grouped, conveniently, under the following heads, viz. :—

- (a) Administration.
- (b) Transmission—Engineering Construction.
- (c) Engineering Maintenance, including removal of faults.
- (d) Traffic.
- (e) Programme of Immediate Additional Construction Work.
- (f) Preliminary Programme of Further Construction Work.

The more important of the individual recommendations—of which those marked \* were amended at the 1924 Conference, as indicated later—were as follows :—

## EUROPEAN LONG-DISTANCE TELEPHONY.

### (a) ADMINISTRATION.

The Preliminary Technical Committee to become a permanent Consultative Committee bearing the name "Le Comité Consultatif International des Communications Téléphoniques Internationales."

(Note.—For convenience, the abbreviation "C.C.I." is used in this article to denote the Committee.)

The C.C.I. to undertake the organisation of, and to centralise all information concerning, European International Telephony.

The C.C.I. to consist of delegations, of not more than four members each, from the various Administrations, and to meet at least once a year.

The C.C.I. to appoint a permanent Sub-Committee—Sous-Commission Consultatif International—for the purpose of preparing and facilitating the work of the C.C.I.; of developing in all their practical details the resolutions of the C.C.I.; and of giving decisions, when required, on matters other than questions of principle: in effect, of acting, within the limits of agreed policy, as the executive of the C.C.I.

\*The Sub-Committee to consist, at the outset, of not more than two members from each of the six countries represented on the Preliminary Technical Committee, with power to co-opt, when desirable, a member of the delegation representing any other country on the C.C.I.

The Sub-Committee to be assisted by a permanent (but not necessarily full-time) Secretary, appointed by the C.C.I., with official residence in Paris, who will act as the connecting link between the Sub-Committee and the various Administrations and whose primary duty will be to collect the reports of investigations, researches and other technical work carried out in the laboratories of the various Administrations and to communicate them to the principal delegates of all the participating Administrations.

The official language of the C.C.I. to be the French language.

The recommendations of the Preliminary Technical Committee, after approval by the Administrations of the six countries represented thereon, to be brought to the knowledge of those countries not represented.

Future meetings of the technical experts of European Telephone Administrations, such as those at Buda-Pest, in 1908, and at Paris, in 1910, to be convened by the permanent Sub-Committee of the C.C.I.

The C.C.I. to consider, as far as the operation of the European International system is concerned, the matter of co-ordinating wireless telephony and ordinary wire telephony (notwithstanding the view of the Preliminary Technical Committee that, in the organisation of the European system, the use of radio-telephony should not be resorted to unless wire telephony is impossible).

## (b) TRANSMISSION—CONSTRUCTION.

(i) *General.*

\**Subscribers' Sets.*—The standard telephone apparatus, for the time being, for all European countries, to be a solid-back microphone and Bell receiver, conforming to the detailed specification annexed to the recommendation. (Note.—This specification is a reproduction of the British Post Office standard). The efficiency of any subscriber's set used in Europe, both as to transmitter and receiver, to be not less than that of the standard apparatus.

\**Transmission Equivalents.*—For the time being and until final agreement has been reached, attenuation or transmission equivalents to be expressed in miles of standard cable, the constants of the standard mile being :—

Resistance : 88 ohms.	Capacity : 0.054 microfarad.
Inductance : 1 millihenry.	Leakance : 1 micromho.
Attenuation constant at 5,000 cycles : 0.1061.	

The total transmission equivalent of an international connection between any two subscribers not to exceed 32 miles of standard cable (m.s.c.) or 38 m.s.c. in certain special cases (including that of composite lines, *i.e.*, lines comprising both aerial and cable sections).

The total attenuation of the line connecting a subscriber with the international telephone office of the subscriber's country not to exceed 10 m.s.c.

The maximum attenuation of all the sections composing an international line not to exceed 12 m.s.c.

The maximum attenuation between two successive relays not to exceed 12 m.s.c.

The transmission loss in any transformer (other than an amplifying relay transformer) not to exceed 1 m.s.c.

*Cross-Talk.*—The cross-talk between any section of an international aerial circuit and any other circuit to be less than 65 m.s.c. and between any international cable circuit and any other circuit in the same cable to be less than 75 m.s.c., the cross-talk to be measured by means of a cross-talk meter at any amplifier relay station or at any central exchange along the line.

\**Amplifying Relays (Repeaters).*—To be of such design as faithfully to reproduce speech, *i.e.*, to amplify to the same extent all frequencies from 200 to 2,500 cycles per second.

To be located always so as to reduce to a minimum the distortion in each section of cable between two successive relays, and so that the transmission equivalent of any circuit in such a section does not exceed 20 m.s.c. for a two-wire circuit or 40 m.s.c. for a four-wire circuit.

The equipment on two-wire circuits (whether aerial or under-

ground) to be, exclusively, reversible amplifying relays provided with two artificial lines balancing separately the two sides of the telephone line.

In the case of a line equipped with several relays, limits to be fixed for the distribution among them of the aggregate amplification. On long-distance cables, automatic or semi-automatic amplification control devices to be installed.

*Superimposing on International Circuits.*—To ensure security of transmission, superimposing on international circuits to be restricted to complete sections terminating at each end in an amplifying relay station.

\**Transmission of Call Signals.*—On aerial lines, which, as a rule, are provided with only a small number of amplifying relays, a low frequency current (16 to 20 cycles per second) to be used for calls, the signals being repeated, at each intermediate relay station between the two terminal offices, by means of an electro-magnetic device.

In the case of cables, where the large number of amplifying relay stations prevents the use of the foregoing method, the necessary researches to be undertaken, as soon as possible, for the purpose of devising a call system actuated by a current of sufficiently high harmonic frequency to enable the relays to amplify the call in the same manner and to the same extent as they amplify speech currents.

*Ring-off or Clearing Signals.*—All apparatus when in shunt to be of large impedance.

*Superimposed Telegraph Circuits.*—For the time being, international circuits and, in particular, such circuits as are equipped with amplifying relays, not to be used for telegraphic purposes.

(ii) *Aerial Lines.*

If provided with amplifying relays, not to be Pupinized (*i.e.*, equipped with loading coils).

To be properly balanced and without any electrical discontinuity between two successive amplifiers, *i.e.*, the electrical constants to be uniform over the entire length between those points.

Conductors to be of copper or copper alloy whose resistance does not exceed that of high-conductivity copper by more than 10% ; not to be of smaller diameter than 3 mm. (*i.e.*, minimum copper = 220 lbs. per mile); and to be of sufficient mechanical strength to reduce to a minimum the risk of accidental breakages.

*Inductive Disturbance from Power Transmission Lines.*—Parallel construction of telephone lines and power transmission lines without adequate separation to be avoided.

For the purpose of determining the maximum induced voltage and the maximum induced noise allowable, tests and researches, as

## EUROPEAN LONG-DISTANCE TELEPHONY.

complete as possible, to be carried out by the various interested Telephone Administrations.

### (iii) \*Cables.

Pupinized cables with amplifying relays not to be used, until further experience has been gained, for circuits between international exchanges more than 1,600 km. (1,000 miles) apart.

Four-wire circuits to be used between international exchanges more than 500 km. (say, 310 miles) apart.

Conductors to be 0.9 or 1.3 mm. in diameter (*i.e.*, 20 lb. or 40 lb. approximately per mile).

Cable pairs to be absolutely homogeneous between two successive amplifiers; cables to be so constructed, therefore, that the circuits are perfectly balanced and their electrical constants uniformly distributed.

Use of conductors for the telegraph service to be conditional on cable being properly balanced and to all pairs of wires allotted to the telegraph service being grouped together.

\**Pupin (Loading) Coils.*—All coils to be of the type having a compressed iron powder core.

To be spaced 1,830 metres (2,000 yards) apart.

Inductance of coils on 4-wire circuits not to exceed 44 millihenries and, on 2-wire circuits, 176 millihenries.

*Inter-connection of 4-wire Circuits.*—When two 4-wire circuits are connected through amplifying relays, transmission losses to be minimised by the use of special wiring establishing the continuity of the circuit in the same manner as at intermediate stations.

When two 4-wire circuits are connected without amplifying relays, the connection to be made by a metallic junction of the two sets of four wires without the insertion of any intermediate 2-wire device.

### (iv) *Composite Lines (i.e., composed of both Aerial and Cable Sections.)*

To be avoided wherever possible. When unavoidable each section between successive amplifying relays to be made completely homogeneous (*e.g.*, by the use of properly Krarupised cables).

The annexes to the foregoing recommendations comprise (in addition to the detailed specification of the standard telephone set) lists of points to be considered in drawing up standard specifications for, respectively,

Pupin (Loading) coils.

The supply and laying of cables intended to provide superimposed (phantom) circuits.

Amplifying relays.

## EUROPEAN LONG-DISTANCE TELEPHONY.

### (c) ENGINEERING MAINTENANCE.

*Protection from High Voltage (Power) Lines.*—The permanent Sub-Committee (after ascertaining the regulations in force in the various countries for the prevention of injury to employees or damage to plant) to draft, as soon as possible, a set of efficient rules for adoption by all countries.

*Testing Points.*—Number to be as small as local conditions permit and each point to be equipped with apparatus for measuring accurately the distance of a fault, such measurement to be made by the testing points on either side of the fault.

In the case of cables, testing points to be restricted to amplifying relay stations; in the case of aerial lines, to such stations as far as possible, and otherwise to exchanges at intervals of approximately 200 km. (125 miles) along the route.

*Supervision of Lines.*—Important aerial lines to be patrolled (*i.e.*, examined regularly) so as to prevent, as far as possible, the occurrence of faults.

In the case of lines (whether aerial or cable) crossing a frontier, conductivity and insulation tests to be made each month at the terminal stations or the amplifying stations nearest to the frontier, the results being communicated by each Administration to the other.

*Prompt Restoration of Circuits.*—The Administration in whose territory a circuit becomes faulty to endeavour, pending repair, to make good the faulty section by a circuit of its own system, appropriate schedules being compiled for this purpose.

### (d) TRAFFIC.

*\*Standard of Service.*—The number of circuits to be such that :

If they are less than 500 km. (say, 310 miles) in length, the wait at rush hours shall not exceed half an hour (which, according to British statistics, corresponds to 50 conversation units during day hours);

If they are from 500 to 1000 km. (say, 310 to 625 miles) in length, the wait at rush hours shall be less than one hour (equivalent to 75 units during day hours); and

If they are more than 1000 km. in length, the basis shall be 100 conversation units during day hours.

*Rates.*—The permanent Sub-Committee to make an investigation of the system under which three different rates are charged during the course of 24 hours.

*Decentralisation of Traffic.*—For the purpose of decentralising the international system and making it independent, international transit centres—similar to the region or zone centres of a national system—to be organised, these centres being connected with each other either directly or indirectly.

EUROPEAN LONG-DISTANCE TELEPHONY.

\**Traffic Statistics.*—At the outset, information (as to number of circuits, available circuit-hours, conversation units and cancelled calls, average wait, etc.) to be scheduled (in prescribed form) for, at least, two days per month in respect of each group of circuits connecting any two places.

Estimates of probable development of traffic to be prepared (in a prescribed manner) and, in the absence of special factors, to be based on the assumption that the rate of increase will be the same as during the five years immediately preceding.

*Language to be used for establishing connections.*—The French language to be used between any two countries of different language, unless arrangements have been made by those countries for the use of another language.

(e) PROGRAMME OF IMMEDIATE ADDITIONAL CONSTRUCTION WORK

No. of Circuits.	BETWEEN					
	Belgium.	England.	France.	Italy.	Spain.	Switzerland.
4	Brussels	London				
2	Antwerp	London				
1	Brussels					Basel
3		London	Paris			
1		London		Milan		
3		London				( <i>viâ</i> ) Basel
1			Paris		Madrid	
1			Paris		Barcelona	
1			Bayonne		St. Sebastian	
1			Hendaye		Irun	
1			Cerbère		Port Bou	
3			Paris			Geneva
1			Paris			Basel
1			Paris			Zurich
1			Lyons			Geneva
1			Nancy			Basel
1			Belfort			Basel
1			Thonon.			Geneva
1			Annecy			Geneva
1				Milan		Berne
1				Milan		Geneva
1				Milan		Basel
1				Milan		Zurich
1				Milan		Lugano
1				Genoa		Zurich

(f) PRELIMINARY PROGRAMME OF FURTHER CONSTRUCTION WORK  
(to be undertaken within a term ranging from 5 to 10 years).

Studies (on the lines referred to under "Traffic Statistics") to be carried out in each country for the purpose of estimating the probable traffic increase for periods of 5 and 10 years respectively; but a number of suggestions, based on information gathered by the Preliminary Technical Committee as to future needs of certain countries, to be taken into consideration. These may be summarised as follows:—

EUROPEAN LONG-DISTANCE TELEPHONY.

*Belgium—England.*

Total circuits required :—

Antwerp—London : 7 within 5 years.

9 „ 10 „

Brussels—London : 12 „ 5 „

16 „ 10 „

*Belgium—Italy.*

1 circuit as soon as possible.

*England—France.*

London—Paris cable (21 circuits) already contemplated, sufficient for 5 years. There will then be required :—

London—Boulogne : 2 circuits.

London—Lille : 3 circuits.

*England—Italy.*

Further circuits (terminal points undefined) required as soon as practicable.

*England—Switzerland.*

Total circuits required :—

London—Geneva and } 6 within 5 years.

other specified towns } 11 „ 10 „

*France—Italy.*

Paris—Turin

Paris—Milan

Paris—Rome

Lyons—Milan

} 2 circuits each (8 in all) within 5 years.

*France—Switzerland.*

31 circuits between various specified towns within 10 years.

*Italy—Spain.*

Genoa—Barcelona : 1 circuit as soon as possible.

*Italy—Switzerland.*

27 Circuits between various specified towns and one undefined (towards Venice).

The 1924 meeting of the Comité Consultatif International took place in Paris from April 28th to May 3rd, and was of a much more representative character, delegates being present from Austria, Belgium, Czecho-Slovakia, Denmark, Finland, France, Germany, Great Britain, Holland, Hungary, Italy, Jugo-Slavia, Latvia, Luxembourg, Norway, Poland, Rumania, Sweden and Switzerland.

Mr. J. G. Hill having retired from the service of the British Post Office, Mr. C. Robinson took his place on the British delegation, which, of course, was headed by Col. Purves. Fortunately,



## EUROPEAN LONG-DISTANCE TELEPHONY.

however, Mr. Hill was able to attend the Conference as a supplementary delegate.

Mons. Milon, Director of the French Telephone Service, was elected President of the Conference.

The Report of the Preliminary Technical Committee was considered in detail and substantially adopted as the basis of future procedure. In the case of certain items, however, the further discussions led to modification of the original recommendations, the amended decisions (grouped under the same headings as above) being as follows:—

### (a) ADMINISTRATION.

The permanent Sub-Committee (Sous-Commission) of the C.C.I. to be composed of one representative of each of the countries most interested in the European network, that representative to have the right to be accompanied by experts and to nominate a substitute.

The Sub-Committee, for the first year, to consist of the principal delegates from the Administrations, respectively, of Austria, Belgium, Czecho-Slovakia, France, Germany, Great Britain, Holland, Italy, Jugo-Slavia, Sweden and Switzerland.

### (b) TRANSMISSION—CONSTRUCTION.

#### (i) *General.*

*Subscribers' Sets.*—In regard to the standard of reference the principle of the British standard was confirmed, viz., that the efficiency of the subscriber's apparatus should be measured in combination with his local circuit; but it was decided to defer the final recommendations as to the actual standard of reference until the next meeting.

*Transmission Equivalents.*—To be expressed, if desired, in terms of the unit  $\beta l$ , as an alternative to "miles of standard cable."

*Amplifying Relays (Repeaters).*—Extension of specified limits for spacing to be permitted in exceptional cases, e.g., a section including a long submarine cable.

*Transmission of Call Signals.*—For aerial lines, the maximum frequency to be 25, instead of 20, cycles per second.

For cables, a frequency of 400 cycles per second to be adopted provisionally.

(iii) *Cables.*—Pupinisation (loading) in accordance with German, as well as British (and American), practice to be permitted.

*Pupin (Loading) Coils.*—Loading coils of types other than the compressed iron powder core type to be permitted.

### (d) TRAFFIC.

*Standard of Service.*—No regard to be paid to circuit loads (i.e., conversation units during day hours).

## EUROPEAN LONG-DISTANCE TELEPHONY.

*Traffic Statistics.*—To be prepared for six consecutive days each quarter instead of for two days each month.

Detailed observations to be made on a representative day each quarter to ascertain proportion of time spent in operating to that occupied in conversation.

The last item of business was the appointment of the Secretary, and on the proposition of M. Marchesi (Italy), Mons. Valensi, Engineer of the French Administration, was elected by the unanimous vote of the delegates. (As some of our readers are aware, the translation into French of Mr. J. G. Hill's book on "Telephone Transmission," was the work of Mons. Valensi.)

The first meeting of the permanent Sub-Committee was held on May 3rd, 1924, after the conclusion of the Conference proceedings, Mons. Milon being elected President for the year 1924-5.

It was decided that the second meeting of the Sub-Committee should take place about the beginning of November next; that in the meantime studies of certain subjects should be undertaken by two or more Administrations jointly; and that the agreed reports should be presented to the meeting mentioned.

The subjects and the Administrations charged with their study are as follows:—

### Transmission:

Subscribers' Apparatus—Standards of Reference.	} Germany and Great Britain.
Transmission Unit.	
Apparatus for Transmission Measurements.	
Specifications for Cables, Loading Coils, Amplifying Relays.	
Interference between Power Circuits and Telephones, and Limits of Induced Voltage and Noise.	} Germany, Italy, and Switzerland.
Telegraph Call-Wire Working—Belgium and France.	
Circuit Loads—Holland and Sweden.	
Tariffs and Apportionment of Revenue—Great Britain and Holland.	
Tariffs, Differential—Holland and Sweden.	

The place and date of the 1925 and 1926 meetings of the C.C.I. will be fixed at the November meeting of the Sub-Committee; but it was agreed that the 1926 meeting should coincide with that of the Conférence Internationale des Techniciens des Administrations des Télégraphes et des Téléphones de l'Europe.

J.W.A.

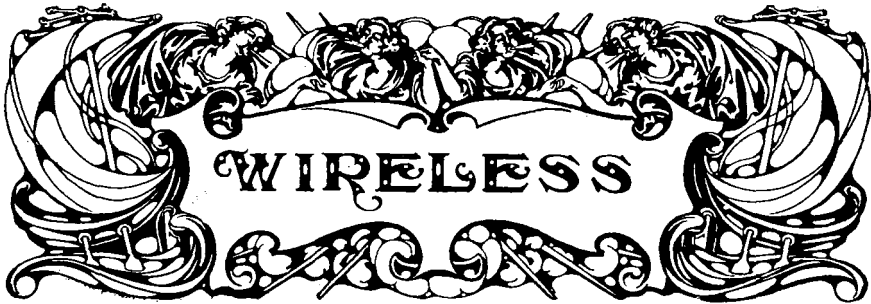

## THE MEASUREMENT OF HIGH FREQUENCIES.

F. E. NANCARROW, A.R.C.Sc., A.M.I.E.E., M.I.R.E.

IN the present state of the art of radio transmission, when not only is it necessary that the frequency band required by transmitting stations should be as small as radio engineering science can devise, but where it is very desirable that the frequency of the transmitting station should remain invariable, it is essential that frequencies shall be capable of accurate measurement.

The importance of having international agreement in high frequency standards has been recently recognised by a series of simultaneous frequency measurements on the emissions of various high power radio stations carried out by the National Laboratories in several countries. Measurements were carried out within this programme at the Radio Laboratory, but, as the results are not yet available, no indication as to the agreement can be given.

A plain frequency-meter, or wave-meter as it is more usually but incorrectly called, *i.e.*, a circuit consisting of an inductance connected across a capacity and provided with some indicating device, is, unless exceedingly carefully constructed, unable to give frequency measurements of sufficient accuracy to enable changes of frequency of the order of a few cycles per second to be observed and measured.

The basis of the method of measuring frequency used in the Radio Laboratory during the past three years, is a piece of apparatus called a Multivibrator,\* controlled by a valve maintained tuning fork. A diagram of the arrangement is shown in Fig. 1, where M is the output coil of the Multivibrator.

Space forbids a detailed description of the apparatus and its functioning, but the Multivibrator serves to set up a periodic dis-

\* For description see Abram and Bloch. *Radiotelegraphic Militaire*, Nov., 1917.

## THE MEASUREMENT OF HIGH FREQUENCIES.

charge of a condenser through a resistance and the output coil M is placed in series with this resistance. There is thus a current flowing through M, which, by the nature of its waveform is resolvable into an infinite number of frequencies which are harmonics of the fundamental frequency corresponding to the frequency of the discharge. This fundamental frequency depends on the values of C and R of the Multivibrator and to a lesser extent upon the filament current, anode volts, etc., of the valves used.

To avoid frequency changes due to changes in the feed conditions of the valves, a tuning fork is used as a frequency control, and the control is such that the Multivibrator will not change its frequency unless radical changes occur. This arrangement was first introduced by Mr. D. W. Dye, of the National Physical Laboratory, who has carried out much work on the constancy of frequency of such controlled tuning forks.\*

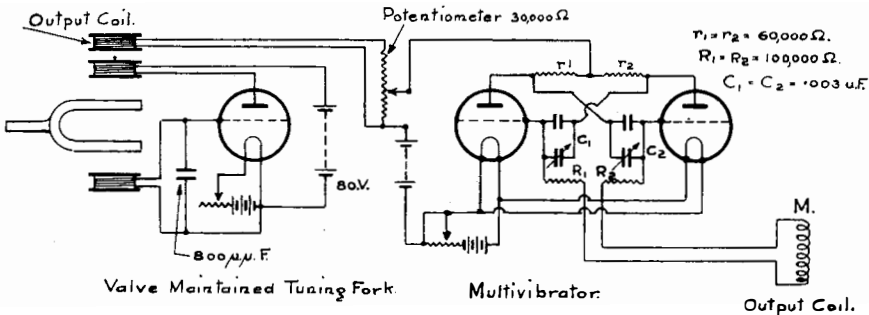

FIG. 1.

The constancy of frequency of such a controlled Multivibrator is thus only dependent upon the tuning fork, and this is constant, except as regards temperature changes when the frequency changes by 1 part in 10,000 per  $1^{\circ}$  C, to within a few parts in 100,000 for all normal conditions of working.

The tuning fork in use in the Radio Laboratory has a frequency of  $1,000 \sim$  p.s. and hence the Multivibrator is capable of giving frequencies which are exact multiples of this.

As, however, the harmonics become too congested for safe discrimination in the region of the 100th, this arrangement is in general used only for frequencies below this value, *i.e.*, below  $100,000 \sim$  p.s., and another Multivibrator having a fundamental period variable between 20 and 30 kilocycles per second, is utilised for the higher frequency range.

The descriptions which follow refer only to the lower frequency range. For the higher range, the procedure, although slightly more complicated, is much the same in principle.

\* See Pro. Royal Society A. Vol. 103. 1923.

THE MEASUREMENT OF HIGH FREQUENCIES.

CALIBRATION OF A SIMPLE OSCILLATORY CIRCUIT.

The schematic arrangement is shown in Fig. 2, where the circuit, O, to be calibrated, is coupled to the output coil of the Multivibrator and is again coupled, very loosely, to an aperiodic type of multi-valve receiver. By simply varying the condenser of the circuit O its frequency can be brought into resonance with successive harmonic frequencies of the Multivibrator and at each resonance a note, of frequency equal to the fundamental frequency of the Multivibrator, will be heard in the telephones of the receiver. The accuracy with which these resonances can be fixed depends upon the decrement of the circuit being calibrated; the lower the decrement the sharper the definition.

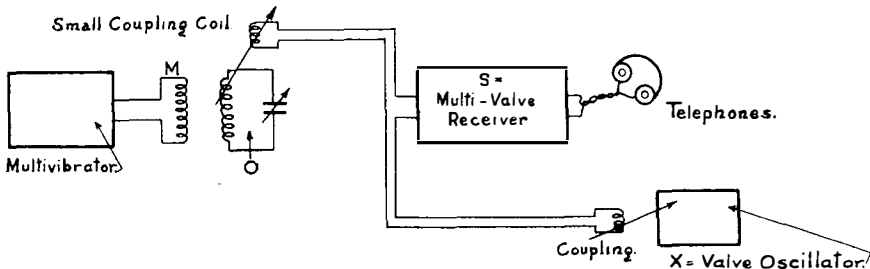

FIG. 2.

Once having calibrated the circuit in turns of successive harmonics it only remains to determine the harmonic order number of one of the points in order to establish the calibration in turns of absolute frequency values. This is very simply done, as follows: A valve exciting oscillating circuit (see X, Fig. 2) is made to give a beat note when the circuit O is set, preferably, on one of its resonances at the top of its scale, and then by varying the oscillator this note is reduced to zero and the oscillator frequency brought into exact coincidence with the frequency corresponding to the setting of O. This exact setting can be done by taking advantage of the fact that not only will there be set up in the circuit O oscillations due to excitation at this frequency, but weaker oscillations due to excitations respectively 1,000  $\sim$  below and above this frequency. The beatings of these frequencies with the valve oscillator will set up notes, and when, say, the valve oscillator is displaced one cycle from true coincidence with the frequency corresponding to the setting of O, two notes of frequencies 1,001 and 999 respectively will be received due to these side excitations. The effect of this is to give a note of 1,000  $\sim$  p.s. beating at the rate of 2 per second, and so by observing this phenomenon the beating note can be reduced and the coincidence obtained quickly and with great accuracy.

## THE MEASUREMENT OF HIGH FREQUENCIES.

If now the valve oscillator be left undisturbed and the circuit O varied by decreasing the condenser value, beat notes of 1,000, 2,000, 3,000  $\sim$  p.s. - - . will be heard as the condenser moves through resonances differing by 1,000  $\sim$  successively from the original setting. As the condenser is still further reduced no notes are heard and then with further reduction notes are again picked up, high pitched at first—reducing to 1,000  $\sim$  p.s.—passing through a no note point of calibration, and then increasing through notes of 1,000  $\sim$  p.s., 2,000  $\sim$  p.s., and so on. This second series of beat notes is due to the 2nd\* harmonic of the valve oscillating circuit beating with the frequencies corresponding to the settings of O and it is clear that the point between the two 1,000 notes, *i.e.*, the point where no note was given, corresponds to

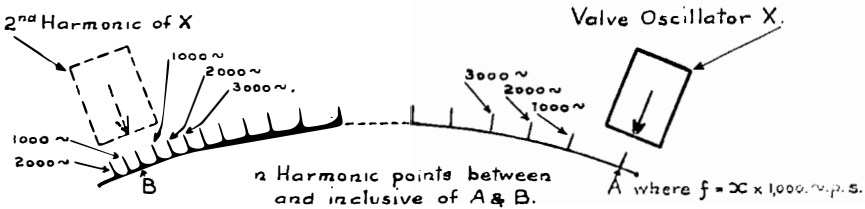

FIG. 3.

a frequency twice that corresponding to the original setting. Fig. 3 depicts what happens, A being the original setting and B the setting coinciding in frequency with the 2nd harmonic of the valve oscillator.

If there are  $n$  points between A and B, including both A and B, then since there is a frequency band of 1,000  $\sim$  between each pair of points and the frequency at B is twice that at A.

Frequency at A =  $(n - 1)$  1,000.

But if  $x$  = order number of harmonic at A

then  $x \times 1000$  = frequency at A.

$\therefore x = (n - 1)$ .

From which the order numbers of all the points are at once obtained and the circuit calibrated in absolute frequency values.

A number of circuits, made up with low decrement coils, and calibrated in the manner above, are kept in the Radio Laboratory for use with the Multivibrator.

### THE CALIBRATION OF A VALVE OSCILLATOR.

The arrangement of Fig. 2 represents the setting of the apparatus, where in this case the circuit O has been previously calibrated whilst X is the oscillator requiring calibration.

\*NOTE.—The fundamental frequency is considered as the 1st Harmonic.

## THE MEASUREMENT OF HIGH FREQUENCIES.

The coupling between ● and the receiver is made so loose that whilst direct reception from the Multivibrator is not possible, reception is possible when the oscillator is caused to beat as indicated previously. Calibration is then very exactly carried out by the method of double beating previously described, the settings of ● being varied through the desired range of calibration.

Oscillations having frequencies ranging up to 100,000  $\sim$  p.s. can be very quickly accurately calibrated in this way. The agreement which can be obtained with the Multivibrator frequencies is exceedingly close, as will be seen by the following example.

Suppose the beating of the two side tones is at the rate of 1 per second—an easily obtainable result generally—then this means that one side frequency is  $1,000\frac{1}{2} \sim$  p.s. whilst the other is  $999\frac{1}{2} \sim$  p.s., *i.e.*, the displacement of the oscillator from the Multivibrator is only  $\frac{1}{2} \sim$ . If the harmonic point under operation is the 50th, this means an agreement of  $\frac{1}{2}$  part in 50,000, or of 1 part in 100,000. Such accuracy is of course usually quite valueless with a valve oscillator used as a frequency meter, where the frequency is liable to change from so many causes, but it illustrates what is easily obtainable and is moreover necessary when measuring external frequencies to a high degree of accuracy by the following method.

### MEASUREMENT OF FREQUENCY OF RADIO TRANSMITTING STATIONS.

The Multivibrator allows of calibration in terms of definite steps—readily in steps of 1,000  $\sim$  p.s. as previously described—and only slightly less readily, by an elaboration of the same phenomenon of double beating, in terms of 500  $\sim$  p.s.

Where, however, some odd frequency is concerned, some method of interpolation is required, and if the accuracy of 1 in 10,000, with which the frequency of the fork can be relied upon, is to be preserved, it is essential that the interpolation must be of a high order of accuracy.

The method whereby such measurements are carried out depends for its accuracy upon a special condenser in the capacity element of a valve oscillator. A valve oscillator of large range is used, having in its oscillating circuit a variable condenser paralleled with fixed condensers of about five times its maximum value. The variable condenser, of maximum capacity 1,200  $\mu\mu\text{F}$ , is fitted with a large scale, 16" in diameter, divided into 1,800 divisions. The condenser is of standard type and has but a negligible deviation from a straight line capacity to scale reading characteristic.

The arrangement of apparatus is as shown in Fig. 4. Here X is the special oscillator and R is the receiver, provided with its own heterodyne oscillator H.O., which is used for picking up the station to be measured.

## THE MEASUREMENT OF HIGH FREQUENCIES.

The procedure is as follows. The station is first received on R and then by the coupling shown the signals are passed on to the receiver S. The oscillator X is set going and set so that it gives a note with the heterodyne oscillator H.O. of the receiver R. The setting of the condenser of X is then adjusted until the notes due to X and H.O., and H. O. and the received signal respectively, sets up a beating audible in the telephones of the receiver S. By adjusting X until the frequency of the beats between the two notes is less than 1 per second, coincidence between the frequency of X and the received signal is obtained. It is necessary to ensure that X and the signal are not on opposite sides of H.O. as regards frequency, and this can be readily tested by varying H.O. slightly. If the beating then ceases, X and the signal are on opposite sides and X must be readjusted to the correct position.

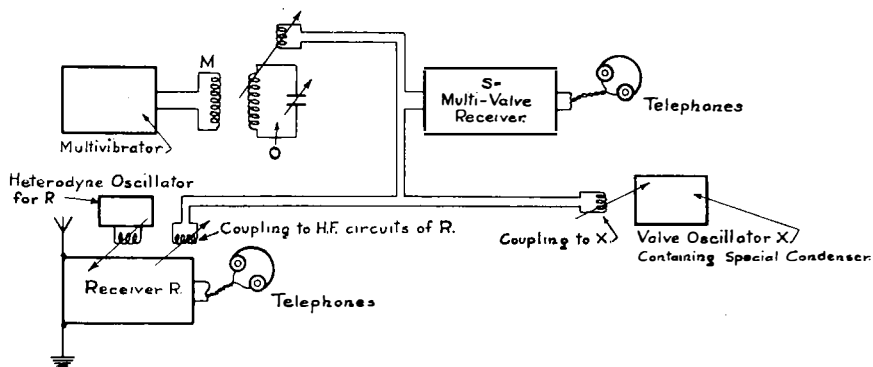

FIG. 4.

The point of coincidence P on the scale of X is then read (the scale is viewed through a lens) and the receiver R cut off. Two points P<sub>1</sub>, P<sub>2</sub> are then obtained, one on each side of P, corresponding to two successive harmonics of the Multivibrator, by the methods previously explained. [The points P<sub>1</sub>, P<sub>2</sub> can be obtained 500 ~ apart, but this is not usually necessary.]

The whole set of readings should and can easily be taken within a few minutes, during which interval, if ordinary precautions are taken, no frequency change of the oscillator within 1 part in 10,000 should occur.

The evaluation of the frequency corresponding to P is then obtained from the following :—

$$f_P = v/\lambda_P \text{ where } \lambda_P = \alpha \left\{ \lambda_1^2 + \frac{P - P_1}{P_2 - P_1} (\lambda_2^2 - \lambda_1^2) \right\}^{\frac{1}{2}} \dots\dots\dots(1)$$

where  $\lambda_1 = v/f_1$  and  $f_1 =$  frequency corresponding to P<sub>1</sub>

and  $\lambda_2 = v/f_2$  ,,  $f_2 =$  ,, ,, P<sub>2</sub>

$v =$  velocity of light and  $\alpha =$  a constant depending on the temperature of the tuning fork.



THE MEASUREMENT OF HIGH FREQUENCIES.

The equation (1) is derived in the following manner :—

Let  $C_P$ ,  $C_1$  and  $C_2$  equal the capacities of the variable condenser corresponding to the scale readings  $P$ ,  $P_1$  and  $P_2$  and let  $C_x$  = total capacity in parallel with the variable condenser.

Then  $\lambda_1^2 = A (C_x + C_1)$  .....(2)

$\lambda_P^2 = A \{ C_x + C_1 + (C_P - C_1) \}$  .....(3)

$\lambda_2^2 = A \{ C_x + C_1 + (C_2 - C_1) \}$  .....(4)

$\therefore \lambda_P^2 - \lambda_1^2 = A (C_P - C_1)$

and  $\lambda_2^2 - \lambda_1^2 = A (C_2 - C_1)$

i.e.,  $\frac{\lambda_P^2 - \lambda_1^2}{\lambda_2^2 - \lambda_1^2} = \frac{C_P - C_1}{C_2 - C_1}$

and  $\lambda_P^2 = \lambda_1^2 + \frac{C_P - C_1}{C_2 - C_1} (\lambda_2^2 - \lambda_1^2)$

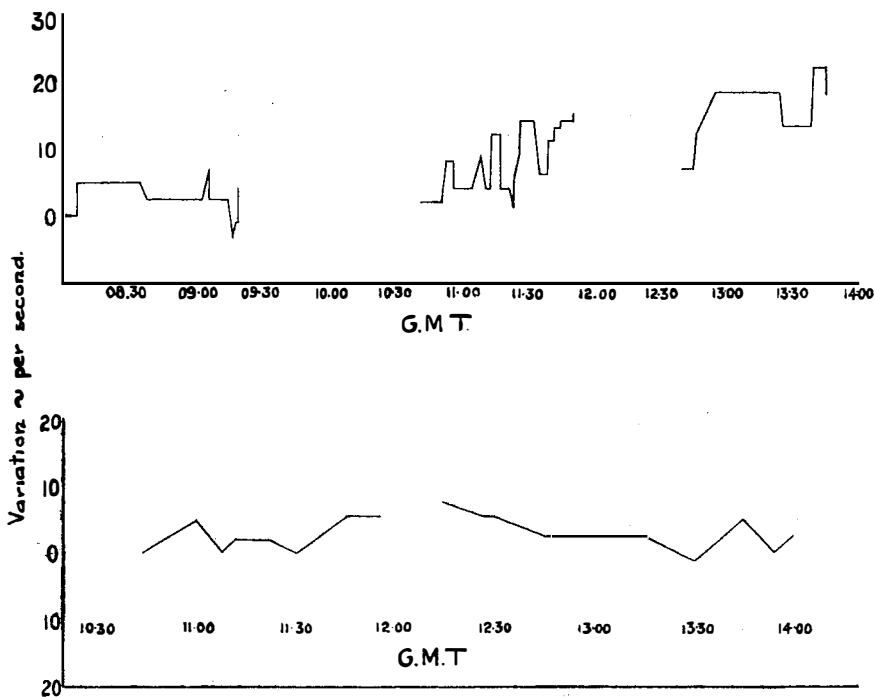

FIG. 5.

With the condenser used no error within 1 part in 10,000 is involved by using the actual scale readings instead of the capacity values; hence we can write :

$$\lambda_P = \left\{ \lambda_1^2 + \frac{P - P_1}{P_2 - P_1} (\lambda_2^2 - \lambda_1^2) \right\}^{\frac{1}{2}} \dots\dots\dots(5)$$

The tuning fork used has a frequency slightly less than 1,000

THE MEASUREMENT OF HIGH FREQUENCIES.

$\sim$  p.s. and this changes with the temperature at the rate of 1 part in 10,000.

Hence if it is assumed that the frequency is 1,000 when it is some other value  $n$ , a correction for frequency  $n/1000$  has to be applied. This fraction reverses when dealing with wave-lengths and becomes  $1000/n = \lambda$  in equation (1).

Besides enabling prior measurements of frequency to be carried out, the method allows of small changes of frequency to be readily observed, the condenser scale of the oscillator X being such that these small changes are easily followed.

Much work has been done in this connection and Fig. 5 gives some examples of observations carried out on Leafield during periods of working extending throughout the day.

Tests carried out simultaneously at the Radio Laboratory, Dollis Hill, and at New York on the frequency of two American Stations gave the following interesting results as affording comparison between the two frequency standards:—

Station.	New York. $\sim$ p.s.	Dollis Hill. $\sim$ p.s.	Station.	New York. $\sim$ p.s.	Dollis Hill. $\sim$ p.s.	
2XS	57,003	56,987	WQL	17,113	17,112	
	56,993			17,117		
	57,007	56,994		17,114		
	57,001			17,113		
	56,999	56,988		17,108		17,110
	56,997			17,107		

A portable piece of apparatus, utilising the principle of double beating and devised in order that the nature of the variations in the frequency of a transmitting station can be observed on the station, is illustrated by Fig. 6.

Here the circuit A is both an oscillator and receiver and serves to pick up the emission of the station and give a beat note in the telephone receiver controlled by the condenser  $a$ . Circuit B is a low frequency oscillator so arranged that variation throughout the range of the condenser  $b$  causes a frequency change of the order of 50 cycles or less, the scale of  $b$  being calibrated.

Thus by suitably adjusting  $b$ , the note due to B and the note given by A with the emission of the station can be caused to give slow beats. Any variation in this beating will be due to variations in the station frequency, and the variation can be measured by bringing the condenser  $b$  into position to give slow beats.

The circuit C is a plain H.F. oscillator similar in construction

## LEAFIELD RADIO STATION.

to circuit A and is for the purpose of testing the constancy of the apparatus. By setting all three circuits going and so tuning that the transmitting station is not audible, the note given by A and C

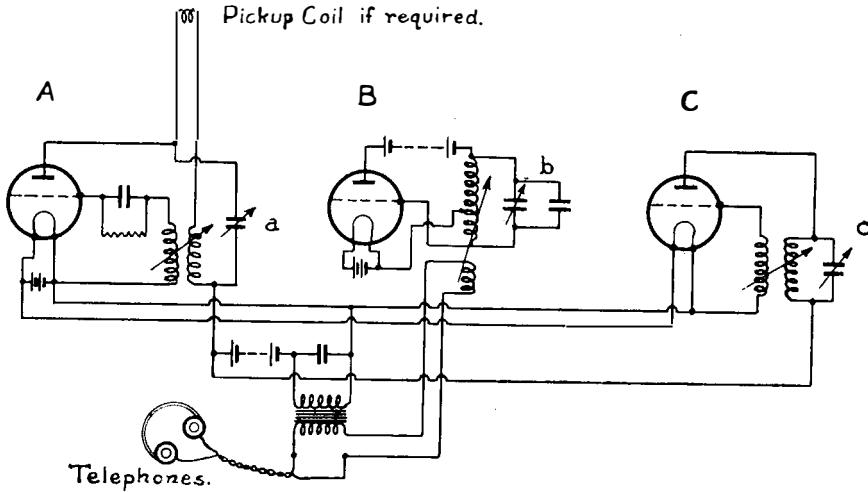

FIG. 6.

can be made to give slow beats with that due to B, and this beating should be maintained constant if the value conditions are in good order.

---

## LEAFIELD RADIO STATION.

### REPAIRS TO COOLING POND.

THE circulating water for the condensing plant at the Leaffield Wireless Station is pumped from a spring about two miles distant from the station, a pond being provided adjacent to the power plant for storage and cooling purposes. The pond has a capacity of 1,000,000 gallons with a surface area of 57,600 square feet, the capacity of the circulating pumps for the condensers being such that this quantity of water is circulated through the condensers in 24 hours.

Fig. 1 gives a plan of the pond and also shows the baffle arrangements of walls provided to make the course of the water from the outlet to the inlet as circuitous as possible in order to secure the maximum cooling effect. Fig. 2, which is a photograph of the whole pond, also shows the baffle walls.

The pond was constructed partly on made-up ground and partly on a natural rock bed. It is lined with 10 inches of puddled

## LEAFIELD RADIO STATION.

clay and finished with a layer of concrete slabs (3 feet square and 2 inches thick) laid on the clay, the joints being grouted with cement. These slabs were provided merely as a protection to the clay, not to serve as a means of keeping the pond watertight. A section showing the arrangement of the clay and slabs is shown in Fig. 1.

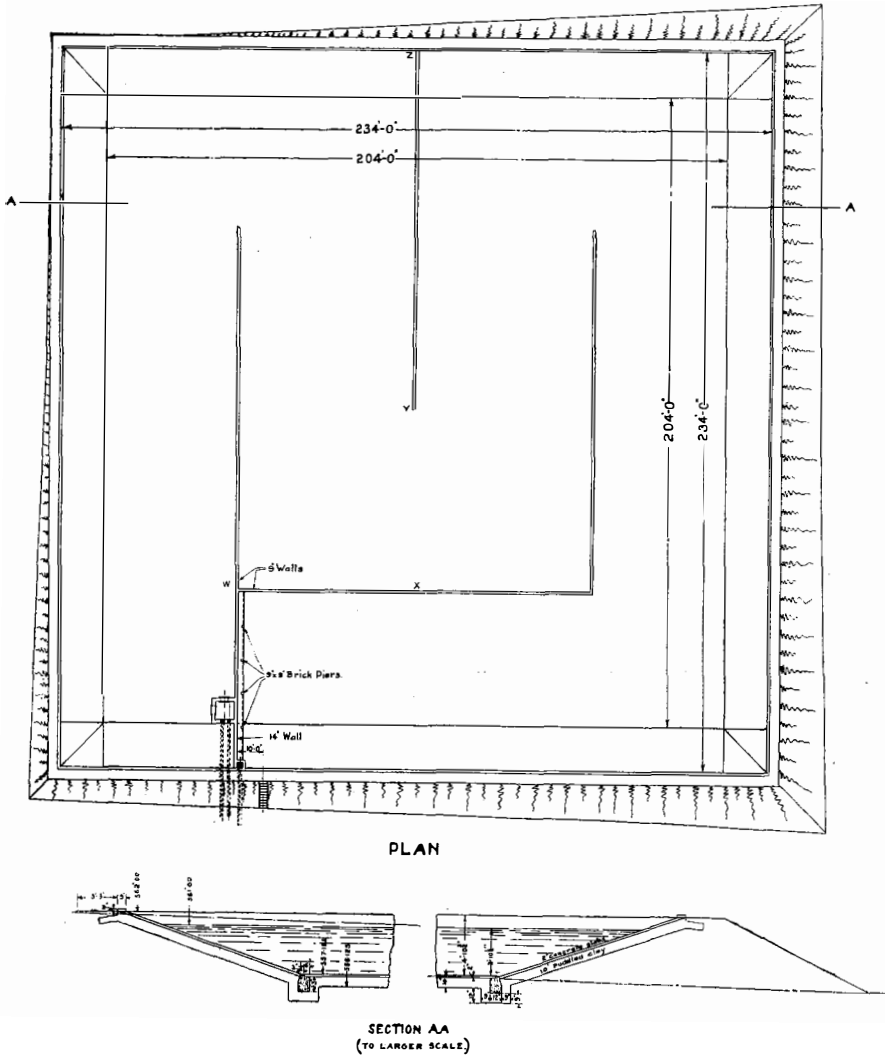

FIG. 1.—PLAN OF THE POND.

Early last year a leakage of the water was observed, which gradually grew worse until towards the end of the year the pumping plant was unable to maintain the level of the water and the repair of the pond became imperative.

## LEAFIELD RADIO STATION.

As repairs of this nature would probably take a considerable time, and as it was not desirable on the ground of economy to run the plant non-condensing whilst they were being effected, it was decided to erect a temporary wooden dam between points X and Y, Fig. 1, which, with the lining of the weir and the cutting of an outlet through the wall at W, would enable the plant to be run on the western half of the pond while the repair of the eastern half was taken in hand. In order to secure complete co-ordination between the somewhat complicated arrangements for carrying out the repairs and the running of the Station, it was considered

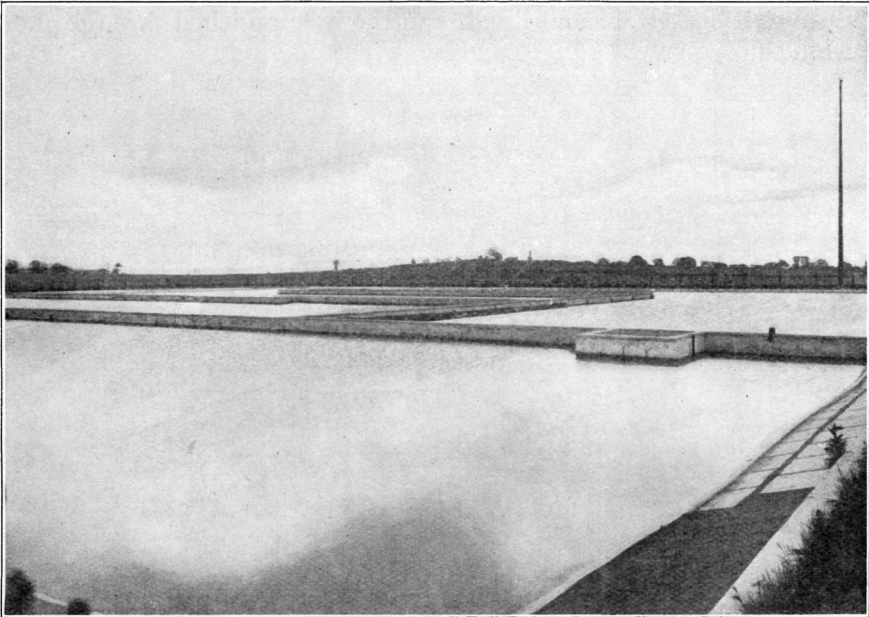

FIG. 2.—VIEW OF THE POND.

essential that the work should be carried out by the station staff augmented by local labour.

The baffle walls are of light construction, and in order to make them sufficiently strong to withstand the load to which they would be subjected while the work was in progress, owing to the pressure of water being on one side only, steps were taken to strengthen walls WX and YZ (Fig. 1). This was carried out in the following manner :—

The water level of the pond was allowed to fall to 1 foot 6 inches, a level which permitted men equipped with waders to work in the pond, and baulks of timber were bolted horizontally along the wall 15 inches from the bottom. Struts were then erected, with notches at each end, one to engage with concrete

## LEAFIELD RADIO STATION.

slabs on the bottom of the pond (a slab being raised at each strut position for the purpose), and one to engage with the bearer on the wall. These struts were spaced six feet apart. Fig. 3 gives the details of the strutting of these walls.

A caisson, which consisted of a three-sided box, 4 feet by 6 feet, fitted with a skirt round the three sides six inches high and six inches from the bottom edge, was used to enable the bolt holes in the walls to be punched and the slabs on the bottom of the pond to be lifted. It was placed in position with its open end against the wall, puddled clay was rammed in the skirt and around the vertical edges. The water in the caisson was then pumped out, the concrete slab broken up and lifted, and the hole punched through the wall.

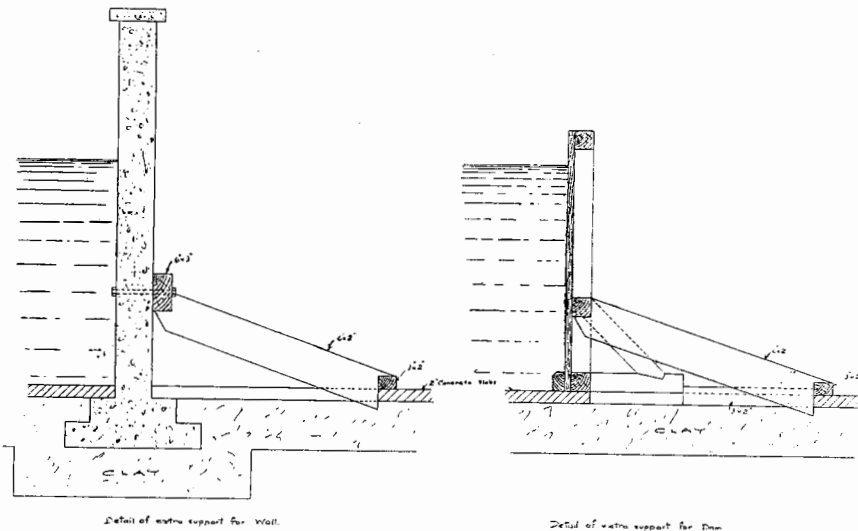

FIG. 3.—DETAILS OF CONSTRUCTION OF DAM AND STRUTS.

When this work had been completed right along the walls, the horizontal baulks were fitted in position, bolted to the walls and the struts cut and fitted. A wooden template was used as a guide in cutting the struts as both baulks and struts had to be fitted under the water. No two struts were of the same length owing to the varying line of the slabs, and in order to avoid the difficulty of cutting the struts to the exact size they were cut slightly short and tightened up by means of wedges driven behind the baulks secured to the walls. This method considerably expedited the work and saved wastage in timber.

The dam was built of six strong wooden sections, each arranged to overlap its neighbour by a few inches. This was strutted in a similar manner to the walls, the caisson being used to lift the floor

## LEAFIELD RADIO STATION.

slabs. The sections were put in position and heavily weighted whilst the struts were fitted. It was next puddled all along its bottom edge of the water side.

Drawings of the dam and its struts are shown in Fig. 3; Fig. 4 shows its construction.

When these preliminaries were completed, the eastern half was cut out of use and the bulk of water remaining in it was pumped into the western half by means of floodgate pumps. The last six inches were pumped and syphoned over the bank owing to the large amount of deposit contained in the pond.

Much difficulty was experienced in keeping the dam tight at



FIG. 4.— THE DAM AND ITS STRUTS.

this stage. On several occasions it was found necessary to re-ram the clay, and it was subsequently found that it was almost impossible to make a tight joint by means of rammed clay in the position which the dam occupied, owing to the fact that a cement seam between the two rows of slabs existed at the line of the dam and that this seam was far from flat. Very wet and cold weather was experienced when this part of the work was in hand, and on two occasions heavy falls of snow had to be cleared away before the work could be proceeded with.

Several leaks were found in the pond bottom, apparently caused by the fact that portions of the clay lining are soluble in the com-

## LEAFIELD RADIO STATION.

paratively warm water of the pond. Having regard to this it was not deemed advisable to rely solely on the rammed clay to keep the pond watertight. Several alternatives were considered and eventually it was found, as the result of experiments carried out on small sections of the pond, that the most economical and satisfactory method was to drive the cement grout between the slabs down to a depth of one inch, caulking above this with tarred strands of hemp rope and finally pouring in molten bitumen on the rope strands until it was flush with the surface of the slab. This involved a large amount of labour; the slabs had to be thoroughly dried before the bitumen was poured into the joints

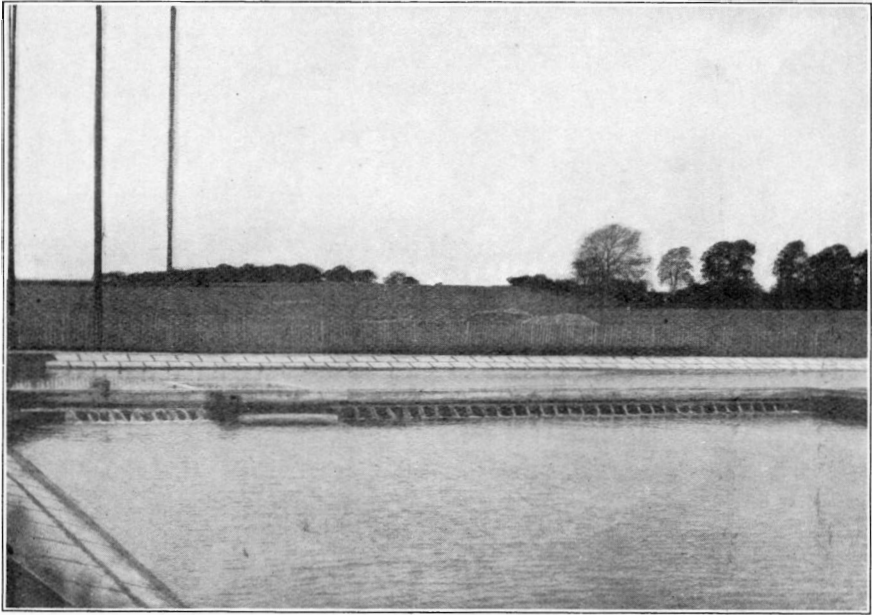

FIG. 5.—THE NEW WALL.

between them, as it will not adhere to wet surfaces. Altogether 15 cwt. of rope and 4 tons of bitumen were used in caulking the 6,000 odd slabs laid on the bottom of the pond.

While the work was in progress it was decided to make arrangements which would enable the work of cleansing the pond, as well as any future work on the bottom, to be carried out without expensive preliminaries. The baffle walls were strengthened by permanent concrete buttresses, these being built over the existing wooden baulks of the temporary strutting. When the buttresses had set, the temporary strutting was removed and the baulks cut away, the piece remaining in the buttress being left.



## OVERDAMPED CONDENSER OSCILLATIONS.

A 12-inch thick concrete wall with a sluice gate was built on the dry side of the dam. The shuttering for this wall presented an interesting problem as all the strutting had to be done without lifting any of the slabs owing to the danger of damaging the temporary dam. This was accomplished by placing in position the footings of the wall and leaving cored holes into which the verticals of the shuttering fitted. The verticals were braced to a horizontal bearer resting on the bottom of the pond. Verticals on each side were placed opposite each other and were securely fastened together at the top. The boards of the shuttering were slipped into position inside the vertical framework as required.

The mixing of the concrete was carried out on the pond bottom adjacent to the new wall and although all material had to be man-handled on to the site the whole of the concrete for the wall from the footings to the top was mixed and poured in one day. A reinforcement of iron wires laid horizontally from end to end was utilized. The new wall can be seen in Fig. 5.

A new suction pit was built and the weir extended to its new position, the latter being carried on the top of the supporting buttresses. Sluice gates were fitted in this weir and on both suction pits to enable the water from the circulating pumps to be delivered to and drawn from either half as required.

Buttresses were next built on the western half of the baffle walls, the caisson being again brought into use as water was still contained in this half.

When the concrete had set the appropriate sluice gates were shut and the bulk of the water in the western half was transferred to the eastern half by means of the circulating pumps. The remainder of the water with the deposit was pumped over the banks and the work completed by treating the bottom of the western half of the pond in a similar manner to that described for the eastern half.

R. G. DE WARDT, A.M.I.E.E.

---

## OVERDAMPED CONDENSER OSCILLATIONS.

By the late CHARLES P. STEINMETZ.

(Extracted from the May issue of the *Journal of the American Institution of Electrical Engineers*.)

REVIEW OF THE SUBJECT.—In the classical equations of the discharge of a condenser of capacity  $C$  into an external circuit of resistance  $r$  and inductance  $L$ , it is found that the discharge is oscillatory if  $r < \sqrt{\frac{4L}{C}}$ , and is impulsive if  $r > \sqrt{\frac{4L}{C}}$ .

As the perfect condenser can never be realized in practice, it is the purpose of this paper to show the effect of the condenser leakage on the discharge wave.

The imperfect condenser is represented by the perfect condenser  $C$  shunted by the conductance  $g$ . This condenser discharges into the circuit  $L$  and  $r$  as above. The mathematical discussion shows that no matter what the relation between  $r$  and  $\sqrt{\frac{4L}{C}}$ , there may always exist some value of  $g$  for which the discharge is oscillatory.

This is the case when

$$(r/L - g/C) < \sqrt{\frac{4}{LC}}$$

$$\text{i.e., } r < \sqrt{\frac{4L}{C}} + \frac{g}{C}L$$

It is to be borne in mind that the above holds true only when  $r$ ,  $L$ ,  $C$ , and  $g$  are constant. If the resistance is that of a third class conductor, the discharge will always be oscillatory.

An apparent paradox is found in the statement that the current may be more than 90 deg. out of phase with the voltage. A study of the derived equations, remembering that the current under consideration is only one of the two components forming the total discharge current  $\left(C \frac{d e}{d t}\right)$  of the condenser (the leakage current  $g e$  being the other), will show that this is true. A study of the oscillograms will further confirm the theory.

## I. GENERAL AND EXPERIMENTAL.

THE classical equations of the condenser discharge through an inductive circuit show that the discharge is oscillatory, if the resistance of the discharge circuit is less than a certain critical value  $2\sqrt{L/C}$ ; and in this case the damping of the wave is geometric, that is, the quotient of two successive half waves is constant. The discharge is impulsive, if the resistance of the discharge circuit is greater than the critical value.

This, however, applies only if the circuit factors: resistance, inductance and capacity, are actually constant. It does not apply if the resistance is that of a third class conductor, that is, if the potential drop across the resistance decreases with increase of current. In this case the discharge is always oscillatory, but the damping is either arithmetic, that is the difference of two successive half waves is constant, or it is a combination of arithmetic damping and geometric cumulation.

Even with constant values of resistance, inductance, and capacity, the classical condenser discharge equations hold only for

## OVERDAMPED CONDENSER OSCILLATIONS.

the *ideal condenser*, that is, a condenser in which no energy losses occur. If energy losses occur in the condenser—as is usually the case—the discharge remains oscillatory even for values of the discharge resistance greater than the critical value  $2\sqrt{L/C}$ , and the discharge oscillates the more; the higher the energy losses in the condenser. No matter how high the resistance of the discharge circuit, there always exists a value of energy loss in the condenser (which depends on the value of the discharge resistance) at which no impulsive discharge is possible, but the discharge is always oscillatory. This occurs when the damping of the wave due to energy losses in the condenser, equals that due to the discharge resistance. The damping is then geometric.

The frequency of the oscillation, and the limit up to which the discharge is oscillatory, depends on the *difference* between the power dissipation in the discharge resistance, and that in the condenser losses, while the attenuation or damping of the discharge wave depends on the *sum* of the losses. As a result of the combined losses, such discharge waves may have rates of attenuation far greater than possible in the classical equations of the ideal condenser. They may therefore be called *Overdamped Oscillations*.

In such overdamped discharge oscillations of the imperfect condenser, only a fraction of the first half wave may be of appreciable magnitude. That is, in the current wave, the maximum (which with the alternating wave occurs at 90 deg., and with a wave of low damping near 90 deg.) may occur at 20 deg. to 30 deg. and still earlier; the wave from then is very much steeper than the wave tail, similar to the case in the non-oscillatory impulse; the wave shape, however, differs from the latter, and the current and voltage wave pass through zero at a definite point, while in the non-oscillatory impulse they never reach zero, but gradually fade out.

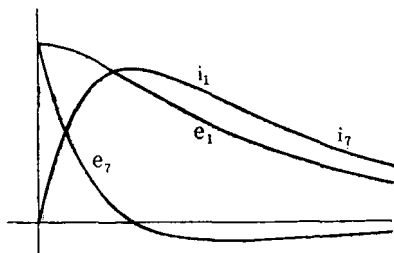

FIG. 1.

As illustrations are shown in Figs. 1 and 3 the calculated current and voltage waves and in Figs. 4 to 7 the observed oscillograms of a series of such overdamped condenser discharge waves, for a condenser of  $C = \mu\text{f.}$  capacity discharging through an in-

OVERDAMPED CONDENSER OSCILLATIONS.

ductance of 5 henrys. This gives the critical resistance  $r_0 = 2\sqrt{L/C} = 2000$  ohms.

In (1) is shown the discharge, given by the classical equations for zero condenser loss and a discharge resistance of  $r = 2400$  ohms, that is, an impulsive or unidirectional discharge.

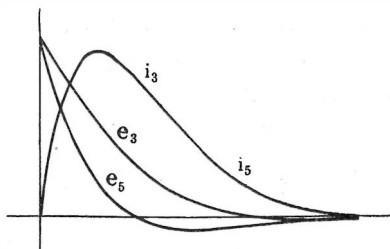

FIG. 2.

In (2) the discharge resistance has been reduced to 2100 ohms (which with a loss free condenser would still give an impulsive discharge) but such a power dissipation in the condenser has been assumed, as to give the same damping constant as (1). The discharge then has become oscillatory.

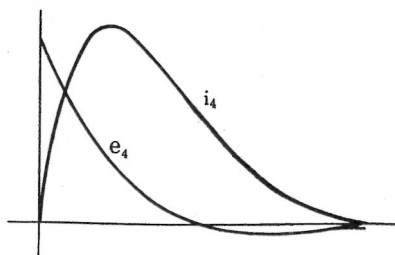

FIG. 3.

(3) to (7) give the discharges for successively lower discharge resistances.  $r = 1800, 1200, 600, 300$  and 0 ohms, but with successively increased power dissipation in the condenser, so as to give the same total resultant dissipation constant. As seen, in (7), for zero discharge resistance, the discharge has again become impulsive, due to the strong damping by the condenser losses,

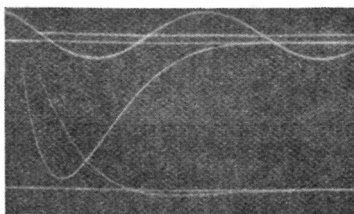

FIG. 4.

OVERDAMPED CONDENSER OSCILLATIONS.

although the shape of the voltage impulse is very different from that in (1). The frequency of the discharge increases with increasing condenser losses, up to (4), the case at which the con-

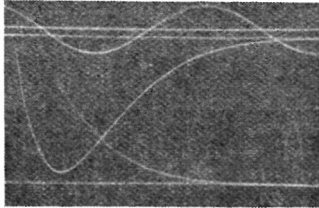

FIG. 5.

denser losses equal the losses in the external circuit and the condenser losses neutralize the effect, on the frequency, of the discharge resistance, and the frequency is the same as that of an undamped wave.

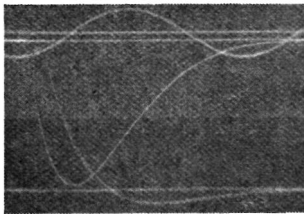

FIG. 6.

(1) to (7) thus give forms of waves, of the same condenser discharging through the same inductance with the same damping, that is, the same attenuation constant, but the losses, that is, the power dissipation which causes the damping, shifting from all in

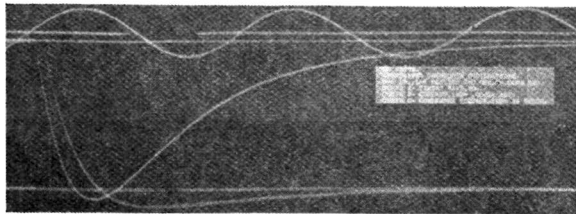

FIG. 7.

the external circuit and none in the condenser, in (1) to all in the condenser and none in the external circuit, in (7). As seen, the current waves in (7), (6) and (5) are the same as in (1), (2) and (3); but the voltage waves are materially different.

OVERDAMPED CONDENSER OSCILLATIONS.

As a further illustration, the current and voltage discharge waves of the same condenser are calculated,  $C = 5 \mu\text{f.}$  over the same inductance  $L = 5$  henrys, and a constant discharge resistance  $r = 2400$  ohms, and with amounts of power dissipation in the condenser, varying from zero in (1), up to a value in (5), which doubles the dissipation constant of the discharge.

II. MATHEMATICAL.

Let :

- C = Capacity of the condenser.
- L = Inductance of the discharge circuit.
- r = Resistance of the discharge circuit (including the effective resistance representing the energy losses in the inductance).

If energy losses occur in the condenser, an energy component occurs in the condenser current, which can be represented by an effective shunted resistance or shunted conductance. Thus let :

- g = Effective shunted conductance representing energy losses in the condenser.

We thus have, in the general case :

- C = Coefficient of energy storage by the voltage, in the capacity of the condenser
- L = Coefficient of energy storage by the current, in the inductance of the external circuit
- g = Coefficient of power dissipation by the voltage, in the effective shunted conductance of the condenser
- r = Coefficient of power dissipation by the current, in the (effective) resistance of the external circuit.

Let :

- e = Voltage at condenser terminals, with  $e = e_0$  as initial value at time  $t = 0$
- i = Current in the external circuit, with  $i = 0$  as initial value.

It is then :

In the external circuit :

$$e = L \frac{di}{dt} + r i \dots\dots\dots(1)$$

In the condenser :

$$- i = C \frac{de}{dt} + g e \dots\dots\dots(2)$$

Substituting (1) and its differential into (2) gives the differential equation of current :

$$\frac{d^2 i}{dt^2} + 2 u \frac{di}{dt} + \frac{1 + r g}{L C} i = 0 \dots\dots\dots(3)$$

where :

$$u = 1/2 (r/L + g/C) \dots\dots\dots(4)$$

OVERDAMPED CONDENSER OSCILLATIONS.

is the attenuation constant, and

$$m = 1/2 (\tau/L - g/C) \dots\dots\dots(5)$$

is the distortion constant.\*

Equation (3) is integrated in the usual manner by terms of the form :

$$i = A e^{-ct}$$

which, in the case that  $c$  becomes imaginary, combine to a term :

$$i = B e^{-ct} \sin q t$$

and by the substitution of the terminal conditions, gives :

A. IMPULSIVE DISCHARGE.

$$m^2 > \frac{I}{LC} \dots\dots\dots(6)$$

$$i = \frac{e_0}{2 s L} (e^{-c_1 t} - e^{-c_2 t}) \dots\dots\dots(7)$$

$$e = e_0 \left( \frac{m + s}{2 s} e^{-c_1 t} - \frac{m - s}{2 s} e^{-c_2 t} \right) \dots\dots\dots(8)$$

where :

$$\left. \begin{aligned} c_1 &= u - s \\ c_2 &= u + s \end{aligned} \right\} \dots\dots\dots(9)$$

$$s = \sqrt{m^2 - \frac{I}{LC}} \dots\dots\dots(10)$$

The current is a maximum at the time :

$$t = \frac{\log c_2 - \log c_1}{2 s \log e} \dots\dots\dots(11)$$

B. CRITICAL DISCHARGE.

$$m^2 = \frac{I}{LC} \dots\dots\dots(12)$$

$$i = e_0/L t e^{-ut} \dots\dots\dots(13)$$

$$e = e_0 e^{-ut} (1 + m t) \dots\dots\dots(14)$$

The current is a maximum at the time :

$$t = \frac{I}{u} \dots\dots\dots(15)$$

C. OSCILLATORY DISCHARGE.

$$m^2 < \frac{I}{LC} \dots\dots\dots(16)$$

$$i = \frac{e_0}{q L} e^{-ut} \sin q t \dots\dots\dots(17)$$

$$e = e_0 e^{-ut} (\cos q t + m/q \sin q t) \dots\dots\dots(18)$$

\* See A. I. E. E., "The General Equation of the Electric Circuit," 1907. Also: "Theory and Calculation of Transient Phenomena, Section IV.," page 462, 509.

OVERDAMPED CONDENSER OSCILLATIONS.

where :

$$q = \sqrt{\frac{1}{LC} - m^2} \dots\dots\dots(19)$$

The current is a maximum at the time :

$$\tan q t = q/u \dots\dots\dots(20)$$

As seen, with increasing energy loss in the condenser,  $m$  decreases to zero and then becomes negative, and the phase relation between voltage and current thus changes from less than quadrature to quadrature to more than quadrature.

Although at first glance this statement may seem impossible, and may be impossible for steady conditions, we believe that this, like many other seeming paradoxes in the study of transients, is perfectly true.

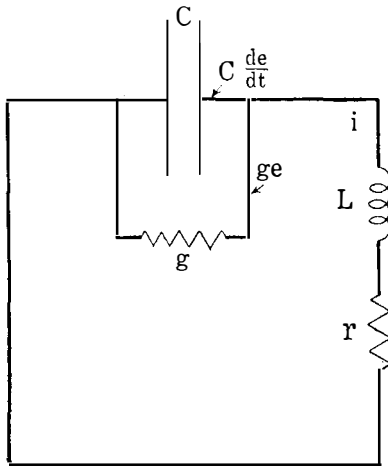

FIG. 8.

Referring to the diagrams, in Fig. 8 the capacity  $c$ , shunted by the conductance  $g$ , represents the imperfect condenser.

$c \frac{de}{dt}$  = current supplied by condenser.

$g e$  = current through  $g$  (through imperfect condenser).

$i$  = current through  $L$  and  $r$  (external circuit).

$e$  = condenser voltage.

(1) The current  $g e$ , being through the pure resistance  $g$ , must be in phase with the voltage  $e$ .

(2) The vector sum of the currents through the external circuit ( $L$  and  $r$ ) and through  $g$  must be equal to the current supplied by the condenser.



In Fig. 9

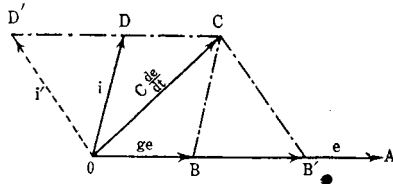

FIG. 9.

- A O represents the condenser voltage  $e$ .
- B O represents the current  $g e$  in phase with  $e$ .
- C O represents the condenser current  $C \frac{d e}{d t}$ , out of phase with  $e$  by the angle C O A.
- D O represents the external current  $i$ , out of phase with  $e$  by the angle D O A.

Now, change the circuit constants ( $g$ ,  $L$ , and  $r$ ) so that  $C \frac{d e}{d t}$  has the same relation to  $e$  as before, but  $g e$  has taken the position O B'. Then, as the vectorial sum of  $i/g e$  must be equal to  $C \frac{d e}{d t}$ , then  $i$  must take the position O D' which is displaced from  $e$  by the angle D' O A obviously greater than 90 deg.

A study of oscillograms for cases 5, 6 and 7 of the first instance given in the paper will corroborate the above analysis.

D. NOTES.

The energy dissipation in the system is given by the same equations in all three cases, as :

$$r (I^2) + g (E^2) = r \int_0^\infty i^2 dt + g \int_0^\infty e^2 dt$$

$$= \frac{r e_0^2 C}{4 L u (l + r g)} + \frac{g e_0^2 (l + u r C)}{4 u (l + r g)} \dots\dots\dots(21)$$

The current slope is a maximum for :

$$\left[ \frac{d i}{d t} \right]_{t=0} = e_0 / L$$

The voltage slope is a maximum for :

$$\frac{d^2 e}{d t^2} = 0$$

at :

$$\tan q t = \frac{q^2 - u^2}{2 q u}$$

$$\frac{d e}{d t} = - e_0 e^{-u t} (u \cos q t + q \sin q t)$$

OVERDAMPED CONDENSER OSCILLATIONS.

In the classical equations of the condenser discharge, the term  $\frac{r}{2L}$  takes the place of both of the terms,  $u$  and  $m$ , of the general equations.

III. INSTANCES.

As an instance, let  $e_0 = 10,000$  volts.

$C = 5 \mu\text{f.} = 5 \times 10^{-6}$  = capacity of condenser.

$L = 5$  henrys = inductance of discharge circuit, thus :

$z_0 = \sqrt{L/C} = 1000$  ohms = surge impedance, and

$r = 2 z_0 = 2000$  ohms = critical resistance, at which the discharge of the ideal condenser changes from oscillatory to impulsive.

$$\frac{1}{LC} = 200 = \text{frequency constant.}$$

Choosing then the discharge resistance  $r$ , and the shunted conductance of energy loss in the condenser  $g$ , so as to give a constant attenuation, that is, at constant total attenuation  $u$ , the energy losses are divided between the external circuit and the condenser, in different proportions.

$$u = 1/2 (r/L + g/C) = 240$$

Seven cases are given in Figs. 1 to 3 and oscillograms Figs. 4 to 7, for the constants :

No.	(1)	(2)	(3)	(4)	(5)	(6)	(7)
Figs. } r =	1 2400	...	2 2100	3 1800	2 1200	...	1 0 ohms
g =	0	0.3	0.6	1.2	1.8	2.1	$2.4 \times 10^{-3}$ mhos
thus							
m =	240	180	120	0	-120	-180	-240
q = $\sqrt{\frac{1}{LC} - m^2}$ =	...	87.2	160	200	160	87.2	...
s = $\sqrt{m^2 - \frac{1}{LC}}$ =	132.6	...	...	...	...	...	132.6

Current.

Terminal Voltage at Condenser.

(1) $i = 7.55 (e^{-107.4t} - e^{-372.6t})$	$e = 10000 (1.41 e^{-107.4t} - .41 e^{-372.6t})$
(2) $i = 23 e^{-240t} \sin 87.2t$	$e = 10000 e^{-240t} (\cos 87.2t + 2.07 \sin 87.2t)$
(3) $i = 12.5 e^{-240t} \sin 160t$	$e = 10000 e^{-240t} (\cos 160t + .75 \sin 160t)$
(4) $i = 10 e^{-240t} \sin 200t$	$e = 10000 e^{-240t} \cos 200t$
(5) $i = 12.5 e^{-240t} \sin 160t$	$e = 10000 e^{-240t} (\cos 160t - .75 \sin 160t)$
(6) $i = 23 e^{-240t} \sin 87.2t$	$e = 10000 e^{-240t} (\cos 87.2t - 2.07 \sin 87.2t)$
(7) $i = 7.55 (e^{-107.4t} - e^{-372.6t})$	$e = 10000 (-.41 e^{-107.4t} + 1.41 e^{-372.6t})$

In the oscillograms, as nearly as possible the same constants were chosen, and as seen, the oscillograms are identical in wave shape with the calculations (except for a slight inductive effect at

## HEADQUARTERS NOTES.

the beginning of the voltage wave). For convenience, the current is shown in reverse direction, and as time measure, a 60-cycle wave is given.

As a second instance, consider :

The same  $e$ ,  $C$ ,  $L$ ,  $z$ , etc., but a constant value of the discharge resistance :

$$r = 2400 \text{ ohms}$$

and various values of shunted conductance  $g$ , from zero to a value equal in energy dissipation to  $r$ . That is :

	No.	(1)	(2)	(3)	(4)	(5)
	$g =$	0	.3	.6	1.2	$2.4 \times 10^{-3}$ mhos
thus	$u =$	240	270	300	360	480
	$m =$	240	210	180	120	0
	$q =$	...	...	87.2	160	200
	$s =$	132.6	64.2	...	...	...

### Current.

- (1)  $i = 7.55 (\epsilon^{-107.4t} - \epsilon^{-372.6t})$
- (2)  $i = 15.6 (\epsilon^{-205.8t} - \epsilon^{-334.2t})$
- (3)  $i = 23 \epsilon^{-300t} \sin 87.2t$
- (4)  $i = 12.5 \epsilon^{-360t} \sin 160t$
- (5)  $i = 10 \epsilon^{-480t} \sin 200t$

### Voltage at Condenser Terminals.

- $e = 10000 (1.41 \epsilon^{-107.4t} \epsilon_{.41} \epsilon^{-372.6t})$
- $e = 10000 (2.14 \epsilon^{-205.8t} - 1.14 \epsilon^{-334.2t})$
- $e = 10000 \epsilon^{-300t} (\cos 87.2t + 2.07 \sin 87.2t)$
- $e = 10000 \epsilon^{-360t} (\cos 160t + .75 \sin 160t)$
- $e = 10000 \epsilon^{-480t} \cos 200t$

## HEADQUARTERS NOTES.

### EXCHANGE DEVELOPMENTS.

The following works have been completed :—

Exchange.	Type.	No. of Lines.
Broughty Ferry ... ..	Automatic	550
Swansea ... ..	"	3340
Sketty ... ..	"	3200
Dundee ... ..	"	300
Cardiff Extension... ..	Manual	1500
Clerkenwell Extension ... ..	"	1800
Liverpool, Old Swan ... ..	"	1080
Liverpool Royal ... ..	"	6140
Cardiff Royal Infirmary... ..	Auto. P.B.X.	50
Cooper Stores, Ltd. ... ..	"	60
Curwen Press ... ..	"	20
Isobel's, Ltd. ... ..	"	40
Jute Industries, Ltd. ... ..	"	90
Oxendale, Ltd. ... ..	"	30
Salts, Ltd. ... ..	"	20
Star & Garter Home ... ..	"	30
United Glass Bottle Co.... ..	"	50
J Wix & Sons, Ltd. ... ..	"	30

HEADQUARTERS NOTES.

Orders have been placed for new Exchanges as follows :—

Exchange.	Type.	No. of Lines.
Hayling Island ... ..	Automatic	107
Holborn Tandem ... ..	"	—
Brighthouse ... ..	Manual	440
East Ham ... ..	"	1700
Hoylake ... ..	"	1520
Leigh (Lancs.) ... ..	"	680
Openshaw ... ..	"	1400
Achille Serre, Ltd. ...	Auto. P.B.X.	40
Ansell's Brewery, Ltd. ...	"	30
Charing Cross Electric Light Supply ... ..	"	50
J. Duckworth, Ltd. ...	"	30
Higgs & Hill ... ..	"	40
Jaegers, Ltd. ... ..	"	90
J. Keiller & Son, Ltd. ...	"	60
Leyton U.D. Council ...	"	30
F. J. Parsons, Ltd. ...	"	30
Spillers Milling Co. ...	"	90

Orders have been placed for extensions to existing equipments as follows :—

Exchange.	Type.	No. of Lines.
Anfield ... ..	Manual	450
Birmingham Central ...	"	1250
London Toll ... ..	"	—
Margate ... ..	"	600

A Valve Amplifier has been designed to enable a subscriber to connect a number of P.B.X. extensions simultaneously at either or each end of a connection without degradation of transmission efficiency. The apparatus which gives single amplification has two valves, one for the transmitters and the other for the receivers.

THE Relay Automatic Telephone Company of Marconi House has secured, in strict competition, an important contract to supply H.M. Dockyard, Chatham, with a special model 550 line "Relay" Automatic Telephone Installation and also to supply a 50 line "Relay" Exchange for the Army, Navy and Air Force Hospital, Chatham. The work of manufacture has already begun and it is anticipated that these exchanges will be working shortly.

The installations are to replace the existing Manual Equipment at both places, but a special building is being erected to accommodate the 550 line "Relay" at the Dockyard, where a new Main and Intermediate Distributing Frame will be installed, also a new Manual Board to control the 40 Trunks to various exchanges. Although two positions will be fitted to the latter, only one

## LONDON DISTRICT NOTES.

operator will be on duty instead of the four at present required to operate the existing Manual Exchange. No operator will be employed in connection with the Hospital Installation. Both models are of the latest 32 volt type, the Dockyard Exchange being on the Trunk Link principle, and operated by batteries having a capacity of 350 A/H. 16 Subscribers will have conference facilities on the Dockyard Exchange and 50 will have priority of service, while 3 lines will have priority on the Hospital Automatic Exchange.

Two ringing machines will be fitted on the 550 line exchange, one of which will run off the 220 volt mains and the other off the exchange battery.

The Hospital Exchange will be equipped with duplicate ringers, both of which will run off the exchange battery.

The Dockyard Building will be equipped with a motor generator for charging the batteries, and in the case of the Hospital Exchange the charging will be carried out by resistance from the 220 volt mains.

Mr. A. T. Kinsey, who retired from the service of the Department some two years ago, has been appointed Engineer-in-Charge of the Telephone Department, States of Jersey. Mr. Kinsey, it will be remembered, was Assistant Superintending Engineer of the South Western District when he retired, and his many friends in the west country and in Ireland will be pleased to hear of his rejuvenation and renewed activities in the salubrious isles in the Channel.

---

## LONDON DISTRICT NOTES.

### MILEAGE STATISTICS.

DURING the three months ended 30th June, 1924, the following changes have occurred:—

*Telegraphs.*—Nett decrease of 192 miles of open wire and a nett increase of 349 miles in underground.

*Telephone (Exchange).*—Nett increase of 10 miles and 25,351 miles in open wire and underground respectively, and a nett decrease in aerial cable of 248 miles.

*Telephone (Trunks).*—Nett decrease of 28 miles of open wire and a nett increase in underground of 1,516 miles.

*Pole Line.*—Nett increase of 87 miles, bringing the total to date to 4,827 miles.

*Pipe Line.*—Nett increase of 55 miles, the total to date being 5,463 miles.

## LONDON DISTRICT NOTES.

The total single wire mileages at the end of the period under review were :—

Telegraphs	...	...	...	...	23,720
Telephones (Exchanges)	...	...	...	1,497,603	
Telephones (Trunks)	...	...	...	47,966	
Spares	...	...	...	...	50,186

The unusual drop in Telegraph open wire mileage is due to a considerable removal of circuits from open routes on the Southern Railway to the Department's underground cables.

### EXTERNAL CONSTRUCTION.

During the quarter ended June 27th, 1924, 10,146 exchange lines, 5,732 internal extensions and 1,161 external extensions were provided. In the same period 2,844 exchange lines, 2,360 internal extensions and 342 external extensions were recovered, making nett increases of 7,302 exchange lines, 3,372 internal extensions and 819 external extensions.

### INTERNAL CONSTRUCTION.

*New Exchanges.*—New Exchanges have been opened at Woolwich and Upper Warlingham during the past quarter. Woolwich is one of the C.B.1 type, and has been installed by Messrs. Siemens Bros. The initial equipment consists of 13 A and 6 B positions. Upper Warlingham is a C.B.S. Multiple Exchange of three positions, and has been installed by the Department's staff.

A new C.B. 10 Exchange of 7 positions is in course of construction by the Department's staff at New Malden.

It is anticipated that the installation of the new Exchanges at Albert Docks, Enfield, Mill Hill, Palmers Green, and Tilbury will be commenced shortly.

The installation of the Holborn Mechanical Tandem Exchange by the A.T.M. Company is proceeding, and the plant for the Holborn Automatic Exchange, which will be located in the same building as the Mechanical Tandem, is being delivered.

*Extensions of Exchange Equipment.*—The amount of work of this nature at present in hand is considerable, a large number of the exchanges in the London District being involved.

*P.A.B.X.'s.*—There are now 21 Private Automatic Branch Exchanges working in the London District, and orders have been placed with Contractors for a further 19.

A small P.A.B.X. of the Unit No. 4 type (Western Electric Company's pattern) has been installed at Messrs. Garstin's, Aldersgate Street. The installation is the first of its type installed by the Department and has equipment for 40 automatic extensions with the usual manual board control of exchange connections. The installation is a compact one and its behaviour is being watched

## LONDON DISTRICT NOTES.

with interest. The whole of the installation was carried out by the Department's officers. A detailed description of the Western Electric Company's pattern P.A.B.X. will appear in next issue of the Journal.

As a result of applications from subscribers, two interesting experiments are to be made. In one case, a subscriber requires a loud speaker to be fitted to his instrument in order to avoid the need for holding the receiver while information is being obtained by the person with whom he is in communication. The loud speaker apparatus has been installed and is now under trial. In the second case, a firm requires what may be termed a "Conference" circuit, to enable several persons in the same office to listen to a telephonic conversation, and, if necessary, to speak, without introducing transmission difficulties. This circuit will, it is anticipated, be installed shortly.

*London Toll Exchange.*—An extension of the equipment has been commenced. Twenty-five additional sections are being provided for incoming order wire junctions and control lines. Equipment for 210 control lines, 100 Toll lines, 240 incoming junctions and 27 incoming order wires is included in the extension. In addition, the Information Desk is being increased by four positions.

*Mechanical Tandem Trial Equipment.*—A trial equipment is being installed in the City Exchange in conjunction with the provision of Coder Call Indicator apparatus at that Exchange. Two Mechanical Tandem Cordless B positions will be provided in the switchroom for handling the local transfer traffic on City Exchange and the calls will be completed on two of the City Coder Call Indicator positions. The trial equipment is to be used to gain some experience of working under the conditions of the London Automatic system.

*The C.T.O. Section* continues to deal with works of an exceptional character, or of special urgency, in addition to a large increase of general work, such as extensions to main frames, cable racks, etc.

Three fuse panels have been made outright, one of which is of considerable size; but the outstanding work has been the construction of three Telephone Kiosks to the design of eminent Architects. The Kiosks are intended to be of metal, but for experimental purposes have been largely constructed of wood. They are all very artistic and it will be interesting to learn which will be adopted to meet the very large demand anticipated as regards Street Kiosks.

*Telegraphs.*—Three types of "start and stop" non-multiple telegraph instruments, of the keyboard variety, all capable of working duplex are now on trial. Morse is dying, but dying hard.

## LONDON DISTRICT NOTES.

### MR. E. W. J. TODD.

His old colleagues in the London Engineering District have learned with deep regret of the death of Mr. E. W. J. Todd.

Mr. Todd was born in 1873. He entered the C.T.O. as a Telegraphist in 1890, was appointed to the Engineer-in-Chief's Department in 1897 and transferred to the Ministry of Pensions in 1919.

Never physically robust, Mr. Todd's energy was expended in mental activities and a well-stored mind made him a pleasant and interesting companion.

Ever ready to help, his kindly nature and practical common-sense were always at the disposal of those in difficulty. He leaves a sweet and fragrant memory. F.F.

Mr. Todd was a member of the Committee elected by the Staff of the Engineering Department, in 1905, for the purpose of establishing the Institution of P.O. Electrical Engineers, and he served on the Institution Council for the first two years. His contributions to the discussions, many of which in those early days turned on points of difficulty, were marked by a breadth of view which was of the greatest help, and his fund of humour proved of particular value on more than one occasion when somewhat conflicting interests were in process of reconciliation. J.W.A.

---

### RETIREMENT OF Mr. RICHARD WARING.

MR. WARING retired on June 30th, 1924, from the position of Superintending Engineer, Scotland West District, at the age of 60, after completing 48 years' service with the Post Office.

Mr. Waring commenced service in March, 1876, at a Sub-Post Office in Cheshire, where he learned the rudiments of postal and telegraph business. On 1st January, 1882, he was appointed Sorting Clerk and Telegraphist at Liverpool, but he was there only long enough to gain an insight into the working of a large office. In December, 1882, he was transferred to a clerkship in the Engineering Department at Liverpool, where he came into close touch with Mr. J. R. Edwards, who was then Superintending Engineer of the North Wales District.

In September, 1885, he was promoted and transferred to Edinburgh, where he served under the late Mr. J. Gibson, and continued at the Heriot Watt College the scientific and engineering studies begun at Liverpool.

In 1890 he was promoted to the rank of second class Inspector, and in this capacity saw service in the North Wales, North



RETIREMENT OF MR. RICHARD WARING.

Western and Irish Midland District. In the last-mentioned District he was responsible for the installation of block signalling apparatus on long sections of the Great Southern and Western Railway of Ireland.

In August, 1897, Mr. Waring was promoted to a first class Engineership under the late Mr. E. Ashton at Liverpool, where he installed the New Trunk Exchange on the acquisition of the Trunk Telephone Lines from the late National Telephone Company. He also laid the Liverpool section of the first dry core cable between Liverpool and Manchester, and was associated with Mr. F. Tremain in installing experimental Pupin coils.

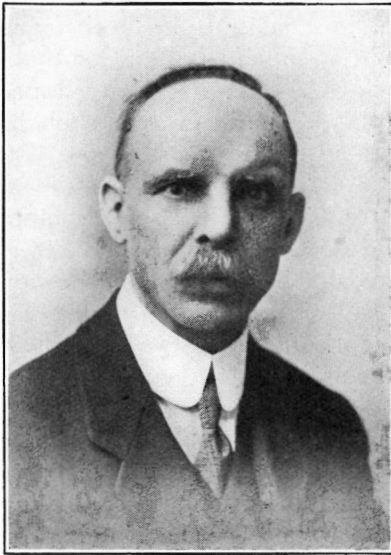

MR. R. WARING.

Eight years later, *i.e.*, in August, 1905, Mr. Waring was promoted to the Engineer-in-Chief's Office as a Technical Officer, and assisted Mr. A. L. DeLattre in preparing for the valuation of the late National Telephone Company's external plant, and for his good work received the thanks of the Postmaster-General.

In April, 1911, he was transferred to the Central Metropolitan District as Assistant Superintending Engineer, where he worked under Mr. (now Sir William) Noble and later under Mr. Moir. In this position he took a prominent part in the arrangements associated with the transfer of the National Telephone Company's plant in London, including the unification of the Engineering Accounting Systems of the Post Office and the National Telephone Company.

His promotion to the rank of Superintending Engineer came

MR. F. McMORROUGH.

in July, 1918, when he was given charge of the Scotland West District with Headquarters at Glasgow on the retirement of the late Mr. D. Stewart, I.S.O.

Colonel Purves presided over a gathering of many of Mr. Waring's colleagues at Headquarters and in the Engineering Districts, which was held in the Deputation Room, G.P.O. (North) on Thursday, 3rd July, in order to say an official good-bye, and also to present several handsome gifts to our old friend.

Apologies for absence were received from Sir William Noble and also from Mr. Alexander Moir, both of whom regretted their inability to be present in order to wish God-speed to an old colleague.

Colonel Purves, in a delightful speech, made reference to the fact that we were not so much saying good-bye to Mr. Waring as welcoming him back to his own home after a period of exile in the remoteness of Scotland, where he had probably been living on porridge and haggis, wearing the kilt and listening to the bag-pipes!

Messrs. DeLattre, Gomersall, Capt. Crompton, and Messrs. E. Turner, J. W. Atkinson, Gibbon, Elston, Twells, Tattersall and J. E. Taylor referred to the sterling qualities of Mr. Waring and his extraordinary capacity for hard work. Testimony was also given to the particularly disinterested way in which he carried out his duties and to the assistance he was always ready to give to his fellows.

It was particularly pleasant to hear Mr. Tattersall speak on behalf of the ex-National Telephone Company engineers. He stated that no man in the Post Office could have done more than Mr. Waring for the welfare of the National staff and the maintenance of good relations between the two groups.

Mr. Waring, in responding, expressed his appreciation of the handsome gifts which had been presented to Mrs. Waring and himself, also of the kindly sentiments which had been expressed towards him. He spoke of the amicable relations that had always existed between his colleagues and himself, and indicated that he did not anticipate spending the remainder of his life in idleness.

---

**Mr. F. McMORROUGH.**

It is with deep regret that we record the passing away of Mr. Frank McMorrough, who, on account of a breakdown in health, retired about two years ago from the position of Executive Engineer in charge of the Lincoln Section of the North-Eastern Engineering District.

MR. F. McMORROUGH.

Mr. McMorrough entered the service as a Sorting Clerk and Telegraphist at Sheerness in 1884 and after transfer to Liverpool in 1889 came to the Engineering Department in 1896. He was promoted to a Sub-Engineership in 1899, a 2nd Class Engineership in London in 1901 and a 1st Class Engineership at Lincoln in 1909. For many years he suffered from periodical attacks of indisposition aggravated, perhaps, by his intense devotion both to official duties and to the many studies which claimed his interest, and after the



MR. F. McMORROUGH.

trying experiences of the war period, in which the Lincoln Section shared heavily, his health gave way. For several years he filled with conspicuous success the position of Secretary to the Society of Post Office Engineers: he was also a Member of Council of the Institution of P.O. Electrical Engineers.

In his official life Mr. McMorrough stood for a level of efficiency—both administrative and engineering—which too often imposed upon him a burden of work far beyond the capacity of most men;

but he was never too busy to give freely to his staff all the advice and help he could, and no man was more accessible in the cause of the day's work.

In private life he was an omnivorous reader, an exceptionally well-informed man and a born raconteur. Those who had the privilege of his personal friendship knew that in the study of the history of minorities lay his heart's great interest: he had an unquenchable hatred of any form of oppression, political or otherwise, engendered no doubt by a knowledge of the sad experiences of many of his countrymen, including his own parents.

He leaves behind the memory of a rich and generous personality and in our grief for the loss of such a colleague we can only say, in words specially appropriate—*Requiescat in pace.*

J.W.A.

#### A PERSONAL NOTE.

Born in Stockport in 1868 of Irish parentage, "Mac," as he was universally called by his colleagues, was transferred as a Telegraphist to Liverpool in 1889. Here he found scope for unbounded energy which was to result in benefit to the service and his fellow workers. Joining a band of young students, of whom the best known is probably Mr. John Lee—now Controller of the C.T.O.—in classes at Liverpool, a fine superstructure of knowledge was built on the solid foundation laid in early years at the elementary school of the Roman Catholic Church at Stockport. In addition to a sound knowledge of Latin, and some Greek, he acquired an intimate knowledge of German (linguistic and written) and French, followed a few years later by way of relaxation from more serious studies by Gaelic! A weekly gathering of seven of these students in a debating coterie led to the acquisition of dialectical powers, which afterwards stood him in good stead in negotiations on behalf of the staff, in which capacity he was probably best known. The fact that the headquarters of the old Postal Telegraph Clerks' Association was at Liverpool brought McMorrough into intimate connection with the early leaders of that virile body, and only those behind the scenes at that time know what a debt his fellow telegraphists owe him. His superabundant energy and natural organising ability had much to do with the successful representation of the P.T.C.A. case before the Tweedmouth Parliamentary Committee—indeed, though his ability had already been recognised officially in 1896 by promotion to a Junior Clerkship in the Engineering Department, which precluded him from giving evidence as a telegraphist, it is well known that his was the ammunition with which many of the more prominent leaders were primed.

A batchelor, he was able to indulge in holiday tours in Britain,

## LOCAL CENTRE NOTES.

in Ireland (his natural home) and on the Continent, accompanied by friends and colleagues to whose entertainment he contributed by a fund of knowledge and anecdotage acquired by extensive reading. Numerous holidays in the Black Forest, Hanover, and Austrian Tyrol led to an intimate acquaintance with the myths and anecdotes of those countries, but it was the legend and history of Ireland (mainly translated from the Gaelic) and Irish life in which he revelled. He probably derived no greater pleasure than when recounting to an interested audience details of ancient Irish history, the feuds between its Kings and the love of its people.

This brief sketch cannot fittingly close without a reference to the spiritual. Born a Catholic, his faith was characterised by simplicity and devotion; none can ever know the extent to which he contributed by time and means to its advancement, while his illness and retirement were soothed by its ministrations.

W.V.R.

---

## LOCAL CENTRE NOTES.

### SOUTH LANCASHIRE CENTRE.

The Local Committee for the 1924-25 Session has been elected and the constitution is as follows:—

- Chairman: Mr. W. J. Medlyn.
- Vice-Chairman: Mr. T. E. Herbert.
- Executive Engineers: Mr. J. F. Fletcher.
- Assistant Engineers: Capt. W. Cowburn.
- Chief Inspectors: Mr. R. B. Graham.
- Clerical Staff: Mr. T. E. Matthews.
- Inspectors: Mr. H. Eaton.
- Draughtsmen: Mr. A. A. Hignett.
- Hon. Librarian: Mr. R. Towers.
- Local Secretary: Mr. G. Wildgoose.

The October, 1923, number of this journal contained a few extracts from a paper read by the Chairman of the above Centre—Mr. W. J. Medlyn—before the Students Section of the Institution of Electrical Engineers, Manchester, on March 27th, 1923.

Following on this it is interesting to note that an invitation was extended to the Vice-Chairman, Mr. T. E. Herbert, who responded by reading a paper on 8th April, 1924, the subject being "The Psychology of Management." Mr. Herbert, after acknowledging the honour conferred upon him by the invitation, gave an excellent address to the Students, who thoroughly appreciated the speaker's characteristic blend of seriousness and humour.

The following extracts indicate the trend of the address and

#### LOCAL CENTRE NOTES.

some of the conclusions drawn from the speaker's own varied experience:—

“ The ideal to be aimed at is the spirit of a cricket team where every man plays, not for his own hand, but for his side under the direction of the Captain who obtains instant, ungrudging, and cheerful obedience to his leadership. An admirable example of the exercise of authority without tyranny. It is up to you to *earn* and to *deserve* the confidence of your staff. If you expect their loyalty, then equally you must be loyal to them and support them in all their laudable undertakings. Experience has taught me that this is not merely ethics, it is a sound business proposition.”

“ To-day, the essential principles of Scientific Management are in nearly universal application, but the name is carefully avoided owing to the vast amount of prejudice—mostly of ignorance—with which its advent was greeted.”

“ The function of the Foreman is to teach, to help, to instruct and not to drive. In this way the relations between the staff are vastly improved and begin to approach the ideal of real team working. It will thus aid the cause of Industrial peace. It is founded on co-operation which demands that all shall know and all shall be taught. And so will come understanding of the rights of others as well as one's own. A cynical philosopher, writing in the New Age, defined modern methods of education as the generic name for underhand schemes for making the child learn of his own free will what he would be jolly well forced to learn anyhow! Perhaps so, but it avoids conflict! ”

“ In studying Scientific Management, then, it is clearly vital never to lose sight of the human aspect of the problem. To do so, means failure and continual controversy accompanied by suspicion and fear which ultimately lead to industrial warfare or strikes. What this may cost in the sum of human wretchedness and misery is well nigh incalculable.”

“ Full understanding generally carries with it forgiveness and so I suggest that you can always profitably spend time in discovering *why* a stupid thing has been done by a workman. Such study will usually reveal that the system in vogue may be improved, that the individual concerned requires special help in certain directions, or that his temperament is such that he works best under close control, or, on the other hand, that he should be made to understand that a certain amount of trust is reposed in him and that it is a disgrace to his manhood to betray it. The true function of the Supervisor is to help and to instruct. It is to *prevent* errors, *not* to allow them to occur and then to punish the offender. Let me make it quite clear that I am not advocating the abandonment of punishment, but I do say that when necessary it should be remedial in purpose so as to produce better results in future.”

## BOOK REVIEWS.

“The remarks to which you have listened with so much patience have been designed to bring home the fact that the human side of your problems is of vital importance. With a hostile and driven staff largely actuated by motives of fear it is quite hopeless to expect the best results. And so I want to suggest to you that it is to your interest, leaving aside all ethical considerations, to endeavour to *understand* your staff and ultimately to attain a mutually co-operative condition of team working from top to bottom.”

K.

---

## BOOK REVIEWS.

“Principles and Practice of Telephony.” By J. G. Mitchell. 5 Volumes. 12s. 6d. per Vol. Published by McGraw Hill Publishing Co., Ltd.

The five volumes of the above work cover the subject in the following manner:—

- Volume I.—Principles and apparatus.
- „ II.—Circuit elements and power plant.
- „ III.—Toll equipment, traffic and trunking.
- „ IV.—Circuit refinements and mechanical switching.
- „ V.—Mechanical manual switching.

The book has been based in part upon material which originally appeared as a “Home Study Course” in an American telephone periodical. Consequently the matter and arrangements are characteristic of America, but in our opinion that does not in any way detract from the utility of the work to British students. Vol III. in particular, which relates to Toll equipments and traffic as viewed from the American standpoint, is of great interest. Vols. I. and II. are full of valuable information relating to the general principles of telephony, and of course apply in both countries.

Throughout the five volumes the author has at the end of each chapter given a set of review questions and it has been verified that the material for answering these questions is available in the preceding chapter. It is certain that the student who is able to answer the whole of the hundreds of review questions appearing in the five volumes will be a well equipped telephone man so far as theoretical knowledge is concerned.

The last two volumes relate to mechanical switching.

The letterpress is well arranged, but some of the descriptions relate to types of equipment that are now obsolescent. Nevertheless the review questions in these volumes bring out a considerable amount of very useful information relative to the practical maintenance of an automatic exchange. It is considered that the dia-

## BOOK REVIEWS.

grams in these volumes are too small and it is thought that if a reprint is undertaken it would be worth while enlarging some of the diagrams even at the risk of adding a volume to the series.

B.O.A.

“Automatic Telephone Systems. Vol. III.: Large Multi-Office Automatic Systems; Semi-Automatic Working; Miscellaneous Systems; Lay Out and Wiring; Etc.” By William Aitken, M.I.E.E., A.Am.I.E.E. Post 4to. 339 Pages, divided into 71 Sections. Ernest Benn, Ltd. 55s. net.

The above details are imposing in themselves and in some measure indicate the magnitude of the book. They convey, however, but an inadequate idea of the mass of information contained therein and the effort and energy which have been forthcoming in producing the complete work.

In addition to the above details it is worthy of note that there are 331 illustrations, the majority of which are circuit diagrams, over 20 of the latter being “through” circuits in folder form. Descriptions of apparatus are also supplemented by photographs and drawings which are clear and adequate.

A number of the largest of the folders are detachable from the book, being normally contained in a pocket attached to the back cover. This is an excellent expedient which could with advantage be applied generally to those technical works on telephony (and many other subjects) which are not of the “arm chair” category.

There is no doubt that this volume and its two forerunners constitute a work which is unique so far as British telephone publications are concerned, covering as it does the whole field of current automatic telephone engineering.

Those to whom the present volume is available cannot but feel it a privilege to have at their disposal full explanations of the principles and detailed operation of the much discussed, but generally little known, systems of automatic working designed for large multi-office areas.

Interest in this country will largely centre on the Director system (with its important auxiliary, the Call Indicator) which is to be installed in London and the larger provincial areas. Here is revealed how automatic working can be dovetailed into the largest manual areas; can grow beside, overtake and ultimately supersede manual working; and all this with practically no change in the original subscriber's numbering scheme or external plant lay-out. These advantages are not peculiar to the Director system; they apply equally to the Panel system, the description of which follows that of the former. The sections devoted to the Panel system include its whole circuit operation and supplement the information contained in Volume I.



## BOOK REVIEWS.

A further system designed for working in busy multi-office areas will no doubt attract considerable attention. This is the Ericsson (Stockholm) system, which is in use on the Continent and which has many attractive features, including ingenious and compact switches provided with wire banks of 500-line capacity.

The three systems mentioned furnish solutions, in their different ways, to the problems of providing automatic service in large multi-office areas. Perhaps readers will speculate as to why three systems designed to the same end are so widely different in form and it would perhaps have been an advantage if the salient features of each, and the reasons for their striking diversity, could have been outlined more strongly. It may be a little confusing, for example, if the reader does not realise that the list of "Advantages of the Director System," enumerated in Section 2, are rather the desiderata of any automatic system to be suitable for introducing into the largest manual areas. They apply with almost equal force to the Panel system, if the word "Director" be changed to "Translator."

Following on the 26 sections devoted to the Director, Panel and Ericsson systems are 16 sections dealing principally with automatic aids to manual operating, including the semi-automatic systems of the Western Electric Co. (Rotary) and of the North Electric Co. (U.S.A.) and Traffic Distributors. These sections are interesting but are tending towards obsolescence on account of the vigour with which full automatic working is developing on all the five continents.

Other matters dealt with in the remaining 29 sections include metering systems with differentiation of charge according both to the duration of a call and the route over which it passes; dialling over phantom circuits; by-path systems; P.B.X. systems; an automatic system using plugs and cords, and a number of interesting miscellaneous sections. The book closes with a few brief sections on trunking and traffic problems.

A number of the systems and devices described in the later sections are not in practical use and it is doubtful if some of them ever will be in their entirety. Whilst being chiefly of academic interest, it must be conceded at once that the matters dealt with in those sections contain many suggestive ideas which might be incorporated in working systems.

The majority of the readers of this volume will no doubt be steeped in manual traditions and will be very interested and almost intrigued by the sections describing the Ericsson (British) automatic system using plugs and cords. The circuit description is complete, but the exposition of the fundamental principle of translation involving the addition and subtraction of dot and dash codes is not very clear. It is hoped that the many readers who will turn

## BOOK REVIEWS.

to these sections first will not receive wrongly and prejudge the remainder.

The book, however, contains such valuable information for engineer and student and is of such admirable quality that anything in the way of criticism in this review should be regarded as quite minor. The complete work will no doubt become a standard of reference for British and other telephone men, and it is to be hoped that it will find its place in technical and scientific libraries in this and other countries.

R.L.B.

“Where to Seek for Scientific Facts.” By Alec. B. Eason (M.A., Cantab), A.M.I.C.E., A.M.I.E.E. Published by S. Rentell & Co. 1s. net.

This compilation of 42 pages contains valuable information for the student and engineer, as it embraces an almost universal compendium of data dealing with scientific literature. Its contents may be indicated by quoting the headings to the chapters, viz., Preface, Chap. 1, Searching for books; Chap. 2, Searching for periodicals; Chap. 3, Bibliographies and Abstracts; Chap. 4, Suggestions. Scientific literature, like the operations of finance, is world-wide, and we are indebted to the author, among other things, for the work he has done in assembling in classified form a list of publications dealing with electrical subjects in most countries of the world.

“Groma: The Ancient Land Surveying Instrument.” By F. Tandy. Reprinted from the *Archæological Journal* and published at the Office of the Royal Archæological Institute.

In this pamphlet Mr. Tandy (from notes supplied by Dr. Matteo della Corte) discusses the construction and gives an illustration of the piece of apparatus used for land measuring by the Roman Arpentor or land-surveyor. The various parts of the apparatus and its use have been clearly elucidated by the aid of material discovered among the ruins of Pompeii.

“The Calculation and Measurement of Induction and Capacity.” By W. H. Nottage, B.Sc. London: The Wireless Press, Ltd. 224 pp.

The first edition of this work was reviewed in Vol. 10, Part 2. For this second edition it has been revised, partly re-written to include formulas recently obtained and new apparatus and added to by inclusion of a section giving the proofs of the formulas. These new features enhance the value of the publication and provide additional reasons for repeating our recommendation of the book to those concerned with measurements of inductance and capacity.

## BOOK REVIEWS.

“An Introduction to the Strowger System of Automatic Telephony.” By H. H. Harrison, M.I.E.E., M.I.R.S.E. Longmans. 143 pp. 7s. 6d. net

This book is intended as a first text-book for class instruction in Automatic Telephony, and is subdivided in such a way that the student having acquired a knowledge of the elementary parts of the subject progresses easily to the more complex portions.

The scope of the book is confined to the Strowger system, but this does not detract from its value, as once having mastered the Strowger system details of other step-by-step systems are quickly learned.

The book is divided into three parts, the first dealing with the elements of automatic telephony, trunking and traffic problems; while the second part is devoted to mechanisms such as dials, pre-selectors, selectors and relays, and a discussion on the effect of impulse ratio on the operation of the various switches. In the third part circuits used in group selectors, final selectors, P.B.X. final selectors, etc., are described and a brief survey is made of large area working, touching on the Director, Call Indicators, Key-senders and Mechanical Tandem operation.

All sections of the book are plentifully and excellently illustrated, the drawings of switches and mechanisms being such that the subject can be intelligently followed by the private student who cannot get to see the actual apparatus.

The book is well laid out, although it would have been preferable for the paragraph at the beginning of the description of a new circuit or piece of apparatus, to have had a heading in addition to the heading at the top of the page. This is a minor point, however, and the book can be recommended to all interested in the subject of Automatic Telephony. Mr. Harrison has tackled the intricacies of automatic telephony in the masterly manner we have become accustomed to in his treatment of machine telegraphs.

“The Thermionic Valve and its Developments in Radiotelegraphy and Telephony.” By J. A. Fleming, M.A., D.Sc., F.R.S. 2nd edition. The Wireless Press.

The first edition of this work appeared in 1919, and a review of it will be found in Vol. xii. p. 258 of this Journal. In the present edition the matter has been re-arranged and includes theoretical and practical developments made since the date of the first edition.

The book has grown to nearly double its original size and forms an extremely valuable record of progress made in the theory, manufacture, and applications of thermionic valves.

The contents may be summarised as follows:—

Chapter I. History and principles of thermionics.

## BOOK REVIEWS.

Chapter II. The Fleming rectifying valve. A theory of rectifying valves due to Prof. C. L. Fortescue and a description of recent types of rectifiers has been added.

Chapter III. The three and four-electrode valve. In addition to some account of legal proceedings, characteristics and applications included in the previous editions, descriptions are given of later types of valves, such as Marconi V<sub>24</sub> and Q types; the Western Electric Co.'s valves, four-electrode valves and those using thoriated tungsten filaments.

Chapter IV. The Theory of the Three-Electrode Valve. This is a new chapter incorporating the theory of amplifying and oscillating valves.

Chapter V. Thermionic valve construction including production and measurement of vacuum, silica and metal valves for high power, etc.

Chapter VI. Thermionic valve as a generator of oscillations.

Chapter VII. Thermionic valves as amplifiers and detectors. This chapter contains details of a number of circuits, including the Armstrong Super-regenerative circuit.

Chapter VIII. describes methods of testing valves and gives details of various laboratory uses, such as the measurement of small A.C. voltages.

Chapter IX. Thermionic Repeaters and Relays. An outline of the adoption of thermionic valves to telephone repeaters and to carrier-wave systems is given.

Chapter X. Thermionic valve plant. Descriptions are given of the circuit arrangements and mounting of various transmitting and receiving sets.

The book may be confidently recommended to those who wish to keep up-to-date in the thermionic valve development.

“ Thermionic Tubes in Radio Telegraphy and Telephony. By John Scott-Taggart. Wireless Press, Limited. 464 pages, 388 illustrations.

In this work on the application of Thermionic Tubes to radio communication the author has dealt with the subject in a progressive manner. The first two chapters deal with two and three electrode tubes respectively, giving characteristic curves and theory of operation. Chapter III. gives a very full description of the detection of radio signals, the various methods of using the grid control being carefully explained.

Regenerative Amplification, High Frequency Amplification and Low Frequency Amplification are covered in the next six chapters. The information on low frequency amplifiers is insufficient and the resistance rather than the impedance of trans-

## STAFF CHANGES.

formers is discussed. The terms Radio Frequency and Audio Frequency would be preferable to those used.

Two chapters are given to the Reception and Transmission of Continuous Waves. The use of alternating current voltage for filament heating and the methods of rectifying extra high voltage A.C. for the anode supply is fully explained in the Transmission chapter. Radio Telephony follows the chapter on Continuous Wave Transmission and the various systems of modulation discussed. Duplex telephony and the quiescent aerial circuits are also illustrated.

Negative resistance tubes are mentioned, but little is said about the magnetic control of the electron stream.

In general the book is well printed and the illustrations are in close proximity to the letterpress to which they refer. As the author mentions in his preface, there is considerable reference to the work of others, but some original work is given. The book should prove useful to anyone who is desirous of understanding how radio communication is carried out by the use of thermionic tubes.

## STAFF CHANGES.

### POST OFFICE ENGINEERING DEPARTMENT.

#### PROMOTIONS.

Name.	Grade.	Promoted to	Date.
Wilson, H. ...	Asst. Suptg. Engineer, S. Wales District.	Superintending Engineer, S. Wales District.	17-7-24
Haynes, J. H. ...	Executive Engineer, S. Mid. District.	Asst. Suptg. Engineer, S. Wales District.	1-8-24
Woollard, F. ...	Assistant Engineer, London District.	Executive Engineer, E.-in-C. Office.	20-7-24
Hunter, H. J. ...	Assistant Engineer, S. Western District.	Executive Engineer, S. Wales District.	17-7-24
Murray, J. K. ...	Assistant Engineer, Scot. West District.	Executive Engineer, Scot. West District.	17-7-24
Smith, H. D. ...	Chief Inspector, N. Wales District.	Assistant Engineer, N. Wales District.	To be fixed later.
Starkey, H. Y. ...	Chief Inspector, E.-in-C. Office.	Assistant Engineer, E.-in-C. Office.	29-7-24
Brown, C. W. ...	Chief Inspector, E.-in-C. Office.	Assistant Engineer, E.-in-C. Office.	To be fixed later.
Boddington, M. F. G. ...	Staff Officer, E.-in-C. Office.	Principal Clerk, E.-in-C. Office.	17-6-24
Young, Capt. A...	Executive Officer, E.-in-C. Office.	Staff Officer, E.-in-C. Office.	17-6-24
Kennedy, W. E. H.	Clerical Officer, E.-in-C. Office.	Executive Officer, E.-in-C. Office.	17-6-24
Ewing, W. B. ...	Clerical Officer, Scot. West District.	Hr. Clerical Officer, Scot. West District.	8-7-24

## STAFF CHANGES.

### APPOINTMENTS.

Name.	Grade.	Appointed.	Date.
Davis, H. G. Little, G. J. S. Harris, L. H. Ray, F. I. Palmer, W. T. Hudson, W. E. Yeadon, N. West, W. Perris, F. R. Cohen, I. J.	Prob. Asst. Engineers, E.-in-C. Office.	Assistant Engineers, E.-in-C. Office.	1-6-24
			1-9-24

### TRANSFERS.

Name	Grade.	Transferred.		Date.
		From	To.	
Crompton, Capt. C., O.B.E.	Superintending Engineer. Executive Engineer. do.	S.W. District.	Scot. West Dist.	1-7-24
Wakefield, J. H. M...		S.Wales District.	S.Mid. District.	9-7-24
Horner, F. H...		Scot. West Dist.	N.Wales District.	3-7-24

### DEATH.

Name.	Grade.	District.	Date.
Fleming, G. ...	Assistant Engineer,	Scot. East District.	30-6-24

### BOARD OF EDITORS.

**E. H. SHAUGHNESSY, O.B.E., M.I.E.E., M.I.R.E., Chairman.**  
 Lieut. Col. A. C. BOOTH, M.I.E.E.                      B. O. ANSON, M.I.E.E.  
 J. W. ATKINSON, M.I.E.E.                                E. H. M. SLATTERY.  
  
**W. CRUICKSHANK, M.I.E.E., Managing Editor.**  
**H. FAULKNER, B.Sc., A.M.I.E.E., Assistant Editor.**

### COMMUNICATIONS.

All Remittances and Communications should be addressed to the **MANAGING EDITOR, P.O.E.E. JOURNAL, Engineer-in-Chief's Office, G.P.O. West, London, E.C.1.**

Binding covers and copies of the Contents Index for Vol. 3 to 16 are available, and may be obtained from the local agents for 1s. 6d. and 3d. respectively. Subscribers can have their copies of Vol. 16 bound, with index included, at a cost of 3s. by sending the JOURNALS to the local agents. Orders should indicate whether the original binding with black lettering, or the later pattern in gold, is required.

The Council of the Institution of Post Office Electrical Engineers has decided to raise the price of the JOURNAL to 2s. (2s. 3d. post free) per copy. This price applies also to annual subscribers, the subscription being 9s. per annum, post free. The price to P.O. subscribers is 1s. 6d. per number. All back numbers 2s. each.

## THE INSTITUTION OF P.O. ELECTRICAL ENGINEERS.

Officers of Colonial and Foreign Telegraph Administrations who are engaged in Electrical Engineering Works may be admitted as Colonial and Foreign Corresponding Members respectively, after application.

Subscription payable annually in advance on 1st April in each year :

Colonial Members	..	...	...	...	£1 0 0
Foreign	..	...	...	...	£1 10 0

These sums include Annual Subscription to the Journal of P.O. Electrical Engineers and the supply of all Professional Papers issued during the period covered by subscription.

Forms of application for Colonial and Foreign Membership can be obtained on application to

The Secretary,  
Institution of P.O.E. Engineers,  
Room 50A,  
G.P.O. West, E.C.1

### BOOTH-BAUDOT AWARD.

The Council wishes to call attention to the "Booth-Baudot Award," which is offered annually for the best improvement in telegraph land-line apparatus or systems. The award for the year 1924 is governed by the following conditions :—

1. British subjects employed by Public Telegraph Administrations throughout the world will be eligible to compete for the award.
2. Applications for the award must be received between January 1st and March 31st, 1925, and such applications should refer to improvements made, or suggested, during the twelve months ending 31st December, 1924.
3. At the discretion of the Council of the Institution of Post Office Electrical Engineers the award may be withheld if, in the opinion of the adjudicators appointed by the Council, after full consideration of the applications received, no award is warranted.
4. Applications for the award, accompanied by full details of the improvement, should be addressed to The Secretary, The Institution of Post Office Electrical Engineers, G.P.O. (West), London, E.C.1.

R. V. HANSFORD,  
*Secretary.*

### ESSAY COMPETITION FOR WORKMEN.

The Council has decided to offer Five Prizes of Two Guineas each for the five most meritorious Essays submitted to it by workmen of the Engineering Department of the Post Office.

The conditions of the Competition are as follows :—

- (1) Competitors must be workmen or youths-in-training who have been in the employment of the Department from a date prior to 31st December, 1921.
- (2) Each Competitor may choose any subject relevant to current Telegraph or Telephone practice.
- (3) Each Essay must be written on one side of the paper only, and must not exceed 5,000 words.
- (4) The Essays must reach the Secretary,  
Institution of Post Office Electrical Engineers,  
Room 50a, G.P.O. (W), E.C.1.  
by the 31st December, 1924.
- (5) The Council reserves the right to refrain from awarding the full number of prizes if, in its opinion, the Essays submitted do not attain a sufficiently high standard.

R. V. HANSFORD,  
*Secretary.*

### CENTRAL LIBRARY.

The following books have been added to the Library and are available for issue to Members.

Applications should be addressed to the LIBRARIAN, Room 50A, G.P.O. West.

No.

783.—My Life Work. Henry Ford.

784.—Control of Speed and Power Factor of Motors. Miles Walker.

785.—Manual of Submarine Cable Testing. G. M. Baines.

CENTRAL LIBRARY.

- 786.—Electrical Measuring Instruments. C. V. Drysdale and A. C. Jolley.  
787.—Engineering Economics. Fish.  
788.—Electrical Vibration Instruments. A. E. Kennelley.  
789.—Clark Maxwell's Electro-Magnetic Theory. Lorentz.  
790.—Automatic Telephony. F. A. Ellson.  
791.— do. do. H. H. Harrison.  
49.— do. do. Vols. II. and III. W. Aitken.  
792.—Prize Essays, Workmen's Competition, 1923.  
793.—Education and Training for the Electrical and Allied Industries.  
794.—Electrolytic Rectifiers. N. A. de Bruyne.  
795.—Atoms and Rays. Sir Oliver Lodge.  
796.—Wireless Telephony and Broadcasting. H. M. Dowsett.  
797.—Telephony. Vol. I.—Principles and Apparatus. Jay G. Mitchell.  
,, II.—Circuit Elements and Power Plants.  
,, III.—Toll Equipment Traffic and Trunking.  
,, IV.—Circuit Refinements and Mechanical Switching.  
,, V.—Mechanical Manual Switching.



**O**UR great experience will help to remove care from your mind.

We have carried out many important contracts in various parts of the World, and our engineers give the best of high service and skilled attention in installation.

**HENLEY**

**TELEGRAPH AND  
TELEPHONE CABLES**

will give you every satisfaction.

*W. T. Henley's Telegraph Works Co.,  
Ltd.*

*Blomfield Street, LONDON, E.C.4.*

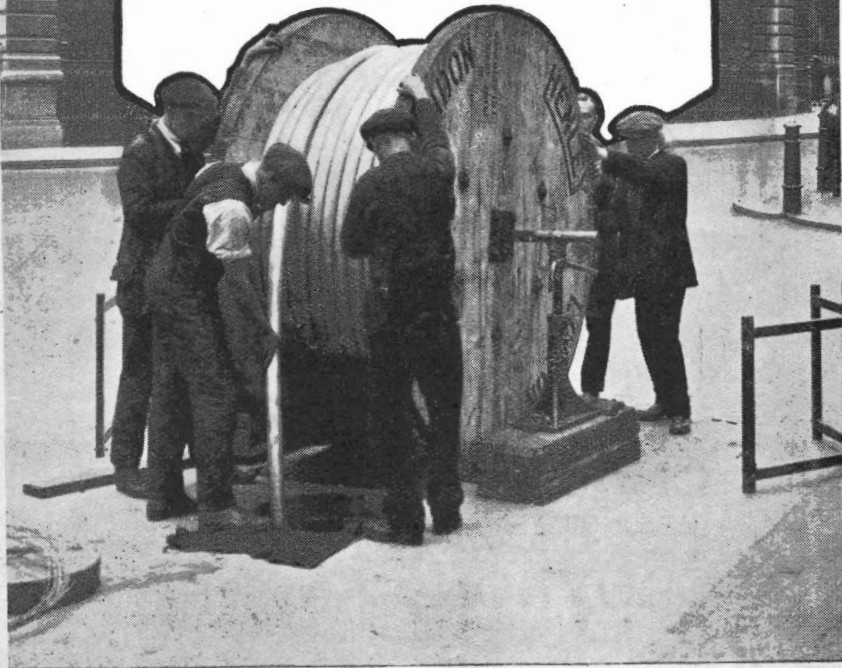

# The House of Creed

*A Selection of its World-Famous Products*

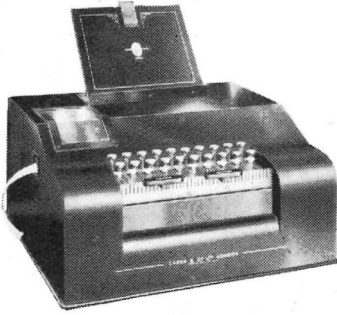

## THE CREED DIRECT PRINTER.

A direct printing telegraph operated from a typewriter keyboard using no perforated slip, and working up to a speed of 70 words per minute. It is designed for use on less important main lines, by banks, factories, railways, etc., and can be duplexed. It has an excellent touch, without any irritating key-locking devices for restricting the speed of the operator. The standard Creed type-head is used on this machine.

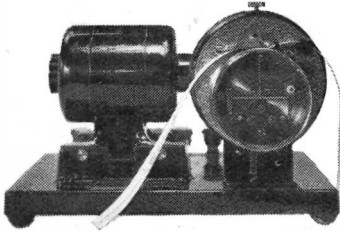

## CREED-WHEATSTONE TRANSMITTER.

Well made, simple, and easy to work, these wonderful little Transmitters are being used all over the world. Their simple design makes it possible for them to be offered at a special low price.

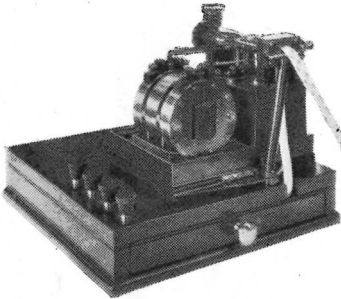

## CREED CABLE RECEIVER.

A development of our standard Receiver for use with Cable Code transmission. Speeds up to 100 words per minute are attainable, and the standard Creed Printer can be modified to work in conjunction with this Receiver.

CREED & CO., LTD.,  
*Telegraph Works,*  
 CROYDON, SURREY.

PHONE:  
 CROYDON 2102.

TELEGRAMS:  
 CREDO, CROYDON

# The House of Creed

*A Selection of its World-Famous Products*

## CREED LINE RELAY (1924 Design).

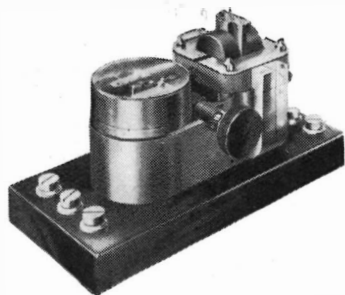

Designed for use where high sensitivity is required combined with robustness and stability of adjustment, firm contact pressure, absence of rebound and short transit time. It will considerably increase the working speed of long telegraph lines, and is in every way a greatly superior Relay to the "B" type so long adopted as standard by Government and Private Administrations. This Relay, when suitably wound, will operate with great efficiency in the anode circuit of a wireless telegraph receiving set.

## CREED RECEIVER AND PRINTER.

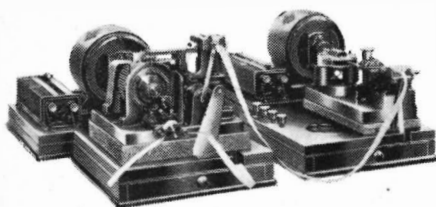

The Creed High-Speed Telegraph System still holds its pre-eminent position as the most reliable and speedy means of handling telegraph traffic in bulk. There are over six hundred Creed installations, giving full service on cables, long land-lines, and wireless routes throughout the world. The Printer is now manufactured to print in column form upon a web of paper, and is proving very popular.

## CREED COLUMN PRINTER.

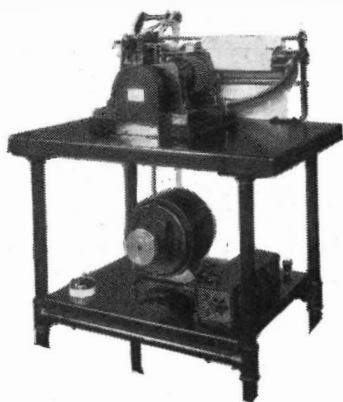

A fast printing Morse slip controlled machine. Prints in large clear type upon a web of paper 8" wide; visible up to and including the last word. The price of this machine also includes the special strongly made pedestal table. Speed 100 words per minute.

CREED & CO., LTD.,  
*Telegraph Works,*  
CROYDON, SURREY.

PHONE:  
CROYDON 2102.

TELEGRAMS:  
CREDO, CROYDON.

# INDEX TO ADVERTISERS.

	PAGE
Annales des Postes, Telegraphes et Telephones	viii
Automatic Telephone Mfg. Co., Ltd.	iii
British L.M. Ericsson Mfg. Co., Ltd.	v
Creed & Co., Ltd.	xii and xiii
Henley's, W. T., Telegraph Works Co., Ltd.	xi
Johnson & Phillips, Ltd.	xvi
London Electric Wire Co. & Smiths, Ltd.	ii
Longman, Green & Co., Ltd.	xiv
Peel-Conner Telephone Works, Ltd.	xv
Pitman & Sons, Ltd.	ii
Rentell, S., & Co., Ltd.	ix
Siemens Bros. & Co., Ltd.	vi and vii
Smith, Frederick, & Co.	viii
The Electrical Review, Ltd.	iv and ix
Western Electric Co., Ltd.	x
Wireless Press, Ltd.	xiv

## JUST PUBLISHED.

# An Introduction to the Strowger System of Automatic Telephony

By H. H. HARRISON, M.I.E.E.,

Member Institution Railway Signal Engineers, Author of "Printing Telegraph Systems and Mechanisms." With 161 Diagrams. 8vo.

7s. 6d. net.

LONGMANS, GREEN & Co., 39, Paternoster Row, London, E.C. 4.

## JUST PUBLISHED.

# FIFTY YEARS OF ELECTRICITY:

## THE MEMORIES OF AN ELECTRICAL ENGINEER.

By J. A. FLEMING, M.A., D.Sc., F.R.S.

731 Pages

Crown 4to.

111 Plates.

NET  
PRICE

**30/-**

(Postage 1/-)

### CONTENTS:

Introduction.—Telegraphs and Telephones from 1870 to 1920.—Dynamo, Alternators, Transformers and Motors, from 1870 to 1920.—Electric Lamps and Electric Lighting in the last Fifty Years.—Electric Heating, Cooking and Furnaces in Five Decades.—Electric Supply Stations, Storage Batteries, Railways and Transmission of Power.—Electric Theory and Measurements.—Wireless Telegraphy and Telephony.—Conclusion.

Send a Postcard for full Prospectus of this Book

**THE WIRELESS PRESS, LTD., (Dept. E. R.)**

**12-13, Henrietta Street, Strand, London, W.C.**

# PEEL-CONNER TELEPHONE WORKS

(Proprietors—The General Electric Co., Ltd.)

## COVENTRY, ENGLAND.

MANUFACTURERS  
AND INSTALLERS  
OF HIGH GRADE

### AUTOMATIC

AND

- MANUAL -

### TELEPHONE

### EQUIPMENT

Visit the G.E.C. Stand at the British Empire Exhibition and see the Peel-Conner Model Automatic installation in operation.

The G.E.C. Stand is in Avenues 11 to 13—  
Bays 11 to 15.

HEAD OFFICE  
AND WORKS:

STOKE, COVENTRY.

Telephone: COVENTRY 1310.

Telegrams:

“SPRINGJACK,” COVENTRY.

LONDON OFFICE:

MAGNET HOUSE,  
KINGSWAY, W.C.2.

Telephone: REGENT 7050.

Telegrams:

Peelcontel, Westcent, London.”

**Upwards of 1000 miles  
of recently laid Trunk Tele-  
phone Cables have been man-  
ufactured and laid by us - -**  
That is a fact which must be of  
special interest to the Post Office  
Engineer.

It implies the confidence  
of those who are responsible  
for the National Telephone  
Service—it is striking evidence  
of our experience, and it  
should influence Dominion  
and other authorities to entrust  
us with their orders.

**Johnson & Phillips, Ltd.**

*Cable Makers since '75,*

**Charlton, London, S.E.7**

*City Office and Stores—*

*12, Union Court, Old Broad Street, E.C.2.*

