

THE POST OFFICE ELECTRICAL ENGINEERS' JOURNAL



**VOL. 20
PART I**

**APRIL
1927**



Price 1/6 net.

ADVERTISEMENT INDEX
see page xii.

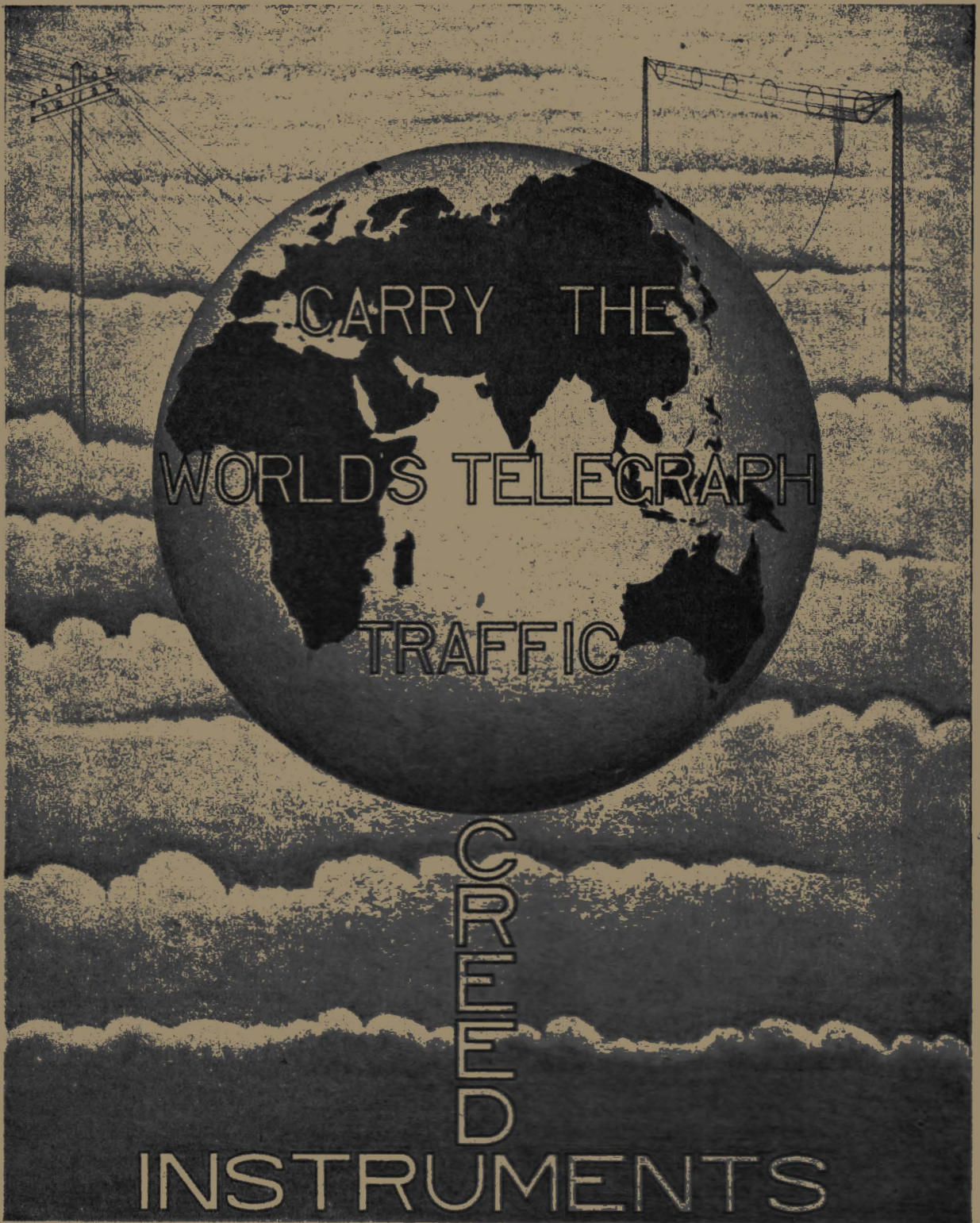

SYSTEMS

1. The Creed Standard for Wheatstone circuits.
2. The Creed Start-Stop for "typewriting by telegraph."
3. The Murray Multiplex—the "5-unit channel system."

CREED & Co., Ltd., Telegraph Engineers, Croydon, Surrey.

Telephone: Croydon 2121.

Telegram: "Creed, Croydon."

3

3

NOTABLE A.T.M. (STROWGER) P.A.X. INSTALLATIONS IN GREAT BRITAIN.

THAT HA'PORTH OF TAR

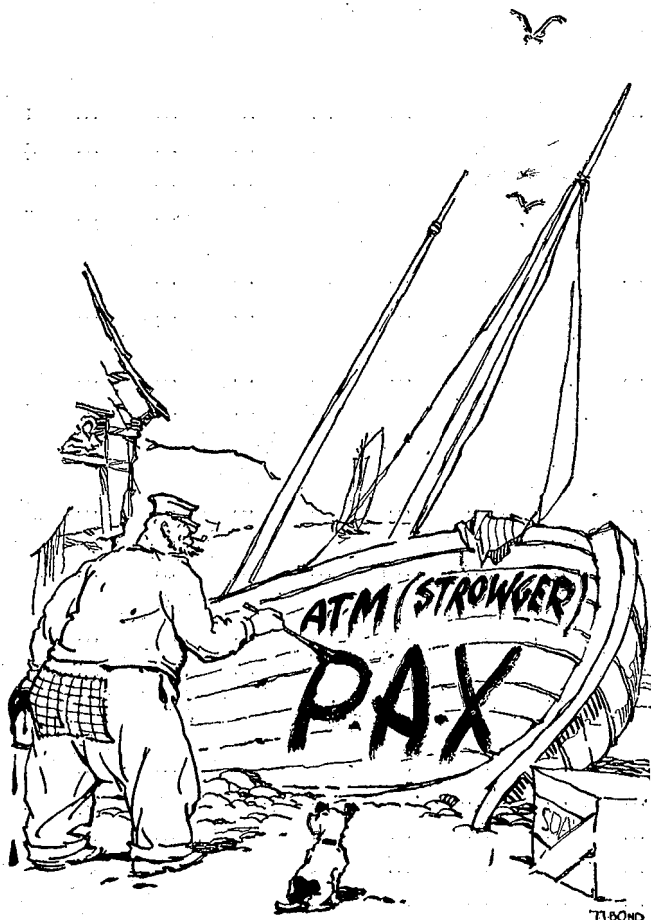

“ Don't spoil the Ship for a Ha-porth of Tar ” is a familiar adage the world over, and it is self-evident that Messrs. Cammell Laird & Co., the well-known Shipbuilders, of Birkenhead, England, have acted up to the spirit of this advice.

They did not intend to penalize their main industry by the retention of inferior methods of communication; in other words they have not spoilt their ships for lack of an A.T.M. (Strowger) P.A.X. to efficiently link-up the departments engaged on their construction.

An A.T.M. (Strowger) P.A.X. was installed at Messrs. Cammell Laird's Yards in 1918.

AUTOMATIC TELEPHONE
MANUFACTURING COMPANY LTD.

STROWGER WORKS
MILTON ROAD
EDGE LANE



LONDON OFFICE
NORFOLK HOUSE
NORFOLK STREET

LIVERPOOL

STRAND, W.C.2

ENGLAND

ASSOCIATED COMPANY: INTERNATIONAL AUTOMATIC TELEPHONE CO. LD., LONDON

A.T.M. (STROWGER)

The Post Office Electrical Engineers' Journal.

A QUARTERLY JOURNAL.

CONTENTS FOR APRIL, 1927.

COPYRIGHT.—The entire contents of this Journal are covered by general copyright, and special permission is necessary for reprinting long extracts, but Editors are welcome to use not more than one third of any article, provided credit is given at the beginning or end thus: "From the 'Post Office Electrical Engineers' Journal.'"

	PAGE
THE C.C.I. TELEGRAPHS, 1926—A. C. BOOTH	1
SPEEDS OF WHEATSTONE TELEGRAPH TRANSMITTERS—A. C. BOOTH	4
THE MEASUREMENT OF TELEGRAPH SPEEDS	4
A KEYBOARD PERFORATOR FOR BAUDOT CIRCUITS—A. C. BOOTH	5
TANDEM AND HOLBORN AUTOMATIC EXCHANGE POWER PLANT—P. B. FROST, B.Sc. (Eng.); A.M.I.E.E.	9
TIME SAVING TESTERS—W. PRICKETT and H. S. SMITH	19
THE TRAFFIC-OFFICE OF THE MUNICIPAL TELEPHONE SERVICE AT AMSTERDAM— DR. IR. CH. E. A. MAITLAND	22
TELEGRAPH AND TELEPHONE PLANT IN THE UNITED KINGDOM	35
THE PACIFIC CABLE BOARD'S CABLE—BAMFIELD (VANCOUVER)—FANNING ISLAND... ..	36
SUBMARINE INSULATION WITH SPECIAL REFERENCE TO THE USE OF RUBBER— R. R. WILLIAMS and A. R. KEMP	41
SOME ASPECTS OF THE ELECTRIC CAPACITY OF TELEPHONE CABLES—A. MORRIS, A.R.C.S., D.I.C., Wh.Ex., M.I.E.E.	43
TRANS-ATLANTIC TELEPHONY—A SHORT HISTORY OF THE DEVELOPMENT OF THE SERVICE—Lt.-Colonel A. G. LEE, M.C., M.I.E.E., M.I.R.E.	52
THE LONDON-NEW YORK TELEPHONE CIRCUIT—R. V. HANSFORD, D.Sc.	55
TRANS-ATLANTIC TELEPHONY—THE POST OFFICE DIFFERENTIAL VOICE-OPERATED ANTI-SINGING EQUIPMENT—C. A. BEER, Wh. Sch., A.C.G.I., and G. T. EVANS	65
NOTES AND COMMENTS	73
HEADQUARTERS NOTES	75
LONDON DISTRICT NOTES	77
LOCAL CENTRE NOTES	78
BOOK REVIEWS	88
STAFF CHANGES	92
COMMUNICATIONS	94

All communications with regard to advertisements to be addressed to:

The Advertisement Manager,
Post Office Electrical Engineers' Journal,
4, Ludgate Hill, London, E.C.4.

PUBLISHERS:

THE ELECTRICAL REVIEW, LTD., 4, LUDGATE HILL, E.C.4.

Single copy 1/6 net, post free, 1/9.

Annual Subscription, postage
inclusive, 6/-, payable in advance.

**Telephone
Pioneers**

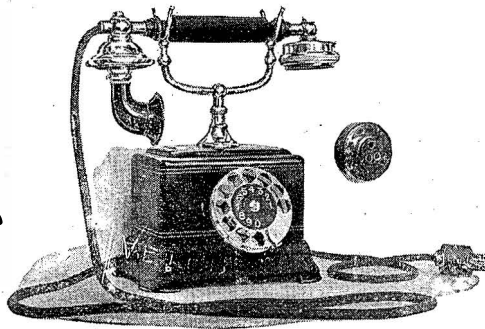

*and still
leaders*

EVER since the late L. M. Ericsson started his tiny workshop over fifty years ago, Ericssons have held a leading position in the telephone world.

The accumulated manufacturing and technical experience of 50 years is therefore at your service *without extra charge!*

Telephone Engineers throughout the world recognise the outstanding merits of "Ericsson" products.

Q *When you require estimates and quotations kindly let us know. Lists and fully informative literature sent post free. Write to-day:*

ERICSSON TELEPHONES LTD.,

67/73, KINGSWAY, LONDON, W.C.2.

Ericsson

TELEPHONES

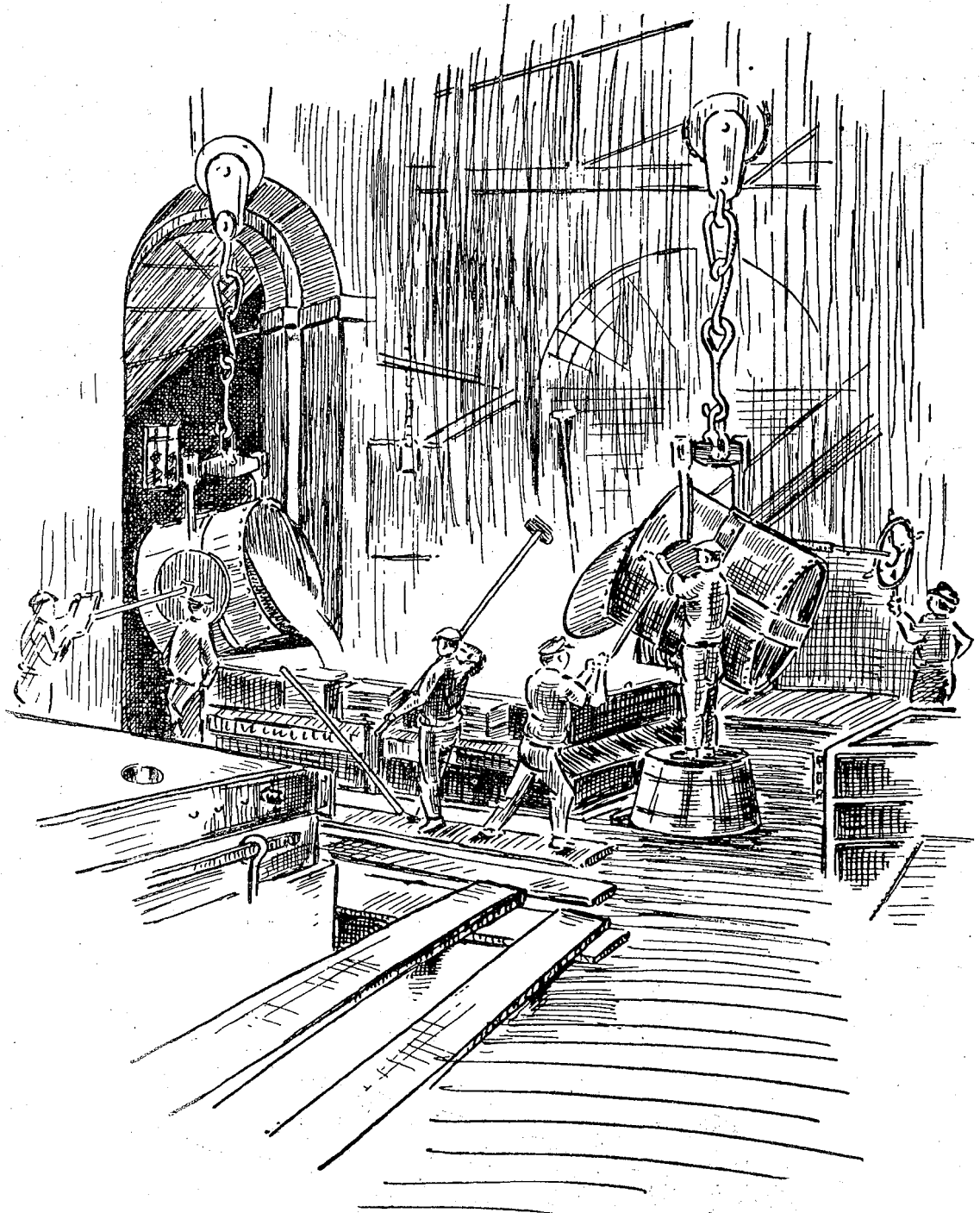

Sheffield the Steel City of the World

The Steel Industry of Sheffield owes much to the late SIR WILLIAM SIEMENS, D. C. L., F. R. S., etc., whose discoveries made the open hearth process of steel manufacture possible.

*It is therefore appropriate that the **Automatic Telephone System** in the **Sheffield area**, inaugurated on March 5th, should have been designed, manufactured and installed by Messrs. Siemens Brothers & Co., Ltd., of which company SIR WILLIAM SIEMENS was the founder.*

This telephone exchange area is the largest in Great Britain to be changed over to automatic working at one time. It comprises 9 exchanges having a total capacity of 18,970 lines equipped.

SIEMENS

AUTOMATIC TELEPHONES

SIEMENS BROTHERS & CO., LTD., Woolwich, S. E. 18.

Representation Abroad: Winnipeg, Rio De Janeiro, Cairo, Khartoum, Cape Town, Johannesburg, Melbourne, Sydney, Brisbane, Adelaide, Perth, Hobart, Wellington, Auckland; Tokyo, Calcutta, Bombay, Madras, Ipoh (Perak, F. M. S.) The Hague

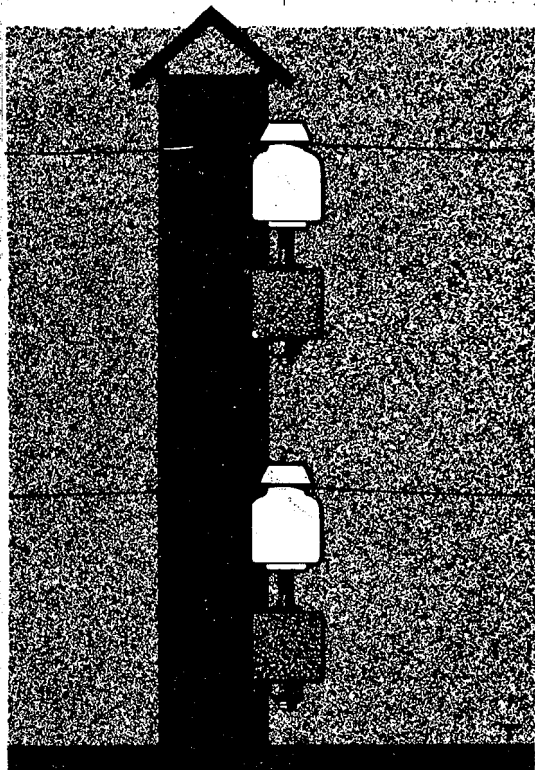

INSULATORS FOR THE G.P.O

The name of Taylor Tunnicliff and Co. has been associated with the manufacture of the best electrical porcelain for nearly sixty years.

During this long period of research and improvement, a vast amount of study and experimenting has been given to the needs of Postal Departments all over the World.

Consequently, we are in a position to supply High Grade Porcelain Insulators of all patterns which for electrical perfection, reliability, strength and durability, can be guaranteed.

For telegraph and telephone line insulation, consult experienced porcelain manufacturers, the superiority of whose products have kept them at the head of the market for over half a century.

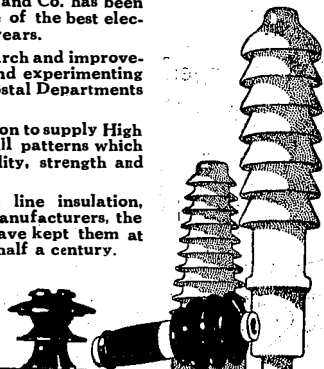

TAYLOR TUNNICLIFF

AND COMPANY, LIMITED.

Head Office: EASTWOOD, HANLEY, STAFFS.

Telephone: Hanley 2012. Telegrams: Eastwood, Hanley.

London Office: 110, CANNON STREET, E.C.4.

Telephone: City 6620.

THE ELECTRICAL REVIEW.

To the progressive Post Office Electrical Engineer the "REVIEW" offers the best means of keeping abreast with modern developments, not only in his own section of the industry, but also in every sphere in which electricity is employed both here and abroad.

Price 6d. weekly from all newsagents,
or 8d. post free.

THE ELECTRICAL REVIEW,
4, Ludgate Hill, London, E.C.4.

Books for Post Office Engineers.

The Telegraphists' Guide, by Bell & Wilson. 8th Edition, Revised and brought up to date by W. Cruickshank.

3s. 9d.

Telephone Erection and Maintenance. A Handbook for the Contractor and Wireman, by Herbert G. White. Third Edition. Cloth, 8vo.

3s. 9d.

Telephone Troubles and How to Find Them. 19th Edition. A very useful work.

10d.

The Creed Pocket Book of Reference. For Telegraph Operators and Mechanics. A real compendium of useful reference for telegraphists.

1s. 2d.

The Hughes & Baudot Telegraphs, by Arthur Crotch. A clearly written and well illustrated work.

2s. 9d.

Electric Bells, Alarms, and Signalling Systems, by H. G. White. A practical textbook for all engineers handling this class of work. 2nd Edition. 113 pp.

3s. 9d.

Elementary Determinants for Electrical Engineers, by H. P. Few. A simple explanation of the application of determinants to Telegraphy, Telephony, etc. Cloth, 8vo. Illustrated.

4s. 4d.

Questions and Solutions in Telegraphy and Telephony, by H. P. Few. Model Solutions to the Grade I. C. & G. Exams, 1904-1909 and 1925, and to typical questions set at the P.O. Exams. for Overseerships. 350 pages. 233 illustrations.

6s. 11d.

All post free at prices stated, send direct.

S. RENTELL & CO. LTD.

37c Maiden Lane, London, W.C.2.

“Where the Cables come from”

Where many thousands of miles of telephone cables have been manufactured.

In 50 years that factory has grown beyond recognition—in 50 years the fame of its products has spread throughout the World—

In 50 years we have gathered an experience which should and does add greatly to the worth of our productions.

And to-day, as ever, that “little more” in quality which means so much in service is ensuring us an ever-widening trade.

May we have your enquiries?

Johnson & Phillips, Ltd.

C HARTON,

LONDON,

S.E.

7.

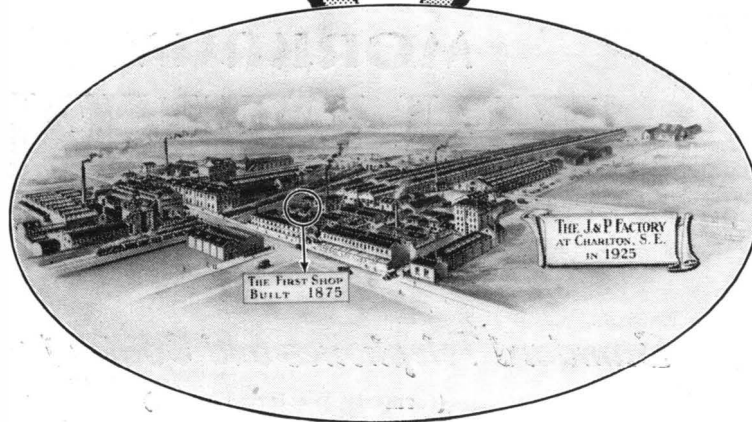

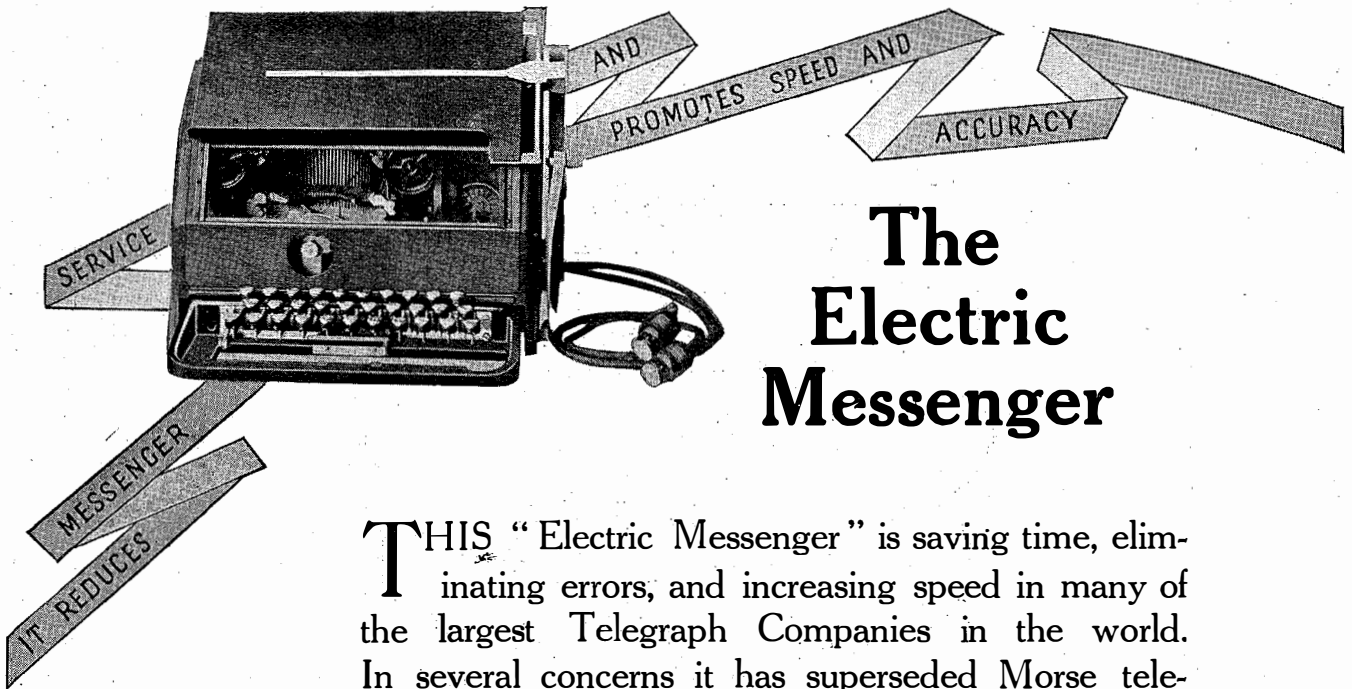

The Electric Messenger

THIS "Electric Messenger" is saving time, eliminating errors, and increasing speed in many of the largest Telegraph Companies in the world. In several concerns it has superseded Morse telegraphy for the handling of telegrams over long-distance lines. For shorter distances it is rapidly replacing messenger boys. It will reproduce a typewritten message simultaneously in any number of places; the message being printed on a narrow paper ribbon or tape which is easily attached to a sheet of paper, an order form, or a report blank. Booklet or full particulars will be sent on application.

MORKRUM TELETYPE

TYPEWRITES BY WIRE.

SOLE AGENTS:

Standard Telephones and Cables Limited

(formerly Western Electric)

Connaught House, Aldwych, London, W.C.2.

Central 7345 (10 lines).

Works: { HENDON.
NORTH WOOLWICH. NEW SOUTHGATE,

Branches: Birmingham, Leeds, Manchester, Glasgow, Liverpool and Dublin.



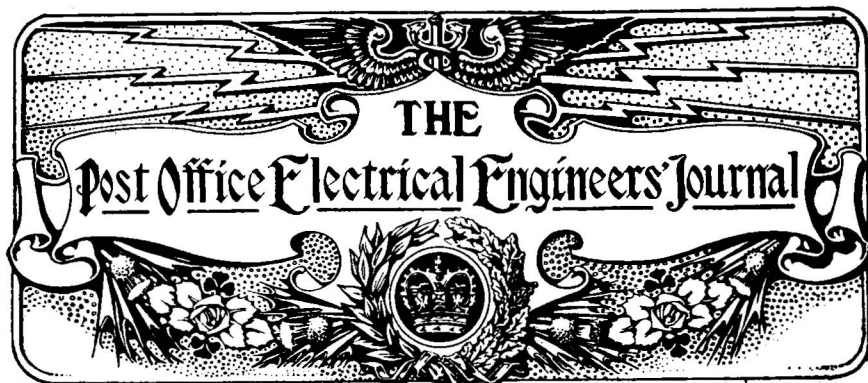

THE C.C.I. TELEGRAPHS, 1926.

A. C. BOOTH.

THE International Consultative Committee on Telegraphic Communications, now generally referred to as the C.C.I. Telegraphs, to distinguish it from the somewhat similar body known as C.C.I. Telephones, had its first meeting in Berlin during the first fortnight of November, 1926.

Delegates were present from most administrations, including China, Japan and Mozambique, also from Cable Companies, Radio Companies and from manufacturers of telegraph apparatus. The absence of representatives from the great telegraph concerns of the United States was noticeable. With the officials of the

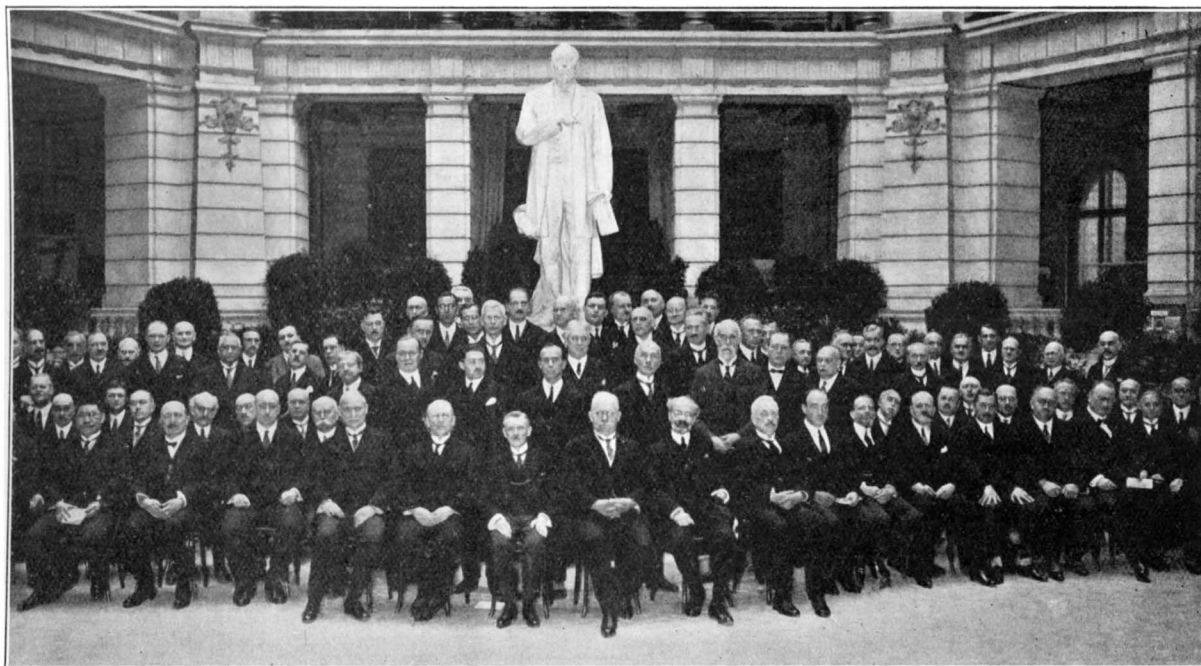

FIG. 1.—BERLIN, NOVEMBER, 1926.

The few notes which follow are intended to convey some idea of the extent of this Committee, the matters that were discussed and the progress made.

German Administration who attended the Committee meetings the number totalled to about 100.

The first photograph shows a view of the first

meeting in the large hall of the Museum of the German Post and Telegraph Administration, where are housed large models of the most important Post Offices in Germany, samples of most types of telegraph apparatus, uniforms of officials of many years ago, models of old-fashioned mail coaches and even of the modern Zeppelins. The British delegates do not appear in the photograph as they were, with others, placed too far to the left of the position to come within the range of the camera. At this meeting His Excellency Dr. Stingl, the German Minister for Posts and Telegraphs, who is seated in the centre of the front row in the photograph, received the delegates and gave an address of welcome, after which he received the delegates individually. The motor-bus service of the Post Office was used to convey the delegates to the Institute of German Engineers, shown in the second photograph, where all the meetings of the Committee were held.

The Agenda for this meeting was an extensive one, needing considerable preliminary study and discussion. It was as follows:—

A. *Technical.*

1. Characteristics of Telegraph communications.
2. Unification of the fundamental methods of working Telegraph Apparatus.
 - (a) Standardisation of working speeds.
 - (b) Unification of Telegraph alphabets.
 - (c) Construction and working of standard apparatus.
3. Co-existence of Telegraph and Telephone circuits in the same cable.
4. Rules for the construction of aerial lines.
5. Protection of Telegraph lines against the effects of Power circuits.

B. *Traffic arrangements.*

1. Rules for working High-speed and Duplex circuits.
2. Traffic rules, abbreviations, etc.

C. *Organisation of the Committee.*

At the first meeting of the Committee Herr Arendt, Ministerialrat of the Postministerium, Berlin, was unanimously elected President, and sub-committees were formed to expedite the work as much as possible.

Regarding the item A.1, it was decided to recommend the adoption of a new speed unit to

be known as the "Baud" in honour of the great telegraphist Emile Baudot.

This unit will be used for all types of apparatus and is easily translated into "words a minutes," "cycles a second" or into other ways of expressing speeds of telegraph working. The Baud is the number in a second of the shortest signal transmitted. For the Morse or Wheatstone system this will be the number of "dots" added to the equivalent spaces transmitted in one second; for the Baudot or similar systems it will be the number of line segments traversed by the Distributor brush in one second. Thus, Wheatstone at a speed of 100 words a minute will be a speed of 80 Bauds, a Baudot Distributor having 22 segments and turning at 180 revolutions per minute will be a speed of 66 Bauds, and a frequency of 20 cycles will be 40 Bauds. This item of the Agenda was not completed and it has been arranged for the Reporters of the various Administrations interested to collect further information for consideration by the next C.C.I. Telegraphs, recommended to take place in the autumn of this year at Como, Italy.

Regarding A.2, with its sub-sections, there was not sufficient time to deal with (a) and (c) and even (b) was not completed, although considerable progress was made with a difficult and highly contentious subject. The international signal for "Full-stop" in Morse is still the three letters "I, I, I," which is not suitable for use with the Creed Printing Telegraph system. It was therefore unanimously agreed to recommend a change to that already in use in this country, viz., "dot dash dot dash dot dash." The "Comma" signal is in use to some extent on the Continent and it was agreed to recommend the use of the Exclamation signal, "dash dash dot dot dash dash," for this purpose, whilst abandoning entirely the use of an Exclamation character.

With regard to the Hughes instrument, which is being rapidly displaced by more useful systems, it was recommended that no changes should be made on account of the cost and inconvenience that would result for a possible very small improvement in working.

The 5-unit code was productive of a great deal of comment and on account of the very large extension of its use throughout the world during the last few years it is the one that requires

urgent settlement. In this country there are already five 5-unit codes in use, viz. :—

1. Baudot, Foreign.
2. Baudot, Inland.
3. Murray, with two space keys.
4. Western Electric, with one space key.
5. Siemens.

Suggestions were made to provide yet another 5-unit code to displace all of the foregoing, also for a 6-unit code, but it was finally agreed to consider a modification of the Baudot code to make it suitable for modern requirements with the minimum possible alteration.



FIG. 2.—HAUS DES VEREINES DEUTSCHER INGENIEURE
IN BERLIN.

Naturally the French and Belgian Administrations, with the very large number of trained Baudot operators and their numerous Baudot circuits, would suffer very great inconvenience and expense in making any changes that may be considered desirable. As the proposal is to apply only to new circuits the disadvantage is not so great to commence with and will automatically grow less as time goes on. The uniformity thus obtained will, in a matter of a few years, amply repay for the cost and inconvenience that will arise for a short period in varying degrees to all administrations con-

cerned. The matter was not concluded and is to be further considered at the next meeting.

With regard to A.3, this matter has to be considered in conjunction with the recommendations of the C.C.I. Telephones, who are more concerned than the C.C.I. Telegraphs, from the point of view that telephone circuits do not interfere with telegraph circuits, while the latter are liable to prejudice very seriously the good working of telephone circuits if certain technical requirements are not fulfilled.

Representatives of both C.C.I. Telegraphs and C.C.I. Telephones are to continue with this matter for the next meeting, on the basis that both systems are to work in the same cable. Consideration is also to be given to the allocation of the bands of frequencies for carrier currents.

The item A.4, dealing with the continuous insulation of land lines, brought forth several opinions strongly in favour of this procedure for circuits which were affected by climatic conditions, and the discussion will be continued.

The item A.5, dealing with the protection of telegraph lines from the effect of power circuits, was not finished, but it was agreed that the conditions should closely follow the requirements on the same subject already under the consideration of the C.C.I. Telephones, with suitable additions or alterations to allow for the different conditions of Telegraph circuits.

The item B.1, for working High-speed and Duplex circuits, was thoroughly discussed and the resulting rules to be recommended follow very closely those made for use in this country prior to 1906 and embodied in the Post Office Technical Instruction on the Hughes Printing Telegraph system, as the result of years of experience of this method of working. They remain equally effective to-day and it will be an all-round advantage for all Administrations to have similar rules.

Numbering of telegrams, instead of sending them in batches of ten or less, is recommended and various methods have been put down for trial by the Administrations and Cable Co.'s willing to make trials on the different classes of telegrams.

The item B.2, dealing with Traffic rules, abbreviations, etc., is to be studied further and reported on at the next meeting.

The item C.1, on the Organisation of the

Committee, dealt with expenditure and procedure as well as the arrangements for the next meeting. It was decided that the Italian Administration should be asked to undertake the work and provide for a meeting in the autumn of 1927. The German Administration would continue with the correspondence for about six months and then hand over all matters to the

Secretary of the new Committee, which would hold its meetings at Como.

[It has just recently been decided to postpone the next meeting until the spring of 1928, on account of the International meeting on Radio matters to be held at Washington in the autumn of this year.]

SPEEDS OF WHEATSTONE TELEGRAPH TRANSMITTERS.

A. C. BOOTH.

ALL those who are acquainted with the Wheatstone method of working are well aware that the speed of the instrument is generally measured by passing through it a perforated tape ten feet long and then dividing 3,000 by the number of seconds occupied by the tape in passing through. The result obtained is the "speed in words a minute."

Another and simpler way for moderate speeds is to count the number of revolutions of the guide-wheel under which the perforated tape passes. This wheel has 20 teeth and will therefore in one revolution pass through 20 complete reversals, or five-sixths of a word. Therefore the number of revolutions of this wheel in 50 seconds is the speed in "words a minute" on the Wheatstone basis of calculation. It is of

course more convenient to take the number of revolutions in 25 seconds and double it. The wheel can be conveniently marked on its side, or a file-cut made in its rim for the convenience of counting revolutions by very lightly touching the rim with the finger.

If the wheel had 24 teeth, one revolution would have been equal to one word, and counts could then have been made for 10, 15, 20 or more seconds, depending on the accuracy required. Arrangements have been made to alter this wheel to 24 teeth for some new instruments, and perhaps later on the older ones will also be altered as they come in for repair if the additional convenience justifies the extra cost, which, however, is not great.

THE MEASUREMENT OF TELEGRAPH SPEEDS.

THE Wheatstone System:—In this system a perforated paper tape with the Morse signals is passed through the transmitter. The fundamental unit of measurement is the distance between centre holes, of which there are ten per inch, or one hundred and twenty per foot. In the punched tape a dot and its space signal are formed whilst the tape between two centre holes passes through the transmitter; the dot is therefore one-twentieth of an inch long, as also is a space. A dash and its space take up three-twentieths and one-twentieth of an inch respectively, whilst a letter space takes up the space of the previous signal plus one-tenth of an inch, or three-twentieths of an inch. In considering the

number of reversals, a dot and its space may be considered a complete cycle at the fundamental frequency in terms of sine waves, it being understood that for well-shaped signals certain harmonics are also present. One cycle therefore corresponds to one-tenth of an inch.

It is stated in the Telegraph Diagram Book that five average words go to a foot of tape, so that one average word is 120 divided by 5, or 24 centre holes long.

For example, 90 words per minute correspond to 90×24 or 2160 centre holes per minute or 36 per second; 90 W.P.M. therefore correspond to a fundamental frequency of 36 cycles per second.

Measurement of speed with stop watch:—

The author's stop watch has an outer scale for timing speeds taken over a quarter of a mile distance reading in miles per hour, which he uses in the following manner:—Three feet of slip are measured off on the base of a Wheatstone receiver; this length will contain fifteen average words and is timed by the stop watch, the speed in miles per hour corresponding to the number of words per minute. This will be seen best if, for example, the slip took exactly 15 seconds; the watch would read 60 miles per hour, since a quarter mile in 15 seconds is a mile in one minute or 60 miles an hour, and 15 words in 15 seconds is 60 words in one minute. For speeds over 60 W.P.M. it is found more accurate to take the time of 6 feet of slip and double the reading in miles per hour to give words per minute.

Baudot System:—In this system, taking the Quadruple Duplex as an example, a brush passes over 22 segments 180 times a minute or 3 times a second. Twenty segments are used for 4 letter signals and 2 for correction of speed. Each letter consists of combinations of 5 signals, there being no spacing interval. In order to get the fundamental reversing frequency, consider alternate arms sending the letter "T" and the letter "G." This will make alternate segments positive and negative, hence the cycle

will correspond to two segments or one revolution to 11 cycles, and therefore when running at 180 revolutions per minute or three per second the equivalent fundamental frequency will be 33 cycles per second.

If the average word has five letters, in the Baudot system this will require an extra signal for the space between the words or six signals per word or six revolutions per word for each channel; one word, therefore, takes 2 seconds or each channel will give 30 words per minute or four channels 120 words per minute and if duplexed this number of words in each direction.

Comparison of Baudot and Wheatstone:—Quadruple Baudot corresponds to 33 cycles per second for 120 words per minute. What is the Wheatstone speed corresponding to 33 cycles per second? From what has been said before, it will be seen that the number of words per minute multiplied by 4 and divided by 10 will give cycles per second (since 24 cycles go to a word and 60 seconds to a minute). Conversely cycles per second multiplied by 10 and divided by 4 will give words per minute. Hence 33 cycles per second correspond to $82\frac{1}{2}$ words per minute; from this it will be gathered that apparently in this respect the Baudot system is superior to the Wheatstone system.

E.S.R.

A KEYBOARD PERFORATOR FOR BAUDOT CIRCUITS.

A. C. BOOTH.

WITH the rapid extension of the use of the typewriter for writing purposes and the development of machine telegraphy in the place of the direct hand-signalling method of the Morse key, or the stick-perforator of the Wheatstone system, it was inevitable that the typewriter machine would soon be adapted to the telegraph system, which after all is only a means for "writing at a distance," and should therefore be done by a typewriter capable of being worked at a distance. That has, in fact, been the development during recent years and has necessitated very important departures in many of the main features of the older telegraph systems. These departures were rather serious handicaps to the introduction of the newer

systems and it was therefore desirable, if at all practicable, to introduce a machine with the typewriter form of operation which would be suitable for actuating receiving apparatus already in use, provided of course that this very great advantage was not outweighed by other serious disadvantages.

The first telegraph keyboard perforator date well back into last century, before the arrangement or lay-out of the keys had been standardised to the extent that has now been attained.

As far as the British Post Office, Inland Telegraph service, is concerned, a standard lay-out of the keys on keyboard perforators and on telegraph typewriters has been adopted. The chief feature of this arrangement is that ther

are only three rows of keys for characters, with two combined space and change levers situated in front to allow for the use of one or other of the two characters assigned to each of the other thirty keys. This arrangement is eminently suitable for the use of the 5-unit code of Murray, Siemens, or of others of the kind, but was not applicable to the Baudot code of the 1870 period,

After the "Letter" key has been depressed, the back row of keys will perforate holes corresponding to the Baudot code Q W E R T Y U I O P, but after the "Figure" key has been depressed these same keys produce figures in the correct numerical order in the Baudot code and have different perforations from the corresponding letters.

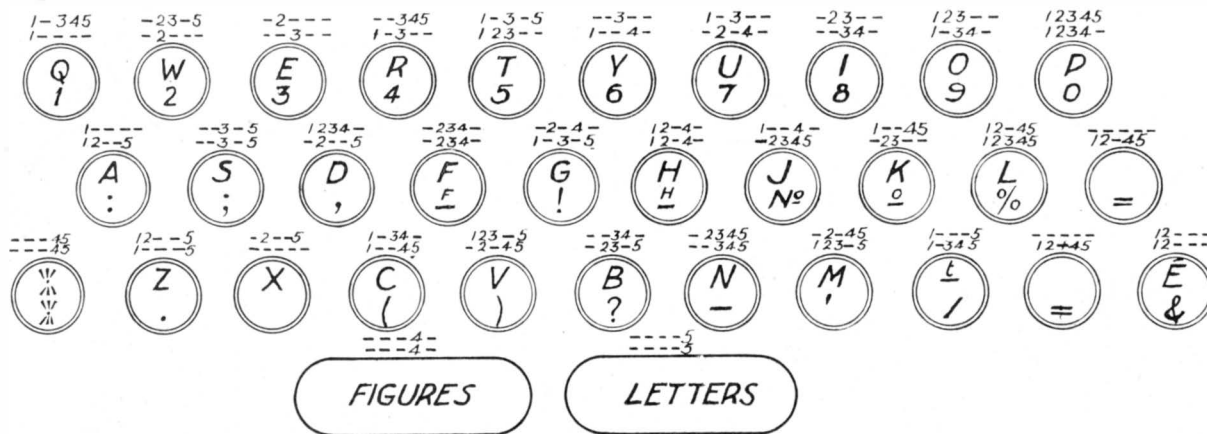

FIG. 1.—BAUDOT KEYBOARD FOR FOREIGN CIRCUITS.

which had the secondary characters allocated differently to that of the standard keyboard layout.

The perforator about to be described is fitted with a device that enables the use of the Baudot code to be made without any alteration to the receiving apparatus when constructed to be

Fig. 1 shows the arrangement of the keys for the Baudot keyboard perforator used on the Anglo-Continental services, with the perforations for the two positions shown in small figures just above each key.

Beneath the key levers is an aluminium frame or carriage capable of sliding on two substantial

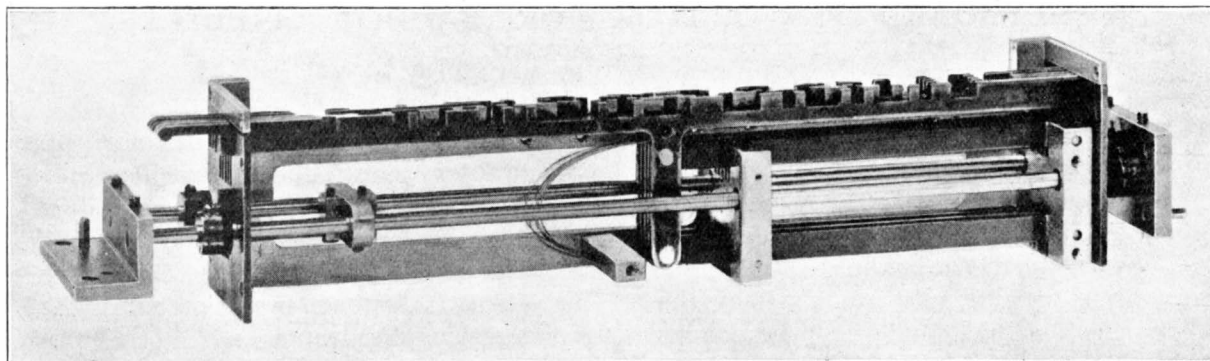

FIG. 2.—CODE BAR CARRIAGE. FRONT PLATE REMOVED.

actuated with the Baudot code. This means that each key must be able to effect two entirely different selections so as to perforate two entirely different sets of holes in the perforated tape, depending on which of the control keys marked "Letters" and "Figures" has been used.

rods to take up either of two positions according to the particular space key which has been depressed. This frame (Fig. 2) contains the five code-bars which, when depressed, actuate one or more of the five selecting levers. The code-bars are slotted in such fashion that in one

position of the carriage, any one key will depress certain of the bars to produce a corresponding Baudot letter, whilst in the second position of the carriage the depression of the same key-lever will act on a different set of the five code-bars.

As there is a possibility of an operator accidentally depressing two keys at once, arrangements were made to reverse the usual operation of selecting the required punches by arranging for the keys to select those that were not required, thus leaving in position for action by the punch-hammer those punches that are required. Hence a depression of any two keys will withdraw out of action more punches than necessary. The operator can then back-space the tape one letter and actuate the correct key. This is a very important economical advantage from the operating point of view as it avoids an erasure, repunching and the transmission of the unwanted signals over the line.

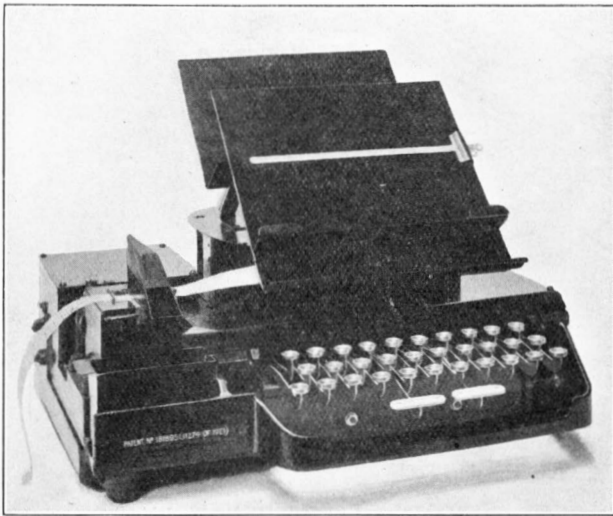

FIG. 3.—GENERAL VIEW OF INSTRUMENT.

Fig. 3 shows a general view of the instrument, with the second desk or rack for accommodating the messages that have already been dealt with. In a later form this second desk has been made of double width for accommodating in the second part those messages awaiting correction, etc. Rubber covers have been fitted over the two space levers to lessen the possibility of fatigue to the thumbs, which does sometimes occur.

As this perforator is required to actuate tape-

printers only, no lamp is required for indicating the end of the line.

Code-bars.—These are slotted differently for each of the five, and are therefore not interchangeable. Key-levers when depressed pass either into the slots and do not actuate the code-bars, or if a slot is not under the key the code-bar is depressed to actuate the selecting lever and to withdraw the corresponding anvil, thus preventing a perforation being made.

Punch-magnet.—Every key lever acts on another common lever which closes the contact of the punch-magnet circuit. The hammer of the magnet acts against any of the five anvils that may be in position, causing corresponding punches to perforate the tape. The return of the armature causes the paper tape to be fed forward one-tenth of an inch ready for the next set of perforations. The punch-hammer also acts every time on a narrower and longer punch which perforates the feed-holes of the tape.

Fig. 4 shows a skeleton of the machine with one key depressed. In its movement it has depressed the front code-bar but not the other four, where slots were beneath it. The front code-bar has actuated the front selecting lever, which has withdrawn the anvil "D" from the path of the punch-hammer "E"; consequently there will be four perforations made corresponding to the Baudot code letter "L" and the progression hole. The punch-magnet circuit is closed by the depression of the frame "G," at the contact "H."

When the key is released the contact-bar and code-bars are restored by their respective springs ready for the next depression of a key; the contact is opened and the armature moves away from the electro-magnet.

The Shift device.—The two space keys which also shift the carriage are each fitted with an extension piece for actuating two bell-crank levers mounted on the framework. These in turn act on two pins fitted on the movable carriage, causing it to shift a distance of one-eighth of an inch. In either position the carriage is locked by a jockey-roller, which bears on the lower edge of the left-hand end plate. To ease the movement of the carriage its weight is supported by a spiral spring on the right and by the spring of the jockey-roller on the left.

The Punch-block is situated on the left side of

the instrument and carries the die-block, the punch-hammer in its bearings, the back-space key and the guide-plate for the selecting levers.

The Die-block carries the punches, the die-plate, the feed-wheel spindle and the paper guides. The punches move in guide holes and are withdrawn from the path of the paper tape by straight wires of spring steel. The distance through which the punches are moved is regulated by adjusting the height of the stop-plate of the punch-hammer, which latter can be adjusted angularly in relation to the armature shaft at the coupling with the hammer shaft.

The Paper-feed mechanism.—A pawl mounted

the punch-block for stepping back the paper tape for correcting a punching error. It releases the feeding pawl and brings in a reversing pawl which steps back the paper tape one progression hole for each depression of the back-spacing lever.

The Electrical Circuit.—The two coils of the electro-magnet are each of 60 ohms resistance, connected on one side to a resistance coil of 60 ohms and on the other to the contact-maker, which is shunted by a condenser of one microfarad connected in series with a resistance coil of 60 ohms to quench the spark resulting from the cessation of the current in the electro

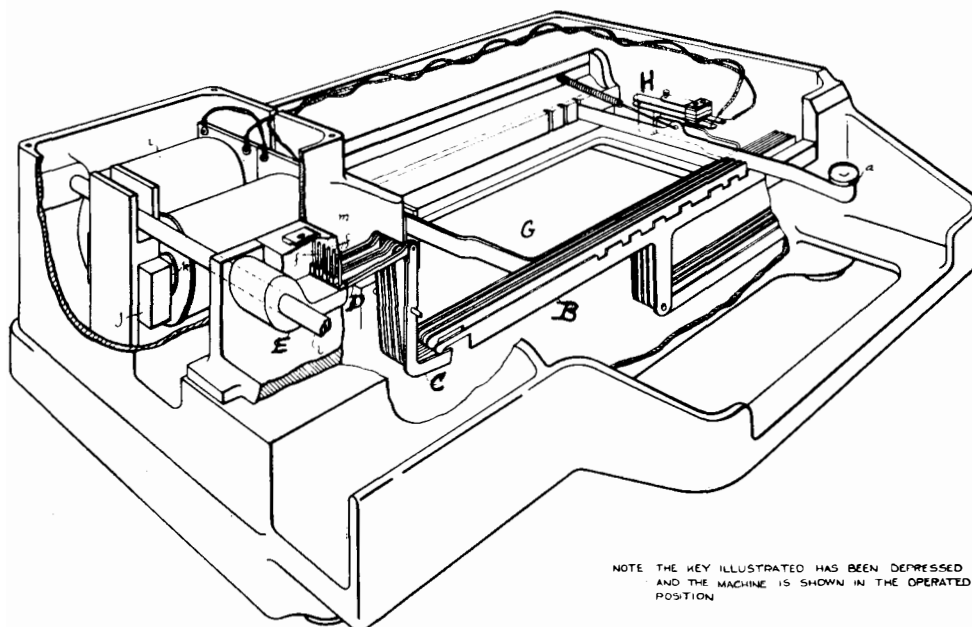

FIG. 4.—SKELETON OF MACHINE. ONE KEY DEPRESSED.

on an extension piece of the punch-hammer steps the ratchet wheel forward one tooth on the return stroke of the punch-hammer. On the same spindle as the ratchet-wheel is a seven-pointed star-wheel which engages with the progression holes in the paper tape and feeds it forward one space for each return stroke of the punch-hammer. The correct position of the paper tape is obtained by a jockey roller which by a spring engages with the spaces between the teeth of the ratchet wheel and is adjustable by means of two screws at the back of the die-block.

The Back-spacer.—This is a key mounted in

magnet. An earth connection is made to the frame of the instrument to avoid the possibility of shocks to operators if a fault should occur to the electrical circuit. The voltage required to operate the punch magnet is normally 110, but may be between 105 and 115.

The instrument weighs 46 lbs., is 17 inches long, 12 inches wide and 11½ inches high.

With this machine and its automatic transmitter a Baudot circuit may have its speed increased from 180 revolutions a minute to 210, 240 or even higher.

The machine has been worked at 80 words or 480 depressions a minute.



TANDEM AND HOLBORN AUTOMATIC EXCHANGE POWER PLANT.

P. B. FROST, B.Sc. (Eng.), A.M.I.E.E.

THE Power Plant at Tandem and Holborn Exchange presents a number of points of interest not only because it differs considerably from that provided for exchange work hitherto, but because it is the first installation of power plant for an automatic exchange of the Director type.

Capacity of Plant.—In the absence of any practical experience of Director and Mechanical Tandem working it was difficult to make a close estimate of the capacity of the plant which would be required. Not only was the available traffic data of an approximate character, but many of the circuits had not reached finality, and therefore the consumption of power for the various automatic operations was more or less indeterminate.

The limitations imposed by floor space for the batteries and a desire not to experiment with cells of a capacity much in excess of what had been used in the past, either in telephone exchanges or by supply authorities, led to the selection of a capacity of 10,000 ampere-hours, at the nine-hour discharge rate, as the maximum size which could be conveniently accommodated and maintained.

As the peak loads were expected to reach 2500 amperes at Tandem and 1500 amperes at Holborn it was considered desirable to provide a means of paralleling the exchange loads and their discharging batteries, in emergency, so that with the lower average discharge rate the supply could be maintained to the exchanges for a longer period.

Under normal conditions, with the discharge

rates named above, it would not be possible to discharge the battery below 1.87 volts per cell without allowing the P.D. at the Distribution Fuse Board to fall below 46 volts, the agreed minimum necessary for the proper operation of the switches. There should, however, be no difficulty in preventing a nearly discharged battery from being called upon to supply the peak load of the exchange.

Design of Generators.—It was considered necessary to provide a type of charging generator which could carry part of the load during busy hours, and with this in view experiments were made upon large commercial type generators serving an exchange with a floating battery to ascertain whether the voltage rise necessary to enable a generator to relieve the battery of half or three-quarters of the exchange load would be within the safe limit for a director exchange, and also to confirm that a sufficiently quiet service could be obtained under such conditions without using special telephone type generators. The conclusion reached was that floating could be resorted to and that semi-telephone type generators would be satisfactory, there being no need to incur the disadvantages of metal brushes or smooth core armatures. The four charging sets, shewn in Figs. 1 and 2, have an output of 1600 amperes at 57 volts each, with voltage regulation between 50 and 68. The generators are 12-pole, shunt-wound, non-interpole machines, with special features, such as high-tooth frequency, semi-closed staggered slots, an air gap tapering from $3/16$ " under the leading pole tip to $3/8$ " under the trailing pole-tip (to check

distortion and ensure greater uniformity of flux density in the teeth) and wide brushes of a graphite-carbon combination.

The motors to which these generators are direct-coupled run at 600 r.p.m., and are ordinary 200-volt, 8-pole, shunt-wound interpole machines with no special features, except a tapered air-gap as described above.

The sets have an overall efficiency of 82% at full load and 78.5% at half load.

Power Supply. Duplicate sources of supply are obtained from the low voltage mains of two different companies. The motor-generator sets constitute a heavy additional load upon the existing mains and the companies have been very doubtful as to whether they have sufficient capacity to carry it. Each company finally agreed to take the load of at least one set, but it is recognised that it may be necessary to discontinue charging while floating is resorted to,

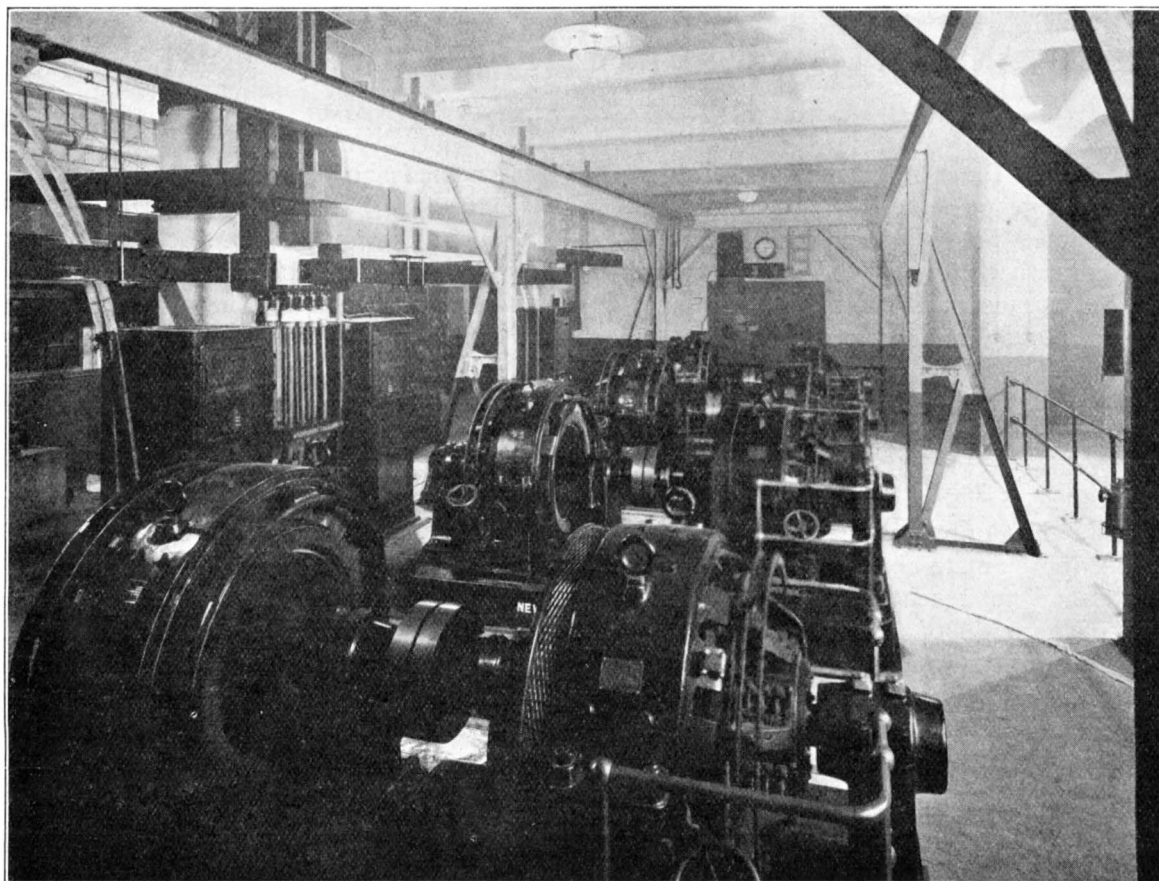

FIG. 1.—POWER ROOM, TANDEM AND HOLBORN EXCHANGES.

They are controlled by the starting pillars seen in Figs. 1 and 2. The latter are completely enclosed by glass doors interlocked with the isolating switch and are practically foolproof. The main circuit is made and broken by an electro-magnetically operated D.P. contactor, all the automatic protective trips and hand trips being arranged to interrupt its holding circuit. A diagram of connections (Fig. 7) and a description are given later in this article.

or even to charge at night. This point can only be decided when the extent to which floating is necessary is known.

The situation has been somewhat relieved by the introduction of an additional high-tension service and step-down transformer to take the lighting, heating and general power load other than battery charging. An earlier proposal by the supply company to instal a rotary sub-station on the premises had to be abandoned for lack of space.

Crane.—An overhead hand operated travelling crane has been provided to facilitate erection and subsequent dismantling of the sets for repairs. It provides movement in both directions over the space occupied by the four charging sets. It will lift 25 hundredweight, which is the heaviest single part of these machines. The steelwork supporting the crane stands out prominently in Fig. 2 and the crane is just visible in Fig. 1 at the far end of the room.

A view of the Tandem battery room is given in Fig. 5, and views of the Holborn battery room in Figs. 4 and 6.

A new feature is the method of supporting the cells, each of which rests upon 8 oil insulators standing upon 8 pedestal insulators of hollow stoneware 10" high, the latter being prevented from sinking into the asphalt floor by large thick tiles. It will be noticed that this type of insulator dispenses with the need for wood still-

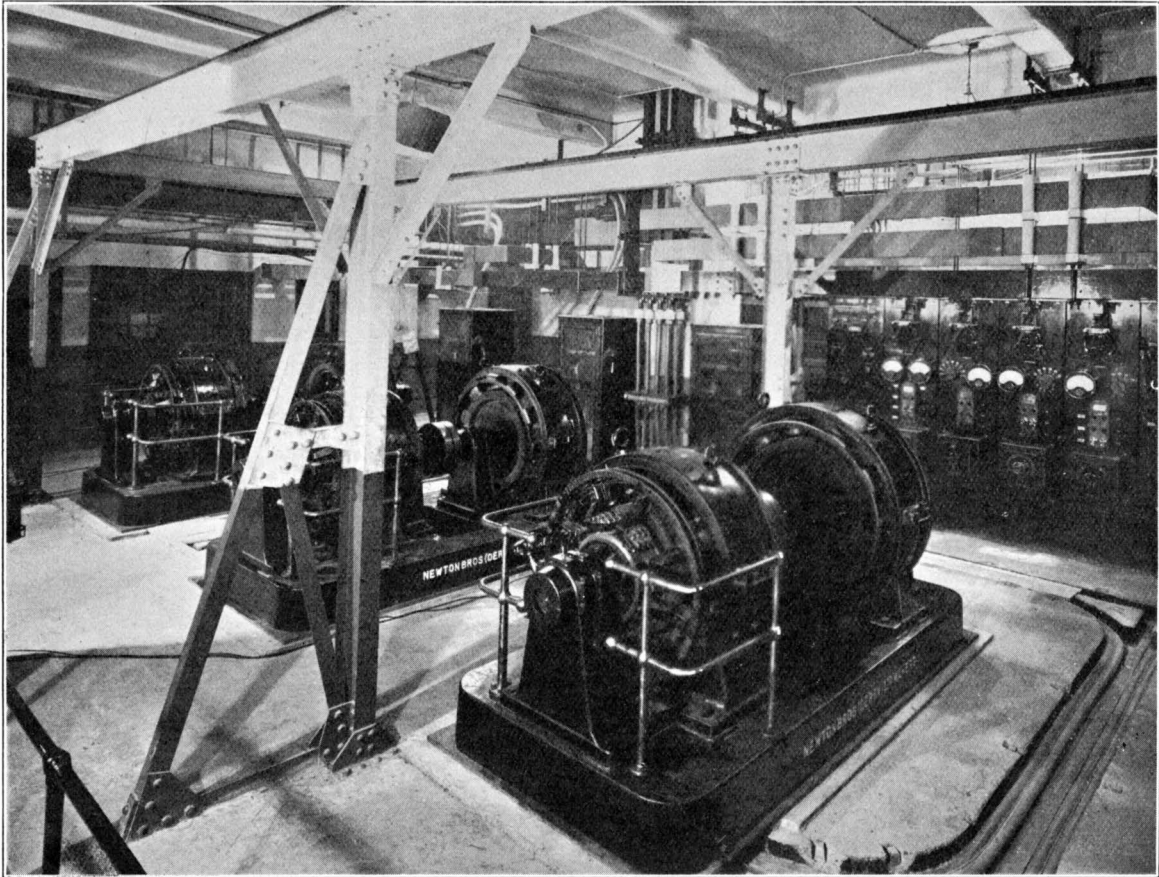

FIG. 2.—POWER ROOM, TANDEM AND HOLBORN EXCHANGES.

Batteries.—Two 25-cell batteries have been provided for Tandem and two for Holborn. Each battery has a capacity of 9870 ampere-hours at the nine-hour rate. The wood lead-lined boxes are spaced at 1'-10½" centres and are 5'-8" long. The overall height of the cells is 5'-0", whereas the minimum clear height of one of the rooms is only 8'-6". Each cell contains 71 plates, 14" × 29", and weighs over 2 tons when fully equipped.

age and permits a hose to be used for cleaning the floor.

Battery Circuit Breakers.—For the protection of the batteries overload circuit breakers with a special time lag attachment have replaced the usual fuses, because the latter give rise to a much higher voltage drop and in such large sizes are unreliable. The circuit breakers are mounted upon a heavy iron frame which is enclosed by uralite boards. They are operated

from outside the battery room through a sliding window, which will normally be locked. This arrangement protects the circuit breakers from corrosion and unreliable operation, and from being accidentally tripped. It also removes the risk of explosion in a low-pitched room in which artificial ventilation by a duct and fan has necessarily been provided.

Main Connections (partly visible in Figs. 1, 2, 3, 4, 5 and 6).—The considerable length of the

circuit current that could easily attain 50,000 amperes, and the diagonal ties at right-angled bends are to check the tendency of the conductor to straighten itself under such conditions. The force between two conductors six inches apart would be in the neighbourhood of 200 lbs. per foot run with a short-circuit such as that referred to.

The positive conductors from all four machines and batteries are brought to the foot

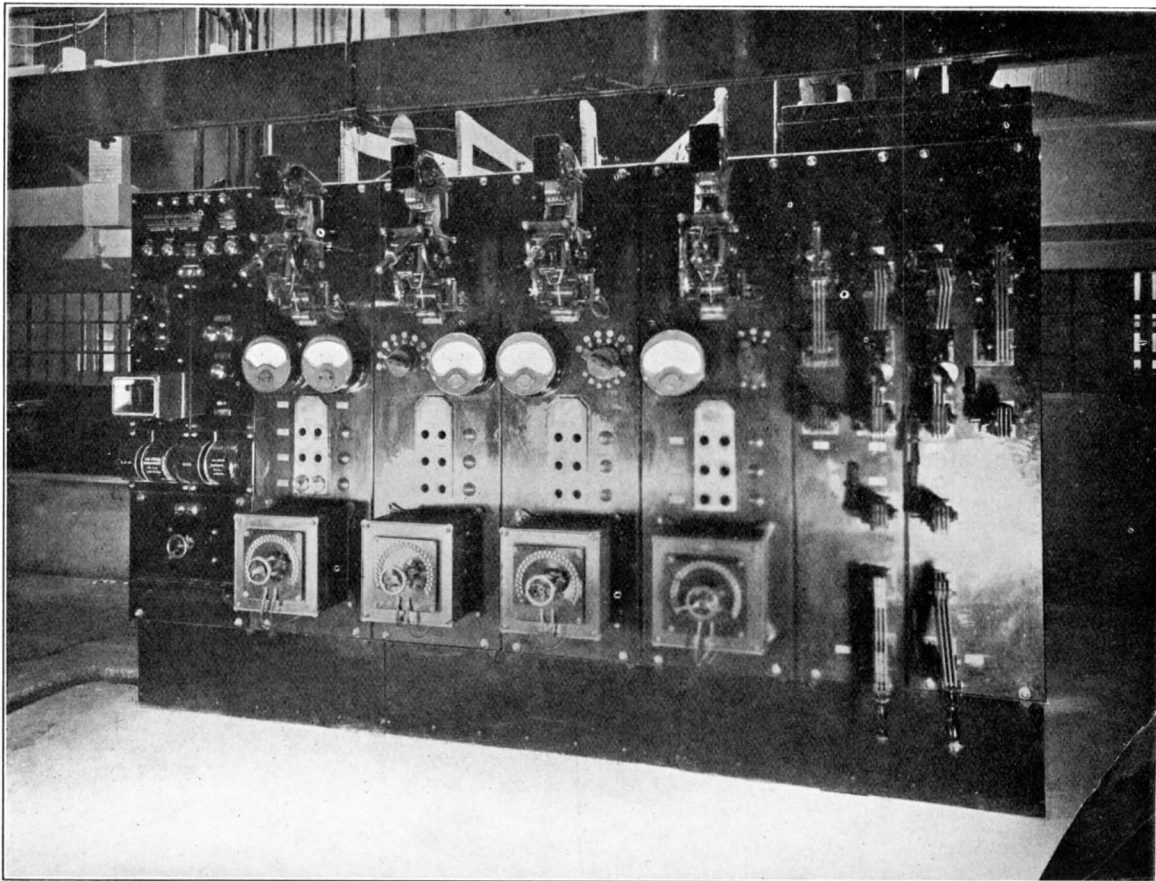

FIG. 3.—POWER BOARD, TANDEM AND HOLBORN EXCHANGES.

discharge circuit, together with the voltage limits of 46 to 52 at the main Distribution Fuse Board busbars, which must be maintained under all conditions of load, have necessitated very careful design of the main connections. Economy led to the adoption of hard-drawn copper bars, supported upon porcelain insulators carried by iron hangers from the ceiling.

The supports were made rigid to withstand the great forces which would result from a short-

of a main column of the building and there commoned. The negative conductors from the battery circuit breakers are run to this point after passing through switchgear upon the power board. From the foot of this column the two main feeds to the two exchanges upon upper floors are formed of copper bars clamped to the column and rising vertically through large holes in the floors to the busbars of the main D.F. Boards.

The Mechanical Tandem discharge circuit comprises 3 copper bars $8'' \times \frac{1}{2}''$, giving 12 square inches, that of Holborn Automatic two bars $8'' \times \frac{1}{2}''$, these large sections being needed to keep the voltage variations at the apparatus within the prescribed limits. The vertical conductors are actually suspended at their upper ends and clamped firmly in guides down the column to allow for any slight expansion due to increase of temperature. Joints occur every 10

taped throughout their length, except that between floors the whole of the conductors are rendered inaccessible by being boxed in with uralite sheets. Uralite box covers are provided at joints where taping was difficult.

Owing to the difficulty of providing chase accommodation for the heavy cables (sometimes two conductors of 1 square inch section in parallel) used to connect up motors and generators, a new feature was introduced in the pro-

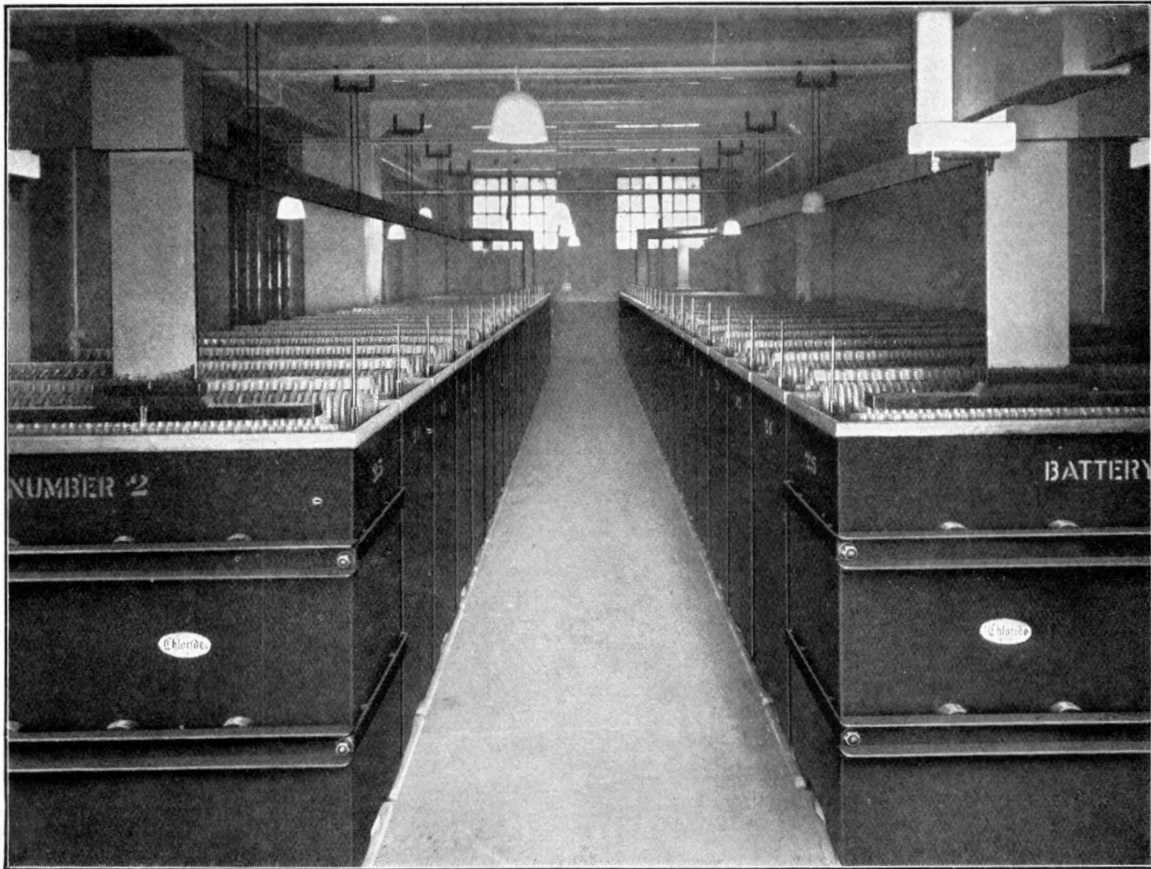

FIG. 4.—BATTERY ROOM, HOLBORN.

feet and a liberal overlap is allowed. The surfaces are trued, tinned, cleaned again and immediately coated with vaseline before being bolted up by six $\frac{5}{8}$ -inch steel bolts. The positive conductors are insulated from their supports by micanite sleeves and plates, except in the case of those conductors which are peculiar to the discharge circuit. The negative conductors are insulated from their supports by both micanite sleeves and porcelain sleeves and blocks and are

vision of pits, $3'-6''$ square and 3 feet deep, formed beneath the generator commutators. The four pits were joined to one another and to the power board and other points by a nest of ducts laid at a low enough level to permit ordinary wide floor chases for the motor cables to cross them, the ducts being used for the generator cables.

The cables connecting the motor control pillars to the supply companies' services were

armoured V.I.R. cables of 1 sq. inch section run overhead on hangers.

The Distribution circuits from the D.F.B.'s to the small fuse panels on the racks are formed of V.I.R. cables run overhead on racks, the cross-section being designed for a drop not exceeding 0.25 volt at full load. The negative distribution cables are taken through enclosed fuses of suitable sizes, the largest being of 150 amperes rated current. Each of these distribu-

arrangement than could be attained by the use of switches. Such switches as had to be used are of a design new to Post Office exchanges. The blades forming contacts pass through rectangular holes in the slate and form the connecting lugs at the back. Powerful clamps are provided on all contacts to improve the contact and reduce the drop to a minimum after the switch has been closed. An overhead and reverse circuit breaker is provided for each generator, as

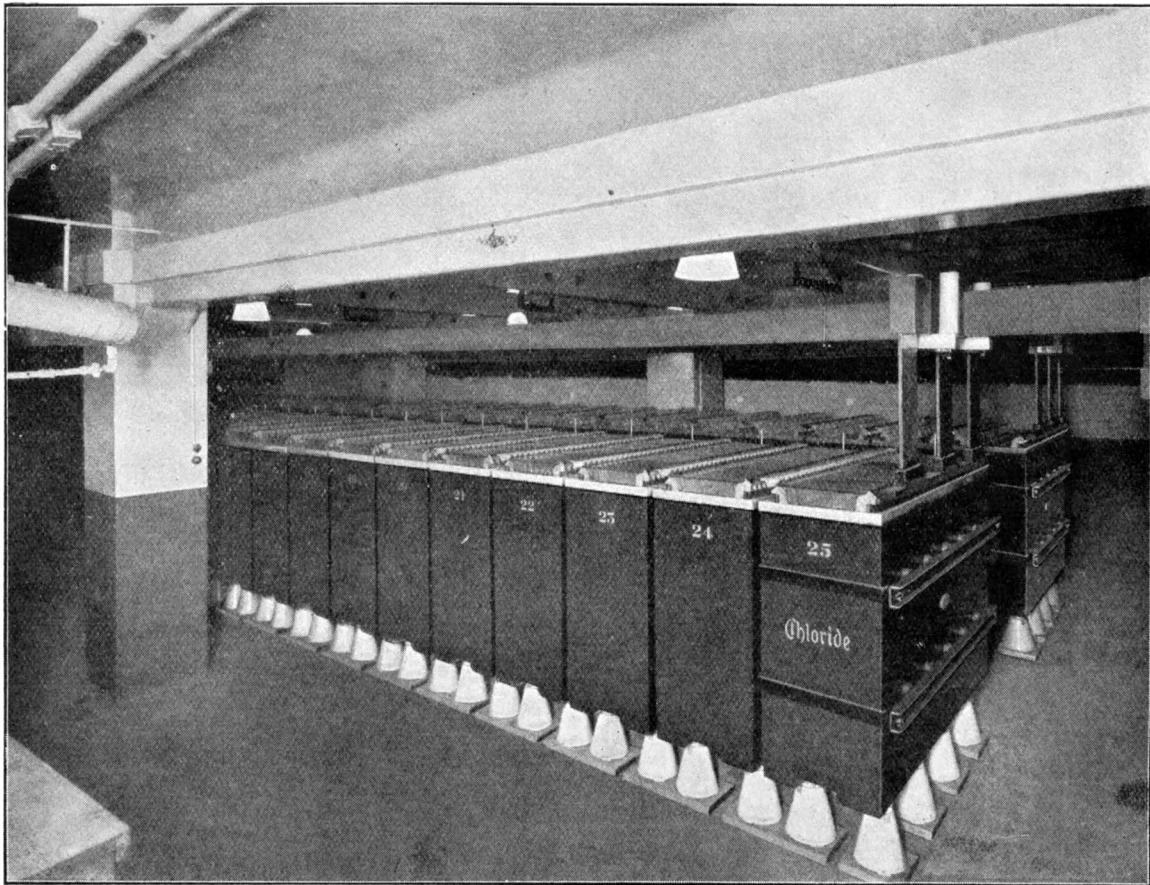

FIG. 5.—BATTERY ROOM, TANDEM.

tion fuses is shunted by a small alarm fuse. Tests have been made to confirm that the alarm fuses blow quietly without injury when the main fuse is blown by a deliberate short-circuit.

Power Board.—The Power Board, shown in Fig. 3, is interesting mainly on account of the capacity of the switchgear. Plug busbars are used to enable any machine to be used for charging any battery or for floating on either exchange, as they provide a more compact

any three might have to run simultaneously. The choke coil can be used in series with any generator to supply current to either exchange, with or without a battery in parallel to share the load. The latter condition will be an emergency one only, as the machines will not give a sufficiently silent supply without a battery.

The choke coil supplied with the machines comprises an iron wire core of 50 square inches cross-section, wound with 20 turns of copper

strip, outside which a return path for the flux is provided by an equivalent section of iron wire arranged concentrically in bundles.

The connections of one motor generator and the four batteries are shown in Fig. 7. The circuit of the motor control pillar indicates how the multiple start lever M.S.L. closes the operating coils of the two contactor switches on its first movement from the off position after the isolating switch has been closed. The starting

shunts out the lighter switch contacts used in the main circuit during starting. It will be seen that the vertical plug bars are each connected to a generator and are mounted on the front of the board. The three horizontal bars are connected to the two charging circuits and the floating circuit respectively and are mounted on the back of the board.

Ringling Machines and Interrupters and Automatic Change Over Gear.—The Ringling

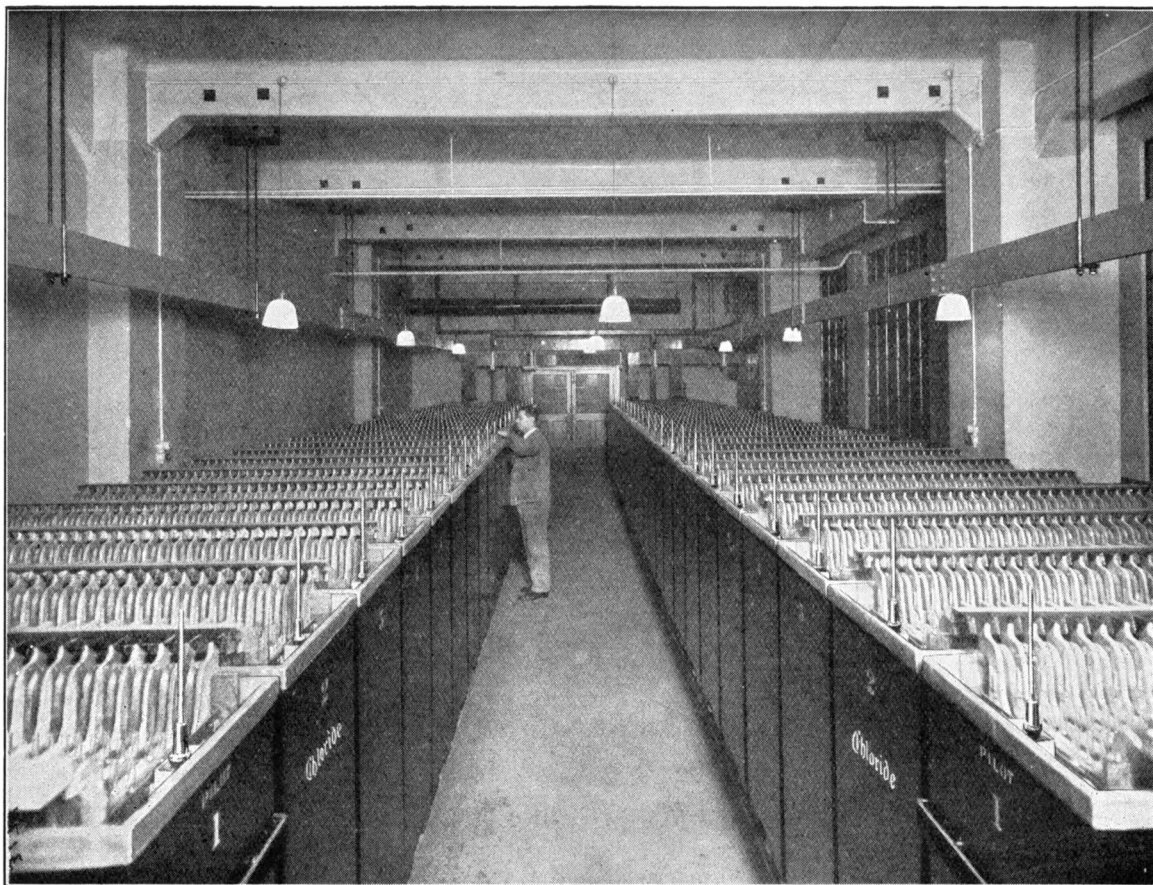

FIG. 6.—BATTERY ROOM, HOLBORN.

resistances are now cut out step by step by a drum controller which operates a series of switches and is worked round by a ratchet when the starting handle is rocked to and fro. The no volt release, two overload trips and push-button release all operate by opening the main contactor holding coil circuit, and are thus operative during starting and running. In its final position the M.S.L. closes the operating coil of an additional heavy contactor which

Machines give an output of 4 amperes at 75 volts at a full load efficiency of 55%. High speed drum-interrupters and low speed cam-interrupters have been used.

A corner of the ringling machine pier can be seen on the extreme left of Fig. 1. The switch-gear controlling the ringers is mounted on the left-hand panel of the power board (Fig. 3).

The Ringer and Interrupter circuits are shown in Fig. 8, which was prepared by Mr. Gillings,

of the A.T.M. Coy., on the detached contact principle.

The diagram is largely self-explanatory, but attention should be drawn to certain features, including the method adopted for automatic changing over to the reserve ringer on failure of the normal machine. The 200-volt ringer is normally in use and RF is operated as long as the supply of ringing current is maintained. The 8-pole and 6-pole change-over switches A for code selector racks and regular selector racks supplies current to S.T.1 when RF releases.

6-pole change-over switch B. This falls into its lower position and cuts out the starting resistance at 9, allowing ringer 2 to run up to full speed.

The circuit breaker is fitted with a thermo element to operate a trip coil with sustained overload but not with the heavy starting current of short duration. It also has a no voltage release coil which holds contact N.V. open so that when the 6-pole switch is in its lower position the circuit of the trip coil is only prepared and not completed by pole 14.

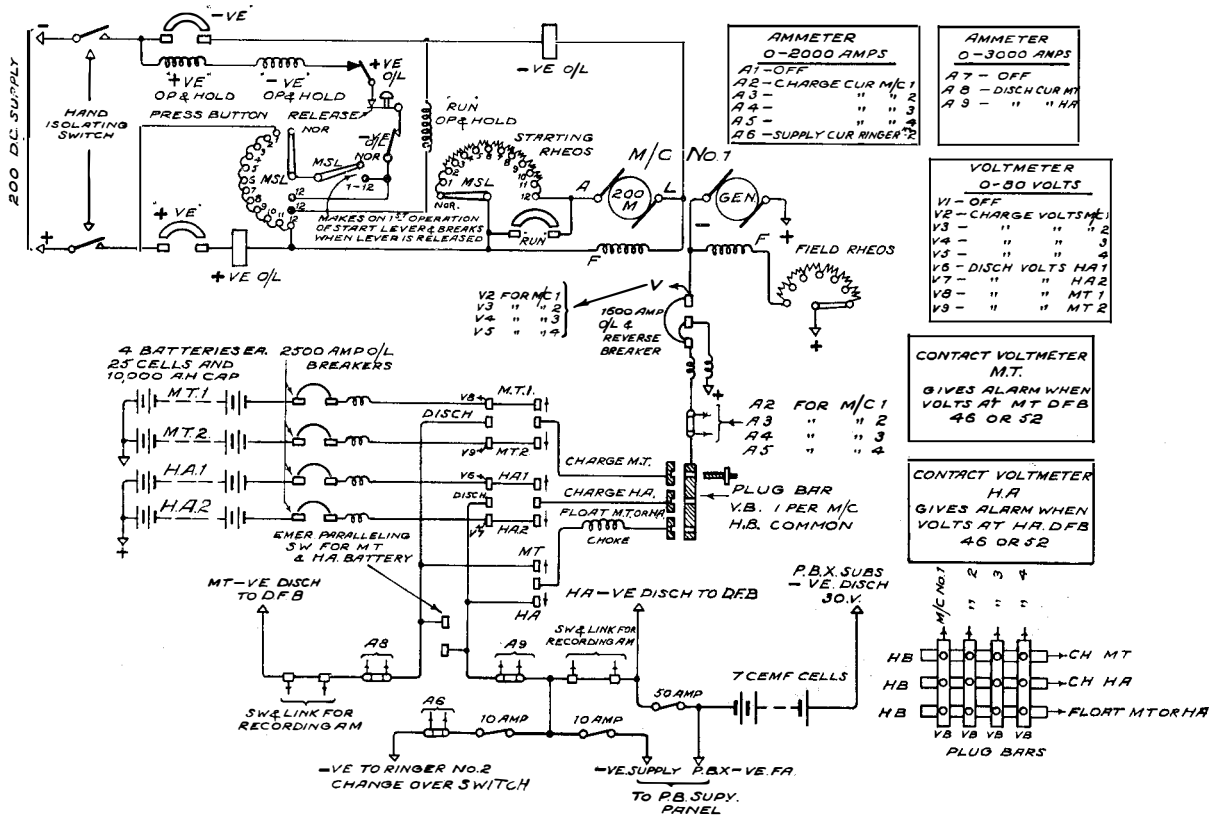

FIG. 7.—CONNECTIONS OF MOTOR GENERATORS.

S.T.1 places a short across the contacts of RF at X and closes the circuit of trip coil A of the 8-pole switch at S.T.1. The 8-pole switch then falls into the lower position by gravity and contact 1 completes the circuit of the battery ringer through the circuit breaker of the "Panel motor starting No. 1" and a starting resistance.

When Ringer 2 has gathered sufficient speed, R.C.O. pulls up and closes a circuit for W, which locks at X and completes a circuit for S.T.2. S.T.2 gives an alarm and also completes the circuit of the trip coil B, which releases the

It will be seen that the change-over switches A and B, in addition to starting up the reserve ringer, also change over the exchange circuits from the normal to the reserve ringer. These circuits include continuous ringing, three phases of interrupted ringing, flicker and flash circuits, interrupted circuits of the primaries of three tone transformers and the interrupter controlling the busy dividing relay BD of the new busy flash circuit.

The busy tone of 400 cycles per second passes through the main busy back transformer BB,

ciently low resistance earth circuit at some risk to themselves, as the current would not be uniformly distributed among them.

The use of the Metropolitan Water Board's main would have involved special permission and the separation of all emergency earth connections from those through which small currents may flow permanently. A good con-

sulted, and in the September, 1926, amendments to their Regulations they have limited the maximum size of earthing conductors to 0.1 square inch.

The installation as a whole has been carried out by the Automatic Telephone Manufacturing Company, with the help of the following sub-contractors:—

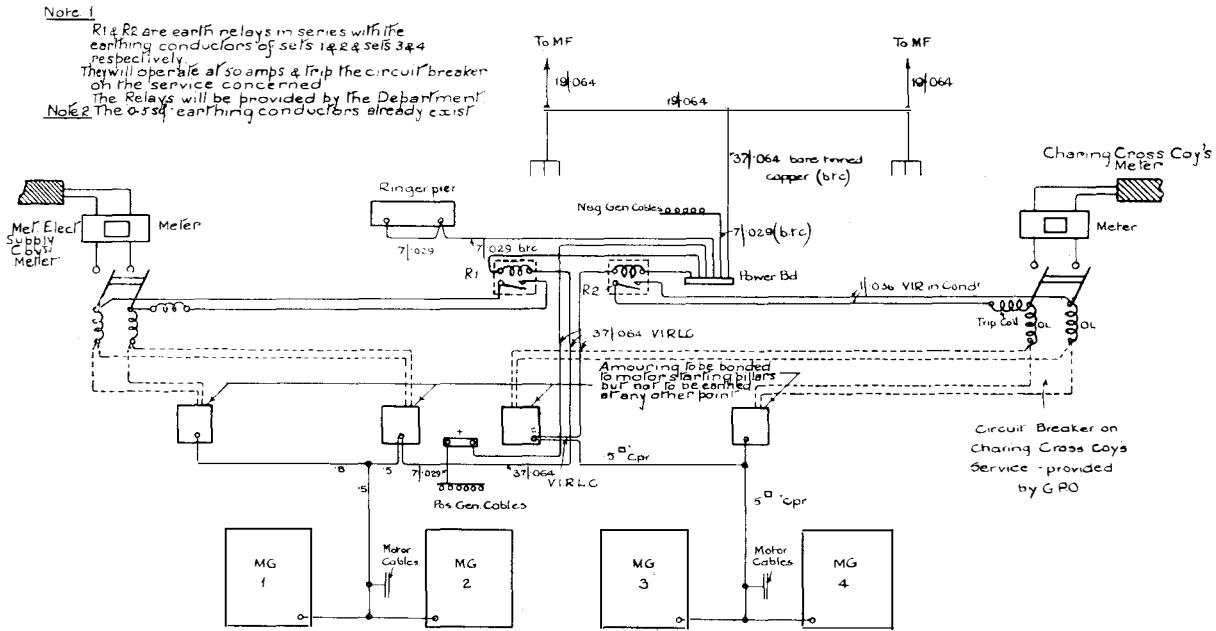

FIG. 9.—CONNECTIONS OF EARTHING CABLES.

nection to this main would be a matter of considerable difficulty.

In the circumstances the earthing conductors have been connected to earth through a relay which will trip at 50 amperes and close a special trip coil of a circuit breaker on the supply company's main service. The earthing connections are shown in Fig. 9.

The Institution of Electrical Engineers was

Motor-Generators, Choke Coil and Ringers—Messrs. Newton Brothers, of Derby.

Batteries—Chloride Electrical Storage Company.

Power Board, Battery Circuit Breakers and Main Connections—Messrs. Bertram Thomas.

Motor Control Pillars—Messrs. Brook-Hirst. Crane—Messrs. Herbert Morris & Co.

SCHEDULE OF PROCEDURE WHEN USING TESTER No. 59.

Circuit under Test.	Cord.	Procedure.		Nature of Test.	Result of Test when Apparatus is O.K.
		Insert Plug in Jack.	Throw Keys.		
A.T. 812 1704 1721 *1703 *1720	Ans.	1.	6.	(a) Continuity of sleeve cct. Operation of relays HJ & HA (* & HR) to manual ccts.	Sup. lamp glows.
			Cord Cct. Dialling Key. Then 6 & 1 & dial.	(b) Dial Connections.	Tester lamps A & B glow, and respond to dial impulses.
			6 & 1.	(c) Operation of relays LA & DA.	Sup. lamp darkens. Tester lamps A & B glow.
			6 & 2. Then 3 also, approx. 3 times per sec.	(d) Release of LA after saturation.	Sup. lamp glows, then darkens on operation of key 3 and glows on release.
			7.	(e) Non-Operation of HR & HJ to auto. ccts.	Sup. lamp does not glow.
			7 & 1.	(f) Operation of IA & non-operation of DA.	Sup. lamp glows. Tester lamps A & B glow.
			7 & 2. Then No. 3 also, approx. 3 times per sec.	(g) Release of IA after saturation.	Sup. lamp glows on operation of key 3 and darkens on release.
			7 & 1. Then No. 4 also, approx. 3 times per sec.	(h) Operation & release of DA on reversals.	Sup. glows, then darkens on operation of key 4 and glows on release.
			8. Then 1 also.	(i) Operation of HR & non-operation of HJ to JE Jc ccts.	Sup. glows. Sup. darkens. Tester lamp A glows (note B does not glow).
			8 & 9. Then 1 also.	(k) do. do.	Sup. glows. Sup. darkens. Tester lamp A glows (note B does not glow).
A.T. 1703 1720	Ans. also Call.	1.	8 & 1. Then 10 also.	(l) Operation of DC & T. for through signalling.	do. do. Tester lamp B glows on operation of key 10 or cord cct. spkg. key (the latter only if through signalling on key is provided. See cord cct. diagram).
		6.			

It will be seen that the answering cord should be inserted in Jack No. 1 of the tester. This connects the tip and ring conductors to the main testing circuit and the third conductor to a series of keys controlling sleeve resistances.

In test (a) key No. 6 is operated. This provides a sleeve resistance of 200 ohms for tests under conditions where the sleeve resistance is normally 100 ohms. The effect should be to operate relays HJ, HR and HA of the cord circuit, the operation of the last two of which is checked by observation of the answering supervisory lamp, which should glow. Relays HA and HJ also cause battery and earth to be connected to the transmission circuit *via* relays IA and LA. This condition is checked by test (c).

Test (b), for which Key No. 1 is operated in addition to key 6, provides a check for the dial circuit connections, by the connection of the tester relays A and B to the tip and ring conductors. When the dial on the keyboard is operated, the dialling key of the cord circuit

having been previously thrown, the loop impulses should cause the relays to vibrate and flash lamps A and B. (Battery dialling connections are checked in the corresponding test of the calling cord.)

In test (c) also, Key No. 1 is operated in addition to No. 6 and applies relays A and B to the tip and ring circuit. If relays HJ and HA have functioned to provide the battery and earth feed to the transmission circuit, relays A and B operate and cause tester lamps A and B to glow. The battery feed *via* relay A under long line conditions should also operate relay LA to actuate in turn DA and extinguish the supervisory lamp.

Test (d), keys 2 and 3 are thrown instead of key 1 to repeat test (c) on relay LA, but under short line conditions with low insulation.

In Test (e) the sleeve conditions are changed to those met with when calls are made to local automatic circuits. The sleeve circuits of the latter are equipped with relays of 6,500 ohms

resistance or in some cases are left disconnected. The cord circuit relays HR and HJ should not operate under these conditions. Key 7 connects a 6,000 ohm resistance in the third conductor as a test condition to meet the case of an automatic circuit relay, wound to less than the specified resistance figure to the extent of the five per cent. variation allowed in coil winding. A check is then made to verify that the supervisory lamp does not glow.

Test (f). Key No. 1 is now thrown in addition to No. 7 and provides, under long line conditions, a circuit for tester relays A and B round the cord circuit loop via relays DA and

in the cord circuit should operate, but HJ should not. The operation of HR and HA is proved correct by a glow on the supervisory lamp and the non-operation of HJ by the absence of the battery circuit through IA preventing the operation of tester relay B and lamp B.

Test (l) proves, by the glowing of lamp B, that continuity of this circuit through IA has been established to provide conditions similar to those obtaining when a through call is completed to a subscriber. This test necessitates the insertion of the calling cord in jack No. 6 and the operation of key No. 10.

The tests on the calling cord are made with

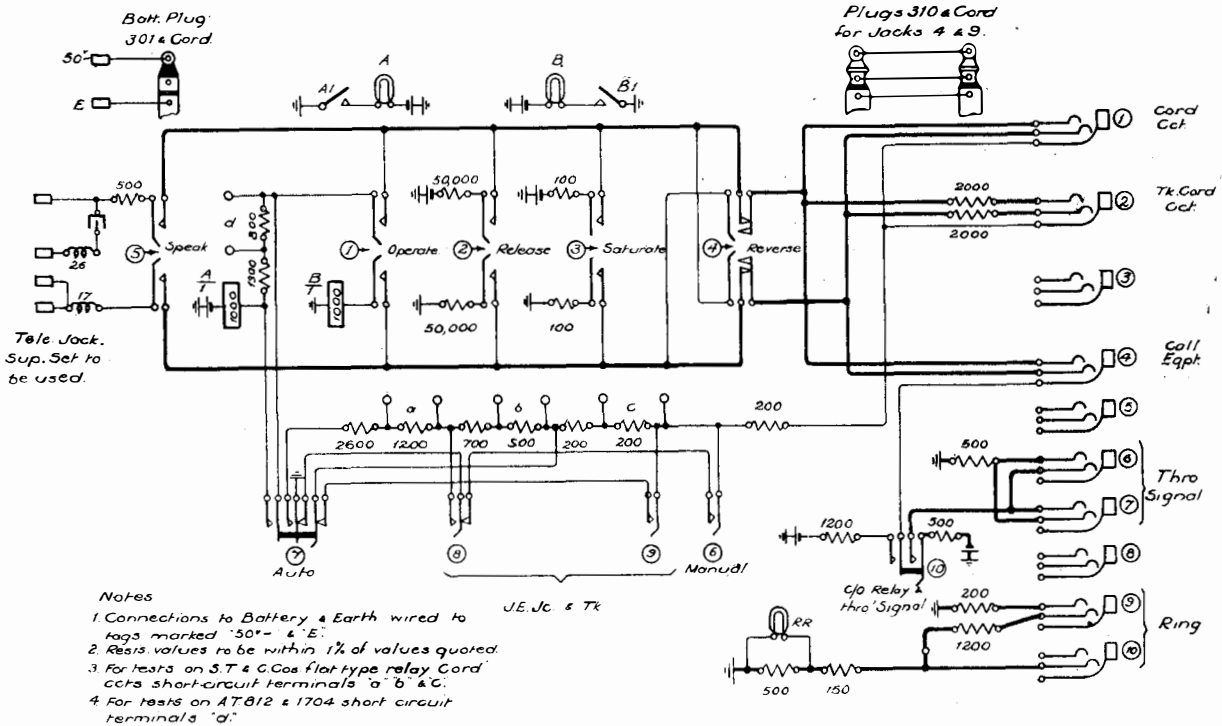

FIG. 2.—TESTER No. 59. FOR TESTING CORD CIRCUITS ON MANUAL BOARDS, AUTO EXCHANGES.

IA. The last mentioned should operate to cause the supervisory lamp to glow.

Test (g). Keys 2 and 3 are thrown instead of No. 1 to repeat test (f) under short line conditions.

Test (h) repeats test (f) with the additional feature of providing a reversed current corresponding to the supervisory signal supplied by a final selector when a subscriber answers a call.

In tests (j) and (k) the conditions set up by keys 8 and 9 provide marginal figures corresponding to the 2,000 ohm sleeve circuit of a jack-ended junction. In this test, relays HR and HA

the aid of a similar schedule. Engaged test circuits are checked by means of the operator's set or the telephone circuit and key 5. The latter is also used for transmission tests in conjunction with any convenient circuit to the test desk. Dial speed tests are also made over the test desk circuit.

The facilities provided by the tester cater for tests on all 50-volt cord circuits including plug-ended junctions. Provision is also made for tests on many other circuits, such as jack-ended junction and trunk calling equipments and for the ringing supply.

THE TRAFFIC-OFFICE OF THE MUNICIPAL TELEPHONE SERVICE AT AMSTERDAM.

DR. IR. CH. E. A. MAITLAND.

THE scientific investigation of traffic problems can be divided into the following parts:—

A.—Traffic as a collective phenomenon.

B.—Traffic from the individual subscribers' lines.

(1) Seen from the management's point of view.

(2) Seen from the subscriber's side.

C.—The internal traffic in P.B.X. installations and its influence on the system as a whole.

There has been a period during which neither in telephone construction, nor in management has traffic been considered as a problem; but with the growth of the system and particularly after the introduction of automatics it has been generally admitted that to construct a telephone exchange without taking into consideration the traffic is as wrong as building a bridge without sufficient knowledge of the load. There is a difference, however. The variations in the load of a telephone exchange and the influence that the individual use of the subscribers' lines exercises on the traffic and the traffic distribution in the system necessitate the continuous study, supervision and control of the traffic in the daily management of telephone systems.

This will be possible only by introducing into the organisation a special service adapted thereto, *i.e.*, the traffic office, having as its function the handling of this kind of problem. This is not generally recognised and very often the assumed costs of such a traffic office prevents its installation though they are undoubtedly less significant than the disadvantages of an inefficient distribution and disposal of traffic causing traffic losses, complaints, troubles and waste of material and labour. The costs of those items, however, never appear as a whole in the accounts and therefore are always underestimated. As soon as this is acknowledged the traffic office is established and in a short time proves to be one of the most important parts of the organisation.

There is, however, a danger in all such services that deal with scientific investigation,

and the real proportions of its task must not be lost sight of. It must be seen that "l'art pour l'art" is not exercised and that only such problems are taken into consideration as have a present or probable future interest for the service. The traffic manager must be a man with scientific sense, but also with a practical view on management.

A.—TRAFFIC AS A COLLECTIVE PHENOMENON.

(1) *Measuring the traffic flow.*

The traffic flow originates from the network of subscribers' lines and returns thereto. The exchange first collects traffic and then distributes it in different paths, *e.g.*, the total traffic emanating from a group of 2000 lines is collected on the 1st Group Selectors and then distributed by the 2nd Group Selectors, 3rd Group Selectors and Final Selectors.*

In each of these paths the traffic flow can be measured, and the losses determined.

The easiest way to do this is to measure the total working-time of all the switches in a traffic path, the traffic being measured in a time-unit, *e.g.*, hours, minutes or seconds. It is, however, also possible to choose another scale, *viz.*: the number of connections. There arises a difficulty because there is a difference between the number of calls and the number of completed connections, and again between those two and the number of answered calls, only the last category being measured for rate purposes.

For this reason the number of connections is not suitable as a unit for the measurement of the traffic flow, and for investigating traffic as a collective phenomenon it is much better to use a time scale (T.C.).†

To analyse the individual traffic per line, however, a knowledge of the number of calls is indispensable.

Two items are rather easily available, the

* For full particulars see *P.O.E.E.J.*, Vol. 19, Part 2, July, 1926, p. 153.

† T.C. is the equivalent of the British term "Traffic Units."

number of calls and the number of completed and answered connections, the last being the base of the rate schedule.

For automatic telephony a call means a 1st G.S. put into action, that is to say the first digit must be dialled. Taking off the receiver from the subscriber's apparatus makes the first selector busy, but this cannot be considered as a call. Therefore calls are registered as the 1st G.S. turns in under the action of the rotary magnet.

For semi-automatic offices the number of calls is registered on the operator's position.

The number of conversations is recorded from the message registers.

The difference between the number of calls and the number of conversations means lost traffic. This consists in:

- (a) The uncompleted connections (owing to the subscriber).
- (b) Failure of connections (owing to the equipment).
- (c) Calls resulting in busy-signals.
- (d) Unanswered calls.

At Amsterdam the traffic flow is *permanently* measured on the 1st and 2nd G.S. and so also are the number of calls and the number of conversations.

The day period is counted from 9 a.m.—5 p.m. and the night period from 5 p.m.—9 a.m.

This means permanent supervision of traffic in all paths where deviations from the normal would be harmful to the service.

During the day period measuring is done by recording ammeters, running 240 m. an hour. The instruments are calibrated to the number of switches that are in action and measuring current is supplied through a resistance specially mounted in each switch for this purpose. This current flows from the moment the selector is connected to the calling line. It will be noticed that time is recorded even when no call follows, *e.g.*, short circuits, receiver off switch-hook, etc. Dividing the time by the number of calls, the average time per call will be found a little too large, but this fault is less than would be made by recording all these cases as real calls.

The recording ammeters are supplied with flameproof celluloid films instead of paper bands. The length of a film suits the period from 9—5. The advantage of this method lies in its economy

as the films can be washed after use. For interesting cases they are blue printed or photographed and for the sake of comparing two or more simultaneously recorded curves the films can be superposed as can be seen from the specimens.

Fig. 1 shows the assembly of the instruments in the traffic office for central office No. 3. The instrument No. 3 from the left, records the total traffic on the 1st G.S. in central office No. 3 (C.B.3).

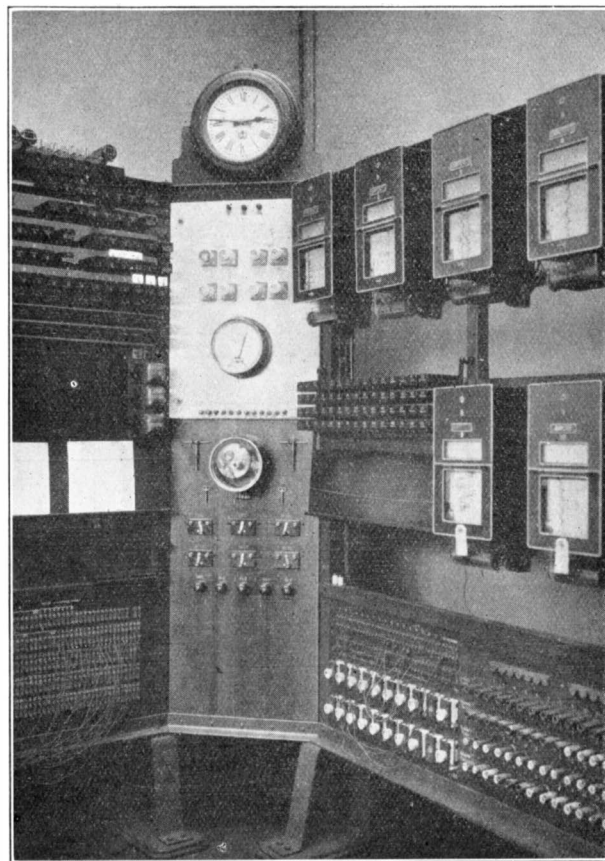

FIG. 1.—INSTRUMENT ROOM OF TRAFFIC OFFICE.

Sometimes it is useful to split up the record among groups of 2,000 lines. This can be done with one ammeter, as shown in Fig. 2, the instrument being connected in each group temporarily for a minute at a time by means of a clock-operated relay. The same electric clock draws a line on the film every hour. The curves on left of Fig. 2, are for groups of 4,000 and 10,000 lines respectively, those on the right for 5 separate groups of 2,000 lines.

During the night period measuring is done

with electrochemical electricity meters. In the semi-automatic offices there are two additional meters recording respectively the waiting time before a calling subscriber is connected to the operators' position, and the number of operators on duty. In conjunction with the number of

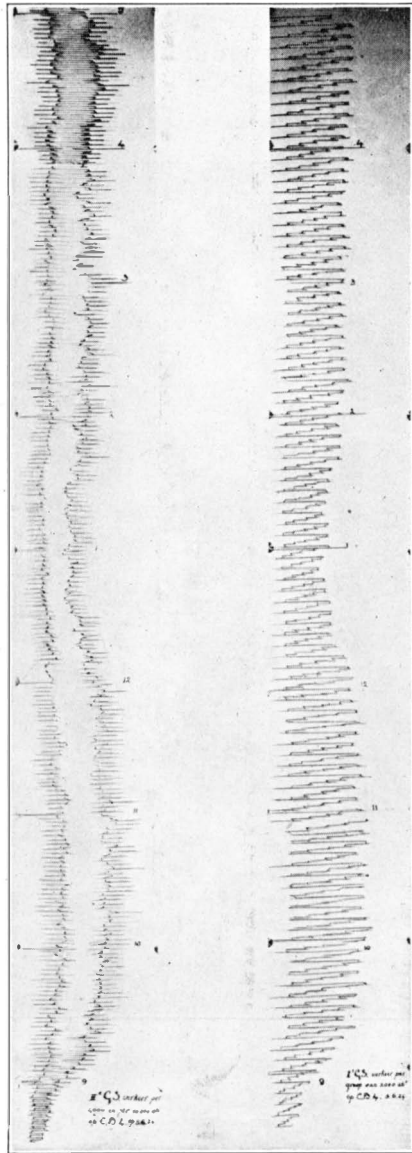

FIG. 2.—TRAFFIC ON FIRST GROUP SWITCHES PER GROUP.

calls handled by the operating staff, the first item gives the average waiting time per call, and the second the average load per telephonist per hour.

In Figs. 3 and 4 are shown examples of the superposition of curves for the traffic, waiting

calls and operators on duty (the last curve has zero to the right) from which their mutual influence can be observed.

The average load per operator is 425 calls an hour; the operating time per call is 5.9 sec., so that the efficiency of operating is 0.7. The average waiting time for the operator to answer in the busy-hour is 2.1 sec., and the number of wrong connections 1.5 % (see Table III.).

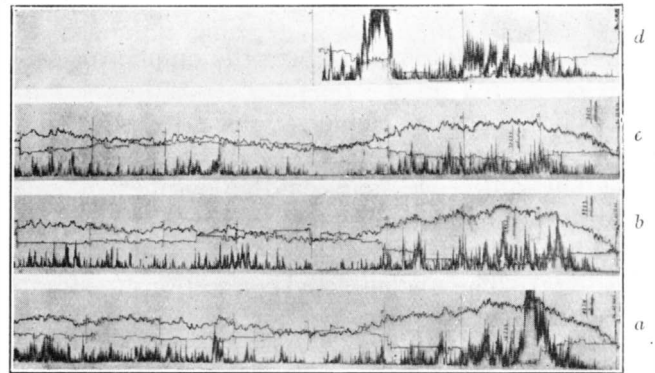

FIG. 3.—SUPERPOSED TRAFFIC CURVES.

Sharp control by the traffic office reduces operating faults to a minimum and supplies much useful information to the chief operator, teaching her how to deal with the regular and also the special variations of the exchange load.

The films of the recording ammeters are planimeted every hour and the results are

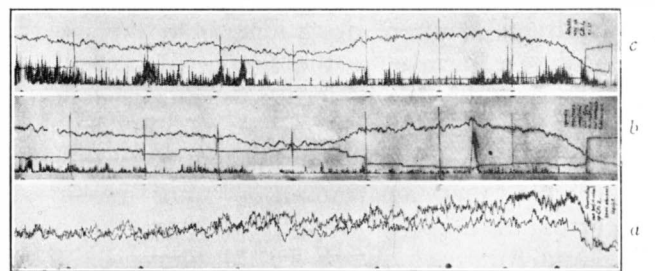

FIG. 4.—SUPERPOSED TRAFFIC CURVES.

systematically recorded in a card system (Kardex-visible-Index) together with the peak load of the group.

Likewise are treated the periodical records of traffic on 3rd G.S. for each group of 1,000 numbers, and of the Final Selectors per group of 100 lines.

The card system therefore contains a very compact summary of the critical traffic data

and a running record of the load in all the stages of traffic distribution, showing the efficiency of each group of switches and the progressive change of the load owing to the normal extension of the system.

This facilitates, by means which will be dealt with later on in this article, the calculation of the number of switches in accordance with the traffic and the promotion of the most economical load for the groups.

The average efficiency of the 1st G.S. has been taken at 70%, that of the 2nd and 3rd G.S. at 50% and that of the final selectors at 30%. The number of switches simultaneously working in accordance with these data is marked with a red line on the instrument, and so long as the curves remain on or below this line no loss of traffic because of shortage of outlets from the switches is to be feared.

In semi-automatic offices the efficiency of the 1st G.S. can be increased up to 85% by a small extension of the waiting time. The same effect can be reached in full automatic systems by introducing the dialling tone, which ordinarily in the Strowger system can be dispensed with. Up to the present no dialling tone is used at Amsterdam, though all the necessary devices are provided for.

The statistics recorded in the card system allow of the calculation of a great many traffic data and their verification as to constancy. Two examples will be described.

(2) *Acquaintance factors.*

If traffic measured in terms of T.C. outgoing from the office I to the office K be called a_{ik} , the total traffic outgoing from I be a_i , and from K a_k , then the acquaintance factor for the traffic from I to K is

$$f_{ik} = \frac{a_{ik}}{a_i a_k} \sum a$$

$\sum a$ being the total traffic of the system.

$$a_{ik} = f_{ik} \frac{a_i a_k}{\sum a}$$

The acquaintance factor f_{ik} has a value between 0, when no traffic from I goes to K, and $\frac{\sum a}{a_k}$ when all of the traffic from I goes to K.

The acquaintance factors determine the character of the exchange in the network and its relation to the other offices, they supply the

necessary data for the calculation of junction traffic and the number of junction lines and switches (2nd G.S.).

It is interesting to know in how far those acquaintance factors are constant, during the variations of the load in the day period and whether they change much over several years under the influence of the extension of the city and of the telephone system.

The acquaintance factors for Amsterdam are calculated every year for two or three months and from 1924 up to the present they show exactly the same figures. To demonstrate the variations during the day period, the acquaintance factors for May, 1926, are reproduced in Table I.

From the figures it will be seen that C.B.2 is a typical suburban exchange, C.B.3 and C.B.4 are the city exchanges and C.B.5 has a character just between.

(3) *Lost Traffic.*

Calling the traffic flow in terms of T.C. on 1st G.S. I_1 and on 2nd G.S. I_2 , the traffic loss

$$V = \frac{I_1 - I_2}{I_1}$$

V amounts to 25% in the semi-automatic office C.B.4 as an average for the day period calculated over a year, and in the full-automatic exchange C.B.5 to 15%. This figure is not constant when considered month by month, it varies in the two cases between 22 and 28%, and 10 and 18% respectively.

Included in the traffic loss mentioned above are the calls for booking toll connections, amounting to 4% in C.B.4 and 2% in C.B.5.

The analysis of the loss runs further, as follows:—

- (1) 2½% normal loss owing to the fact that the 1st G.S. must have worked before the second G.S. is put into action.
- (2) ½% results from normal busy calls (3 sec. per call).

There remains 18% in semi-automatic and 20% in full-automatic offices. In the former 8% is the normal time expenditure for the service, waiting time, setting up the keyboard, etc. In both types of exchanges there remains 10% real loss of traffic, which has been occasioned by various causes, e.g., unnecessary listening to the busy signal (which is given from 1st G.S.), uncompleted connections, dialling on a

level not in use, leaving receiver off switchhook, shorts on the line, poor service on P.B.X.'s, etc. All those avoidable losses ought to be detected and, if possible, reduced by the traffic office. This leads to a close examination of the traffic on the individual subscriber lines, as being one of the most important details of the task of the traffic office.

The next process in the analysis of the traffic loss is the comparison of the number of calls and the total number of conversations that are accounted for. The proportion of these two figures is calculated every 24 hours and proves to be always between 69 and 71%. The percentage of lost calls in 24 hours is fairly constant and is the same for all the exchanges, semi- or full automatic. Calculated over the various hours of the day period the loss varies from 32% in the busy hour to 22% in the slack hours.

The analysis runs as follows:—

	S.A.*	F.A.
(1) Calls not accounted for owing to rate schedule, principally calls for booking toll connections	2-3%	2-3%
(2) Subscriber orders no number or is unintelligible	1.5%	—
(3) Interrupted connections	1.5%	0.5%
(4) Call reaches a spare level	0.5%	3.5%
(5) Uncompleted connection	—	1.5%
(6) Busy calls	15-20%	15-20%
(7) No answer	4-7%	4-7%

The loss caused by busy calls is rather important and is a consequence of the flat rate system. There are at Amsterdam many business connections with over 100 calls a day. This is one of the greatest evils with which the traffic office has to contend, and though overloading the line is forbidden in the service regulations the only way to deal effectively with the subscriber is to convince him that he is wrong.

As a result of test calls, which are made extensively every day, it is clear that the probability of finding a line busy is much less than would be gathered from the number of busy calls recorded in regular service. It is only one third.

* S.A. = *Semi-automatic offices.*

F.A = *Full automatic offices.*

This means that as an average the subscriber, finding a line busy, calls three times while the desired number is engaged. This could be avoided by waiting about a minute after a busy call. Something similar occurs in the case of no answer calls, where also the call is repeated several times. This is very difficult to counteract, but very often the "no answer" is due to poor service at the called subscribers' telephone, sometimes arising from inadequate P.B.X. equipment. There is a fertile territory for the activity of the traffic office by working in conjunction with the installing department. The public observes action of this kind from a public service at first with reluctance, then with a certain kind of surprise, but finally with appreciation for the results obtained.

(4) *Checking up traffic data as to constancy.*

Out of the mass of scientific material compiled by the traffic office during the two or three years it has been working, some figures will be taken to show whether the data which are ordinarily used as a basis for the planning of telephone systems and exchanges are really constant. To what extent do they vary?

In Table II. are reproduced the following data relating to a semi-automatic office (C.B.4) and a full automatic office (C.B.5), covering the year 1925 and calculated for the busy hour (10-11 a.m.) as an average per month:—

- (1) Average load in T.C. on 1st G.S.
- (2) Maximum load in T.C. on 1st G.S.
- (3) Minimum load in T.C. on 1st G.S.
- (4) Maximum number of 1st G.S. simultaneously engaged.
- (5) Traffic loss in T.C.
- (6) Concentration, viz., the proportion between busy hour T.C. and total T.C. in the day period (9 a.m. to 5 p.m.).

The concentration is extremely constant even when the daily records are compared (ordinarily concentration is expressed as a fraction of the 24-hour traffic, but the figure is also constant). The average duration of a call depends a little upon the traffic loss, but proves to be fairly constant. Figures are respectively:—

C.B.2—Full automatic suburban exchange	95 sec.
C.B.3—Full automatic business exchange	100 ,,

C.B.4—Semi-automatic business exchange 100 sec.

C.B.5—Full automatic residence and small business 85 ,,

The duration of a conversation (that is an effective call) is 1.25 times the duration of an average call, being about 120 seconds. The average day calling rate per line during week-day for the year 1925 is as follows:—

C.B.2 = 12.3, C.B.3 = 14.8, C.B.4 = 15.0, C.B.5 = 13.5, C.B.6 = 13.2, and for the system as a whole 13.9.

B.—TRAFFIC OF THE SUBSCRIBERS' LINES INDIVIDUALLY.

(1) *Distribution of the traffic.*

The distribution of the traffic flow in the different channels is one of the most important factors in automatics. All calculations are made up on averages, but an average has only a meaning for a large group of equivalent values and quantities. The smaller the group and the greater the difference between the values or quantities mutually, the less reliable will be a calculation based on averages. Part of the task of the traffic office is to keep up as well as possible the averages provided for in the number of switches installed, and the only way to do so is to stimulate the most equal distribution of traffic in all channels.

One of the most effective means of getting an equal distribution of traffic in the groups is in the allotting of subscribers' numbers. When the spare numbers are equally distributed over the groups, the right choice of the number for each new subscriber allows the regulation of the traffic in the group.

For that reason the determination of new subscribers' numbers is made by the traffic office with regard to outgoing traffic from the subscriber. The permanent traffic measurement on the 1st G.S. determines which group of 2000 lines first must be taken into consideration to take new numbers. The periodical measurements of the final selector groups shows which is the best as to incoming traffic (to the subscriber). For this reason the results relating to final selector groups are recorded in a card system showing in a concise manner the number of lines connected to this group, the average load (F.C.) and the maximum load during the

busy hour. Each group has a card and on its rear side are marked the space numbers. The cards are arranged on the visible index method (Cardex system), so that the necessary data can be found without removing a card. The group being determined, the right number is found with the aid of the rear side of the card. Fig. 5 shows the method of assembling the cards in the

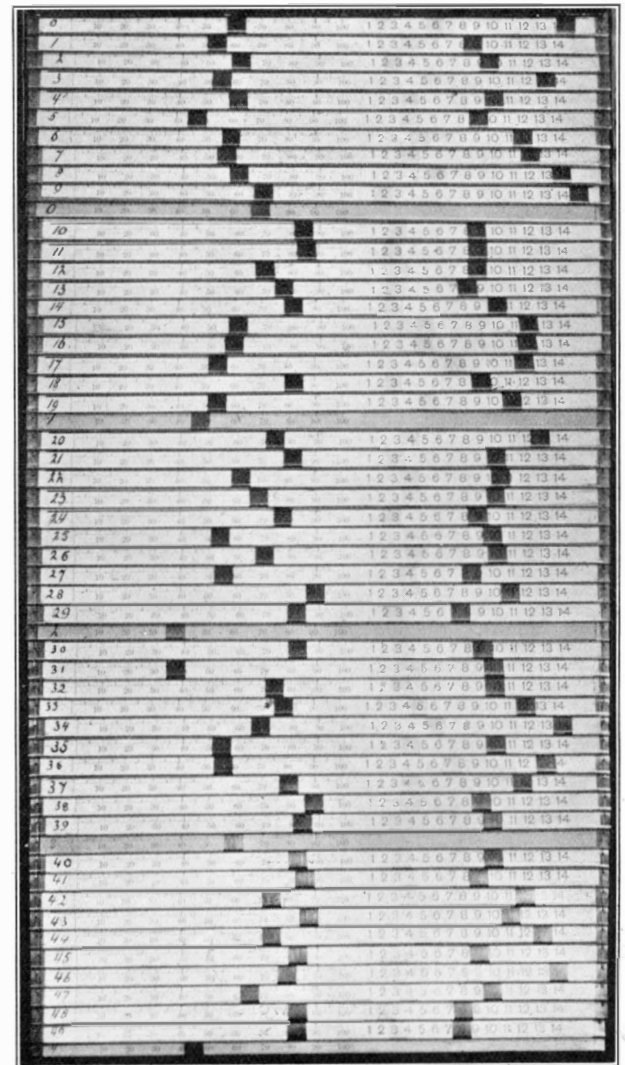

FIG. 5.—DRAWER OF CARD CABINET WITH CARDS AND GUIDE SIGNALS.

drawers of the Cardex cabinet with the guide signals. Every ten cards of final selector groups are separated by a yellow card recording the traffic on the 3rd G.S. leading thereto.

It will be evident that for the right application of the method the traffic of each new subscriber must be estimated. This demands a good deal

of practice and special records are kept for this purpose.

There is a second method of regulating traffic, *i.e.*, the application of auxiliary line finders on P.B.X. lines. By means of these some overloaded group can be relieved at the expense of underloaded ones. All the numbers of the same exchange can be jumpered to a call number on which the auxiliary line finder is working through a special intermediate distributing device.

The traffic office has to supervise the use of those extra line finders, for which a supplementary fee is charged to the subscriber.

As a proof of the efficacy of the working methods of the traffic office it is stated that in 1924 there were on C.B.4 147 hours in which

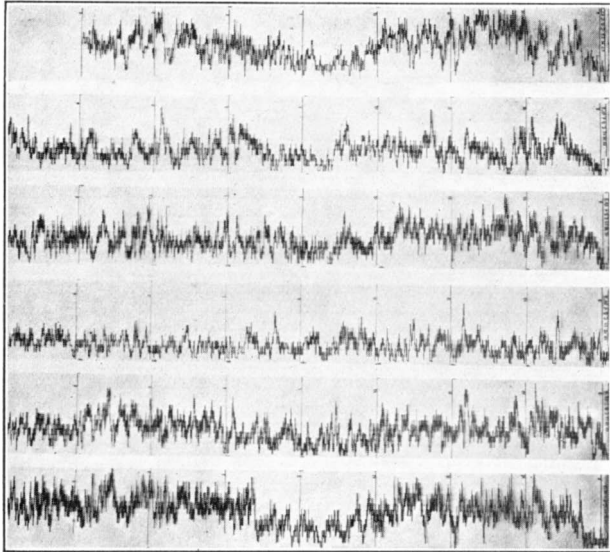

FIG. 6.—GRAPHS OF LINE-FINDER GROUPS.

the 1st G.S. had been overloaded and only 24 in 1926. In 1924 there were, in the same exchange, 43 final selector groups that were overloaded in the busy hour to the extent of 60 T.C. hours; in 1924, 31 to the extent of 30 T.C. hours.

Fig. 6 finally shows some traffic curves of 100 line final selector groups.

(2) *Quality of the service.*

In all business continuous controlling of the product will be necessary to reveal faults and to detect their causes. For that reason quality must be checked by a standard and all the

differences must be explained. Waiting till complaints arise means losing one of the most valuable assets a public service can have, namely, the confidence of the public. In telephony this is still more true, because the manner of acting of the public, who actively participate in the functions of the service, nearly always accentuates every decrease in its quality, giving to all faults the character of a cumulative evil. When, for instance, some irregular loss of traffic appears, the number of calls increases rapidly, increasing the loss again, and so on. Should in this way the critical point* of an automatic exchange be surpassed, the controlling power over the service is lost and most serious and disagreeable surprises are to be expected.

All this has been acknowledged long ago and service tests have existed in telephone practice for a long time. Ordinarily this is performed by listening in to regular connections.

This method has some disadvantages. The controlling officer gets all sorts and conditions of calls and connections mixed up, such as subscribers who make a regular use of their set and children playing with the apparatus, calls from and to lines where some trouble exists, where for some reason or another calls are not answered, or where attention to the telephone is bad.

Mistakes of the public, whether of the calling or the called subscriber, and faults in the apparatus and on the lines cannot be distinguished from real traffic faults. By this method a survey can be got of the working of the telephone system as a whole, but not of the service that is given.

Secondly, it is difficult to detect technical faults because the collaboration of the subscriber is wanted.

In the third place, this method of testing occupies much time, so that only a restricted number of calls can be observed, and at the same time it requires a highly trained officer who must be able to distinguish and to analyse all the cases he will observe, and, last of all, it is not desirable to listen in to connections when it can be avoided.

The manner just described is derived from the practice of manual systems where, for obvious reasons, no other method would be

* *I.P.O.E.E.J.*, Vol. 19, Part 2, July, 1926, p. 167.

practicable, but in automatic systems it is preferable to choose another way.

At Amsterdam service tests are made as follows :—

An experienced officer makes, during the busy hour, a great number of test calls, with carefully overhauled standard sets, *from* numbers in a group highly loaded with outgoing traffic *to* numbers in a group heavily loaded with incoming traffic (seen from the subscribers' side). The sets can be continuously changed from one group to the other, so that connections cross the system in all possible directions.

The following are observed :—

- (a) Waiting time, S.A. exchanges.
- (b) Service of the operator, S. A. exchanges.
- (c) Faults.
- (d) Ringing signal (both incoming and control on caller's box).
- (e) Wrong connections and the reason for the failure.

The cause of faults and wrong connections can be found because the controlling officer has both sets in front of him, so that he can keep every connection in the position in which the fault occurs.

It will be obvious that in this way a record is made of the service afforded under the most unfavourable conditions, independent however of faults and mistakes due to the subscriber, his line and the apparatus. It may be presumed that an average subscriber under normal conditions will experience a more favourable result.

Every day 100 test calls are made in about 60 minutes for semi-automatic and in about 15 minutes for full automatic exchanges. The results are summarised in monthly records, which are compiled from year to year. In Table III. are reproduced the results for two consecutive periods running from July to July. In this way the effect of exchange trouble is determined.

To get an idea of the working manner of the called subscriber the test calls are sometimes altered in such a way that instead of the second standard set a certain series of subscribers is called up.

Besides the data mentioned above, the character of which however is slightly changed, are found :—

- (f) Time that elapses between first calling

signal and the moment the subscriber answers.

- (g) The probability of busy calls.
- (h) The probability of no answer within 60 seconds.
- (i) Fault and mistakes owing to the called subscriber's lines.

This opportunity is utilised to ask the subscriber his opinion of the service, but complaints are seldom raised in this way. The method, however, is rather dangerous and cannot be recommended when the service is generally poor. The results of the second class of test calls, which are only made at long intervals because

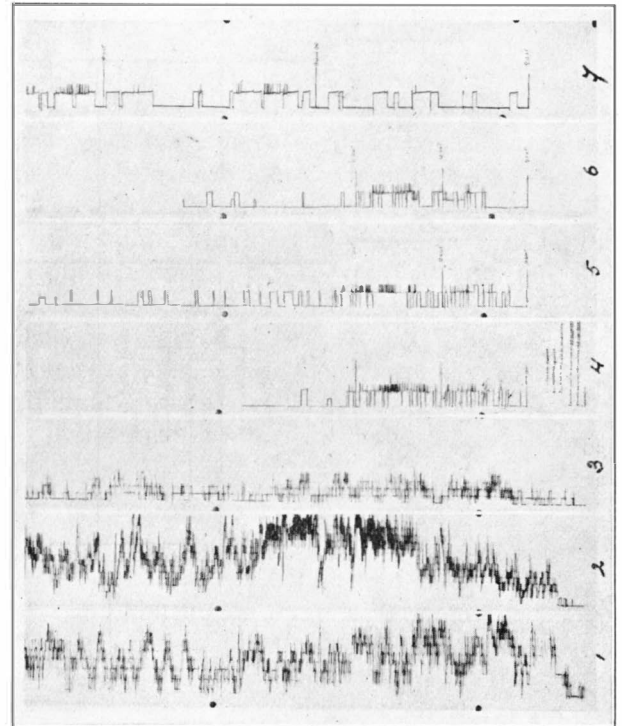

FIG. 7.—OVERLOADED LINES.

they take too much time (2 hours for 100 calls) are :—

- A. 8930 lines on C.B.2 (residence exchange).
 - (f) Waiting time till subscriber answers 10.9 sec.
 - (g) Called line busy 4.17%
 - (h) No answer within 60 sec.... 12.7 %*

* This is extremely high because the tests are made during the summer season when many people are out of town.

found in the records of the final selector groups. It can be seen immediately from the curve when there is an overloaded line in the group, as might be shown by Fig. 7, curves No. 1 and 2, the first being normal, the second containing the overloaded line. To persuade the subscriber the curves of Fig. 7, No. 3-7, are taken, in which the number of busy calls can be easily detected from the dashes on the top of the traffic curve. There are other indications inducing a search for overloaded lines, as for instance, complaints from subscribers or staff. Another reason for taking a line under control is the suspicion that the apparatus is not correctly used. There are many

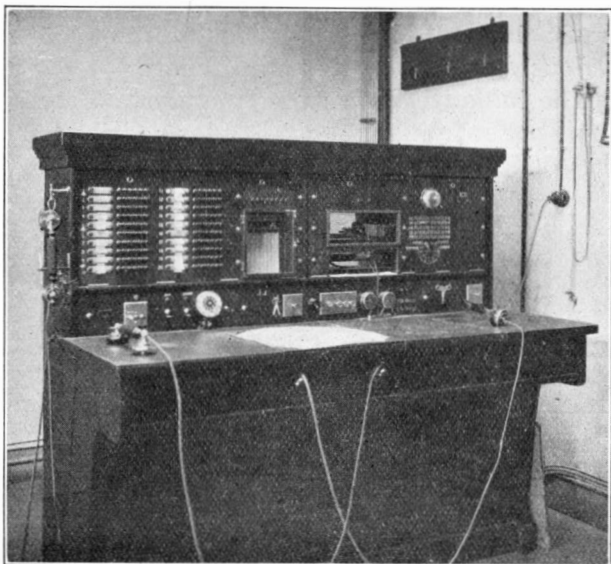

FIG. 9.—CONTROL DESK.

people who dial a wrong number and don't say a word when they discover their mistake. This raises complaints from the wrongly called subscriber to the trouble service, resulting in an unnecessary investigation.

(d) In the last resort the traffic office takes a line under control when neither the trouble service nor the repair staff has been able to get rid of a trouble of which the subscriber repeatedly complains. It may be very difficult to distinguish a technical trouble from a traffic fault due to one subscriber or the other, and this can only be determined by permanent control of the line.

(e) The last reason for controlling a particular line is to restrain an evil that has very

much increased since the introduction of the automatic system, viz., subscribers calling up numbers for annoyance or insult, or to blockade the line.

All data collected from controlling particular lines are kept in a special record containing a mass of useful information on the working of the service as a whole.

Finally follows a short description of the means used by the traffic office for the work mentioned above.

Every line of the system can be connected to a control desk by means of a special repeater set on the M.D.F. when the lines are plugged in the same way as for trouble investigation.

Fig. 8 shows the circuit of the repeater and Fig. 9 a front view of the desk.

The desk is equipped with 20 control lines running to the M.D.F. in the different exchanges; each of these lines contains 5 push-buttons, a calling lamp, which lights as soon as the subscriber takes off the receiver, and a supervising lamp, which lights when the fifth button is pushed down.

The desk contains further two chronographs each fitted with 8 pens, two recording registers, a telegraphone and some switches to cut in different signals.

The 5 push-buttons fulfil the following functions:—

- (1) Listening in.
- (2) Speaking.
- (3) Cutting in the chronograph.
- (4) Cutting in the telegraphone.
- (5) Holding up a connection to prevent release of the switches. This is to identify calling subscribers or to determine the switches that have been in action in the case of a fault.

The chronographs run 240 or 1200 m.m. an hour. They record the exact time a call begins or finishes, its duration and, besides, a great deal of useful information which can be seen from the specimen reproduced in Fig. 10. Explanation is given in the letterpress underneath. These instruments are particularly useful when all the lines of the same subscriber are to be investigated. They show then the distribution of the traffic.

The chronographs procure convincing documents to support negotiations with the sub-

scriber concerning the re-organisation of his traffic.

The telegraphone serves to record conversations; it reproduces later the spoken words.

The recording register is shown in Fig. 11. It is a combination of a register and a typewriter, and writes down the dialled numbers. It is very useful to find out mistakes made by the subscriber in dialling, to detect a faulty dial, and sometimes is used to register the complete operations of a subscriber's line under observation. Moreover, it furnishes a written document that can be used as a proof.

It will now be understood that the traffic office is a very useful, indeed, an essential part of the organisation in telephone management. It has by no means an easy job, but it pays for itself, while creating and consolidating the confidence of the public in the service which, as in no other business, is so indispensable to the telephone service, the results of which depend entirely

upon the trustful collaboration between the subscriber and the management.

C.—THE TRAFFIC IN P.B.X. INSTALLATIONS.

This task lies further in the field which the traffic office has to explore and cannot be started before the confidence of the public has been won and deserved.

The traffic office then begins to act as an advising office for the organisation of internal telephone traffic in large business enterprises. There, too, the interest of both parties is the same. An efficient and good working telephone system in large business houses has a prominent importance for the service as a whole.

The methods of investigating the internal traffic in P.B.X. installations do not differ seriously from those explained above.

The initiative for a closer examination sometimes arises from the subscriber, sometimes from the traffic office.

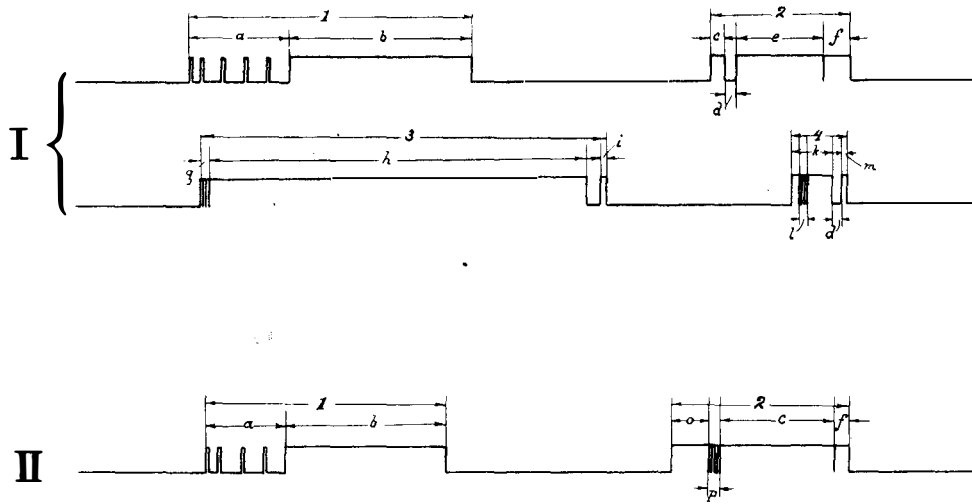

FIG. 10.—CHRONOGRAPH CURVES.

- I. Semi automatic : 1 Incoming call : a ringing signal.
b conversation.
- 2 Outgoing call : c waiting time.
d expedition.
e conversation.
f connection not cleared after the end of the conversation.
- 3 Toll connection : g ringing signal.
h conversation.
i report from toll office.

- 4 Outgoing busy-call : k waiting time.
l subscriber moves the hookswitch.
d expedition.
m subscriber listens to busy-signal.
- II. Full-automatic : 1 Incoming call : f see semi-automatic.
- 2 Outgoing call : o subscriber takes off telephone too early.
p dialling.
c see semi-automatic.
f see semi-automatic.

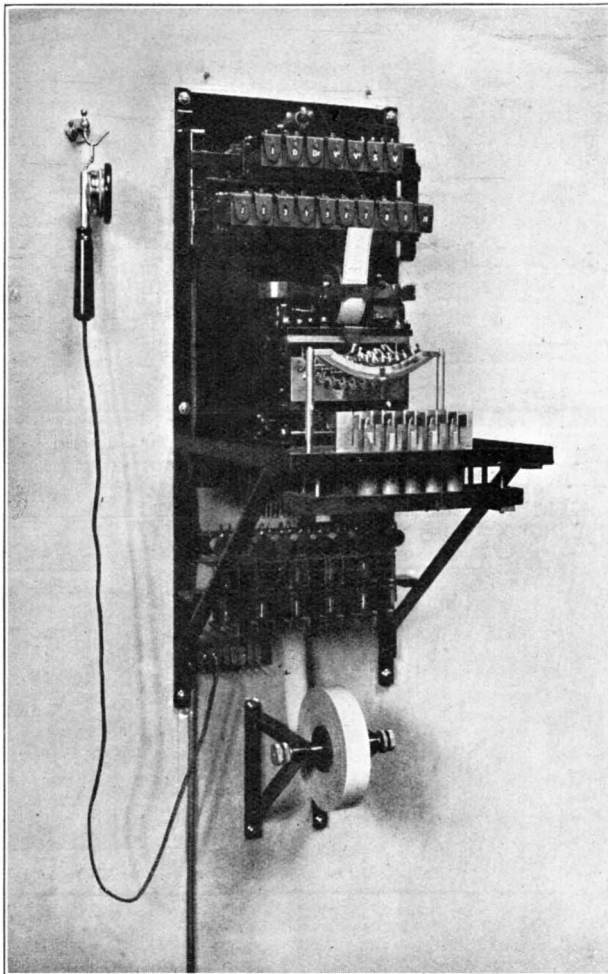

FIG. 11.—RECORDING REGISTER.

In many cases the result will be a re-organisation of the P.B.X. installation and the collaboration of the traffic office, the subscriber and the installing department have already given birth to a lot of particular P.B.X. installations designed to give the highest possible efficiency of service. It may be stated in this connection that in Amsterdam no P.B.X. installations are allowed to give through connections to the system except those designed and owned by the municipal telephone service.

The traffic office also, in conjunction with the chief of the operating staff, takes care of the training of the telephonists in the P.B.X. offices.

More and more the public comes to appreciate the work of the traffic office and public opinion proceeds to the conviction that a reasonably operated and well organised internal telephone system is one of the most powerful means of avoiding waste of time and of increasing the efficiency of business organisation.

Then the activity of the traffic office impinges on the territory of propaganda, which surely may not degenerate into a mere advertisement.

The task of a public service is "not to create facilities, but to satisfy a want"*

* Holcombe, "Public Ownership of Telephones on the Continent of Europe," *Harvard Economic Studies* VI., 1911, p. 418.

TABLE I.
SCHEDULE OF ACQUAINTANCE FACTORS, MAY, 1926.

Hour.	From C.B.2 To				From C.B.3 To				From C.B.4 To				From C.B.5 To			
	C.B.2	C.B.3	C.B.4	C.B.5	C.B.2	C.B.3	C.B.4	C.B.5	C.B.2	C.B.3	C.B.4	C.B.5	C.B.2	C.B.3	C.B.4	C.B.5
9-10	1.37	0.88	0.89	0.66	0.69	1.2	1.3	0.67	0.54	1.05	1.5	0.72	0.72	0.86	1.10	1.6
10-11	1.57	0.78	0.61	0.73	0.66	1.2	1.2	0.70	0.53	1.06	1.4	0.77	0.79	0.74	1.05	1.9
11-12	1.58	0.78	0.83	0.75	0.71	1.2	1.3	0.67	0.55	1.02	1.3	0.76	0.86	0.75	1.00	1.8
12-1	1.51	0.80	0.8	0.74	0.75	1.1	1.2	0.72	0.63	1.05	1.33	0.79	0.83	0.72	1.00	1.9
1-2	1.42	0.88	0.83	0.70	0.88	1.1	1.1	0.73	0.63	1.08	1.38	0.76	0.81	0.78	1.00	1.8
2-3	1.54	0.83	0.8	0.72	0.81	1.2	1.1	0.71	0.57	1.05	1.35	0.79	0.84	0.74	1.00	1.7
3-4	1.70	0.77	0.8	0.73	0.80	1.2	1.1	0.68	0.61	1.00	1.32	0.77	0.83	0.72	1.00	1.8
4-5	1.70	0.78	0.83	0.76	0.78	1.1	1.2	0.66	0.61	1.00	1.32	0.77	0.86	0.78	1.00	1.71

TABLE II.
TRAFFIC DATA, 1925.

Month	700 I.G.S. 70% = 490 T.C.						240 I.G.S. 70% = 148 T.C.					
	Av. Load		Max. Load		Loss	Conc.	Av. Load		Max. Load		Loss	Conc.
	TC (BH) 1	TC (BH) 2	TC (BH) 3	Max. Number I.G.S. 4			TC (BH) 1	TC (BH) 2	TC (BH) 3	Max. Number I.G.S. 4		
1	444	495	423	569	22.8	15.8	123	140	103	160	14.6	14.7
2	428	443	428	506	22.1	15.8	120	130	103	168	18.5	14.1
3	419	457	386	527	22.8	15.8	116	125	97	155	9.8	14.8
4	419	457	407	534	22.8	15.8	119	134	97	172	12.8	14.9
5	464	520	422	612	24.9	16.2	126	145	107	182	18.3	14.7
6	444	473	409	554	28.0	15.2	123	138	100	178	15.2	15.0
7	413	447	379	534	22.0	16.2	113	122	93	155	13.5	14.8
8	384	454	344	545	22.4	15.7	105	118	85	148	12.0	14.7
9	440	500	384	578	24.2	15.8	128	143	107	182	13.5	15.1
10	466	507	444	583	28.4	15.8	129	142	112	183	17.0	14.7
11	468	507	451	592	27.0	15.7	131	153	112	181	17.2	14.8
12	468	548	451	602	27.5	15.2	142	161	119	194	15.9	14.8
					24.64	15.75					14.86	14.77

TABLE III.
SERVICE LIST DATA.

No.	Year.	1.VII. '24—I. VII. 25.		1.VII. 25—I. VII. 26.	
		S.A.	F.A.	S.A.	F.A.
1	Number of test calls ...	24,291	34,726	14,980	20,837
2	Average waiting time sec. ...	2.1	—	2.1	—
3	Double connection % ...	0.51	0.1	0.23	0.04
4	Uncompleted connection % ...	1.32	0.1	1.33	0.05
5	Wrong number % ...	1.71	0.01	1.15	0.01
6	(3—5) Total % ...	3.54	0.21	2.71	0.1

TELEGRAPH AND TELEPHONE PLANT IN THE UNITED KINGDOM.
TELEPHONES AND WIRE MILEAGES, THE PROPERTY OF AND MAINTAINED BY
THE POST OFFICE IN EACH ENGINEERING DISTRICT AS AT 31ST DECEMBER, 1926.

No. of Telephones owned and maintained by the Post Office.	Overhead Wire Mileage.				Engineering District.	Underground Wire Mileage.			
	Telegraph.	Trunk.	Exchange.	Spare.		Telegraph.	Trunk.	Exchange.	Spare.
518,347	566	4,172	53,661	408	London	23,280	58,721	1,852,442	93,189
63,161	1,881	21,534	61,191	1,734	S. East	3,868	39,891	139,060	15,808
68,333	4,466	29,062	48,627	2,437	S. West	16,302	8,015	120,280	56,802
52,553	8,320	33,127	46,271	3,202	Eastern	18,364	29,266	77,083	82,911
86,091	8,668	42,725	54,529	3,647	N. Mid.	22,681	43,185	179,579	124,232
65,723	4,802	28,549	63,927	3,950	S. Mid.	12,901	19,207	131,891	90,572
53,050	4,827	29,339	48,585	2,150	S. Wales	5,472	22,324	96,561	72,591
90,732	8,215	25,100	46,334	5,072	N. Wales	12,759	37,503	202,756	61,497
141,641	1,576	16,974	42,191	3,096	S. Lancs.	12,470	75,366	423,782	46,900
83,890	6,003	29,937	43,676	3,626	N. East	10,170	38,961	192,248	43,850
56,636	3,648	24,206	35,841	1,746	N. West	8,644	31,485	137,224	37,340
42,737	2,302	15,755	23,404	2,611	Northern	4,498	10,571	85,611	55,053
19,457	4,779	6,535	12,778	317	Ireland N.	140	263	37,417	717
59,006	5,337	23,937	35,172	1,258	Scot. East	2,676	9,165	133,021	50,573
78,443	7,333	24,126	40,937	892	Scot. West	12,176	24,186	204,961	35,479
1,479,800	72,723	355,078	657,124	36,146	Totals.	166,401	448,109	4,013,916	867,514
1,447,128	73,169	352,254	649,543	34,814	Figures at 30th Sept., 1926.	160,895	437,757	3,810,671	805,738



THE PACIFIC CABLE BOARD'S CABLE--
BAMFIELD (VANCOUVER)-FANNING ISLAND.

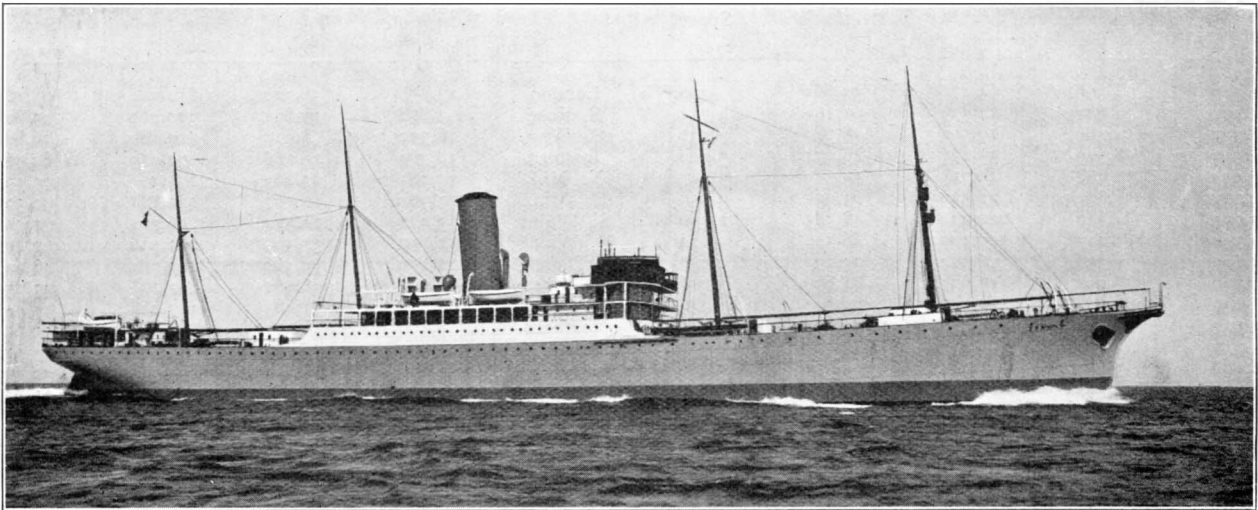

C.S. "DOMINIA" OF THE T.C. AND M. CO.

THE completion of the duplication of the Pacific Cable Board's Cables between Canada and Australia in November last, with the laying by the C.S. "Dominia" of the Telegraph Construction and Maintenance Co. of a continuously loaded cable in one section of 3,466 nautical miles between Bamfield, Vancouver, and Fanning Island, with the eminently satisfactory results obtained, proves at once the possibility of manufacturing and laying such a cable and also the very superior efficiency of the new over the old type. It is particularly satisfactory also that the cable was not only made in England at the Company's works at Wharf

Road and Greenwich, but that the whole of the "Mumetal" alloy (the patent of the Company) for continuously loading the core was made by them at their Bilston (Staffs.) works.

NOTES RE TYPES.

Types 1 and 2—A₁3 B.T. and A₂2 B.T.

23/1 and 17/2 indicates twenty-three No. 1 iron wires each .300" in diameter over seventeen No. 2 iron wires each .284" in diameter.

Types 3 and 4—E₃ B.T. and E₂ B.T.

17/2 indicates seventeen No. 2 iron wires each .284" in diameter.

Types 5 and 6—B₃ B.T. and B₂ B.T.

20/6 indicates twenty No. 6 iron wires each .200" in diameter.

Type 7—D₂ B.T.

35/14 (F.W.T.) indicates thirty-five No. 14 steel wires each .083" in diameter. Each wire separately compounded and taped.

Type 8—D.

20/14 (E.W.T.) indicates twenty No. 14 steel wires each .083" in diameter. Each wire separately compounded and taped.

One core in the three core types is unloaded.

NOTE.—B.T. indicates that the cores are brass taped for teredo protection.

Y.O.S indicates an outer serving of jute yarns.

T.O.S. indicates an outer serving of hessian tape.

The following are the external diameters of these types.

General Design.—In addition to the usual specification for tests by direct current, a guarantee was required regarding attenuation to alternating current which largely governed the design of the cable.

This guarantee was as follows:—

“ The completed cable when laid and through-

BAMFIELD-FANNING ISLAND CABLE, 1926.

Core $\frac{590}{370}$ lbs. $\frac{CU \text{ loaded}}{G. \text{ Percha}}$ per N.M. Half full size.

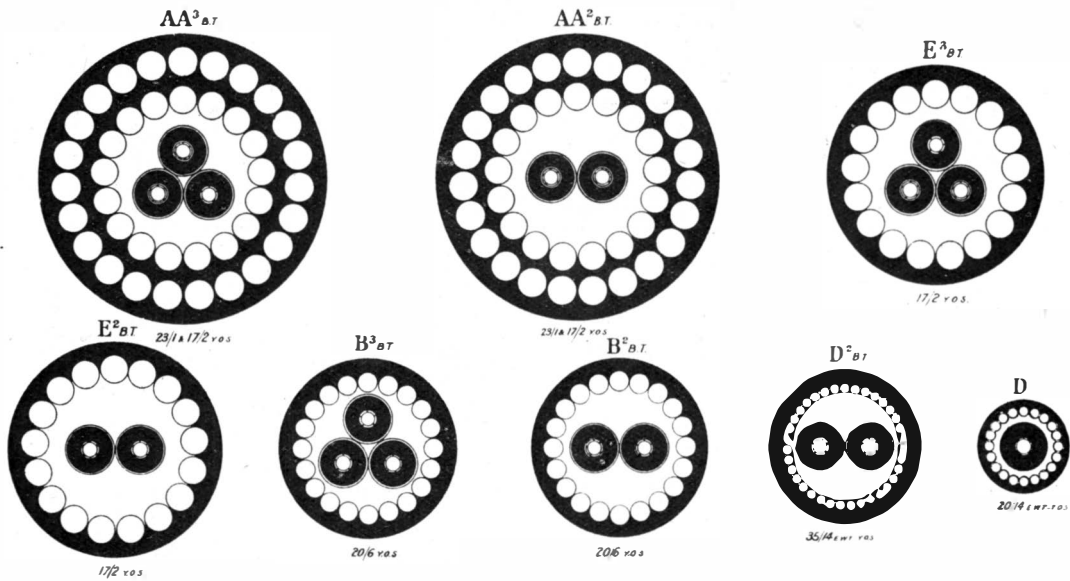

The illustration shows the line core, and also the sending and receiving earths in certain sections.

Type.	Diameter in inches.	Shipping Weight in tons per n.m.
AA ₃	2.98	33.
AA ₂	2.92	33.
E ₃	2.21	15.
E ₂	2.21	15.
B ₃	1.835	9.8
B ₂	1.800	9.4
D ₂	1.500	4.5
D	0.955	2.1

out the guarantee period shall be capable of transmitting at the rate of 600 letters per minute simplex; the speed shall be calculated on the basis of a minimum received current of 10 R.M.S. microamperes with receiving apparatus of impedance equal to the characteristic im-

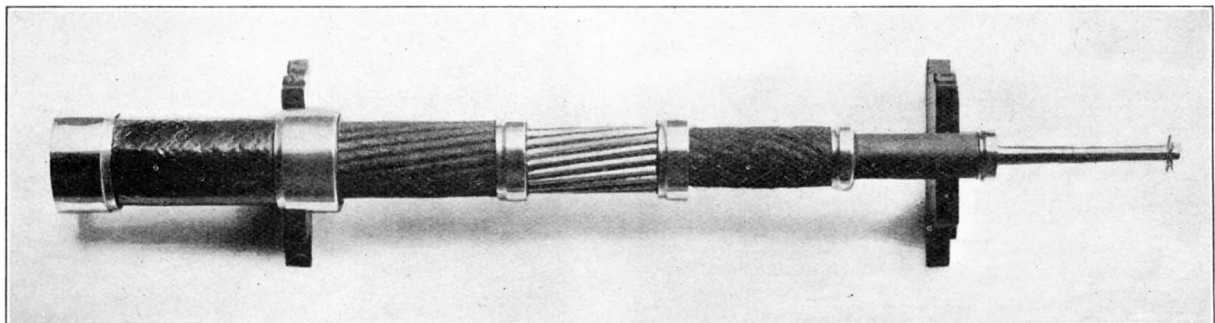

TELESCOPIC VIEW OF CABLE SHOWING MAKE-UP.

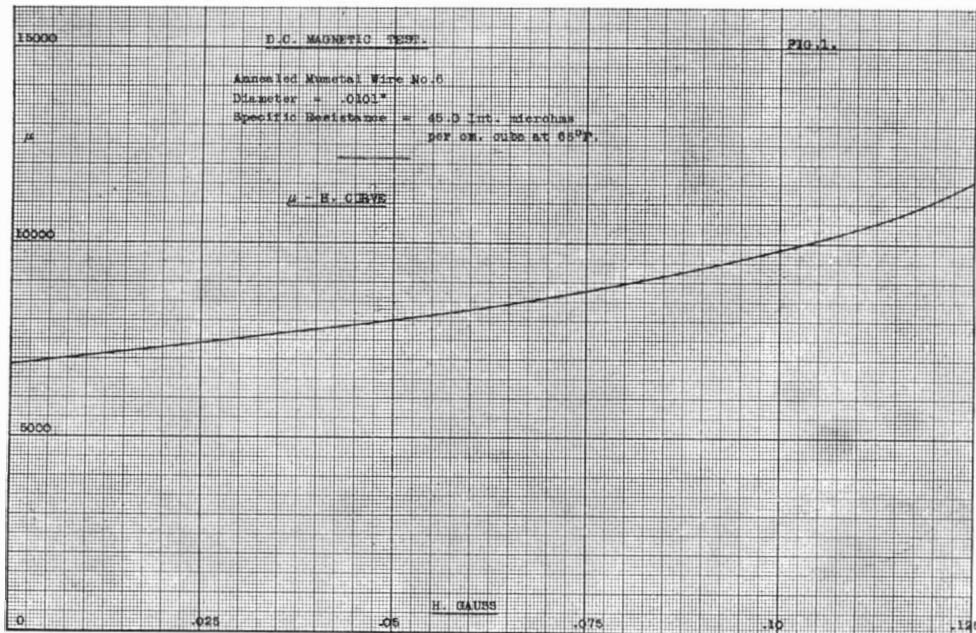
FIG. 1.— μ H CURVE FOR MUMETAL.

pedance of the Cable when sending reversals with 60 D.C. volts at the dot frequency, counting four centre holes per letter."

After a mathematical investigation of alternative designs and the manufacture and test of short specimens, it was decided that the core should be constructed as follows:—

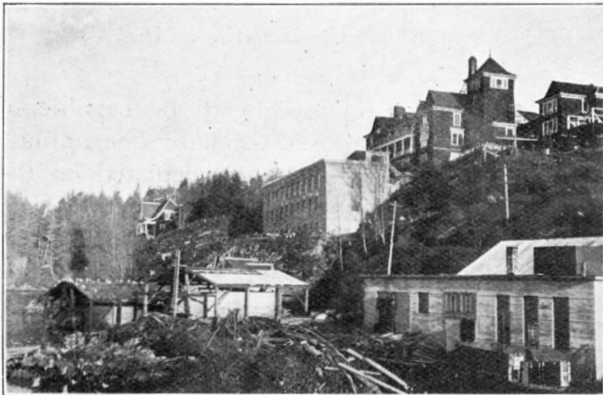

BAMFIELD REPEATER STATION, VANCOUVER.

Copper Conductor.—Central wire of diameter .150 inch surrounded by five tapes each .100 by .016 inch. Weight 590 lbs. per nautical mile.

Loading.—One layer of .010 Mumetal wire. Weight 104 lbs. per n.m. of conductor.

Insulation.—Gutta Percha. Weight 370 lbs. per n.m.

In Fig. 1 is given a typical μ H curve of the Mumetal as used for loading submarine tele-

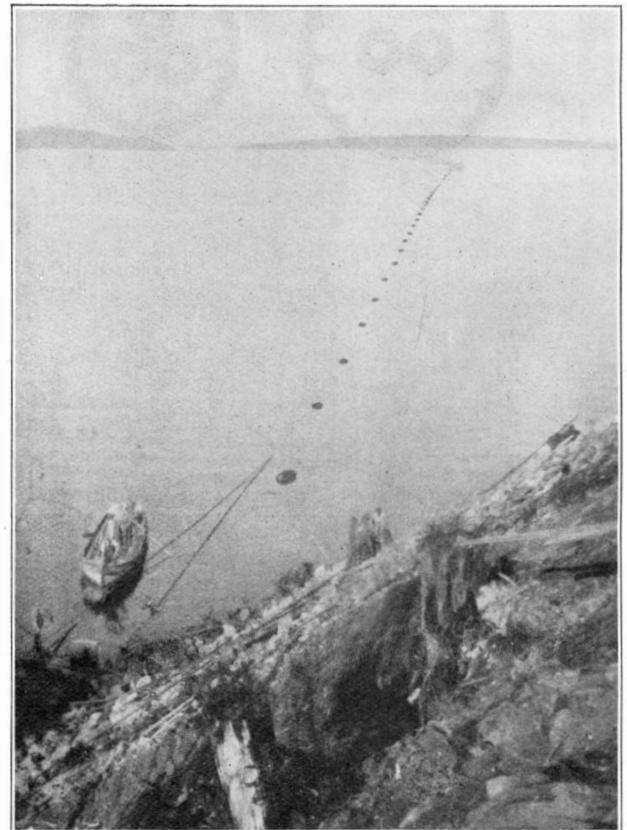
LANDING SHORE END AT BAMFIELD FROM C.S. "DOMINIA,"
27TH OCTOBER, 1926.

graph cables. The total length of loading wire in the cable was nearly 250,000 miles.

For the comparatively large sending currents at the ends of the cable the high hysteresis loss accompanying the maximum inductance obtainable made the development of such inductance inadvisable. Owing to the long length of the cable and the specification requirements as to speed of working, it was necessary to keep the

hysteresis loss was reduced to a minimum by suitable heat treatment and by graduating the inductance of the cable. That is, the inductance of the part near the ends, where the current would be high, was kept to a relatively low figure at which the accompanying loss was low, being increased in steps to a maximum in the centre of the cable. Mean values of inductance obtained are given below.

Direct Current Tests.—Each coil (of average



ANOTHER VIEW OF BAMFIELD LANDING.

direct current resistance of the cable below 2 ohms per n.m., and to ensure that this figure was not greatly exceeded for A.C. at 20 \sim . Special attention was therefore given to the eddy current and hysteresis losses, any undue excess of which would form a large percentage increase on the low total resistance of the cable. The eddy current losses were kept low by the high specific resistance—45 microhms per centimetre cube—of the loading material, while the

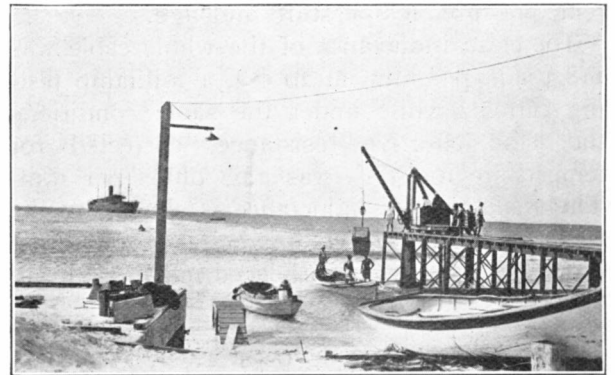

INSTRUMENTS BEING LANDED AT FANNING.

length $1\frac{3}{4}$ n.m.) was tested for conductor resistance, capacity and insulation, at 75°F., 14 days after manufacture. The mean values per n.m. obtained for the whole cable were:—

Conductor Resistance	1.967	Int. ohms.
Capacity3927	„ microfarads.
Insulation (after 1 min.)	1110.	„ megohms.

Alternating Current Tests.—For the purpose of ascertaining the inductance and added resistance due to the loading material, each length of core was wound bifilar, thus reducing the geometric inductance of the core (as distinct

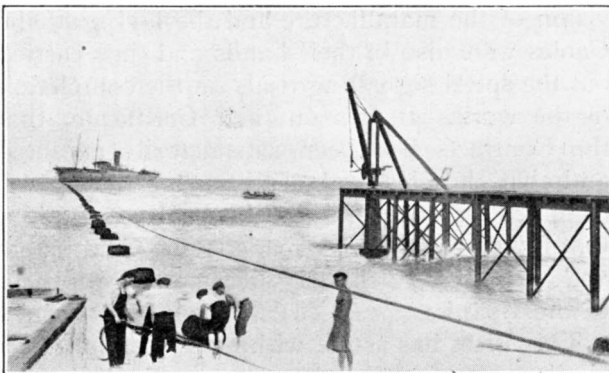

LANDING SHORE END AT FANNING ISLAND FROM C.S. "DOMINIA," 14TH NOVEMBER, 1926.

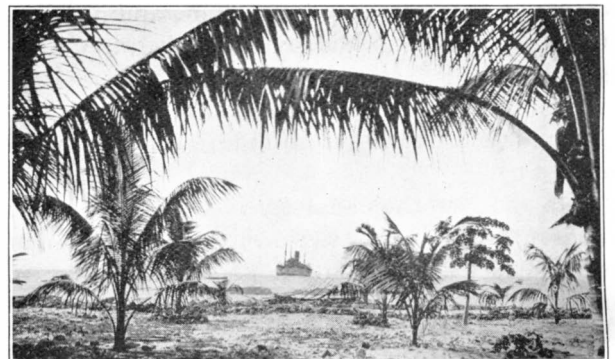

THE "DOMINIA" FROM FANNING ISLAND.

from the inductance added by the loading) to a small and calculable amount. The standard test was taken at 20 \sim with a testing current of 1 m.a., but a test was also taken at 20 \sim with 100 m.a. to observe the increase in hysteresis loss for this current.

The leakance of the core was observed by tests at 1000 \sim at 75°F. on selected short lengths, and from time to time determinations were made of the variation of each of the primary constants with frequency, testing current, pressure, temperature and age.

The mean inductance of the whole cable was 118.3 m.h. per n.m. at 20 \sim , 1 milliamp testing current, while under the same conditions the mean effective resistance, corrected for temperature to 75°F. was 2.08 ohms per n.m. The graduation of inductance is shown by the following table, the sections being given in the order in which they were placed in the cable —

Section No.	Approx. length n.m.s	Average inductance m.h. per n.m.
Shore end	750	106.
A	250	110.
G	250	122.
C	250	129
D	500	144.
E		
F	250	137.
B	250	123.
H	250	110.
Shore end	750	106.

At 1000 \sim , 75°F. the mean leakance on test pieces was 14.4 micromhos. per n.m. and the mean capacity was .382 microfarads.

The original Bamfield-Fanning Cable, having a core of 600 lbs. copper per n.m. and 340 lbs. G.P. per n.m. was laid by the Telegraph Construction and Maintenance Co. in 1902. It is still in continual use, working at a duplex speed of about 270 letters per minute, *i.e.*, 135 l.p.m. each way.

On the new cable the received current under guarantee conditions was nearly five times that specified, while the speed on the basis of 10 microamps received current exceeded 1000 l.p.m.

We give below specimens of messages received at various speeds. The limit of legibility

is not reached until a speed considerably above the 1200 l.p.m.

Specimen Signals received over Bamfield-Fanning (1926)
Cable. Length 3466.51 N.M. Sending with 60 volts.

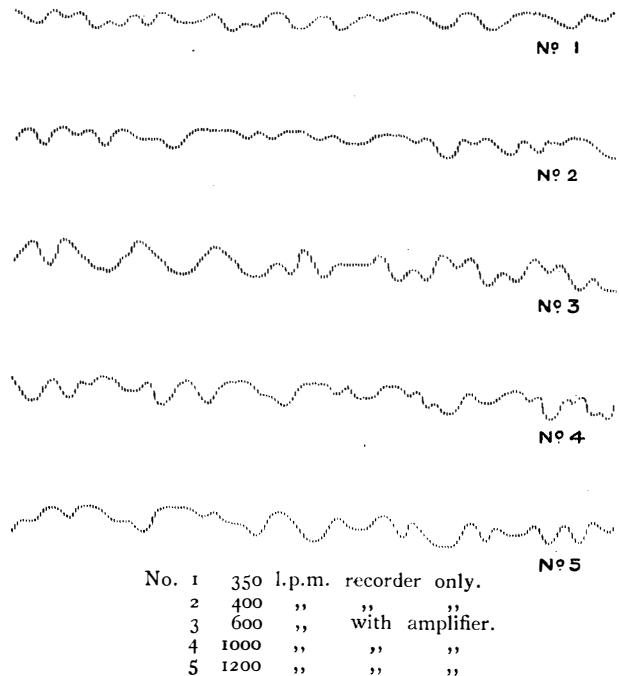

We are indebted to the T.C. and M. Coy. for the information contained in the foregoing description, and for the loan of the photographs. The signal slips were supplied by Messrs. Clark, Forde & Taylor, of 4, Great Winchester Street, E.C., who have been the Board's Consulting Engineers for the last 27 years, and who were the advisers to the Board for this project. They were responsible for the decision to adopt this loaded type of cable and drew up the Contracts and Specifications, which, for the first time with that type of cable, included a guarantee of performance. The selection of routes, the supervision of the manufacture and the laying of the Cables were also in their hands and they carried out the speed signalling trials on the completion of the work. It was on their Certificate, that the Contracts had been satisfactorily executed and that the electrical condition of the Cables complied in every way with the Specification, that full payments were made to the Contractors and the Cables definitely became the property of the Board.

This Firm has acted, with one exception, in a similar capacity for the owners of all loaded cables laid up to the present, including the German Cable between Borkum and the Azores.

SUBMARINE INSULATION WITH SPECIAL REFERENCE TO THE USE OF RUBBER.

By R. R. WILLIAMS and A. R. KEMP.

Bell Telephone Laboratories Inc.

IN the Journal of the Franklin Institute for January, 1927 (Vol. 203, No. 1), a long and important article appears under the above heading. The experience gained with the rubber-covered Seattle-Sitka cable is understood to have been unsatisfactory. The authors of the above article have made an exhaustive investigation into the behaviour of rubber under various conditions, particularly those met with in submarine practice, and their results are set forth in the article in considerable detail. Tables of results and charts of electrical and other tests are given and the article will well repay detailed attention by those interested in rubber-covered cables. The following notes have been extracted from it.

Gutta percha (with or without admixture of Balata) is regarded as the only reliable material for submarine insulation. High cost of these materials constitutes a handicap on the industry. The only reasonable prospect among existing materials as a substitute for gutta percha or balata appears to be some form of rubber. Examination of samples of the Seattle-Sitka cable, which had lain some sixteen years or more at sea-bottom, has shown that the rubber insulation is still in an excellent state of preservation in respect to its mechanical characteristics (N.B.—This cable was replaced by a Gutta Percha cable last year). However, rubber has some distinct technical limitations which will be discussed later. As is well known, rubber may be more fully plasticised by mixing with it a solid material in a finely divided condition. In order, however, to attain the maximum toughness it is necessary to incorporate sulphur in the mixture and after forming the insulation in place to vulcanize it by heating, usually at 120°C. to 150°C. From the standpoint of permanence of mechanical and electrical characteristics, gutta percha has proved to be nearly ideal, there being practically no change over a period of fifty years at sea-bottom. All available evidence indicates that vulcanized rubber as heretofore manufactured is equally permanent

in its mechanical properties under the same conditions but is lacking in stability of its electrical properties.

This instability in electrical properties is manifested in rubber-insulated cables principally by slow increase in capacity over periods of years. In some cases the dielectric constant of the insulation has become double what it was at the time of manufacture. The other electrical properties are also adversely affected in some cases. These changes are largely due to penetration of water. The insulation engineer must not count on anything being "water-proof" in the sense of being unaffected electrically by moisture. Rubber insulation shows the same sort of changes in water content and in electrical values with wetting and drying as gutta percha. However, the magnitude of the changes in most rubber insulation is very much larger than in well prepared gutta percha. On a dry basis unfilled vulcanized rubber is comparable with gutta percha in dielectric constant and phase difference angle. On the other hand, after prolonged immersion in water, rubber commonly compares quite unfavourably with gutta percha. In order to evaluate materials for submarine insulation a method was devised to give a reasonably rapid approximation of the effects of sea-bottom conditions on such insulations. Thin sheets of the various materials were prepared and their water content and electrical characteristics measured both dry and after various periods of immersion in aqueous media. Also a method of electrically testing sheets was developed and applied quite generally, as some correlation of water content and electrical characteristics was to be anticipated. Essentially the method consists of placing a sheet of rubber of known thickness between two accurately plane-surfaced steel electrodes and measuring the capacity and conductance at 1000 c.p.s. with a suitable bridge. Direct current insulation resistance is also measured with a sensitive galvanometer. The changes in weight of the rubber sheets are noted as an index of the water content from time to time. A sys-

tem carefully standardized so as to be uniform is necessary for surface cleaning and drying to avoid anomalies due to surface contact between electrode and insulating material. The sheets are rinsed with distilled water, blotted with filter paper, exposed to a current of dry air for one minute and immediately placed between the electrodes, readings being taken after one minute. The fact worthy of first mention is that the amount of water absorbed by sheets of uniform thickness of a given material depends on the salt content of the water in which the sample is immersed. The results of observations suggested that water absorption is dependent on the osmotic pressure of the external solution and led to the corollary proposition that the amount of water absorbed is also controlled in part by the molecular concentration of water-soluble substances contained within the mass, *i.e.*, the osmotic pressure of the internal solution. This viewpoint can be readily illustrated by milling into a rubber mass a small amount of salt and immersing the sheet in fresh water. In a few weeks the position of the salt particles is marked by water-filled blisters which protrude from the surfaces of the rubber and often burst from the internal osmotic pressure which is developed. The effect of the water-soluble constituents normally present in rubber is also to cause increased water absorption, but in this case, on account of the higher degree of dispersion, no visible blisters appear. Removal of water-soluble substances, especially of chrysoloidal character, by thorough washing, produces substantial reduction in the water absorption. Soft vulcanized rubber shows this osmotic effect as markedly as raw rubber.

It will be recalled that fillers are required to give the plasticity necessary to good extrusion of rubber. It is a well known fact that fineness of fillers increases the mechanical strength of rubber compounds. Fineness of fillers might be expected to increase water absorption and decrease electrical stability in water because the area of interface between rubber and filler increases with increasing fineness. The results obtained with silica show that this is true. In many filled rubbers this interface appears to be the greatest source of electrical weakness. Certainly the adhesion of rubber to mineral particles is commonly very poor. Whether or not actual adhesion occurs between rubber and filler par-

ticles and adsorbed gas film on the surface of filler particles might have an important influence on the volume of interfacial voids. Experience with scores of rubber compounds seems to show a relationship between the amount of adsorbed gas per unit surface of fillers and the changes which rubber compounds containing the fillers show on prolonged immersion in water. The case of zinc oxide is especially interesting. Its particle size is very small and the surface per gramme much higher than that of any other filler studied.

Yet the gas adsorbed per unit area of surface is of a lower order than that of other fillers, and in spite of its fineness zinc oxide produces rubber compounds of maximum electrical stability on immersion in water. Other factors of course may be responsible in whole or in part for this result. Among varieties of silica of equal fineness those which adsorb the least gas are those which produce the most stable compounds.

The influence of gas on adhesion is of less importance in the case of organic fillers. Although the gas adsorbed on particles of hard rubber dust (note, ebonite is known as hard rubber in America) has not been studied, apparently adsorbed gases do not play an important rôle in the case of this filler, as numerous attempts to improve its compounds with rubber by mastication in vacuum have not given the slightest evidence of benefit. Probably this filler is sufficiently plastic at the temperature of vulcanization, so that any gases adsorbed at the surfaces of the original particle distribute themselves throughout the particle. If this takes place no interference with the wetting of the particle of the rubber magma would be expected.

The absorption of water by rubber is attended by an increase in dielectric constant. A similar change is observable in filled rubbers. In general the leakance also rises with water content and the insulation resistance declines. These changes in ordinary commercial rubbers are often extremely large, but in material properly treated to reduce water absorption are comparable with those occurring in gutta percha.

The influence of the factors controlling the dielectric constants of rubber compounds have been evaluated for practical purposes in a fairly

consistent though far from mathematical manner. This is less true of the factors controlling phase angle. Fortunately, rubber compounds which exhibit a satisfactory degree of stability of dielectric constant are usually satisfactory as to phase angle as far as our experience extends.

The Authors' summary is as follows:—

(1) Soft vulcanized rubber, though not well adapted to some of the processes of manufacture of submarine cable, can be so made as to be mechanically and electrically suitable and to withstand the action of sea water in a manner comparable with that of gutta percha over a period of a few years. Whether such rubber will retain these characteristics for decades remains to be demonstrated, but it seems probable that it will.

(2) The principal factor to be controlled in producing this result is the amount of water absorbed by the rubber.

(3) Osmotic pressure of internal and external

fluids is of prime importance in governing the in-flow of water into rubber and gutta percha.

(4) Lowered water absorption is achieved by removal of water-soluble matter from the rubber, the choice of an insoluble non-reactive filler of suitable particle size and having a minimum of adsorbed gases or other contamination on its surfaces.

(5) The electrical characteristics of rubber compounds and of gutta percha are clearly related to their water content but are not simple functions of the water content.

(6) It appears that the mode of distribution of water is also extremely important.

(7) Most fillers for rubber compounds are not suitable for submarine insulation, either because of undesirable intrinsic electrical properties or because they are conducive to changes incident to water absorption. Hard rubber dust, silica, and zinc oxide are the best fillers from these standpoints so far as known.

F.L.H.

SOME ASPECTS OF THE ELECTRIC CAPACITY OF TELEPHONE CABLES.

A. MORRIS, A.R.C.S., D.I.C., Wh.Ex., M.I.E.E.

GENERAL.—Modern developments in long-distance telephonic communication have rendered necessary a more detailed and intimate knowledge of that property of multi-core telephone cables which is known as electric capacity. Such knowledge is necessary to all concerned with the technique of wire telephony, including those engaged upon cable manufacture, since a true conception of this property is the first step towards fulfilling the exacting requirements which need to be met in the factory stage of modern long-distance cables. The full capacity requirements of factory lengths of modern trunk cables were first laid down, as far as the British Post Office is concerned, in Specification 73, U. of January, 1926; Clause 7, Section (b) of which reads as follows:—

“ In each factory length of cable the average electrostatic capacity of all phantom circuits of each group taken separately shall not differ by more than 5% from the value, which shall be determined by multiplying the actual average

pair capacity of that group in the same factory length by the factor 1.62.”

This article is directed principally to those aspects of cable capacities which are involved in this clause. Theoretical consideration is given to the subject, supporting data being furnished in the form of test results obtained from representative cables during the last ten years or so. The manufacturing means whereby the specified requirements may be met are outside the scope of the article and no attempt has been made to indicate them. In achieving the desired object it will be necessary to deal with the electric capacities associated with the conductors of telephone cables in some detail. In this connection certain general methods of treatment due to Campbell⁽¹⁾ will be emphasised, the only reason and justification for their re-statement in this article being the author's belief that they are neither very generally known, nor their analytical value fully appreciated.⁽³⁾

Direct Capacity Networks.—Consider an electrical system consisting of a number of

associated conductors, capable of mutual electric action within their own group, but so isolated from all other conductors as neither to give rise to nor to be subject to external electric action. Each conductor will have a capacity to every other conductor in the group and the whole electrical system may be exactly represented so far as capacity is concerned by a network of condensers. If there are N such conductors, each of which has a terminal, then the total number of condensers connecting such terminals together in pairs will be $N(N-1)/2$. Each condenser will represent what is known as the "direct capacity" between the two conductors whose terminals are thereby connected, the whole arrangement of capacities being referred to as the "equivalent direct capacity network" of the system or group of conductors.⁽¹⁾

The method of dealing with the interactions between a system of conductors by reference to its equivalent direct impedance or admittance network is of extreme general utility. In the case of problems relating to communication circuits, the method provides a valuable means of analysis and for this reason further consideration will be given to it, in its application to cable circuits. Details will also be given of a theorem^{(1), (2)} and of certain properties⁽¹⁾ relating to direct capacities which permit of calculations being readily effected.

Network transformation theorem.—In considering the effective or resultant capacity (for transmission purposes) of a single circuit AB of a multi-core cable the problem resolves itself into the determination of the magnitude of the single capacity between A and B which will have an exactly equivalent effect, as far as transmission along the circuit AB is concerned, as all the capacities associated with that circuit and with the whole of the remaining wires of the cable. For this purpose it will be necessary to consider the direct capacity network of the whole system of cable conductors and then eliminate all the conductors or terminals except the two under consideration. This may be done by well known methods involving the application of Kirchhoff's Laws and the use of determinants. Such methods effect the elimination of all the necessary terminals simultaneously. Alternatively the effect of all the redundant terminals may be eliminated one at a time by the application of a network transformation theorem,⁽¹⁾ due

to Prof. G. A. Campbell, which may be stated thus:—

In any network of conductors, a star of N rays OA, OB, ON, may be replaced by a mesh of $N(N-1)/2$ conductors, AB, BC, CD, etc., joining every pair of the terminals A, B, C, N (terminal O being thereby eliminated) without affecting, as far as concerns its external reaction upon any other electrical system with which it is associated only by conductive connections through the points A, B, C, N, the rest of the network. With admittance operators:—

$$AB = (OA \cdot OB) \left[\frac{1}{OA + OB + \dots + ON} \right]$$

$$BC = (OB \cdot OC) \left[\frac{1}{OA + OB + \dots + ON} \right]$$

etc.

With impedance operators:—

$$AB = (OA \cdot OB) \left[\frac{1}{OA} + \frac{1}{OB} + \dots + \frac{1}{ON} \right]$$

$$BC = (OB \cdot OC) \left[\frac{1}{OA} + \frac{1}{OB} + \dots + \frac{1}{ON} \right]$$

This theorem is of such exceptional utility in problems relating to telephonic networks that its method of application will be demonstrated later in reference to the mutual electrostatic capacity of the circuits of a two-pair core of M.T. Cable.

Additive properties of Direct Capacities.—One of the greatest advantages attending the utilisation of direct capacity networks lies in the ease with which the alterations effected in direct capacities by external operations upon the network may be calculated. The above-described transformation theorem is useful for this purpose and when used in conjunction with certain additive properties of direct capacities, constitutes an invaluable analytical process. The additive properties referred to have been stated by Campbell⁽¹⁾ and are quoted below, thus:—

(1) A capacity connected between two terminals of an electrical system adds to any direct capacity existing between such terminals, and is without effect on all other direct capacities.

(2) If the terminals of two distinct electrical systems are connected in pairs, the resulting system is one in which each direct capacity is the sum of the corresponding two direct capacities of the individual systems.

(3) If two terminals of an electrical system

are joined together to form a single terminal, the two direct capacities from the two merged terminals to any third terminal, add together. All other direct capacities remain unchanged, except the direct capacity between the two merged terminals, which becomes a short circuit.

(4) If the terminals of an electrical system are joined together into any number of merged groups, the total direct capacity between any pair of groups remains unchanged, whilst the direct capacities within each group become short circuited.

Equivalent Direct Capacity Network of a Multi-Core Cable.—If a group of N conductors be totally enclosed within an earth-connected conductor, then in addition to the $N(N-1)/2$ direct capacities which connect such conductors together in pairs, it is obvious that N further capacities will be brought into existence, since each conductor will have an additional direct capacity to earth. If each of the N conductors is a wire of a multi-core cable and the earth-connected conductor represents the cable sheath, then the equivalent direct capacity network of such a system will be represented by $N(N-1)/2$ direct wire-to-wire capacities and N direct wire-to-earth capacities.

Direct Capacity Network of a two-pair Multiple-Twin Core of a Multi-Core Cable.—For the purpose of examining the nature of the mutual reactions arising wholly within a two-pair core, e.g., either the relative effective transmission capacities of its various derived circuits or their mutual interference possibilities, it is necessary to consider the equivalent direct capacity network of such a core. If it existed alone within an earthed sheath, its equivalent network would, according to the foregoing, obviously consist of six direct wire-to-wire capacities and four direct wire-to-earth capacities. In a multi-core cable, however, such a core is associated with a number of other cores which must be given consideration. In dealing with this general case it is convenient to consider in the first instance the equivalent direct capacity network of the whole cable. The core under consideration may then be regarded as consisting of four accessible terminals, the cable sheath as consisting of a single accessible terminal and the remaining $(N-4)$ wires of the cable as consisting of $(N-4)$ inaccessible terminals or concealed branch points, subsequently

to being eliminated. Elimination of these terminals by the method already indicated will result in the equivalent network of the core, which will consist of ten direct capacities as heretofore, six connecting the wires of the core directly and four connecting the wires to earth. Thus the direct capacity between any two wires is the single capacity which is the exact equivalent of all the other capacities connecting the two wires (or accessible terminals) either directly or *via* the remaining $(N-4)$ wires (or concealed branch points). The six capacities complying with this definition are the six direct wire-to-wire capacities of the core. The direct capacity between any wire of the core and earth is the single capacity which is the exact equivalent of all the capacities connecting the wire and sheath (both accessible terminals) either directly or *via* the remaining $(N-4)$ wires (or concealed branch points). The four capacities complying with this definition are the four direct wire-to-earth capacities of the core.

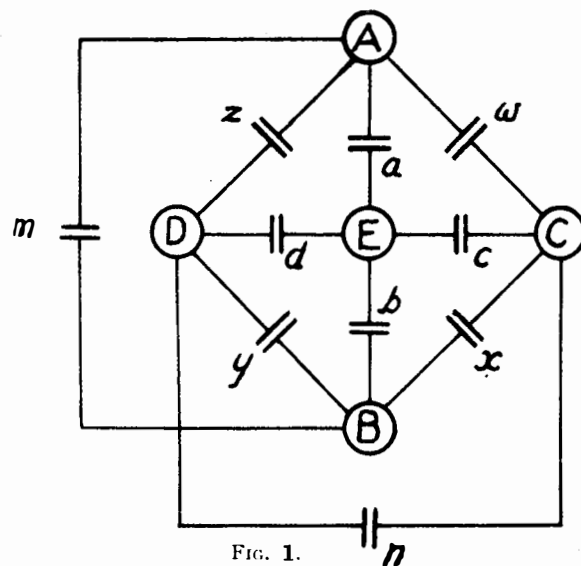

FIG. 1.

Fig. 1 represents diagrammatically and symbolically the equivalent direct capacity network or the direct capacity couplings of the conductors of a four-wire core or unit of a lead sheathed cable. A and B form one pair or side circuit, C and D the other pair or side circuit. The cable sheath is assumed to be connected to earth. The component capacities, w , x , y , z , m , n , a , b , c and d , the first six being wire-to-wire capacities, and the remaining four wire-to-earth capacities, are the direct capacities of the system defined in accordance with the foregoing.

It will be obvious, from the actual mode of definition, that the magnitudes of these direct capacities when the core exists alone inside the sheath will be different from the magnitudes obtaining when the core—without change of the relative position of its wires—is associated with a number of other cores. Furthermore, the extent of the difference will be accentuated by earth-connecting such associated wires. Table No. II., which gives the results of actual measurements, demonstrates this feature, which will be dealt with at greater length later. In dealing subsequently with the direct capacity networks of individual four-wire units of multi-

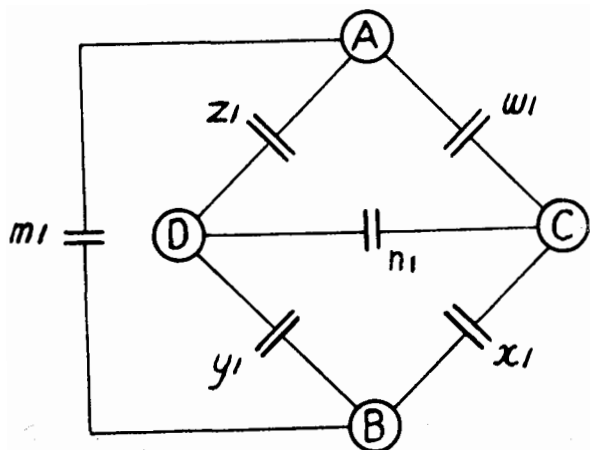

FIG. 2.

core cables it will be assumed that the conductors of all cores other than the one under consideration are disconnected from each other and from the lead sheath. Under these conditions the direct capacity between A and C, B and C, B and D, and A and D, which are respectively $w, x, y,$ and $z,$ will be referred to as the direct capacities between wires not in the same pair. The direct capacities between A and B, and C and D are respectively m and n ; each will be referred to as the direct wire-to-wire capacity of a pair, a, b, c and $d,$ the capacities of the wires A, B, C and D respectively to the cable sheath—assumed to be earthed—are the direct earth capacities of the wires of the core.

Mutual Electrostatic Capacity of the Circuits of a two-pair Core of Multiple-Twin Cable.—With the direct capacities of the core as represented by the five terminal, ten member mesh of Fig. 1, the mutual capacity of any of the

circuits which may be formed on the core can be readily calculated by the methods which have already been indicated. In illustration of these methods the AB side circuit capacity will now be computed. Thus:—

(1) Referring to Fig. 1, replace the four ray star EA, EC, EB, ED by the six member mesh AC, CB, BD, DA, AB, CD. The resulting network is shown in Fig. 2, where:—

$$\left. \begin{aligned} w_1 &= w + ac/\delta_1 \\ x_1 &= x + bc/\delta_1 \\ y_1 &= y + ba/\delta_1 \\ z_1 &= z + ad/\delta_1 \\ m_1 &= m + ab/\delta_1 \\ n_1 &= n + cd/\delta_1 \\ \delta_1 &= a + b + c + d \end{aligned} \right\}$$

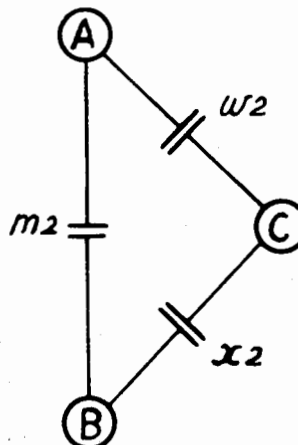

FIG. 3.

(2) Referring to Fig. 2, replace the three ray star DA, DC, DB by the three member mesh AC, CB, AB. The resulting network is shown in Fig. 3, where:—

$$\left. \begin{aligned} w_2 &= w_1 + n_1 z_1/\delta_2 \\ x_2 &= x_1 + n_1 y_1/\delta_2 \\ m_2 &= m_1 + z_1 y_1/\delta_2 \\ \delta_2 &= y_1 + z_1 + n_1 \end{aligned} \right\}$$

(3) Referring to Fig. 3, replace the two ray star CA, CB by the single member AB. The result is the single capacity $m_3,$ shown in Fig. 4, where:—

$$\left. \begin{aligned} m_3 &= m_2 + w_2 x_2/\delta_3 \\ \delta_3 &= w_2 + x_2 \end{aligned} \right\}$$

m_3 is the mutual wire-to-wire electrostatic capacity of the side circuit AB and is exactly

analogous to the quantity which is referred to in British Post Office Specification No. 73, as the electrostatic capacity from wire-to-wire of the cable pairs—all other wires of the cable being insulated from each other and from the lead sheath during any measurement which may be made to determine its magnitude.

A similar expression, n_3 , may be derived for the mutual wire-to-wire capacity of the CD side circuit. If these results are evaluated in terms of the direct capacities of the core (see Fig. 1),

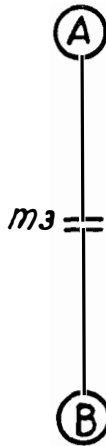

FIG. 4.

rather lengthy expressions will be obtained. They will be simplified, however, if the core under consideration has some degree of electrical symmetry or balance. Thus if $w = x = y = z$, $a = b$, and $c = d$, then:—

$$m_3 = m + w + a/2, \text{ and } n_3 = n + w + c/2.$$

The mutual pair-to-pair capacity of the two-pair superposed or phantom circuit may be calculated in a similar manner. The result for the general case will be $w + x + y + z + [(a + b)(c + d)/(a + b + c + d)]$. For the degree of balance already postulated, this expression will reduce to $4w + 2ac/(a + c)$, which may be written thus:—

$$2 [(m_3 + n_3)/2 - \{(m + n)/2 - w\} - (a - c)^2/4(a + c)]$$

Since with ordinary construction, the mean direct wire-to-wire capacity of a pair is greater than the direct capacity between wires not in the same pair, it will be evident from the above expression that the mutual pair-to-pair capacity

of the phantom circuit of a two-pair core of multiple-twin cable is less than twice the mean mutual wire-to-wire capacity of its associated side circuits.

Relative values of the Wire-to-wire Direct, the Wire-to-earth Direct and the Mutual Capacities of a Balanced Core of Multiple-Twin Cable.—It is often convenient when dealing with the various capacities of a core of commercially manufactured cable to compare each of them with the magnitude of the mutual wire-to-wire capacity of a side circuit of that core. For this purpose each of the direct capacities as well as the phantom circuit capacity is expressed as a fraction of the wire-to-wire mutual capacity. These quantities will subsequently be referred to as the direct and phantom circuit capacity ratios of a core.

In the case of a two-pair core of multiple-twin cable, for which $w = x = y = z$; $a = b = c = d$; and $m = n$, the phantom circuit capacity P will be equal to $2 [S - (m - w)]$ where S is the mutual capacity of each side circuit. The phantom circuit capacity ratio can accordingly be expressed symbolically as follows, namely:—

$$P/S = 2 [1 - \{(m - w)/(m + w + a/2)\}]$$

The numerical value of this ratio will depend upon the magnitude of the direct capacity ratios, but since in a multiple-twin unit of normal construction w can never be greater than m , the phantom circuit ratio for such a unit can accordingly never exceed 2. In practice w is always smaller than m and hence the phantom circuit ratio is always less than 2. Values ranging from 1.26 to 1.72 have been observed in practice. Table No. I. gives the average value of this ratio for cores of balanced loading coil section lengths of each of a number of existing cables, manufactured within the last twelve years.

In cable manufacture, where the direct effects of one feature are often masked by the effects of another, or by secondary effects of the former, it is well known that great care needs to be exercised in arriving at definite conclusions as to the exact control imposed by each of the special features embodied in a design. The following statements have accordingly been carefully worded; they give the author's views on the basis of his experience, and do not rule out the possibility of alternative explanations.

If two multiple-twin cables each containing N

cores arranged in an exactly similar manner in n layers underneath a lead sheath of internal diameter d , are so constructed as to have exactly the same side circuit mutual capacity value, the direct capacity ratios for the cores, may be quite different in one cable from what they are in the other. This is obviously possible from the form of the expression for mutual wire-to-wire capacity of a side circuit, and is in fact borne out in practice. The fundamental reason for this would appear to lie in the permissible choice during manufacture of the relative tightness of the twinning, quadding and stranding operations, which govern the mean distances separating (1) associated wires of the pairs, (2) associated pairs of the cores, and (3) adjacent cores. The actual twinning and quadding lays, the relative lengths of which are of primary importance from the interference point of view, appear to exercise little effect in normal practice, upon the magnitude of the direct capacity ratios. The choice in tightness of make up, already referred to, is limited in practice by many considerations, but such scope as does exist is sufficient to give rise to noticeable differences in the relative magnitude of the direct capacities obtaining in cables which are nominally of similar design.

For any particular cable of normal manufacture, the mutual electrostatic capacity of the side circuits is the same, excepting for small manufacturing deviations, for all cores contained in the same layer. The direct capacity ratios and in consequence the phantom circuit capacity ratios are also respectively of the same magnitude for such cores. The mean mutual capacity of the side circuits of one layer is usually somewhat different from that in another layer, although modern design and manufacture are conducive to equalisation of the different layers in this respect. For cores contained in different layers the direct capacity ratios are always materially different; thus the direct wire-to-wire capacity ratios are smaller and the direct wire-to-earth capacity ratio is larger for cores situated in the outer layer, than for those nearer the centre of the cable. This is illustrated by the tests of a 176 yard factory length of 60/40 M.T. cable, the results of which are given in Table No. II. The fundamental idea underlying the representation of the four-wire system by its equivalent direct capacity network is probably sufficient to explain this fact.

If during manufacture undue tensions are permitted in the twinning, quadding or stranding operations, crushing of the multiple-twin units either partially or wholly will occur and marked differences in the direct and phantom circuit ratios of the cable cores will arise, not only as between the cores of different layers, but also between cores of the same layer. Thus crushing in the twinning stage, by increasing the m ratio at the expense of the w ratio, will tend to a decrease in the phantom circuit ratio. Crushing in the quadding stage will increase the w ratio, either at the expense of or independently of the m ratio, and so tend to an increase in the phantom circuit ratio.

In the ideal multiple twin cable the cores would be perfectly twinned and quadded. Furthermore, the stranding operations would be performed in such a manner as to ensure that each core occupied (and completely filled) exactly the same amount of space. This latter feature is aimed at in the design and manufacture of modern multiple-twin cables and seems to be an important feature in ensuring stability, *i.e.*, no capacity change during handling. For such a cable the mutual capacity of the side circuits would be the same for each two-pair core (except for the differences imposed by reason of the different lengths of the cores of the various layers) and from the very nature of the direct capacities, their values would regularly and progressively decrease in the case of the wire-to-wire and increase in the case of the wire-to-earth, from the centre layer outwards to the exterior layer. In these circumstances the phantom circuit capacity P , *i.e.*, $2[S - (m - w)]$ (where S is the associated side circuit capacity) of the cores situated in one layer may be different from those situated in some other layer, tending generally to progressively increase from the centre to the outer layer. In this ideal case the same remarks will apply to the phantom circuit capacity ratio of the cores. Such a condition is actually found to exist in practice, in those uncommon instances where the side circuit capacity of the cores is essentially the same in all layers. The test results shown in Table No. II. for a 60/40 M.T. cable, illustrate this feature.

More generally the side circuit capacity differs in different layers and there is accordingly no regular gradation in the values of the direct or phantom circuit capacity ratios from

layer to layer. The test results given in Table No. I. for a 96/70 M.T. cable (Example 1) illustrate this point, the phantom circuit capacity ratios being 1.61, 1.59, 1.63 and 1.51 for cores of the centre, first, second and third layers respectively. The example is of further interest on account of the fact that the actual magnitudes of the direct capacities of the cores of the first and third layers are such that their phantom circuit capacities are essentially the same, namely, 0.0949, and 0.0948 micro-farads per mile respectively.

If for the ideal case, the phantom circuit ratios could be determined for the various layers of cables of various sizes and make-up, a criterion for judging this aspect of commercially manufactured cables, which of course fall short of perfection, would be available. The determination of these ratios by calculation would, it is thought, be an extremely complicated operation and has, as far as is known, never been achieved. It is probable that their magnitudes are to some extent dependent upon the gauge of the cable conductor, and it is certain that the type of construction adopted in manufacture materially affects their value. The British Post Office specifies (Specification 73 U. of January, 1926) an average value for this ratio of 1.62, with a permissible tolerance of 5%, *i.e.*, a value ranging from 1.54 to 1.70. This specified value is applied to all multiple-twin cores, independently of their position in the cable.

Effect on the Mutual and Direct Capacities of a single Cable Core, of Earthing the remaining Cable Cores.—Hitherto the direct capacity network of any core of a multi-core cable has been defined on the basis of the conductors of the whole of the remaining cable cores being insulated from each other and from earth. If these conductors, however, are connected to earth, it will be obvious that the direct capacity network of the core under this condition will be quite different, as far as the magnitudes of the direct capacities are concerned. This has already been indicated in the paragraph headed "Direct capacity network of a two-pair core of multiple-twin cable." The original direct wire-to-wire capacities will clearly be reduced by reason of certain of the capacities composing them being diverted to earth, whilst these latter capacities will augment the original direct wire-to-earth capacities. As between the two conditions, the

direct wire-to-wire values will be smaller and the direct wire-to-earth values larger when the other cores are earthed, than when they are insulated. This conclusion is borne out by the results of actual measurement.

In regard to the mutual capacities of the pair and phantom circuits, the calculations necessary for the purpose of comparing the values under the two conditions lead to rather lengthy expressions in the general case. If the decrease in the wire-to-wire and the increase in the wire-to-earth components exactly neutralised one another, there would be no change in the mutual capacity values under the two conditions. Careful measurements show that no change does in fact take place.

Table No. II. gives the results of tests on a 2.6 mile length of cable of 60/40 M.T. cable and also a 176 yard length of cable of the same type, but of different manufacture. Figures are given for centre, first and second (or outer) layer cores under "free" and "earthed" condition of the remaining cable cores. Each core was separately insulated under the "free" condition. The constant values of the mutual capacities and the changes in the direct capacities are clearly shown. Tests were also made with the remaining cores bunched together, but insulated from earth. The results obtained have not been tabulated, but whereas the mutual capacities remained constant, the direct capacities were intermediate in value between those quoted for the "free" and "earthed" condition respectively. The table gives the mutual capacity S of the side circuits in micro-farads per mile. The magnitudes of the direct capacities and of the phantom circuit mutual capacity are expressed as fractions or ratios of the relevant side circuit mutual capacity in the manner previously indicated.

This constancy of value of the mutual capacities, irrespective of whether the whole of the remaining wires (including those of the associated pair, in the case of the side circuit capacity) of the cable are insulated (either separately or as a bunch) or earth-connected has an important bearing on "bunched" mutual capacity measurements, during works tests of the circuits of factory lengths of cable.

From consideration of the expressions for the mutual capacities of a side and phantom circuit respectively, it will be evident that the magni-

tude of the increase in each of the direct wire-to-earth capacities, consequent upon the earthing of the remaining cores, is four times that of the decrease in each of the direct wire-to-wire capacities—at least as far as a balanced core is concerned. Table No. II. demonstrates this feature.

References have been given, wherever possible, to sources of information, the use of which

in this article is gratefully acknowledged. The data contained in the Tables has been included by the courtesy of Colonel Purves, Engineer-in-Chief. The author desires especially to tender his thanks to those of his colleagues who have from time to time furnished and discussed with him the results of many tedious and laborious measurements.

TABLE I.
PHANTOM (P) TO SIDE (S) CIRCUIT MUTUAL CAPACITY RATIOS FOR CORES OF M.T. CABLES OF VARIOUS MAKE-UP AND MANUFACTURE.

Cable Type.	Layer.	EXAMPLE 1.		EXAMPLE 2.	
		Side circuit capacity.(S) Microfarad per mile.	Ratio P/S.	Side circuit capacity.(S) Microfarad per mile.	Ratio P/S.
2/300 M.T. +	Centre	0.0545	1.57	0.0564	1.50
14/200 M.T. +	1st	0.0572	1.49	0.0655	1.26
12/150 M.T. +	2nd	0.0685	1.47	0.0697	1.51
24/100 M.T.	3rd	0.0579	1.49	0.0575	1.57
24/100 M.T.	Centre	0.0620	1.64		
	1st	0.0619	1.64		
14/100 M.T. + 36/40 M.T.	1st	0.0619	1.53		
	2nd	0.0607	1.59		
96/70 M.T.	Centre	0.0573	1.61	0.0732	1.39 ₈
	1st	0.0597	1.59	0.0735	1.39 ₇
	2nd	0.057	1.63	0.0734	1.39 ₅
	3rd	0.0628	1.51	0.0701	1.39 ₁
60/70 M.T.	C & 1st	0.0579	1.60		
	2nd	0.0561	1.72		
160/40 M.T.	C, 1st & 2nd	0.0598	1.50	0.0598	1.44
	3rd	0.0634	1.41		
	4th	0.0599	1.51	0.0581	1.51
96/40 M.T.	C & 1st	0.0585	1.63		
	2nd	0.0607	1.56		
	3rd	0.0603	1.67		
38/40 M.T. +	C, 1st & 2nd	0.0619	1.49	0.0595	1.55
28/40/M.T. +	3rd	0.0638	1.62	0.0633	1.58
54/20 M.T. +	4th	0.0638	1.44	0.0608	1.49
50/40 M.T.	5th	0.0610	1.60	0.0643	1.57
60/40 M.T.	Centre	0.0627	1.60		
	1st	0.0614	1.63		
	2nd	0.0616	1.68		

TABLE II.

MUTUAL AND DIRECT CAPACITIES OF A M.T. CORE, WHEN EACH OF THE REMAINING CORES OF THE CABLE ARE EITHER (i) INSULATED OR (ii) EARTHED.

Cable Make-up.	Layer.	Side cct. capacity (S) microfarad per mile.	Condition of each of the other cable cores.	Magnitude of Ratios:—			
				w/S.	m/S.	a/S.	P/S.
60/40 M.T. (2.6 mls. length)	Centre	0.059	Insulated Earthed	0.24 0.16	0.48 0.40	0.56 0.88	1.52 1.52
	1st	0.067	Insulated Earthed	0.20 0.16	0.50 0.45	0.58 0.76	1.39 1.39
	2nd (Outer)	0.064	Insulated Earthed	0.18 0.15	0.42 0.40	0.79 0.90	1.51 1.51
60/40 M.T. (176 yds. length)	Centre	0.0600	Insulated Earthed	0.266 0.180	0.447 0.362	0.572 0.915	1.64 1.64
	1st	0.0601	Insulated Earthed	0.240 0.183	0.426 0.368	0.670 0.897	1.63 1.63
	2nd (Outer)	0.0593	Insulated Earthed	0.199 0.175	0.339 0.324	0.900 0.990	1.70 1.70
24/100 M.T. (1.125 mls. length)	Centre	0.0620	Insulated Earthed	0.188 0.167	0.365 0.344	0.890 0.973	1.645 1.645
	1st (Outer)	0.0619	Insulated Earthed	0.185 0.167	0.368 0.350	0.906 0.978	1.645 1.645
14/100 M.T. + 36/40 M.T. (1.125 mls. length)	1st	0.0619	Insulated Earthed	0.245 0.203	0.476 0.436	0.545 0.716	1.531 1.531
	2nd (Outer)	0.0607	Insulated Earthed	0.227 0.215	0.434 0.421	0.682 0.733	1.587 1.587
28/100 M.T. + 48/40 M.T. (1.125 mls. length)	Centre	0.0625	Insulated Earthed	0.223 0.174	0.425 0.376	0.703 0.901	1.598 1.598
	2nd (Outer)	0.0605	Insulated Earthed	0.165 0.154	0.347 0.335	0.975 1.024	1.637 1.637

REFERENCES AND BIBLIOGRAPHY.

- (1) "Direct Capacity Measurement." G. A. Campbell, Bell System Technical Journal, Vol. I., No. 1, July, 1922.
- (2) "A new Network Theorem." A. Rose, J.I.E.E., Vol. 62, p. 916, November, 1924.
- (3) Discussion on "A new Network Theorem." J.I.E.E., Vol. 63, p. 303, March, 1925.
- (4) "Balancing of Telephone Cables which require to be loaded for superposed working." S. A. Pollock, J.I.P.O.E.E., Vol. V.I., Parts 1 and 4, April, 1914, and Jan., 1915.
- (5) "The Capacity and Insulation of Cables." S. A. Pollock and A. Morris, J.I.P.O.E.E., Vol. XII, Part 4, Jan., 1920.
- (6) "Trunk Telephone Cables. Balancing by resultant capacity methods." E. A. Beavis, *The Electrician*, March 21st, 1924.

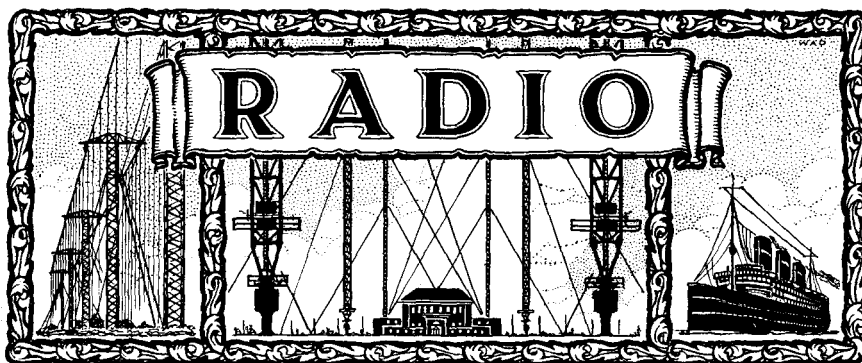

TRANS-ATLANTIC TELEPHONY.

A MESSAGE FROM SIR EVELYN MURRAY.

THE opening of the transatlantic telephone service is an historical event in the sphere of communications, and I should like to take this opportunity to congratulate the Wireless Engineers of the Post Office who, in collaboration with our friends of the American Telephone and Telegraph Company, have achieved this notable success.

Credit is also due to the London Telephone Service and to the Traffic Staff for the smooth and efficient organisation at the Trunk Exchange, and last, but not least, to the admirable team of operators, who worked the service under the difficult and somewhat discouraging conditions of the opening day with enthusiasm and efficiency.

G. E. P. MURRAY.

A SHORT HISTORY OF THE DEVELOPMENT OF THE SERVICE.

Lt.-Colonel A. G. LEE, M.C., M.I.E.E., M.I.R.E.

TELEPHONY by radio is no new thing, for it followed soon after the invention of radio telegraphy over a quarter of a century ago. Its development, however, languished until the advent of the thermionic valve which rendered it possible to control and amplify the speech currents in the various portions of the path between one talker and the other. The production of the radio waves in a form suitable for telephony may also be said to be dependent upon the valve, because while there are other methods of producing and modulating radio waves, the valve is by far the most convenient for radio telephony.

About 1914 the valve was becoming a practical article and in 1915 the American Telephone and Telegraph Company decided to attempt telephony by radio across the Atlantic. For this purpose they grouped in parallel a large number of small valves at the Arlington, U.S.A., radio station, and after some experiment succeeded in producing speech which was heard at the Eiffel

Tower in Paris. After this came the invention by Carson of the single side-band, suppressed carrier, system of working and the development of the high power metal-glass water-cooled valve. Such was the state of affairs in 1923 when the Company again attempted telephony across the Atlantic, this time with such marked success that the Postmaster-General decided to co-operate with the American Telephone and Telegraph Coy. and the International Western Electric Coy. (now the International Standard Electric Corporation) in an attempt to still further develop the system for commercial working.

At this stage it became necessary to review the progress and possibilities and to outline the work necessary to ensure successful commercial operation. The inventions of the valve and the single side-band method formed the groundwork on which it was proposed to build. But for any engineering project it is necessary to know what specification has to be met. General

experience of radio work had shown that fading of signals and disturbance by atmospherics were amongst the real difficulties encountered in long distance communications. Organizations were therefore set up on both sides of the Atlantic to measure these quantities, observations being taken at each hour of the day once each week. These measurements have been continued for nearly four years and have involved thousands of tests, and with the preliminary data of this sort on hand it became possible to decide what amount of power was necessary at the transmitter, what kind of receiving arrangements were desirable, and what was the best wave-length on which to work. From this point engineering design proceeded to the manufacture of a 200 k.W. telephony transmitter at Rugby, which was installed by the Western Electric Coy., using an aerial supported on the 820 ft. masts of that station, and also the installation of special receiving apparatus and the erection of a directional antenna at Wroughton, near Swindon. On the completion of this work two-way telephony across the Atlantic became possible and the first conversations took place on February 7th, 1926, between the Engineers engaged in the work on both sides. These first conversations were made using separate wave-lengths for each transmitter, but owing to the congestion in the ether and the practical impossibility of finding room for two separate wave-bands, it was decided to attempt to work both transmitters on the same frequency. Voice operated switching devices were designed for this purpose in which special means were taken to prevent atmospherics capturing the control of the switching devices, which is a trouble not present on ordinary land line telephony. After these arrangements had been successfully developed, it became necessary to clear a frequency band for commercial use. We had been working experimentally on Sundays to avoid interference with numerous radio telegraph services and it is a pleasure to record the very friendly spirit of co-operation in which the Government Administrations of Germany, Italy and Russia, as well as the Air Ministry and the Marconi Coy. in this country, arranged for the removal of their services to other wave-lengths in order to make room for the newcomer, Trans-Atlantic Telephony. In America the U.S. Naval Administration also assisted by

clearing their stations from the wave-band required.

The engineering work of investigation, erection, development and testing having been satisfactorily concluded, the Traffic Staff took up the task of training the special staff of operators and developing the operating procedure, and practical trials of the system between officials of the Post Office on this side and those of the American Telephone and Telegraph Company on the other side of the Atlantic were instituted.

Finally, on January 7th, 1927, the day for opening the service to the public arrived. At the New York end Mr. W. Gifford, President of the American Telephone and Telegraph Coy., in the presence of a group of the officials of the Company and a number of press representatives, lifted his receiver at 8.45 a.m., New York time, and asked for Sir Evelyn Murray in London. He was immediately connected and in his greeting to Sir Evelyn Murray Mr. Gifford said:—

“To-day, as a result of very many years of research and experimentation, we open a telephonic channel of speech between New York and London. Thus, the people of these two great cities will be brought within speaking distance. Over 3,000 miles of ocean individuals in the two cities may by telephone exchange views and transact business instantly as though they were face to face. I know that it is your aim, as it is ours, to extend this service so that in the near future anyone in either of our countries may talk to anyone in the other. No one can foresee the ultimate significance of this last achievement of science and organization. It will certainly facilitate business; it will be a social convenience and comfort; and, through the closer bond which it establishes, it will promote better understanding and strengthen the ties of friendship. Through the spoken word, aided by the personality of the voice, the people of New York and the people of London will become neighbours in a real sense, although separated by thousands of miles.

“We are glad to have co-operated with you in this notable enterprise, and shall actively continue to work with you in extending and improving the service. I congratulate you upon your successful solution of your problems, and wish to extend to you and to your associates the greetings and good wishes of the officers and staff of the American Telephone and Telegraph Com-

pany and of their associates in the Bell Telephone System."

In reply Sir Evelyn Murray said:—

"The opening of a public telephone service across the Atlantic between London and New York is a conspicuous milestone on the road of telephone progress, and marks the beginning of a new epoch in the development of communication between our two countries. Personal conversation between Great Britain and the United States has emerged from the stage of

take this occasion to acknowledge the notable contributions which your company has been able to make, through its great engineering and research organization, towards the solution of the many baffling problems which have been encountered. We recognize, as we believe you recognize, that there are difficulties still to be overcome before the Transatlantic service can attain the standard of regularity and reliability at which we aim; but we are convinced that there is no better means of solving these diffi-



THE FIFTEEN-POUND TOUCH.

John Bull—"That you, Sam? A happy New Year to you."
 Uncle Sam—"You said a pocketful, John! The same to you."

Reproduced from "Punch," 5-1-27, with permission of the proprietors. We might say that all the comments about the charges have been of the same good-natured description, although coupled with many hopes that they will come down soon.

experiment into a practical reality, and we are confident that the service which we are inaugurating to-day will be a boon to both nations, whether as an aid to commerce or as a medium of social and domestic intercourse, and will tend to strengthen the bonds which unite the two communities.

"I am charged by the Postmaster-General to

culties than by putting the service to the crucial test of daily use, and we share your hope that before long Transatlantic conversation will be available not only to the citizens of London and New York, but to every telephone subscriber in both countries.

"We of the British Post Office look back with pleasure upon the cordial co-operation with the

American Telephone and Telegraph Company, which has led to the success so far achieved, and on behalf of the Postmaster-General and the officers of the General Post Office I warmly reciprocate your greetings and good wishes. I now declare the service open to the public."

In Sir Evelyn Murray's room at the G.P.O. were gathered some of the officials of the Post Office who had been associated with the development of the service, Messrs. R. A. Dalzell, C.B., C.B.E., W. T. Leech, L. Simon and F. W. Phillips of the Secretary's Office, Col. T. F. Purves, E. H. Shaughnessy, and Lt.-Col. A. G. Lee, of the Engineering Department, and Lt.-Col. H. E. Shreeve of the American Telephone and Telegraph Company.

In this quiet way was launched one of the most outstanding events in Telephone history. There have been many marvellous inventions in telephony, including the most marvellous of all, the telephone itself, but even to our modern

minds, rather surfeited with the wonders of scientific development, there is something which appeals to the imagination in being able to converse with another English speaking nation 3000 miles across the seas.

In looking back over the progress in radio telephony for the last 12 years, admiration must be expressed for the genius and far-sighted vision of the American Telephone and Telegraph Coy. and its associated Company, the Bell Telephone Laboratories, which at that time envisaged the spanning of the Atlantic telephonically and have since worked steadily and methodically at one development after another until the goal was reached. It is a striking example of the value of painstaking research, organised as it is in America on large lines, and illuminated from time to time by flashes of brilliance, which light the way from one stage of development to another.

THE LONDON-NEW YORK TELEPHONE CIRCUIT.

R. V. HANSFORD, D.Sc.

THE writer has been requested to give the readers of this Journal a general technical description of the Trans-Atlantic Telephony Circuit. The exigencies of space must necessarily limit the article to one of a general nature only, and I would refer those readers interested in specific details to one or other of the technical articles which have been published by the American Engineers who have been responsible for the development of the system. A short bibliography is given at the end of this article.

It seems necessary in the interests of clarity that any description of this complicated circuit should commence with a general schematic diagram of the London-New York circuit as given in Fig. 1, although this has been made so familiar by the popular press.

The circuit across the Atlantic is the equivalent of a long 4-wire telephone circuit. The channel from East to West is from London, by 85 miles of underground cable to Rugby, thence by radio to Houlton, Maine, and from there by 600 miles of open and underground lines to New York.

The channel from West to East is from New York, by 70 miles of underground to the Rocky Point Transmitting Station, thence by radio to the English Receiving Station at Wroughton, which is connected by 90 miles of underground to London.

The normal difficulties of a very long telephone circuit of this type, such as "echo" and "singing" effects, are accentuated by the variability of a circuit which includes two radio links. In an ordinary wire circuit, the conditions remain fixed and for a given speech-input volume at one end of the circuit, the level of speech-output at the other end is constant. Also, under modern conditions, the land line circuits are reasonably quiet and there is very little extraneous noise to disturb the telephone user. With radio links in the circuit, the conditions are very different. The signal strength received varies from hour to hour and sometimes from minute to minute; "atmospherics" are nearly always present and at times may be as loud as the signal which it is desired to receive.

A very real difficulty in modern radio communication is the congestion of the ether due

to the ever-increasing number of stations. When it is borne in mind that a radio telephone service necessitates a very wide band of frequencies as compared with radio telegraph service, it will be realised that it is not an easy matter to find room for a telephone service between the wavelengths of 5000 and 6000 metres which will not interfere with existing telegraph services and will also be free from interference.

There are two possible means of reducing the frequency band utilised for such a service: the first is to reduce the band used for the transmission of speech to a minimum; the second is to use the *same* frequency band for the transmission in both directions.

band suppressed carrier system (further discussed later) the radiation from the transmitting station can be limited to a single band of the order of 2,700 cycles.

The utilisation of this single side band system thus limits the frequency band by more than a half, but the use of different frequency bands for the transmission in the two directions, even when of such relatively narrow width, would occupy the greater part of the frequency spectrum corresponding to the band of wavelengths between 5,000 and 6,000 metres. It was felt therefore that a great effort should be made to utilise the same wave-length for the transmission in both directions, and this development has been realised. The magnitude of the diffi-

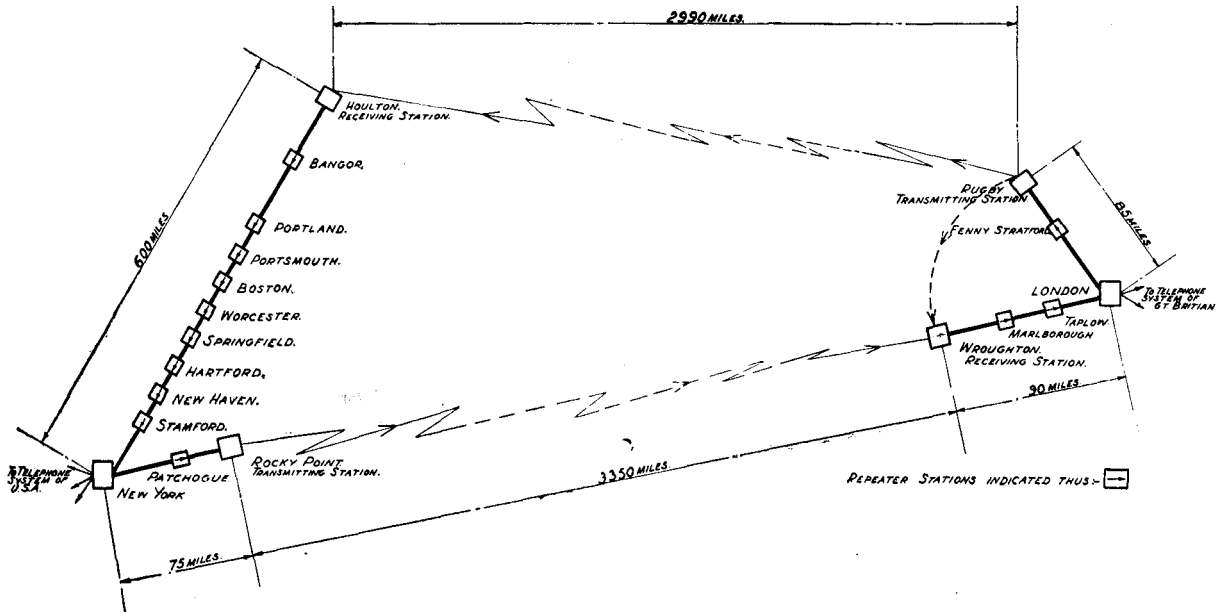

FIG. 1.—SKELETON DIAGRAM OF LONDON-NEW YORK TELEPHONE CIRCUIT.

As regards the reduction of the frequency used for a single transmission to a minimum, ordinary speech includes frequencies varying from about 50 to 8,000 cycles per second. It is not necessary, however, to transmit the complete range of the speech frequencies in order that intelligible speech may be received; speech of reasonably good quality can be transmitted notwithstanding that frequencies below 300 and above 3,000 cycles per sec. have been cut off. The usual type of radio-transmitting station using a modulated carrier would need a frequency range of 6,000 cycles to transmit even this restricted band, but by using the single side

culty will be understood when it is stated that the strength of the signal at the receiving station at Wroughton (near Swindon), due to the transmitting station at Rugby, is from one thousand to ten thousand times as strong as the signal received from America on the *same* wave-length, and that the system as a whole has to discriminate between these signals.

The Post Office Radio Station at Rugby was designed as a thermionic valve station and the power plant, etc., was therefore very suitable for the addition of a radio-telephony transmitter. The h.t.d.c. generators and alternators provided for the main anode supply and the filament

heating respectively of the telegraphy transmitter are also used for the telephony installation. The article by Mr. Shaughnessy in the last number of this Journal included a general description of the plant common to the telegraph and telephone installations, such as power plant, etc., together with an account of the type of inductances used.

The telephony transmitter itself was provided

to those within this 2,700 cycle band.

It is well known that if a high frequency F_1 (called the carrier) is modulated in amplitude at a low frequency f_2 , there are produced, in addition to the carrier frequency, two resulting frequencies of $F_1 + f_2$ and $F_1 - f_2$ (corresponding to the upper and lower side bands respectively). Therefore if the frequency band A is used to modulate the carrier (F_1) of 31,750

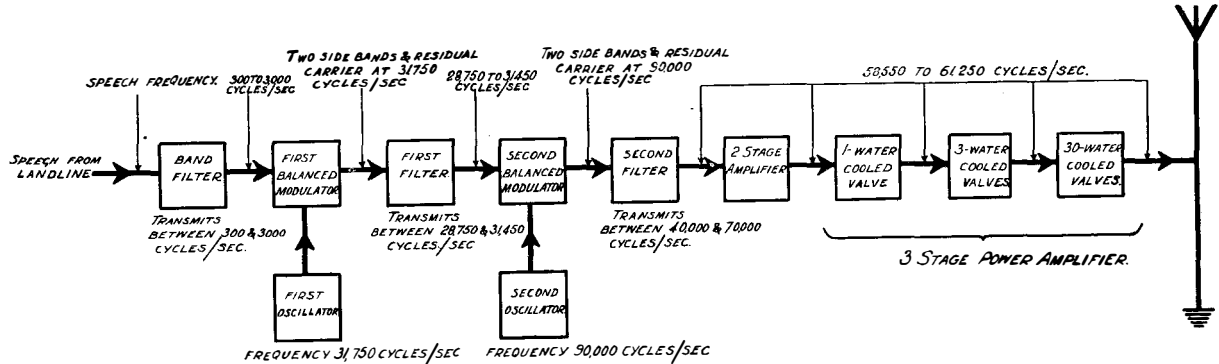

FIG. 2.—SCHEMATIC DIAGRAM SHOWING ARRANGEMENT OF RADIO TELEPHONY TRANSMITTER AT RUGBY.

by the Standard Telephones and Cables Co., Ltd., with the consulting advice of the Bell Telephone Laboratories, Inc., which had been responsible for the telephony installation at Rocky Point in America.

A brief description will now be given of the radio transmitter at Rugby, beginning with the production of the single side band. A diagram showing the general arrangement of the com-

cycles/sec. the result is the production of two side bands B_1 and B_2 . This modulation is carried out by means of a balanced modulator which produces the two side bands with a minimum of carrier frequency. A skeleton diagram of the balanced modulator is given in Fig. 4. The device uses two valves and it will be observed that the carrier is applied to both grids in parallel while the speech input causes

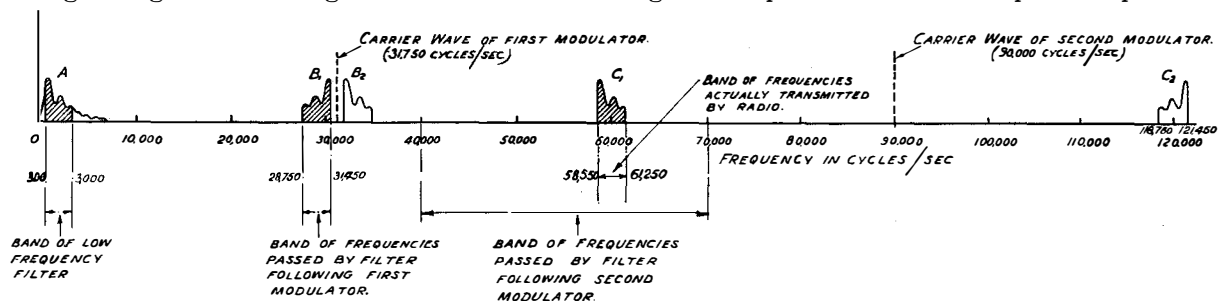

FIG. 3.—FREQUENCY SPECTRUM SHOWING RELATIONSHIP OF FREQUENCY BANDS IN A TRANSMITTER PRODUCING A SINGLE BY DOUBLE MODULATION.

plete radio transmitter is given in Fig. 2.

The speech frequencies arrive at the radio transmitting station, it should be noted, as a single band of frequencies represented as A in the frequency spectrum of Fig. 3. By means of filters the frequencies below 300 and above 3,000 cycles per sec. are cut off and the speech frequencies used for the transmission are reduced

one grid to be positive when the other is negative. The result is that the two side bands are produced in the output from the device and the carrier is largely balanced out. A band filter now selects the side band B_1 , thus eliminating the remainder of the carrier and the side band B_2 .

This band of frequency, B_1 , is now used to

modulate a carrier (F_2) at the frequency of 90,000 cycles per sec., giving the two side bands C_1 and C_2 which are separated by 60,000 cycles. (See Fig. 2). A wide band filter now selects the side band C_1 , which is in the final frequency form required, and this is amplified through successive stages from 3 milli-watts to the final aerial power of the order of 100 kilo-watts. It will be observed that the difference between the

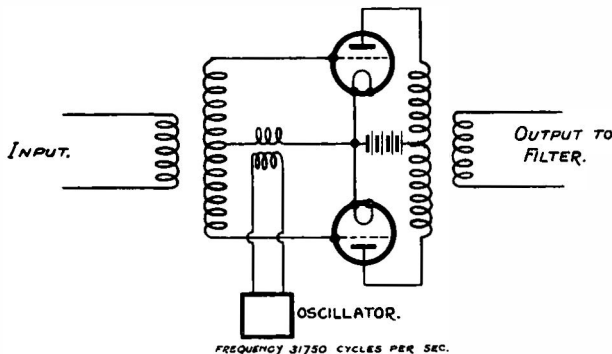

FIG. 4.—SKELETON DIAGRAM OF BALANCED MODULATOR.

two carrier frequencies ($F_2 - F_1$) of 58,250 cycles per sec. is the value of the single frequency which would have to be modulated by the original speech to produce the final result, and that this carrier frequency of 58,250 cycles which has to be re-inserted at the receiving station is

not actually generated, as such, at any stage of the generation of the high frequency power at the transmitting station.

The advantages of the double modulation, *i.e.*, the successive use of two carrier frequencies, are briefly as follows:—

1. It is easier and more economical to build an efficient filter to select the single side band at the lower frequency (and this filter can be a fixed filter); this single side band can then be moved by the second modulator to the required transmission frequency.
2. It permits an easy adjustment of the transmitted wave-lengths with fixed filters; the second fixed filter transmits a wide band of frequencies from about 40,000 cycles to 70,000 cycles and therefore a variation of about 30,000 cycles in the radio transmission can be obtained by altering the frequency of the second carrier, which is a comparatively simple manner.

The advantages of the single side band suppressed carrier system can be summarised briefly as:—

1. Economy in power; in the usual method of radio telephony transmission $\frac{2}{3}$ of the total energy radiated is con-

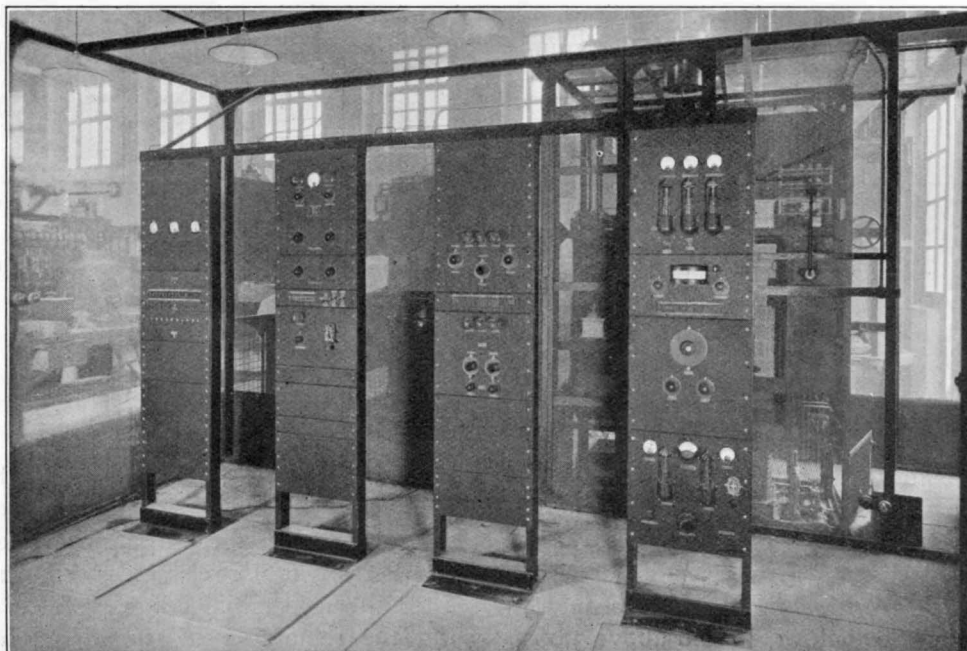

FIG. 5.—VIEW OF SIDE BAND EQUIPMENT OF RADIO TELEPHONY TRANSMITTER AT RUGBY.

tained in the carrier. There is a further saving in power by the suppression of one side band in addition to the carrier.

2. The frequency range is reduced by one half with a consequent economy in the frequency spectrum for other radio transmissions.
3. The design of the power amplifiers and the circuits associated with the antenna system is greatly simplified since the frequency band over which uniform amplification is aimed at as an ideal, is halved.

The side band equipment at Rugby is illustrated in Fig. 5. Beginning from the left the first rack contains power controls, fuse panels, arms, etc.; the second rack contains the speech input equipment, included in which are facilities for measuring and adjusting the level of the speech received from London; on the third rack is mounted the first and second modulating circuits and the output from this rack is in the final frequency form; the last rack contains the first two stages of high frequency amplification and also a variable frequency test oscillator.

The amplification of the output from the side band equipment to the full aerial power is

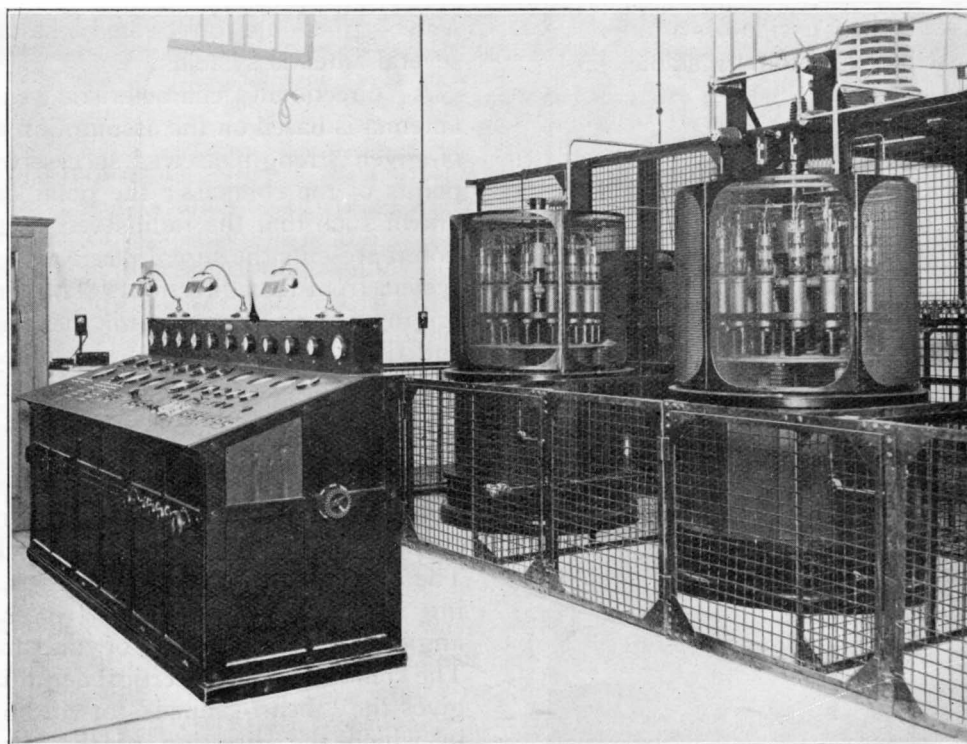

FIG. 6.—VIEW OF POWER AMPLIFIER AND CONTROL TABLE OF RADIO TELEPHONY TRANSMITTER AT RUGBY.

4. The narrow frequency band permits the use of a more selective receiver and consequently improves the signal-noise ratio at the receiving station.
5. The fluctuations in signal strength at the output of the radio receiver are less; the signal strength at this point depends on the product of carrier amplitude and the side band amplitude and by the insertion of a *constant* carrier amplitude at the receiving station one variable is eliminated.

carried out by means of a three-stage high-frequency power amplifier. The valves used in the three stages are all of the 10 kilo-watt water-cooled type, manufactured by the Standard Telephones and Cables Co., Ltd., at their New Southgate Works. The first stage uses one valve, the second stage utilises three valves and the last stage consists of 30 such valves in parallel, *i.e.*, 2 banks of 15 each. The valves in all these stages use the same power supply from the main h.t.d.c. generators.

In Fig. 6 the two units of 15 valves which

form the last stage of the power amplifier can be seen; in front of them is the control table from which central position the duty officer is able to watch and control the complete installation.

The question of radio reception will now be considered. It is necessary to replace the carrier at the receiving station and this may be done in one or two stages, that is, it may be added as a single carrier frequency of 58,250 cycles or double demodulation may be used with two oscillators similar to the method of double modulation utilised at the transmitting station. The accurate re-insertion of the carrier is essential if the received speech is to be of good quality and therefore the oscillator or oscillators at the receiving station must be exceptionally stable.

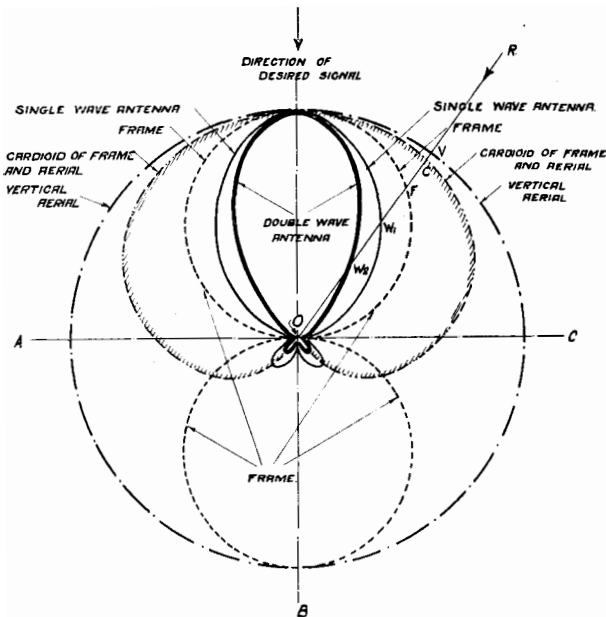

FIG. 7.—DIRECTIONAL CHARACTERISTICS OF VARIOUS RECEIVING ANTENNA ASSUMING EQUAL RECEPTION FROM DIRECTION OF ARROW.

The problem of long-distance radio reception is not one of amplification, which under modern conditions is a matter of well-known thermionic valve technique. It is the problem of obtaining what is called a good signal/noise ratio. It is of little consequence how low the required signal is in level if the noise is relatively much lower. Experience shows that the level of the signal to be received should be of the order of 30 T.U. stronger than the noise in order to provide a commercial service. This problem of signal

noise ratio is essentially one of selectivity. The first step is to obtain frequency selectivity in the receiver itself, which means that it should have a very sharp cut-off on each side of the 2,700 frequency band it is desired to receive. In the interests of good quality the frequency characteristic within this band should be practically constant.

Atmospherics may come from any and every direction; therefore, having obtained frequency selectivity by means of the receiver, the second step is to discriminate between the desired signal and interference of all kinds by having an antenna system with directive selectivity. This can best be explained by reference to Fig. 7, which gives the directional characteristics of several antenna systems.

A directional characteristic curve of an antenna is based on the assumption that a signal of given strength arrives successively from all points of the compass; the polar curve is then drawn such that the radius vector in any direction represents the signal received by the antenna system from that direction. Thus in Fig. 7 the origin of the vectors for all the curves is at O and the magnitude of the signal received from any selected direction OR is represented by OV, OC, OF, OW₁ or OW₂, depending on the type of antenna system used.

It is clear that a vertical antenna will pick up equally well from all directions and that its characteristic curve is therefore a circle as shown. The curve for a frame is two circles, thus showing the well-known "null" points at right angles to the direction of maximum signal. The combination of a vertical aerial with a frame gives the "heart-shaped" or cardioid diagram, in which the direction of the zero signal is exactly opposite to the direction of the maximum signal.

A directional antenna of an entirely different type is that known as the Wave Antenna. Such an antenna consists of two wires erected on ordinary telephone poles extending in a straight line in the direction from which it is desired to receive. Its length is of the order of a wavelength, which means that it is over 3 miles in the present case.

With such an antenna the signal depends on the "tilt" of the wave-front (*i.e.*, the deviation from the vertical) and the E.M.F.'s consequently induced by the electro-magnetic wave as it

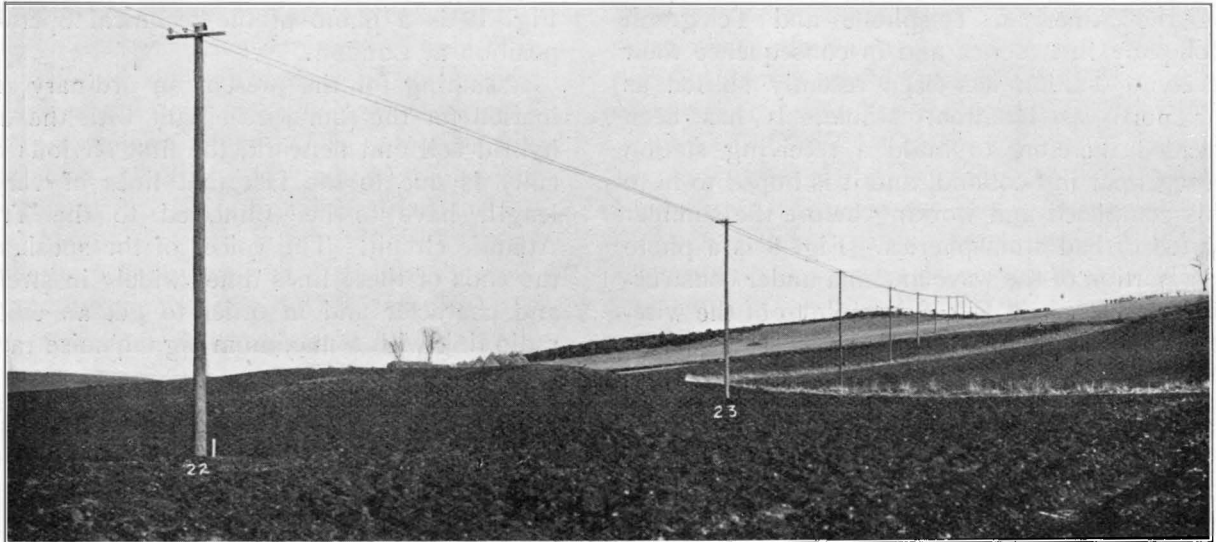

FIG. 8.—A PORTION OF THE WAVE ANTENNA FOR THE RADIO RECEIVING STATION AT CUPAR.

passes along the antenna; this is in contradistinction to the ordinary antenna or frame where the signal strength is a function of the vertical dimensions. The directional diagram of such an antenna is shown in Fig. 7 and is clearly to be preferred to any previously mentioned, the reduction in the reception of signals or or atmospherics from directions behind the direction of the desired signal, *i.e.*, within the 180° A.B.C., being specially noticeable. A double wave antenna can be obtained by erecting two parallel single wave antennæ about 2 miles apart and combining them by transmission lines to the receiving station.

A directional diagram for a double wave antenna is given in Fig. 7 and the improvement as regards the "tails" at the "back-end" is very marked. The Post Office uses such a double wave antenna at Wroughton (near Swindon), which is the present receiving station.

Unfortunately the data obtained over a considerable period indicate that difficulty would be experienced, on account of the summer atmospherics, in maintaining a commercial service from Wroughton during the overlapping business day all the year round. Experiments were therefore made to ascertain if better receiving conditions were available elsewhere in Great Britain. Experiments showed that in Scotland atmospherics are generally less than at Wroughton and also that as the latitude of a receiving station became higher the signal

strength became relatively greater than calculations would lead one to expect. This is in accord with the experience previously obtained

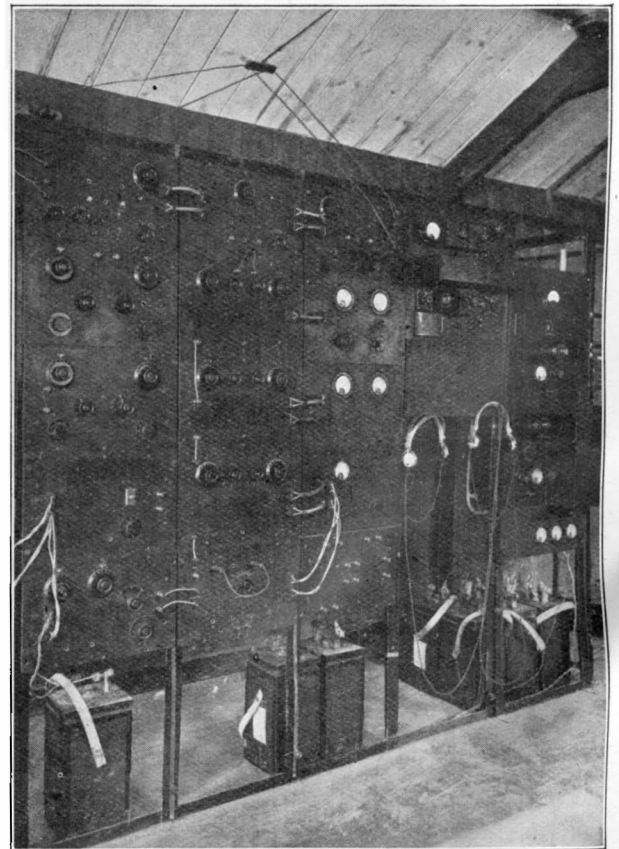
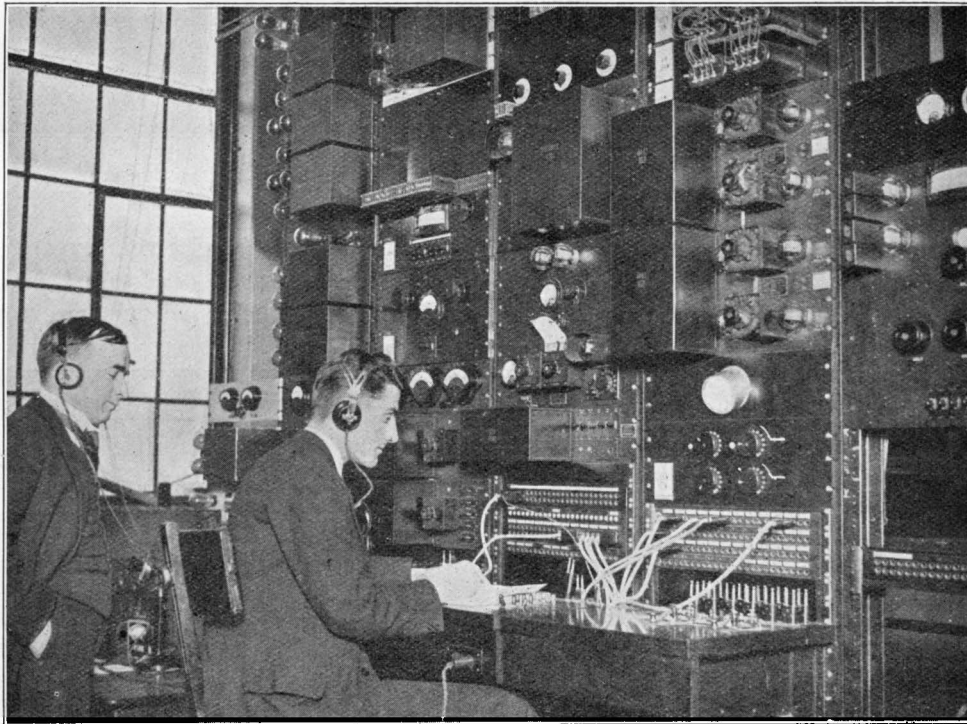

FIG. 9.—WIRELESS RECEIVER AT WROUGHTON.

by the American Telephone and Telegraph Company in America and in consequence their receiving station has been recently shifted as far north as Houlton, Maine. It has been decided therefore to build a receiving station near Cupar in Scotland, and it is hoped to have this completed and working before the summer period of bad atmospherics. Fig. 8 is a photo of a portion of the wave antenna under construction at Cupar and Fig. 9 is a photo of the wireless receiver at Wroughton.

Fig. 10 is a photo of the technical operator's position at London.

Assuming for the present an ordinary termination for the four-wire circuit with the usual hybrid coil and network, the first obvious difficulty is due to the fact that lines of varying length have to be connected to the Trans-Atlantic circuit. The voices of the speakers at the ends of these lines differ widely in strength and character and in order to get an efficient radio link with a maximum signal/noise ratio it



[Photo by Pacific and Atlantic Photos Ltd.]

FIG. 10.—TECHNICAL OPERATOR'S POSITION AT THE LONDON TERMINAL OF THE LONDON-NEW YORK CIRCUIT.

We now come to the problem of combining the two sides of the four-wire circuit at the terminal stations, *e.g.*, the combination of the outgoing circuit to Rugby with the incoming circuit at Wroughton into a two-wire channel which can be connected to the ordinary telephone system of the country. The special requirements of this radio circuit necessitate the provision of special technical control points at London and New York equipped with control and testing apparatus and at which there are skilled technical operators in continual observation while the circuit is in commercial service.

is essential that every person using the circuit should fully load the radio transmitter in order to produce the maximum signal. Therefore at London (and New York) the duties of the technical operator include the adjustment of the amplification so that the speech sent to the transmitting station is reasonably constant.

Referring back to Fig. 1 there will be, as explained previously, a large "throw-in" from the transmitting station to the receiving station on the same side of the Atlantic. There will consequently be a large gain round the circuit London-Rugby-Wroughton-London which will

therefore "sing" and render conversation impossible unless special measures are taken. This difficulty is overcome by the use of voice operated devices at London and New York, the general principle of which can be explained by consideration of Fig. 11, which represents diagrammatically the terminal position on the British side.

It will be seen by reference to this diagram that normally the circuit to the transmitting path is open at D and the circuit from the receiving

four-wire circuit is not at present practicable, it is clear that if the received currents due to speech or atmospherics reach a certain level, "out of balance" or "echo" currents may get into the circuit G B C by one of the dotted paths and operate C, thus cutting off the received speech; to avoid this it is necessary that a portion of the received currents passing up the high impedance path A.C. shall prevent device C being operated by "echoes," etc., of the received speech. These are very stringent conditions and speaking in general terms they mean that the subscribers' voices have to clear their own path by the operation of a sensitive device. After the speech currents have passed the device has to restore quickly enough to enable the reply from America to be received. This operation has to be quick, certain and effective or the subscriber will be inconvenienced by the loss of intelligibility. Every time the subscriber says a single short word such as "Yes" the word itself has to cause a definite switching change of the circuit conditions and the special apparatus required has to be under the careful control of the technical operator in order to ensure that the varying types of voice fully operate the device.

Alternative devices for this unique requirement in the history of telephony have been developed by the American Telephone and Telegraph Company and by the Post Office Engineering Department of this country and both are available at London as alternatives. The device of the former organisation is an ingenious and extraordinarily reliable combination of mechanical relays, operated by the voice currents after amplification and detection, and associated with electrical delay circuits. The device of the P.O. Engineering Department is a thermionic valve device and is described elsewhere in this Journal. Each of the systems has been proved to be very satisfactory and reliable in operation. Fig. 12 is a photo of the voice-operated device of the American Telephone and Telegraph Company as installed at London.

These voice-operated devices by nature of their essential sensitivity will not function entirely satisfactorily if the long distance and other lines connected to the Trans-Atlantic circuit are not of a high grade as regards both noise and level of speech. A circuit which may be satisfactory for long distance land-line communication may have a noise level which makes it quite

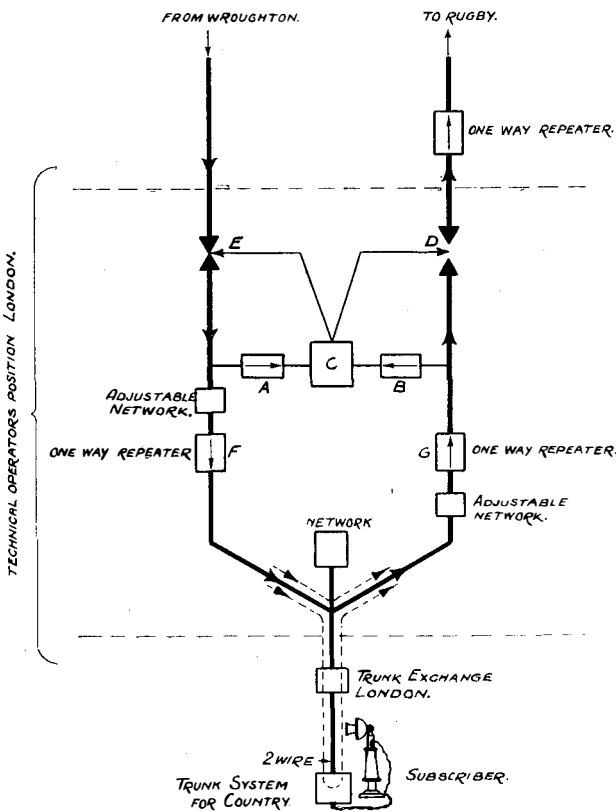

FIG. 11.—SKELETON DIAGRAM OF TERMINATION OF 4-WIRE CIRCUIT BETWEEN LONDON AND NEW YORK.

station is closed at E. Under these conditions the subscriber on this side can hear the speech from America, but the break at D stops the circuit "singing." When he speaks the voice currents pass through the repeater G to device B (high impedance) and operate the device C which closes D and opens E. This permits him to speak and the circuit restores automatically to enable him to receive a reply.

Since the ideal of a perfect balance with a

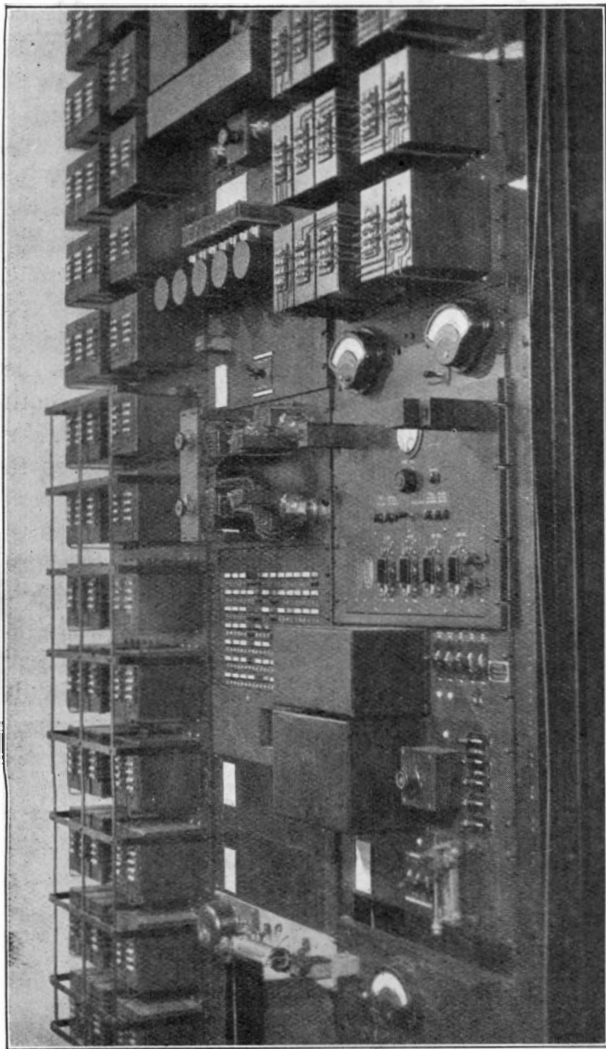

FIG. 12.—VOICE-OPERATED DEVICE DEVELOPED BY THE A.T. AND T. COY. FOR THE TRANSATLANTIC TELEPHONE CIRCUIT.

unsuitable for extension to the Trans-Atlantic radio circuit.

Finally, it is unnecessary to explain to the readers of this Journal that, with the system described, no claim is made for secrecy. It is,

however, difficult to receive both sides of the conversation and it is thought that the average user will not be deterred by the fact that his conversation, or part of it, may be overheard by a stray radio eavesdropper. However, the Engineer-scientist is indefatigable and the problem of secrecy must soon yield to the same patient research which has conquered the great problems involved in the establishment of commercial Trans-Atlantic telephony.

SHORT BIBLIOGRAPHY.

- E. H. Colpitts and O. B. Blackwell.—“Carrier Current Telephony and Telegraphy,” *Journal Amer. Inst. E.E.*, April, 1921.
- H. W. Nichols.—“Trans-Oceanic Wireless Telephony,” *Inst. E.E.*, Vol. 61, July, 1923.
- H. D. Arnold and L. Espenschied.—“Trans-Atlantic Radio Telephony,” *Journal Amer. Inst. E.E.*, August, 1923.
- R. A. Heising.—“Production of Single Side-band for Trans-Atlantic Radio Telephony,” *Proc. Inst. R.E.*, Vol. 13, June, 1925.
- A. A. Oswald and J. C. Schelleng.—“Power Amplifiers in Trans-Atlantic Radio Telephony,” *Proc. Inst. R.E.*, Vol. 13, June, 1925.
- A. B. Clarke and R. C. Mathes.—“Echo Suppressors for Long Distance Telephone Circuits,” *Journal Amer. Inst. E.E.*, Vol. 44, p. 618, 1925.
- A. A. Oswald and E. M. Deloraine.—“The Single Side-band Equipment and Power Amplifier at the P.O. Rugby Radio Station,” *Electrician*, June 4, 1926.
- E. H. Shaughnessy.—“The Rugby Radio Station of the British Post Office,” *Inst. E.E.*, Vol. 64, June, 1926.

TRANS-ATLANTIC TELEPHONY.

THE POST OFFICE DIFFERENTIAL VOICE-OPERATED ANTI-SINGING EQUIPMENT.

C. A. BEER, Wh. Sch., A.C.G.I., and G. T. EVANS.

INTRODUCTION.—The use of the same wavelength in both radio channels of the Trans-Atlantic Radio telephone circuit could not be realised until a practicable arrangement had been devised to prevent the radiated energy from the Rugby radio transmitter being returned through the radio receiver at Wroughton into the land wire system at such a high level that “singing” and “echo” effects would render telephonic conversation with America impracticable.

On account of the enormous magnitude of the electric field produced by Rugby at the Wroughton receiving station—65 miles distant—in relation to the more feeble field received from the American side, the consequent “gain,” inherent in the path from *a* to *b*, in Fig. 1, when *B* is adjusted to amplify the speech waves from America, necessitated a more effective means for the prevention of “singing,” than that of the Hybrid Coil loss method shown schematically in the same figure and which is usually employed for repeated circuits.

This article describes briefly a device which has been developed for the suppression of Singing and Echo effects in the circuit and this device is in satisfactory operation at the junction or terminal of the transmitting and receiving lines in London.

The device essentially consists of a system of Thermionic Valve Relays which are operated by voice currents in such a manner that the circuit is only operative in one particular direction at a time, although the principle of utilizing a hybrid coil and balancing network is taken advantage of in order to prevent, as far as possible, currents travelling in the path *BD* towards *A* from entering the opposite bound-path *DC*, Fig. 1.

Referring to Fig. 2, the path from the receiving station *B* to the subscriber’s telephone at *A* is normally operative while a “loss” is introduced by the device into the path towards the radio transmitter to prevent the circuit singing.

When the subscriber at *A* speaks or utters a

syllable the path *AC*, Fig. 3, is made operative and a loss is made to occur in the receiving path *EA*. As a matter of fact the loss in the path *BA* is established before the loss in the path *AC* is removed, otherwise, the circuit would be in a singing condition during the transitory period.

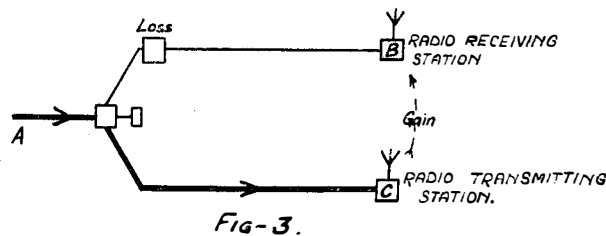
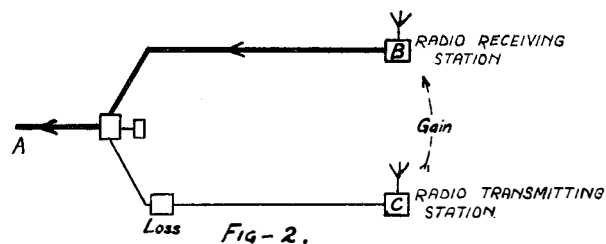
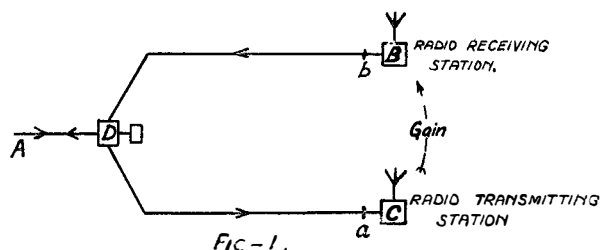

SCHEMATIC OF THE 4-WIRE ARRANGEMENT.

When the subscriber at *A* ceases to speak or pauses during conversation the circuit will revert to the normal condition of Fig. 2. In reverting, the loss is re-established in the transmitting line before the receiving line is again made operative.

Since the circuit is always in a one way condition “singing” cannot occur. Moreover, the

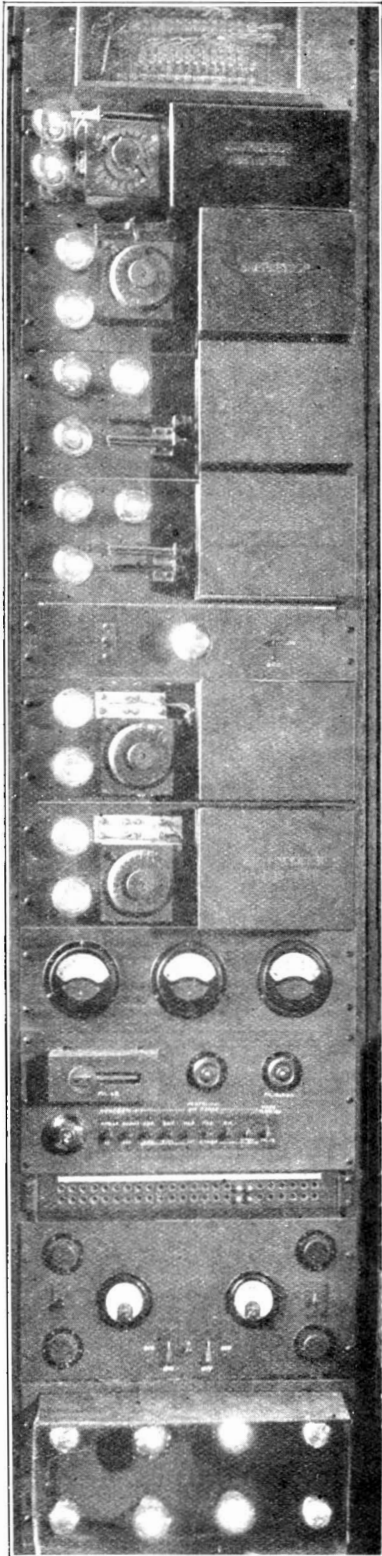

THE P.O. DIFFERENTIAL VOICE-OPERATED
ANTI-SINGING EQUIPMENT.

complete device, as will be explained in subsequent paragraphs, is designed so that false operations by echoes is prevented.

Outside the scope of this article a considerable amount of research work has been carried out in connection with (1) the sensitivity of the device to enable the weakest syllables of speech to be transmitted; (2) the discrimination that must be provided so that echoes, atmospherics and line noises do not cause false operations, and (3) the proper time intervals of operation necessary, so that the presence of a voice operated device shall not be manifest to the listener, and two-way conversation be satisfactorily effected. Mention, however, must be made of one feature of the experimental equipment which was necessary in connection with the development of the device. A circuit, shown schematically in Fig. 4, was set up for the purpose of simulating as far as possible the British end conditions of the Trans-Atlantic circuit.

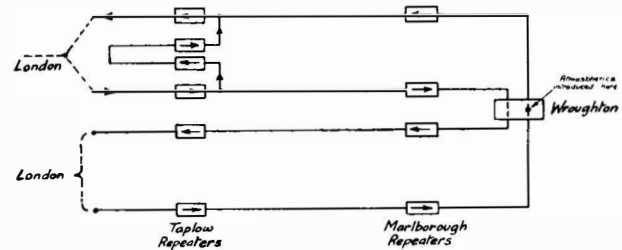

FIG. 4.—EXPERIMENTAL SIMULATING CIRCUIT.

The arrangement consisted of two repeated cable circuits from London to Wroughton and back. At Taplow, where the "go" and "return" circuits were repeated, two separate repeaters joined in cascade and connected across the transmitting and receiving lines simulated the gain across the Rugby-Wroughton path. Atmospherics were introduced when necessary into the lines from the radio receiver at Wroughton. By this means a considerable amount of the data necessary for the design of the device was obtained.

Voice Operation—Sensitivity.—The ability to render operative the transmitting line, and thus enable every syllable to be transmitted, depends—provided the time of operation is kept to within a few thousandths of a second—on the sensitivity of the device in relation to the magnitude or intensity of the speech delivered to it. Voice

currents delivered at the output of an ordinary subscriber's instrument have widely different magnitudes for different sounds spoken into it. For example, generally the sound "Ah" produces a substantial amount of power, while the output from the vowel "e" is very feeble. If the device be not sufficiently sensitive, initial parts of certain syllables will be "clipped." For instance, insufficient sensitivity would make the word "England" appear to the listener as "gland," while the same sensitivity would show no initial clipping on the word "landing"; and in the latter case a "hangover" feature in the operation of the device ensures the transmission of the end syllable.

It was found that speech from an ordinary subscriber's set delivering reference volume at, say, the point B in Fig. 5, was satisfactorily

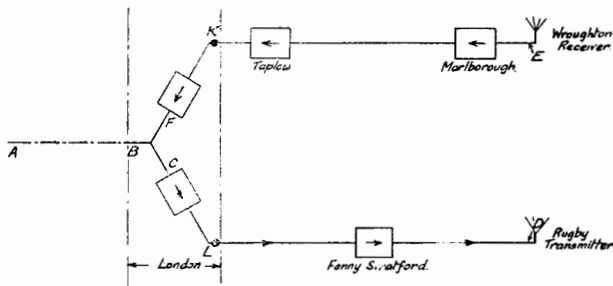

FIG. 5.—SCHEMATIC DIAGRAM OF CIRCUIT IN THIS COUNTRY. Voice-operated equipment indicated by dots at K and L.

transmitted without clipping, if the transmitting line were rendered operative by .0032 milliwatt of alternating current at 1300 cycles applied to the line at the same point in the system.

Singing.—Referring to Fig. 5, the transmission equivalents of the various parts of the circuit located in this country are as follows:—

From C to D a transmission gain of 5 T.U. is normally existent and this is increased by the Technical Operator to a maximum of 30 T.U. gain when the subscriber at A produces speech at the two-wire junction B, which is 25 T.U. down in relation to reference volume. This means that the speech or other noise level at D is 30 T.U. higher than at C. From D to E via the Rugby and Wroughton path the nett gain may perhaps be approximately 50 T.U. For example, a typical record shows that at Wroughton the signal field strength received from Rugby and Rocky Point (America) were

18,900 and 3.7 micro volts per metre respectively. The effective gain is, however, less than that indicated by the field strengths on account of the discrimination afforded by wave antenna reception. From E to F a normal gain of 5 T.U. occurs, and provision is made whereby the equivalent may be varied from a gain of 10 T.U. to a loss of 20 T.U. A reduction in the gain, *i.e.*, lowering of the volume of speech delivered to the two-wire circuit, may become necessary when considerable noise is present in the radio link. From F to C is a loss, the magnitude of which varies considerably, and a variable transmission time factor is present due to reflections or echoes from the extension circuit BA.

The circuit C D E F C will sing if there is a nett gain. Therefore adding the gains in the links of the circuit as above designed, we have:

C to D	max., gain	30 T.U.
D to E	gain	50 T.U.
E to F	gain	10 T.U.
F to C	min., loss	6 T.U.

Nett gain 84 T.U.

It is this gain of 84 T.U. that has to be offset by a loss introduced by the voice operated device at either K or L.

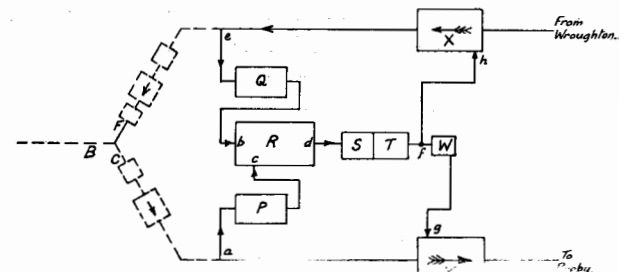

FIG. 6.—DIAGRAMMATIC ARRANGEMENT OF ANTI-SINGING VOICE-OPERATED EQUIPMENT.

General Description and Operation of Device.—Fig. 6 shows diagrammatically the circuit arrangement at London, the voice operated equipment being drawn in full outline.

Considering firstly the main 4-wire circuit, when a conversation is not taking place, the singing is prevented by means of the repeater Y in the "Go" line. Under these conditions the grids of the first stage valves of this repeater are negatively primed sufficient to cause it to produce a transmission loss of the order of 100

T.U., instead of the zero gain, at which this repeater is used when it is operative. When this repeater is inoperative, the repeater X, in the "Return" line is operative, and *vice versa*.

Speech from a subscriber connected to London is received on the two-wire extension at B, whence it is transmitted to C and "a"; and at the latter point the speech is normally at the level of 10 T.U. above reference volume. At "a," the speech voltage is applied to the amplifier P, thence through R (from "c" to "d") and S, to the rectifier T, so that, while the London subscriber is actually speaking, there is generated at "f" a unidirectional voltage which, by means of a condenser-resistance combination, is maintained at about 40 volts.

During the rise of the voltage at "f" and as it reaches approximately 5 volts its application at "h" on the receiving suppressor repeater X, renders the latter inoperative, and at an infinitesimally short period of time afterwards a higher unidirectional voltage, applied to the valve W, causes the removal of the large grid bias at "g" and the transmitting suppressor repeater Y becomes operative for the period of transmission of speech.

After the cessation of speech from the London end the repeater Y at first becomes inoperative after which X becomes operative, this condition remaining until London speaks again.

Speech from New York, *via* Wroughton, arrives through X, "e," F and B and normally its level at the point "e" is 10 T.U. below reference volume. The voltage at "e" is applied, *via* the amplifier Q, to "b" in R where it is rectified and the unidirectional voltage, generated across a resistance and resistance-condenser combination in R, prevents a voltage arriving at "c" from being transmitted to "d." That is, during the passage of current in the receiving line, and for a certain length of time after its cessation, a bias of a small or large magnitude is impressed on R to retard, or completely suppress, the effect of any voltage at "c" which would otherwise cause a false operation of the device with the consequent liability of cutting off, or clipping, of the received speech, or the transmission of an "echo" *via* C a Y to New York.

Under conditions of heavy atmospherics on the receiving line the bias so produced *via* "e"

and the amplifier Q may be of sufficient magnitude to prevent speech from the London subscriber satisfactorily operating the device. That is, in the presence of atmospherics, the amplification of Q has to be reduced, with the result that it is sometimes necessary to degrade the receiving repeater, shown dotted, in order to prevent the echo of the received speech, *via* F, C, "a," from causing a false operation. Under these circumstances a lower received speech volume is consequently delivered to the London subscriber.

Under the following headings a more detailed description is given of the separate apparatus and its performance.

Suppressing Repeaters.—These are indicated as X and Y in Fig. 6, and their common circuit diagram is shown in Fig. 7.

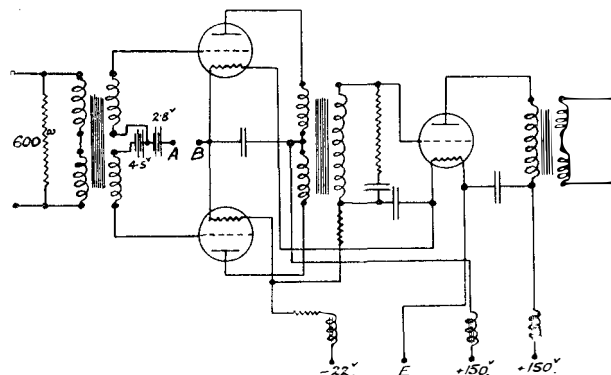

FIG. 7.—CONNECTIONS OF SUPPRESSOR REPEATER X OR Y.

Each repeater has three valves, two of type LS 5B in push-pull relationship in the first stage, and a type VT25 in the second stage. The former valves, having characteristics which make them suitable for suppressing, are not, however, in the case of the transmitting line, capable of delivering the necessary output power, namely, that of the preceding repeater; and for this purpose the second stage valve is provided.

An important feature of the first stage arrangement is that the steady plate currents of the two similar valves are made to oppose one another in the split primary winding of the intervalve transformer. Hence there is no magnetic flux produced by the steady components of their plate currents; and the arrangement prevents the generation of a pulse of voltage in the transformer secondary and its application to the grid

of the second stage valve when the grid priming is suddenly varied, but does not otherwise affect the performance of the repeater.

The additional grid voltage for the purpose of suppression is applied across the terminals shown as A and B in Fig. 7.

In the case of the receiving repeater X, the voltage across the above terminals AB is zero when the subscriber connected at the London end is not talking. The repeater is then properly primed at 2.8 volts and its gain is zero. Speech from this subscriber, however, produces an additional grid priming potential, the value of which remains relatively steady at about 40 volts, and the repeater thereby constitutes a loss of more than 100 T.U.

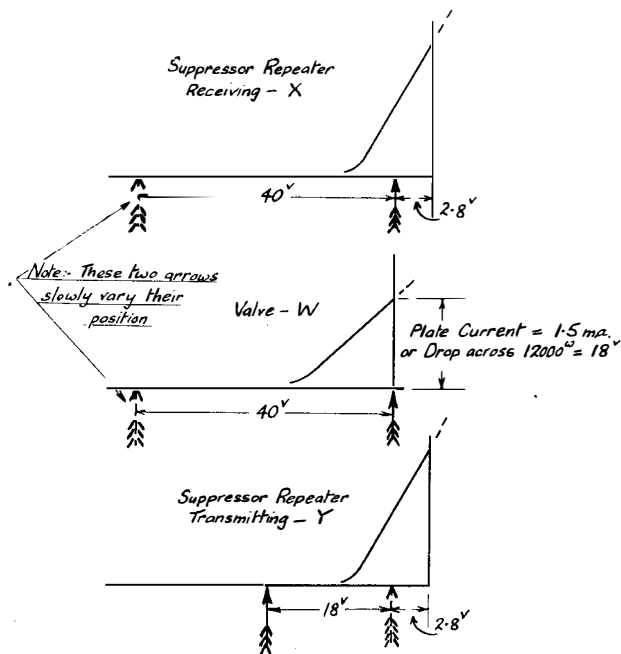

FIG. 8.—DIAGRAM SHOWING THE GRID PRIMING POTENTIALS OF SUPPRESSOR REPEATERS X AND Y AND INTERMEDIATE VALVE W. ALL FULL ARROWS OCCUR WHEN LONDON LISTENS; DOTTED WHEN LONDON SPEAKS.

In the case of the transmitting repeater Y, an additional negative potential of 18 volts, applied across the terminals AB, causes this repeater to have a loss of more than 100 T.U. when the London subscriber is not talking; speech from London, removing this additional voltage, restores the priming potential to 2.8 volts and the repeater then has a gain of zero.

It will be seen from the figure that the line windings of both input and output transformers

are balanced; screens to earth are provided for the reduction of out-of-balance cross-talk effects between the lines connected to the repeater. A shunt, across the secondary of the intervalve transformer, ensures that the repeater has a transmission equivalent of zero, for all frequencies from, say, 200 cycles to 4000 cycles per second; and the repeater is designed for input power levels up to 18 T.U. above one milliwatt.

In connection with the alternate functioning of the transmitting and receiving suppressor repeaters, Y and X respectively, Fig. 8 shows their grid potential-plate current characteristic curves, and that of the valve W, which controls the operation of the former repeater. The full line arrows indicate the grid potentials when the London subscriber is silent; speech emanating from this end operates, in the first instance, simultaneously on the arrows in the two upper

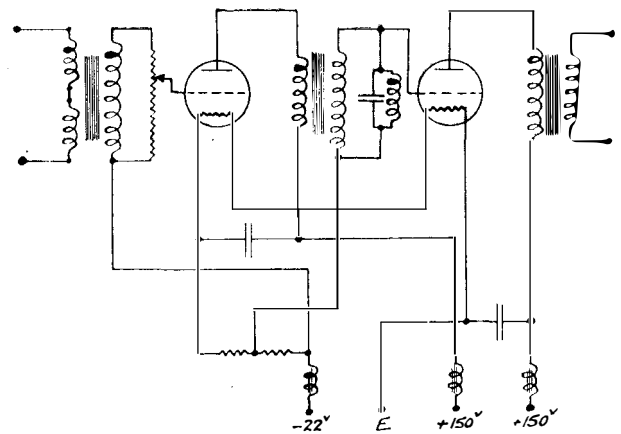

FIG. 9.—DIAGRAM OF CONNECTIONS OF AMPLIFIER P OR Q—EXCEPT THAT Q HAS NO RESONANT CIRCUIT AT INTER-STAGE.

diagrams, and it will be seen that, when they have moved about 3 volts to the left, the receiving repeater X begins to suppress, but that approximately 1 m.a. is still passing through W, and the consequent 12 volts drop is maintaining the repeater Y in the suppressed state. For a further small movement of the two upper arrows it follows therefore that both repeaters will be in the suppressed state simultaneously, and that this transitional position to prevent singing will occur when London speaks or ceases to speak. The above figure shows also, by dotted arrows, the grid potentials when the London subscriber is actually speaking.

Amplifiers P and Q.—Referring to Figs. 6 and 9, these are provided for transmitting to R, at the points “b” and “c,” the necessary magnitude of speech or other currents. Each has an input impedance of not less than 20,000 ohms and connection is made to the main “Go” and “Return” lines at the points “a” and “e” respectively, the shunting effect on the lines being of the order of one-tenth of a T.U. Furthermore, to reduce out-of-balance cross-talk effects, the primary windings of the input transformers are balanced and screened, while their ratio of transformation is such as to prevent grid overloading, and the consequent distortion of speech in the main lines. The filament and

voice operated equipment is obtained, while for a considerable proportion of land line noise, atmospherics, and some of the speech echo, the frequencies of which are remote from the above value, the device becomes insensitive. It will be noted later that another resonant circuit is introduced in the amplifier S, and it is obvious that the overall frequency characteristic from “a” to T mainly determines the complete operation of the device.

The receiving amplifier Q is at present untuned, and its circuit diagram is as shown in Fig. 9, but without the provision of the resonant circuit. The transformers in this case are designed so that by means of the potentiometer

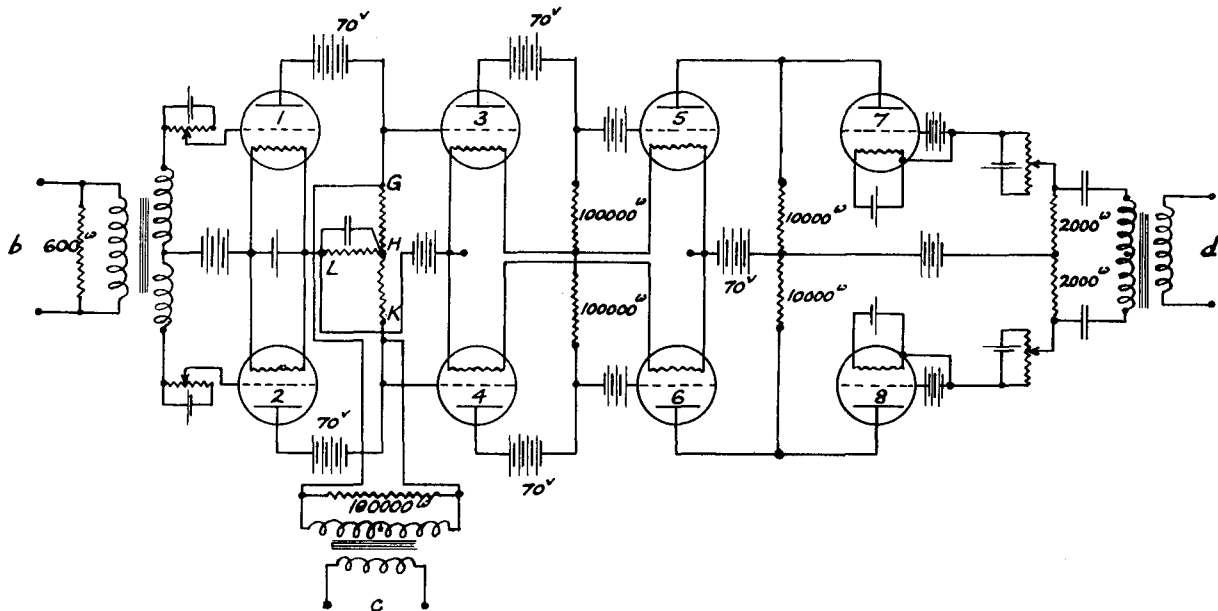

FIG. 10.—RECTIFIER AND HIGH BALANCE SYSTEM.

Valves 1, 2, 7 and 8 Type VT33. Valves 3 and 4 Type LS 5B. Valves 5 and 6 Type VT25.

plate battery for both amplifiers is the common supply, while grid priming is obtained by utilising potential drop in the filament circuit.

The transmitting amplifier P, by means of a resonant circuit in shunt across the intervalve transformer, is designed to have a maximum gain at a frequency of 1200 cycles per second, and a potentiometer across the input enables this gain to be varied in 2 T.U. steps from + 10 T.U. to - 10 T.U. when measured at the above frequency. The greater part of the voice power from the transmitter occurs in the neighbourhood of this frequency; so that by the above tuning more efficient operation by speech of the

the gain of the repeater may be varied in steps of 2 T.U. from 12 T.U. to 32 T.U.

Rectifier and High Balance System.—This is shown as R in Fig. 6, while a diagram of connections is given in Fig. 10.

In its present form it may be regarded as comprising two rectifying valves 1 and 2 in the receiving circuit, and six valves 3 to 8 in the transmitting circuit. Valves 3 and 4 are made to function mainly as rectifiers; 5 and 6 thereby work in only one direction; while 7 and 8 are diodes made to operate as very efficient rectifiers.

At the junction GHK of the receiving and transmitting valve system, the input speech or

other voltage from "c" is impressed, and, in the absence of any other voltage at "b," the former is transmitted through valves 3, 4, to 8, to the suppressing devices which are thereby operated. If, however, speech or other currents are impressed at "b," it will be seen that, by virtue of rectification, unidirectional current flows through LHG and LHK according as the pulse is, say, positive or negative. By this means, the grid potentials of the valves 3 and 4 become much more negative, causing these valves, and more particularly valves 7 and 8, to become to a small or large extent inoperative, depending upon the magnitude of the above biasing voltage.

Furthermore, the condenser connected across LH, when current is traversing this path,

cause larger echoes the greater will be the bias imposed at "b." At the same time, it is obviously important, in view of the great sensitivity employed in connection with voice operation, to so adjust the rectifiers, more especially 7 and 8, as to prevent any effective transmission from "b" to "d," caused by currents, however small, at "b." The stability and high balance in the system is assisted by a balanced and screened winding on each transformer.

In Fig. 19, the values of the resistances GH, HK and LI are each 12,000 ohms, while the condenser across the latter is 2 microfarads. Speech on the receiving line from Wroughton with a normal setting on the amplifier Q produces an average current of one milliamp in each of the paths LIIG and LIIK, and the peak

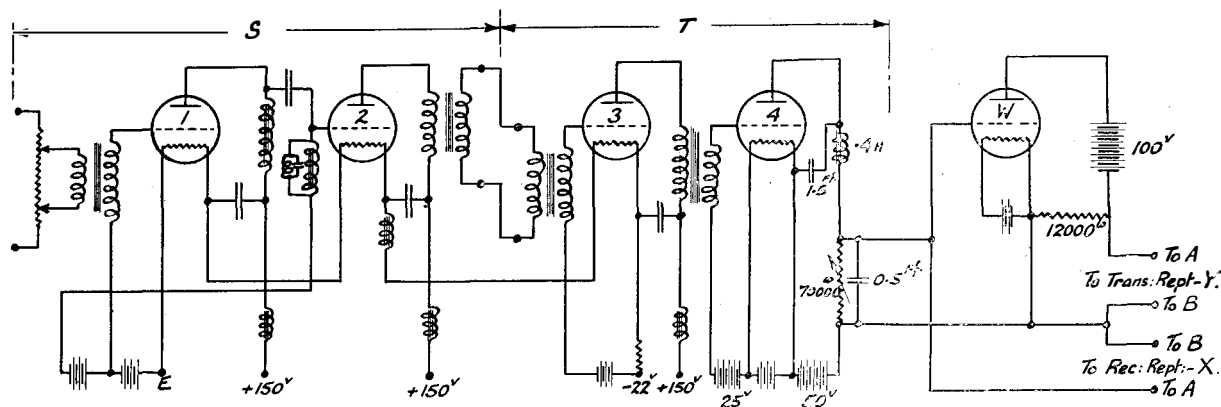

FIG. 11.—AMPLIFIER, RECTIFIER AND GRID BIAS UNITS. Valves 1, 2, 3 and 4 Type VT25; Valve W Type DE4; See also Fig. 7.

acquires a charge, and by virtue of the magnitude of the resistance LH a potential persists, which renders the transmission path from "c" to "d" inoperative both for the interval between positive and negative pulses of current at "b," and for a certain time after these pulses have ceased.

Hence alternating currents, due to speech or noise in the return line at "e," in Fig. 6, thereby impose *via* "b" and the resistance-condenser junction in R instantaneous, intermediate and delayed protection or bias, to prevent or retard the possibility of echo, or other noise currents which may traverse the "Go" line at C and "a," causing false operation of the suppressor device. It will be observed that this rectifier system functions differentially, inasmuch as the larger the currents in the return line which will

voltages acquired across HG and HK may be of the order of 24 volts. It will be seen therefore that, during the arrival of received speech a voltage of, say, 24 volts will be acquired across LH, and provision is made for a total maximum instantaneous bias of 48 volts, a minimum instantaneous and transitional bias of 24 volts; and, after the cessation of the speech, the discharge of the condenser through the resistance LIH determines the magnitude of the delayed or echo hangover protection. The latter biasing potential, which has the initial value of approximately 24 volts, falls exponentially and it is computed that, apart from the protecting feature provided by the trailing weak parts of speech, the potential drop on LIH is sufficient to prevent false operation by an echo attenuated not less than 18 T.U. when the delay of the echo is

0.025 second; or not less than 26 T.U. when the delay is 0.05 second. The amount of the attenuation of the echo is here referred to as the difference in the received volume at B, in Fig. 6, from the 4-wire circuit and that of the echo on arrival back at the same point. Also the attenuation figures quoted refer to the most severe case; that is, when the volume at B produced by the London subscriber is 25 T.U. below reference volume, the maximum gain then being in operation in the "Go" line.

The Suppressor System.—This is shown as S, T and W in Fig. 6, while a diagram of connections is given in Fig. 11.

The alternating output from the rectifier system R (at "d") in Fig. 6, is applied to the input of the amplifier unit S, Fig. 11, comprising valves 1 and 2, whence it is transmitted to the amplified rectified unit T, comprising valves 3 and 4, and, across the resistance condenser combination in the latter, a unidirectional potential is obtained.

This potential is applied to the grid circuit terminals A B of the receiving repeater X, which is thereby suppressed, the performance being similar to that employed on ordinary long distance 4-wire telephonic communication.* During the continuance of ordinary speech, the condensers operate to maintain a value of unidirectional potential which varies relatively slowly from, say, 15 volts to 40 volts, and the voltage will persist for a time after the cessation of speech from London.

When there is no speech from London, it will be seen that the grid priming potential of the valve W is zero, whence its plate current of 1.5 m.a, through an external resistance of 12,000 ohms, produces a drop of 18 volts, which being applied to AB of the transmitting suppressing repeater T renders the latter inoperative. Speech from this end, however, producing the potential of 15 to 40 volts stated above causes the

* *Recent Research Work on Telephone Repeaters* by C. Robinson and R. M. Chamney, I.P.O.E.E. Paper No. 99, page 15.

plate current of W to fall to, and be maintained at, zero; whence, the repeater Y, losing its additional grid bias, is made to function and the speech is freely transmitted to Rugby.

In the rectifier circuit of T the resistance condenser combination and the additional inductance and condenser units, as shown in Fig. 11, are such that the unidirectional voltage is rapidly acquired, the minimum operating time being approximately 2.5 milli-seconds, and the necessary hang-over, at present about 0.35 second, is obtained. The latter inductance and condenser units also largely perform the function of eliminating much of the alternating component of the current, while the latter unit assists the rectification.

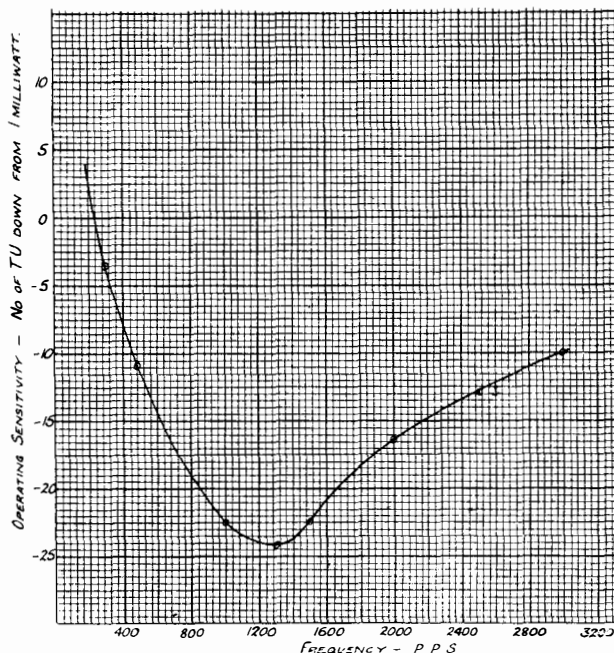

FIG. 12. — CURVE SHOWING RELATIVE TRANSMITTING SENSITIVITY MEASURED AT POINT B. See Fig. 6.

As stated previously, a resonant circuit is introduced in the amplifier S, and the frequency response operating in conjunction with that of the tuned amplifier P, produces the overall response shown by the curve Fig. 12.



NOTES & COMMENTS

WITH this issue of the Journal two important changes have been introduced.

In the first place we have reduced the price to five shillings per volume to all annual subscribers, and secondly the size of the magazine has been altered. We do not expect to hear any objections from our readers on the first score, except that some may wish to argue that the price should have been lowered still further, to the original sum of four shillings. Our answer to this would be that we must hasten slowly, that twenty-five per cent. over 1914 figures is better than the present prices for most articles, as the cost of living indicates, and that the question of a still further reduction rests with the rank and file of the Engineering Department themselves. The position is favourable: if the Inspectors, Skilled Workmen, U.S. W.'s and youths respond to the appeals circulated to the sections, as the Board confidently hopes they will do satisfactorily and enthusiastically, the price of the Journal will be reviewed again. We have no axe to grind, no need of profit making; our sole desire is to present a record—as full and as accurate as possible—of the progress being made and the developments taking place in the art of electrical communication both at home and abroad at a price just high enough to cover the working expenses.

We must admit to being not quite so happy and confident with regard to the second change. Those subscribers who have had their volumes bound from the start will undoubtedly have a grievance, as the uniform series in their bookshelves will be broken, but we submit that the new shape and size will permit of much better

and clearer illustration, and as many of our diagrams are intricate, to say the least, the wider page will give better opportunity to spread them out and thus render them more readable than they have been in the past. It may be argued that the new size is not so suitable for the pocket, but we do not anticipate that the thickness will ever reach a size that will prevent the magazine from being folded for that purpose. The type of binding for the volume and its price will be announced in due course.

At the annual meeting of the Telephone Development Association, Sir Alexander Roger, Chairman, said the revenue for the past year was £15,962, of which 79% was spent on advertising and propaganda and 15% on administration. The membership had increased from 54 to 95. He emphasised the importance of the telephone industry and said that the capital invested in this country alone was about £80,000,000, employing 100,000 people, in addition to probably 50,00 to 60,000 engineering and operating staff.

We must return thanks for the following letter, which appeared in "The Times," on the 18th February:—

BEAUTY WITH TELEGRAPH POLES.

A little time ago you published some correspondence on "unsightly" telegraph poles. May I, very belatedly, put the other point of view? Has it not been noticed how beautiful they are, especially on the Portsmouth Road? The great black poles with their crossed bars

and white cups allure one as a woodcut. They are banner-shaped and edge the long road like an exquisite border. And on a frosty night, when the traffic pours down to the coast and the moonlight shimmers on the wires all rimed with white, they are, to those who have the eyes to see, like the banners of a celestial army which is marching in triumph to the sea.—Mrs. C. M. COTTON, Great Beech, Battle.

Comment is needless. Mrs. Cotton's beautiful conception must come as balm to the soul of the engineer who built that Portsmouth Road line.

The Hon. J. C. Coates, M.C., Prime Minister of New Zealand, visited the Hendon Factory of Standard Telephones and Cables, Limited, on the 31st December, and inspected the new 5 K.W. Broadcasting Set recently manufactured there for installation at Wellington, N.Z. The apparatus was actually demonstrated, and Mr. Coates expressed keen pleasure at the purity of speech and music obtained.

A model exchange, forming part of the new Automatic Telephone System for London, was also demonstrated, and Mr. Coates was shown, and discussed, many other new and interesting aspects of the Company's activities in the advancement of speech transmission.

King Alfonso, General Primo de Rivera, together with over two hundred Government Officials, Diplomats and leading citizens of Spain, participated recently in the establishment of a new European long-distance telephone record, when a conversation was carried on over a circuit 3,800 Kilometers long, as a feature of inauguration of Standard Rotary Automatic Telephone Service throughout Madrid.

The record was established in a demonstration of the lines of the nation wide system that has been built in the last eighteen months by the Compania Telefonica Nacional de Espana and although the distance covered was equal to that from Madrid to Moscow the circuit did not extend beyond Spanish territory. It did, however, cross the Straits of Gibraltar by submarine cable uniting the Continents of Europe and Africa. Starting at Madrid, the circuit travelled north of San Sebastian on the Bay of Biscay, passing thence south-easterly to Barcelona on the Mediterranean, then turning westward to

Madrid, deflected to the South and diving beneath the surface of the sea at Algeciras, brought up at Ceuta in the Spanish Protectorate of Morocco. Returning northward to Madrid by another line the circuit then shot off toward Galicia, terminating at Coruna on the north-west corner of the Iberian Peninsula. Sixteen stations responded to the roll-call over this circuit and greetings were exchanged with the four corners of Spain. The demonstration was opened with a talk by the Marques de Urquijo, President of the Company, in which he described the work accomplished in the past year. General Primo de Rivera replied in the name of the Government, expressing his appreciation and congratulating the Company on what it had accomplished for the benefit of the National communication in such a short time.

After the roll-call was completed, His Majesty addressed the sixteen stations over the circuit, congratulating the Compania Telefonica Nacional de Espana and the Spanish Nation, expressing his satisfaction upon the important advance which had been made in the Telephone service of the country.

This event was preliminary to the formal opening by King Alfonso of the new Madrid Local Telephone system completely installed in a space of fourteen months by the Compania Telefonica Nacional de Espana, the old manual switchboards and overhead lines being replaced by Standard Rotary Automatic equipment and underground cables.

The change in service was accomplished simultaneously throughout the Capital and was loudly acclaimed by the public, who had endured many years of inadequate facilities. Madrid is second in the series of nineteen cities in which the Compania Telefonica Nacional de Espana will convert the telephone service to Rotary Automatic within the coming three years.

Mayor's Parlour,
Southwark Town Hall,
Walworth Road, S.E.17.

15th February, 1927.

The Editor,

Post Office Electrical Engineers' Journal.

Dear Sir,

Will you kindly permit me to invite the interest of your readers in the following:—

The progress of electrical science and industry in the past century is founded largely upon the results of the labours of the illustrious natural philosopher, Michael Faraday, whose experimental researches and discoveries opened wider the power-houses of nature and pointed the way to the utilisation of the forces stored therein, as evidenced by the present universal application of them, particularly electricity in the service of mankind, and who, in the words of Sir Oliver Lodge, initiated a whole new profession—Electrical Engineering, while Sir Richard Gregory, in a recent presidential address, declared that “every dynamo in the world owes its origin to Faraday.” In his life time he was described as “our great Electrician.”

Michael Faraday, to whom the world thus owes so large a debt of gratitude, was born in Southwark, the son of a blacksmith whose forge stood near the well-known local landmark, the “Elephant and Castle.”

To commemorate this great pioneer worker, who, in the world of science, holds a place almost equivalent to that of Shakespeare in the world of literature, the Southwark Borough Council desire to form a special collection of standard and current literature on electrical and allied sciences in the Central Reference Library of the borough, which is situated close to the spot where the forge stood.

It is suggested that the Memorial shall include also a bust of Faraday.

The use of the library is not limited to local residents, but, like the benefits of Faraday's discoveries is open to all. Moreover, it is centrally and conveniently situated near the junction of all the main thoroughfares of populous South London converging upon the principal London bridges; and it is well used—there was an issue of over 100,000 volumes last year.

It is proposed to create a Faraday Memorial Library Fund, the income from which would be expended in the acquisition of the best new books year by year and so keep the Memorial Collection always abreast of developments in, and practical application of the sciences for which Faraday did so much.

The Council would welcome the co-operation of electricians and scientists generally, many of whom it is believed would be glad to know of this opportunity to assist, if only in a small measure, in establishing in Faraday's native borough a memorial that will be worthy, permanent and increasingly useful in character.

The year 1927 has been described as the “Dawn of Britain's Electrical Age,” and the time would thus seem appropriate to pay tribute to the memory of the man who made the “Electrical Age” possible.

The project has the interest and generous support of, among others, The Royal Society, The Royal Institution, Messrs. Benn Brothers, The British Electrical and Allied Manufacturers' Association, The Eastern Telegraph Co., The British Thomson-Houston Co., The General Electric Co., The Western Union Telegraph Co., Provincial Tramways Co., Ltd., Messrs. J. Dewrance & Co., Ltd., The County of London Electric Supply Co., The City of London Electric Light Co., The Edison Swan Electric Co., Messrs. W. H. Willcox & Co., Ltd., Sir R. A. Hadfield, Bart., F.R.S., and a number of private individuals.

I shall be happy to acknowledge any contributions which may be sent to the Town Hall, **Walworth Road, S.E.17.**

Believe me,

Yours faithfully,

W. HEWITT,

Mayor.

HEADQUARTERS NOTES.

PAPERS READ AT THE PARENT INSTITUTION

Mr. G. F. O'dell read a paper on the 2nd December on “An Outline of the Trunking Aspect of Automatic Telephony,” and repeated it before the North Western and North Eastern Centres later. We hope to be able to give a

summary of this valuable paper in an early issue of this Journal.

Another paper of outstanding interest was one on “Some Notes on Design Details of a High Power Radio Telegraphic Transmitter using Thermionic Valves,” contributed by R. V. Hansford and H. Faulkner and read before the Wireless Section on the 1st December.

EXCHANGE DEVELOPMENTS.

Following works have been completed:—

Exchange.	Type.	No. of Lines.
Torquay	New Auto.	1280
Coventry	"	3100
Foleshill	"	500
Cosham	"	160
Marlow	Auto. Extn.	80
Popesgrove	New Manual.	1360
Letchworth	"	540
Slough	"	550
Clerkenwell	Manual Extn.	560
Kingston	"	1680
Royal (London)	"	2300
Sydenham	"	1580
Douglas (Glasgow)	"	1820
Brixton	"	1480
Leamington	"	380
Park (London)	"	2500
Clisold	"	2750
Midland (Birmingham)	"	2050
Leeds Trunk	"	Trunk Section.
Glasgow Corporation	P.A.B.X.	400
Garrould's	"	50
Bowater's	"	30
Shell Mex (Leeds)	"	30
Anchor Cable Coy.	"	60
Hampton's	"	30
Lewis (Manchester)	"	70
Gardner's	"	60
United Dairy's	"	50
Bristol Docks	"	60
Albright & Wilson	"	40
International Combustion	"	70
Jas. Hare	"	30
Crawford's	"	60
Barnsley Co-op.	"	40
Van Moppe's	"	30
Simpson & Coy.	"	20
Heaton's Ltd.	"	30
Barrow, Hepburn & Gale	"	60
Moss Gear Coy.	"	40
Clyde Valley	"	60
Wiggins, Ltd.	"	40
North of England Indemnity	"	20
Bootle Corporation	"	50
Liverpool Corporation	"	60
Parkinson's Stove Coy.	"	30
Bevin & Sons	"	30
Stott & Smith's	"	30
Kingseat Hospital	"	40
Morrison's, Ltd.	"	30
Crabtree's	"	40
Shell Mex (Leicester)	"	30
Archdale & Coy.	"	30
Earl of Dudley	"	70
Greenock Corporation	"	80
Southend Council	"	70
Crawford's, Ltd.	"	60

Orders have been placed for the following new Exchanges:—

Exchange.	Type.	No. of Lines.
St. Marychurch	Auto.	320
Forestfach	"	150
Rochdale	"	2000
Middlesbro' Area (4)	"	4200
Walsall	"	1740
Bloxwich	"	230
Bath Area (3)	"	3450
Bermondsey	"	2600
Beckenham	"	3000
Kensington	"	10000
Fleet	Manual.	520
Dunlop Rubber Coy.	P.A.B.X.	80
Crabtree (Walsall)	"	40
Crawford's (London)	"	60
Dewhurst, Ltd.	"	30
Kaye, Sons & Coy.	"	60
Archdale & Coy.	"	30
Blackburn Infirmary	"	30
Morrison's & Coy.	"	30
Britannia Assn.	"	40
Reading Guardians	"	30
Illustrated London News	"	70
Royal Arsenal Co-op.	"	60
Macclesfield Co-op.	"	50
Dorset Council	"	60
British Xylonite Extn.	"	10
Midland Bank	"	700
Carpet Manufactures	"	40
Hove Council	"	50
Newcastle-on-Tyne Corporation	"	130
Shell Mex (Birmingham)	"	50
Middlesborough Co-op.	"	20

Orders have been placed for extension to existing Equipments as follows.—

Exchange.	Type.	No. of Lines.
Sherwood, Notts	Auto.	680
Arkwright Street, Notts	"	500
Epsom	"	300
Buckhurst	Manual.	480
Sloane M.F.	"	—
Worcester	"	720
Malvern	"	200
Riverside	"	1380
Finchley	"	1740

LONDON DISTRICT NOTES.

DURING the quarter ended 31st December, the nett increase in the number of Exchange lines and extensions was 9,324.

MILEAGE STATISTICS.

During the three months ended 31st December, 1926, the following changes have occurred:

Telegraphs.—A nett decrease in open wire of 16 miles.

Telephones (Exchange).—A nett decrease in open wire (including Aerial Cable) of 240 miles and a nett increase in underground of 105,430 miles.

Telephones (Trunk).—A nett decrease in open wire of 9 miles and a nett increase in underground of 291 miles.

Pole Line.—A nett increase of 85 miles, the total to date being 5,634 miles.

Pipe Line.—A nett increase of 670 miles, the total to date being 7,903 miles.

The total single wire mileages at the end of the period under review were:—

Telegraphs	24,604
Telephones (Exchanges)			1,906,890
Telephones (Trunks)	64,135
Spares	93,596

INTERNAL CONSTRUCTION.

The transfer of the Epsom Manual work from Sutton to Streatham took place on January 22nd last. The equipment made spare at Sutton will be valuable for extension purposes.

An extension of the multiple at Enfield by 1,100 and the answering equipment by 760 was commenced on January 11th. This work is being carried out by the General Electric Co.

Paddington Extension of 1060 answering equipment and 1000 multiple has been started, and is being carried out by Standard Telephones and Cable Co.

Wallington New Exchange is nearing completion and will be opened on March 16th with an equipment for 3000 lines. The Exchange is a No. 1 C.B. type and has been installed by the General Electric Co. 297 lines will be transferred from Sutton Exchange coincident with the opening of the new exchange.

Streatham: An extension of 2480 is in hand,

a portion of which was completed in November, and a further instalment will be completed about the end of February.

The work of installing the New Toll Exchange is proceeding and is being carried out by the Standard Telephones and Cable Company.

Considerable progress is being made with the installation of Holborn, Mechanical Tandem, Bishopsgate, and Sloane Exchanges. In addition, the installation of the New Auto Exchange at Monument has been commenced. The work at Holborn Tandem is nearing completion and 53 positions are under test by the Department in conjunction with the associated C.C.I. Equipment at the existing manual exchanges. The provision and testing out of the equipment at 5 exchanges have been completed.

TELEGRAPHS.

C.T.O.—The strengthening of the walls, precedent to the erection of a fifth floor at the C.T.O., has been completed. Extensive shifts of tubes, telegraphs, telephones and common services have been involved, in order to make space for the thickened walls, stanchions, etc. The opportunity has been taken to straighten out the routes of the tubes, and brass has replaced lead in several instances.

Clocks for Post Office Tube Railway.—The C.T.O. Section is installing a system of Electric Clocks throughout the Post Office Tube Railway System. The number of clocks to be fitted is 32, including two Master Clocks. The two Master Clocks will be fitted in the Control Room on the 2nd Floor at Mount Pleasant, and will be wired to a change-over switch to give facilities for either Master Clock to be used at will.

These Master Clocks in turn will actuate 8 Standard B. Relays (joined in series), one of which will be fitted at each station. Each relay, together with a Condenser and resistance coil of suitable value, is contained in a small case and is fitted in the Control Cabin on each platform.

The clocks on the platforms will be wired to the local contacts of the above relays, and an impulse will be given to the clocks each half minute. All wiring is Cable V.I.R. .002, and

is contained in steel conduit, the power being supplied from local batteries at each platform.

The clocks are distributed in the following manner:—

(1) King Edward Street, Western Central District Office and Mount Pleasant: one 12" and four 24" clocks each; the 12" clock is placed in the Control Cabin and two 24" clocks on both Eastbound and Westbound platforms.

(2) Eastern District Office and Liverpool Street Station: one 12" clock in the Control Cabin and two 24" clocks on Westbound platform.

(3) Western District Office, Western Parcels Office and Paddington Station: one 12" clock in the Control Cabin and two 24" clocks on the Eastbound platform.

The current required to operate the relays is 16 m.a. and that for the platform clocks 300 m.a.

Batteries.—The bulk of the London District battery renewals and installations are now carried out by the Staff of the C.T.O. Section, and work is now in hand to provide for duplicate batteries at all Exchanges and also for the necessary additional capacity to meet the new requirements. The battery parts supplied by Contractors include plates, separators, etc., of standard sizes, and wood lead-lined boxes of suitable dimensions, the work of making the connection lugs, battery stands, burning plates

into sections and alterations to switching gear being done by the C.T.O. Staff.

During the past twelve months batteries have been installed to a capacity of approximately 3,500 kilowatts, and work is now in hand for the installation of batteries to a capacity of 1,300 kilowatts.

Wireless.—The Canadian Beam Station at the C.T.O. is now in full swing, and consists of Wheatstone with Creed apparatus of the modern airless type. The Australian beam apparatus is ready, as far as the Post Office is concerned, but the trial has not yet been completed. These, and other wireless extensions, have rendered it necessary to double the floor-space originally occupied by the Central Radio Office. The operating does not present any unusual feature, except that a telegraphist may "get his own marks" on a loud-speaker to enable him to be certain that the signals are being relayed effectively.

Start-Stop Apparatus.—In addition to the increasing numbers of Teletypes, start-stop apparatus of the Creed type is being introduced. This apparatus is already in use on the Norwich and Newmarket circuits and is being tried on a private "A" to "A" wire. The appearance of the column-printed copy is very good, but the apparatus is, necessarily, more or less experimental.
R.A.W.

LOCAL CENTRE NOTES.

LONDON CENTRE.

SESSION 1926-27 (SECOND HALF).

What might be regarded as the second half of the session was opened on January 11th, when Mr. R. T. Robinson read a paper entitled "Motor Transport in the Engineering Department." The paper dealt with the growth of Motor Transport in the Engineering Department from the earliest days and showed by means of numerous slides, curves and figures how simple the control of the transport organisation has become. Mr. H. Wilson (Superintending Engineer, South Wales) was in town and gave us the benefit of his District experiences.

On the 8th February, Mr. W. Cruickshank gave a highly interesting and instructive contribution on "Voice Frequency Telegraphs." The paper provided an exhaustive survey of Voice Frequency Systems covering voltages, lines, methods of operating, signal codes and shapes, the disturbing effects of telegraph signals on telephone pairs, and a description of trials carried out in such far places as Germany, Czecho-Slovakia, America and Japan. A keen discussion followed, in the course of which representative opinions were obtained from members of the International Electric Corporation and the General Electric Company.

On the 8th March, the Vice-Chairman (Mr. J. W. Atkinson) gave a valuable discourse on

"A Short History of the Post Office Engineering Department." The author, in the course of his remarks, pleaded for the preparation of a concise history of the Engineering Department, preferably in narrative form with that dash of humour which would enable an easy divorce from ponderous official phraseology to be achieved. The paper covered the whole growth of the Engineering Department from its inception and showed how the taking over of the various Telegraph and Telephone organisations culminating in that of the National Telephone Co.—veritably the sprat "taking over" the mackerel—affected the growth of the staff, and, incidentally, the Engineer-in-Chief's salary, the increase in the latter, however, bearing no relation whatever to the former. The names of many illustrious men were mentioned and the value of their work for the Department appraised. A good discussion followed.

The Informal Meetings are still proving to be good "draws." The third meeting of the series was held on January 25th, when Mr. James Cowie opened a discussion on "Training for Management." Mr. Cowie's inimitable Scottish manner and the humour of his remarks made one realise why his compatriot, Harry Lauder, is enabled to run mansions, motor cars and knighthoods at the public expense. An excellent discussion rounded off a delightful evening.

The fourth Informal Meeting took place on February 22nd, when Mr. T. Hargreaves, before a large assembly, opened a discussion on "Staff Problems and Efficiency." The author tackled his question fearlessly and there was a spirited discussion.

Arrangements were made for visits to the Holloway Factory on the 11th, 12th and 13th January, three days being necessary as the number of members wishing to attend was so large. The parties were looked after in a manner which reflected great credit upon the officers of the Stores Department and the Committee would like to take the opportunity of thanking the Controller and his staff for the excellent programme arranged.

It is proposed to visit the Lighting Service Bureau of the Electric Lamp Manufacturers Association in the middle of March.

F.W.F.

SOUTH MIDLAND CENTRE.

The attendance at the opening meeting of the 1926-7 Session, held on the 27th October, 1926, numbered 68.

The Chairman offered Mr. J. C. Eaton the best wishes of the members of the Centre for happiness in his retirement and Major Harris eulogized Mr. Eaton's work in the Oxford Section. Mr. Eaton acknowledged the felicitations.

Mr. J. E. Taylor, the Chairman of the Centre, read a paper "The Theory of the Electric Current. An Historical Survey." The lecturer in preliminary remarks announced that the opinions to be given were frequently unorthodox and that it therefore behoved his audience not to be too easily influenced by them.

It was explained that, previous to Faraday's work, there was a belief in an electric fluid and also a magnetic fluid which produces magnetism. These views were, however, dispelled by Faraday, who originated the "lines of force" view which emphasised the primary importance of the di-electric medium. Maxwell's contribution and his introduction of the conception of "displacement current" were elucidated, together with some reference to Lord Kelvin's views on the theory of transmission along cables. Professor Poynting's theory of the electrical transfer of energy was the next to be explained and this was followed by an exposition of Sir J. J. Thomson's view that the electron is not the final limit of disintegration.

The views of the late Oliver Heaviside were then discussed at greater length and the lecturer expressed the opinion, which appears to coincide with Heaviside's ideas, that there was no fundamental difference between displacement currents in the ether and currents in conductors. It was pointed out that the electronic theory of currents in conductors was strongly deprecated by Heaviside and considered by him to be a retrograde view.

The lecturer finally touched on the point as to whether Ohm's Law could be regarded as a representation of something which really occurred, or whether it was merely true mathematically but not physically. The lecturer took the position that, as a physical representation of fact, it was erroneous and misleading.

Replies were given to the questions asked by the Vice-Chairman, Messrs. Atkins, Lewis and Lines, and the Vice-Chairman in thanking the

lecturer on behalf of the members made reference to the honour done to the Centre by the reading of a paper of so high an order.

On the 24th November 61 members and visitors heard a paper entitled "Local Line Plant Economics," prepared by Mr. H. Kitchen, read by Mr. W. B. Crompton, who is also on the Staff of Engineer-in-Chief's Office.

It was pointed out that the annual expenditure on local line plant, which amounts had been rising for some years, was increasing at a rate faster than the revenue and some effects of the provision of wires and ducts in advance of requirements were explained.

The cost of laying the various types of conduits used by the Department were compared and the possibilities of utilizing boring apparatus explored. The planning necessary before a contract for underground work is let was detailed and the importance of these preliminary arrangements emphasised. Teeing systems received consideration at some length and various proposals were demonstrated on the screen. The economies which follow the provision of composite cables were set out and a new type of "quad" paper core cable described.

The lecturer passed on to show the savings which could be effected by employing an Ingersoll-Rand outfit for erecting poles where the ground was suitable. The principles influencing the decision whether the provision of open or of underground conductors was the more desirable were enunciated. The closing chapters of the paper were devoted to the consideration of the amount of plant which should be provided in Multi-office, Automatic, new Exchange and existing Exchange areas.

Numerous questions were put to the lecturer and opinions expressed by Mr. Halton, Major Harris and Mr. Dwyer, and after Mr. Crompton had replied the Chairman thanked him on behalf of the audience.

A.W.L.

NORTH EASTERN CENTRE.

The 1926/7 Session opened on the 12th October by Mr. J. T. Tattersall, the Executive Engineer stationed at Hull, who gave an interesting survey of the History and Telephone Development of Hull, and as the local telephone service at Hull is still in the control of the Cor-

poration, it will readily be imagined that the reading of the paper was followed very closely.

The members who had been transferred from the National Telephone Company mentally compared the conditions obtaining in the "good old days" and found that the comparison did not justify the "good" and came to the conclusion that the present was better than the past and the best was yet to be—whilst the P.O. men were amazed at the tactics employed in the early days of telephone competition and consequent upon their rigid training in the school of "safety first" longed for the authority to display their initiative, which authority they knew could not be given.

The evening provided an interesting study to the student of human nature, proving that human nature generally wants what it has never had and, when it gets it, longs for the good old days when it hadn't it.

The November meeting was favoured with a visit from Mr. Crompton, of the Engineer-in-Chief's Office, and these visits of the gentlemen from Headquarters are always the most interesting of the Session, consequent upon

- (1) the expert touch,
- (2) the decisive method of dealing with questions consequent upon (1),
- (3) the appearance in the flesh of "paper" men whom the majority have known for years.

No. 3 often comes as a shock.

Who would have ever imagined the signature of—well, I won't say who, but it is quite a thin weedy signature—had behind it a voice like rolling thunder amongst the hills, whilst another signature, giving one the impression of rolling thunder, has behind it the shrillness and perkiness of the cock sparrow in spring, and so on and so on.

Mr. Crompton was no exception to (1) and (2) and his paper on "Local Line Plant Economics" supplied information which was being sought in many round-about ways; he collects the rivulets of information; takes out the mud gathered on the way and presents a full flow of clear crystal knowledge. The visit was much appreciated and Mr. Crompton was no doubt repaid by the keen interest displayed by all present.

The December meeting was a happy continuation of Mr. Crompton's subject by Mr. G.

Bailey, late of the Northern District, but presented with the tongue of the Tynesider joyfully lilting off words many of which did not "get over" at first throw. His subject was "The Preparation of Underground Development Schemes and Suggestions *re* Lay-out," and was dealt with in the typically northern shrewd manner, much to the enjoyment of all present.

Our meetings are becoming more helpful each Session, and one of the most pleasing features is that practically all members feel quite at home in the discussions and readily bring forward any difficulty they have experienced touching on the subject under discussion.

SCOTLAND WEST CENTRE.

The second fixture for Session 1926-27 was reached on 1st November, when Mr. M. McKenzie delivered a paper on "Main and Local Overhead and Cable Records."

The paper dealt exhaustively with the whole of the Department's records of line plant, details being illustrated by lantern slides. The Department's machinery for keeping its records up-to-date was fully described and the difficulties encountered in obtaining and recording the necessary information were outlined by the lecturer. Instances were quoted where, especially in regard to pole diagrams, the instructions were not closely adhered to and resulted in unnecessary work. The instructions regarding such cases were explained and illustrated on the screen. The lecturer expressed his indebtedness to Messrs. Dacombe and Donellan, of the North Wales Centre, for the assistance contributed by the loan of their paper on "Plant Records."

A long and interesting discussion followed the delivery of the paper, in the course of which many points were brought up and dealt with by the lecturer.

The third fixture for this session took place on 6th December, the lecturer for the day being Mr. A. Arnold, who took for his subject "A Description of working 4-Wire Trunk Circuits from Glasgow Trunk Exchange."

The attendance of visitors from other Departments was indicative of considerable interest.

The lecturer first of all explained the necessity for the introduction of the 4-wire system and then, with the assistance of lantern slides, de-

veloped the subject. The ringing difficulty on 2-wire, echo effect on 4-wire and the means for its suppression, the reed armature and other features of the system were fully explained and illustrated. Repeater diagrams at intermediate points were also shown and traced out. Some of the slides used were loaned from Mr. Jones, of Fenny Stratford Repeater Station, and the lecturer expressed his thanks to Mr. Jones for the facilities.

A large number of questions were put by the members and visitors and to these the lecturer replied.

The fourth meeting for the current session was held in the Royal Technical College, Glasgow, on 17th January, when Mr. Aitken presided over a good attendance. The programme card indicated Mr. H. Kitchen, of the Engineer-in-Chief's Office, as the lecturer for the day on the subject of "Local Line Plant Economies," but, owing to unavoidable circumstances, Mr. Kitchen was unable to be present. His place, however, was ably filled by Mr. W. B. Crompton, of the Local Lines Section of the Engineer-in-Chief's Office.

Most readers of the Journal will be conversant with the contents of the paper, as it has been delivered before several Centres.

A long and interesting discussion followed the reading of the paper and the meeting terminated with a hearty vote of thanks to Mr. Crompton.

NORTHERN CENTRE.

At the third meeting of the Session, held on the 15th December last, a paper entitled "Wayleaves and Relative Difficulties," was read by Mr. B. Miller.

The author outlined in an apt and concise manner the various Acts of Parliament relating to telegraphs passed since 1836, and explained fully the Postmaster-General's statutory powers and how those powers were derived. He then gave an interesting history of the status and control of roads.

Before dealing with the difficulties met with in exercising the Postmaster-General's statutory powers, a resumé of the procedure followed in a Sectional Engineer's office for obtaining any consent was given, together with an appendix setting forth the whole of the forms required in connection with wayleaves and the circum-

stances in which each form is used.

The many pitfalls waiting for the unwary were pointed out and ways of avoiding them indicated. The importance of duly observing the Postmaster-General's statutory obligations was emphasised.

In the course of the paper several suggestions relating to the placing of plant in streets and roads and on railways, etc., and the attachment of wireless aerials to the Department's poles, were made with a view to expediting the Department's business. Although the adoption of some of the suggestions would involve further legislation, it was thought that the end would justify the means.

The comprehensiveness of the paper was freely commented upon in a well sustained discussion, the opinion being expressed that the information furnished would be helpful to the Staff and that the paper would be useful for reference purposes.

Disappointment was felt because of the inability of Mr. H. Kitchen, late of the Northern District and now in the Engineer-in-Chief's Office, to deliver personally his paper on "Local Line Plant Economics" at our January meeting, but the welcome given by 82 members to his capable substitute, Mr. W. B. Crompton, was none the less hearty. The paper was taken as read and Mr. Crompton's introduction of the paper and description of the lantern slides was followed by a brisk and spirited discussion. Eleven members participated in the discussion and several others were prevented from making contributions owing to the application of the closure by the Chairman due to time considerations. The parts of the paper which were subject to most comment and criticism were those dealing with the relation of Revenue to Capital Expenditure, the Teeing system described in the paper, the furnishing of development figures, the limiting of resistance for local exchanges, the use of aerial cable and the carrying out of duct work by the Department's own staff. Mr. Crompton dealt with the points raised in the discussion, his advocacy of the proposed Teeing system whereby a group of D.P.'s is formed, each D.P. being either directly or indirectly interconnected with the others in the group by means of teeing so as to form the equivalent of one large D.P., being a strong feature.

Mr. J. Brown's paper on "Local Under-

ground and Open Line Faults—Their Detection and Clearance," which was read on the 16th February, proved to be popular and was well discussed. The paper enumerated defects frequently met with in open line construction and in laying underground cables which give rise to faults, and useful preventative measures were suggested.

The visit to Cowgate Repeater Station, Newcastle, arranged for the 23rd February, has been postponed.

Three Associate Members, Messrs. H. Fisher, C. W. Hall and F. Bell, have retired from the service under the age limit during the last two months.

NORTH EASTERN CENTRE.

The second half of our programme opened on January 11th, 1927, when Mr. W. V. Ryder, M.I.E.E., read a paper on "Impressions of the Engineer-in-Chief's Automatic Training School," making it clear that the School met a real need and proving that the organisation was of the most efficient character. High tribute was paid to the instructors' abilities and patience, and every member of the meeting who had attended the School confirmed the excellent impressions gained by Mr. Ryder during his visit.

On February 9th another phase of the Institution's activities was entered upon.

In Leeds there is a "Cinema Exchange" where, in a well appointed room, Trade shows are given to advertise the films on the market. These trade shows are not given every day, but only twice or thrice per week and therefore on the other days of the week the "operating theatre" is available for outsiders to make use of, and for the information of those Centres who have not yet engaged such a room the charge made is £1 is. od. per hour inclusive of room and operator.

Mr. J. Shea, M.I.E.E., had obtained a film from The Equipment and Engineering Co., who are the suppliers of the Simplex Pole Lifting Jack, and this film was shown as part of Mr. Shea's paper on "Overhead Construction." The film clearly showed men at work with the Lifting Jack—(1) fixing the Jack in position, (2) attachment of chain to pole, (3) men working the Jack, (4) the pole gradually being pulled

direct out of the ground, (5) the use of guy ropes, (6) the fall of the post, the whole operation being a startling revelation of the advance made in the method of recovering poles, and proved that in a large percentage of pole recoveries, a remarkable saving in labour is effected by the use of the jack. A continuation of the film showed the working of the pole loading gear which has been fitted to one of the Department's 3-ton Albion lorries, and the facility with which poles were loaded on to the lorry and readily placed in position made one appreciate to the full what great advantages lie in mechanical contrivances which reduce manual

show the result of a test made between an ordinary A pole and the Rutter. With a pull of 14½ cwt. one leg of the A pole gave way but the Rutter pole only gave very little, as will be seen from the photo, when the pull reached 31½ cwt. Both poles had been in position 6 months at the time the test was made.

	A Pole.	Rutter Pole.
Ground Line ...	11½"	9½"
Depth in ground...	6'	6'
Height of pole ...	40'	40'

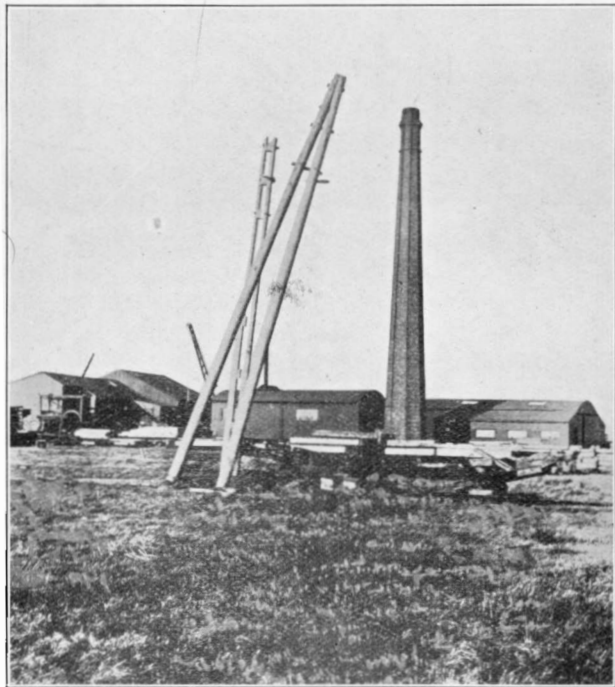

THE RUTTER POLE, COMPARATIVE TEST.

labour to a minimum and at the same time deal more expeditiously with heavy loads.

During the showing of the films Mr. Shea, in his characteristic manner and consequent upon his wide and varied experience on overhead construction, made running comments which added greatly to the fuller appreciation of the several operations depicted on the films.

Then followed a series of slides showing different structures, etc., which had come under Mr. Shea's special notice and a few of these will be specially interesting.

The Rutter Pole (Patented).—This photo

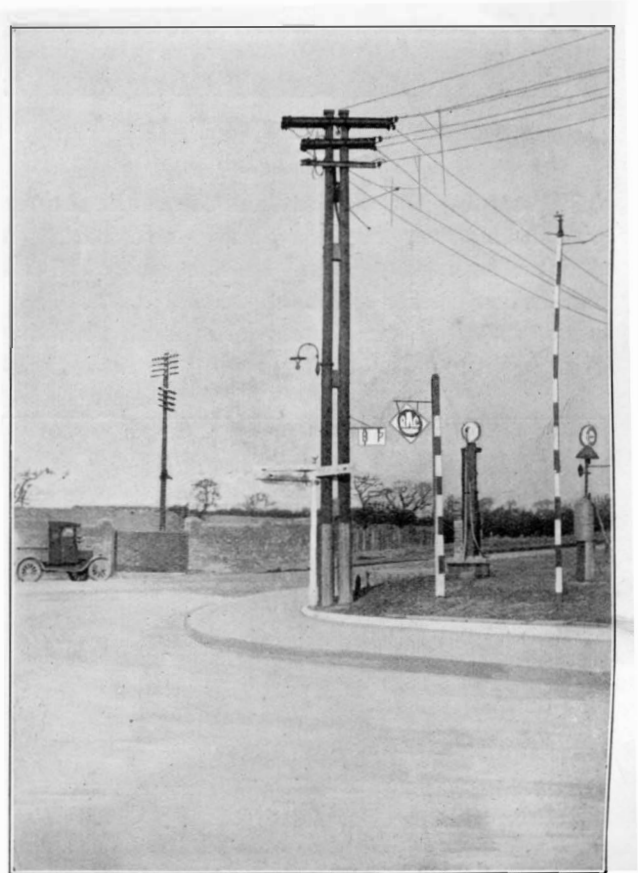

RUTTER POLE AT ANGLE.

The advantages claimed for the Rutter pole may be summarised as follows:—

- (a) Size for size stronger than any other pole yet designed.
- (b) Take up less ground space.
- (c) Less excavation necessary.
- (d) Neater in appearance.

The Rutter is obtainable from Messrs. Gabriel Wade, English & C., Hull, who kindly furnished the details of test and the photo.

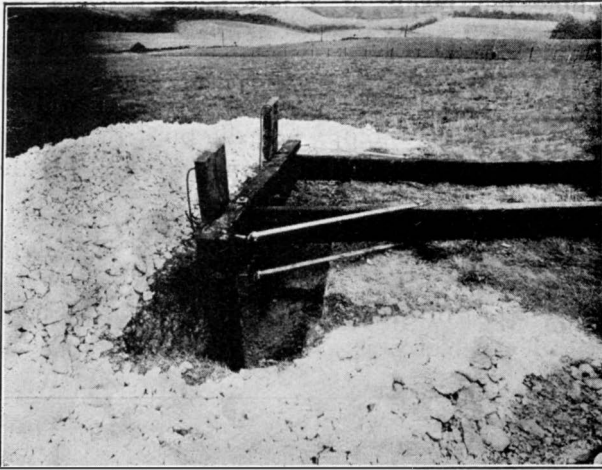

PATENT ANCHOR A POLE.

The second photo shows the use of the Rutter pole for a power line at a point where there is a definite right-angle pull on the pole and its stability is clearly indicated in the photo.

Patent Anchor A Pole.—This is an ordinary A pole with special strengthening at the founda-

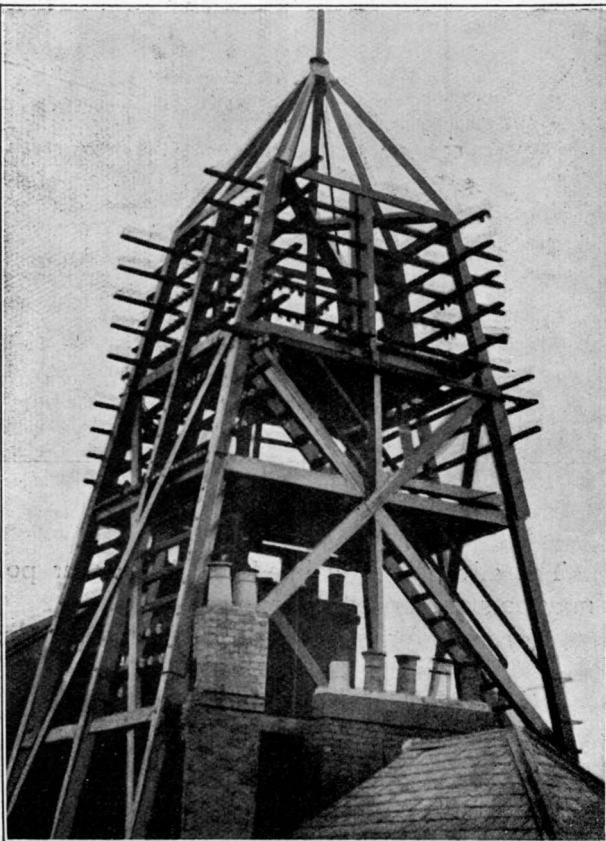

SUNDERLAND EXCHANGE DERRICK.

tion. It stood the test of 70 cwt. as against 15 cwt., the maximum of an ordinary pole. This patent pole is claimed to be as efficient as A poles set in concrete, without the added expenditure. The patent is one of Messrs. The Electrical Improvements, Ltd. The photo is one supplied by Messrs. W. T. Henleys.

Sunderland Exchange Derrick.—Erected about 1888; cost said to be approx. £600. This is a most unusual structure and from the appearance it will readily be understood that other than telegraph engineers had a hand in the construc-

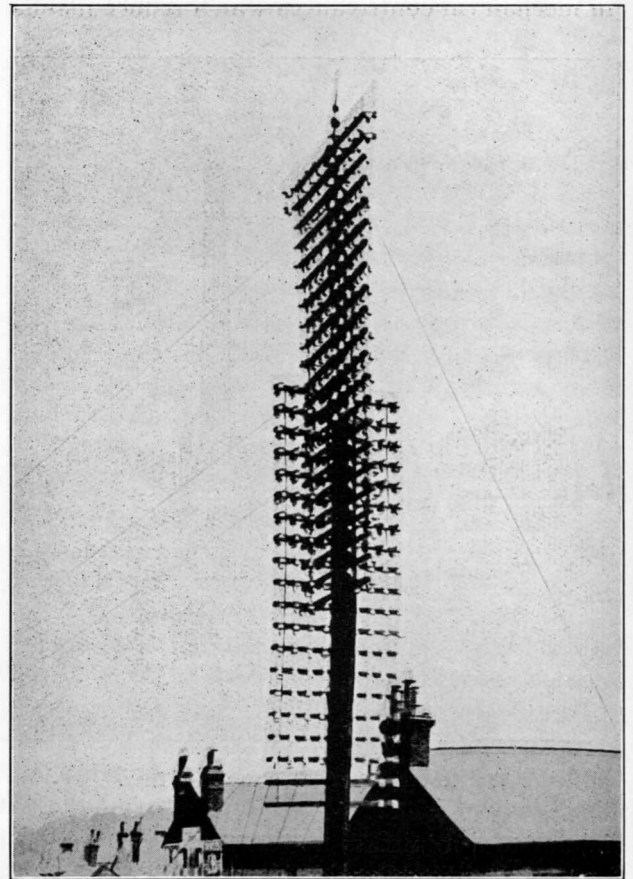

A D.P. (NOT IN THE N.E. DIST.).

tion; as a matter of fact, it was built by a firm of local shipwrights and was built for all time. The winds blew, the rains fell and beat upon this structure and it fell not, for it was built like a rock!

A D.P. (not in the N.E. Dist.).—This is the sort of structure one finds at his bed-head after a heavy supper . . . a thing to be avoided!



LONDON OVERHEAD CONSTRUCTION—OF AN EARLIER DATE.

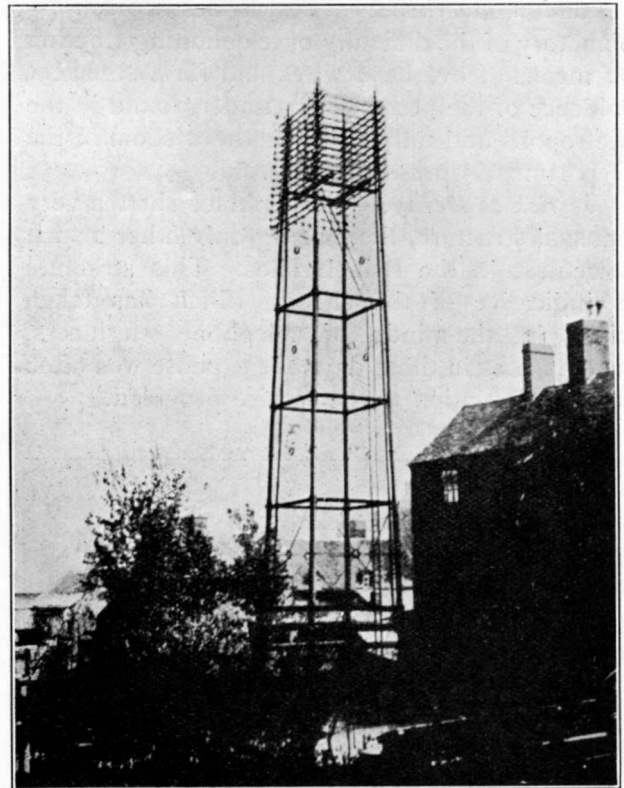

DERRICK AT DERBY.

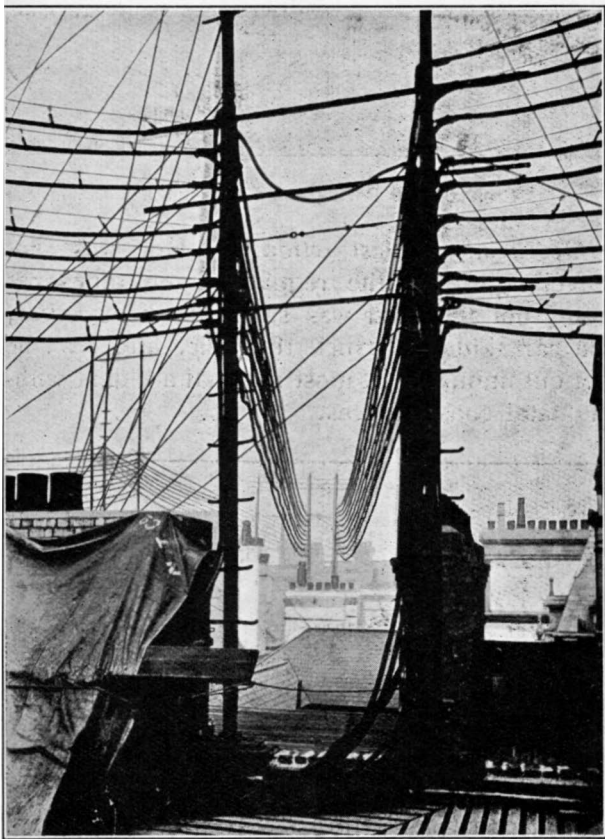

ANOTHER EXAMPLE OF OVERHEAD CONSTRUCTION IN LONDON.

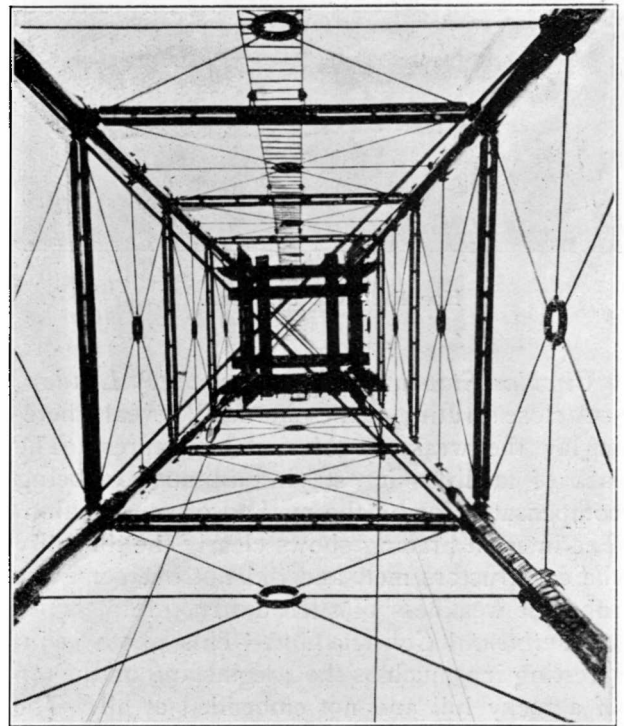

DERBY DERRICK FROM BELOW.

London Overhead.—These slides are self-explanatory of the difficulty of telephoning London by means of overhead wires and form sufficient evidence of the necessity for underground in the Metropolis and fully supports the wisdom of the Department's present policy.

Derrick at Derby.—These photos show a very unusual structure, there being only other 2 such structures in the British Isles. This structure is indicative of the change which has taken place in the minds of telephone engineers, inasmuch as in those days the expense was often out of all relation to the service provided.

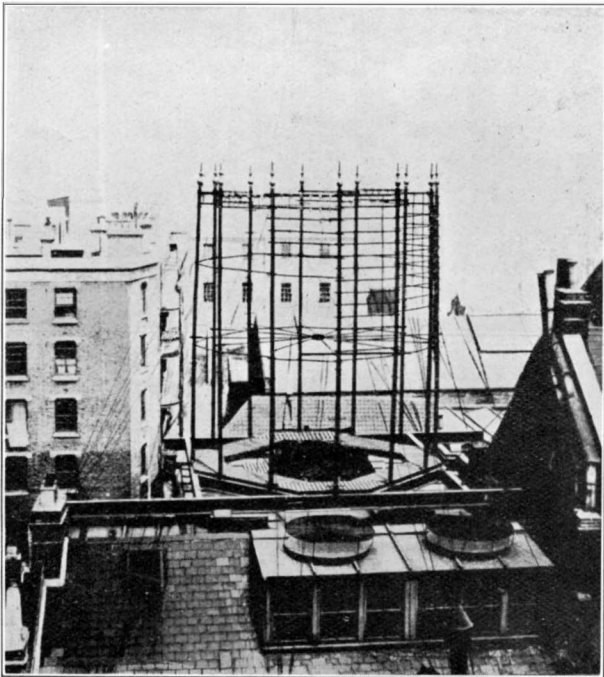

HOP EXCHANGE STANDARD.

Circular Standard (Hop Exchange) London.—A close scrutiny of the photo will reveal wherein lay the weakness of such structures. The lack of facilities for staying in no way being compensated for by the method of construction. The internal bracing shows clearly the difficulty the constructors met, and did not overcome the inherent weakness of such a structure.

Continental Construction.—This photo is interesting inasmuch as the 4 legs stand on the top of a rocky hill and not embedded at all. The wires on the one side come up the hill and on the other side go down, thus there is compression

and the arrangement is indicative of the ingenuity of our Continental friends.

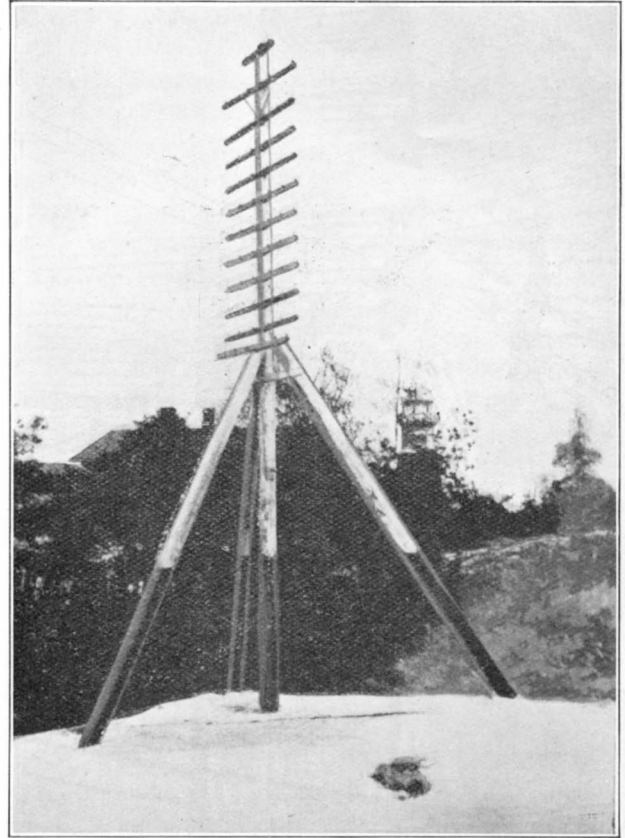

CONTINENTAL POLE (UNDER PRESSURE).

Overhead "Destruction."—He was not travelling above the regulation ten miles per hour, but the road was slippery; he swerved, the car skidded, struck the pole, and . . . he got out unhurt! A most unusual accident without fatal consequences.

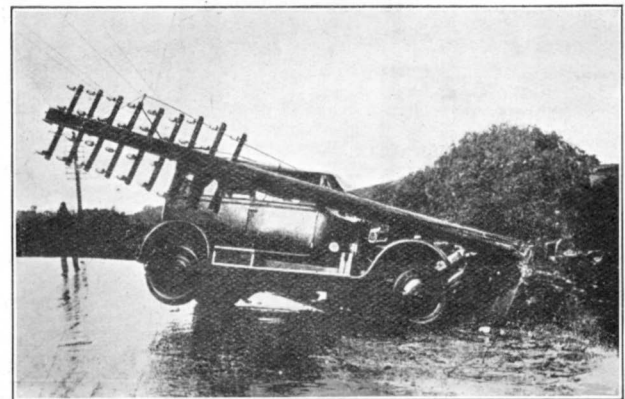

OVERHEAD DESTRUCTION!

When it is stated that about 130 slides were thrown on the screen, all of equal interest to those just referred to, it will be appreciated that Mr. Shea gave the local members a most interesting evening. Following the slides, another film was shown, "Beyond the Range of Vision," kindly loaned by Mr. T. Roles, the Bradford City Electrical Engineer, and described the operations of the American Telephone and Telegraph Company (Bell System), proving a very interesting comparison to the previous film and slides.

Naturally, an animated discussion followed and the meeting proved to be one of the most successful ever held in the N.E. District.

NORTH WALES CENTRE.

The fourth meeting of the 1926-27 Session was held at Shrewsbury on 12th January, 1927, when Mr. H. B. Somerville, B.E., of the Engineer-in-Chief's Office, read a paper entitled "The Inspection of Amateur Wireless Stations" to an audience of over 100. At the beginning Mr. Somerville referred to the different kinds of licences issued by the Postmaster-General, and to the conditions usually attached to these, and then went on to describe the kinds of transmitters usually met with at amateur Stations. Slides were projected showing the various circuits usually adopted by amateurs, and the lecturer enumerated the most important points to be observed by officers inspecting such stations, and gave many valuable hints arising from his experience in this branch of the Department's activities. Finally Mr. Somerville illustrated and described the design and use of the D.F. wagon recently placed in commission for tracking down oscillators, and referred also to the portable testing apparatus now being designed for the use of officers engaged on inspections. A prolonged discussion followed, and after Mr. Somerville had replied fully to the numerous enquiries which were raised, the meeting terminated with a hearty vote of thanks.

The fifth meeting of the Session was held at Shrewsbury on 23rd February, 1927, when a paper by Mr. K. Kitchen, of the Engineer-in-Chief's Office, entitled "Local Line Plant Economics," was read by Mr. W. B. Crompton, in Mr. Kitchen's unavoidable absence. The attendance was somewhat below the average for

this District owing to the prevalence of influenza and gales. The paper which was copiously illustrated by lantern slides has already been described in the January issue, and the subject was very exhaustively covered. The discussion which ensued revealed many diverse points of view upon some of the details of practice advocated by the lecturer, and only the proximity of "train times" brought it to a close, in time to enable Mr. Crompton to reply to the numerous points and enquiries which had been put forward.

J.G.K.D.

NORTH WESTERN CENTRE.

A meeting of the Centre was held in the Lecture Hall of the Preston Scientific Society on the 11th January, 1927, when a paper entitled "A Comprehensive View of Automatic Telephony" was read by Mr. W. Beattie, A.M.I.E.E. The object of the paper was to present an exposition of the system on popular lines, avoiding as far as possible any involved technical details.

Mr. Beattie opened his paper with a comparison of Manual and Automatic switching methods and proceeded to deal with the questions of the "holding-time" factor and the grading of traffic. A full description of automatic switching apparatus was then given and the switching of a through call on a provincial 4 digit exchange explained. This was followed by a description of "director" working and an explanation of the means employed in the switching of a call between two exchanges in a "director" area. The paper was illustrated by a working demonstration set and electric arc lantern.

A visit of inspection to the Southport new Automatic Exchange was paid on the 25th January, 1927.

The proceedings opened with a lucid review of the general principles of automatic switching by Mr. S. Upton, A.M.I.E.E. (Executive Engineer) and a working demonstration set was available for purposes of illustration. The members then divided into groups and inspected the Switch, Manual, and Accumulator Rooms, Power Plant, etc., the various details being explained by Messrs. Upton, Beattie, Carr, Tough and Thompson. The visit proved most illumin-

ating and the thanks of the Centre are due to Mr. Upton and his assistants for their co-operation and unsparing efforts which so largely contributed to the success of the function.

On the 14th February, a paper entitled "More about Amateur Wireless Stations" was read by Mr. H. Horrocks. The lecture was in continuation of the one given by the author during the

1925-26 Session. The paper dealt mainly with the question of Oscillation, its causes, detection and remedies, and a description was also given of the new Post Office motor van designed for the purpose of localising "howlers." Receiving and Transmitting Sets were also touched upon and the paper was illustrated by specially prepared diagrams. D.B.

BOOK REVIEWS.

"Radiotechnique Generale." By C. Gutton. (Paris J. B. Bailliere et Fils.) Pp. 572.

This volume contains a comprehensive survey of the fundamental principles of radio communication. The book forms one of a series of works forming an Encyclopædia of Industrial Electricity and edited by Professor M. A. Blondel.

The work consists of eighteen chapters and contains over three hundred diagrams and illustrations. Even in a volume of this size it is only possible to touch the fringe of many of the problems of radio telegraphy; the author has wisely kept to fundamentals and avoided lengthy excursions into the more specialized ramifications of the subject.

The first and second chapters deal with production of high frequency oscillations by spark discharges; chapter three deals with the production of oscillations by means of the electric arc, and chapter four with high frequency alternators. Chapters five and six are devoted to three electrode valves and their use in the production of oscillations. Chapters follow on coupled circuits, propagation along wires, propagation of electromagnetic waves and high frequency resistance of conductors. The actual equipment of transmitting installations is next described, space being given to spark, arc, alternator and valve sets and under the latter some mention is made of short wave transmitters. These first eleven chapters comprise about three hundred pages.

The subject of reception is dealt with under the headings of detection and amplification and this is followed by a long chapter on receiving sets.

Succeeding chapters are devoted to Direction Finding, Radiotelephony and high frequency measurements.

The work is well balanced and the author gives mathematical proof as far as possible for the formulæ used. Chapters which appear to be particularly good are those on the production of oscillations by three electrode valves, on coupled circuits, and on amplification and receiving apparatus. The first-mentioned chapter contains a mathematical analysis of the conditions governing the production of oscillations, which is probably fuller than that presented in any other text book. On the subject of reception the author states that the grid leak method of detection is more sensitive than anode rectification. Experience seems to indicate that this is not necessarily the case, since the additional damping introduced by the grid leak method can nullify its advantage when the detector is preceded by circuits having very low decrements.

Articles on high frequency measurements would be much more valuable if the percentage error likely to be encountered were stated. In the present work such figures are given in only a few instances. The chapter on this subject would have been improved by the substitution of more modern methods in place of those involving the use of buzzer excited wavemeters.

The work is a valuable contribution to literature on Radio communication, and can be confidently recommended. A. J. GILL.

"Dictionary of Wireless Technical Terms." By S. O. Pearson. London, *The Wireless World*, Iliffe & Sons, Ltd. 254 pp. 2/- net.

This is a useful little volume, of handy size for the pocket, containing simple definitions of a large proportion of the terms used in radio telegraphy.

There are one or two definitions which should receive amendment. The definition of "tone wheel" is incorrect. The tone wheel is a rectifying commutator for C.W. reception and was first used in connection with the Goldschmidt system. An interrupter for converting C.W. into I.C.W. is usually called a "chopper."

The definition of the Push-Pull Amplification implies that this is only used in the final stage of a low frequency amplifier. This is not strictly correct as it has important applications for ultra high frequency amplification.

It is also hardly correct to say that the three electrode valve has almost entirely superseded the two electrode valve. This is true only so far as receiving rectifiers are concerned, but it is not the case as regards transmitting rectifiers.

These points detract little from the value of the work, which is full of useful information for those who require something a little more explanatory and discursive than a list of standard definitions.

A. J. GILL.

"A First Course in Wireless." By R. W. Hutchinson, M.Sc., A.M.I.E.E. London, University Tutorial Press, Ltd. 262 pp., 207 illust. 3/6 net.

This book is stated by the author to be intended for beginners, for wireless amateurs and experimenters and for students in Secondary and Technical Schools and evening Technical Classes.

The first six chapters, comprising a hundred pages, are devoted to elementary electricity and magnetism.

The remaining portion of the book is devoted to a brief elementary survey of radio telegraphy and telephony, chiefly from the point of view of the broadcast listener, although other applications are occasionally mentioned.

There are a number of illustrations of broadcasting sets and components by different makers and a large number of circuit diagrams of broadcast receiving sets, which appear to have been culled from the popular press. At the end of the book formulæ are given for the calculation of inductance and capacity, but the reader is not told how to use these values to determine the wavelength or other properties of a circuit.

There are numerous errors and loose state-

ments, as for example on page 161 the performance of frame aerials with radial and axial windings are compared to the disadvantage of the former type. Actually the directional properties of both types are identical.

On Fig. 203 a telephony modulation circuit is shown and the student is recommended to "carefully think out the action of this circuit." The student is set a difficult task, as an essential item, the modulation choke, has been omitted. The writer also appears to be unable to distinguish between genuine advances in engineering practice and the fads and fashions of a few weeks duration, as for example when we are informed that in the best wireless receivers the square low condenser has replaced the ordinary type.

The title of the work and the claims in the preface suggest that it would be suitable as a class book, whereas in fact it is quite unsuited for the purpose. The subject matter is neither suitable in type nor sufficiently quantitative in character for the book to have any value for educational purposes.

A. J. GILL.

"The Practical Telephone Handbook." By Joseph Poole, A.M.I.E.E., Wh.Sc. Sir Isaac Pitman & Sons. 18/- net.

This, the seventh edition of this well-known handbook, is a great advance on previous editions. The book has now 870 pages and contains 687 figures, the whole excellently printed and the diagrams well drawn and clear. The increase in size since the sixth edition is 140 pages, but this does not represent the whole of the new matter, as a considerable amount of obsolete and less important material has been omitted to make way for the augmented and rewritten chapters on Automatic Telephony Transmission, Telephone Repeaters and Wireless Telephony. The chapter on Automatic Telephony is now 112 pages in length, but there are numerous points not covered. We think that instead of giving circuits of each of several systems it would be better to give one system in greater detail, but it is realised that there will continue to be difficulties from an author's standpoint until the B.P.O. standardises the circuits. At the same time it must be agreed that the 112 pages could be put to much better use if such standardisation existed. It is noticed

that the author has not yet adopted the "detached contact" system of diagrams which is so helpful and now so widely adopted in this country for study purposes.

B.O.A.

"Junior Technical Electricity." By Robert W. Hutchinson, M.Sc., A.M.I.E.E. University Tutorial Press, Ltd. Price 4/6.

The appearance within a year of a second edition of this excellent little work shows that it has been well received by teachers of First Year Electrical Engineering Courses. The new edition contains a little new matter in connection with "wireless," but otherwise is substantially a reprint. It is a book that can be thoroughly recommended.

B.O.A.

"Intermediate Text-book of Magnetism and Electricity." By Robert W. Hutchinson, M.Sc., A.M.I.E.E. University Tutorial Press, Ltd. Price 9/6.

We have also received a copy of the second edition of Mr. Hutchinson's Intermediate Text-book. The chief changes are in respect of Chapter XXI. on Electric Oscillations, etc. The book covers the Intermediate Examinations of the Universities, and is also suitable for the use of candidates for the various examinations of Civil Service, where Electricity and Magnetism is offered as a subject. The book well upholds the high standard of the series in which it appears.

B.O.A.

"Makers of Science—Electricity and Magnetism." By D. M. Turner, M.A., B.Sc. (Lond.). Oxford University Press. Price 7/6.

This volume is one of a series designed to introduce to the young student the philosophical outlook of men of science eminent in their particular branches. It deals with the work of the pioneers in electrical science from the earliest records, and is not merely biographical; it describes in an admirable way the steps by which the Science of Electricity and Magnetism has progressed, and the method by which the great experimenters worked. The book contains

very complete references to the critical literature of the subject and this forms a valuable aid to a student who wishes to follow up any particular line of development in greater detail.

B.O.A.

"Alternating Current Rectification." By L. B. W. Jolley, M.A. (Cantab.), M.I.E.E., Assoc. Amer. I.E.E. Chapman & Hall, Ltd. Price 30/- net.

The first edition of this work was published in 1924, but recent improvements in the design and manufacture of most of the important types of rectifier have necessitated a somewhat early revision.

The book covers an extensive field and deals not only with apparatus depending upon the basic principles of electrical engineering, but also with rectifiers where operation is due to chemical and physical phenomena.

Following an introduction on the subject of rectification in general, the first chapter deals in a comprehensive manner with the subject of Harmonic Analysis of Wave Form. This matter is clearly explained and an indication is given of the correct type of instrument to use in given circumstances.

The second part of the book is devoted to a consideration of mechanical rectifiers, an especially interesting chapter being given on synchronous commutator rectifiers. A very clear exposition is given of the "Transvertor," which at present appears to be the only machine capable of converting a large amount of power to very high D.C. voltages.

The mercury arc rectifier, which owing to its high efficiency, simplicity of operation and other advantages has gone far to displace motor and rotary converters on the Continent and in America and which will no doubt become more popular in the British Isles with the development of A.C. generating stations, receives adequate treatment, about one quarter of the book being devoted to its consideration.

The operation of the vacuum tube rectifier is now well understood in its relation to radio work, but it is not fully appreciated that the valve may have a field of application in power electrical engineering. The author describes an installation of water-cooled valves capable of giving an output of 5 amps. at 30,000 volts and

indicates that further developments in this direction are likely to take place.

The latter portion of the book deals chiefly with apparatus which is becoming of practical importance due to the increasing popularity of wireless broadcast reception.

The foregoing is not by any means a comprehensive statement of all the book contains, but is an outline of the salient points likely to be of great interest. Its value is considerably enhanced by the extensive bibliography at the end of each section. This feature might with advantage be followed by other writers of scientific works.

The volume is well compiled and is excellently illustrated by photographs and diagrams. Comparatively speaking it is free from errors, although on figure 252^a the scale has been omitted from a graph of an efficiency curve and on page 395 there is a reference to sulphuric acid with a specific gravity of 1.00. An error also appears in the index where page 251 should read 351.

H.C.J.

“Wireless Loudspeakers.” Iliffe and Sons. 139 pages. By N. W. Mclachlan. 2/6 net.

This little book has been written with a view of collecting together information covering the salient points concerned with the design and use

of loudspeakers of various types. A considerable section deals with the use of suitable circuits for operating the loudspeaker. If the information and advice given were taken to heart and acted upon there would be heard less of the raucous and unpleasant reproduction so prevalent at present, even with exhibition outfits where one would at least expect better quality.

The treatment is generally of a popular character, but a great deal of useful information is included.

The book opens with some general comments upon acoustics and discusses the requirements to be met for good reproduction and the causes of poor reproduction. The effects of diaphragm resonance, size and shape of diaphragms, use of baffles, etc., are lucidly dealt with and the author then passes to the description and discussion of various methods of drive.

One or two horn type loudspeakers are illustrated, but the author is evidently very much in favour of some form of Cone type of loudspeaker. Several of these are described, including a powerful model designed by the author.

In the section dealing with suitable amplifiers the author refers to the faults usually found and their remedy and emphasises the necessity for careful design in the amplifier.

The paper, printing and diagrams are all very good and the book can be confidently recommended.

STAFF CHANGES.

POST OFFICE ENGINEERING DEPARTMENT.

PROMOTIONS.

Name.	Grade.	Promoted to	Date.
Jenkins, I. H.	Executive Engineer, E.-in-C.O.	Assistant Staff Engineer, E.-in-C.O.	29-12-26
Harris, Major E. C.	Assistant Engineer, S. Mid. District.	Executive Engineer, S. Mid. District.	17-12-26
Morgan, J. A.	Assistant Engineer, E.-in-C.O.	Executive Engineer, E.-in-C.O.	5-1-27
Lock, F.	Assistant Engineer, E.-in-C.O.	Executive Engineer, E.-in-C.O.	5-1-27
Stretch, W.	Probationary Assistant Engineer.	Assistant Engineer.	1-2-27
Owen, J. McA.	"	"	"
Jones, F.	"	"	"
Wyllie, T. O. K.... ..	"	"	"
Hodge, G. W.	"	"	"
Chapman, F. B.	"	"	"
Procter, W. S.	"	"	"
Morrish, H. E.	"	"	"
Houchin, R. E. H.	Inspector, S. Mid. District.	Chief Inspector, S. Mid. District.	7-6-26
Humphries, P. W.	Inspector, S. Western District.	Chief Inspector, S. Western District.	5-7-25
Prior, G.	Inspector, Testing Branch.	Chief Inspector, Testing Branch.	24-11-26
Dunk, W. G.	Inspector, E.in-C.O.	Chief Inspector, E.-in-C.O.	27-4-26
Woodward, G. W.	Inspector (Wireless Overseer) Devizes Radio Station.	Chief Inspector, Devizes Radio Station.	1-10-26
Goddard, J. R.	Inspector (Wireless Overseer) St. Albans Radio Station.	Chief Inspector, St. Albans Radio Station.	1-10-26
Lewis, A. F.	Inspector, London District.	Chief Inspector, London District.	24-11-26
Sullivan, W. A.	Inspector, London District.	Chief Inspector, London District.	24-1-27
Baillies, D. C.	Inspector, Scot. West District.	Chief Inspector, Scot. West District.	25-10-26
Elwell, R. A. J.	Telegraphist, C.T.O.	Repeater Officer, Class II., Eastern District.	10-7-26
Richards, C. E.	S.W. Class I., E.-in-C.'s Office.	Inspector, E.-in-C.'s Office.	2-11-26
Mortimore, W. H.	Repeater Officer, Class II., Eastern District.	Repeater Officer, Class I., Northern District.	21-9-26
Honeyman, J. B.	S.C. & T., Edinburgh.	Repeater Officer, Class II., Scotland East.	26-9-26
Gaunt, J. L.	S.W. Class I., Oxford Radio.	Inspector, Oxford Radio.	24-10-26
Godfrey, G. M.	S.W. Class I., S. Mid. District.	Inspector, S. Mid. District.	6-3-26
Peck, H. J.	S.W. Class I., S. Mid. District.	Inspector, S. Mid. District.	1-4-26
Leake, R. J.	S. W. Class I., N. Ireland.	Inspector, N. Ireland.	1-11-26

APPOINTMENTS.

Name.	Grade.	District.	Date.
Sloss, J.	Fourth Engineer.	H.M.T.S. Alert.	26-1-27
Doust, J. F.	Probationary Assistant Engineer.	E.-in-C.O.	5-1-27
Dunford, L. G.	"	"	"
Sephton, N. F.	"	"	"
Bell, H. S.... ..	"	"	"
Bentlett, W. J.	"	"	"
Smith, H. S.	"	"	"
Halsey, R. J.	"	"	29-1-27
Ramsay, M. W.	"	Testing Branch.	17-1-27
Millar, H. T. W.... ..	"	"	31-1-27
Salter, L. F.	"	"	19-1-27
Blake, D. E.	"	"	18-1-27
Phillips, R. S.	"	E.-in-C.O.	19-1-27
Bourdeaux, N.	Probationary Inspector	"	—
Arman, L. T.	"	"	1-3-27
Simpson, C.	"	S. Lancs.	—
Young, J. E.	"	Testing Branch (Birmingham).	1-3-27
Dore, L. J.	"	E.-in-C.O.	21-2-27
Devereux, R. C.	"	"	16-2-27
Shrubsall, F. W.... ..	"	"	—
Henderson, V. R.	"	London.	17-2-27
Barrett, H.	"	E.-in-C.O.	22-2-27
Barry C.	"	S. Lancs.	—
Blackburn, E.	"	North East.	—
Millen, G. J.	"	E.-in-C.O.	21-2-27
Perryman, C. F.	"	"	21-2-27
Hibbs, A.	"	Testing Branch (London).	21-2-27
Salt, R. S.... ..	"	" (Birmingham).	18-2-27
Seymour, E. H.	"	" (London).	28-2-27

APPOINTMENTS—continued.

Name.	Grade.	Promoted to	Date.
Hayes, H. C. S.	Probationary Inspector.	S. Wales.	—
Roberts, J. H.	"	Testing Branch (London).	23-2-27
Neale, J.	"	E.-in-C.O.	—
Knox, A. H. C.	"	Testing Branch (Birmingham).	16-2-27
Lowne, W. R. J.	"	" (London).	15-2-27
Coleman, W. I. A.	"	" (Birmingham).	23-2-27

RETIREMENTS.

Name.	Grade.	District.	Date.
Ramsay, M.	Staff Engineer.	E.-in-C.O.	22-3-27
Macpherson, H.	Executive Engineer	S. Midland.	11-2-27
Rolfe, W. J.	"	N. Western.	31-3-27
Bell, A. J.	Assistant Engineer.	E.-in-C.O.	31-3-27
Savage, A.	Chief Inspector.	S. Lancs.	31-12-26
Hayward, J.	"	"	1-1-27
Hall, C. W.	Inspector.	Northern.	4-2-27
Johnston, R.	"	London.	31-1-27
Bell, F.	"	Northern.	12-2-27
Bagley, W.	"	N. Wales.	31-12-26
Thomas, W.	"	S. Western.	11-12-26
Stow, J. S.	"	London.	14-2-27

DEATHS.

Name.	Grade.	District.	Date.
McInnes, H. A.	Assistant Staff Engineer.	E.-in-C.O.	11-1-27
Watson, D. W.	Executive Engineer	Scot. West.	15-2-27
Gill, R.	Assistant Engineer.	N. Eastern.	13-1-27
Bell, H. S.	Probationary Assistant Engineer.	E.-in-C.O.	20-1-27
Smith, F.	Chief Inspector.	London.	15-1-27
Judd, H. I.	Inspector.	"	11-1-27

TRANSFERS.

Name.	Transferred.		Grade.	Date.
	From.	To.		
Hansard, A.	E.-in-C.O.	S. Mid. District.	Assistant Engineer.	1-1-27
Parker, T.	S. Eastern District.	N.E. District.	"	29-12-26
Whittle, J. G.	London District.	S. Lancs. District.	Chief Inspector.	17-2-27
Winter, J.	S. Lancs. District.	N. Ireland District.	"	7-11-26

CLERICAL ESTABLISHMENT.

PROMOTIONS.

Name.	Grade.	District.	Date.
Owen, W. G.	Clerical Officer, London.	Executive Officer, E.-in-C.O.	9-1-27
Dauncey, A. J. W.	Clerical Officer, N. Wales District.	"	9-1-27
Copeland, P. L.	Clerical Officer, E.-in-C.O.	"	12-8-26
Price, Capt. C. E.	"	"	"
Cowley, P. J.	"	"	"
Bolt, F. R.	"	"	"
Eames, E.	"	"	4-11-26
Dunster, H. L.	"	"	11-12-26
Smalley, A. T.	"	Acting Executive Officer, E.-in-C.O.	18-10-26
Davidson, R. S.	"	"	4-11-26
Ost, H. J.	"	"	11-12-26
Blackman, Miss I. C.	Writing Assistant, E.-in-C.O.	Female Clerical Officer, E.-in-C.O.	2-2-27

BOARD OF EDITORS.

B. O. ANSON, M.I.E.E., Chairman.

E. H. SHAUGHNESSY, O.B.E., M.I.E.E., M.I.R.E.

Lieut.-Col. A. C. BOOTH, M.I.E.E.

J. W. ATKINSON, M.I.E.E.

H. LONGLEY.

W. CRUICKSHANK, M.I.E.E., Managing Editor.

J. J. MCKICHAN, Assistant Editor, A.M.I.E.E.

COMMUNICATIONS.

All Remittances and Communications should be addressed to the MANAGING EDITOR, P.O.E.E. JOURNAL, Engineer-in-Chief's Office, Alder House, London, E.C.1.

Binding covers and copies of the Contents for Vol. 3 to 19 are available, and may be obtained from the local agents for 1s. 6d. and 3d. respectively. Subscribers can have their copies of Vol. 19 bound, with index included, at a cost of 3s. by sending the JOURNALS to the local agents. Orders should indicate whether the original binding with black lettering, or the later pattern in gold, is required.

The price of the JOURNAL is 1s. 6d. (1s. 9d. post free) per copy, or 6s. per annum, post free. All back numbers 2s. each.

THE INSTITUTION OF P.O. ELECTRICAL ENGINEERS.

Officers of Colonial and Foreign Telegraph Administrations who are engaged in Electrical Engineering Works may be admitted as Colonial and Foreign Corresponding Members respectively, after application.

Subscription payable annually in advance on 1st April in each year:

Colonial Members	£1	0	0
Foreign	„	„	£1	10	0

These sums include Annual Subscription to the Journal of P.O. Electrical Engineers and the supply of all Professional Papers issued during the period covered by subscription.

Forms of application for Colonial and Foreign Membership can be obtained on application to

The Secretary,
Institution of P.O.E. Engineers,
G.P.O., Alder House, E.C.1.

THE INSTITUTION OF POST OFFICE ELECTRICAL ENGINEERS.**ESSAY COMPETITION, 1926-27.**

The Judges have reported to the Council that the Prize Winners in the recent Essay Competition, arranged in order of merit, are as follows:—

1. J. S. Dennis, Repeater Station, Fenny Stratford.
"The Modern Conception of the Structure of Matter."
2. J. Bingham, Repeater Station, Newcastle.
"The Fundamental Principles and Characteristics of the Western Electric Telephone Repeaters."
3. F. V. Padgham, Repeater Station, Guildford.
"Transmission Testing Sets."
4. R. L. Ryan, Radio Station, Devizes.
"The Arc Transmitter."
5. E. H. Jeynes, Repeater Station, Gloucester.
"Photo-Telegraphy and Television."

The Council has decided to award Certificates of Merit to the following five competitors who were next in order of merit:—

6. S. E. Price, Testing Branch, Birmingham.
"The Secondary Cell."
7. N. V. Knight, Automatic Exchange, Oxford.
"Automatic Exchanges—Non-Director Areas."
8. J. H. Sundewall, Repeater Station, Fenny Stratford.
"Management of Oil Engines in Telephone Repeater Stations."
9. W. F. Goodman, Sectional Engineer's Office, Exeter.
"Local Line Records."
10. W. G. Johnson, Birmingham Section.
"The Change Over of the M.D.F. at Birmingham H.P.O."

The number of entries was 91, and the Judges reported that there was a further improvement in the average quality of the essays submitted.

March, 1927.
R. V. HANSFORD,
Secretary.

CENTRAL LIBRARY.

The following books have been added to the Central Library. Applications for the loan of same should be addressed to the Librarian, Institution of P.O. Electrical Engineers, Alder House, E.C.1.

<i>List 1.</i>	<i>Title.</i>	<i>Author.</i>
No.		
827	Portland Cement, Everyday Uses of	The Cement Marketing Coy.
828	Alternate Current Rectification...	L. B. W. Jolley.
829	High Vacuum	Kaye.
830	Wireless Pictures	Baker.
831	Director System of Automatic Telephony	W. E. Hudson.
832	Radio and High Frequency Currents	E. T. Larner.
833	Elements of Radio-Communication	O. F. Brown.
834	Electrical Condensers	P. R. Coursey.
835	Theory of Vibrating Systems and Sound	J. B. Crandall.

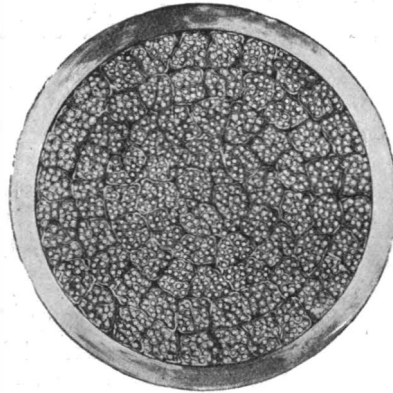

Dry Core Cables

The manufacture of Dry Core Cables demands experience, careful workmanship, the best quality materials, and up-to-date plant.

All these are embodied in the manufacture of Henley Dry Core Cables.

*Let **HENLEY CABLES**
carry the current*

and let Henley Staff carry out the contract.

W. T. HENLEY'S TELEGRAPH WORKS CO., LTD., HOLBORN VIADUCT, LONDON, E.C.1. Telephone : CITY 2271

1

PITMAN'S TECHNICAL BOOKS

Just Published.

ELECTRICAL CONDENSERS.

By PHILIP R. COURSEY,
B.Sc., F.Inst. P., M.I.E.E.

A Fellow of the Physical Society of London.

A treatise on the theory, design, construction, and testing of every kind of electrical condenser intended for the use of telephone engineers, radio engineers, designers of power stations and plant for power factor correction, consulting engineers and students.

An extensive and valuable bibliography has been included making it a most exhaustive and complete reference book.

635 pp., with 514 Illustrations.
37/6 Net.

Detailed prospectuses containing full list of Contents will be sent post free on receipt of a card.

New and Enlarged Edition.

POOLE'S TELEPHONE HANDBOOK and Guide to the Telephone Exchange.

By JOSEPH POOLE, A.M.I.E.E., Wh.Sc.

Seventh Edition, thoroughly revised and enlarged by 140 extra pages and 100 new illustrations.

This classic work, which is specially recommended by the Examiners of the City and Guilds Institute for candidates preparing for the examination in Telephony, has been thoroughly revised by the author in collaboration with experts on the G. P. O. Engineering Staff and other specialists in telephone engineering. The latest developments in every branch of the subject are now included.

893 pp., with 687 illustrations and 12 inset plates.
18/- net.

The Director System of Automatic Telephony

By W. E. HUDSON, B.Sc. (Hons.), Wh.Sc., A.C.G.I., Chief
Assistant in the Engineer-in-Chief's School of
Automatic Telephony, G.P.O.

This new work is intended for students of telephony, linesmen traffic officers and telephone engineers who wish to make themselves familiar with the Theory of the Director System.

160 pp., with 155 illustrations.
5/- net.

Sir ISAAC PITMAN & SONS, Ltd., Parker Street, Kingsway, LONDON, W.C.2

INDEX TO ADVERTISERS.

	PAGE		PAGE
Automatic Telephone Mfg. Co., Ltd.	iii	Rentell & Co., Ltd.	viii
Creed & Co., Ltd.	ii	Standard Telephones and Cables, Ltd.	x
Ericsson Telephones, Ltd.	v	Sterling Telephone and Electric Co., Ltd.	xiv
Henley's, W. T., Telegraph Works Co., Ltd.	xi	Siemens Bros. & Co., Ltd.	vi and vii
Johnson & Phillips, Ltd.	ix	Taylor Tunnicliff & Co., Ltd.	viii
London Electric Wire Co. & Smiths, Ltd.	xii	Telephony Publishing Corp.	xii
Peel-Conner Telephone Works, Ltd.	xv	The Electrical Review, Ltd.	viii
Pirelli-General Cable Works, Ltd.	xvi	The Relay Automatic Telephone Co., Ltd.	xiii
Pitman & Sons, Ltd.	xi	Zeva Elektricitats AKT. GES.	xii

The London Electric Wire Company & Smiths, Ltd.

Manufacturers of

EVERY DESCRIPTION OF
CABLES and WIRES
for Electrical Purposes.

COTTON-COVERED AND BRAIDED WIRES.
COTTON-COVERED STRIPS AND CABLES.
SILK-COVERED AND ENAMEL INSULATED WIRES.
MULTIPLE CABLES. FLEXIBLE CORDS.
CABLES AND FLEXIBLES FOR WIRELESS WORK.

"Eureka," Nickelchrome and other High Resistance Wires.

Playhouse Yard, Golden Lane, London, E.C.1.

Telegrams:
"Electric, London."



Telephone:
Clerkenwell 1388, 1391.

Special Electric "Zeva" **SOLDERING IRON**

FOR TELEGRAPH AND
TELEPHONE PURPOSES.

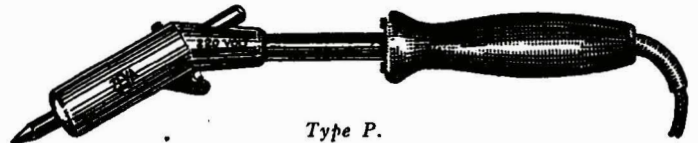

Type P.

Electric "Zeva" Soldering Irons
have no need of spare-elements.
As a consequence the costs of
maintenance are nil.

Zeva Elektricitats Akt. Ges.

CASSEL. Wilh. 150.

Telegraphic Address: "ZEVA."



The Engineering talent

all over the world reads TELEPHONY because it helps them keep abreast of the important developments in the telephone industry.

Telephony

THE AMERICAN TELEPHONE JOURNAL

has been the leading journal in the field for 25 years—a quarter of a century of valued service to its readers. Subscription price (foreign, including postage) \$5.00, Issued weekly.

Address: S. Rentell & Co., Ltd., 36, Maiden Lane, Strand, London, W.C.2.
for sample copy of TELEPHONY.

TELEPHONY PUBLISHING CORP., 606, S. Dearborn St., Chicago, Ill., U.S.A.

ACROSS the ATLANTIC

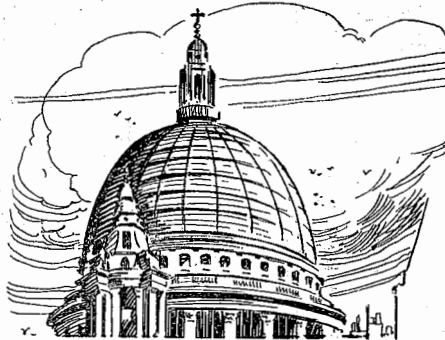

One of the first telephone calls across the Atlantic was made in the "Daily Express" Office, London, on the Relay Automatic Branch Exchange.

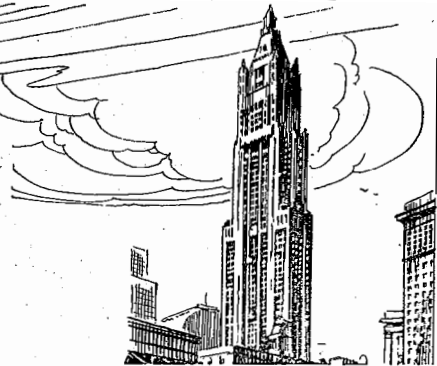

Value of Relays.

TELEPHONE service has been improved in proportion as relays have been more largely employed, and this perhaps is the most convincing testimony that can be offered to the reliability and high reputation enjoyed by relays.

The Relay Automatic Telephone System is composed entirely of specially designed relays—it is all electrical and employs no electro-mechanical switches or other moving parts. Relay installations require no oiling or cleaning; they are practically silent and motionless and are not affected by varying climatic conditions.

Various Types of Installations.

The Relay Automatic Telephone Company manufacture the

following types of Automatic Telephone Installations:—

Public Exchanges, Private Automatic Exchanges (P.A.X.).

Village Exchanges, Private Automatic Branch Exchanges (P.A.B.X.).

Satellite Exchanges.

Over 90 per cent. of the Private Automatic Branch Exchanges rented to subscribers by the British Post Office have been supplied and installed by the Relay Company.

Adopted extensively at Home and Abroad.

The Relay Automatic Telephone System has been adopted by the British Government and 16 other Public Administrations; by 34 Municipalities; by 50 Banks, including the Bank of England; by 50 principal

Hospitals including the London Hospital, and by leading houses in Commerce and Industry throughout the world.

Public Exchanges on the Relay System are operating in England, Czecho-Slovakia, France, Federated Malay States, India, South Africa, etc., while large contracts are at present in hand in Czecho-Slovakia.

British throughout.

Relay Exchanges are British-made throughout and represent the highest standard of automatic telephone apparatus.

Write for Booklet No. 9.

THE RELAY AUTOMATIC TELEPHONE CO. LTD.,

Marconi House, Strand, London, W.C.2

Telephone: City 0281.

Representatives throughout the world.

RELAY

AUTOMATIC

TELEPHONES

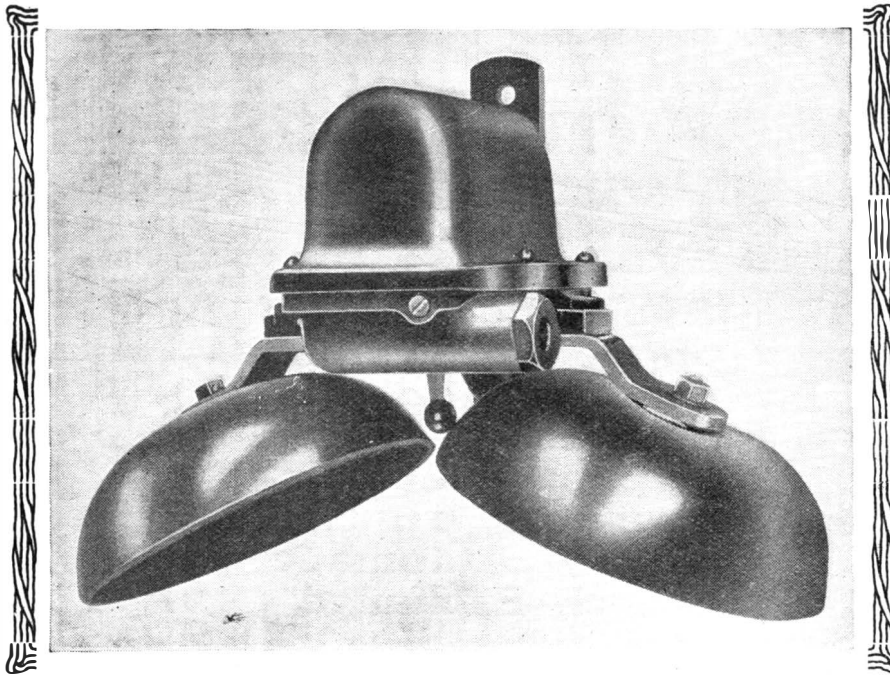

Weatherproof LOUD RINGING BELLS.

THE accompanying illustration is of a weather-proof Bell of unusual design and high efficiency, for use on alternating current circuits of any frequency up to 75 periods. The operating movement is extremely powerful, having a resistance of 1000 ohms for standard use.

It can be used on pressures up to 220 volts for continuous working. This voltage may be increased by 50% to 100% for intermittent working.

The signal given is of a very distinctive character, easily distinguished from other signals, and can be heard over a considerable area.

As a Telephone Extension Bell for use in conjunction with standard pattern telephones it is superior to those previously designed. It eliminates relays and local bell circuits so often used for want of an efficient loud extension bell.

Brief Specification:

Robust cast metal case, bright black stoved enamel finish.

Hammer protrudes through aperture underneath: protected by gongs. Access to terminals and working parts by removing cover, held with four screws. Cover clamps down on to suitable packing in base: watertight joint. A No. 1 watertight cable gland of British Engineering Standards Association specification is fitted at side to take incoming cable. A wrought iron fixing strap is fitted to eliminate the risk of the Casting breaking, due to strain when fixing. Gongs mounted eccentrically to allow of ample adjustment. Earthing terminal is fitted near cable gland.

“Sterling” are contractors to the Admiralty, War Office, India Office, Air Ministry, Postmaster-General and Foreign and Overseas Governments.

Write for Booklet No. 16.

Sterling

TELEPHONE AND
ELECTRIC CO., LTD.
DAGENHAM, ESSEX, ENGLAND.

PUBLIC AUTOMATIC TELEPHONE EXCHANGES

CONSTRUCTED, OR UNDER CONSTRUCTION, BY

Peel-Conner Telephone Works

(Proprietors—THE GENERAL ELECTRIC CO., LTD.)

Great Britain.

BROUGHTY-FERRY (800).
 BURNLEY (3,600).
 BURSLEM (2,200).
 CHESTERTON (200).
 COVENTRY (5,500).
 DUNDEE (4,500).
 EXETER (3,500).
 FOLESHILL (1,000).
 HANLEY (2,000).
 HARROGATE (5,500).
 KEIGHLEY (2,000).
 LONGTON (1,100).

NEWCASTLE-UNDER-LYME (1,000).
 STOKE-ON-TRENT (1,500).
 TOPSHAM (400).
 TRENTHAM (500).
 MIDDLESBROUGH (3,800).
 STOCKTON-ON-TEES (2,200).
 LINTHORPE (1,000).
 SOUTHBANK (400).
 ARCHWAY (5,800).
 EDGWARE (2,900).
 KENSINGTON (9,900).
 RELIANCE (4,400).

} LONDON
 DIRECTOR
 SYSTEM.

Australia.

CENTRAL (TANDEM).
 BRIGHTON (1,000).
 GLENELG (2,000).
 HENLEY (1,000).
 PROSPECT (3,000).
 WOODVILLE (1,000).

India.

CAWNPORE (2,000).
 MADRAS (9,000).
 RAISINA (NEW DELHI), (3,000).
 LOTHIAN ROAD (OLD DELHI), (3,000).
 BENGAL COAL FIELDS } (2,260).
 (SIX EXCHANGES)

New Zealand.

DANNEVIRKE (1,900).
 HAWERA (2,000).

Gibraltar.

GIBRALTAR (800).

NOTE—The bracketed figures are the subscribers line capacities of the exchanges.

HEAD OFFICE AND WORKS:
STOKE, COVENTRY

Telephone: COVENTRY 4111.
 Telegram: SPRINGJACK, COVENTRY.

LONDON OFFICE:
Magnet House, Kingsway, W.C.2

Telephone: REGENT 7050.
 Telegrams: PEELCONTEL, WESTCENT, LONDON.