

THE POST OFFICE ELECTRICAL ENGINEERS' JOURNAL

VOL. 42

JULY 1949

PART 2



CONTENTS

	PAGE
A CATHODE-RAY TUBE FREQUENCY COMPARATOR FOR 1 kc/s SUB-STANDARD TONES—F. J. M. Laver, A.M.I.E.E. ..	61
CONTACT RESISTANCE AND ITS VARIATION WITH CURRENT—S. Rudeforth, A.M.I.E.E.	65
SPECIAL ADMINISTRATIVE CONFERENCE FOR THE NORTH-EAST ATLANTIC (LORAN) JANUARY 17TH-FEBRUARY 14TH, 1949	69
A 200-LINE MOBILE AUTOMATIC EXCHANGE—E. Siddall, B.Sc.(Eng), A.M.I.E.E., and A. A. Page	70
TRUNK POLE RECOVERIES USING A POWER-OPERATED JIB CRANE—P. Nicolson	74
A NEW TELEVISION REPEATER FOR TELEPHONE CABLE CIRCUITS—T. Kivington, B.Sc.(Eng.), A.M.I.E.E.	76
LAYING OF ARMoured COAXIAL CABLE ON ANGLO-BELGIAN ROUTE—W. A. Collett	81
THE RECEIVING SYSTEM AT COOLING RADIO STATION—Capt. C. F. Booth, O.B.E., M.I.E.E.	84
AERIAL CABLES AND THEIR INSTALLATION—P. R. Gerry, A.M.I.E.E.	90
THE GERMAN RIVER AND SEA BED CABLE WASHING-IN PROCESS—C. R. Dickenson, A.M.I.E.E.	95
BOAT RACE TELEVISION BROADCAST—B. H. Moore	99
THE WIRE ROPE TRACTION DRIVE—R. S. Phillips, M.I.E.E. Part 1—Methods of Roping; Tractive Force; Coefficient of Friction	102
THE INSTITUTION OF POST OFFICE ELECTRICAL ENGINEERS..	106
JUNIOR SECTION NOTES	107
NOTES AND COMMENTS	108
REGIONAL NOTES	109
STAFF CHANGES	114
BOOK REVIEWS	73, 89, 94, 98, 101

Price 1/6 net

THE INSTITUTION OF POST OFFICE ELECTRICAL ENGINEERS



≡ A ≡ New ≡ G. & C.

Dial



THE
TRIGGER
DIAL

THE OUTSTANDING NEW FEATURES . . .

- Inter-digit pause preceding the digit.
- Inter-digit pause increased in length.
- Articulated trigger action.
- Simplified finger stop.
- Efficient governor mechanism.
- Still quieter action.
- Impulse ratio unaffected by wear.
- Improved dust exclusion.
- Sealed rear cover, if required.
- Interchangeable with B.P.O. and other standards.

**FOR THE MOST UP-TO-DATE
TELECOMMUNICATION EQUIPMENT**

Consult

**THE GENERAL ELECTRIC COMPANY LTD. OF ENGLAND
HEAD OFFICE: MAGNET HOUSE, KINGSWAY, LONDON**

THE POST OFFICE ELECTRICAL ENGINEERS' JOURNAL

Vol. 42

July, 1949

Part 2

A Cathode-Ray Tube Frequency Comparator for 1 kc/s Sub- Standard Tones

F. J. M. LAVER, A.M.I.E.E.

U.D.C. 621.317.361 : 621.385.832

A comparator is described which enables the frequency of a, nominally, 1 kc/s tone transmitted by land line from a distant source, to be measured in terms of a 100 kc/s frequency standard. The instrument has a measurement accuracy of $\pm 3 \times 10^{-8}$ over the range $1 \text{ kc/s} \pm 10 \times 10^{-6}$, and may be used over the range $1 \text{ kc/s} \pm 100 \times 10^{-6}$ to reduced accuracy. The principle and application of the comparator are discussed and the sources of error considered.

Introduction.

STABLE oscillators have been installed at various Post Office stations for use as frequency sub-standards¹ and as master oscillators controlling the carrier frequencies of multichannel telephony systems². These oscillators are calibrated regularly by deriving from them at each station a tone, with a frequency—nominally 1 kc/s—which is rigidly related to that of the local oscillator, and by transmitting the tones over land lines to a central laboratory for measurement in terms of a primary frequency standard. The tone frequencies are normally within $\pm 3 \times 10^{-6}$ of 1 kc/s, and a measurement accuracy of $\pm 1 \times 10^{-7}$ is required. The tones are not transmitted over carrier circuits, since any small frequency difference between the carriers at the two terminals would, by producing a corresponding change in tone frequency, lead to errors.

The use of a line for the comparison requires that the measurement be made quickly, which precludes heterodyne comparison with a 1 kc/s standard since a frequency difference of 1×10^{-6} at 1 kc/s corresponds to a beat period of about 17 minutes. The measurement time may be reduced by generating a harmonic of the received tone for heterodyne comparison with the standard, but experience has shown that this procedure is satisfactory only when the received signal is "clean." When noise or interference accompanies the signal the phase of the generated harmonic varies, and in unfavourable conditions false generations of the beat-recording equipment result. Even with more favourable line conditions the apparent completion of a beat may be advanced or retarded by an unknown amount. Two types of phase variation are found; the first, continuous, rapid and usually of low amplitude, is probably caused by noise, mains hum or speech interference; the second, intermittent, impulsive and of much larger amplitude, may be caused by signalling or switching operations.

The effects of phase variation on the accuracy of comparison may be reduced by using a cathode-ray

tube method, in which the rate of relative phase change of the signal from the local and distant oscillators is continuously monitored. The continuous type of phase variation blurs the indications, and its effect can be reduced by averaging. The occurrence of impulsive phase variations may be recognised and, as it is intermittent, the measurement may be timed to avoid the worst effects. The ways in which a cathode-ray tube can be used to compare two frequencies are well known, and include the use of linear deflections to produce Lissajous figures³, combination of circular and "vertical" or radial deflections to produce gearwheel figures⁴, combination of circular deflection with modulation of the beam intensity or focus to produce spot wheel figures⁵, and combination of two circular deflections to produce figures with loops, or cusps^{6, 7}. Cathode-ray tube methods are most often used to indicate isochronism, that is to show when two oscillations have equal frequencies, but in the present application a measurement of frequency difference is required with an indication of its sense. As with heterodyne comparison, the measurement time, using the cathode ray oscilloscope method, may be reduced by comparing the incoming signal of nominal frequency 1 kc/s with a standard signal of higher frequency. The higher the frequency of comparison, however, the more rapid is the motion of the figure and the greater the amplitude of its flutter for given magnitudes of frequency difference and phase variation respectively, and a comparison frequency of 100 kc/s has been chosen from a knowledge of the probable frequency differences and phase variations. The method selected is a modification of the spot wheel technique.

Principle of Operation.

The comparator is shown schematically in Fig. 1, in which the voltage waveforms at various points are also illustrated. The incoming 1 kc/s tone is amplified, passed through a narrow band filter, and applied to a limiting amplifier; the limited output, in the form of truncated sine waves, produces a full scale X-deflection of the cathode ray. The 100 kc/s standard

¹For references see Bibliography at end of article.

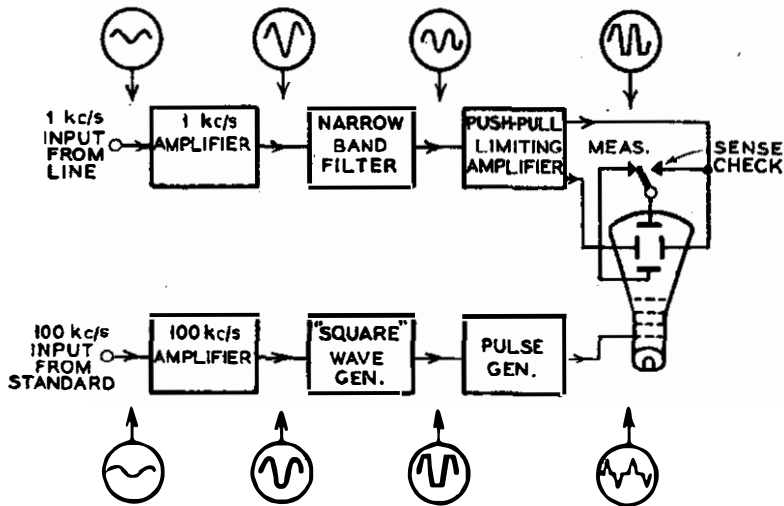

FIG. 1.—BLOCK SCHEMATIC OF COMPARATOR.

input is amplified, limited, converted into a pulse waveform and used to modulate the brilliance of the trace. The mean modulator electrode potential is adjusted so that in the absence of 100 kc/s pulses the trace is invisible; then, when the 100 kc/s input is applied, the screen is illuminated for a brief interval during each cycle of the 100 kc/s oscillation. If the nominal 1 kc/s and 100 kc/s oscillations are harmonically related the resultant figure on the screen of the cathode-ray tube consists of a row of 100 stationary bright dots arranged along the X-axis of the tube. Each pulse of the 100 kc/s oscillation produces one dot, so that 100 dots equally spaced in time are produced during each cycle of the 1 kc/s X-deflection. Since, however, the X-deflection is of truncated sine-wave form equal time spacing of the dots corresponds to wide separation near the centre of the trace and crowding together at the ends of the trace, as shown in Fig. 2 (a). Moreover, there are two sets of

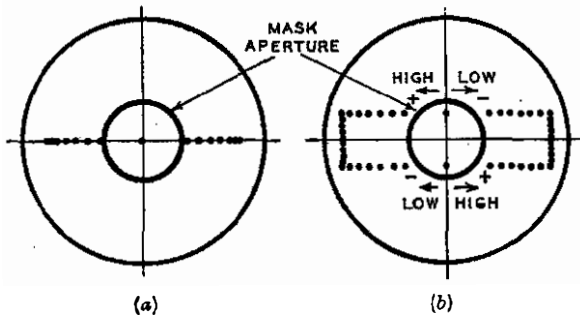

FIG. 2.—OSCILLOSCOPE SCREEN PATTERN: (a) FOR MEASUREMENT; (b) FOR SENSE CHECK.

dots, namely those produced during the forward (left to right) X-trace and those produced during the return trace, and if the 100 kc/s and 1 kc/s frequencies are not in exact harmonic relation, the dots appear to move, one set from left to right and the other set from right to left.

The determination of frequency difference is made by measuring the interval between the recurrence of identical figures, and for convenience, the figure used

is one in which the dots coincide in pairs. It should be noted that there are two distinct phase relationships of the two oscillations for such coincidences and that the corresponding figures occur alternately. This follows from the fact that there are two sets of dots moving in opposite directions at equal speeds, so that coincidences will occur when each set has moved one-half of the distance between dots, as well as when each dot has reached the position previously occupied by its neighbour. To avoid the possibility of error from this cause the screen is masked, as indicated in Fig. 2 (a), so that only one pair of dots is visible, and their coincidence occurs at the centre of the screen; the intermediate coincidences are then hidden by the mask and cannot confuse the observer. The

motion of the dots is analysed in an appendix and it is shown that the following relationship holds:—

$$f = \frac{F \pm 1/T}{100}$$

where f = tone frequency (c/s)

F = standard frequency (c/s)

T = interval between similar figures (secs.)

It may be noted that the interval T is equal to the period of one beat between the standard and the 100th harmonic of the tone. The action of the comparator is, in fact, analogous to that of a stroboscope presenting a series of views of a radius vector rotating in synchronism with the 1 kc/s tone, the views being shown at intervals of $1/F$ sec. and the viewpoint being in the plane of rotation.

The sense of the frequency difference, that is the sign to be applied in the formula quoted, is determined by applying a small fraction of the 1 kc/s voltage between the Y-plates of the cathode-ray tube, which opens the linear X-trace into a narrow and greatly distorted "ellipse," as shown in Fig. 2 (b). The sense may then be determined by observing the direction of apparent motion of the dots on the upper and lower traces, the appropriate directions being indicated on the mask.

Description of Circuit and Apparatus.

A circuit diagram of the instrument is shown in Fig. 3. The incoming line is terminated in a resistive load of 600 ohms, balanced to earth, and the nominal 1 kc/s voltage developed across this resistor is amplified in two stages before filtering. The gain from the amplifier input to the filter output is 32 db. at 1 kc/s, and the filter reduces this gain by 13 db. at 950 c/s and by 11.5 db. at 1,050 c/s. The filter output is amplified by a two-stage push-pull amplifier, the second stage of which operates as a grid limiter, and the push-pull output is connected to the X-plates of a 2½-in. cathode-ray tube. A key enables an output from one half of the amplifier to be connected to the Y1 plate (normally earthed) the Y2 plate being earthed, and operation of the key produces an open trace for sense

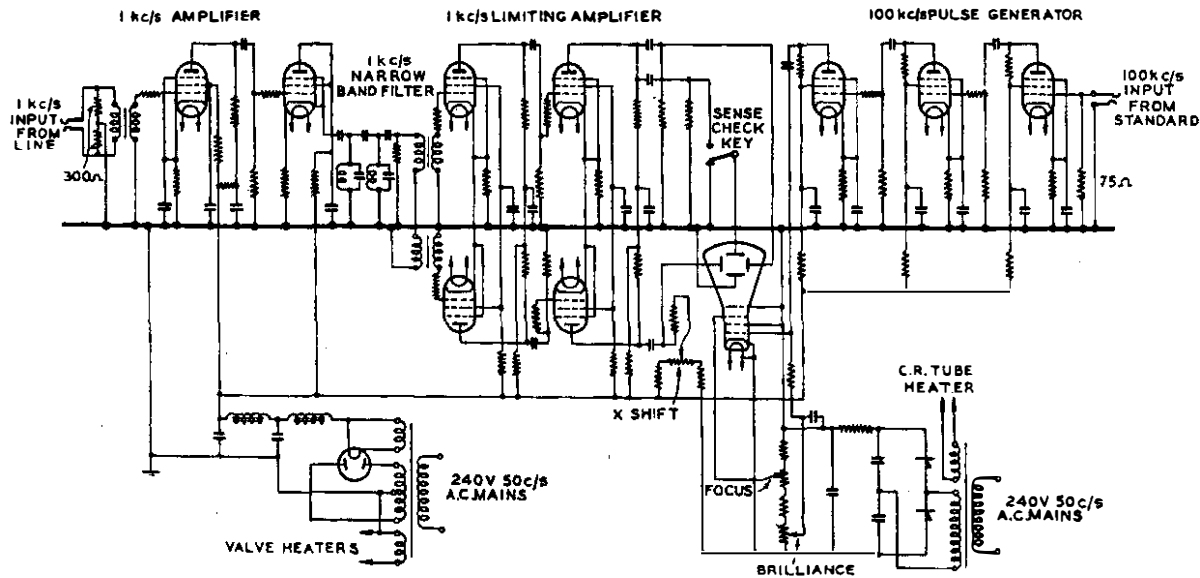

FIG. 3.—CIRCUIT DIAGRAM OF COMPARATOR.

checks. A received level of -40 db. (reference 1 milliwatt in 600 ohms) is sufficient to produce an X-trace in which the spots near the centre of the screen are about 20 mm apart, and as the amplifier is of the limiting type a gain control is not necessary.

The 100 kc/s input from the standard, at a level of 1 milliwatt in 75 ohms impedance is amplified in two stages and applied to a limiting stage. The anode potential of the limiter valve takes the form of truncated sine waves, which are converted into positive and negative pulses of peak amplitude about 20 volts, by a circuit of short time-constant before application to the modulator electrode of the cathode-ray tube. The pulse generator circuits operate satisfactorily for inputs greater than 0.03 volt over the range 10-500 kc/s.

The cathode-ray tube and power unit circuits are conventional; 6.3 volts 1.8 amps and 260 volts 40 milliamps are provided for the amplifiers and pulse generator; 4.0 volts 1.1 amps and 750 volts 2 milliamps are provided for the cathode-ray tube. The total power consumption of the comparator is 70 volt-amps at 240 volts, 50 c/s. The amplifiers, filter, pulse generator and cathode-ray tube are mounted as one unit, 19 in. \times 12 $\frac{1}{4}$ in. \times 10 $\frac{1}{2}$ in., and the power supplies form a separate unit, 19 in. \times 10 $\frac{1}{2}$ in. \times 10 $\frac{1}{2}$ in. The controls provided on the main unit are: Brilliance, Focus, X-shift, Sense Check key and a key for selecting alternative 100 kc/s inputs to the pulse generator.

Analysis of Errors.

The method of use follows from the description given previously. Thus, if N intervals between coincidences are observed to occur in T seconds the corresponding frequency difference between the 1 kc/s tone and the standard is $N/T \times 10^{-6}$. Errors in N arise from errors in the determination of coincidences, owing to the finite size of the dots and to the effects of phase variations. The dots are approximately 1 mm.

in diameter and, at the centre of the screen, are about 20 mm. apart; the minimum usable diameter being determined by the effects of halation and the need for a brilliant spot. It is estimated that the error introduced by dot size is about ± 0.02 cycle. The effect of phase variation is more difficult to assess; it depends upon the degree and character of the variation and upon the skill of the observer. At the centre of the screen the spot separation of 20 mm. corresponds to 3.6° at 1 kc/s, the equivalent peak sine wave amplitude of X-deflection is therefore $20/\sin 3.6^\circ = 318.3$ mm. and a noise pulse of peak amplitude $1/318.3$ of the signal amplitude would therefore produce a spot movement of 1 mm., i.e. about 0.05 cycle; this corresponds to a signal/noise ratio of 50 db. With average lines, however, the phase variations which occur are sufficient to cause errors of about 0.1 to 0.5 cycle, and this is the major source of error in the determination of N , so that an increase of spot separation or a decrease of spot size would not appreciably improve the measurement accuracy.

Errors in the determination of T arise from variations in the observer's reaction time and from the discrimination of the timing device. It is estimated that the effect of the observer's reaction time is as much as 0.1 sec., for which reason a stop watch is sufficiently accurate for timing. The proportional timing error may be reduced by prolonging the measurement but, as the use of a line is involved, the measurement period is usually restricted to about 50 seconds.

It is difficult to count coincidences occurring at a rate exceeding about 1 per second over a period of 50 seconds, so that the maximum frequency difference that can conveniently be measured is about 1 c/s, i.e. about 10×10^{-6} at 100 kc/s. The minimum measurable frequency difference depends only on the patience of the observer, and for a measurement period of 50 secs. the minimum frequency difference is 0.2×10^{-6} . However, with a choice of two or more

frequency standards of slightly different absolute frequencies it has always been possible to select a standard so that the frequency difference was about 1×10^{-6} . The comparator may be used, at reduced accuracy, to measure frequency differences up to 100×10^{-6} by replacing the standard 100 kc/s input to the pulse generator by standard 10 kc/s. Table 1 shows the estimated error of comparison over the working frequency range, in the absence of phase variation and for a period of measurement of about 50 seconds.

TABLE I.

Frequency difference—parts in 10^6	Std. Comp. Freq. kc/s	Number of intervals between coincidences. N	Time for N intervals— T secs.	Maximum errors—%			Total comparison error—Parts in 10^6
				in N^*	in T^\dagger	in N/T	
0.2	100	1	50	2.0	0.2	2.2	0.44
1	100	5	50	0.4	0.2	0.6	0.6
10	100	50	50	0.04	0.2	0.24	2.4
100	10	50	50	0.04	0.2	0.24	24.0

* Based on error of 0.02 cycle. † Based on error of 0.1 second.

The instrumental error has been checked by the intercomparison of two local standards, for which the effects of phase variation were negligible, with a frequency difference of 2×10^{-6} and measurements extending over 50 seconds. Comparison errors of $\pm 0.6 \times 10^{-8}$ were found, agreeing well with an estimated error of $\pm 0.8 \times 10^{-8}$ on the basis of the assumptions used in Table 1. Under average conditions of line noise, with a frequency difference of 1×10^{-6} and a measurement time of 50 seconds, the maximum comparison error is about $\pm 3 \times 10^{-8}$, as checked by successive measurements of a distant standard (70 miles) of short period frequency stability better than $\pm 1 \times 10^{-8}$.

Conclusions.

The cathode-ray tube method of frequency comparison described above and in use since June, 1944, has been found to be more useful than heterodyne methods for the intercomparison of a 100 kc/s frequency standard with 1 kc/s tones transmitted over land lines up to 200 miles long, since it is less susceptible to the presence of noise or interference voltages. This probably arises from two causes; observations are made at a point corresponding to the maximum rate of phase change of the 1 kc/s tone, and the rate of phase change is monitored continuously so that the observer may use his judgement to determine a suitable period of measurement. The comparator has proved to be simple and reliable in

use and has the advantage that if the signal fails, even for a brief interval, the failure is obvious and errors from this cause may be avoided.

Bibliography.

- 1 "Baldock Frequency Control Station." C. F. Booth and G. Gregory, *P.O.E.E.J.*, 33, 105, 1940.
- 2 "The London-Birmingham Coaxial Cable System, Part II." A. H. Mumford, *P.O.E.E.J.*, 30, 270, 1938.
- 3 "Frequency Measurements with the Cathode-ray Oscilloscope." F. J. Rasmussen. *Trans. A.I.E.E.*, 45, 1256, 1926.
- 4 "An Improved Cathode Ray Tube Method for the Harmonic Comparison of Frequencies." D. W. Dye, *Proc. Phys. Soc.*, 37, 153, 1924.
- 5 "Application of the Cathode Ray Oscilloscope in Radio Research." R. A. Watson-Watt, J. F. Herd and L. H. Bainbridge-Bell, *H.M.S.O.*, 1932.
- 6 "Superposition of Circular Motions." T. S. Rangachari, *Wir. Eng.*, 6, 184, 1929.
- 7 "A New Frequency-Comparison Circuit for the Cathode-Ray Tube." G. H. Rawcliffe, *J.I.E.E.* 89, Part III, 191, 1942.

APPENDIX

Analysis of Dot Motion.

Let F = the standard frequency (c/s)

and $f = \frac{F}{a} (1 + x)$ = the tone frequency (c/s)

where a is an integer, and x is the proportionate difference of f from harmonic relationship with F .

On the oscilloscope screen the dots will coincide in pairs whenever a certain phase relationship exists between the two oscillations. But, since F is lower in frequency than the a th harmonic of f , the phase lag of F on f will increase, and the same arrangement of dots recurs whenever this lag has increased by an amount equal to 1 cycle of F . This will happen at intervals of T secs., corresponding to n cycles of f and to $(na-1)$ cycles of F , where n is an integer.

$$\text{Hence } T = \frac{na-1}{F} = \frac{n}{f} = \frac{na}{F(1+x)}$$

$$\text{whence } \frac{na-1}{F} = \frac{na}{F(1+x)} \text{ or } n = \frac{1+x}{ax}$$

$$\text{Therefore, } T = \frac{na}{F(1+x)} = \frac{1}{xF}$$

$$\text{But, } f = \frac{F(1+x)}{a} = \frac{F + xF}{a} = \frac{F + 1/T}{a}$$

A similar analysis for the case where $f = F(1-x)/a$, leads to the result $f = \frac{F-1/T}{a}$.

In the particular comparator described,

$$a = 100 \text{ so that } f = \frac{F \pm 1/T}{100}$$

Contact Resistance and its Variation with Current

S. RUDEFORTH, A.M.I.E.E.

U.D.C. 537.311.4

Empirical relationships have been derived for the non-linear resistance/current characteristics of specified contacts. It is shown that both the average contact resistance and deviation in individual values from the mean as represented by the standard deviation, increase with reduction in the contact current; and that the ratio of standard deviation to the average resistance also increases with reduction in contact current.

Introduction.

ALTHOUGH the effects of contact current on contact resistance have been studied theoretically and qualitatively in some detail,¹ published work on the treatment of those effects on a quantitative basis is slight.

The work here described was carried out early in 1944 in the Post Office Research Station, and shows how, by making a sufficiently large number of measurements, and by statistical assessment of them, empirical relationships between contact resistance, contact current and standard deviation may be established.²

It is shown that, at least for the type of contact tested, the mean resistance and the deviation in extreme values from the mean increase with reduction in current; and that the mean resistance, \bar{R} , and standard deviation, S , are related to the current, I , by expressions of the form, \bar{R} or $S = a.I^{-n}$.

Type of Contact Investigated.

Fig. 1 shows part of a switching mechanism in common use in automatic telephone systems and

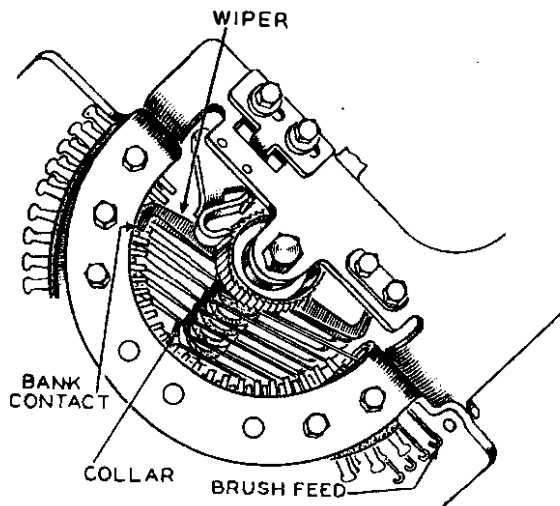

FIG. 1.—PART OF UNISELECTOR—SHOWING CONTACTS INVESTIGATED.

referred to as a uniselector. The driving mechanism is not fully shown, but consists of an electromagnet,

¹Fairweather, A. "The Closure and Partial Separation of Metallic Contacts." *J.I.E.E.*, Vol. 92, Pt. 1, p. 301.

²For reference to statistical methods employed see, for example, Doust, J. F., and Josephs, H. J. "A Simple Introduction to the use of Statistics in Telecommunications Engineering." *P.O.E.E.J.*, Vol. 34, p. 36, et. seq.

pawl and ratchet device. A circuit through the uniselector comprises two sliding contacts, i.e., between the wire brush-feed and collar, and between one end of the wiper and the bank contact. The composition of the contact materials is given in Table 1.

TABLE 1

ITEM	MATERIAL
Bank contact ..	Nickel-silver; 18 per cent. nickel; hard rolled, bright dipped.
Wiper	Phosphor bronze; 6 per cent. tin, 0.2 per cent. phosphorus with the remainder pure copper; hard rolled.
Brush	Phosphor bronze; 5 per cent. tin, 0.15 to 0.2 per cent. phosphorus with the remainder pure copper; hard drawn spring; bright dipped.
Collar	Brass, naval; 62 per cent. copper, 37 per cent. zinc, 1 per cent. tin; bright dipped.

Contact resistance measurements were made on uniselectors fitted with eight levels comprising 25 bank contacts per level, and with double-ended wipers, some of which were of the bridging, and some of the non-bridging, type. Measurements were confined to the latter type which "break" a bank contact before "making" on the next one.

General Considerations.

Primarily, it was desired to find the overall brush-feed/bank contact resistance when the contacts were carrying a current of 3 amps. from a low voltage D.C. supply. It was stated that very inconsistent values of resistance were obtained from contact to contact; values quoted ranged from 2 to 10 ohms, measured by means of an "ohm-meter," and 0.3 to 1.0 ohm, from P.D. measurements when the contacts were carrying a current of 1.0 amp.

To increase the usefulness of the work and to show the degree of dependence of contact resistance on the value of the current, it was decided to obtain results for a variety of current values. The problem was essentially a statistical one and was attacked on that basis.

Ten new uniselectors were used for the tests. The actual distributions of contact pressures were not determined but were within the ranges:—

- (a) 25 to 45 gms. between brush-feed and collar.
- (b) 20 to 40 gms. between wiper tip and bank contact.

The majority of the measurements made refer to

“static” contacts, although, as will be seen later, consideration was given to the effect on the contact resistance under “dynamic” conditions, i.e. when the wipers were rotating at the rate of 10 steps per second.

Except where stated, it was arranged that the contacts neither made nor broke the current, either by establishing it after a wiper had been positioned on a contact or, under “dynamic” conditions, by means of a relay contact.

RESISTANCE MEASUREMENTS UNDER “STATIC CONDITIONS”

Method of Measurement.

The bank contacts were commoned with No. 11 S.W.G. tinned copper wire. The contact current was obtained from a 12-volt supply, this being a convenient testing voltage well above that required to break down the semi-conducting film (referred to later) and enabling the use of a series resistance of value high in comparison with the contact resistance, so that the current could be pre-set with accuracy.

The wiper of a uniselector was stepped on to a bank contact to be measured; after pre-adjustment to the required value, the current was switched on, and the total P.D. across the brush-feed and bank contact measured, in the first instance, by a milli-voltmeter. However, preliminary tests showed that the contact resistance usually diminished at such a rate that its initial value could not be observed with such an indicating instrument. Frequently, too, the resistance was subject to comparatively slow variations in both directions and it was difficult to estimate its maximum value.

To obtain maximum values of resistance occurring during short-term periods after switching on the current, a valve, peak-millivoltmeter was devised. The arrangement, operated on the capacitor charge principle, had an operating time-constant of 5 mS, and was such that the maximum P.D. was indicated on the instrument as a steady reading for at least two or three seconds. The operating time-constant was purposely arranged to be of the order stated so as to ensure that the measurement obtained corresponded to the metallic condition. After disconnecting the current and discharging the peak-voltmeter capacitor, the wiper was stepped to the next contact to be measured; by this means accurate and rapid measurements of the maximum “static” contact resistances were made.

Tests Made and Results Obtained.

For each of seven constant current values between 0.25 amp. and 3 amp., the total brush-feed/bank contact resistances were obtained for 10 uniselectors, 50 brush-feeds and non-bridging wipers (five per uniselector), and for 500 available bank contacts. The same end of a wiper was always used. Between each set of tests at a particular current value the uniselectors remained idle for at least a day to ensure similar conditions prior to testing with each current value. In all, about 8,500 resistance measurements were made and statistically analysed, of which about 5,000 were confirmatory tests.

In general, it was not possible to repeat results, contact for contact, at a given value of current.

However, the mean resistance of 500 contacts, \bar{R} , and the statistical distribution of resistance about the mean value, represented by the standard deviation, S , could invariably be repeated. Fig. 2 shows

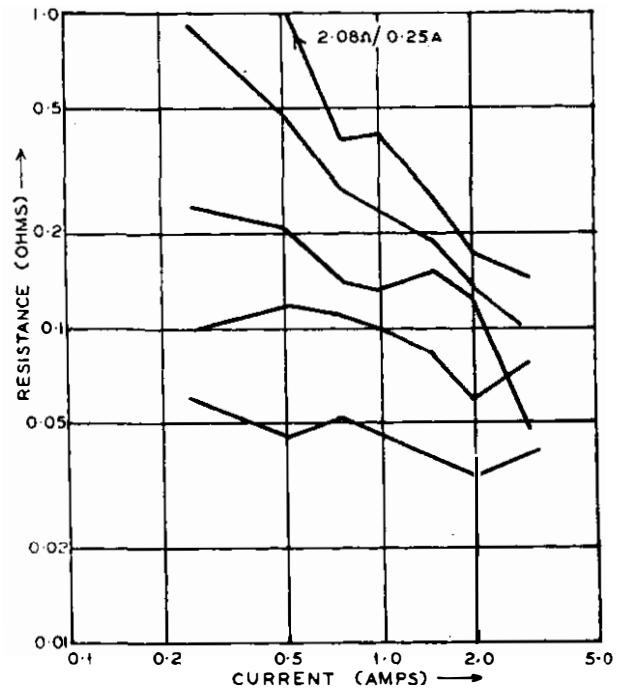

FIG. 2.—RESISTANCE/CURRENT CHARACTERISTICS FOR FIVE TYPICAL CONTACTS.

resistance/current characteristics, plotted on a log-log scale, for five typical individual contacts. It is seen that in some instances there is an apparent reduction in contact resistance for lower values of current whilst in others the contrary is the case. Certainly from a few measurements such as these there appears no semblance of “law and order.”

In Fig. 3, the distributions of resistance for the

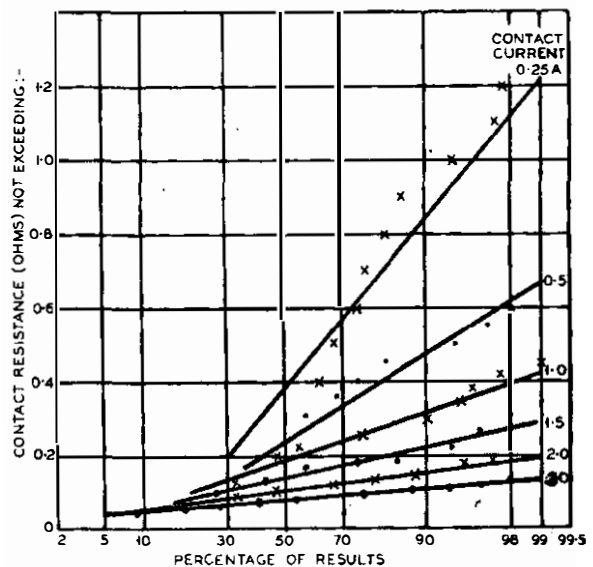

FIG. 3.—DISTRIBUTION OF RESISTANCE FOR VARIOUS CURRENT VALUES—500 CONTACTS.

500 contacts and for various values of current are plotted on an arithmetic probability scale. The distributions are reasonably stable and approximate to a normal error law at the highest current values and become less stable and less in accordance with a normal error law as the test current decreases. However, the best fitting "normal error" distributions were found for each set of results obtained from seven current values, by computing the parameters \bar{R} and S . The calculated distributions are represented by the straight lines in Fig. 3.

When the statistics S and \bar{R} are plotted against current, I , on a log-log scale as shown in Fig. 4 (graphs (1) and (2) respectively) the relationships approximate to the form: \bar{R} or $S = a.I^{-n}$, where a and n are constants for either \bar{R} or S . The values of a and n best fitting the experimental data were calculated, and the resulting empirical equations giving the mean resistance, \bar{R} ohms, and standard deviation, S ohms, in terms of the current, I amperes, are given in Fig. 4. Graph (3) in Fig. 4,

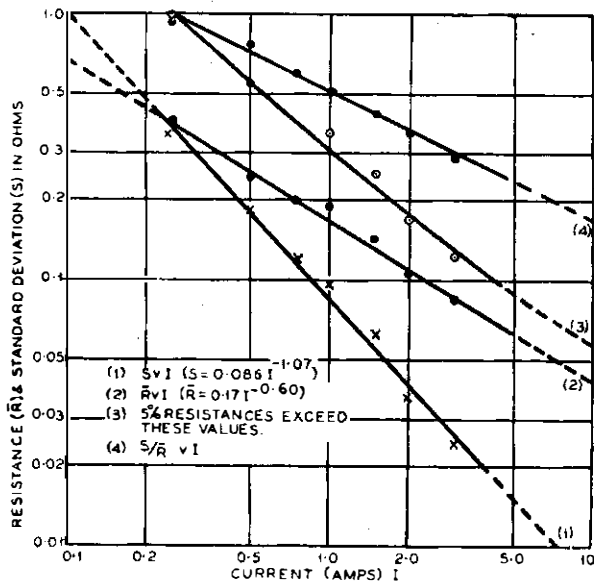

FIG. 4.—STATISTICS \bar{R} AND S PLOTTED AGAINST CURRENT.

gives the resistances exceeded by 5 per cent. of the contacts and was computed from:—"5 per cent. resistances exceed $\bar{R} + 1.65S$."

The relationship between the mean resistance and standard deviation is shown in Fig. 5 and, for the contacts tested follows the law shown therein.

Thus, not only the mean resistance, but also the deviation in values from the mean increase as the current is reduced. That is to say, more and more consistent and lower resistance values are obtained as the current is increased.

Graph (4) in Fig. 4 shows that the ratio of the standard deviation to the mean resistance also increases as the contact current is reduced. In other words, the deviations in the values of individual contact resistances from the mean value increase at a rate greater than that of the mean value as the current is reduced.

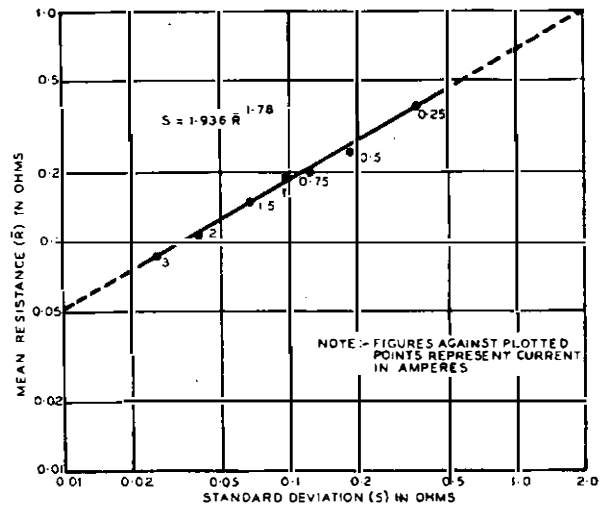

FIG. 5.—RELATIONSHIP BETWEEN MEAN RESISTANCE AND STANDARD DEVIATION AT VARIOUS CURRENT VALUES.

Comprehensive theoretical studies of contact resistance phenomena appear elsewhere,³ but a simple and probable explanation of the overall results from the present work is as follows. Contact resistance for given contact materials is a function of the contact pressure, the current flowing and the surface conditions, i.e. roughness and tarnish and other films. For low values of current, only the pressure and surface conditions are important and these may be expected to produce wide variations in contact resistance with comparatively low pressures and base metal contacts. Current reduces the resistance because the heating effect softens the materials at the point of contact, the pressure then causing plastic deformation to increase the area of contact. As the current is increased, so the plastic deformation and area of contact increase, and the resistance decreases. This effect becomes predominant at high current values and consequently the resistance then tends to be more constant from contact to contact for a given current. Thus, a contact which for other reasons would tend to have a high resistance is subject to greater heating and therefore more plastic deformation with resultant greater reduction in resistance than a contact more nearly average in its characteristics.

Tests showed that the results given were valid for either direction of current through the wipers.

P.D. Required to Break Down the Semi-Conducting Film.

Not all contacts pass a current for a small P.D. across them. At any one time a percentage of contacts behave as though they were separated by either a non-conducting, or semi-conducting film. A certain P.D. must exist across the contacts to ensure breakdown of this film and to cause them to behave as metallic contacts.

Of the 500 contacts (brush-to-collar and wiper-to-bank) of the uniselectors tested, about 10 per cent. of them failed to pass a current on the application of a small P.D. For these, the P.D. causing the current to rise to a value commensurate with that for the metallic

³ *Loc. cit.*

contact condition was measured. The distribution of results is shown in Fig. 6 plotted on a logarithmic

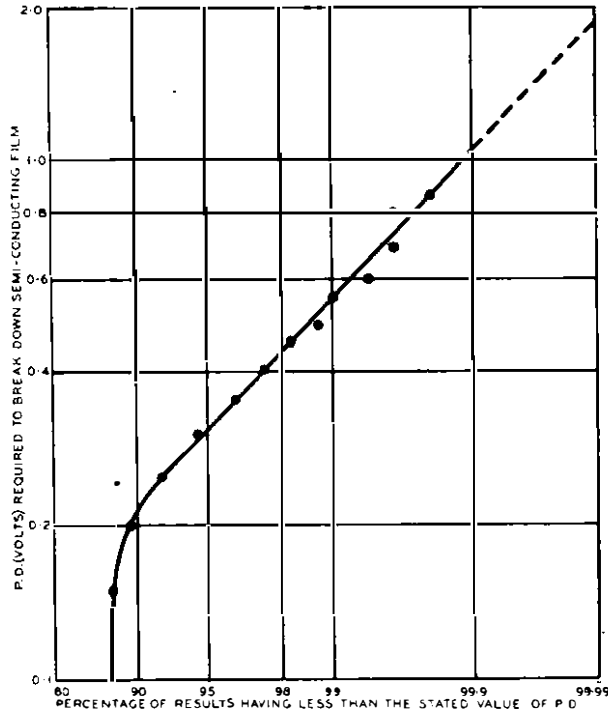

FIG. 6. DISTRIBUTION OF P.D. REQUIRED TO BREAK DOWN SEMI-CONDUCTING FILM.

probability scale. The results suggest that, for the contacts tested, contacts requiring more than 2 volts to promote the metallic contact condition would be very rare. Therefore, it is considered that the relationships given in Fig. 4 are applicable to all values of contact current provided that the E.M.F. applied to the circuit is, say, not less than 2 volts.

Application of Results to Low Current Values.

It will be appreciated that many thousands of measurements would have to be made in order to verify the validity of the given empirical relationships for low values of contact current. Nevertheless, it is thought that a reasonably good estimate of the order of contact resistance to be expected is obtainable from the given data. Table 2 summarises some of the measured results, and also the results for contact currents of 1, 5 and 25 mA estimated from the equations of Fig. 4.

It will be remarked that maximum values were in some instances twice as great as the maxima for 95 per cent. of the sampled contacts.

GENERAL EFFECTS UNDER DYNAMIC CONDITIONS

When a uniselector was arranged to step at the rate of 10 steps per second, the P.D. across the contacts resulting from a steady current passing through them, and hence the contact resistance, was subject to

rapid variations as shown in Fig. 7. Marked peaks of resistance occurred due to vibration, on operation, "●," and release, "R," of the driving magnet. Similar variations occurred when the uniselector was subject to external vibration. Such variations in resistance are no doubt a source of noise in switching systems using switches with base metal contacts. For

TABLE 2

Contact Current, <i>I</i> , Amperes	Mean Contact Resistance, <i>R</i> , ohms	Standard Deviation, <i>S</i> , ohms	5 per cent. Resistances Exceed — ohms	Minimum and Maximum Contact Resistances from Samples	
				Minimum — ohms	Maximum
3.0	0.088	0.027	0.132	0.031	0.193
1.0	0.170	0.086	0.312	0.040	0.460
0.25	0.390	0.375	1.020	0.052	2.080
0.025	1.560	4.440	8.80	See Note below	
0.005	4.10	25.0	45.0		
0.001	10.70	130.0	240.0		

NOTE. From measurements made on a small sample of 40 contacts selected at random, and for a current of 0.005 amp., contact resistances ranged from 0.12 to 50 ohms.

example, a subscriber may sometimes hear quite distinctly the sound of a selector in the process of stepping, as though, indeed, there was a microphone located in the apparatus-room. This is due to vibrations from the stepping of an adjacent selector causing sympathetic vibrations of the wipers of the selector through which the subscriber's connection is established, so producing corresponding variations in the wiper/bank-contact resistance, akin to those shown in Fig. 7. This phenomenon is commonly referred to as "microphonic noise."

For the purpose for which the investigation was originated, resistance measurements were made using circuit arrangements designed to cut off the peaks at "R" and "●" and, as before, without permitting the wipers to make or break the current. This was considered reasonable from a practical point of view because there was ample time available for operation of an electromagnet while the wipers were resting on a bank contact and while the contact resistance was comparatively steady between the peaks mentioned. Even so, the average contact resistance for a given current was higher than it was under static conditions although it was noted that the standard deviation was lower.

Effect on the Contacts when they Make and Break a Current.

Up to at least 500 revolutions of the wipers there was negligible change in the contact resistance when the

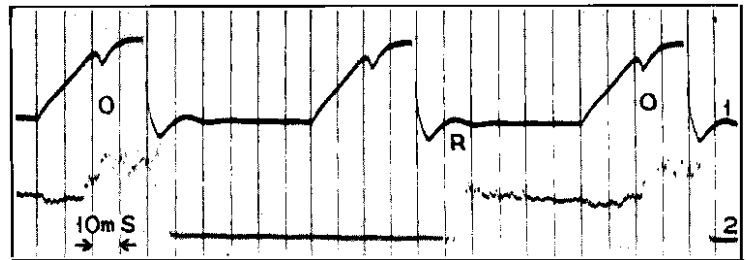

FIG. 7.—OSCILLOGRAM SHOWING DRIVING MAGNET CURRENT (1) AND BRUSH FEED—BANK CONTACT P.D. (2).

wipers neither made nor broke a current. However, at a later stage in the investigation when the wipers made and broke a 3 amps, non-inductive, non-quenched circuit for 250 revolutions, the average contact resistance, measured whilst the contacts were carrying a current of 3 amps. under static conditions, increased by 50 per cent. This resulted from changes in the contact surfaces arising from sparking and illustrates the advisability of using such a switch solely as a selective device with a relay contact to make and break the current.

Conclusions.

Widely differing resistance/current characteristics and inconsistent results are obtained from measurements on individual contacts. However, from tests on a large number of contacts, their mean resistance and their distribution about the mean can invariably

be repeated provided that the general conditions have remained unchanged.

Contact resistances of a high order are to be expected when carrying small currents even though the contacts are operated within the metallic contact condition, and in some circuits it may be necessary to make allowance for relatively high switch contact resistances.

Although the results which are given refer to a particular type of contact, it is probable that similar resistance/current laws apply to other contact materials and it was desired to obtain more comprehensive results before publication of the work. However, as this has not been possible the hope is expressed that sufficient data are given and interest aroused to encourage other investigators to study the subject of the quantitative determination of contact resistance by the use of the statistical method.

Special Administrative Conference for the North-East Atlantic (LORAN) January 17th-February 14th, 1949

THE Atlantic City Radio Conference (1947) made provision for the Long Range Aid to Navigation (Standard Loran), which was developed during the war and operates in the frequency band allocated to small ships' radio-telephone services, to continue operating so far as the North-East Atlantic area is concerned, until the 1st July, 1949; this was regarded as an exceptional measure in view of the very considerable interference caused to small ships' services. Since, however, it was not possible to say with certainty that alternative aids, generally acceptable, would be available by this date and since the safety of life was concerned, an escape clause was added, providing that, if no suitable aid was available by the 1st July, 1949, a Conference of the fifteen countries* concerned could, at the request of any three, be called to review the matter.

Following formal requests from Canada, the Netherlands, the United Kingdom of Great Britain and Northern Ireland, and the United States of America, the Conference assembled on Monday, 17th January, 1949. The Conference began by electing Mr. Monaghan, Ireland, to the chair, and after much argument two technical groups were set up, one with a United Kingdom chairman (Mr. Mumford) to study the interference aspect, and the other with a French chairman (M. Petry) to study the position regarding alternative systems.

The Plenary Assembly set a time limit to the work of the two groups and, as a result, the Draft Reports of the Groups, together with all outstanding amendments, had to be taken over by the Plenary Assembly. The substance of the report of the first group was broadly to the effect that considerable interference was being caused, although all practicable measures had been taken to reduce it; and that the provision

* Belgium, Canada, Denmark, Finland, France, Iceland, Ireland, the Netherlands, Norway, Poland, Portugal, Sweden, the United Kingdom of Great Britain and Northern Ireland, the United States of America, and the Union of Socialist Soviet Republics.

of the latest type of transmitter would improve the position still further. The second group said in effect that no suitable alternative aid could be expected to be available in less than three years.

It soon became clear in the meetings of the Plenary Assembly that certain countries were going to oppose completely any continuation of Loran and that others would only accept it with the qualification that it should operate on a time-sharing basis. After much argument it was apparent that no unanimous agreement could be reached and that the only possible way of resolving the question was by vote. The Chairman, therefore, first put the Scandinavian time-sharing proposal to the vote, with the following result: in favour, three (Denmark, Norway, Sweden); against, eight (Belgium, Canada, United States, France, Netherlands, Portugal, United Kingdom, Ireland). Iceland abstained, Finland was absent and Poland and the U.S.S.R. did not take part in the vote. The next resolution provided for the existing North-East Standard Loran Chain (Iceland-Faroes-Hebrides) to continue to operate temporarily in the band 1,900-2,000 kc/s, until a substitute, which has been agreed upon by the International Civil Aviation Organisation, is in operation in this area, on the understanding that all practicable measures should continue to be taken to minimise harmful interference from Loran transmissions to other services, and for the matter to be reconsidered at the next regular International Administrative Radio Conference, scheduled for Buenos Aires in 1952. The voting on this resolution was as follows: in favour, nine (Belgium, Canada, United States, France, Ireland, Iceland, Netherlands, Portugal, United Kingdom); against, two (Poland, U.S.S.R.). Abstentions, four (Denmark, Norway, Sweden, Finland). It was then agreed that the Final Acts should contain the resolution as adopted by the majority, and also declarations by those delegations which dissented in part or in whole from this resolution.

A.H.M.

A 200-Line Mobile Automatic Exchange

E. SIDDALL, B.Sc.(Eng.), A.M.I.E.E., and
A. A. PAGE

U.D.C. 621.395.34 : 621.395.722 : 629.113

A new mobile automatic exchange with capacity for a maximum of 200 subscribers has recently been developed, the equipment being housed in two trailer vehicles. This article describes the design, construction and installation of the prototype now in service at Alfriston, Sussex, and indicates the trend of further developments contemplated.

Introduction.

THE production of the first Mobile Automatic Exchange of the U.A.X. No. 13 type is an important sequel to the Mobile U.A.X. No. 12 which provided emergency exchange facilities in a single trailer vehicle for about 90 subscribers.¹ Since its inauguration 11 years ago, the M.A.X. No. 12 fleet has already grown to 20, more being still under construction. The original equipments were fully self-contained with special petrol engine sets, but several special trailers are now being made available for installation of U.A.X. No. 12 equipments (without prime mover) by Regional staff.

Because of continued administrative difficulties in acquiring sites and delay in erecting buildings since the war, the need for a larger type of transportable exchange became urgent in 1948 and, as a result, further study was made of the practicability of

¹ P.O.E.E.J., Vol. 32, p. 1.

developing a mobile version of the U.A.X.13, which is normally used for exchanges up to 200 lines.

Owing to restrictions on the permissible size of vehicle, i.e. 7 ft. 6 in. overall width and 22 ft. overall length, it had been realised in previous studies of the problem that two vehicles per exchange would almost certainly be necessary, and that this would raise considerable problems in the installation of the equipment. It was, however, decided that the mobile No. 13 type exchange must have the maximum capacity for subscribers, namely 200, though a limit of five junction equipment units would be necessitated by the vehicle size. This limitation was not considered to be a serious matter since the majority of existing exchanges of this type have five or less junction units. The standard clearances around the units were required to avoid maintenance difficulties, and it was decided that mobile exchanges of this size would not need to be provided with petrol engine sets.

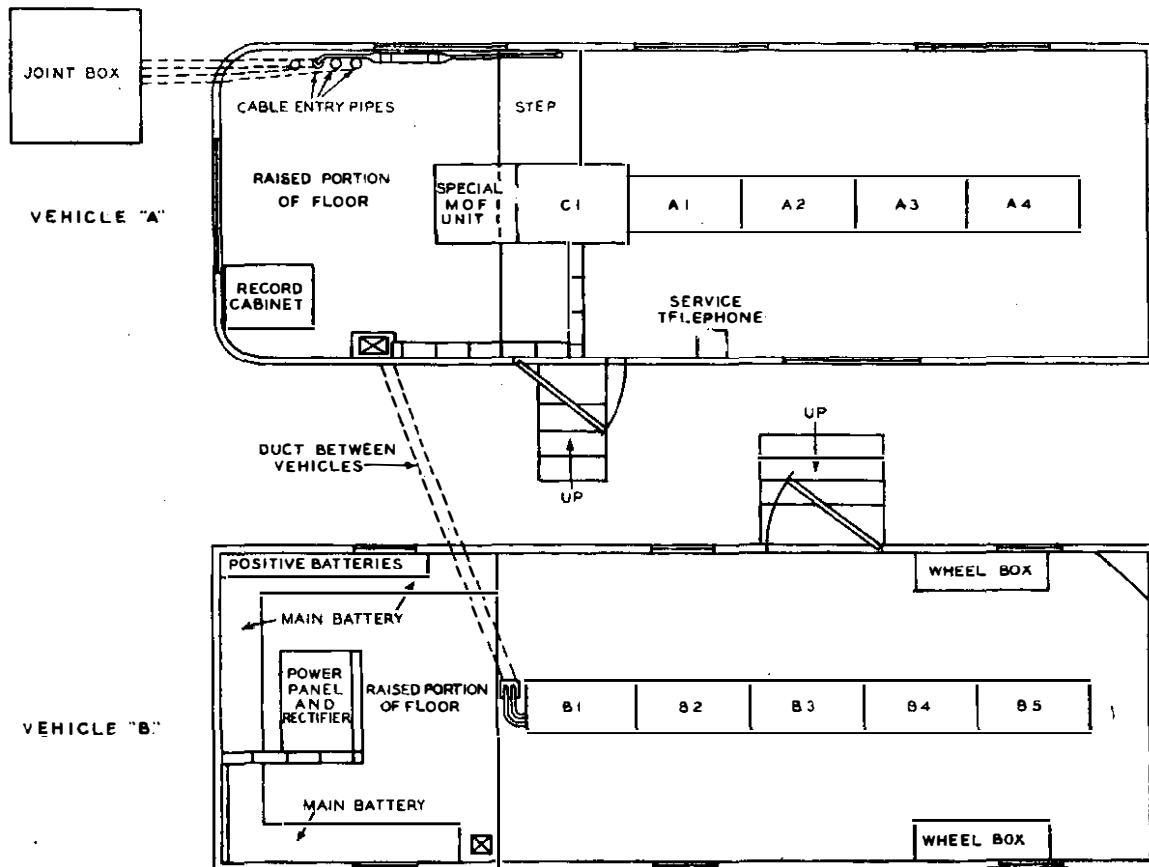

FIG. 1.—PLAN SHOWING LAYOUT OF EQUIPMENT IN VEHICLES.

Modification of Available Vehicles.

The first two vehicles that became available were ex-service vehicles of the articulated type. They were designed to be hauled by a four-wheeled mechanical "horse," the trailer and horse forming a 3-axle combination. When the horse is withdrawn from the trailer a pair of retractable wheels is automatically lowered to support the front end of the trailer. The rear axle of the trailer has brakes which are linked to the servo brake-operating mechanism of the horse when the two parts are joined, but can also be applied by a hand lever at the front of the trailer. Mechanical horses suitable for hauling these trailers are already extensively used by the Post Office.

The two trailers are designated vehicle A and vehicle B, and are shown in plan in Fig. 1.

Vehicle A, illustrated in Fig. 2, was originally

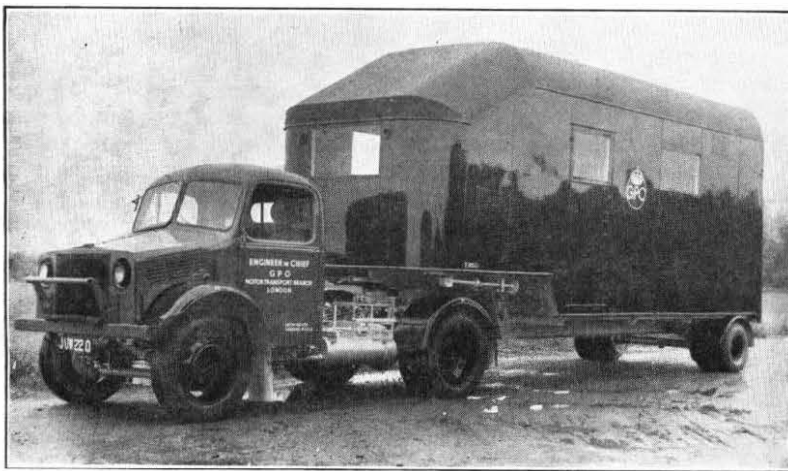

FIG. 2.—VEHICLE A.

designed for transporting cables. The existing body was partially rebuilt and a new roof provided. An inner skin was built on to the walls and roof and the space enclosed was filled with an insulating material. Three pipes for the entry of external cables were built into the floor at the front end, with a separate pipe for the exchange earth lead. A large panel of the wall above these inlet pipes was strengthened so that brackets to hold the cable joints could be attached.

For vehicle B, the chassis was strengthened and an entirely new body was built on to it, a double skin with intermediate insulation being used as in the case of the A vehicle. Wooden panels were fitted to carry miscellaneous equipment such as electricity meters, fuses and switches, and wooden lockers, to house the main and positive batteries, were constructed at the front end.

In both vehicles cable holes were provided in the floor for the inter-vehicle cables, and inlets in the form of short, inclined pipes were inserted in the front walls for overhead power supply connections. The floors are finished with $\frac{3}{16}$ in. sheet rubber and all the interior decoration is in light colours to assist the illumination. Adequate artificial lighting is

achieved by the use of bulkhead fittings, wired with lead-covered V.I.R. cable.

The doors of the vehicles are on opposite sides, and are arranged to suit the layout shown in Fig. 1, where the vehicles shelter each other to some extent. It is not essential to have the vehicles in this relative position, however.

Screw jacks have been built on to the chassis of each vehicle at the front end. These are to steady the vehicles in view of the shortness of the auxiliary axle. Steel wheel plates are provided to replace the rubber-tired wheels when the vehicles are parked on a site.

THE EXCHANGE EQUIPMENT

A Vehicle.

The A vehicle contains—

- 4 A type units, each containing equipment for 50 subscribers ;
- 1 C type unit containing common equipment and terminations for 320 cable pairs ;
- 1 special distribution frame unit containing terminations for a further 280 cable pairs and miscellaneous equipment.

The special unit is of reduced size so that it can stand on the raised part of the floor, and is necessary because of the large number of cable pairs which generally exist at exchanges of this size. It contains connection strips for the cables to the B vehicle and has room for 32 terminating units for amplified junction circuits. All connections to the special unit pass through the C unit and full inter-jumpering between the two units is possible.

The frameworks of the units are bolted together and to the floor of the vehicle, and are braced to the walls of the vehicle in the usual way. The service telephone is on a shelf at the rear of the doorway and a second instrument is provided in the B vehicle. A record cabinet is housed at the front of the vehicle.

The cables to the B vehicle are taken to connection strips in the distribution frame unit. This was done so as to reduce to a minimum the complexity of the work requiring to be carried out when the trailers are on site. When the exchange is in use, lead-covered cables are taken from these connection strips through the cable exit at the front of the C unit. They are carried on an open steel rack to the cable hole in the floor (Fig. 1), through flexible steel protecting tubes, into a length of 3 in. duct and so into the B vehicle. The power cables from the B vehicle to the C unit are taken across in the same way.

B Vehicle.

The B vehicle, an interior view of which is shown in Fig. 3, contains five B units for junction equipment and the power plant and batteries.

The cables from the other vehicle enter through the step in the floor and pass through the end of the

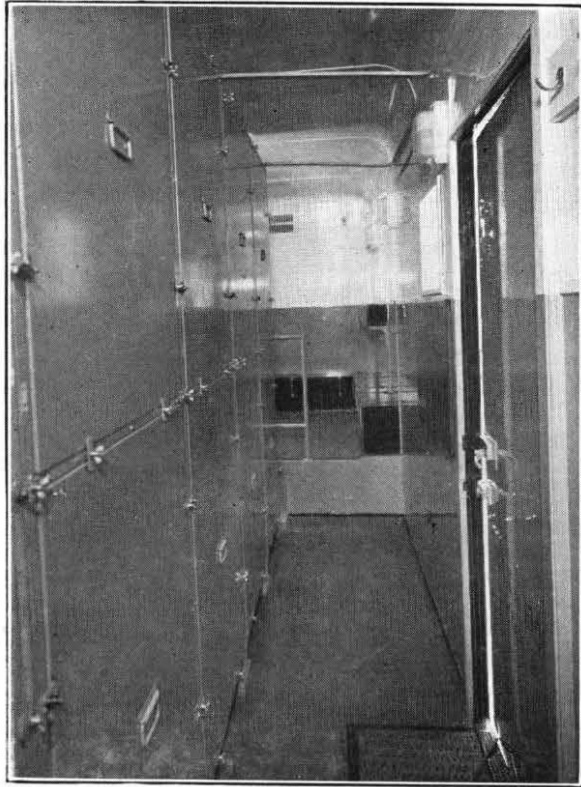

FIG. 3.—INTERIOR OF VEHICLE B.

first B unit where a special cable entry was made near the floor level. At the bottom of the unit, connection strips are provided from which enamelled switch-board cable carries the connections to the junction equipment. The holes into the normal cable runway in the first unit have been enlarged to cater for the unusual number of cables involved, since all the B units are connected through this unit. It is intended that junction equipments should be fitted only as required.

To reduce weight and bulk, a single 50-volt 150 ampere hour traction type battery is used. The battery together with the four lead-acid counter E.M.F. cells are housed in lockers around the front end of the B vehicle. The construction of the ebonite cased cells is such that each row required to be firmly wedged together endwise to prevent expansion with use. Each locker is ventilated to the outside so as to reduce the possibility of spray or gases entering the vehicle. The battery fuse, C.E.M.F. cell fuses and fuses protecting the cables to the C unit are mounted on a wall board adjacent to the negative battery terminal.

A charging panel (type 31) and rectifier (47B) of 3 amps. capacity are mounted on the raised part of the floor. This equipment automatically float charges the battery under the control of an ampere hour meter and switches the C.E.M.F. cells to maintain the exchange voltage between the limits 46-52 volts. No provision has been made for petrol engine charging or for connection to D.C. mains.

Because of the possibility that the exchange earth may not be of the usual standard, so that under fault conditions an appreciable voltage may exist between

the vehicle chassis and the ground, earth leakage protection has been adopted. The mains wiring is in lead-covered cable and wooden battens were provided at suitable positions to carry this.

CONSTRUCTION AND USE OF THE FIRST M.A.X.13

Means of giving temporary service was urgently needed at Alfriston, Sussex, where a C.B.S.2 exchange with 197 subscribers required replacement and no site had, at the time, been acquired.

The first mobile U.A.X. No. 13 type was therefore built as a matter of urgency by direct co-operation between Headquarters and the Brighton Telephone Area. After the work on the vehicles had been completed, the main suites of exchange units were placed in position and bolted up at the H.Q. Motor Transport Depot. At this stage the vehicles were towed to a convenient depot in the Brighton Telephone Area where installation of the batteries and cabling of the exchange was completed within four months of the availability of the vehicles.

The 20-mile journey of the completed M.A.X. from the depot to Alfriston was covered without incident except that the brakes appeared to become overheated on a steep and long downhill section, and the trailers were slightly scratched by overhanging tree on a minor road. There was no difficulty in starting from rest on a gradient of about 1 in 7 where the road surface was good. Manœuvring the vehicles into position on the restricted site called for considerable skill on the part of the drivers.

Each trailer weighs over five tons when equipped and, since only one axle of the combination is driven it was expected that the vehicles would have difficulty in crossing soft ground such as an ordinary field. It was intended to overcome this difficulty by laying pressed steel track of the type used by the Forces for this purpose, but the temporary site obtained at Alfriston was already surfaced with rubble so that no such precautions were necessary.

No damage or maladjustment to the exchange equipment could be attributed to the movement of the vehicles, which travelled at a maximum speed of 20 m.p.h. on reasonably good roads. As a precaution the ampere hour meter locking device was operated to prevent leakage of mercury.

The site was somewhat uneven and sloped slightly to the rear of the vehicle. There was, however, no difficulty in levelling the vehicles, though on a level site the retractable wheels would require blocking up a few inches. Stayblocks were used to give a good footing to the jacks and wheel plates.

External Cables.

A 3 in. duct was laid for a distance of about 30 yds. to carry the external cables from an existing route to a joint box just in front of the A vehicle. When this duct was laid a length of old lead-covered cable was buried with it to form the exchange earth electrode. The site did not permit the use of the normal system of driven rods. From the joint box the cables are led up into the A vehicle and are protected by three 2 in. internal diameter flexible steel tube originally intended as motor cycle exhaust pipe.

These are joined by hose connections to short lead-in pipes through the floor of the vehicle. The joints to the waxed terminating cables are immediately inside the vehicle so as to give the maximum length for cutting back and rejoining when the exchange is moved to other locations. The cables cross the floor under a removable step and enter the C unit in the normal way.

About a fortnight was required to connect up and test the exchange, day and night shifts being employed. Since all the subscribers' instruments had already been changed to automatic and work on the external cables was under way beforehand, this period was the limiting factor in opening the mobile exchange for service. Fig. 4 shows the M.A.X. in service a few weeks after the transfer.

Conclusion.

Work is now progressing at Headquarters on the production of further M.A.X.s 13, using four-wheeled trailers with entirely flat floors. These trailers will consist of entirely new bodies built on to existing chassis which have been somewhat strengthened.

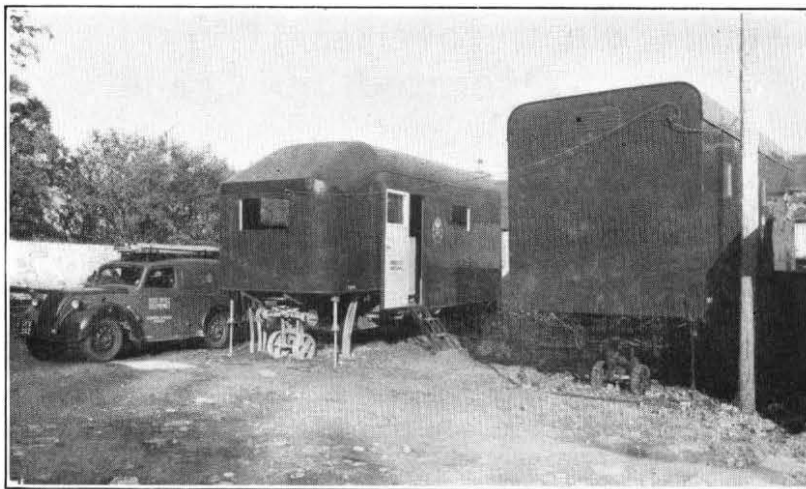

FIG. 4.—THE M.A.X. IN USE AT ALFRISTON, SUSSEX.

Many of the difficulties associated with the use of the articulated trailers will thus be avoided and it will be possible to provide a cable trough in the floor somewhat resembling a standard cable trench.

The special M.D.F. unit already mentioned will be replaced by a standard D unit, and many other minor improvements will be made as a result of the practical experience gained with the first model.

Book Reviews

"Components Handbook." Edited by J. F. Blackburn. McGraw-Hill Publishing Co. Ltd., London, 1949. 626 pp. 369 ill. 48s.

The handbook is the seventeenth volume of the Radiation Laboratory Series, from the Massachusetts Institute of Technology. It lives up to the high standards of clarity and presentation set by earlier volumes.

In his preface the editor apologises for the title sounding more inclusive than is warranted and admits, for instance, the serious omission of fixed capacitors; he has indeed foreseen the only serious criticism of the book.

A competent chapter on wires and cables opens the book; British readers must remember that American wire gauges differ from ours however. Fixed resistors are treated carefully—perhaps too carefully in markings and mechanical details—and their power rating, temperature coefficient, noise and H.F. properties all receive good attention. Later, other resistors receive equal treatment, although the carbon film resistor, so popular in Britain, is hardly mentioned. A chapter on iron-cored inductors presents many useful formulæ and aids to production, though communications transformers are not prominent. A short chapter on piezo-electric crystals precedes an excellent one on electromagnetic delay lines by the leading authority. The description given of supersonic (ultrasonic) delay lines includes many practical details and speaks volumes for M.I.T.'s superb techniques; and much the same can be said of a chapter on wire wound potentiometers, where the former, the wire, the winding the finishing, the moving contact and the performance get full attention. Many pages are devoted to rotary inductors, a tribute to their frequent use in radar. Fractional h.p. motors, engine-driven generators and their regulation, and inverters are well described. A lengthy chapter on relays is less well planned than most, but has merits. The final chapter on receiving tubes is little more than a catalogue (one of less interest to

British than to American readers); it will help no one to understand the thermionic valve.

The reader cannot help but be impressed by the American thoroughness in considering the desirable properties of a component, how to make it and how to test it. All manufacturers and users will find something to interest them; and the users should learn much to help them appreciate the limitations and new possibilities of the components used in light current and electronic engineering.

J. R. T.

"Basic Technical Electricity." H. Cotton, M.B.E., D.Sc., A.M.I.E.E. Cleaver-Hume Press, Ltd. 238 pp. 74 ill. 8s. 6d.

This is decidedly not a re-hash of previous textbooks on "Mag. and Elec." It is the first elementary textbook, to my knowledge, in which the author commences by giving an explanation of the nature of electricity based on the mechanism of the atom. The atomic theory is presented simply and clearly, followed by a lucid explanation of current flow and electrical resistance. By reason of this approach the beginner will not have to "unlearn" as he progresses in his studies, since he will have a sure grasp of the fundamentals. The electrochemical effects of a current as in primary cells and accumulators, and the heating and magnetic effects are described with many illustrations of their practical application. As one would expect from this author, Work, Power and Energy are so clearly defined with apt practical examples that no student is likely to confuse them.

The book is excellently illustrated, and throughout the text there are many numerical examples showing "all the working." The student can check the accuracy of his calculations of the test questions on each chapter because the answers are also given.

This book will be invaluable to all students taking City and Guilds Technical Electricity Grade I and can be read with enjoyment and benefit by more advanced students.

J. R.

Trunk Pole Recoveries Using a Power-Operated Jib Crane

P. NICOLSON

U.D.C. 621.315.66 : 621.873.3

By employing a power-operated crane with variable jib length, poles difficult to recover by more orthodox means have been successfully and economically dealt with. The author gives a brief account of the procedure adopted and results achieved.

Introduction.

RECENT representations by local road authorities in the Glasgow Telephone Area have necessitated considerable recoveries of old main line poles. In most cases they are situated in built-up areas in which there are tramway overhead trolley wires, and the removal of the poles by normal means presented many difficult problems and would have involved heavy expenditure in labour. The possibility of employing a powerful mechanical aid on this work was investigated and eventually a jib crane having sufficient power to extract the poles unaided and a jib length suitable for controlling the extracted poles, was hired from a local firm. Before tackling the heavy routes, experiments were made on a medium route in a rural area with very encouraging results.

The Crane.

The crane, which is of American manufacture, is normally used by the owners to undertake miscellaneous hoisting jobs, e.g. the installation and removal of safes or comparable heavy loads where tall buildings are involved. It is mounted on a six-wheeled chassis and is capable of rotation through a complete circle. Blocking lugs are provided for supporting the chassis with baulks of timber during lifting. The jib length can be varied from 25 to 55 ft. by bolting in additional 10 ft. sections, and the power unit is capable of lifting 15 tons. The operations involve hiring a heavy lorry with a four-wheel platform trailer to transport the recovered poles.

Pole Recovery Operations.

The recovery operations are as follows. The crane is manoeuvred into its most suitable position and a sling is attached at a point where the extracted pole will be butt heavy (Fig. 1). A rope is slipped loosely round the butt for control purposes as the pole leaves the ground. The crane then extracts the pole and the butt is pulled to one side by two or three men while the pole is lowered on to a piece of timber. Fig. 2 shows the suspended pole under control of the rope and the timber supports under the blocking lugs, while in Fig. 3 the pole has been lowered. The sling is now adjusted to the approximate point of balance and the pole, still controlled by the rope, is again lifted (horizontally), swung round and lowered on the trailer drawn up alongside. On narrow roads,



FIG. 1.—POSITIONING THE CRANE.

traffic has temporarily to be stopped while the lorry is alongside but the stoppage is of very short duration and no difficulties have occurred. This sequence of operations for a normal pole occupies from 10 to



FIG. 2.—LIFTING THE POLE.



FIG. 3.—READJUSTING THE SLING FOR LIFTING POLE ON TO TRAILER.

15 minutes and over the first two days the average time for all poles was 20 minutes per pole. Over the two days 50 poles were recovered, the sizes ranging from 36 ft. Stout to 55 ft. Extra Stout.

The 55 ft. Extra Stout pole was on the kerb line, 6 in. from a surface water drain. As a precaution, a start was made with pole jacks, but after a lift of only two inches the crane drew it smoothly out. Although the butt was down 8 ft. 6 in. and it was 21 in. in diameter, the drain was completely undisturbed. The A poles had braces at a depth of about 8 ft. After cutting off the poles and excavating about 4 ft. it was possible by attaching the sling to one of the stumps to pull out all that remained.

One failure must be recorded. One of the 50 ft. Stout poles stubbornly refused to yield to the most powerful persuasion from the crane. Two pole jacks with two men on each succeeded in starting the lift and when this was about 18 in. the crane (which had gone ahead to recover other poles) returned and after some struggle completed the extraction. The pole was 14 ft. 3 in. in the ground. This furnished a fine example of what can be achieved with pole jacks.

Normally a clean hole remains after the operation with only slight loosening of the surrounding paving. To

emphasise this point, Fig. 4 shows the worst disturbance encountered during the work; this was caused by the crane pulling against and eventually breaking, a length of stay wire attached to the butt of the pole.

In addition to the Contractors' men, ten of the Department's staff were required. Of these, four were employed in assisting the crane operators in jockeying poles, blocking the crane, etc. The remaining six men were engaged in filling the holes, with occasional breaks to accompany the lorry to the dump to unload the recovered poles.

Conclusion.

It is difficult to assess accurately the considerable savings achieved, because the presence of tramwires, buildings, Post Office wires, etc., caused each pole to present an individual problem. Only about three of the 50 poles recovered could have been

dropped normally; many would have had to be cut down in sections and in nearly all cases a temporary derrick pole would have been required and additional reinstatement costs incurred.

The use of this crane has avoided the diversion of staff from works of more immediate importance to the Department and there is still plenty of work ahead for which it will be suitable.



FIG. 4.—DISTURBANCE OF FOOTWAY—THE WORST CASE.

A New Television Repeater for Telephone Cable Circuits

T. KILVINGTON, B.Sc.(Eng.), A.M.I.E.E.

U.D.C. 621.397.64: 621.315.21

Telephone cable pairs intended only for the transmission of audio frequencies can be used to provide circuits for the transmission of television signals over short distances. The author gives details of a new video repeater and a method of line-up using a pulse technique, which enable such circuits to be provided with a frequency response which is sensibly flat up to about 3 Mc/s.

Introduction.

THE Post Office arrangements for the provision of television channels over cable circuits for outside broadcasts (O.B.s) during the early post-war period have already been described in an article in the Journal.¹ The present basis of the television O.B. cable network in London is still the balanced pair cable connecting Alexandra Palace² with Broadcasting House and then following a devious route around the West End of London. This special balanced pair cable has been supplemented from time to time by short spurs of the same cable and more recently by a number of new coaxial cables converging on Museum exchange, the Post Office focal point for television circuits in London. In addition, its coverage has on many occasions been extended temporarily by using audio frequency pairs in the ordinary telephone network to provide short links for television transmission between the actual scene of an O.B. and the nearest convenient point on the special cable network. It is with this latter form of transmission—on telephone pairs—that it is proposed to deal in some detail in the present article, for it is in this direction that a most interesting development has taken place during the last year or so.

The practicability of using ordinary telephone pairs for the transmission of television signals was demonstrated in this country in 1938³ when a number of broadcasts were carried out using this method of transmission and in America in 1939⁴. Since the war, such circuits have been provided by the Post Office on a large number of occasions with very satisfactory results, and the provision of circuits capable of carrying frequencies up to 3 Mc/s on cables intended for frequencies up to about 3 kc/s is no longer regarded with astonishment among those familiar with the technique.

General Description of Equipment.

The equipment used at a telephone pair video repeater point is shown in block schematic form in Fig. 1. It comprises a phantom filter coil through

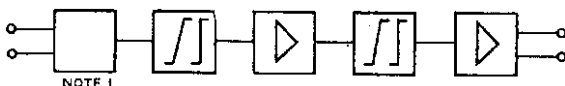

Note 1.—This Unit comprises phantom coil and balance-to-unbalance unit.

FIG. 1.—BLOCK SCHEMATIC OF VIDEO REPEATER.

¹ P.O.E.E.J., Vol. 40, p. 33.

² *Ibid.*, Vol. 30, p. 215.

³ *World Radio*, 28th April and 5th May, 1939.

⁴ *Bell Lab. Record*, Vol. XVII, p. 313.

which the incoming signal from the telephone pair passes and which helps to discriminate against longitudinal currents which may have been induced in the pair by sources of interference close to its route; this is followed by a valve circuit which takes the input from the balanced telephone pair, gives further discrimination against longitudinal currents and feeds the signal in unbalanced form into the first part of the equaliser; this in turn is followed by the first amplifier, the remainder of the equaliser and the output amplifier, the latter having a balanced output suitable for connection either to the special balanced pair cable or to a further section of telephone line.

The insertion loss/frequency characteristic of a typical telephone pair as used for vision transmission has the form shown by Curve 1 of Fig. 2, when

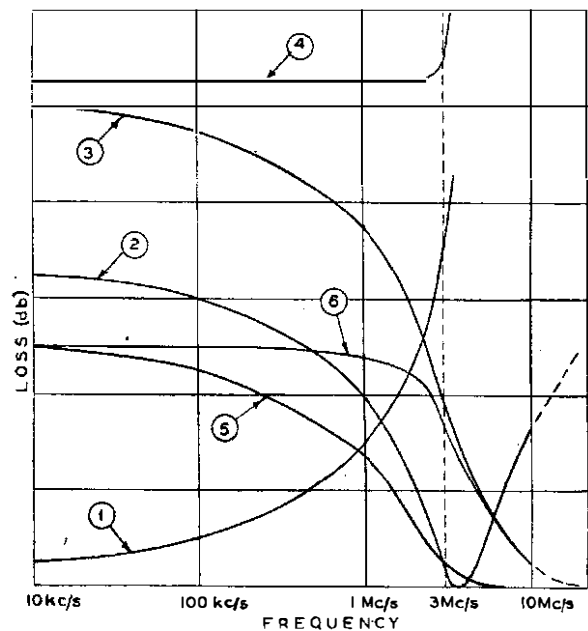

Note.—Loss scale omitted as curves represent a hypothetical case. Cable loss at 3 Mc/s may be as much as 70 db.

FIG. 2.—LOSS/FREQUENCY CHARACTERISTICS OF CABLE AND EQUALISER.

measured between sending and receiving impedances of the order of 100-150 ohms. This is fairly flat at a value of about 5-10 db. for frequencies up to 20 kc/s, but as the frequency is further increased the loss rises more and more rapidly to a value which may be as much as 70 db. at 3 Mc/s. The need then is for an equaliser which will have the inverse characteristic so that when it is connected in tandem with the cable the two together will have substantially constant

loss and propagation time over the required video band from 50 c/s to 3 Mc/s. This equaliser may be made up of a number of constant-impedance sections, either resonant or non-resonant, of the forms illustrated, with their associated frequency characteristics, in Fig. 3 (a) and (c). If combinations of resonant

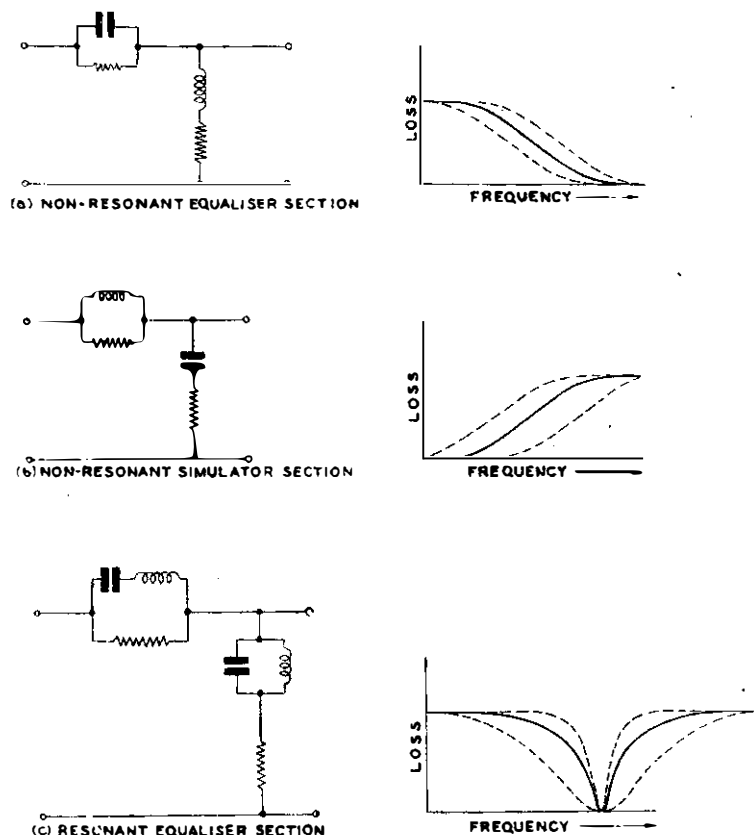

FIG. 3.—EQUALISER AND SIMULATOR SECTION CHARACTERISTICS.

sections are used it is possible to construct an equaliser operative over the range up to 3 Mc/s without introducing very much additional loss at the upper frequency limit as shown by Curve 2 of Fig. 2. On the other hand, if combinations of non-resonant equaliser sections are used it is not possible to achieve the desired characteristic sufficiently closely without introducing considerable additional loss at the upper frequency limit of the transmitted band, the equaliser characteristic being shown by Curve 3 of Fig. 2; this additional loss usually amounts to some 50 per cent. of the cable loss at the highest frequency. The phase characteristic of the non-resonant type of equaliser, however, shows a useful tendency to equalise the phase characteristic of the cable as well as the loss characteristic since the equaliser comprises series capacitance and shunt inductance as opposed to the series inductance and shunt capacitance of the cable. Non-resonant equalisers were therefore chosen in preference to resonant ones which produce phase distortions at the high-frequency end of the band where the transmitted frequency approaches the resonant frequency of the sections. The loss of cable and non-resonant equaliser is shown by Curve 4 of Fig. 2.

With non-resonant equalisers it is undesirable to introduce the equaliser into the circuit before the amplifier at a repeater station since the additional loss at the top frequency would further depress the level of the high frequency components of the signal which have already suffered severe attenuation in the cable, and would worsen the signal-to-noise ratio at the grid of the first valve by an amount equal to the added loss (assuming that the major noise component is that generated in the valve itself). On the other hand, if the signal is amplified before being passed through the equaliser, the low frequency components of the signal which have suffered very little attenuation in transmission over the cable, and which mainly determine the peak-to-peak amplitude of the signal, will certainly overload the amplifier unless this is designed to handle very high powers, which would be uneconomical. A compromise is reached, therefore, as indicated in Fig. 1 by splitting the equaliser into two parts, one of which is put in circuit before the first amplifier; this part has the characteristic shown by Curve 5 of Fig. 2, and although it reduces the level of the low frequencies so that they will not overload the amplifier, it does not worsen the signal-to-noise ratio by introducing additional loss at the high frequency end of the band. After passing through the first section of amplifier the high frequency level has been increased by the gain of the amplifier and the second part of the equaliser (Curve 6 of Fig. 2) which has appreciable loss at the top frequencies can then be introduced without worsening the overall signal-to-noise ratio.

Early Type Repeater.

There is no particular difficulty in designing a suitable equaliser for a given case, but when a flexible arrangement is required, enabling a wide variety of different circuits to be equalised, the problem is more difficult. Early attempts to solve this problem were made on the assumption that the insertion loss/frequency characteristic of all telephone pairs could be expressed in the form $\{a + b.g(f).l\}$ db. where a is a constant for a given cable circuit, b is a constant independent of the length of the cable l and the frequency; and $g(f)$ is a function of frequency which is zero at zero frequency and is, to a first approximation, independent of the length and the gauge of the conductor. This is the type of cable characteristic illustrated by Curve 1 in Fig. 2. The required equaliser should have a characteristic of the form $\{A - B.g'(f)\}$ db. in which A and B are adjustable constants, B being adjusted to have a value equal to $b.l.$, and $g'(f)$ being equal to $g(f)$ over the video frequency range to be transmitted. The total loss of the cable and equaliser in tandem will then be constant over the entire video frequency range and equal to $(A + a)$, and A can be adjusted to give the desired overall

equivalent of the cable plus equaliser plus amplifier.

The average form of the function $g(f)$ was found by analysing the results of a large number of insertion loss measurements on typical cable pairs, and was used as the basis for the design of the equalisers. The latter were designed and made for values of B equal to $B/11$, $2B/11$, $4B/11$ and $4B/11$, B being the maximum value of B for which an equaliser was required. Any value of B ($= b.l$) up to the maximum, B , could therefore be approximated to within one twenty-second part of B by choosing the appropriate equalisers out of the four available and connecting them in tandem. Since the value of $B.g(f)$ was taken as 66 db. at 2 Mc/s; this meant that the equaliser plus cable characteristic should be flat to within ± 3 db. up to 2 Mc/s. Each equaliser was divided into two parts, one for inclusion before the first amplifier and the other for insertion between the two amplifiers on the basis already explained.

A little practical experience of the use of these equalisers soon showed that they were far from ideal, firstly, because the minimum step of one eleventh of B did not give a sufficiently close tolerance on the overall characteristic; and secondly, because the form of $g(f)$ is not in fact sufficiently independent of the length and type of cable. It was therefore necessary to resort to other means to flatten out the best characteristic that could be obtained with the standard equaliser and for this purpose a number of "mopping-up" sections were used. These were constant-impedance, non-resonant equaliser and simulator sections of the form shown in Fig. 3 (a) and (b). The cable equaliser sections have a certain maximum loss at zero frequency and zero loss at high frequencies, the frequency at which the loss is half the maximum being known as the "half-loss frequency." The cable simulator sections have the opposite characteristic—zero loss at zero frequency and a maximum loss at high frequencies; their "half-loss frequency" is similarly defined. The inclusion of suitable numbers of such sections in the overall circuit enables any residual steps or bumps to be smoothed out. The process of lining up the overall circuit is, however, a very lengthy and laborious process involving a large number of frequency runs.

Latest Type Repeater.

It was the use of a "mopping-up" equaliser with a number of sections of different half-loss frequencies which could be put into circuit by means of keys that led to the suggestion that the whole of the equalising process might be carried out by such means if it were practicable to provide a sufficient number of sections with half-loss frequencies distributed throughout the transmitted band and switch them into circuit by means of keys. At the same time a novel and very con-

venient method of choosing the sections required in any particular case was suggested which will be explained later. Development work was carried out, the method was shown to be practicable and the equipment shown in Fig. 4 was produced. In block schematic form this is exactly similar to the previous equipment (see Fig. 1), but it contains a number of refinements and has the modified key-operated equalisers. The equipment is mounted in a number of carrying boxes 19 in. \times 10 in. \times 8 $\frac{1}{2}$ in., which can conveniently be stood upon one another, a carrying cradle being used for the stabilised H.T. supply unit. All interconnections between the units are by means of plugs and sockets and flexible leads carried in an additional box which also acts as a power distribution board having a number of mains sockets mounted upon it.

Provision is made for switching the phantom coil in or out of circuit as desired, since it inevitably introduces a little additional loss at the high frequency end of the band and it is better to exclude it from any circuit which is found to be sufficiently noise-free. The impedance terminating the incoming line can be switched to 100, 120, 150 or 186 ohms (balanced) at will; most telephone lines appear to have impedances of the order of 100 to 120 ohms over most of the video band. The 186 ohm termination is provided in case it is necessary to use the equipment with the special balanced pair cable which has this value of impedance. The output valve of the unit is a cathode follower capable of feeding into a 75 ohm load.

The first part of the equaliser comprises 48 constant impedance, non-resonant equaliser sections with losses at zero frequency ranging from 0.5 db. to 2 db.

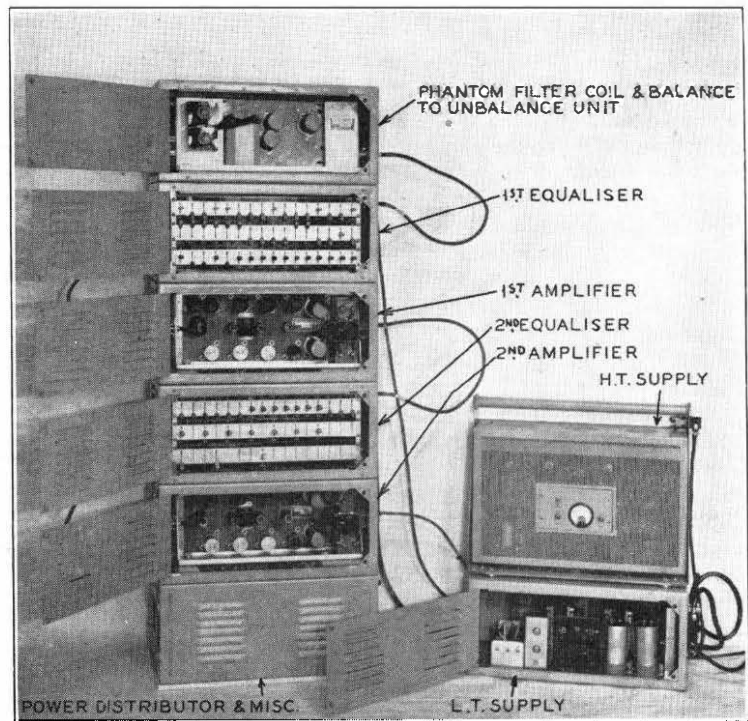

FIG. 4.—THE VIDEO REPEATER COMPLETE WITH POWER PACK.

and with half-loss frequencies ranging from 15 kc/s to 2.3 Mc/s. Each section is controlled by a three-position key, the circuit being shown in Fig. 5. With the key in the upper position the section is completely

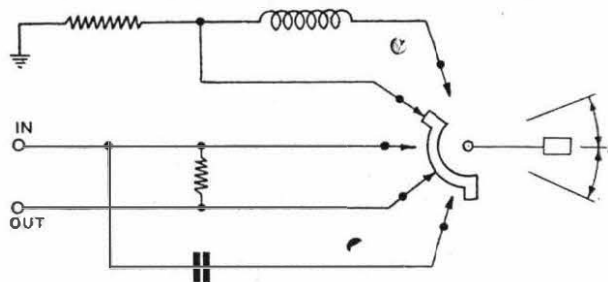

FIG. 5.—CIRCUIT OF EQUALISER SECTION.

out of circuit. In the central position the key introduces only the resistive components of the section which then has a constant loss at all frequencies, equal to the zero frequency loss of the equaliser section. In the lower position the key introduces the reactive components of the section which then assumes its equalising characteristic. The second equaliser box contains a further 16 similar sections with 3 db. zero frequency loss and half-loss frequencies ranging from 2.42 to 4.67 Mc/s. It also contains three low-pass filters and seven phase-modifying sections which can be put into circuit by means of keys. Since the loss of the equalisers goes on decreasing outside the desired band (see Curve 3 of Fig. 2) and the gain of the amplifiers is substantially constant up to frequencies well above the upper limit, the overall gain of the complete assembly of equipment goes on rising for frequencies above the band and where it is necessary to approach the maximum amount of equalisation instability may occur. In such instances, one or more of the low-pass filters can be included to reduce the gain of the equipment outside the band. In certain conditions, especially when these filters are in use, it may be difficult to achieve the desired overall characteristic without introducing overshoot (a feature which will be discussed later) and it may then be found beneficial to introduce one or more of the phase-modifying sections. All the equaliser sections, the filters, and phase sections, are designed to have a constant impedance of 75 ohms.

The two amplifiers are identical and both have a gain of about 50 db. which can be reduced smoothly to about 30 db. by introducing cathode feedback on one of the stages. Their input impedance is 75 ohms and their output impedance, which is balanced, can be switched to 100, 120, 150 or 186 ohms, according to the load into which they are required to feed. The first amplifier which feeds the second equaliser is switched to 150 ohms and the output into the 75 ohm equaliser is taken from one side of the balanced output only. The first three valves of each amplifier are supplied with D.C. on the heaters to avoid introducing hum and the amplifiers are resiliently mounted to avoid microphony.

Method of Setting Up.

The method of setting up the equipment, which in the present application is believed to be quite novel,

employs a pulse technique. The equipment is installed and connected up to the cable and pulses of about 20 microseconds length with a build-up time of the order of 0.1 microsecond and repetition rate 10 kc/s are fed into the cable at the sending end. After passing along the cable and through the equipment the pulse is examined on a high speed oscilloscope, i.e., one with time base speeds up to about 1.5 microseconds for the tube diameter and arrangements for viewing a particular part of the received pulse. Fig. 6 shows a series of photographs of the oscilloscope screen at various stages of the lining-up process. In this case it is the trailing edge of the pulse which is displayed though the leading edge would be equally satisfactory.

A start is made with all the equaliser keys in the central (constant-attenuation) position and the amplifiers at full gain. In this condition the pulse over 2,000 yds. of telephone cable (1,000 yds. 10 lb. + 1,000 yds. 20 lb.) has the appearance

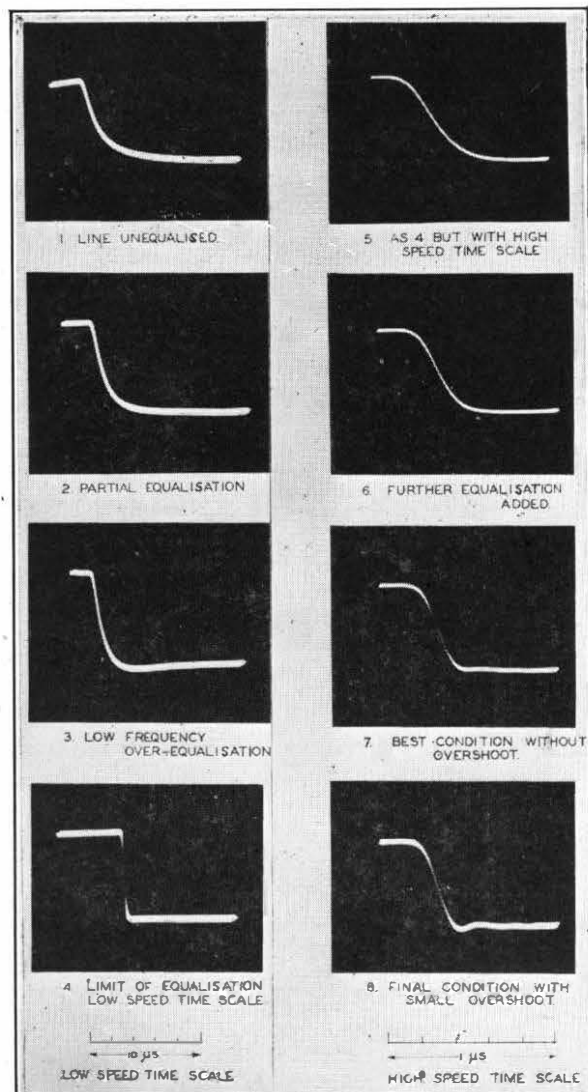

FIG. 6.—STAGES IN THE EQUALISATION OF A LINE BY PULSE TECHNIQUE.

shown at 1 in Fig. 6. The trailing edge, which ideally would be a straight vertical line, descends slowly and only reaches its final value after about 10 microseconds (see scale at bottom), i.e. the build-up is slow. Starting with the lowest half-loss frequency section, the keys are now moved over to the lower (equaliser) position one by one and the effect of introducing any particular section is examined. Since the throwing of a key does not change the level of the low-frequency components of the signal, the overall amplitude of the picture does not change during the process but as equaliser sections are introduced the build-up of the trailing edge of the pulse is gradually improved as shown at 2 on Fig. 6. If at any stage excessive equalisation is introduced, overshoot as illustrated at 3 on Fig. 6 is introduced. The criteria, therefore, in choosing the equaliser sections for a particular cable circuit are: if a section improves the build-up without introducing overshoot, allow it to remain in circuit; if it introduces overshoot reject it. In this way, working through the available sections in ascending order of half-loss frequency, a stage is reached as at 4 of Fig. 6 where no further improvement can be noted on the low speed time scale. The scale is therefore increased to that of the pictures on the right of Fig. 6, 5 showing the same condition as 4 but with the faster time base. The process is continued until as shown at 7 the best condition obtain-

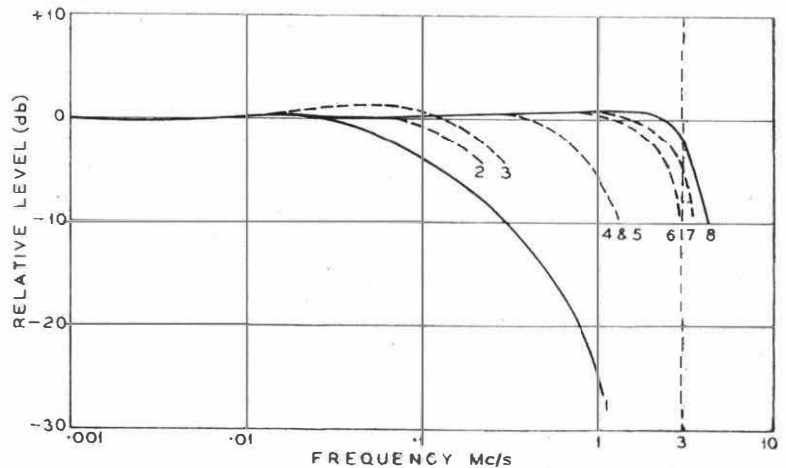

FIG. 7.—FREQUENCY RESPONSE CURVES CORRESPONDING TO PULSE RESPONSES SHOWN IN FIG. 6.

runs were taken at each of the stages illustrated and are reproduced in Fig. 7. The flat part of the characteristic is seen to extend to higher and higher frequencies as the process is carried through. For condition 3, which shows overshoot on the pulse response, the frequency characteristic shows a bump above the general low-frequency level.

When the equalising process has been completed, any sections which are left in circuit in the attenuator position, i.e. those which have been discarded during the line-up, are switched out of circuit and the gain of the appropriate amplifier is reduced accordingly. This improves the overall signal-to-noise ratio by increasing the signal level at the input to each amplifier.

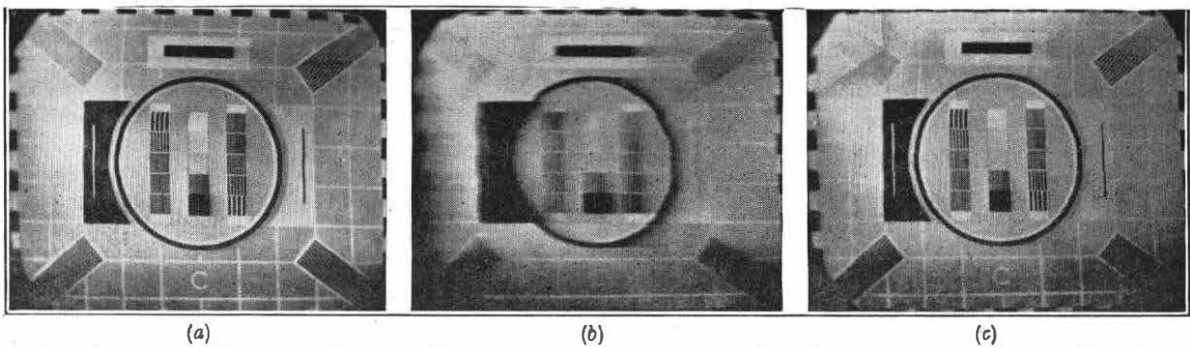

FIG. 8.—(a) TEST PATTERN, (b) AFTER TRANSMISSION OVER 2,000 YDS. (1,000 YDS. 10 LB. + 2,000 YDS. 20 LB.) UNEQUALISED, (c) AS FOR (b) BUT CIRCUIT EQUALISED.

able without overshoot is reached, after which one or two high frequency sections may be introduced to give the condition shown at 8 on Fig. 6. The last condition shows some overshoot; this can be tolerated provided that it is not too large in amplitude and does not last for more than a small fraction of a microsecond. The advantage of introducing this slight overshoot in the final stage is that the steepness of the edge is made slightly greater.

No frequency runs need be taken during the course of the line-up process which can normally be completed in a matter of about half an hour, a considerable saving of time over former methods. For the example illustrated in Fig. 6, however, frequency

Fig. 8 shows a test pattern and the results of transmission over a typical circuit before and after equalisation. The equipment as designed is capable of equalising and amplifying the signal received over about $\frac{3}{4}$ mile of 6½-lb. conductor, 1½ miles of 10-lb. conductor, or two miles of 20-lb. conductor or intermediate lengths of mixed cable circuits.

Acknowledgments.

The author's thanks are due to Mr. W. E. Thomson, who conceived the idea, and to the staff of the London Telecommunications Region, who have used the equipment in the field. He would also like to pay tribute to the excellent work of the late Mr. B. R. Martin, who engineered the equipment.

Laying of Armoured Coaxial Cable on Anglo-Belgian Route

W. A. COLLETT

U.D.C. 621.315.285

In the laying of a section of armoured coaxial cable for the latest Anglo-Belgian link, difficulties were experienced due to the steep gradients on the selected route and the need for rapid completion of the work. In this article the author details the operations involved, including those relating to the landing and termination of the shore end of the new submarine cable.

Introduction.

A FURTHER link with the Continent has recently been provided by means of a coaxial type cable, similar in all respects to the Aldeburgh-Domburg No. 6 cable.¹ The laying of the land portion of the new cable between St. Margaret's Bay repeater station and the cable hut on the beach presented some unusual difficulties, and an account of the methods by which these were overcome and of the laying of the shore end may be of interest.

The route chosen, although the best available, was very difficult, since, in the total length of about 680 yds. there is an overall fall from end to end of approximately 250 ft. Roughly half this fall is on the first 230 yds., which is over a public footpath only 7 ft. wide between high, close fencing; over a portion of this footpath the gradient is about 1 in 2. The second portion of the route, of approximately 450 yds., is over the only road leading to the beach. As St. Margaret's Bay is a high-class residential area and a beauty spot attracting many visitors during the summer season, and the laying of an armoured cable necessitates the whole length of the trench being open at one time, it was, of course, important to limit the period of disturbance to the absolute minimum.

Another material factor in the advisability of the quickest opening and closing of the trench was the nature of the subsoil. This is a medium chalk throughout the whole length, which with even moderate rainfall is difficult to work in, and in the event of heavy rains on such steep gradients would be extremely so, if not almost impracticable. Furthermore, the cable was to be laid with 3 ft. cover, and the very considerable amount of soil placed on the narrow tarmac road—without verges—if allowed to become wet, would have made foot traffic dangerous and motor traffic practically impossible.

Cable-laying Operations.

To achieve a very quick opening and closing of the trench, a detailed plan of operations was drafted well in advance. The preliminary work involved the clearing of undergrowth in the repeater station grounds and on the public footpath; all piloting and the preparation of timber for the cable drum mounting; the preparation and erection of spoil-bays, etc., for which otherwise scrap poles were carted to and from a local timber yard for cutting up; the overhauling of all digging tools and their sharpening and resetting as necessary, and the supply of rollers. This preliminary work involved one 4-man gang for a fortnight. The spoil-bays (Fig. 1) were erected in the public footpath to hold back the spoil as it was dug out; otherwise on this steep gradient every shovelful taken

out would have rolled to the bottom. The spoil-bays consisted of 6 in. × 1 in. boards made up into 3 ft. squares placed vertically at the side of the trench against the close fencing at 8 ft. intervals and strutted by 8-way arms.

On completion of the preliminary work, trenching was commenced in the section from the repeater station to the lower end of the public footpath. Forty men were employed and the whole length of 230 yds.—including one road-crossing—was trenched 3 ft. 6 in. deep by 18 in. wide in a day and a half.

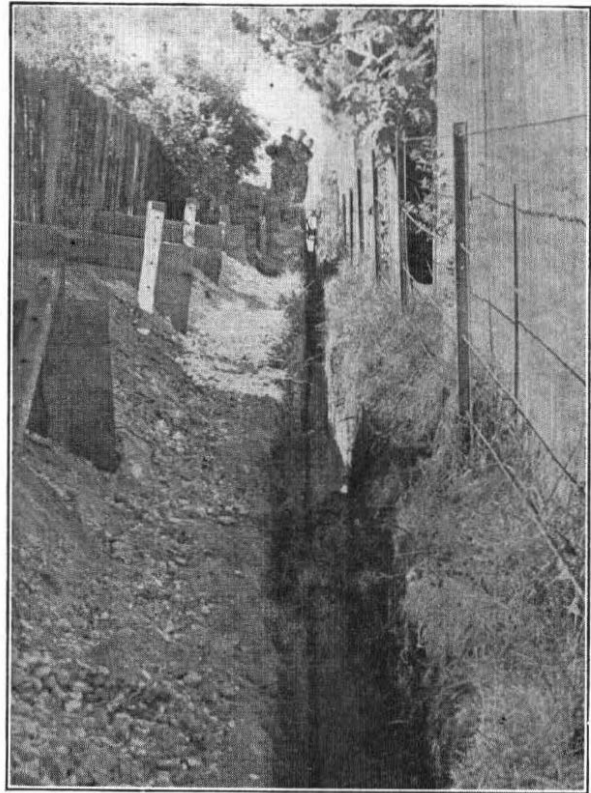

FIG. 1.—SPOIL-BAYS IN STEEPER PART OF PUBLIC FOOTPATH.

Fortunately, the cable arrived on site upon the completion of trenching and it was decided to lay it forthwith. The cable drum (Fig. 2) was erected in the roadway outside the repeater station grounds, and as this drum was 9 ft. in diameter, and weighed 4½ tons, some care was needed in jacking-up. The jacks were raised on a temporary platform in order to get the necessary lift; the whole was side-strutted with lengths of 4 in. × 4 in. timber to prevent side movement and back-stayed to prevent any possibility of the drum getting out of control and taking-off down the steep gradient. It was necessary to pay-off

¹ P.O.E.E.J., Vol. 41, p. 1.

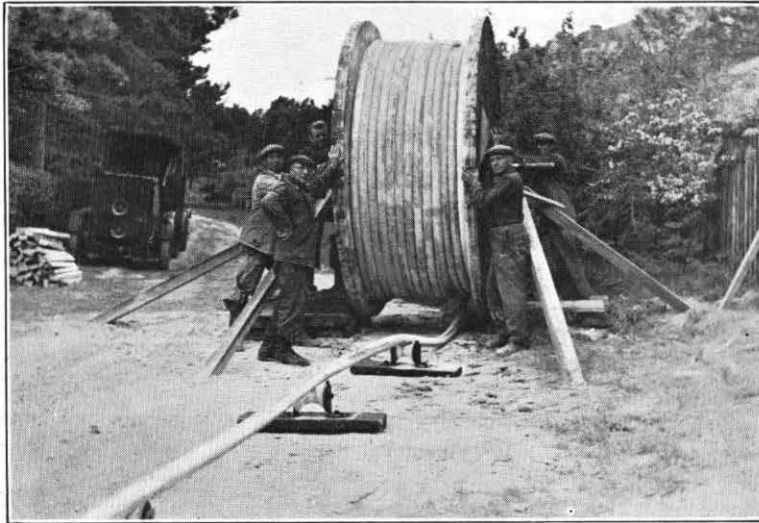

FIG. 2.—CABLE DRUM ERECTED.

the cable in this position in order to negotiate two obstructions in the roadway; the cable was fed over one obstruction, drawn out to the foot of the pathway, and then the remainder was man-handled off the drum under the second obstruction, and again man-handled into the repeater station and up a vertical chase into the apparatus room on the first floor.

The long length down the footpath was drawn over rollers placed in the bottom of the trench. These rollers were not placed at regular intervals, but two gaps were left at suitable points where the cable was allowed to drag on the chalk bottom of the trench to act as a brake. By suitable adjustment of the length of these gaps, the cable was drawn along with the minimum manpower yet with safety against the possibility of it running away after the bulk of it was off the drum and running freely down the steeper part of the gradient. The roadway was stopped to traffic for only a few minutes while the cable was fed under the obstructions, and was re-opened by fitting boiler plates over the trench during the major operations. This length of 230 yds. was laid, anchored in the repeater station and the road-crossing filled in and temporarily reinstated in just under three hours. The whole length of the trench was filled in on the next day, the complete operation having taken only three days' normal working time.

Trenching over the second length of 450 yds.—the same depth and width—was commenced on the next day and completed in two days. Again rollers were used for drawing in the cable. Over the first half of the length—a straight run with a gentle gradient—the rollers were placed across the top of the open trench but, having about midway to negotiate a road-crossing, the rollers were taken to the bottom of the trench to permit the road being maintained open to traffic by means of boiler plates over the top. As the trench from this point to the cable hut snaked rather badly along the winding road, the rollers were kept in the bottom of the trench. To prevent the cable pulling against the side of the trench on the bends, a combination of vertical and horizontal rollers were used in pairs (Fig. 3), the vertical roller being braced

against the inside of the bend and the horizontal roller so placed as to keep the cable up into it. At one point where it was necessary to dip down in a valley to pass under an obstruction bedded in rough concrete, horizontal rollers were fixed upside-down to keep the cable from pulling up against the rough surface, so preventing damage to the protective covering.

The proper positioning of the rollers contributed largely to the ease with which the cable was subsequently drawn in. The fixing of the rollers, the mounting of the cable drum in a similar manner to the first—but the second drum weighed $6\frac{1}{2}$ tons—and another operation, that of having to cut out many lengths of old and abandoned armoured cable which were obstructing the trench, occupied another half a day. After this preparatory work, the actual drawing in of the cable was simple; the whole length of 450 yds. was drawn in with one pull at a steady rate by a winch stationed outside the cable hut, manpower being required only to fleet the last few yards round the final bend. The whole work on this length was entirely completed on the fourth day, which was occupied by filling-in and temporary reinstatement.

One point of interest about the rollers should perhaps be mentioned and that is that the usual Post Office type, having the spindle parallel with the length

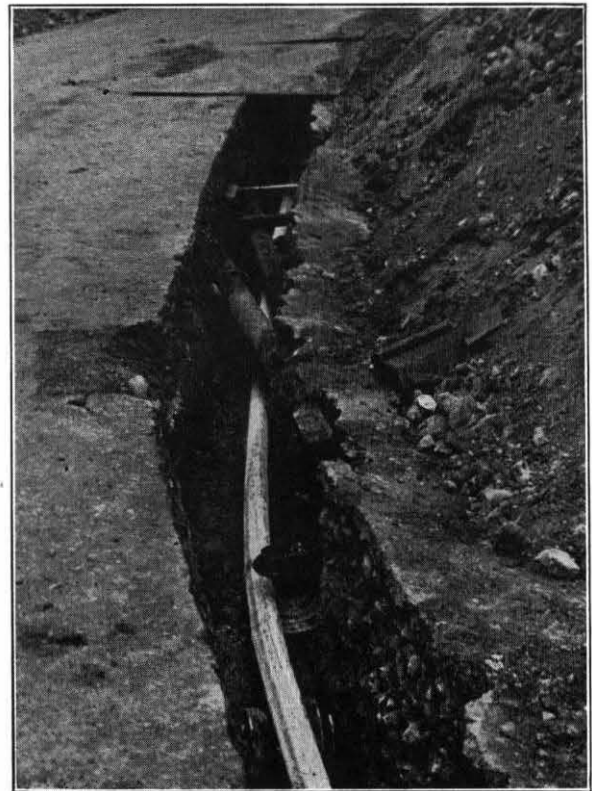

FIG. 3.—VERTICAL AND HORIZONTAL ROLLERS IN COMBINATION.



FIG. 4.—APPARATUS FOR MOULDING THE POLYTHENE COVER.

of the wood base, can be used only across the top of the trench, and thus have a limited application. There was in this instance a need for rollers having the spindle across the wood base enabling them to be used in the bottom of the trench, and 150 were kindly lent by the local Electricity Authority.

Jointing.

The joint between the two lengths, which required special apparatus (Fig. 4) for moulding the polythene cover, was made by a jointer and mate from the cable manufacturers. After stripping and laying back the armouring, the lead sheathing, and the outer concentric, the polythene was pared away, exposing the inner concentric and central conductors. The two ends of the cable were then brought together and the central conductors jointed in a straight marriage joint. The inner concentric was joined through by five short lengths of copper wire in the form of a bird-cage. The partly-made joint was then clamped into a hollow water-jacketed mould and hot polythene injected under pressure, the whole being subsequently cooled-off gradually by cold water circulating through the hollow mould. When cold, the joint so far made was removed from the mould and the outer concentric joined through. The lead sheathing was then lapped in position and tacked down, no attempt being made to plumb this in the normal way as the lead sheathing is required only for anti-interference purposes. The joint was then completed in the normal manner by splicing the steel armouring and making good the tarred jute yarn.

The Shore End.

Preliminary arrangements for the landing of the cable were made on site with Captain Wallis of H.M.T.S. *Alert* on the 14th August, and the actual landing carried out on the 18th August. The *Dominence*, acting as tender to the *Alert*, arrived in the bay just before high tide, carrying a length of two nauts of cable. At this state of the tide she was able to come well inshore (Fig. 5), and thus

only a short pull was necessary. Immediately on arrival a towing line was sent ashore and the cable, floated on barrels, was pulled inshore by a winch stationed near to the cable hut. A sufficient length of cable having been pulled in and up over the sea wall it was made fast and the *Dominence* was able to move away before the turn of the tide. She steamed seaward laying the remainder of the cable, buoys the distant end for the subsequent operation of jointing to the main length of sea cable.

Later the cable was manhandled back on to the beach, the end pushed up the duct through the seawall, led into the cable hut, and made ready for jointing. For this operation, which could not, except in its final stages, be assisted by any mechanical aids,

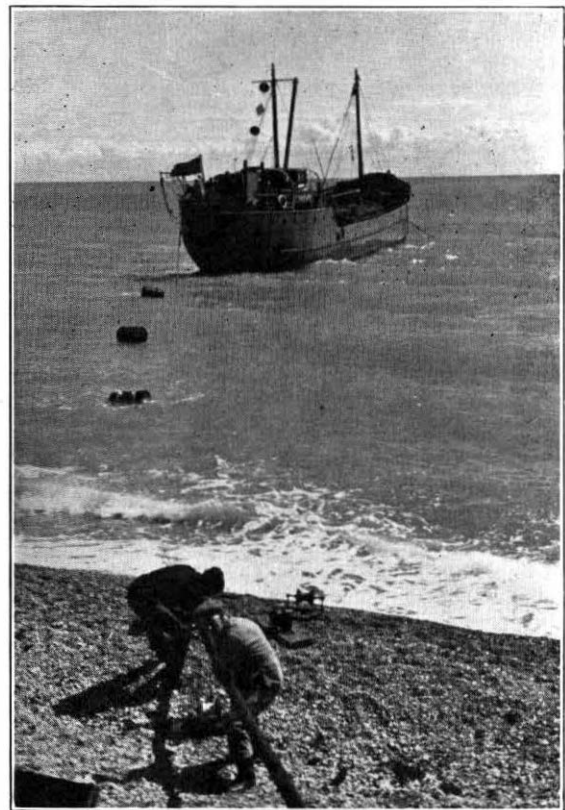

FIG. 5.—PULLING IN THE SHORE END.

the co-operation of the Military Authorities at Dover was sought, and they generously loaned 20 soldiers to assist. The joint to the land cable was made on the next day in a similar manner to that described previously. At the joint between the shore and land cables, as well as at that in the land cable, a 9-ft. diameter loop was laid on both ends to provide spare cable in the event of the necessity for remaking the joint at any time in the future.

The Receiving System at Cooling Radio Station

C. F. BOOTH, O.B.E., M.I.E.E.

U.D.C. 621.396.65.029.58 : 621.396.75

The factors limiting the performance of long-distance radio telephone links operating in the frequency range 3 to 30 Mc/s are briefly outlined and the design of a receiving system using a highly directive antenna is described. Possible future developments of directive receiving systems are considered.

Introduction.

SINCE the introduction into the international trunk network of long-distance radio-telephone links operating in the high-frequency band, 3 to 30 Mc/s, such as those between this country and the United States of America, much attention has been directed towards better performance and, as a result, the quality and reliability of the circuits have been steadily improved. Nevertheless, it must be emphasised that radio transmission over long distances is only possible because of the reflection of electromagnetic waves from the ionised layers which comprise the ionosphere and from the earth's surface. On occasion, the effectiveness of the layers as reflectors may markedly fall and the absorption of the waves in the ionosphere may increase considerably above the normal value. These conditions are beyond control, and, when they do arise, the circuits concerned may fail until more normal conditions arise. The improvement has been achieved in two main ways, viz. increase of signal-to-noise ratio of the received signal and reduction in the distortion arising under certain propagation conditions. Increased signal-to-noise ratio has resulted from several developments, including the use of larger transmitter powers, more exact knowledge of the optimum frequencies for a link, greater receiver sensitivity and selectivity, the introduction of single-sideband operation and the development of transmitting and receiving aerials of high directivity. Perhaps the major contribution to distortion reduction has been the introduction of single-sideband operation¹.

There is of course a limit to increase of transmitter power and it is often more convenient to obtain an equivalent gain by corresponding improvement of transmitter or receiver antenna directivity. As an example, consider a system in which the transmitter radiates 10 kW, and in which omnidirectional antennæ are used at both the receiver and transmitter. If the two omnidirectional antennæ are replaced by directive aerials giving a 10 db. gain in the required directions over that of the omnidirectional antennæ, then the signal-to-noise improvement at the receiver will be 20 db. To achieve a similar improvement by increase of transmitter power would mean an increase from a 10 kW unit to 1,000 kW. It is apparent, therefore, that improvement in aerial directivity is extremely useful and it is the purpose of this article to describe a system in which the directivity of the receiving antenna has been sharpened to the practical limit. However, before doing so, it is desirable to consider in some detail the mechanism of radio transmission over long distance.

¹ W. J. Bray and W. R. H. Lo ry : "A New Short-Wave Transatlantic Radio Receiver." *P.O.E.E.J.*, Vol.32, p. 24.

As already mentioned, such transmissions are made possible by the reflection of waves between the ionosphere and the earth (Fig. 1). The diagram is idealised in as much as it represents an ionised region as a perfectly reflecting surface, whereas there may be several such layers whose ionisation densities, thicknesses and effective heights are varying continuously. The variations of the ionosphere broadly follow daily and seasonal cycles superimposed on an eleven-year cycle which follows the sunspot cycle. However, the diagram does illustrate a condition often experienced when the resultant field at the receiver is the sum of those due to several waves which have travelled by different paths—in the example given, by one-, two- and three-hop paths. This is known as multi-path transmission, and, because of the different distances travelled, the three sets of waves at the receiving antenna will mutually interfere. Since the effective heights and ionic densities of the layers are usually varying, the resultant field at the receiver will rise and

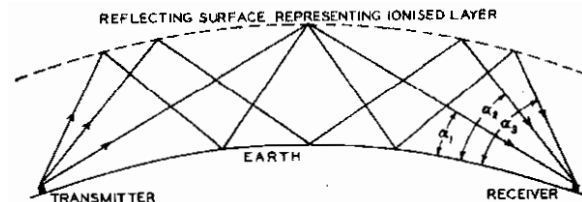

FIG. 1.—MULTIPLE-PATH TRANSMISSION.

fall (fade) as the constituent waves go in and out of phase.

For an unmodulated carrier wave of frequency 10,000 kc/s under a two-path condition with an unvarying reflecting layer, the resultant at the receiving antenna will be a signal of magnitude determined by the difference in path length. If this difference is equivalent to an even number of half wavelengths ($\lambda/2 = 15$ metres), the two signals will be in phase, giving a strong signal, while a path difference of an odd number of half wavelengths will give two out-of-phase waves and a weak resultant signal. With a changing reflecting layer, the signal will fade, the period being determined by the rate of change of path-length difference, and the amplitude of the resultant signal by the relative amplitudes of the two components. Thus the signal will suffer only amplitude variations, and, subject to adequate signal-to-noise ratio at the trough of the fade, the variations can be smoothed by automatic gain control of the receiver.

If the 10,000 kc/s carrier is modulated with a 1 kc/s tone, the resultant can be considered as comprising three signals of frequencies 9,999, 10,000 and 10,001 kc/s, corresponding to wavelengths of 30.003, 30.000

and 29.997 metres respectively. For the two-path condition the three components will not fade simultaneously and the fading will be frequency-selective in character. Thus as the path-length difference changes through $n/2 \times 29.997$, 30.000 and 30.003 metres, where n is an odd number, first the upper sideband, then the carrier, and finally the lower sideband will fade independently. This gives rise to asymmetry of sideband amplitude and phase relative to the carrier and consequently to distortion of the modulation envelope. The effect of this distortion on speech is of course a function of the time delay between the paths, being more serious for short delays of some 100 microseconds than for longer delays of 1,000 microseconds. Unfortunately little can be done to reduce envelope distortion of a modulated signal resulting from frequency-selective fading. The introduction of automatic gain control in the receiver will smooth out signal variations but will not reduce distortion. In addition to the distortion described, fading of the carrier with respect to the sidebands gives the effect of over-modulation and produces non-linear distortion. However, with single-sideband operation only one sideband is transmitted, a high-level carrier voltage being provided at the receiver for the demodulation process, and non-linear distortion is thereby avoided. For this reason and others concerning the more economical use of the radio-frequency spectrum and of transmitter power, single-sideband operation is replacing double-sideband operation.

Unfortunately, the unique and constant wave arrival angles, α_1 , α_2 and α_3 , shown in Fig. 1, are not realised in practice due to the continuous changes occurring in the ionosphere, and, in fact, the downcoming angles and the corresponding signal amplitudes change from second to second. Also the energy is not concentrated in a narrow beam but is distributed over several degrees of angle. A typical example of the actual distribution of the energy received in this country from the United States on a frequency of 14,590 kc/s is shown in Fig. 2. The horizontal scale covers downcoming angle, 0° to 22.5°, and the vertical scale indicates wave amplitudes of component waves. The curves of Fig. 2 (a) indicate a single predominant wave at about 5° with small-amplitude waves at several other angles, while Fig. 2 (b) illustrates a condition observed on the same day when there were two predominant waves at angles of 9° and 13°. The successive traces in each set which represent the conditions at two-second intervals clearly demonstrate the variability of downcoming angle and of the individual wave amplitude.

It will be appreciated from what has been said on propagation that if full advantage is to be taken of a very directive receiving antenna on a long-distance circuit, the directivity must be capable of adjustment in the vertical plane in order to take account of the variability of the wave arrival angle relative to the ground. Thus, a fixed directivity system would give only part of the nominal gain, since, for an appreciable proportion of the time, the actual direction of wave arrival would not coincide with the optimum direction of the antenna system. Such a highly directive system with adjustable directivity in the vertical plane was

developed more than ten years ago in the United States by the Bell Telephone Laboratories^{2, 3} and was given the name of Multiple Unit Steerable Array or M.U.S.A. The American Telephone and Telegraph Company set up a M.U.S.A. at Manahawkin, New Jersey, to receive telephony signals from Rugby on short waves. A receiving station based on the same principles, but differing in design details, was set up at Cooling, near Rochester, on the south bank of the River Thames, to receive the corresponding signals from Lawrenceville, New Jersey. The Cooling Radio Station was nearing completion in 1939, but, on the outbreak of war, the work was stopped for a time, and the station was not brought into operation until July,

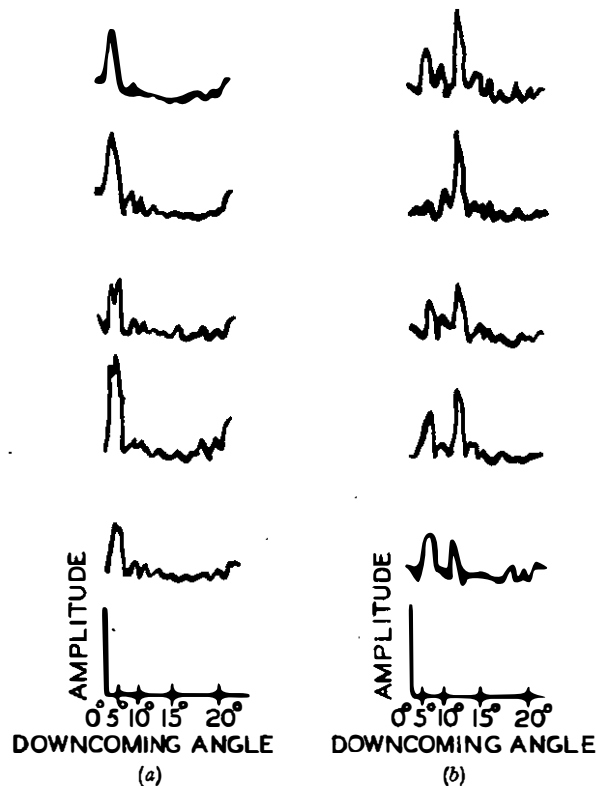

FIG. 2.—RECEIVED WAVE ANGLE PATTERNS.
(Transmissions from U.S.A., 14590 kc/s, Dec., 1943)
(a) Simple Conditions, Single Predominant Wave at about 5°.
(b) Two Predominant Waves at about 9° and 13°.

1942. Since that date the receiving terminals of four of the short-wave telephone circuits between this country and the United States have employed M.U.S.A. These circuits also operate on a single-sideband basis which gives the additional advantages already indicated, and, in particular, freedom from non-linear distortion under frequency-selective fading conditions.

The M.U.S.A. System.

The M.U.S.A. receiving system comprises a series of unit antennæ arranged on the great circle path

² H. T. Friis and C. B. Feldman: "A Multiple Unit Steerable Antenna for Short-Wave Reception." *Proc.I.R.E.*, July, 1937.

³ F. A. Polkinghorn: "A Single Sideband M.U.S.A. Receiving System for Commercial Operation on Transatlantic Radio Telephone Circuits." *Proc.I.R.E.*, April, 1940.

towards the transmitter. The signals are fed from the unit antennæ to the receiver by coaxial feeders. At the receiver, these signals are so combined that the polar diagram of the antenna system has a narrow lobe which may be steered electronically in the vertical plane to the optimum angle of the downcoming waves. Since the ionised layers at the areas of wave reflection are varying continuously in height and density, the downcoming angles and the magnitudes of the constituent waves are also varying from moment to moment. It is necessary, therefore, to know the most effective downcoming angles to enable the lobe of the antenna system to be steered. This information is obtained from a cathode-ray monitor which gives a pictorial presentation of the component waves, similar to Fig. 2.

The Cooling antenna system⁴ comprises sixteen antennæ spaced out over two miles on the great circle

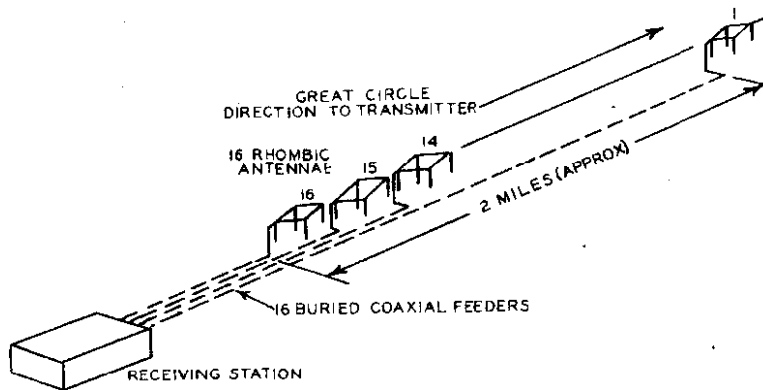

FIG. 3.—LAYOUT OF M.U.S.A. SYSTEM.

path towards the transmitter and connected to the receiving building through buried coaxial cable (Fig. 3). Each unit antenna is of the form shown in Fig. 4, it is 60 ft. high, of 315 ft. side, and has a larger included angle of 140° ; the units are spaced 656 ft. between centres. At the receiver the 16 inputs are amplified, frequency-changed and phase-corrected to

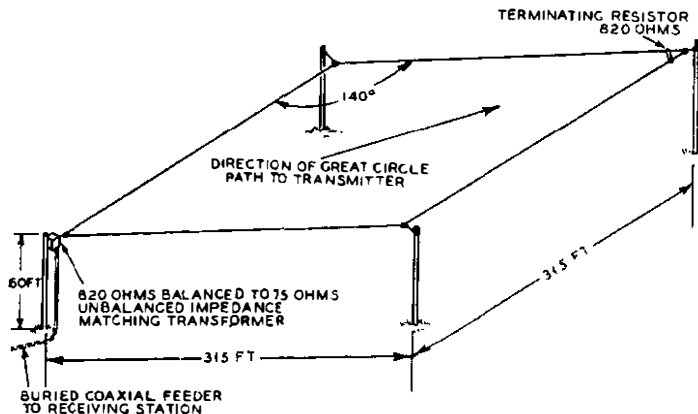

FIG. 4.—UNIT RHOMBIC ANTENNA.

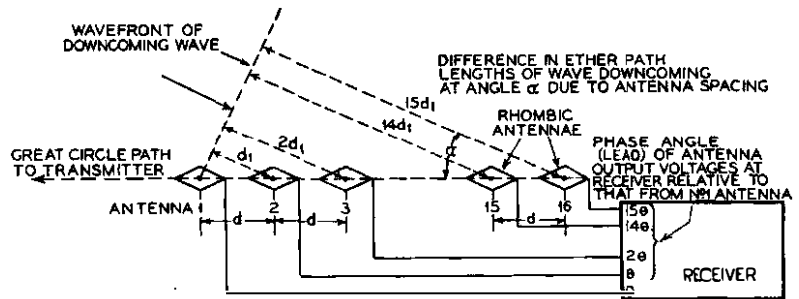

FIG. 5.—PRINCIPLE OF M.U.S.A. SYSTEM.

compensate for the time delays in the different transmission paths. Considering the reception of a single wave at a downcoming angle α , (Fig. 5) the voltage at the receiver from antenna No. 2 will lead that from antenna No. 1 by an angle θ , because although the ether-path length from the transmitter to antenna No. 2 is greater by d_1 than the distance to antenna No. 1, the signal from antenna No. 1 has to travel over an additional length of transmission line equal to d , and

the time of transmission over ether-path d_1 is less than that over a length of coaxial cable equal to d . Similarly, the output voltage at the receiver from antenna No. 3 will lead that from antenna No. 1 by 2θ and that from antenna No. 16 by 15θ . The 16 output voltages from the antennæ are phase-corrected at the receiver, the correction being made for convenience at a fixed intermediate frequency (I.F.) rather than at the signal frequency. The 16 sets of I.F. signals from the respective antennæ are then additive while the signals arriving with downcoming angles differing from α will tend to cancel each other according to their departure from that angle. It will be seen, therefore,

that the phasing process provides a means of steering the directivity of the antenna system in the vertical plane, variations of the unit phase correction relative to θ causing the optimum downcoming angle to vary relative to α .

The simplified diagram of Fig. 6 shows the application of the method of phase correction. After amplification at signal frequency the 16 outputs are frequency-changed to 3,100 kc/s, amplified, and changed to 600 kc/s, the phase correction being introduced at the second frequency changers. The phase-corrected signals are then combined, amplified, frequency-changed to 100 kc/s, amplified and demodulated and amplified at audio frequency. The phase correction is not applied directly to the 600 kc/s I.F. signals but indirectly by provision of appropriate phase changes of the 2,500 kc/s oscillator feeds to the second frequency changers. The phases of the oscillator voltages are adjustable by a single control for any required downcoming angle of the incident wave.

⁴ A. J. Gill, Chairman's Address, Wireless Section, *Journal I.E.E.*, 1939, Vol. 84, p. 248.

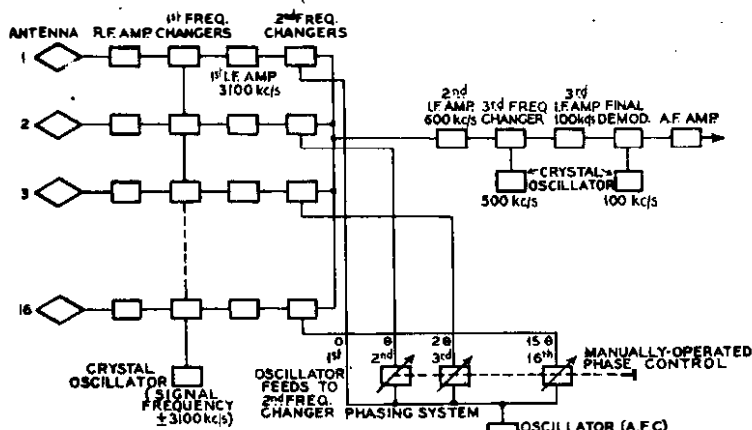

FIG. 6.—SIMPLIFIED DIAGRAM OF M.U.S.A. SYSTEM.

Thus, by adjustment of this single control, which is calibrated in terms of downcoming angle, the directivity of the antenna can be electronically steered to the optimum angle. Three parallel receiver branches are provided, which can be manually and independently adjusted to three different angles α_1 , α_2 and α_3 . A fourth branch, the monitoring branch, gives an energy-wave angle diagram on a cathode-ray tube; a representative set of diagrams is shown in Fig. 2. The optimum angle for each receiver branch is thus determined and this information is used in setting the three branches. A branch selector is provided to select automatically and pass to line the signals from the audio frequency amplifier in the branch giving the highest level at any instant. The method of provision of the three working and one monitor branches is shown in Fig. 7. The monitor branch phasing is automatically varied to sweep over the range of unit phase shift once every two seconds, and the long persistence of the cathode-ray tube screen provides a good picture of the energy-wave angle pattern. In operation the monitor tube is observed more or less continuously, depending on the stability of the circuit. The three working branches are set to the three best angles, and the three settings are not changed until the monitor indicates that such a change is desirable.

Although only two receivers are installed at Cooling, it would be practicable to use several on the one antenna system. Each receiver operates on any of five frequencies in the range 4,000 to 22,000 kc/s and, since twin-channel operation is used, a total of four telephone channels is at present available.

As will have been realised from this simplified description, the equipment is very complex; it employs more than 1,000 valves and it occupies some sixty 10 ft. 6 in. repeater racks, back and front mounting. Fig. 8 shows a view of the monitor position; the wave-angle monitor oscilloscopes can be seen in the centre with the manual wave-angle steering controls below them.

Performance.

The improvement of signal-to-noise ratio of a 16-aerial M.U.S.A. receiver compared with a single-

sideband receiver with a unit rhombic antenna is some 12 db., and over a single-sideband receiver using only an omnidirectional antenna is at least 26 db. These improvements would necessitate increases of approximately 16 and 400 times respectively in transmitter power for a similar signal-to-noise ratio using the simpler aerial system.

Despite these figures the reader may ask whether the results have shown that the complexity of equipment has been repaid by increased circuit time over that which would be obtained from a single-sideband receiver associated with a unit rhombic antenna. Subjective tests of the two systems have been made and the results are summarised in Table 1.

TABLE 1

Factor (speech transmission)	Percentage of time M.U.S.A. gave improved performance over that of single-sideband receiver with unit rhombic antenna				
	Much improved	Improved	The same	Slightly degraded	Much degraded
Quality	6.2	72.8	18.5	2.5	0
Fading	5.7	67.4	25.2	1.5	0.2
Noise	6.0	73.7	18.5	1.7	0.1
Radio Interference	2.4	41.7	45.2	9.5	1.2

Thus for some 79 per cent. of the time the speech quality was better, for 18.5 per cent. the same, and for 2.5 per cent. slightly degraded. In this connection the narrow beamwidth of M.U.S.A. does reduce the effects of selective fading between signals which have travelled by widely different paths. However, since the components of a wave bundle accepted by the M.U.S.A. may still have time delays between themselves of up to 100 microseconds, a certain amount of selective fading remains. The improvements in respect of fading and noise are similar to those for quality, but for interference from other radio transmissions are somewhat less. The small percentage of time for which M.U.S.A. was judged to be inferior, about 2 per cent., may have been due to rare occasions of severe ionospheric disturbance when highly dispersed reflections were obtained. Under these conditions the M.U.S.A. system with its pronounced directivity receives only a fraction of the total dispersed wave energy, whereas a less directional antenna would receive a much larger proportion.

Experience has shown generally that most of the estimated improvement is realised when it is most needed, that is, when the circuit is poor using a unit rhombic antenna. When the signal-to-noise is some 40 db. or more with a simple rhombic the improvement is less marked. Experience has shown that the complexity and cost of the M.U.S.A. is worth while when applied to a group of important circuits carrying heavy traffic such as those between this country and the United States, but is probably not justified for more lightly loaded circuits.

The Cooling M.U.S.A. has proved invaluable in providing information on wave arrival angles. Details of these angles and of other important factors are

systematically recorded and this information is of great value to development engineers concerned with the design of long distance circuits. In addition, it is useful in the theoretical study of the ionosphere and of its behaviour to high-frequency signals. The variation of the downcoming wave angles for a transatlantic channel operating on 9,870 kc/s in July, 1942, as determined by the monitor branch of the Cooling M.U.S.A. is shown in Fig. 9. The wave-angle values were determined at 15-minute intervals and were

averaged for each hour of the day. The results clearly demonstrate the variability of the predominant angles with time.

Future Developments.

It will be apparent that a M.U.S.A. system is not flexible in as much as it is suitable only for reception from a direction in line with the antenna. In addition, since steering is limited to the vertical plane, the system fails for waves normally in line with the

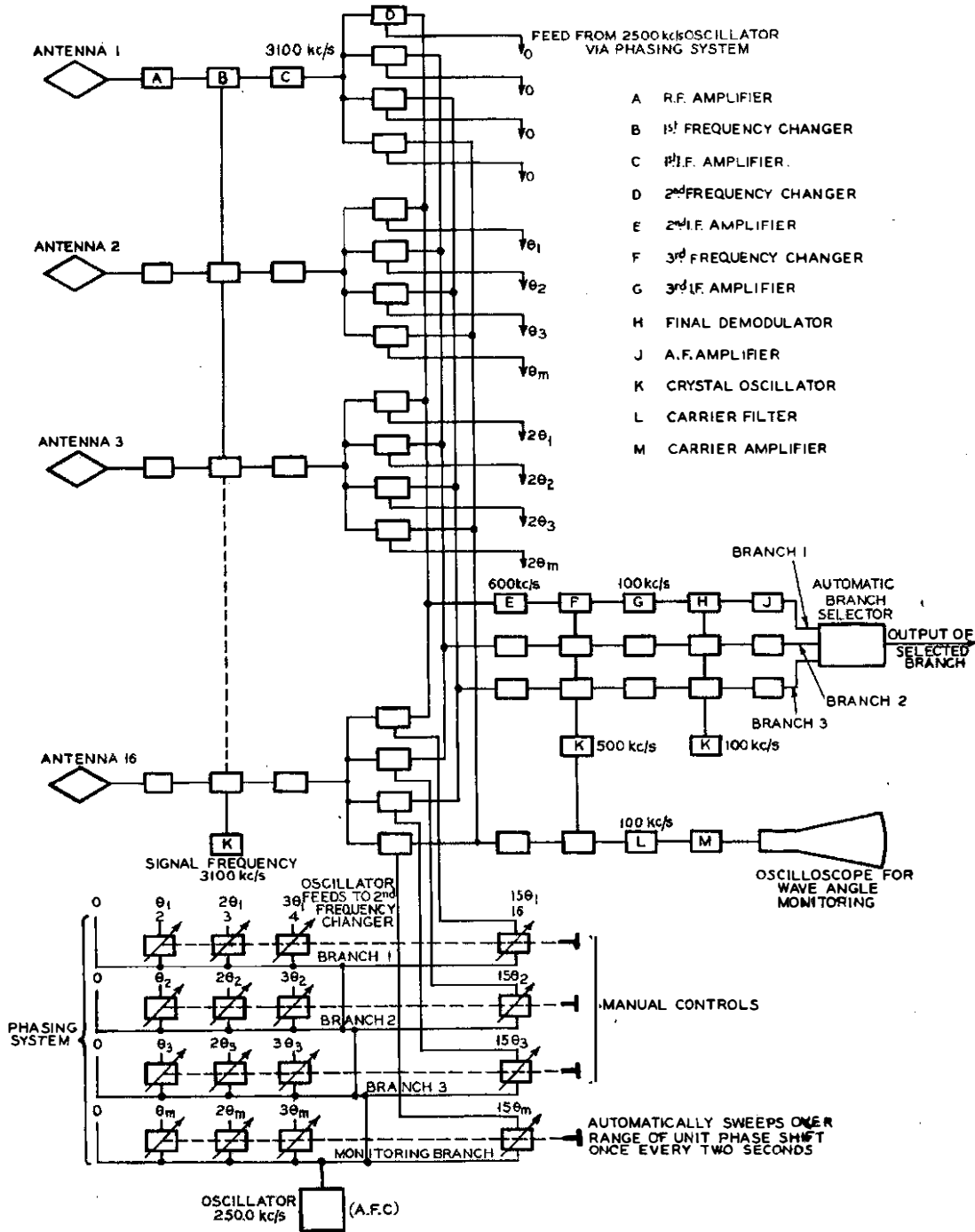

FIG. 7.—M.U.S.A. RECEIVER—SHOWING THE FOUR BRANCHES.

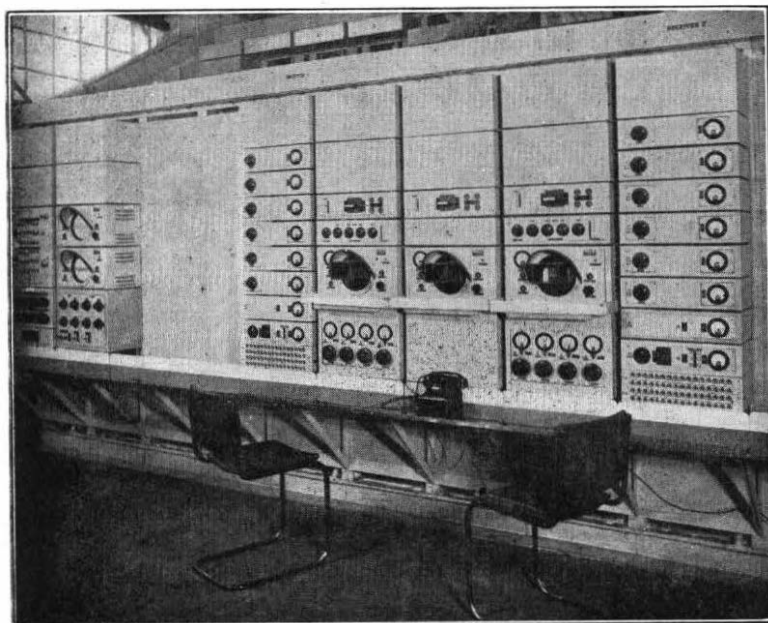

FIG. 8.—GENERAL MONITOR AND CONTROL POSITION.

antenna which suffer appreciable lateral deviation. An extension of the system to provide for the simultaneous reception of several transmissions from different directions on one array has been proposed by W. J. Bray.⁵ Such a system would be universal, giving horizontal and vertical steering for each of the transmissions being received. In a proposed design a monitor branch would scan automatically the hemisphere centred on the antenna system, and from the display, other branches would be independently steered to the optimum directions of the required signals. The antenna system could comprise, say,

⁵A. H. Mumford, *Journal I.E.E.*, 1947, Vol. 94, Part IIIA, p. 23.

Book Review

"The Electrolytic Capacitor." Alexander M. Georgiev, M.Amer.I.E.E.; 191 pp. 72 ill. Crosby Lockwood & Son, Ltd. 15s.

The use of electrolytic condensers has been widespread for 15 years, but there has been little authoritative information available on their manufacture and their properties. For the engineer who wishes to use electrolytic condensers with safety, and for anybody feeling curiosity concerning the methods of manufacture, this book may be a useful introduction. It is written mainly from a practical point of view; and its account of the raw materials and manufacturing processes, and its recommendations to users, are clear and comprehensive. The brief account of the nature of the dielectric film offers eight different theories (about six too many for a book of this type), but makes no serious attempt to weigh their relative merits. The objections to the first theory given, which assumes a solid film of aluminium oxide of high permittivity, do not seem very serious, and are certainly not overcome by any of the other seven theories. The number of references to condensers for A.C. operation is surprising, although possibly justified by the increasing use of these condensers for the starting of induction motors. The theory of A.C. operation given on

100 vertical antennæ arranged in the form of a circle or square of some 200 to 300 yards diameter or side. Such a system would possess many advantages over M.U.S.A. and it is possible that it may be used by the radio engineer in his never ending search for improvement of the quality and reliability of long-distance radio-telephone links.

It may be asked whether the M.U.S.A. principle could be applied equally effectively to the transmitting terminal. In this connection tests on the transatlantic circuit have shown that the principle of reciprocity is in general applicable and the preferred angles for transmission are the same as those for reception on the same, or an adjacent, frequency, but the application of M.U.S.A. to a high power transmitter is not an easy problem and it has not to the present been so used.

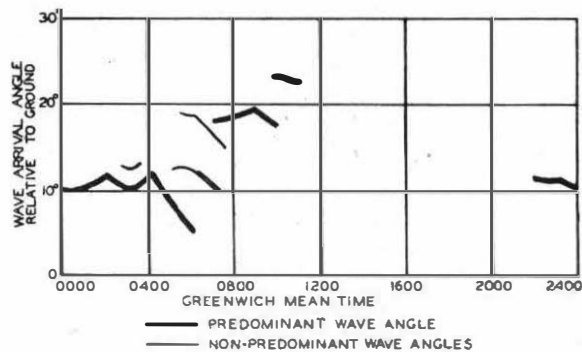

FIG. 9.—WAVE ANGLE DATA.
(Transatlantic Channel, 9,870 kc/s, July, 1942.)

page 21, however, is astonishing; it states that in each cycle "the dielectric properties of the films are alternately reduced to a small value and during that time the foils on which they are formed serve to distribute the current over the electrolyte by conduction."

The bibliography is good; the glossary and the index show the unusual fault of being so comprehensive as to be confusing. The list of patents is long, but it includes only a few British patents and none of these later than 1938. The diagrams are mainly good; but Fig. 8, although accurate, is so misleading (in showing film on the back of the anode) that it should be modified, and Figs. 62 and 64 gain nothing in authenticity by being copied, weird symbols and all, from radio-set makers' diagrams.

The general impression is that this book contains little, if anything, that was not mentioned in Coursey's book of six years earlier. Presumably there have been more recent developments in America; perhaps they are omitted from this book because they have not yet affected the commercial product. But the conclusion must be that while this book is a fair alternative to the earlier one, it certainly does not supersede it.

A. C. L.

Aerial Cables and their Installation

P. R. GERRY, A.M.I.E.E.

U.D.C. 621.315.24

Details are given of past and present types of aerial cable used by the Post Office : the methods employed for their installation and the reasons for changing the types and methods are also described.

Introduction.

THE advantage of providing circuits by aerial cable lies in the lower cost of installation compared with its underground equivalent but the initial saving is, generally, offset over a period of years by greater annual charges. Most of the changes in aerial cabling over the past 50 years, which have been made with the object of reducing these charges, have been effective in remedying a particular defect, but as will be seen from the following paragraphs they have been responsible for other troubles, with the result that no appreciable decrease in annual charges has been achieved.

Early Aerial Cables.

The earliest aerial cables used by the Post Office consisted of rubber-covered conductors with an overall bitumen-impregnated braided covering. Included in the core of one type was a wire consisting of seven strands of 22 s.w.g. steel which was wrapped with prepared tape. The steel wire had a tensile strength of 80 tons per square inch and was sufficiently strong to support the cable when it was erected, which obviated the need for a separate suspension wire. The cable was made in three sizes only, each having two, four or six conductors. The overall diameter of the two-wire cable was 0.4 in. and of the six-wire cable 0.74 in. This type of cable did not prove satisfactory in service due to the stranded steel wire cutting through its own tape wrapping and the rubber covering of the conductors at points where it was secured to poles or buildings. It was not used on an extensive scale. The other types of I.R. cable were more satisfactory in use but in most cases they were used for temporary work only. The more permanent aerial cables were of the lead-covered paper core type and the main cause of trouble with these was the failure of the sheath due to fatigue. This was eventually overcome by adding 3 per cent. of tin to the lead used for the sheath.

Early Methods of Suspension.

Most of the aerial cables—both rubber covered and lead covered—were suspended from single or stranded steel wire with rawhide suspenders. Several changes were made in the type of suspension wire, the first being in 1895 when an instruction was issued that future cables should be attached to solid 400-lb. copper wires "as being more durable in bad atmospheres."

With the growth of the telephone and telegraph service it became necessary to provide larger cables, which caused the copper wires to stretch, and this led to the reintroduction of stranded steel wires except in corrosive atmospheres where the use of a bi-metallic wire—copper-covered steel wire—was specified. The stranded steel wires were, however, found to have insufficient strength and eventually a single high tensile

steel wire, weighing 190 lb. per mile, was introduced, the number of wires used varying from one to four according to the size of the cable to be suspended. At a later date bronze wires were specified in lieu of bi-metallic wire for use in corrosive atmospheres.

The rawhide suspender used is shown in Fig. 1 and

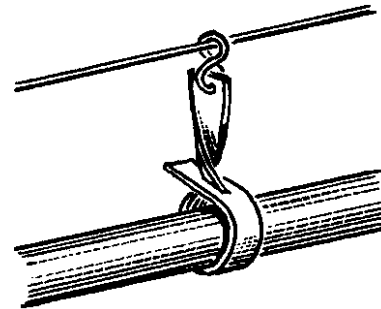

FIG. 1.—RAWHIDE SUSPENDER.

consists of a strip of suitably dressed rawhide or chrome leather. At one end of the strip an eyeletted hole or slit was provided for attaching the "S" shaped hook and at the other end was a slit through which the hooked end was passed to form an eye for the cable. The hooks were of copper, bronze or galvanised iron to match the material used for the suspension wire. With this method of suspension the suspension wires were first placed in position after which the suspenders were attached to the cable, as it left the drum, at 2-ft. intervals for lead-covered cable and 3-ft. intervals for rubber-covered cable. With the suspenders attached, the cable was lifted and every fourth or fifth suspender was hooked on to the wire as the cable was pulled along. At each pole along the line the suspenders were detached, taken past the pole and replaced in the next span. When the last span of cable was being pulled into position a man on each of the poles placed all the suspenders on to the suspension wires.

This method of suspension was used for several years. It was found, however, that the grip of the rawhide was insufficient to prevent it moving along the cable. This movement resulted in the suspenders congregating at various points along the line. Apart from the unsightly appearance created by the bunching, long lengths (sometimes several yards) of cable were left without support and this led to premature failure of the sheath. Another defect was irregular stretching of the leather of individual suspenders which resulted in the cable being spaced at varying distances below the suspension wire.

There are several types of rawhide suspenders which, by means of specially shaped hooks, grip the suspension wire and thus prevent bunching, but there is no record of any having been used by the Post Office.

Marline Suspenders.

The rawhide suspender was eventually superseded by the marline type shown in Fig. 2. The hook was of

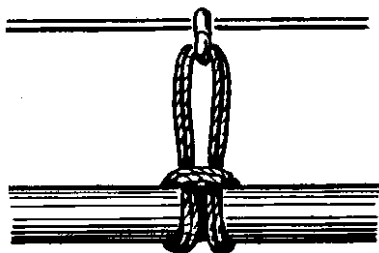

FIG. 2.—MARLINE SUSPENDER.

bronze or galvanised iron and the loop was a spliced length of marline impregnated with a bitumen compound.

The method of erecting the cable was the same as with the rawhide suspender. The marline suspender gripped the cable better than its predecessor but did not entirely prevent bunching. Its chief defect was the short life—in some cases the marline broke and had to be renewed after five years of service. The renewal of the suspenders was, generally, a hazardous task because the strength of the suspension wires did not always provide much margin for supporting the ladder from which the operator worked.

Steel Rings.

The ring shown in Fig. 3, which superseded the marline suspender, is made of spring steel of rectangular section. The original rings used had an oval section.

Stranded high tensile steel wire is used with the rings and the hooks are designed to grip a particular size of wire. The rings are placed in position, after the stranded wire has been erected, by an operator who springs the two hooks on to the suspension wire while riding along the wire in a special chair. As each ring is attached a rope or sash line is placed inside and when all the rings have been placed the rope or line is used to draw the cable through them. Movement of the rings during the drawing-in of the cable is prevented by the hooks, which are shaped to lock the ring in position. With this method of erection installation costs are considerably less than with rawhide or marline suspenders as it does not need a man at each pole to transfer the cable from one side to the other.

The rings satisfactorily overcome the bunching of previous suspenders and being galvanised have a longer life. They have, however, proved troublesome by cutting the lead sheath. The cut may penetrate through the lead or the cable may fail due to fatigue cracks occurring at points where the cutting action has reduced the thickness of the sheath, but in either

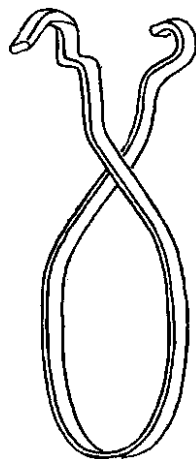

FIG. 3.—STEEL RING SUSPENDER.

event the ingress of moisture into the cable is gradual and the fault is, therefore, difficult to trace.

Ring-cutting.

The cutting has been found to be due to a variety of causes. One cause is the use of misshapen or twisted rings which allow the cable to rest on the comparatively sharp edge of the rectangular section, instead of the broader surface of the strip from which the ring is made. To avoid faults from this cause it is necessary to examine each ring closely as it is placed in position on the wire, changing any which do not hang so that the broad surface of the strip forming the eye of the ring will be parallel to the cable. The large quantity of rings used precludes a thorough examination of each ring before it is issued and, while all reasonable precautions are taken during manufacture and acceptance examination to ensure that the rings are of the correct shape, it must be expected that an occasional ring received for a particular work will not be up to standard.

It has been found that the cutting usually takes place near the pole. This is to be expected as at the pole the cable is relatively free to move whereas the suspension wire is fixed to the pole; conditions are thus favourable for independent movement of the cable in the rings. Away from the pole the cable and wire are equally free and movement of the cable is likely to be in unison with the wire and rings.

To prevent the independent movement of the cable at the pole causing ring cuts the cable was lifted clear of the first three rings on both sides of the pole. This was done by tying marline round both cable and suspension wire but the ties did not remain effective for very long due to the marline deteriorating or the knots slipping. The ties were eventually abandoned in favour of special rings fitted in the first and last three positions in each span. These rings were similar to the ordinary rings but had a wide cradle fixed at the bottom of the eye, as shown in Fig. 4. The cradle provided a broad surface, with well-rounded edges, on which the cable rested.

In the early trials, which were on a small scale, the cradle rings proved satisfactory and in due course their use was extended to all positions in the span where the cable was in an exposed situation. It was not long after the general introduction of these rings, however, that cases came to light where the ring cut through the lead sheath within a few months of being fitted. Cradle type rings were then tried with the cradle covered with lead, but this only delayed the failure of the cable as the lead seating became worn through in a few months.

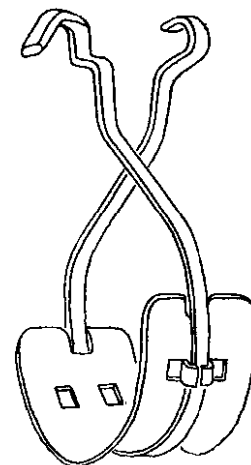

FIG. 4.—STEEL RING SUSPENDER WITH CRADLE.

The most troublesome cases of ring-cutting occur

where small cables are erected in very exposed situations. Under these conditions, cutting is not confined to positions near the pole but occurs throughout the spans and is due to the high winds blowing the relatively light cable about in the rings. It has become evident that cable rings of any type would not be satisfactory under such conditions.

Cable Creepage.

A further source of trouble with cable ring suspension has been cable creepage, which occurs on gradients at angle and terminal positions and also where the cable joints are made in a vertical position and supported on the poles. The effect of creepage is to produce stretching of the sheath at points where the cable is fixed (e.g. at cable cleats on terminal poles and at joints). To prevent creepage the cable is anchored to the suspension wire at all points where experience has shown that conditions favourable to creepage exist. While it is necessary to anchor the cable to prevent creepage, the anchors prevent free expansion and contraction of the cable during changes in temperature and it is likely that the anchoring devices may be a contributory factor to the bowing of large cables.

Bowing.

Bowing is the condition where the cable takes the form of a bow or arc at local points and it occurs usually at high temperatures. It is due to the different rates of expansion and contraction of the steel suspension wire and the cable, the temperature coefficient for the wire being 6.4×10^{-6} per °F and for the cable between 10 and 11×10^{-6} per °F, according to its size and make-up. In practice these differences are greater than the coefficients indicate because the tension in the wire (which may be several thousand pounds) restricts its change in length, while the cable, which is relatively unstressed, has no such restriction. A 96-pair 40-lb. cable, for example, would increase in length by 1.2298 in. when the temperature rises from 20°F to 100°F and the distance between adjacent poles is 40 yd. The wire from which the cable is suspended, however, would increase its length by 0.241 in. only for the same rise in temperature. For a 70-yd. span the same size of cable and wire would increase in length by 2.1332 in. and 0.59 in. respectively.

If the movement of the cable were not restricted by the rings the excess length would be absorbed near the centre of the span and its sag would be greater than that of the wire. As the rings prevent this increase in sag a state of compression is created in the cable in each span. On small cables the compression results in a series of small waves along the length; on large cables it causes the cable to bend at the pole, where the buckling resistance is less than in the span due to the change in direction as the cable passes from one span to the next.

When a fall in temperature occurs the cable becomes shorter than the wire and the resulting tension in the cable may be sufficient to cause permanent stretching. Lead-covered cables have a very low yield point. A 150-pr. 10-lb. cable, for example, would elongate permanently by 0.13 per cent. when a tension of 2 cwt. is applied, while a tension of 40 cwt.

would produce a permanent stretch of 8.2 per cent. The amount of permanent elongation will vary according to the size of cable but the values quoted indicate that some permanent stretching will occur during several cycles of temperature rise and fall. This accounts for the bows which exist in some cables even during periods when the temperature is low.

The extent of the bowing can be reduced by adopting lower tensions when erecting the suspension wire and by tensioning the cable when the joint is made while the temperature is high: these measures would reduce the difference in tension between cable and wire.

The most serious bowing occurs in large cables where, as already explained, it is concentrated at local points along the cable, generally at pole positions. It is unlikely, however, that large cables will be erected in future and the main problem is to ascertain what should be done with the many cables in position which are bowed severely. Observations on several cables are being made and it is hoped that sufficient data will be forthcoming to determine whether the bowing is likely to lead to premature failure of the sheath and, if so, what measures should be taken to avoid breakdown of the cable. The issue is confused by the fact that some cables, and some sections of cable, show very little, if any, sign of bowing even in hot weather.

It is evident that bowing must be expected even if suspension wire having the same coefficient of expansion as the cable were used, but the risk of it causing premature failure of the sheath may be reduced by restricting the movement of the cable during temperature changes. Such a restriction is achieved when the cable is kept in close contact with the suspension wire throughout its length. Two methods of doing this have been tried, one where the cable is bound to its suspension wire in the factory, and the other where the binding operation is done in the field.

Factory Bound-in Cable.

The cable tried by the Post Office consisted of the normal lead-covered aerial cable which was attached in the factory to a stranded steel wire by two galvanised iron tapes spirally wound round both cable and wire. The initial costs and installation costs of this cable were high, the latter due to the extra fittings required temporarily at each pole to support the cable while it is tensioned and to the difficulty of transferring the tensioned suspension wire from the temporary to the permanent supports on each pole.

The one cable of this type erected by the Post Office was recovered after 12 years of service. Recovery was decided upon after frequent failures of the sheath. The failures were attributed to slackness of the tapes, which enabled the cable to move independently of the wire. The tapes were terminated at the ends of each span and the method adopted to secure the ends consisted of a few turns of binding wire around cable, tapes and wire; it is evident that an improved method of terminating the tapes, which would have kept the tapes in their original position and thus prevented the cable moving about in the loosened tapes, would have extended the life of the cable.

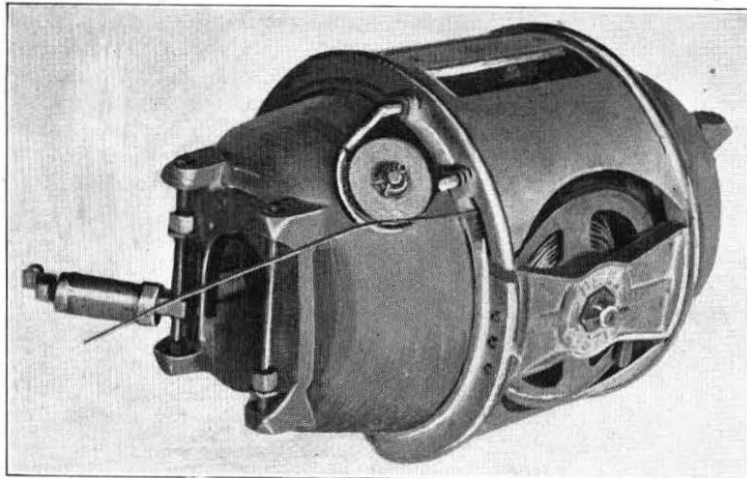

FIG. 5.—" B " TYPE CABLE LASHER.

Cables Bound to the Suspension Wire in the Field.

With this method of installation the suspension wire is placed in position on the poles and, by the use of a machine propelled along the wire, the cable is lashed or bound to the wire. A single-strand wire is used to bind the cable and suspension wire together. Three types of machine, all of American origin, have so far been tried by the Post Office. The first machine to be tried, which has been described in a previous article,¹ is propelled along the wire by a man seated in a special chair suspended from the machine and, although the machine functions satisfactorily, considerable time is spent by the operator in removing himself from his seat at the end of each span, transferring the machine to the next span and getting into position again. The second machine, which is illustrated in Fig. 5, is of a more compact design. It is propelled along the suspension wire from the ground by pulling on a rope attached to the machine. The weight of this machine is about 45 lb. (approximately 60 per cent. of the earlier machine) and because of its compact shape and reduced weight the machine is much easier to transfer from one span to the next. The lashing wire is held in a special chamber in the centre cylinder, which rotates as the machine moves along the suspension wire and thereby wraps the lashing wire around both cable and wire. Two grooved rubber-tyred wheels which are fitted inside the machine ride on the suspension wire and, in rotating, drive the cylinder.

The machine has been used extensively for installing cables of all sizes up to 1.6-in. diameter and has proved very economical in manpower. Given normal conditions the cable can be placed in position in less time than is required to attach cable rings to a suspended wire.

¹ "Aerial Cable Suspension by the Spinning Method." C. A. Mitchell. *P.O.E.E.J.*, Vol. 38, p. 19.

The third machine is illustrated in Fig. 6 and incorporates several improvements over its two predecessors. It has approximately the same weight as the second machine and is propelled along the wire in the same manner. Two independent drives are provided for rotating the centre cylinder holding the lashing wire. One drive is operated by a grooved rubber-tyred wheel inside the machine which rotates as it rides on the suspension wire, and the other by a rubber-tyred wheel on the outside of the machine; as the lashing wire leaves the machine it is taken for one complete turn around the periphery of this second wheel so that the pulling of the wire under tension causes the wheel to rotate. This second drive overcomes the chief defect experienced on the earlier machine, which often skidded

along the suspension wire in wet weather.

The trials which have been made with this method of construction show that the overall installation costs are less than with cables supported in rings and a much neater appearance is achieved. Provided the cable is kept in close contact with the suspension wire, maintenance costs should also be less. To ensure the necessary close contact between cable and suspension wire it is necessary to use a lashing wire which is sufficiently soft to ensure that any bends or kinks in it will be removed by the slight tension applied during the lashing operation. It is also important that the lashing wire should last as long as the suspension wire. Experiments are proceeding to find the most suitable wire. Aluminium wire was found effective in providing a tight lashing but its corrosion resistance when in contact with lead was found to be very low, the wire showing signs of serious corrosion within two years of being placed in position. The most successful wire so far tried is a soft iron wire having an extra heavy galvanised coating.

The machine shown in Fig. 6 is now being made

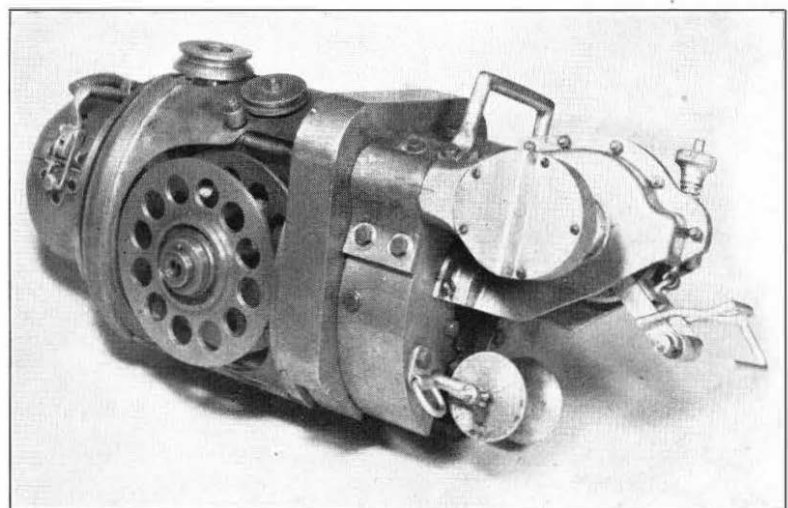

FIG. 6.—" D " TYPE CABLE SPINNER.

under licence in this country by Pirelli-General, of Southampton, and an order for 60 machines has been placed with the firm. When these machines become available it is proposed to abandon the present method of erecting cables in rings and standardise the lashing method.

Stainless Steel-sheathed Cable.

This type of cable has been described in a previous article.¹ The sheath is of stainless steel instead of lead and is strong enough to support the cable between poles without excessive sag. Several lengths which were erected in 1943 are showing no sign of deterioration and maintenance costs have been negligible. Experience to date indicates that it is likely to prove the most satisfactory cable ever used by the Post

¹ "Stainless Steel-sheathed Aerial Cable." J. J. Moffatt. *P.O.E.E.J.*, Vol. 36, p. 107.

Book Reviews

"New Advances in Printed Circuits." Miscellaneous Publication 192. Published by the Superintendent of Documents, U.S. Government Printing Office, Washington 25, D.C. 73 pp. 43 ill. Price 40 cents.

This publication is the proceedings of the First Technical Symposium on Printed Circuits held in Washington, D.C., on 15th October, 1947, under the sponsorship of the Aeronautical Board and technical direction of the National Bureau of Standards. A preface lists 26 known methods employed in P.C. technique, describes the essential features of these methods and gives examples of the application of P.C. to the design of a variety of types of electronic equipment. Then follow 16 papers on various developments by men in industry who were responsible for them. Considerable attention is given to the electrical performance of printed resistors, metal film resistors, vitreous enamel dielectric capacitors, the printing of electrical circuits on plastics and of electronic components on glass. A photographic technique of applying the conductor to the insulating base is described, and also methods of mechanising and die stamping wiring. The mass production of printed components to close tolerances is difficult, however, and the alternative of printing only the circuit and associating specially designed prefabricated miniature components with it is considered. The discussion which followed the presentation of the papers answers many questions relating to P.C. technique and the replies to questionnaires were emphatic that P.C. would achieve miniaturisation, result in efficient design and reduce costs.

Printed circuit technique is undoubtedly here to stay, and this publication will be found stimulating by all who read it and a good introduction to the subject.

L. E. R.

"Traffic and Trunking Principles in Automatic Telephony." Revised Edition. G. S. Berkeley, M.I.E.E. Ernest Benn Ltd. 339 pp. 87 ill. 21s.

A revised edition of this well-known book on traffic and trunking has recently appeared. It has been considerably enlarged and its production is very pleasing. The author has brought the book thoroughly up to date in regard to current practice. Thus, there are chapters on the multi-metering scheme for non-

Office. It has a very neat appearance when in position and its sheath is impervious to gunshot. Installation costs are approximately one-third the cost of installing the same size of lead-covered cable in rings. Against these advantages must be set the high initial cost of the cable and the slow rate of production due to the limited manufacturing capacity available.

Conclusions.

The lack of success in the measures taken in the past to reduce maintenance costs on aerial cables has been due, to a large extent, to a restricted use of aerial cables. In recent years, particularly during the war years, this method of construction has been used more extensively and this has provided greater scope for observing its performance. From the observations made there is reason to expect that the service given by future aerial cables, i.e. stainless steel or lashed lead-covered cables will approach, and in some cases surpass, that provided by underground cables.

director areas, trunking of U.A.X.s, the group selector rack with grading facilities, as well as other recent developments. The chapter on the Erlang Lost Call Theory has been retained. In addition, a chapter dealing with the delayed call formulæ, hunting problems, and an outline of the theory of probabilities has been added. In an Appendix, tables are given showing the basis of provision of trunk and junction circuits at 1/50 and 1/30 grades of service and the circumstances in which they should be used.

Almost the whole of the material in the first edition has been retained so that the book gives full information on trunking schemes, racks and cabling, and a most valuable chapter on the method of design of an automatic exchange. The book will be particularly valuable to students for the City and Guilds examinations and contains many references for further reading. It is a pleasure to recommend this revised edition of a book dealing with an important and interesting phase of automatic telephony.

A. T. H.

"The Properties of Soft Solders and Soldered Joints." J. McKeown. D.Sc., Ph.D., M.I.Mech.E., F.I.M. The British Non-Ferrous Metals Research Association, London, N.W.1. 140 pp. 56 ill. 17s. 6d.

This book is a record of the work carried out by the British Non-Ferrous Metals Research Association with the object of increasing metallurgical knowledge of low-tin-content solders, the use of which was forced upon the Allies during the last war by the Japanese occupation of the Malayan Peninsula. The author, Dr. J. McKeown, was leader of the team engaged on the work and it is very fortunate for those interested in solders and soldered joints that he has published the results of the experiments for which he was responsible.

The book is divided into six chapters: these cover (1) properties required in solders and soldered joints, (2) composition of solders, (3) "soldering-power" tests, (4) mechanical properties of solders and joints, (5) hot-tearing in solders and (6) soldering of aircraft oil-coolers. Experimental procedure and results are dealt with in considerable detail, but for those who have not the time or inclination to read all the author has to say, a very concise summary of the conclusions reached is given at the end of each section.

E. V. W.

The German River and Sea Bed Cable Washing-in Process

C. R. DICKENSON, A.M.I.E.E.
(Control Commission, Germany)

U.D.C. 621.315.285

For cable crossings of navigable rivers and sea estuaries a washing-in process is frequently employed in Germany ; in this process the sub-aqueous cable is laid direct in the river or sea bed, the trench being cut by high-pressure water jets. The author describes the apparatus used and gives details of a typical cabling work across the Rhine.

Introduction.

DURING the last few months of the war, the Germans destroyed all the Rhine bridges and following the Occupation one of the first problems in road and rail communications was to effect temporary restoration of certain of the more important bridge crossings. This was done utilising various forms of temporary bridges.

International telephone communications from the British Zone of Germany to the West were initially carried by two international routes specifically provided for military purposes ; one of these, consisting of 14 pr. carrier cables laid across country, passed from Minden through Venlo into Holland, crossing the Rhine over a temporary bridge at Wesel ; the other utilised the German trunk cable network to Borkum (an Island in the North Sea off Emden) and, from there, a British coaxial submarine cable across the North Sea to Lowestoft.

With increasing demands on international communications it became obvious fairly early in 1946 that additional international routes would have to be opened up. One of the main German routes had originally passed through the Ruhr and across the Rhine at Düsseldorf and it was decided that this route should be restored. The fact that no permanent bridge existed at Düsseldorf and that the Skaggerak bridge, which had originally carried the cables, was not likely to be repaired and opened until 1948 gave rise to consideration by the Reichspost and British Posts and Telegraphs staff of the possibility of laying a sub-aqueous cable at this point.

Various problems had to be faced, including the necessity for using capacitor building-out networks and provision of an additional loading coil section, due to the fact that a new route across the river bed must allow reasonable separation for bridge restoration work and must therefore of necessity be approximately 200 yards longer than the old direct crossing over the bridge.

Some of the difficulties involved in arranging for manufacture of the capacitor networks and cable loading pots, etc. can be appreciated only if one knows the chaotic state of German industry and raw material supplies at the time in question.

It has been German procedure, largely due to the very extensive use of German waterways for shipping and the dangers of damage by floating ice floes, to bury sub-aqueous cables in the river and estuary beds at such a depth that they will not be damaged by ships' anchors. On the Rhine, barges of up to 2,000 tons displacement frequently anchor in the stretch opposite Düsseldorf and considerable anchor dragging takes

place, due to the 5-6 knot current. It was therefore evident that the cable would have to be buried if damage was to be avoided.

The German Washing-in Process.

The AEG-Harmstorf process used for the cable laying is, as are all good schemes, a fairly simple one and relies on the force of a jet of water being able to loosen and carry with it solid matter up to and including quite large stones, if a sufficiently high pressure and large enough flow of water is available. Original experiments in cutting trenches for cables under water were carried out using normal jets and fire type hydrants positioned and operated by divers. As a result of experience gained and developments made, the prototype of the present apparatus was brought into use in 1934.

Fundamental principles of the apparatus used are shown in Fig. 1. It will be noted that this consists of

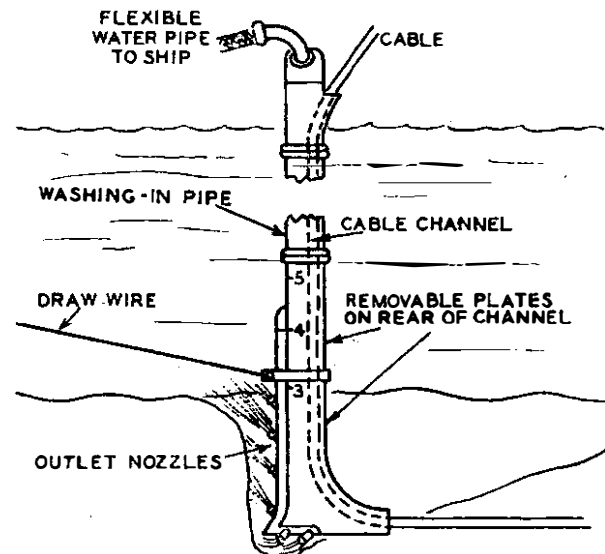

FIG. 1.—PRINCIPLE OF THE WASHING-IN PROCESS.

the washing-in pipe, which contains a number of water pressure channels led out to nozzles at various points on the leading edge, in the rear of which is located a cable feeding channel, leading out through an easy bend into the toe of the shoe at the bottom of the pipe. The pressure of water supply to any of the outlet nozzles can be adjusted by means of independent valves. This facilitates excavation at different depths and under various ground conditions. Fig. 2 gives some idea of the jet angle and pressure.

The rear edge of the cable feeding channel can be

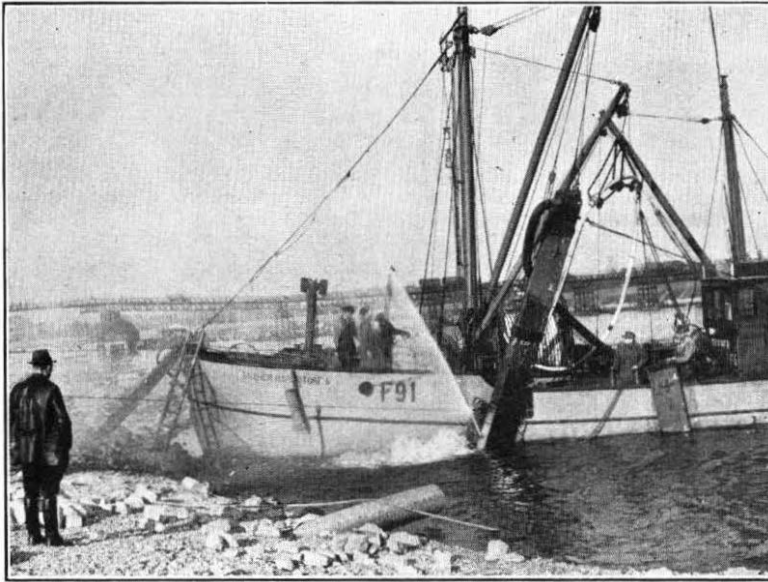

FIG. 2.—THE WASHING-IN PIPE RAISED TO INDICATE ANGLE AND PRESSURE OF THE JETS.

fairly easily opened and the cable lifted out (see Fig. 3). The cable is fed into the top of the channel

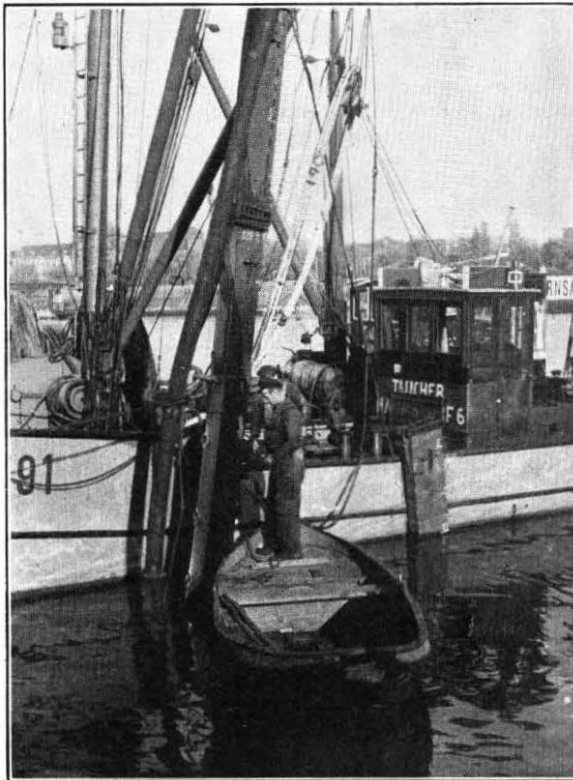

FIG. 3.—REMOVING REAR EDGE OF CABLE FEEDING CHANNEL TO FREE CABLE.

over open rings and may be taken directly off a drum located on an adjacent barge or can be taken on a normal submarine cabling basis from a cable tank in the hold of an adjacent ship. The length of the wash-

ing-in pipe can be adjusted, to the respective water and/or washing-in depths, as ten separate extension sections are provided which can be fitted or removed during the actual process of the operation. The depth of the cable in the river bed is computed from a measurement of the water depth, subtracted from the reading given on a scale printed on the side of the pipe.

Water supply is obtained from a bank of pumps fitted in the cable ship, the maximum output being 1,000 galls./min. at a pressure of 12 atmospheres.

The laying process is normally carried out by the cable ship which has coupled to it the barge in which the cable is stored. Operation from a raft or platform is also possible, utilising a portable pump, usually located on shore, and a long flexible hose. During the laying process the two ships move transversely along the line of laying, in the manner shown in Fig. 4.

A continuous draw wire passing over a running pulley either anchored to the sea bed or attached to the shore on the line of lay is used for forward progression, one end drawing the bottom section of the washing-in pipe, and the other end drawing the ships. The lower section of the washing-in pipe is also guyed to the ship or barge. The top end of the washing-in pipe is not attached in any way to the ships as this arrangement is found to facilitate steering and movement and obviates strains on the pipe. The ships are held on the correct line of laying by means of fore and aft anchors, which are taken through winches to allow the correct course to be maintained.

The normal procedure for cable laying using this process consists of :—

- (a) A survey and an examination on site with tests of the river or estuary bed.
- (b) Preparation of a detailed plan.
- (c) Sailing of ships to site.
- (d) Loading cable on auxiliary barge.
- (e) Test excavation, during which the ship will proceed over the actual route and cut a trench, but will not actually lay the cable. Any obstacles encountered during the test process will be removed by raising or blasting.
- (f) The actual laying of the cable using the procedure previously described.

Advantages and Capabilities of Plant.

The scheme has many advantages over other methods of laying. The cable is not under mechanical strain during the laying process and is fed easily into the ground through the feeding channel; the depth under the sea or river bed can be continuously controlled and adapted to requirements in the section concerned and the cable is continuously laid before silting up of the trench occurs, a serious problem when using normal type dredgers. The trench excavated is

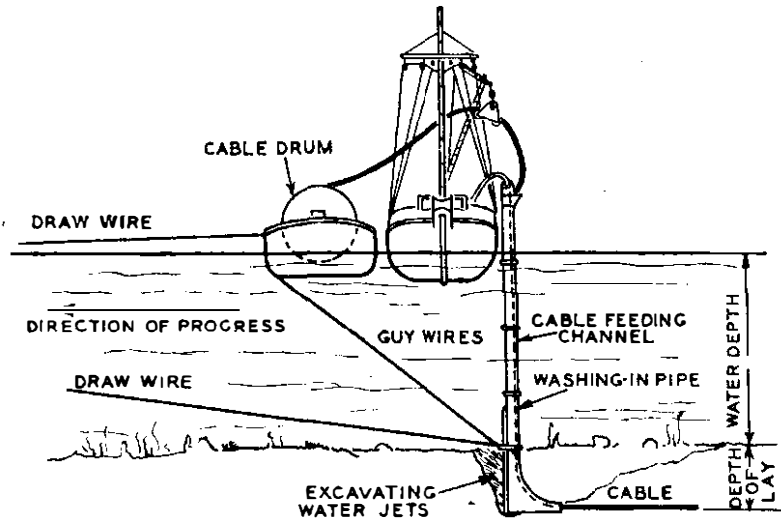

FIG. 4.—POSITION OF SHIPS, PIPE AND CABLE DURING LAYING.

an extremely narrow one of 6 to 12 in. in width, which facilitates silting up and covering of the cable; the use of divers to place the cable in the trench is thus avoided.

Table 1 gives some indication of the amount of cover which is obtainable under various river and sea bed conditions.

TABLE 1

Type of Bed	Classification for Washing-in Process	Actual Formation of River Bed	Depth of Washing-in possible
CLASS I Loose	Easy	Soft mud, very loose river sand	Up to 16 ft.
CLASS II Medium soft	Good	Very soft clay, peat, mud, clayish sand and fine gravel up to ½ in.	Approx. 13-16 ft.
CLASS III Medium heavy	Medium	Hard, sandy mud and medium gravel up to ¾ in.	Approx. 10 ft.
CLASS IV Solid ground	Heavy	Close hard mud and loose gravel up to 1 in.	Approx. 10 ft.
CLASS V Very heavy ground	Washing possible	Very hard mud, large gravel over 1 in. with stones up to 2½ in.	Approx. 6 ft.
CLASS VI Rock and stone	Only possible after preparation and removal of major obstacles.	Marl rock, very tight dry clay	Up to 6 ft.

In Class VI explosives are sometimes used to clear large rocks and loosen the ground, but for solid rock, of course, and with very large stones the process is not a practicable one. The ships are fitted with diving equipment and diving is resorted to in order to clear obstructions.

The greatest depth to which the washing-in pipe can be extended is 72 ft., which, allowing, say, 12 ft. as the depth the cable is to be buried under the river or sea bed, gives a margin of up to 60 ft. to cope with water depths during laying operations. There is no restriction on the length of cables which can be continuously laid, but the greatest length the particular

firm concerned has yet had experience of is approximately 7 miles.

The speed of laying is dependent on various factors, such as the depth of water and the consequent resistant pressure at the river or estuary bed and the type of ground involved. Under favourable conditions the maximum speed of laying reached is about 1 yard per minute.

Cables must be laid singly and cannot be laid together, but navigational control is so good that it is normally possible, even under the most difficult conditions, to lay cables safely within 10 or 12 yards of each other. The largest cable laid using this process is one of approximately 5½ in. diameter.

It may be interesting also to note that the apparatus can be adapted with a special type shoe to recover cables previously laid out and embedded

under silt, whether they have been laid under this process, or have been covered by normal siltage. The same principles apply for clearance of the silt as for cutting a trench but in this case, of course, the cable has to be taken up from the leading edge by the shoe. This facility makes possible excavation of the cable in the unlikely event of faults occurring.

The Rhine Crossing.

For the Düsseldorf cable crossing of the Rhine, everything was in readiness by the end of June 1946, but, successively, faults in the ships' equipment and difficult weather conditions delayed arrival from Hamburg and they finally reached Düsseldorf on the 18th of July. The cable for the first crossing was loaded into the auxiliary barge on 25th of July and was taken from Düsseldorf harbour to the point just North of the Skaggerak bridge, where the crossing was to be made. During the last week of July work commenced on the trial washing excavation. It was found, however, that due to unforeseen conditions the crossing was not immediately possible. Silting behind destroyed sections of the original bridge lying in the water made excavation to the depth required impracticable, if the cable were to remain protected when these underwater obstructions were subsequently removed and the sand banks behind them washed away by normal erosion. Use of a bucket dredger was therefore called for and a channel cut in the sand banks concerned. The dredger was employed on this work from 2nd to 15th of August.

On the 22nd of August, 1946, the trial washing, using the special apparatus, was again commenced and this time successfully completed. On the 24th of August the actual crossing and laying of the cable was carried out.

Fig. 5 shows the ships and all equipment at the finish of the laying operation. The boats have at this stage moved round to an end-on position and are out of their normal laying position.

The cable was 166 pr., 1.9 mm. conductor air core multiple twin with lead sheath and tape armouring of

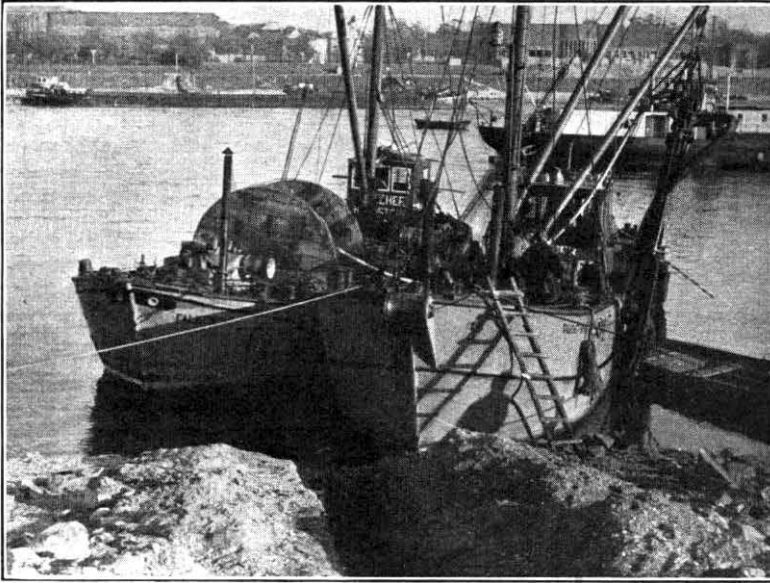

FIG. 5.—SHIPS AND ALL EQUIPMENT AT END OF LAYING OPERATIONS.

overall diameter approximately $3\frac{1}{2}$ in. (9.2 cms). The total length involved was 428 yards.

Direction of the lay was from the East to the West bank of the river. The river bed in normal section was found to be of sand and heavy gravel. The depth of excavation below the normal bed level was between 8 ft. and 10 ft. throughout, the actual depth of water varying between 7 ft. and 24 ft. Laying of the cable in the excavations at shore ends was carried out by a diver from the ship on the 25th of August.

The flow of the river was considerable at the time, but in spite of that the laying was completed without difficulty and the cable was found to be in perfect condition when tested by the Reichspost.

Conclusions.

The scheme unquestionably gives added protection

to cables laid across estuaries and waterways. In Germany, this is a factor of very great importance in view of the extensive use of such waterways for shipping and also the amount of icing which occurs during the winter months and which, in the case of a river having the flow of the Rhine, Elbe or Weser, might result in considerable damage to cables from ice floes.

Under such conditions before the war, the Germans found it economical to maintain four cable ships with this type of equipment and four portable equipments for operation from rafts or platforms built out over the river or estuary. The ships are, of course, quite small ones of about 100 tons displacement and have crews of 6 to 8 men, so upkeep cost would not be abnormally high.

The firm concerned also had a considerable interest in salvage and other diving operations.

It appears questionable whether the process could be applied economically in Great Britain in view of the different climatic conditions and the restricted use of inland waterways by shipping. The system would appear to be one worthy of investigation, however, particularly for use in the vicinity of some of the major ports. The facility of recovering existing cables which have become silted in the ground might also be one which would add justification to the provision of at least one ship for use in Great Britain.

Acknowledgments.

The actual laying described was carried out by the firm of Alwicks Harmstorf using the AEG-Harmstorf process, and acknowledgment is made to this firm for the assistance given in the supply of information for this article.

Book Review

"Micro-waves and Waveguides." Professor H. M. Barlow. Constable & Co., Ltd. 122 pp. 70 ill. 15/-.

This book is essentially a re-statement of the elementary theory of the propagation of electromagnetic waves in rectangular and cylindrical waveguides; most of the book is in fact devoted to this subject and the more practical aspects are dealt with only briefly. Since there are already several British and American text books which deal adequately with the elementary theory it may perhaps be wondered whether there is a real need for the present volume.

The book would have been more valuable to telecommunications engineers, for whom according to the preface it is particularly intended, if the scope had been extended in the practical direction. For example, the effects of surface irregularities and bends in waveguides, which are likely to play a very important part in determining the

feasibility of waveguides for long-distance telecommunication systems, are not discussed. Techniques for the amplification of microwaves are not referred to, although there is some discussion of the generation and detection of such waves.

On the credit side it may be said that the theoretical treatment is thorough within the narrow scope defined above and is suited to the needs of a student requiring an introduction to this side of the subject. The treatment of the coaxial line as a special case of the cylindrical waveguide is a useful alternative to the usual approach via transmission line theory.

Engineers using the book will need to note carefully that the non-rationalised M.K.S. system of units is employed, as compared with the rationalised M.K.S. system with which they are more likely to be familiar.

W. J. B.

Boat Race Television Broadcast

B. H. MOORE

U.D.C. 621.397.743

On the 26th March, 1949, an important television outside broadcast was made by the B.B.C., when the Oxford and Cambridge Boat Race was televised from start to finish. The whole of the broadcast passed over the Post Office cable network, and this article gives a brief account of the arrangements made to provide the necessary links.

Introduction.

THERE are certain centres of entertainment where sufficient events of television programme value are held for the B.B.C. to rent a special circuit. The cable used for such circuits may be Siemens balanced pair cable¹ or the more modern coaxial cable. When, however, a circuit is needed once only, or on relatively few occasions, it is usual to provide it by using junction cables and subscribers' local distribution cables in association with special wide band amplifiers and equalisers. The technique for using telephone cables to transmit television signals has been described in a previous article.²

The cables may be of any one of several gauges of copper: 6½ lb.; 10 lb.; 20 lb., and the maximum repeater length for each is shown in Table 1.

TABLE 1

Conductor Gauge	Maximum Length in Miles	Maximum D.C. Resistance	db./mile	
			100 kc/s	3 Mc/s
6½ lb.	0.75	202	14	80
10 lb.	1.25	220	8	55
20 lb.	2.0	176	4.5	34

However, a cable cannot be assessed for television transmission in terms of mileage, D.C. resistance and loss. The use of such a wide frequency range makes it necessary to pay special attention to interference of various kinds, and the signal/noise ratio assumes great importance.

Although it has been possible over the last three years to build up a record of useful data for a large number of the junction cables which assists in the routing of circuits, special problems were involved in providing the line network for the recent Boat Race television broadcast, as will be realised from the following description.

The O.B. Line Network.

The network shown in the diagram of the course (Fig. 1), apart from the Putney link, comprised line links that had not previously been used for television. It was, therefore, necessary to spend a considerable amount of time on survey and preliminary measurement work.

The details of the four links used are given in Table 2.

¹P.O.E.E.J., Vol. 30, p. 215.

²P.O.E.E.J., Vol. 40, p. 33.

Repeater and Switching Arrangements.

In addition to the four fixed television camera positions shown in Fig. 1, the B.B.C. had a camera mounted in the bows of the launch, *Consuta* (Fig. 2), which followed the race throughout.

The signals from the camera on the launch were relayed by the B.B.C., using a 25W 52.5 Mc/s radio transmitter, to one of the three radio receivers located at the camera positions serving links 2, 3 and 4. Three receivers were necessary as the radio signals from the launch were seriously attenuated by the bridges over the river.

Since there was only one video circuit from each of these three camera positions to Broadcasting House, the choice between sending the pictures from the *Consuta* or from the camera on the bank of the river had to be made locally by B.B.C. staff. Only at the start when the boats were within range of the camera at Putney Bridge was it possible to send pictures from both the *Consuta* and a camera on the river bank to Broadcasting House.

It will be clear from the diagram that while change-over from Link 1 to Link 2 could be effected at Broadcasting House, subsequent changes from Link 2 to Link 3 and from Link 3 to Link 4 had to be made at Riverside and Chiswick exchanges respectively, on cue signals from the B.B.C. at the camera positions. In considering the switching arrangements, at first it appeared necessary to make the cable characteristics of the two legs beyond the switching point identical by

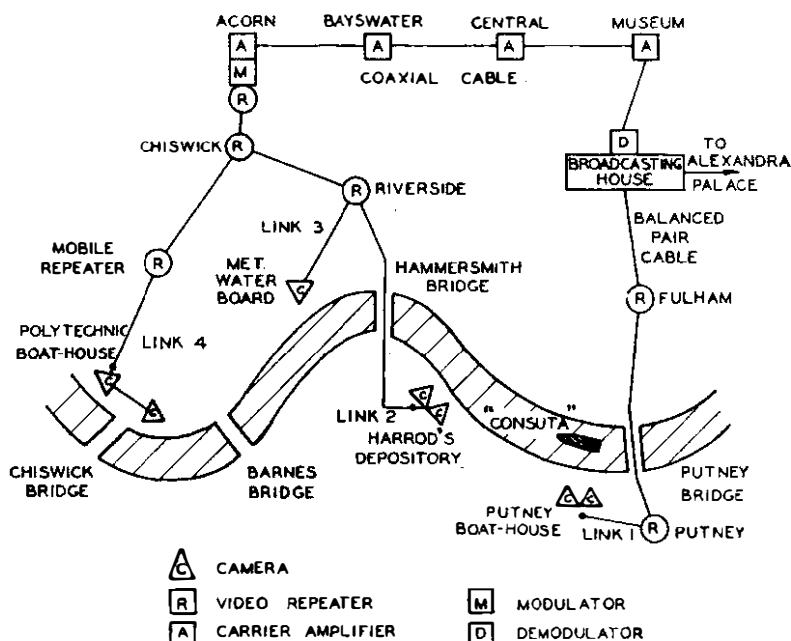

FIG. 1.—SCHEMATIC DIAGRAM OF LINE NETWORK.

TABLE 2

Link	Outside Broadcast Site	Local Cable	Junction Cable	Balanced Pair Cable	Coaxial Cable	Video Repeaters
1	Putney Boat House	Boat House to Putney Exchange	Putney Exchange to Fulham Exchange	Fulham Exchange to B.B.C., Broadcasting House		Putney Fulham
2	Harrods Depository	Harrods to Riverside Exchange	Riverside Exchange to Chiswick Exchange Chiswick to Acorn Exchange		Acorn Bayswater Central Museum B.B.C., Broadcasting House	Riverside Chiswick Acorn
3	Metropolitan Water Board	Metropolitan Water Board to Riverside	As Link 2		As Link 2	As Link 2
4	Finish—Polytechnic Boat House	Boat House to Staveley Road Staveley Road to Chiswick Exchange	Chiswick Exchange to Acorn Exchange and route of Link 2		As Link 2	Repeater in Post Office van at Staveley Road and using Chiswick and Acorn Repeaters as Link 2

inserting in one a network simulating the difference between the two. Tests showed, however, that simulators were unnecessary as the picture deterioration on switching was negligible and only a very small adjustment of the equalisers was required.

Owing to the length of cable between the Chiswick Boat House and Chiswick exchange it was necessary

requirements was at a road junction and it was necessary, therefore, to fit the repeater in a van which could be moved on completion of each day's testing. A 12-ft. pole was erected temporarily in the grass verge and the incoming and outgoing cable pairs were terminated on terminal blocks 10 ft. from the ground. Separate feeds and terminal blocks were provided to ensure that the outgoing signals from the repeater were not fed back into the low level input circuits. With the ready co-operation of the Supply Authority an A.C. supply was led from a nearby distribution pillar and terminated by a watertight socket fixed to the pole.

Fig. 3 shows the pole with the separate cables, the distribution pillar, the van housing the repeater, and a mobile generating set provided as a standby to the A.C. mains. The ladder supports a dipole aerial for a television set receiving the B.B.C. transmission. This enabled the staff of the van to see when the circuit through their repeater was carrying a "live" broadcast.

Circuit Tests.

Early tests were entirely satisfactory but, as happens often in work for special events, a difficulty arose later. In this case trouble was caused by unwanted radio signals which suddenly appeared in the circuit, being picked up by a number of spans of open wire, which were connected to pairs in the cable carrying the video circuit. These radio signals had no effect on the normal telephone circuits but made conditions impossible for the satisfactory transmission of television.

Alternative routing being impossible, the difficulty was met by the provision and installation, at short notice, of a rising gain amplifier. This amplifier raised the input to the cable from 2V to 4V (double amplitude peak) with an increasing gain towards the H.F. end of the band. With the equalisers re-set the ratio of signal to the interference was quite satisfactory and this link proved to be at least as good as the others.

An important repeater point on the circuit was at Acorn exchange and the equipment used is shown in



FIG. 2.—THE *Consuta*, SHOWING TELEVISION CAMERA AND PORTABLE RADIO TRANSMITTER.

to insert an intermediate video repeater in the fourth link. Some difficulty was experienced in finding a suitable location immediately over the route of the cable, within the desired limits of distance from the ends of it, and having a frequency controlled A.C. supply readily available. The only position meeting these

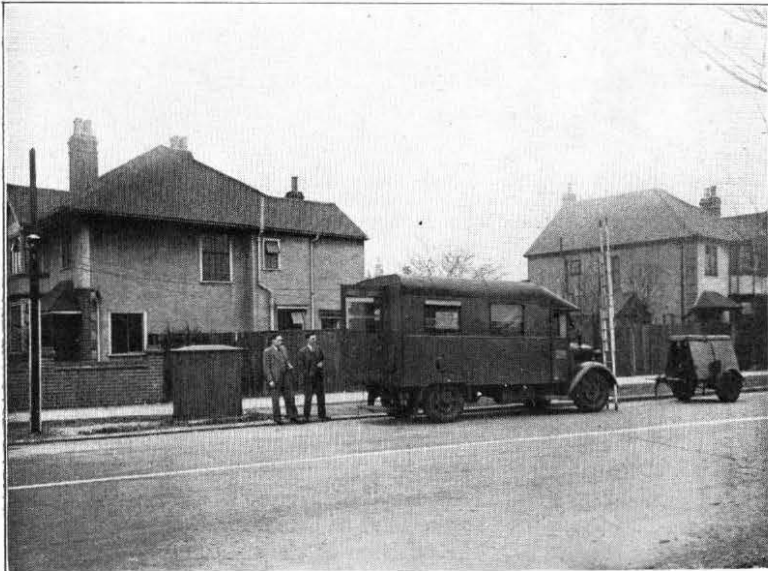

FIG. 3.—THE "MOBILE" REPEATER STATION AT STAVELEY ROAD.

Fig. 4. Here the final repeater was fitted for the three video links, Harrods, Metropolitan Water Board and Polytechnic Boat House. The output from the video repeater passed into the modulator for the coaxial link, Acorn, Bayswater, Central and Museum exchanges, where carrier amplifiers are fitted. The modulator accepts a video signal at standard level (1 V D.A.P. into 75 ohms) to produce a double sideband signal in a frequency band 4 to 10 Mc/s with carrier at 7 Mc/s.

After setting up the circuits comprehensive tests were made with the B.B.C., which culminated in full dress rehearsals on the two days preceding the race.

It is satisfactory to record that the broadcast was generally considered to have more than justified the preparatory work.

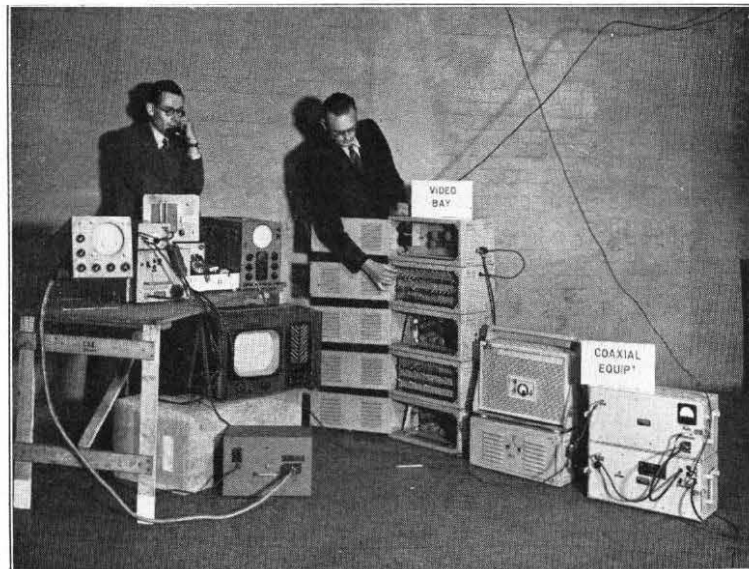

FIG. 4.—EQUIPMENT AT ACORN EXCHANGE.

Acknowledgments.

Sincere thanks are due to the B.B.C. for providing the photograph of the launch *Consuta* and to the Engineers of the B.B.C. Design Section who gave the fullest co-operation in testing the circuits, the Headquarters Branches of the Post Office, who assisted with the coaxial link, and the staff of the London Telecommunications Region, who worked so loyally on the many late evenings.

Thanks are also due to the Area staffs who so willingly assisted in providing the local connections at the O.B. sites and to the Supply Authority who provided the main supply.

Book Review

"Electrical Measurements in Theory and Application."
A. W. Smith, Ph.D. 371 pp. 250 ill. McGraw Hill. Price 25s. 6d.

In presenting the fourth edition of this book the author has re-written much of the text to clarify portions and to bring the text up-to-date. It should be said at once, for those not familiar with the earlier editions of this American work, that it deals with measurements almost wholly from the theoretical standpoint. It is therefore a book for the student rather than for the apprentice, and for the student whose mathematics includes elementary calculus.

The ground covered in the D.C. section includes the use of ammeters, voltmeters, wattmeters, potentiometers

and the usual forms of bridge, followed by two chapters dealing with magnetic measurements. Finally, a series of chapters deals with the measurement of capacitance and inductance and with A.C. ammeters, voltmeters and wattmeters. Each section is preceded by an excellent outline of the theory on which the measurements are based so that the book is really an introduction to electrical engineering rather than solely a textbook on electrical measurements.

The fact that a textbook has reached its fourth edition is, in itself, proof that it fills a definite want and that any major points of criticism have been met. The present work is no exception.

H. L.

The Wire Rope Traction Drive

R. S. PHILLIPS, M.I.E.E.

Part I.—Methods of Roping; Tractive Force; Coefficient of Friction

U.D.C. 621.876 : 621.853

Part 1 of this article gives an introduction to the wire rope traction drive as used on most types of lift. The various methods of roping are explained and important features such as tractive force, coefficients of friction and sheave groove shape considered. Part 2 will include details of rope construction, lubrication and stresses and discuss factors of safety and the effect of speed.

Introduction.

THE wire rope traction drive is employed mainly for lifts and hoists and in its simplest form is illustrated in Fig. 1 (a). Power is applied to the sheave and the drive depends for its

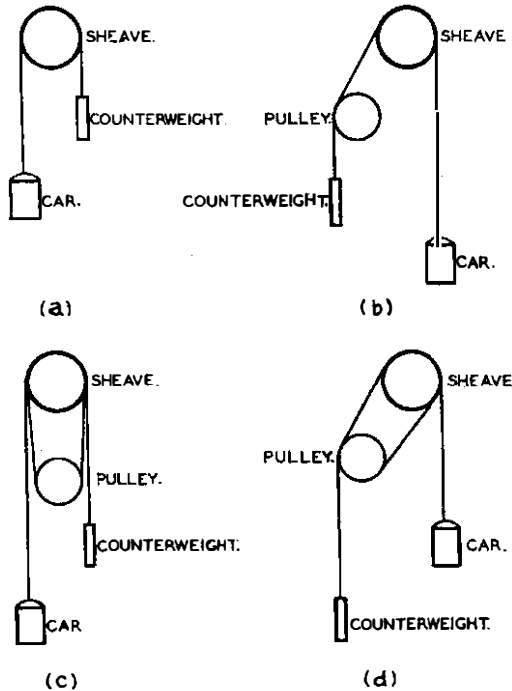

FIG. 1.—TYPES OF ONE-TO-ONE WIRE ROPE TRACTION DRIVE.

action on friction between the rope and the sheave groove. The size of the machine is independent of the height of rise, the roping is simple and, as the tractive force ceases immediately the car or counterweight reaches the bottom limit of travel, an important safety feature is provided as there is no possibility of overwinding. Because of these advantages over the drum machine the traction drive is now used almost exclusively on all types of lift. These operate at speeds up to about 600 ft. per minute in this country and up to 1,200 ft. per minute in America.

For the same reasons the Koepe winder, which is a wire rope traction drive similar in principle to that illustrated in Fig. 1 (a), is being used in increasing numbers for mining work in preference to the various types of drum drive which have been employed for many years. The Koepe machine is used particularly for winding heavy loads from great depths and shafts are being worked at present in this country and on the Continent at depths as great as 5,000 ft. The maximum speeds employed are 3,900 ft. per minute for mineral

winding and 2,300 ft. per minute for men winding with pay-loads up to about 20 tons.

Methods of Roping.

The roping shown in Fig. 1 (a) is known as single-wrap or half-wrap, as the ropes wrap the sheave for approximately 180° and pass from the car over the driving sheave to the counterweight. The number of ropes employed may be as many as six or even eight, depending on the load to be raised. When the size of the well or the position of the sheave will not permit of the arrangement shown, one or more idle pulleys may be used as in Fig. 1 (b). These pulleys do not transmit power but merely change the direction of the ropes.

The tractive force may be increased by using a double-wrap or full-wrap drive as in Fig. 1(c), which employs an idle pulley under the sheave thus giving a total rope wrap of approximately 360° . The ropes pass from the car over the sheave, around the idler, again over the sheave and thence to the counterweight. The load on the sheave is therefore double that with a single-wrap drive. The ropes may also be changed in direction as in Fig. 1 (d). All drives in Fig. 1 are known as one-to-one drives because the speed of the car is the same as that of the sheave.

For large capacity lifts it is sometimes desirable to remove some of the load from the sheave bearings and to do this the drive shown in Fig. 2 is used. The ropes

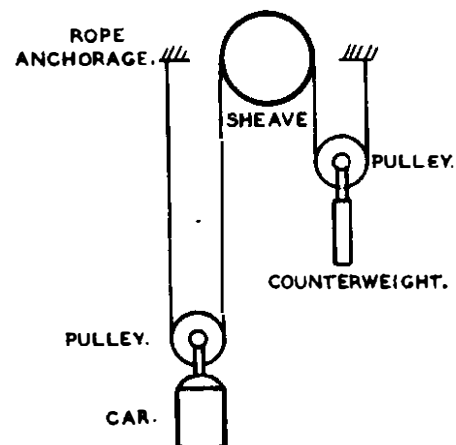

FIG. 2.—A TWO-TO-ONE DRIVE.

pass from an anchorage in the building structure, around an idler fixed to the car, around the sheave to an idler on the counterweight and thence to another structure anchorage. This results in a car speed of half that of the sheave and permits the use of high-speed variable voltage equipment for low car speeds.

One disadvantage, however, is that the reverse bends in the ropes result in a short rope life. Additional idlers may be employed, when necessary, to lead the ropes from the sheave into the well. This two-to-one drive may also be used with the full-wrap roping system.

Where possible, the winding machine is situated above the well as in Figs. 1 and 2. This position results in simple roping and the loads on the overhead structure are usually smaller than when the machine is below the well. This latter arrangement is shown in Fig. 3 and it may be modified when necessary to full-

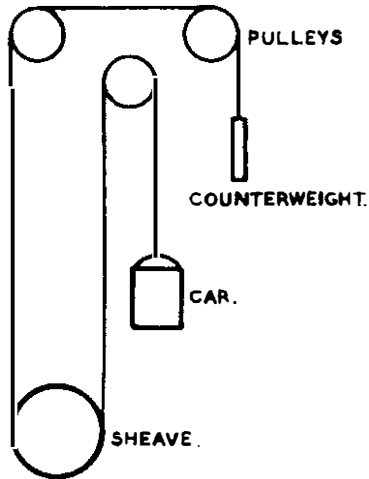

FIG. 3.—HALF-WRAP, ONE-TO-ONE DRIVE WITH MACHINE BELOW WELL.

wrap or to two-to-one roping similar to the overhead drives.

In mining applications the drive is single-wrap, one-to-one with an idle pulley on the outside of the rope thus giving a wrap of about 220° as in Fig. 4.

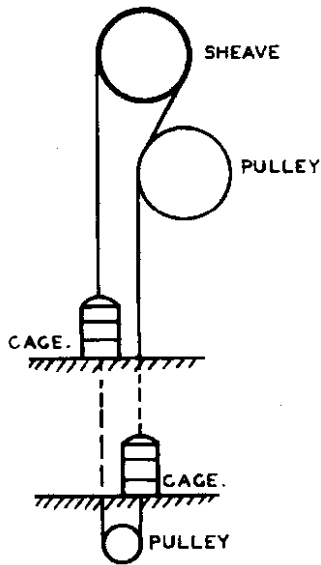

FIG. 4.—A DRIVE SUITABLE FOR MINING APPLICATIONS.

This arrangement is necessary because the sheave may be as large as 30ft. diameter. In the drive illustrated,

the equipment is directly above the shaft and is supported on a tower structure which may be as high as 150 ft. Alternatively, in the ground Koepe drive, the winding sheave is at ground level about 150 ft. from the shaft head and diverting pulleys are one under the other, directly over the shaft and in a tower about 150 ft. high.

Tractive Force.

(a) *U Groove*.—The maximum tractive effort is determined by the relative tensions on the two sides of the sheave when the ropes begin to slip in the grooves. This maximum value depends upon the tension in the tight side, which is limited by the economic strength of the rope, and on the permissible tension in the slack side which is limited by frictional properties. If the tensions¹ in the tight and slack sides are T_1 and T_2 respectively, the relation between these tensions is expressed by the formula

$$T_1/T_2 = e^{\mu\theta}$$

where μ represents the coefficient of friction between the rope and the sheave and θ the angle subtended at the centre by that portion of the rope in contact with the sheave, i.e. the rope wrap. This formula is quoted in most Applied Mechanics text books² and although it has been accepted for many years, opinion is divided as to its correct application.

(b) *Vee Groove*.—In many lifts the rope lies in a Vee groove as shown in Fig. 5 (a) and as friction occurs on

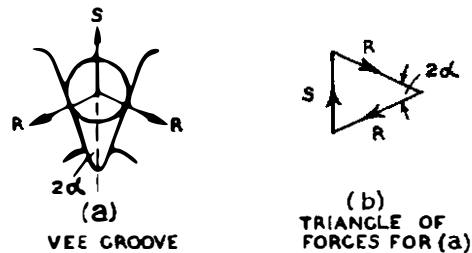

FIG. 5.—FORCES ACTING ON ROPE IN A VEE GROOVE.

two surfaces the resistance to slipping is greater than when the rope is in a circular groove. In an element of the rope the resistance to slipping is μR on each side of the Vee, i.e. a total of $2\mu R$. From the triangle of forces in Fig. 5 (b),

$$S = 2R \sin \alpha$$

where 2α is the angle of the groove.

$$\text{Hence } 2R = S \operatorname{cosec} \alpha$$

and the elemental resistance to slipping is $\mu S \operatorname{cosec} \alpha$. The resistance to slipping in an element of the rope when in a U groove is μS and in the formula $T_1/T_2 = e^{\mu\theta}$ it will therefore be necessary to substitute $\mu \operatorname{cosec} \alpha$ for μ to make the formula applicable to a Vee groove. Hence for a rope in a Vee groove

$$T_1/T_2 = e^{\mu\theta \operatorname{cosec} \alpha}.$$

¹ R. S. Phillips, "Electric Lifts," Pitman, 1948.

² e.g. D. A. Low, "Applied Mechanics," Longman.

(c) *Double-wrap Drive*.—This is as shown in Fig. 6. With the tensions in the various ropes as indicated,

$$T_1/T_3 = e^{\mu\theta_1 \operatorname{cosec} \alpha} \text{ and } T_3/T_2 = e^{\mu\theta \operatorname{cosec} \alpha}$$

$$\therefore T_1/T_2 = T_1/T_3 \times T_3/T_2 = e^{\mu(\theta + \theta_1) \operatorname{cosec} \alpha}$$

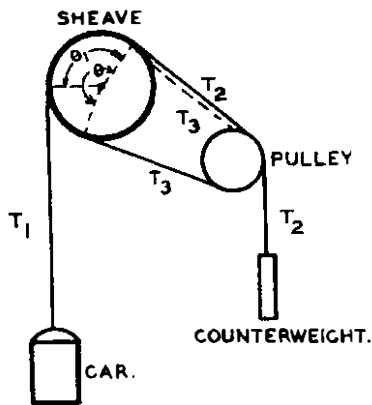

FIG. 6.— A DOUBLE-WRAP DRIVE.

It is clear from this equation that the maximum tractive effort with a double-wrap drive is greater than that with single-wrap.

Lindquist³ carried out practical tests with ropes on lift sheaves to determine values for T_1/T_2 and when the ropes worked in round grooves he obtained a maximum value of 1.56 and a minimum of 1.40. The maximum value was obtained with new ropes and sheaves and dry surfaces and the minimum value with worn sheaves, lubricated ropes, light tension and high speed. He considered that with light tension and high speed there was an oil film between the rope and the sheave and that the rope did not contact the sheave for 180° due to stiffness of the rope and centrifugal action. With a full-wrap drive the maximum value of T_1/T_2 was 2.43 and minimum value 1.96. These figures indicate a remarkable constancy of traction under such widely varying conditions.

Coefficient of Friction.

From the formula $T_1/T_2 = e^{\mu}$ it will be seen that for a given rope wrap the maximum ratio between the two tensions depends on the coefficient of friction between the rope and the sheave. To ensure a satisfactory drive this coefficient must be large enough to prevent slipping under the worst service conditions. This occurs during the period of maximum acceleration. If the weights of the car and maximum load are 2,000 and 1,600 lb. respectively, the weight of the counterweight will be assumed to be 2,800 lb. The average acceleration will be taken as 3 ft. per second per second and it will therefore be reasonable to assume that the maximum rate will be 6ft. per second per second.

(a) *If the car is empty,*

$$\frac{T_1}{T_2} = \frac{2,800}{2,000} \text{ during the steady velocity stage.}$$

³ D. Lindquist, "Modern Electric Elevators," *Trans. Amer. Soc. Mech. Engrs.* 1915, p. 705.

During maximum acceleration the accelerating force on the counterweight ropes

$$= \frac{2,800 \times 6}{32} = 525 \text{ lb.}$$

and the accelerating force on the car ropes

$$= \frac{2,000 \times 6}{32} = 375 \text{ lb.}$$

When the car is moving up, the tension in the car ropes

$$= 2,000 + 375 = 2,375 \text{ lb.}$$

and the tension in the counterweight ropes

$$= 2,800 - 525 = 2,275 \text{ lb.}$$

$$\text{therefore } \frac{T_1}{T_2} = \frac{2,375}{2,275} = 1.04$$

If the drive is double-wrap and $\theta = 300^\circ$ then from the formula $T_1/T_2 = e^{\mu\theta}$,

$\mu = 0.0075$ at the moment when slipping occurs (1)

Similarly when the car is moving down,

$$\frac{T_1}{T_2} = \frac{3,325}{1,625} = 2.04$$

$$\text{and } \mu = 0.136 \dots \dots \dots (2)$$

(b) *If the car is fully loaded,*

$$\frac{T_1}{T_2} = \frac{3,600}{2,800} \text{ during the steady velocity}$$

stage and when the car is moving up with maximum acceleration

$$\frac{T_1}{T_2} = \frac{4,275}{2,275} = 1.88$$

$$\therefore \mu = 0.121 \dots \dots \dots (3)$$

When the car is moving down

$$\frac{T_1}{T_2} = \frac{3,325}{2,925} = 1.13$$

$$\therefore \mu = 0.0234 \dots \dots \dots (4)$$

It will thus be seen that the tendency to slip is greatest when the empty car is moving down at maximum acceleration and to prevent slipping the coefficient of friction must exceed 0.136.

The effect of a car of heavier construction on the tendency to slip may be seen by repeating the above but substituting the car by one of 2,500 lb. in weight. When the empty car is moving down at maximum acceleration,

$$\frac{T_1}{T_2} = \frac{3,919}{2,031} = 1.93$$

$$\text{and } \mu = 0.126 \dots \dots \dots (5)$$

Hence the conditions for slipping are worse when the car is of light construction and in difficult cases it is necessary to give careful consideration to the value of the counterweight to ensure that there is no slipping during acceleration.

The above is not strictly correct as the coefficient of friction varies with the unit pressure between the rope and the sheave. The total pressure depends upon the values of T_1 and T_2 while the unit pressure depends on the rope construction, type of groove and the conditions of the wires and grooves. Values of μ for steel on cast iron are 0.17, 0.30, 0.34 and 0.35 for pressures of 125, 186, 260 and 390 lb. per sq. in. respectively. These values are for dry surfaces and are different if oil is present. In the design of traction

drives for mines the rope-to-groove pressures are usually limited to 200 lb. per sq. in., the pressure being calculated as

$$\frac{T_1 + T_2}{\text{Rope Diameter} \times \text{Sheave Diameter}}$$

and with normal accelerations of 3-4 ft. per second per second, endeavour is made to obtain a condition where μ does not exceed 0.2. Although this formula does not give the actual unit pressure it is sufficiently correct for pressure comparisons between various designs.

The results of laboratory tests⁴ carried out with steel wire ropes on cast iron sheaves indicate how the coefficient of friction varies with the rope tension, type of rope construction, size of sheave and shape of groove. With 6/7 Ordinary lay ropes* of 1 in. circumference in a 42° Vee-grooved sheave, tests were made with various rope tensions and the value of the coefficient of friction was calculated from the expression

$$T_1/T_2 = e^{\mu \theta \operatorname{cosec} \alpha}$$

On a 12 in. diameter sheave the value of μ varied from 0.098 to 0.124, with a mean value of 0.117, as the rope tension was increased from 175 lb. to 975 lb. When this rope was replaced by a Lang lay rope† of otherwise similar characteristics the corresponding range for μ was 0.111 to 0.124 with a mean of 0.123.

The same Ordinary lay rope in the round groove of a 12-in. sheave gave a mean value of μ of 0.174. The Lang lay rope in the round groove gave a mean of 0.157 for μ .

In all the above tests the ropes were lubricated and when the tests were repeated with dry ropes the following figures were obtained. In the Vee groove the ropes gave mean values of μ of 0.245 and 0.208 for Ordinary and Lang lay respectively. In the round groove means of 0.175 and 0.176 for Ordinary and Lang lay, respectively, were obtained. For a correct comparison of these coefficients for Vee and round grooves, however, it must be remembered that $\mu \operatorname{cosec} \alpha$ must be used for the Vee groove and μ for the round groove.

These tests indicated that μ increased slightly as the rope tension was increased and the value of T_1/T_2 was greater for the Vee groove than for the round groove. The value of μ varied very little with the type of lay but, as was expected, was smaller with lubricated ropes than with dry ropes. The coefficient of friction also decreased as the angle of the Vee groove was increased, e.g. with a Lang lay it was 0.123 and 0.110 in grooves of 42° and 54° respectively.

Grooves.

The grooves of all pulleys (these merely change the direction of the ropes and do not transmit power) are semi-circular in shape but this groove is also used for some lift traction sheaves which transmit power and for sheaves of mine winding machines. It might appear that such a groove, if it were made the exact size of the rope, would provide a large bearing surface

and thus give increased traction. Although theoretically correct, this condition cannot be maintained in practice as a new rope may be 1/16 in. over its nominal diameter and when nearing the end of its life may be 1/16 in. under size. If the size of this groove is made slightly less than that of the rope there would be binding on each side with consequent high local pressures and early rope distortion and failure. The only alternative round groove is one of diameter slightly larger than the rope diameter. Field and laboratory tests⁵ have shown that where the sheaves have grooves 1/16 in. larger than the rope diameter the life of the ropes is from three to four times as long as when the grooves are slightly smaller than the rope diameter. B.S.329 states that the radius of a round groove should be larger than the radius of the rope by 1/20 to accommodate ropes 5 per cent. over nominal size.

When used on sheaves this U groove has the advantage that pressures are not high enough to cause excessive rope wear but on the other hand the pressures are usually too low to ensure a value of μ that will be high enough to give adequate traction with a single-wrap lift drive. Consequently round grooved lift sheaves are only used with double-wrap drives.

The commonest form of lift sheave groove is Vee shaped, the included angle being between 35° and 42°; the Post Office standard for lift sheaves is 35°. This groove results in high pressures between the rope and sheave due to the wedging action and consequently higher values of μ . These values are sufficiently high to provide enough traction with single-wrap lift drives. Because of the high pressures there is a reduction in the life of the rope and hard ropes should be used. These high pressures serve to adapt the groove to the rope and after a short time the area of contact is greatly increased, thus reducing the wedging action and wear on the rope but with resultant loss of unit pressure, lower coefficient of friction and lower maximum torque. A new rope in an old groove may thus be severely damaged before it is formed to the shape of the groove.

In an endeavour to secure the advantages of both of these two main types of groove, other shapes have been used which are compromises between the U and the Vee. Some of these have the groove bottom undercut to relieve the pressure on the rope as shown in Fig. 7.

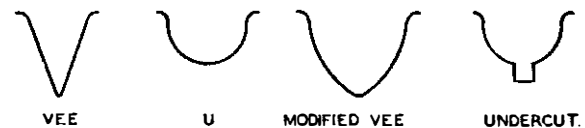

FIG. 7.—TYPICAL GROOVE SHAPES.

For lifts the grooves are turned in the rim of a plated type cast iron sheave and are unlined. Mining sheaves, however, are spoked and the grooves may be unlined cast iron or may have linings of wood, Ferodo, leather or aluminium.

The exact shape assumed by the cross-section of a

⁴ "Fifth Report of the Wire Ropes Research Committee," *J.I.M.E.* 1935, p. 373.

* Wires and strands twisted in opposite directions.

† Wires and strands twisted in same directions.

⁵ C. D. Meals, "Bending Stresses in Wire Ropes." *Trans. Amer. Soc. Mech. Engrs.*, 1929, Vol. 51.

rope when bent round a plain cylindrical drum does not appear to have been investigated but is clearly important in arriving at the correct shape of groove to support the rope. It is probable that to give equal radial support to all wires in the groove the shape of the groove should not be circular. Its correct shape to support the bent rope depends upon the diameter of the sheave, the rope construction, tension and other factors. If such a special groove could be turned for each set of conditions, however, wear would be minimised and the life of the rope greatly increased.

In practice it is important that the grooves should

substantially retain their original shape and so avoid slip. When the drive comprises more than one rope, as is usually the case, it is essential that the rope centre diameter be exactly the same for each rope. If, for example, one of the grooves is of slightly smaller diameter than the others due to inaccurate manufacture or wear, the rope in this groove will travel at a slower speed than the remaining ropes. It must, therefore slip in order to keep pace with the others with the result that both rope and groove wear rapidly.

The Institution of Post Office Electrical Engineers

ESSAY COMPETITION, 1948/49. RESULTS

Prizes of £3 3s. each and Institution Certificates have been awarded to the following five competitors :-

C. J. Williams, Technician, Exeter. "Telecommunications and the National Effort."

A. L. Deighton, Technician, Lincoln. "Television Power Supplies."

R. E. Beasley, Technician, Nottingham. "Time and Telephony."

H. F. Bentley, S.W.11 (A), Oxted. "Fitting the 500,000."

S. M. Creed, S.W.11 (A), Centre Area, I.T.R. "Some aspects of Internal Wiring of Buildings."

Institution Certificates of Merit have been awarded to :-

J. G. A. Wallace, S.W.11 (A), Southport. "The Radio Link as a solution to present-day Telecommunications Problems."

R. E. Pugsley, S.W.11 (A), Cardiff. "Physiological Acoustics."

Miss M. M. Jeans, D/O. Asst., Cardiff. "The G.P.O. Engineering Training School—Welsh and Border Counties Region."

J. READING, Secretary.

N.B.—Particulars of the next competition, entry for which closes on December 31st, 1949, will be published later.

Institution's Library

Recent additions to the Library include the following :-

1788 *Statistical Quality Control*. E. L. Grant (American 1946).

A working manual whose object is to explain simple but powerful statistical techniques that can be widely used in industry to reduce costs and improve product quality.

1789 *Quartz Crystals for Electrical Circuits*. R. A. Heising (American 1946).

Deals with the development and manufacture of quartz plates for electrical circuits, with specialist treatment of particular phases of piezoelectric research and its engineering applications.

1790 *Chemical Thermodynamics*. J. A. V. Butler (British 1946).

An elementary introduction to the thermodynamical method in chemistry stressing the underlying principles and applications. Part II is concerned with the thermodynamical functions, energy, free energy and entropy, and their partial derivatives.

1791 *Ball and Roller Bearing Engineering*. A. Palmgren (American 1946).

Explains the fundamental principles of ball-bearing engineering. Covers common bearing types; forces and motions in bearings; the carrying capacity of ball and roller bearings; bearing selection; design of bearing applications; mounting and dismounting, lubrication and maintenance; bearing failures.

1792 *The Atom and its Energy*. Prof. E. N. da C. Andrade (British 1947).

Sets out to explain to the reader untrained in the physical sciences the broad principles involved. General elements of the atomic theory are so discussed, that the developments appear to be the inevitable outcome of an ordered body of investigation which has led to a more and more detailed knowledge of the atom and its structure.

1793 *Telegraph Transmission Theory*. E. H. Jolley (British 1947).

A treatment of telegraph transmission in a way suitable for students. Covers telegraph transmission; line transmission theory direct current; A.C. transmission theory; relations between steady state and transient conditions; electrical wave filters, transmission of A.C. telegraph signals; transmission requirements for telegraph switching systems.

1794 *An Introduction to Transmission Lines*. C. J. Mitchell (British 1946).

The treatment of this simple approach to a difficult and complicated subject is based on well-known fundamental laws of electrical engineering and gives a clear insight into R.F. phenomena.

1795 *The Metre-Kilogram-Second System of Electrical Units*. Sas and Pidduck (British 1947).

Information concerning the unitary metre-kilogram-second system of electrical units which was adopted by the International Electrotechnical Commission in 1938, is set out in accessible form in this book with a view to the wider use of the system in this country among students of physics and engineering.

1797 *Education for Management*.

Management subjects in Technical and Commercial Colleges. Report of a special Committee appointed by the Minister of Education to advise him on educational facilities required for management in industry and commerce.

- 1800 *The Common Sense of the Exact Sciences.* W. K. Clifford (British 1946).
A re-issue of Clifford's famous classic in which he purposes to explain modern scientific and mathematical thought to the uninitiated.
- 1804 *The Experimental Study of Structures.* A. J. S. Pippard (British 1947).
An attempt to encourage the more general use of small scale experimental work in the teaching of theory of structures. Covers theorems and methods; direct experimental methods; experimental applications of Clerk Maxwell's theorem; strain energy and distribution methods; experimental study of arches; experiments with sand.
- 1805 *Construction and Maintenance of Buildings.* J. O. Cave and R. A. Earthrohl (British 1947).
Particularly a subject of the moment dealt with in a practical manner and with the aid of suitable sketches clearly to illustrate the text.
- 1806 *Klystron Tubes.* A. E. Harrison (American 1947).
A clear introduction to the behaviour of klystron tubes bringing out the chief difference from that of older type tubes which do not involve transient

time effects. The theoretical basis for the electrical characteristics of velocity modulation tubes is thoroughly presented and data on the operation of klystron tubes, power supply considerations, and microwave techniques are given, to aid in the application of these tubes.

- 1807 *X-Rays in Research and Industry.* H. Hirst (British 1946).
The aim of this book is to deal with X-ray technique in a concise and practical way. Covers production of X-rays; properties of X-radiation; structure of crystals; methods of crystallographic examination; applications of the X-ray method; industrial radiography.
- 1808 *Iford Manual of Process Work.* L. P. Clerc (British 1946).
A very comprehensive and up-to-date book on photo-mechanical processes.
- 1809 *Mathematical Aids for Engineers.* R. W. Dull (American 1946).
Presenting the basic mathematical tools essential to higher mathematics.

W. D. Florence, Librarian.

Junior Section Notes

Middlesbrough Centre

A meeting was held on the 28th October, 1948, in an endeavour to infuse more enthusiasm into the activities of the centre and to bring it back to its pre-war standard. Consequent on this meeting the Committee arranged a programme for the remainder of the session as follows:—

4th December '48.—Visit to North Tees Power Station.

14th December '48.—Film Show (Open night to members and friends).

19th January '49.—"Metallurgy." F. Atkins, A.I.M.

17th February '49.—"Long Line Transmission." C. Allison.

10th March '49.—"Carrier Simplified." E. P. Smith.

12th and 16th March '49.—Visit to Kemsley House Newspaper Offices.

14th April '49.—Annual General Meeting.

Although the meetings were not too well attended the standard of the lectures and the following discussions was good. It is hoped and anticipated that a larger number of members will take a more active part in the Centre's activities next session. The Committee wish to make the activities of the Centre as interesting as possible so it is up to all members to take an active interest in the affairs of the Centre and to attend meetings whenever possible and take part in the discussions.

Officers for the 1949-50 session elected at the General Meeting are:—

Chairman: O. G. Prutton; *Vice-Chairman:* E. P. Smith; *Secretary:* J. Brown; *Assistant Secretary:* F. Fountain; *Treasurer:* A. Bonnier; *Committee:* D. Watson, J. C. Hall, J. L. Robinson, P. A. Bulmer, C. Allison, G. A. Buckle.

The Council of the parent Institution offer several annual prizes for the best papers read by members of the Junior Section and it is hoped that members will make an effort to enter for this competition. J. S. G.

Darlington Centre

The 1948-49 Session has been a success and it is hoped that the Centre will continue to receive the support of all the staff. The programme has been very varied and the

papers have been of a high standard and, with an average attendance of 75 per cent. of the membership at each meeting, the discussions have been lively and interesting. There is every indication that the enthusiasm shown this year will continue and even better results may be achieved next session.

The programme for the 1948-49 session was as follows:—

23rd November '48.—Film Show.

14th December '48.—"Electrical Reproduction of Gramophone Records." H. C. Naylor, A.M.I.E.E.

20th January '49.—Visit to Northern Echo Newspaper Offices.

15th February '49.—"Radar." R. Dodds.

17th March '49.—"Bridge Building." G. E. Thompson, A.M.I.C.E., A.M.I. Mech.E.

5th April '49.—"Television." A. V. Northall.

26th April '49.—"Multi-Channel V.F." D. Watson.

10th May '49.—Film Show.

By the time these notes are in print a General Meeting will have been held and the officers for the forthcoming session elected and the programme prepared.

To the Centre officers and members—many thanks for a good job well done and may that spirit of esprit de corps continue. J. S. G.

Sheffield Centre

After a period of inactivity, it is a great pleasure to announce that an inaugural meeting was held on the 18th February, 1949.

There was a good attendance and several Senior Section members were present to offer advice and assistance.

Officers and committee were duly elected as follows:—

Chairman: G. Grandfield; *Vice-Chairman:* W. B. Green; *Secretary:* G. Fearn; *Treasurer:* S. Shephard; *Librarian:* U. Leclère; *Committee:* L. Ward, J. Brown, C. J. Lund, R. Darbyshire.

The following programme, consisting of four meetings, was formulated to cover the remaining two months (March, April) of the session.

10th March '49.—"Some Comparisons of British and German Telecommunication Practice." A. M. Hunt.

(Continued on page 116)

Notes and Comments

Roll of Honour

The Board of Editors deeply regrets to have to record the deaths of the following members of the Engineering Department:—

Birmingham Telephone Area Cotterell, W. E... Skilled Workman, Class IIA .. Signalman, Royal Signals
 Birmingham Telephone Area Ford, P. M. .. Skilled Workman, Class IIA .. Signalman, Royal Signals

Recent Award

The Board of Editors has learnt with great pleasure of the honour recently conferred upon the following member of the Engineering Department:—

London Telecomms. Region. . Kennedy, D. B... Draughtsman, Class II Captain, Royal Signals Mentioned in Despatches

New Year Honours

The name of Mr. J. A. Dickson, Senior Draughtsman, North-Western Region, was inadvertently omitted from the New Year Honours list published in the last issue. The Board of Editors notes with pleasure his appointment as a Member of the Order of the British Empire and offers its congratulations.

Mr. G. F. O'dell, C.B.E., B.Sc., M.I.E.E.

Mr. G. F. O'dell, formerly an Assistant Engineer-in-Chief retired from the post of Director, Contracts Department, on 11th April after 40 years' service in the Post Office. Most of this period was spent in the Engineering Department, where many friends and former colleagues will remember with pleasure the contacts, official and otherwise, made with him throughout those years.

We extend to Mr. O'dell our best wishes for his health and happiness in retirement.

The new Director of the Contracts Department is Mr. A. G. Robertson and under his direction we look forward with confidence to a continuance of the cordial relations existing between our two Departments.

Editorial Appointment

Mr. W. A. Humphries has been appointed an Assistant Editor in place of Mr. F. Warren, who resigned owing to his transfer to the North-Western Region.

Errata

It is regretted that the following errors occurred in Vol. 42, Part 1, April, 1949:

The London-Birmingham Television Cable. In Fig. 8, p. 37, the values 73, 75 and 77, on the vertical axis of each part of the graph, should be 74, 76 and 78 respectively.

Unification of Screw Threads. In Fig. 3, p. 42, the American National Fine Series, No. 6, shown as 44 threads per inch, should be 40 threads per inch.

Correspondence on Nomenclature of Frequencies

The Managing Editor.

Sir,—Captain Booth, in your issue of April, 1949, has outlined a scheme and announced a policy which should, once and for all, do away with the superlative adjectives in the nomenclature of frequencies.

I would submit, however, that in the frequency chart (Fig. 1 in the article) the relative positions of the figures and the scale marks obscure the distinction between bands and "spot" points.

I enclose a revision of part of this chart in which I have attempted to emphasize this distinction by the use of horizontal lines.

Yours faithfully,

L. H. BAINBRIDGE-BELL.

Editor's Note.

The point raised by the correspondent is an Editorial matter, and we are pleased to publish his letter and reproduce below the chart which accompanied it.

BAND NUMBER	FREQUENCY IN c/s	WAVELENGTH IN cms	
	$3 \cdot 10^{15}$	10^{-5}	
15			
	$3 \cdot 10^{14}$	10^{-4}	
14			
	$3 \cdot 10^{13}$	10^{-3}	
13			
	$3 \cdot 10^{12}$	10^{-2}	
12			
	$3 \cdot 10^{11}$	10^{-1}	
11			MILLI-METRIC
	$3 \cdot 10^{10}$	1	
10			CENTI-METRIC
	$3 \cdot 10^9$	10	
9			DECI-METRIC
	$3 \cdot 10^8$	10^2	
8			METRIC
	$3 \cdot 10^7$	10^3	
7			DECA-METRIC
	$3 \cdot 10^6$	10^4	
6			HECTO-METRIC
	$3 \cdot 10^5$	10^5	
5			KILO-METRIC
	$3 \cdot 10^4$	10^6	
4			MYRIA-METRIC
	$3 \cdot 10^3$	10^7	
3			
	$3 \cdot 10^2$	10^8	
2			
	$3 \cdot 10$	10^9	
1			
	3	10^{10}	

This illustration will clarify any difficulty experienced in the interpretation of the chart published originally. Apologies are offered to readers and to the author for the obscurity referred to.

Regional Notes

North-Western Region

PNEUMATICALLY-DRIVEN MECHANICAL AIDS

A "Broomwade" 3-tool air compressor has been in use in the Liverpool Area for some time and has proved invaluable for the normal operations of concrete breaking, rock excavation and the like. Its use has recently been extended, however, to a more unusual type of work; unusual that is for this equipment, but unfortunately only too common in the lives of Post Office underground staff, namely, removing water from manholes.

There are a number of rather deep chambers in the city, one in particular some 25 ft. deep has been a source of considerable difficulty whenever it has been necessary to enter it. This manhole is situated at the lowest level of a 36-way duct track within a short distance of the Mersey estuary and acts as a sump for the surrounding district. On several occasions during the war the National Fire Service emptied the water from this manhole, using several different types of equipment.

The salt in the water had caused corrosion of the iron-work and renewal of the brackets became necessary. On removing the cover, water was found to be standing in the shaft to a point about 6 ft. below ground level. It was realised that a very large quantity of water had to be dealt with, not only that contained in this manhole but also that in the duct line and neighbouring manholes. This, then, was the opportunity to try out the recently supplied compressed-air-driven submersible pumps.

Some particulars of the type of pump may be of interest:—

The "Broomwade Type 3" pump is powered by an air-driven motor with four renewable blades and consumes

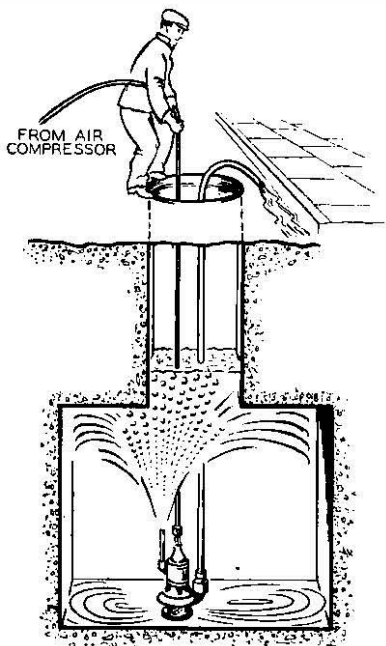

THE SUBMERSIBLE PUMP IN USE.

65/70 cu. ft. of air per minute at a pressure of 75 lb./sq. in. The motor is directly connected by a vertical spindle to the impeller of a centrifugal pump. The output of the pump, through a 2-in. hose, varies from 20 gallons per minute against 100-ft. head to 140 gallons per minute

against 5-ft. head. The complete pump is 30 in. long and 12 in. wide and weighs 68 lb.

Two such pumps were available; the compressor was run up, the pumps coupled to it and lowered into the manhole. Five and a half hours later the manhole was empty of water and working operations could begin. It was estimated that over 60,000 gallons of water had been removed. One pump left working in the manhole sump was sufficient to deal with the inflow of water and the "maid of all work", the compressor, supplied the power for pneumatic drills used to make fixing holes for new bearers.

The whole operation was completed in two days, which compares very favourably with similar jobs using petrol-driven suction pumps. The output of a suction pump from this depth would have been very small indeed and some days would probably have been required to empty the chamber.

An interesting sidelight on the working of the pump is that, the short exhaust pipe from the air motor being below the surface of the water for most of the time, there is considerable agitation of the water (it appears to be boiling very vigorously) and there is consequently a washing action on the manhole walls, cables and bearers while the pump is working.

G. H. P.

AINTREE (LIVERPOOL) CONVERSION

Aintree director exchange was brought into service at 1 p.m. on Saturday, 22nd January, 1949, when 2,662 exchange lines were transferred from Aintree manual,

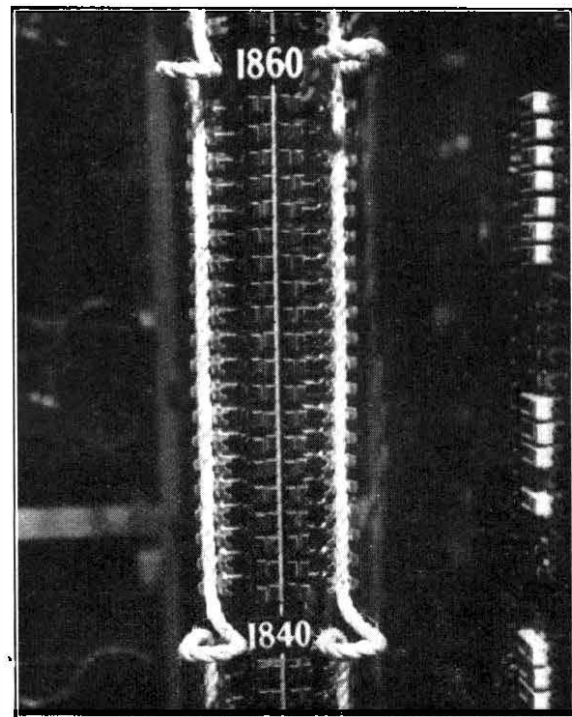

METHOD OF FIXING SASH CORD TO PROTECTORS.

C.B. No. 10, exchange. The new equipment, of the 2,000-type with multiple of 3,300, was provided and installed by Ericsson Telephones, Ltd. It is the first exchange in the Liverpool Area in which the new-type graded group selector racks have been provided together with a separate equipment I.D.F.

One novel feature used for the "cut-in" operation of the automatic equipment was the use of sash cord in the place of wedges. The Wedges, Locking No. 13, which have

superseded the Wedges No. 4, were not available and as experiments with Wedges No. 12 were not considered satisfactory it was decided to use sash cord. Two days before the transfer the Wedges No. 12 were replaced by lengths of sash cord of suitable diameter, one length being used for each vertical of the M.D.F. that had to be "cut-in." A bight was made in the cord between each protector mounting to allow for the easy withdrawal of the cord and the insertion of Wedges No. 12 for last-minute T.O.S.s, etc. The cords were secured at the top of the M.D.F. and a convenient length hung free at the bottom for the withdrawal procedure. At the "cut-in" signal the cords were withdrawn and the operation was very simple, but efficient. There were no faults due to bent springs or other causes which sometimes arise with the wedge method.

One further item which might be of interest was the extension of the meter circuit for the telephones provided for the traffic tests which were carried out from the old exchange. Each telephone had its corresponding meter



TESTING TELEPHONE SHOWING POSITION OF METER.

mounted by its side. This allowed the traffic staff to carry out their tests and check the metering condition simultaneously, a great advantage when checking multi-metering on junctions; also, there is a saving of the staff normally required at the automatic exchange for meter readings.

In addition, arrangements were made at the automatic exchange whereby the traffic-testing telephone circuits could be switched to uniselectors or first numericals as required. Consequently, the bulk of the post-transfer testing and a large amount of the pre-transfer testing were carried out with 4-digit dialling instead of 7-digit. Bearing in mind that some 25,000 test calls were made, including 3,000 post-transfer test calls, a considerable reduction in testing time was achieved. This facility is no new feature, but it is one which has not been used in the Liverpool Area to any extent before. As a result of the experience gained with the Aintree transfer, however, it is a facility which will be provided for future conversions where sufficient first numericals are available.

H. G. C.

London Telecommunications Region

OPENING OF KNIGHTSBRIDGE EXCHANGE

To relieve the waiting list in the Kensington area, a new director automatic exchange to be called Knightsbridge is in the course of construction in the Kensington building. For a number of reasons it has become desirable to give service to as many applicants as possible in advance of the completion of the automatic equipment later this year. Knightsbridge exchange was, therefore, opened on May 2nd on a manual basis using a suite of eight positions of P.M.B.X. 1A equipment situated in the Kensington switchroom. Since Kensington automatic equipment has insufficient common equipment to carry outgoing traffic and no spare first or second numerical levels for incoming traffic, other methods have had to be adopted.

For outgoing service, non-multiple junctions have been provided, terminating on first code selectors at the neighbouring exchanges of Bayswater and Victoria. The two routes are necessitated by a compromise between transmission requirements and common equipment capacity at the two exchanges. On receipt of a calling signal, subscribers are not challenged by the "A" operator who behaves purely as a human uniselector and gives the subscriber a line. The subscriber then dials his own calls and receives the same service as subscribers on the two exchanges. A suitable arrangement of the face equipment enables the operator to know which outgoing route to use for each subscriber.

Incoming service is entirely by tandem and toll exchanges, the code KNI being used by subscribers in the director area. These junctions are multiplied throughout the suite and use a modified private wire type of relay set, which retains the transmission bridge in the cord circuit to satisfy transmission requirements. It is unfortunate that KNI-KNI calls are routed via outgoing junctions and tandem exchange but, so long as outgoing calls are unchallenged, this is unavoidable. Consideration is being given to the provision of direct routes between Victoria and Bayswater exchanges and Knightsbridge.

Special arrangements have been adopted for "0", TOL, "999" and ENG calls which are, of course, received on the manual switchboards and test desks at Bayswater and Victoria exchanges respectively. On completion of the Knightsbridge automatic equipment, all subscribers' lines will be transferred without change of number.

A. B. C.

South-Western Region

GUERNSEY CENTRAL T.E. TRUNK SUITE

It is not often that the Department is called upon to install exchange equipment for other telephone administrations but it has recently fallen to the lot of the Bournemouth Area to assume the role of a "Contractor" and, in this capacity, to install a new trunk suite in the Guernsey Central T.E. in the Channel Islands.

It is perhaps not generally known that the Guernsey telephone system, together with those of the neighbouring islands of Alderney and Sark, is operated by the States of Guernsey Telephone Department. A similar condition exists in Jersey but the communications to the mainland, to France and between the four islands are administered by the Post Office.

The growth of telephone traffic in the islands since their liberation has led to the retention of the 6-channel radio link with the mainland, in addition to the 12-channel carrier submarine cable links, London-Guernsey and Guernsey-Jersey, which have recently been brought into service. The three existing trunk positions were quite inadequate for the additional circuits and the terminating

and call-timing equipment was not really suitable to obtain the optimum use of the circuits. The States Telephone Department were unable to cope with this job since they still had their hands full with the permanent restoration of their local plant after the ravages of the German occupation. Their usual contractors were also unable to offer any immediate relief and so the Bournemouth Area was called upon to fill the breach.

The first essential was naturally the survey, planning and estimating, which were carried out by the Area planning staff. Seven new trunk positions were designed, constructed and wired by the Factories Department, whose aid was also sought in the manufacture of the subscribers' and outgoing junction multiples. The former consisted of 2,600 lines on a six-panel basis while the latter catered for 60 lines and this was to be extended over eight positions including four angle sections.

The new O/G trunk multiple with free line signals and the I/C trunk answering jacks and the ancillary appearances were all provided by the Area.

The incidental work was considerable since it involved installing the chargeable time clock circuits, trunk-terminating equipment and an additional "A" position, and a small extension of 140 lines of subscribers' multiple and calling equipment. Since the new suite was to be continuous with the existing suite, there was a good deal of rearrangement work and this included the conversion of one of the three old trunk positions to a test and plugging-up position, and the T. and P.U. position to an "A" position. While the new local form was being made up for the latter modification opportunity was taken to make two additional forms, which were handed over to the States so as to simplify their task in converting the remaining two old trunk positions to "A" positions at a later date.

Despite stores delays and all the other ills that construction works are heir to in these difficult times, the job was carried out and brought into service in time for the season's traffic. All the work was done by fitters of the Area Internal Main Works Group who are to be congratulated on a "good show."

A similar job comprising an island suite of ten positions was planned and estimated for the Jersey Central T.E. but in this case equipment is being installed by the staff of the Jersey States Telephone Department. A. D. F.

USE OF DEWATERING PLANT AT LYNDHURST

The much needed widening of the Bournemouth-Southampton main road on the outskirts of the village of Lyndhurst in the heart of the New Forest is now in progress and the well-known raised footpath—a nightmare to motorists on account of the narrow roadway at this point—will disappear as a result of these operations. Before the road widening could be commenced, extensive alterations to the Department's plant were necessary. This plant consisted of a 2-way and 3-way duct line and associated manholes laid in the raised footpath, containing the Bournemouth-Southampton audio and carrier cables and three local cables.

The district is noted for its unstable subsoil, which consists of extremely fine waterlogged sand, and considerable difficulty was anticipated in the construction of a large non-standard manhole to replace two loading manholes located at the lowest level of the section of road concerned. Dewatering plant consisting of ten 12-ft. "well points"¹ had already been requisitioned from the Mechanical Aids Pool and these were held to be available immediately the alterations to the plant commenced, together with four Pegson Marlow 2-in. portable pumps

¹ P.O.E.E.J. Vol. 35, p. 1.

and the necessary "Y" pieces. The bulk of the work consisted of lowering and slewing the 2-way and 3-way duct lines, to give sufficient cover under the new road surface, and the services of the Highway Resident Engineer were in constant demand to give the new levels, particularly as the existing road surface was scheduled to be regraded. The average dimensions of the excavations for this work were 60 in. wide and 48 in.-60 in. deep and advantage was taken to lay a 4-way duct line in open trench at the same time.



GENERAL VIEW OF THE EXCAVATION.

Due to the road operations being planned to follow on immediately, the surveyor requested the filling of the excavation with over-sanded gravel flooded with water to hasten the consolidation and eventually agreed to the use of sand as this was the cheapest material available in the locality. Approximately 600 cubic yards of sand was needed for this purpose. In addition to constructing the non-standard manhole previously mentioned it was necessary to reduce the size of the shafts of three manholes and build a B.I.A manhole in lieu of a JF.6 box. This work presented little difficulty.

The two existing loading manholes to be demolished each contained two loading pots; one manhole was built of brickwork and the other of reinforced concrete. It was decided to leave the side walls of these manholes adjacent to the road extending for a distance of 18 ft. 6 in. in situ for retaining purposes as, due to the running sand, there was a danger of undermining the road.

The floor of the reinforced manhole was found to be constructed on corrugated iron sheets and, apparently due to pumping during construction, a cavity of 18 in. existed below the bottom of the floor. The brickwork manhole was of older construction but there was no evidence of difficulty being experienced during its construction, the floor being 6 ft.-8 ft. above that of the adjacent manhole and just above the ground water level.

The internal dimensions of the non-standard manhole were 16 ft. 4 in. × 5 ft. 6 in. × 7 ft. 2½ in. and the additional headroom, together with the extra depth required under the new road level necessitated an excavation of over 10 ft. which was over 3 ft. 6 in. below the ground water level.

Shortly after the floors of the existing manholes had been demolished the contractor found that it was impossible to carry out the excavation by ordinary methods, as after a short period of digging the men sank up to their knees and although having little faith in the use of the well points and reluctant to try them, expressed a desire for them to be used. Difficulty was at first experienced in sinking the well points, due partly to lack of experience and to insufficient water being available to start the well points sinking. From the description given in the published article it was thought that the well points would sink under their own weight directly the jetting commenced. This was not the case and assistance became necessary by pushing and turning the pipe until the triple gauze screen sunk below the surface; unless this assistance is given most of the water is lost through the back pressure operating the ring valve and escaping through the screen before becoming effective. Six points were eventually sunk around the excavation and after approximately two hours' pumping it became possible to work on firm sand. Ultimately eight well points were sunk and an attempt was made to work them from two pumps to reduce the noise made by the four pumps in operation together. This proved to be unsuccessful and after further experiments it was found that six well points served by three pumps were sufficient to keep the

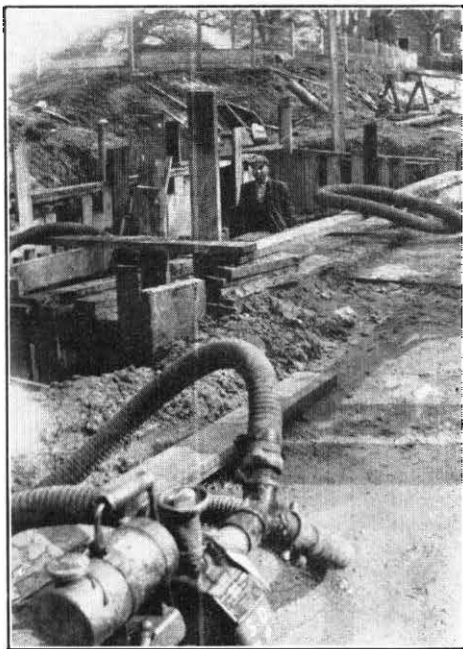

"WELL POINTS" IN USE DURING CONSTRUCTION OF MANHOLE.

water at the level required. Immediately after the floor had been laid and until the brickwork walls had reached a safe height it became possible to keep down the level of the water by using two pumps connected to four well points and these were in operation for the full 24 hours. Due to the high level of the ground on the field side of the manhole and the large disturbance of the soil at each end of the manhole, caused by the slewing and lowering, close shuttering was necessary, but even with this in use a

deposit of sand appeared on the floor of the manhole each morning and was caused by sand coming through the gaps between the runners.

Before the well points were used it was thought that, due to the fine sand, there would be a danger of undermining the surrounding ground as, when disturbed, the sand resembled a mixture of distemper, but the water emitted from the well points was as clear as that from the local water supply. The contractor was impressed with the action of the well points and asked for particulars with a view to purchasing a set, and the writer would like to see them used to a greater extent as for instance in wet situations where pole or stay holes require excavation.

E. W. N.

Home Counties Region

SPECIAL JUMPER RINGS

At Luton exchange, an old C.B. No. 1 type, it has been necessary to extend the M.D.F. by fitting fuse mountings on a wall some 6 ft. away from the original main frame.

This meant that some means of connecting circuits between the two parts of the frame had to be devised. Tie cables were not considered desirable or practicable because of lack of space and it was decided to provide facilities to enable jumpers to be run. A cable rack with centre vertical guides and vertical side members was erected between the two frames and a row of specially made jumper rings was fitted along the top of the old main frame. One ring was fitted per vertical on approximately 40 verticals in such a manner that the jumper wires could drop off correctly to the desired position for terminating.

The rings were made of mild steel rod, the fixing end being screwed to take two nuts, and the internal diameter of

rings was 8 in. A local garage proprietor, an excellent craftsman who delights in fashioning anything out of metal, made the rings and he had them covered with a black plastic material by a firm in the Midlands which specialises in manufacturing such items as motor vehicle steering wheels.

E. H. P.

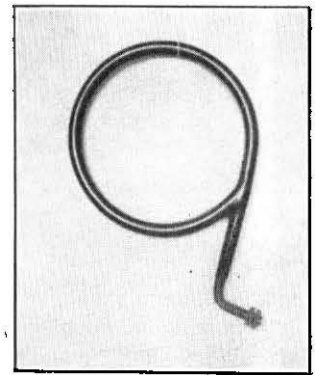

THE SPECIAL JUMPER RING.

"D" FOR DANGEROUS?

At mid-day on a day in September last advice was received from a lineman that tree-felling operations were in hand on the Lewes-Eastbourne road and the contractor had just reported that damage to the telegraphs might result. At this point the route, which is part of the original Brighton-Eastbourne trunk route, consists of 28/150 lb., 4/200 lb., and 4/70 lb. wires, supported on 32-ft. Stout poles. There being little time to organise safety measures, it was arranged to have a working party proceed to the site to deal with any breakdown which might occur. On arrival the foreman found the tree-felling operations too far advanced to allow of any safeguarding being effected, and therefore decided to stand by until the tree was down. During this time the poles on each side of the tree were tested by the foreman, that on the south side being classified "D." Below the ground line decay extended all round the pole to depths varying

between one and two inches, and above ground line the hammer test indicated that the pole was hollow. By this time the top of the tree had been sawn almost through, a rope had been fixed, the other end being attached to a tractor which was ready to move off. As the tractor gradually took the strain, it appeared that the tree would fall as intended, thereby clearing the roadway and overhead route. Suddenly, however, the rope snapped with the result that the tree top whipped back with great force, broke, and fell down across the main road, cutting through every wire on the route. The poles on each side of the break, set in the grass verge, held! Apart from a pole or two on each side needing re-setting, no other damage resulted.

The behaviour of the "D" pole was most unexpected. From the degree of decay below ground line and the suspected hollowness above, it seemed certain that it would break, when subjected to probably the severest strain which could be imposed on the pole. It was renewed prior to re-erection of wires and was found to be hollow for a height of approximately 6 ft. leaving a crust of about 4 in. of good wood. The diameter of the pole at ground line was 12 in.

SOME UNUSUAL U.A.X. No. 13 INSTALLATIONS

Normal Unit Automatic Exchange equipment No. 13 which was designed for a maximum of 200 lines has been used in varying forms in the Brighton Area to give service in accommodation which is different for every case completed recently. These alternatives have involved very little change from the normal working and have all been entirely satisfactory.

At Partridge Green equipment for 300 subscribers has been installed in a prefabricated concrete building B.1, size 16 ft. x 21 ft. The two main frame units are placed adjacent to one another so that jumpering is possible in the normal manner between the two units.

At Ardingly a normal U.A.X. 13 for 200 lines has been installed in a B type building, 10 ft. 6 in. x 19 ft., but the whole of the wiring between units has been in plastic insulated cable.

An existing U.A.X. 13 in B type building at Southwater has had an extended cable trench built and the existing A and C units moved without re-cabling, to allow a new C unit to be placed alongside the existing unit. Two additional A units were installed to make a total multiple of 300. The cabling to the new A racks and the existing junction B units has been in plastic cable because of the excellent results on the Ardingly installation.

Due to the site difficulties at Alfriston a complete 200-line U.A.X. has been installed in two vans, A and C units in the one, and B units and power plant in the other. These are 2-wheeled vehicles which are coupled to the motive power unit when they have to be moved, forming an articulated 6-wheeled vehicle. A further mobile U.A.X. No. 13 is now being cabled in two 4-wheeled trailers. The permanent exchange to replace the Alfriston mobile equipment is being planned and will be in a larger B.1 building, 14 ft. x 28 ft., which has to be of Sussex flint construction to harmonise with the local surroundings.

F. N. C.

Welsh and Border Counties Region

ERECTION OF STAINLESS STEEL AERIAL CABLE

The erection of some 3,000 yards of 28/20 stainless steel-sheathed "self-supporting" aerial cable over difficult terrain in the Neyland area provided a useful trial of this type of cable and revealed various peculiarities as compared with lead cable.

It was soon observed that one of the most important factors in the operations was to have complete control of the cable drum, since the cable has a tendency to unwind itself, similarly to a clock spring. Control was obtained by an improvised braking system, arranged with four Arms, Wood No. 13, which were clamped on the drum spindle by means of arm bolts. This effectively prevented the cable becoming loose on the drum and kinking.

The use of cable rollers was fairly satisfactory for erecting the cable. They were lashed at the bracket level on six poles. A hauling rope was then passed through to the cable which was pulled through and tensioned. Where an angle was involved it was found that the operation of pulling the cable through the roller was made rather difficult by the cable fouling; it is thought that if the roller could be secured at the top and bottom, this operation would be considerably simplified. Very little difficulty was experienced on angles, however, where the pull was away from the pole. The cable went through the roller, and when clamped left a perfect loop well clear of the pole. Where the pull was to the pole various difficulties arose. It was found that the stays did not give the necessary clearance and the question of making off the stays below the cable clamp appears to warrant consideration. It is suggested also that where the angle is less than 120° or pull on pole is more than 25 ft., the pole should be made a terminal pole and the cable jointed on the pole.

Some difficulty was experienced in one section of the line where two right-angled bends were necessary within the distance occupied by four poles. As a cable trailer was not available, it was decided to run out the cable far enough to reach the second angle and then manhandle the cable into position. This was a difficult operation due to the cable being so rigid and liable to kink.

Over the easier parts of the route a saving of 50 per cent. was made in labour costs as compared with erection of lead cable, and the finished job looks much neater.

F. C.

Scotland

OLD POLES

The systematic inspection of pole routes now being carried out has brought to light some interesting facts about 19th-century poles still in service in the Dundee Area. On an old telegraph route on the Perth-Kinross road, now used for subscribers' and junction circuits, every pole of a straight 2-mile section is supported by a strut and stay on the same side of the pole, to withstand the frequent high winds experienced during winter.

On examination, a fair number of the struts was found to bear the date 1872, the remainder bearing dates varying from 1879 to 1886. Some poles and struts bear no dates and it is thought that they may be of an even earlier date than those already mentioned. It is believed that soon after 1882 the route was blown down during a storm and that some of the original poles were re-used in their present capacity as struts. After years of service none of the poles and only nine of the struts show signs of decay.

The earliest record of circuits on the route is a pole diagram book issued in December, 1904, the circuits carried at that date being entirely telegraph and including Newcastle-Bergen, Glasgow-Dundee Anglo, Edinburgh-Dundee Eastern and London Foreign 72.

A technician who retired from the Engineering Department last year after 45 years' service was unable to say when the route was originally built but admitted that it was "long before his time."

D. Mc. K.

Staff Changes

Promotions

Name	Region	Date	Name	Region	Date
<i>Exec. Engr. to Asst. Staff Engr.</i>			<i>Prob. Engr. to Engr.—continued</i>		
Hough, F. A. ..	S.W. Reg. to E.-in-C.O.	1.4.49	Dafforn, D. G. ..	E.-in-C.O. ..	17.3.49
Salt, R. S. ..	L.T. Reg. to E.-in-C.O.	22.4.49	Chappell, A. J. ..	E.-in-C.O. to L.T. Reg.	31.3.49
<i>Exec. Engr. to Principal</i>			Haworth, W. ..	E.-in-C.O. to L.T. Reg.	31.3.49
Sulston, W. J. ..	E.-in-C.O. to Personnel Dept.	1.4.49	McDowell, E. ..	E.-in-C.O. to L.T. Reg.	25.3.49
<i>Engr. to Exec. Engr.</i>			de Wardt, R. H. ..	E.-in-C.O. ..	31.3.49
Renshaw, G. A. ..	E.-in-C.O. ..	3.4.49	Gordon, F. C. ..	E.-in-C.O. ..	14.4.49
French, E. J. ..	Scot. ..	17.4.49	Aucott, A. T. ..	E.-in-C.O. ..	8.4.49
Watson, L. R. ..	L.T. Reg. ..	10.4.49	Hickish, D. E. ..	E.-in-C.O. ..	14.4.49
Turtle, G. R. ..	W.B.C. Reg. to E.-in-C.O.	1.5.49	Marriott, P. E. ..	E.-in-C.O. ..	21.4.49
Horner, G. H. ..	E.-in-C.O. ..	10.4.49	Haynes, E. R. ..	L.P. Reg. ..	14.4.49
Brown, R. C. C. ..	S.W. Reg. ..	10.4.49	Dixon, W. ..	Mid. Reg. ..	21.4.49
Grant, C. G. ..	E.-in-C.O. to L.T. Reg.	1.5.49	Flood, J. E. ..	E.-in-C.O. ..	14.4.49
Gerrard, J. ..	E.-in-C.O. ..	19.4.49	Scholey, E. A. ..	N.E. Reg. ..	1.4.49
<i>Engr. to Asst. Insp. W/T.</i>			Siddall, E. ..	H.C. Reg. ..	3.4.49
Gleadie, G. H. M. ..	E.-in-C.O. to A. & P.R. Depts.	23.3.49	Stretton, F. C. ..	E.-in-C.O. ..	1.4.49
<i>Prob. Engr. to Engr.</i>			Dolman, W. ..	E.-in-C.O. ..	12.5.49
Mitchell, M. ..	E.-in-C.O. ..	24.2.49	Mayne, R. T. ..	E.-in-C.O. ..	14.5.49
Thwaite, H. ..	E.-in-C.O. ..	20.3.49	<i>Asst. Engr. to Engineer.</i>		
Gandon, W. ..	E.-in-C.O. to W.B.C. Reg.	17.3.49	Hartshorn, H. ..	Mid. Reg. ..	4.4.49
Partington, E. V. ..	E.-in-C.O. ..	13.3.49	Attenborough, C. E. ..	W.B.C. Reg. ..	21.4.49
Gill, J. S. ..	E.-in-C.O. ..	8.3.49	McMillan, F. N. ..	Scot. ..	30.4.49
Haley, G. ..	E.-in-C.O. to L.T. Reg.	31.3.49	<i>Technician to Asst. Engr.</i>		
Birchell, J. V. R. ..	E.-in-C.O. ..	27.3.49	Clarke, W. H. ..	E.-in-C.O. ..	14.4.49
Haward, J. W. G. ..	E.-in-C.O. ..	11.3.49	<i>Asst. R.M.T.O. to R.M.T.O.</i>		
Lloyd, H. F. ..	E.-in-C.O. ..	5.3.49	Dring, G. S. ..	Mid. Reg. ..	21.3.49
Looser, R. C. ..	E.-in-C.O. ..	15.3.49	<i>Asst. Engr. to M.T.O. III.</i>		
Rutterford, L. F. ..	E.-in-C.O. ..	13.3.49	Humphrey, M. C. ..	E.-in-C.O. ..	17.4.49
			<i>D'sman Cl. II to D'sman Cl. I</i>		
			Ingram, A. C. ..	Scot. ..	24.4.49

Transfers

Name	Region	Date	Name	Region	Date
<i>Exec. Engr.</i>			<i>Asst. Engr.—continued</i>		
Newley, E. F. ..	E.-in-C.O. to Admiralty	19.4.49	Edgerton, R. L. ..	E.-in-C.O. to Personnel Dept.	19.4.49
Rusbridge, E. S. ..	Scot. to S.W. Reg. ..	17.4.49	Green, G. W. ..	E.-in-C.O. to S.W. Reg.	15.5.49
<i>Engineer</i>			Elstree-Wilson, E. C. ..	E.-in-C.O. to N.E. Reg.	21.3.49
Fleetwood, C. H. J. ..	E.-in-C.O. to Personnel Dept.	21.3.49	<i>R.M.T.O.</i>		
Siddall, E. ..	H.C. Reg. to Min. of Supply	16.5.49	Ball, F. T. ..	Mid. Reg. to Min. of Works	21.3.49
<i>Asst. Engr.</i>			<i>M.T.O. III</i>		
Phillips, A. J. ..	H.C. Reg. to E.-in-C.O.	1.4.49	Border, W. A. ..	E.-in-C.O. to Mid. Reg.	4.4.49

Retirements

Name	Region	Date	Name	Region	Date
<i>Engineer</i>			<i>Asst. Engr.</i>		
Cattell, F. T. ..	Scot. ..	11.3.49	Organ, E. C. H. ..	E.-in-C.O. (Resigned)	31.3.49
Hindle, J. N. ..	E.-in-C.O. ..	31.3.49	Smith, G. S. ..	E.-in-C.O. (Resigned)	21.4.49
Read, A. J. ..	Mid. Reg. ..	31.3.49	Simpson, W. F. ..	L.T. Reg. ..	30.6.49
Taylor, W. L. ..	W.B.C. Reg. ..	31.3.49	Frith, A. C. ..	L.T. Reg. ..	15.11.48
Hickish, D. E. ..	E.-in-C.O. (Resigned)	30.4.49	Clinch, F. A. ..	Scot. ..	31.3.49
Thompson, J. W. ..	N.W. Reg. ..	30.4.49	Pearson, C. ..	N.E. Reg. ..	31.12.48
Faulkner, C. G. ..	N.W. Reg. ..	18.5.49	Farnworth, W. R. ..	N.E. Reg. ..	8.4.49
Cottrell, H. E. ..	E.-in-C.O. ..	13.5.49	Woolmer, W. T. ..	L.T. Reg. ..	23.5.49
Gay, S. G. ..	S.W. Reg. (Health grounds)	26.5.49	Jackson, A. G. ..	N.W. Reg. ..	31.5.49
			Morrison, G. ..	Scot. (Health grounds)	13.5.49

Retirements—continued

Name	Region	Date	Name	Region	Date
<i>Sen. D'sman.</i>			<i>D'sman. Cl. I</i>		
Wisikin, A. R.	E.-in-C.O.	31.5.49	Fuse, R.	W.B.C. Reg.	30.4.49

Deaths

Name	Region	Date	Name	Region	Date
<i>Exec Engr.</i>			<i>Asst. Engr.—continued</i>		
Cherry, D. W.	E.-in-C.O.	28.3.49	Foskett, G. E.	E.-in-C.O.	15.4.49
<i>Engineer</i>			Weekes, H. H.	L.T. Reg.	27.11.48
Lewis, H. C.	W.B.C. Reg.	15.3.49	Nokes, W. J.	L.T. Reg.	13.4.49
<i>Asst. Engr.</i>			Winson, R. W.	E.-in-C.O.	26.4.49
Davies, N. S.	W.B.C. Reg.	27.2.49	Drummond, J.	Scot.	9.5.49
Dixon, P. E.	E.-in-C.O.	2.3.49	<i>Inspector</i>		
Lawson, P. G.	L.T. Reg.	6.4.49	Groombridge, H. E.	L.T. Reg.	11.5.49
			<i>D'sman. Cl. I</i>		
			Storm, J.	Scot.	26.2.49

CLERICAL GRADES

Promotions

Name	Region	Date	Name	Region	Date
<i>Exec. Off. to H.E.O.</i>			<i>C.O. to Exec. Off.</i>		
Wilkinson, F. W.	E.-in-C.O.	31.1.49	Poltock, G. F.	E.-in-C.O.	1.4.49
Evans, H. O.	E.-in-C.O.	9.4.49	Ogilvie, H. G.	E.-in-C.O.	3.3.49
			Newton, B. J.	E.-in-C.O.	17.3.49
			Tourret, L. J.	E.-in-C.O.	1.3.49

Transfers

Name	Region	Date
<i>Exec. Off.</i>		
Lambert, F.	E.-in-C.O. to Min. of Ag. and Fish.	23.4.49

Retirements

Name	Region	Date	Name	Region	Date
<i>Exec. Off.</i>			<i>Exec. Off.—continued</i>		
Ashby, C.	E.-in-C.O.	2.3.49	West, A. M.	E.-in-C.O.	2.5.49
Copeland, P. J.	E.-in-C.O.	31.3.49	Dufton, Miss A. M.	E.-in-C.O. (Resigned)	31.5.49
Glasscock, J. A.	E.-in-C.O.	31.3.49			

(Continued from page 107)

31st March '49.—A visit to the B.E.A., Blackburn Meadows Generating Station.

10th April '49.—Film Show.

28th April '49.—"Installation by Contractors."

C. B. Allinson (Siemens Bros.).

At the time these notes were prepared the first paper, by Mr. A. M. Hunt, had been presented. It was received with much interest and a lively discussion ensued.

Now that the centre has been reformed it is intended that the programme for the coming session will be given more publicity and a successful series of meetings, visits and social functions is ensured.

The renewal of activities has been helped in no small way by the sincere co-operation of the Telephone Manager, Mr. C. A. G. Salmon, and the Area Engineers, Messrs. A. M. Hunt and V. G. Critchlow. J. W. B.

York Centre

The last session has been very successful with an average attendance at the meetings of 23, composed roughly of 20 members and three guests from the Senior Section, to whom a cordial invitation is always extended. The Centre held a total of six meetings covering a wide range of subjects, including a 5-minute essay competition which was keenly contested. Prizes were awarded to the winners.

The highlight of the session has been, without doubt, the inter-centre quiz with the Scarborough Centre. The quiz was conducted over land lines, loudspeakers being used to enable each audience to hear the activities at the

distant end. It was found that by the judicious siting of microphones and loudspeakers it was possible to provide sufficient volume for good room strength without howling. Scarborough were worthy winners by a small margin. I. C.

Scarborough Centre

The Annual General Meeting of the Centre was held on the 28th April, 1949. A brief review of the year's work was given, some of the points being:—

(1) Six papers were read.

(2) 16 Committee Meetings were held.

(3) The Annual Dinner and Social was attended by 144, including:—Mr. W. F. Smith, A.C.G.I., B.Sc., M.I.E.E. (Chief Regional Engineer); Brig. F. Jones, C.B.E., M.Sc., M.I.E.E. (Telephone Manager); Mr. J. Collins (Acting Area Engineer); Mr. H. Whitehead (Head Postmaster, Scarborough); Mr. C. A. Hartley, (Engineer); Mr. J. W. Barratt, A.M.I.E.E. (Liaison Officer) and other Senior Members.

(4) The Certificate of Registration establishing the Centre on 10th October, 1938 (Certificate No. 82) is still framed and prominently displayed and shows that the Treasurer, Chairman and Secretary who were elected on that day are still in office and have again been elected this year, i.e. 11 years in office.

(5) The officers elected for the 1949-50 session were:—*Chairman*: Mr. F. Cowper; *Deputy Chairman*: D. Stephenson; *Treasurer*: P. L. Mitton; *Secretary*: A. B. Clarke. A Committee of 12 was also elected and forms the Entertainment and Social Committee and a main I.P.O.E.E. Working Committee. A. B. C.

BOARD OF EDITORS

H. FAULKNER, C.M.G., B.Sc., M.I.E.E., Chairman.

F. E. NANCARROW, O.B.E., A.R.C.Sc., M.I.E.E.

P. B. FROST, B.Sc., M.I.E.E.

A. H. MUMFORD, O.B.E., B.Sc.(ENG.), M.I.E.E.

C. W. BROWN, A.M.I.E.E.

W. T. GEMMELL, A.C.G.I., B.Sc., M.I.MECH.E., A.M.I.E.E.

W. WEST, B.A., M.I.E.E.

C. E. C. SKUSE.

G. E. STYLES, A.M.I.E.E., Managing Editor.

W. A. HUMPHRIES, A.M.I.E.E.

J. P. HARDING, B.Sc.(ENG.) } Assistant Editors.

A.M.INST.C.E., A.M.I.E.E. }

A. J. BAKER, Secretary-Treasurer.

Copyright

The entire contents of this JOURNAL are covered by general copyright, and special permission is necessary for reprinting long extracts, but Editors are welcome to use not more than one-third of any article, provided credit is given at the beginning or end thus: "From the *Post Office Electrical Engineers' Journal*."

The Board of Editors is not responsible for the statements made or the opinions expressed in any of the articles in this JOURNAL, unless such statement is made specifically by the Board.

Communications

All communications should be addressed to the Managing Editor, *P.O.E.E. Journal*, Engineer-in-Chief's Office, Alder House, Aldersgate Street, London, E.C.1. Telephone: HEADquarters 1234. Remittances should be made payable to "The *P.O.E.E. Journal*" and should be crossed "& Co."

Binding Cases

Cases for binding are available, and may be obtained from the Local Agents for 2s. Subscribers can have their copies of Volumes bound, at a cost of 7s. 6d., by sending the complete set of parts to the Local Agents or to the *P.O.E.E. Journal*, Engineer-in-Chief's Office, Alder House, Aldersgate Street, London, E.C.1. Orders for binding for Vols. 1-19 should indicate whether the original binding case with black lettering, or the later pattern with gold, is required. Cases with gold lettering are the only type stocked from Vol. 20 onwards.

Back Numbers

The price of the JOURNAL, which is published quarterly, is 1s. 6d. (1s. 9d. post free) per copy, or 7s. per annum post free. Back numbers can be supplied, subject to availability of stocks, at 1s. 6d. each (1s. 9d. post free). Orders for back numbers may be sent to the Local Agents or to the Publishers.

Advertisements

All communications relating to space reservations should be addressed to the Advertisement Editor, *P.O.E.E. Journal*, Alder House, Aldersgate Street, London, E.C.1. Communications regarding advertisement copy, proofs, etc., should be addressed to the Publishers, Messrs. Birch & Whittington (Prop. Dorling & Co. [Epsom], Ltd.), 49 Upper High Street, Epsom, Surrey.

INDEX TO ADVERTISERS

	<i>Page</i>		<i>Page</i>
Alton Battery Co., Ltd., The	vii	Neill, James, & Co., Ltd.	viii
Automatic Coil Winder & Electrical Equipment Co., Ltd.	x	Painton	xiv
Automatic Telephone & Electric Co., Ltd.	xii, xiii	Pirelli-General Cable Works, Ltd.	xxiv
Bennett College, The	viii	Pitman, Sir Isaac, & Sons, Ltd.	xxiii
British Institute of Engineering Technology	xxi	Salford Electrical Instruments, Ltd.	xxiv
Creed & Co., Ltd.	ix	Savage Transformers, Ltd.	xxi
Edison Swan Electric Co., Ltd., The	x	Savage, W. Bryan, Ltd.	xiv
Edwards & Co., Ltd.	xvii	Siemens Brothers & Co., Ltd.	xvi
Ericsson Telephones, Ltd.	xviii	Smith, Frederick, & Co.	v
Evershed & Vignoles, Ltd.	vi	Standard Telephones and Cables, Ltd.	xi, xv
General Electric Co., Ltd., The	ii	Sullivan, H. W., Ltd.	xxi
H.T.A., Ltd.	iv	Telephone Manufacturing Company, Ltd.	xvii, xix
International Correspondence Schools	xxiii	Tudor Accumulator Co., Ltd., The.	viii
Lydiat Ash	iv	Tungstone Products, Ltd.	xx
Muirhead	v	Westinghouse Brake & Signal Co., Ltd.	xix
		Winn & Coales, Ltd.	xxiii

MODEL ANSWERS

TO

CITY AND GUILDS OF LONDON INSTITUTE EXAMINATIONS

Students preparing for City and Guilds examinations in Telecommunications will find the Model Answers published in book form a useful aid to study. The questions and answers have been extracted from Supplements to the Journal issued during recent years, and, after careful revision, have been grouped under headings corresponding with the new syllabuses introduced by the City and Guilds in 1947.

Model Answers to questions which, on account of paper shortage, were unanswered in Supplements issued during the war years are also included.

The following books have been published to date :—

TELECOMMUNICATIONS (PRINCIPLES) I* TELECOMMUNICATIONS (PRINCIPLES) II
RADIO I TELEGRAPHY I
TELEPHONE EXCHANGE SYSTEMS I TELEPHONE EXCHANGE SYSTEMS II

*Stock temporarily exhausted—now reprinting.
(PRICE 2/6 EACH 2/9 POST FREE)

Orders may be placed with the JOURNAL LOCAL AGENTS or with THE MANAGING EDITOR, POST OFFICE ELECTRICAL ENGINEERS' JOURNAL, ALDER HOUSE, ALDRSGATE STREET, LONDON, E.C.1

In course of preparation. Publication dates and prices to be announced later:

RADIO II TELEGRAPHY II LINE TRANSMISSION I

THE OSCILLOSCOPE FOR EVERY INDUSTRIAL PURPOSE.

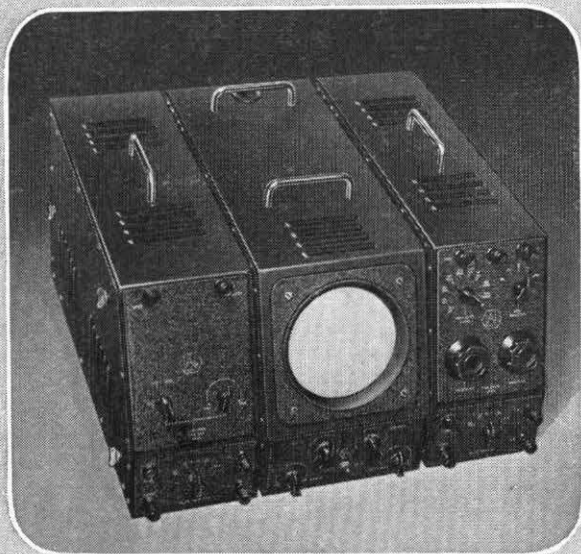

LAL UNIT Oscilloscope

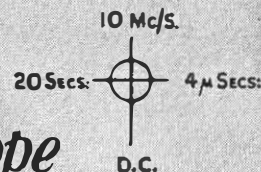

EVERY Oscilloscope requirement for Industrial Research or Production can be satisfied by the comprehensive range of UNIT Amplifiers and Time Bases. All instruments are immediately interchangeable without loose wires or the use of tools and many can be used independently of the Oscilloscope. Full details will be sent by return of post.

Also available:—
D.C. Amplifiers, medium and high gain. Extra low frequency time base. Circular or spiral heptode time base. Voltage calibrator.



A Typical Example of H.T.A. DESIGN

Included in the range of H.T.A. Products are Telephone Coin Collectors, Stamp Selling Machines, Autodials, Commodity Vending Machines, Coin Operated Mechanisms, Kitchen Control Units, Gas Leak Indicators, Ticket Printing and Issuing Machines, also Coin Operated Totalisator Ticket Issuing Machines of which a model is illustrated here.

This machine is an independent ticket printing and issuing unit, constructed to operate on the insertion of a 2/- (two shilling) piece or other denomination of coin. Runner numbers can be varied from 1-99, which enables the machine to be used for both dog and horse betting.

The machine is portable and can, therefore, be moved from one track to another and run from power mains or portable accumulators.

It has two slots, one for "Win" bets and the other for "Place" bets. There are no buttons or other complications on the front of the machine: the public merely have to insert a coin.

The tickets are printed from plain rolls of paper and a warning light is shown when the roll reaches a predetermined minimum—diameter usually equivalent to 100 tickets.

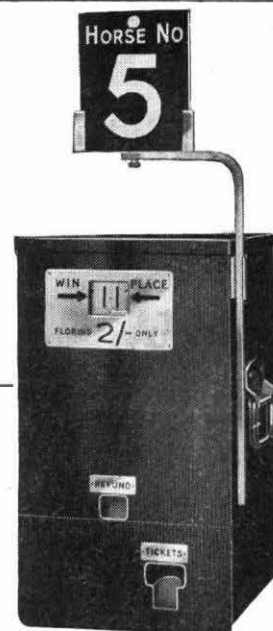

HALL TELEPHONE ACCESSORIES LTD

Precision Engineers & Instrument Makers

DUDDEN HILL LANE · WILLES DEN · LONDON · N. W. 10

PHONE: WILLES DEN 5141

Latest Developments IN TELECOMMUNICATIONS

Keep abreast of the rapid developments in Telecommunications by ordering the

POST OFFICE ELECTRICAL ENGINEERS' JOURNAL

A quarterly publication appearing in April, July, October and January, it includes a free Supplement giving Model Answers to Questions set by the City and Guilds of London Institute.

Order Your Copy To-day

Obtainable from Journal Local Agents or from the Managing Editor, Post Office Electrical Engineers Journal, Alder House, Aldersgate Street, London, E.C.1.

Price per copy 1/6 (post free 1/9), or 7/- per ann., post free.

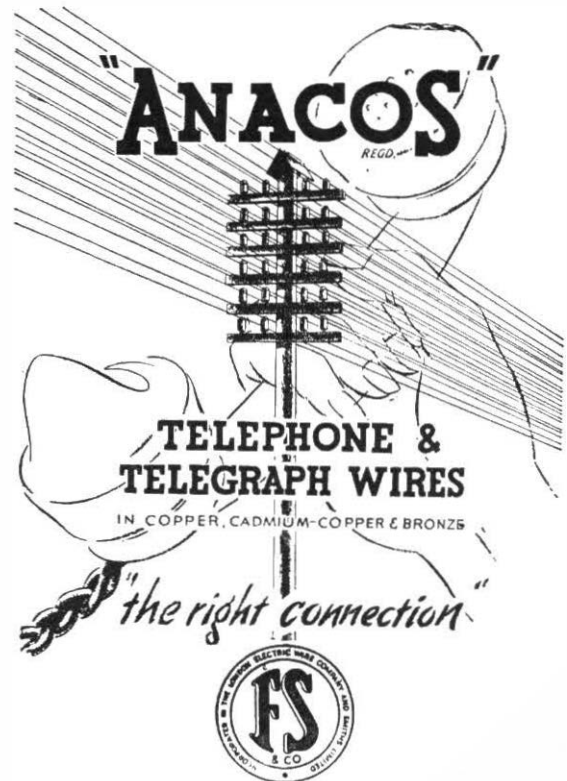

FREDERICK SMITH & COMPANY

(Incorporated in The London Electric Wire Company and Smiths, Limited)
ANACONDA WORKS, SALFORD 3, LANCS.
Phone: Blackfriars 8701 (9 lines) • Grams: "Anawonda," Manchester

Laboratory Precision in Production Testing

A direct-reading capacitance bridge that will measure capacitance and power factor with laboratory precision but is built to withstand the heavy usage encountered in production testing.

The quartz insulated variable air capacitance standard guarantees the highest accuracy and stability under all working conditions.

SPECIFICATION :

Modified Schering Bridge, double screened and direct reading in capacitance at any frequency between 50 c/s and 10 kc/s. Direct reading in power factor at 1 kc/s; a simple correction is necessary at other frequencies.

CAPACITANCE STANDARD :

High quality quartz insulated variable air condenser with precision worm drive gives discrimination to 0.2 $\mu\mu\text{F}$. Directly calibrated in $\mu\mu\text{F}$ from 100 to 1000; measurements outside the normal ranges may be made by the substitution method.

RANGES :

Capacitance: 100 $\mu\mu\text{F}$ to 1 μF on 4 ranges.
Power Factor: 0 to 0.05 at 1 kc/s.

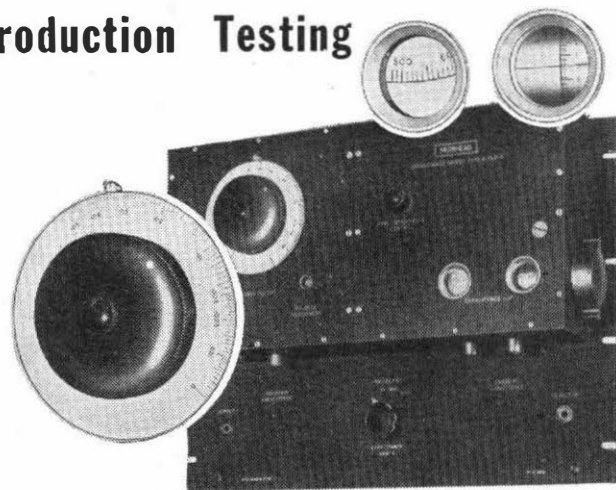

ACCURACY :

Capacitance: $\pm 0.1\%$ of full scale reading on all ranges.
Power Factor: by direct reading: $\pm 0.0003 \pm 3\%$ of scale reading.
by substitution: $\pm 0.0005 \pm 3\%$ of scale reading.

May we send you Publication C-104 giving full details of this and other A.C. Bridges?

MUIRHEAD

Muirhead & Co. Limited · Elmers End · Beckenham · Kent Telephone: Beckenham 0041-2

FOR OVER 60 YEARS DESIGNERS AND MAKERS OF PRECISION INSTRUMENTS

NEW LONG SCALE MEGGER TESTERS

Trade Mark

The many users of Megger Insulation Testers throughout the world will appreciate the additional testing facilities provided by these new instruments.

Similar in appearance to the original Megger Testers in hard wood cases, each new instrument has two ranges and a twin scale with an effective scale length of 8½ inches. The megohm ranges are also greatly increased, the scales illustrated showing the comparison between the old and the new scale lengths on a 1000 volt instrument.

For particulars write for leaflet X051/1

NEW RANGES:—

- 500 volts 0-10,000 megohms
- 1000 volts 0-20,000 megohms
- 2500 volts 0-50,000 megohms

★ NEW SCALE
Arranged to show
effective length

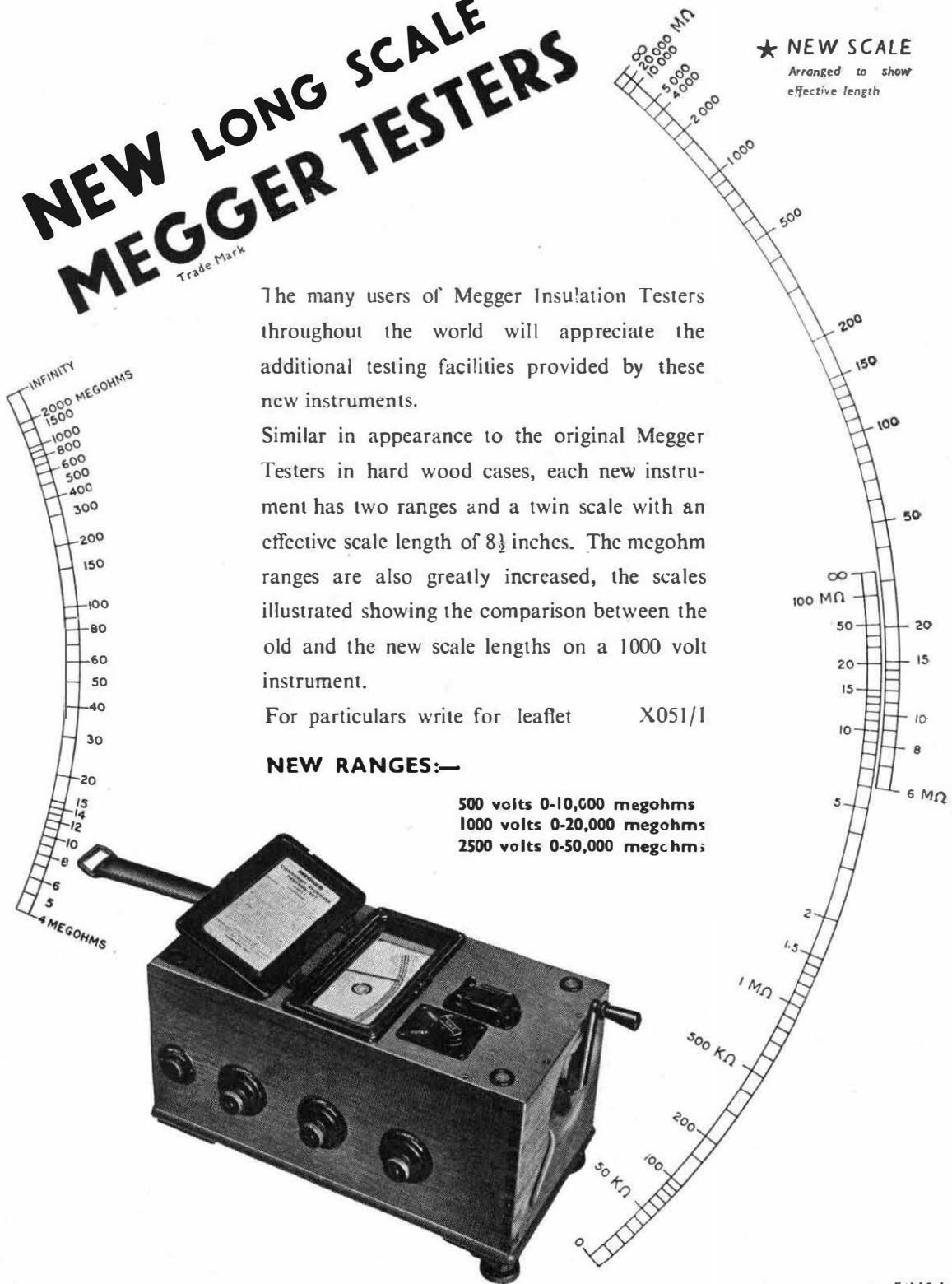

EVERSHED & VIGNOLES LIMITED · LONDON W.4
 TELEPHONE : CHISWICK 3670 · TELEGRAMS : MEGGER, CHISK, LONDON · CABLES : MEGGER, LONDON

5/110 b



Alton has been exporting batteries for thirty years. In installations in sixty-five countries Alton Batteries, in capacities from 10 to 15,000 ampere-hours, are giving the service only good batteries can give. Alton, in any language, means good batteries and firm delivery dates.

ALTON

BATTERIES OF MERIT

THE ALTON BATTERY COMPANY LIMITED

Alton, Hants. Telephone: Alton 2267 and 2268

Telegrams: Battery, Alton

Alton can also supply renewal plates for all makes of battery, British & Continental

STUDY
AT
HOMEYou Can Have a College Training
For a Few Shillings MonthlyIN YOUR
SPARE
TIME

CITY and GUILDS (Telecommunication) EXAMINATIONS

To every student we send
a written Guarantee of
Tuition until the
examination is
actually
passed

*The most progressive and most successful
Correspondence College in the world*

Our
tuition
is so graded
that each stage
is reached without
difficulty.

Personal attention is given
to every student.

FULL PARTICULARS AND
ADVICE SUPPLIED FREE.
WE TEACH BY POST IN ALL
PARTS OF THE WORLD.

The **Bennett College** *Limited*



Dept. 24, THE BENNETT COLLEGE, SHEFFIELD



Eclipse PERMANENT
MAGNETS

IN
TUNGSTEN · CHROME
COBALT · ALNI · ALNICO
& ALCOMAX

Our Technical Development Section
will be pleased to advise on any
problem connected with applied
magnetism

Made by the manufacturers of
"ECLIPSE"
PERMANENT MAGNET CHUCKS

6M7

JAMES NEILL & CO. (Sheffield) LTD., SHEFFIELD, ENGLAND

*For large scale
Electrical
Purposes*

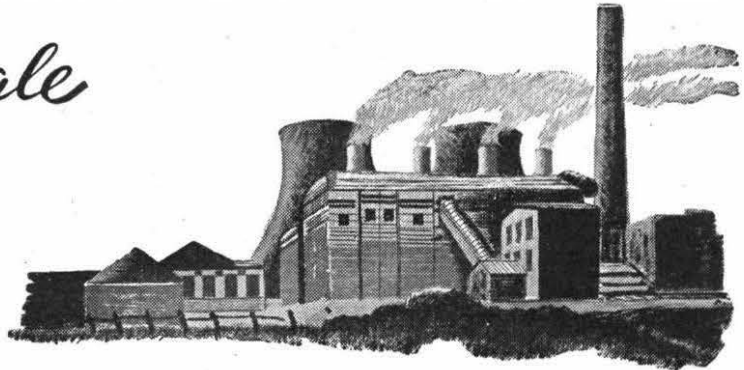

It is noteworthy where Tudor accumulators are
to be found fulfilling the most important duties:
over 500 British Power Stations installed Tudor.
Many Tudor installations rank among the largest
in the land and have an enviable reputation for
long-lived reliability. No matter whether they
were installed only yesterday, or over thirty

years ago—as many of them were—they are
to-day functioning with consistent efficiency.

SAFETYLYTE is the Tudor Emergency Light-
ing System, which is automatic and
instantaneous in operation. It is installed
in thousands of schools, hospitals, factories
and other large buildings.



TUDOR ACCUMULATORS

THE TUDOR ACCUMULATOR CO. LTD
50 GROSVENOR GARDENS, LONDON, S.W.1

No. 47 TAPE MODEL TELEPRINTER

FOR —

MODERN TELEGRAPHY—

A NEW  PRODUCT
Creed



- Printing point is in ideal position on left side.
- Receiving cam orientation device facilitates optimum adjustment.
- Conforms to C.C.I.T. recommendations.
- Tape and ink ribbon are replenished without removing cover.
- Accessible printing unit using typewriter ink ribbon.
- Answer-back unit (20 characters).
- A cover attachment for accommodating message forms, etc., can be provided for handling heavy traffic.
- Simplified maintenance with unit construction.
- Quiet in operation.

Creed and Company Limited

TELEGRAPH HOUSE • CROYDON • ENGLAND

TELEGRAMS: "CREDO, TELEX, CROYDON."
TELEPHONE: CROYDON 2121 (7 lines).

● CABLES: "CREDO, CROYDON."
● TELEX: CROYDON, TELEX 1082

EDISWAN

Telephone Line Protectors

FOR THE PROTECTION OF LINES OF COMMUNICATION FROM SURGES INDUCED BY LIGHTNING OR FAULTS ON NEIGHBOURING POWER LINES

Ediswan Telephone Line Protectors have now been in commission for nearly twenty years. They have proved their worth in all parts of the world and are being called for and installed in ever increasing numbers. Many thousands were employed during the war years for the protection of vital lines of communication and were eminently successful. Reports of their outstanding merit and successful operation continue to reach us and in recent years they have proved of particular interest for protection against surges caused by lightning discharges.

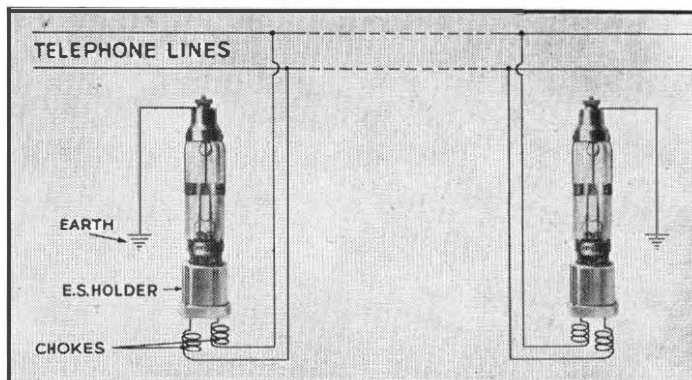

Continued research has enabled us to patent a further improvement which removes any suggestion of delay in operation.

Further information and prices on application.

THE EDISON SWAN ELECTRIC CO. LTD., 155 CHARING CROSS ROAD, LONDON, W.C.2

T.E.3

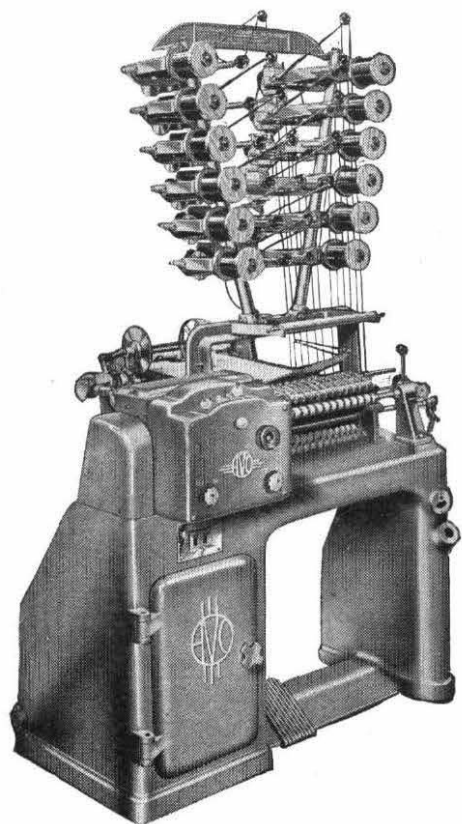

DOUGLAS AND MACADIE

Automatic COIL WINDERS

The large illustration depicts the new improved "Douglas" Fully Automatic Multi-Winder, specially developed for the high-speed production of large quantities of coils with or without paper interleaving. It will produce round, square

or rectangular coils up to 6 in. each in length and up to 4½ in. diameter. As many as 12 smaller coils can be wound simultaneously within the total available winding length of 12 in. at headstock speeds of between 600 and 2,000 r.p.m.

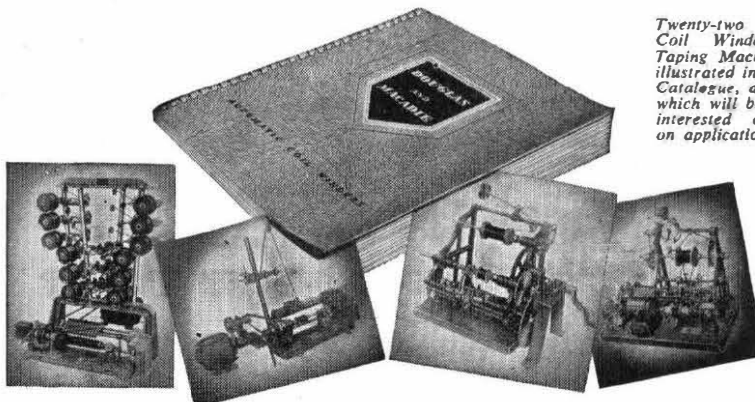

Twenty-two different Coil Winders and Taping Machines are illustrated in our new Catalogue, a copy of which will be sent to interested executives on application.

Sole Proprietors and Manufacturers

The AUTOMATIC COIL WINDER & ELECTRICAL EQUIPMENT CO. LTD.
WINDER HOUSE · DOUGLAS STREET · LONDON · S.W.1 Telephone: VICTORIA 3404/9

COAXIAL CABLES

FOR
TELEPHONY AND TELEVISION

THE coaxial design affords considerable economy where large numbers of telephone circuits are required. With a standard repeater spacing, each pair of coaxial cores will provide economically from a few to nearly a thousand high quality telephone circuits. Where desired one or more cores may be utilised to provide television transmission. In addition, surrounding paper insulated quads can be included, which may be used for short distance traffic.

The illustration is a typical example of a cable of this type.

This Company engineers, manufactures and installs complete coaxial systems comprising cable, amplifiers and terminal equipment.

Standard Telephones and Cables Limited

(Registered Office: Connaught House, Aldwych, London, W.C.2)

(Telephone Line Division)

NORTH WOOLWICH LONDON E 16

TELEPHONE: ALBERT DOCK 1401

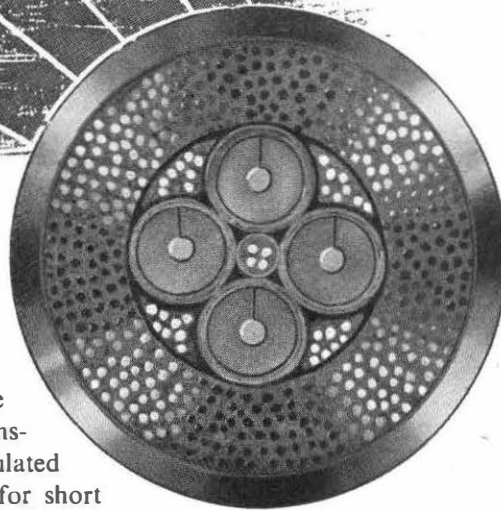

① CENTRALISED
RESEARCH, DESIGN, MANUFACTURE

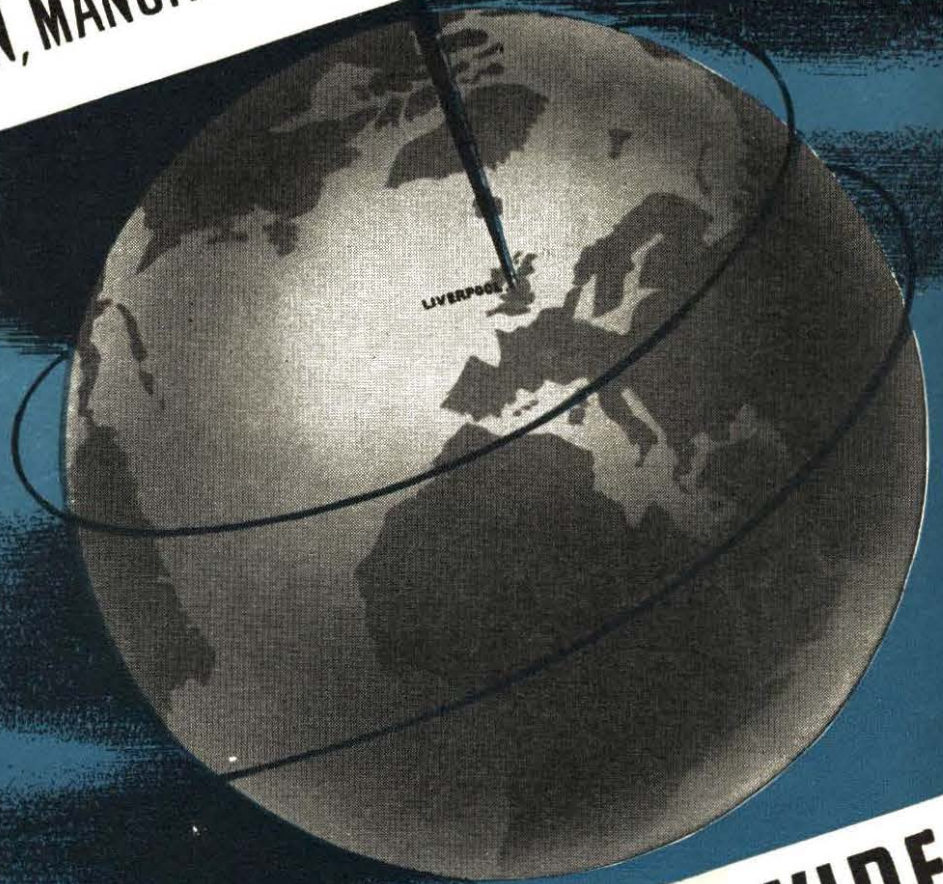

② WORLD-WIDE



A.T.M. Products include:—

Complete Strowger automatic telephone exchange equipment for networks of any size; Strowger automatic or key-controlled telephone equipment for private use; Electromatic vehicle-actuated road traffic control equipment; A.T.M. selective supervisory remote control, indicating and telemetering equipment for power networks; A.T.M. mine telephones and colliery signalling equipment; single and multi-channel (Carrier) transmission systems and associated apparatus; Rythmatic centralised ripple control equipment.

ORGANISATION, DISTRIBUTION, APPLICATION

FIRST—a modern telecommunications factory, containing the most scientific research equipment, machine tool, assembly, finishing and inspection departments. Within it are employed expert designers, technicians, and many thousands of highly-skilled workpeople.

SECOND—an organisation with many branches throughout the world which bring the knowledge and resources of the Company to all those seeking a solution to any telecommunication or light current signalling problem.

STROWGER TELECOMMUNICATIONS EQUIPMENT

for all communities—large or small



AUTOMATIC TELEPHONE & ELECTRIC CO. LTD.

Regd. Office and Works:— Strowger Works, Liverpool, 7, England.
Export Dept.:— Norfolk House, Norfolk Street, Strand, London, W.C.2. Cables: "Autelco, London."

A7513-A2101



In public address and music relay to various points requiring different levels, the most satisfactory method is to pre-set speaker output on stud faders, either at the control panel or on individual speakers.

Agent in Denmark:
Janko Kondensatorfabrik A/S,
Holbergsgade 15, Copenhagen.

IN ANY CASE IT IS MOST DESIRABLE
TO RELY ON

Control by **PAINTON**

PAINTON & CO · KINGSTHORPE · NORTHAMPTON

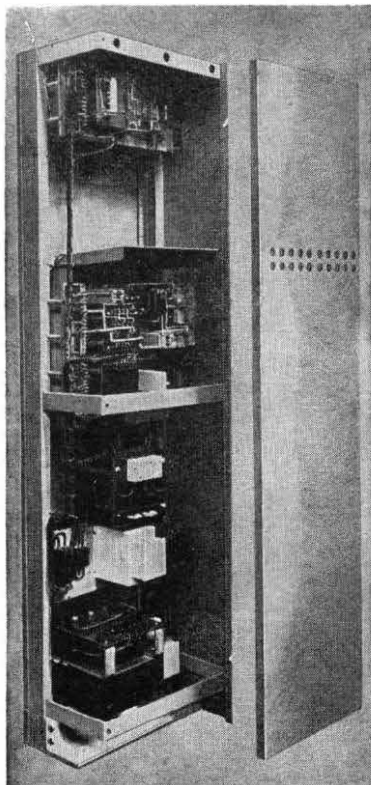

The Mark II series of
SAVAGE AMPLIFIERS
for Broadcast Relay

● These Amplifiers are examples of what careful design can achieve. A lift-off back panel affords immediate access for maintenance purposes and the removal of six screws releases the side covers of the rack and exposes all the interpanel wiring. Even when the rack is sandwiched between others the side covers can be removed just as easily.

All valves are accessible from the front of the rack, and are protected by quick release grilles. The rack is completely flat fronted. The general appearance is further enhanced by the absence of a projecting front foot, and the masking of all panel fixing bolts. Similar racks carrying auxiliary apparatus can be placed side by side with amplifiers so that the whole installation is uniform in appearance.

*Complete specifications
available on request.*

WESTMORELAND ROAD
LONDON N.W.9
TELEPHONE: COLINDALE 7131

**W. BRYAN SAVAGE
LIMITED**



*Constant
Automatic*

BATTERY CHARGING

For unattended batteries such as those used in telephone exchanges and in sub-stations for switch-closing, tripping and supervisory duties.

NO maintenance whatever is needed by the *Standard Automatic* Battery Charger, since control is obtained from the battery voltage itself, maintaining a level of $\pm 2\frac{1}{2}\%$ of its nominal value by means of vacuum tube thermal relays.

Equipments can be designed to suit individual needs, whilst our comprehensive standard range is fully described in Bulletin SRT-37, a copy of which we shall be happy to send you.



Selenium rectifiers of all types, including Uniplate, tubular and spindle mounted stacks. Equipments for stationary or vehicle battery charging, electrostatic precipitation, aircraft and vehicle engine starting, electro-plating and similar electrolytic processes. Power supplies for circuit breaking and other operations.

Standard Telephones and Cables Limited

Registered Office: Connaught House, Aldwych, London, W.C.2

WARWICK ROAD

BOREHAM WOOD

HERTFORDSHIRE

Telephone: Elstree 2401.

Telegrams: Sentercel, Borehamwood

RECTIFIER DIVISION

SIEMENS

VOICE-FREQUENCY DIALLING AND TANDEM SWITCHING EQUIPMENT

*for
Canada*

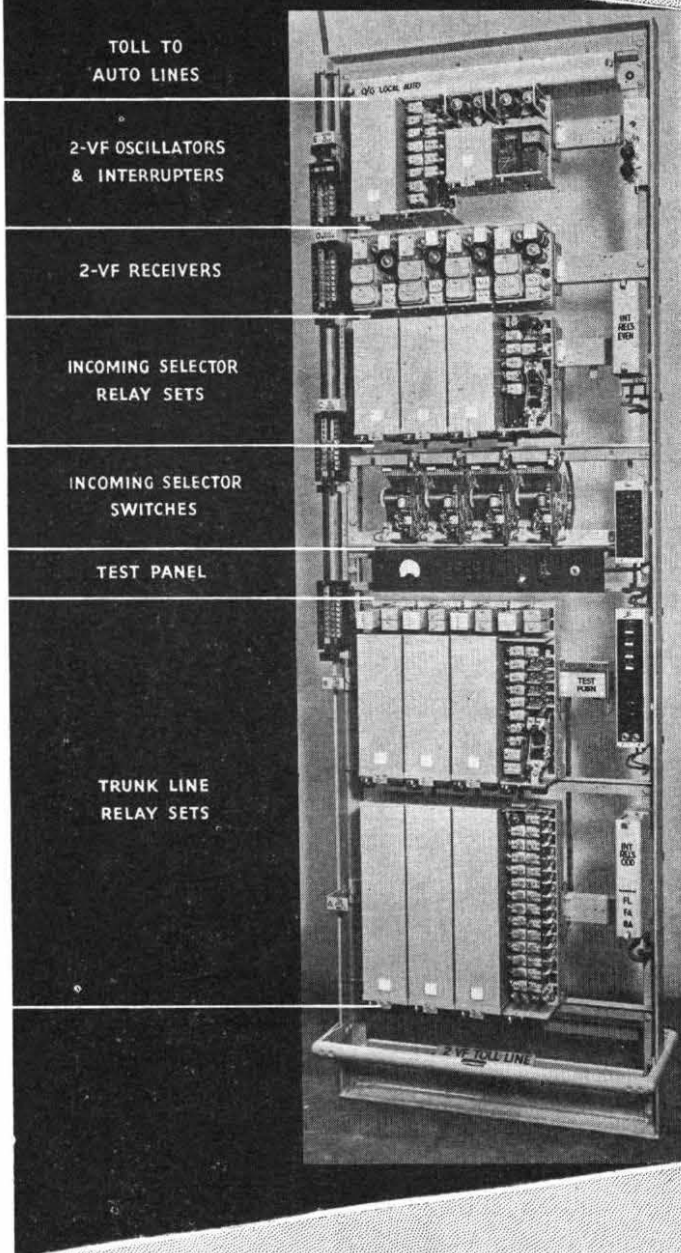

THE illustration shows the advance equipment supplied by us for use at Calgary to effect tandem switching on long distance traffic between Red Deer and Winnipeg, prior to the installation of a complete Automatic Trunk Exchange at Winnipeg.

Facilities are provided for VF dialling, direct to auto subscribers, between Winnipeg, Calgary and Red Deer.

In addition to the Winnipeg equipment the Company has in course of manufacture Automatic Trunk Exchanges for Brandon (Manitoba), Edmonton (Alberta) and Halifax (Nova Scotia)

SIEMENS BROTHERS & CO., LIMITED
WOOLWICH • LONDON • S. E. 18.

CARPENTER Polarized RELAY TYPE 4

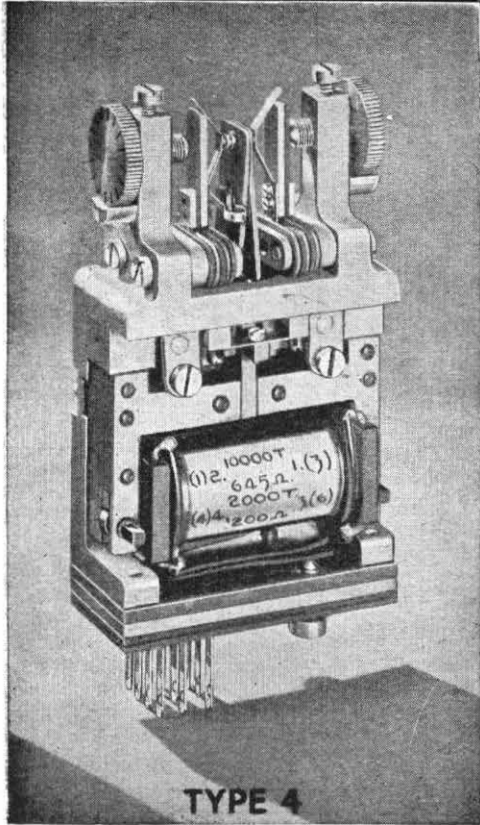

This is a medium speed, sensitive relay with long contact travel designed primarily as a telephone impulsing relay (D.C. dialling up to 100 miles and V.F. dialling on trunk circuits). It has also been successfully adopted for use in Telex systems.

Its sensitivity is such that when the gap is adjusted to .004 in. the relay will just operate at 50 cycles with 4 ampere-turns (corresponding to approximately 1 mVA) or on 2½ D.C. ampere-turns at low speeds. In service, however, the relay is normally operated at currents substantially larger than the minimum operating current.

Contact chatter is absent if the contact gap does not exceed .004 in. The contact gap is adjustable by means of fine pitch screws with knurled heads marked with .001 in. divisions.

Contacts on the armature tongue are insulated from it and thereby from the frame.

Terminals for soldered connections are fitted as standard.

The relay is supplied with a magnetic screening cover with transparent removable top to facilitate contact adjustment.

Dimensionally the relay is interchangeable with the type "3000" relay and can be supplied to fit directly to the drilling normally provided for the "3000" relay.

Dimensions of the Type 4 Carpenter Relay are:— (With cover. Excluding wiring tags)
3³/₁₆ ins. high x 2¹/₁₆ ins. wide x 1 in. deep. Weight: 13 ozs.

For Further Particulars Apply to the Manufacturers and Sole Licensees for the Eastern Hemisphere

TELEPHONE MANUFACTURING CO. LTD.

Contractors to the British Commonwealth and Foreign Governments

HOLLINGSWORTH WORKS · DULWICH · LONDON, S.E.21

Telephone: GIPay Hill 2211 (10 lines)

CATHODIC SPUTTERING UNIT

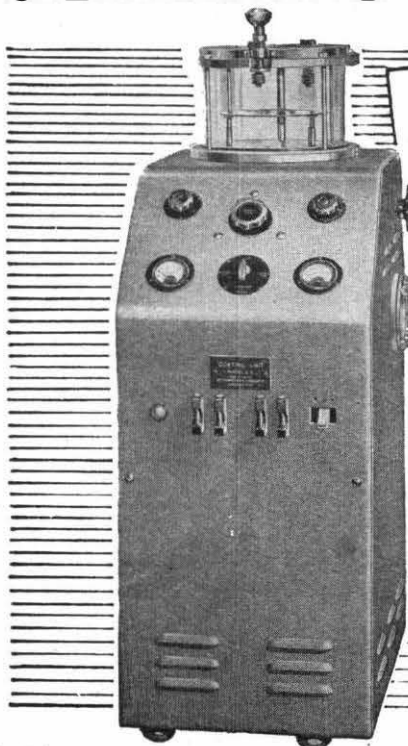

★ Front reflecting films of gold, platinum, etc., on plastics or glass for decorative or scientific purposes.

★ Sputtered gold on selenium for photo-cells, gold and silver on quartz crystal oscillators.

★ Semi-reflecting films on glass, etc., for optical filters, colour camera pelli-cles, etc.

★ Vacuum Deposition Unit for small and large laboratories.

Some Typical Applications

Cathodic sputtering is an easily operated process for obtaining uniform and reproducible thin metallic films on conducting and non-conducting bases. It is an essential step in many important manufactures and an invaluable research technique.

Many other new sputtering developments, including precision resistors and radiation detectors, are reported.

Illustrated is Model S5 Sputtering Unit, one of several units manufactured by us for specific or general purposes. Glass work chamber 24 cms. dia. X 17 cms. high; maximum cathode diameter 21 cms. (Cathodes up to 45 cms. approx. dia. can be supplied for other models).

W. EDWARDS & CO. (LONDON) LTD.
LOWER SYDENHAM, LONDON, S.E.26

Phone: SYDenham 7026 (8 lines) Grams: EDCOHIVAC, Souphone, London



.. and we repeat...

ERICSSON AUTOMATIC DIALS are British Post Office Standard. Uniform pulsing. Impulsing contacts, gold, silver, platinum. Normal finish, black with black figures on white ground. Normal impulse ratios — 33% make, 66% Break. Can be supplied with neat dust cover with stainless steel finger plate and with sockets suitable for mounting in either the horizontal or vertical plane. Instruction labels and number plates can be arranged to suit customers' requirements.

Ericsson

AUTOMATIC DIAL SWITCHES

Large Signalling Current from Mains Supply by **SYNCYCLE**

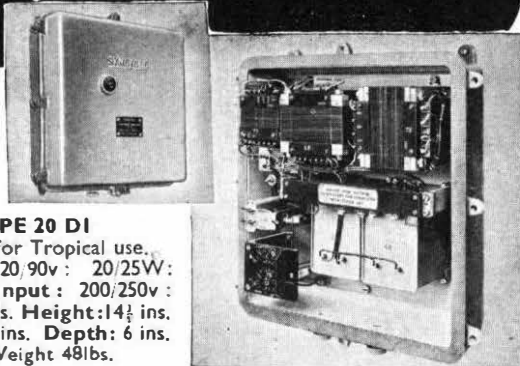

TYPE 20 DI

Sealed case for Tropical use.
Output : 20/90v : 20/25W :
16 $\frac{2}{3}$ c/s. Input : 200/250v :
140vA : 50 c/s. Height : 14 $\frac{1}{2}$ ins.
Width : 14 ins. Depth : 6 ins.
Complete Weight 48lbs.

LOW FREQUENCY CURRENT, at one third Mains supply frequency, for signalling, alarm systems, laboratory use, etc., is efficiently provided by the "SYNCYCLE" static frequency Converter. It is particularly suitable as a source of ringing current for telephone exchanges.

The "SYNCYCLE" is compact, noiseless, interference-free and easily installed. It is automatically protected against overloads and has no moving parts, valves, electrolytic capacitors or other components liable to require replacement.

Models with nominal output ratings of 5 Watts at 75 Volts and 20/25 Watts at 90 Volts with mains supply of either 50 c/s or 60 c/s are available in standard patterns for use in temperate climates, or in hermetically sealed patterns, with flame-proof and waterproof cases for use in tropical conditions.

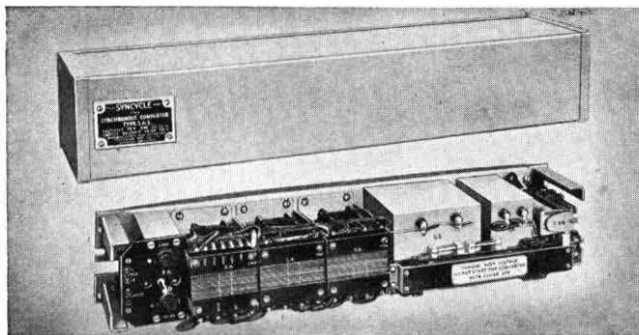

TYPE 5A1 for Rack Mountings.

Output : 75v : 5W : 16 $\frac{2}{3}$ c/s. Input : 90/260v : 40vA : 50 c/s.
Height : 3 $\frac{1}{2}$ ins. Width : 19 ins. Depth : 4 $\frac{3}{4}$ ins.
Complete Weight 23 lbs.

Ask for Brochures giving complete details.

The "SYNCYCLE" is patented and Manufactured By

TELEPHONE MANUFACTURING CO. LTD.



Dept. 350/7 TRANSMISSION DIVISION
HOLLINGSWORTH WORKS, DULWICH,
LONDON, S.E.21.

Telephone & Telegrams: GIPsy Hill 2211 (10 lines)



RECTIFIERS

for **ALL PURPOSES**

TELEGRAPHY & TELEPHONY POWER SUPPLY

DIRECT OPERATION

Constant voltage rectifiers
Teleprinter operation
V.F. signalling
Carrier telephony
Amplifiers

BATTERY CHARGING

Single battery working
Westat constant voltage chargers
Constant current system
Resonant relay control system
Small magneto and C.B.S. exchanges
P.B.X. systems
Automatic telephone exchanges
Portable chargers
Repeater station equipment
Two battery system

TELEGRAPHY & TELEPHONY CIRCUIT APPLICATIONS

Relay operation
Rectifiers as variable impedances
Measurements
Rectifiers for use at radio frequency

RADIO COMMUNICATION POWER SUPPLY

H.T., L.T. and G.B. rectifiers
Multi channel supply unit

WESTINGHOUSE
WESTALITE

THE ALL-PURPOSE RECTIFIERS

Write for details to Dept. P.O.E.E J.4

WESTINGHOUSE BRAKE & SIGNAL CO. LTD.
82, York Way, King's Cross, London, N.1

POWER BEHIND THE LINES

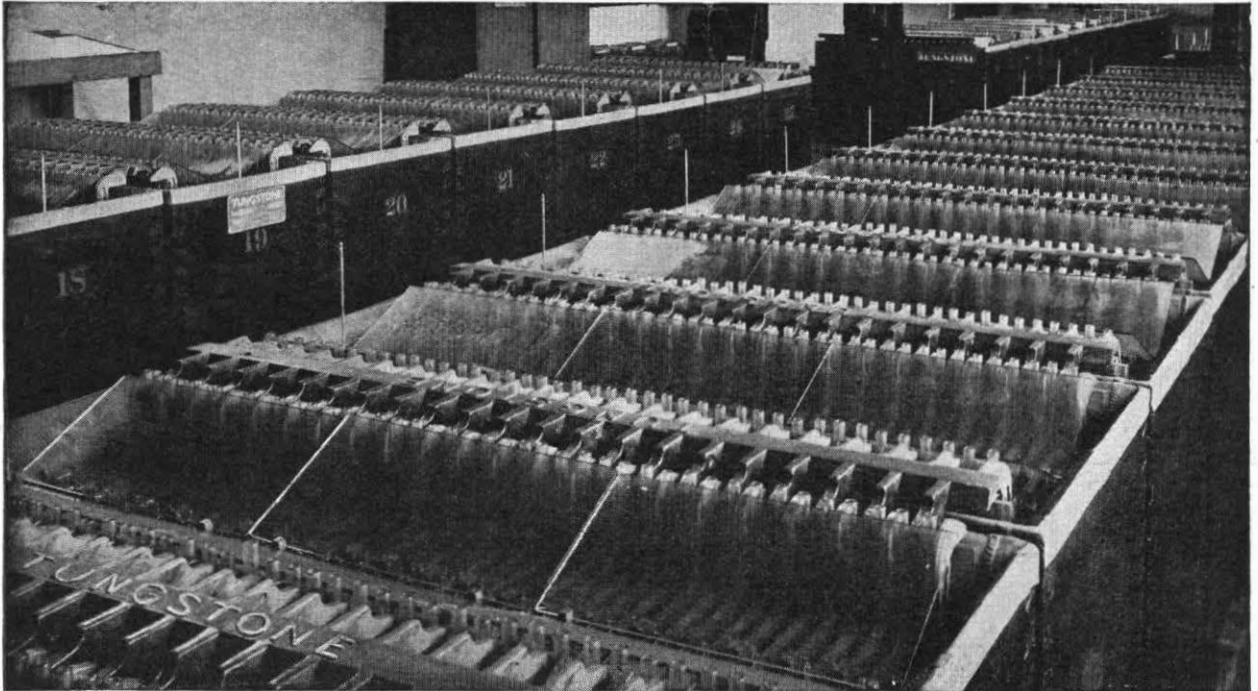

Tungstone Planté cells are being supplied to the British Post Office and to Posts and Telegraph departments abroad and conform fully to *G.P.O.* and *British Standard* specifications. Delivery is reasonable on all types and sizes.

Open type cells

Similar to the illustration above, these are available in glass and/or lead-lined wooden boxes, in capacities from 100 a.h. to 5000 a.h.

Replatal

We are in a position to supply plates for the replatal of any size of existing Planté batteries.

Overseas Enquiries

Export customers are invited to cable or write their enquiries for batteries or parts. Visitors to London are welcome at our offices.

Enclosed cells

Illustrated on the right, these are in sealed glass boxes, in capacities from 10 a.h. to 200 a.h., delivered in the U.K. filled and charged.

Technical Service

We are glad to advise on most suitable types and layouts for any installation and for any purpose.

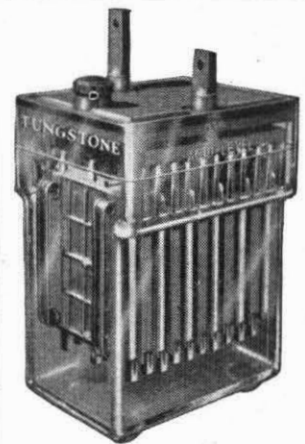

ENCLOSED TYPE CELL

TUNGSTONE *Batteries*

For further particulars write: **TUNGSTONE PRODUCTS LIMITED,**

St. Bride's House, Salisbury Square, London, E.C.4. Telephone: CENTral 8156 (4 lines.).

Cables: DILUTUM, London Works: Market Harborough, Leicestershire.

Transformers made to measure

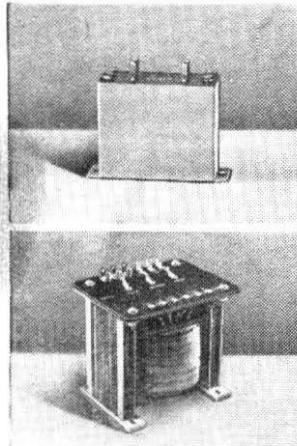

SAVAGE TRANSFORMERS are built to satisfy customers' individual requirements — they are *not* mass-produced. They are designed specially for the work they have to perform.

Every **SAVAGE TRANSFORMER** is subjected to exhaustive electrical and mechanical tests before despatch, to ensure years of faultless service. Available in all capacities up to 5 kVA.

If yours is a **TRANSFORMER PROBLEM** — write to us. We can solve it. Please address technical enquiries personally to our **Mr. W. BRYAN SAVAGE** at

Savage TRANSFORMERS LTD
OF *Devizis*

SAVAGE TRANSFORMERS LTD.
NURSTEED ROAD, DEVIZES, WILTS.
Telephone 536.

141283

A PRACTICAL PLAN for EARLY PROMOTION

Valuable Free Handbook Tells You
How to Pass Your C. & G.
or Promotion Exam. at First Attempt!



All Post Office Engineering personnel who are anxious to obtain early promotion should at once send for a copy of our handbook "**ENGINEERING OPPORTUNITIES**," which, among other intensely interesting matter, describes our unique methods of preparation for **TECHNICAL APPOINTMENTS IN THE POST OFFICE** (Assistant Engineer—New Style and Assistant Traffic Superintendent), **A.M.I.E.E., CITY AND GUILDS EXAMINATIONS** in Principles of Telecommunications (1-5), Radio (1-4), Telephone Exchange Systems (1-3), Telegraphy (1 and 2), Line Transmission (1 and 2), Lines Plant Practice (1 and 2), Mathematics for Telecommunications (1-5), Electrical Engineering Practice (Prelim. Inter. and Final), and outlines a wide range of non-examination courses in all branches of **Electrical, Mechanical, Civil, Automobile, Aeronautical and Radio Engineering.**

**We definitely guarantee
"NO PASS—NO FEE"**

If you intend to make the most of to-day's opportunities, you cannot afford to miss reading "**ENGINEERING OPPORTUNITIES**." It tells you everything you want to know to secure advancement, and describes many opportunities you may now be missing through lack of information. Send for your copy to-day — **FREE** and without obligation.

**BRITISH INSTITUTE
OF ENGINEERING TECHNOLOGY**
369 SHAKESPEARE HOUSE,
17-19 STRATFORD PLACE, LONDON, W.1

BIET

SULLIVAN GRIFFITHS INDUCTANCE STANDARDS

THE ONLY STANDARDS IN USE TO-DAY WHICH ARE UNAPPROACHED THROUGHOUT THE WORLD FOR STABILITY, FREEDOM FROM TEMPERATURE COEFFICIENT AND PERMANENCE OF ALL CHARACTERISTICS.

$1\mu\text{H}$ to 1H — FOR ALL FREQUENCIES
HIGH PERMANENCE — $< 5 \times 10^{-6}$
ZERO TEMPERATURE COEFFICIENT —

$< 5 \times 10^{-6}$ PER °C.

ACCURATELY CERTIFIED — 1×10^{-4}
ADJUSTED CLOSELY TO NOMINAL VALUE
 2×10^{-4} .

LOW SELF CAPACITANCE.
EXTREMELY LOW LOSSES.
EXCELLENT FREQUENCY CHARACTERISTICS OF BOTH L AND R.

Electrical Standards for Research and Industry Testing and Measuring Apparatus FOR COMMUNICATION ENGINEERING

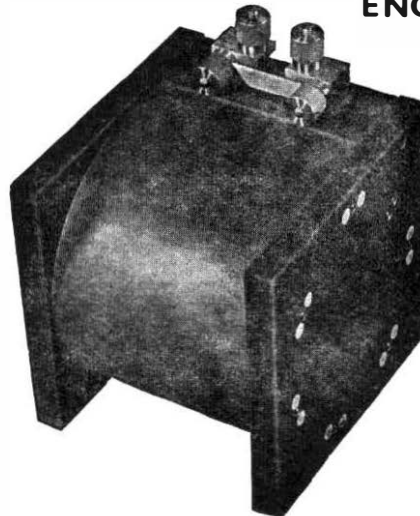

THESE STANDARDS ARE ALSO AVAILABLE IN VARIABLE AND DECADE FORM AND ALSO ARRANGED FOR MUTUAL INDUCTANCE

The illustration shows the new terminal arrangement which is now fitted to all coils to facilitate the reproduction of standardisation conditions

**H. W. SULLIVAN
LIMITED**

LONDON, S.E.15

Telephone: New Cross 3225 (P.B.X.)

ESSENTIAL FOR ACCURATE WAVEMETERS
AND BEAT-TONE-OSCILLATORS.

INDISPENSABLE FOR USE AS REFERENCE
STANDARDS IN COMMUNICATION ENGINEERING.

PRINTED PAPERS

The following papers contributed to the proceedings of the Institution have been printed by the authority of the Council and may be obtained, if still in print, from

“THE LIBRARIAN, THE INSTITUTION OF POST OFFICE ELECTRICAL ENGINEERS, G.P.O. (ALDER HOUSE), LONDON, E.C.1.”

The prices do *not* include postage. Members, Associate Members, and Associates have the privilege of purchasing copies at two-thirds the stated price.

- | | | |
|-----------|--|---------|
| †No. 118. | “SPARKING AND ARCING AT RELAY CONTACTS AND THE USE OF SPARK QUENCH CIRCUITS.”—A. H. JACQUEST, A.M.I.E.E., and L. H. HARRIS, M.Sc., A.C.G.I. 1927 | 1s. |
| †No. 124. | “THE MEASUREMENT OF SOUND AND ITS APPLICATION TO TELEPHONY.”—A. J. ALDRIDGE, A.C.G.I., A.M.I.E.E. 1929 | 9d. |
| No. 125. | “THE DEVELOPMENT OF AUTOMATIC ROUTINERS IN THE BRITISH POST OFFICE”—A. SPEIGHT, A.M.I.E.E. 1929 | 9d. |
| No. 140. | “SOME NON-METALLIC SUBSTANCES AND THEIR CHARACTERISTICS.”—Capt. N. F. CAVE-BROWNE-CAVE, B.Sc., A.M.I.E.E. 1931 | 9d. |
| †No. 146. | “LAYING ARMoured CABLE BY MEANS OF A MOLE-DRAINER.”—L. G. SEMPLE, B.Sc.(Eng.), and R. O. BOCCOCK, B.Sc.(Eng.). 1932 | 9d. |
| No. 148. | “STORES SPECIFICATIONS AND ACCEPTANCE TESTING.”—Capt. J. LEGG, B.Sc., A.M.I.E.E. 1933 | 9d. |
| †No. 165. | “PROPERTIES AND TESTING OF DIELECTRIC MATERIALS.”—J. F. DOUST and W. J. SULSTON, M.Sc., A.Inst.P. 1936 | 1s. |
| †No. 166. | “CHEMISTRY AND COMMUNICATIONS.”—D. W. GLOVER, M.Sc., A.I.C. 1937 | 6d. |
| †No. 167. | “TWELVE-CIRCUIT CARRIER TELEPHONE SYSTEMS.”—G. J. S. LITTLE, B.Sc., A.M.I.E.E. 1938 | 6d. |
| †No. 169. | “CROSSTALK.”—H. C. S. HAYES, A.M.I.E.E., R. A. SBYMOUR and P. R. BRAY, M.Sc.(Eng.), Grad.I.E.E. 1938 | 1s. 3d. |
| No. 174. | “METALLURGY AND COMMUNICATIONS.”—E. V. WALKER, B.Sc., A.R.S.M. 1940 | 6d. |
| No. 177. | “RECENT APPLICATIONS OF THE QUARTZ AND X-RAY SPECTROGRAPHS TO POST OFFICE PROBLEMS.”—R. TAYLOR, M.A., Ph.D., B.Sc. 1941 | 1s. |
| No. 180. | “SUBSCRIBERS’ CABLE DISTRIBUTION—SOME FURTHER CONSIDERATIONS.”—F. SUMMERS, A.M.I.E.E. 1944 | 1s. |
| †No. 182. | “LONDON INLAND TRUNK SERVICES.”—W. H. SCARBOROUGH, A.M.I.E.E. 1943 | 1s. 6d. |
| †No. 183. | “FREQUENCY MODULATION.”—J. H. H. MERRIMAN, M.Sc., A.Inst.P., A.M.I.E.E. and R. W. WHITE, B.Sc., F.Inst.P., A.M.I.E.E. 1945 | 1s. 6d. |
| †No. 184. | “THE FUNDAMENTALS OF DIRECT CURRENT IMPULSING IN MULTI-EXCHANGE AREAS.”—S. WELCH, M.Sc.(Eng.), A.M.I.E.E. 1944 | 1s. 6d. |
| †No. 185. | “THE OPERATION OF VALVE OSCILLATORS AND THEIR SYNCHRONISATION.”—A. C. LYNCH, M.A., J. R. TILLMAN, Ph.D., and D. G. TUCKER, Ph.D., A.M.I.E.E. 1944 | 1s. |
| †No. 187. | “CABLING PROBLEMS IN SUBWAYS AND TUNNELS.”—T. G. TURLEY, A.M.I.E.E. 1945 | 1s. |
| No. 188. | “POWER SUPPLIES FOR TELEGRAPHS.”—G. N. DAVISON, B.Sc.(Eng.), D.I.C., A.M.I.E.E. 1945 | 1s. 6d. |
| †No. 189. | “DEVELOPMENT OF TELEGRAPH SWITCHING IN GREAT BRITAIN.”—J. A. S. MARTIN, A.M.I.E.E., and J. W. FREEBODY, Whit. Schol., B.Sc.(Eng.), D.I.C., A.M.I.E.E. 1944 | 1s. 6d. |
| †No. 190. | “WIDEBAND TRANSMISSION OVER COAXIAL CABLES.”—R. A. BROCKBANK, Ph.D., B.Sc., A.M.I.E.E., and C. F. FLOYD, M.A., A.M.I.E.E. 1946 | 1s. 6d. |
| No. 191. | “PIEZO-ELECTRIC QUARTZ AND ITS USE IN TELECOMMUNICATIONS.”—C. F. BOOTH, M.I.E.E., and J. L. CREIGHTON, A.M.I.E.E. | 1s. 6d. |

† The Council have awarded Institution Medals for these papers.

Take YOUR word for it

“Denso
will be used
exclusively”

An enlightening series of candid opinions of the efficacy of Denso Anti-corrosive and Sealing Products expressed by “Men on the Job.”

★ Report by a Cable Contractor dealing with the use of Denso for sealing cable ends :

★ “. . . Instructions have been received that in future Denso will be used exclusively for protecting cable ends and leaks. This will obviate carrying fires for melting bitumen — and should save valuable time.”

WHAT WE SAY

DENSO TAPE—a permanently plastic wrapping of open-weave textile impregnated and coated with a formula based upon a protective medium known through the centuries for its water and rust-proofing qualities.

USES—Protects Services, Mains, Cables and Metalwork below and above ground against Chemical and Electrolytical corrosion and corrosive atmosphere.

Temporary repairs. Frost, Water and Gas-proofing. Sealing temporary cable joints.



Denso

Regd. Product

INDUSTRY'S SEAL AGAINST CORROSION
Write for Specification and Price List

WINN & COALES LTD.

Terminal House, Grosvenor Gardens, London, S.W.1.
Telephone : Sloane 6264 Telegrams : DENSELTE, SOWEST, LONDON

SOUND INSTRUCTION by Postal Method

The I.C.S., largest school in the world devoted to spare-time training by the postal method, offers you highly specialised Courses for the following examinations :

P.M.G. Certificates for Wireless Operators.
Associate Membership of I.E.E.
C. & G. Electrical Engineering Practice, Installation and Telecommunications.
Graduateship of the B.I.R.E.

Other Courses meet the requirements of all who desire to qualify for responsible positions in Electric Power, Illumination, Heating and Traction Systems. Equally successful is our instruction for Telegraph and Radio Engineers, Radio Servicemen, and in Elementary Radar and Electronics, and Advanced Short-Wave Radio.

Instruction is by correspondence from textbooks specially prepared by many experts.

WRITE FOR OUR SPECIAL BOOKLET and state the particular subject or Examination in which you are interested. *I.C.S. Examination students are coached till successful.*

YOU MAY USE THIS COUPON

International Correspondence Schools Ltd.

Dept. 108, International Buildings, Kingsway, London, W.C.2

Please send me, free of charge, your special

booklet on _____

Name _____ Age _____

(BLOCK LETTERS, PLEASE)

Address _____



TELEPHONY Vol. I.

By J. Atkinson, A.M.I.E.E., Area Engineer, Post Office Engineering Department. The first volume of a completely revised edition of Herbert and Procter's great work, universally recognized as the standard guide to telephony. Volume I deals with general principles and manual exchange systems. With 694 illustrations. 35/- net.

Electronics in the Factory

Edited by Professor H. F. Trewman, M.A.(Cantab), M.I.Mech.E., M.Brit.I.R.E.
An extensive survey of the applications of electronics in modern industry. Illustrated. 20/- net.

Calculation of Fault Currents in Electrical Networks

By R. T. Lythall, A.M.I.E.E. A sound introduction to the subject of circuit-breaker selection. Second Edition. 12/6 net.

Elements of Electro-magnetic Waves

By Lawrence A. Ware, Professor of Electrical Engineering, State University of Iowa. A useful course in electromagnetic theory for students of electrical engineering, commencing with the necessary vector algebra. With numerous examples and problems. 20/- net.

Hydro-Electric Engineering

By Geoffrey Gerard, F.R.S.E., A.M.I.E.E. A sound study of this important subject, containing useful information on plant and schemes in operation. 20/- net.

Engineering Workshop Drawing

By A. C. Parkinson, A.C.P.(Hons.), F.Coll.H., F.I.E.D., etc. A standard work for engineering students, just reprinted. Fourth Edition. 5/-.



PITMAN

Technical Books

Sir Isaac Pitman & Sons, Ltd., Pitman House, Parker Street, Kingsway, London, W.C.2

DECADE SWITCH

*A Precision Component Embodying
All The Best Design Features*

Very low contact resistance. Sturdy action.
Positive location. Twelve positions—providing two extra contacts
—30° angular spacing simplifies dial calibration.
Two types available—416A (Shorting) and 416B
(Non-Shorting).

PRICES ON APPLICATION

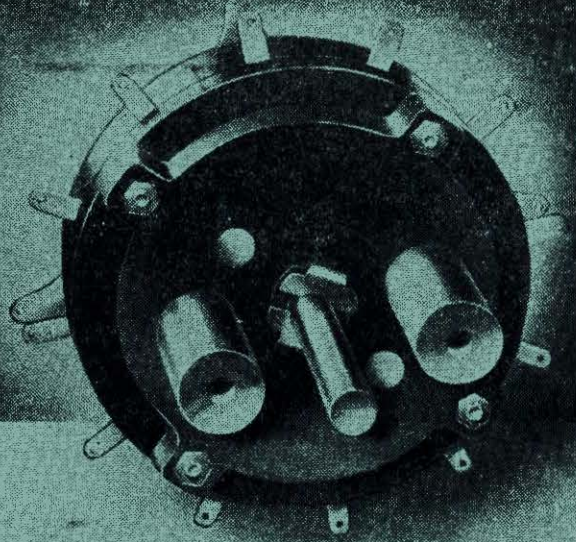

G.E.C.

PRECISION CONTROLS FOR COMMUNICATIONS & MEASURING EQUIPMENT

SALFORD ELECTRICAL INSTRUMENTS LTD.
PEEL WORKS SALFORD 3
Phone: B.L.A. 6688 (6 lines) Grams & Cables "Sparkless", Manchester
Proprietors: **THE GENERAL ELECTRIC CO. LTD.** England

TELEPHONE CABLES

OUR BROCHURE No. 9E (1949),
GIVING INFORMATION AND SPECI-
FICATIONS FOR A WIDE RANGE
OF TELECOMMUNICATION CABLES
MANUFACTURED BY US, IS
AVAILABLE UPON REQUEST.

TELEPHONE:
SOUTHAMPTON
2141 (5 lines)

IRELLI-GENERAL
CABLE WORKS, Ltd., SOUTHAMPTON.

TELEGRAMS
"PIGEKAYBEL"
SOUTHAMPTON.