

THE TAPE MACHINE — HOW IT WORKS

NEWNES

PRACTICAL MECHANICS

SEPTEMBER



IN AUSTRALIA
AND
NEW ZEALAND

AWESOME

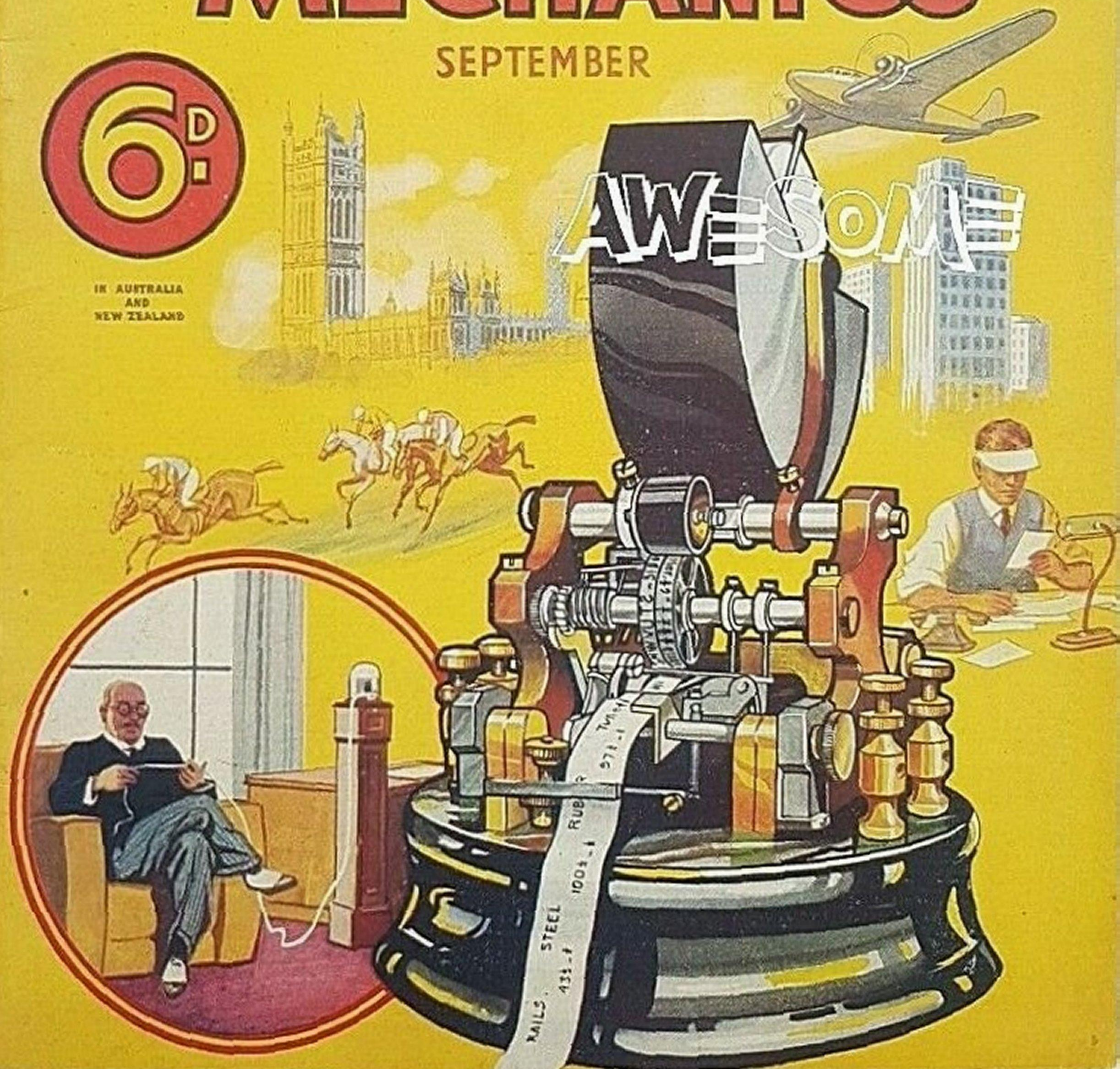



SHERLOCK HOLMES says...

"PIFCO will test everything RADIO or ELECTRICAL in your HOME WORKSHOP or GARAGE"

Why waste time tracing faults when a PIFCO ROTAMETER De Luxe will find the trouble in a matter of seconds.

This PIFCO ROTAMETER De Luxe abolishes old-time hit-or-miss methods of fault-finding; with it, any amateur electrician can swiftly and surely trace electrical faults in radios, vacuum cleaners, irons, clocks, bells, house lighting systems, automobile ignition and lighting circuits, etc. In fact, faults in everything electrical immediately respond to the magic touch of the PIFCO ROTAMETER De Luxe.



RANGES

- 1—0.5 volts
- 2—0.20 volts
- 3—0.100 volts
- 4—0.400 volts
- 5—0.10 mA
- 6—0.50 mA
- 7—0.250 mA
- 8—Resist valve test
- 9—Plug-in test for valves

Complete in velvet-lined case with testing leads.

42/-

PIFCO ALL-IN-ONE AC/DC RADIOMETER



PIFCO RADIOMETERS. The only instrument of its kind in the world for making both A.C. and D.C. tests.

RANGES

0.6 volts, 0.240 volts, 0.30 mA. Filament and Resistance Test, and socket for plug-in test for valves. 8,000 ohms Resistance. Complete with two 15-inch flex cables. Fitted with PIFCO DRY CELL.

12/6

Your regular dealer can supply you, or write:
PIFCO LTD., WATLING STREET, MANCHESTER.
London Address: 58, City Road, E.C.1

THE SHERLOCK HOLMES OF RADIO

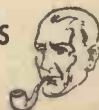

PIFCO ROTAMETERS and RADIOMETERS
PIFCO ON THE SPOT WILL TRACE YOUR TROUBLES LIKE A SHOT

ENGINEERING WORKSHOP PRACTICE

This up-to-date book provides a complete practical course of instruction in every important branch of engineering workshop methods, materials and equipment. It deals with the underlying principles, craftsmanship, machines, tools, measuring processes and machining methods of to-day, and it will prove indispensable to the engineer, draughtsman, mechanic, apprentice and engineering student. Its scope extends from simple hand tools and machines to the latest elaborate machines and methods employed for mass-production purposes.

SOME OF THE SUBJECTS

Files, Chisels, Scrapers, Shears, Punches, Burnishers, Hand Screw-cutting Tools, Spanners, Vices, Various measuring methods. Verniers, Micrometers, Gauges, Optical Devices, Fluted and Twist Drills. Grinding Angles, Drilling Data, Small and Large Drilling Machines, Electric Drills, Practical Lathework in all its branches, Machining of Metals and Synthetic Materials. Tungsten-carbide and Diamond Tools. Lapping, Honing, Cleaning, Polishing and Rust-protection of various metals. Grinding Operations and Machines, Milling Operations, Cutters and Machines. Planing, Shaping, Slotting and Broaching Operations. Special Machines for Production Purposes. Plate and Bar Machines. Gears and Gear Cutting Methods. Templates, Jigs and Fixtures. Overhauling and Adjusting Machines, Millwright Work. Welding, Brazing and Soldering Metals. Forging Work. Sheet Metal Work. Foundry Work. Patternmaking Practice. Press Work. Engineering Steel and other Metals; their Properties, Testing. Hardening, Tempering and Annealing. Engineers' Drawings. Workshop Calculations, Data, Hints and Recipes.

THE ILLUSTRATIONS

The book is lavishly illustrated so that the explanations are rendered very clear with examples taken from actual works practice in many instances. There are 24 full-page plates and 877 line and photographic illustrations in the text.

ENGINEERING CHART

In order to make the work even more comprehensive, we have brought out a chart, which is supplied free to all purchasers. It is designed so that it can either be hung upon the walls of the workshop, or can be folded and carried in the pocket for quick reference.

A FREE BOOKLET

To the Caxton Publishing Co., Ltd.,
119 Clun House, Surrey Street,
London, W.C.2.

Please send me, free of charge, Illustrated Booklet describing "Engineering Workshop Practice."

Name.....

Send this form in unsealed envelope (1/2d. stamp) or a postcard.

Address

.....

G.13.

AMBITIOUS ENGINEERS

THIS IMPORTANT HANDBOOK
ON
SUCCESSFUL ENGINEERING CAREERS

FREE ON REQUEST



After months of intensive effort and research, we are pleased to announce that the 1938 edition of our Handbook, "ENGINEERING OPPORTUNITIES," is now out of the publishers' hands and ready for free distribution. Containing 268 pages of practical guidance, this book is, beyond argument, the finest and most complete handbook on Successful Engineering Careers ever compiled. It is a book that should be on the bookshelf of every person interested in engineering, whatever his age, position or experience.

The Handbook contains, among other intensely interesting matter, details of B.Sc., A.M.I.C.E., A.M.I.Mech.E., A.M.I.E.E., A.M.I.A.E., A.M.I.W.T., A.M.I.R.E., CIVIL SERVICE, and other important Engineering Examinations: outlines courses in all branches of CIVIL, MECHANICAL, ELECTRICAL, AUTOMOBILE, RADIO, TELEVISION and AERONAUTICAL ENGINEERING, BUILDING, GOVERNMENT EMPLOYMENT, etc., and explains the unique advantages of our Employment Department.

WE DEFINITELY GUARANTEE
"NO PASS-NO FEE"



If you are earning less than £10 per week you cannot afford to miss reading "ENGINEERING OPPORTUNITIES." In your own interests, we advise you to write (or forward the coupon) for your copy of this enlightening guide to well-paid posts—NOW. *There is no cost or obligation of any kind.*

BRITISH INSTITUTE OF ENGINEERING TECHNOLOGY

410a, SHAKESPEARE HOUSE,
17, 18 & 19, STRATFORD PLACE, LONDON, W.1

-----TEAR OFF HERE-----
FREE COUPON

BRITISH INSTITUTE OF
ENGINEERING TECHNOLOGY,

410a, Shakespeare House,
17-19, Stratford Place, W.1.

Please forward, Free of cost or obligation of any kind,
your 268-page Handbook.

NAME.....

ADDRESS.....

.....

.....

EDITED BY F. J. CAMM

SUBSCRIPTION RATES

Inland and Abroad 7s. 6d. per annum
Canada. - - 7s. per annum

Editorial and Advertisement Offices: "Practical
Mechanics," George Newnes Ltd.
Tower House, Southampton Street, Strand, W.C.2.

Phone: Temple Bar 4363.

Telegrams: Newnes, Rand, London.

Registered at the G.P.O. for transmission by
Canadian Magazine Post.

Copyright in all drawings, photographs, and
articles published in "Practical Mechanics"
is specifically reserved throughout the
countries signatory to the Berne Convention
and the U.S.A. Reproductions or imitations
of any of these are therefore expressly
forbidden.

PRACTICAL MECHANICS

VOL. V. SEPTEMBER, 1938. No. 60.

The Civil Air Guard

I AM glad to know that the Air Minister, Sir Kingsley Wood, has given to civil aircraft the only fillip it has received in the 25 years of its existence. Although this country has been dependent on private enterprise for the development of its air force, it has given very little encouragement to the industry. In many ways it has hampered it. This country would have been in a very difficult position had it relied upon Government enterprise in developing aviation.

The industry in this country was founded by such pioneers as A. V. Roe, The Short Bros., T. O. M. Sopwith, De Havilland, Colonel Cody, and one or two others. For many years the industry, such as it was, was run purely for development purposes and it lost many tens of thousands of pounds per year. It is good to know that at last the country has recognised the work of flying clubs, and proposes to encourage them by granting subsidies to approved clubs when their pupils gain their pilot's certificate. The club, of course, must be approved by the Air Ministry, and elsewhere in this issue I publish full details of the Air Minister's scheme, together with a list of the flying clubs. This scheme brings cheap flying within the means of all. Normally, it takes from 20 to 30 hours to learn to fly an aeroplane (actual flying time) and the cost varies between £2 and £2 10s. an hour. Under the new scheme it will only cost a few shillings an hour, and those who were formerly unable to afford to learn to fly will now be able to do so.

This journal has taken a practical lead in bringing flying within the means of all on several occasions. It has described the building of practicable full-size aeroplanes and gliders. I hope that in placing before my readers the details of this scheme many of them will be able to satisfy their desires to become pilots.

Fair Comment

By The Editor

The Wireless Exhibition

JUST a reminder that if any readers wish to consult me on any particular problem I shall be available on our Stand No. 9—Ground Floor at the Radio Exhibition, at Olympia. I shall be very glad indeed to meet my readers.

The Model Engineer Exhibition

THE 20th Annual Model Engineer Exhibition will be held at the Royal Horticultural Hall, Westminster, from September 15 to the 24th. As all of my readers know this Exhibition is organised by my old friend Percival Marshall and I hope that all of my readers who can manage it will pay this most interesting exhibition a visit. They are bound to find something there to interest and amaze them.

The exhibits represent the very quintessence of ingenuity, patience, and high-class workmanship. I have long ceased to marvel at the remarkable inventiveness of the exhibitors. You will also find at the exhibition exhibits from most of the well-known model and tool firms, so a visit enables you not only to spend a pleasant afternoon or evening, but also to examine the castings, tools, and model making materials relative to your interests, and also to make purchases. The exhibition this year will be opened by the Rt. Hon. The Earl of Northesk, who is the president of the Society of Model and Experimental Engineers, which this year celebrates the 40th anniversary of its existence. The Royal Air Force is arranging a fine exhibit illustrating its aircraft apprentice training methods in connection with the

present Air Ministry recruiting campaign. Many of the important clubs are arranging exhibits, including the Model Railway Club, the Model Power Boat Association, Society of Model Aeronautical Engineers, the Kent Model Engineering Society, the Model Yachting Association, the British Puppet and Model Theatre Guild, and the Ship Model Society. The exhibition will be open from 11 a.m. to 9.30 p.m. daily, except Sunday.

New Books

MY readers may be interested in two new volumes which I have just produced—"Workshop Calculations, Tables and Formulæ" and the "Practical Wireless Service Manual." The former deals with gear cutting, screw-cutting, the micrometer and vernier, mensuration formulæ, the pulley, the lever, belts, the dividing head, differential indexing, trigonometry, logarithms, screw-cutting tables, and in fact with all of the formulæ and tables which the draughtsman, fitter, turner, and mechanic need.

The second volume deals with the tracing and remedying of faults in all types of wireless receivers. It deals with the subject from the point of view of the amateur and the professional, and it is the first really practical work on the subject.

The Practical Mechanics Handbook

READERS should turn to page 646 of this issue and claim their copy of the "Practical Mechanics Handbook" without delay. At the end of this month the book will be listed in our catalogue at 5s. By claiming your copy now you will thus save yourself 3s.

The volume is strongly bound in black cloth, with gilt lettering, and contains 400 pages of information on workshop practice. It is fully indexed and printed on good paper. The text is illustrated by no less than 380 drawings and photographs.

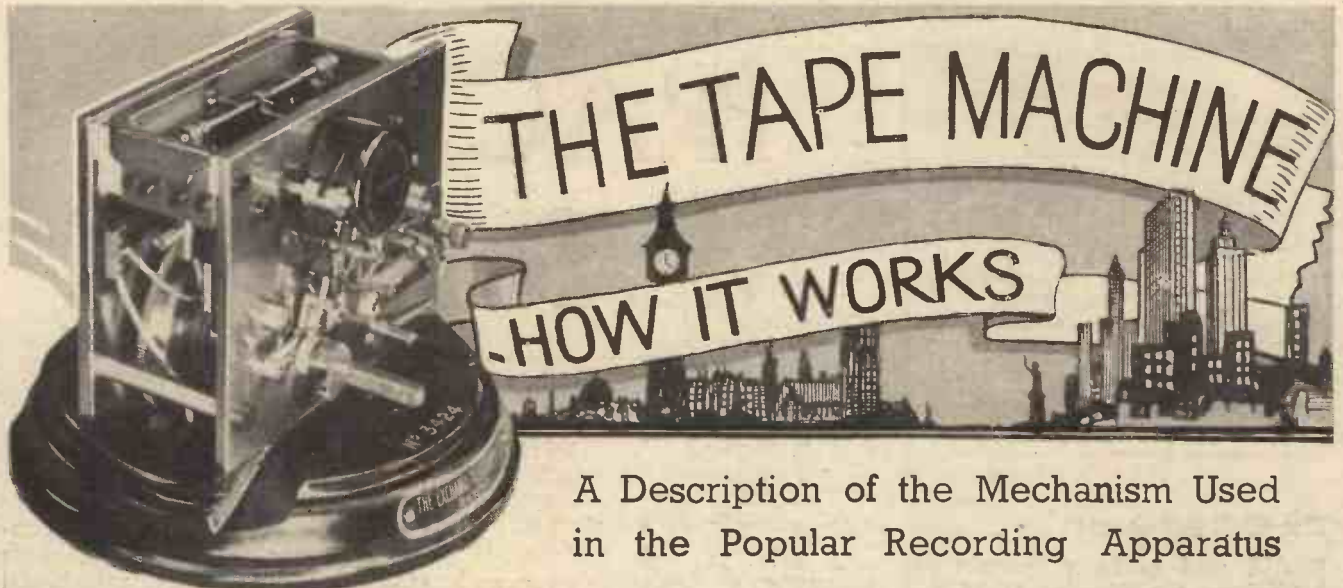

A Description of the Mechanism Used in the Popular Recording Apparatus

THE tape machine is regarded by many as an instrument of mystery, wrapped up in the secrecy which they think surrounds the Stock Exchange. But it is not only in the supply of the latest Stock Exchange prices that the Tape carries out its duties. It is used to relay news items or any other important details which the owners consider of value to subscribers. The accompanying illustrations show the various pieces of mechanism and two complete cabinet models such as are available for subscribers. It receives its name from the fact that the received news is printed on a tape which is fed out of the machine and may be torn off when a statement is completed and affixed to a notice board or otherwise made use of. The line illustration shows the inside details from which it will be seen that a large spool of paper tape is housed in a container suspended over the important parts of the apparatus. Relays play an important part in this apparatus, which, in brief, has a disc or wheel round the periphery of which are embossed letters in reverse. The disc rotates until the desired letter is at the under side at which moment the paper is pressed into contact with the edge of the disc and thus an impression of the letter is obtained—the disc, of course, travelling in contact with an inked roller for printing purposes.

The Line Connection

There are several important problems to be considered in the connection of the apparatus with the transmitter and the method of linking to ensure that the type disc at the receiver will travel in step with the transmitter, or in other words, to ensure that the correct letter is printed. The transmitter incorporates a spindle which is rotated through a slipping clutch at a constant speed. Spaced round this spindle are a number of radial stop pins, arranged at regular angular intervals and a series of type keys is so placed that each pin may be arrested by a corresponding detent carried by the type keys. In addition, a commutator is placed on the spindle and as this rotates by means of intermediate relays, a series of electrical impulses—or reversals—is transmitted in the line which is carried to the distant receiver. The number of interruptions or reversals is equal to the number of stop pins, which in turn is equal to the type keys of the transmitter. Thus, when a key is depressed the commutator will continue to rotate until the stop pin

appropriate to that key arrests its travel and this means that a given number of impulses will be carried into the line according to the key which is operated.



This type of machine is used for relaying racing results and other sporting events.

The Receiver

At the receiver the type wheel is carried on a spindle which also carries a toothed wheel and a simple ratchet or pawl is arranged to pull round the wheel one tooth at a time for each impulse. An electro-magnet operates the gathering pawl,

and thus as the impulses from the transmitter arrive at the electro-magnet the pawl is continually depressed and released, rotating the type wheel. It will now be seen that when a type key is depressed at the transmitter the given number of impulses will travel through the transmission line, the gathering pawl will rotate the type wheel for that number of impulses, and provided that the type wheel was in the correct position at the start, the letter equivalent to the depressed type key will be brought into the printing position. At this point the movement of the type wheel is arrested momentarily and a relatively prolonged current will then flow along the transmission line. This current will operate the printing mechanism in the receiver which pushes the paper tape into contact with the type face, and thus the letter is printed.

Additional Features

A very small current may be supplied to the apparatus from a local source to energise a relay which may be controlled by the impulses from the transmitter and this may bring into operation a higher voltage supply to operate the instrument. Similarly, a given impulse or series of impulses at the end of the message may be made to switch off the supply and reconnect the initial low-voltage supply which operates the relay. It will be noted in the line illustration that the model there shown has the letters on one type disc and the figures on another, with the result that the message appears in two rows—letters at the top and figures

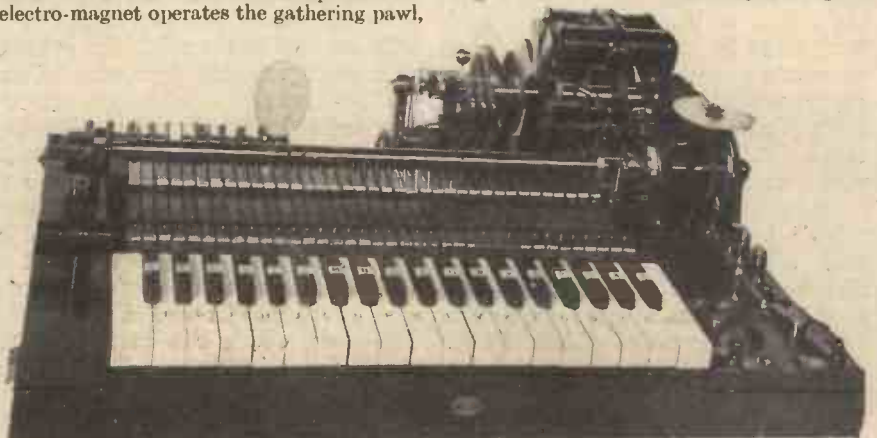

A single word transmitter which is no longer in use.

at the bottom. Both discs revolve together, but the pressure pad which pushes the tape into contact with the disc is split and the appropriate pad is selected by further impulses. In an alternative version, of course, the two discs could be shifted sideways so that the message becomes printed in a single line.

This description covers the main essentials of a type telegraphic printer. For instance, in place of the narrow paper type it is possible to use wide paper, and to so arrange the relay-operated mechanism to move the paper up by a space equal to one or more lines. This follows, of course, on the same principle as the ordinary typewriter, and the printed message appears from the top of the machine exactly as in the ordinary typewriter.

A GYROSCOPIC CAR

A REMARKABLE find of the greatest interest to the motoring world has recently been made at the Ward End property of Wolseley Motors Ltd.

Workmen, digging on a vacant site near the railway, unearthed a portion of mechanism which aroused their curiosity sufficiently to make them dig further. As a result of their operations the very well-preserved remains of a massive two-wheeled car were disclosed. This was later identified with the gyroscopic car invented by a Russian lawyer, Count Peter Schilowsky, as far back as 1912.

This amazing motor car, which since its first appearance has been the subject of copious technical argument from time to time, was constructed by the Wolseley Tool & Motor Car Company Ltd., at their Adderley Park works, Birmingham, under Count Schilowsky's direction.

The inventor claimed that a two-wheeled motor car, working on the gyro principle, could reach a given speed with a smaller engine than the ordinary four-wheeled car, and also that the frame and body construction would be correspondingly lighter.

Work was begun on the car in 1912 and several tests of an experimental nature were held. After overcoming many difficulties, Count Schilowsky was able to give the first successful demonstration run in London in April, 1914.

The car was then driven back to Portman Square to be examined at the garage, the Count being loudly cheered and congratulated on the journey.

There is no saying how this interesting invention might have developed had the work upon it been allowed to continue uninterrupted. Unfortunately, with the outbreak of War, work on the car was suspended and never resumed.

Some years ago the car was buried and no more was heard of it until it was re-discovered the other day. Realising the interest attaching to their discovery, the Wolseley Co. arranged to have the car properly excavated. The body, originally panelled in aluminium, had suffered through being under the ground, but the chassis proved to be in wonderfully good condition. The engine turned over and the gyro could be revolved. The replacement of the chains to the pendulum control was all that was necessary to make it possible to follow how the mechanism originally worked.

Of the many machines built by the Wolseley Co. during their 43 years of existence, this is probably one of the most interesting, and is certainly unique. It has now been cleaned and in part re-constructed and stands in company with other historic Wolseley models in the Company's museum.

Special Models

The makers of the tape machine supply various models according to the particular requirements to which the receivers are to be placed. For instance, the two line model illustrated is designed primarily for financial reports, and accordingly the second type disc carries a large number of fractions and other figures which might be needed in a financial report.

Another model shown is for more general news and only carries one type disc, the necessity for a large number of figures or fractions not arising in more normal news. It will be appreciated, of course, that to accommodate a large number of letters or figures on a single disc would lead to complications in view of the number of stop impulses which would have to be introduced

into the driving mechanism in order to select the individual characters, and a reduction in the size of the disc is thus desirable to simplify the transmitting and the receiving mechanism.

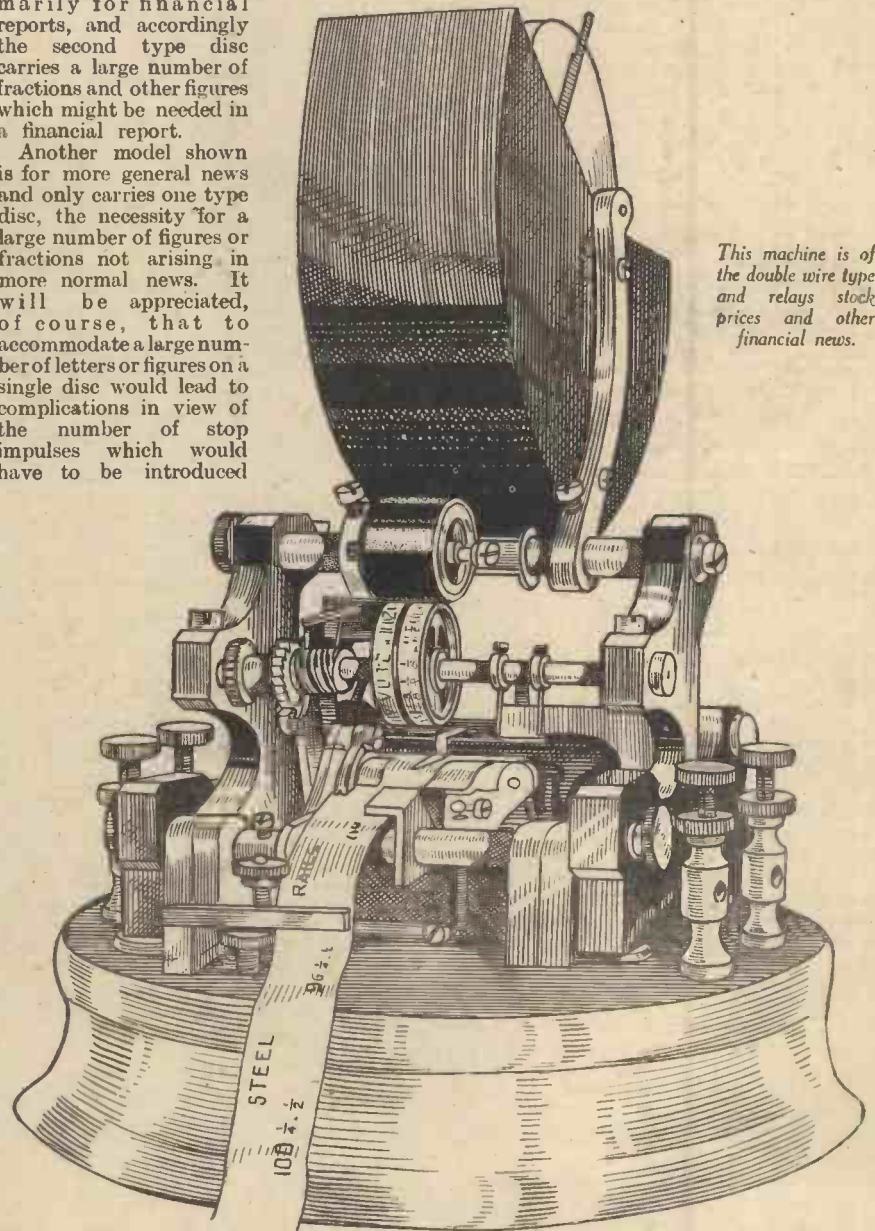

This machine is of the double wire type and relays stock prices and other financial news.



The two-wheeled gyroscopic car built to the order of Count Schilowsky in 1912. Several successful runs were made in it.

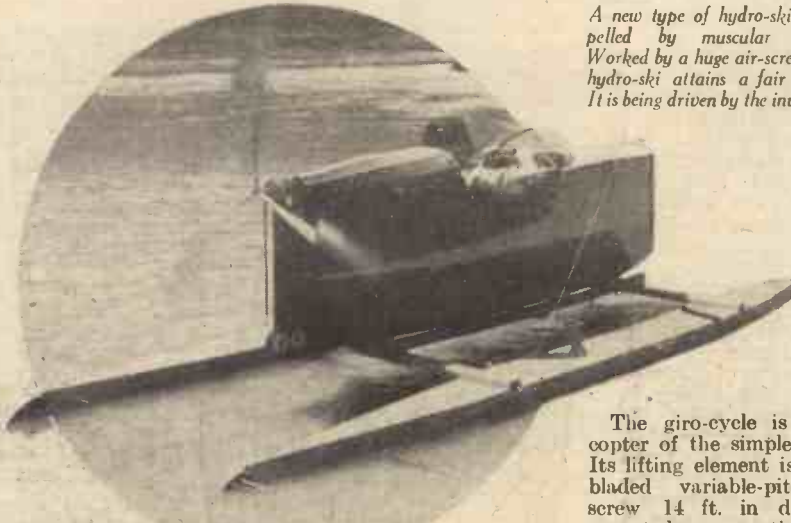

A new type of hydro-ski, propelled by muscular force. Worked by a huge air-screw, the hydro-ski attains a fair speed. It is being driven by the inventor.

Remarkable Wire

ALUMINIUM wire has been produced which is so thin that it can only be seen through a high-powered microscope. It would take 600 of these wires to equal the thickness of a human hair. Twenty ounces of the wire would more than encircle the earth at the equator—25,000 miles—but would cost £101,000,000.

Fine aluminium wires of this type are used in seismic prospecting, a modern method of finding oil by means of sound detection.

"Invisible" Aircraft

BBRITISH technical experts are now experimenting with a new aircraft construction material which may make aeroplanes nearly invisible. Although it is transparent like glass it is much stronger and by means of special presses can be moulded into any shape. A warplane built from the material would be extremely difficult to see in some lights, especially when looking down on it over water. The material is claimed to be as strong as any used in aeroplane construction at the moment.

Telephone on Wheels

THE assistant Postmaster-General recently revealed that the latest telephone idea was an automatic exchange on wheels. It is being developed for use in an emergency such as the breakdown of the exchange plant serving a rural area. He said that the exchange would be equipped for about forty subscribers and six junction lines, and would be operated from its own power plant. The complete equipment will be housed in a weatherproof body mounted on a trailer, with suspension suitable for conveying delicate apparatus over rough country.

A Human-powered Flight

APARTIALLY successful flight of a heavier-than-air machine propelled by human muscular energy, was recently made at the laboratories of Wayne University at Detroit, Michigan. The machine, known as a giro-cycle, was designed by Dr. W. Frederick Gerhardt, head of the department of aeronautical engineering, who also directed the construction.

The giro-cycle is a helicopter of the simplest form. Its lifting element is a two-bladed variable-pitch air-screw 14 ft. in diameter, mounted on a vertical drive shaft through a pinion gear of a 2-to-1 ratio by ordinary bicycle foot pedals. The giro-cycle is set up in the laboratory and is not yet a completely free flying machine, but is controlled literally by a stationary tripod. The operator mounts the saddle of the cycling apparatus, and revolves the propeller to the maximum velocity with the

THE MONTH IN SCIENCE AND

blades flat or at zero pitch. The moment the highest speed is reached the operator pulls the switch control handle sharply towards him thus increasing the pitch of the screw to the position of maximum thrust. The thrust so produced raises the machine into the air. When perfected this machine will be capable of ascents of 12 ft.



Two operators sending and receiving messages over a tone channel provided by the girl at the organ. In commercial operation the electric organ generator is concealed in a bank of other carrier equipment.

Mechanical Specialist

A REMARKABLE machine, which is indeed a robot specialist, has been installed in the new School of Medicine at Westminster Hospital. Data concerning the thyroid gland is automatically compiled by it. The patient has oxygen pumped into his lungs whilst reclining on a couch, and the robot records his breathing on a chart. A complete and accurate charted diagnosis of the case is in the possession of the doctor in charge in the short space of 15 minutes. The amount of excess oxygen inhaled by the patient is revealed by vibrations on the chart.

Telephones for Gliders

GLIDERS seem to be very much in the news lately, and now successful experiments in two-way telephone conversations between two gliders and a ground station have been made with a wireless telephone set six inches by two inches, and weighing 2 lb. The set has a range of 30 miles from glider to ground and five miles between one glider and another.

A New Communication System

A NEW development in communications which utilises the tone generator principle of the Hammond electric organ

and which makes it possible to send 96 telegraphic messages in one direction over a single circuit simultaneously was demonstrated recently by engineers of the Western Union Telegraph Company at New York City. The new improvement makes use of the principle that multiple messages can be sent over a single circuit on different tone

itches. To show how the organ generator functions in a system which more than doubles the capacity of telegraphic wires, Western Union engineers had a regular Hammond organ console installed adjacent to a bank of carrier channel equipment where the organ generator is introduced to the system. They also used a "tone detective" which, by a series of clefs on the musical scale, showed the frequencies of the tones being used at any time by the generator in the carrier channel system.

On the left can be seen a girl at the organ providing the tone channel for sending and receiving messages.

70 Million Radio Sets

There are now nearly 70,000,000 radio sets in use throughout the world of which 31,000,000 are in Europe.

Apart from the United States, Germany now leads the world, with more than 9,000,000 licences issued. Of these nearly 600,000 are free. Britain claims the record for paid licences.

These facts and figures are issued by the International Broadcasting Union in Geneva.

A Formidable Warplane

A NEW concern known as the Martin Aircraft Corporation, with a capital of £400,000, has been formed to build a super-speed fighting aeroplane which will carry seventeen machine-guns.

The machine has been designed by the president of the concern, Captain Wilson, and he claims that it will be capable of cruising at a speed between 300 and 400 m. p. h. Some of the most efficient fighter warplanes of to-day are only equipped with seven machine-guns.

Fighting Cancer

CONSIDERED the forerunner of the most powerful cancer weapons of the future, a huge 2,000,000-volt machine that

Showing a new radio invention under test. It is designed to eliminate the peril of level crossings to motorists.



smashing of particles out of the hearts of the atoms, or nuclei. They will now have twice as much energetic ammunition to bombard these nuclei, thus making it possible to break down heavier elements than before. Although the general design of the mechanism is not new, it is the world's first

radio invention which is designed to eliminate the peril of level crossings to motorists, near Chicago, U.S.A. The device consists of a small radio transmitter placed at crossings and actuated by approaching trains as are warning bells and gates. A wire is strung from the transmitter to a distance of about one quarter mile along the road on both sides of the crossing. Waves emanating from the wire within a 100-foot radius are picked up by a mechanism in motor car receiving sets. The pick-up in the car radio can be set to operate at varying distances from the crossing. It operates only when a train is approaching. Even if the radio is playing music, the warning signal will drown out the harmony.

THE WORLD OF INVENTION

it is claimed will transmute the elements and manufacture artificial radium rays was recently unveiled at the California Institute of Technology. The new combination atom smasher and X-ray mechanism, is twice as powerful as that already in use at the Institute with which 800 patients have been treated during the past eight years. The mechanism, technically, is a modified type of Vandegraaff electrostatic generator. Although it is not expected that human cancer victims will be treated with this particular machine, tests will be made with a view to confirming Dr. Lauritsen's belief that machines of similar type are destined to supplant present high-voltage cancer tubes. Measuring more than 21 ft. in height and weighing over 10,000 lb., the scientific giant is to be used in two fields of research. Dr. Lauritsen and his associates have, for some years, been engaged in measuring energies released when one element is changed into another element by the

Vandegraaff generator adapted for use in producing 2,000,000 volt X-rays.

A Radio Warning

MR. J. E. SMITH, of Gary, Indiana, and Mr. L. Clausing, a Chicago radio consulting engineer, have produced a new



The giro-cycle which is a helicopter in the simplest form. The machine is being tried out under the supervision of Dr. Gerhardt.

Glasgow's Tower of Steel

IN the article under the above heading which appeared in our issue for July last, we stated that passengers were conveyed to the top of the tower by two high-speed lifts at the rate of 30 ft. a second. We regret that this statement supplied to us by the exhibition press bureau is incorrect and that the exact speed of the lifts is 500 ft. per minute.

Whilst on the subject of lifts it may interest readers to know that the fastest lifts in the world are installed in the Radio City Building and the Empire State Building in New York. The approximate speed of these lifts is 1,500 ft. per minute.

Handled With Care

AT a recent demonstration at the Grocers' Exhibition eggs were sorted, candled and graded at the rate of 3,600 an hour by means of a machine known as a robot poultryman.

Iron That Can Be Kneaded

DR. HANS VOGT, of Berlin, has produced an iron which is so soft that it can be kneaded into any desired form. This remarkable iron is manufactured by placing iron powder in a hydrogen filled container and treating it under very high temperature (1,200-1,300 degrees Celsius). A metal sponge is produced in this way which is rust-proofed by treating it with resin. This new material will be found extremely useful for repairing pipelines.

Roads from Sugar Cane

SUGAR CANE is the latest material to be employed in road construction.

Its use is the result of many years research to overcome the problem of the extrusion of jointing material between concrete road sections which sometimes gives arterial road driving the quality of a switchback ride.

The new material, which has been developed after thousands of experiments in Great Britain and America is made from the spring-like fibres of sugar cane after the sugar has been extracted. It is felted into strong resilient strips and boards and saturated with a special water-proofing compound. The final product does not expand in the heat or extrude from the joints under pressure and is almost everlasting. Flexcell as the material is known is already being employed in a number of big road and building undertakings in Great Britain, and its production on a large scale began last July in a new factory near London.

A "Fire-Fighting" Bomb

SIGNOR FINZE, an Italian, has invented a new fire-fighting device. It is in the shape of a "bomb" and is made of papier mâché, filled with powder. When the "bomb" is thrown into the centre of a fire it bursts at a temperature of 200 degrees C. and puts out the fire.



A test pilot looking over the "uni-twin" power plant of a specially redesigned Lockheed Altair monoplane.

Rail Radio

THE use of radio in connection with the railways has already received attention in most countries. In England it has been mainly in the direction of entertainment, whilst on the Continent it has been experimented with in connection with signalling, with a view to dispensing with existing methods of indication. It enables a driver, fireman or guard to be in constant communication with the signal-boxes and would greatly increase safety. We now understand by order of the Ministry of Public Works all trains on the Turkish State Railways are to be equipped with radio.

"Talking Lamp Posts"

IT is stated that a suggestion has been put forward and tried out to facilitate traffic movements during a "black-out" arising

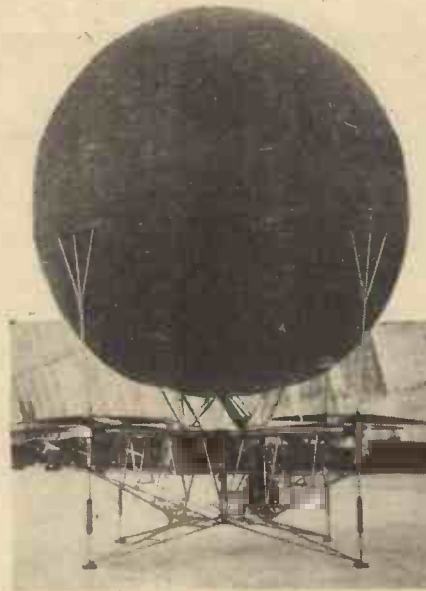

A new flying machine introduced to the French Academy of Science, called a "Helicostat" and invented by M. Oehmichen, can ascend and descend vertically. It can also stop in the air, go backwards, and take passengers on board without landing.

from an air raid. The suggestion is that loudspeakers and talking film equipment be fitted to lamps at cross-roads, the film being automatically set in motion with the changing of the traffic lights, and the loudspeaker then announcing clearly the name of the cross street or intersection.

A Pipeless Organ

THE latest type of organ is pipeless and occupies only a few square feet of floor space and is worked entirely by electricity. The console itself creates not sound, but electrical waveforms which are converted into music in a small power cabinet.

Aluminium Alloy Lorry Body

PROMPTED by the economic requirements of modern transport and to demonstrate the versatility of aluminium alloys for body building, The Northern Aluminium Company, Ltd., has designed and had constructed from its standard products an all-aluminium body for its transport fleet.

The unit has been designed to comply

One of the transport fleet of the Northern Aluminium Company, Ltd., fitted with an all-aluminium body. The versatility of this metal is once again demonstrated.



with current legislation in the 50 cwt. unladen class, but no sacrifice of strength has been permitted in achieving this object and the principles of construction may be applied to any range by suitable modifications. Moreover, the saving due to the low specific gravity of the structural materials is utilised to produce a vehicle of pleasing appearance, easily serviced and maintained in a clean condition, rather than to obtain the minimum tare weight.

An Uncanny Thermometer

DR. JOHN STRANG, astrophysicist at California Institute of Technology has designed a remarkable thermometer. It is an electric telescope in effect, which, when pointed at any distant object such as the sun or a cloud, takes the temperature of the object. Made in parts out of specks of pure gold, rock salt lenses, quartz crystals and almost invisible wires, this space defying thermometer promises to make it possible to obtain important new data not only for astronomers, but for weather forecasters, physicians and orange growers as well.

A Uni-Twin Powered Plane

HARRY FOWNES, test pilot for the Lockheed Aircraft Corporation recently made some experimental flights in a specially redesigned Lockheed Altair monoplane. Using a revolutionary principle for its power plant, the plane was powered with two Menasco 260-h.p. motors mounted side-by-side in the nose, and geared to a single propeller operated by a free-wheeling clutch. If either engine should fail, the remaining motor twirls the prop without drag. The Vega Aircraft Company, a Lockheed subsidiary, is building a new type of aeroplane designed to accommodate the "uni-twin" power plant.

Steering Planes by Radio

THE latest invention to aid aircraft is a device whereby aeroplanes on long-distance flights can be steered home by radio. It is to be tried out on Empire survey work. The personal factor is entirely eliminated by this new apparatus, because the "homing device" sets the course of the machine in the direction of a radio transmitting station, which normally would be an aerodrome with a special call sign. In an emergency, however, any radio station could be used to steer the plane to safety. Thus the pilot is left practically free, and he need only watch and adjust the radio apparatus as the necessity arises.

A TEN-WATT ELECTRIC MOTOR

The finished electric motor which is rated at approximately ten watts; that is to say, that at 4 volts it will consume current at the rate of about $2\frac{1}{2}$ amps.

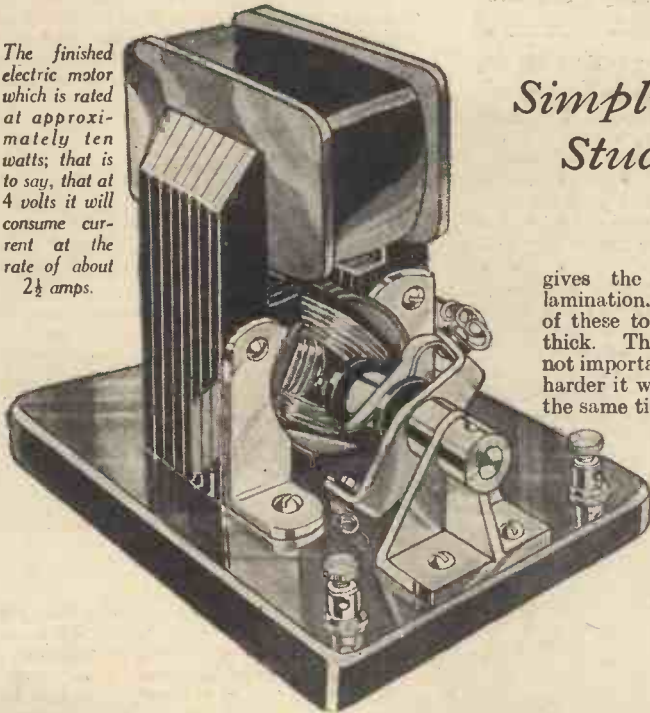

Simplicity in Construction has been Studied in the making of this Small Electric Motor

gives the dimensions of each lamination. You will want enough of these to build a magnet $1\frac{1}{4}$ in. thick. The gauge of the iron is not important; the thicker it is, the harder it will be to cut, but at the same time you will need fewer laminations. The procedure is as follows: First cut out sufficient "blanks." Then carefully mark out and drill a hole $1\frac{1}{16}$ in. in diameter in each for the armature tunnel. This is best done with the aid of a good quality $1\frac{1}{16}$ in. centre bit as shown in Fig. 3. It will probably ruin the

each. This is done with one of the armature stampings. It should pass through with about $\frac{1}{16}$ in. clearance. If it does not, the hole should be eased with a half-round file, Test each lamination in this way, enlarging the hole if necessary. Now finish cutting away the remaining part of each lamination by means of the shears and file. It is best to give one side of each lamination a coat of shellac varnish before bolting the magnet together.

The Armature

Before going any farther with the magnet it is a good plan to build up the armature. This is made from stampings. They are of the tri-polar type, $1\frac{1}{4}$ in. in diameter, and

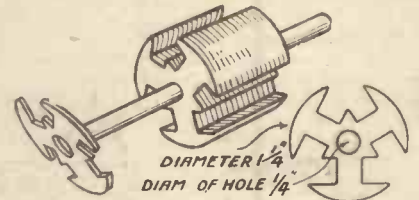

Fig. 4.—How to make up the armature.

MODEL electric motors may be divided into two classes: those that merely go round, and those that are capable of doing some useful work! The one here illustrated comes into the second category, but at the same time, knowing the limitations of the average home mechanic's workshop, we have tried to keep the construction as simple as possible. No castings are required, and what little lathe work may be necessary the local garage will be able to do for a few pence. It is rated at approximately ten watts; that is to say that at 4 volts it will consume current at the rate of about $2\frac{1}{2}$ amps. It can, however, be run at 6 volts, when the power used will be nearer 15 watts.

The Field Magnet

The order of construction does not really matter, but as the field magnet is perhaps the most difficult, it is wise to get that made first. It is composed of laminations of ordinary soft sheet iron. This type is chosen because it is more efficient than a cast one, and can be made at home. Fig. 3

bit, but will be found the easiest way to cut a clean circle if you have not the use of a tank cutter or panel cutter. If you use thick laminations, however, you will almost certainly have to use a cutter, as drilling small holes round the edge and removing the waste matter with a file is the only alternative and is very tedious. You will need to punch a small hole for the centre of the bit to turn in. You should rest the work on a block of hardwood, and as soon as you have partially cut through the metal you should reverse it. The "prong" of the bit may need sharpening after you have cut several holes.

Now drill four small holes in each lamination. The position of these must be exact, otherwise the magnet will not bolt up true. A good idea is to drill the holes in one lamination and use it as a template to drill the others, each of which is in turn clamped in the vice with it. See that the armature tunnel holes coincide exactly each time. Now, before cutting away the rest of the middle part of each lamination, you should test the size of the armature tunnel hole in

about fifty go to make up an inch. As your armature is to be $1\frac{1}{4}$ in. long you should order six dozen to be on the safe side. Each stamping must now be shellacked one side, or may be separated from the next with a thin piece of waxed paper. Shellacking, however, is quite sufficient. Now thread them on to a steel spindle $\frac{1}{4}$ in. in diameter and $4\frac{1}{2}$ in. long, as in Fig. 4. Pack them together as tightly as possible. Before putting the two outside ones in place, clean them thoroughly and tin them round the spindle hole and also emery the spindle. Then slide them on and tie the whole thing round tightly with string. A touch of solder will secure the end plates of the spindle, when the string may be removed and the core is complete. Before adding the

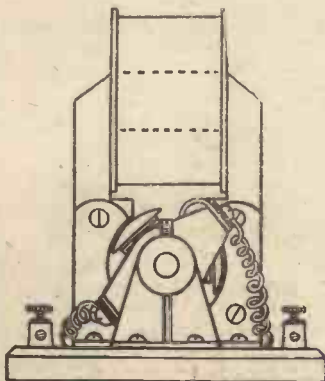

Fig. 1.—An end view of the electric motor.

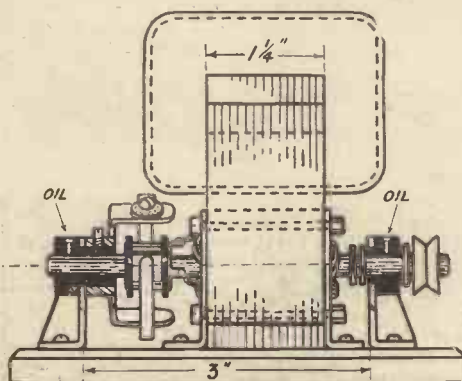

Fig. 2.—A side view.

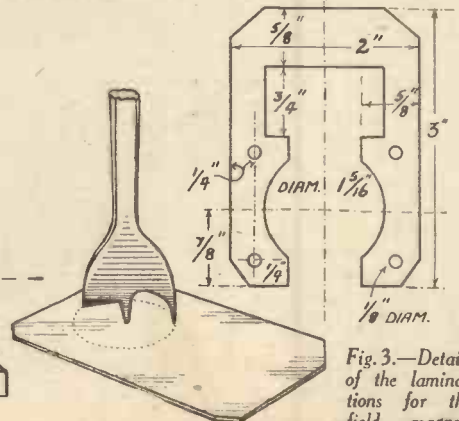

Fig. 3.—Details of the laminations for the field magnet.



Fig. 5 (left).—How to wind the armature

Fig. 7 (right).—Details of the brass brackets, four of which are required.

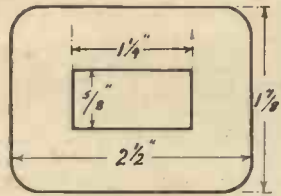
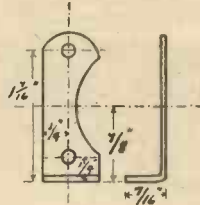

Fig. 6.—The fibre end plates.

shown so as to form three soldering tags. Three evenly spaced saw cuts are now made down the length of the tube, but not passing through at one end. A fibre ring is forced over the cut-through end as in Fig. 10 (d). In Fig. 10 (e) the saw cuts are extended to the other end by means of a small file and a second fibre ring is forced on.

When you have made the commutator, you should drive it on the spindle and solder the armature wires to the tags. Do not worry about the position of the segments relative to the armature poles as the rocker allows of the brushes being turned to the correct position.

Testing Out

When you have made all the parts, mount them very carefully on a hardwood base. See that the armature spins freely. The bearings should be quite free, but with no appreciable up and down play. Any irregularities in the construction of the field magnet brackets or the bearing brackets can be compensated for by placing thin washers under the brackets when screwing them down. Connect up the field magnet and brushes as in Fig. 12. You are now ready to put the machine through its paces! Oil the bearings with thin oil. See that the brushes are pressing fairly firmly on the commutator and then switch on. If the

windings carefully insulate the core by winding on a layer of insulating tape in the slots. Do this properly, so that there is no chance of the wire anywhere touching bare metal. It is a good plan to use tape sufficiently wide to fill the sides and bottom of the slots and to cut it narrow where it has to pass round the ends of the poles. It is the usual practice to fit a fibre washer of the same shape as the stampings at each end of the armature core before winding the insulation tape. This is an added precaution against the corners of the metal stampings cutting into the wire and causing a "short," and it is advisable to fit a pair if you wish your motor to give long service.

The completed core should be wound with 1 3/4 ounces of 20-gauge double silk-covered wire, or just under two-thirds of an ounce for each pole. Fig 5 shows how it is wound. Each must be wound in the same direction. Leave the ends twisted together ready for joining to the commutator. It is now advisable before tackling the commutator and bearings to see if the armature fits nicely in its tunnel in the field magnet. With the bolts slacked off a little, any laminations which may be slightly out of place can be tapped in position. When you are satisfied that the armature will be able to revolve without touching, take out the bolts from the field magnet, and slip on the two fibre end plates from the field coil. These are shown in Fig. 6. Before putting the bolts back again you should cut out four brass brackets of the dimensions given in Fig. 7, and then replace the bolts, passing them through the brackets. Once more check the clearance between the armature and the sides of the tunnel and bolt up tightly.

The Field Windings

Before commencing to wind on the wire, put a layer or two of insulating tape to prevent the magnet chafing the wire. Then carefully wind on 3 1/2 oz. of 20-gauge double silk-covered wire. Wind it tightly and evenly in layers and finish off by winding some more tape round the outside. If you intend running the motor continuously from a 6-volt supply you will find 4 oz. of 22-gauge wire more suitable.

To complete the motor there now remains the bearings and brush gear and the commutator. They are shown in Figs. 8, 9, and 10 respectively. The bearings shown are each

composed of a bracket fitted with a brass bush to take the spindle. The bush is sweated into place and a web is added to ensure rigidity. This also is soldered into position. Unless you happen to have something just the right size amongst your odds and ends you will have to get the bushes turned up on a lathe. Fig. 8 gives the measurements. The brush rocker arm is of stout sheet brass and fitted with a brass bush, which is a stiff sliding fit on the narrow part of the front bearing. The bush is tapped and fitted with a set screw so that the rocker may be locked in any position. Fig. 9 (a) gives a general idea of the assembly and b, c, and d give the measurements of the rocker arm and its bush. The brushes are each made of springy brass and are bolted to the rocker arm, but insulated from it by two fibre washers and a fibre bush (see Fig. 11).

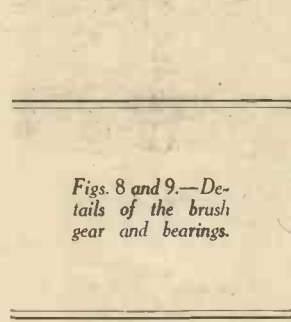

Figs. 8 and 9.—Details of the brush gear and bearings.

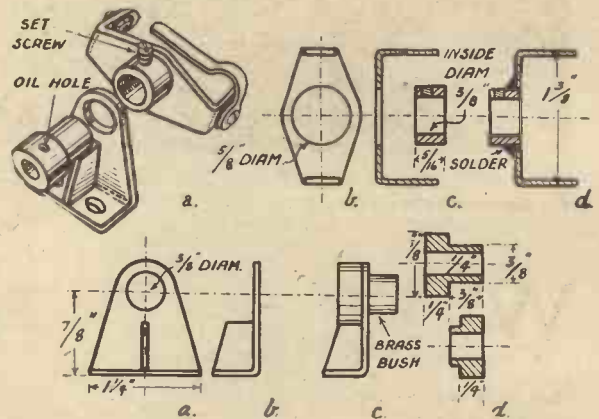

The Commutator

Fig. 10 shows the various stages in the construction of the commutator. This is often a difficult part for the amateur to make owing to the need for having the hole in the bush perfectly concentric with the outside. If a lathe is not available you will most likely save time by getting the bush turned up for you. It should be a tight fit on the spindle and also in the brass tube which is to form the segments. It is forced into the tube as in Fig. 10 (c), and the end of the tube is then filed to the shape

brushes are in the right position the motor will zoom into life. However, if it does not, switch off immediately, or you will heat up the motor and exhaust the battery. Re-set the rocker arm to a new position and try again. When you get it running you can make the final adjustments. Set it at the position giving the greatest speed and the least sparking at the brushes.

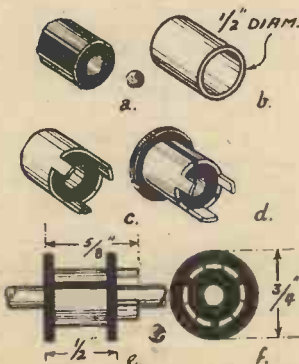

Figs. 10 to 12.—(Left) Details of the commutator. (Above) How the brushes are made. (Right) The wiring diagram for the field magnet brushes.

THE P.M. LIST OF BLUEPRINTS

- F. J. CAMM'S PETROL-DRIVEN MODEL MONOPLANE
7s. 6d. per set of four sheets, full-size.
- The "PRACTICAL MECHANICS" £20 CAR
(Designed by F. J. CAMM.)
10s. 6d. per set of four sheets.
- The "PRACTICAL MECHANICS" OUTBOARD SPEEDBOAT
7s. 6d. per set of three sheets.
- A MODEL AUTOGYRO
Full-size blueprint, 1s.
- SUPER-DURATION BIPLANE
Full-size blueprint, 1s.
- The P.M. "PETREL" MODEL MONOPLANE
Complete set, 5s.
- The 1-c.c. TWO-STROKE PETROL ENGINE
Complete set, 5s.

The above blueprints are obtainable post free from Messrs. G. Newnes Ltd., Tower House, Strand, WC2

How Margarine is Made

Sunshine Vitamins
for Everyone

By
A Special Correspondent

the most hygienic conditions, and the most up-to-date principles of science are used to effect its manufacture, the theory of which is based on the emulsification of fresh dairy milk with refined vegetable and nut oils, the use of animal fats having practically died out.

A New Product

Napoleon III could have had little idea how extensively the invention he sought would sweep the world. Shortly after Mège-Mouries started to make oleo-margarine on as large a scale as the facilities at his command would permit, two young men at Oss, in Holland, named Simon Van

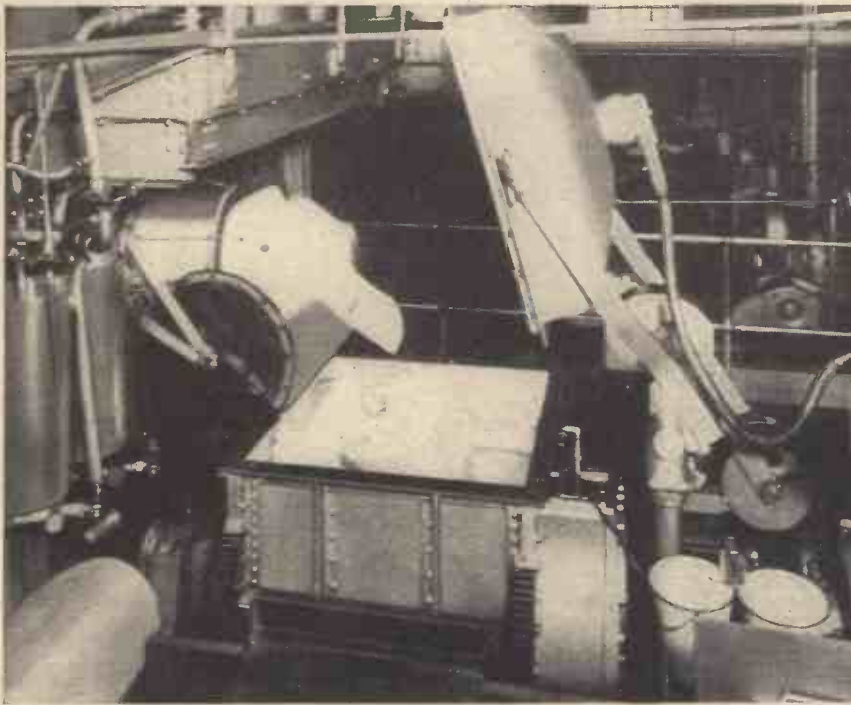

The final blending in margarine manufacture. At this stage the moisture content is checked. This is fixed at 15 per cent. by law—the same as in the case of butter.

WHEN the Germans were advancing on Paris during the Franco-Prussian war the shortage of food supplies, especially dairy produce, became acute. The price of butter soared so high that none but the very rich could afford it. In 1870, Napoleon III, gravely concerned at the plight of his people, offered a prize for the invention of an article "as nutritious, as stable, as palatable as butter."

The challenge was taken up by the scientist Mège-Mouries. Setting to work on the problem he noticed that when cows were not given their food they still yielded milk, although they quickly lost in weight. He found that it was possible to make butter from this milk, and concluded that the butter must come from the body fat of the animal. If this were so, he reasoned, it must be possible to get butter from the cow's own fat.

How It Was Made

A little research showed that in actual fact this was the case, and before long Mège-Mouries was supplying the whole of Paris with his butter substitute. His method was to heat to 45 degrees finely minced beef suet, water, carbonate of potash and fresh sheep's stomach cut up into small fragments. The combination of pepsine from the sheep's stomach and the heat separated the fat from the cellular tissue. Mège-Mouries removed the fat and when it was cool submitted it to hydraulic pressure, which separated the edible from the unedible fat.

The former, which Chevreul, the famous French chemist, named oleo-margarine, was mixed in a churn with milk and water

in such proportions as to produce a fatty emulsion similar to butter.

The substance that went by the name of margarine in those days, however, was very different indeed from the margarine of to-day—so much so that strictly speaking we should have adopted an entirely new name for the product.

The margarine of to-day is made under

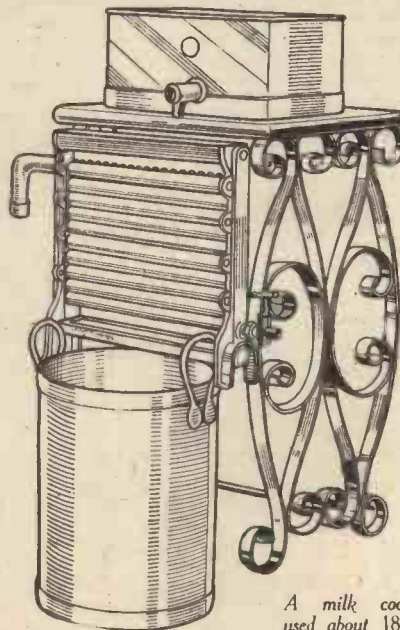

A milk cooler used about 1880.

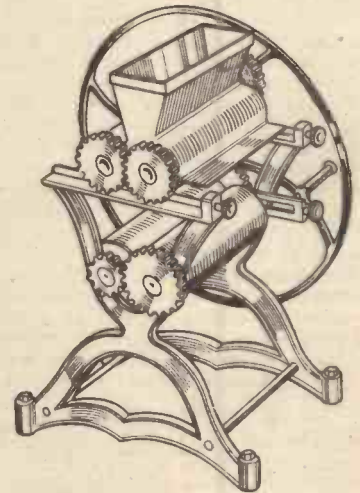

Mège-Mouries' animal fat crusher. Mège-Mouries reasoned that it must be possible to obtain butter from the cow's own fat. His reasoning proved correct for at one time he supplied the whole of Paris with his butter substitute.

den Bergh and Anton Jurgens started to make the new product. In 1934 Mr. J. P. Van den Bergh and Mr. Frans Jurgens, great-grandsons of Simon Van den Bergh and Anton Jurgens, unveiled at Purfleet, Essex, a plaque to commemorate Mège-Mouries on the occasion of the Diamond Jubilee of the introduction of margarine into this country.

The leading margarine factories in England to-day are at Bromborough, in Cheshire, and Purfleet, in Essex. They are set in the ideal surroundings of vast undulating pastures so that the fresh dairy milk that plays the leading part in the manu-

facturing process can be obtained with the minimum difficulty.

The milk is conveyed to the factories in glass-lined tanks. Upon arrival it is pasteurised before undergoing special treat-

ment in preparation for churning with the refined oils and fats. In one factory alone over 12,000 gallons of milk are used every week.

together in enormous churns, where they are bleaded together to form a smooth, creamy emulsion. This emulsion is cooled by bringing it over huge revolving drums kept at freezing point. By the time the liquid has travelled once round the drum it has been converted into a solid layer that is shorn off by scrapers to fall like a cascade of snowflakes into aluminium containers.

it underneath the margarine just a fraction of a second before a set of steel "fingers" pushes the paper round.

Although such enormous strides have been made in the manufacture of margarine since Mège-Mouries, it was not until comparatively recently that one of the greatest achievements in its manufacture was accomplished. While manufacturers were striving to attain the highest ideal standards there was one respect in which it differed considerably from butter.

Summer butter embodies the sunshine vitamins A and D which help bone and teeth formation and enable us to build up resistance against infection from influenza and many more serious ills. After considerable scientific research margarine manufacturers in this country discovered a process of incorporating these vitamins in margarine. Their achievement has exceeded their greatest hopes, for whereas the vitamins A and D are only abundant in butter in summer time, there is now a standard quantity of them in most brands of margarine all the year round. Wherever

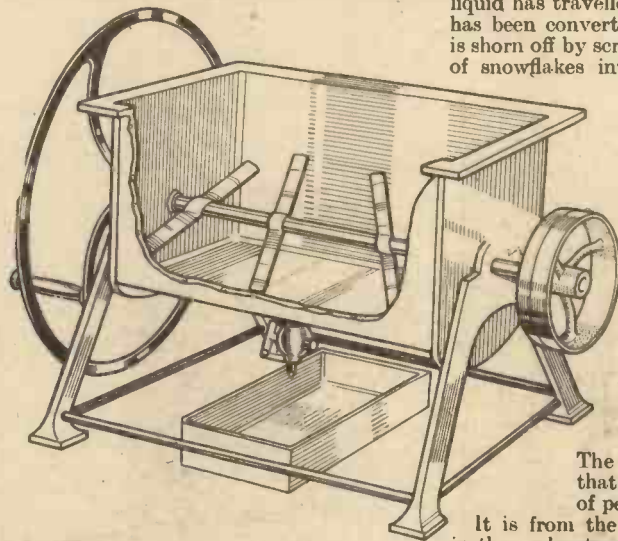

The forerunner of the churn as we know it to-day. The churn shown is one of the earliest models which came into use about 1885.

The result is a glistening mass that has been likened to a heap of pearls.

It is from the appearance of margarine in the early stages of manufacture that we get the name "margarine;" it is derived from the Greek *margarites*, which means a pearl.

The Maturing Rooms

Electric trucks whisk the containers away to the maturing rooms. Here the margarine is left to "settle" before being tipped into aluminium hoppers fitted with worm screws that carry the margarine forward, kneading it thoroughly to give it the pliability that it must have. This first kneading is given by pressing the margarine through granite rollers, and after that it receives another pommelling on revolving tables equipped with paddles.

Very finely ground salt is added where necessary during the kneading, and after standing in a cool room for a period the margarine passes on to the packing-room where hundreds of machines, almost human in their ingenuity, cut and wrap pounds and half-pounds with absolute accuracy. The machinery that is used for the actual wrapping is fascinating to watch. A "hand" which gets its power from a vacuum pump picks up the paper in which the margarine is to be wrapped and thrusts

Another early type of churn.

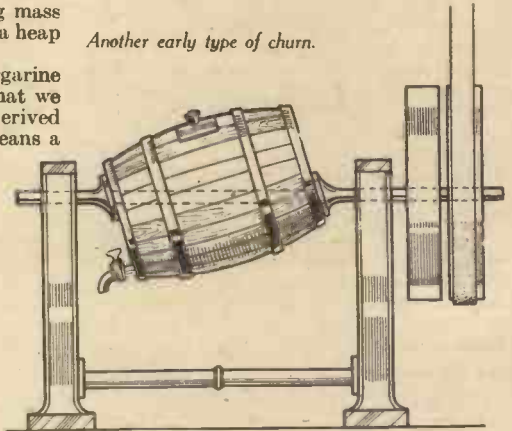

this applies the fact is clearly stated on the wrapper. Another very interesting fact about the dietetic value of margarine was revealed when the Nutrition Committee of the British Medical Association published its famous report. Whereas a pound of butter gives 3,503 calories (energy-giving units), a pound of margarine gives 3,579.

During the last few years a considerable amount has been said about the lack of margarine manufacturers in this country. Thus they are to be congratulated in having placed a food containing two of the most important vitamins within reach of everyone.

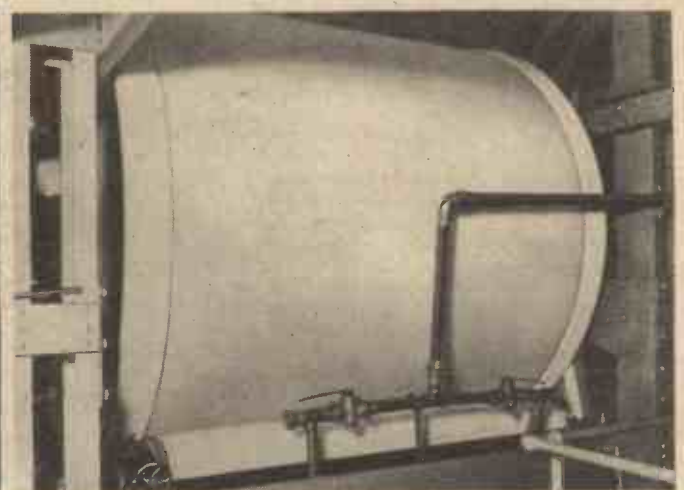
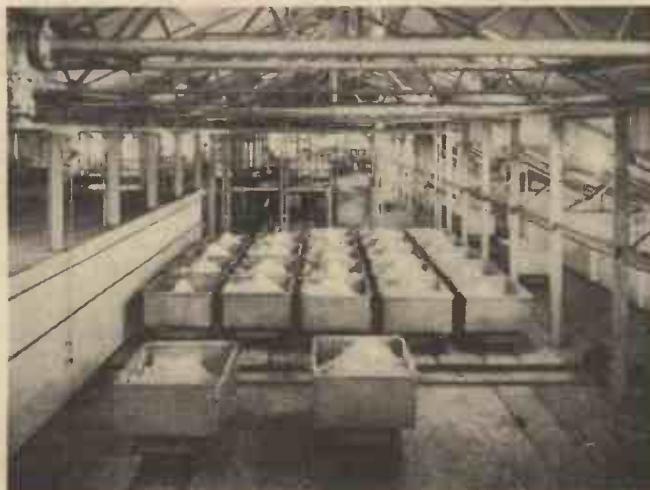

(Left) Maturing the margarine before the final blending. (Right) One of the giant cooling drums used to solidify the emulsion of milk, vegetable and nut oils used in margarine manufacture.

THE CIVIL AIR GUARD

Cheap Flying For All!

In view of the important part which PRACTICAL MECHANICS has played in encouraging gliding and the construction of aeroplanes by amateurs, we are glad to publish the Air Ministry's plans

THE object of this organisation is to provide, in times of emergency, a body of men and women physically fit, with a knowledge of flying, and pledged to give their services at once in any state of National emergency arising from war or the threat of war, to the Royal Air Force or in any other direction concerned with aviation, for which these services are wanted. All sections of the Community will be represented. There will be no obligation on the part of the authorities that members' services would be used exclusively for piloting.

Membership of the Civil Air Guard will be open to any person between 18 and 50 years of age, irrespective of sex, provided that the member has no reserve liability.

Payment of Air Ministry subsidy will be dependent upon the obtaining of the "A" pilot's licence and its maintenance in force. Each light aeroplane club participating in the scheme will have a section of Civil Air Guard members.

Five Commissioners

The central administration will be undertaken by a board of five honorary "Commissioners of the Civil Air Guard," with a secretary. These Commissioners will help in forming and stimulating the Civil Air Guard Sections of the Clubs, and will act as policy advisers and liaison between Air Ministry and Civil Air Guard. Their address is:—

Commission of the Civil Air Guard,
Ariel House,
Strand, W.C.2.

At a later stage an area organisation will probably be built up, on a voluntary basis, to form the intermediate structure.

Financial Arrangements

Air Ministry subsidy will be paid to clubs on their rendering periodical returns of licences obtained, flying carried out, and undertakings maintained in force.

The object of the financial arrangements

is to enable light aeroplane clubs to offer flying facilities at specially low rates, in view of the large numbers of suitable persons who at present have not sufficient means to pay for club flying. The intention is that for all flying in respect of which Civil Air Guard subsidy will be paid, the charges to the member shall be fixed at the low figures of 5s. per hour for flying on week-days (Monday to Friday), and 10s. per hour at week-ends (Saturdays and Sundays), so far as such flying is carried out upon ordinary types of aircraft similar to those for which club subsidy is at present payable. With regard to light aircraft of foreign manufacture and low operating costs which cannot earn subsidy under the existing Light Aeroplane Club scheme, but which are used for the purpose of affording cheap training, and could be regarded as suitable for air guard purposes at the present time, the intention is that the charge to the member should be 2s. 6d. per hour for flying during the week, and 5s. per hour for flying at week-ends. It will be a condition that all aircraft used for Civil Air Guard purposes shall have a certificate of airworthiness issued or validated by the Air Ministry.

The use of foreign aircraft will not, however, be accepted as appropriate for permanent arrangements, and it is proposed to review this aspect of the scheme after, say, four years, thus allowing a fair period of use to be obtained, should a decision ultimately be taken that such aircraft can no longer be used.

In order to make the above arrangements possible, and at the same time to allow a small margin to encourage the clubs to assist the scheme to the utmost of their capacity, it is proposed that in the case of members who undertake Civil Air Guard liability and obtain the benefit of low charges for flying, the ordinary subsidy will

*Sir Kingsley Wood,
who was responsible
for forming the Civil
Air Guard.*

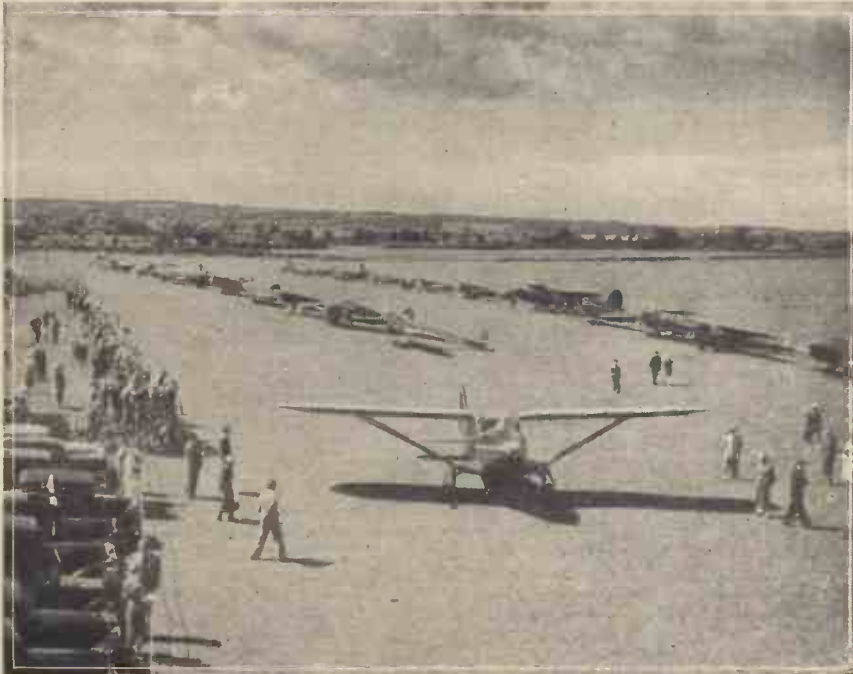

A meeting of the Bristol and Wessex Aeroplane Club at Whitchurch, near Bristol.

General Conditions Governing the Approval of Clubs under the Air Ministry Scheme for the Financial Assistance of Light Aeroplane Clubs

1. A Company shall be incorporated under the Companies Acts to manage the club and to afford it flying facilities and a copy of the Memorandum and Articles of Association of the Company shall be submitted to the Air Ministry.
2. The profits of the Company beyond a reasonable rate of interest on the share capital subscribed shall be used for the main purposes of the club.
3. The Company shall own its own aircraft, registered in the name of the Company. Aircraft in respect of which a Certificate of Airworthiness has not been issued or validated by Air Ministry shall not be used for Club purposes.
4. An aerodrome or a portion of an aerodrome, and hangar accommodation, shall be owned or rented by the Company.
5. The instructors and engineering staff necessary for the Club shall be employed by the Company.
6. The Directors' fees, the rents, the flying charges payable by the Members and payable to air pilot instructors, ground engineers and mechanics shall be approved by the Air Ministry.
7. Participation in the Civil Air Guard scheme will be subject to the concurrence of the Commissioners of the Civil Air Guard.
8. It is also required that the Articles of Association should include a clause on the following lines:—

The dividends paid on the share capital (whether present or future) of the Company shall be limited to 5 per cent. per annum in any one year, and any remaining profits after payment of the dividend of 5 per cent. per annum on the share capital shall not be capitalised or carried forward or to reserve, but shall be applied in furtherance of the maintenance and for the benefit of the Club.



An aerial view of some of the machines during a meeting at Brooklands Flying Club, Surrey.

Air Guard grants. The existing limit of £2,000 per club for ordinary club subsidy will be retained. Ordinary club subsidy in respect of club members who do not undertake Civil Air Guard liability at the rate of £25 new pilot's grant, £10 renewal grant and 10s. per hour flying grant will continue to be payable.

It is not intended at present to place a limit on the amount which can be earned by individual clubs by way of Civil Air Guard subsidy, which will be payable at the higher rates above mentioned (£50 or £30, £15 and £2), in respect of all qualified members who undertake Civil Air Guard

liability, and benefit by the reduced charges for flying; but this matter will be reviewed in the light of circumstances after experience of the scheme has been gained.

It is intended also that there shall be an Air Guard section of the gliding movement. This side of the scheme will take some time to consider, and it is not intended meanwhile to delay the setting up of the Light Aeroplane Club arrangements.

It should be emphasised that the Air Guard scheme is designed to meet the special circumstances of the present time and may be revised on due notice in the light of altered conditions.

(See page 667 for list of light aeroplane clubs in Great Britain)

not be payable, but will be replaced by the following arrangements:—

1. New pilots grant for Civil Air Guard members will be £50 in respect of pilots trained on standard training types of aircraft, and £30 in respect of pilots trained on the lighter types.
2. Renewal grant will be £15 irrespective of type of aircraft used.
3. Flying grant for trained members up to a maximum limit of 10 hours per member will be paid at £2 per hour. This maximum will be also the minimum flying required to qualify for renewal grant. Flying by Civil Air Guard members above 10 hours per year will be paid for by them at ordinary club rates.
4. Monthly progress payments will be made in respect of *ab initio* training at the rate of £3 per hour in respect of standard training aircraft, and £2 per hour in respect of lighter aircraft with a limit of six hours. These payments will be deducted from the new pilots grant when earned.
5. Flying grant will be paid at £2 per hour in the same way (i.e. monthly) up to a limit of 10 hours. The monthly payments indicated in sub-paragraphs 4 and 5 would not be returnable in the event of the pilot failing either to obtain a licence or to renew his licence.
6. Claims for grants will be dealt with monthly instead of quarterly as in the existing subsidy scheme, but this provision will be subject to review in the light of experience.

No special provision will be made to assist the clubs in the matter of purchase of aircraft.

Club Charges

Club members who do not join the Civil Air Guard will pay ordinary club charges; and Civil Air Guard members will pay ordinary club charges in respect of flying in excess of the amount covered by the Civil

DETAILS RELATING TO WORKING ARRANGEMENTS

1. It is hoped that an area organisation will in time be built up under voluntary arrangements, which will co-ordinate the Civil Air Guard activities of clubs according to areas; but the central organisation described in the memorandum will at all times be the principal link between the Air Ministry and the Civil Air Guard. This central Board of Commissioners of the Civil Air Guard is accordingly being set up at once, since both the initiation and the continuation of the arrangements will be carried out through their agency. The Board will consist of five honorary Commissioners with a Secretary. Accommodation for secretarial work and for meetings of the Commissioners will be made available by the Air Ministry. Communications between the Air Ministry and the Clubs (or Sections), and vice versa, will in general take place through the channel of the Central Board.
2. Any light aeroplane club, whether at present receiving Air Ministry subsidy or not, may apply for inclusion in the Civil Air Guard scheme. In order to qualify for inclusion, a club must:
 - (a) Give an undertaking that Civil Air Guard members will be required to pay

not more than the prescribed charges for flying laid down in the Memorandum;

(b) Undertake to operate a Civil Air Guard section of not less than 12 members.

3. Before members are approved for participation in the scheme, they will be required to sign an undertaking that they will offer their services at once in any state of National emergency, for the purpose of employment in connection with Royal Air Force requirements or in any other direction concerned with aviation.
4. Clubs approved as qualifying, will render monthly statements to the Air Ministry, giving details of licences granted or renewed during the month, and of flying carried out in connection therewith; also information regarding undertakings in force.
5. Arrangements are being made for the introduction of the scheme at an early date.
6. In order to distinguish Civil Air Guard members during training, it is thought that a suitable overall outfit should be worn; this might be brown in colour with an "Air Guard" badge on the pocket. For general purposes an Air Guard button badge could be made available.

MASTERS OF MECHANICS

No. 37. Thomas Savery—one of the most interesting characters associated with the Early History of the Steam Engine



Thomas Savery.

THE ingenious Mr. Savery," as he was semi-officially designated, comprises one of the most interesting characters associated with the early history of the steam engine. We know singularly little about him, many portions, indeed, of his life being enshrouded in as much mystery as those of Shakespeare. Yet Thomas Savery, of Devon, is a personality of great import in the record of steam power development, since, as far as it is now possible to ascertain, it was he who devised, patented and actually manufactured and set up what may be truly termed the world's first working steam engines.

Before Savery's time, another curious figure, the romantic Marquis of Worcester, whose life-record has been outlined in a previous article of this series, gained a modicum of success in the primitive application of steam power. At the best, however, the Marquis's so-called "steam engine" was an impracticable affair which, unlike Savery's engine, was incapable of being commercially applied.

First "Practical" Engineer

Savery, therefore, goes down in the record of steam engineering as the first of the "practical" engineers, the immediate successor of Thomas Newcomen, from whose famous "atmospheric" engine, the world's steam power providers have, for the most part, evolved.

Savery called his steam-power device, which he patented in 1698*, a "fire engine." It consisted of an apparatus by means of which a vacuum set up by the condensation of steam in a large cylinder was caused to draw up water from a sump or a well, steam pressure subsequently being used to force the drawn-up water to a greater height.

The working of Savery's "Fire Engine" will be apparent from a glance at the illustration on this page which is reproduced from the inventor's original drawing of his apparatus. Steam, raised in a copper boiler, was admitted to one of two airtight metal chambers or "cylinders." The steam supply was then cut off and the steam within the cylinder was allowed to condense, thereby forming a vacuum. Under the effect of atmospheric pressure, water from the well or sump was thus forced up into the cylinder through a non-return valve of a simple pattern. Steam was again admitted to the now water-filled cylinder, whereupon its pressure forced the water out of the cylinder up a vertical pipe into an elevated tank or cistern.

* The patent—one of the earliest recorded steam-power patents—is entitled: "A grant to Thomas Savery, Gent., of the sole exercise of a new invention, by him invented, for raising of water, and occasioning motion to all sorts of mill works, by the impellent force of fire, which will be of great use for draining mines, serving towns with water, and for the working of all sorts of mills when they have not the benefit of water nor constant winds; to hold for 14 years; with the usual clauses."

Savery's Engine

Savery's actual working engine had a pair of cylinders so that one could be filling with water whilst the other was having its drawn-up water ejected by means of steam pressure. By this means, given a practised manipulation of the necessary steam cocks, it was possible to set up a more or less continuous flow of water along the vertical delivery pipe of the apparatus.

Naturally enough, the "Fire Engine" was wasteful in the extreme. It took an enormous amount of steam to get up the pressure necessary to force the water out of its "cylinders," for the simple reason that the cold water in the latter chambers condensed the steam immediately it was admitted and much steam had to be used for heating up the water in the cylinders before it could be ejected under steam pressure.

Despite the obvious crudity of the whole affair, Savery's engine gained quite a measure of success in actual practice. The inventor established near Fleet Street, in London, what he called a "workhouse" for the commercial production of his engines and in which, according to an advertisement which Savery issued in 1702, the engines could be seen working "from 3 to 6 in the afternoons."

Savery's "workhouse" off the Strand, in London, is interesting as constituting the very first commercial factory for the production of steam engines.

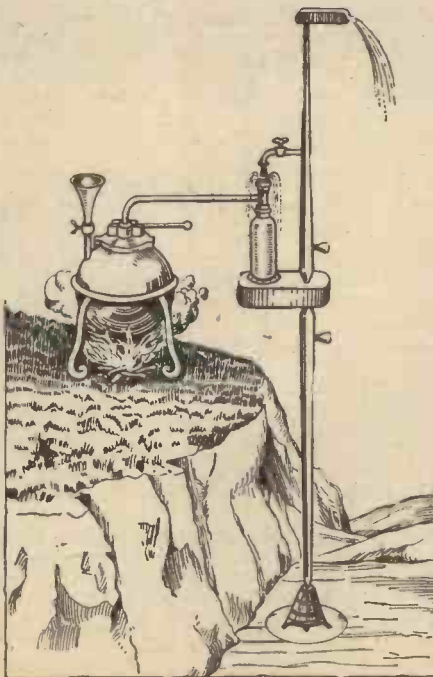

A sketch of one of Savery's first engines.

Truth to tell, the age in which Savery lived had considerable need of his "fire engines." Coal mines were beginning to be opened up, here and there, particularly in the Midlands, the well-known Cornish tin mines needed some type of serviceable pump for dealing with the water with which they were often flooded and even the owners of large private houses showed themselves willing to purchase Savery's engines in order to raise water for domestic purposes from a well to an elevated tank.

Too Ambitious

If Savery had been content to supply his "fire engines" for the latter use alone, all might have gone well with him. But Savery, it would seem, was an ambitious soul. He claimed that his engines would raise water easily to a height of 80 feet or even more, whereas in actual truth his cylinders and boilers were, for the most part, quite unable to withstand the necessary steam pressures for the raising of water to such heights. Consequently there were many explosions of engines which had been set up in Cornwall and in the Staffordshire coalfields, some of which disasters resulted in accidental loss of life. Savery's engines, therefore, declined in popularity, despite the fact that their inventor managed to obtain the passing of a special Parliamentary Act prolonging the period of the patent under which they were manufactured.

It is a strange fact that Thomas Savery never conceived the idea of obtaining actual motive power from steam. True it is that he contrived a motive power device consisting of an overshot water wheel operated by means of water supplied from an elevated tank to which it had been raised by one of his "fire engines." But the basic idea of the piston moving up and down under the pressure of steam or in virtue of a vacuum created on its under side by means of the condensation of steam never once occurred to him. If it had done so, Savery's name would have been more in evidence at the present day as an inventor and a pioneer of steam power and the course of steam engine history might have been much different.

A "Mechanical" Boat

Savery, indeed, even went so far as to design and construct a "mechanical" boat operated by paddle wheels. But never once

did he think of driving the paddle wheels by means of an engine operated by steam. Instead, he rather prosaically designed his paddles to be worked by a hand crank.

Of the life history of Savery, there is, as mentioned at the beginning of this article, comparatively little known. That he was born in the tiny hamlet of Shilston, near Modbury, Devon, about the year 1650 is tolerably certain, although you will search the local parish registers in vain for evidences of his birth and baptism. The Saverys were a family which had been long established in Devon and it is supposed that Thomas Savery, the future inventor, was educated for the profession of a military engineer, at that time an exceedingly useful, albeit decidedly hazardous occupation, owing to the troubled state of the country.

There is little doubt that Thomas Savery obtained his knowledge of mechanical matters from the experience which he gained with the forces. He is referred to as "Captain" Savery about the close of the 17th century, although whether his title was a purely military one or one merely designating him a "Captain" of Cornish mines (as many of the early mining engineers were called) is still open to question.

His First Invention

Savery's first recorded invention was a device for planing cast sheets of glass. Then came his paddle-wheel contrivance for boats, which was not a success, owing to the many objections put forward by the Admiralty to whom Savery had submitted his invention.

Exactly how Savery came to invent the "fire engine" water-raising device upon which his fame now rests is entirely unknown. Many suggestions to account for his original conception of utilising steam power in this manner have been put forward from time to time but all to no purpose. For instance, it has been supposed that the first idea of the "fire engine" came to its inventor when the latter immersed in a bowl of water a long churchwarden tobacco pipe which had become very hot and when he noticed that, under the cooling influence of the water, the latter was drawn up for a considerable distance along the stem of the pipe. Whether, of course, this account of

the invention's origin—the most likely of all the accounts—has any germs of truth in it we have no means of knowing.

In order to popularise his engine and to dispel certain objections which had been raised against it, Savery, in 1702, wrote and published a book describing his contrivance

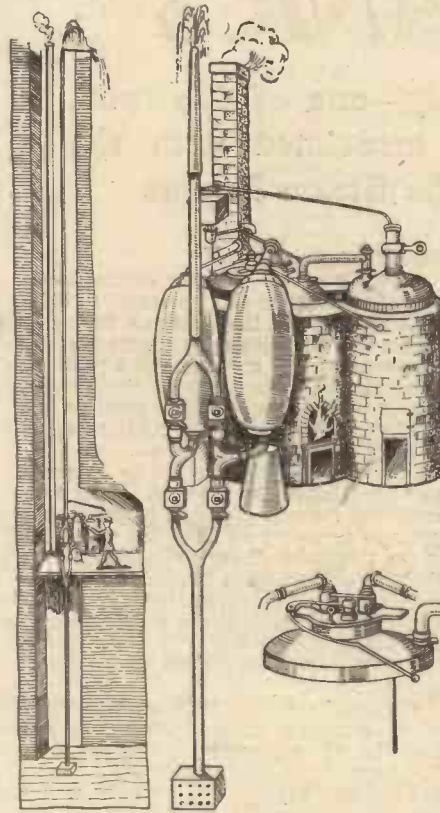

A sketch from Savery's original drawing of his "fire engine," showing, also, its use in a mine.

in detail. It was entitled "The Miner's Friend, or an Engine to Raise Water by Fire, described, and of the manner of fixing it in Mines, with an account of

the several uses it is applicable unto."

Perhaps "The Miner's Friend" went a certain way towards popularising Savery's water-raising engine, but the book itself could do nothing to remedy its many imperfections. After a few years of repeated explosions due to the employment of high-pressure steam, Savery's engine went out of existence.

Advance in Position

In view of the fame which his engine had brought him, Savery advanced considerably in position. In 1705, we find him still in the army, and in that year he issued a book on military fortification. In the same year he was appointed to the position of Treasurer of the Hospital for Sick and Wounded Seamen, a post of some official importance. Subsequently, he became Surveyor to certain Waterworks which had been established at Hampton Court.

The above are practically the only certain details which we know of concerning Savery's life. He seems to have amassed a fair sum of money from the sale of his "fire engines" and through various other activities, but such wealth, it would appear, must have been of little use to him, for he did not live long enough to enjoy it. He died on the 15th May, 1715.

Savery's inventions, or, at least, his chief invention—his celebrated "Fire Engine"—died with him, too. For it was in the summer of 1712 that Thomas Newcomen introduced his famous "atmospheric" engine by means of which actual motive power was, for the first time in the world's history, usefully obtained from steam.

Some have said that Savery was an inventor who failed. Such statements, however, are untrue ones. The role of Thomas Savery was that of the forerunner. Entering the arena of steam power invention at the appropriate time, Savery and his "Fire Engine" attained a considerable amount of success, despite the crudity of the device. Furthermore, they prepared the way for Newcomen and his "atmospheric" engine; and upon the latter device, of course, the whole history and development of the practical steam engine had been based.

A "WIRELESS" DEAF AID SYSTEM

Remarkable Experiments Prove Utility of Simple Device

A NEW era for deaf people who have hitherto heard talkies under difficulties was opened up by a "wireless" deaf-aid system for cinemas and churches introduced by Sir Ambrose Fleming, the well-known inventor who is himself very deaf, at the Gaumont Palace, Camden Town, London, N.W.

The apparatus, entitled the Multitone Telesonic Deaf Aid Instrument, consists of a little portable receiver barely larger than a cigar box, and a light pair of headphones for the ears. These are handed to patrons by an attendant, and, strong argument in favour of the new system, the deaf person can sit wherever disposed, instead of being "harnessed" to specially wired seats. This in itself should overcome the main objection, preventing a great number of the deaf who are not at present film fans, from attending.

The receivers are miniature three-valve

amplifiers of very robust construction, but extremely light. They provide a high order of quality reproduction from the receivers in spite of the very loose coupling that had necessarily to be employed. It was also necessary to ensure that the working of the system in a theatre would not suffer from external electrical interference or itself cause undesirable disturbance outside the theatre.

The system works, not by modulated radio-frequency radiation, but by speech-frequency induction between specially arranged loops of copper foil underneath the carpets and a search coil in the base of the receiver. No plugging in or attachment to any fixed point is required, and volume control is secured by a simple knob device attached to each receiver.

That the system is of great value for other things than helping deaf people in cinemas was demonstrated by a number of

exceedingly interesting experiments, including one with a gas-mask. The Home Office was represented among the audience. A man in a regulation gas-mask on the stage could talk easily to all those with receivers, although those standing close to him without receivers could only hear a confused jumble of muffled sounds.

A film was shown, and as a test of the range of the instrument we walked about in the auditorium and through the corridors into the outer vestibule and could still hear the programme which was going on inside the cinema.

It will be possible for private persons to possess their own Telesonic receivers, Sir Ambrose Fleming stressed. He himself was using one which was scarcely larger than a sixpenny packet of cigarettes.

The system is equally efficient for cinemas, churches, theatres, lecture halls and board rooms. It is cheap to install and the upkeep costs are negligible.

Test installations already carried out by Gaumont-British engineers in two cinemas at the Empire Exhibition, Scotland, and at the Camden Town Gaumont Palace have proved very successful. Since the official opening over 1,200 people have used the receivers in the Beardmore Cinema at the Exhibition, and orders for further receivers have been fulfilled.

THE JUBILEE OF THE PNEUMATIC TYRE



(Left)—Johnny Dunlop on the very first pneumatic tyred bicycle.
(Right)—John Boyd Dunlop.



1888 ————— 1938
Dunlop's Patent is Dated July 23rd, 1888

JOHN BOYD DUNLOP was born at Dregghorn in Ayrshire in 1840, and educated at Irvine Academy under the late Dr. White, from whom he acquired a love of mathematics, which remained with him until the end of his life. He entered the veterinary profession when quite a young man, qualifying when he was nineteen. On obtaining his degree, he came to Ireland, where he made two successful practices—the first in Downpatrick, which he gave to his younger brother, another "vet.", and the second in Belfast, where he invented his tyre.

When Dunlop invented and made the first pneumatic tyre he had never ridden a cycle, and there was not a cycle or a rubber factory in Ireland. Yet he made the first practical air tyre for his son's little tricycle, and made it out of ordinary sheet rubber and canvas. His only tool was a pair of scissors.

Great Obstacles

That the first practical air tyre should have come from a country where there were no cycles or rubber factories, and that the wheels were built and the air tyres made by a man who was not an engineer and had never ridden a cycle, was something of an achievement. Of course, the experience he had gained in making rubber appliances in connection with his veterinary work stood him in good stead. To-day it is almost impossible to realise the difficulties he had to face, and the opposition and ridicule he had to endure in those days in the 'eighties. But tenacity of purpose was one of his strongest characteristics, and neither derision nor discouragement would turn him from what he had once made up his mind to do.

There is a general impression that the invention of the rubber pneumatic tyre was

more or less an accident or a sudden inspiration. This is quite untrue.

Killing Vibration: Making Speed

From boyhood Dunlop had been interested in scientific problems, particularly those of road transport. He had always recognised the waste of power and reduction of speed produced by the uneven road surfaces of his time. Many methods of damping vibration between the rim of the wheel and the axle occurred to him. He thought of flexible spokes, flat springs and coiled springs, but discarded them all, and finally decided that vibration must be intercepted at the source—that is, between the road and the rim. He had very little time for actual experiments, as he was kept busy at his veterinary work. Not until he was about to retire at the age of 48 did he have the opportunity to try

out his ideas. It was then that the idea came to him of enclosing air under pressure in a rubber and canvas tube placed between the road and the rim. It sounds so simple and obvious now, but that is true of most of the really revolutionary inventions.

He made four important experiments with his tyre. We quote from his own writing:

The First Experiment

"The problem which I set myself to solve was to produce a tyre which would overcome vibration, and at the same time, be fast on all surfaces. My first experiment—I produced a disc of wood about 16 ins. in diameter and then purchased some sheet rubber $\frac{1}{2}$ of an inch thick, out of which I constructed an air tube. The air tube was secured to the periphery of the disc of wood by a covering of thin linen, which was tacked to the edges of the disc. I inflated the air tube through a small supply tube with my son's football pump, and tied the little air supply tube in the same manner as one would tie a football. I then brought the small front steering wheel of my son's tricycle, and also the air-tyred disc, into my business yard. I asked my assistant, John Caldwell, in a casual way, which of the tyres would be the faster. He answered: 'The small one of course.' I first threw the solid-tyred wheel along the yard, but it did not go to the full length of it. Then I threw the air-tyred disc. It went the whole length of the yard and rebounded with considerable force off the gate. My assistant said I must have used more force when I threw the air-tyred wheel, and he tried the two wheels, with the same result. Mr. R. Kyle, and my handyman, and my son also witnessed this experiment."

Referring to his second experiment he writes:



A wheel of the first pneumatic-tyred bicycle, now in a museum. The tyre was correctly constructed with the threads in tension.



One of the first half-dozen pneumatic-tyred bicycles, built in Belfast. It is now in a Belfast museum.

Equipping a Bicycle

Dunlop's next move was to order a bicycle without wheels. He got strips of mild steel and had them shaped in rollers by Edlin and Co. to form the rims, which were to take the pneumatic tyre. The rubber tubes and rubber for the covers were ordered from Messrs. Thornton of Belfast. He fitted the tyres himself, using best quality yacht sail-cloth for the inexpandible covers. This bicycle was subjected to even more severe tests, and was ridden for 3,000 miles. The front tyre was never punctured, nor removed from the rim during that time.

In referring to this bicycle Dunlop wrote:

"I attach great importance to the fact that I made and fitted the first bicycle tyre, and that I have the honour of having presented it to the Governor of the Royal Scottish Museum, where it will never again be represented as being the work of another man's hands."

"After this, my son Johnnie, then about 11 years of age, often asked me to hurry and make air tyres for his tricycle, as he wanted to race with his companions, whom he usually met after school in the People's Park, so before the end of December, 1887, I procured two strips of American elm about 9 ft. long by 3 ins. wide and $\frac{1}{4}$ in. thick, and bent them in the form of a hoop, overlapping and rivetting the ends together. I purchased a quantity of sheet rubber $\frac{1}{2}$ in. thick, the finest and thinnest in stock, and with this I constructed two air tubes. After drawing each air tube into a canvas tube, and inserting a small air-supply tube, the ends of the air tube were joined with solution. Before joining the ends of the air tube, I secured a thin strip of rubber over the inner end of the supply tube, and thus formed a simple non-return valve. The canvas cover or jacket, being made of two pieces, was in the form of a tube with flaps. The flaps were secured to the wooden rim with solution, and the rims secured to the driving wheels of the cycle with copper wire.

Johnny's Tricycle

"The driving wheels were 36 ins. in diameter. The outer end of the air-supply tube was concealed in a recess in the rim. The canvas jacket was then covered with one fold of sheet rubber ($\frac{1}{2}$ in. thick) with the addition of two folds of the rubber on the tread. The tyres were of "D" section, and the rims made broad with the idea of preventing side-roll, which always has a retarding effect. The tyres were made large, so that they would not require to be inflated as hard as smaller ones, and therefore would be less liable to cut. The tyres and rims were completed and secured to the rear wheels on the night of the twenty-eighth of February, 1888. Johnnie, eager to have a special trial of the machine, rode out before 10 p.m. The moon was full and the sky clear. I told him to ride over any newly laid macadam which he could find on his way. As it happened, there was an eclipse of the moon about 11 o'clock, so he came home. After the shadow on the moon had passed, he went out again and had a long run.

"Next morning the tyres were carefully examined, and no scratch could be found on the rubber."

For the third experiment, he ordered a tricycle without driving wheels, but he built wheels with wooden rims and attached the tyres to them as before. In this instance, there were no metal rims, and the wheels were built large in order to gear up the machine.

Universe and must be permanent."

Not only did his invention revolutionise road transport, but indirectly it helped the development of the internal-combustion engine. High speed on the road would be impossible without the pneumatic, however powerful the engine. This in turn helped aviation, where light and efficient engines have been evolved from experience gained on the road.

THE first advertisement for Dunlop's great invention appeared in an Irish cycling journal dated December 19, 1888. This is the announcement:—

"Look out for the new Pneumatic Safety. Vibration Impossible. Sole Makers, W. Edlin & Co., Belfast."

IN 1870 solid tyres were from 2 in. to $2\frac{1}{2}$ in. in diameter. As the diameter of the front driving-wheel got larger, smaller tyres were used, $\frac{1}{2}$ in. diameter tyres being considered the correct thing for racing.

SUCH tyres were extremely heavy, and no doubt gave rise to the now defunct term "push" cycling.

THE first pneumatic tyres were looked upon as a joke, but they soon demonstrated that they sounded the death knell of solid tyres.

THE first appearance of pneumatic tyres in the South of England was at the spring sports of the Surrey Bicycle Club at Kennington Oval in April, 1890, when two machines so fitted were used. Frank Shorland, heavily handicapped and riding a geared Facile (the rider of the second pneumatic-tyred machine was second from scratch after two other men had won heats on the same machine) won from a short mark with such ease that its merits were quickly realised.

THE first race in which pneumatic tyres were used was held at the Queen's College Sports at Belfast in 1889, when W. Hume won each of the events.

THE precursor of the Cycle Show was the Stanley Show. At the Stanley Show of 1889 only 1,201 machines were exhibited, all equipped with solid tyres.

IN 1890, there were 1,564 machines exhibited, twenty having pneumatic tyres, one cushion tyres, and the remainder solids.

IN 1891 the solids had dropped to 307, the cushion had risen to 571, and the pneumatics to 148, out of a total of 1,053.

AT a second Stanley Show in 1891 the pneumatics had climbed to 567 out of a total of 1,427; in 1892 to 882 out of a total of 1,346; in 1893 to 919 out of a total of 1,327; in 1894 to 2,248 out of a total of 2,551; in 1895 to 2,609 out of a total of 2,690; in 1896 to 4,013 out of a total of 4,334; in 1902 to 1,629 out of a total of 1,636.

THE history of the cushion tyre is spurious. At the 1890 show one of the brothers Stanley, piqued by the attention the pneumatic tyres were causing, had a big hollow tube-tyre made up, which he labelled "the anti-rheumatic tyre."

SHEET RUBBER NAILED TO EDGE OF WOODEN DISC

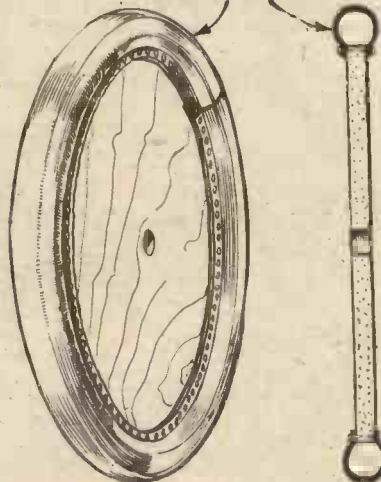

The first experimental wheel.

BE A SUPERMAN

*fitness,
wins*

THIS AUTUMN

Here is a NEW BOOK

FREE

SIMPLY POST COUPON
for this
GREAT NEW BOOK

in which

HAROLD LAURANCE

tells you about his Wonderful...



The WORLD-BEATER COURSE

Of HOME TRAINING that Ensures

★ RADIANT HEALTH ★ PERFECT PHYSIQUE ★ VIRILE MANHOOD ★ MENTAL POWER
★ MIGHTY STRENGTH ★ SELF CONFIDENCE ★ MAGNETIC PERSONALITY ★ TIRELESS ENERGY

HERE is a clarion call to every man - a golden opportunity for all between the ages of 16 and 60 to gain glorious health, wonderful strength and superlative physique in 1938.

Young men will secure and delight in the pride of Strength and Beautiful Development. Professional men, Business men, Men in the 30's and 40's will regain and maintain the full fitness and vigour of youth. Men in the 50's and 60's will rejoice in the healthiest form of rejuvenation of body and mind.

Nothing like the "WORLD-BEATER" course offered to-day has ever before been seen. Simple to follow, and requiring 20 minutes every day, it can lift the weakest, thinnest man from physical inferiority to the very pinnacle of perfection. It shows pupils how to rid themselves for ever of indigestion, constipation, catarrh, bad circulation, anaemia, pimples, bad breath, etc. It teaches the care of the vital organs so that perfect

for only

1/- per week

health may be preserved throughout life. It reveals the true secrets of respiratory power and scientific muscle manipulation. It directs the pupil how to systematically increase his bodyweight where desired and increase muscular development to the very limit of his possibilities. Every pupil is under the personal care of Harold Laurance; each lesson is personally prescribed to suit the pupil's individual requirements; every pupil is supplied with a splendid assortment of apparatus FREE; and every pupil is guaranteed SUCCESS.

"Enrol for my 'WORLD-BEATER' course," says Harold Laurance, "complete the 8 lessons, and if at the end of that period you are not fully satisfied that you have reached 'Supermanity,' I WILL CONTINUE TO TRAIN YOU AND SUPPLY APPARATUS-WITHOUT ANY CHARGE WHATSOEVER-UNTIL YOU ARE COMPLETELY SATISFIED."

As an extra incentive, Harold Laurance also offers £1,000 in prizes for progress on the "WORLD-BEATER" Course.

Never before has such an offer been possible because never before has such an astonishing record of success been achieved. More than 90 per cent. of Harold Laurance pupils report prize-winning progress!!!

Take the first step to-day—Post the Coupon below. The Apparatus which is sent FREE to every pupil can be used in the smallest space. It includes "The 'LAURANCE STAMINATOR'" (PRONOUNCED BY EMINENT DOCTORS THE GREATEST BODY-BUILDING APPLIANCE OF ALL TIME), SPINAL DEVELOPERS, WRIST UNITS, TRIPLE RESISTANCE UNITS, etc.

The "World-Beater" Course consists of 8 complete lessons. There is no special diet, but pupils are shown how to double the value of ordinary foods. The newly-evolved and wonderfully effective tendon strengthening movements are included. Special instructions on scientific muscle-manipulation, the control of nervous energy, the strengthening of the vital organs and

the preparation of the body for maximum muscular development are all part of this gigantic Course. The range of scientific exercises for the rapid development of great strength and muscular symmetry is the greatest and most comprehensive ever compiled. Pupils are also taught how to overcome common ailments—indigestion, constipation, catarrh, bad breath, pimples, anaemia, etc. Detailed instructions are given on weakening complaints and habits. The "WORLD-BEATER" Course transcends in positive value and amazing effectiveness anything that the world has seen before.

£1,000 PRIZES

To Encourage the Manhood of the Country in the Pursuit of Physical Fitness

HAROLD LAURANCE OFFERS

- ★ Two 1st PRIZES of £100
- ★ Two 2nd PRIZES of £25
- ★ Two 3rd PRIZES of £15

● Every Pupil taking the "WORLD-BEATER" COURSE at 1/- per week is eligible for the Grand Award of £100. Every pupil has 9 separate chances of winning £10, £5, 1 Medal or a Diploma. The same pupil can win an unlimited number of awards month by month.

● The prizes will be awarded on the progress reported by postal pupils in relation to each pupil's original measurements on joining. Thus, all have a fair and equal chance in every month.

● The Judges under this offer are Editor of "Health and Strength," Geo. Walsh and Frank Miles, so you know you can rely on a fair decision.

GRATEFUL PUPILS TESTIFY TO VALUE OF LAURANCE TRAINING

AGE 19 Body Weight increased

★ Pupil A. Knight, of Northampton,



was a typical young man with small measurements, below average strength. In 18 months, Harold Laurance personal instruction increased his weight from 9st. 2lbs. to 12st. 6lbs. and his chest measurement from 34 ins. to 45 ins. Pupil Knight is now a claimant for the title of "Britain's Strongest Youth." His deep chest, herculean shoulders and powerful arms speak volumes for "Laurance" methods.

AGE 30 Strength and Measurements increased

★ Pupil W. Simpson,

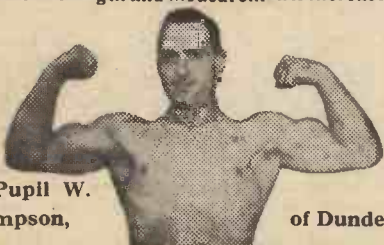

had spent many years at Physical Culture without achieving the desired results. He found the "Laurance Staminator" and "Laurance" personal instruction the ideal method for real results. He rapidly reached 1st. in weight, 46in. chest, 18in. biceps, and other splendid measurements.

Take The First Step to SUPERMANITY

POST THIS FOR FREE GIFTS

- Please send me free of cost or obligation particulars of your "WORLD-BEATER" COURSE which I can obtain for 1/- a week and details of your £1,000 Prize Offer.
- Also Free Copy of your book, "Supermanity" and a FREE Presentation Copy of your autographed Prize-winning Pose Photograph.

NAME.....

ADDRESS.....

Practical Mechanics Sept., 1938.....

Post To—HAROLD LAURANCE, Laurance Institute of Health and Stamina, Ltd., Ludgate House, 110 Fleet Street, London, E.C.4

Post in Unsealed 1d. STAMPED Envelope.

MAKE WHAT YOU WANT WITH

UNIT 'X'

THE COMPLETE WOOD AND METAL WORKING MACHINE

Pro. Pat. 14570.

Works with either a small motor or treadle.

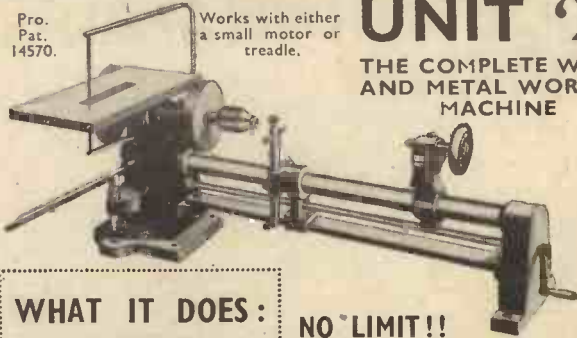

WHAT IT DOES:

- TURNS—Wood or Metal.
- DRILLS—Press drills $\frac{1}{8}$ in.
- MOULDS & GROOVES.
- SURFACE GRINDS.
- SANDS.
- JIGSAWS.
- RIVETS.
- CIRCULAR SAWS.
- POLISHES.
- MILLS.
- PUNCHES.
- SPINS.
- DOVETAILED.
- GRINDS TOOLS.

Clean accurate work, to fine limits.

NO LIMIT!!

There is no limit to the number of operations possible on this marvellous machine. It is an engineering education in itself and will develop the mechanical ingenuity of the user.

Full length 26 ins. Turns objects 4 ins. diameter and certain wood patterns to 12 ins. diameter.

EQUIPMENT INCLUDES

Circular Saw, Grinding Stone, Buff, Jigsaw and Blades, Sanding Drum, One Tilting Table, $\frac{1}{8}$ in. Chuck, Punch, Tool Post and Cutting Tool, Spanner, Oil-Can

95/-

COMPLETE

or 15/- cash and 9 monthly payments of 10/-

TRIANGLE PRODUCTS LTD.

Blake Street, Hulme, MANCHESTER, 15



Wizard Power Tools

TRADE MARK



Ball-bearing Spindle Moulders

So designed and constructed that they can be recommended for any duty within the capacity of the machine.

In general use by practical mechanics throughout the country. Made in two sizes, 10" and 14". The 14" size has a rise and fall table.

Price 10" (as illustrated) £4 1s. ; 14", £8 2s.

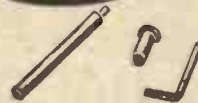

Write for illustrated priced catalogue No. 137C.

WIZARD MACHINERY CO.

13 VICTORIA STREET, LONDON, S.W.1

TELEPHONE ABBEY 3018



WE ARE MOVING

to a new showroom.

- **MONDAY, SEPTEMBER 19th** is the date. Hours 9—7 daily, Sat. 9—1.
- **10 NEW BURLINGTON STREET, REGENT STREET, W.1** is the address.
- **WE INVITE YOU** to call and see us—An increased staff of experts will be available to attend to your requirements.

MULTI-MODELS LTD.

MAKERS OF MODELS TO SCALE.
RAILWAYS—SHIPS—COMMERCIAL—

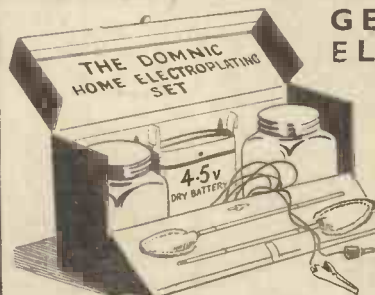

GENUINE 6/9 ELECTRO PLATING OUTFIT

Post Free

This is not an applied polish, but a perfect Electro-Plating Process. Metal is definitely electrically deposited. Not a toy but a scientific apparatus devised by experts.

Safe, easy and simple to operate, no fuss or bother, follow the simple instructions and you will be amazed at the result. Brighten up your home, plate your taps, door handles, fittings, etc., without removing. Do your own Electro-Plating, besides beautifying your home, it becomes a fascinating pastime and is so easy to use, and is permanent.

Packed in neat case with full instructions, Post free 6/9, from **DOMNIC PRODUCTS LTD.**, Dept. P.M.19, Campbell Road, West Croydon and from all the Principal Stores.

"DOUBLE O" MODEL RAILWAYS

The small gauge with the big appeal

A layout in "OO" takes only ONE QUARTER the space of the same design in "O" gauge. You can have a real Model Railway in a small room. We have the most extensive range of models and specialise in this gauge. Send 6d. in stamps for our new 1938-9 Catalogue. Ask for FREE SAMPLE of scale model Permanent Way.

GEORGE E. MELLOR (DEPT. P.M.)
5, Brewis Road, Rhos-on-Sea
NORTH WALES

LABORATORY MICROSCOPES



Equivalent to £20 Instruments*
Triple Nosepiece Objectives
100 x 200 x 300 x Rack & Pinion Focusing
GUARANTEED AGAINST DEFECT
See Page 688 Miscellaneous
27/6 Polarizing Attachments, 15/6
Sent Per Registered Post, Free
J. K. M. HOLMES, DEPT. PM6,
Scientific Instrument Dealer,
"Vizcaya," Wolvleigh, Gosforth,
NEWCASTLE-ON-TYNE



The 'ADEPT' Bench Hand Shaper
Length of stroke of ram, 3 1/2 ins.; Length of cross travel of slide, 3 ins.; Size of Table, 4 1/2 ins. — 4 ins.; Rise and fall of Table, 2 ins.; Vertical feed of tool slide, 1 1/2 ins.; Maximum distance between tool and table, 3 ins.; Weight, 18 lb. Also the 'Adept' No. 2B.H. Shaper, 6 1/2 in. stroke. Price £6-9-6.
Manufactured by **F. W. PORTASS**
SELLERS STREET, SHEFFIELD



The Hallam "Nipper" Aero Petrol Engine
MINIATURE PETROL ENGINES . . . for Aero-planes and Speed Boats. 1 c.c. 3 and 6. Easily made from our Castings, 12/6 per set. Complete Engines ready to run, £3 15.

SEND 3d. FOR PARTICULARS
J. HALLAM & SON, Upton, Poole, Dorset

Photographing Sound

An Interesting Article About The Audiometer

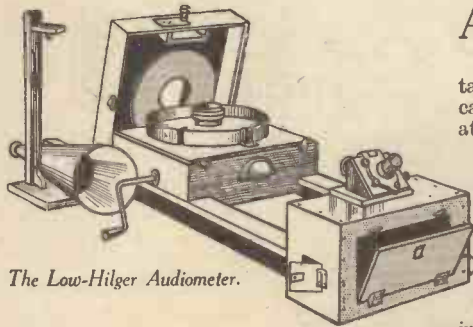

The Low-Hilger Audiometer.

If you were asked to say exactly how much water was in a jug of strange and peculiar shape, you would not give it one glance and attempt to supply an accurate answer. Yet, this is exactly what the majority of people do in the case of sound.

Air Oscillations

Before dealing with the methods adopted to render sound, or the irregular vibrations of noise, visible for examination, it is as well to realise that air oscillations are of a mechanical and vigorous nature. Although the amount of sound energy radiated from quite a large orchestra is less than the radiated power from a burning safety match the human frame is very sensitive to sound and the ear itself can often detect a movement of a telephone diaphragm which is less than one-millionth of a millionth of an inch!

The mechanical nature of sound is shown by the ease with which it can be reflected. A mirror for sound is sometimes used to reflect voices on to the microphone when a

talkie is being made, and the same principle can be employed to render a watch audible at a comparatively long distance: Fig. 1. Sound can also be bent by layers of hot air, as is shown by the example of a motor-car driving along a road on a hot summer day. It commonly occurs that the exhaust note seems louder as distance increases.

Sound Recording

Noise and sound have another property, in that they heat the air through which they pass. This was used during the War to assist in range finding by allowing the waves of compressed air due to noise to impinge upon wires of which the exact temperature could be measured and, from this result, the distance gauged.

It is very obvious that the ordinary microphone, such as is used in the telephone mouthpiece, affords one method of sound recording. This is carried into effect on many sound films by amplifying the microphone current and causing it to operate a lamp which marks on a film.

All these methods have the disadvantage

Photographing Sound

There is another method of photographic sound and noise which is particularly accurate because it employs a diaphragm thinner than a soap bubble. This diaphragm is made from floated celluloid, and is so thin that the surrounding air damps out any resonance it might possess.

Sounds at speeds of over 6,000 cycles per second are often inaudible, but a really thin diaphragm will work well up to 30,000 cycles per second. These notes which cannot be heard are very important, for they may combine with other sounds and produce varying effects.

No one would think of measuring the amount of current in an electric light bulb by feeling its heat. Most methods of examination of sound are almost as absurd, but the audiometer which is fitted with one of these diaphragms can show the exact changes of voice produced by a singer and can enable both irritating noises and the sweetness of sounds to be analysed, tested, or, in the case of gramophones and radio, compared with the original.

Fig. 1.—A simple experiment in reflecting sound.

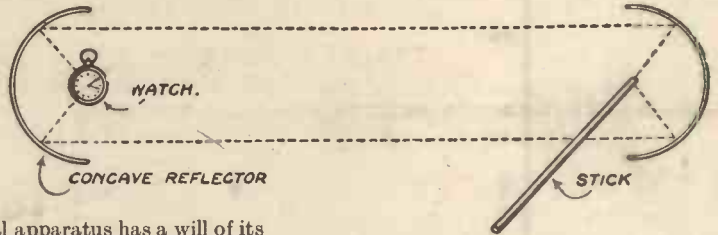

that the electrical apparatus has a will of its own, and that, in consequence it may produce records which are not really true to fact.

Another important point is that the diaphragm and moving portion of most forms of microphone are comparatively heavy. Ordinary sound waves may take place at the rate of 2,000 or 3,000 cycles per second, and, as each instrument or voice alters, the rate at which air pressure changes.

The Low-Hilger Audiometer

The principle of the Low-Hilger Audiometer is very simple. A light is thrown from a strong bulb, or an arc, on to a small mirror platinised on to the surface of the celluloid diaphragm. It is then reflected on to a travelling strip of film, a lens system being provided for focussing. When the sound strikes the diaphragm from the horn the mirror moves in accordance with the change of air pressure and tilts the beam of light so that a curve is traced on the film. Ordinary mechanical arrangements are

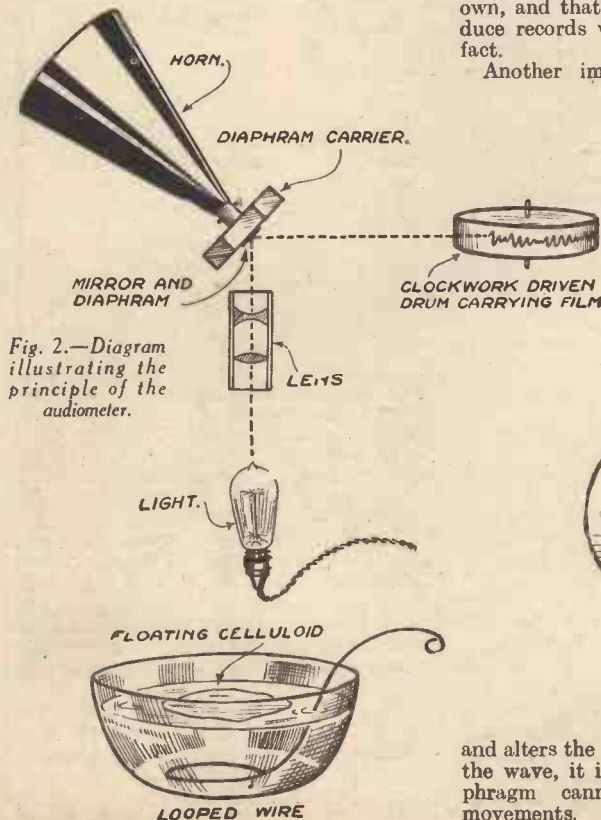

Fig. 2.—Diagram illustrating the principle of the audiometer.

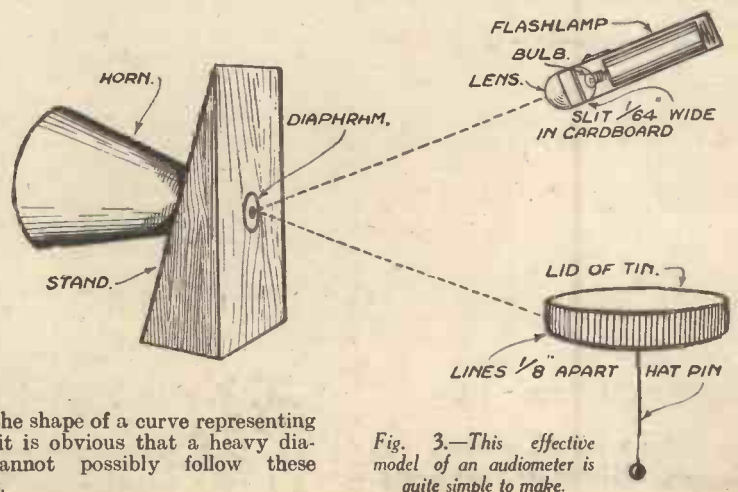

Fig. 3.—This effective model of an audiometer is quite simple to make.

and alters the shape of a curve representing the wave, it is obvious that a heavy diaphragm cannot possibly follow these movements.

made for exposing different parts of the film as may be required, and in the case of optical examination a line of light instead of a spot is thrown on a strip of black paper bearing wide vertical white lines. Owing to the persistence of vision this enables the actual wave form to be seen before a permanent record is made. (Fig. 2.)

Quite an effective little model can be made by preparing a cardboard stand as shown in Fig. 3 and by covering a hole with a thin celluloid diaphragm. To make this diaphragm a solution of celluloid in amyl-acetate is prepared, or accumulator repairing

cement can be used. One drop is allowed to fall on a bowl of water, when it will immediately spread out and often show iridescent colours due to "separation" of the white light into its component colours.

The Suspended Drum

A loop of wire is then slipped into the water and lifted out carefully, carrying with it the diaphragm, which can then be gently pressed against a rim of glue laid round the hole in the cardboard stand. A small piece of silvering can be scraped off an old looking glass and a portion about

$\frac{1}{4}$ -in. square glued to the diaphragm.

By suspending a drum, upon which the necessary lines have been ruled, and, by using a slot in connection with a lens from an ordinary pocket flash torch, a beam of light is projected on to the disc while the latter is spun round gently by blowing on the rim.

As soon as sound is allowed to enter the trumpet the wave shape of the sound recorded can be seen. Such diagrams help to locate acoustical faults in buildings and to analyse the many stray sounds which so seriously waste physical and mental energy in our everyday life.

HOW MANY READERS KNOW—

—How Rock, Hollow Toy Soldiers, or Nuts are made?

IT is highly improbable that, at some time or other, every reader has not eaten and enjoyed a stick of rock, watching as they did so, the name or picture continued throughout its length until the last piece has vanished, and many of them, no doubt, have wondered exactly how the colouring is obtained so accurately right through the centre. Well, this is roughly how it is done. The rock itself is firstly not made in the lengths in which you buy it, but is much larger in diameter, like a thick slab, and in the centre are placed the words or picture, say, for instance, "Brighton Rock," moulded in coloured sweetmeat. A rolling operation now takes place, and gradually the thick slab begins to lengthen, becoming smaller and smaller in diameter as it does so, but with the pink or red words still retaining their shape in the centre. So it continues until the desired size is obtained (see Fig. 1), when it is cut into various lengths ready for the shops.

Model Soldiers

We come now to an entirely different subject, in the shape of model soldiers. When one of these little men is broken it is found that the metal from which it is made is almost of paper thickness. Many of you know that when a casting is made in which it is necessary to obtain hollow portions, sand cores are used, in order that after the cast is made the sand can be broken up and removed. This course, obviously, is not practical in the case of toy soldiers. How, then, is it done? It is by this method. The metal in the first place is not pure lead—it would be much too soft and heavy for the purpose—so with it is mixed a certain proportion of antimony and zinc. This metal is very brittle and flows quickly, being known commonly as type metal, owing to its application for that purpose.

The Mould

Metal moulds are used, split into halves and hinged together at one end, being in turn firmly fixed to a pair of long handles, similar to a pair of tongs.

At the foot of the mould is a small plate

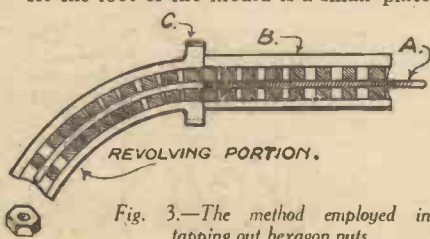

Fig. 3.—The method employed in tapping out hexagon nuts.

bearing a pouring cup, as shown in Fig. 2. This plate is pivoted at one end, and when in position clips under the small screw. With the metal hot, the mould is held firmly together and the metal poured in, and this is where the whole secret lies, for immediately enough metal is in the mould the latter is quickly turned upside down and the molten metal allowed to run out into the ladle or pot again; with a quick flick the hinged plate is knocked round cutting off the flow and forming the foot-plate upon which the soldier stands. The mould now being opened, discloses a glistening miniature soldier complete in every detail. Exactly what happens is this: immediately the metal is poured into the mould it chills, and by the quick reverse most of it runs out, leaving behind a thin shell adhering to the mould. This is the toy soldier, entirely hollow, and weighing about fourteen to the pound.

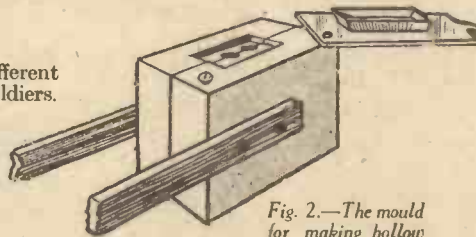

Fig. 2.—The mould for making hollow toy lead soldiers.

Tapping Out Hexagon Nuts

The third ingenious idea, which probably took quite a lot of thinking out, is the method employed in tapping out hexagon nuts in mass production. All readers are aware that to tap out a nut—that is, to put a thread in it—it is necessary, with the exception of screw-cutting in a lathe, to put a tap through it. To do this with single nuts, is, of course, quite a simple job—you place a wrench upon the square of the tap and turn it through—but the problem arises when a hundred or two are to be screwed, how to hold the tap, and also how to turn it and at the same time allow the nuts to pass completely over the end of it.

The Problem Solved

This problem was solved in the following manner, and those of you who have already scanned the drawing have guessed the secret. It is, in short, a bent tap. Glance at Fig. 3 and you will see that the tap A rests inside a hexagon tube B, into which the nut fits snugly, and in passing along the tap they hold it exactly in the centre. At the end of this tube there is another piece C, which is allowed to revolve, taking with it the tap. You will see now



Fig. 1.—How are names and pictures made to continue through the length of a stick of rock?

that the nuts pass over the cutting edges of the tap, receive their thread, and are then forced along the revolving section C by the nuts following, where they are free to drop out into a receptacle placed ready to receive them. There are many other methods of making screwed nuts, but of all of them this is the most modern and certainly the most ingenious, for it ensures that every nut is of the same size.

FIGHTING CRIME

Police Cars that are Bullet Proof

IN a recent broadcast by Edward G. Hoover, head of the G-men in America, striking figures were given as to the annual cost of crime in the U.S.A. The speaker gave an interesting survey of the steps taken in that country against crime, and the use of rapid transport was noteworthy. In this connection, special cars are frequently employed, these cars being designed to provide a high degree of protection.

Effects of Bullets

The ordinary car can be penetrated throughout its entire length by high velocity bullets, such as may be used in revolvers and sub-machine guns frequently employed by criminals in resisting arrest. The latest police cars, however, are equipped with light-weight armour plate placed between the body panels and the upholstery so that the car does not differ in appearance from a standard machine and is only slightly heavier.

Armour Plate

The light armour plate is a nickel-chromium steel, and sheets as thin as $\frac{3}{32}$ in. provide adequate protection against revolvers, pistols and sub-machine guns. In many cases, the weight addition due to the armour plating of a standard saloon is as little as 500 lb. It is interesting to note that accredited private citizens may be supplied with bullet-proof cars with the special permission of the authorities, but the sale of protective equipment of this nature has, by agreement with the makers and the authorities, been so limited as to prevent it falling into the hands of law-breakers.

Predicting the Weather

How Science aids Meteorological Experts to give a Reasonably Accurate Forecast of the Weather.

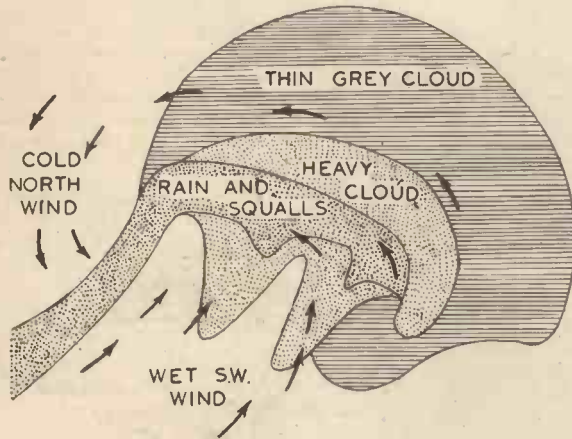

Fig. 1.—Arrangement of winds, rain and cloud in a depression.

THE weather is one of the greatest topics of human interest. Sensational droughts, gales and phenomenal rain-falls always claim front page news value, for the weather governs the abundance of crops or their failure. A fog can lose millions of pounds to business in one day, rain or sunshine is the making or marring of holidays and sport. And so we all like to be wise about the weather.

Scientific prediction of the weather has come before our notice since the broadcasting of weather reports. We are all sufficiently familiar with the methods by which meteorological stations in all parts of the globe, ships at sea and aeroplanes in the upper air gather reports of wind velocities, barometer and temperature readings and of the way these are marked on a map and lines plotted to show the probable course of the weather.

The Barometer

Roughly speaking a high barometer means fine weather and a low barometer storm and rain. Why is this?

The barometer reads the weight of a column of air stretching up from the level of the barometer into the infinitely rarified zones of the stratosphere. This weight supports the long leg of the barometer, and the height of the long leg is a measure of the weight of this column of air.

Two factors cause the weight of the air to vary. One of these is the temperature of the air. The warmer the air the more rarified it is and the less its weight. The other and by far the more important factor is the moisture content of the air.

A cubic foot of air of the atmosphere contains practically a fixed number of molecules. If the air is moist it means that the number of water molecules in a cubic foot of the atmosphere has increased, and diminished the number of nitrogen and oxygen molecules. Now water vapour weighs less than oxygen or nitrogen molecules. Therefore the greater the moisture content of the air the lighter it is. Going one step further this means that when the air over the barometer increases in moisture content the pressure on the barometer decreases. This may be contrary to what you would expect at first, but it explains why a low barometer means rain and a high

barometer inevitably means fine, dry weather.

Isobars

Now referring to the weather maps given here it is seen they show more or less circular lines. These are the isobars connecting places of the same barometric pressure. They are exactly like contour lines on a map, and they form circles round either

particularly unevenness of air pressure, so there is always an initial tendency for the air to flow into a depression and to flow outwards from a high-pressure area.

In Fig. 3 is shown the weather map of the British Isles which predicted stormy conditions on Derby Day of this year. The arrows on this map represent wind. The focus of the depression and gale was situated to the south-west of the Midlands. Now notice that the winds are not flowing straight inward, but are focusing round it in an anti-clockwise spiral, rushing round the eye of the depression like a whirlpool. The

Fig. 2.—The wind goes inwards anti-clockwise, in the northern hemisphere, in a depression. In an anticyclone it goes outwards clockwise. The continuous lines (circles) represent isobars and the arrows wind direction.

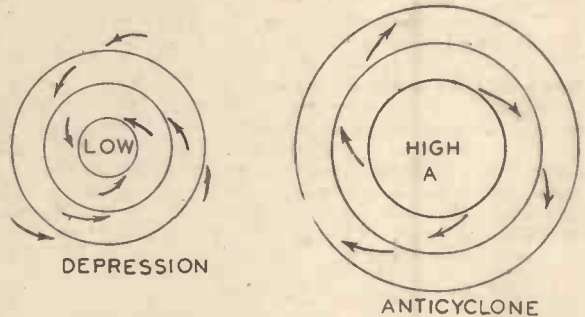

atmospheric valleys of low pressure or round peaks of high pressure. The pressure of the air does form humps and hollows exactly like this. The hollows are called depressions or cyclones, and the humps are high pressure regions or anticyclones. When on a weather map you see a depression approaching it means bad weather, while an anticyclone, the system of high barometer pressure, means fine weather.

Air-Flow

Nature abominates unevenness of any kind,

spin of the winds is connected with the earth's rotation.

The Earth's Rotation

One of the first principles of mechanics is that any body or particle when in motion keeps both the force and direction of that motion. Now imagine a particle of air being drawn in from the North of Scotland to that focus over the South West Midlands. The air over Scotland, left to itself, is rotating with the earth from west to east. If it didn't, there would be a perpetual

HOW CLOUDS INDICATE WEATHER CONDITIONS

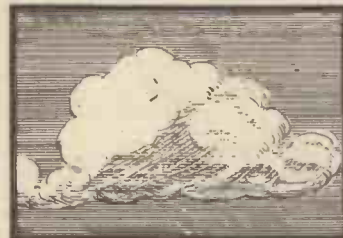

(Left) Cumulus clouds in the morning denote fine weather. (Right) Stratus clouds indicate fine weather.



(Left) Cirrus clouds mean a change in the weather. (Right) Nimbus are storm clouds.



east to west gale blowing over all parts of the earth. But as Scotland is nearer the poles than the Midlands the earth rotates more slowly there. So the particle of Scotch air being sucked south is too slow to catch up with the eye of the depression and in fact it spirals off westward.

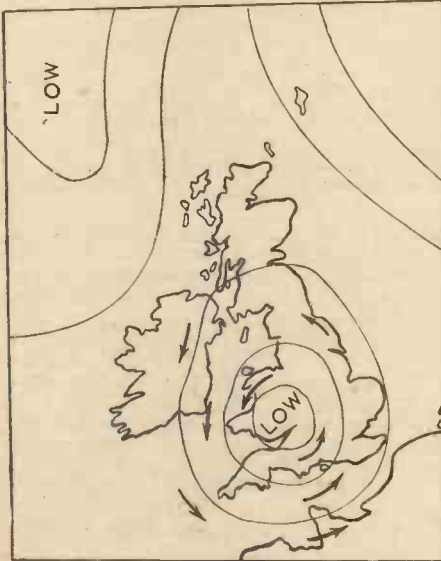

Fig. 3.—Storm conditions on Derby day 1938. An intense depression situated over Cornwall. Barometer read 29.2 in. in the centre of the depression.

Similarly a particle of air from the North of France is travelling too fast to hit the eye of the depression and so it spirals off eastward. By following this line of reasoning it is seen that winds spiral anti-clockwise round a depression north of the equator just as shown in Fig. 3.

The winds of an anticyclone move outward and clockwise in the northern hemisphere. And thus an anticyclone situated off the south west of England gives north and north-east winds. Just imagine the toe of Cornwall placed at point A on the anticyclone system Fig. 2, and you will understand why the fine dry anticyclone weather of this spring was accompanied by north and east winds.

South of the equator the spin of the winds is the converse of that in our own hemisphere, clockwise round a depression, anti-clockwise round an anticyclone.

Direction of Weather

Now that these principles of barometer influence on wind and weather have been stated, weather maps are more intelligible. It becomes interesting to watch these maps such as are given in one or two of our newspapers and which are put up daily somewhere in all towns. From them it can be seen how local conditions bear out predictions of wind direction, sunshine and rain.

Prediction

In prediction it is always the weather to the west of us that matters most. You will notice that big weather maps always include the whole of the Atlantic Ocean and only a small part of the continent. The reason for this is that the weather always travels eastward. It may be south-east, due east or north-east, but there is always east in it. Further observation will show that anticyclones and their associated fine weather travel up north-eastward from over the south part of the north Atlantic, while depressions start out from over Newfoundland or Greenland and move somewhat

south-east. The weather over the British Isles is as a result a struggle between the south-east travelling depressions and the anticyclones travelling north-east.

This year's Whitsun weather was an example of this. An anticyclone centred over Spain was in conflict with a depression off the north-west of Ireland. The official weather prophets backed the depression to bring bad weather. Actually the anticyclone just held off and we only got the skirts of the depression system, giving us fine but rather close weather. Subsequently the anticyclone got the upper hand and held it right through June. Fig. 4 shows the two systems in conflict rather well.

Anticyclones

When an anticyclone gets its foot in, fine weather can always be predicted and usually a long spell of fine weather, because anticyclones are very stable. If at any time an anticyclone is seen to be situated over the English Channel fine weather is then a pretty safe estimate. That is rule one in being weather wise.

Depressions

Depressions are much more fickle. They can give all types of weather. A study of Fig. 1 shows the system in detail. It is not quite the simple local arrangement of Fig. 2. There are two wind systems. Cold north and east winds lie to the northward; warm wet south-west winds lie to the south. Where these two systems meet rain, squalls, and in summer particularly, thunderstorms result. The clash of the warm southerly winds and the cold northerly winds causes the generation of atmospheric electricity resulting in thunder and lightning. The chilling of the southerly winds by the cold north winds causes the deposition of heavy rain. The worst weather is therefore across the band shown in Fig. 1, which is fairly local. Districts which lie to north and south may escape the worst of the weather.

So although the presence of a depression means broken weather, it does not necessarily mean that all districts will get rain and storm. It is here that weather-wise seamen and countrymen who know the signs of the sky have the pull on scientific prediction. They can judge from the force and direction of the wind and the clouding of the sky and the height of the barometer and predict fairly accurately if rain is to be expected or not. But as a rough rule a low barometer with a south wind turning round to west means rain. Those fine clear summer mornings with a south wind which first brings small white cotton-wool clouds increasing to grey scudding cloud usually

signify that rain will set in before nightfall. But if the cloud decreases then it is pretty safe to estimate that the depression has edged off northward and that the weather, though close, will be fine.

It is impossible to give all the rules for predicting the uncertainties of anticyclone weather but if you make your own observations of the weather maps from day to day as published in such papers as *The Times* or the *Telegraph* and watch the barometer, the winds and the sky, a reasonable accuracy of weather wisdom can be soon acquired.

Long Range Prediction

Scientific long range prediction depends on estimating the chance of depressions or anticyclones travelling eastward from over the Atlantic and gaining control of our weather system. For an instance, the

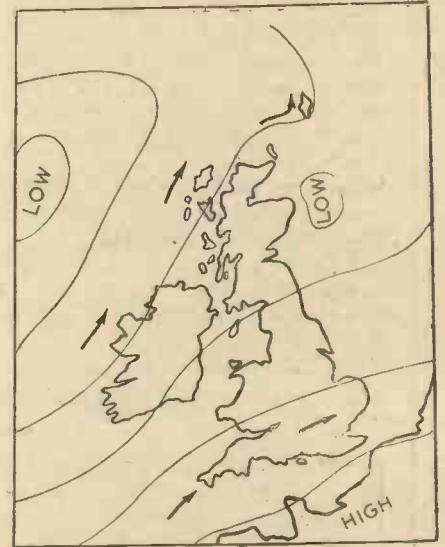

Fig. 4.—Mixed weather at Whitsun 1938. An anticyclone over France was keeping back the depression system to the north-west of Ireland.

weather at the end of last June was stormy. The cause of it was an intense area of depression situated to the north of the British Isles. But there was every chance at the time that large anticyclone areas over the Atlantic would give, on the whole, fair and even extremely hot weather conditions.

But whether the weather is bad or good it becomes more interesting to watch its causes.



PRACTICAL COURSE IN MECHANICAL DRAWING.—By William F. Willard. Popular Mechanics Company. 160 pages.

This is a handy little volume on draughtsmanship, dealing with the draughtsmen equipment, geometric exercises, working drawings, conventions, detailed working drawings, pattern workshop drawing, penetrations, isometric drawing, miscellaneous exercises, a suggested course for high schools, and a useful reference vocabulary. It is well illustrated.

MECHANICS WORKSHOP HANDBOOK.—By Paul N. Haslow. Technical Press, Ltd. 136 pages. 3s. 6d. net.

This is a tenth impression of a very old book, and it seems a pity that the Publishers have not taken the opportunity to revise the very ancient contents. The first chapter dealing with metals and alloys is hopelessly out of date, and this criticism applies in a more or less degree to the rest of the chapters. These deal with iron and its treatment, steel and its treatment, brass and its treatment, solders and soldering, files and filing, tool grinding, drills and drilling, and abrasive and finishing processes. Vast changes in all of these subjects have taken place since this book was first published, and a newcomer to the industries dealing with metal is likely to gain from this book a wrong impression of modern processes.

ABOLISH FEAR OF THE FUTURE

One of the following Courses taken at home in your spare time can definitely be the means of securing substantial promotion in your present calling, or entry into a new and more congenial career with far better prospects.

We have helped thousands of others to success. Why not let us do the same for you—you should at least investigate the opportunities we can place within your reach—it will cost you nothing to enquire.

ENGINEERING

- Inst. of Electrical Engineers, A.M.I.E.E.
- Inst. of Wireless Technology, A.M.I.W.T.
- Inst. of Civil Engineers, A.M.I.C.E.
- Inst. of Structural Engineers, A.M.I.Struct.E.
- Inst. of Builders, L.I.O.B.
- Inst. of Sanitary Engineers, A.M.I.S.E.
- Royal Sanitary Institute, M.R.S.I.
- Inst. of Mechanical Engineers, A.M.I.Mech.E.
- Inst. of Automobile Engineers, A.M.I.A.E.
- Royal Aeronautical Society, A.F.R.Ae.S.
- London B.Sc. Degrees
- Wireless — Telegraphy — Telephony
- Electrical Engineering
- Television — Electric Wiring

- Talking Picture Work
- Works Management
- Building Construction
- Sanitary Engineering
- Sheet Metal Work — Refrigeration
- Motor Engineering
- Engineering Draughtsmanship
- Electrical Draughtsmanship
- Jig and Tool Draughtsmanship
- Die and Press Tool Draughtsmanship
- Structural Draughtsmanship
- Building Draughtsmanship
- Clerk of Works
- Building Inspection

Weights and Measures Inspector
M. & Cy. Engineers

GENERAL

- Matriculation — Bookkeeping
- College of Preceptors
- Chartered Institute of Secretaries
- Massage — Institute of Hygiene

CIVIL SERVICE

- Clerical (age 16-17)
- Executive (age 18-19)
- Tax Inspector (age 21-24)
- Patent Office (age 20-25)
- G.P.O. Engineering (age 18-23)
- Typist (age 16½-25)
- Customs (age 19-21)
- Board of Trade (age 20-24)
- Police College (age 20-26)
- Police Force (under 27)

MUNICIPAL SERVICE

- School Attendance Officer
- Handicraft Teacher
- Registrar — Relieving Officer
- Sanitary Inspector

If you do not see your requirements above just explain what they are. We are able to advise on all branches of Engineering, Civil Service, Municipal Work, etc.

Become a Draughtsman AND EARN BIG MONEY



Numerous vacancies are now available in Electrical, Mechanical, Structural and other Branches of Engineering, Building, Civil Service and G.P.O., etc., for men age 17-40. Practical experience is unnecessary for those who are willing to learn—our "Guaranteed Home Study" courses will get you in. Those already engaged in the General Drawing Office should study some specialised Branch such as Jig and Tool or Die and Press Tool Work and so considerably increase their scope and earning capacity.

THE ACID TEST OF TUTORIAL EFFICIENCY:

SUCCESS — OR NO FEE

We definitely guarantee that if you fail to pass the examination for which you are preparing under our guidance, or if you are not satisfied in every way with our tutorial service—then your Tuition Fee will be returned in full and without question. This is surely the acid test of tutorial efficiency.

If you have ambition you must investigate the service we are able to offer. Founded in 1885, our success record is unapproachable.

Why not fill in and post the attached coupon for further details and free authoritative guide to openings in Engineering, Civil Service or Municipal Work? These books contain a mine of valuable and exclusive information and may well prove to be the turning point in your career.

NATIONAL INSTITUTE OF ENGINEERING

(Dept. 29)

STAPLE INN BUILDINGS
LONDON, W.C.1

FIFTY-THREE YEARS
OF
CONTINUOUS SUCCESS

SOUTH AFRICA BRANCH: E.C.S.A., P.O., BOX 8417, JOHANNESBURG.

COUPON

To NATIONAL INSTITUTE OF ENGINEERING (Dept. 29),
Staple Inn Buildings, London, W.C.1.

Please forward your FREE Guide to :—

NAME

ADDRESS

My general interest is in : **ENGINEERING,** (Place a cross against
MUNICIPAL WORK, the branch in which
CIVIL SERVICE you are interested.)

The subject or examination in which

I am especially interested is.....
(To be filled in where you already have a special preference.)

Founded 1885 - - - Over 85,000 Successes.

(½d. stamp only required if unsealed.)

SOUTH AFRICA BRANCH E.C.S.A., P.O. BOX 8417, JOHANNESBURG

NEW INVENTIONS

Combined Hat and Bag

THE work of inventors has come to a head. In other words, several recent devices relate to the summit of the human anatomy. For example, there has been applied for in the United States a patent for a combined hat and handbag. Nowadays one sees some weird creations riding upon the permanent waves. So, if one meets a lady wearing her handbag on her head, one will regard it simply as another freak of fashion.

This accommodating hat is in the form of a pouch with a cross-wise mouth. The pouch is large enough to fit over the crown of the head when the bag is performing the part of a hat. Means is provided for fastening the pouch across its mouth, and a sling is formed for carrying the pouch when it goes on duty as a bag.

Methinks that Queen Anne Boleyn, whose ghost is addicted to midnight strolls in the Tower of London, would find this new handbag convenient for holding her head when tucked underneath her arm.

It is significant that the inventress is a lady living in Pennsylvania—a State founded by William Penn. This worthy was a Quaker, who, opposed to all formalities, refused to take off his hat in the presence of King Charles II; whereupon the Merry Monarch doffed his plumed hat to his unconventional, though not disloyal, subject.

Hat Preserver

FOR a hat, when off duty, there has been devised a portable warehouse to preserve it from dust and other dangers. This comprises a casing closed at the top, but open at the bottom for the insertion of the hat. It has an arrangement for hanging the hat within the casing and also for suspending both hat and casing in a wardrobe or elsewhere.

This hat case reminds one of Mrs. Sarah Gamp, the notorious character invented by Dickens. That lady's bonnet boxes were bottomless. Consequently, when she stowed away her bonnets, she appeared to extinguish them in the manner that she put out her candle.

Head Protector

THE next invention I shall notice likewise concerns the head, being a baseball head protector. It is interesting to conjecture how long the human race has played ball. Probably, Baby Cain indulged in this pastime while he toddled on the Antediluvian turf. And, as the ball has been kept rolling down the corridors of time, children of larger growth have devised numerous games in which the ball plays the leading rôle—I almost spelt it "roll."

Owing to the hardness of the ball, some of these games are not free from danger. For instance, during the eighteenth century an heir to the English throne is stated to have been killed by a cricket ball.

It appears that, in the game of baseball—so dear to the heart of the American—the player is likely to receive a blow on the occiput. I use that high sounding term as it is employed in the abridgement of the specification relating to the head protector in question. It is not necessary for me to inform the courteous reader that it is the anatomical name for the back of the head. Incorporated with this protective cap is a pneumatic section, so that the headgear forms a resilient buffer. At the same time, it adapts itself to the shape of the skull. Defended by this armour, the said occiput may be invulnerable, but, to descend to a

The following information is specially supplied to "Practical Mechanics," by Messrs. Hughes & Young (Est. 1829), Patent Agents, of 9 Warwick Court, High Holborn, London, W.C.1, who will be pleased to send readers, mentioning this paper, free of charge, a copy of their handbook, "How to Patent an Invention."

colloquial expression, one may "get it in the neck."

All is Not Gold

THE American poet, Longfellow, moralised, "Things are not what they seem." According to an invention, for which a patent has been applied for in the country of the aforesaid poet, "Rings are not what they seem." The device in question consists of a finger ring, the top portion of which has an inset on its outer face of a more precious metal than the other part. The base metal portion is more or less concealed by the adjacent fingers of the wearer.

Flood-lit Lips

A COMBINATION lipstick mirror and flashlight has been submitted to the United States Patent Office. The light bulb is lit by holding the casing endwise between the fingers of one hand. The lady who uses this illuminating contrivance may, in the distance, appear to be playing an harmonica, but she will actually be throwing light upon an intriguing subject—her carmine lips shaped *à la* Cupid's bow.

Compressible Umbrella

I NOW return to the fold of the umbrella, relating to which I have in these notes commented upon more than one device. An improved folding umbrella has a telescopic stick and ribs. There are supplemental braces for supporting the frame, jointed to an auxiliary runner shiftable on the stick. In addition, means is provided for braking the runner in the first part of the expansion of the frame.

By the way, there is room for an invention to enable one to park one's umbrella with safety in a restaurant. I myself have recently been one of the subjects of an inadvertent exchange of umbrellas. In this instance—wonderful to relate—the umbrella left in place of my own happened to be slightly superior to the latter. Would it not be possible to devise a simple locking arrangement to attach one's umbrella to the stand, so that it could be released only by a key in the owner's possession?

For the Rising Generation

THE toys which amused our forbears imitated the inventions of their own age. And the current youngster naturally demands a plaything resembling the latest development of mechanical genius. An improved toy aeroplane is in the air. This invention relates to the toy flying machine driven by an electric motor, in which the miniature plane travels in a circular path about a vertical pivot under the power of a motor operating near the pivot.

The primary object of the device is to provide a novel aeroplane of this kind which will closely resemble the action of its full-sized prototype. It is claimed that different angles of flight may be assumed; that it can rise and descend, increase or decrease its speed and describe various manoeuvres of flight.

By means of the manual control remotely located from the aeroplane, it may have its speed controlled. The movements possible include looping the loop, and the inclination of the plane during the take-off and when landing, just like the genuine article.

This toy de luxe will delight the heart of the juvenile who is fortunate enough to possess it, or at least to have the opportunity of witnessing its evolutions. It should educate on the subject of flying the rising generation. I use that term "rising generation" advisedly, for, the immense impetus to aviation which is being manifested, suggests that the next generation generally will all be rising, but not, let us hope, falling.

Road Marks

THE old-fashioned signpost pointing the way to Mudborough or some other enlightened town, used to be the only inanimate guide on the highways. Our roads are now furnished with many indications and much lettering to warn the rash and the unwary. At present the two chief methods of marking lines and words on the surface of our roads and providing guidance to pedestrians, are painting them and inserting studs. Paint, however, soon wears off and has to be periodically renewed. And, although studs are permanent, it is stated that the metal contracts and expands to an appreciable extent with the changes of temperature, and the studs gradually become loosened.

To obviate these disadvantages, an inventor proposes that roads be marked with a tile of china or vitreous material. The tile may be white or tinted with any desired colour. It may even resemble the carmine nails of the fair, although a light tone would naturally be more conspicuous.

The One-Man Orchestra

AMONG street musicians of the past, the most comprehensive was the one-man band. The performer himself alone played a number of instruments attached to his body, including cymbals, a drum and the pipes of Pan. This multiple musician was a humble forerunner of the cinema organist, whose giant instrument has been termed a one-man orchestra.

I am moved to refer to this topic, owing to the fact that that popular radio star, Mr. Reginald Foort, proposes to cart round to the music halls a 25-ton cinema organ. No doubt the organ that he will erect on the variety stage will be the latest thing in electrical organs.

While upon the theme of that remarkable example of inventive genius—the cinema organ—I pay a tribute to the man who was largely instrumental in making the electric organ a wonder-compelling fact. He was Robert Hope-Jones, who was born in Cheshire in 1859. An organ-building genius, his ideas were taken up enthusiastically by the Rudolph Wurlitzer Co., of America. English folk have reason to be proud of the fact that the pioneer of the electric organ hailed from this side of the Atlantic.

What Might Be

THE London Underground Tube railway may fairly claim to be the eighth wonder of the world. The passengers who thread its labyrinth of passages are guided by many infallible signs. It has occurred to me that the inventor might with advantage employ his ingenuity by yet further ministering to the convenience of the subterranean travelling public. Many years ago the District Railway exhibited in their carriages indicators which informed passengers the name of the next station. A revival of these indicators in an improved form would help travellers on the Tube. DYNAMO.

Conjuring With Paper

Surprising Number of Simple and Amusing Tricks can be Performed with the Aid of an Ordinary Newspaper



Fig. 1.—A false thumb tip which fits over the conjurer's thumb and so provides a secret receptacle for a strip of paper in the trick of tearing and restoring the paper.

A VERY simple and useful appliance which makes possible a number of effective tricks is shown in Fig. 1. It was originally used for the feat of tearing up a strip of paper and restoring it again. The fake is a hollow artificial thumb tip, sometimes of metal and sometimes of ivory, painted flesh colour and worn on the right thumb. With the fake in position if the thumb were held up in front of an audience the presence of the false tip would be very noticeable, but in using it the conjurer takes care, when showing his hands empty, to hold them with the tips of the thumbs pointing directly at the audience. In this position it is quite impossible to detect the presence of the fake even at close quarters and the flesh coloured paint need be only an approximate imitation of natural colouring.

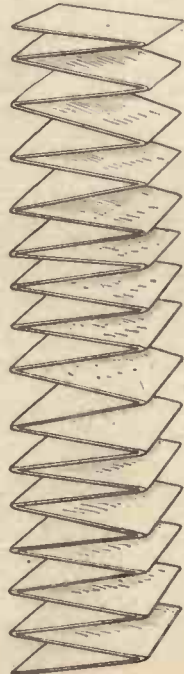

Fig. 2.—A strip of paper folded into zig-zag pleats.

By Norman Hunter
(The Well-known Conjurer of "Maskelyne's Mysteries")
Further Articles on the Secrets of Conjuring will appear Regularly and Exclusively in this Journal

duplicate strip, is tucked into the waistcoat pocket. When he wants to perform the trick the conjurer takes the strip from his pocket and brings out the thumb tip on his thumb with the folded strip inside it. The strip having been shown, it is torn into small pieces which are folded together and exchanged for the duplicate strip, the pieces being left inside the thumb tip. The whole strip is gradually opened and allowed to flutter to the ground, the hands being seen to be quite empty.

Changing the Strip

In addition to the tearing and restoring feat, one strip of paper may be changed to

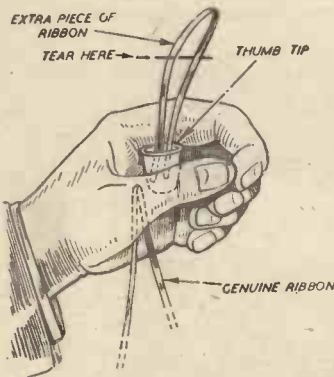

Fig. 3.—When the centre of the paper is apparently drawn through the closed left hand, the dummy thumb tip is left behind and the centre of the short length of ribbon is drawn out.

another of a different colour. Or two pieces, say yellow and blue, may be torn up and restored as a green strip, or as a strip composed of alternate blue and yellow sections. Or again a very long strip of paper may be shown and the ends initialled by members of the audience. The centre of the ribbon is then torn out and the paper restored again, the marked ends being identified to prove that only one strip was used.

For this trick you require simply a strip

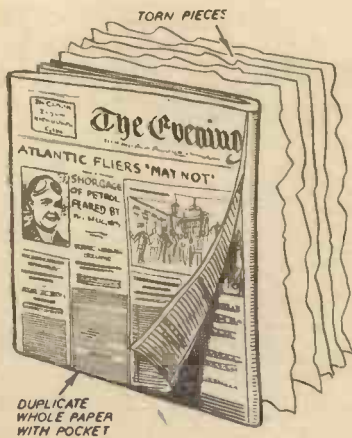

Fig. 5.—A sheet of newspaper with a pasted-on pocket which holds a duplicate sheet also equipped with a pocket. The visible paper being torn up, the pieces can be hidden in the pocket of the whole sheet and so the torn paper be apparently restored.

of paper a few inches long like the long strip. This is concealed in the thumb tip. The ends of the long strip having been marked, the centre is grasped by the thumb and forefinger of the right hand. The thumb tip is on that thumb. When the centre of the paper is apparently drawn through the closed left hand the thumb tip is left behind and the centre of the short length is drawn out. (See Fig. 3.) This short piece appears to the audience to be part of the long strip. It is torn or cut or even burned, the remains being tucked down into the false thumb which is carried away on the thumb which does the tucking down and the long strip drawn out and



Fig. 4.—Details of the pocket in the newspaper. Both sheets for the trick are prepared in the same manner.



Figs. 6 and 7.—
(Left) A packet
of large pieces of
paper with the
pocket at the back.
(Right) Message
cut out on paper.



handed for examination. The marking of the ends makes no difference to the working of the trick but adds immensely to its effectiveness.

Tearing and Restoring a Newspaper

On a larger scale comes the trick of tearing up a newspaper and restoring it. In actual fact it is only the outside sheets of newspaper that are used. Two are required, both of the same issue. Each has a large pocket in one corner. The pocket is made by cutting a section from yet another sheet of the same issue of the paper and pasting it down by two adjoining sides. (See Fig. 4.) One sheet is now folded until it is just the size of the pocket and with its pocket on the outside, it is then folded once more and inserted in the pocket of the other sheet as shown in Fig. 5.

To perform the trick the sheet is held up with the pocket at the back, the hand holding the corner where the pocket is situated. The paper is then torn into strips which are placed one in front of the other and then across into pieces. The pieces are always placed in front of the part with the pocket so that the final stage leaves the conjurer with a packet of large pieces of paper with the pocket at the back, as shown in Fig. 6. He then tears off the pocket and places that in front of the packet, opens the whole paper behind the pieces and turns the whole packet round so that the whole paper is in front.

It is now a simple matter under cover of opening out the whole paper, to place the pieces in the pocket of the whole sheet. The fact that two adjacent sides of the pocket are open makes this part of the trick easy and straightforward.

Tearing Patterns

Tearing patterns from folded paper is more in the nature of an amusement than a mystery, but there is a development of this which produces a very baffling effect.

The conjurer takes the double outside page of a newspaper, folds it into complicated folds and proceeds to tear out a pattern. When he has finished he shakes out the paper and the audience see that he has torn the paper away so as

to leave in large letters a message formed by the untorn part of the paper. (Fig. 7.) The message is, of course, suited to the audience and provides a good opportunity for the performer to be very local or topical.

Actually, of course, it is quite impossible so to fold a sheet of paper that letters can be torn out in this way. The paper is prepared before hand by cutting or tearing the message out. A duplicate double sheet is then prepared with a pocket in exactly the same way as described for the restored paper trick and the paper with the message is folded neatly and placed in the pocket.

Performing the trick is literally child's play. The paper is folded in as many fancy looking folds as the conjurer cares to make and pieces are then torn haphazard, but apparently great thought and care, from all parts of the sheet until finally the entire sheet has been torn up and discarded. Towards the latter part of the tearing the prepared sheet with the message is unfolded bit by bit so that as the last scrap of paper is thrown aside a few shakes serve to unfold completely the paper with the message on it.

Two Paper Tearing Effects

Two more rather tricky paper tearing

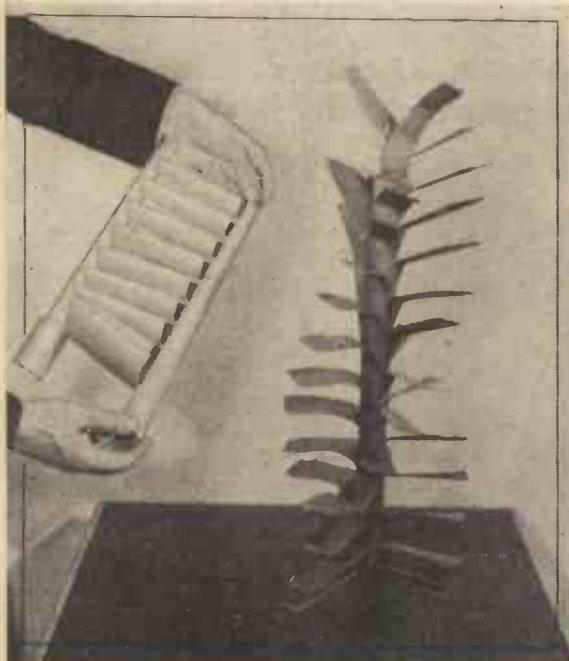

Fig. 8.—Trick paper tearing. A fir tree and a ladder made by rolling and tearing paper as described in this article.

effects are illustrated in Fig. 8. In each case the performer takes a long strip of paper, rolls it up, makes a few cuts or tears in it and pulls it out telescope fashion. One roll transforms itself into a fair representation of a fir tree while the other becomes a quite realistic ladder.

The method of tearing the rolls of paper is shown quite clearly in Figs. 9 and 10. Fig. 9 shows the four simple vertical tears down from one end of the roll which serve to make the fir tree. The paper having been torn, the sections of the tube are bent well down and the roll pulled up from the centre. The ladder is made by tearing the paper roll across near each end so that the roll is almost severed, then connecting the tears with a cut or tear along the length of the roll. The short ends are bent down at right angles and the ladder pulled out by the centre. In both these tricks the effect is enhanced if coloured papers are used. The paper must not be thick or it cannot be torn. The most suitable paper to use is known as M.G. paper and can be obtained from any printer in a variety of bright colours. It is quite cheap.

An Amusing Trick

Now we come to a fairly elaborate trick with a strong element of comedy. Two

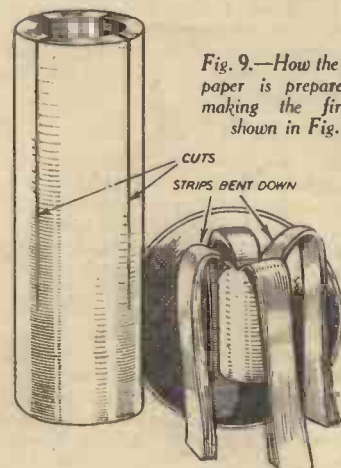

Fig. 9.—How the roll of paper is prepared for making the fir tree shown in Fig. 8.

pieces of tissue paper, each about twelve inches square are shown, one is red and one white. A member of the audience is asked to assist and is given one piece. He is asked to cut a circle from the centre and the performer, to demonstrate, cuts a circle from the centre of his piece. Both pieces and the cut-out circles are then folded together and given to the assistant who is told to repeat a spell which will make the papers complete again. He tries but of course fails. When the papers are opened the red piece is seen to have a white centre while the red centre has become joined into the white sheet.

The conjurer takes the pieces back, sets fire to them and restores them to one complete white and red piece once more. Finally he rolls both sheets together and changes them either to a flag or what would perhaps be more logical, a large square of silk made up of alternate red and white stripes.

Commencing the Trick

The first part of the trick is simple. Having cut the centre from his piece of paper the conjurer hands the scissors to his assistant and then stands with one hand in his pocket waiting for the other piece to be cut. In his pocket he has a neat packet composed of the two pieces with the wrong centres folded together. This he

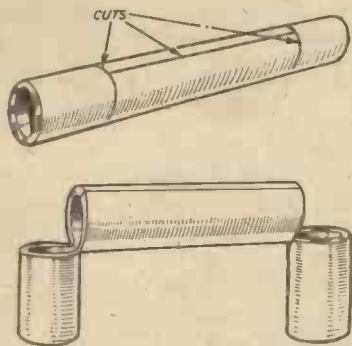

Fig. 10.—How the paper is prepared for making the ladder shown in Fig. 8.

conceals in his hand. When the cutting is finished the performer takes the scissors and puts them on his table, takes his hand from his pocket and folds the cut pieces together, keeping the small packet concealed. He then reverses the positions of the packets, hands the packet of wrong centre pieces to his assistant and gets rid of the other packet by dropping it into a bag behind his table as he picks up a book from which to read the magic spell.

The word is duly read out, it should be a long and complicated word which the assistant is not likely to get right first go. He is then told to open the papers and of course finds them with the wrong centres.

A Prepared Matchbox

The conjurer then picks up a box of matches and burns the paper, pronouncing the magic word correctly as he does so. Fig. 11 shows the paper in process of burning, a plain white piece being used for the sake of simplicity in the photograph. The matchbox has the drawer pushed out half way and in the space so formed in the case are tucked the two duplicate whole papers, folded together. As the paper burns down the matchbox is closed and the whole papers are thus forced out into the left hand. It will be understood that Fig. 11 gives a back view, as seen by the performer. The securing of the papers from the box is concealed from the audience by the performer's hand holding the burning pieces.

As the papers burn down the box is

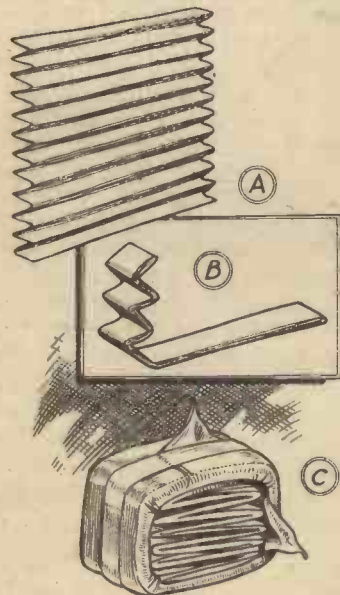

Fig. 12.—Folding a flag or sheet of paper for easy and rapid opening.

tossed aside, the flames are blown out and the hands brought together to develop the whole papers from the ashes of the burned ones. A very effective part of the trick.

Finally the performer hands his assistant the two papers and asks him to admire the way in which the centres have been joined in, leaving no trace of the mending. This, of course, is just misdirection for the pieces of paper have no joins in them, but while the assistant and the audience are for a moment looking at the papers, the conjurer, with his hand on his hip, secures from under the edge of his waistcoat, the flag or striped silk neatly folded into a small packet. He then takes back the papers, rolls them together in his hand and shakes out the flag, keeping the rolled up papers hidden in his hand.

A Method of Folding

In Fig. 12 I have shown a useful method of folding either a sheet of tissue paper or a flag so that it may be quickly unfolded when required. The flag is first folded in accordion pleats as at A, Fig. 12, making it into a long strip. One end is placed under a weight and the strip is again pleated about two thirds of its length as at B. The remainder of the strip is then rolled round the pleated part and the bundle is secured



Fig. 11.—Mending by fire! A piece of paper burned and restored again or the ashes changed to a flag. The duplicate paper or the flag is concealed in the space left by the half-open drawer of the match-box and pushed secretly into the hand as the box is closed.

by placing a strip of paper round it, or a fine elastic band may be used. The two corners now on the outside are pulled out a little so as to be easily found. C. (Fig. 12.)

Producing Flags

To produce a flag so folded it is only necessary to grasp the two corners and pull them vigorously apart when, owing to the pleating, it will rapidly unfold without tangling. The same method of folding can be used for the tissue paper squares in the trick I have just described, but in this case no fastening will be needed and when the paper is unfolded it must be shaken out, mere pulling of the corners not being sufficient to open out the stiffer folds of the paper.

The method of changing the burning papers into whole ones by means of the matchbox can also be used to transform a piece of burning paper into a handkerchief, flag, or length of ribbon. The article in question is simply placed in the space formed by pushing out the drawer of the box and produced as already described.

Now here is a pretty and unusual paper-

tearing trick which I performed a large number of times at Maskelyne's. It is not at all difficult but the effect is in the nature of a surprise.

Two strips of paper are shown, one blue and one yellow. They are placed together and torn into short lengths. A shake of the hand and the torn pieces drop out in the form of a paper chain having its links alternately blue and yellow.

Paper Chain

The paper chain is made from short strips of paper after the manner of the ordinary decorations constructed by children at Christmas time. The bottom link is weighted by laying a halfpenny or similar sized piece of metal on the paper and pasting another piece of paper over it. (Fig. 13.) The entire chain is then folded link by link until it forms a flat cross-shaped packet as shown in Fig. 14. A short tab of paper is pasted to the centre of the cross so that if this tab is lifted the weight at the other end of the chain will open the links.

The chain, folded flat, is then made into a small packet by folding the arms of the crossover to the centre away from the tabbed side and the packet is placed in a clip under the back edge of the table.

Concealing the Chain

In performing the trick the two strips of paper are shown and laid over the table while the hands are shown empty. In picking up the strips again the folded chain is drawn out of the clip and retained concealed behind the fingers. The strips of paper are then torn into short lengths which are folded together. These short lengths are placed on top of the folded chain and the fingers grip the tab of the chain and the pieces together the chain being prevented from unfolding by the other fingers curled beneath it. At the right moment the chain is released and the weight causes it to run down neatly and open out. As most of the audience will be expecting the papers simply to be shown restored, this surprise ending always gets a good round of applause. The torn papers are disposed of along with the paper chain as the chain is dropped into a convenient box or basket.

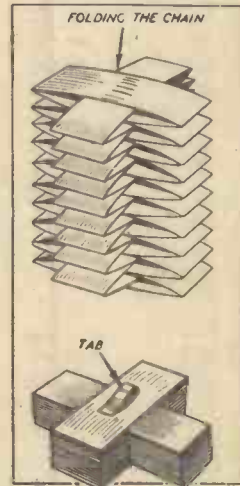

Figs. 13 and 14.—(Left) Details of the paper chain with the weight attached to the last link. (Right) How the paper chain is folded to form a cross-shaped packet.

MODEL AERO TOPICS

The Model Hawker Hurricane— Competition Result

THE Model Hawker Hurricane Competition—in connection with which a free blueprint was given with our issue dated May, 1938—was held at Brooklands on Saturday, August 6. In many respects it was a great disappointment, for in spite of the fact that nearly four months had elapsed between the issuing of the blueprint and the date of the competition, most of the competitors had not finished their models until the eve of the competition, with the inevitable result that many of the models had not been tuned up. Another disappointing factor was that although nearly 300 competitors had advised me in writing of their intention to compete, only about 15 per cent. of that number actually turned up. Perhaps the summer holidays had something to do with that, but competitors will appreciate that these competitions have to be fitted in with the Brooklands arrangements and the available dates are not numerous.

Nothing, however, can excuse the fact that most of the competitors who did arrive had given themselves insufficient time to carry out the necessary tuning up which is vital to the success of what is virtually a flying scale model. Some of the competitors, in fact, were actually completing their models on the field, and astonishing though it may sound, some had not even flown their models before they appeared in front of the judges!

I am also disappointed that the competition did not attract some of our crack clubmen. The prize was attractive, and I am certain that we should have witnessed some better flying. In any future competition of this sort I shall make it a rule that each competitor must make a qualifying flight, witnessed by members of an affiliated club, before they are entitled to enter the contest. It is difficult to organise a competition when competitors do not put their models in competition trim.

It was obvious that most of the competitors had only the vaguest notion of how to adjust a model aeroplane. Some of them were endeavouring to fly the model without dihedral angle; some were flying without angle of incidence; some did not understand how to trim the model; many of the models were under-powered; and nearly every one of them was not in a fit condition to enter a competition. The conditions governing the competition were not onerous. It must be remembered that it was a free competition, and any competitor who

CURRENT NEWS FROM THE WORLD OF MODEL AVIATION

BY F. J. C.

felt that the conditions were outside his ability need not have entered. Every competitor was supplied with a detailed list of rules by post, and not one of them wrote to consider that the rules were too difficult—which in point of fact they were not. Full instructions for building and adjusting the model were given in

modify the design, or even to add to it so there is really no excuse for the very poor show.

It is the considered opinion of the judges, therefore, that not many of the competitors had a reasonable knowledge of model aeronautics, or of the methods to be adopted in adjusting a flying scale model. After due consideration the prize money has been added to and sub-divided and awarded in the following way:—

First prize—£8.—Mr. O. M. Wareham, 65a Hounslow Road, Twickenham.



Messrs. Hamleys' "Southern Star," winner of the Bowden Trophy. It is powered with a $7\frac{1}{2}$ c.c. engine, the wing span is 6ft., and the complete model weighs 3½ lbs.

Second Prize—£4.—Mr. G. Newstead, c/o 96 New Haw Road, Addlestone, Surrey.

Two Third Prizes—£2 10s.—Mr. A. K. E. Gyford, 21 Everton Road, Yeovil, Somerset; and L. J. Hensley, 1 New Avenue, Broadway, Worcester.

Two Consolation Prizes—£1 10s.—F. E. Clayton, 5 Hurst Grove, Walton-on-Thames; and F. W. Day, Moorcroft, London Road, Rickmansworth, Herts.

Two Consolation Prizes—£1 5s.—D. Colyer, Summerfield Road, Claygate, Surrey; and F. Manning, Ewton House, Heath End, Farnham, Surrey.

None of the competitors made a flight worthy of the complete award.

There can be no doubt that Mr. Wareham's model from a constructional point of view was streets ahead of any of the other models. He had not only gone to the trouble of making a fuselage of correct scale form, but he had carefully finished the model in camouflage colours, so that it actually did resemble in every way the complete machine. It also showed the most promising flying capabilities.

S.M.A.E. Gala Day

MR. E. F. H. COSH, hon. sec. of the S.M.A.E., apropos my note in last month's issue, tells me that my

this journal together with photographs of the structure, and every assistance was rendered to them through the post.

It is worth while remembering, also, that every competitor was permitted to



Mr. T. Merkler, of Bracknell, with his model of our Hawker Hurricane.

suggestion for an S.M.A.E. Gala Day is already in hand, and will almost certainly be included in next season's programme. At the last council meeting he suggested that a one- or two-day national meeting should be held at which almost all of the S.M.A.E. centralised competitions could also be run off. This would enable members of the provincial affiliated clubs to enter these by making only one journey to London during the season. Mr. Cosh also pointed out that one large meeting of this description would have a far greater publicity value than a number of small ones, such as are held at present.

Wakefield Competition Results

REGRET that, according to our team, the method of conducting the Wakefield Competition this year which was held in France, under the auspices of the French model authorities, gives cause for grave disquiet. In the first place, although the S.M.A.E. rules stipulate that two timekeepers must time each flight until they pass out of sight, and that binoculars or field glasses must not be used, we learn from members of the team, that only one timekeeper timed some of the flights, and in many of them the timekeepers actually used field glasses. Quite naturally a protest was lodged on the spot, and although the British team did not wish to be unsportsmanlike, I know that a great deal of resentment is felt. This country has always prided itself on the hospitality expressed through the S.M.A.E., to foreign model aircraft teams visiting this country, and it is with extreme surprise and with great regret that it is reported that this hospitality was not reciprocated in France. Unhappily, also, it is my duty to say that the spirit of sportsmanship and strict

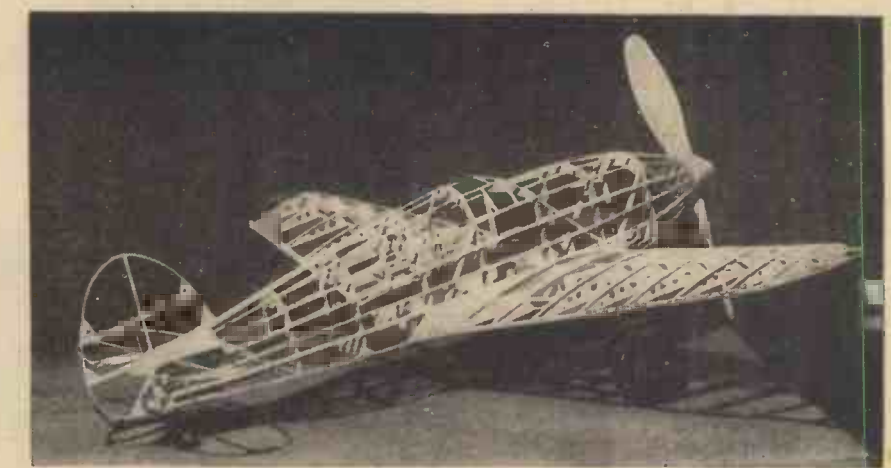

The framework of Mr. W. T. Gaskill's Model Hawker Hurricane.

adherence to the rules did not seem to permeate the proceedings on this occasion. In view of the great interest Lord Wakefield has taken in this contest, it is a matter of grave concern that the French people should have been guilty of this carelessness in judging what is manifestly the most important model aircraft competition in the world. This sort of incompetence in an international model aircraft competition must not be allowed to recur.

For what they are worth I append the results which I do not accept as revealing the true results:—

	Secs.	
1. United States	654	Cahill
2. France	418	Bougueret
3. Sweden	402	Magnusson
4. Germany	375	Klose
5. Gt. Britain	357	Almond
6. Canada	296	Milligan
7. S. Africa	285	Beatty
8. Australia	267	Fullarton
9. Poland	203	Degler

10. Belgium	174	Van Wymersch
11. Holland	97	Bezener
12. Czechoslovakia	93	Vyskocil
13. Norway	57	Olsen
14. Switzerland		(machine broken) Degen

I hope there will be an inquiry for it seems that the competition should be run afresh.

S.M.A.E. Competition Results

Results of the Frog Senior Cup

R. Mackenzie (Blackheath)	...	122.7
B. Montgomery (Blackheath)	...	95.0
C. R. Moore (Unattached)	...	68.1
L. B. Mawby (Ealing and District)	...	Retired

Results of the Junior Cup

J. Cumber (Barnes)	...	88.16
J. Neale (Unattached)	...	72.8
C. Field (Unattached)	...	44.63
A. Shanks (Unattached)	...	39.3

S.M.A.E. Notes

The following records were passed:—
R.O.G. Duration, I. W. Hall, 14 m. 25 s.

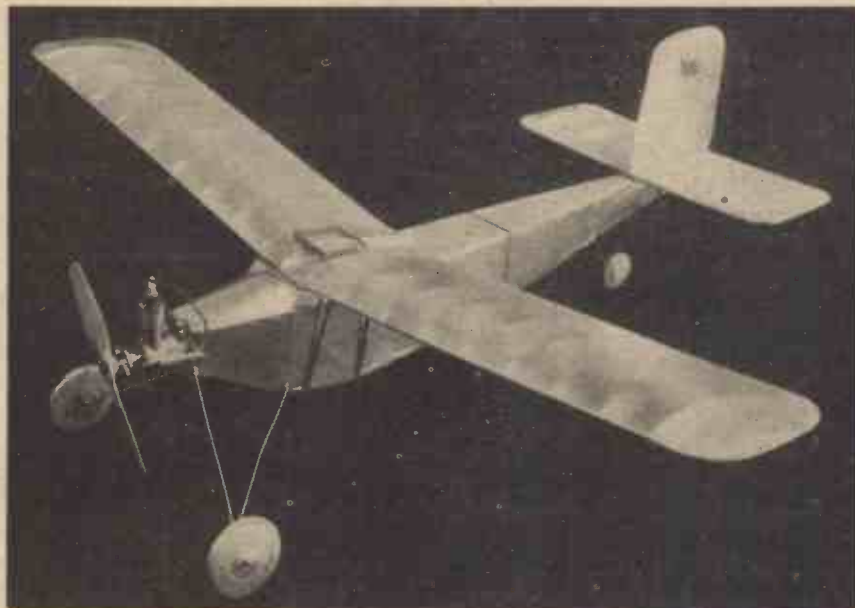

This machine, made by Mr. J. T. Hallam, has made a number of successful flights and is powered with a 2.5c.c. engine. On the right is shown a close-up of the engine.

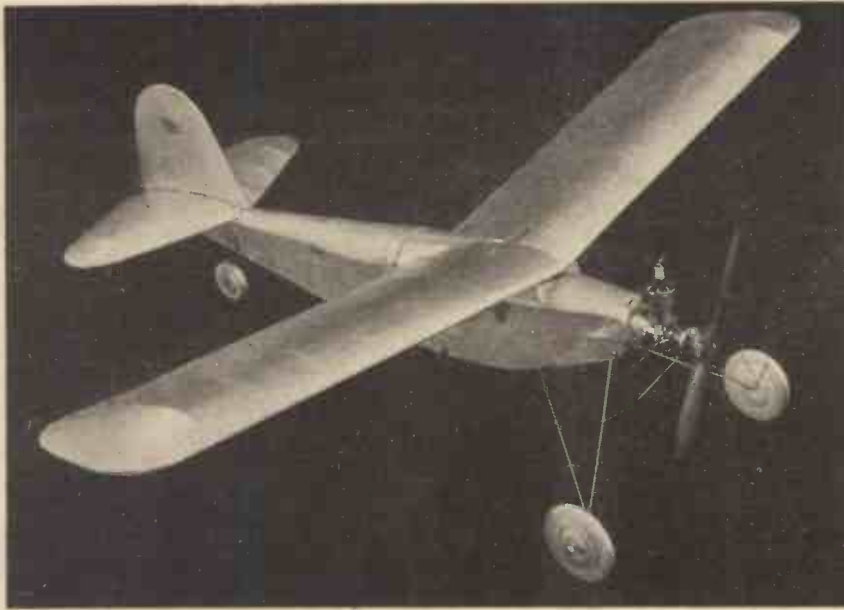

Another attractive model made by Mr. J. T. Hallam, which is fitted with a 2.5 c.c. engine. On the right is shown a close-up of the engine.

- R. O. G., Duration, R. Copland, 27 m. 56 secs.
- Type Ol. Pl., I. W. Hall, 56 s.
- R.O.W. (Tank), Ol. Pl., R. T. Parham, 45 s.
- R.O. Open Water Ol. Pl., R. T. Parham, 1 m. 3.3 s.
- Hand Launched Ol. Pl., R. T. Parham, 1 m. 3.1 s.

Petrol Model Insurance

The Council decided that, provided Mr. Smith was notified, the registration figures could be transferred to a new model. A small charge would be made if new transfers were required. Mr. Smith had also received inquiries as to whether more than one machine belonging to one entrant could be entered in S.M.A.E. competitions. It was pointed out that in the minutes of the Society only one machine per entrant was allowed.

Results of the Sir John Shelley Cup :

	Points
1. J. S. Wreford	57
2. F. J. Almond	57
3. J. C. Gardner	57
4. W. E. Evans	56
5. A. Poulton	55
P. W. Clempson. Flew away.	

Results of the Bowden Cup :-

	Points
E. Ross	120
L. A. George	120
C. R. Jeffries	90
R. F. Brigden	90
J. E. Pitt	90
J. K. Ward	90
J. S. Wreford	90
R. H. R. Curwen	90
W. E. Evans	90
J. Coxall	90
J. C. Gardner	90
A. L. Dalton	90
H. Norman	90

Petrol Model Hints

MR. R. J. O'Neil, of Cloud Aircraft, sends me the following hint relating to petrol models :-

One of the small snags connected with petrol models I have found is that with a model such as ours which has a good rate of climb, when the time switch cuts the ignition, the model is left with its nose in a steep climb, in other words, in a stalled condition; the result is that the model makes a stall, recovers and then goes into a normal glide. This fault has been apparent on nearly all petrol models.

Now obviously what is needed is a means of shutting down the power a few seconds before the power cuts; this would allow the model to enter a glide from a normal altitude.

I think the appended sketch will be quite clear. The time switch pulls down the flap over the air intake and causes the engine to four-stroke, this takes place about five seconds before the power cuts. Another advantage is, that the Ohlsson as fitted always needs to be rich for starting. I have found that when the model lands, it always starts right away, as it is already primed.

The second gadget is one I have used for some time. I think the sketch will explain itself. It is a switch for cutting the ignition in the event of the model

getting into a spin or dive with power on.

The mercury flows forward in the tube and brakes the circuit.

Ball Thrust Races

I HAVE received from the Model Aerodrome, Birmingham, 11, one of their miniature propeller shaft ball thrust races which was used by almost every competitor at the Wakefield trials. It consists of a very miniature, but well made, thrust race and two hardened steel thrust plates. These plates are hardened and the thrust washer runs free on the shaft between the nose block and prop. They cost 6d. each. They have also sent me a sample of the Drome free wheel propeller shaft complete with free wheel loop. This costs 4d., postage extra. This company supplies all of the accessories necessary for model aircraft construction.

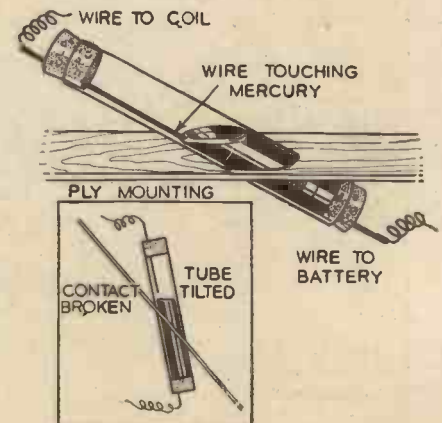
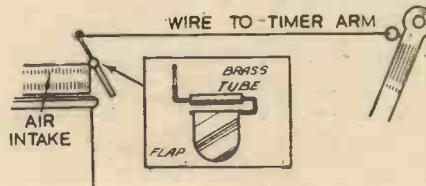

Mr. R. J. O'Neil's Petrol Model hint to prevent stalling due to ignition cutting out. The second sketch shows a mercury switch to cut-out ignition when the model stalls or dives

THE "CARDIOPHONOSCOPE"

A MUCH-USED apparatus in the medics' consulting-room is the electro-cardiograph. This instrument registers the minute currents set up in the walls of the arteries through the rhythmic contraction of the heart muscle. Pads of cloth saturated with salt solution and covering zinc plate electrodes are bound to the arms and legs of the subject, who forms a closed circuit through a galvanometer. A record may be made in this way by registering the needle deflection either upon a smoked roll of paper, upon a photographic film or else as an inked graph. Such an apparatus is extremely useful in diagnosing the condition of the heart by studying the force or tension of the relaxed and contracted muscle as the heart admits and expels blood through the appropriate valves.

Now, if the reader will refer to the article on "the lie-detector" published in our February issue, he will notice that Fig. 1 represents a simple series arrangement which measures resistance of the tissues interposed at the electrodes. A precisely similar effect takes place in the electro-cardiograph as the result of a current generated on the zinc electrodes via the saline electrolyte. As a matter of fact, the milliamperage of this current is registered in the galvanometer and gives a fairly constant needle current—this is the "skin current" and may be compensated by a suitable variable resistance shunted across the meter—in some instruments it is usual to provide a resistor in the form of a potentiometer which can be adjusted to bring the needle-deflection to zero. At each contraction of the heart there is a spontaneous needle movement, and a graphical representation is thus given. Apart from these small currents generated in the arteries there are others which are being investigated with great care and interest, they are typical nerve impulses having a tension somewhere near half a millivolt with current values of a few micro-amperes. Obviously, very sensitive instruments are necessary and it is fortunate that the development of radio technique has made possible amplifying apparatus suitable for detecting these minute currents. Very good work is being conducted at many hospital centres in this country and abroad.

By F. Britton, D.Sc. Constructional Details of an Ingenious Piece of Apparatus.

The "Berger Rhythm"

While on this subject of current development in the nerves and surface tissues of the body, it might be of interest to note that

working at the National Hospital for Nervous Diseases, London, has met with success using this rhythm as a means of diagnosing the location of certain brain lesions and injuries. For example, during a fit of epilepsy there is a violent exhibition of electrical energy in the brain-cells and a wave of energy is induced. Consequently, different physical conditions are responsible for manifestations of radiation which may be measured with suitable amplification.

Returning to the piece of apparatus already mentioned, namely the electro-cardiograph, it has occurred to me that a

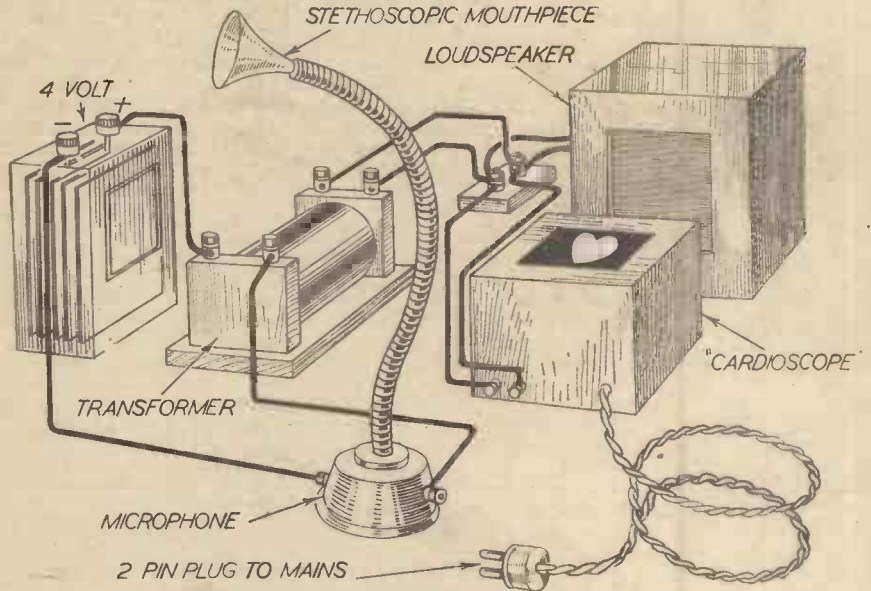
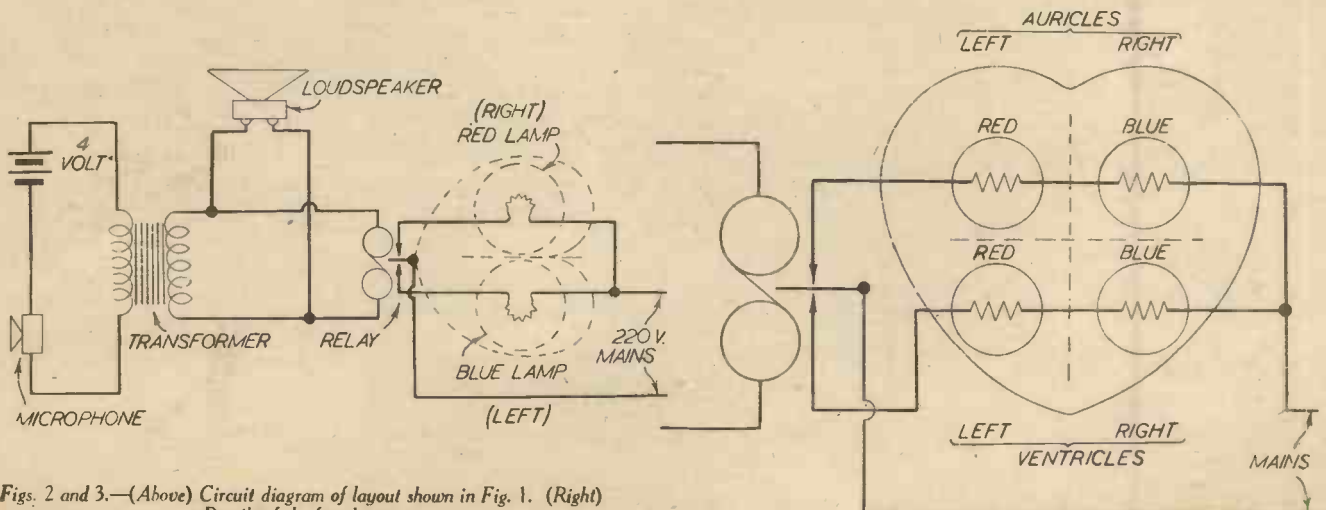

Fig. 1.—General layout of the apparatus

the electrical disturbance known as the "Berger rhythm" is a regular electrical wave at a frequency of ten per second and is constantly generated by a part of the brain. It is interfered with by thought-concentration and Professor Adrian and Mr. B. Matthews of Cambridge have done a considerable amount of research on the problem of the inter-relationship between the thought process and senses like those of sight and hearing. Dr. Lemere too,

modification of this instrument would be distinctly useful in providing a combined record. More correctly, the apparatus makes use of the heart-sounds rather than of the current generated during the beat. From the diagram it appears that either a valve amplifier or the usual type of transformer may be used, the latter obviously is the cheaper and more simple in design. It is preferable to have the microphone fitted in the cabinet itself and not portable since



Figs. 2 and 3.—(Above) Circuit diagram of layout shown in Fig. 1. (Right) Details of the four lamps.

the slightest extraneous vibration is likely to upset the record. The mouthpiece is attached to a rubber tube, the other end of which is firmly fixed in the aperture of the microphone within the cabinet. The microphone itself is in series with a battery and the primary of a transformer, the secondary of which passes direct to a loudspeaker via a terminal block from which is also shunted the leads for the visible recorder—the cardioscope proper.

Construction of Cardioscope

Details of the construction of the instrument need not be very thorough since most of the particulars may be gathered from the illustration. Fig. 1 represents the general lay-out of the circuit, etc., from it will be seen the distribution leads to the cardioscope. Inside the cabinet of the latter is a relay, the contacts of which are closed by current circulating in the appropriate coils (of same) flowing from the transformer secondary. The contacts close circuits through two lamps one of which is blue the other red—these two lamps are arranged on either side of the cabinet and shine through the top panel which is made of frosted glass on which is painted or drawn a diagram of the heart (right and left halves). Pulsations travelling from the microphone to the transformer are amplified and passed to the relay, the contacts of which close and pass current from the mains to either of the lamps, thus giving a visual idea of the heart movement. Another development which might suggest itself to the reader would be the projection of the image on to a screen, and I am experimenting with this in order to make the apparatus of use for demonstration purposes.

When the instrument is working satis-

factorily the sound in the loudspeaker synchronises with the image in the "viewer," and quite an interesting effect is produced. One thing must be borne in mind however: the result is not the exact replica of what is happening in the heart, for it must be remembered that the two ventricles contract together as do also the two auricles and that, since each half or chamber contains a ventricle and auricle, it appears as though the two (ventricle and auricle) contract together. The image should be taken as representing the flooding and discharging of blood from the heart. One thing which the constructor may be able to carry out would be the provision of four lamps—one in each quarter of the heart—the two auricles having blue, and the two ventricles, red lamps (see Fig. 3). Red and blue, by the way, stand for arterial and venous blood respectively. But if four lamps are used, the two reds and the two blues must be in the same circuit, much after the style of the traffic signals.

In conjunction with a recording cardiac-wave apparatus, electro-cardiograph, etc., some very valuable data may be accumulated and the entire instrument would be extremely useful in many ways. Another apparatus which could be incorporated is the one already described in the February issue; the capacity instrument and also the resistance one under the heading of "The Lie Detector." If separate readings of these instruments are taken and compared there should be ample material for study. But personally, I imagine, the reader himself will be more interested in the working of the apparatus and will be keen to try it out on himself and friends. While to the student of physiology a more definite and real conception of the movement of

the heart will be available by the above means. As far as purely anatomical study is concerned nothing comes up to the actual handling and close scrutiny imparted by a careful observation on a sheep's heart which may be procured from the butcher's. But in conjunction with such an apparatus the somewhat morbid subject of anatomy may be made to "live in the mind's eye" as it were, and a far more lasting impression will be made on the mind.

I believe that quite a number of practical mechanics are keenly interested in the more vital working of their own bodies and especially is this so since the inception of the Fitter Britain Campaign. The surgeon, remember, is very much a mechanical engineer, and his work necessitates a very exact technique in the handling of delicate machinery.

In the February issue of this journal I described an apparatus which could be constructed for showing the variability of the body-capacity of a person, and before going on to discuss a similar piece of apparatus I want to point out a rather confusing statement which I made regarding the lay-out of the components used. Referring to p. 257 middle column, it is mentioned that "The output terminals (the L.S. of set) are connected in series with a polarised relay (G.P.O. pattern), and the Secondary of a 100/1 transformer..." In place of "secondary" read "primary" since this is a "step-down" transformer. And again it is stated: "... so that the secondary now becomes the primary." This may be omitted altogether and in order to avoid confusion the reader should refer to the diagrams—Figs. 2 and 3; these are correct and will furnish the results desired.



The attractive appearance of the "Practical Mechanics" Handbook.

CLAIM YOUR COPY TO-DAY

"PRACTICAL MECHANICS" HANDBOOK

OUR GREAT
PRESENTATION
BOOK OFFER

THOSE readers who reserved their copy of PRACTICAL MECHANICS HANDBOOK on the forms given in last month's

issue, and also cut out the Token, now have the two Tokens required, and should claim their book to-day.

If you have any two Tokens numbered consecutively, that is, 1 and 2, or 2 and 3, or 3 and 4, or 4 and 5, attach them to the Voucher sent to you and fill it up in accordance with the instructions. Post the Voucher and your Postal Order at once to the address given, and the copy which has been reserved in your name should be in your possession in about fourteen days.

Special arrangements have been made for readers who overlooked the offer. Apply for a Voucher to: "Practical Mechanics" Presentation Dept., Tower House, Southampton Street, Strand, London, W.C.2, enclosing halfpenny-stamped, addressed envelope. The Voucher gives full particulars of the offer.

SATISFIED READERS WRITE:—

"It is really a useful handbook, especially the collection of tables at the back."—E. WATTS, 139 Bellemoor Road, Southampton.

wonderful value for the price and wish to thank you for putting forward such an offer."—J. WILSON, 27 Mottram Street, Barnsley.

"I am delighted with my copy of 'Practical Mechanics' Handbook, and have already found some of the tables extremely useful. Its handsome appearance has found it a place in the front of my bookcase. I consider the book

and is a mine of information. Another point is the cover which will stand up to workshop usage."—C. GASTAKE, 30 Edge Lane, Chorlton-cum-Hardy, Manchester.

A MOISTURE BAROMETER

It Should be Noted that Moisture Barometers are not Barometers in the Strict Sense of the Term, but Rather Hygrometers. They do not record Atmospheric Pressures, but merely the Degree of Moisture in the Air. Cellophane, the Material used in the Instrument which Forms the Subject of this Article, shows whether the Atmosphere is Damp or Dry, and thus Acts as a Reasonably Efficient Weather Prophet.

CELLOPHANE is familiar as the wrapping of cigarettes, chocolates and other perishable goods. If you cut out a square of Cellophane, immerse it in water for a minute, and then spread it out on a flat surface, you will find that it is no longer square. The material absorbs water and expands considerably in so doing, but more in one direction than in the other, owing to the method of manufacture. It is this property of expanding under the influence of water which renders

Cellophane a fit material for a hygrometer. Some idea of the amount of expansion available may be gathered from the fact that a piece of Cellophane 9 ins. long in the dry state will reach a length of 9½ ins. when it is saturated



Fig. 1.—The finished barometer.

with water. On drying, the piece returns to its original length.

This useful property can quite readily be applied in such a way that a definite indication of the relative degree of dampness of the atmosphere is obtained. With a 9-in. length of cellophane you will not have the whole of the ½ in. of expansion to utilise, since the material will never get either bone

dry or saturated with water. Actually you can reckon to have a clear ¼ in. of movement, and this can easily be magnified.

The completed hygrometer (Fig. 1) shows how this is achieved. One end of a strip of Cellophane is

held in a clamp. The other end is similarly held in a clamp, to which is attached a length of silk. The other end of the silk is wrapped round a drum, mounted on a spindle with a pointer attached. A slight rotary movement of the drum makes a comparatively large movement of the tip of the pointer, and gives readings on a good open scale. By suitably proportioning the parts, the movement can be magnified to any degree desired.

The Base

The base of which the working parts are

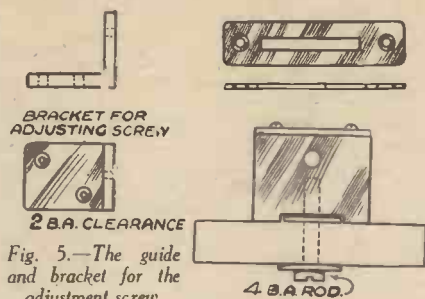

Fig. 5.—The guide and bracket for the adjustment screw.

mounted is a wood batten 2 ins. by ½ in., and 16 ins. long. Polished mahogany will give an attractive and workmanlike finish to the instrument. The pointer and drum are mounted on a 6 B.A. threaded rod as a

spindle. The ends of the rod are turned off to a point, and the bearings are made by drilling halfway through two brass strips (Fig. 2). The drum is the mainspring barrel from an old watch. This should be about ¼ in. in diameter, not much less, or the magnification of the movement will be so great that the pointer will run off the scale. In line with the pointer at the opposite end of the spindle is fixed another strip of brass with a small hole drilled in the outer end. A little lead weight is to be hung on here, to steady the pointer and

assist in giving "dead beat" readings.

Set up the spindle in its bearings truly perpendicular to the baseboard (Fig. 3), and see that it turns quite freely and without undue shake in the bearings. The silk thread is passed through a hole in the periphery of the drum and secured by a knot inside. The free end is passed once round the drum anti-clockwise and fixed to the lower brass clamp. The faces of the clamps which come into contact with the Cellophane must be true and smooth (Fig. 4). The lower half of the bottom clamp has a small hole drilled near its edge for attaching the silk, while a nick is cut with a small round file in the top half to clear this hole. The top clamp is so mounted that it provides for adjustment of the setting of the pointer. The adjusting rod is threaded 2BA, and is equipped with a knurled ebonite knob. Rotation of the knob moves the clamp in the desired direction to raise or lower the pointer. Shape the guides for the clamp with care, so that the clamp runs easily with the least possible side-play. A piece of 4BA rod is screwed into the underside of the clamp, and secured with a nut behind the baseboard.

The Guides

To cut the slots in the guides, mark out with dividers, drill holes (4BA clearance) at each end of the slots, then more holes close together along their length (Fig. 5). Chip out the webs with a chisel and finish

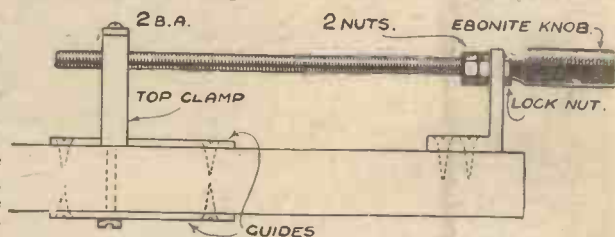

Fig. 6.—Assembly of the top clamp and adjustment.

to the scribed lines with a file. Now fix the top guide on the baseboard with two screws. Drill right through the baseboard at each end of the slot, and clear out the slot with a sharp chisel. This will give you the correct location for the brass guide underneath. The assembly of the top clamp and adjustment is shown in Fig. 6.

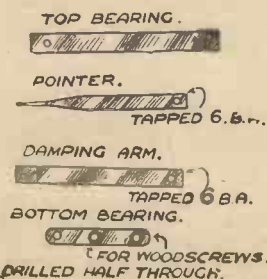

Fig. 2.—Details of the bearings and the pointer.

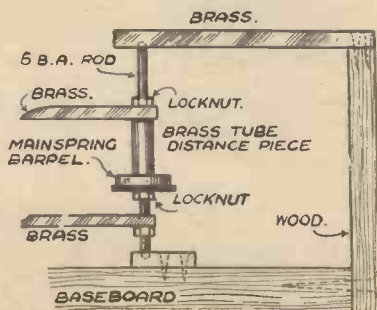

Fig. 3.—The assembly of the movement.

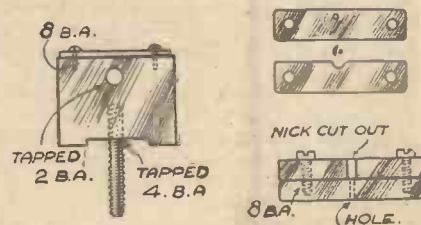

Fig. 4.—(Left) The top clamp. (Right) The bottom clamp.

The scale is drawn on paper and gummed to a wooden platform fixed between the drum and the pointer, close underneath the latter, with a piece cut away to clear the spindle. Lines at every ten degrees will be ample for all practical purposes. The instrument is intended to work in a vertical position, so you will need to fix a brass hanger at the top of the baseboard.

Now you are ready for the Cellophane. This is not an expensive item. A sheet 17 ins. by 15 ins. costs 2d., and provides enough material for more than two dozen hygrometers! Ask for standard Cellophane, thickness 600. Do not make the mistake of trying to use "moisture-proof" Cellophane—it is no use for our purpose. Hold the sheet up to the light, and you will see fairly well-defined lines running in one direction across it. Cut a strip $\frac{1}{2}$ in. wide off the edge at right angles to these lines; this direction of cutting takes off a strip with the greater expansion. Use a razor blade or a very sharp knife, cutting on a sheet of glass. Make your cut with one sweep of the blade so as to avoid nicks in the edge of the strip. Do not handle the strip more than you can help, as the material readily absorbs grease, which will

interfere with its expansion and contraction.

Set the top clamp midway in the guide slot, fix the ends of the Cellophane strip in the clamps, leave 1 in. projecting through the top clamp for subsequent adjustments, and cut off the remainder. There should be about 9 ins. of Cellophane between the clamps. Now hang up the instrument, and make sure that the silk is wound round the drum. Adjust the top clamp till the pointer is horizontal. You will find that slight vibration of the Cellophane makes the pointer wobble up and down. To counteract this tendency, hang a small blob of lead on the damping arm by means of a wire hook. Vibration and draughts will then not affect the pointer so seriously.

To test the hygrometer, hold it above a gas-burner. Keep it at least 2 ft. above the flame, since scorching of the Cellophane destroys its properties. You will find that the pointer rapidly rises as the Cellophane dries. Play the steam from a kettle on it, and it will fall again as rapidly. Having submitted the instrument to this test, and made any necessary adjustments, you can finish it off. Remove all the brass fittings from the baseboard, stain and polish the latter, and then re-assemble.

To Adjust the Hygrometer for Use

Dry over the gas as before until the pointer will go no higher, indicating that the Cellophane has fully contracted. Adjust the top clamp till the pointer coincides with one of the scale divisions near the top, and mark this "Very Dry." Incidentally, this is a condition which you are unlikely to meet with in this country! Now hang the hygrometer up out of doors in a sheltered place where rain and sun cannot reach it. The pointer will go down several divisions within a short time, and if it happens to be a wet day, you will be able to mark the "Rain" position at once. You can then fill in other zones, such as "Fair," "Stormy," etc., to suit your fancy.

The sensitivity of the hygrometer may be gauged from a simple experiment. Breathe heavily on the strip, and the pointer will at once fall two or three degrees, returning to its original position within a few seconds, as the surplus moisture dries off. If you live in a dusty locality, you will do well to protect the strip with a cover of perforated zinc. Bend this into a hoop-shaped cover, taking care that no part of it comes within an inch or so of the Cellophane, so as to allow a completely free circulation of air.

Hardening and Tempering

USEFUL HINTS FOR THE HANDYMAN

(Concluded from page 578 of last month's issue)

Quenching

HAVING heated the steel to the correct hardening temperature, or slightly in excess to allow for temperature drop during transfer to the bath, the part being dealt with is immersed in the cooling medium. The object should be in the majority of cases to secure cooling at an even rate and as rapidly as possible. The nature of the coolant is dictated by the class of steel used and may consist of water, water and oil, brine, oil, or air.

High-carbon steel hardens in water, and if the formation of the part made from this material is such as is likely to induce the formation of hardening cracks, a layer of oil is sometimes used on the surface of the water. Most of the tool steels now in use fulfil the same purpose, but are oil hardening, in which the risk of deformation and cracking is greatly minimised if not entirely eliminated.

Where the bath is being frequently used or the mass to be hardened is sufficient to cause an appreciable rise in the temperature of the coolant, some means of dissipating the heat generated is introduced. The means used generally consists of water cooling, either by circulating the coolant through pipes surrounded by water or circulating water through pipes situated in the cooling tank.

Case Hardening

For water hardening, clean water should be used at a temperature not lower than 60 degrees F. Soft water is preferable to hard, and it is often beneficial to introduce a proportion of washing soda to the water to create this effect. Hardening oil should have a high flash-point, be comparatively thin, and not readily become gummy. Special oils are made for this purpose.

Carbon steels having a low carbon content and which do not respond to direct heating and quenching may be surface hardened after treatment to introduce additional carbon. This process is known as case

hardening. The hard case so obtained is in the form of a skin, the depth of the case depending upon the duration of the process employed.

In thickness the case may vary according to circumstances from a mere skin of a few thousandths of an inch to anything up to $\frac{1}{2}$ in. This is entirely dependent on the service for which the part is required and if a proportion of the hard surface needs to be subsequently removed by grinding. For ordinary commercial purposes the depth of the case ranges from $\frac{1}{32}$ in. to $\frac{1}{16}$ in.

A Simple Method

The simplest method of case hardening is to heat the steel to a bright red and either apply "rapid" case-hardening compound by dusting on to the heated surface or rolling the part in the powder. After allowing sufficient time for the compound to melt on the surface of the work, it is reheated and the process repeated two or three times, finally heating and quenching in water. This has the effect of producing a thin, glass-hard skin and is suitable for many purposes, the main advantage lying in the fact that the operation is a quick one. If a deeper case is required the work is packed in steel or iron boxes surrounded by a carbonaceous material, such as charcoal specially prepared for carburising steel, the lid of the box being sealed with fireclay to exclude the entry of air. The box is then maintained in the muffle at a temperature of 900 degrees C. for a period of from four to ten hours, according to the depth of penetration required. If the work is then removed in the heated condition and quenched the parts are surface hardened. If a specimen so treated is broken the depth of penetration of the case shows in the form of a fine-grained ring of metal surrounding a more or less coarse-grained core. A refinement which normalises the core consists of allowing the box to cool down, without unpacking, and reheating to 830 degrees C. and quenching the parts and reheating to

750 degrees C. and quenching again. The treatment recommended by the makers of the steel used should be followed to secure the best results. Another method similar to the foregoing has gained prominence in recent years, the difference in the process is that gas is passed through the boxes for the same purpose that the solid material is used.

Cyanide Hardening

Small objects are to a great extent treated in a cyanide furnace. Here molten potassium or sodium cyanide is maintained at a certain temperature in a steel pot and the work soaked in it for the requisite period to give the desired depth of case, after which the parts are removed and quenched.

Tempering

Tempering is carried out where necessary in a bath of oil at the required temperature. Smaller parts which may need to be tempered by visual means are polished and reheated on a hotplate or in a bath of hot silver sand. Where sand is employed the temperature of the work may be more easily controlled and the tempering localised more readily than with a hotplate.

The Model Engineer Exhibition

THE 20th Annual Model Engineering Exhibition will be held at the Royal Horticultural Hall, Vincent Square, Westminster, from September 15th to the 24th, and will contain a record show of engineering and ship models of all kinds, lathes and light machine tools, and workshop equipment. The Exhibition will be opened by the Earl of Northesk, President of the Society of Model and Experimental Engineers. The Royal Air Force is arranging a special exhibit illustrating its aircraft apprentice training methods, in connection with the present Air Ministry recruiting Campaign. In addition to the usual championship cups and other prizes, Admiral Sir Reginald Bacon is this year offering a special cup for the best model made by a lady. The Exhibition is organised by Percival Marshall and Company Limited, 13-16 Fisher Street, London, W.C.1, from whom all information may be obtained.

SCALE MODEL LOCOMOTIVES and SCALE TRACK

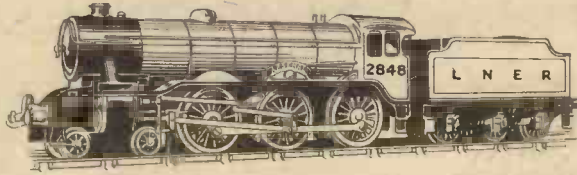

to run them on!

That is the ideal combination, but see to it that they are also by **BASSETT-LOWKE**, the firm who have been making Scale Models for thirty years, and are still as up to date as ever. You can rely upon them for good workmanship at reasonable prices. When up in London for the Exhibition call at our Holborn Branch, just opposite the Holborn Tube Station and only 10 minutes from the Horticultural Hall by taxi. All our latest productions on view.

Here is L.N.E.R. "ARSENAL," a capable 4-6-0 type locomotive, from the series taking its name from well-known football teams, each of the engines carrying the club's colours and a model of a football on the driving splasher. Model is hand made and hand finished. Price clockwork, electric a.c. 20 volts, or d.c. 8 volts., Gauge 0. £7.18.6.

Complete Model Railway Catalogue A.12, 6d. post free.
Twin Train Table Railway Catalogue TT.12, 2d.

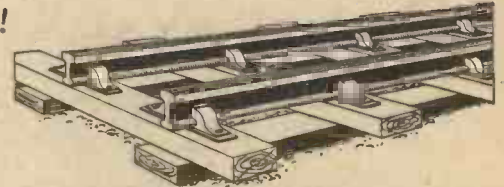

Bassett-Lowke Permanent Way—the finest yet produced. Despite heavy increases in the cost of raw materials the price and quality of our steel railway remains the same. 2.3d. per length. Points 10/6d. Also parts for building. B.12 Model Engine Catalogue. Section 1. Stationary Engines, Boilers & Fittings. Section 2. Materials, Castings & Drawings. 3d. each section post free.

BASSETT-LOWKE LTD., NORTHAMPTON

LONDON: 112, HIGH HOLBORN, W.C.1.

MANCHESTER: 28, CORPORATION STREET.

THE "LONDON B" 3-in. CENTRE LATHE

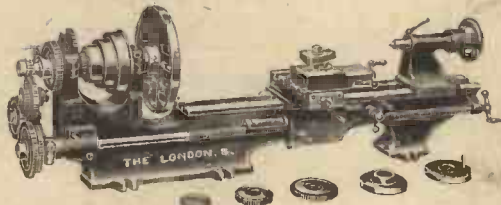

Back Gear
Screw-cutting

Distance between Centres 20-in. Fully compound Slide Rest set over Tailstock, Quick Traverse Action, Hollow Mandrel. Complete with Face Plate, Catch Plate.

Price £5-17-6 Carriage Paid.

Specification Free on Application. Have you had our Lathe Accessories List?

● This Model must not be confused with any other Model of similar design on the market.

DENNIS & SMITH, 83 Goswell Rd., London, E.C.1
Tel.: Clerkenwell 4457. Telegrams: Ferretor Barb, London

THE SPECIALISTS ANNOUNCE—

"BROWN" ENGINES

Sole Agents British Isles.

Type "M" (Marine) ...	£4/15/-	Type "C" ...	£4/18/6
" " "B" ...	£5/17/6	" " "D" ...	£3/17/6

All models complete with propeller and flywheel.

"CYCLONE" ENGINES

Model "F" £5/2/6 complete with propeller.

SUPER "1938" SPITFIRE

Britain's "Baby" Engine. Colossal power. Platinum points. Easy starting. All-on weight, 7½ ozs. at £4/17/6 complete with propeller.

AND ALL SUNDRIES. Send 3d. stamp for Price List.

MODEL AIRCRAFT STORES (B'NM'TH) Ltd.,
127b, HANKINSON ROAD, BOURNEMOUTH

Telephone: 1922 Winton

20th Year

THE "MODEL ENGINEER" EXHIBITION

ROYAL HORTICULTURAL HALL,
Vincent Square, Westminster, S.W.

SEPTEMBER 15th—24th

11 a.m. to 9.30 p.m. daily
Sunday excepted.

Admission 1s. 3d. (tax included)

A wonder show of Engineering Models of all kinds; Steam Locomotives at work on a 72-ft. passenger-carrying track; working model railways; Steam and Sailing Ship models. Speed-boats and Aeroplanes.

Hundreds of models in competition for the Championship Cups and other prizes.

A splendid trade display of lathes, small machine tools, workshop equipment, and model-making materials.

Exhibits by many of the leading Model Engineering and Railway Clubs.

EVERY READER OF "PRACTICAL MECHANICS" SHOULD VISIT THE MOST FASCINATING SHOW OF THE YEAR.

CLIX

FLEXIPIN Self-Adjusting PLUGS

THE "PRICELESS" PLUG

Wherever there is a mains radio or domestic electric apparatus Clix 5-amp. plugs fill an essential service. They give perfect contact in any make of BSS Socket, and the pins are non-collapsible. They only cost a few pence, but the service they give is "priceless."

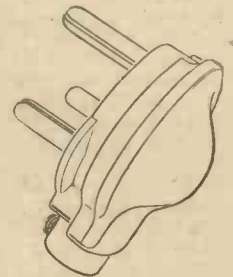

Obtainable from all Radio and Electrical Dealers.

LOUDSPEAKER CONTROL PANEL

This Clix control carries out an important duty, since it obviates the sudden cessation of load on the output valve. In the case of a Pentode it can be very disastrous since the voltage on the auxiliary grid will build up and seriously impair the emission of the valve. This must happen when an internal speaker is disconnected before connecting the Extension Speaker. Excellent also for using Headphones on DX listening or while testing for faults.

FREE BOOKLET "P.M." gives you details and 6 circuits for different uses which can be made of this control panel.



1/-

Complete as illustrated.

Details of all Clix products are given in folders P.1 and 2.

BRITISH MECHANICAL PRODUCTIONS LTD.
79a, Rochester Row, London, S.W.1.

CLIX

Railway Centenaries of 1938

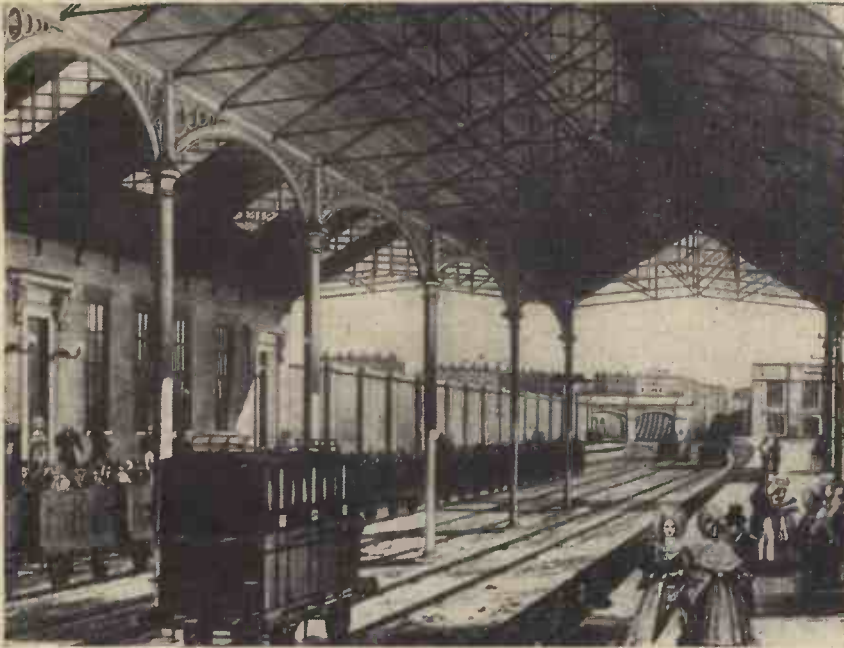

The Euston terminal of the old London-Birmingham railway which celebrates its centenary in September of this year.

1838 saw the Opening of Several Important Lines

railway construction in many parts of England was in a really advanced condition.

The year 1838 saw the opening of several important lines. Indeed, apart from the year 1830, when the Liverpool-Manchester railway was first rendered available for traffic, 1838 constitutes an outstanding twelve months in the annals of railway engineering.

South Western Railway

It was, for instance, on May 21st, 1838, that the old London and Southampton Railway (afterwards the South Western Railway) opened its lines for public traffic as far as Woking, some 23 miles from London. Previously, on the 12th of the same month, the Directors of the railway and several Members of Parliament had made a ceremonial trip over the line and had expressed great satisfaction with the progress of its construction.

On September 29th of the same year, this line, which began in Battersea, a short

It is often not easy for us to realise the fact that the railway, as an everyday means of safe and convenient travel, is only barely one hundred years old.

True it is that a railway between Stockton and Darlington was opened for traffic in 1825 and the famous Liverpool-Manchester railway, the prototype, perhaps, of all modern railways, was publicly and ceremoniously opened in 1830.

Yet in those early days, a railway journey, for the majority of individuals up and down the country, was a rare and novel experience, much as, for instance, an aeroplane flight is for many of us at the present day.

Added to this is, also, the fact that the British railways, during the early days of their inception and construction, were popularly regarded with suspicion, dislike and even terror. Powerful landlords over whose estates it was proposed to take the early railroads rose up in great ire against the projects and, even when, in spite of their oppositions, the railroad tracks had been surveyed, cut and laid down, these local worthies still continued their maledictions upon the "mechanical monsters" which were threatening, so they said, the very stability of the country.

One by one, however, local landowners began to realise that the existence of a railway adjacent to their estates usually brought extra conveniences to their lands, the net result being that rentals in the vicinity rose in value. Thus it was that as the number of railways in England increased, the bitter opposition to them which had shown itself in so many corners, gradually ceased.

100 Years Ago

One hundred years ago, this country was passing through a period of revolution, so far as railway activities were concerned. Opposition to the many railways which were then under construction was still, in many places, very intense, but, on the other hand,

the public was beginning to realise the enormous convenience of railroad travel and to foresee the great extension of trade and commerce which the railway system had in its power to bring about.

The Liverpool-Manchester line, so ably laid down by the Stephensons over the notorious Chat Moss, in Lancashire, had proved an enormous success. Parliament, since that time, had been besieged with applications for Acts permitting the construction of railways in other parts of the country. The majority of these Acts, notwithstanding the strongest opposition, it had passed and thus, one hundred years ago,



The first railway station in the world. Here, as it stands to-day, is the original platform at Manchester of the old Manchester-Liverpool railway. The second window from the left shows the first railway booking office.

distance from the old Vauxhall Bridge in London and which passed through Wandsworth, Wimbledon, Kingston-on-Thames, Weybridge, Chertsey and Woking, extended its traffic through Farnborough to Sharpley Heath, near Basingstoke, another event which was at that time hailed with considerable ceremony.

In the May of 1838, too, another important railway line was opened. This was the Manchester to Bolton line which, in reality, constituted the first section of an extensive network of lines which afterwards became the old Lancashire and Yorkshire Railway, now absorbed into the L.M.S. railway. Owing to the industrial nature of the two towns which the line connected, little opposition was made to its construction. Indeed, the coming of the Manchester-Bolton railway was, by most people in the two districts, looked forward to and hailed as a great triumph of engineering skill and invention.

London-Birmingham Line

Most important of all, perhaps, of the railway centenaries which occur this year is that of the completion and opening of the London-Birmingham line which took place on September 17th, 1838.

The construction of this railway was begun in 1834. Throughout the whole of its making, the bitterest of opposition was shown to the projectors of the line and, indeed, in many practical ways, to the actual constructors of the track. But the work succeeded in the end and the London-Birmingham line came into being.

Originally, the line started from Camden Town, in the North of London, but it was quickly rendered apparent that a terminal in Euston Square would be far more convenient. Parliament, therefore, was petitioned to allow an extension of the line from Camden Town to Euston Square. At the same time, however, it refused to allow the locomotives to create any smoke or other disturbance which might annoy the residents of the Euston district of London.

Smoke and Noise Annoyance

To get over this difficulty, the railway company constructed their track on an inclined plane from Euston to Camden Town, down which the carriages (without locomotive) proceeded by the effect of gravity alone. The up-trains from Camden Town, had their locomotives uncoupled at that station and were then hauled up the

incline to Euston station by means of a long rope and windlass arrangement, the latter being worked by a stationary engine.

From Camden Town, the London-Birmingham railway passed through Harrow, Watford, Tring, Blisworth, Rugby, Coventry and Hampton. The line was opened in stages, its final opening throughout taking place, as already mentioned, on September 17th, 1838.

many of the great western expresses take their daily departure

Two Centenaries to Come

Two more interesting railway-opening centenaries crop up this year, both of these occurring in October, in which month of the year 1838, the Sheffield-Rotherham and the Wigan-Preston (Lancs.) Railways were completed. The latter was a branch or



1838— The "Lion"—one of the original trains of a century ago.

June 4th carried, this year, an interesting centenary of a railway opening, for it was on that date in 1838 that the Great Western Railway first opened its line as far as Maidenhead. Ultimately, of course, the line, which was engineered by the celebrated engineer, Brunel, was extended to Bristol.

It was originally intended that this line should start at Euston and branch away from the London-Birmingham line at or near Kensal Green, some four miles or so from Euston station. Agreement between the Great Western directors and those of the London-Birmingham Railway could not be reached and thus, in consequence, the Great Western side wisely decided to have a separate London terminal of its own. It established this terminal at Paddington and from that station even to the present day

section of the old North Union Railway and by means of this highly important and industrialised line continuous communication was established between London (Euston) and Preston, a distance of 216½ miles. The line at that time ran through Birmingham, for it was not until nearly ten years later that the direct line through Rugby and Stafford was opened.

Like the Wigan-Preston section of the North Union Railway, the Sheffield-Rotherham line was an important and a highly industrialised one. It succeeded immediately and, in the course of time, gave rise to many subsidiary lines.

No doubt many of these 1938 centenaries will be allowed to pass unrecognised. Yet, to the student of constructional engineering, and of railway matters in particular, they are well worthy of careful note.

1938—



A view of the striking L.M.S. streamlined train "The Coronation Scot," now in operation between Euston and Glasgow.

A Model Water-Tube Boiler

Constructional Details of a Simple Model "Babcock and Wilcox" Type Boiler are Given in This Article

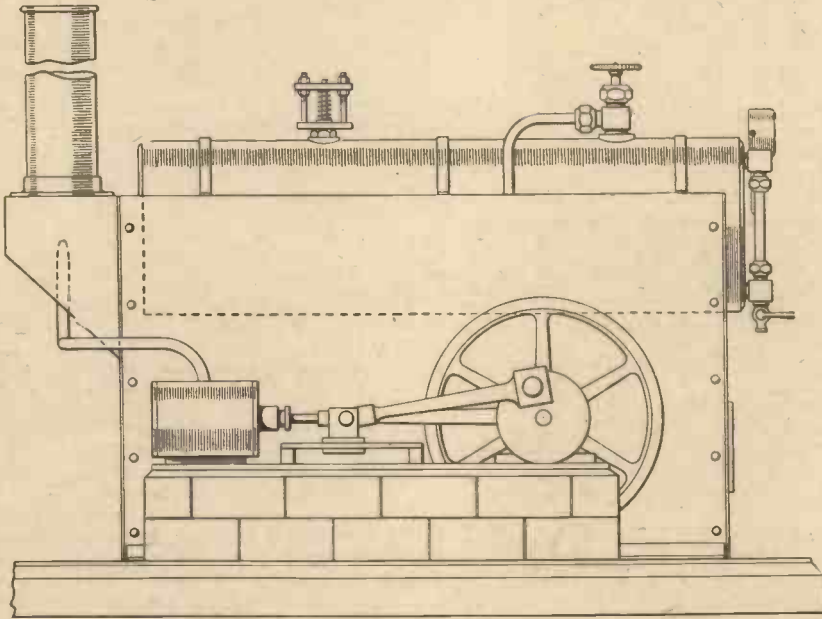

Fig. 1.—Side elevation of the finished water-tube boiler, connected up to the simple slide-valve steam engine previously described in "Practical Mechanics."

ALTHOUGH primarily intended for use in conjunction with the horizontal slide-valve engine previously described in "Practical Mechanics" (June, 1936 issue), the model boiler dealt with in the present article is equally suitable for supplying steam for any other type of model stationary steam engine of a similar size.

It will be seen, by reference to Figs. 1 and 2, that the boiler barrel is supported by an outer casing which also houses the spirit burner. This is provided with a gravity-fed device to prevent flooding of the wick tubes, and to economise in spirit consumption.

The boiler fittings comprise a spring-loaded safety valve, steam valve, water gauge and steam pressure gauge, all of which can be purchased from advertisers in this journal. As the boiler is only intended for low-pressure steam (20 to 25 lbs. per square inch) all the joints can be soft soldered.

The Boiler Barrel

The best material to use for the boiler barrel is solid drawn copper tubing, and a piece 2½ in. outside diameter and 9½ in. long, will be required. The tubing should be 3/64 in. thick, or No. 19 S.W.G.

After carefully squaring the ends of the tubing with a file, scribe a centre line (Fig. 5), and mark the positions of the two holes for the safety-valve bush and steam-valve bush respectively. After drilling these holes a good fit for the bushes, the latter can be soldered in place.

Mark a centre line along the bottom of

the boiler barrel, diametrically opposite the one along the top surface, and carefully set out the positions of the eight holes for

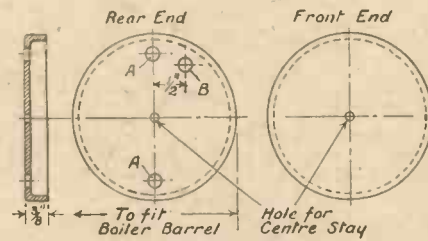

Figs. 3 and 4.—Details of boiler ends.

the water tubes, to the dimensions given in Fig. 3. Drill the holes 7/32 in. diameter, and with fine emery cloth, well clean the boiler barrel round the holes. For the

tubes four 9½ in. lengths of 7/32 in. outside diameter thin copper tubing will be required, the ends of each tube being bent, as shown in Fig. 2, after being annealed. Clean the ends of the tubes, press them into the holes till they project about ¼ in. on the inside of the barrel, at the steam-valve end, and ½ in. at the other end, and then well solder all the joints.

Boiler Ends

Brass stampings can be used for the two boiler ends, and these must be turned, or filed, a good push fit in the ends of the boiler barrel. The outer faces of the boiler ends should also be filed flat and then rubbed down with fine emery cloth.

Mark out the positions of the holes, as in Fig. 3, in each end, and drill and tap these, to suit the boiler fittings. The holes A-A are for the water gauge, and hole B is to take the bush for the pressure gauge connection. The rod in each end for the centre stay-rod should be drilled a clearing size for the screwed ends of the latter.

With a piece of fine emery cloth, clean the inside of the boiler barrel at the ends, press the rear boiler end in place, and adjust it so that the holes are in the correct position in relation to the top and bottom of the boiler. The end should be pressed in

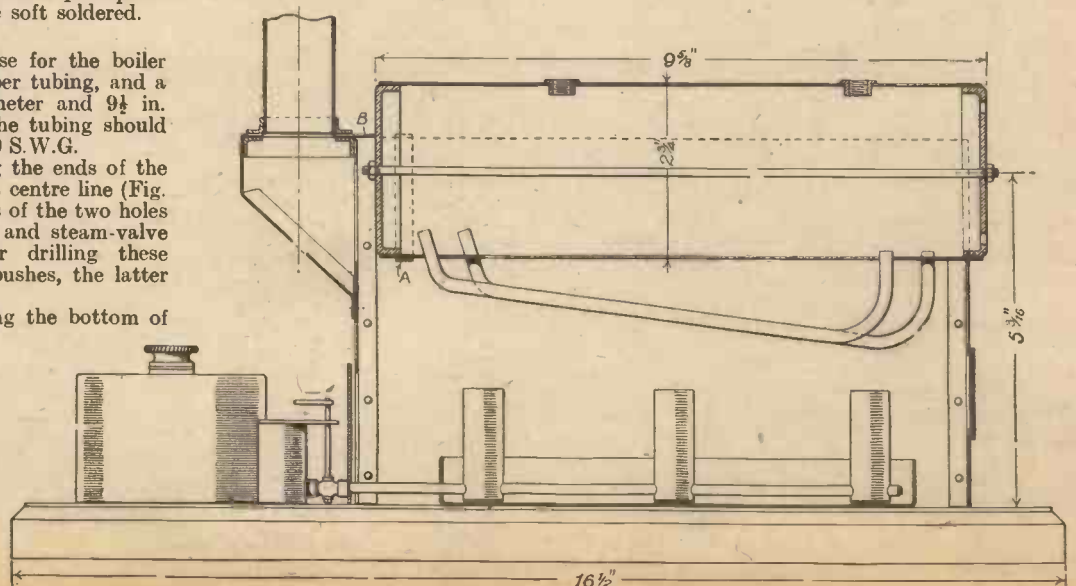

Fig. 2.—Sectional elevation of the boiler, showing spirit burner in position.

till $\frac{1}{8}$ in. of the rear face projects, so as to form a narrow flange for assisting the solder to flow round. After well sweating the solder in the joint, treat the other boiler end in exactly the same way.

For the boiler stay-rod, cut a piece of $\frac{1}{4}$ in. hard brass wire, 10 in. long, and cut a thread on each end for a distance of $\frac{1}{4}$ in. to take the clamping nuts. Pass the rod through the holes in the boiler ends, and screw on the nuts, after which well solder them in place to make steam-tight joints.

Boiler Casing

Tinplate or Russian iron can be used for the boiler casing which supports the boiler, and also forms the firebox. Mark out each side of the casing to the dimensions given in Fig. 6, and after cutting out with tin-snips, or hammer and cold chisel, finish the edges down to the scribed lines with a file. Drill $\frac{1}{8}$ in. rivet-holes along each edge, as indicated, and bend the top edge over at right angles.

The front and rear ends of the boiler casing can be marked out, as shown in Fig. 7, and after cutting out the rectangular holes, and the circular one for the boiler barrel, with the aid of a hammer and small cold chisel, finish the edges with a file. Carefully bend the long edges of each part

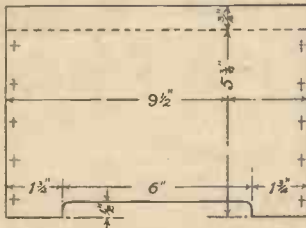
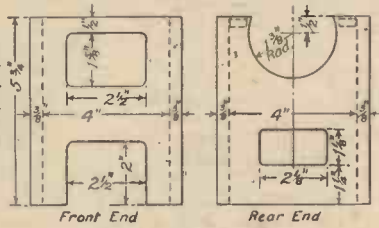

Fig. 6 (left) and Fig. 7.—Details of the side plate and ends for the boiler casing.



to form right-angled flanges, as indicated and then place them in position between the side plates, and lightly solder the joints in two or three places to prevent the end plates shifting whilst the rivet holes are drilled through. The rear end plate can now be riveted in place with $\frac{1}{8}$ in. copper rivets, but before riveting up the front end-plate it would be as well to rivet the chimney support in place.

soldered into a flanged brass ring which is mounted on the chimney plate B (Figs. 2 and 10). This plate is $3\frac{1}{2}$ in. long, and $2\frac{1}{2}$ in. wide, and has a $1\frac{1}{2}$ in. diameter hole bored through it, over which the chimney is mounted. Pieces of $\frac{1}{4}$ in. brass angle are soldered round the inside of the chimney support, flush with the top edge, and to the flange so formed the chimney plate, B, is screwed.

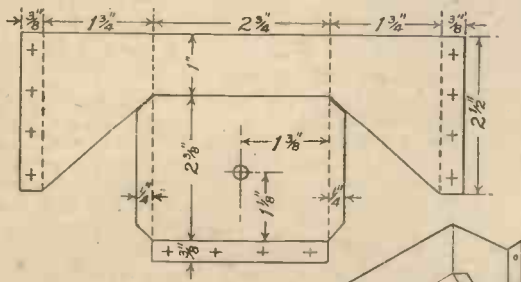

Fig. 8 (above).—How to mark out the plate for forming the chimney support. Fig. 9 (right).—The chimney support bent to shape.

Chimney Support

A piece of tinplate, or Russian iron, 7 ins. long and $3\frac{1}{2}$ in. wide will be required for the chimney support. Mark out the shape to the dimensions given in Fig. 8, and after drilling $\frac{1}{8}$ in. holes for the rivets, and the hole for the exhaust pipe, bend the plate at the dotted lines to the shape shown in Fig. 9. Solder the two diagonal flanges on the inside of the support, and lightly tap the three riveting flanges down on a flat surface to make the faces flush. Place the chimney support in place on the front

brass tubing, cut it to a length of $8\frac{1}{2}$ in., and at the points indicated, make deep nicks on each side of the tube, with a small round file. The holes so made must be arranged sideways of the supply pipe when the latter is in position in the wick tubes. Slip the tubes on to the pipe, adjust them so that the nicks come about the middle of them, and then solder the tubes to the pipe. Plug the end of the pipe with a short piece of brass wire, C, and solder it in place.

The drip tray, D, can be made from a

end plate of the casing (see Fig. 10), lightly solder it in one or two places, and drill the rivet holes through. Rivet up with $\frac{1}{8}$ in. copper rivets, and remove any superfluous solder.

The boiler is placed in position, rear end first, by passing it up inside the casing. The front end is supported by a brass strap, A (Fig. 2), which is bent round the boiler barrel, the ends of the strap being bent over and fixed to the top of the casing with small bolts. The three straps which go over the boiler barrel (see Fig. 1) are also bolted, or screwed, to the top flange of the casing.

For the chimney, cut a piece of $1\frac{1}{4}$ in. diameter brass tubing, 5 in. long, file the ends square, and solder a strip of half-round brass round the top edge to form a beading. The lower end of the chimney is

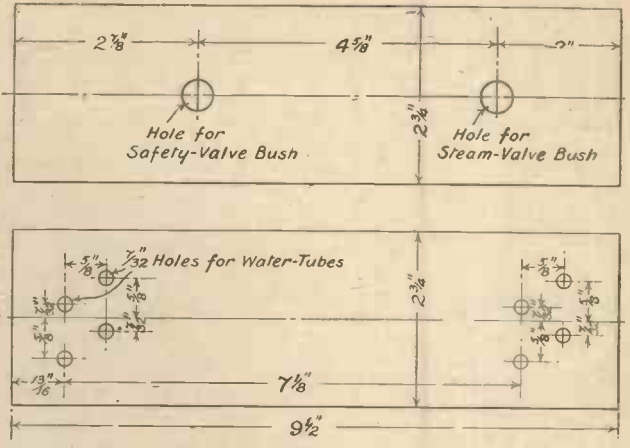

Fig. 5.— Top and underside views of the boiler barrel.

single piece of tinplate, cut to the sizes required, with the edges turned up to form a tray $\frac{1}{2}$ in. deep. Solder the joints, and make a hole in one end for the supply pipe, the end of which is threaded to receive the tap, E, which shuts off the supply of spirit to the burner, when necessary. The plate F is $2\frac{1}{2}$ in. long and $2\frac{1}{2}$ in. wide, and has a hole drilled $\frac{1}{4}$ in. from the bottom edge to take the end of the supply pipe. The brackets G, which can be bent to shape from $\frac{1}{4}$ in. strip metal, are soldered in place.

The main spirit reservoir can be made from any round tin, cut down to the required height. The top consists of a circular piece of tinplate in the centre of which a hole for the filler bush is drilled. Soldered to one side of the reservoir is a small auxiliary chamber, H, open at the top, a small hole being made in the reservoir, near the bottom, to allow the spirit to flow. A piece of $\frac{5}{8}$ in. diameter brass or copper tubing, bent as shown, and with the end filed at an angle of 45 degrees, is pushed through a hole made in the side of the reservoir, and soldered in place. A space of at least $\frac{1}{8}$ in. should be left between the top of the tube and the underside of the reservoir top, while the top of the hole at the lower end of the tube is $\frac{1}{8}$ in. from the bottom of the chamber, H. Reference to Fig. 11 will make these points clear.

A shaped plate, K, drilled as indicated, is soldered across the top of the chamber H, after the end of the supply tap has been screwed and soldered in place. The larger

(Continued overleaf)

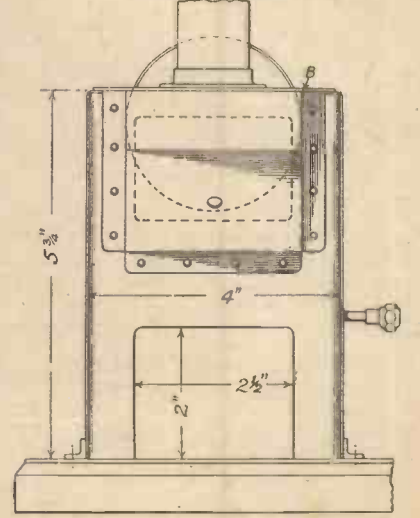

Fig. 10.—Front view of boiler showing chimney support.

A MODEL WATER-TUBE BOILER

(Continued from previous page)

hole is for admitting air, and the other hole is to take the spindle which operates the tap E. This form of tap is supplied with a short bent handle which must be cut off flush with the top of the plug. One end of the spindle, which can be cut from a steel knitting needle, is soldered to the centre of the plug. A short brass handle can be soldered to the top of the spindle.

After soldering the filler bush in place, the reservoir top can be soldered on. As the filler plug must be an air-tight fit, it

indicated in Figs. 1 and 12. The angle-pieces, which are $1\frac{1}{2}$ in. long, are screwed to the casing on each side of the ventilation openings.

"Fire-Hole" Door

It will be noticed that in the rear end of the boiler casing there is a rectangular opening, or "fire-hole," through which a taper can be inserted when lighting the wicks of the spirit burner. The cover for the "fire-hole" can be made with a piece of stout tinplate measuring $2\frac{3}{8}$ in. by $1\frac{1}{2}$ in., and two small lugs can be riveted on to engage with the inside of the fire-hole to hold the cover in place. A metal handle

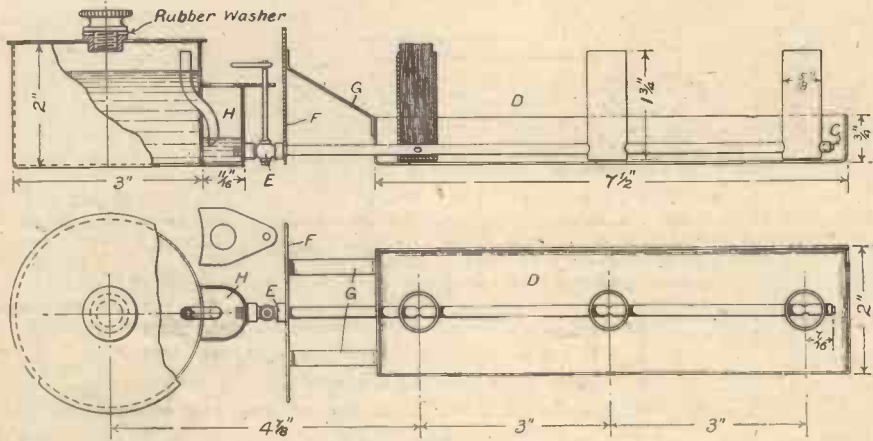

Fig. 11.—Part sectional elevation and plan of the spirit burner with automatic gravity feed.

should be provided with a thin rubber washer, as shown in Fig. 11. Fine asbestos string can be used for the burner wicks, and the tubes should be packed, not too tightly, allowing at least $\frac{1}{8}$ in. of the wicks to project beyond the tops of the wick tubes.

When using the spirit burner, fill the reservoir to within $\frac{1}{4}$ in. of the top, as shown in Fig. 11, and screw the filler plug down tightly. The automatic action of the burner is as follows: After lighting the wicks, the level of the spirit in the chamber H gradually falls until the hole in the bottom of the bent tube becomes partly uncovered, thus allowing a small quantity of air to pass into the main reservoir above the spirit. This immediately displaces some of the spirit which passes through the hole near the bottom of the reservoir, and into the chamber H, until the opening at the lower end of the bent tube becomes sealed again. This action continues automatically while the burner wicks are alight, thus making the burner a self-regulating one.

Baseplate and Plinth

A piece of polished steel plate should be used for the baseplate on which the boiler and engine are mounted. The baseplate is 16 in. long, the width varying according to the type of model engine that is to be connected up to the boiler. For the plinth, on which the baseplate is mounted, a piece of straight-grained wood should be selected of sufficient length and width to allow of a $\frac{1}{4}$ in. chamfer all round the top edge, as in Figs. 2 and 12. Use countersunk iron screws for fixing the baseplate to the plinth, and carefully countersink the holes in the baseplate so that the screw heads come flush with the top surface of the plate.

Short pieces of angle-brass or aluminium are used to form flanges for fixing the sides of the boiler casing to the baseplate, as

can be screwed into the centre of the door.

Finally, a piece of $\frac{3}{8}$ in. diameter copper tubing will be needed for the steam pipe.

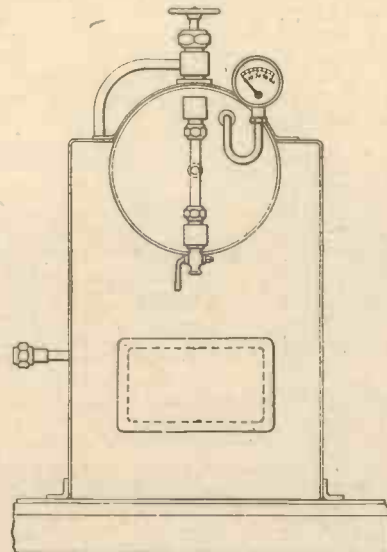

Fig. 12.—Rear view of boiler, showing boiler fittings.

which is bent at one end to connect to the union on the steam valve. The pipe then passes through a slot in the top of the boiler casing, down by the side of the water tubes, and then out through a hole in the side of the casing. The end of the pipe is provided with a union for connecting up to the cylinder of the model engine. The exhaust pipe from the engine cylinder is bent as shown in Fig. 1, the end being passed through the hole in the bottom of the chimney support, so that the exhaust is directed centrally up the chimney.

STARGAZING for AMATEURS

(Continued from page 653)

mistakable. Close to the south-west horizon lies the winding constellation Serpens (the Serpent), the head of which is well to the westward immediately below Corona Borealis (the Northern Crown). From thence the sinuous body of this celestial reptile coils round Ophiuchus and extends some distance beyond it. There are several double stars near the head of Serpens, among them δ (Delta) and θ (Theta).

Just beyond the end of the serpent's tail is Aquila (the Eagle), wings outspread according to the old maps. Its principal component Altair (α) is conspicuously situated between two much less bright stars γ (Gamma) and β (Beta) Aquilae, the three being collectively styled the Family of the Eagle. Altair is at a distance of only 16 "light years" and is the nearest of the brilliant stars visible from Britain during these summer evenings. Its diameter and temperature are half as much again as those of our Sun and it sheds nine times more radiance. The name is derived from the Arabic Al Tair, signifying the "Flying Vulture," a bird that was supposed to have been sent by the mythological god Jupiter to seize the boy Ganymede whom he desired as a cup bearer. Beta and Gamma Aquilae are a great deal farther away than Altair; Gamma, moreover, is considerably larger. η (Eta) Aquilae is an unusually short-period variable of the pulsating type, which causes it to double itself in size from $3\frac{1}{2}$ to $4\frac{1}{2}$ magnitudes and back again, in slightly over seven days. Aquila is actually a widely scattered cluster, set against a glittering star-strewn background on the verge of a particularly rich section of The Milky Way. In the contiguous minor group Scutum (the Shield), between Aquila and Serpens, will be found half a dozen faint star clusters, stellar clouds and nebulae indicated on the atlases as M.11, M.16, M.17, M.18, M.24 and M.26. They are quite worth investigating under favourable atmospheric conditions with adequate optical assistance.

Notes

The 1937-38 "apparition" of Mars afforded another opportunity at the Mt. Wilson Observatory, California, of searching for evidence of water vapour among the lines in the planet's spectrum. Disappointingly enough, none of the spectograms secured while Mars was approaching the Earth showed any signs of the presence of aqueous moisture. Fortunately, the forthcoming oppositions in 1939-40 and 1941-42 will be even more favourable for such investigations, as Mars will then come closer than for many years. It is consequently hoped that these two unusually near approaches will not only finally settle that vexed question, but also throw definite light on the mystery of the alternately expanding and contracting white polar caps. These shining spots are generally assumed to be composed of snow and ice; but photographs taken with infra-violet screens suggest that they may be located in the Martian atmosphere and not on the "ground." If there is really no water on Mars, our romantic terrestrial analogies of vegetation-covered swamps, seasonally irrigated by the ebb and flow of freezing and melting liquid, must be materially modified.

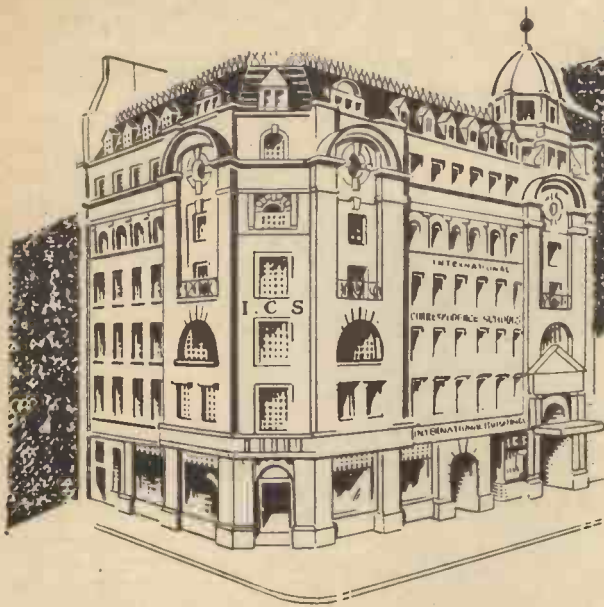

Your Work - AND Your Pay

This is

**INTERNATIONAL BUILDINGS
KINGSWAY, LONDON**

Head Offices of the

**INTERNATIONAL
CORRESPONDENCE SCHOOLS**

It is the centre from which radiates technical, commercial, and professional instruction that has been of great benefit to tens of thousands of ambitious people.

The I.C.S. is the greatest as well as the largest institution in the Empire devoted to spare-time training. Its prestige is unequalled. Several State Departments have entered into working arrangements with the I.C.S. for the training of men.

More than 1,500 I.C.S. text-books, prepared at International Buildings, are marvels of clearness, accuracy, and practical helpfulness.

There are 80 Instructors at Kingsway, many of them Associates, Members, or Fellows of their respective technical or professional bodies. All are specialists, and expert in giving the student individual attention throughout his Course of Study.

Among the 400 I.C.S. Courses there is one that can qualify YOU for Promotion and better Pay.

The size of your salary is more or less in accordance with the measure of what you know and therefore can do. The more you know, the greater your pay.

Success—progress won by merit—depends on trained ability. Unless you have studied IN YOUR SPARE TIME, you have little chance of promotion, for knowledge that comes through everyday work is not enough.

You must know the principles underlying your work and be familiar with the many processes closely related to that work. *The one and only means of obtaining such knowledge is specialized study*

No man need be without that extra efficiency which adds so much to his income, security, and happiness. He can acquire it on easy terms, by the simple I.C.S. method of teaching by post.

If you are in the early stages of your career and have not yet had a specialized training, you should start to get one without delay. Or perhaps you feel that your knowledge is a little out of date and ought to be modernized. In either case

The International Correspondence Schools can help you.

Our expert advice on any matter concerning your work and your career is yours for the asking—free and without obligation. Let us send you a booklet dealing with the subject in which you are especially interested. It is packed with valuable information.

The I.C.S. offer instruction in the subjects given below.

Write for Special Booklet to-day or use the Coupon.

COUPON FOR FREE BOOKLET

INTERNATIONAL CORRESPONDENCE SCHOOLS, LTD.; (Dept. 95), International Buildings, Kingsway, London, W.C.2

Please send me your booklet containing full particulars of the Course of Correspondence Training before which I have marked X. I assume no obligation.

- | | | | |
|---|--|--|---|
| <input type="checkbox"/> Accountancy | <input type="checkbox"/> Diesel Engineering | <input type="checkbox"/> Marine Engineering | <input type="checkbox"/> Scientific Management |
| <input type="checkbox"/> Advertising | <input type="checkbox"/> Draughtsmanship | <input type="checkbox"/> Mechanical Drawing | <input type="checkbox"/> Short-Story Writing |
| <input type="checkbox"/> Aeronautical Engineering | <input type="checkbox"/> Electrical Engineering | <input type="checkbox"/> Mechanical Engineering | <input type="checkbox"/> Steam Engineering |
| <input type="checkbox"/> Air Conditioning | <input type="checkbox"/> Engineering Shop Practice | <input type="checkbox"/> Mining Engineering | <input type="checkbox"/> Surveying |
| <input type="checkbox"/> Architecture | <input type="checkbox"/> Fire Engineering | <input type="checkbox"/> Motor Engineering | <input type="checkbox"/> Telephone and Telegraph Eng. |
| <input type="checkbox"/> Boiler Engineering | <input type="checkbox"/> Garage Management | <input type="checkbox"/> Pattern-making | <input type="checkbox"/> Textiles |
| <input type="checkbox"/> Book-keeping | <input type="checkbox"/> Gas-Power Engineering | <input type="checkbox"/> Plumbing | <input type="checkbox"/> Welding, Gas and Electric |
| <input type="checkbox"/> Building | <input type="checkbox"/> Heating and Ventilation | <input type="checkbox"/> Radio Equipment and Servicing | <input type="checkbox"/> Wireless Engineering |
| <input type="checkbox"/> Chemical Engineering | <input type="checkbox"/> Hydro-Electric | <input type="checkbox"/> Salesmanship | <input type="checkbox"/> Woodworking |
| <input type="checkbox"/> Civil Engineering | <input type="checkbox"/> Journalism | <input type="checkbox"/> Sanitary Engineering | <input type="checkbox"/> Works Management |

EXAMINATIONS

Technical, Professional, Matriculation, and Civil Service. State the one you wish to pass.....

NOTE.—If your subject is not on the above list, write it here.....

NAME..... AGE.....

ADDRESS



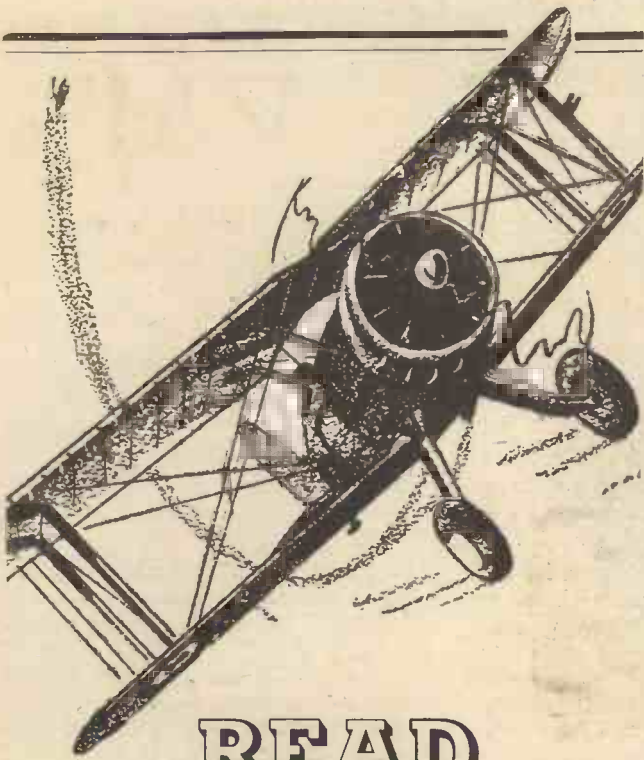

READ ALL ABOUT THE CIVIL AIR GUARD

Thousands of people all over the country are becoming interested in the newly-formed Civil Air Guard. If you want to know what the Civil Air Guards do, how you may join, and the branch which operates nearest your home, get **FLYING!** It contains all the latest official information on the movement.

FLYING

*The New Popular
Air Weekly*

Of all Newsagents and Bookstalls every Friday or by post 4d. from the Publisher, George Newnes, Ltd., Tower House, Southampton Street, Strand, London, W.C.2.

3^d ON SALE
FRIDAY
AUGUST 26th

George Newnes, Ltd.



CHEAP BOOKS FOR THE HANDYMAN

THE HOME MECHANIC SERIES

This series of practical handbooks is designed specifically to help the amateur mechanic or craftsman. Each volume is simply written by an expert and profusely illustrated with photographs and diagrams.

From all booksellers

1/6 EACH

ACCUMULATORS
MOTOR CAR UPKEEP AND OVERHAUL
THE HOME WOODWORKER
MODEL AEROPLANES AND AIRSHIPS
25 SIMPLE WORKING MODELS
THE HANDYMAN'S ENQUIRE WITHIN
SIMPLE ELECTRICAL APPARATUS AND EXPERIMENTS
MODEL BOAT BUILDING
TOY MAKING FOR AMATEURS
LATHE WORK FOR AMATEURS
HOUSE DECORATION AND PAINTING
POWER-DRIVEN MODEL AIRCRAFT
THE HOME ELECTRICIAN

Also available by post 1/2 each from the publishers

GEORGE NEWNES LTD.
(BOOK DEPT.)

**TOWER HOUSE, SOUTHAMPTON STREET,
LONDON, W.C.2.**

“PRACTICAL MECHANICS” WIRELESS SUPPLEMENT

The P.M. Converter

An Efficient Two-Valve Unit Suitable for the Beginner or Advanced Constructor

By “Experimenter”

Fig. 1.—The completed Converter ready for use.

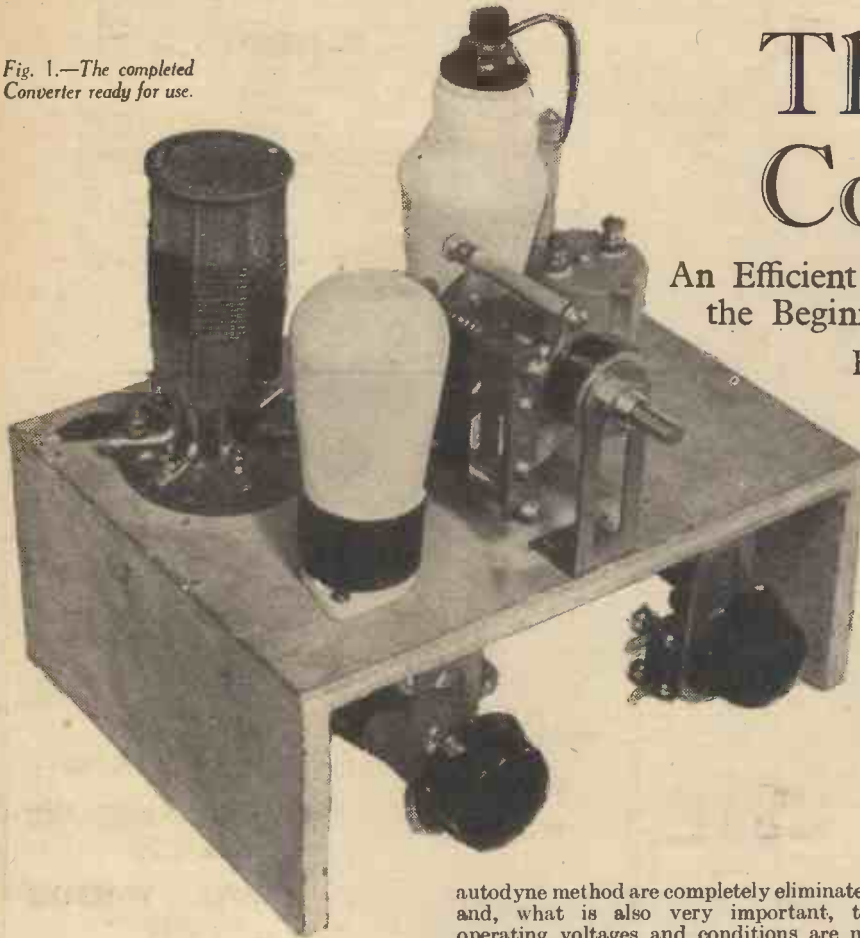

AN inexpensive alternative to a first-class all-wave or a complete short-wave receiver is a good S.W. converter, which allows any receiver embodying pre-detector amplification to receive the worth while programmes now being transmitted on the various short-wave bands.

It is not for me to enlarge on what the short-waves have to offer you; that is done elsewhere in these pages, but I would like to say that if you have already tried a converter or adaptor, and have given up the matter through dissatisfaction, provided that your local conditions are average, have another try with the unit described below, and I am sure you will alter your views.

To use two valves may seem to many as both unnecessary and extravagant, especially in view of the heptodes and triode-hexodes available, but the trouble is that these valves are not lying spare in everybody's den, whereas those employed in the circuit are quite likely within the reach of all who might be interested in the circuit.

The Circuit

It will be seen from Fig. 1 that an ordinary triode and screened-grid or “straight” H.F. Pentode are required. The first acts as a local oscillator in a similar manner to the oscillator section of a normal superhet receiver, while the second is used as a S.G. detector, the complete arrangement combining to form a very efficient superhet unit, the wave-range of which is governed by the coil employed.

By using a separate oscillator valve it will be found that the efficiency holds good right down to the ultra-shorts, and that the objectional features of the single triode

autodyne method are completely eliminated, and, what is also very important, the operating voltages and conditions are not super-critical.

To avoid that being taken too literally, I would add that reasonable care *must* be taken in the selection and layout of the components. For example, a poor detector valve will ruin the whole thing; a triode which will not oscillate consistently, and smoothly, can cause poor results while inefficient H.F. chokes or variable condensers having high H.F. losses can all contribute to unsatisfactory performance. Therefore, watch those points and, where possible, adhere to the original specification.

The variable condenser C.1 is wired in series with the aerial to allow the selectivity to be varied, and to control the damping which might be imposed on the grid circuit

by certain aerial arrangements. If an aerial of excessive length, or one having a high capacity to earth is employed, it is possible that the first valve will be damped to such an extent as to prevent it acting as an oscillator. However, C.1 will take care of any normal arrangements, but do see that your aerial is, at least, of average efficiency.

The three windings shown, namely, the aerial coupling, the grid and reaction coils are all wound on one former, the necessary connections being made to the terminals

of a six-pin valve holder into which the specified coil—Eddystone—fits.

For the 40 to 94 metres a type 6.R. coil is required, this being identified by a Red spot on the top flange, while for the 22 to 47 and 12 to 26 metres, a Yellow spot and a Light Blue spot coil are required respectively. An additional feature of the design is that the specified coils can also be obtained to cover higher wave-bands, for example, the type 6.B.R. covers all the usual trawler transmissions.

The grid circuit is tuned by the variable condenser C.2 and it is this control which acts as the station selector, no tuning adjustments being made on the broadcast receiver which has to be used in conjunction with the converter.

The only other control is that provided by C.3 which allows the degree of reaction or regeneration to be varied until the triode is oscillating smoothly. If all operating conditions are satisfactory, it will often be found that it is not necessary to alter C.3 once it has been set for any particular coil, so that operation is reduced to one knob control, i.e., C.2.

Construction

To assist in the assembly, and to keep various leads reasonably short, the complete unit is built on a very compact chassis which has a metallised surface to provide the required degree of screening and a common earth point.

The valve and coil holders should be fixed in position to start with, and the filament and grid circuits wired according to the plan.

After this mount the two H.F. chokes, taking care to notice that the short-wave

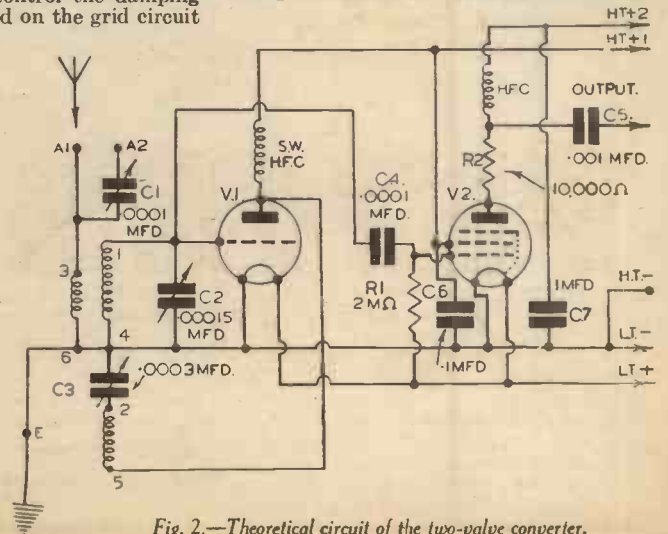

Fig. 2.—Theoretical circuit of the two-valve converter.

type is used in the anode circuit of the oscillator, while the screened one is in the detector anode high-tension supply. Actually, the first one is mounted underneath the chassis and the second on top, so no mistake should be possible. The fixed condensers C.5, 6, and 7 can now be secured, and the resistance R.2 fastened to the anode side of the second H.F. choke. When all wiring has been checked, the brackets can be screwed down to hold the three variable condensers, these, in turn, being mounted in their respective positions.

A word here may be necessary regarding the J.B. Special S.W. condenser, C.2. This model is designed for three or single-hole fixing, the latter being obtained by screwing on a little attachment provided with the component. See that it is securely fastened, and that all condensers are really firm on their brackets.

The aerial and earth socket strip can now be fixed, and then the remaining wiring completed, not overlooking the lengths of flexible wire required for the battery and output connections.

Operation

First of all the battery leads must be connected to suitable voltage supplies. The same batteries that are used with the broadcast receiver will do, providing that in the receiver the H.T. and L.T. negative are common with the earth. This arrangement is practically universal, so there is little likelihood that any alterations will be necessary.

The earth connections can be left on the receiver, but the aerial must be removed and connected to the appropriate socket on the converter, while the receiver should be switched over to the long waves, and the tuning condensers set to, say, somewhere near the bottom of that wave-band.

When the valves are plugged into the converter, the output lead from C.5 can then be connected to the aerial terminal of the broadcast set, and the complete arrangement is ready for use as soon as the receiver is switched on.

The reaction control C.3 must be adjusted until a faint rushing sound is heard in the speaker or 'phones. The noise should not be too fierce or too weak. It is a matter for experience and adjustment, though one soon knows by practice if the circuit is "alive."

If the tuning control C.2 is now rotated slowly, the rushing noise will continue until a station is heard. Should the noise

stop, gently adjust C.3 until a setting is found for the complete movement of C.2. It may be necessary to reduce C.1 or increase slightly H.T.1.

When a station is tuned-in, don't touch C.3, but you can experiment with the reaction control on the receiver although a shade too much of that will make the whole circuit hopelessly unstable.

One of the main secrets of S.W. tuning,

is the manipulation of the tuning control. This must be adjusted very slowly, otherwise it is possible to pass over several stations without even knowing that they are there. In this direction it will be noted that no slow-motion dial has been specified. This does not mean that one is not required, but that the choice is left to the constructor, to enable him to suit any particular cabinet in which he may wish to house the converter.

Above and Underneath Chassis Wiring Diagram of the P.M. Converter

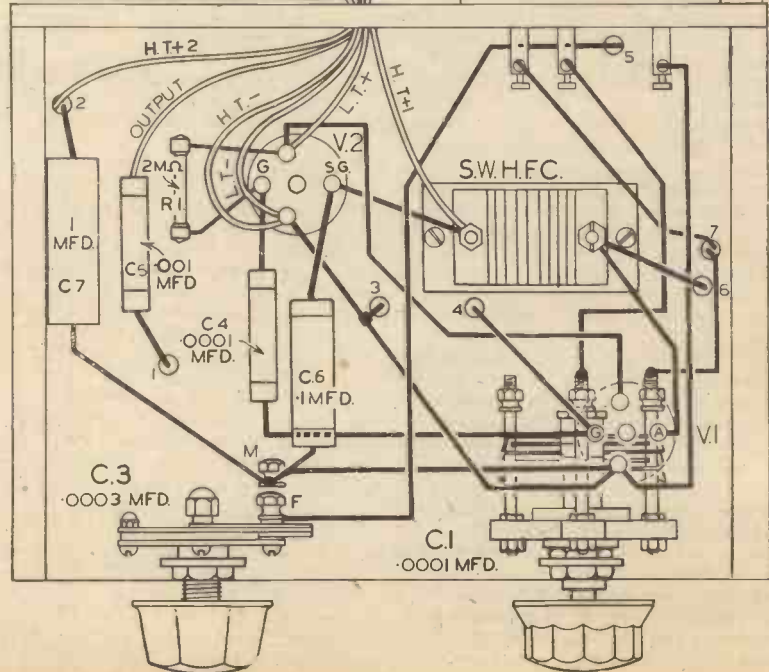
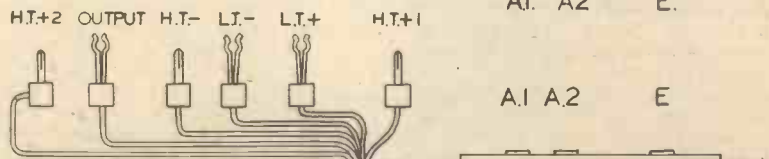
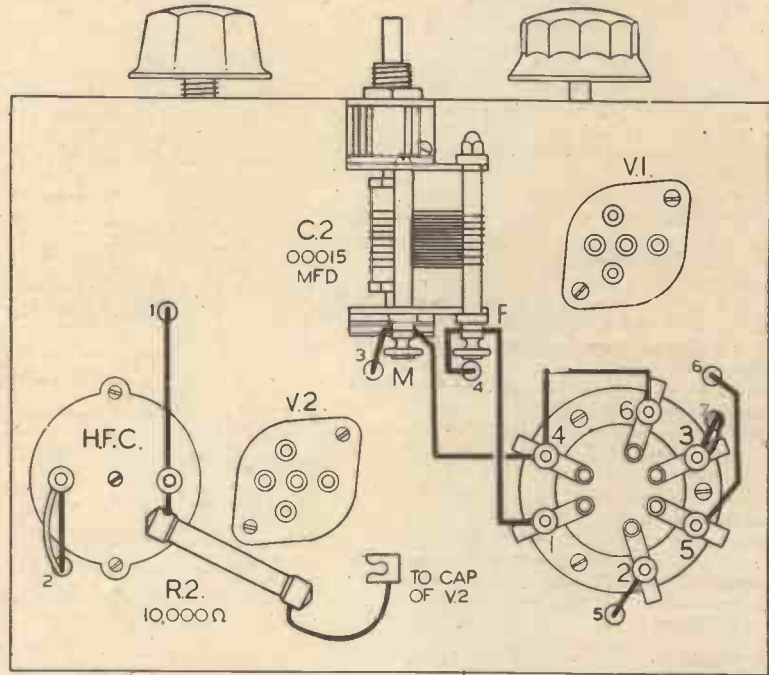

Components for the P.M. Converter

	s. d.
1 Clix socket strip, A, A1, and E	7
2 Clix S.W. 4-pin valveholders, type V5	each 10
1 J.B. S.W. special .00015 variable condenser	5 9
1 J.B. Dillcon. .0003	2 6
1 Dubilier 10,000 resis., 1 watt	1 0
1 Dubilier grid leak, 1/2 watt, 2 megohm	6
3 Component mounting brackets, Peto Scott	each 4
1 Bulgin screened H F Choke, type HF9	4 0
1 Bulgin S.W. H F Choke, type HF3	2 3
1 Eddystone 6-pin coil holder, type 969 (and coils to match for wavelength desired)	2 3
1 Eddystone variable condenser, .0001, type 900/100	5 0
1 T.C.C. fixed condenser, 1 mfd., type 250	2 3
1 T.C.C. fixed condenser, 1 mfd., type 250	1 4
1 T.C.C. fixed condenser, .001 mfd., type 300	1 0
1 T.C.C. fixed condenser, .0001 mfd., type 300	1 0
1 Peto Scott chassis, 8 ins. by 6 ins. with 3-in. runners	3 6
1 Tungram valve, LD210	
1 Tungram valve, HP210	

BUILDING AN ALL-ROUND UTILITY BOAT

Continued from page 611 of last Month's Issue

THE thirteen curved floors can be marked out either with a pricker through the drawing or by means of carbon duplicating paper laid under the drawing. If the elm boards have a curved grain, so much the better; the floors should be cut across the grain as little as possible.

Since the frame and transom sizes were taken from the body plan without deduction for the thickness of the side and bottom planking, these members leave the saw too wide and too deep.

In part this is to allow a generous safety margin for truing up, but mainly it is to provide for the bevelling of the edges to the bottom and side curvatures of the hull. The edges at frame 8 have no bevel and are square; but both forward and aft the frames increase in bevel until, taking the extreme case of the ribs at frame 1, when finished these will have been pared down $\frac{1}{4}$ in. on the after face and $\frac{3}{8}$ in. on the forward face.

The sawn frame members must first of all be planed, and if the grain is inclined to lift and tear, plane with a curving diagonal stroke like the motion of a scythe.

The planed pieces can now be assembled and temporarily nailed at the joints with wire nails. You can then scribe lines on each floor and rib where they meet; take them apart, and cut away half of each with a tenon saw, putting them together again as a halved joint.

Halved Joints

These halved joints need rigidity and strength, and so must be copper riveted. Cramp the joint firmly. Drill one clean hole near the inner angle a shade smaller than the nail thickness. Drive a 1 in. nail through, and supporting the nail head, drive a rove over the point with the hollow punch. Cut off the nail point, leaving $\frac{1}{16}$ in. of nail projecting above the rove, and still supporting the nail head, swage the projecting stem over the hole in the rove with a series of very light hammer blows.

Next put in two more rivets, taking care to leave room for the 1 in. by 1 in. nick that must come later to take the chine stringer.

The frames as they are completed should be numbered.

The transom being a single wide board will buckle badly if one side should be dried more than the other. Should this have happened, wet it all over, and let it dry again slowly and equally. Plane it up, and re-mark it with accurate vertical centre lines on both faces, also with finishing border lines on the after face, allowing a bare $\frac{1}{2}$ in. under the horns at the outer top tips to cover the top edges of the side planks. On the forward face of the transom copy exactly the border lines for bottom and side edges from the after face. Then to get the bevells correct with allowances for finishing, draw in a cutting line $\frac{1}{4}$ in. below the bottom line copied from the after face, and cutting lines at the sides rather more than $\frac{1}{8}$ in. outside the copied lines. The horns on their forward sides will be $\frac{1}{4}$ in. deeper than on their after sides, and should be marked accordingly. This latter variation is caused by the slope of the transom and the "sheer" or drop and rise of the gunwales.

The Stem

First trim the oak down to a triangular section with faces measuring 3 in., 4 in. and 3 in. The 4 in. side will form the back of the stem, and must be flat and straight. The apex opposite should be planed away, leaving a flat $\frac{3}{8}$ in. wide. This flat, as the outward edge of the finished stem, will look the better for a slight rounding of its outline towards the lower end (see Fig. 6).

The rabbets to be cut into either side of the stem to take the "hood ends" of the side planking require to be finished $\frac{1}{2}$ in. deep by a breadth of $1\frac{1}{4}$ in. and a length from the bottom of $18\frac{1}{2}$ in. full. These rabbets may now be cut to the full depth of $\frac{1}{2}$ in. at their forward limits. The stemhead may be left in the rough, but at the bottom of

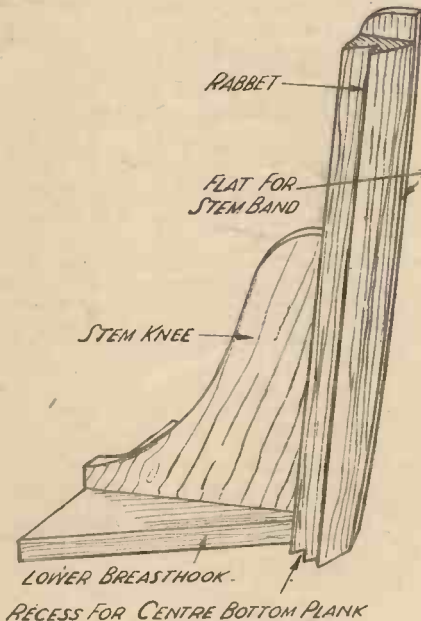

Fig. 6.—Details of the stem.

the stem a recess $\frac{3}{4}$ in. deep in the fore-and-aft direction, and $\frac{1}{2}$ in. vertically, needs to be cut out to take the tip of the central bottom plank.

The two chief knees: one for the transom 13 in. and $7\frac{1}{2}$ in. along its arms at 104 degrees, and the other for the stem 7 in. and 6 in. at 109 degrees, may now be worked up from $1\frac{1}{2}$ in. hardwood, and firmly attached to the transom and stem with brass screws driven from the latter into the knees, and having their heads well countersunk.

In the case of the stem knee it should be noted that the knee is $1\frac{1}{2}$ in. from the foot of the stem, leaving room there for the bottom plank and the lower breasthook.

Wood Preservatives

All the chief parts of the framework have now been made, though not finished, and should be dressed with a preservative. A mixture that is both cheap and effective consists of raw linseed oil 4 parts, creosote 1 part, and paraffin 1 part. Brush this in generously, and a day later give the parts a

thin coat of varnish to seal the wood surface.

The varnish being dry, the whole framework is set upside down on the stocks that the bottom planking may be laid.

The Bottom Planking

The pencil line along the stocks represents the reference line above the elevational drawing, which is in the same plane as the line X in the body plan.

Put a $1\frac{1}{4}$ in. block under the reversed transom, and let the stemhead into the stocks so that the clearance to the stem rabbet from the stocks is $\frac{3}{8}$ in. Brace both stem and transom firmly into position with struts to the stocks and to the workshop floor.

The simplest way of setting the frames in place is to take 26 pieces of crate-wood about 2 ft. long. Cramp two batches of 13 each together.

Bore a $\frac{3}{4}$ in. hole right through the lot, $1\frac{1}{2}$ in. from one end, and saw down to the hole, forming a slot $\frac{1}{2}$ in. wide by a short 2 in. deep in each piece. These slotted sticks, nailed to the stocks in pairs, grip each upturned frame by its floor member (see Fig. 7). The heights, outside edge of floor to top of stocks, should be adjusted as follows: Frame 1, $20\frac{1}{2}$ in.; 2, $22\frac{1}{2}$ in.; 3, $24\frac{1}{2}$ in.; 4, $26\frac{1}{2}$ in.; 5, $27\frac{1}{2}$ in.; 6, $27\frac{1}{2}$ in.; 7, $28\frac{1}{2}$ in.; 8 and 9, $28\frac{1}{2}$ in.; 10, $27\frac{1}{2}$ in.; 11, $27\frac{1}{2}$ in.; 12, $26\frac{1}{2}$ in.; 13, 26 in.; and transom, 25 in.

The framework should now be stiff enough for truing up without fear of the parts shifting. If not, struts should be put in as required.

Now take one of the 1 in. by 1 in. sectioned chine stringers, and binding one end of it to the foot of the stem, bend it round the frames, and bind its other end to the transom by means of cramps and string. Adjust the stringer so that its distance from the rib heads is $17\frac{1}{2}$ in. Mark this point on each frame, and saw into it 1 in. Then saw vertically downwards till the cuts meet, leaving a recess for the stringer. Repeat this with the other stringer. Then bind both into the recesses, and very carefully cut off their ends so that one pair butts against the transom, and the other pair against the stem $\frac{1}{2}$ in. clear of its foot. Then screw down the stringers with very fine $1\frac{1}{2}$ in. brass screws deeply countersunk into them, and similarly fasten the ends, but driving the screws into them from the stem and transom.

The Lower Breasthook

The framework is now ready for final fairing up and bevelling to take the planks except for the lower breasthook, a wedge of $\frac{3}{4}$ in. hardwood, that should be driven between the forward ends of the chine

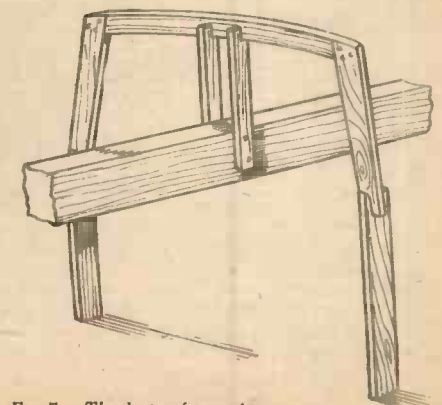

Fig. 7.—The device for setting the frames.

stringers, and screwed to them and to the stem knee. With this in place, take a batten 15 ft. long, cramp one end of it to the lower breasthook, and weight down the other end to the transom. Probably you will find it bearing on some floorboards but not on others. Plane down those it bears upon till it will rest fairly upon all and upon the transom.

Shift the batten outwards 6 in., cramping its forward end to the chine stringer, and repeat the fairing process, and so carry on until it will bend fairly anywhere along the bottom, right to the edges, where the chine stringers will want planing down until flush with the floors.

The framework is now ready for the bottom planking, but because the bottom seams must be close-fitting and Columbian pine is a wood that shrinks, it is essential that it shall be thoroughly dry.

Taking one of the longest planks plane it all over to 5 in. wide by a clear $\frac{1}{2}$ in. thick, and then, starting at its mid-length, plane its edges to a very slight, curving taper, like a barrel stave, so that $\frac{1}{4}$ in. is taken off each edge at the forward end, and no more than a thick shaving at the transom end, so that the total width of the plank forward is left as $4\frac{1}{2}$ in. and after as $4\frac{1}{4}$ in.

The plank now being ready, put some thick white-lead on the foot of the stem and its recess, the forward ends of the chine stringers, and the transom edge; weight the plank into position, and seeing that its tip is a snug fit in the recess in the stem, screw it to the lower breasthook. To the floors, starting from frame 1 and working aft, nail it with three copper nails to each, and with four copper nails to the transom.

From this centre plank work outwards, laying the remaining ten planks, putting the same taper on each.

Except for the centre plank and the outside ones, the bottom planks should not be nailed hard down until they are all in position.

Side Planking

The bottom planking overlapping the chine stringers and transom now wants to be trimmed off. The seams between the planks though tight on the inside will be open on the outside owing to the convexity of the bottom. This is as it should be, as it leaves room for caulking.

Before the side planks are fitted, the transom edges, rib edges and stem rabbet need fairing with a batten.

The first side planks to put on should be those covering the chine stringers. To equalise the strains on the framework cramp or tie on a pair. One alone would tend to shift the frames away from it.

When both are tied approximately in position nail one of them lightly to the rib at frame 7, and gradually strain in the forward end of the plank towards the stem.

Now cut the end of that plank to fit the rabbet, run some white-lead into the rabbet and along the chine stringer, and cramp the plank end into the rabbet and fasten it there with screws at inch intervals.

The next pair of side planks may now be put on in like manner, making the structure stiff enough for the battens to be removed from the rib heads, when the last pair of planks can be fitted. These have to fill the stem rabbet to the top, and lodge tightly under the transom horns. Plane the ends down sufficiently for this, leaving the remainder of the gunwale edges to be levelled with the rib heads after the hull has been turned upright, as may now be done after trimming the side planks level with the transom.

Fitting the Thwarts

Before fitting the thwarts, which come next, fit the risings—the short battens that carry them. These should be slightly let into the ribs to take the strain off the screws that hold them.

Cutting the thwarts and stern seat to fit nicely is a good deal more difficult than it looks, so much so that it is a wise precaution to make these from cardboard patterns that have been tried in position. As the thwarts do much to stiffen the hull they must fit tightly against the ribs.

The hull is now complete inside except for the gunwale fittings. First come the inwales. These elm battens should be planed down to $\frac{1}{2}$ in. x $1\frac{1}{2}$ in. Notch the rib heads to receive them, and then chamfer off the forward ends of these battens to fit against the back of the stem. Cramp them in that position, and draw them into the rib-head notches as far as possible while their after-ends rest on the top of the transom. Trim the after-ends until they can be pushed down against the forward face of the transom into their allotted positions, and fastened with 2 in. riveted nails to the rib-heads and planking, after which they should be treated with the oil and creosote preservative.

There is now left a gap of $\frac{3}{8}$ in. between the inwales and planking, and after the gunwales have been planed true with the rib heads and inwales, this gap must be filled in for 6 in. at the ends to back up the quarter knees and breasthook, and also for 4 in. under the rowlock sockets.

Quarter Knees

The quarter knees and breasthook are small wedges of $1\frac{1}{2}$ in. hardwood, and rather difficult to fit accurately. Start them considerably over-size and work them down with a sharp chisel and a rasp. Their concave curved inner faces need to be reinforced with 8 in. lengths of half-round copper strip, $\frac{3}{8}$ in. x $\frac{1}{4}$ in. attached with small countersunk screws; 30 in. of this strip is also wanted for a stem band.

When the strips are fitted, round off the exposed wood edges above and below them,

and with screws from outside the gunwales and transom draw them into position. The ends of the copper strips are screwed from inside. 1 ft. 3 in. is the best distance for rowlock sockets to be located from the thwart centres. Fit the sockets into hardwood pads 6 in. x $1\frac{1}{2}$ in. x $\frac{3}{8}$ in., and fasten them firmly over the filling pieces.

Bore holes through the filling pieces for the rowlock shanks.

The whole interior of the boat after cleaning with sandpaper may now be varnished, and when the varnish is dry cut up about 150 ft. of the plasterers' laths into $11\frac{1}{2}$ in. lengths, varnish them on one side, and tack them, varnish side down, along the plank seams inside the hull between and beyond the frames from end to end.

Rubbing Pieces

The rubbing pieces under the forefoot and transom can be made of hardwood of $1\frac{1}{2}$ in. x $1\frac{1}{2}$ in. section. These are punt-shaped pieces, rounded out on their upper sides to fit the centre bottom plank. White-lead them and screw them on. The stemhead should also be squared up from its triangular section by cutting away the sides. The copper stem band may then be fitted over it and bent round the stem and forefoot to terminate under the forward rubbing piece.

The smartest outside finish for a boat of Columbian pine and elm is varnish, with white for the bottom and sides up to an inch above the loaded waterline. The pine topsides should be set off by a D sectioned fillet of varnished elm screwed to the outside of the gunwale. The transom and sides require at least three coats of boat varnish. The bottom two coats of white-lead paint followed by "hard gloss" paint.

For lightness in weight and for dryness the floorboards of deal may have spaces between them of 1 in. to $1\frac{1}{2}$ in. They can be in two lengths, meeting under the middle thwart. Each will have ten 3 in. x $\frac{1}{2}$ in. boards, nailed to cross-battens underneath with copper nails. The boat is now complete for rowing or outboard motor propulsion.

AROUND THE TRADE

The Clix Switch-Plug Unit

BRITISH MECHANICAL PRODUCTIONS, LTD., 79a Rochester Row, London, S.W.1, makers of the famous "Clix" products, have recently issued an 8-page leaflet showing six different uses for their switch-plug unit shown on this page. Details of the device, which was originally designed for extension speaker switching, were given in our March issue.

It can be used for tests in short wave work, safety-first switching, radiogram switching, an A.E. plug wave-change switch, wave-change and battery switching and extension speaker switching. In each case a theoretical diagram is supplied showing the wiring connections. Interested readers should write to the above address, mentioning "Practical Mechanics," when they will receive a copy of the leaflet free of charge.

Lionel Trains

S. GUITERMAN & CO., LTD., 35-6 Aldermanbury, London, E.C.2., have just issued the 1938 edition of the Lionel Electric Train catalogue. Two new and attractive models listed in the junior sets are Nos. 1067E and 1068E. They are moderately priced at 45s. per set

inclusive of track and transformer. There are numerous illustrations of the latest examples of scale model sets which represent the highest attainment in model engineering skill, embodying minute details of construction.

Among the many accessories will be found an addition this year in the form of a whistling station, which enables a whistling mechanism to be fixed to any set at a minimum cost.

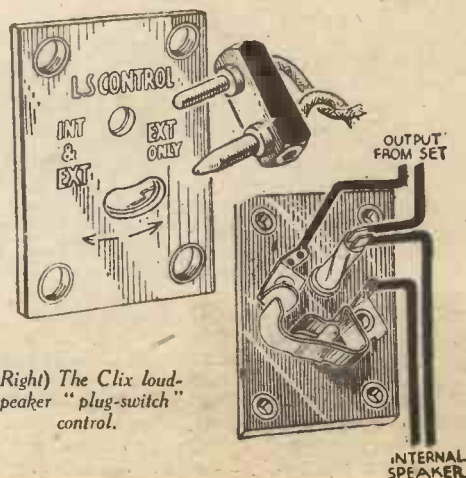

(Right) The Clix loud-speaker "plug-switch" control.

South Africa Comes To Glasgow

Details of the model of South Africa, built by Twining Models, Ltd., which forms an attractive centre-piece for the South African Pavilion at the Glasgow Exhibition

EARLY in January of this year a contract was entered into by Messrs Twining Models, Ltd., of Northampton, to construct, to the order of The High Commissioner for the Union of South Africa, a model which was intended to form, and does form, a centre-piece for the South African Pavilion at the British Empire Exhibition in Glasgow. The model is the largest of its kind in the Exhibition and the greatest in area ever built in Northampton. It is also probably the heaviest, for it weighs approximately five tons.

It is not a topographical representation, but is an attempt to portray in composite form all of the characteristic features of the scenery, the European and native life, the fauna and flora, and the railways to be found in the whole of territory covered by the Union.

Dominating the model and rising upwards in its centre is mountainous country representing the famous Drakensberg, the highest peaks of which soar to between 5,000 ft. and 6,000 ft. Around this are modelled ravines with waterfalls and rushing torrents, open country with farms, fruit orchards, vineyards, orange groves, sugar, tobacco, bananas, paw-paws, and all of the many other products of the Union. There are Kaffir kraals, native villages and, in one corner, a portion of a town typifying Johannesburg with buildings of the skyscraper type as well as a residential suburb with parks.

In another part of the model is the Kruger

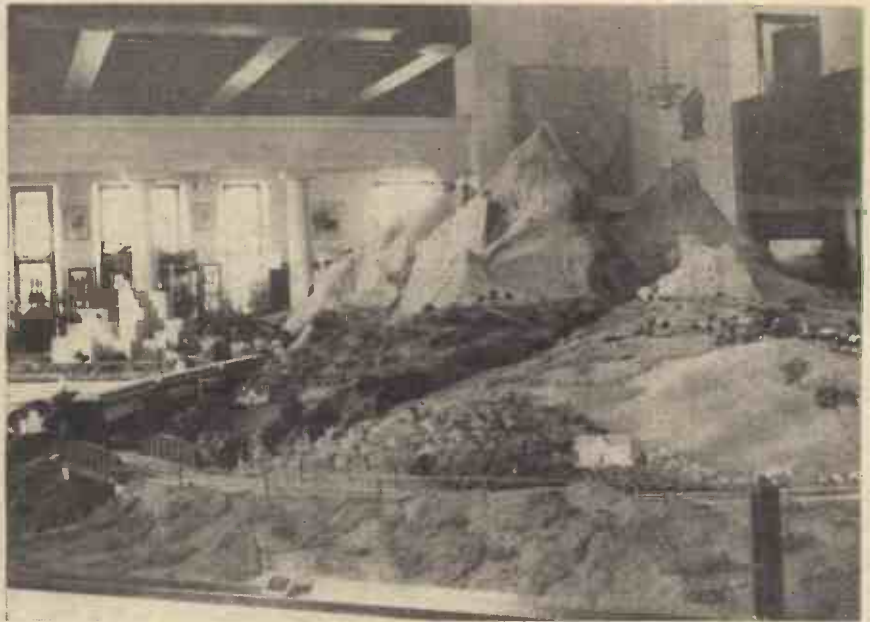

The model in the South African Pavilion, showing orchards in the foreground.

National Park with the game reserve in which are elephants, rhinoceroses, hippopotami, lions, wildebeeste, and leopards, besides the more harmless animals such as giraffes, zebras, springbok, etc. There is an airport with aircraft of several types, and the pit-head gear and debris of a typical gold mine.

Brilliant colour is given by dozens of examples of each of the many flowering plants, shrubs and trees, chief amongst the last of which are the lovely crimson Flamboyant, the mauve Jacaranda and the scarlet Kaffir-boom.

Besides rickshas and teams of oxen drawing the typical carts, there are some hundreds of human figures of both natives and Europeans.

The scale of the model is not uniform. On the outside edges it is 1/24th full size, or 1/2 inch to 1 foot. This gradually diminishes towards the centre to give the effect of perspective and distance. Thus, in the foreground human figures are nearly

3 in. high, whereas near the Drakensberg they are but a fraction of an inch.

Running around the whole model and passing through a tunnel under a spur of the Drakensberg mountains there is a railway to a scale of half an inch to the foot, the gauge of the track being the scale reduction of the South African standard 3 ft. 6 in. On this two trains work, a passenger of three cream-and-blue coaches drawn by a 4-6-2 type locomotive and a mineral train headed by an engine of the 4-8-2 wheel arrangement. These locomotives are driven by Klaxon motors operating off the 250-volt mains through a transformer. There is no third rail, and so accuracy of appearance of the track is not departed from. The coaches of the passenger train are completely fitted internally and lighted each by six miniature lamps, the current for which is, of course, picked up from the track. The length of each of the locomotives, with its tender, is approximately 3 ft. and the complete train measures nearly 12 feet overall. Engines are painted the standard black with chromium plated boiler bands and other bright parts.

There are two stations on the railway, one at "Johannesburg," and the other on the "Natal Coast," where the line runs beside the "sea."

The overall length of the model is 40 feet and width 20 feet. To the tallest peak in the Drakensberg the height is nearly 6 feet above "sea" level, or approximately, 9 feet above the floor upon which the model stands.

For the general and details design and layout of the whole, as well as for the supervision of the construction, Mr. Gilbert E. Twining, director, was responsible, whilst Mr. E. H. Clifton, another director, had charge of the rolling stock. The electrical and mechanical portions of the engines and the system which provides for the trains operating on two-rail track was designed by our contributor, and author of "Indoor Model Railways," M. E. W. Twining, managing director of Twining Models, Ltd.

A close-up view of the 4-8-2 type engine, with entrance to the Kango caves in the background.





QUERIES and ENQUIRIES

A stamped addressed envelope, three penny stamps, and the query coupon from the current issue, which appears on page 668, must be enclosed with every letter containing a query. Every query and drawing which is sent must bear the name and address of the sender. Send your queries to the Editor, PRACTICAL MECHANICS, Geo. Newnes, Ltd., Tower House, Southampton Street, Strand, London, W.C.2.

A NEW KITE DESIGN

"I HAVE devised an entirely new design in kites and would like to take out a patent for it. Does the kite form fit subject matter for registration as a design?"

A. H. (Yorks).

THE improved kite, if novel, forms fit subject matter for registration as a design, and it is quite possible, if the design of the kite embodies a new principle, that the subject matter may be sufficient to support a patent.

The protection afforded by a patent is, of course, much wider than that of a design, and, therefore, of more commercial value.

For the registration of a design an application form, stamped with a 10s. stamp and accompanied by three representations (preferably photographic prints) of the kite, should be forwarded to the Patent Office, 25 Southampton Buildings, W.C.2.

If, subject to the above proviso, it is desired to patent the invention, you are advised to file an application for patent with a provisional specification which will give you protection for about 12 months at the least expense, and during such period it should be possible to ascertain if the invention is likely to prove commercially successful.

Unless you are in a position to manufacture in quantities and can make use of a sales organisation, it would be better to endeavour to interest a firm to make and sell on a royalty basis. A fair royalty would be 7½ to 10 per cent. of the selling price. Messrs. W. Brooke & Co., of 9a Mill Hill Grove, W.3, or Messrs. Spencer Bros., Ltd., of 22 Bouverie Road, N.16, are firms that might be interested in the invention.

It is suggested that split and glued bamboo cane for the ribs would probably be both cheaper, lighter and stronger than oak, and artificial silk (Rayon) or transparent paper (Cellophane) would be lighter and less expensive than silk.

A SOUND-PROOF WALL

"I WISH to build a sound-proof dividing wall across my laboratory. I have considered using two layers of insulating board about 4 in. apart, or building board and filling the 4-in. space between with sawdust or granulated cork." H. W. B. (Walsall).

WE would hesitate to advise you to employ sawdust as a sound-insulating material, the objection to this material being that it tends to "pack" closely together and to form a dense solid mass the sound-insulating properties of which are not very great.

As a sound-insulating medium, fibrous material is much superior. If you are able to procure dried seaweed in sufficient quantity, you will find this an excellent medium for sound insulating. Possibly, you may be able to obtain this material through Messrs. Phillip Harris & Co., Ltd., Laboratory Furnishers, etc., of Birmingham.

Coarse-grained cork, kapok fibre, shoddy, cotton wool and even shredded wool are all excellent sound insulating materials and you may use them with confidence.

It is essential, however, to see that they are not compressed so as to form an absolutely solid mass.

As regards the actual wall structure into which the sound insulating material is to be incorporated, two ordinary building boards at a distance of five or six inches apart will form the cheapest type of construction. Insulating boards, however, are better to use, since they themselves cause some sound deadening.

If a little extra expense is not objected to, why not construct your sound-insulating partition by having two boards at a distance

are employing, we cannot possibly advise you with certainty as to the composition of a suitable strip material for striking them against.

All we can say is that, usually, safety-match heads are composed of a mixture of antimony sulphide, potassium chlorate and glue (suitably coloured), in which case they will strike satisfactorily when rubbed on a strip surfaced with a mixture of red phosphorus, powdered glass, red lead and glue.

Sometimes, however, the red phosphorus is incorporated with the match-head material, the antimony sulphide being mixed with the striking-strip material. Other ingredients are, also, changed about in this manner. It is, therefore, as you will now realise, impossible to give you a definite answer to your query, since we are not aware of the precise composition of your match heads.

At the same time, however, we would advise you to experiment with the above mixtures and, also, to approach one or more of the match companies in this country, as, for instance, the Regent Match Co., Ltd., 16 Monument Street, London, E.C.3 or the Union Match Co., Ltd., 28 Martin Lane, London, E.C.4.

SQUARE CORNERING

"I HAVE invented a device for the purpose of square cornering with a



This photograph of a shop window displaying model aeroplanes and accessories was taken at night by Mr. S. C. Benfill.

of six inches apart with a central board between them, the intervening spaces being filled up with any of the above-mentioned materials? This type of structure will damp out all but the most penetrative of sound vibrations.

It is difficult, of course, to insulate sound entirely by means of a single wall, no matter how well constructed it may be, for some of the vibrations will tend to find their way across the insulative wall via the floor or the ceiling or the side walls. To be entirely sound-proof, a room must have its four walls, floor and ceiling suitably constructed.

A MATCH FOLDER

"I HAVE patented a special match folder, and wish to submit the complete article to certain firms. Having made the folder I desire to paint the strip on which the matches (safety) are struck. Can you advise me of the composition of a suitable strip of material that will effectively ignite the matches?"

WITHOUT knowing the actual composition of the matches which you

tractor-drawn mower or binder. Do you think it has any commercial value, and if so, would it be possible to take out a patent for the device?" M. M. (Worcestershire).

THE device for square cornering with a tractor-drawn binder or mower is fit subject matter for protection by patent. The idea is thought to be novel, but it would be necessary to make a search amongst prior patent specifications to ascertain the novelty, which is a relatively expensive matter. It would possibly be less expensive to file an application for patent with a complete specification, and so obtain the result of the official search which is made on all patent applications before the complete specification is accepted. In order to ascertain if the invention is likely to be commercially successful, you are advised to file an application for patent with a provisional specification which will give you protection for about 12 months, during which time you should be able to interest agricultural machinery manufacturers in the invention, and so ascertain if there is a market for such an invention.

MAKING A THERMOSTAT

"I HAVE an aquarium of tropical fish, and wish to make a thermostat to keep the water at a constant temperature of 75 degrees F. What is meant by 'bimetallic strip'?" J. S. (Oxon.).

BY the term "bimetallic strip" is meant merely a strip of metal consisting of two different metals, soldered, riveted, welded or otherwise bound together in close contact. No two metals have the same "coefficient of expansion." That is to say, no two metals expand alike when heated to equal temperatures. In consequence of this fact, a "bimetallic strip" consisting of two dissimilar metals, always shows a tendency to curve inwards or outwards when heated, owing to the fact that one of its components expands more than the other. Upon this basic fact, the principle of many electrical thermostatic devices and other instruments is based.

Naturally, the greater the difference in expansion between the two metals constituting the "bimetallic strip" the greater will be the extent of curvature of the strip. In theory, any two dissimilar metals may form a bimetallic strip, but you will find that in actual practice, the best combination (for temperatures not exceeding about 300 degrees F.) is steel and zinc.

Accordingly, take a strip of steel, say, a length of clock-spring, and firmly solder to it a strip of zinc of approximately equal thickness. If you prefer not to solder the metals together, you may rivet them. It is essential, however, that the two strips make firm and effective contact at all parts.

Having soldered or otherwise secured the two strips of metal together, trim up the composite strip around its edges with a pair of strong scissors or shears. The composite strip should, of course, be perfectly flat at ordinary temperatures. When heated, it will curl either inwards or outwards according to the position of the more expansible metal.

By means of careful adjustment of the grub screw which you depict in your drawing, you should be able to regulate your thermostat very finely so that it will come into action at a definite temperature. This matter, of course, is one for your own trial and experiment.

We very much doubt whether bimetallic strips of the type you mention are procurable commercially. Nevertheless, you might make inquiry for one at Messrs. Electradix Radios, 218 Upper Thames Street, London, E.C.4.

A FOUNTAIN PEN NOVELTY

"I HAVE invented a miniature blotting pad which can be incorporated in the end of a fountain pen. Do you think it has any commercial value?" A. T. (London N.2).

THE fountain pen blotting device is not broadly novel. Many devices having the same object in view have been invented and many protected by patent.

It may be possible to obtain a patent for the exact construction of the device, but in view of the necessarily restricted claims which would be allowed, it is not thought that any patent would be of any great commercial value.

"WHAT SHAPE IS THE EARTH?"

IN our issue for March 1938, we published an article entitled "What Shape is the Earth?" It created considerable interest, and many readers wrote in for further information. Below we explain a number of interesting points raised by readers.

THE point has been raised that there is actually no means of demonstrating the

concavity of the Earth's surface (assuming for the moment that it is concave), since the "straight line" which we should use in comparison, whether mechanical or optical, would be equally affected by the Field. This is perfectly true in respect of the optical straight line, and explains why by any optical means of comparison the surface appears convex, since tangential optical lines tend to recede from the surface when they pass the point of contact. It is believed possible, however, to produce a mechanically straight line which would be straight in either Euclidean or "Field" space by taking a short straight-edge and producing it in either direction by placing other equal straight-edges end to end with it and alternately reversing them. This was the process adopted in the experiment referred to in the article, and, as stated, the results were positive.

Similar arguments have been adduced in relation to the Calumet Mines phenomenon, on the assumption that the rule or tape measure used in the measurements would contract in length as it was carried down the mine, and therefore should give a reading consistent with convex curvature.

This argument implies attributing to Field Space a property which has not been attributed to it by its proponents.

The Field Theory does not presume that the Field affects the physical dimensions of matter, which means that if a foot-rule, by some means were taken high up, i.e., towards the centre of the Field Universe, near the Sun, say, it would be found to be very large compared with the Sun. Conversely, if it were possible to bring the Sun to the Earth's surface, it would be found to be quite a small body, though giving out energy at an enormous rate.

An interesting point has been raised by asking how the centre of the Earth (as we know it in orthodox geometry) is represented in the Field Theory. By applying the conversion rule, this centre would become a circle at infinity, meaning that the Earth's crust was infinitely thick. Now the internal structure of the Earth is not known. It is guessed that it is a molten mass at a high temperature. We might equally well be justified in guessing that it is hollow, i.e., that the crust has a definite, relatively small thickness. If this guess is correct, there is no philosophical difficulty in effecting the transformation, though speculation as to what is outside the Field Earth may be somewhat difficult, but not more so than some of the speculations arising out of the orthodox theories.

TWO NOVELTIES

"I ENCLOSE details of two gadgets I have invented and would like your advice as to their novelty." (E. B., Oxford.)

THE improved toasting fork is known to be no longer novel. The same idea has been marketed on and off for many years past.

With regard to the anti-rattle fitment for sliding sashes, this is also not thought to be novel, but the exact construction is not known as far as we know. However, should it be novel it could not be protected by patent as it does not contain sufficient subject matter or invention over known devices for analogous uses. If novel, some measure of protection might be obtained by registration as a design, but that is not advised as any registration for the device would have but little commercial value.

K. J. N. (Portsmouth).—Wire for primary No. 28 D.C.C. 1,850 turns, approx. $\frac{1}{2}$ lb. Wire for secondary, 100 turns No. 24 D.C.C., about 20 yds.

THE DAY-DREAMER

Will He Ever Wake Up?

His life is made up of rosy visions; he sees himself in a Manager's Office: the head of a firm, with a £2,500 a year salary; perhaps even as a millionaire with a large car, a yacht, and a country estate. But all this grandeur is in his day-dreams; he lives in the golden paradise of to-morrow—and it never comes. He does nothing with the opportunities that surround him to-day; he will always be somebody else's servant, instead of master of his own destiny.



How does he get into such a mental state? Because he uses only about one-tenth of his mental energies in doing the vital things that count. We are nearly all victims of the vicious habit of living far below our natural-born endowments. What can be done about it?

There is one very simple thing you can do—now! You can find out what Pelmanism has done for over half a million men and women, some of whom were facing the very same dissatisfaction with their attainments that you are facing. Pelmanism developed the mental powers they lacked—it replaced procrastination with "do it now" efficiency; it put concentration in the place of mind-wandering; it substituted self-confidence for self-distrust.

Write to-day for a copy of

"The Science of Success."

This book contains a full description of the world-famous Pelman Course; and tells you what some of the most eminent men and women of the day think about scientific mind training and its uses in daily life.

A copy of this book will be sent free to everyone, together with some remarkable testimony from men and women engaged in various Professions, Trades, and Occupations, showing what this system is doing in every walk of life.

PELMANISM teaches you how to think straight and true; it crystallises your scattered ideas; it focuses your aim on one thing; it gives you the will-power to carry out your ideas; it dispels your fears; it teaches you how to concentrate, how to observe keenly. Initiative, resourcefulness, organising ability, forcefulness are a natural result. You stop putting things off; inertia disappears; mind-wandering and indecision are things of the past. With new allies on your side, and old enemies beaten, there is nothing to hold you back.

If, therefore, you wish to make the fullest use of the powers now lying latent or only semi-developed in your mind, you should send to-day for a free copy of this most interesting book.

Write (or call) to-day to:

PELMAN INSTITUTE

(Established over 40 years),

130, Pelman House, Bloomsbury Street, London, W.C.1,

and by return you will receive a free copy of "The Science of Success," and particulars enabling you to enrol for a course of Pelmanism on specially convenient terms.

Write or call for this free book to-day.

Readers who can call at the Institute will be welcomed. The Director of Instruction will be pleased to have a talk with them, and no fee will be charged for his advice.

PELMAN (OVERSEAS) INSTITUTES:
PARIS, 176 Boulevard Haussmann. NEW YORK,
271 North Avenue, New Rochelle. MELBOURNE,
396 Flinders Lane. DURBAN, Natal Bank
Chambers (P.O. Box 1489). JOHANNESBURG,
P.O. Box 4928. CALCUTTA, 102 Clive Street.
DELHI, 10 Alipore Road. AMSTERDAM,
Damrak, 68. JAVA, Malabarweg, Maling.

ELECTRADIX

Learn Morse at Home



ALL BRITISH MORSE AND SIGNAL KEYS, Royal Air Force model, balanced action, solid brass bar, contacts, indicator lamp. Type KBSL a guinea key for 7/6. Other keys from 3/- to 30/- Learner's outfit complete, 4/9. Ask for special illustrated Key List "K.P.M."

TELEPHONES for all purposes. House, Office, Garage and A.R.P. Portable. Wall type, 15/-. Other Wall and Table models cheap. Stamp for list.

HEADPHONES. Lightweight, 2,000 ohms, 4/6. Single high-resistance, 2/6. Sullivan 120 ohm W.D. model. Aluminium body and headbands. Maker's price to-day 15/-. Our price 2/9 per pair. 3d. postage. Pocket Headphones all leather headband and corus, 2/9 pair. S.W. 4,000 ohm sets, 4/6.

DIAL SELECTORS, 1 to 10, G.P.O. type, fitted governor, operating contacts and disc drive, complete, finger dial, 2/6. We have auto and hand switches for any purpose. Send us your inquiries.

H.M.V. MAINS TRANSFORMERS, 100/250 v. to 700 C.T. 60 m/a. 4 v. 1 a., 4 v. 2 a., 10/6. 30 Hy. Chokes, 50 m.a. 4/-, 1 Amp. Chokes, 10/-, Projection Lanterns, on Stand, with 250-watt focus bulb, 25/-.

DYNAMOS, D.C. 110 volts 1 amp., 15/-. 200 volts 1 amp., 17/6. 200 volts 1 1/2 amp., 26/-. Lucas Aero 12 volts 10 amp., 3,500 revs., as on aircraft, cost £15, for 20/-. Aero H.T. Dual Dynamo, 6 volts 5 amps. and 600 volts 100 m/a. for 20/-.

MOTORS. Small and Medium. A large stock of really fractional horse-power motors have been released at bargain prices. 300 for immediate delivery, from 12/6.

WIND DYNAMOS for windmill drive for cell charging, etc., 6 volts 10 amps. slow speed, 30/-. 16 volts 10 amps., 35/-. Large type, 56 lbs., 16 volts 25 amps., 45/-.

ELECTRO-MAGNETS for Mains or Battery. Lift 14 oz., 3/6; 10 lbs. lift, 5/-; 6-volt Solenoids, 1-in. travel, 1 oz. lift, 3/6. 6-volt two-way Relays, 6/-. Remote Radio Control, 1 mile Radio Transmitters, 25/-. Coherers, 5/-. 10,000-ohm Relays, 4/-, only, 10/-. Pierce Spark, 8-volt coils, 10/6. Shocking Coils, with handles, 4/6.

MICROPHONES. Button Mike, 1/-, Bakelite Transmitter No. 11, 5/6. Brass with announce grille 11a, 7/6. Table Mike and Transformer combinal, Set PM11, 15/-. Crystal Sets work on any aerial, 5/6 and 7/6 for B.B.C.



RELAYS. For tiny currents from light cells or radio. Moving Coil pivoted, work on 250 v. a.c. Only 60/- each. Lightweight mov. iron telephone type, 2-way, 5/-. Heavier current relays for Transmitters, American, 7/6. Sounder type, 15/-. Creed Polarised, 2-way, 30/-.

MOVING COIL MICRO-AMMETERS

for Panels, 100 ma., per div., 0 to 50

microamps, full scale, 50 mV, moving

coil, 1,000 ohms, flush panel, 2 1/2 in.

dial, 40/-, Fitted platinum contacts to close at

50 m/m.a., 60/-.

Large Stock of Laboratory Apparatus, Oscillators,

Bridges, Galvos., Meggers, etc.

PARCELS of experimental odd coils, magnets, wire, chokes, switches

terminals, etc., sent free: 10 lbs., 7/-; 7 lbs., 5/-.

Our latest sale list of 15 foolscap pages has over 100 illustrations of Electrical and Radio Bargains not obtainable elsewhere. Free for stamped envelope.

Over 1,000 other Bargains in our enlarged Illustrated List "P.M."

ELECTRADIX RADIOS

218 Upper Thames Street, London, E.C.4

Telephone: Central 4611

BECK'S CHEMISTRY

BUILD UP A HOME LABORATORY WITH OUR APPARATUS AND CHEMICALS SPECIAL SAMPLE PARCEL

FLAT BOTTOM FLASK, 150 cc.

BEAKER, SPOUTED, 100 cc.

3 TEST TUBES 4" x 1/2"

THISTLE FUNNEL 20 cm., RUBBER

CORK (2 Holes), 3 FT. GLASS TUBING,

GLASS STIRRING ROD,

RUBBER CONNECTION TUBING.

FOR DETAILS OF CHEMISTRY SETS

Price 2/6 to 105/-

SEND FOR OUR FREE CATALOGUE

BOOKLET of Tested Experiments, 6d. Post Free

BECK (Scientific Dept. A), 60, High St., Stoke Newington, London, N.16.



PROTRUDING EARS

ORO, a simple modern method sets them in position immediately. Invisible—Comfortable—Harmless, used any time by adults and children. Endorsed by physicians and users as the best method for correcting this disfigurement. Write for free booklet and testimonials to—

M. TRILETY (R 158)
45 Hatton Garden, London, E.C.1.

LUTON MINOR

with 35-h.p. LUTON ANZANI, Dual

Ignition, Starter, £225. Materials,

£10. Semi-manufactured, £75.

Blue Prints & Instruction Book, £5.

LUTON AIRCRAFT LTD., Phoenix Works, Gerrards Cross,

REPLIES IN BRIEF

W. S. (Coventry).—You can use a ram only when there is an existing head of water and not for pumping the same water round and round. If you have a head of water, then put this straight to the fountain. We advise a small electric pump that can be switched on when required as wind power is not reliable.

You will require a resistance of 15 ohms, and we advise you to use the seventh part of an electric fire spiral as obtainable from the sixpenny stores.

(E. Lothian).—The motor cannot be converted to a 1/2 h.p. Its maximum useful output on A.C. will be in the region of 1/30 h.p. You need not touch the armature but should re-wind the fields with No. 28 D.C.C. Use a fan and Swedish iron.

L. L. (Surrey).—Wind the core with 400 turns of No. 26 D.C.C. wire and make the core 3 in. x 1/2 in. of laminations of soft iron. Both Ohm's Law and the principles of wiring are dealt with in the "Practical Wireless Encyclopedia" obtainable through this office.

H. W. H. (near Birmingham).—It is not possible to re-wind a car dynamo to give a useful output at a lower speed; the whole machine would have to be changed. A double-bladed mill is used with a stiffening bar running the whole length. It should be 6 ft. in diameter and 8 in. wide set at an angle of 45 degrees—do not trough the blades.

J. T. (Newcastle-on-Tyne).—You must put the converter into an earthed metal box, and if this fails then the machine itself must be readjusted. Messrs. L. Dixon & Co., an advertiser, can supply small machines. Yes, the stampings will do for the transformer, primary 1,500 turns No. 22 D.C.C. wire. Secondary of copper strip 1/2 in. x 1/4 in. and 75 turns. This machine is not suitable for a dynamo; it should have at least a 16 segment com.

P. A. S. (Gloucester).—The strip referred to is 3/4 in. x 1/4 in. soft copper, and is insulated with ordinary insulating tape. The rough estimate would be, buying stampings from J. Sankey, Bilston, Staffs, about £4. You cannot wind the second transformer on to such a small core; this should have a section of not less than 1 sq. in. Primary 1,850 turns No. 28, Secondary 930 turns No. 24 D.C.C. wire.

J. W. (Coventry).—Your suggested re-wind is as near correct as possible, but the actual figure would work out at a little under 5 turns per slot; however, as this is a re-wind you can put on 5 turns, using No. 6 S.W.G.

F. H. (Kensington).—You omitted your address. If you will let us have this we shall be pleased to help you.

J. R. T.—You omitted to give your address, therefore we are unable to answer your letter.

Mr. H. Jew (Surrey).—You omitted to send your address. It is not possible to explain all of the methods of hardening steel. The method depends upon whether the steel is mild, carbon, vanadium, etc., and it will be necessary for you to know this. We expect you are referring to the litho papers. These are obtainable from Bassett-Lowe, Ltd., of Northampton. It is not possible to make a suitable alloy for rails which may be melted over a gas ring. Any metal which could be melted at this low temperature would be too soft to remain rigid, and would soon wear.

An Absorbing Hobby

BUILDING A STUART MODEL IS AN ENGROSSING PASTIME, AND THE RESULT A CONTINUOUS PLEASURE



We illustrate:

STUART
NO. 10.
High Speed
Steam Engine.
Bore 1/2".
Stroke 3/4".

Each set is quite complete—drawings and instructions are included.

If you have a lathe—
The rough castings - - - 8/6
If not—
Fully machined set - - - 18/6
Ditto, with all holes drilled
and tapped - - - 25/-

This and many other Stuart engines are fully described in the 72-page CATALOGUE No. 3, 6d. post free.

STUART TURNER LTD.
HENLEY - ON - THAMES

HOME STUDY FOR EXAMINATIONS

University Correspondence College, founded 1887, prepares students for London University Matriculation, Intermediate, and Degree exams; also for Oxford or Cambridge School Certificate, Civil Service, R.S.A., Book-keeping, etc. The College has a resident staff of Tutors, specialists in their subjects. Over 1,000 U.C.C. students pass London University examinations each year. 5,029 matriculated during the ten years 1928-1937.

FREE GUIDES to London University and other exams. (mention exam.) may be obtained post free from the Registrar,

UNIVERSITY
CORRESPONDENCE COLLEGE
62 Burlington House, Cambridge

Engineers' Guide To Success Free!

For a well-paid post study at home with The T.I.G.B. Write NOW for this great Guide containing world's widest choice of engineering courses—covering all branches—and which alone gives the Regulations for Qualifications such as A.M.Inst.C.E., A.M.I. Mech. E., A.M.I.E.E., etc. Training until successful guaranteed

The Technological Institute of Great Britain, 123, Temple Bar House, London, E.C.4.

(Founded 1917.
20,000 Successes.)

200 Courses

LIGHT AEROPLANE CLUBS IN GREAT BRITAIN

(See article on page 625)

SUBSIDISED LIGHT AEROPLANE CLUBS

- Barnstaple and N. Devon Flying Club** (with effect from 5-3-35).—Aerodrome: Heanton Court, Barnstaple. The Secretary (at Aerodrome).
- Bedford Aero Club** (with effect from 1-1-38).—Aerodrome: Barton Airport, Barton, Beds. The Secretary (at Aerodrome).
- Border Flying Club** (with effect from 1-6-35).—Aerodrome: Carlisle Aerodrome, Kingstown, Carlisle. The Secretary (at Aerodrome).
- Bournemouth Flying Club** (with effect from 10-12-35).—Aerodrome: Bournemouth Airport, Christchurch, Hants. The Secretary (at Aerodrome).
- Bristol and Wessex Aero Club** (with effect from 1-11-27).—Aerodrome: Bristol Airport, Bristol. The Secretary (at Aerodrome).
- Brooklands Flying Club** (with effect from 1-2-33).—Aerodrome: Brooklands Aerodrome, Weybridge, Surrey. The Secretary (at Aerodrome).
- Cambridge Aero Club** (with effect from 5-11-34).—Aerodrome: Newmarket Road, Cambridge. The Secretary, 18 Jesus Lane, Cambridge.
- Cardiff Aeroplane Club** (with effect from 1-4-33).—Aerodrome: Cardiff Airport, Cardiff. The Secretary (at Aerodrome).
- Cinque Ports Flying Club** (with effect from 1-4-28).—Aerodrome: Lympe Aerodrome, Lympe, Kent. The Secretary (at Aerodrome).
- Civil Service Flying Association**—Aerodrome: W. Malling Aerodrome, Malling, Kent. The Secretary, 128 Green Lane, Edware.
- Cotswold Aero Club** (with effect from 1-10-34).—Aerodrome: Cheltenham Road, Gloucester. The Secretary (at Aerodrome).
- Coventry Aero Club** (with effect from 1-4-37).—Aerodrome: Whitley (Howes Lane), Coventry. The Secretary, 25 Wainbody Avenue, Coventry.
- Eastbourne Flying Club** (with effect from 1-4-36).—Aerodrome: Wingham, Sussex. The Secretary, 21 Gildredge Road, Eastbourne.
- Edinburgh Flying Club** (as from 1-2-35).—Aerodrome: MacMerry Aerodrome, East Lothian. The Secretary, 50 Melville Street, Edinburgh.
- Exeter Aero Club** (with effect from 1-6-37).—Aerodrome: Exeter Airport, Exeter. The Secretary (at Aerodrome).
- Hampshire Aeroplane Club** (with effect from 1-5-26).—Aerodrome: Southampton Airport, Southampton. The Secretary (at Aerodrome).
- Herts and Essex Aeroplane Club** (with effect from 1-4-31).—Aerodrome: Broxbourne Aerodrome, Nazeing, Essex. The Secretary (at Aerodrome).
- Hull Aero Club** (with effect from 13-9-34).—Aerodrome: Hull Airport, Hedon, Hull. The Secretary (at Aerodrome).
- Insurance Flying Club** (with effect from 1-11-34).—Aerodrome: Hanworth, Middlesex. The Secretary, 54 Leadenhall Street, E.C.3.
- Ipswich Aero Club** (with effect from 20-11-36).—Aerodrome: Ipswich Airport, Ipswich, Suffolk. The Secretary (at Aerodrome).
- Isle of Wight Flying Club** (with effect from 7-11-35).—Aerodrome: Sandown Aerodrome, I.O.W. The Secretary (at Aerodrome).
- Kent Flying Club** (with effect from 4-4-35).—Aerodrome: Canterbury Aerodrome, Bekesbourne, Kent. The Secretary (at Aerodrome).
- Lancashire Aero Club** (with effect from 31-7-27).—Aerodrome: Manchester (Woodford), near Stockport. The Secretary (at Aerodrome).
- Leamington, Warwick and District Aero Club** (with effect from 9-2-35).—Aerodrome: Bishop's Tachbrook, Leamington Spa. The Secretary (at Aerodrome).
- Leicestershire Aero Club** (with effect from 1-10-30).—Aerodrome: Leicester Aerodrome, Braunstone. The Secretary (at Aerodrome).
- Liverpool and District Aero Club** (with effect from 1-4-28).—Aerodrome: Hooton Park, Liverpool, and Liverpool Airport. The Secretary (at Aerodrome).
- London Aeroplane Club** (with effect from 31-7-27).—Aerodrome: Hatfield Aerodrome, Herts. The Secretary, 119 Piccadilly, W.1.
- London Air Park Flying Club** (as from 7-1-35).—Aerodrome: Hanworth, Feltham, Middlesex. The Secretary, 7 Park Lane, W.1.
- London Transport (C.B.) Sports Association Flying Club** (with effect from 1-10-34).—Aerodrome: Broxbourne Aerodrome, Nazeing. The Secretary, 88 Gladstone Avenue, Manor Park, E.12.
- Malling Aero Club** (with effect from 1-4-36).—Aerodrome: W. Malling, Maidstone, Kent. The Secretary (at Aerodrome).
- Midland Aero Club** (with effect from 31-7-27).—Aerodrome: Castle Bromwich. The Secretary (at Aerodrome).
- Midland Bank Flying Club** (with effect from 1-5-38).—Aerodrome: London Air Park, Feltham, Middlesex. The Secretary, Midland Bank, 27/32 Poultry, E.C.2.
- Newcastle-upon-Tyne Aero Club** (with effect from 31-7-27).—Aerodrome: Newcastle Airport, Woollington, Kenton, Northumberland. The Secretary (at Airport).
- Norfolk and Norwich Aero Club** (with effect from 1-11-27).—Aerodrome: Norwich Municipal Aerodrome, Norfolk. The Secretary (at Aerodrome).
- North British Aero Club** (with effect from 21-4-36).—Aerodrome: Aberdeen Aerodrome, Dyce, Aberdeen. The Secretary (at Aerodrome).

- North of Ireland Aero Club** (with effect from 8-4-36).—Aerodrome: Ards Airport, Newtownards. The Secretary (at Aerodrome).
- North Staffordshire Aero Club** (with effect from 1-10-34).—Aerodrome: Meir Aerodrome, Stoke-on-Trent. The Secretary (at Aerodrome).
- Northamptonshire Aero Club** (with effect from 1-4-30).—Aerodrome: Sywell Aerodrome, Northampton. The Secretary (at Aerodrome).
- Northern Aviation School and Club**—Aerodrome: Barton Airport, Manchester. The Secretary (at Aerodrome).
- Plymouth and District Aero Club** (with effect from 1-4-37).—Aerodrome: Plymouth Airport, Crownhill, Plymouth. The Secretary (at Aerodrome).
- Portsmouth Aero Club** (as from 10-12-35).—Aerodrome: Portsmouth Airport, Hants. The Secretary (at Aerodrome).
- Reading Aero Club** (with effect from 14-10-37).—Aerodrome: Reading Aerodrome, Woodley, Bucks. The Secretary (at Aerodrome).
- Redhill Flying Club** (with effect from 1-1-35).—Aerodrome: Redhill Aerodrome, Surrey. The Secretary (at Aerodrome).
- Romford Flying Club**—Aerodrome: Romford Aerodrome, Essex. The Secretary (at Aerodrome).
- Scottish Flying Club** (with effect from 1-12-27).—Aerodrome: Renfrew Aerodrome, Renfrew. The Secretary (at Aerodrome).
- Sheffield Aero Club** (with effect from 1-4-36).—Aerodrome: Nether Thorpe, Sheffield. The Secretary, 2 Bank Street, Sheffield.
- South Coast Flying Club** (with effect from 1-9-35).—Aerodrome: Shoreham Airport, Sussex. The Secretary (at Airport).
- Southend Flying Club** (with effect from 12-7-35).—Aerodrome: Southend Airport, Rochford, Essex. The Secretary (at Airport).
- South Staffordshire Aero Club** (with effect from 1-4-37).—Aerodrome: Aldridge Road, Walsall, Staffs. The Secretary (at Aerodrome).
- Strathay Aero Club** (with effect from 1-4-37).—Aerodrome: Perth Aerodrome, Scone. The Secretary, 1 Charlotte Street, Perth.
- Thanet Aero Club** (with effect from 1-4-36).—Aerodrome: Ramsgate Airport, Kent. The Secretary (at Airport).
- Tollerton Aero Club** (with effect from 1-9-34).—Aerodrome: Tollerton, Nottingham. The Secretary (at Aerodrome).
- University Aero Club** (with effect from 29-4-36).—Aerodrome: Cambridge. The Secretary, 18 Jesus Lane, Cambridge.
- Wiltshire Flying Club** (with effect from 1-10-34).—Aerodrome: High Post, Salisbury. The Secretary (at Aerodrome).
- Witney and Oxford Aero Club** (as from 1-10-34).—Aerodrome: Witney Aerodrome, Oxford. The Secretary (at Aerodrome).
- Worcestershire Flying Club** (with effect from 1-11-37).—Aerodrome: Pershore (Tlrochmorton), Pershore, Worcestershire. The Secretary (at Aerodrome).
- Yapton Aero Club** (with effect from 1-3-35).—Aerodrome: Portsmouth Airport, Portsmouth. The Secretary (at Aerodrome).
- York and Leeming Flying Club** (with effect from 1-4-36).—Aerodrome: York Municipal Aerodrome, Clifton, York. The Secretary (at Aerodrome).
- Yorkshire Aeroplane Club** (with effect from 11-8-34).—Aerodrome: Leeds-Bradford Aerodrome, Yeardon. The Secretary (at Aerodrome).

- ### UNSUBSIDISED LIGHT AEROPLANE CLUBS
- B.B.C. Flying Club**—Aerodrome: Redhill, Surrey. The Secretary (at Aerodrome).
- Civil Aviation Service Corps**—Aerodrome: Gravesend and Cambridge Aerodromes. The Secretary, Maxwell House, Arundel Street, Strand, W.C.
- County Flying Club Ltd.**—Aerodrome: Rearsby, Leicestershire. The Secretary, 10 New Street, Leicester.
- Doncaster Aero Club**—Aerodrome: Airport, Doncaster. The Secretary (at Airport).
- Ely Aero Club**—Aerodrome: West Fen Road, Ely. The Secretary, City Chambers, Market Street, Ely, Cambs.
- Heston Airport Club**—Aerodrome: Heston Airport. The Secretary (at Airport).
- Household Brigade Flying Club**—Aerodrome: Heston Airport. The Secretary (at Airport).
- Lincolnshire Aero Club**—Aerodrome: Airport of Grimsby. The Secretary (at Airport).
- Northern Aviation School and Club**—Aerodrome: Barton Airport, Manchester. The Secretary (at Airport).
- Romford Flying Club**—Aerodromes: 1. Romford Aerodrome, Colchester Road, Harold Park, Romford. The Secretary (at Aerodrome).
2. Stapleford Aerodrome (Women's Air Patrol).
- Royal Air Force Flying Club**—Aerodrome: Hatfield, Hertfordshire. The Secretary (at Aerodrome).
- R.E. Flying Club**—Aerodromes: by arrangement. The Secretary, R.E. Mess, Aldershot.
- R.N. Flying Club**—Aerodrome: Hanworth. The Secretary, C30 Royal Aeronautical Society, 7 Albermarle Street, W.1.
- Old Etonian Flying Club**—Aerodrome: Heston Airport, Middlesex. The Secretary (at Aerodrome).
- Luton Flying Club**—Aerodrome: Luton Aerodrome, Beds. The Secretary (at Aerodrome).



VARNENE OIL VARNISH STAIN

will make a better job of it

Woodworkers and Model makers will find "Varnene" Oil Varnish Stain the most efficient method of giving a professional finish to their handiwork. "Varnene" ensures a high-gloss finish of extreme durability. Its stain sinks deeply into the wood, leaving the varnish to provide a tough surface which will not readily chip or scratch. Insist on "Varnene," the finer quality Oil Varnish Stain.

In Dark Oak, Walnut, Mahogany, Light Oak, Ebony Black and Clear (Colourless) Varnish. From Handicraft Stockists, Ironmongers, Oilmen, Grocers and General Dealers.

TINS 6d., 1/- & 1/6.

VARNENE
The finer OIL VARNISH STAIN

Chiswick Products, Ltd., London, W.4.

V/DY/57



Watching Smith, the old clock sghed, "It's rather a shame to get into a lather. Let me put you right What you need is FLUXITE. I learned that much from your grandfather."

See that FLUXITE is always by you—in the house—garage—workshop—wherever speedy soldering is needed. Used for 30 years in government works and by leading engineers and manufacturers. Of Ironmongers—in tins, 4d., 8d., 1/4 and 2/8. Ask to see the FLUXITE SMALL-SPACE SOLDERING SET—compact but substantial—complete with full instructions, 7/6.

Write for Free Book on the ART of "SOFT" SOLDERING and ask for Leaflet on CASE-HARDENING STEEL and TEMPERING TOOLS with FLUXITE.

.....
TO CYCLISTS! Your wheels will NOT keep round and true unless the spokes are tied with one wire at the crossings AND SOLDERED. This makes a much stronger wheel. It's simple—with FLUXITE—but IMPORTANT.
.....

THE FLUXITE GUN

is always ready to put Fluxite on the soldering job instantly. A little pressure places the right quantity at the right spot and one charging lasts for ages. Price 1/6.



ALL MECHANICS WILL HAVE

FLUXITE

IT SIMPLIFIES ALL SOLDERING

FLUXITE Ltd., Dept. P.M., Dragon Works, Bermondsey St., S.E.1

BUY, EXCHANGE OR SELL

TOOLS

Special large purchase $\frac{1}{8}$ " Split Circular Dies, guaranteed quality, usual price 10d. to 1/3' each. Sizes in stock, $\frac{1}{8}$ ", $\frac{3}{16}$ ", $\frac{1}{4}$ ", $\frac{5}{16}$ ", $\frac{3}{8}$ ", $\frac{1}{2}$ ", $\frac{5}{8}$ ", $\frac{3}{4}$ ", $\frac{7}{8}$ ", $\frac{1}{1}$ " Whit., B.S.F., also Brass Tube Thread, Cycle Thread, and Model Engineer 40 Thread; also in 0, 1, 2, 3, 4, 5, 6 B.A. Thread. Offered at the low price of 6d. each, 5/6 per doz. Also Taps to suit, guaranteed, 6d. to 10d. quality clearing at 3/- doz., 4d. each; all B.A. sizes and others to $\frac{1}{4}$ " diam.; also $\frac{3}{16}$ " and $\frac{1}{8}$ " 6d. each. Also best Adjustable Tap Wrenches to $\frac{1}{2}$ ", 9d.; Die-Stocks, 9d.—Below.

12 only, Ball-Bearing Double-ended Grinding Heads to take $\frac{1}{2}$ " bore wheels, practically new, 15/- each. Six only, Stands for same fitted with rise and fall slide suitable for converting to surface or special tool grinder, bargain 10/- each.—Below.

300 Sets 1" Circular Dies, $\frac{1}{8}$ ", $\frac{3}{16}$ ", $\frac{1}{4}$ ", $\frac{5}{16}$ ", $\frac{3}{8}$ ", $\frac{1}{2}$ ", $\frac{5}{8}$ ", $\frac{3}{4}$ ", $\frac{7}{8}$ ", $\frac{1}{1}$ " Whit., B.S.F., Brass Thread, also American S.A.E. Thread for Yankee Cars; clear at 2/9 set of Five; also best quality Taps to suit any above sets, 2/9 set of Five. Adjustable Tap Wrenches to $\frac{1}{2}$ ", 1/9 each; 1" Die-Stocks, 1/9 each. Guaranteed.—Below.

3,000 High Speed Twist Drills, $\frac{1}{16}$ " to $\frac{3}{8}$ ", actual value from 5d. to 8d. each. Bargain 2/- doz.—Below.

Finest Quality Tool Steel, Round, Bright, $\frac{1}{8}$ " to $\frac{3}{4}$ " diam., 4 lb., 2/6; larger sizes, 8 lb., 4/-. Costs 2/- lb.—Below.

- 1/9 any lot. Wonderful Value.—Below.
- One Gross Bright Steel Hex. Bolts with Nuts.
- Dozen Assorted Files, 4" to 6".
- Six Assorted Files, 6" to 12".
- Three Assorted Files, 12" to 14".
- Six Assorted Grinding Wheels, 2" to 2 1/2" diam.
- Dozen Twist Drills, $\frac{1}{16}$ " to $\frac{1}{4}$ " diam. Best quality.
- Grinding Wheels, Carborundum, about 6" by 1" wide, 1" hole.
- Three Hex. Die Nuts, Cycle Thread, $\frac{1}{16}$ ", $\frac{1}{8}$ ", $\frac{3}{16}$ ".
- Three Slitting Saws, 2 1/2" diam., $\frac{3}{32}$ " to $\frac{1}{4}$ " thick.
- Four M.M. Dies, $\frac{1}{8}$ " diam.
- Dozen Assorted Taps.
- 3" Square Tool Holder, with H.S. Tool.
- 2 Doz. Hack-saw Blades, 9", 10", or 12".
- Two H.S. Tap Fluting Cutters, 1 1/2" diam.—Below.
- 2/9 any lot.—Below.
- 0 to 1/2 Drill Chuck, Morse Taper or half-inch Straight Shank.
- Dozen Drills, $\frac{1}{16}$ " to $\frac{3}{8}$ ".
- One each, 3", 4", 1" Whit. Taper Taps.
- 18 Assorted Flexible Shaft Grinding Wheels, 1" to 1 1/2" diam.—Below.
- 4/- any lot.
- 16 Lengths Silver Steel, $\frac{1}{8}$ " to $\frac{1}{2}$ " Round.
- Dozen Superfine Swiss Files.
- 2 Dozen Files, 4" to 10".
- Taper, 2nd and Plug Taps, Whit., $\frac{1}{16}$ ", $\frac{1}{8}$ ", $\frac{3}{16}$ ", $\frac{1}{4}$ ".
- Set Hex. Die-Nuts, $\frac{1}{8}$ ", $\frac{3}{16}$ ", $\frac{1}{4}$ ", 1", Whit. or B.S.F.

400 Dozen Tool-makers' Needle Files. An absolute necessity for small work. Clearing at 2/9 per dozen; assorted shapes.—Below.

600 Morse Taper Sleeves, 1-2, 1/6; 2-3, 1/10; 3-4, 2/6. Best quality, ground finish. British made.—Below.

1,000 Fine Emery Wheels, 2" to 4" diam., 1" hole, 1" to 1 1/2" thick, slightly used, but quite serviceable, 1/6 per dozen.—Below.

Super Quality High-Speed End Mills, Right hand, for use in Lathe. Straight Shank, $\frac{1}{8}$ ", 2/-; $\frac{1}{4}$ ", 2/9; actual value nearly treble. Also $\frac{3}{8}$ ". Best Quality Carbon Steel, 1/9 each.—Below.

Genuine Carborundum Wheels, 9" diam., 1" hole, 1" wide, 5/-; $\frac{1}{2}$ ", 6/6; $\frac{3}{4}$ ", 7/6; 2", 10/- each; 7" diam., 1" hole, 1" to 1 1/2" wide, 2/6 each. All suitable for general tool use. Also Rough Wheels, 1 hole 1 1/2" wide, 8", 3/6; 7", 3/-; 6", 2/3.—Below.

Please Note.—£1 orders and above only are post paid; small orders please allow for postage.—Steel Bars, carriage forward.—Below.

J. BURKE, 30 TRIPPET LANE, SHEFFIELD.

BRAND NEW POWER TOOLS of quality. 10 in. Bandsaws, 54/-. Jigsaws, 22/6. Wood Planing Machines, 80/-. Bench Drills, 11/-. Circular Saws, from 25/-. 3 in. S.C. Toolroom Lathes, from £4 11s. New 1 in. Chromium Plated Micrometers, 12/6. Electric Drills, 32/6. Grinders, Spray Plants, Guns, Air Compressors, etc.—John P. Steel, Clyde St. Mills, Bingley.

BE A MAN!

STRENGTHEN YOUR VITAL FORCES!

Are you a victim of Inferiority Complex, Self-Consciousness, Unreasonable Fears, Bad Concentration and Memory, Timidity, Lack of Self-Control, Weak Will, Bad Habits, Thinness, Flabbiness, Nervous Disorganisation, etc.

To trace the cause, write for my free book—
"DO YOU DESIRE HEALTH?"

Sent POST FREE in plain envelope.
 Also write to me fully in confidence for a FREE and considered opinion of your case.

Over 30 years' experience in the drugless treatment of Nervous disorders and ill-health arising from weakening and health-destroying habits and a lack of manly self-control.

All replies and books sent in plain sealed envelopes.
 T. W. STANDWELL, Curative Physical Culture Consultant
 Dept. P.M., 329, High Holborn, London, W.C.1

JUBILEE WORM DRIVE HOSE CLIPS



The long-life clip with the ever-tight grip
The Best Known
 For Radiator Joints
 Air, Oil, and Water
 Hose Joints.

We guarantee a Tight Joint

Stocked by all Garages and Accessory Dealers.

L. ROBINSON & CO.,
 25 LONDON CHAMBERS,
 GILLINGHAM, KENT.

WEBLEY AIR PISTOLS

Marvellously accurate for target practice.

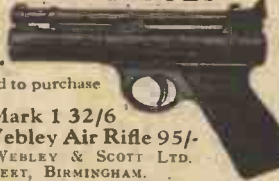

No licence required to purchase or use at home
 Senior 45/-, Mark 1 32/6
 Junior 21/-, Webley Air Rifle 95/-
 Write for List, WEBLEY & SCOTT LTD.
 106 WEAMAN STREET, BIRMINGHAM.

FOYLES

Booksellers To The World
 Enrolments taken for the Scientific Book Club
 119-125 CHARING CROSS RD., LONDON, W.C.2
 Telephone: Gerrard 5660 (14 lines)



How to Obtain
A Perfect-Looking Nose
 My latest improved Model 25 corrects all ill-shaped noses quickly, painlessly, permanently and comfortably at home. It is the only nose-shaping appliance of precise adjustment and a safe and guaranteed patent device that will actually give you a perfect-looking nose. Write for free booklet and testimonials.
 M. TRILETY, SPECIALIST (D.257),
 45, HATTON GARDEN, LONDON, E.C.1.

INVENTORS

VALUABLE GUIDE

General Advice Free. POST FREE 6d.
CHATWIN & CO. Est. 1880
 Regd. Patent, Design and Trade Mark Agents for all countries.
 253 (D) Gray's Inn Road, London, W.C.1.

TOOLS—Continued

GRAYSON'S Glass-boring Outfits and Tube Cutters avoid risk.—Below.

DRILLS, Taps, Dies, Files, Chisels and Punches. Best quality at keenest prices.—Grayson & Company, 300, Campo Lane, Sheffield.

WOODWORK

CABINET HARDWOODS, Oak, Mahogany, Ash, Whitewood, Ply-woods. Lowest Prices. Send Cutting Lists.—Wilfred Parr & Co., March Works, Lancaster Road, Leytonstone, E.11.

MISCELLANEOUS

ASTRONOMICAL TELESCOPE OUTFITS 5/6 !! For assembling 30 ins. Instrument comprising 1 1/2 ins. aperture objective with brass cell, superior eyepieces with tubes, one day, two celestial, magnification, 12, 35, 50 diameters. Latter equivalent 2,500 x area. In compartment box with illustrated instructions.—Below.

SUPER MIDGET TELESCOPES, 1/3 !! Bound in real hide. Triple brass sections. Open fountain pen size. 10 mile range. 2 for 2/.—Below.

MIDGET ELECTRIC AEROPLANE MOTORS, 8/6 !! Masterpiece in miniature. Weight only 50 grammes. Royal blue tubular case, enclosed crushproof. Diameter 24 mm., length 30 mm. 2,000-4,000 R.P.M. 1 1/2-4 1/2 volts. Complete in box with 3 midget 4 oz. cells. Operates from one or more. With detailed instructions describing adaptation, time switching, etc., etc. Enormous experimental field. Photograph, 2d.—Below.

4-VOLT A.C.-D.C. ELECTRIC MOTORS, 1/- !! 6,000 R.P.M. Complete kit of parts, easily assembled. With illustrated instructions. 2 for 1/9.—Below.

LAB. MICROSCOPES T.N.P., 27/6 !! Exceptional bargains. Illustration, see page 632. Supplied to every profession. Numerous testimonials. Magnification 100-300 diameters. Latter equivalent 90,000 x area. Photograph, 2d. Polarizing attachments, 15/6 extra.—Below.

ABOVE POST FREE. C.W.O. C.O.D. 1/- extra. Postage abroad. J. K. M. Holmes, Scientific Instrument dealer, Dept. PM.6, "Vizcaya," Wolveleigh, Gosforth, Newcastle-on-Tyne.

A LARGE QUANTITY of surplus engineering electrical materials, low prices.—London Electric Firm, Croydon.

"MODEL ENGINEER" EXHIBITION. Do not miss our display on SAMPLE STAND. Complete equipment and supplies for the AMATEUR.—Queen's Engineering, 60 Queen's Road, Battersea, S.W.8.

INDUCTION MOTORS

"Wilco" are now able to deliver from stock a new range of reliable first-class A.C. Motors. The enclosed type as illustrated, has self-lubricating bearings, bronze impregnated with graphite. These "Wilco" motors are silent running and will not interfere with radio. Excellent for model driving, sign display mechanism, etc. The range includes two types geared down to 96 and 47 r.p.m. respectively.



1/40th H.P.

21/-

Post Paid

OUR NEW CATALOGUE, Fully revised; many new motors etc. included. 4d. Post Free Cash or C.O.D.
L. WILKINSON, 204, Lower Addiscombe Road, Croydon, Surrey.

USED MODEL TRAINS

Perfect bargains, equal to new. Send 41d. for our catalogue of used trains and models and save money. GEORGES', 11, FRIARS STREET, IPSWICH.

OUR ADVICE BUREAU

COUPON

This coupon is available until September 30, 1938, and must be attached to all letters containing queries, together with 3 penny stamps. A stamped addressed envelope must also be enclosed.
PRACTICAL MECHANICS, SEPT., 1938.