

Christmas Number

NEWNES

PRACTICAL MECHANICS

6^d

IN AUSTRALIA
AND
NEW ZEALAND

DECEMBER 1939



DO NOT CONCENTRATE ON WAR

Do not concentrate your thoughts upon war subjects. You will find it very worrying and very bad for the nerves.

Read, write, sketch, paint, study your vocation; anything that will occupy your mind and your time. Make use of the long dark nights by concentrating upon something useful.

During the last war many people learned how to write short stories etc., to-day a number of them are world-famed authors.

By becoming efficient in your vocation you can give the best service to your country and to yourself. The more you increase your earning power the better it is for the country and for yourself personally.

War or no war, earning power always brings its possessor to the front. It is no use waiting for better times. The ideal opportunity never arrives. We have to make the best of existing conditions. Therefore, delay is useless; it is worse, it is harmful.

YOU CANNOT MAKE MONEY BY SAVING

If you save 10s. per week for 10 years you have only got £260, but if you spend 2s. 6d. per week for 12 or 18 months on a correspondence course, you give your brains a chance to earn thousands of pounds, then there is no need to save. Savings are likely to vanish, but earning capacity is a permanent investment.



DO ANY OF THESE SUBJECTS INTEREST YOU?

Accountancy Examinations
Advertising and Sales Management
Agriculture
A.M.I. Fire E. Examinations
Applied Mechanics
Army Certificates
Auctioneers and Estate Agents
Aviation Engineering
Banking
Blueprints
Boilers
Book-keeping, Accountancy and Modern Business Methods
B.Sc. (Eng.)
Building, Architecture, and Clerk of Works
Builders' Quantities
Cambridge Senior School Certificate
Civil Engineering
Civil Service
All Commercial Subjects
Commercial Art
Concrete and Structural Engineering
Draughtsmanship. All branches

Engineering, All branches, subjects and examinations
General Education
G.P.O. Eng. Dept.
Heating and Ventilating
Industrial Chemistry
Institute of Housing
Insurance
Journalism
Mathematics
Matriulation
Metallurgy
Mining, All subjects
Mining, Electrical Engineering
Motor Engineering
Motor Trade
Municipal and County Engineer
Naval Architecture
Novel Writing
Pattern Making
Play Writing
Police, Special Course
Preceptors, College of Press Tool Work

Pumps and Pumping Machinery and examinations
Radio Communication
Radio Service Engineering
Road Making and Maintenance
Salesmanship, I.S.M.A.
Sanitation
School Attendance Officer
Secretarial Exams.
Sheet Metal Work
Shipbuilding
Shorthand (Pitman's)
Short-Story Writing
Speaking in Public
Structural Engineering
Surveying
Teachers of Handicrafts
Telephony and Telegraphy
Television
Transport Inst. Exams.
Weights and Measures Inspector
Welding
Wireless Telegraphy and Telephony
Works Managers



If you do not see your own requirements above, write to us on any subject. Full particulars free.

STUDY AT HOME IN YOUR SPARE TIME



CAN YOU CHANGE MY EXPRESSION?

IF SO, YOU MAY BE THE ARTIST THAT COMMERCE IS WAITING FOR

Jim Duck

Just try it for yourself. Trace or draw the outline and then put in the features

There are hundreds of openings in connection with Humorous Papers, Advertisement, Drawing, Posters, Calendars, Catalogues, Textile Designs, Book Illustrations, etc.

60 per cent. of Commercial Art Work is done by "Free Lance Artists" who do their work at home and sell it to the highest bidder. Many Commercial Artists draw "retaining fees" from various sources, others prefer to work full-time employment, or partnership arrangement. We teach you not only how to draw what is wanted, but how to make buyers want what you draw. Many of our students who originally took up Commercial Art as a hobby have since turned it into a full-time paying profession with studio and staff of assistant artists; there is no limit to the possibilities. Let us send full particulars for a FREE TRIAL and details of our course for your inspection. You will be under no obligation whatever.

Jim Duck ART DEPT. 76.

LET ME BE YOUR FATHER

Let me tell you how to make a success of your career.

If your future is undecided or appears unsatisfactory, let us talk it over together. I want to help, and it will cost you nothing to get my help; you will be under no obligation whatever.



I HAVE HELPED THOUSANDS OF OTHERS

And when I say thousands, I do not exaggerate, as I can produce well over 10,000 unsolicited testimonials from grateful students who, through our Postal Training, have achieved their life's ambition.

W. Bennett



Dept. 76, THE BENNETT COLLEGE, SHEFFIELD

EVERY DEPARTMENT IS A COMPLETE COLLEGE: EVERY STUDENT IS A CLASS TO HIMSELF

JOURNALISM

Short-Story, Novel and Play Writing

There is money and pleasure in Journalism and in Story Writing. No apprenticeship, no pupillage, no examinations, no outfit necessary. Writing for newspapers, novels or pictures is not a gift; it is a science that can be acquired by diligent application and proper guidance. It is the most fascinating way of making pastime profitable. Trained ability only is required; we do the training by post. Let us tell you all about it.

DEPARTMENT OF LITERATURE 76

If you attend to this now, it may make a wonderful difference to your future.

COUPON—

CUT THIS OUT

To Dept. 76, THE BENNETT COLLEGE LTD., SHEFFIELD
Please send me (free of charge)

Particulars of.....
Your private advice about
(Cross out line which does not apply)

PLEASE WRITE IN BLOCK LETTERS

Name.....

Address.....



If it's a RAWLPLUG PRODUCT it's the BEST OF ITS KIND



RAWLPLUG DUROFIX

Durofix resists heat and water, and is ready for instant use without first warming as is necessary with most cements. It is colourless, and joins made with Durofix are almost invisible. There are hundreds of uses for Durofix in every home. Sold in tubes at 6d. and 1/- each.

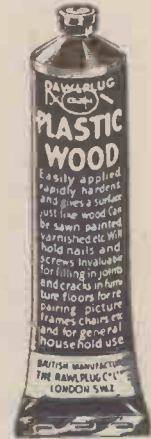

RAWLPLUG PLASTIC WOOD

Rawlplug Plastic Wood is a pliable material which can be moulded and fashioned into any shape desired. Hardens when dry and becomes exactly like real wood, when it can be cut, stained, planed or painted. Waterproof and weatherproof. Tubes at 6d. and 1/- and in tins from 9d. upwards.

RAWLPLUGS

It's so easy to make neat permanent fixtures with Rawlplugs—without damage to walls or decorations. Every Rawlplug Outfit contains full equipment for fixing any ordinary article to any material. A Rawlplug Outfit is indispensable to every householder who takes a pride in his home. Complete outfits, 1/6, 3/6 or 5/6.



RAWLPLUG TILE DRILLS

The Rawlplug Tile Drill is a twist drill of very high quality. It can be used for drilling holes in tiles, brick and soft stone, and can be re-sharpened very easily. Very quiet and outstandingly efficient in use. Prices from 9d. to 1/9 each. Sizes from 3/16" to 3/4".

'JUNIOR' ELECTRIC DRILL

A practical electric hand drill for the handyman's workshop. Sturdy, light and dependable, it ensures accurate drilling. Drills wood or metal. Takes up to 1/4" drills. Can also be used for sandpapering, buffing, burnishing, etc. All voltages. Price 42/- each.



RAWLPLUG BLOW LAMPS

The Rawlplug Spirit Blow Lamp is an efficient lamp for all soldering work. Can be used for heating and tinning the soldering iron and for "sweating" joints. A very useful lamp for all general heating purposes. Price 1 6 each.

227 The Rawlplug Co., Ltd., Rawlplug House, Cromwell Road, London, S.W.7

Christmas Presents

How about a Model Train, Boat or Aeroplane? Or if you would like to build something we can supply all types of fittings, castings, materials and tools. Send 6d. for Bond's 208-page catalogue which illustrates and lists all the items that we can supply.

"Endeavour" Yachts



These new Yachts are the latest thing for fast racing work. All of the hulls are hand made in best yellow pine. Cabin skylight extra.

Prices:

- 17-in. Yacht with automatic rudder ... 13/2
- 21-in. Yacht with automatic rudder ... 20/4
- 27-in. Yacht with Braine type steering ... 43/5
- 36-in. Yacht with Braine type steering ... 82/6

Carriage extra.

Megow Balsa Flying Kits



Kits for 12-in. wing span Flying Models of the AERONCA, BOEING P12E, CURTISS PURSUIT, HELL DIVER, LOCKHEED VEGA, MONOCOUCPE, PUSS MOTH, STINSON RELIANT, TAYLOR CUB, VULTEE VIA, WACO, CURTISS FALCON, SPAD, SOPWITH CAMEL, NIEUPORT, GULF HAWK, HORNET MOTH, MILES MAGISTER.

Price 11d. Postage 3d.

Kits for 24-in. wing span Flying Models of the STINSON RELIANT, WACO CUSTOM, MONOCOUCPE, CONSOLIDATED P/30, FAIRCHILD, HAWKER FIGHTER, CURTISS HAWK, RICHMAN and MERRILL'S VULTEE. Price 2/6.

Postage 4d.

BOND'S O' EUSTON ROAD LTD.
357, Euston Road, London, N.W.1

Telephone: EUSton 5441-2.

Est. 1887.

Deciding Factors...

The DLP Vice-Screwing Machine should occupy a central position in YOUR workshop.

Adaptability

The DLP Machine combines the functions of all these tools, without loss of individual efficiency.

- Parallel Vice
- Pipe Vice
- Tube, Rod and Strip Bender
- Cable, Rod and Pin Cutter
- Screwing Machine
- Punching Machine
- Cable Stripper
- Flat and Conical Anvils

Compactness

The space required on your bench is only 12" x 18".

Economy

The purchase price is but a fraction of the cost of the separate tools listed above.

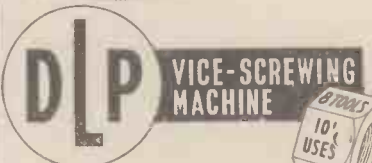

£5-17-6

Illustrated Folder on Application.

Patent No. 418,829



SOLE DISTRIBUTORS FOR THE BRITISH ISLES:
BUCK & HICKMAN LTD.
2 WHITECHAPEL RD., LONDON, E.1.
Overseas Enquiries to DeLaPre Components Ltd., Northampton

ENGINEERS!

EQUIP YOURSELF FOR WORK OF NATIONAL IMPORTANCE

BY BECOMING TECHNICALLY QUALIFIED



Men with technical knowledge are as important as troops and ammunition. For the country's immediate needs and your own future gain you are urged to send immediately for a free copy of "ENGINEERING OPPORTUNITIES."

Containing 268 pages of practical guidance, this book is, beyond argument, the finest and most complete handbook on Successful Engineering Careers ever compiled. It is a book that should be on the bookshelf of every person interested in engineering, whatever his age, position or experience.

The Handbook contains, among other intensely interesting matter, details of B.Sc., A.M.I.C.E., A.M.I.Mech.E., A.M.I.E.E., A.M.I.A.E., A.M.I.W.T., A.M.I.R.E., Civil Service and other important Engineering Examinations; outlines courses in all branches of Civil, Mechanical, Electrical, Automobile, Radio, Television and Aeronautical Engineering, Building, Government Employment, etc., and explains the unique advantages of our Employment Department.

WE DEFINITELY GUARANTEE "NO PASS-NO FEE"

If you are earning less than £10 per week you cannot afford to miss reading "ENGINEERING OPPORTUNITIES." In your own interests we advise you to write (or forward the coupon) for your copy of this enlightening guide to well-paid posts—NOW.

There is no cost or obligation of any kind.

BRITISH INSTITUTE OF ENGINEERING TECHNOLOGY

410a, SHAKESPEARE HOUSE,
17, 18 & 19, STRATFORD PLACE, LONDON, W.1

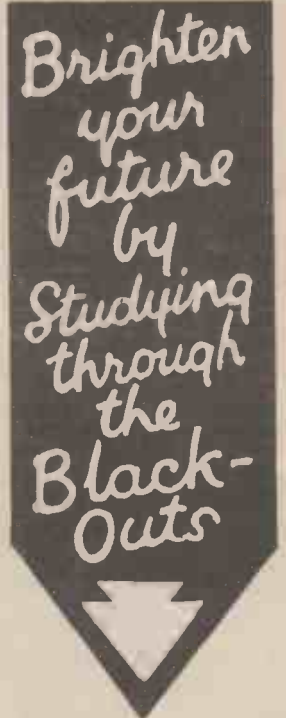

-----TEAR OFF HERE-----
FREE COUPON

BRITISH INSTITUTE OF
ENGINEERING TECHNOLOGY,
410a, Shakespeare House,
17-19 Stratford Place, W.1.

Please forward, Free of cost or obligation of any kind, your 268-page Handbook. "ENGINEERING OPPORTUNITIES."

Name.....

Address.....

.....

.....

PRACTICAL MECHANICS

Editor: F. J. CAMM

VOL. VII. DECEMBER, 1939. No. 75

SUBSCRIPTION RATES

Inland and Abroad 7s. 6d. per annum
Canada - - 7s. per annum

Editorial and Advertisement Offices: "Practical
Mechanics," George Newnes Ltd.
Tower House, Southampton Street, Strand, W.C.2.

Phone: Temple Bar 4363.
Telegrams: Newnes, Rand, London.

Registered at the G.P.O. for transmission by
Canadian Magazine Post.

*Copyright in all drawings, photographs, and
articles published in "Practical Mechanics"
is specifically reserved throughout the
countries signatory to the Berne Convention
and the U.S.A. Reproductions or imitations
of any of these are therefore expressly
forbidden.*

Will you Help?

EVERY reader of this journal is by now aware of the fact that all newspapers, and some periodicals, are available only to standing order. Newsagents in many cases are not permitted to return unsold copies, and whilst many of them have the wisdom to order extra copies so that they can still supply casual sales and thus take the risk of having a few unsold copies on their hands, some are adopting the practice of ordering only such copies as will meet their certain requirements. During the past month I have received a large number of complaints from readers who, accustomed to purchase their copies from different newsagents, have found that they have been unable to purchase a copy. There have been cases of other readers who have placed a standing order but have still been unable to obtain the copies because an assistant behind the counter, unaware that copies in stock are on order, has supplied casual sales and then even regular readers have been unable to obtain copies. We hope our readers will co-operate with us by sending us details of all such cases. Where a reader has had the wisdom and foresight to place a standing order, it is unfair that his copy should be sold to a casual customer. We are, of course, endeavouring to supply each newsagent with an adequate supply, of copies to meet all demands.

Cost of Paper Increased

WE are doing our utmost to ensure the widest possible distribution throughout the war, which brings inevitable problems to journals of this character. On the cost side alone, the paper on which this journal is printed has risen by as much as 60 per cent., and there are indications that prices will rise even beyond that figure. The Government is controlling the paper output and rigidly rationing supplies

because wood pulp forms one of the ingredients of munitions. Additionally, it is exceedingly difficult now to import paper and the raw materials used in its manufacture.

Readers, therefore, will be performing a service which we shall greatly appreciate if they will at once place a standing order with their newsagents for the regular supply of this journal, and thus help us to conserve our paper supplies. It is important that we should not waste the paper used in the production of unsold copies. In normal times we are happy to supply newsagents with a sufficient number of copies to supply all needs and we permit them to return unsold copies. Now that we have been compelled to economise in this direction the reader in helping us in the manner suggested will be helping himself and also the State.

I drew the reader's attention to this matter last month, but there are many who did not heed my advice. I hope, now that I have stressed the point, that it will not be necessary for me to have to answer further letters explaining why copies have not been so readily available for casual sales.

Power from the Pithead

COAL is one of the vital minerals of industry. Upon its production depends the generation of millions of horse-power per year for the operation of power plants, locomotives, ships, and steam-driven machinery, quite apart from its use as a fuel for heating purposes. It has always seemed to me futile to mine the coal and to dispatch it all over the country, thus adding to its cost, when the power itself could quite easily be produced at the pithead, where the coal is cheapest, and the power distributed through the country by means of the grid scheme. This latter links up the various electrical undertakings of the country, whereas by the pithead production of power it could be used merely to link up the

mining districts and distribute the power throughout the country.

As far as the overhead-grid system is concerned, I regarded it with mixed feelings when it was first mooted. I pointed out, in the Press and elsewhere, that in time of war it would provide the enemy with a means of locating every power station in the country, as well as providing him with an aerial map of Great Britain. Unfortunately, my words were not heeded, for the scheme was planned soon after the last war closed, when peace and disarmament were in the air and politicians were paying lip service to peace in our time. I am quite certain now that those responsible see the error of placing cables overhead. It has advantages if the world can be kept at peace. Unfortunately, we now know that war is one of those inevitable and recurring disasters which overtake the world at least once every 25 years.

When this present war is over I hope that due consideration will be given to the economical production of cheap power and a modification of the grid scheme on the lines I have suggested.

Our Workshop Series

THIS month I commence the first of a series of practical articles intended for all those thousands of readers who are now engaged in the workshops of this country. The series will cover every aspect of engineering, from the foundry to the finished product, and the workshop processes to be dealt with will include tool making, fitting, turning, pattern making, milling, planing, shaping, boring, works layout, precision grinding, forging, press tool work, finishing, polishing, plating, sheet metal work, and plastics.

Each process will be dealt with by an expert in that particular field, and the series will be illustrated by practical drawings and photographs. A further article will appear next month.

Easy Magic For Christmas

Mystifying Tricks that
Need Neither Skill nor
Special Apparatus

By Norman Hunter
(The Well-known Conjuror of
"Maskelyne's Mysteries")

Further Articles on the Secrets of
Conjuring will appear Regularly
and Exclusively in this Journal



Fig. 1.—A trick with smoke. The painted metal disc is white on the reverse side and covers the prepared letters on the ready smoked plate

THE conjurer shows two white china plates and proceeds to blacken the insides by smoking them with a burning taper. He carefully wipes the edges clean, leaving a black disc in the centre of each plate and places the plates together, one upside down on the other.

He now asks members of the audience to name various towns in England. One of these is chosen and when the plates are separated the name of the chosen town is seen printed on the soot-covered surface of one plate. To prove that the printing

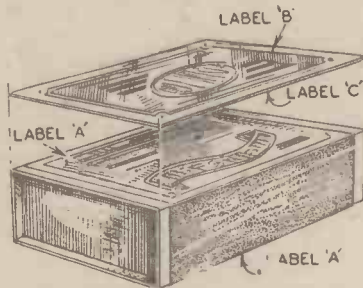

Fig. 2.—Camouflaging a matchbox

has genuinely been done by wiping the letters out of the soot, the performer takes a cloth and rubs the whole of the black off the plate.

Fig. 1 shows practically the whole of the secret. The plates are not prepared, but with them is used a disc of tin enamelled white on both sides. One side of the disc is now painted with flat black, leaving about half an inch margin round. The disc fits neatly into either plate.

Preparing the Trick

To prepare the trick, carefully smoke one plate with a wax taper and wipe round the edge so as to leave a neat black disc in the centre of the plate. With one finger print, by wiping away the soot, the name of a town as shown in the photograph. Place the tin disc on this plate, black side down. The two plates may now be shown and will

appear to be quite clean as the white enamelled surface of the disc hides the writing. The plates are now smoked over by allowing the flame of a wax taper to play on the surface of the plate. Move the taper about so that no part of the plate gets too hot. In smoking the plate with the disc on it, the disc is held in position by pressure of the fingers, and it is the disc which receives the sooty deposit. Wipe round the edges, and in doing so clean away all the soot from the faked plate, leaving only the disc sooty.

The unprepared plate is now placed over the other and the two reversed in placing them on a side table. When they are again separated the painted side of the disc represents the smoked part of one plate, while the prepared word stands out in the sooty deposit on the other.

To ensure that the right name is chosen is simple. As the names are called out you write the same one down each time on slips of paper. The slips are then folded and dropped into a hat from which a member of the audience is asked to take one. As all slips bear the same name, he cannot fail to choose the word the conjurer has prepared.

Camouflaging a Matchbox

The performer shows an ordinary box of matches. He holds it in his left hand and

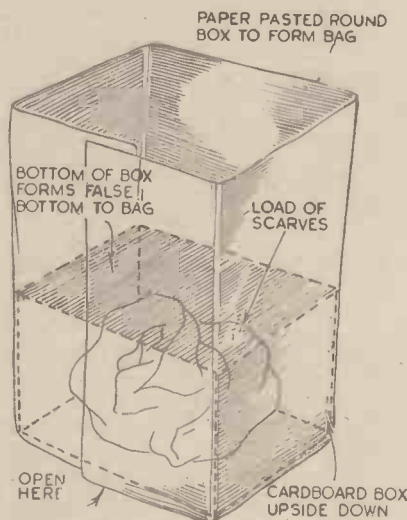

Fig. 4.—The overflowing bowl. The fake bag is made by pasting brown paper round a cardboard box



Fig. 3.—The overflowing bowl. How the silk scarves are concealed in the space below the false bottom of the bran bag

shows his right hand empty. By passing his hand in front of the box he causes the matchbox label to change to an entirely different one. Another pass produces another change, the right hand being shown empty each time and the back and front of the matchbox being also shown each time. Finally, a third change takes place and the box is thrown out for inspection.

The box is not prepared. With it is used a fake consisting of a piece of cardboard cut to the size of the front of the box. A

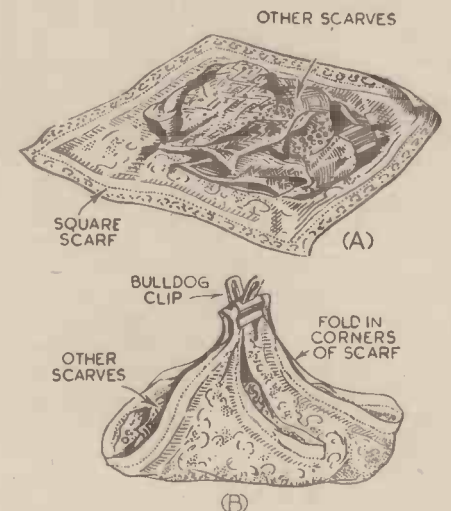

Fig. 5.—The load for the overflowing bowl

different matchbox label is pasted on each side of this fake. The ordinary box should be one of the kind that has a label on both sides (Fig. 2).

At the start the fake is underneath the box. Both hands are shown empty except for the box, but the reverse side of the box is not shown. In making the first change the box is simply turned over under the cover of the right hand. This exposes one side of the fake. The second change is made by turning the fake over on the box



Fig. 6.—Method of cutting the cards for the kings' congress trick

as the hand passes across it. The third change is accomplished by again turning the box over, thus bringing the original label into view. The loose fake is then slid off and concealed in the bend of the fingers while the box is thrown for inspection. While the audience are busy looking for spring flaps, the conjurer quietly drops the fake behind some object on his table as he picks up some object for the next trick.

Now for a showy trick :

The Overflowing Bowl

The bowl is an ordinary one of brass or papier mâché, and it is shown to be quite empty. Bran is poured from a bag into the bowl, and the pouring is done from sufficient height to prove that nothing is introduced with the bran. Yet, in spite of this, the conjurer plunges his hands into the bowl and produces from the bran numbers of silk scarves or flags.

The secret in this case lies in the bag. This has a false bottom placed some way up inside the bag, and it is in the space so formed under the bag that the load of scarves is concealed, as shown in Fig. 3.

The easiest way to make the fake bag is to take a cardboard box of suitable dimensions and paste stout brown paper round it as shown in Fig. 4. Crease the corners down and trim the paper level with the rim of the box at the bottom, or else turn the edge of the paper in and paste it down. The load of scarves is now prepared as shown in Fig. 5. A large square scarf is spread out and the remaining scarves, or any other articles it is desired to produce are placed in the centre of the square. The corners are now turned in and the folded corners so formed are turned in again, until the bundle is small enough to slip easily into the space under the bag. An ordinary bulldog clip is then used to fasten the corners together. Fig. 5 A shows the first stage of this preparation and B the finished parcel. In Fig. 3 the scarves are shown loose in the fake bag for the sake of explaining the general idea. Actually, however, the load must be done up tightly so as to drop out of its own accord.

Performing the Trick

To perform the trick, have some loose bran in the upper part of the bag. Show the bowl, which should be large and deep. Put the bag of bran bodily inside, keeping one hand under the bag as you lift it to prevent the load from falling out. Take a handful of bran from the bag and trickle it on to a plate to show what it is, then lift the bag out of the bowl, holding it by the top edge. This will leave the load behind in the bowl. Bran is now poured into the

bowl and over the load. If desired the bowl of bran may be tipped forward and shown. The production then proceeds by simply releasing the clip and drawing out the silks.

Kings' Congress

This is a card trick. The four kings are taken from the pack. Two are placed respectively on the top and bottom of the pack; the remaining two are put in the centre. Yet when the conjurer deals out the cards all four kings have come together in the centre of the pack.

No preparation and no special cards are needed. After placing one king at the bottom of the pack and one at the top you say that you will cut the pack. This you do. But instead of lifting off the top half to make the cut, you slide cut the bottom half. Fig. 6 shows you how to do this. When the remaining two kings are placed between the two halves, they naturally go on top of the king already on top of the pack. Similarly the king which is on the



Fig. 7.—How the wineglass is held in the fingers under cover of the cloth

bottom of the pack comes on top of the other three when the halves of the pack are placed together. The best way to finish the trick is to spread the cards out face upwards on the table with a sweeping movement.

A Wineglass from Nowhere

The performer shows a large handkerchief on both sides and spreads it over his out-



Fig. 8.—Producing a wineglass. Here the glass is being brought up to stand on the outstretched hand under cover of the cloth

stretched hand. The handkerchief lies quite flat over the palm of his hand. With the other hand he picks up the handkerchief by the centre and slowly lifts it, revealing a wineglass standing on the palm of his hand.

This is quite easy, but if neatly performed the effect is a small sensation. Use a handkerchief or scarf about two feet square. The wineglass is concealed under the left arm under the jacket, the bowl being gripped under the armpit and the foot sloping down and forwards. Hold the scarf four square to the audience with the thumbs on top and all the fingers behind. The backs of the hands will be turned towards the audience.

Having shown one side of the scarf, pass the right hand behind the left, bringing the left hand across to the right side. This shows the back of the scarf and brings the right hand naturally inside the jacket. Take hold of the stem of the wineglass between the first and second fingers, the foot of the glass resting against the inside of the fingers.

Bring the hands back to the original position and the glass will remain hidden behind the scarf. Now hold the right hand palm upwards, quite flat and drape the scarf over it, taking care not to expose the glass as you do so. The position is now as shown in Fig. 7.

To produce the glass, nip the scarf just on the palm of the hand and raise it straight up. As you do so, under cover of the folds, bend the fingers of the right hand over until the glass stands on the palm of the hand. See Fig. 8. All that remains to be done is to release the grip and straighten the fingers, which leaves the glass standing on the outstretched hand as the cloth is lifted right away.

If you possess a rubber cover to fit the glass (you can buy these covers from shops



Fig. 9.—Vice versa. The wineglass being inverted under the covering cloth, allowing the egg to drop into the hand

which sell conjuring tricks) you can produce the glass full of wine, the rubber cover keeping the liquid in. In this case the cover is pulled off in the folds of the scarf.

Vice Versa

An egg is placed in a wineglass and covered with a cloth. A small silk handkerchief is rolled between the hands and it changes to stand on the outstretched hand under cover of the cloth. When the glass is uncovered the handkerchief is found inside.

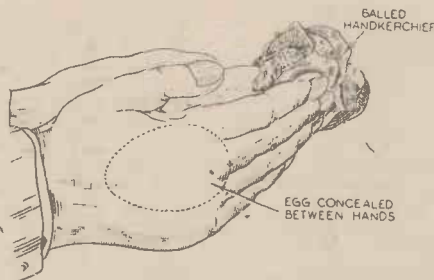

Fig. 10.—The balled handkerchief is held at the finger tips whilst the egg remains hidden between the palms

As only one egg and one handkerchief are used in this trick, the egg may be marked and the handkerchief borrowed, thus adding to the effect.

Fig. 9 shows the move upon which the whole secret depends. Choose a wineglass of the port type which has an open bowl. The foot of the glass is approximately the same diameter as the rim. Take the egg (use a hard-boiled one or a wooden one for safety) and get someone to initial it. Drop the egg into the glass. Hold the glass by the bowl and throw the cloth over it. As the cloth covers the glass, quickly turn the glass upside down as shown in Fig. 9. The foot of the glass now shapes the draped cloth and to the audience it looks exactly the same as if the glass was right way up. Take the covered glass with the right hand and stand it on the table. The egg drops out and remains concealed in the slightly curled fingers of the right hand.

Concealing the Handkerchief

The borrowed handkerchief should be on a table to your left. Pick it up with the hand that holds the egg. Roll the handkerchief into a ball, then conceal the balled handkerchief behind the fingers and bring the egg into view instead. The simplest way to do this is to hold your hands as if you were saying a prayer that the trick will come off all right. Hold the balled handkerchief at the finger tips, the egg remaining hidden between the palms (see Fig. 10). The fingers now draw back the handkerchief while the thumbs roll the egg up and over it.

Take the egg in the left hand and give it for identification. Pick up the covered wineglass by the foot. Place the right hand under the folds of the cloth and tuck the handkerchief into the inverted glass. Grip the bowl of the glass between forefinger and thumb. Let the glass swing round to its normal position as you remove the cloth.

Melting Money

The conjurer says he wants a small coin for the trick. He finds sixpence among the other coins in his pocket and, returning the other coins to his pocket, deliberately puts the sixpence into his left hand, which he closes. He now gets two members of the audience to hold his left wrist. Yet when he opens his hand the sixpence has gone.

Although this is a rather dishonest sort of trick, it is extremely puzzling. When you find the sixpence among the other coins you hold it up between thumb and forefinger with the remaining coins still in the hand. Say "We shan't want the other coins," plunge the hand into your pocket and leave the coins there. Now comes the crafty part. In leaving the loose coins in your pocket you also leave the sixpence there and bring your hand out empty but still held as if it had the sixpence between thumb and finger. Keep the hand moving and very deliberately

pretend to put the sixpence into the closed left hand.

You can now lay great stress upon the fact that with your wrist held by two people you cannot possibly get the sixpence out of your left hand undetected. Quite true. But as the sixpence has never been in the left hand, its disappearance is now quite easy.

The Picture Comes to Life

A plain wooden frame is freely shown and a sheet of paper is stretched over it, being fastened down with drawing pins. Both sides of the frame and paper are shown and the conjurer then picks up the frame and draws upon it a sketch of a bunch of flowers.

Having finished the sketch, he breaks the paper, puts his hand through the picture and produces from the empty frame a bunch of flowers similar to the sketch, thus making the picture come to life.

This trick is very simple and easy to do in spite of its brilliant effect. The frame is

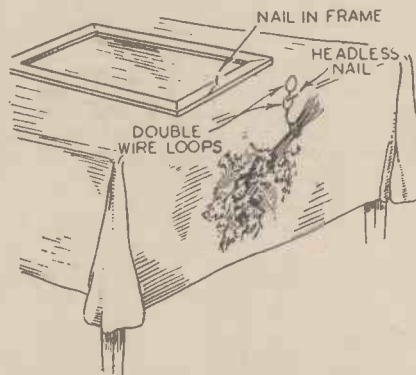

Fig. 11.—A bunch of flowers suspended behind the table by means of a loop of florist's wire

just an ordinary wooden picture frame without glass or back. In the centre of the top a small nail is driven.

The bunch of flowers, which can be real or artificial, just as you like, is suspended behind the table by a loop of florist's wire as shown in Fig. 11. The wire goes round the stems of the flowers and is then twisted into a double loop, one loop being above the other. The lower of the two loops is slipped over the nail, which should have the head cut off. The cloth on the table hides the flowers from the audience.

Preparing the Frame

In performing the trick, show the frame freely but keep a finger over the nail so that it is not seen. Place the frame on the table with the nail towards the loop of wire

which suspends the flowers. (See Fig. 11.) Slip the double loop off the nail in the table and over the nail in the frame. The double loop makes this easy because you simply take hold of the top loop and lift it over the nail on the frame, which automatically frees it from the nail in the table. The

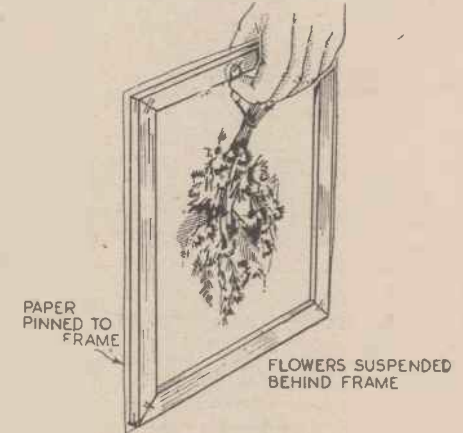

Fig. 12.—Lay the frame flat and pick it up again by the top. This will cause the bunch of flowers to come up and hang behind the frame

movement is covered by the other hand picking up a large sheet of paper.

Pin the paper to the frame with drawing pins. Now lift the bottom edge of the frame, which is nearest to the audience as the frame lies on the table. This permits the audience to see the back of the paper. Lay the frame flat and pick it up again by the top. This will cause the bunch of flowers to come up and hang behind the frame as in Fig. 12.

Sketching the Picture

To sketch the picture use either very soft pastel chalks or else a small paintbrush and a bottle of black ink. To make sure of getting a reasonable looking sketch quickly you can draw it out on the paper before the show, using very pale yellow chalk or pencil. The outline will not be visible to the audience, but you will be able to see it clearly enough to follow with your brush and ink.

When the sketch is complete, break through the paper, unhook the flowers and pull them through the torn sketch. The frame and paper can again be shown on both sides.

One final word of advice. Do not attempt any of these tricks, simple though they are, in front of an audience without trying them over once or twice in private. It is fatally easy to fumble even the simplest action if you haven't done it before.

A Novel Soldering-iron Jet

If you do a great deal of constructional work in radio and use an ordinary soldering iron, the use of the kitchen gas

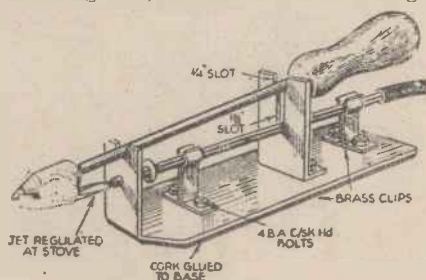

Details of the device

ring proves too expensive, and the illustration depicts a method adopted for introducing the element of economy.

The mounting base is made of 14 gauge aluminium, being fashioned at the jet end, although this is not absolutely essential. The jet is provided by clipping the pilot flint jet normally supplied with a certain type of popular gas stove into small brass spring clips, as shown; then, by regulation at the stove, any heat intensity can be obtained, preventing the iron from either cooling off or over-heating.

The iron supports are provided by turning up one end of the aluminium, whilst fashioning one other bracket piece which is screwed to the base with 4BA bolts as for the spring clips.

BROADCASTING YOUR OWN PROGRAMMES

How to Connect and Use the Gramophone with any Existing Receiver, and suggestions for Increasing the Entertainment provided by Gramophone Records with various Devices

THESE are occasions when the broadcast material does not provide the necessary entertainment, and in the ordinary way this would mean that at a party or family gathering a sudden lull descends upon the proceedings. The usual problem then arises as to what to do next. Some would like to play games, others want to do something else, and so on. Where, however, a gramophone pick-up is fitted as part of the radio equipment no such problem can arise, as the vast variety of gramophone records which is available will enable any desired programme to be given to your guests. You can have any of your favourite radio stars, instrumentalists, or dance bands, and there is no need for any dull moment when you possess a radiogram. Contrary to the views held by many listeners, it is not necessary to have access to the electric-supply mains before you can use a radiogram. Although the majority of radiograms on the market are designed for mains operation this does not indicate that mains are essential, and this point seems to have prevented many listeners from obtaining a pick-up and converting their receiver into a radiogram. Provided that the volume delivered by your receiver on the radio programmes is ample for your normal listening needs without the necessity

at high frequency. Therefore, the high-frequency portion of the receiver is out of action when a pick-up is being used, and although you can use the detector valve in addition to your L.F. stages, you cannot employ the reaction control. The pick-up

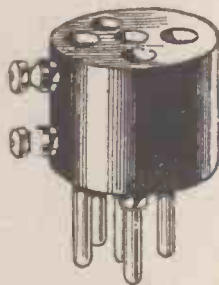

Fig. 1.—This adapter enables the pick-up to be used with any receiver which is not already provided with pick-up terminals or sockets

may be used with any receiver without the need for breaking or disconnecting a single wire, and it is possible to purchase a special



plug to which the pick-up may be joined, and this plug is inserted into the valve-holder beneath the valve. That is to say, the valve is pulled out of its holder in the set, the plug inserted in its place, and then the valve is put back on top of the plug. The pick-up is then in position and may be used in the usual way. From what has been said previously, it is obvious that an H.F. valve must not be removed, and thus the pick-up plug or adapter is inserted only in the detector or L.F. valve-holders. If there is no volume control on the L.F. side of the receiver it may be found with some pick-ups that overloading and consequent distortion will take place if the pick-up is used with the detector valve, due to the fact that the amplification is too great to enable the output valve to handle the signal. In such a case the pick-up would be joined to the L.F. valve.

Choosing a Pick-up

When obtaining your pick-up, therefore, you must first consider your circuit. If there is only one L.F. stage, you can only use the detector with that stage and this will provide quite a good degree of amplification. Consequently you should obtain a pick-up with a moderate voltage output. Similarly if your receiver employs a metal rectifier feeding the output stage, you can only use one stage of L.F. amplification, and a very sensitive pick-up would be needed to obtain sufficient volume. You can obtain a pick-up for as low as 5s., or if you have no portable gramophone with which to use this simple type of instrument, you may obtain one complete with a carrier arm. As a motor has to be used to turn the record, however, a simple portable gramophone of the standard type may be obtained quite cheaply and will enable you to make your receiver into a radiogram at the minimum of expense. If you desire to re-design your present receiver to make it into one of the modern types of radiogram, you can obtain a clockwork or electric motor to mount on the top of the cabinet, and fit a standard pick-up with arm and volume control. In this case the makers will supply a template showing the correct position for the carrier arm to ensure that the tracking is correct. That is to say, if not correctly mounted, the angle of the needle in respect to the sound grooves on the record will change and this may result in the records being damaged owing to the sides being scraped. The position varies according to the type of pick-up and, therefore, you should follow the makers' instructions on this particular point.

Correct Motor Speed

If you use a clockwork motor, or an electric one with speed control, you will only obtain the correct musical pitch when the turntable turns at the correct speed. With the majority of modern records this speed is seventy-eight revolutions per

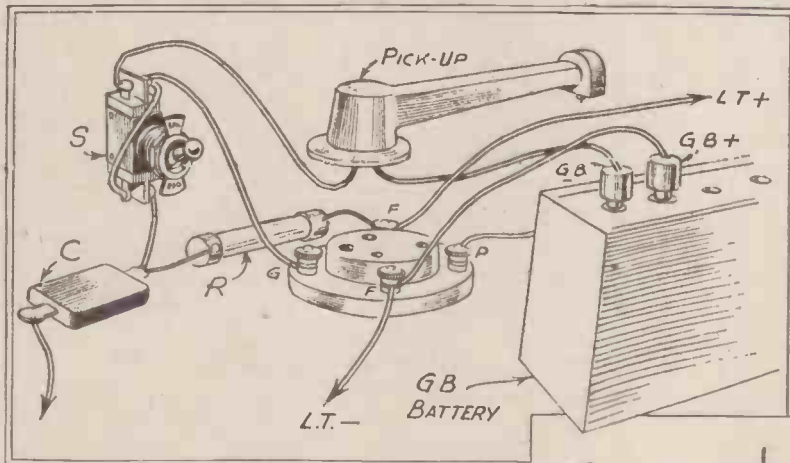
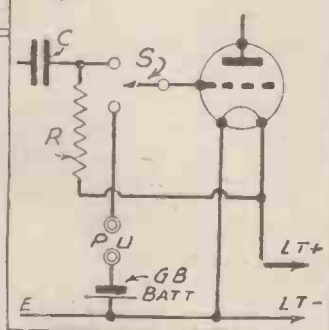

Fig. 2.—The method of connecting a pick-up permanently to a battery detector stage.

for using excessive reaction, then you can obtain a similar volume from a gramophone pick-up.

Fitting a Pick-up

To explain the last point it may be mentioned, for those who are not familiar with the subject, that the gramophone pick-up operates at low frequency, or audio frequency, and the reaction control operates



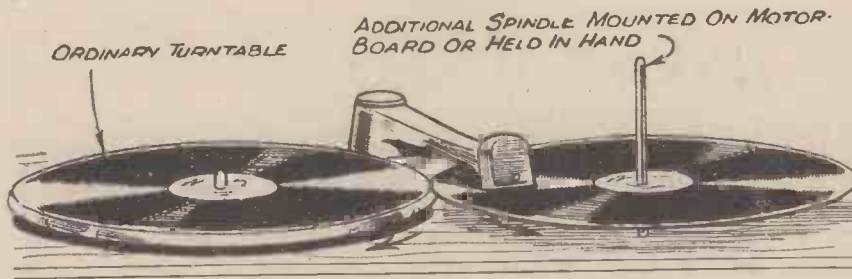

Fig. 3.—By playing a record backwards as shown here, you can obtain some very weird effects

minute, and if the speed regulator is marked in revolutions per minute it is a simple matter to set the indicator to the correct position. If no indication is provided or you wish to check the speed you can use a stroboscope (provided you have A.C. lighting mains available). This consists of a disc having black and white markings round the edge and these are in such a position that when the disc rotates at the correct speed, and it is viewed in the light from an ordinary 50-cycle A.C. lighting supply the markings appear to remain stationary.

If the motor runs slowly the pitch of the music will fall and you can add to the amusement of your guests by playing a record at half-speed. It is interesting to note the effect of this arrangement, as the instruments which have few harmonics (such as the saxophone, trumpet, etc.) do not sound much altered, but the piano, which is rich in harmonics, has a most weird tone and you will find that many people cannot identify it as a piano. Similarly, by running at a very high speed the pitch is raised and the human voice becomes very squeaky, producing an effect similar to the old-fashioned gramophone, owing to the apparent elimination of the lower frequencies. A further scheme to add to the liveliness of a party is to play records backwards, or by the use of an eccentric hole. For the latter another hole should be drilled (or burnt with the aid of a cigarette end) about $\frac{1}{4}$ in. from the correct hole. As the record then rotates eccentrically it is not possible to start it, and then place the needle on the groove. The needle, must, therefore, be placed into position first, and the motor started up, spinning the record so as to obtain the correct speed as soon as possible. (Fig. 4.)

To play a record backwards, a separate spindle should be mounted on the motor board, and the record may then be placed on this with its edge resting against the

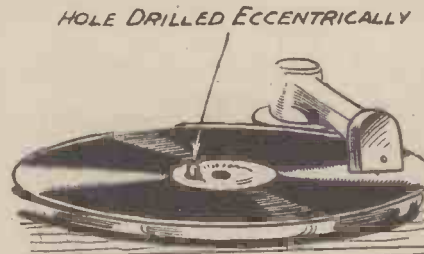

Fig. 4.—Adding to the fun by playing a record eccentrically

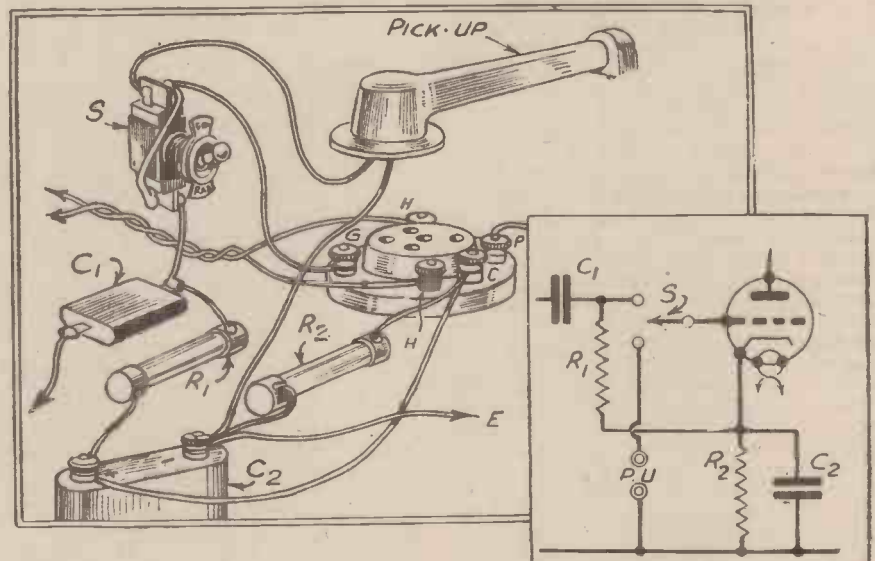

Fig. 5.—Fitting the pick-up to a detector stage in a mains receiver

edge of the turntable. (Fig. 3.) Alternatively, you can hold the record on a pencil or similar round object, resting the under surface on your thumb, and can then press the edge of the turntable giving the required pressure to prevent the record from slipping.

A Permanent Connection

If you require the pick-up to be a permanent connection, a simple single-pole change-over switch may be fitted as shown in Fig. 2. The grid condenser and grid leak are disconnected from the grid terminal of the valveholder and are connected to one side of the change-over switch. The grid is joined to the arm of the switch, and the other side of the switch is joined to the grid bias battery. If the receiver is of the mains type the grid-bias connection is ignored, and that side of the switch is joined direct to earth. To provide the bias for the detector valve (which, you will remember, is not operating as an L.F. valve), a suitable resistor is joined in the cathode lead and by-passed by a suitable condenser. The grid leak is then joined direct to the cathode. The arrangement is shown in Fig. 5, and in the majority of cases a resistor of 1,000 ohms would be needed for the bias circuit and a 25-mfd. electrolytic condenser may be used for by-pass purposes.

Rare Non-Metallic Element

ALTHOUGH iodine is an essential of human life, it is one of the rarest non-metallic elements. Less than one-fiftieth of a gram is contained in a ton of sea water, and although iodine is scattered about the earth in minute quantities, there is only one place in the world—Chili—where it exists in sufficient concentration to be workable.

Trip to the Moon

OWING to the present war, the British Interplanetary Society have ceased all their official activities and the Society's records have been placed in safe custody for the duration. A space ship had been built in theory for a projected trip to the moon, and at the outbreak of the war the Society were mainly engaged in designing a speedometer for the ship. It was claimed that a trip to the moon was on the way to

NOTES AND NEWS

becoming an actual fact, and that pioneers "intend to land on the night side of the moon as the sunlit side is hotter than boiling water and they did not want to go looking for trouble until they were ready for it."

A Thunderbolt

ALTHOUGH there are people who state that they have seen a thunderbolt fall, scientists have now decided that there is no such thing as a thunderbolt. They admit a rare and strange phenomenon known as ball lightning—a luminous, circular body which descends to earth or travels along the ground comparatively

slowly during an electrical storm, and finally bursts—without as far as is known, doing any harm. As, however, it never leaves anything behind to investigate, it is impossible to say with certainty of what it consists.

Heaven in Fourth Dimension

SIR AMBROSE FLEMING recently made the suggestion that Heaven may be in the fourth dimension. He states that although it is the custom to speak of the abode called Heaven as if it was some region in our space of three dimensions, yet scientific analysis has shown that our space may be only, as it were, one section of a larger four-dimensional space-time continuum, and that passage from one to the other is by a movement in a fourth dimension.

A Model Of John Cabot's Ship

Old Time Ships Make Picturesque Models. The Model Described Below Measures 12 in. in Length and is made on the Solid Hull Principle



Fig. 1.—The finished model of John Cabot's ship

LITTLE is known of the details of the actual ship in which Cabot sailed from Bristol in 1479, and in attempting to reconstruct it in model form the best plan is to design it on the lines of a typical late 15th century ship. The general form and details of this can be gathered from old pictures and records which have survived. Ships of this time were extremely picturesque, though, judged by later standards, they left much to be desired from the point of view of navigation. In proportion to their length they were very broad in the beam, and the poop rose high above the waist. From the modelling aspect, however, they make splendid subjects, for the whole hull was brightly painted, and coloured shields were fixed around the sides, giving a rich and decorative affect.

Solid Hull Principle

Fig. 1 shows a model designed on these lines. It measures just over 12 in. in length over-all, and is made on the solid-hull principle with the various parts built up one over the other. Scale diagrams are

shown in figure 8 and the use of these makes the construction simple since it is only necessary to scale the parts to obtain the shapes. The detail given represents the minimum that should be put in to give good effect. A great deal of extra rigging and deck fittings can be added with advantage. There are many pictures and models in libraries and museums from which these can be taken.

The Hull

This consists in the main of a centre keel, A, with the shaped hulls,

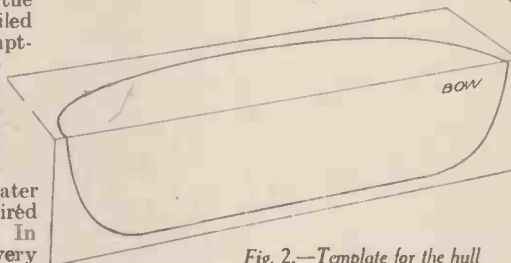

Fig. 2.—Template for the hull

B, glued on at each side. Cut out the keel in 1/8 in. ply to the shape shown by the thick line on the design. It can be fretted out and the edges cleaned up with glasspaper. The hulls, B, follow, and in this case drawings of both plan and elevation are needed. It is a good plan to make a crease along a sheet of tracing paper and make the tracings at each side of this in their correct relative positions as shown in Fig. 2. A suitable wood to use is pine or American whitewood. Prepare the blocks to the finished over-all size and mark in the curves.

The top and the inner side facing the keel should be marked. Otherwise the cutting of the shape will remove the pencil lines.

Begin by cutting the plan shape straight down at right angles. Much can be sawn away, the chisel being used afterwards to remove the lumps. A spokeshave or file is used to finish off. The elevation shaping follows, this again being taken straight across at right angles. The resulting shape is shown at the top in Fig. 3. It is square in section and needs to be rounded.

As the fullest part of the hull is amidships, this shape can be cut first, and a reverse template of it should be cut in cardboard. The stern view to the left in the design shows it. The wood should be fixed in the vice or held down with a clamp and the waste chiselled away. Be careful not to remove too much, and place the template frequently against the hull to see just where the wood needs removing. Having made the centre approximately correct, work first towards the stern and then the bow, making the shape to sweep in a fine curve. After chiselling, a block plane or bullnose plane can be used with advantage. Following this a file is run over the whole thing with a sweeping movement to take out lumps. It is finished off with glasspaper. It is advisable to place the two parts together to make sure that they balance. The lower hull piece, B, in Fig. 3 shows the completed part.

These are now glued to the keel as in Fig. 4. Two or three nails can be driven through the keel into one hull piece, but when fixing the other hull the nails must be driven in askew through the hull at the ends. The nails are punched in and the holes filled in with plastic wood. The cramps shown are useful to make tight joints, but the nails are necessary to prevent the parts from moving under the pressure. Note the blocks of wood to prevent the surface from being damaged.

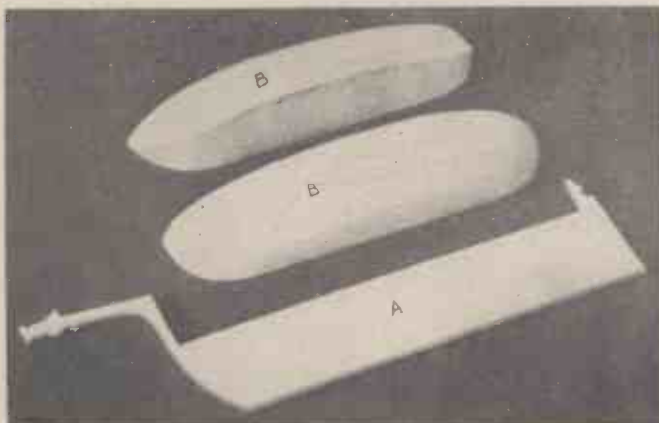

Figs. 3 and 4.—(Left), The two hull pieces B, and the keel A. (Right) The hull pieces glued to the keel

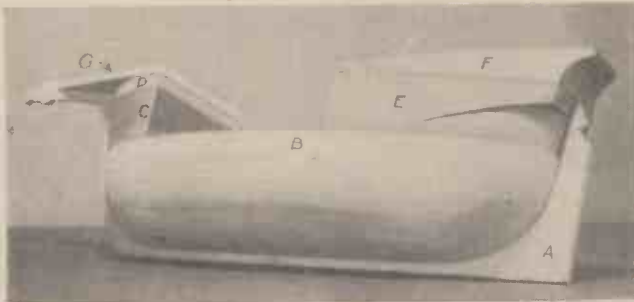

Figs. 5 and 7.—(Above) How the upper decks are mounted on the keel. (Right), The hull ready for painting

Upper Decks

These consist of a series of blocks mounted upon the hull. At the stern are the two quarter deck blocks, E and F, and, although they follow the line of the hull for the greater part, they project at the extreme stern to form the square end as shown in Fig. 5. The length can be taken from the diagram, but it is advisable to place the wood on the hull so that the exact shape at the sides can be marked, the projecting end being continued along in an uneven sweep. Prepare and fix the lower block E first. It can be a trifle full to allow for shaping afterwards. The block F above it projects more than that beneath and is hollowed out as shown, though this part of the work is best done after fixing. The taper, however, must be planed first.

The two fore-castle decks C and D follow, and these are dealt with similarly. When the glue has set, the joints can be levelled and the final shaping worked with the spoke-shave and file. There should be a slight inward slope towards the top, this increasing as the stern is reached. Note that the quar-

ter deck block E is given a sort of sloping notch as in Fig. 5 so that in its lower part it follows the round shape of the hull. At



Fig. 6.—Bending the bulwarks round the sides

ter deck block E is given a sort of sloping notch as in Fig. 5 so that in its lower part it follows the round shape of the hull. At the top it lines up with the block F above it. The line of the notch is in line with the wales which run around the sides of the

vessel. The exact position can be taken from the side view in the design. After glasspapering, the beak floor G is added. This is of 1/8 in. ply and it lies on the fore-castle and projecting stem of the keel piece.

The Bulwarks

For these 1/16 in. ply with the grain upright is used. Two are required, and they are cut to the shape H. The holes for the ports can be either drilled or sawn. At the bow a cut is made so that the lower part will bend around the hull whilst the top is secured to the beak. Fig. 6 shows one of the pieces fixed and the other being bent round. At the stern they line up with the sloping notch. Use glue and fine nails for fixing, bending the wood gradually. Punch in the nails and fill in the holes with plastic wood. At the rear the stern piece J is fixed between them, and the sides of this must be bevelled so that they form close joints with the bulwarks and deck.

The wales and upright pieces are also in 1/16 in. ply. The shape of the former is given on the design. The exact shape is

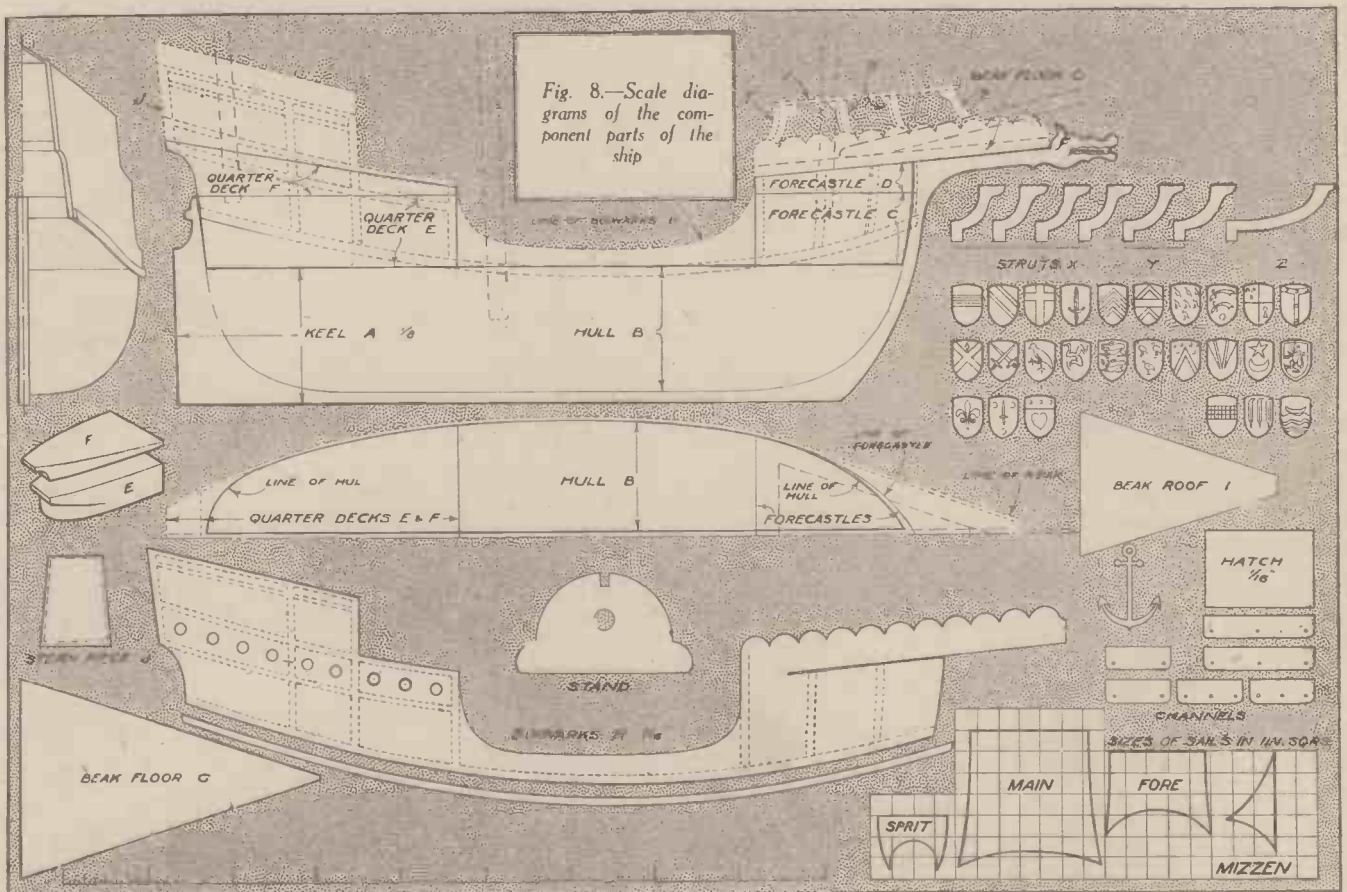

Fig. 8.—Scale diagrams of the component parts of the ship

not important, however, because the wood will bend to an extent in its width. Fig. 7 shows them in position. This illustration also shows the beak roof I and its supports X, Y, Z. The last named are fretted out and fixed with a touch of glue. It is a good plan to allow the glue to become tacky before fixing as the parts will then stay in position. The roof I is also glued. It has a hole drilled through it to allow the mast to emerge, and it is as well to drill the hole in the deck before fixing. Channels to hold the shrouds are cut in 1/8 in. or 3/16 in. wood. Screws hold them in position. Finally the hatch is glued to the main deck and the remaining mast holes drilled.

Painting the Model

Showcard colours are the best to use. Two coats are advisable, the first being rubbed down with fine glasspaper. The portion below the wales is white, and the bulwarks brown. A light brown can be used for the wales and channels, and touches of red and black can be given to give a realistic effect to the figure head. When dry the whole thing is given a coat of clear cellulose lacquer. The design of the shields should be cut out and stuck to thin cardboard. They are painted with a variety of bright colours and glued around the sides.

Rigging

The following are the sizes of the masts and yards. Bowsprit, 5 in. by 3/16 in.

Fore mast, 7 in. by 3/16 in. Main mast, 10 in. by 1/4 in. Mizzen mast, 7 in. by 3/16 in. Bowsprit yard, 3 1/2 in. by 3/16 in. Foremast yard, 5 in. by 3/16 in. Main mast yard, 6 in. by 3/16 in. Mizzen mast yard, 5 in. by 3/16 in. All yards are fixed to the masts with a clenched nail before the last named are glued in place. Holes should be drilled to prevent splitting.

Fig. 9.—How the shrouds are attached to the channels and knot hull

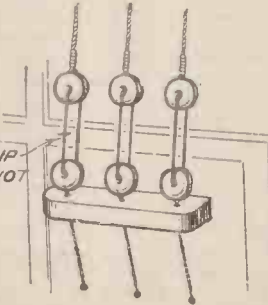

Fig. 9 shows how the shrouds are secured to the channels. The lower row of dead eyes have a piece of thin wire passed around their grooves. It passes thence through holes in the channels to small nails driven into the hull. To make the wires of the same length drive a nail into a board and pass over it one of the dead eyes. Drive in another nail 7/8 in. from the first. The wire is then taken around the groove in

the dead eye, twisted around itself, and taken around the other nail where it is twisted into a loop through which the fixing nail is to be passed.

To these lower dead eyes those above are secured with loops of fine twine which pass through the holes. Before these are added the main shrouds are fixed with twine passed around the masts. They should be all the same length with their dead eyes secured to their free ends. The twine joining the two rows of dead eyes should be tied in a slip knot so that all can be pulled taut. The cross pieces of the shrouds if added can be lengths of fine wire bent around the shrouds and held by pinching in tightly with pliers.

Sails

The sizes of these can be set out from the squared diagrams on the design. Lamp shade vellum is excellent for the purpose. The heraldic device can be painted in showcard colours. The sails are either glued to the yards or stitched on. A length of twine joining the free ends will enable them to retain their bellied shape. The addition of the remaining shrouds and the flags completes the model.

The stand consists of either two shaped pieces of 1/4 in. or 3/8 in. oak joined by a 1/4 in. dowel glued to the holes, or of a solid stand as in Fig. 1. The notches at the top should make a fairly tight fit over the keel.

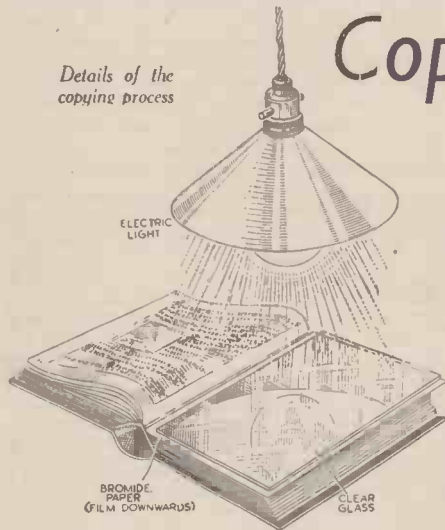

Copying Without a Camera

An Ingenious Idea for Copying Articles from Books Without Damaging the Book

This paper is not usually stocked by photographic dealers, but they could probably obtain a supply to order. Alternatively, any contrasty grade of bromide paper will give reasonably good results if the paper itself is not too thick.

How to Commence

Let us suppose that we require a facsimile copy of a page from a book. First lay a piece of bromide paper—sensitive side downward—on to the page to be copied and hold it down with a fairly thick piece of glass. The glass may be weighted by standing a weight at each corner if necessary, so as to bring the bromide paper into close contact with the printed page. Arrange the whole lot under an electric lamp, as shown in the illustration; all this must, of course, be done in the dark room by red light only. Then make the exposure by switching on the electric lamp, thus exposing the bromide paper through the back. This, perhaps, sounds rather a silly thing to do, for obviously, the bromide paper will be "fogged" all over; but never mind that—make a trial exposure, and when you get the exposure right you will find that although the paper is fogged, the part corresponding to the white background is much denser than the lettering, which will be easily visible by transmitted light.

This depends upon several conditions, such as nature of copy, speed of bromide paper, thickness of bromide paper, the type of lamp used and the distance of the lamp. As some sort of guide, the exposure should be about three seconds, using "Kodak Contrasty Nikko" bromide paper, on a good copy from a magazine printed on good white art paper, with a 40-watt lamp at a distance of 30 ins. from the book.

After exposure the bromide paper should

be developed up fully in the usual manner, and you will get a foggy-looking negative image. This paper negative is then fixed, washed and dried.

The next operation is to make a positive copy from the paper negative. This is done by placing another piece of the same bromide in contact with the negative film to film—and exposing in an ordinary printing frame through the negative. In fact, you just make a bromide print in the ordinary way. The exposure this time will take a lot longer than before, owing to the heavy veil of fog on the negative, something between 30 seconds and one minute will probably be about right for a first trial.

The Best Results

When this print has been properly exposed and developed in the ordinary way, a good clear copy of the original page should result. The best results are obtained from a good black image on smooth white paper; creamy-coloured rough paper will not be so satisfactory, but in such cases an improvement will be obtained if the first exposure is made through a slightly tinted yellow glass screen, if such can be obtained, but the colour must not be very deep, or no results will be possible.

Although the writer has not actually tried it, probably a similar result to that obtained by using the screen could be achieved, by using an oil lamp for making the first exposure. This would necessitate considerable increase in exposure, but would probably give improved results.

Do not be discouraged if your first attempt is not satisfactory, and make several trial exposures on small pieces of paper only before risking a full size sheet, otherwise your failure may become rather expensive.

At first sight it would appear essential to use a camera for copying such subjects as the page of a book by photography, but by making use of the method described below, such work can be done without camera or plates. This is called the "Player-type Process," after the name of its inventor; it is very useful for copying articles from a book, thus avoiding the work of writing out the copy, or else cutting out the article and spoiling the book. You may, for instance, copy an interesting page from a library book; it does not matter if the paper is thick or thin, or whether it is printed on both sides. Illustrations can be reproduced as well and it is possible even to copy photographs, although the results are not likely to be as satisfactory as a proper camera copy in such a case.

As we are not making use of dry plates for this process we naturally require some other light sensitive material, and for this purpose bromide paper will be needed. The most suitable for this work is "Ilford Photo-Mechanical Paper," which has a very contrasty sensitive film on thin paper.

A Mysterious Substance

Facts About the Discovery of Radium and Its Varied Applications

EVER since 1898, when Prof. and Mme. Curie, working in conjunction with M. G. Bémont in Paris, announced the discovery of radium, the word has been familiar to all of us, but few, outside the medical and scientific world, realize exactly what this mysterious substance is.

What is Radium?

In the first place, although radium is classified as an element, in the strictest sense of the word it is no such thing, for it is actually a stepping-stone in a series of ever-changing phases which characterise Nature's surprising alchemy. Actually, we must begin with radium's ancestor uranium which, through time and the workings of Nature, gradually passes through various forms until it appears as radium—in other words radium is an exceedingly active period in the transmutation of uranium to the final stage in which it becomes that common element lead. The process of disintegration—one might almost say decay—is the reason for the powerful emanations or "rays" which are given out by radium, and this process goes on at a fixed and immovable rate. The radioactivity is unceasing, yet it takes over 2,000 years for half a given amount of radium to become lead. Experiments have been made to "hurry up" the process, and so unleash the terrific atomic power contained in radium, but to no avail, though such power, if it could be tapped, would revolutionise the whole world. Some idea of the power available may be formed when it is realised that there is sufficient potential energy in ONE GRAIN of pure radium to lift 5,000,000 tons weight one foot off the ground!

Interesting as such speculations are, and fascinating as may be the transition of the elements from uranium through ionium, radium, radon and polonium to lead, it is with the by-products of this transition that we are really concerned, for it is these emanations that make radium such a powerful factor in medicine and the treatment of that dreadful scourge cancer. Briefly there are four emanations, *alpha* particles, *beta* particles, *gamma* rays and radon—a gaseous emanation which is in itself radioactive.

The *alpha* particles are actually doubly-charged atoms of helium, and are thrown off by radium at the amazing velocity of 10,000 miles per second. Astounding as this speed is, it is a bad second to the *beta* particles which are radiated at a speed varying from 50,000 to 186,000 miles per second, or at roughly the speed of light. The *gamma* ray (which is a ray in the true sense of the word) is identical with that produced by the X-rays. Radon, as before mentioned, is a gas and, in medicine, is collected and stored for use just as any other gas may be.

Making a Spinthariscopes

"Probably very interesting," you say, "but I'd like to see these emanations at work."

That is a relatively simple matter, and a glance at Fig. 2 will show you how to make a simple "viewer" for observing the bombardment of particles from any weakly

radioactive material—or to give the instrument its proper name, a SPINTHARISCOPE.

A B is a tube which may be of tin, wood, cardboard or similar material with two lenses mounted suitably at C and D. This slides in an outer tube, E F, which is closed at the bottom by a disc G. The inner surface of G is coated with ZINC SULPHIDE, while a piece of wire, H, projects from the tube E F in such a way that it is close to, but not touching, G. If a tiny piece of radioactive material (such as a scrap of the coating off a luminous watch hand) is affixed to the end of the wire H, the particles thrown off bombard the zinc

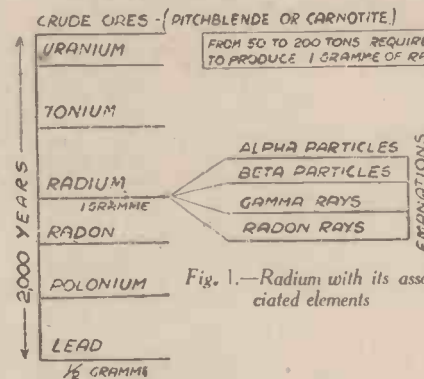

Fig. 1.—Radium with its associated elements

sulphide coating, causing bright scintillations of light on impact, which may be clearly seen on viewing through the aperture J in a dark room. The cheap schoolboy's microscopes sold in shops are quite suitable, or the projection tubes of a toy magic lantern may be easily adapted to make one of these fascinating instruments.

The Benefits of Radium

Quite soon after the discovery of radium, experimenters found that, like the X-ray, it could be used with distinctly beneficial results in the treatment of certain types of cancer. The development of radium-therapy has progressed to such an extent

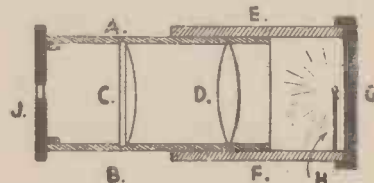

Fig. 2.—Section of a simple spinthariscopes

that thousands of lives have been saved and countless agonies alleviated by the judicious application of this wonderful "element."

The natural result is that many people have jumped to the conclusion that radium is a certain and infallible cure for all kinds of cancer, and that the only obstacle is its prohibitive price! Nothing could be more misleading. Radium has a distinctly curative power over certain types of the disease, but is definitely without any beneficial effect whatever in others and may indeed, if used inexpertly, do more harm than good. Briefly summarised, the reason for this curative action is that while radium

has in time a certain destructive action on all healthy human tissue, this action is many times more powerful on certain types of growths or diseased tissue. It, therefore, destroys the disease long before it can affect the healthy tissue and, with modern methods, the action is limited to the diseased part entirely. The most usual method is to place tubular containers or "needles" of radium or its emanation in the growth itself, and these needles are withdrawn again after each treatment.

The use of radium in this field is a highly specialised job, and calls for a skill only obtainable from practitioners who have made a special study of radium-therapy, as the operator must needs be, not only a doctor, but a physicist as well. Were radium available to the general public, as say, Epsom-salt is, the damage done would be incredible.

The Menace of Radium

We have spoken of the danger of radium in inexperienced hands, and this is indeed a menace. Careless handling of radium or its salts by quite healthy people would result in sores being inflicted which are much akin to the dreaded "X-ray Burn" or dermatitis, which martyred so many of the heroic pioneers of Röntgen's discovery.

It may be easily understood that this danger exists, but what is not so easy to understand is that there are "quack" medicines, cure-alls and "patent" nostrums actually on the market, which are sold under fancy names implying that all the wonderful benefits of radium may be derived from their use.

These fall into two distinct categories. First the plain fake which is radioactive in name only, and does not contain any derivative of radium whatsoever.

Secondly comes the smaller but very important class which embraces "radioactive" waters, ointments, salves and "jars"—this latter type is a semi-porous earthen container in the wall of which are certain radioactive substances, and water left in it for a specified period is alleged to become radioactive itself.

A Danger

Certain preparations of the above type actually do contain material more or less radioactive, and they are a positive danger to health. Eminent specialists are agreed that, owing to the "cumulative" effect of radium preparations, any such nostrum taken into the system and dispersed throughout the human body may not only cause serious injury but actually death, for radium attacks the bone structure and sets up that terrible disease of the bones known as necrosis.

Furthermore, there is no antidote or curative treatment known to science for this condition, once the radium salts have deposited in the bone tissue!

Much has yet to be learnt by science about radioactivity, but in the meanwhile the "man in the street" may reap all its known benefits by seeking the expert without fear or hesitation, but to play with such a terrific source of power or to risk its use without such expert guidance and supervision is a grave risk.

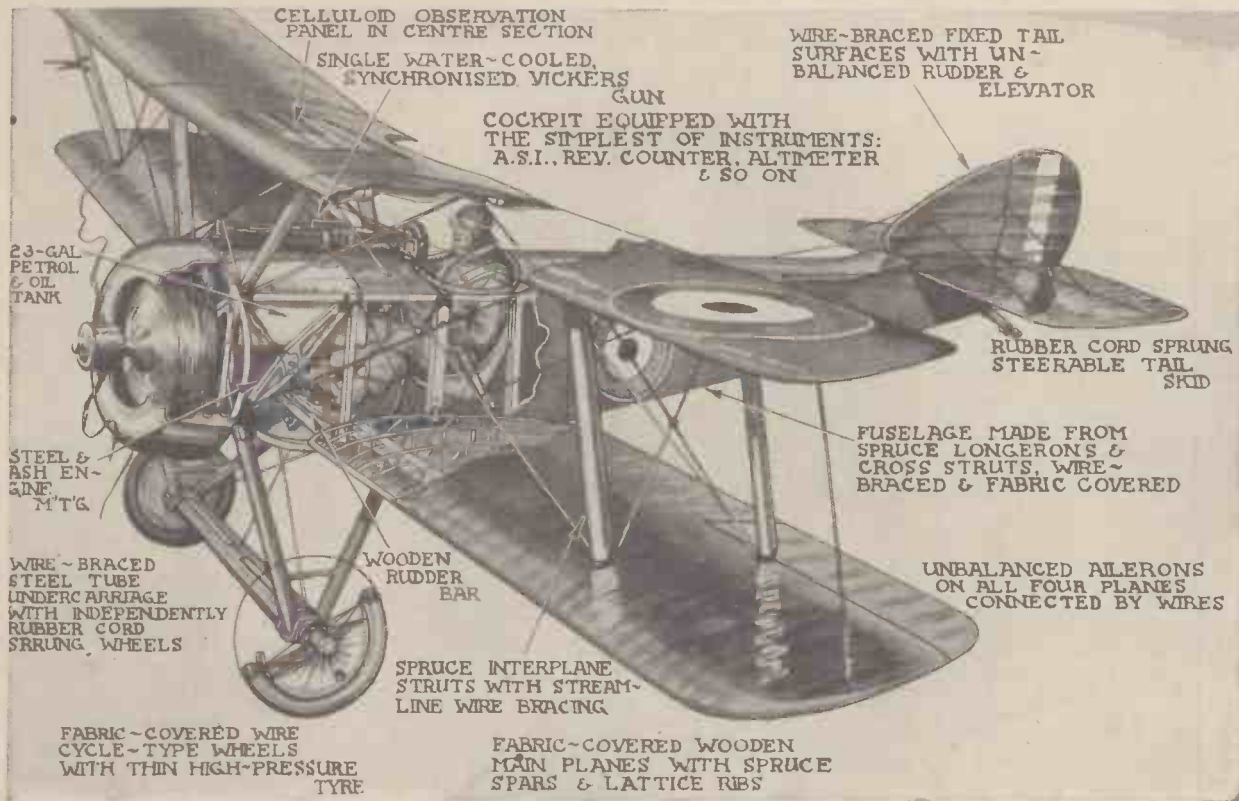

The Pup, a fighting plane of the Great War

Flying in the 1st Great War

By G. Long, F.R.G.S.

THERE is no more wonderful story than that of the Air Force in the Great War. Few people to-day realise how crude, inefficient and dangerous were the machines on which those intrepid pioneer pilots risked their lives. Engines at first were air-cooled—like clumsy motor-cycle engines—and grossly underpowered, usually 70 or 80 h.p. Valves would break, bearings run, or the whole contraption seize up at the slightest provocation, and when such a disaster happened near the ground a fatal crash was highly probable. The 'planes too were no better, rickety "crates" at best, dangerous death-traps at worst, they were built of wood and canvas, and held together by wires like a bird cage. Often they broke up in the air when meeting sudden gusts of wind, or stalled and crashed when taking off. The fact is, of course, that flying was in its infancy when the war broke out in 1914. On November 1st, 1910, there were only 22 pilots in all England and the first crossing of the English Channel (in a 25 h.p. monoplane) had only taken place one year earlier. The first flight over English soil was made by Mr. A. V. Roe in 1908 with an Antoinette Engine, and a year later he flew with an all British J.A.P. engine of 9 h.p., but it was not until 1912 that the Royal Flying Corps was founded, and the Army officially took up aviation, but progress was so slow that when war broke out in August, 1914, only 37 machines were fit to go to the front. They all flew across the Straits of Dover and arrived safely at Amiens on August 14th. The 'planes were mostly B.E.'s and B.E.2C's, with a few monoplanes. They went into action at once and during the Retreat from Mons they staved off a disaster by

THE PUP, 1916		
Maximum power	...	84 h.p.
Span	...	26 ft. 6 ins.
Length	...	19 ft. 4 ins.
Wing area	...	254 sq. ft.
Weight empty	...	787 lb.
Weight loaded	...	1,225 lb.
Speed at 6,500 ft.	...	106.5 m.p.h.
Speed at 10,000 ft.	...	104.5 m.p.h.
Climb to 6,500 ft.	...	8 minutes
Climb to 15,000 ft.	...	30 minutes
Ceiling	...	20,000 ft.
Endurance	...	3 hours
THE HURRICANE, 1939		
Maximum power	...	1,030 h.p.
Span	...	40 ft. 0 ins.
Length	...	31 ft. 5 ins.
Wing area	...	257.5 sq. ft.
Weight empty	...	4,670 lb.
Weight loaded	...	6,000 lb.
Speed at 17,500 ft.	...	335 m.p.h.
Normal cruising speed, 15,000 ft.	...	276 m.p.h.
Stalling speed	...	68 m.p.h.
Service ceiling	...	34,000 ft.
Endurance, at 200 m.p.h.	...	800 miles

discovering that three German Army Corps were attacking Le Cateau instead of one, as imagined by the British staff.

Sir Horace Smith-Dorrien wrote on September 9th, 1914 :

"Our aeroplane officers are real heroes. Not only do they appear to have put the fear of God into the German airmen, for they hunt them wherever they see them, with the result that there have been none in the air for two days, but in spite of being shot at every time they go up, they continue their reconnaissances, and bring back quite invaluable information."

The R.F.C.

Having served with them in the R.F.C. and the R.A.F. I know that this is true,

in fact I am doubtful if any service obtained such splendid keen young men as the pilots of the R.F.C. Many came from the Public Schools, but all were intelligent, plucky, and enthusiastic.

In the course of the war our airmen destroyed more than eight thousand enemy machines, dropped more than eight thousand tons of bombs on enemy objectives, brought down three hundred enemy balloons, and took over half a million photographs. In August, 1914, there were fewer than two hundred and fifty officers, in the whole service, in November, 1918, there were more than thirty thousand, and the thirty-seven 'planes which crossed the Channel at the outbreak of war had grown to twenty-two thousand, and formed the greatest air force in the world.

The High Command of the period were not air-minded. Only a short time before the war began our War Office twice refused the offer of the first really successful 'plane. The generals had never flown themselves, they had no experience of air warfare, and their text books were silent on the subject. It was the young men of the flying services who built up our matchless air force. They worked out problems of strategy and tactics while soaring through the skies in their primitive "crates" and not in the padded armchairs of G.H.Q.

Fighting 'Planes

They soon exploded the uninstructed theories of mere foot soldiers. The first of these was that a 'plane was a mere scout, and incapable of fighting. Within a few weeks, our airmen were fighting the Germans with pistols or carbines—usually without effect. The first German 'plane

was forced down by an R.F.C. scout using a rifle on August 27th, 1914. The Hun was in a "pusher" plane (that is one with the propeller behind). The Englishman got behind—sat on his tail—and could not be fired at by reason of the German's propeller.

At first "pushers" were favoured, because they gave a free zone of fire for shooting ahead, but "tractor" planes were more efficient because the propeller in front got a better grip of the air than a screw behind, where the air was broken up by wings and struts.

The next clever invention was the machine gun firing through the propeller. The number of revolutions of the "prop" were anything from 1,200 to 1,400 per minute, which means that there would be blades in the way of the gun twice that number of times in a minute. The machine guns of the period fired 500 to 600 rounds a minute, and the first idea was the "deflector" prop which was a propeller armoured with steel plates at the point where it might be struck by a bullet. By this arrangement all but about 5 per cent. of the bullets passed through the propeller without striking it, but the bullets seriously affected the smooth running of the engine, and in a few cases actually broke the prop with disastrous results.

There came next a really brilliant idea. It was an interrupter gear, which prevented the firing of the gun during the brief periods of time that the blades were in front of the muzzle.

All this time tactics were being worked out. The great thing was not to let an enemy "get on your tail" in which case he might shoot you down before you knew he was there. If your gun jams so that you cannot fight, the idea is to fly at right angles to the enemy, as it is very difficult to hit a machine so crossing.

A Favourite Dodge

A favourite dodge was to hide in a cloud bank, and pounce on an enemy below. Sometimes big slow bombers were sent as a bait to attract enemy fighters, while our own fighters high aloft were

waiting to swoop down on the unsuspecting foe.

Formation flying was another development, it was modelled on the phalanx of antiquity, and its basis was the triangle. The leader flew in front, and had two other machines slightly behind and above. The rear machines by diving can overtake the leader and support him. Sometimes one such triangle is supported by another triangle overhead and somewhat to the rear. The British airmen were the first to prove the fact that if you charge an enemy plane directly, he will sheer off—but it took some pluck to do it. The planes of that period were controlled by a single lever—called the "Joy-stick." If you push it forward the nose of the machine goes down, if you pull it back the machine begins to climb, banking was also controlled by it in a similar fashion.

War On Zepps.

No story of the R.F.C. in the Great War would be complete without telling how our gallant airmen smashed the Zeppelins. These great gas-bags could fly very high, and for a long time they bombed London and other cities with impunity. Although the Air Peril ought to have been realized, and prepared for, from the very first, nothing whatever was done by the War Office. London's first anti-Zepp. defence consisted of a machine-gun mounted on a motor car. It was in any case hopelessly outranged, but if it had struck the gas-bag it would have had no effect. It was much later that a clever inventor produced the luminous "tracer" bullet, which enabled an airman to direct a stream of bullets on a target like a gardener working a hose. He could see when his aim was correct, and the fire-bullets quickly put paid to gas bag airships.

Nothing was more disheartening to the British public that the complete impunity with which the early Zepps. bombed our great cities. The High Command appeared totally indifferent, and it seemed impossible to make them see that it was of little avail to capture fifty square yards of water-logged shell holes in Flanders, if meanwhile

the heart of the empire was to become a flaming ruin. One Brass Hat even said that the proper remedy for Zepp. raids was "darkness and composure" on the part of the civilian population. In view of the fact that raiding Zepps. actually lighted up their objectives by dropping parachute flares, and sailed away unscathed, the absurdity of this remark is self evident. Happily, however, the skill of our inventors, and the courage of our flying men solved the problem. The first Zepp. was brought down in Belgium by Sub-Lieut. R. J. Warneford, afterwards awarded the V.C. He dropped six bombs upon it, and the explosion turned his plane completely over. The debris of the Zepp. fell on a convent and killed two nuns.

Spectacular Exploit

More spectacular, because witnessed by millions of Londoners was the exploit of Lieut. Robinson on September 3rd, 1916. Thirteen Zepps. raided England that night, set three gasometers on fire at Retford and did extensive damage elsewhere. Five of them reached London, one of them—a Schutte-Lanz semi-rigid type—was flying at a height of two miles when the heroic Robinson sighted it. Ignoring the fire from its machine-guns, and the shells of our A.A. guns, he fired a stream of tracer bullets into the envelope and only barely escaped destruction in the flaming ruin, as it crashed to the ground. Millions of Londoners saw this splendid exploit, and crowds flocked to view the ruins of the "Zepp" at Cuffley.

From that date the Zeppelin peril was overcome. Many more were brought down in flames, and on October 19th, 1917, they met their Waterloo. Twelve of the largest and finest Zepps. set out on a "baby-killing" raid over England, but only four returned to Hunland. In order to escape our planes they were forced to fly at a great height, where their engines froze up. The Zepps. were then carried by the wind over France to the Mediterranean. Five are known to have been brought down in France, two were driven out to sea, and two were lost altogether.

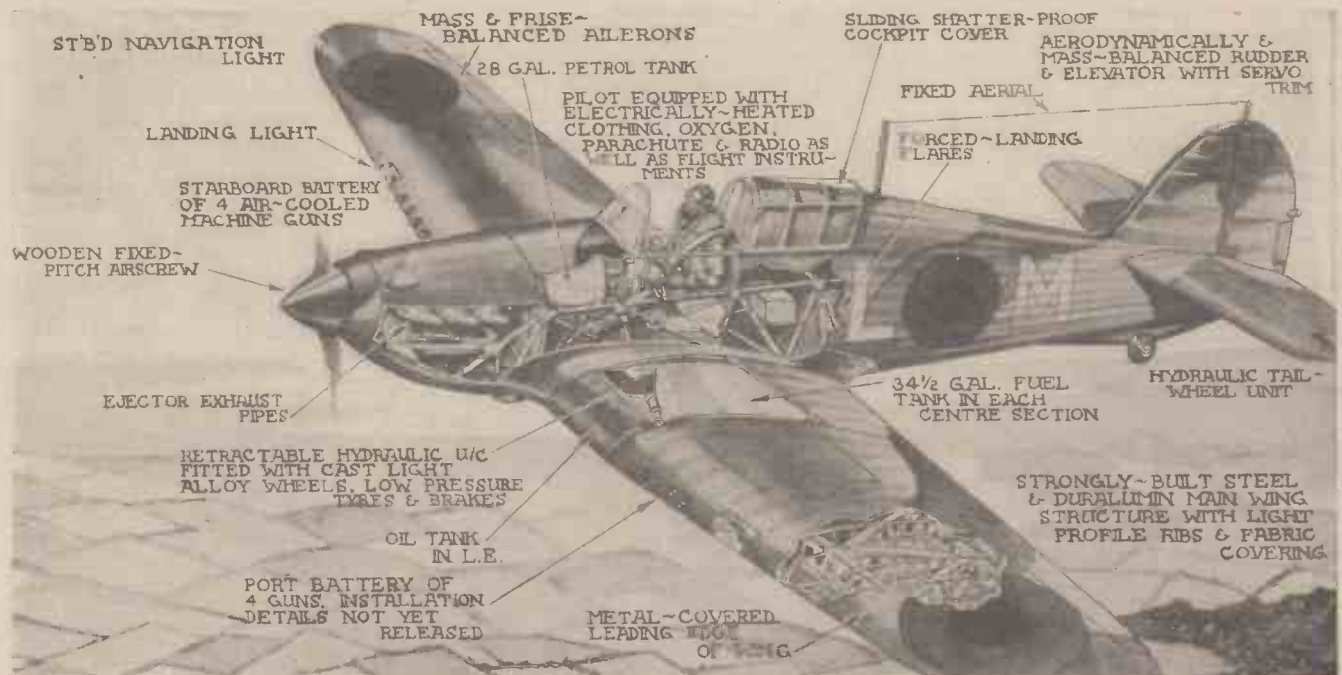

The "Hawker" Hurricane, which is one of the fighter planes now in use

Synchronising Sound with Your Ciné

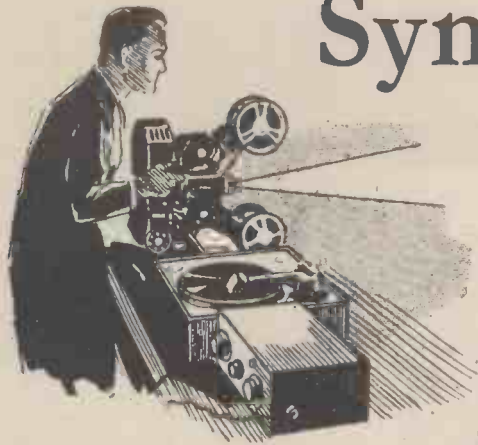

How Gramophone Records Can be Made for Use in Conjunction with Cinematograph Films

THE home ciné may frequently be used to provide considerably better entertainment if it can be converted to a form of "talkie." Of course, it is now possible to obtain a complete "home talkie" outfit, but the price is very high. Even when cost does not prohibit its use, it is seldom that suitable sound-picture scenes can be "shot." As an alternative, the ciné enthusiast might consider the possibilities of making gramophone records to synchronise with the reproduced pictures. Briefly, the idea is that the film should be thrown on to the screen at the same time as a gramophone record is being made. If both film and record are started together, they can later be reproduced at the same time to give the same effect as a sound film.

Question of Cost

The method of procedure can be either simple or fairly complex, cheap or rather costly, according to the amount which can be spent and the quality of reproduction demanded. When it is not proposed to spend more than a few shillings an ordinary gramophone pick-up can be used as a recording head in conjunction with a loud-tone needle; it might be found necessary to weight the pick-up head in order to ensure a better "cut" in the record blank. As to the latter, it might be possible to obtain a few aluminium blanks very cheaply, although it appears that there are not now many of these on the market. There are many other types, however, although many of them cannot be used satisfactorily, except in conjunction with a complete recording and tracking head—which costs something like four guineas on the average. One well-known type of record blank is the "Musikon"; this requires a proper recording head and has to be "processed" after recording. The "processing" consists of baking the comparatively soft original record. The baking makes it quite hard and reasonably permanent.

Another Record Blank

There is another type of record blank available which does not require to be baked. This is similar in appearance to the normal type of record and must be used in conjunction with a tracking head. After recording, a small amount of special chemical is applied to the surface with a wad of cotton wool, and then the surface is polished by applying a second solution in a similar manner. This simple treatment renders the record perfectly hard and suitable for use time after time. Yet another pattern is of semi-transparent material, rather like celluloid in appearance. With this record no processing is necessary, but it is not as permanent as the others.

There are several points to watch when making records, and it is not proposed to deal with them here, since space does not permit. Most of the suppliers of record

being ready tracked and requiring only a recording head or pick-up. The recording pick-up can be connected as shown in Fig. 1, where it takes the place of the loudspeaker in a choke-capacity output circuit of the broadcast receiver, which is to be used as an amplifier. When choke-capacity output is not used, the speaker being connected directly between the anode of the output valve and H.T.—the pick-up can be connected as shown in Fig. 1, but using the speaker in place of the choke. In that case it will be desirable to disconnect one of the secondary terminals on the transformer from the speech coil, but this is not essential when the set provides upwards of 2 watts output. Incidentally, an output of at least $\frac{1}{4}$ watt is needed for good results.

A microphone should be connected to the pick-up terminals of the receiver or amplifier. Then, with the film running and the pick-up on the record, it is necessary only to speak, play, sing, etc., into the microphone, making the sounds coincide with the pictorial events.

Preliminary Experiments

It might be necessary to make a few experiments before the desired results are obtained, for which reason it is suggested that the record be stopped every half-minute or so and "played back." This will enable the operator to judge the best positions for the microphone volume control for certain kinds of sound, and will necessitate the waste of only a single record blank. Before commencing the "full dress" performance it will be helpful to run through

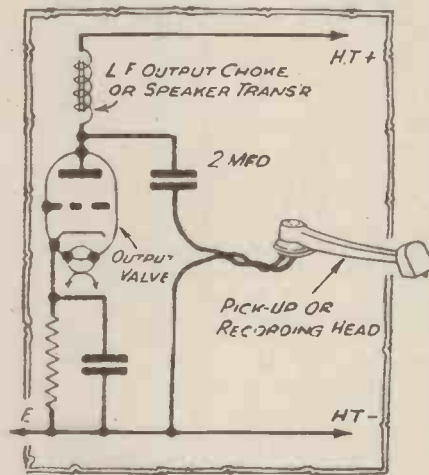

Fig. 1.—Connections suitable for a pick-up used as a recording head. A mains set is assumed, but the method is the same for a battery receiver

blanks, however, will provide the necessary instructions for their efficient use.

Recording

In the first place, it will be assumed that aluminium blanks are being used, these

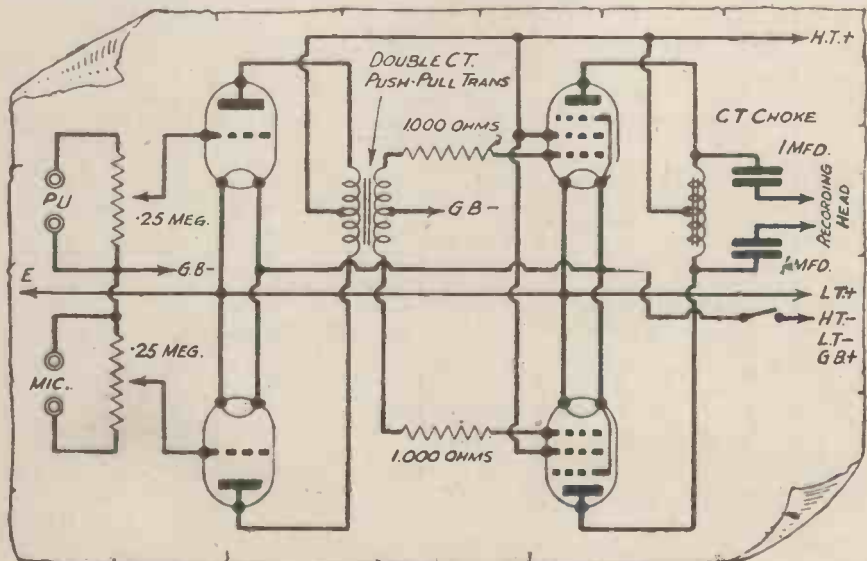

Fig. 2.—A useful type of double-push-pull circuit for recording

the film three or four times, making notes of the best sound accompaniment and of the number of words which can be spoken in connection with the various scenes. Those who are able to write shorthand will probably write out the script, correcting and "cutting" it each time the film is shown through as a preliminary to recording.

Input Connections

In many cases it will be found better to record both speech and music, "fading in" either as required. Gramophone records will be useful for the musical portions, and so both a pick-up and microphone will be required. These may be connected as shown in Fig. 3. In this case there are two triode-input valves (H.L. type are suitable), the output from these being fed into a common output valve, or into a pre-output amplifier. Two separate volume controls are used, and these might be either on the microphone and pick-up respectively, or mounted separately near the amplifier. The latter arrangement is better, since they are then more accessible and can be operated simultaneously without difficulty. The connections given are for resistance-capacity

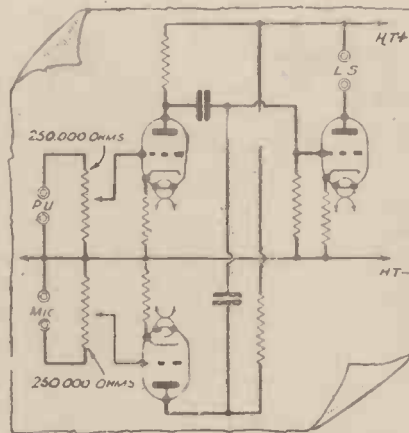

Fig. 3.—Method of using two input valves for the pick-up and microphone. Both feed into a single amplifier valve

coupling, but transformer coupling can be employed by using a push-pull transformer with centre-tapped primary, and by employing the centre-tapping and one

and connection only of the secondary.

A Simple Amplifier

Another method is to use a double-push-pull amplifier, of the general form shown in Fig. 2. This is for a battery-fed amplifier using two triodes and two high-efficiency pentode valves. Those who propose to build an amplifier especially for recording or low-power public-address use will find that one based on this general circuit is very satisfactory. Of course, the output, when using battery valves, will not be more than 1 watt for an H.T. current consumption of about 20 mA. But by using a mains-operated amplifier a much greater output could be obtained. It would not be possible to give full constructional details here, but the brief particulars supplied by the circuit diagram will be sufficient for the guidance of experienced constructors.

After the records have been made they can be played through in exactly the same manner as commercially-made records, using a pick-up, amplifier and speaker. If they are labelled to agree with the title of the film to which they are appropriate, a complete album of sound-cine combinations can be built up.

THIS MONTH IN THE WORLD OF SCIENCE AND INVENTION

Man Becoming Taller

RECORDS taken over the past thirty years show that schoolgirls of eleven are to-day two inches taller than girls of the same age only ten years ago. In several European countries the height of conscripts joining the colours shows a similar increase, amounting on the average, to about one inch, in the period of the past 25 years. The increase is sometimes put down to improved diet, and this view is supported by the fact that, in America, a colony of rats fed on the best possible diet over a period of twenty-five years has shown a steady and continuous advance in size through many generations.

Dead Reckoning

GREENWICH TIME is considered to be absolutely accurate but astronomers are sometimes worried because the clock is occasionally a tenth of a second wrong.

They are therefore building a clock which will not vary more than a hundredth of a second. The revolving earth, which is never fast or slow, is the standard clock and by observing the stars astronomers can tell the time with complete accuracy. The drawback with this method of telling the time, however, is that heavy clouds often obscure the stars for considerable periods, so an accurate clock is necessary to fill in the gaps from one time-observation to the next. The electric clocks in present use are controlled by pendulums, but for no apparent reason all pendulum clocks have a tendency to start running a little fast or slow. The new clock is similar to a mains clock which regulates itself by pulses of current from a dynamo, but differs in that it makes its own alternating current and times it perfectly by means of a piece of rock crystal which vibrates 100,000 times a second. The clock will be kept at a constant temperature all the year round, and would run for a year without losing or gaining a third of a second.

1,000 Years Hence

£1,400 worth of manicure sets, perfumes and powder puffs are to be buried in the mountains near Tucson, Arizona. A granite pillar bearing the inscription "Do not open until 2939" is to be placed over them.

New Synthetic Fibre

FROM Tokio comes the news that a Korean research doctor has discovered a new synthetic fibre made from lime, coal and acetylene gas. The feature of the fibre is that it is as elastic as wool and four times as strong. It can be easily dyed, and weaving machines for handling viscose rayon can use this new fibre. It has been called Synthesis No. 1.

"As Quick as Lightning"

THE above expression, which is often used, has lost some of its effectiveness now that scientists have found that its rate of travel is only 10,000 miles a second as compared with light with a speed of 186,000 miles a second. Whilst on the subject of lightning there is a belief that it never strikes twice in the same place. This is incorrect, because it does—and sometimes as many as four or five times.

THE HOME MECHANIC ENCYCLOPÆDIA

An up-to-date and comprehensive guide to the Mechanical, Scientific and Technical Interests of the day—with expert articles on Aircraft, Television, Models, Astronomy, Electricity, Photography, Chemistry, Woodwork, Motor Cars, Wireless, Home Cinema, with over 600 illustrations.

Only 3/6 Net

4/- post free from the publishers, Book Dept., George Newnes, Ltd., Tower House, Southampton Street, Strand, London, W.C.2

NEWNES: LONDON

Soap Fruit

BEFORE soap was invented plants were used for washing. To-day there is a tree in tropical America which has a soft pulpy fruit having many times the emulsifying and cleansing properties of manufactured soap—and it will not shrink woollens.

The Speed of Birds in Flight

SCIENTISTS have often tried to solve the problem of how small birds are able to fly for hour after hour over oceans and desolate country. This problem has now been partly solved by pilots on the Pan-American Airways routes who were asked to make notes of the speed and the height of the birds they saw. The theory that birds fly at fairly slow speeds near the ground when migrating has been disproved by the notes. It was found that they fly in the clouds at a height of about 3½ miles from the ground, and in this way they are able to cover great distances in a short space of time. Constant winds blow at this height at up to 100 miles an hour, always at the same speed and in the same direction. The birds are thus aided by the winds and with little effort sail along at the same speed as the wind.

BOOK RECEIVED

"The Beginner's Guide to the Lathe." By Percival Marshall. Published by Percival Marshall & Co., Ltd. 88 pages. Price 1s. 6d. net.

THIS is a useful handbook for amateurs desirous of making their acquaintance with the lathe and its uses. The first part of the book describes in simple language the various parts of plain lathes, self-acting and screw-cutting lathes. Methods of holding and driving work, turning in wood and metal are next dealt with, followed by a description of the slide-rest and its uses, and drilling and boring in the lathe. The book, which is well illustrated, contains all the information necessary to enable the beginner to make a start in the fascinating craft of turning in wood or metal.

BUILDING A GLIDER

Light in weight and a staple Flyer, this glider fully conforms with all F.A.I. Rulings and is eligible for the King Peter II Cup

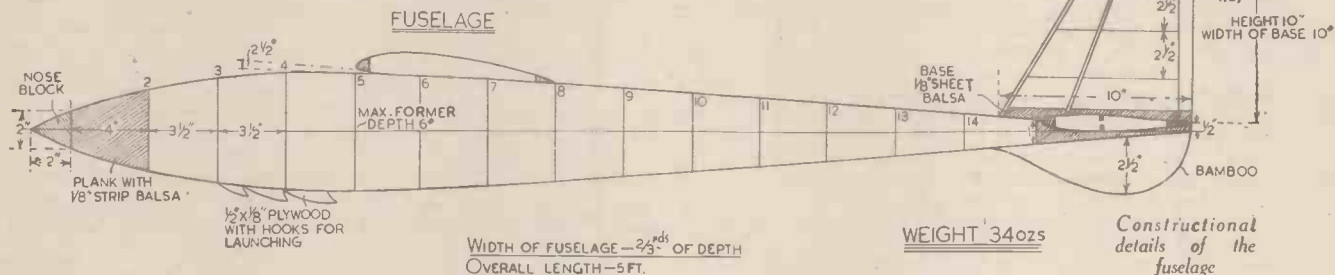

WEIGHT 34ozs

Constructional details of the fuselage

THIS glider fully conforms with all F.A.I. rulings, and can be flown in any contest under their rules. It is also eligible for the King Peter II Cup contest for gliders.

Built mainly of silk and spruce, it is very strong, and is also a very stable flyer.

Draw the plans carefully to full size. The fuselage is built slab sided first of all, then 1/8 in. sheet balsa half circles are added to the top and bottom, in order to streamline it. The method is shown in the drawing of the maximum former.

The main structure is 1/8 in. square spruce and when the half circles are added, a 1/4 in. square spruce stringer is fitted top and bottom and ten 1/8 in. square spruce stringers are added, in each half circle as shown.

The Keel

The plywood keel in which 3 hooks are shaped, is cemented in the formers, in place of the 1/8 in. square spruce stringer, between

mounting for the tailplane can either be built up, or carved from a very soft block of balsa which is cemented into the rear end of the fuselage. The noseblock is carved from a block of hardwood and hollowed out to receive the weight required for balancing the model. This will be approximately 6 ozs. Once the model is correctly balanced, the noseblock can be cemented to the fuselage.

The Rudders

The upper and lower rudders are then built on to the fuselage. The section of the upper rudder is biconvex, slightly thinner than that of the tailplane (which is drawn here). The leading edge is shaped from 1/4 in. square balsa, the trailing edge is shaped

The tailplane section which measures 8 in. in chord

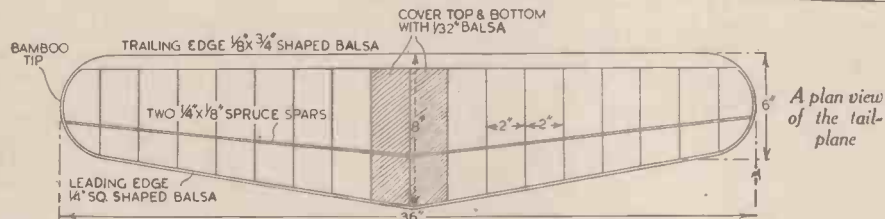
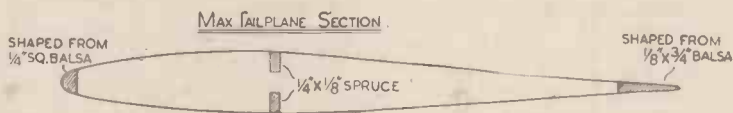

sheet balsa and shape the leading edge from 1/4 in. x 1/4 in. balsa and the trailing edge from 1/8 in. x 1/4 in. balsa.

The wing is built in four pieces. Build sections Nos. 2 and 3 and then join them together, reinforcing the back of the leading edge, the two 1/4 in. x 1/8 in. spruce spars, the two 1/8 in. square spruce spars, and the trailing edge, with plywood at the joints.

Then build sections Nos. 1 and 4. The tips are bent from bamboo and carefully cemented in position and when completed join them to the centre section (Nos. 2 and 3) making sure that there is 8 in. dihedral under each wing tip.

Be careful to reinforce the back of the leading edge, both sides of the two sets of spars and the front of the trailing edge, with plywood.

formers Nos. 3 and 5. Care should be taken in cutting the hook positions and these should be in exactly the same place as on the drawings.

Plank the nose with 1/8 in. strip balsa, between formers Nos. 1 and 2, and carefully sandpaper smooth. Then build the wing mounting on formers Nos. 5, 6, 7 and 8, make sure that this is at the 2 1/2 degrees of incidence shown on the drawings. The

from 1/4 in. x 1/4 in. balsa, and the mainspar is 1/4 in. x 1/8 in. spruce tapering to 3/16 in. x 1/8 in. at the top. The base, which is carefully shaped to fit the top of the tailplane, is made from 1/4 in. sheet balsa.

The ribs are cut from 1/32 in. sheet balsa and the tip is bent from a piece of bamboo. The lower rudder is made of bamboo, care-

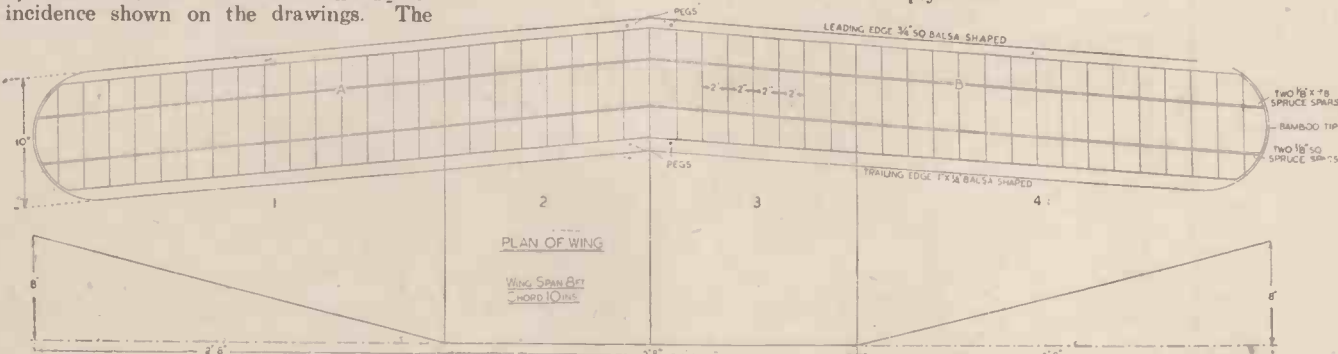

A plan view of the wing

Great care must be exercised in building the wing, and especially when making and reinforcing the joints. Firmly cement 4 long bamboo pegs into the leading and trailing edges where shown. The whole machine can now be covered with silk.

This should be applied damp as it will tighten when dry. The best adhesive is Grippix, as this allows the silk to be pulled tightly over the framework and if misplaced it can easily be lifted up and replaced correctly.

Covering the Fuselage

The covering of the fuselage should present little difficulty, except around the wing mount, where care has to be exercised to see that the silk is tight and unwrinkled. Then cover the upper and lower rudders with silk, but be careful that the silk does not warp the lower rudder when drying. Cover the tailplane carefully with silk, and be sure that it lies smoothly over the $\frac{3}{32}$ in. balsa sheet covering in the middle.

Lastly, comes the covering of the wing. First, cover the undersurface, and here a glue such as Secotone will have to be used. Carefully smooth out all the wrinkles and

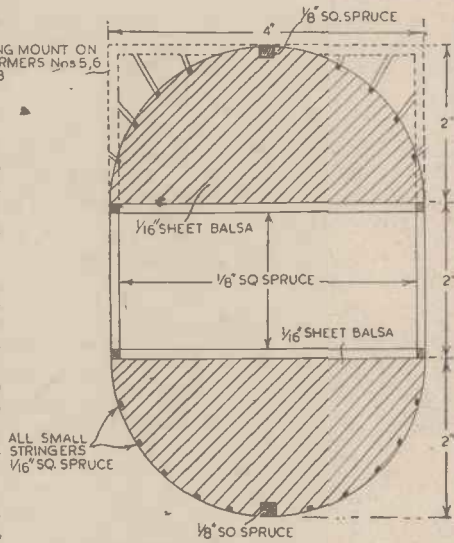

(Above) Size and shape of maximum former. (Left) A section of the wing which is 10 in. long. (Right) A front view of the glider

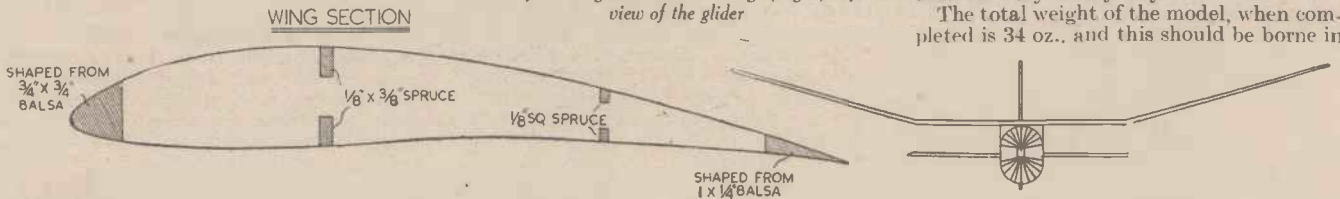

then cover the top of the wing. Care will have to be exercised in the covering at the tips, as the silk tends to wrinkle here,

but with a little patience these can be smoothed away. When the silk is dry, apply two or three

coats of clear dope, and then the model can be finished with coloured dopes to suit the modeller's taste.

Assembling the Model

The model should be assembled by fitting the wing on the wing mounting, in the position shown, and passing several rubber bands, at least $\frac{1}{16}$ in. wide round the fuselage from the pegs cemented in the wing. These bands should be strong enough to hold the wing firmly in position, but see that they are not too tight, as they are likely to damage the fuselage in the event of a heavy landing. The tailplane should fit tightly between the shaped rudder base, and the shaped block in the fuselage. The wing should be set at $2\frac{1}{2}^\circ$ pos. incidence as shown on the drawing, and the tailplane at 0° incidence. The weight in the noseblock can now be adjusted until the model balances at the points A and B (marked on the wing drawing).

Only very slight adjustments should then be required for perfect flying trim. The model should normally be launched off the middle hook and on fairly calm days off the back hook. The front hook should be used on very windy days.

The total weight of the model, when completed is 34 oz., and this should be borne in

mind by the reader, if he thinks that some of the reinforcing is not necessary, or that balsa could be used instead of spruce.

NEW INVENTIONS

A Nose Filter and a Use for Horse Hides

Nose Filter

IN the days of Queen Victoria delicate folk were seen wearing what was termed a respirator. In those alleged good old times mustard and other harmful gases were not known in warfare. The enemy against which the respirator in question was provided was cold air. To protect against this foe, the mouth was shielded with a kind of sieve or filter, which was attached to the face by means of loops over the ears. Like the current gas mask, this respirator was certainly not an ornament to the countenance.

Of an imperceptible character, is a nasal filter which has just made its debut. Inserted in the nostrils, this filter is intended to prevent pollen, dust and injurious germs from entering the nasal passages. Nature has already designed the nostrils with the object of barring the entrance of hostile particles. If we were to cultivate the habit of breathing through the nose, it would be very greatly to our benefit. Apparently yet further to protect the human subject, this filter has been contrived. It is fitted with a fine mesh impregnated with a compound, the vapours of which are said to shrink the mucous membrane. As a result, the inhaling of harmful germs, if not entirely prevented, will be reduced to a minimum.

New Use for Horsehide

"A HORSE! A horse! My kingdom for a horse!" cried King Richard III. Well, the horse is coming into his kingdom again. Owing to the rationing and

high cost of petrol, the faithful animal which, for many centuries, has carried and drawn man and his wares, has returned to our streets.

Now the hide of the horse will come into the limelight (the black-out permitting) if a recent invention is successfully commercialised. I learn that, hitherto, horse hides have been used only in the manufacture of leather for soles. And the skins of foals have been employed in the production

of fur coats, the hair-face being on the outside of the cloak, which is provided with a fabric lining.

With this invention, horse-hides may be utilised in the manufacture of garments such as coats, cloaks, sports jackets, etc. According to the new process, the hides are chamois-dressed to show the nature of chamois-leather or deerskin at the leather face. The garments are made in such a manner that the leather face, prepared as mentioned above, is at the outside. On the inside is the hair-face which warms the wearer and makes a separate lining unnecessary.

The leather face may be coloured in any desired shade. "DYNAMO."

AN IMPORTANT ANNOUNCEMENT

WORKING MODEL OF THE FLYING SCOTSMAN

We have received during the past two years a large number of requests from readers for working drawings of a model of the Flying Scot. Accordingly, we have pleasure in announcing that the first of a series of articles describing the construction of a working scale model in $2\frac{1}{2}$ inch gauge of the Flying Scotsman, will appear in next month's issue. Every detail will be shown and full instructions will be given for building a realistic replica of this famous locomotive. We have had the machine built in the workshops of Messrs. W. J. Bassett-Lowke, Ltd., and stage by stage photographs and drawings will illustrate the text.

Next month—first of a series describing the $2\frac{1}{2}$ inch Gauge Flying Scotsman.

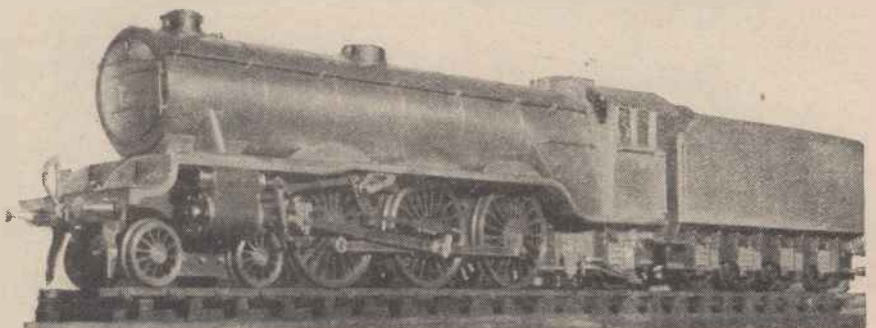

The L.N.E.R. $2\frac{1}{2}$ inch gauge "Flying Scotsman" which will form the subject of a new series of constructional articles starting next month



SCIENTISTS ON GHOSTS

The Unsolved Problem of Ghosts and Their Hauntings

CHRISTMAS is traditionally the season of ghosts and hauntings, the more venturesome of supposed discarnate spirits are alleged to thrust their inexplicable presences upon us for the sake, it would seem, of disturbing certain individuals and exciting in them a due attitude of terror and dismay.

Why, however, the peaceful season of Christmastide, with its atmosphere of goodwill, has so frequently, in legend and in story, been associated with the appearances of eerie visitants from another sphere of existence has never been adequately explained. Maybe, as is more probably the case, the majority of these Christmas ghosts have never been anything else other than mere figments proceeding from the imaginations of countless story-tellers. Certainly, all Christmas ghosts exhibit, if one believes the many stories concerning them, a great degree of sameness and of conventionality, so much so that such spooks are now regarded by the British public as part and parcel of the traditional atmosphere of Christmas, in almost the same manner as the holly, the filled stockings, the Christmas log and the indispensable plum pudding.

"All-the-Year-Round" Ghosts

But what about these ghosts and their hauntings which have no connection with Christmas festivities, and which, if the related circumstances of their appearances are in any way true, represent the very antithesis of Christmas cheer? They present a far deeper problem to the thinking individual, if only for the reason that they cannot adequately be disposed of (like a Christmas ghost) with a smile and a wink. These "all-the-year-round" ghosts, indeed, are apparently real and substantial ones, that is to say, if any type of apparition may be so styled, and, in many instances the very nature of their hauntings, with its character of constant repetition, seems to put out of court the charge of such phenomena being merely hallucinatory.

No matter what the individual may say, there is no doubting the fact that mankind in the mass is a believer in ghosts. Right from the earliest beginnings of recorded history, through the folklore and the stories of all nations, civilised and uncivilised alike, one comes across, times without number, the story of the ghostly visitant, of the unexpected and mystifying occurrence which can only be explained (or, rather, to be more accurate, which, in the past, has only been explained) on the assumption of its being caused by intelligences beyond the reach of a living man.

We all have our pet ghost yarns, and,

no doubt, we all think them absurd and senseless enough, as most of them, perhaps, undoubtedly are. Behind all ghost stories, other than those of acknowledged fiction, however, there is a basic residue of actuality, and few, indeed, are the thinking men who would deny such a fact.

Ghosts and Scientists

The scientist, of course, does not like the ghost, for the spectre, and its many weird phenomena, consistently refuses to fit into the prescribed domain of science. And that is why, perhaps, the professed scientist has as little to do with ghosts as he possibly can. Not being able to explain them in any adequate terms, he almost automatically inclines to ignore them.

Still, however, the phenomena of hauntings and of manifestations rise up continually here and there, even in the most crowded

untrue, for most accredited accounts of spectral manifestations have so many points in common that it is possible to generalise very definitely on this subject without bringing in individual instances for special consideration.

Three Alternatives

There are only three possible ways of explaining a ghost or a ghostly manifestation, although, of course, each of these ways can be varied almost indefinitely.

In the first place, all cases of hauntings and apparitions can be put down to pure hallucination on the part of the individual. That is to say, such happenings have no cause or being outside of the consciousness of the person who experiences them.

This explanation is, naturally enough, to many persons, a very satisfactory one, for it simply says that ghosts are all bunkum,

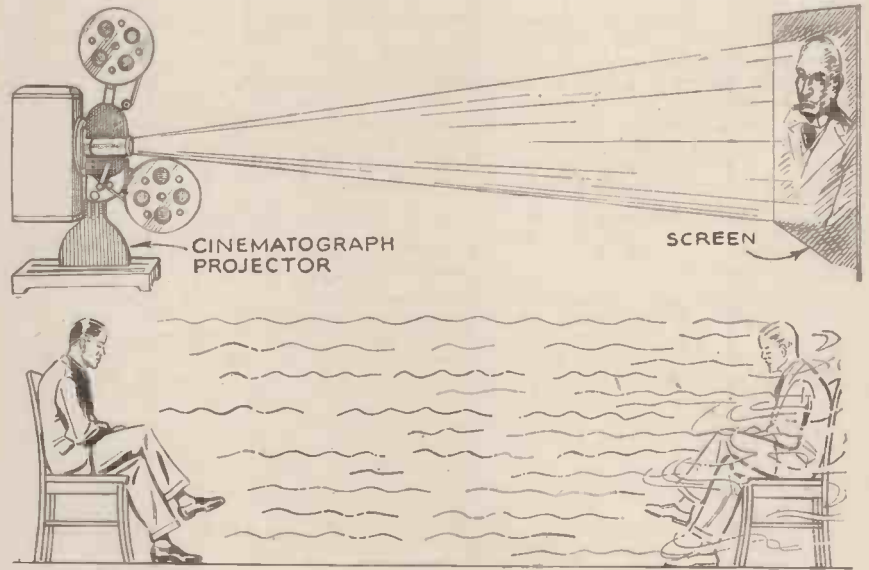

DORMANT PERSON IN CHAIR

DISTANT PROJECTED "GHOST" OR REPLICA

Just as images can be projected on to a screen, one theory of ghosts asserts that, in certain conditions, a "living" image, replica or counterpart may be projected by an individual to any distance

of our cities. They are usually hushed up, for we all have an inevitable tendency to keep quiet on matters which we prefer not to think about. Hence it is seldom that even the most accredited ghostly manifestation is given a full ventilation of its details in the light of day, so to speak. Occupying a house in which there is a ghost or some unexplained manifestation is re-acted to in much the same manner as living in a house in which there are mice or black-beetles. The unwanted parasites are frequently accepted, so long as they do not interfere too greatly with the normal mode of living.

It is not the purpose of this article to relate any particular ghost story, true or

and that they are utterly imaginary and nothing else. Few thinking people take this view, however. Even scientists don't.

The second explanation of ghostly happenings is, to put it rather strangely, that they do actually happen. This general explanation would have it that ghosts and all their various paraphernalia do actually exist apart from our consciousness and that these entities have a being of their own either in or out of Time and Space.

General explanation number three states that all ghostly phenomena is the result of telepathic activity on the part of living or dead individuals. On this theory a spectre or a ghost has no actual existence. It is merely an image projected by some other

person, living or dead, and it is no more tangible as an existing entity than the image of a film star projected upon the screen of a cinema.

Whether a dead person, or a disembodied intelligence, if we so prefer to use the latter term, can possibly project a "living" image of itself or of some other individual or thing, we have no possible means of telling. It does seem definitely possible, however, for a living individual to project a distant ghostly image or replica of himself under certain abnormal conditions, and in this way is explained with a fair amount of feasibility the phenomena of "bilocation," or the ability to be in two places at the same time which has apparently characterised a few religious ascetics in the past, and, also, the often-heard modern accounts of an individual appearing to another distant one at the moment of the death of the former.

Human Personality

It may well be that the human personality, when loosed, either temporarily or permanently, from the body, can thus bridge Space and Time and give rise to some sort of telepathic or televisual manifestation of itself. The fact, also, that, in certain hypnotic states, individual personalities have been more or less expelled from the body and have claimed to have visited other scenes lends additional colour to this "telepathic" theory of ghostly manifestations. Although such a theory cannot cover all accredited instances of hauntings, particularly those of a long-standing nature, it is one which must carry due weight in many given circumstances.

Perhaps the second of the above generalised explanations of ghostly phenomena is the one which represents the best field for active theorising and research. This is, of course, the generalisation which accounts for ghosts and all related phenomena by definitely asserting that they actually exist externally in Time and Space and apart from the observer of them.

That which may be termed the "supernatural" theory of hauntings comes under this main generalisation. This theory has it that ghosts, spectres, hauntings and all associated manifestations are directly the results of un-bodied intelligences acting upon or through the world of matter. This, perhaps, is the oldest theory of ghosts. That such intelligences have been usually presumed to be evil ones, and that many of the phenomena of spectral manifestations are, to say the least, of an extremely childish and even an idiotic nature, cannot be cited directly against this theory. After all, our standard of so-called "normal" intelligence is merely an arbitrary, although, no doubt, a well-founded one, and it may, in all likelihood, differ a good deal from the intelligence standard of the unknown class of other-world busybodies and mischief-makers whose ghostly object is apparently that of striking fear and panic in the minds of their human observers.

The fact that the ceremony of "exorcism," or the casting out of spirits, has been in modern times successfully practised as an aid to ridding a ghost-ridden dwelling from its recurrent manifestations certainly strengthens the "supernatural" theory of such hauntings, but it in no way explains their meaning of their mechanism.

Hauntings are repetitive in nature. That is to say, having once started, they tend to recur at regular intervals. Another curious fact about hauntings is that they are seemingly dependent upon the actual material surroundings or environment of the haunted area. The majority of accredi-

ted hauntings nowadays are those of the "poltergeist," or "noisy ghost" which manifests itself not in any visual apparitions but in sundry and oft-repeated mysterious and uncanny noises, such as knockings, shufflings, wailings and so forth. If a house which is infested with such manifestations is pulled down, the phenomena cease at once and do not recur.

It seems, therefore, that if you are able to destroy the close material associations of the ghost you can destroy the ghost itself.

Another fact connected with hauntings is that, although they are repetitive in nature, the intensity of the manifestations tends gradually to become weaker and weaker.

It almost seems as if all this ghostly business with its recurrences and its senseless harping on one selected and particular theme is the product of some wound-up energy source which gradually dissipates itself through one particular set or pattern of intricate channels resulting in the recurrent manifestations.

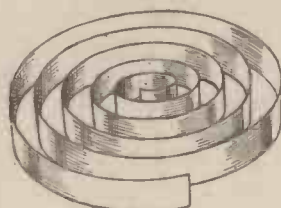

An uncoiling spring

These occurrences represent the dissipation of energy, or flow of energy from high to low potentials. In much the same manner according to a theory explained in this article, ghostly manifestations are the result of other energy-releases in Time-Space

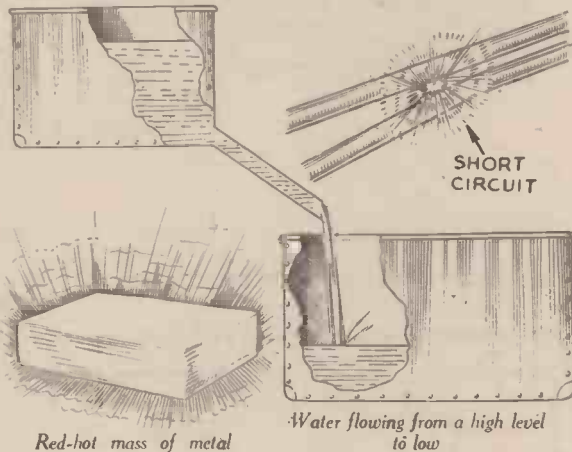

Red-hot mass of metal

Water flowing from a high level to low

"Physical" Theory

There is, indeed, one theory of hauntings—the "physical" theory we may call it—which attempts to account for the facts in this manner. Such is the only "scientific" theory of ghosts which can be said to hold any weight.

According to this "physical" theory a sort of strain may be set up in Space-Time in much the same manner as a molecular strain is created in the spring of a clock or other mechanism when it is wound up.

Many different varieties of Space-Time strains must be possible and, no doubt, the gradual release of such strains underlies many of the curious happenings in the Universe.

Now, if the intelligence-principle departs from a human being under certain unexpected and usually sudden conditions, if, for example, an individual is brutally murdered, it may be possible that the departing mind of that individual is able to set into existence certain energy patterns which, containing within themselves considerable vitality, form a source of potential energy or force.

It is a well-known law of the Universe that all sources of energy tend to run themselves down. The wound clock spring at all times tends to become unwound. Heat energy tends to dissipate itself. Electrical energy invariably attempts to leak away. Water at high level makes every effort to flow from that level. In a word, high energy potentials in Nature tend always to run down to low energy potentials.

An "Energy" Pattern

If, in the above-mentioned instance, an energy "pattern" is in some totally inexplicable manner formed in Time-Space as the result of a violent death or from other circumstances, it is quite feasible that the resulting ghost and/or the various phenomenal haunting may arise from the energy complex gradually dissipating itself in one recurring set of manifestations, just as the playing of a gramophone record is the result of the energy of the instrument's motor dissipating itself through the one particular sound pattern of the record.

Regarded in the light of this "physical" theory, a ghost is nothing more than a picture on a screen, even though it may move and perform all sorts of mysterious and complicated actions. Such a spectre is merely a visible yet quite impersonal marionette which is danced and rattled before our senses as a result of the entirely automatic workings of some unknown type of energy strain or complex in Time-Space.

Such a theory of ghosts dissociates all spectres from supernatural attachments and

from all volitional attributes. A ghost, in the light of this theory, has no more mind of its own than the actual black-and-white image of a film actor flashed on to a cinema screen.

The energy complex which causes the ghost, says this theory, is closely associated with the material environment existing at the time of its setting up.

In other words, murder a man in his bedroom at the dead of night, and you stand a chance of creating his ghost which may appear in the same room or, at least, in the same house for a couple of hundred years or so. But having thus brought into existence (or pseudo-existence) his ghost, you can do away with it by pulling the house down, for, by doing so, you have destroyed the actual material environment of the murder. And if, subsequently, you decide to build another house on the same site it is hardly likely that you will be troubled with the recurrent ghost of your victim, for the spectre was primarily haunting his environment, not your own guilty individuality.

A strange theory this, no doubt, and one which, with the methods of modern science, cannot yet be proved. Yet it has its possibilities.

If, believing in or having had any first-hand experience of ghosts, spooks and spectres, we can bring ourselves round to face the fact that such apparitions (if they have any existence at all outside our minds) must necessarily represent a source of energy, we shall have then based our reasonings on scientific principles.

WONDERFULLY ACCURATE FLYING MODELS

RE-DESIGNED 18-inch PUSS MOTH

Our most popular kit now, better and bigger than ever—bigger span with 6-inch prop gives startlingly good flights. Very clear plan with helpful undercarriage drawings. Easy to build. Complete kit, British made, with all balsa, tissue, balsa flying prop neatly finished, quick drying cement, etc. ... 2/9



WESTLAND LYSANDER

Wingspan 19 in. Length 11 in. Exact scale 1/2 in. to 1 ft. Really detailed plan but easy to follow with many helpful drawings. Latest squadron insignia. Full details for built-up motor, and bomb racks. Ready turned balsa cowl. Complete kit of parts, British made, with all balsa, quick drying cement, dope, handcarved flying prop, wheels, tissue, etc. ... 3/11

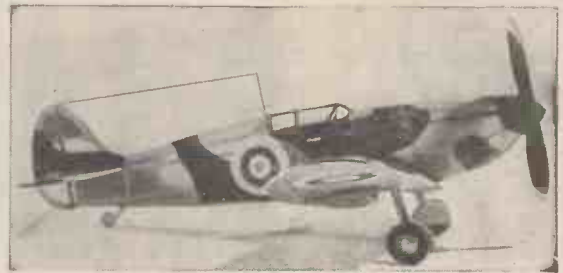

SUPERMARINE SPITFIRE

The BEST AND CHEAPEST KIT. 16 inch wing.

Biggest value in kits ever offered and all British made. Fine flier, sturdy model with strong undercarriage. Very detailed plan and all radiator cowlings. Three large printed balsa sheets, all strip balsa, partly shaped special balsa prop, all cements, two colours of tissue, etc. Wing dihedral and fairings automatically built in. 2/6

BLACKBURN SHARK

Wing 34 in. Length 25 in. Exact replica of the Navy's dive bomber. Shock absorbing undercarriage and tail wheel, wing jigs, torpedo, machine guns, very large clear plan, handcarved hardwood flying prop, complete kit for 7/6



HESTON PHOENIX

Wing 18 in. Length 13 in. Marvellously exact with fine flying performances. Retractable undercarriage. Complete kit, balsa, handcarved flying prop, printed silver insignia, etc. 4/3



HAWKER HURRICANE

Wing 20 in. Length 15 in. Build this 400 m.p.h. R.A.F. fighter; details for shadow shading. Movable controls. Fuselage jig. Special instructions 6 pages. Complete kit, balsa, tissue, flying prop, etc. ... 5/6



Satisfaction Guaranteed or Money Refunded

CATALOGUE 28 pages, fully illustrated Send 3d. stamps

P. M. SWEETEN LTD.
Bank Hey Street, BLACKPOOL

Send your Order NOW to:

"In these times," soliloquised Pugh,
"For economy, old things must do."
FLUXITED, this kettle.
Will be in fine fettle,
In fact, quite as good as when new!"



See that FLUXITE is always by you—in the house garage—workshop—wherever speedy soldering is needed. Used for 30 years in Government works and by leading engineers and manufacturers. Of Ironmongers—in tins, 4d., 8d., 1/4 and 2/8. Ask to see the

FLUXITE SMALL SPACE SOLDERING SET—complete with full instructions 7/6. Write for Free Book on the ART OF "SOFT" SOLDERING and ask for Leaflet on CASE-HARDENING STEEL and TEMPERING TOOLS with FLUXITE.

TO CYCLISTS! Your wheels will NOT keep round and true unless the spokes are tied with fine wire at the crossings and SOLDERED. This makes a much stronger wheel. It's simple—with FLUXITE—but IMPORTANT.

THE FLUXITE GUN

is always ready to put Fluxite on the soldering job instantly. A little pressure places the right quantity on the right spot and one charging lasts for ages. Price 1/6, or filled 2/6.



ALL MECHANICS WILL HAVE

FLUXITE

IT SIMPLIFIES ALL SOLDERING

FLUXITE Ltd., Dept. P.M., Dragon Works, Bermondsey St., S.E.1

BOOKS TO GIVE AND CHOOSE

(Post free prices are shown in *italics*)

- PRACTICAL LESSONS IN METAL TURNING AND SCREW-CUTTING** Price 3s. 0d. net. (3s. 3d.)
By Percival Marshall Illus.
- Handbook for the young engineer and apprentice.**
The lathe and its parts—Tools and toolholders—Measuring appliances—Chucks and mandrels—How to centre work—Driving work between lathe centres—Turning a cross-head pin—Setting out centres for a crank pin—Speeds, feeds and lubricants—Face-plate work—Four-jaw and angle-plate chucking—Drilling transverse hole on cylindrical object—Shapling curved surfaces—Screw-cutting—Wheel trains—Change-wheel tables.
- MCHANIC'S REPAIR SHOP MANUAL** Price 2s. 8d. net. (2s. 9d.)
By H. J. Dyer Illus.
- Removal of studs, screws, plugs and sockets—Extraction of keys—Lifting and removing valves—Piston troubles—Making split bearings—Turning and screwing a long tube—Oilways.
- ELECTRIC CIRCUITS SIMPLY EXPLAINED** Price 2s. 0d. net. (2s. 3d.)
By F. H. Taylor pp. 98. Illus. 70
- Diagrams and fully descriptive text.
Simple, parallel and series circuits—Switch control—Distribution and main circuits—Bells and indicators—Telephones—Motor starters—Testing circuits.
- THE BEGINNER'S GUIDE TO THE LATHE** Price 1s. 6d. net. (1s. 8d.)
By Percival Marshall. (Revised and enlarged) Illus.
- The lathe and its parts—Methods of holding and driving work—Turning in wood—Turning in metal—The slide-rest—Drilling and boring in the lathe—Self-acting and screw-cutting lathes.
- MARKING OUT FOR MACHINISTS** Price 1s. 6d. net. (1s. 8d.)
(Revised and enlarged) Illus.
- Preparing work for the marking-out table—Tool outfit—How errors multiply—Marking-out and machine operations—Transferring positions for stud holes—Marking-out connecting-rod, crankshaft and piston—Keyways—Marking-out a motor-car frame.
- EVERYBODY'S BOOK OF ELECTRICITY** Price 1s. 0d. net. (1s. 2d.)
By R. Barnard Way Illus.
- Introduction to elementary principles and explanation of simple appliances and machines.
Batteries and currents—Magnetism—Induction—Alternating currents—The power station—Welding—Telephones—X-rays—The magneto.

Write for complete list, post free.

PERCIVAL MARSHALL & CO. LTD., 60N, Kingsway, W.C.2



This is FIGHTING TALK

Two vitally important matters demand your attention—one is your immediate future, the other your position when peace returns.

Perhaps you have lost your job and have to turn to some different kind of work. Perhaps you are faced with new duties and requirements calling for specialised knowledge. Or perhaps you are realising at last that without trained efficiency a man is badly placed in the life of to-day.

I.C.S. FACTS

Branches in 30 countries; students in 50. Total of British students 900,000.

The Admiralty and other State Depts. have made special arrangements with the I.C.S. for training of men.

More than 1,000 Instruction Manuals, prepared by I.C.S. in London for postal teaching, are marvels of clearness, accuracy and practical helpfulness.

80 Instructors, many of them Associates, Members or Fellows of their respective technical bodies. All are specialists.

400 Courses of Instruction, including one for YOU.

LIFE HAS BECOME A BATTLE. WE MUST FIGHT IF WE ARE TO HOLD OUR OWN

Technical Training is a National Necessity. The Government are making widespread demands for men possessing it.

The I.C.S. have been giving technical training through the post, in unsurpassed quality, for nearly half a century. We trained many thousands of men during the years 1914-1918 and are splendidly equipped to render similar service throughout the coming months or years of this second Great War.

If you need technical training, our advice on any matter concerning your work and your career is yours for the asking—free and without obligation. Let us send you a booklet dealing with the subject in which you are specially interested. It is packed with valuable information. DON'T DELAY. Make "ACTION" your watchword.



The time to start preparing yourself for the fight is **NOW**

COUPON FOR FREE BOOKLET

INTERNATIONAL CORRESPONDENCE SCHOOLS, LTD. (Dept. 95), International Buildings, Kingsway, London, W.C.2

Please send me your booklet containing full particulars of the Course of Correspondence Training before which I have marked X. I assume no obligation.

- | | | | |
|---|--|--|---|
| <input type="checkbox"/> Accountancy | <input type="checkbox"/> Diesel Engineering | <input type="checkbox"/> Lettering | <input type="checkbox"/> Scientific Management |
| <input type="checkbox"/> Advertising | <input type="checkbox"/> Draughtsmanship | <input type="checkbox"/> Mechanical Drawing | <input type="checkbox"/> Short-Story Writing |
| <input type="checkbox"/> Aeronautical Engineering | <input type="checkbox"/> Electrical Engineering | <input type="checkbox"/> Mechanical Engineering | <input type="checkbox"/> Steam Engineering |
| <input type="checkbox"/> Air Conditioning | <input type="checkbox"/> Engineering Shop Practice | <input type="checkbox"/> Mining Engineering | <input type="checkbox"/> Surveying |
| <input type="checkbox"/> Architecture | <input type="checkbox"/> Fire Engineering | <input type="checkbox"/> Motor Engineering | <input type="checkbox"/> Telephone and Telegraph Eng. |
| <input type="checkbox"/> Boiler Engineering | <input type="checkbox"/> Garage Management | <input type="checkbox"/> Pattern-making | <input type="checkbox"/> Textiles |
| <input type="checkbox"/> Book-keeping | <input type="checkbox"/> Gas-Power Engineering | <input type="checkbox"/> Plumbing | <input type="checkbox"/> Welding, Gas and Electric |
| <input type="checkbox"/> Building | <input type="checkbox"/> Heating and Ventilation | <input type="checkbox"/> Radio Engineering and Servicing | <input type="checkbox"/> Wireless Engineering |
| <input type="checkbox"/> Chemical Engineering | <input type="checkbox"/> Hydro Electric | <input type="checkbox"/> Salesmanship | <input type="checkbox"/> Woodworking |
| <input type="checkbox"/> Civil Engineering | <input type="checkbox"/> Journalism | <input type="checkbox"/> Sanitary Engineering | <input type="checkbox"/> Works Management |

EXAMINATIONS

Technical, Professional, Matriculation, and Civil Service. State the one you wish to pass

NOTE.—If your subject is not on the above list, write it here

NAME..... Age.....

ADDRESS.....



Chemistry for Beginners

No. 9.—*The Study of Organic Chemistry.*
A Field of Engrossing Interest for Every
Amateur

matter. If, for instance, you stir the bed of a country pond, the bubbles of gas which will arise to the surface will contain a large proportion of methane.

Now methane has the formula, CH_4 , which expression means that it contains four atoms of hydrogen united to one atom of carbon. Actually, the hydrogen atoms of methane are arranged symmetrically around the central carbon atom, so that the "structural formula" of methane is:—

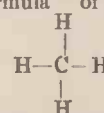

In the laboratory, it is quite easy to make methane simply by heating in a test tube a mixture of 1 part of anhydrous sodium or

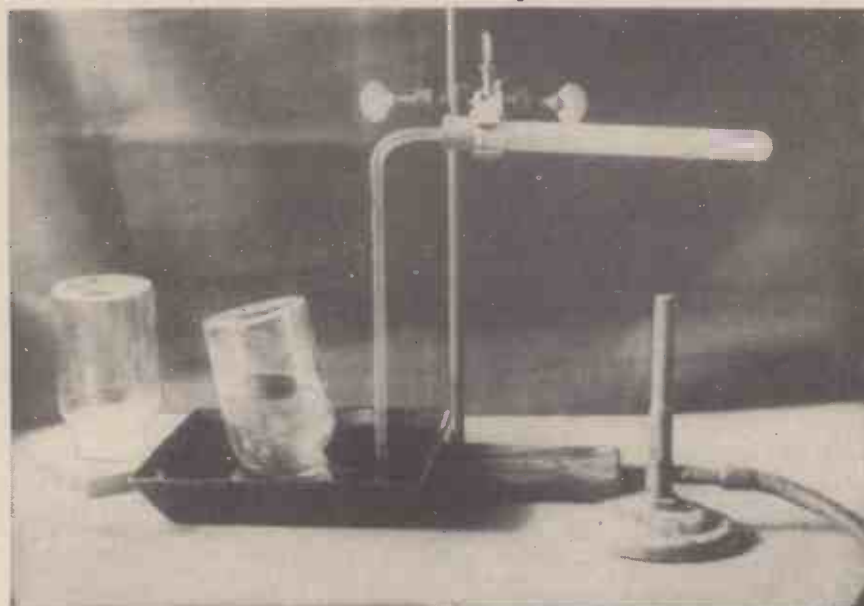

Making methane or "fire-damp," by heating a mixture of anhydrous sodium or potassium acetate and soda-lime, the evolved methane being collected over water in the usual manner for gases

WHEN the Science of Chemistry was in its infancy just a little more than a hundred years ago, theoretical chemists considered that there existed a vast and fundamental difference between chemical materials of mineral origin, such as, for instance, sulphate of iron, and those materials which were derived from animal and vegetable sources, as, for example, quinine, sugar tannin, or fat.

The latter substances, it was said, would never be capable of being produced artificially in the laboratory since, for their formation in the plant or animal organism, a certain *vis vitalis* or "life-force" was necessary, a vital energy which was, of course, altogether absent from all laboratory operations.

This theory, however, was eventually disproved in 1828 by the German chemist, F. Wohler, who showed that an aqueous solution of ammonium cyanate, which can be derived from purely mineral sources, can, under certain simple conditions, be changed into one of the chemicals existing in the human and animal body. Obviously, therefore, Wohler had succeeded in preparing a "life" compound without the medium or intervention of actual life in any form whatever.

Theory Abandoned

Thus it was that the whole previous theory of *vis vitalis* gradually became abandoned, for, after Wohler's pioneer discovery, several other so-called purely natural substances were prepared artificially in the laboratory.

With the investigation and artificial preparation of these naturally-occurring materials, arose the nowadays far-reaching and overwhelmingly important science of "Organic" Chemistry, or, as we shall see later, the "Chemistry of the Carbon Compounds." For all these compounds which were produced by "organised" forms of plant and animal life were shown to contain fundamentally the element carbon,

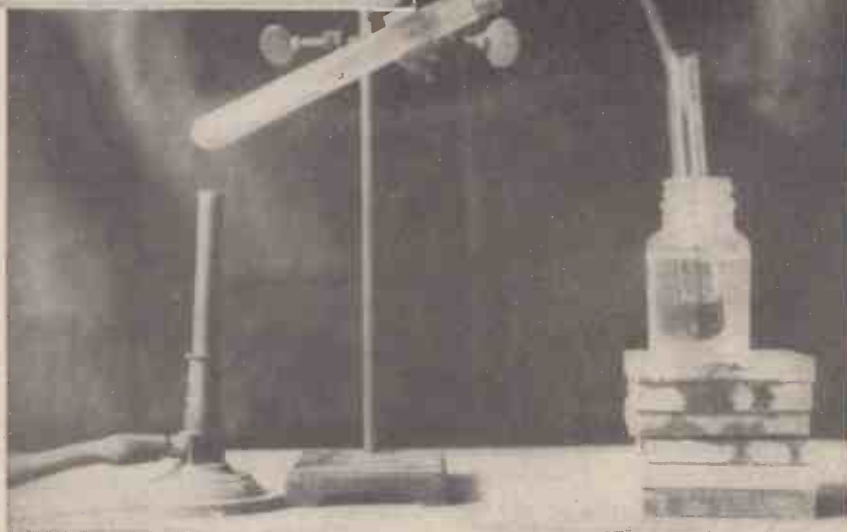

Making acetone by heating dry calcium acetate in a test tube, the acetone being condensed in another tube cooled in water

together with oxygen and hydrogen, and sometimes nitrogen, sulphur, phosphorus and a few other elements.

Carbon, however, is, as mentioned previously the one element which underlies all the known organic compounds, of which, at the present day, there must exist at least a hundred thousand separate and distinct varieties. And the reason why carbon is so extraordinarily fertile in its production of these almost numberless "organic" compounds is due to the fact that in some strange and, as yet, not entirely explained way, it is capable of linking up with itself, as it were, one carbon atom forming chains and linkages with other carbon atoms, which chains can have numerous branch chains, circular chains and so on, to which atoms of other elements may be attached.

Methane

The very simplest organic compound is the gas, methane, which is, of course, the deadly "fire-damp" of coal-mines. Methane is also sometimes evolved during the decomposition of slowly-decaying organic

potassium acetate with 4 parts of soda lime. The evolved gas can be collected over water in the usual manner, as depicted in the illustration accompanying this article.

Methane is a colourless, invisible gas which is inflammable and burns with a pale, non-luminous flame. It forms a highly explosive mixture when mixed with air or oxygen, this characteristic of the gas underlying all the "fire-damp" explosions in coal-mines.

Now if, in methane, we substitute a chlorine atom for one of the atoms of hydrogen, we obtain chlor-methane or methyl chloride, CH_3Cl . Substituting two chlorine atoms for two hydrogen atoms, we get di-chlor-methane, or methylene dichloride, CH_2Cl_2 . Three chlorine atoms substituted for the hydrogen atoms in methane gives tri-chlor-methane or chloroform, the well-known anaesthetic liquid, whilst, if we substitute all the hydrogen atoms in methane by chlorine atoms we obtain tetra-chlor-methane, or carbon tetrachloride, the nowadays much-used fire-extinguishing liquid.

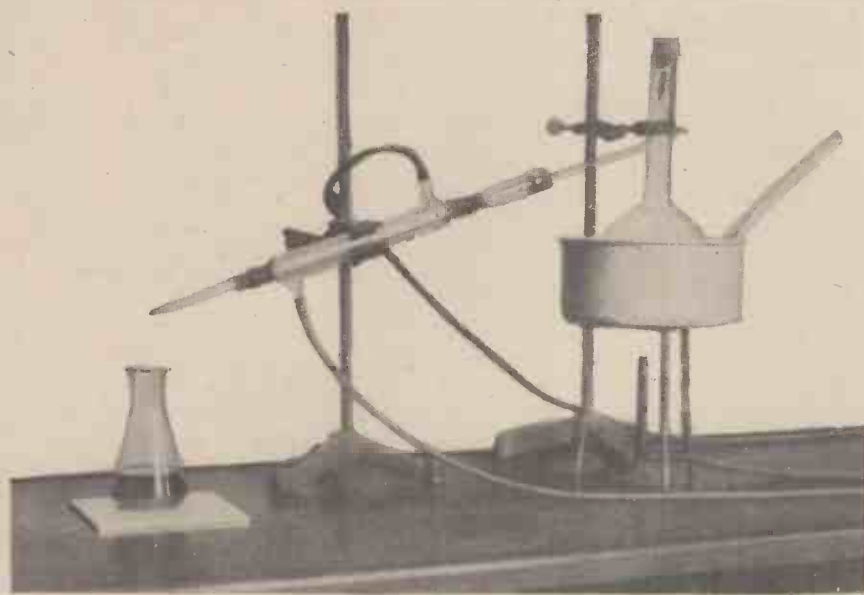

Laboratory apparatus for making chloroform. Bleaching powder and water are distilled with acetone or alcohol

The following scheme of "structural formulae" will render clearer the meaning of the foregoing paragraph:—

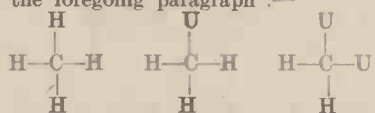

Methane. Chlor-methane (Methyl chloride) Di-chlor-methane (Methylene dichloride)



Tri-chlor-methane (Chloroform) Tetra-chlor-methane (Carbon tetrachloride).

Long Names

The amateur student of organic chemistry should not allow himself to be frightened by the long names which he will inevitably meet with in his reading of the subject. These names, although more or less entirely unintelligible to the layman, really reveal the inner structure of the compound. Such names comprise essentially certain chemical codes which are readily translatable after the student has had a little acquaintance with the engrossing study of organic chemistry, and, in reality, they are no more mysterious and ponderable than is the expression, "Deputy-Chief-Assistant-Secretary-to-the-Council-for-the-Protection-of-National-Liberties."

Indeed, run that designatory title into one word, and you will make up a descriptive title equally as forbidding as the longest of chemical terms.

In an outline article such as this, it is obviously impossible to describe more than a very few organic preparations which can be made in the home laboratory. Referring, however, to the above methane series of compounds, perhaps the most practically interesting is the anaesthetic liquid, chloroform, or tri-chlor-methane. This may readily be made by placing in a fairly large flask connected to a condensing apparatus a cream of water and bleaching powder (chloride of lime). About one-quarter of the bleaching-powder cream's bulk of methylated spirit is then added and the flask is subsequently very gently heated on the water bath. A vigorous re-actio will set

in and a mixture of chloroform, water and alcohol will distil over, the chloroform collecting as a heavy, almost colourless liquid at the bottom of the receiver.

Chloroform

The chloroform prepared in this way is not perfectly pure. All the same it possesses the characteristic heavy, somewhat pleasant smell of the anaesthetic. Its vapour, of course, should not be breathed unduly.

Another interesting preparation in organic chemistry is the production of acetone, the peculiar-smelling celluloid-dissolving liquid which is nowadays so greatly used in the manufacture of aeroplane dopes, and synthetic varnishes and lacquers of all types.

To make acetone on a small scale all we need do is to heat calcium acetate in a test tube provided with a suitable glass delivery-tube leading down into a cooled receptacle, whereupon an almost colourless, inflammable liquid of characteristic odour will collect in the receiver. Ace-

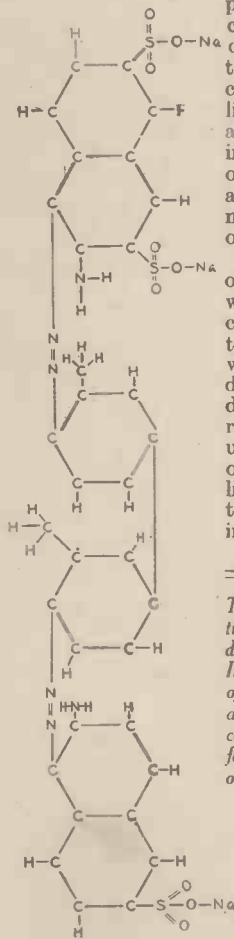

The chemical representation of a molecule of the dyestuff, "brilliant Congo." It represents a triumph of chemical architecture and it is interesting to compare it with the formula of the simplest organic compound methane or "marsh gas"

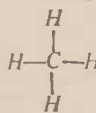

tone has the formula $\text{CH}_3\text{CO}\cdot\text{CH}_3$, and, when pure, it is a colourless liquid boiling at 56°C . When mixed with a strong solution of sodium bisulphite, it forms a crystalline compound—acetone sodium bisulphite—from which acetone may again be regenerated by distilling it with sodium carbonate.

Acetic acid, which has the chemical formula, CH_3COOH , and which is, of course, the acid contained in vinegar, is readily made in the laboratory by distilling anhydrous sodium acetate with sulphuric acid. Sodium acetate can be prepared by neutralising strong vinegar with sodium carbonate, and thus, by this means, pure acetic acid can be obtained from ordinary vinegar. The pure acid is a colourless, pungent-smelling liquid which boils at 118°C . and freezes to a mass of white, ice-like crystals at about 12°C . Note should be taken of the fact that acetic acid is inflammable at its boiling point.

Acetylene

Acetylene is still another simple organic compound which is, perhaps, too well-known to need description. By its preparation from calcium carbide and water it is obtained in a fairly pure form and if the gas is passed into a solution of copper chloride, made alkaline with ammonia, a brick-red precipitate of copper acetylide is formed. This material should never be allowed to dry, since, when dry, it explodes on striking or when heated to about 120°C . Sulphuric acid strongly absorbs acetylene gas, and when the resulting solution is distilled, acetaldehyde, a liquid smelling of apples, passes over.

Acetylene has the formula C_2H_2 and when, under certain conditions, it is heated to a dull red heat, a portion of it changes into benzene, which possesses the formula C_6H_6 , three molecules of acetylene condensing together to form one molecule of benzene.

Now benzene, of course, is one of the most commercially important of all organic compounds, since from it is prepared nitrobenzene, aniline and a host of other synthetic compounds.

Nitrobenzene is prepared without difficulty in the home laboratory. All we require for this purpose is a fairly capacious flask in which is placed a quantity of benzene. Double this quantity of a mixture of equal parts of strong nitric and strong sulphuric acids is now added to the benzene in the flask bit by bit and with constant shaking. During the gradual addition of this acid mixture, the temperature of the benzene should be kept as low as possible by immersing the flask in cold water.

After all the mixed acids have been added to the benzene, the flask is fitted with an upright or "reflux" condenser and heated on a water bath at about 80° for three-quarters of an hour. Afterwards, the contents of the flask, after cooling, are poured into a large quantity of water in a basin. A heavy yellow oil will separate. This is impure nitrobenzene. It should be collected and re-distilled, using, for this purpose, not a water-condenser but an ordinary length of glass tubing which will act as an air-cooled condenser.

Nitrobenzene

Prepared in this manner, nitrobenzene will be obtained as a heavy yellow oil smelling strongly of almonds. It boils at 205°C . and is miscible with most organic liquids, but is practically insoluble in water. Under the name of "Essence of Mirbane," nitrobenzene, which has the chemical formula, $\text{C}_6\text{H}_5\text{NO}_2$, is used as a flavour and perfume for cheap products such as boot polish and certain disinfectants.

Alcohol is a typical organic liquid, since it is usually prepared by natural fermentation of sugar solutions. To prepare alcohol (ethyl alcohol— $C_2H_5.OH$) successfully, all we need do is to make up a weak solution (say a 5 per cent. one) of common sugar and add to this one or two fragments of ordinary yeast. When kept in a warm room, the liquid will soon begin to froth and to give rise to bubbles of carbon dioxide gas owing to the yeast cells feeding upon the sugar in the solution and converting it into alcohol and carbon dioxide.

After about twenty-four hours' time, the liquid should be filtered and distilled until about one-third of its volume has distilled over. This latter distillate (as the distilled liquid is called) will contain practically all of the alcohol. It should be placed in a clean flask and lumps of fresh quicklime added to it and allowed to remain in contact with it for three days. Quicklime has a very powerful affinity for water and it will abstract most of the water from the alcohol mixture so that when the latter is again distilled an alcohol of fairly high purity will be obtained.

Anhydrous calcium chloride which is so often used for "drying" liquids in this manner, cannot be employed in this

particular instance, since the alcohol actually combines with it.

Alcohol

Ethyl alcohol, when pure or nearly pure, is a pleasant-smelling colourless liquid which boils at $78^{\circ}C.$ and which takes fire when ignited by a flame. All its characteristic properties are due to the $-OH$ (or oxygen-hydrogen) group of atoms which it contains. There are very many different kinds of alcohols known to organic chemistry, but they all contain at least one of these $-OH$ groups. Glycerine contains three of these groups. It is, therefore, essentially an alcohol—the alcohol of fats—and it possesses the formula: $CH_2(OH).CH(OH).CH_2(OH)$, a fact which well illustrates the chain-forming habits of the carbon atom.

Finally, details may be given of the preparation of a couple of well-defined synthetical organic compounds which will serve as good experimental exercises in laboratory chemistry.

The first of these is nitro-naphthalene, a material which crystallises in yellow crystals which melt at $61^{\circ}C.$ Nitro-naphthalene is made by dissolving ordinary naphthalene (the white, odoriferous material from which "moth balls" are made) in

acetic acid. Add to this solution about a third of its volume of strong nitric acid and heat the resulting liquid for half an hour on a water-bath. On pouring the product into water, nitro-naphthalene will be precipitated. It can be re-crystallised from alcohol or methylated spirit.

The second of the above-mentioned preparations is that of iodoform, CHI_3 , the well-known powerful antiseptic substance. Iodoform, CHI_3 , is structurally akin to chloroform, $CHCl_3$, but it contains three atoms of iodine instead of chlorine.

Iodoform

To make iodoform, gradually add 2 parts of iodine to 2 parts of carbonate of soda dissolved in 2 parts of water. Add 1 part of alcohol or acetone and heat the mixture to about $70^{\circ}C.$ for a quarter of an hour. Iodoform will now separate out as a yellow precipitate. It should be filtered off and purified by re-crystallisation from alcohol or spirit. When pure, it is a yellow solid, melting at $120^{\circ}C.$ It has a very characteristic, penetrating and, to most people, not unpleasant odour and it is volatile in steam. Owing to its powerful antiseptic properties, iodoform is much used in surgery and medicine at the present day.

MAKING A PERSPECTOGRAPH

A Device for Enabling Artists to Draw Buildings, etc., in Correct Proportion

THIS useful instrument will be found a great aid to the sketch artist. It is intended to be screwed to a tripod stand, and this is the way to use it. Fig. 1 is a view of the instrument minus the stand; you will see it consists of a horizontal bar of wood with a vertical rod at one end and a sliding view-point at the other. On the rod are two crossbars, the top one capable of movement up or down the rod, and itself fitted with two horizontal slides.

Now, suppose you desire to sketch a building of some kind, say, for example, a church. Look through the eyehole, and arrange the height of the tripod until the edge of the lower crossbar coincides with what will be the baseline of your sketch. Slide down the top crossbar until its front edge appears to touch the ground line of the church. The rod is marked in quarter inches, read off the distance between the crossbars, and draw a line on your paper this distance above the baseline already drawn. Raise the crossbar to a level equal to the roof of the church, then read off the distance as before and draw the roof line on the paper.

Moving the Slides

Movement of the horizontal slides will now indicate the width of the church, and the points on the roof where the steeple rises from. The crossbar can now indicate the height of the steeple, and you will have the body of the building drawn in correct proportions. Details are put in the same way, such as windows, etc.

Hardwood is used for the work, 1 in. by $\frac{1}{2}$ in. in section, the main dimensions being given in Fig. 1. The rod is a piece of $\frac{3}{8}$ in. or $\frac{1}{2}$ in. dowel rod, glued in a hole bored in the lower crossbar with an inch projecting below; this is tightly fitted in a similar hole bored in the perpendicular bar. To provide a firm seating for this part

of the rod, a thickening block, $\frac{1}{2}$ in. thick, is glued at the end of the bar.

The rod is accurately marked into inches by lines scratched half-way round, $\frac{1}{4}$ -in. lines being a quarter of the way round, and the $\frac{1}{2}$ -in. lines being short cuts between.

The top crossbar is similar to the bottom, and should slide easily up and down the rod. This can be effected by lining the hole with a piece of cloth or rubber.

The pattern for the slides at each side is shown at Fig. 3, which should be cut in thin sheet brass and bent to shape. The edge, facing the artist, of the crossbar should be marked in quarter inches, and numbered in inches from the centre outwards.

The View Point Support

This has a small hole bored in, and is screwed to a sheet brass slide, bent to the shape as in Fig. 2.

Bore a hole in the centre of the main bar for a tripod screw, and varnish.

For the tripod stand, cut three legs from wood $\frac{1}{2}$ in. thick, to the size in Fig. 4, and at each of the lower ends drive in a

nail. Cut off the heads of these nails, and file the shanks to a point, thus forming a spike to prevent the legs slipping. To the tops fix a 2-in. brass hinge.

Now mark out and cut the tripod top as shown in Fig. 5 using wood 1 in. thick. It should then be varnished. The instrument can be taken to pieces and strapped to the tripod for easy carrying.

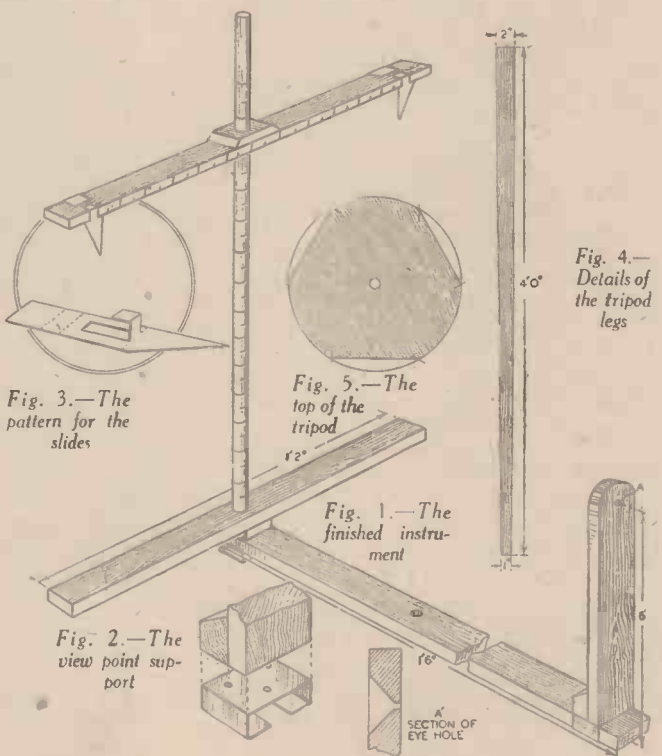

Fig. 3.—The pattern for the slides

Fig. 5.—The top of the tripod

Fig. 1.—The finished instrument

Fig. 2.—The view point support

Fig. 4.—Details of the tripod legs

Our Busy Inventors

Convenient for Callers

THE sum total of all the time visitors and tradesmen are kept waiting at our doors in a single day would, probably, amount to one lifetime. I have seen pencilled near an area bell this crude couplet:

"Gentle tradesman, do not weep;
They are not dead but gone to sleep."

When one rings at a door and there is no immediate reply, the inclination is to assume that no one is at home. It may happen that the housewife is occupied with some domestic duty which she cannot at the moment leave. Thanks to a new invention, the lady can press a conveniently placed button, which lights a small bulb at the front door. On this bulb is the word "Wait." It is asserted that, to fix this device, only one wire need be added to the regular doorbell wiring.

By the way, in a suburb of London, a man with a brush and a pot of black paint used to knock at a door. If it were opened, he inquired whether he could re-paint the knocker at the modest cost of one penny. However, should there not be a response to his knock, he assumed that no one was at home and robbed the house.

In this connection, my mind goes back some years to a device which indicated whether an electric doorbell were functioning properly. When one pushes the button, if the bell is out of reach of the ear of the caller, there is no evidence as to whether it is in order. When this indicator bell push was installed, the visitor could tell if the bell were not behaving correctly.

Noise Analyser

THAT industrial orchestra, whose music is the hum of machinery in a factory, is not invariably in tune. Unnoticed by the ordinary listener, the discord of the irregularity of rhythm is often apparent only to the trained engineer. But not even he always detects a flaw in its incipient stage.

An apparatus has been conceived which can analyse noise in machinery. It is an electrical acoustical device, which at once reveals abnormal sounds and informs the machine minder that there is a defect in the mechanism, thus preventing a breakdown. It is stated that one manufacturer of canned goods is using this noise analyser to discover solder pellets which may drop in during the filling and sealing operations.

At this juncture I recall a near relative of the stethoscope which was announced some time since to have been constructed by German technicians. The aim of this amplifier is to detect the presence of wood worms in trees before it is too late to save the latter from destruction. It is affirmed that, when the apparatus is held close to the trunk of a tree, should wood worms be present, their chewing can be heard as loudly as the chopping of wood—for example, the sound produced by the Kaiser felling a tree on his estate at Doorn.

Handy Stilts

IN this country stilts serve only as a form of amusement. The circus clown vests them in flamboyant pantaloons which go to great lengths and give the impression of abnormal height. Somewhere in Germany I believe the stilt once performed some useful office. Presumably there is a demand for these twin poles in the United States, since some inventor there has thought it worth-

By "Dynamo"

while to apply for a patent. The new brand of stilts is less stilted than its predecessors, at least as far as portability is concerned. They appear to be nearly related to the fishing rod. Each standard is hollow and in two parts, which can be joined together. The footrest is hinged, so that it will swing upwardly from the normal position. These compressible features enable the stilts to be packed or carried with convenience, though the compass attainable hardly justifies them being styled a pocket pair of stilts. It should be added that, when they are adjusted for use, a locking arrangement prevents the sections from becoming unmattd.

Watertight Watch

FROM Switzerland, whose inhabitants have for centuries been famed for watch-making, comes a watertight watch case. The purpose of the inventor has been to construct a watch case, in which the number of joints is so limited that the chance of water gaining admission is very remote.

Obviously water in a watch is not conducive to the health of the works. I pre-

The information on this page is specially supplied to "Practical Mechanics" by Messrs. Hughes & Young (Est. 1829), Patent Agents of 9 Warwick Court, High Holborn, London, W.C.1, who will be pleased to send readers mentioning this paper, free of charge, a copy of their handbook, "How to Patent an Invention."

sume that, on an extremely hot day, the average watch in the waistcoat pocket is not impervious to perspiration. And this new invention should militate against the entrance of any kind of moisture.

No Admittance to Gas

AT the moment of writing, the noxious gas menace has not materialised. But, as unremitting vigilance in relation to this danger must not be relaxed, an anti-gas door which has been devised is appropriate to our times. The object of the inventor has been to provide a swing door which functions in the normal manner, but can be rendered gas-proof at a moment's notice.

In an emergency, a tube can be inflated, and, when the door is closed, this tube expands to seal the entire space between the edges of the door and its surround. The door is formed with a cavity which houses a piston pump for inflating the tube. And this device will, it is claimed, absolutely refuse admittance to harmful gases.

To Prevent "Housemaid's Knee"

AMONG recent patents granted in the United States, I note a tree-climbing device comprising a frame adapted for attachment about the trunk and including penetrating teeth. This elevating invention will enable one to be "up a tree," not involuntarily, but according to plan.

Another American patent is styled a "Kneeler bench." It includes a rectangular wood strip, a cushion which consists of a soft, flexible porous rubber base secured to the wooden strip and a thin, solid rubber layer on top of the rubber base vulcanised to the latter. This device should prevent "housemaid's knee."

A third patent in the United States has been granted for an illuminated globe. This sphere is surrounded with a map of the world. A lamp within, shining through the translucent wall of the globe, causes the countries of the earth to be exhibited in various colours, as is the manner of maps. This globe will teach the young idea to shoot as regards geography. It will also enable the adult to examine the configuration of those unhappy countries where a considerable amount of shooting is taking place.

Mask for Motorists

YET another protective mask is the subject of an application to the British Patent Office. This time it is not designed to guard us from the machinations of our human foes; it is intended more particularly for motorists, cyclists and ski-runners. The mask consists mainly of two pieces of flexible transparent material, such as celluloid, joined by a seam. The upper portion of the mask has a rim of a material qualified to provide tightness between the edge of the mask and the skin. This material may be plush or sponge rubber.

Inside the mask, there is arranged above the mouth and nostrils a partition, so as to prevent the upper part of the mask from becoming bedewed by exhalation. Otherwise the mask, like a motorist's windscreen, would need a wiper.

Anti-ooze

SEEPAGE, or the art of gently oozing, is a besetting sin of lagoons, reservoirs, small streams and of dams made of earth, wood and concrete. To counteract these Lilliputian leaks, a new powder has been produced. This powder forms with water a gelatinous mass and fills voids in construction materials. There are two kinds of the powder. The first is employed where the water can be drawn off. After draining, earth construction is ploughed to a depth of a few inches. The material, spread in the proportion of 100 pounds to each 400 square feet, is raked into the surface and then rolled.

The second type is used where it is impossible to drain away the water. The powder is cast on the surface of the water. It sinks to the bottom and fills the crevices and the points where the water would otherwise stealthily make its escape.

A Full Crop

AN appliance for a patent relating to poultry food has been made to the British Patent Office. I am informed that the feeding of fowls and other birds by means of meal is not always economical. To avoid waste, it has been usual to compress the meal into cakes or pellets. These have generally been manufactured in vermicular form—that is worm-like—and cut up into short lengths, so that each is in the form of a tiny cylinder.

According to the above-mentioned invention, meal is made up in the form of small prisms of triangular cross-section. It is claimed that meal in this shape enables more food to be taken into the crop, as compared with the little cylinders. I infer that the prismatic form can be packed more tightly in the crop, which it seems it is desirable completely to fill.

"MOTILUS" PEEPS INTO THE MODEL WORLD

Around the Stores

ROUND about Christmastide I generally make a tour of the London model shops—Hamleys, Bonds, Mills, Bassett-Lowke's, and the toy departments of the big stores like Selfridges, Harrods and Gamage's—but I'm afraid this year displays will not be on such a large scale as usual, for London to-day is the scene of intensive air-raid precautions and the black-out rather limits visits, although I am glad to hear many of the cheap train excursions to the metropolis have been re-established. Therefore, I hope as many modellers as possible will try to make their usual London trip. The model shops are still open, you know, and rely on your custom.

Here "Motilus" Brings you further News and Pictures of Wartime Model Making

For instance the other day I had a pleasant surprise when calling in at Bassett-Lowke's at High Holborn to find they have placed on the market a really comprehensive

from start to finish in thirty hours!
Trix Trains

In Hamleys I saw the Trix trains running

as merrily as ever, despite the black-out. You can see them in many places and shops in London. Last month I told you about the new "Lowko" gradients, which are

already proving very acceptable to those who want to make their railway different without adding overmuch to the cost. Well, Messrs. Trix, Ltd., are producing a limited number of the many novelties they had planned before the war, and the splendid range of their existing lines is available. Outstanding among these new items is the "Coronation Scot" presentation set fitted for remote control uncoupling, which was illustrated in the October issue (now being sold from stock). This month I am able to show you a photograph of their very attractive Pullman Car. The windows are glazed in transparent Celastoid and the car is designed to take lighting units and fitted for remote control coupling. Other attractive but not so expensive models are the L.M.S. and L.N.E.R. 4-4-0 locomotives, both scale models, the L.M.S. designed as a Deely Compound, the L.N.E.R. a model of the well-known "Shire" class. There are also the derelict hut, crane truck and crane with base to fit into the system of the Many Ways Platforms. In response to the wishes of many owners and would-be owners who want ideas for their layouts, special blue prints which contain on them a tabulated



The finished "Mogul"—an impressive model



The T.T.R. Pullman Car

set of parts for building a "live steam" locomotive. In pre-pre-war days I believe they did something similar in gauge 1, but this time they have adopted the more popular size of gauge "O" and have made it possible for the relatively unskilled amateur to build one of their popular—modern type—2-6-0 L.M.S. steam Mogul locomotives. The set of parts has many vital components—such as the boiler and cylinders—in finished condition, and complete, consisting of over 50 parts costs £3 17s. (that is including the 10 per cent. increase due to A.R.P. expenses and the cost of the Government's compulsory scheme for insuring stock against war risks). A fully descriptive booklet with good illustrations is at present in the printers' hands and can be obtained, price sixpence. It is to be included, free of charge, in every set, and tells you how to complete the model



Some of the parts used in the construction of Bassett-Lowke's L.M.S. steam "Mogul"

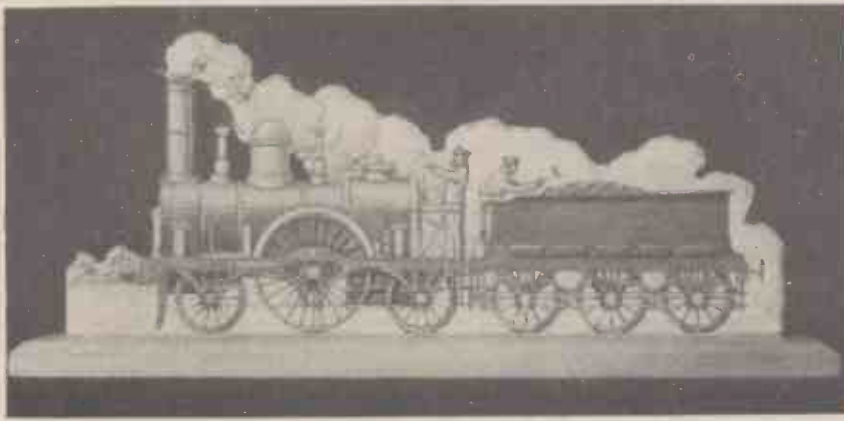

The cut-out railway model of Robert Stephenson's "North Star," painted and mounted on a wooden base

list of the amount of track, points, etc., has been drawn up. Even the complicated layout which Messrs. Trix, Ltd., showed at the British Industries Fair this spring has been included, and the cost per print is 1s. 6d. A list of the dimensions and types of layouts is obtainable from Bassett-Lowke, Ltd. This is a step in the direction of real help from the "professional" to the amateur.

New Zealand Centennial Exhibition

It is hardly possible in peace time for me to get as far as the Antipodes and in war time I should say the chances are one thousand to one! But I am able to tell you about some of the attractive features of the New Zealand Centennial Exhibition, which, despite the war, opened at Wellington last month, and marks the completion of 100 years of British Sovereignty and organised settlement in New Zealand. The Department of Overseas Trade has naturally participated in this exhibition of a dominion overseas and has a specially designed United Kingdom Government Pavilion. The theme is Commerce and Transport, and one of the notable exhibits illustrated in this space is a moving panorama of British Merchant Vessels, which was originally shown at the Paris Exhibition of 1936, but has since been redesigned and brought up to date for the New Zealand display. The ships, which are accurate to a scale of 100 ft. to 1 inch, move at varying speeds across a sea viewed through port-holes symbolising the shell of a modern ship. Representative ships of the Mercantile Marine of over 20,000 tons built in Great Britain since 1926 are shown and these include vessels of the Canadian Pacific, Cunard White Star, Orient Line, Peninsular and Oriental, Union Castle, besides the new Royal Mail Liner *Andes*, the Shaw Savill *Dominion Monarch*, and, last, but not least, the new Cunard White Star, *Mauretania*.

Plywood Cut-Outs

Readers will remember the series of articles which appeared in "Practical Mechanics" in the summer of 1938 on "The Progress of the British Steam Locomotive" illustrated by 3½ m.m. drawings in outline by Mr. E. W. Twining. There were thirty in all, containing in the series famous and representative locomotives since Richard Trevithick's *Peny-Darren* in 1803, Hedley's "Puffing Billy," etc., up to the present day

and the first of their series is of course the Prime Minister, Mr. Neville Chamberlain, complete with his umbrella! He is now in stock and other figures of eminent statesmen and heads of the fighting forces—Viscount Gort, Sir Cyril Newall, Evans of the Broke, Winston Churchill, are being produced in "model" form. In Bassett-Lowke's London shop is a very nice range of seamen of all periods to two different scales, and my photographs show other figures constructed by the artist who is doing this work for Mr. Bassett-Lowke. Every figure is hand-made and displays good accuracy and a high class of workmanship combined with artistic merit.

Lead Figures

Some years ago, Bassett-Lowke, Ltd., made up a series of famous passengers for gauge "O" railways. They included, if I remember rightly, Amy Johnson, George Bernard Shaw, Stanley Baldwin, Charlie Chaplin and Lloyd George, and had a very successful run among model railway enthusiasts. I hear they are now reviving this idea and the first of their series is of course the Prime Minister, Mr. Neville Chamberlain, complete with his umbrella! He is now in stock and other figures of eminent statesmen and heads of the fighting forces—Viscount Gort, Sir Cyril Newall, Evans of the Broke, Winston Churchill, are being produced in "model" form. In Bassett-Lowke's London shop is a very nice range of seamen of all periods to two different scales, and my photographs show other figures constructed by the artist who is doing this work for Mr. Bassett-Lowke. Every figure is hand-made and displays good accuracy and a high class of workmanship combined with artistic merit.

Wartime Models

I notice many of the shops are bringing forward their wartime toys and models and here are two of the latest items of this

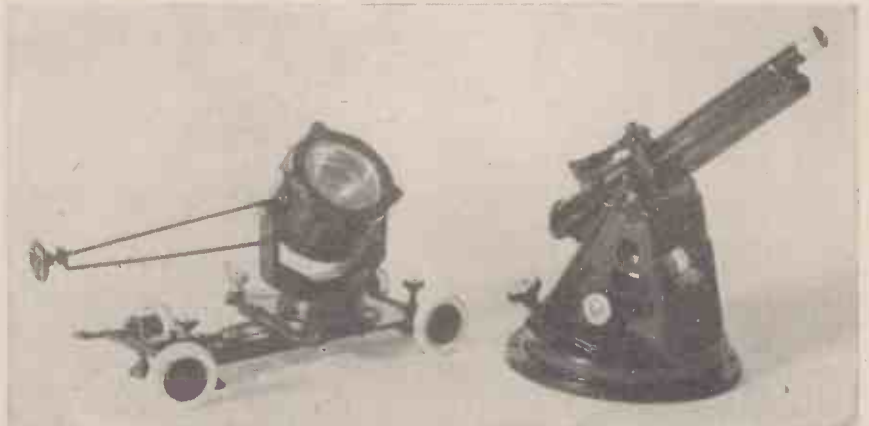

Models of anti-aircraft units of the British Army

I have heard from an artistic model maker who has bought the complete series of black line prints and mounted each locomotive on plywood. He has fretsawed out the wood and finished the main outline neatly with a fine file, then mounted each one on a slotted base and painted it in natural colours. Here is a photograph of one done in this way and I think you will agree it makes a useful and compact record of locomotive progress, besides providing in the work skill for painting and at the same time making it possible to have a set of these models at the mini-

character—anti-aircraft gun and searchlight on mobile chassis. The gun is a working model in every sense of the word. It fires a wooden shell in manner similar to the full-size machine. The barrel is elevated by quadrant and pinion gears and traversing by pinion and internal toothed wheel. The searchlight, too, is a working model with a bulb to light up. It swivels on a turntable on rubber tyred trailer chassis and four levelling screws, the latter being used to raise the searchlight from the wheels when in action.



Picturesque models of our fighting forces (left to right) R.A.F. pilot, R.A.F. pilot officer, the Navy, the Army (42nd Division Royal Artillery), 4th Hussars, the Queen's Bays, the 16½th Lancers, the Royal Horse Artillery, the Scottish Clan Sinclair and the Macleod of Lewis

A DICTIONARY OF

Metals and Their Alloys

(Continued from page 64 of last month's issue)

Anatomical Alloy.—An alloy which is sometimes used for taking casts of certain portions of the human and animal body, such as an ear, after death. It melts at 169°F. and remains liquid at 140°F. Composition: Bismuth, 53.5; lead, 17.0; tin, 19.0; mercury, 10.5 per cent.

Anka Steel.—A type of stainless chromium-nickel steel containing about 15.5 per cent. of chromium and 10 per cent. of nickel. It is a well-known Sheffield steel.

Annealing.—The process of slowly cooling a metal or alloy from bright red heat (or other suitable temperature) down to ordinary temperature. It usually increases the softness and malleability of a metal.

Anodised Aluminium.—Aluminium which has been made the anode or positive electrode of an electrolytical chemical bath containing sodium phosphate or other solution. On passing a current through such a bath, the aluminium is chemically oxidised on the surface, giving it a fine matt appearance. See *Aluminium*.

Anticorodal.—A modern aluminium alloy of Swiss origin. Composition: magnesium, 0.6; silicon, 1.0 per cent.—remainder aluminium. It can be heat-treated and has a tensile strength of approximately 20 tons/sq. in.

Anti-friction Metals.—Name given to various alloys which are employed for the provision of high-speed bearings. Owing to the softness of the alloys, they stand up to friction well—hence the name “anti-friction”—and they are also able to withstand heavy pressures. A common practice is to make the foundation of the bearing of brass or bronze and then to line this with the anti-friction metal. This practice has the advantage of enabling the bearing to be readily renewed merely by melting-out the anti-friction metal.

In the preparation of anti-friction metals, alloys containing copper, tin, lead, antimony, zinc are used, but it is seldom that more than three of these metals enter into the composition of any one alloy.

Owing to the white appearance of these anti-friction metals, they are frequently termed “White metals.”

Antimonial Lead.—Lead containing antimony.

Antimony.—Metallic element. Chemical symbol, Sb (from the Latin, *Stibium*). At. No. 51; At. Wt. 120; M.P. 629.2°C.; B.P. 1440°C.; Sp. Grav. 6.7; Sp. Ht. .0495; Coef. Exp. .000012; Therm. Cond. (Silver=100) 4.03; Elec. Cond. at 0°C (Mercury=1) 2.05. Chief Ores: Stibnite, Sb_2S_3 ; antimony bloom, Sb_2O_3 ; and antimony blend, $Sb_2O_3 \cdot 2Sb_2S_3$. Also occurs in free metallic state. Antimony was known in medieval times, its preparation being described by Basil Valentine, a Benedictine monk, in 1413. The meaning of the name “antimony” is not known, but it has been supposed to be derived from the Greek, *anti*, against; *nomos*, the law.

Antimony is a silvery-white metal having a pronounced crystalline structure. Very brittle and easily powdered. A poor electrical conductor. Does not readily tarnish in dry air, but becomes covered with a film of oxide in moist air. All antimony compounds are highly poison-

LIST OF ABBREVIATIONS	
The following abbreviations are used throughout this Dictionary:	
At. No.	Atomic Number
At. Wt.	Atomic Weight
M.P.	Melting Point
B.P.	Boiling Point
Sp. Grav.	Specific Gravity
Sp. Ht.	Specific Heat
Coef. Exp.	Coefficient of Expansion
Therm. Cond.	Thermal conductivity
Elec. Cond.	Electrical conductivity

ous. When molten antimony solidifies, it expands very slightly. Hence the metal is useful in alloys such as type-metal, etc., from which fine and sharp castings are to be made. Chemical science has shown that antimony can exist in several different forms, such as yellow and black antimony (which see). The metal is attacked by most mineral acids and is chemically closely related to arsenic on the one hand and bismuth on the other.

It is used principally in the making of casting alloys.



(Left) A rod of antimony. (Right) A rod of pure tin. The antimony is coarsely crystalline. It will not withstand the slightest shock without breaking. The tin, being finely crystalline, will resist considerable strain without fracture

Aphtit.—An iron-nickel alloy containing tungsten and copper. Composition: Iron, 66; nickel, 23; copper, 5; tungsten 4 parts.

Ardal.—An aluminium alloy of British origin. Contains: Copper, 2; iron, 1.7; nickel, 0.6 per cent.—remainder aluminium.

Argasoid.—An imitation silver. Composition: Tin, 4; lead, 3.5; copper, 55.5; zinc, 23; nickel, 13.5 parts; together with a trace of iron.

Argentan.—A nickel or German silver.

Argentiferous Lead.—Lead containing a small proportion of silver, as it often does in the natural state. (From the Latin, *argentum*, silver.)

Argentine Metal.—A bright-looking tin alloy sometimes used for making toys, etc. Composition: Tin, 85.5; antimony, 14.5 per cent.

Argent-ruolz.—(Ruolz's silver.) A series of alloys patented in France by M. de

Ruolz in 1853. Very similar to silver in appearance. Composition: Silver, 20 parts; nickel, 30-75 parts; copper, 70-75 parts.

Arguzoid.—A white nickel-silver metal of composition: Nickel, 20½; copper, 48½; zinc, 31 per cent. Used as a solder for nickel silver articles.

Armco Iron.—A nearly pure iron. It contains under 0.1 per cent. of impurity.

Arsenic.—Semi-metallic element, often referred to as a *Metalloid*. Chemical symbol, As; At. No. 33; At. Wt. 75; Sublimes slowly without melting, but if heated under pressure melts at 817°C. Sp. Grav. 5.727; Sp. Ht. .083; Coef. Exp. .000059; Elec. Cond. at 0°C. (Mercury=1) 2.679. Chief Ores: Realgar, As_2S_2 ; orpiment, As_2S_3 ; arsenical pyrites; mispickel; mundic, $FeS_2 \cdot FeAs_3$. Also occurs in free state. Arsenic was known to the ancient Greeks, its name being derived from the Greek, *arsenicon*, meaning “potent.” Arsenic is a steel-grey metal or “metalloid” which, when sublimed, forms lustrous hexagonal rhombohedral crystals. Like antimony, it can exist in several different forms or “atropic modifications,” such as “Grey Arsenic,” “Yellow Arsenic,” etc. (which see). When ordinarily heated, arsenic does not melt, but passes off as a garlic-smelling vapour. Arsenic and all its compounds are exceedingly poisonous, but many of the latter are used in medicine. Chemically, arsenic is a reactive element. As a metal, however, it is useless, except, perhaps, for alloying in minute quantities with other metals. Thus, a trace of arsenic (say 1 in 1,000) in lead makes the lead harder. “Chilled shot” is usually hardened with arsenic.

Arsenical Copper.—Copper containing small amounts of arsenic. It has, in the past, been employed for locomotive firebox service on account of its supposed lower rate of oxidation. Recently, however, it has been shown that the addition of arsenic to copper actually increases its rate of oxidation, and nickel-silicon-copper alloys have been introduced to replace it.

Ashberry Metal.—A type of Britannia metal. Composition: tin, 80; antimony, 14; copper, 2; zinc, 1; nickel, 3 per cent.

Ash Metal.—A very low-grade brass alloy made from metal skimmings and ash from brass foundries.

Auer Metal.—An alloy of iron and cerium metals, similar to “Mischmetal” (which see). It is a pyrophoric metal and emits a bright shower of sparks when struck. Used in automatic lighters, etc. It was introduced into commerce by Dr. Carl Auer (later Baron Auer von Welsbach), the inventor of the incandescent gas mantle. Hence its name.

Austenite.—Name given to a solid solution of carbon in pure iron (“gammaferrite”) Named after W. C. Roberts-Austen, the metallurgist. Steels, containing austenite are termed “austenitic.”

Austenitic Steel.—See *Austenite*.

Australian Gold.—The standard gold coinage of Australia (as minted at Sydney) contained 91.66 per cent. of gold and 8.33 per cent. of silver, thus giving to the Australian gold coinage its characteristic

greenish-yellow appearance. In English standard gold the silver is replaced by copper.

Autogenous Soldering.—The uniting of two pieces of metal together simply by melting their edges by means of a blowlamp or other source of heat. The word "autogeneous" means "self-generated."

The lead linings of chemical and acid tanks are usually autogenously soldered because the presence of any dissimilar metal at the joints would set up electrolytic actions which might attain serious proportions.

Avional.—A Swiss aluminium alloy. Composition: Copper, 4.75; magnesium, 0.5; manganese, 1.0; silicon, 1.4 per cent.; remainder aluminium. Is hard and enduring. Tensile strength about 30 tons/sq. in.

B

Babbitt's Metal.—The original alloy recommended by Babbitt was made up of the following ingredients: copper, 4 lb.; antimony, 8 lb.; tin, 24 lb. To every pound of the above, 2 lb. more of tin was added.

Many soft lining and anti-friction bearing metals have subsequently borne the name of "Babbitt," but the above is the original alloy devised by Babbitt himself.

Bahnmetall.—"Railway Metal." A soft bearing metal used on the German State Railways for the linings of axleboxes. Was introduced during the Great War and is still used with, it is said, excellent results. It consists of lead alloyed with small amounts of sodium, calcium and lithium. Approximate composition: sodium, .58 to .62 per cent.; calcium, .59 to .73 per cent.; lithium, .04 per cent.; remainder lead. It has a hardness of about 34 Brinell, and a compressive strength of between 25,000 and 30,000 lb. per sq. in.

Banka Tin.—Tin from the Island of Banka, in the Dutch East Indies.

Barium.—Metallic element. Chemical symbol, Ba; At. No. 56; At. Wt. 137; M.P. 850°C. Sp. Grav. 3.75; Sp. Ht. .068. First prepared (in an impure form) by Davy in 1808. Its name is derived from the Greek, *baros*, heavy, in reference to the heavy mineral "barote" (afterwards called "baryta") which contains the element.

Chief ores: Heavy spar, Barytes, BaSO₄, Witherite, BaCO₃. Barium, when pure, is a silvery, lustrous metal, having a yellow tinge. It has rarely been obtained in the pure state, however, owing to the extreme difficulty of its preparation. It tarnishes rapidly in air, becoming coated with a film of oxide. It decomposes water with the evolution of hydrogen and the formation of barium hydroxide, Ba(OH)₂.

As a metal, barium has no uses whatever, although its chief ore, barytes, is of great value in industry. Alloys of barium with lead, aluminium, bismuth and antimony have been reported from time to time. Barium is closely related in chemical properties to calcium and strontium.

Base Metals.—See Noble Metals.

Bath Metal.—An alloy which was at one time very popular in England for the manufacture of teapots, sugar basins and other tableware. It is silvery-white in colour, and takes a high polish. Composition: copper 55 parts; zinc 45 parts.

Baudoin's Alloy.—An imitation silver. Composition: copper, 72 per cent.; nickel, 16.6 per cent.; cobalt, 1.8 per

cent.; tin, 2.5 per cent.; zinc, 7.1 per cent. Sometimes about .5 per cent. of aluminium is also added.

Bearings Metals.—See Anti-friction Metals.

Bell Metal.—A type of bronze or copper-tin alloy containing from 12 to 24 per cent. of tin. Technically known as "Hard Bronze."

Beryllium.—Formerly named "Glucinum." Metallic element. Chemical symbol, Be; At. No. 4; At. Wt. 9; M.P. 962°C.; Sp. Grav. 2.1; Sp. Ht. .397.

Chief ore: Beryl, 3BeO.Al₂O₃.6SiO₂. Occurs also in gems, such as emerald.

Name of the metal derived from its principal ore, *beryl*. Beryllium was first isolated in an impure form by F. Wohler in 1827. Not prepared in a pure state until 1885, and until very recent times it has remained an uncommon metal. Nowadays, however, beryllium is rapidly attaining a status of commercial importance, as a light alloying metal, particularly in America.

Beryllium is a white metal resembling magnesium in appearance but being considerably lighter in weight. Next to lithium, beryllium is the lightest metal known. It is fairly malleable, and remains unchanged in ordinary air, even when heated. Powdered beryllium, however, when heated, burns much in the same manner as magnesium, emitting a brilliant light.

Beryllium is acted upon by mineral acids and bears a close chemical resemblance to magnesium. It has now become an important alloying metal, and it may yet be employed in the pure state in view of its extreme lightness, provided that its manufacture can be cheapened sufficiently.

Beryllium-Cobalt-Copper.—A high-conductivity copper alloy, not unlike beryllium-copper, but containing .4 per cent. beryllium, 2.6 per cent. cobalt, balance copper. Has an average tensile strength of 95,000 lb. per sq. in.

Beryllium Copper.—A copper-beryllium alloy containing from 1.5 to 2.75 per cent. of beryllium, the standard alloy having a beryllium content of 2.25. Sometimes up to .5 per cent. of nickel is added to these alloys to restrict grain size during annealing. They were originally investigated by Dr. G. Masing in 1926 and are now of much commercial interest.

In the annealed condition, the standard beryllium-copper alloy has a tensile strength of 70,000 lb. per sq. in., whilst by cold rolling and heat-treatment, its tensile strength can be still further increased. The alloy is obtainable in rod, strip, sheet or cast form. It is now being much used for the production of springs, which show remarkable endurance properties, and, also, for the making of non-sparking tools. With the gradual cheapening of metallic beryllium, beryllium copper alloys have a promising future.

Beryllium Gold.—Gold-beryllium alloys containing from .5 to 5 per cent. of beryllium have been worked out in America. When the beryllium content exceeds the former percentage, however, they become too brittle to work, the beryllium exerting an extreme hardening effect upon the gold. Some of these alloys have been used as gold solders and dental inlays.

Beryllium Silver.—An alloy of silver and beryllium containing from .41 to .90 per cent. of beryllium. It has the remarkable property of remaining untarnished in atmospheres charged with sulphur compounds which would rapidly blacken pure silver.

Beryllium-Silver-Copper.—A group of cop-

per alloys recently introduced in America. Typical composition: silver, 70.44 per cent.; copper, 28.90 per cent.; beryllium, .87 per cent. Used as a resistance-wire material.

Bessemer Steel.—Steel manufactured by the Bessemer process (the invention of Sir Henry Bessemer in 1856). In the Bessemer process, the molten "pig" iron is run into a receptacle known as a "converter," in which a blast of air is passed through it. Impurities are thus burned out of the molten metal.

Bibra Alloy.—Composition: Bismuth, 8 parts; tin, 9 parts; lead, 38 to 40 parts.

Bidery Metal.—An alloy which was at one time very popular in India. It was first manufactured at Bider, near Hyderabad, in India, from which town it takes its name. The metal does not easily tarnish or oxidize, and was at one time employed for the manufacture of Indian cooking vessels. Its composition (average) is: Tin, 1.4 per cent.; copper, 11.4 per cent.; zinc, 84.3 per cent.; lead, 2.9 per cent.

Billet.—A short, thick metal bar which is used for forging or rolling.

Bimetal.—Name given to two dissimilar metals sweated or fused together so as to make up a composite metal sheet. Nowadays, bimetal is much used in consequence of the unequal rates of expansion of their constituent metals, causing the bimetal to curl when heated and thereby enabling a temperature-measurement to be made or an electrical circuit to be opened or closed at a definite temperature.

Binary Alloy.—An alloy containing two constituent metals.

Binary Steels.—These are alloy steels containing one special alloying metal, as, for instance, chromium steel.

Birmabright.—An aluminium-magnesium alloy containing about 7 per cent. magnesium (and sometimes 1 per cent. of manganese). Can be worked easily and is resistant to atmospheric tarnishing and corrosion.

Birmails Special Alloy.—An aluminium alloy containing from 10 to 13 per cent. of silicon and from 2.5 to 3.5 per cent. of nickel, in addition to small amounts of copper, iron and manganese. It has a good resistance to corrosion and a high tensile strength. It is tough and ductile.

Birmidium.—An aluminium alloy produced in Birmingham. Hence its name. It has a composition and properties similar to "Y" alloy, which see.

Birmingham Platinum.—A white brass of variable composition. The following is typical: copper, 43 per cent.; zinc, 57 per cent. Also known as "Platinum Lead." This alloy was formerly used for casting buttons.

Bismuth Amalgam.—A thin fluid amalgam prepared by adding mercury to molten bismuth. Almost any proportions of these two ingredients may be used. Bismuth amalgams, on account of their fluidity are useful for filling very delicate moulds. Other amalgams are also rendered more fluid by adding to them a small proportion of a bismuth amalgam.

Bismuth amalgam is sometimes used for silvering glass globes and similar articles.

The amalgam will pass through chamois-leather like mercury. The drops, however, are pear-shaped and not perfectly globular as in the case of pure mercury.

(To be continued)

FOR ACCURATE WORK AND PERFECT FINISH
A "MILNES" LATHE is Essential



7 in. diameter Centre Lathe

SELF-CONTAINED ELECTRIC OR COUNTERSHAFT DRIVE
 Robust construction in every detail with easy means of adjustment ensure a lifetime's efficient service from "MILNES" MACHINES
 Send for full lists to: **HENRY MILNES, LIMITED, INGLEBY LATHE WORKS, BRADFORD, YORKSHIRE, ENGLAND**

GRAYSON LATHES, TOOLS, MATERIALS AND SUPPLIES



£12/13s.

THE GRAYSON 3 1/2" CENTRE LATHE
 Fully Compound Slide-rest. Set-over Tailstock. No. 2 Morse Tapers. Tumbler Reverse. Double Clasp Nut. Full Set Change Wheels. 18 in. Between Centres.
3 in. MODELS From £6 6s. 6d.
 Write for Free Descriptive Leaflets and Catalogues of Tools and Materials
E. GRAY & SON LTD.
 18-20 Clerkenwell Road, London, E.C.1
 Telephone: CLE 1174

CHEMISTRY



ARE YOU INTERESTED?
 Whether you dabble in experiments or pursue a course of serious study, you will need our **LABORATORY EQUIPMENT**. We offer you a wide range of Standard Sets, or a choice of **APPARATUS** and **CHEMICALS** which may be purchased separately.

CHOOSE A CHEMISTRY SET FOR CHRISTMAS!

WRITE for FREE CATALOGUE
 OUTFITS FROM 2/9 to 120/-
SPECIAL 3/4 OFFERS
 (CARRIAGE PAID)

FLASKS AND BEAKERS SET	GAS PREPARATION SET
Round Bottom Flask	Kipp's Apparatus (for generating gases, designed for home use)
Flat Bottom Flask	Gas Jar
Conical Flask	Gas Jar Plate
Wide Mouth Flask	Glass Delivery Tube
Small Beaker	Large Boiling Tube
Large Beaker	
Cleaning Brush	

BECK (Scientific Dept. A) 60 High St., Stoke Newington LONDON, N.16
 BOOKLET OF "TESTED EXPERIMENTS" 6d. (P.O.) post free

GREAT NEW AUTHORITATIVE PART WORK

NEWNES **COMPLETE ENGINEER** 1/- WEEKLY PARTS

Advisory Editor: **LT.-COL. D. J. SMITH, O.B.E., M.I.A.E.**

FIRST PARTS NOW ON SALE

THE war is responsible for the insistent demand for men with a sound practical knowledge of all branches of engineering. The up to the minute information they need is not to be found in any convenient form, and that is why Newnes **COMPLETE ENGINEER** is published. It provides expert guidance for the thousands in engineering work, and also for those coming into the workshops to meet the vital needs of increased production. Absolutely comprehensive, containing specialist information on modern production, installation, maintenance and operation in all the various branches of engineering, it is a most valuable collection of facts and data for the progressive engineer.

Many hundreds of specially taken photographs, drawings and diagrams.

Brief outline of Newnes COMPLETE ENGINEER

Workshop Processes and Methods

How to Read a Blueprint. Pattern Making. Foundry Work. Chipping and Filing. Fitting. Turning. Drilling. Milling. Grinding. Die Casting. Micrometers and Gauges. Welding. Riveting. Brazing. Electro-plating. Anodising. Sherardising. Galvanising. Cost-estimating, etc. Wire-drawing. Sheet and Plate Metal Work. Metal Spinning. X-Ray Examination of Materials, etc.

Machine Tools and Production Methods

Modern Production Methods. Capstan and Automatic Lathes. Precision Grinders. Milling Machines. Multiple Drills (Broaching Machines). Planing and Shaping. Pressing and Stamping. Drop Forging. Profiling Machines. Jigs and Fixings. Tool and Machine Setting. Automatic Chucks. Magnetic Chucks, etc. Specialised applications of the above processes will be illustrated and described by experts, e.g.: Aircraft Manufacture. Marine Engineering. Shipbuilding. Automobile Engineering. Locomotive Engineering, etc.

Installation Work

Line Shafting. Belt and Rope Drives. Gears and Gearing. Electric Motor Drives (Group and Individual). The installation of Prime Movers—Steam Engines, Steam Turbines, Gas and Oil Engines, Diesel Engines, Electric Motors. Power-Driven Machinery. Machine Tools, Presses, Pumps, (Reciprocating), Pumps (Rotary). Electrical Generators. Transformers and Switchgear. Boiler Plant. Condensers. Coolers and Scrubbers. Water Turbines, etc.

Operation and Maintenance

Steam Engines. Steam Turbines. Gas, Oil and Petrol Engines. Diesel Engines. Electric Motors and Control Gear. Water Turbines. Wind Motors. Lifts. Cranes. Conveyors. And many other specialised applications of engineering. Fault Tracing. Repairs and Testing form an important section of this volume.

Get Your Copies Now Of all Newsagents and Bookstalls

TO BE COMPLETED IN ABOUT 40 WEEKLY PARTS

PRICE 1/- NEWNES **COMPLETE ENGINEER** PART 1

A RELIABLE GUIDE TO THE EVERYDAY WORK OF THE ENGINEER



DEALING WITH
 WORKSHOP PROCESSES
 ENGINEERING PRODUCTION
 INSTALLATION WORK
 OPERATION AND MAINTENANCE OF ALL TYPES OF ENGINEERING PLANT AND MACHINERY
 GIVEN IN THIS PART DATA SHEET TRANSMISSION SHAFTING

George Newnes Ltd.



This smart Tank Locomotive is available in L.M.S., L.N.E.R. and S.R. colours. It is a powerful model with first class mechanism, whether clockwork or electric, and, has the additional embellishment of outside cylinders. Prices: clockwork, £2; electric d.c. 6-8, £2 5s.; a.c. 20 volts., £2 10s. 0d. (Gauge "O.")

FOR MODEL ENTHUSIASTS:—

- AB.12 "Steam Locomotives, Stationary Engines and Everything for the Model Constructor." Post Free 8d.
- GR.12 New List of Gauge "O" Locomotives—clockwork, electric, steam. Post Free 3d.
- TT.12 New List of Gauge "OO" Equipment for the Twin Train Table Railway. Post Free 2d.
- S.12 Catalogue of Model Ships Post Free 6d.
- Laying Permanent Way. 2d.
- Building a Traction Engine. 3d.
- The T.T.R. Permanent Way Manual. 1s. 6d.
- Building a Gauge "O" Steam Mogul. 6d.

ENTERPRISE

The splendid steam locomotive in Gauge "O" 4-4-0 type; length overall 18 in.; weight 3 lb. 10 oz. Price £2 15s. Sister loco 4-6-0 type "Super Enterprise." Price £4 2s. 6d.

● WONDERFUL DEVELOPMENTS ON THE TWIN TRAIN RAILWAY GET LIST TT12 PRICE 2d.

MIDLAND COMPOUND

For the Model Man who wants an L.M.S. locomotive, that will run speedily and does not require large curves, take a look alongside! No. 1108 is inexpensive and smart. Prices: Clockwork, £1 15s. 6d.; Electric d.c. 6-8 volts, £2; a.c. 20 volts, £2 6s. 0d. Also available in G.W.R. colours.

KEEP THOSE WHEELS REVOLVING!

"Keep the Wheels of Trade Revolving," says Mr. Neville Chamberlain, our Prime Minister. To-day is the golden opportunity to keep those Model Railway Wheels revolving and to keep life in this most fascinating hobby. BASSETT-LOWKE Ltd. have always been noted for their variety in modelling, and to-day their varied stock of locomotives of every type and price stands them in good stead. Anything to do with a Model Railway is an Ideal Present in war time. It is a diversion from the black-out in these times when we are thrown on our own resources for entertainment.

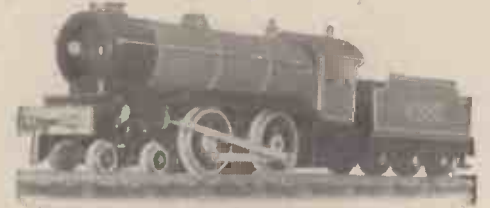

BASSETT-LOWKE, LTD., NORTHAMPTON

LONDON: 112, High Holborn, W.C.1. MANCHESTER: 28, Corporation Street

THE FAMOUS "ADEPT" & "SUPER ADEPT" LATHES



The "Super Adept" as illustrated, 33/-. "Adept" Lathe with Compound slide rest, 22/-. Or with Hand Rest only 13/9. Screw Barrel Tailstock 3/6 extra. Post 1/-. All models are 1 1/2 in. centre, 6 in. between the centres. Good range of accessories available.



The "Adept" 2 1/2 in. independent chuck with 4 reversible jaws, 15/-. Post 6d. The back of this chuck is screwed to fit the "Adept" and "Super Adept" lathes. The "Adept" countershaft for speed reduction when driving the "Adept" or other small lathes by electric motor. 10/-. Post 9d.

Manufactured by **F. W. PORTASS** SELLERS STREET, SHEFFIELD, 8. WRITE FOR PARTICULARS

The modern lathe

MYFORD

3 1/8 IN. AND 3 1/2 IN.

The hard-wearing qualities combined with exceptional accuracy have made Myford Lathes the standard by which others are judged.

Ask your nearest Tool Merchant for particulars or write direct to the sole manufacturers—



MYFORD ENGINEERING Co., Ltd., Beeston, Nottm.

Be sure YOU have it!

The famous All-British

TILLEY LANTERN



(Burns ordinary Paraffin)
Light of 300 c.p. for 6 hours for 1d. Mechanics and owners of small workshops, lathe sheds, observatories, etc., will find it invaluable for work after dark, either in or outdoors. Holds enough oil for 10 hours' use on one filling. Can be placed anywhere with absolute safety. Easy to light. Wind and rain proof. Strongly made. No parts to rust, corrode or get out of order. For dependability you cannot do better than get the Tilley Storm Lantern. Price 36/., plus 5%. Sold by all good Ironmongers and Stores. If any difficulty, write to:—

TILLEY LAMP CO. (Dept. P.M.), HENDON, N.W.4

BARGAIN OFFER INSTRUMENT WIRE
At Half Ordinary Price

25 SWG 1/8	28 SWG 2/2	30 SWG 2/10
32 SWG 3/4	34 SWG 3/10	36 SWG 4/9
Price per lb. for Double Silk Covered		
26 SWG 2/8	28 SWG 2/10	30 SWG 3/2
32 SWG 3/8	34 SWG 4/8	40 SWG 9/-

Postage 6d. Reels and Winding 6d. per reel

SPLIT PHASE A.C. MOTORS

1425 r.p.m. All voltages. Ideal for workshop and industrial uses. Heavy duty rating. No radio interference and silent. 1/4 h.p. 55/-; 1/2 h.p. 78/-. Other motors from 16/6. Universal, Capacitor, Repulsion, at low prices. Low voltage Transformers; secondary tapings 10-20-40 volts 6/6 Post 6d.



Leaflets free. L. WILKINSON, 204 LOWER ADDISCOMBE ROAD, CROYDON

ELECTRIC MOTORS TO CLEAR



We have a number of new and guaranteed Electric Motors to offer at special prices. Now is the time to get one. These comprise Shaded Pole, Split Phase, D.C. 1/50 h.p. to 1/4 h.p.

Call and see them or write
BATWIN ELECTRIC MOTORS Ltd.
138 Southwark Street, S.E.1.
Waterloo 4551.

MASTERS OF MECHANICS

No 51. "Father of the Gas Engine."

The Life of Etienne Lenoir, Engineer
and Designer

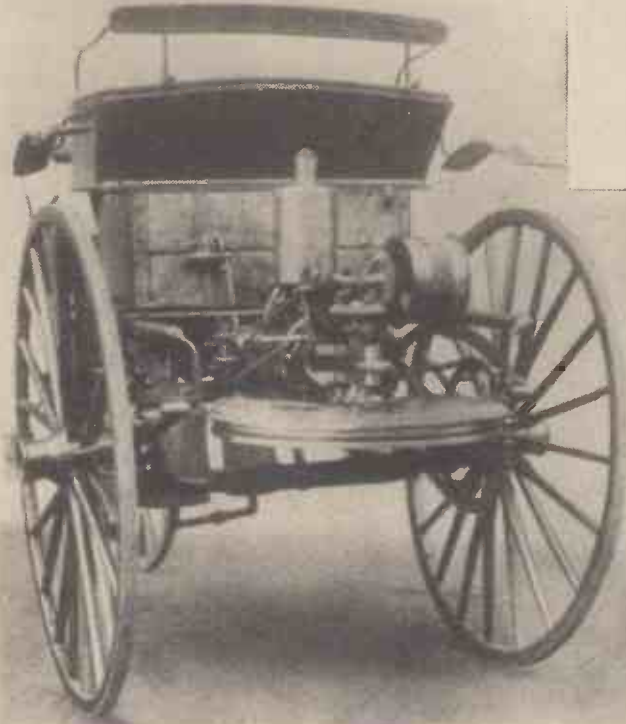

The facts of Lenoir's early career can be related very briefly. He was born in the year 1822 at Mussy la Ville, a small Belgium village. His parentage was honest but humble, and he received a very sparse education. At the age of sixteen, he left Mussy la Ville and journeyed to Paris, there, he said,

incorporate all the good points of the engines of previous inventors and possess none of their very numerous drawbacks. To this end, gathering to himself a little assistance, financial and mechanical, he was soon devoting all his energies.

Several gas engines were built in Lenoir's tiny workshop until eventually one was designed which he considered to be a practicable and a marketable proposition.

In 1859 Lenoir formed his first Company for the commercial manufacture of his new gas engine. Under the name of *Société des Moteurs Lenoir*, the Company had a capital of two million francs, the works being situated in the Rue de la Roquette, in Paris.

The first Lenoir gas-engine patent for "an engine dilated by the combustion of gas" was taken out in France on January 24th, 1860. On April 17th of the same year, a complete French patent was obtained, whilst a very similar one was granted to Lenoir by the British Patent Office on February 8th, 1860.

One of the first
Daimler cars fitted
with a miniature
Otto four-stroke
gas engine

First Gas Engines

Lenoir's first gas engines were of the "stationary" type. Fundamentally, there was nothing really new in Lenoir's designs. Rather, Lenoir had proceeded according to his intention of welding into a complete and satisfactorily working whole the good points of previous inventors.

Virtually, the Lenoir gas engine was very much like an ordinary high-pressure steam engine, except that it had valves to admit both gas and air and to release the products of combustion.

The piston of the 1860 Lenoir gas engine was driven forward for a portion of its stroke by the inertia of a very large and heavy flywheel. At the same time, it sucked into the cylinder a mixture of air and gas at normal atmospheric pressure, there being no attempt to compress this explosive charge.

The valves of the cylinder were then automatically closed, whereupon an electric spark, derived from a battery-operated spark-coil, exploded the mixture thereby causing the piston to be driven along the cylinder to the completion of its stroke. The products of combustion within the cylinder were automatically exhausted on a principle similar to that of the steam engine, whereupon the inertia of the flywheel took charge of the piston's movements until the next firing spark occurred in the cylinder.

Lenoir's first gas engine was of 3 horsepower. Despite the fact that it was rather wasteful of fuel, it was smooth and relatively silent in action, and, structurally, it comprised a thoroughly sound mechanical proposition.

400 Engines At Work

In 1865, there were no fewer than 400 Lenoir engines at work in Paris alone, driving lathes, printing machinery, saw-mills, pumps and other varieties of mechanical appliances, whilst in England an almost similar "attack" on industry had been made

IN the annals of French engineering, the name of Etienne Lenoir occupies a high and important position. It is, of course, untrue to state that he actually invented the first working gas engine, for gas engines, good, bad and indifferent—mostly the two latter—had been created by various individuals during the early and middle portions of the last century. Lenoir, however, deserves the title of "Father of the Gas Engine" which has been bestowed upon him with almost universal accord since it was he who raised this type of prime mover from its experimental stage and placed its design and production upon a satisfactory commercial basis.

It is, indeed, to Lenoir that we owe our first industrial gas engines. The first of these engines which were made successfully in England were turned out under Lenoir's patents, and although they were possessed of disadvantages which now seem almost ludicrous they initiated in Britain the era of the gas or explosion engine which subsequently underwent an enormous amount of development through the stage of the four-stroke gas engine to the modern diesel and semi-diesel engines.

Little Known Career

In consequence of the activities of subsequent inventors who have improved the original type of gas engine almost out of all recognition, the career of Lenoir is nowadays little known. Of a modest and retiring disposition, Etienne Lenoir seldom sought a place in the limelight, and history seemingly has dealt with him according to this characteristic, for, apart from a certain amount of enthusiasm concerning his inventions which crops up now and again in French engineering circles, the life and activities of Lenoir are little known elsewhere.

to "make good in the world." Arrived in Paris in the early part of 1838—just over one hundred years ago, by the way—Etienne Lenoir obtained a job in an enamelling shop. Out of his meagre earnings, he scraped enough money to attend classes during the evening, and in this way he gradually completed his neglected education and taught himself the rudiments of science and mechanics.

His First Invention

The art of enamelling is, of course, an ancient one. It seems to have fascinated Lenoir, for he studied the details of this art with much intensity, so much so that it was not very long before he was able to bring out a new and easier method of fixing white enamel on the dials of clocks and watches.

This was Lenoir's first invention. He seems, however, to have made but little out of it, for we next hear of him experimenting with a system of electric braking of railway trains and, also, of electrical railway signal control. These activities, like those of his enamelling career, did not bring him any material satisfaction. He relinquished them, therefore, and settled down in the machinery trade, starting for himself a diminutive workshop in a suburb of Paris.

At this time, that is to say, during the early "fifties" of the last century, the subject of gas engines was very much "the thing" in engineering circles. As we have already seen, a number of engines driven by the combustion of air-gas mixtures had been devised, but none of these had proved satisfactory.

His First Company

Lenoir, at this period of his career, became greatly attracted by the prospect of devising a gas engine which would

by the English Lenoir interests, whose factory had been established at Reading.

Besides being the creator of the first commercially successful gas engine, Lenoir must also be accorded the honour of being the first individual to run a road carriage by means of a gas motor.

Lenoir's claims to the invention of the earliest form of "motor car" have been much overlooked, mainly in consequence of the striking success of the German inventors in this line. There is, however, no gainsaying the plain fact that in May, 1862, Etienne Lenoir fitted a portable gas engine to a heavy road carriage and, after numerous alterations and readjustments of design, at last succeeded in driving the carriage from his Paris works to Vincennes. This fact has been officially credited by the Automobile Club of France, and it, therefore, constitutes a definite milestone (no doubt the very first one) in the history of automobilism.

The gas engine which Lenoir fitted to his first car appears to have been a rather strange one. The maximum "revs." of the engine were only 100 per minute, and, as the engine was provided with a huge and weighty flywheel, its speed was correspondingly slow. The maximum speed of this first Lenoir vehicle seems to have averaged about three miles per hour (breakdowns not included).

Obviously, the Lenoir type of gas engine was hopelessly unfitted for portable use. And, perhaps, because of his inner realisation of this fact, Lenoir soon lost interest in this side of his mechanical activities. He sold his "mechanical carriage" patents to the French *Compagnie Parisienne du Gaz* in 1863. The latter concern, however made little use of them.

Powering A Motor Boat

Almost immediately afterwards, Lenoir experimented in the production of a gas engine suitable for powering a motor boat. This creation held out better prospects. Referring to his 2 h.p. motor-boat gas engine, the inventor relates:

"I obtained much better results with the motor fitted into a boat. This proved the best 'testing bench.' Another advantage was that I did not have to carry any water, and this reduced the weight of the engine considerably.

"In 1865, I made a 6 h.p. motor for Monsieur Dalloz, editor of the *Moniteur Universel*. This was fitted into a boat 12 metres long, but the speed was insignificant owing to the slow-running motor, and we used far too much essence of petroleum."

Lenoir's reference to not having to carry water refers to the fact that his ordinary gas engines ran exceedingly hot, and that they required large amounts of cooling water, a fact which militated against their successful use in road vehicles. As motor-boat engines, however, they could be cooled adequately by means of river water.

"Essence of Petroleum"

It should be noted, also, that Lenoir, in the above-quoted passage, refers to his employment of "essence of petroleum." This constitutes one of the very earliest references to the use of petrol for gas-engine purposes.

Naturally enough, the Lenoir interests experienced a great deal of open hostility from makers of steam engines. Owing to the fact that the Lenoir engine consumed lubricating oil abundantly, and generated an excessive amount of heat, it used to be said in a vein of much sarcasm that "The Lenoir motor is self-heating—and oil-eating!"

The Franco-Prussian war of 1870-71 completely suppressed the Lenoir interests in Paris. Lenoir, however, rallied to the service of the hard-pressed French Government. He remained in Paris through the historic siege of that city by the Germans, and was subsequently naturalised a Frenchman for his services during that hour of trial.

Lenoir's Award

Ten years later Lenoir received the award of the French Legion of Honour, not, however, for the invention of his gas engines, but, rather strangely, in consideration of a minor invention of his comprising a system of telegraphy by means of which letters and characters were inscribed on a moving tape.

Here, of course, Etienne Lenoir appears as one of the early inventors of our nowadays much commercially used "tape machine."

This invention, however, brought little or no profit to Lenoir. He sold it, and, with the proceeds, devoted himself to the furtherance of his earlier love—the gas engine.

In 1883 Lenoir invented a new form of gas motor in which he utilised the four-stroke principle. The engine was an extremely economical one, so much so that it caused quite a sensation among the gas engine-makers of the day.

The Four-Stroke Principle

Lenoir's utilisation of the four-stroke principle in his new engine brought him at once into direct conflict with the Otto interests, of Germany, whose patent rights had, at that time, still some eight years to run. The consequence was that the Otto faction sued Lenoir for infringement of their master patents. A battle royal took place in the French courts between the rival factions. For a time, the Otto camp seemed to be heading for victory. It was proved, however, that the Otto four-stroke principle was fundamentally based upon the patent of a French engineering theorist, one Alphonse Beau de Rochas, who, in 1862,

had enunciated the basic principles of a form of gas engine in which four cycles of operations occurred, these operations comprising the nowadays well-known cycle of suction, compression, ignition and exhaustion of the cylinder charges.

Proving that Dr. Otto had built up his famous four-stroke engine upon Beau de Rochas' patented principle, the Lenoir interests were able to hold their own and to claim that it was, indeed, the Otto patents which should be annulled.

Famous Legal Action

This, actually, is what took place as a result of the famous legal action. Lenoir's patent was upheld and the Otto patents were quashed. Hence, at a stroke the Otto monopoly fell to the ground and it thereupon became legal for anyone to make four-stroke engines without licence from the Otto Company or its agents.

In fighting this important patent action, Lenoir undoubtedly helped on the coming of the motor car, which came into practical existence soon afterwards. Any individual inventor could thereafter design and construct a motor vehicle for himself and fit into it a petrol engine operating basically upon the four-stroke principle. Thus it was that an enormous impetus was given in all civilised countries to the invention of petrol-propelled vehicles, an impetus which fructified in the rise and progress of many varied types of mechanically propelled carriages during the early "nineties" of the last century.

Despite his activities and his commercial inventions, Lenoir never became a rich man. Rather, he was always endeavouring to ward off the spectre of poverty which ever seemed to follow in his footsteps. This was, no doubt, on account of the fact that Lenoir was not endowed with a businesslike sense. He parted with his patents too easily, selling them at a very low figure, and spending considerable sums of his own money on further mechanical experimentation and research.

Indeed, had it not been for the *Compagnie Parisienne du Gaz*, of Paris, Lenoir, no doubt, would have died in extreme poverty. As it was, however, this famous French concern allowed the inventor a small regular income upon which, in his later years, he had solely to live.

In Retirement

About 1890, Lenoir, then fast approaching the allotted "three score years and ten" and being not a little disheartened and disillusioned by the meagre and cheese-paring treatment which his inventions had received, retired to a small villa on the river Marne at La Varenne-Saint Hilaire. Here he remained in retirement until death carried him away in the year 1900 at the considerable age of 78.

At the time of his death Etienne Lenoir had been more or less completely forgotten in the influx of motor-car and gas-engines inventions which came around that period. It was, indeed, only when a Lenoir commemorative plate was ceremoniously unveiled in the Paris "Institute of Arts and Trades" (*Conservatoire des Arts et Métiers*) in 1912, that the true memory of the man and his inventions returned.

To Etienne Lenoir, "Father of the Gas Engine," engineering in general owes a debt which it should not lose sight of. For if Lenoir had not lived, gas-engine development might have been much different from and much slower than its progress which took place at Lenoir's hands. Indeed, without Lenoir, gas-engine design might have been delayed by a quarter or a century or even more.

THE P.M. LIST OF BLUEPRINTS

- F. J. CAMM'S PETROL-DRIVEN MODEL MONOPLANE
7s. 6d. per set of four sheets, full-size.
- The "PRACTICAL MECHANICS" £20 CAR
(Designed by F. J. CAMM)
10s. 6d. per set of four sheets.
- "PRACTICAL MECHANICS" MASTER BATTERY CLOCK
Blueprint 1s.
- The "PRACTICAL MECHANICS" OUTBOARD SPEEDBOAT
7s. 6d. per set of three sheets
- A MODEL AUTOGIRO
Full-size blueprint, 1s.
- SUPER-DURATION BIPLANE
Full-size blueprint, 1s.
- The P.M. "PETREL" MODEL MONOPLANE
Complete set, 5s.
- The I.-c.c. TWO-STROKE PETROL ENGINE
Complete set, 5s.
- STREAMLINED WAKEFIELD MONOPLANE—2s.
- A LIGHTWEIGHT GLIDER
Full-size blueprint, 2s.
- MODEL DURATION MONOPLANE
Full-size blueprint, 2s.
- WAKEFIELD MODEL
Full-size blueprint, 2s.
- "FLYING" LOW-WING PETROL MODEL PLANE
Full-size blueprint of wing sections, 6d.
- LIGHTWEIGHT DURATION MODEL
Full-size blueprint, 2s.

The above blueprints are obtainable post free from Messrs. G. Newnes Ltd., Tower House, Strand, W.C.2

Two Famous Training Ships

By "Seafarer"

Famous Ships which Give
the Budding Sailor the
Finest Possible Prepara-
tion for a Sea Life

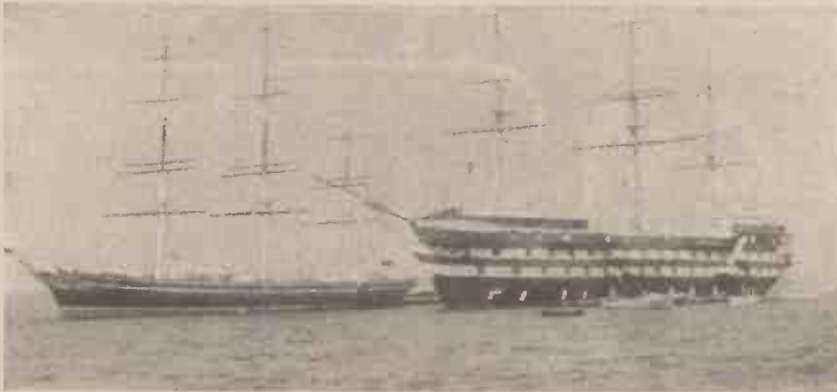

H.M.S. "Worcester" and "Cutty Sark"



The bow of the H.M.S. "Worcester" showing the old figurehead of the "Frederick William"



Looking astern from the forecabin head of the "Cutty Sark," showing one of the anchors in the foreground

THE Thames, from its source to its mouth, is probably the most fascinating river in England, passing as it does through the greatest city in the world, and combining beauty, industry and romance.

It bears many ships which give the budding sailor, whether for the Navy or the Merchant Service, the finest possible preparation for a sea life. Above bridges the Navy League has its training ship *Stork*, while lower down the *Warspite*, *Exmouth* and *Triton* render good service to the lower deck and forecabin hands. But perhaps the most interesting of all is the H.M.S. *Worcester* moored off Greenhithe, famed for the turning out of fine officers for the British Merchant Service. Recently to the *Worcester* has been added the *Cutty Sark*, most famous clipper of all times, and these two ships, together with magnificent playing fields on shore and the beautiful Ingress Abbey (which is built from the stones of old London Bridge), make an excellent training establishment for the Merchant Service.

A Special Visit

As a member of the Ship Lovers' Society I took the opportunity the other day, in company with other kindred spirits of paying a special visit to both ships. It was a

glorious afternoon when we arrived at Greenhithe station and wended our way through the picturesque streets of the old town. Greenhithe has an historical interest in being the port from which the explorer and navigator John Franklin sailed on May 18th, 1845, for his last tragic voyage in command of the *Erebus* and *Terror* to search for the North West Passage. I recalled, too, as we left by motor boat from the old quay that Franklin had fought under Nelson at Trafalgar.

The "Cutty Sark"

Our first visit was paid to the *Cutty Sark*. This fine old clipper bears the same relation, I should say, to the Merchant Service, as the *Victory* does to the Royal Navy. She was presented to the College in 1938 by Mrs. Downman, widow of the late owner, to be used in conjunction with the *Worcester* for the training of cadets, and classes are sent over to her daily for instruction. Fortunately the ship retains all her sea-going appliances such as anchors, windlass, holds, steering gear, life boats in davits, as well as a complete set of sails and running rigging. It is a great pleasure to know that this vessel has been preserved in its original form so that people can know what ships built in 1870—the time of the

Franco-German war, were like. The *Cutty Sark's* old 'tween decks have been converted into a main deck extending the whole ship and lighted by 36 scuttles, a space which is a very useful addition to that available in the *Worcester*. Readers will remember the famous grain races of the clippers home from Australia and China, in which the *Cutty Sark* played no small part (running home from Shanghai on one occasion without her rudder, which had been carried away in a terrific gale)—so it is not surprising to learn that the plans to which she was constructed were intended to make her beat all sailing ship records in speed and seaworthiness. She was built in Dumbarton in 1869.

The "Worcester"

Leaving the *Cutty Sark* our motor boat took us on to the *Worcester*. Like many other London shipping benefits, this vessel owes her being to the famous "Dickie" Green of Blackwall, though from the very beginning he worked in collaboration with William Bullivant, inventor of the modern wire rope and himself an old ship's officer. This was in 1861, when the disappearance of the old East Indiamen had made it difficult to secure a type of Merchant service officer approximating to the naval officer. The training ship *Conway* had been established on the Mersey in 1859, and London shipowners were determined to do

just as well or better on the Thames. After some discussion the Admiralty lent the 50-gun frigate *Worcester*, a ship of 1,500 tons by the old measurement, and the venture was inaugurated in August, 1862, with 14 cadets. To begin with, the *Worcester* was moored off Erith, but when it was decided this locality was unhealthy she moved to Southend for some years, then up-river again to Greenhithe where she now is.

The Admiralty, prejudiced against the Merchant service and the Royal Naval reserve in the last century, gave tardy acknowledgment to this work, but shipping companies soon appreciated the officers turned out by the *Worcester* and the original very modest scheme had to be changed to meet demand. The old frigate was too small and after much discussion the Admiralty exchanged her for the two decked line-of-battleship *Frederick William*, which took

the frigate's name, and is the present training ship.

This second *Worcester* was laid down as a 74-gun sailing line-of-battleship in 1833. Her name was to have been *Royal Sovereign*, but the Admiralty decided to honour a Hanoverian prince and *Royal Frederick* was the name-to-be. However she remained on the stocks another twenty years and finally was launched as the *Frederick William* in 1860!

Pioneer on the Thames

This same year produced the ironclad *Warrior*, a pioneer on the Thames which rendered all wooden line of battleships obsolete. For this reason the *Frederick William* was completed slowly, did work as a guardship in the River Shannon, and later was paid off into the reserve at Portsmouth. It was not until 1876 she was lent to the Thames Nautical Training College—her

engines and boilers removed—and was towed round to the London river to be converted into the training ship, which she remains to-day, smart and tight despite her somewhat unpromising career.

When we paid our first visit naturally the ships were untenanted and we had ample opportunity of inspecting all points of interest. The gun ports are now fitted with windows and the lower decks used for accommodation for the students. But the old cook's gallery still remains and they still use the old coal fire cooking range. In contrast the ship contains the latest navigational instruments, wireless telegraphy, etc.—in fact ancient and modern combined. The present *Worcester*—4,725 tons displacement, length 214 feet, breadth 60 feet—is the largest wooden ship afloat. These ships, I might add, are only open to visitors by special permission, which is most probably withheld in wartime.

MAGIC WITH CHEMICALS

Amusing Tricks which will Provide Plenty of Fun at Xmas

THERE are three polymerides of acetaldehyde. One of these polymers, metaldehyde, a white crystalline compound, sublimes on heating, giving off clouds of feathery crystals and the not unpleasant odour of paraldehyde. This is the secret of the drawing-room trick, wherein a tiny pellet placed on the glowing end of a cigarette fills the air with "snow." The pellet is, of course, compressed metaldehyde, which is also sold in sticks under the name of "Meta" solid fuel, a well-known substance intended as a substitute for methylated spirit. If you place half a stick of this on a hot shovel, it will sublime completely, and in doing so will produce enough "sham snow" to fill a large hall. For a less lavish display, a small corner of a "Meta" stick on a lighted cigarette end will prove very effective.

It is interesting to observe the progress of the sublimation process on the surface of the compound. Colourless, feathery crystals appear as if from nowhere. They cling to the surface, and to one another, forming a long chain which, being very light, grows upwards like a tree. In a still atmosphere this "tree" will attain a height of three or four inches before breaking up into "snow flakes."

Parlour Lightning

This is also known as "Flash Paper," and consists of a thin square of nitrated paper which, when ignited, burns immediately and completely with a bright flash. To make it, steep a few squares of thin typewriter paper in a mixture of three parts fuming nitric acid and one part concentrated sulphuric acid. This mixture must be made very cautiously by adding the sulphuric acid very slowly to the nitric acid and stirring all the time. It is an extremely dangerous, fuming, corrosive fluid, and the steeping operation is best conducted out of doors. At the end of twenty-four hours' immersion remove the papers from the bath on a glass rod, wash them until free from acid (test for this with blue litmus paper) and allow them to dry slowly without heat. The paper has now lost its former texture and taken on a tough, leathery appearance. When ignited it will burn instantly with a flash.

A Retentive Mirror

Obtain a little fluorspar (calcium fluoride) and make it into a paste with concen-

trated sulphuric acid on a slab. With a glass rod, spread this mixture on the surface of a mirror in the form of some design—a face, a name, writing, or anything else you fancy, but be careful to avoid bodily contact with the paste, which is of a highly corrosive nature. After a few minutes' contact with the mirror, wash the paste away. When dried and polished, the mirror will appear unchanged, but if you breathe gently on it, the design will stand out boldly. It is important that the fluorspar paste is not in contact with the mirror too long, otherwise the design will be permanently visible.

In a similar way you can etch on glass. Coat the glass with melted paraffin wax, and when it is set, scratch it away with a needle in the parts where you intend the etching to take place. The fluorspar paste is now applied to these exposed patches, and left in contact for about ten minutes. At the end of this time, the paste and the wax are removed, leaving the complete etched design.

How to Make Ice Flowers

At this time of the year there is no difficulty in making Ice Flowers. Obtain three drachms of gelatine, soak it in water until it swells, pour off, and squeeze out adherent water and dissolve the gelatine in about a pint of warm water. Pour this solution into a shallow tray, and leave out of doors during a frosty night on a flat surface. In the morning the surface of the solution will be frozen. This is ice, the frost having separated the dispersed phase (gelatine) from the continuous phase (water) in the colloid suspension you left in the tray. Remove the layer of ice by washing it gently with methylated spirit, when the gelatine is exposed, woven, and spun into a thousand designs which resemble foliage and flowers.

To preserve this most interesting record of Jack Frost, flood the gelatine with a solution of potassium bichromate and set aside for ten minutes. Pour off the solution, wash the gelatine with a little water, dry, and expose to sunlight for an hour. This renders the gelatine insoluble, and the record is thus permanent.

A Chemical Oracle

This entertaining piece of apparatus will take little making and is capable of producing much fun.

A shallow glass topped box is shown and the performer states that it can judge one's character and foretell future events. Taking a piece of writing paper, he invites a member of the audience to breathe upon it. The paper is then laid in the magic box. In full view of watchers, lines of handwriting are seen to appear on this paper which is then passed round for examination, and is voted an accurate character delineation.

Now for the construction of this wonderful oracle. Obtain a shallow cardboard box with a hinged lid. Cut a large rectangle out of the latter and back it with a piece of glass, using Seccotite adhesive. A cardboard tray is now cut to fit inside the box loosely, and it is supported by wooden blocks at each corner which give a clearance between box bottom and tray of about $\frac{1}{4}$ in. Your magic box thus has a false bottom, the apparent bottom being a loose fitting tray. To prepare it for use, remove the tray and place a small tin lid containing a few crystals of iodine in the box bottom. Replace the tray which, being a slack fit, allows the iodine vapour to fill all the box.

The paper is next prepared. Make a little starch paste and thin it with water until you find that it is sufficiently thin to be used with a pen as a writing ink. As you are sure to know many of those likely to be present at your performance, it will not be difficult to write out the main points in their character, nor will it be difficult to state a few very obvious future happenings. Mentally give each intended victim a number and write this number in small figures on a corner of the corresponding paper which you have written out for them. The starch solution is of course quite invisible when dry.

The performance of the trick needs no skill whatever. The starch in contact with the iodine vapour forms starch iodine which is a blue compound; that is how the writing appears.

WORKSHOP CALCULATIONS TABLES AND FORMULÆ

by F. J. CAMM

A handbook dealing with methods of calculation, solution to workshop problems, and the rules and formulæ necessary in various workshop processes. It contains all the information a mechanic normally requires.

From all booksellers, 3/6 net,
by post 3/9 from the publisher:

GEORGE NEWNES LTD. (Book Dept.),
Tower House, Southampton St., London, W.C.2

Buried Alive in the Ocean-Bed . . .

Down in the depths a diver was facing death in its most terrible form—he had been boring a tunnel in the sea-bed when its walls had collapsed and entombed him! Read how he faced the situation.

- Read of the photographer who went alone into the swirling gas of a filled gasholder to try to get pictures.
- Read of buried miners who had a stand-up fight after a pit explosion because one man insisted on singing hymns.
- Read of the lumberjack who swam under a mountain to dynamite a log jam. These stirring true episodes are in:—

ROUND THE WORLD IN INDUSTRY

By Gerald Collins **5/-** net.

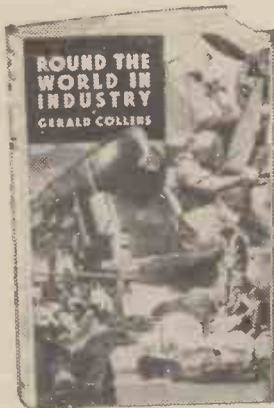

Above are only a few incidents in the lives of the world's daring workers—the men whose efforts ensure that you earn your living, but whose bravery goes unsung. This is a book you will read over and over again, for it tells you of these work-a-day heroes, and the tremendous risks they face. **ROUND THE WORLD IN INDUSTRY** is the perfect Christmas Gift for all who have a spirit of high adventure in their make-up.

- Read how wrecks are lifted off the ocean bottom like diablo reels.
- Read of the methods of drilling for oil, the costs, and the drama behind the work.
- Read about the joke that sent a young man prospecting for gold where none existed—only for him to make an amazing "strike."

Ask your bookseller to get you **ROUND THE WORLD IN INDUSTRY**, thus saving postage. Alternatively, send the form to the Publishers, with Postal Order (plus postage), and the book will be sent direct to you.

To the Publisher, **GEORGE NEWNES, Ltd.** (Book Dept.), Tower House, Southampton Street, Strand, W.C.2.

Please send me by return **ROUND THE WORLD IN INDUSTRY**. I enclose Postal Order value 5/6

No.
 Name
 Address

P.M. 12/39

BOYS!

You can make real **BRICK** and **MORTAR** Buildings with **BRICKPLAYER**



BRICKPLAYER is not a toy, but a constructive and useful outfit with which to make real brick and mortar buildings. Think of it! You can build your own railway arches, bridges, stations, platforms, castles, houses, churches, villages, forts; in fact, the list of buildings is only limited by your own ingenuity. And what's more, each model has permanent utility, because once the mortar is dry the building sets solid and will stand any amount of use—yet it can be easily dismantled by soaking in cold water, and the bricks may be used over and over again without deterioration. Nothing like **BRICKPLAYER** has ever been produced before. It is the ideal hobby and will give hours of pleasure. It's only a week

or so to Christmas, so have a word now with Mother and Father about **BRICKPLAYER**.

BRICKPLAYER is obtainable complete with bricks; tube of cement; trowel; windows; doors; roofs; and full-size working plans at 6/- and 9/- from all good toy shops and stores. Spare bricks 1/3 per 100 full-size bricks.

BRICKPLAYER

THE BRICK AND MORTAR BUILDING KIT

J. W. SPEAR & SONS, Ltd. ENFIELD, MIDDLESEX. Trade Inquiries Invited.

WORKSHOP

Behind the Scenes in a Modern Machine Shop. How the Milling, Shaping, Broaching, Grinding, Multiple Drilling



Drilling oil-feed holes in a crankshaft is a tricky operation calling for highly accurate drilling machines. The operator feeds the drills into the crankshaft shown, by hand

In the machine shop the rough castings or forgings from the foundry pass through a number of successive operations, eventually emerging as finished parts ready, after inspection and test, for the assembly line. The batteries of machines are so arranged that the sequence of machining operations on any given component follows a logical order. In many cases, each machine is driven by its own electric motor, eliminating the overhead shafting and belting which is so often a source of accidents, while the parts are carried from one machine to another on overhead or bench-level conveyors.

Universal Milling Machine

One of the most important items in the modern machine shop is the universal milling machine. Originally designed for the purpose of forming the spiral flutes in twist drills, it is now adapted to a wide variety of machining operations. Basically, the milling machine consists of a rotating spindle or arbor on which a cutter provided with a number of hardened cutting edges or teeth is carried. The arbor may be horizontal or vertical, while below the cutter is an adjustable table to hold the work, so that the parts being machined can be fed up against the cutter, moved crosswise or lengthwise in relation to it, or rotated at the same time. When a number of machining operations have to be performed on one part, a rotating table, located by a series of stops, known as an index head, is mounted on the work-table. Thus, when milling a bolt with a hexagonal head, one cut might be made, the index head rotated through one-sixth of a revolution, and a fresh cut taken, further revolutions of the index head being made until all the faces of the hexagon have been milled. This process is known as rapid indexing, and is capable of elaboration to provide almost any sequence of machining operations.

Types of Cutter

Different forms of cutter are used to produce various surfaces and profiles on the casting or forging. The plain milling cutter cuts a flat surface parallel to its axis, the wider cutters usually having helical teeth in order to prevent chatter. Narrow plain cutters are used for producing grooves, splines, keyways, etc. Side cutters, as their name suggests, have the cutting teeth on their side faces. Two are often arranged on an arbor a short distance apart in order to mill both sides of the component simultaneously, an example being a valve rocker, which is clamped to the work-table and passed slowly between the rapidly rotating cutters.

A face mill has the cutting teeth arranged on its outer face, and is used for machining flat surfaces, such as cylinder heads, etc. An end-mill cuts both along its length, and at the end, and is used for machining squared shoulders, and for cutting slots and some keyways.

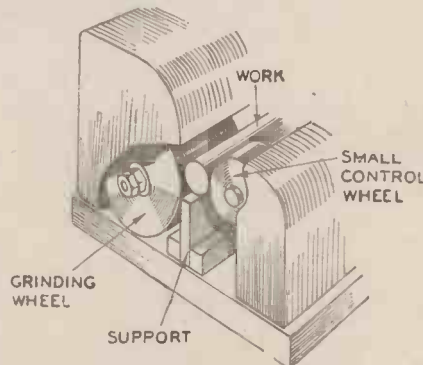

The arrangement of grinding wheel and control wheel with the work resting on the support, as used in centreless grinding is here shown in a simplified form

Milling the Cylinder Block

As a practical example of the use of milling machines, operations on a cylinder block casting after it has been cleaned up on leaving the foundry by shot blasting and "pickling" for an hour-and-a-half in a weak solution of sulphuric and hydrochloric acid, followed by immersion in a hot soda solution to neutralise any remaining acid,

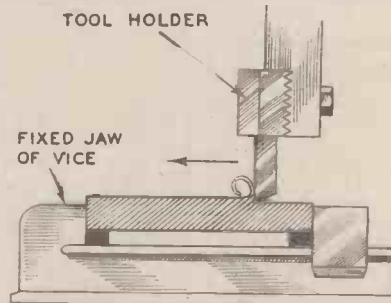

usually commence with the milling of the cylinder head and sump joint faces, the cutters usually being of the face type, with inserted blades. Often the milling machine has a rotating work-table with two vertical spindle cutters, one of which takes a rough cut, and the other a finishing cut, the table being rotated to bring the casting under each cutter in turn. When the cylinder head joint face and the sump face have been accurately machined, the casting can be positioned for the various other machining operations, such as milling the timing cover flanges, manifold joints and similar points. The main bearing housings also call for accurate machining, end-mills and side cutters generally being used to face up the various surfaces.

Shaping Machines

Apart from the milling machine, the shaper is sometimes used, chiefly to produce flat surfaces. Although there are many different designs, the principle of the shaper is illustrated in an accompanying sketch. It will be seen that the surface of the metal or casting is "planed" by the tool carried at one end of a ram. The ram forces the tool slowly forward across the metal, with a quick return at the end of the stroke. During the return stroke the table carrying the vice in which the work is clamped is moved sideways slightly so that the next cutting stroke takes place on a fresh section of the casting. The ram itself is moved by a rack-and-pinion gearing, or by a crank driven from an eccentric. The planer or shaper, however, has not the wide scope of a milling machine.

Broaching

A broaching tool has a number of applications in a modern factory. At one time, for instance, the splines in gear wheels were cut separately. Now, however, they are produced simultaneously by means of a broach, which takes the form of a long, tapered bar, provided with sharp cutting edges in parallel rows. The narrow end of the broach is passed through the plain hole at the centre of the gear wheel, and the coupling of a hydraulic or mechanically-operated ram attached to it. This pulls the broach through the gear, the cutting edges producing the splines. The final length of the bar is parallel, and is often provided with finer

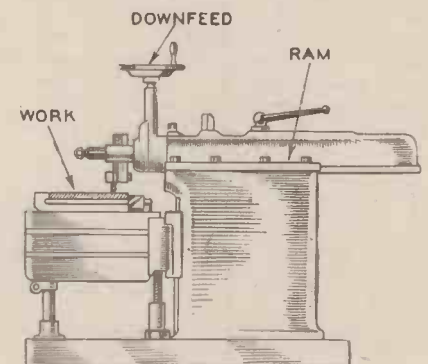

The shaper is used for "planing" metal from castings, the tool, shown above (left) being forced across the surface of the metal by means of the ram

PRACTICE — THE FIRST ARTICLE OF A NEW SERIES

various Processes such as and Turning are Carried Out

teeth, so that a good finish is obtained. Apart from forming splines, broaches are used to produce plain bores in gear wheels and bearings, and for machining such parts as connecting rods. In the case of split big-end bearings, each half may be separately broached by a D-shaped tool. Sometimes the broach is passed through the bearing before it is split to form the two halves. Broaches with flat or specially-shaped cutting surfaces are also used in some cases for external finishing of connecting rods and other components. In this case the cutting teeth are arranged vertically behind the work-table, and the work is fed up against them.

Lathe Work

The rough castings or forgings of a large number of parts, such as pistons, crankshafts, etc., and similar circular components are usually brought to the finished shape by turning in a lathe. This is similar in essentials to the ordinary workshop lathe, the chief difference being the very wide range of attachments provided, while control is largely automatic. It is usual for a number of operations to be carried out simultaneously. The rough turning and finish-turning on a layshaft gear cluster, for instance, may be carried out on an automatic lathe on which as many as seven tools are carried by the front slide, in order to produce the correct diameter at various points along the shaft, while shoulders and radii are simultaneously produced by five tools on the rear slide. During the finishing operation an additional slide may be added, operating from below, and carrying tools to chamfer the edges of the gear collars. When dealing with back axle casings, special designs of lathe enable both ends of the axle housing to be machined simultaneously. Twenty or more tools may be in use at once.

A diamond-tipped tool is frequently used in the lathe when an exceptionally accurate finish is required. When turning out the white metal bore of a big-end bearing, for instance, it has been found that a diamond produces a particularly smooth

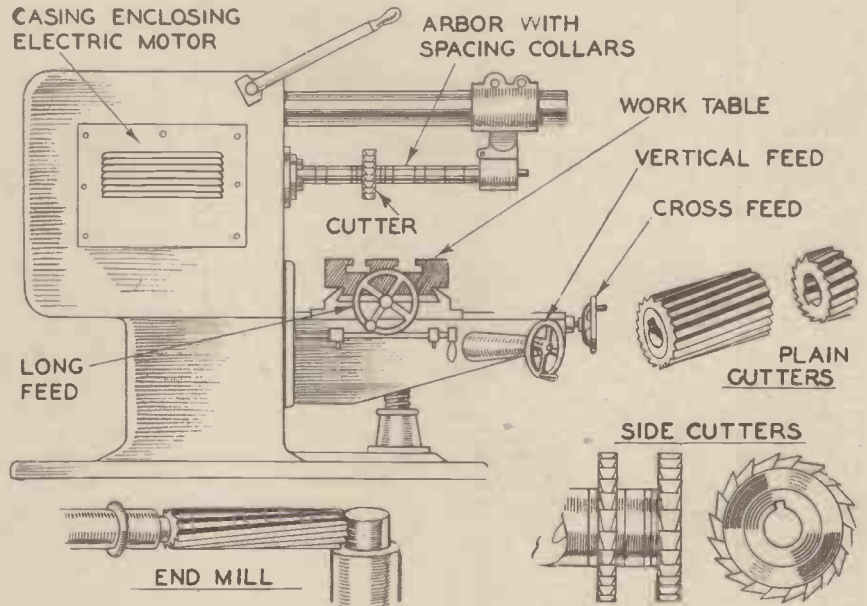

The upper sketch shows the construction of one type of universal milling machine. Specialised designs are used to carry out various machining operations in modern works, but the principle is similar. Different types of cutter are also shown

and long-wearing surface. Similarly, on soft metals, such as aluminium, only diamond boring is usually considered to give the degree of accuracy required in modern engines in the case of machining operations on pistons, diamond turning being used when finishing the gudgeon pin bores and finish-turning the outside diameter.

Turning Crankshafts

Crankshafts are usually turned in lathes of very heavy structure designed solely for this work. The various journals and flanges are machined in turn, elaborate precautions being taken to ensure that the shaft is correctly centred, and that whip or distortion is avoided. Similarly, the rough camshaft forgings are turned on special lathes on which the cutters for each cam are controlled by master cams, to form the correct cam profiles on the shaft.

Multiple Drilling

After machining or turning operations, oilways and stud holes have to be drilled in a number of components. Multiple drilling machines are used in most cases, as many holes as possible being drilled at one operation. At the Ford works, for instance, a machine controlled by one man drills 92 holes in the "V-8" cylinder block casting in 35 seconds. On Austin engines a multi-spindle tool simultaneously drills 53 holes in both ends, one side and the top of the engine casting, the drills advancing from four sides, and withdrawing automatically when the end of their feed is reached. Very similar is the threading operation, in which the taps, after having cut the thread in each hole, reverse their motion and screw themselves out.

A tricky job is the drilling of crankshaft oilways. The crankshaft is mounted in a

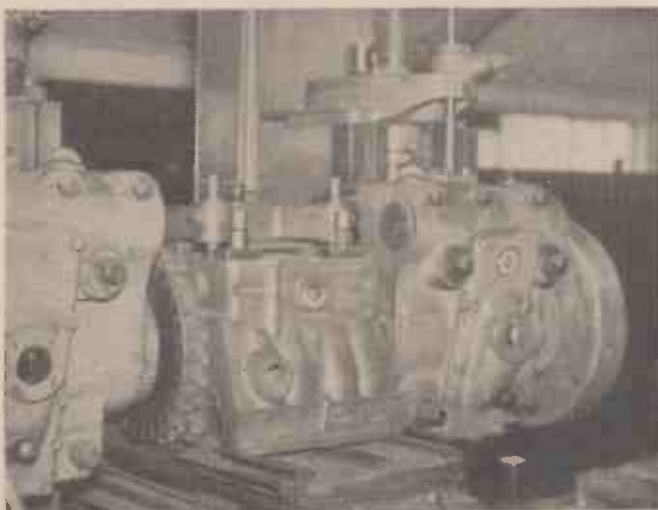

A face mill being used to machine the flanges on a cylinder block. The cutter can be clearly seen on the left

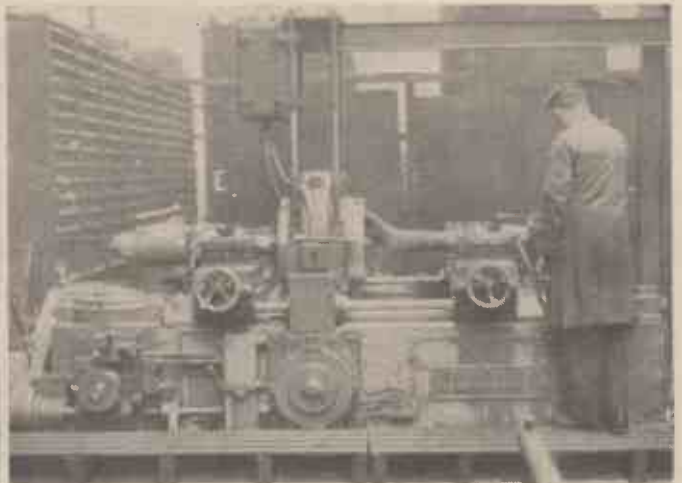

A special form of lathe used for turning both ends of a rear-axle casing simultaneously. No fewer than twenty-one tools are in use at once during this operation

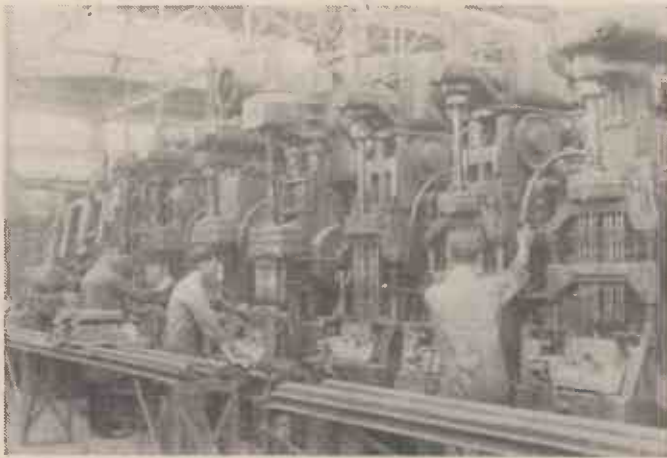

Multiple drilling machines drilling and reaming holes in cylinder blocks at the Ford works

fixture, either horizontally or vertically, and long, slender drills, each driven by an independent overhead electric motor, are fed into the webs by rotating a hand wheel. The operator skilfully feeds the drill forward and then withdraws it, repeating the action until the passages are complete.

High-Speed Valve Grinding

Frequently drilling and reaming are carried out by one machine. In a typical instance the cylinder head of a six-cylinder overhead-valve engine is clamped to a work table beneath a 24-spindle drilling machine. The table has two positions. When in the forward position, the 12 valve-guide holes are drilled simultaneously. The table is then slid to the rear, when 12 reamers pass through the valve guide holes, enlarging them to just the right diameter to ensure a press fit for the guides.

To digress for a moment, it is interesting to note that even valve grinding is carried out automatically in a modern factory. The valves are assembled in the guides, treated with abrasive compound, and lapped in by machines which give them a reciprocating movement of over 100 strokes a minute, the valve being automatically lifted after every eight strokes. As a result, the complete set of valves is perfectly ground in less than two minutes.

Whenever machined parts have been case-hardened, final finishing must be carried out by grinding with an abrasive wheel, or by lapping with abrasive compounds, as normal machine tools make no impression on the case-hardened surface. The part is machined to very nearly its final size before hardening, but some allowance must be made for the slight distortion which usually takes place during carburising, reheating and quenching. Where a flat surface is concerned, the final finishing is carried out by passing the component under a rapidly rotating grinding wheel. The wheel is automatically trued up by a diamond-tipped tool before each cut is taken.

This procedure is often followed in the case of the top and bottom faces of detachable cylinder blocks, and the top faces of normal cylinder block and crankcase castings; although these are not case-hardened, the grinding enables a very accurate surface to be obtained, essential in this case to prevent gasket leakage. In many cases the cylinder blocks travel under the grinding wheel while held in the magnetic bed of the surface grinder.

Grinding Splines

When splines have to be ground on a shaft after hardening, the shaft is mounted between the centres of a spline-grinding machine, and the grinding wheel passed

along each spline, the shaft being rotated to bring another spline upwards when one is finished. Where gear teeth are concerned, the grinding wheel is specially shaped in order to provide the correct tooth form.

Internal bores of gear wheels and similar components which must be accurately finished, perhaps to take a ball race, are ground with the aid of a small grinding

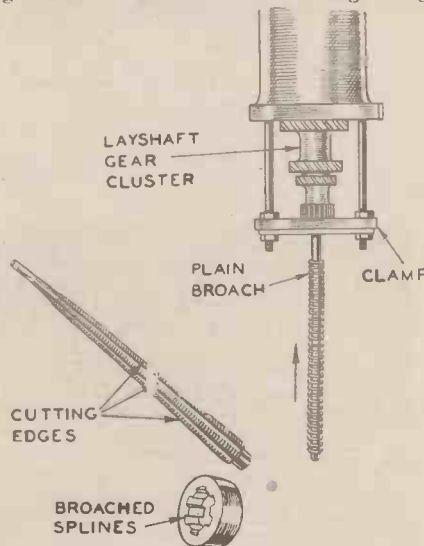

Two forms of broaches, one for broaching plain bores, and the other for cutting splines

wheel running at high speed on the end of a spindle which can be passed into the bore. At the Morris works the gear bores are finish-ground in this manner, the grinding wheel spindle rotating at over 12,000 r.p.m., while the gear itself is being rotated at 450 r.p.m.

The flanges and journals of crankshafts are usually finish-ground by mounting the crankshaft in a special machine so that the journal is rotated at high speed while the grinding wheel is passed along it. Camshafts are ground after hardening in yet another special grinding machine in which the cut is controlled with extreme accuracy by moving the shaft towards and away from the grinding wheel, so that the correct cam profile is obtained.

Grinding Small Parts

Short circular parts are ground in a centre-less grinding machine. Instead of mounting the part between centres, it is passed across the face of the grinding wheel, and at the same time guided by a rotating control wheel; the part meanwhile rests on a fixed support, as shown in an accompanying sketch. By suitably position-

ing the grinding wheel, support and control wheel in relation to one another, a part can be accurately finished to within .0001 in. Parts such as gudgeon pins can be fed from a hopper, passed automatically across the face of the grinding wheel, and accurately finished at the rate of 100 or more pins an hour.

By altering the shape of the grinding and control wheels, moreover, tapered work or several different diameters on one shaft can be produced with great accuracy.

It will be appreciated that throughout the machine shop each cutting tool must be fed with a supply of special coolant; this is a liquid which combines lubricating with cooling properties, and is fed onto the work from pipes adjacent to the points at which cutting is taking place. Although most of the coolant is caught and returned for reconditioning, some of it remains in the metal turnings and cuttings. Before these are loaded into trucks or compressed into small bricks in order to be returned with other scrap metal to the furnaces, the cutting oil is reclaimed by centrifugal separators. No less than 14 gallons of oil is reclaimed from about 1½ cwt. of "swarf." Four thousand gallons of oil are reclaimed weekly.

NEWNES COMPREHENSIVE WAR ATLAS

DO you know where Emden is? Do you know how many flying miles from Wilhelmshaven to Scapa Flow? Do you realise the depth of the Siegfried zone? Do you really know how much easier it is to follow the daily war news with the aid of a really good map? NEWNES COMPREHENSIVE WAR ATLAS which has just been published at the modest price of 1s. 6d. is the finest atlas of its kind. It is absolutely up to date and gives eight pages of maps covering all the countries affected by the present conflict and those bordering upon them. There is a special double page map of the Western Front showing the Siegfried and Maginot Zones and a number of statistical facts relating to the comparative strengths of the Naval, Military and Air Arms of the belligerent countries. Particularly interesting is a chart showing the distances by air between various strategical points in Europe.

These maps are, without a doubt, absolutely ideal for the home. No wall space is required and they can be referred to instantly and in comfort while reading the paper for the print is large and clear and the atlas is the handy size of 12 in. by 9½ in.

NEWNES COMPREHENSIVE WAR ATLAS is obtainable through all bookstalls and newsagents or by post 1s. 9d. from the Publishers, Tower House, Southampton Street, Strand, London, W.C.2.

CHANGE OF PREMISES

CHAMBERS COLLEGE and the National Institute of Engineering have removed their premises to Chislehurst, Kent, where they will continue their tutorial activities throughout the present emergency. The whole of the tutorial and executive staff have now removed to this address.

The first article of a series describing the construction of a 2½ in. gauge Flying Scotsman will appear in next month's issue.

A MODEL COTSWOLD VILLAGE



A general view of the model village at Bourton-on-the-Water

WE are proud of our picturesque little villages, and, in the Cotswolds, the very heart of England, we find a cluster of beauty spots—Broadway, Burford, Stow-on-the-Wold, and Bourton-on-the-Water.

The last-named has always been a pretty village, with its golden Cotswold stone houses and the river Windrush running through their midst, but in the last two or three years it has acquired another interest, that of a "Model Village."

To-day, we must admit, a model village is by no means unique. Most model enthusiasts have visited the Bekonscot Model Village at Beaconsfield, complete with its working railway and ships. In the Cotswolds, too, quite near at hand, is the model seventeenth century fishing village of Mr. Charles P. Wade of Snowhill Manor, near Broadway, quite the finest and most accurately constructed of any I have seen. This village is made of perishable material and each winter is stowed away, when its

owner visits his West Indian sugar plantation on St. Kitts.

Interesting Details

But to return to the Bourton village, this has the new feature of being a representation in miniature of a real village—that

By
W. J. Bassett-Lowke
M.I.Loco.E.

A Representation in Miniature of the Village of Bourton-on-the-Water

of Bourton-on-the-Water itself, and has been built by Mr. Morris, landlord of the "Old New Inn" at Bourton since he took over three years ago.

On my first visit to the village recently, I had a talk to the chief mason, Mr. L. J. Cooke, and learnt from him some interesting details of its construction.

Approximately half an acre of real Cotswold stone has been used and they are still building. Mr. Morris used to fetch the stone in a trailer behind his car, and though since it was commenced eight or nine local



A Cotswold bungalow with walls built "in courses" and a garden wall built in the Cotswold manner, without cement



The church—one of the finest pieces of model work in the village

men have been engaged on it, there were three men chiefly responsible for its being, Mr. Cooke, Mr. R. Pratley, his assistant mason, and Mr. H. Hagg who helps with the excavating and does the gardening work of the model village.

Miniature Mountain Glen

The scale is 1/9th actual size, which equals 1 1/3 in. to the foot, and the idea of building it came to Mr. Morris when he decided to turn the kitchen garden behind the "Old New Inn" into a miniature Mountain Glen with hills, rivers and waterfalls. He made the bridges in Venetian



The old Mill with working water mill

style as those in Bourton village and from thence developed the idea of a model Bourton-on-the-Water.

The first building, Mr. Cooke tells me, was the memorial which sprang up among the raspberry canes! Then came the mill with its wheel over which the little Windrush starts its flow. Outside the mill is the Jolly Miller, who stands arms akimbo, with millstones around his feet—and a happy smile on his face—albeit of stone! The rockery waterfall has given the gardener wonderful scope for his talent, and the water I discovered was pumped from a well in the garden itself at just the right pressure to give the normal flow and to turn the mill wheel.

The village itself was mapped out from an old council plan and Mr. Morris has had the whole-hearted help of the villagers with details, such as the reproduction of gardens, the shop fronts and window dressing, and the vital question of measurements.

The Village Church

Setting off down one of the streets, treading carefully as Gulliver did in Lilliput, you come across butchers', bakers' and



The mason's workshop, situated close by the village



A model of the model situated at the back of the model of "The Old New Inn"

candlestick makers' shops—not to mention the Police Station—all with their names and signs and little front gardens exactly as they really are a few hundred yards away in Bourton itself. There is the chapel with its fine rose-window, and the *pièce de résistance* is, I consider, the village church. The greater part of this is built "in courses" just as the real one (instead of being marked out in bricks on a solid slab of stone) and on the northern side the door swings open to reveal the inside with its nave filled with pews with prayer books and hassocks. As I gazed there came to my ears in clear treble tones, the hymn "Hear My Prayer." Just behind the church was a pretty cottage building made completely "in courses," with a realistic Cotswold stone wall built up without mortar. A fine piece of model work.

Model of a Model

At the entrance to the village is the model of "The Old New Inn" itself with its sign, its sundial, its saddle stones, and behind it—a model of the model! Another tiny river—three inches wide this time instead of three feet—Manor House,

Church, Mill and Inn—the stream flowing, the mill wheel turning, the water cascading down the rockery. A model in fact nine times as small again.

At the top of the village I had a look in the special periscope which brings the village up to the level of the eye, and makes it appear to be as in life.

House Interiors

All the lamps and the house interiors light up after dark, and the music transmission for the church is by radio gramophone. Each year as the stone weathers, it will become more and more like the real village, but of course there is still much work to be done, for new buildings are continually requested. The church for instance actually is well out of the village on an old Saxon site, but was incorporated by general vote, in the model.

Before I left I had a peep in the stone shop and show here a picture of the stone laid out in slabs. The entrance fee of sixpence charged for visiting the village goes entirely towards the continual work entailed in upkeep and new building—a charge which all model lovers will appreciate.

Radio Control of Model Aeroplanes

By E. L. Rockwood Webb

(Concluded from page 54
of last month's issue)

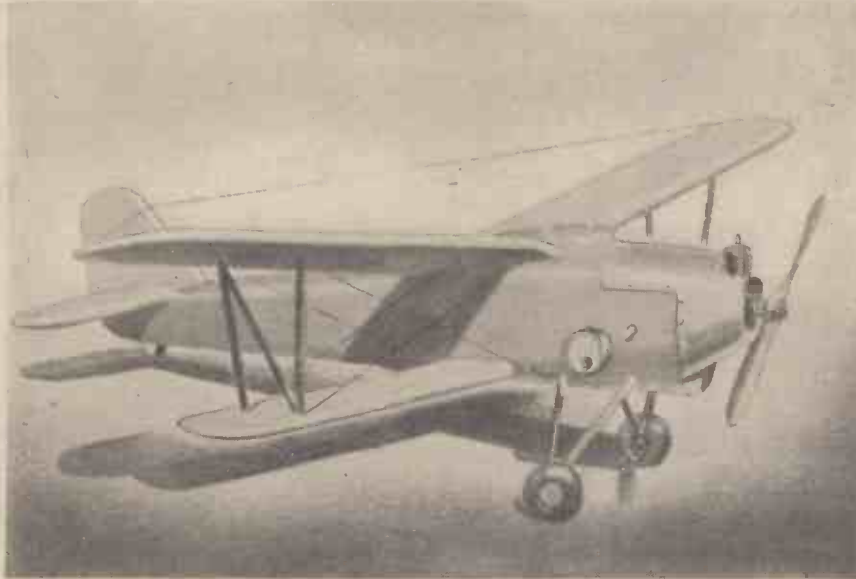

Fig. 10.—The 5-ft. biplane model which is equipped with radio control. The tuning meter which is removed for flying can be seen just above the landing gear

THE whole thing may be replaced by a small motor operating on 6 volts and using a form of commutator chopper. The vibrator system is the easiest arrangement to make, however.

Drive System Details

The steering unit drive starts with a worm gear on the motor shaft. This drives a short jack-shaft with a 16-tooth pinion on one end; a worm gear on the other end drives a 32-tooth gear on a second jack shaft at right angles to the first, and the disc is mounted on the far end of the second jack shaft. A pin near the edge of the disc operates in the slot of the scotch yoke. The jack shafts are 3/32-in. model-aeroplane landing-gear wire or piano wire—the bearings are 3/16-in. outside diameter brass tubing glued down to the balsa frame of the unit. A small quantity of vaseline is used as lubricant. Machine screws used in the unit are No. 2-56. The gears may be obtained, with the motor, at a model railway supply store. The completed steering unit used by the writer weighed 3½ oz., including the left-turn shut-off switch.

The receiver finally decided upon and in use at the present time (diagram Fig. 7) is a simpler device than that shown in Fig. 4 and diagrammed in Fig. 1. The RK62 developed in the last few years by the Raytheon Company is a special valve for the one purpose of operating a relay directly in its plate circuit by introducing a radio frequency signal into its grid. The valve is a thyratron—it behaves as a normal detector unless the bias falls below a certain definite amount. Then suddenly the gas content in the tube ionizes, greatly reducing the internal resistance of the valve, causing more current to flow and operating the relay. When the valve operates as an oscillating detector, the bias is high enough to limit the plate current to a value of about .02 ma. If it is caused to super-regenerate, the current may be 1.5 ma. or so. A signal introduced into the grid circuit will restore the bias, dropping the current to the lower value.

Fig. 8 shows the top view of the receiver using this tube, and Fig. 9 shows the

bottom view. The balsa-wood case to the right is a dust-cover for the receiver. The tube has been unbased for lightness, the weight of the base and socket necessary being about 2 oz. A strap of stiff cardboard is bolted around the tube and down on either side, to the balsa panel of the receiver, to hold the tube in place.

The photographs show the use of a block of synthetic sponge taken from a bath sponge and glued to the receiver panel and to the piece of balsa which shows on top of it in the bottom view. The set is mounted in the 'plane by resting the unit on cross-pieces built into the model and lashing with rubber bands the narrow projections to the crosspieces. The vibration



Figs. 8 and 9.—(Top) Top view of RK62 receiver showing balsa cover for the unit. (Below) Underneath view of RK62 receiver showing the relay and shock-absorbing pads of sponge rubber

of the little petrol engine makes it necessary to do this to shock-mount the receiver, otherwise the relay contacts would vibrate back and forth independent of the signal. The Sigma relay is shown in the bottom view directly in front of the panel mounting the Fahnestock clips which serve to lead connections from the unit. The plate by-pass condenser is standing on end in front of it, directly behind the APC-25 tuning condenser. To the right of the latter is a high-frequency honeycomb choke used in the plate circuit.

Adjustment of the Detector

Various values of grid leak and condenser other than those shown in the diagram furnished with the tube may be used, as well as other values of plate by-pass condenser. Operation of the set should be such as to cause an audio-frequency tone to be audible when the ear is placed near the coil of the relay. Detection of this tone may be accomplished by inserting a pair of 'phones into the plate circuit. But this alters the resistance in the plate circuit, changing the tone and the value of plate current so that when the 'phones are removed the conditions are changed. The grid leak and condenser values will have a great effect on what tones may be obtained, but the actual adjustment depends on the aerial coupling.

Grid-leak and condenser values also affect the peak value of plate current which is available to pull up the relay when no signal is being received. The more current through the relay, the less chance there is of vibration affecting the contacts, and the spring may also be set up tighter. However, operating conditions producing 1½ ma. correspond to a condition of low sensitivity to signals.

Very low frequency audio tones also reduce sensitivity and both low tones and high plate current introduce a lag in the response of the relay. I have found a satisfactory arrangement to be that of allowing a current of about 1 ma., adjusting the spring of the relay to allow the armature to pull up smartly at that value, and using a very high audio tone obtained by adjustment of antenna coupling. Cushioning the receiver and relay with the synthetic sponge material gives satisfactory freedom from vibration effects.

In this connection the writer rigged up a vibration tester, using a weight attached off centre on a block of wood fastened to the shaft of a series soda-mixer electric motor. The receiver in its shock-absorbing mount and the motor were then mounted upon a board which was then mounted on rubber so it was free to vibrate. A variable series resistance controlled the motor speed and consequently the degree of vibration. The receiver was operated and a signal sent into it, then the vibration was increased until the point was found where the set was no longer reliable in its operation due to relay chatter. This point was found, with the arrangement shown, to be vibration of a

degree much more violent than that encountered in actual use in the airplane.

Plane Aerials

In Fig. 10 is shown a 5-ft. span biplane model of the U.S. Army Ferliner-Joyce pursuit plane of several years ago. The aerial used on this installation was about 10 ft. long, starting from the lead-in located in the fuselage opposite the leading edges of the wings, going to the tip of the rudder fin, from there to the right wing tip, and then to the left wing tip. A small spring was used at the first fitting to maintain tension without drawing the wires too tight. This length of aerial is not entirely necessary, but it increased the sensitivity greatly.

In other installations, such as a 6-ft. span model of a Curtis Robin monoplane an aerial of only 30 in. was used from the front of the cabin to the rudder tip. The aerial may be enclosed in the fuselage if desired, or the wings may be fitted with an aerial before they are covered.

Resonating Receiver and Transmitter

In Fig. 10 will be noted a meter just above the landing gear of the model. This is the plate milliammeter shown in the circuit in Fig. 7, and has been converted from an old 0.5 pin-jack voltmeter. It is made removable by plugging it into a pair of pin-jacks in the fuselage. To adjust the transmitter to the receiver, the latter in position in the 'plane is removed to about fifty feet from the oscillator unit on the tripod, and set on the ground. The frequency of the transmitter is adjusted till maximum plate current dip shown in this meter is obtained.

The degree of this dip is controlled somewhat by adjustment of R Fig. 7, the shaft of which may be seen to the right and above the meter in the fuselage of the 'plane. This is adjusted to compensate somewhat for changes in H.T. battery voltage as the battery ages. Its adjustment must be made after resonance has been reached between receiver and transmitter. When these adjustments have been made the meter is removed and its place taken by a link of No. 14 wire or a short length of hookup wire with a 'phone tip soldered to each end.

What Surfaces To Control?

Regarding the decision as to what controls are desirable in a model aeroplane, it may be mentioned here that the first thing many people with a smattering of aeronautical knowledge will think of is aileron control. This is possibly the least useful of all the controls possible. Dihedral built into the wings, that is, the angle of the wing panel to each other and to the horizontal, takes the place of this control, making the 'plane automatically bank when it is steered into a turn, and maintaining the model on an even keel laterally in flight. A model 'plane does not have to be "flown" or continually controlled to keep it in the air, but due to inherent stability will fly itself and needs only to be directed. Even the dreaded "stall" or loss of lift due to too steep a climb, will automatically be rectified if the model is properly built. A tail-spin is a very rare occurrence in a model, and will never occur if the model has been properly built.

Rudder control alone may be used to cause the 'plane to climb, lose altitude, head into the wind and return to the landing area. A right turn normally causes a model to lose altitude in a spiral turn whereas a left turn causes a climbing spiral due to the influence of the gyroscopic action of the motor swinging a propeller at upward of 5,000 r.p.m.

The best method of engaging in the fascinating sport of radio-controlled model aeroplanes is to co-operate with someone who has already had some experience with "petrol jobs," as they are called. He will probably know the vagaries of the species, which are numerous enough to bewilder the novice who is more versed only in the radio end of the game. This practice will save the anguish of cracking up a model which required many hours of careful construction, to say nothing of probable damage to delicate radio equipment. On the other hand he will be delighted with the use of a control which will prevent the eventual loss of nearly every "free flying" model. These losses are inevitable no matter how good the design and adjustment due to uncontrollable collisions with "immovable objects" such as buildings and electric poles, to say nothing of the damage done by "cross-wind" and "down-wind" landings which are not preventable without remote control.

The writer is in the fortunate position of having had several years' experience with "free-flying" models before adding control to them, as well as having actively engaged in short-wave radio since 1918.

Many systems of operating the desired control surfaces of the model will occur to the interested amateur if he has any mechanical ability whatever. The engine speed has been changed from idling to full, and back to idling, by the writer, using the equipment above described. The air intake of the petrol engine is simply fitted with a flipper which cuts down the air flowing into the mixing valve. This flipper is controlled by a piano-wire lever which is led back to the scotch yoke of the steering unit. When the model is ruddered full left

the flipper cuts down the air and a trigger locks the flipper in place. From then on the rudder may be used normally to steer the 'plane as it glides in for a landing. A quick full right rudder causes the yoke to operate a trip which releases the flip trigger. This has a spring causing it to jump back, opening the air intake fully. The model may then be steered normally under power as long as the position of extreme left rudder is avoided.

The thrills of flying these small 'planes seem to appeal to anyone who has ever seen them in action. Their normal rather short life may be prolonged many times by flying them under control, and the sport can be increased greatly by the ability to make them perform exactly according to the owner's wishes.

Control Frequency

While 56 Mc. is the frequency commonly employed in these controls, 112 Mc. is equally satisfactory for the purpose. This cuts down the size of the portable aerial used in the transmitter and the valves mentioned in the two receivers of this article perform very well at this frequency. Equipment should be designed from the standpoint of low weight as well as electrical efficiency. Also, the construction methods employed in model aeroplane building will somewhat modify the tendencies that are natural in a constructor who has been dealing exclusively in equipment designed from the angle of the radio experimenter. For this reason, it is again urged that co-operation with a builder of model aeroplanes will greatly increase the chances of ending up with a successful radio-controlled model aeroplane.



"The Elements of Sheet-Metal Work." By W. Cookson and A. Bold. Published by The Technical Press, Ltd. 120 pages. Price 6s. net.

ALL interested in pattern development, including apprentices, draughtsmen and students, will find much useful information in this book, which clearly explains some of the elementary problems connected with sheet metal work. The authors have avoided technical details, and have striven to make the information as practical as possible. The explanations accompanying certain problems have been put in easily understandable form. The book is divided into eleven chapters, covering such subjects as Workshop Arithmetic; Geometry and Mensuration; Pattern Layout; Parallel-Line Development; Radial-Line Development; Triangulation; Metals and Their Properties; and Workshop Tools and Appliances. The book is illustrated with numerous diagrams, and also includes an index.

"Ships: How they Sail." By James Holland. Published by Country Life, Ltd. 24 pages. Price 3s. 6d.

THE story of the sailing ship and steam-boat makes interesting reading at the present time, especially when presented in the attractive style displayed in this book. Intended for the younger generation, the book explains, with the aid of numerous beautifully coloured illustrations, how navi-

gation developed, how and why ships sail, and how to recognise the different types of ships afloat. The book is printed in bold type, and is in simple language which any intelligent child can understand.

"How They Fly." By James Gardner. Published by Country Life, Ltd. 32 pages. Price 3s. 6d.

THIS is a very interesting book, especially for young readers, and explains with the aid of many coloured illustrations, and diagrams, the flying mechanism of insects, birds and aeroplanes. A brief description of the work of early pioneers of aeronautics, is followed by some interesting facts concerning modern aeroplanes, and how they are piloted. The book concludes with a peep into the future.

"The Old English Master Clockmakers." By Herbert Cescinsky. Published by George Routledge and Sons, Ltd. 182 pages, 227 illustrations. Price 15s. 0d. net.

THIS book is intended as a guide for the clock collector, antiquarian, and antique dealer. It has been written by an acknowledged expert on the subject, and is profusely illustrated with fine examples of English clocks from private sources. The book describes the problems of early horology, and deals with the development of the pendulum, trains and escapements. Brass lantern clocks, clock dials, and the development of grandfather clock cases are discussed in following chapters, illustrated by some fine examples by old masters such as Fromanteel, Edward East, William Clement, Thomas Tompion, Henry Jones, Daniel Quare, and George Graham. Various types of clock cases are illustrated, including some designs by Chippendale and Sheraton, and there is also a chapter on Mantel or Table Clocks.



Striking An Arc

USING two carbons taken from the centre of dry cells, I endeavoured to strike an arc. The supply was 200 v. A.C., and the maximum current available was 3 amps. The arc obtained was fairly strong, but would remain steady for a few seconds only, and then require re-striking.

Was the supply wrong, or was the carbon unsuitable? How can I make the experiment successful?—M. P. (Surrey).

WHEN attempting to work a small arc light from a 200 volt A.C. circuit it is necessary to have a stabilising series resistance in circuit. There is a counter EMF of 30-35 volts across the arc itself, consequently about 170 volts must be dissipated in the resistance. If the current is to be limited to 3 amperes therefore the value of the resistance will be about 57 ohms. The actual EMF across the arc will be found to vary with its length, so that the resistance should be variable also. Dry cell battery carbons are not very suitable for the experiment, nor do you state what diameter you are using. Probably you will not get a steady arc with any carbons larger than 7 or 8 millimetres in diameter. A suitable grade can be obtained from The General Electric Co., Ltd., Magnet House, Kingsway, London, W.C.2.

Connections of Single-Phase Induction Motor

I HAVE unfortunately burnt out my $\frac{1}{2}$ h.p. single-phase induction motor, 250 A.C. at 50 cycles, 21 kilowatt running at 1450 r.p.m. I have rewound it but am in doubt as to how the four connections are connected to the supply via the starter switch. For your information there are four large coils with smaller coils inside, the small coil being wound in the same direction as its accompanying large coil; each of the eight coils having 90 turns of 22 SWG wire.—G. B. (Hinckley).

YOUR diagrams accompanying the enquiry show four sets of running coils, each consisting of two concentric sets forming one pole. These coils require connecting all in series so that the circulation of current alternates first in one direction and then the other in consecutive pole groups. This would be accomplished if you connect your second and third leads together. Nothing is shown, however, in your sketch as to the starting coils, which are always necessary for starting up single-phase motors. These should consist of another four sets of coils of finer gauge wire, arranged with their pole centres half way between those of the main running coils. When starting up, these two sets of coils, main and starting, must be put in parallel until the motor acquires nearly full speed, the starting coils then being cut out, leaving the running coils only in circuit. This can best be carried out if hand-starting is resorted to by a "Lundberg

QUERIES and ENQUIRIES

A stamped addressed envelope, three penny stamps, and the query coupon from the current issue, which appears on page 111 of cover, must be enclosed with every letter containing a query. Every query and drawing which is sent must bear the name and address of the sender. Send your queries to the Editor, PRACTICAL MECHANICS, Geo. Newnes, Ltd., Tower House, Southampton Street, Strand, London, W.C.2.

Twinob" switch. The switch has two arms, one of which is spring controlled and returns itself to the open position when the knob is released.

A Football Game

I HAVE constructed a football game (drawing attached), and would like your opinion as to novelty, etc., also if suitable for patent protection. The playing surface is formed by the wood laths in this case, but it could be produced in metal, clearance slots for the strikers being punched out.—B. G. (South Wales).

THE improved football game, if novel, forms fit subject matter for protection by patent. The invention is thought to be novel, but as a considerable number of patents have been granted for such games, particularly automatic or coin freed machines for playing games, you are advised to search amongst prior patent specifications dealing with the subject, before expending money in protecting the invention.

Option on an Invention

I HOLD a provisional patent in which a particular firm is interested. They want me to grant them a 3-months' option, after the granting of the patent proper, during which time they would have the first refusal of a licence. They are willing to pay me a small sum for this option. Can you give me some idea of what this sum should be?

The invention, if it proves successful, would be of major importance.—W. W. (Somerset).

AS you have not given any particulars of your invention for which you have obtained provisional protection (not provisional patent as stated by you), it is almost impossible to give you the information you desire.

It is quite a usual proceeding for an inventor to give a firm likely to be interested in his invention an option for a limited period, either after the complete specification has been accepted or after a patent

PRACTICAL MECHANICS HANDBOOK

By F. J. CAMM.

An extremely valuable book, packed with facts and figures, tables and formulae for the mechanic, engineer and designer.

From all booksellers 6s. net, by post 6s. 3d. from the publisher: George Newnes, Ltd. (Book Dept.), Tower House, Southampton Street, Strand, W.C.2.

is actually sealed. The reason for this is that until the official search has been made on a Patent Application, which is only made after the filing of a Complete Specification, neither the inventor nor the firm proposing to take an interest in the invention, knows the extent of the novelty, or the extent of the monopoly which will be obtainable by the patent.

If the firm is entitled to the first refusal of a sole licence, the sum to be paid for the option should be more than if for a general licence. The sum to be paid for any option must depend on the importance of the invention and the particular trade concerned, but in any case it is a matter of agreement between the parties, and should bear some relation to the amount to be paid as royalty during the first year of manufacture.

Improved Electric Light Bulb Socket

I HAVE thought of an idea for improving an electric light bulb socket, and would like your opinion as to its novelty and whether it forms fit subject matter for a patent.—E. S. (Liverpool).

THE improved electric light bulb socket, if novel, forms fit subject for protection by letters patent. There may be a market for such an invention, but it is considered that the additional cost of manufacture would militate against its general adoption and so not prove commercially successful. It is also thought that the drawbacks inherent in making and maintaining the additional contacts would nullify the advantages to be gained by the more complicated construction.

Vitreous Enamelling

I AM interested in the commercial application of vitreous enamelling.

I wish to enamel some small refrigerator cabinets (approx. 3 ft. sq.).

Is it necessary to shot-blast steel to obtain a good bond? If so, where can I obtain chilled iron shot and what is price per cwt. of shot?

Is it necessary to pickle steel? If so can you recommend a good pickling solution?

What is the price per gallon of white vitreous enamel and where can it be obtained?

What is the fusing temperature of the enamel? Can it be fired on and the article removed from the oven, or is it better to leave article to slowly cool?

Can you advise me of price and where I can obtain any up-to-date literature on the subject?—O. I. (New Zealand).

It is not ordinarily necessary to shot- or sand-blast steel or other metal previous to vitreous enamelling it. Indeed, such treatment might very easily be injurious owing to its liability to give a highly roughened surface to the metal.

Usually, iron sheets which are to be enamelled are placed in special furnaces and heated to a dull red heat. This treatment loosens the surface scale, which is then dissolved off by immersing the sheet metal in a pickling bath comprising dilute hydrochloric or sulphuric acid. The sheets are scrubbed beneath the surface of the acid in order to remove the scale quickly, after which they are transferred to fresh water and thoroughly well washed. Sometimes, during this latter washing process, the sheets are scrubbed with perfectly clean sand made into a paste with water. A final washing with water follows, after which the cleaned metal surface is ready for the application of any enamel.

OUR STUDENTS GET GOOD JOBS

You can qualify for a well-paid technical post, or learn to earn money in your spare time. Send now for details of our modern Home-study Radio Courses

T. & C. RADIO COLLEGE
FAIRFAX HOUSE, HIGH HOLBORN, W.C.1

WANTED

Used Trix and Bassett-Lowke Locos., rolling stock and track. Any quantity. Also models, airguns, boats, meccano, etc. Turn your unwanted goods into cash. Send carriage forward. Best cash offer by return. Or call. LOCAL AGENT FOR TRIX TWIN RAILWAY. SALES AND SERVICE DEPOT. "MODELS, LATHES & TOOLS" 399, Hendon Way, N.W.4 Telephone: Hendon, 6642

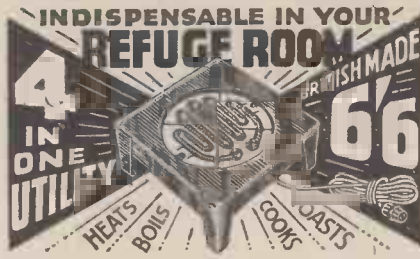

Having acquired complete Factory's output of this superior appliance enables us to pass immense saving on to Public. Every home A.R.P. refuge room needs one. Uses little more than 4-unit. Size 6in. by 6in. Usually 15/-, Our Price 8/6. Post & Packing 9d. Flex and Plug 1/3 extra. A definitely superior article—not to be confused with similar foreign goods being advertised. Satisfaction guaranteed. Send P.O. 8/6. With complete confidence to: **WHITEHALL SUPPLIES** (Dept. P.M.), 51 Whitehall, London, S.W.1. Callers invited • Open all day Saturday • WHI 6982

FREE SERVICE FOR READERS

READERS requiring information concerning goods or services advertised in PRACTICAL MECHANICS should give names of Advertisers from whom particulars are desired. Any number of names may be included and we will obtain for you catalogues, lists, and any other information you may be wanting. THERE IS NO CHARGE FOR THIS SERVICE.

Readers desiring particulars from a number of Advertisers will, by this method, save time and postage. If any Advertiser stipulates that stamps or postal orders are necessary before samples or catalogues are sent, please enclose the necessary amount with your instructions. You are cordially invited to make full use of this Service.

ADVERT. SERVICE DEPT.,
PRACTICAL MECHANICS,
TOWER HOUSE, SOUTHAMPTON STREET, STRAND, W.C.2

Please obtain and send to me particulars from the Advertisers in your December issue whose names I give on the list attached.

Advertiser | Page No. | Information Required

Attach sheet of paper, with particulars, and your name and address (written in BLOCK letters), with date, to this announcement.

It is the custom of many enamelling firms in England to make up their own supplies of enamel and each firm possesses formulæ which are more or less secret. You may, however, obtain supplies of ordinary white vitreous enamel from the following firms:—

National Enamels, Ltd., Norman Road, East Greenwich, London, S.E.10.

L. le Personne & Co., Ltd., 99 Cannon Street, London, E.C.4.

The Ferro Enamelling Company of Holland, Rotterdam, Holland.

Incandescent Heat Co., Ltd., Cornwall Road, Smethwick, Birmingham.

Messrs. La Barre & Co., Heath Town Works, Wolverhampton.

Messrs. John King & Son (Enamellers), Ltd., Whittington Moor, Chesterfield.

The fusion temperatures of vitreous enamels vary a good deal. Around a thousand degrees Fahrenheit (which is rather below the melting point of copper) is an average temperature. After fusion of the enamel in a specially designed muffle furnace (a process which takes about 15 minutes) the metal sheet upon which the enamel has been allowed to fuse or "run" may be withdrawn from the furnace and allowed to cool down at its own rate, i.e. without any special control.

The literature on the subject of vitreous enamelling is very scanty. The only book on the subject of which we are aware is the following:—

L. R. Mernagh: "The Manufacture of Enamelled Ware." (18s. nett.) This can be obtained through any British bookseller (as, for instance, Messrs. W. & G. Foyle, Ltd., Charing Cross Road, London, W.C.2), but even this does not cover the subject fully.

Vitreous enamellers of metal ware, as previously indicated, find it advantageous not to publish the technical details of their processes. Hence, it is next to impossible to ascertain detail practical information.

No doubt, however, you may find some of the firms whose addresses we have given you willing to assist you with specialised information and to forward you any literature which they may have available. We would not, however, advise you to embark upon large-scale vitreous enamelling until you are quite sure that you have a workable process in your hands.

Pressure Indicator

ENCLOSE details of an improved pressure indicator for pneumatic tyres. What do you think of its novelty, practicability and commercial possibilities? H. N. (Belfast).

THE improved pressure indicator for pneumatic tyres is novel, and forms

fit subject for protection by letters patent.

The invention appears to be a practicable one, and if novel, should have commercial value. You are advised to protect your invention before submitting it to persons likely to be interested. The least expensive way of obtaining protection is to file an application for patent with a provisional specification which will give you about 12 months, during which time it should be possible to ascertain if the invention is likely to be commercially successful.

Copper Sulphide

COPPER sulphide, CuS, as made by the direct combination of copper scrap and sulphur heated in an open crucible, is a brittle, even friable, substance. It is not, chemically, very stable, tending to revert to Cu₂S when heated and to become CuSO₄ when damped. It disintegrates into a red hot powdery ash of unknown composition when acting as a (fairly good) conductor to a direct current of say 12 volts x 2 amps. Moreover, making good electrical contact with it is not easy.

In Art. 938 of Ganot's Physics (Atkinson), a description is given of a thermo-electric battery by Becquerel which employs solid permanent blocks of this material approximately 4 in. x ½ in. x ½ in.

I should be grateful if you could give any suggestions as to how copper sulphide might be made in such solid block form.—J. J. (Hants.).

YOU cannot prevent the reduction of cupric to cuprous sulphide by the action of heat, but its oxidation to copper sulphate will not take place unless moisture is present. Hence by preserving the dry material in dry air, this process of oxidation could be prevented, particularly if the sulphide were perfectly pure.

The only way in which you can obtain pure cupric sulphide, CuS, in block form is by submitting the material to powerful, hydraulic compression. Even then, however, the material would still show friable properties which could, of course, be lessened by incorporating a small proportion of an adhesive and binder with it. In order to obtain the sulphide in the pure condition, it is best to precipitate copper sulphate with hydrogen sulphide.

Small cubes (or blocks) and rods of copper sulphide are articles of commerce and may be obtained from Messrs. Harrington Bros., Ltd., City Road, London, E.C. Probably, also, Messrs. Philip Harris & Co., Ltd., Laboratory suppliers, Birmingham, may be able to supply the material in the fairly large block-form which you require.

The Handiest Book Yet Published for Draughtsmen, Fitters, Turners, Mechanics, Pattern-Makers, Erectors, Foundrymen, Millwrights and Technical Students

WORKSHOP CALCULATIONS, TABLES AND FORMULÆ

By F. J. CAMM
(Editor of Practical Mechanics)

3/6 or 3/10 by post from Geo. Newnes, Ltd., Tower House, Southampton Street, Strand, London, W.C.2.

Its Comprehensive and Fully Illustrated Contents include:—The Micrometer and Vernier; Mensuration; Trigonometrical Formulæ; Extracting Square Root; Extracting Cube Root; Continued Fractions; Arithmetical Progression; Geometrical Progression; Harmonical Progression; English Weights and Measures; Horse Power; Force, Energy and Power; Heat, Time, and Velocity; Electrical Units; Comparison of Thermometers; Pulleys; Parallelogram Forces; Pendulum; Levers; Centrifugal Force; Moments of Inertia; Metric Systems; Screw Cutting; Tool Grinding Angles; Lubricants for Cutting; Spur Gearing; Tapers and Angles; Bevel Gears; Worm and Worm Wheels; Spiral or Screw Gearing; Pulley Calculations; The Dividing Head; Differential Indexing; The Slide Rule; H.P. Required to Drive Shop Tools; Table of Cutting Speeds; Proportion of Keys and Cotter; Standard Screw Threads; Drill Sizes; Circle Spacing Table; Tapers and Angles; Melting Points of Metals; Weights of Materials; Twist Drills for Wood Screws; Wood Screw Proportions; Weights of Woods; Powers and Roots of Numbers; Wire and Sheet-Metal Gauges; Natural Sines, Cosines and Tangents; Logarithms and Antilogarithms.

A SHEET OF BLACK PAPER



A TUBE OF

Ste-Fix



ECONOMICAL ANTI-GLARE
LAMP SHADE FOR

A. R. P.



Ste-Fix is the neat, clean, speedy way to do a strong, lasting job. Colourless, odourless, needing no heat, it is a powerful adhesive and spreads straight from the tube. 2d., 6d. and 1s. the tube. Made by the proprietors of Stephens' Inks, 57 Aldersgate St., London, E.C.1.

HAVE YOUR OWN
CINEMATOGRAPH SHOW
AT HOME



The New "Homray" Projector
Hand Turned Model 27/6
Mains Motor Driven Model (Universal) £3.17.6

Obtainable from leading Stores and Photographic Dealers
Write to-day for Illustrated list, and name of nearest stockist
HOMRAY PROJECTOR COMPANY
(P.M. Dept.), 46 High Pavement, Nottingham



NEW MODELS
A.C. Motors. Self Starting. Switch built in. 1/4 H.P. 53/-
1,440 R.P.M. 200/250V. Universal Usages.



GRINDING AND POLISHING UNIT
1/10th H.P., A.C.-D.C., 100 or 250 Volts, 5,000 r.p.m. Fitted with 4in. Mop, 3in. Grinding Wheel, Guard and Tool Rest. Built-in Switch and 4 feet of Flexible Cable. Price £3/9/6 Plus 10% Increase

EASCO 18 P.M., Brixton Rd., London, S.W.9
Telephone: RELiance 1693

BUY, EXCHANGE or SELL

TOOLS—Continued

Send for My Lathe Lists.—L. MATTHEWS, 83, Shrewsbury Road, Forest Gate, E.7.

BRAND NEW POWER TOOLS of quality, 10-inch bandsaws, 54/-; Jigsaws, 22/6; Bench Drills, 11/-; Circular Saws from 25/-; 3-inch S.C. Toolroom Lathes, from £4 5s. New 1-inch chromium plated, Micrometers, 12/6; Electric Drills, 37/6; Grinders.—John P. Steel, Bingley.

GRAYSON'S Glass-boring Outfits and Tube Cutters avoid risk.—Below.

DRILLS, Taps, Dies, Files, Chisel, Punches. Best quality at keenest prices.—Grayson & Company, 300 Campo Lane, Sheffield.

Finest quality Tool Steel Round Blanks and Short Pieces, 1/2" to 2 1/2" Diam., easily hardened in ordinary fire. Originally cost over 1/- per lb., while stock lasts, we are clearing at 28 lbs. useful assortment, 5/- carr. for.—Below.

For Re-grinding Cutters, Taps, Drills, etc. Thin Fine Emery Wheels, 1/2" to 1" Thick, 2 1/2" to 3" diam., 3/4" hole. These wheels will be found extremely useful for Tool Jobs. Clearing at 1/9 per doz. assorted.—Below.

85 Machine Vices for Drilling or Milling Machine. Robust design, Width of Jaws 2 1/2", opens 3 1/2", very cheap to clear, 4/9 each.—Below.

2/9 any lot. Eight lots £1.—Below.

3/4" Toolholder with four H.S. Tools.

3/4" Adj. Boring Tool with H.S. Tool.

1/2" to 1 1/2" Silver Steel, 13 pieces, 13" long.

3/4" to 1 1/2" Silver Steel, 4 lb., 2" to 4" long.

100 Steel Hex. Bolts and Nuts, 1/2" to 1".

16 H.S. Drills, 1/32" to 3/32".

Sitting Saws, five 1/32" to 1/4" thick, 1" hole.

Two dozen Fine and Odd Thread Taps, to 1".

Three dozen Tungsten Hack-Saws, to 12".

18 Grinding Wheels, 1/2" to 1" diam.

Three H.S. Tap Fluting Cutters, 1 1/2" diam.

One dozen Ass. Files, 4" to 12".

Dozen Toolmaker's Needle Files, indispensable.

Best Carborundum Wheel, 6" by 1 1/2" by 3/4" hole.

200 Springs to approx. 6" long.

Four Ass. Carborundum Wheels, to 3 1/2" diam., 3/4" hole.

Burke.—Below.

12 Sets Stocks and Dies, etc., 1 1/2" Split Dies, cutting 3/32", 1/8", 5/32", 3/16", 7/32", 1/4", 5/16", Whit. or B.S.F. or 0, 1, 2, 3, 4, 5, 6. B.A. Complete with Taper Taps, Adjustable Tap Wrench and Die-Stocks. Seven Dies and Taps, usual price of these sets is 12/6, clear while stock lasts at 6/6 per set, extra sets of Taps, Seconds or Plugs, 1/9 set of seven.—Burke.

Small Taps, 7, 8, 9, 10, 12 B.A.; 1/16" Whit. 6d. each. No dies these sizes.—Burke.

1" Round Dies, Screwing 1/4", 5/16", 3/8", 7/16", 1/2" Whit., B.S.F.; or Brass. 26 Threads; Set of Five Dies 2/9; Best Quality 1" Die-Stocks, all Steel unbreakable with Hardened adjusting Screws, 1/9 each.—Below.

4,000 Taps, Taper, 2nd or Plug, same sizes and Threads as Dies, 2/9 set.—Below.

Vee Blocks and Clamps, Starret pattern, accurate, first-class finish, 5/- pair.—Below.

£1 orders carriage paid, except abroad.

J. BURKE, 30 TRIPPET LANE, SHEFFIELD, 1.

STAMPS

FREE!! Twenty Unused Colonials. "Néurope," 1 1/2d. Fifty for 10 1/2d.—G. H. Barnett, Limington, Somerset.

FOYLES

BOOKSELLERS TO THE WORLD

NEW & SECONDHAND TECHNICAL BOOKS

and books on all other subjects. Stock of nearly three million volumes. Catalogues free on mentioning your interests

JOIN THE SCIENTIFIC BOOK CLUB

113-125, CHARING CROSS ROAD, W.C.2

Telephone: Gerrard 5660 (16 lines)

PERFECT USED MODELS

Send 4 1/2d. for our Railway Catalogue and Save Money
GEORGES', 11, Friars St., Ipswich

AUTHORITATIVE TRAINING in Wartime

In peace-time the T.I.G.B. home-study courses provided first-class technical education. For several years past the pass percentage of T.I.G.B. Students at Professional Engineering Examinations such as A.M.Inst.C.E., A.M.I.Mech.E., A.M.I.E.E., A.F.R.Ae.S., C. and G., etc., has not once been lower than 96%—and no fewer than 22 FIRST PLACES have been gained. In War-time the advantages of T.I.G.B. Training—free from black-out and travel difficulties—are most marked. To-day, The T.I.G.B. courses are the ideal method of qualifying quickly for the great range of posts being offered by Industry and the Government to technically trained engineers, the need for whom needs no over-stressing. Write TO-DAY for "The Engineer's Guide to Success," containing the world's widest choice of engineering courses covering all branches and recognised qualifications. Mention branch, post or qualification that interests you. The T.I.G.B. guarantees training until successful for the one fee.

Free!



The Technological Institute of Great Britain

218 Temple Bar House London - - E.C.4

(Founded 1917) 20,000 Successes

200 Courses

An Absorbing Hobby

BUILDING A STUART MODEL IS AN ENGROSSING PASTIME, AND THE RESULT A CONTINUOUS PLEASURE

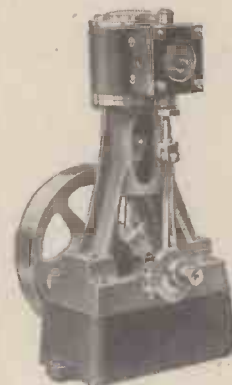

We illustrate:
STUART NO. 10.
High Speed Steam Engine.
Bore 3/4".
Stroke 3/4".

Each set is quite complete—drawings and instructions are included.

If you have a lathe—
The rough castings - - - 8/6
If not—
Fully machined set - - - 18/6
Ditto, with all holes drilled and tapped - - - 25/-

This and many other Stuart engines are fully described in the 72-page CATALOGUE No. 3, 6d. post free.

STUART TURNER LTD. HENLEY - ON - THAMES

BUY, EXCHANGE OR SELL

Advertisements are accepted for these columns at 3d. per word (minimum 12 words at 3s.—advertisements of less than 12 words are charged at the minimum rate of 3s.) subject to a discount of 2½% for 6 consecutive monthly insertions or 5% for 12 consecutive monthly insertions. **TERMS** :—Cash with order. Cheques, Postal Orders, etc., should be made payable to George Newnes, Ltd. *The Proprietors reserve the right to refuse or withdraw advertisements at their discretion.* All advertisements must be received on or before the 5th of the month preceding date of publication and should be addressed to the Advertisement Manager, "Practical Mechanics," George Newnes Ltd., Tower House, Southampton Street, Strand, W.C.2.

CANOEES

BOATS AND CANOE KITS. Hobby for long evenings. Prices unaffected, few bargains. Metacraft (P) Christchurch, Hants.

ELECTRICAL

AC/DC MOTORS, 1/12th to 1/8 h.p., from 10/- Stamp particulars.—Brookes, Banners Street, Cradley, Staffs.

ENGINEERING

METAL FOR THE MODEL ENGINEER. Sheet, Tube and Sections in Aluminium, Copper, Brass, etc. No quantity too small. Stamp for lists. The Universal Productions, Rigby Lane, Bromsgrove, Worcs.

METAL WORK

MAKE METAL TOYS. Easy, profitable with "Success" Moulds. List free. Complete trial mould 1/8.—Lees, 1 Birkin Avenue, Nottingham.

MICROSCOPY

MICROSCOPES, Telescopes, Glasses and all Optical Instrument repairs, etc. Dept. 2: Lathes, Files, Saws, Emery Grinders, Engineering requirements, repairs general.—Mackett & Company, Manufacturing Opticians and Engineers, 51 Millers Road, Brighton.

JUBILEE WORM DRIVE HOSE CLIPS



The long-life clip with the ever-tight grip.

The Best Known
For Radiator Joints, Air, Oil, and Water Hose Joints.

We guarantee a Tight Joint.

Stocked by all Garages and Accessory Dealers

L. ROBINSON & CO.,
25 London Chambers,
GILLINGHAM, KENT.

It's easier to solder with

"Baker's" Solderine. For all electrical work and wherever paste flux is preferred. Popular sizes include: 2oz. tins, 6d.; 4oz. tins, 8d. Also supplied in bulk. Obtainable from all wholesalers.

"Baker's" SOLDERINE PASTE

Sir Wm. BURNETT & Co. (Chemists) Ltd.
Great West Rd. Isleworth Middx.
TEL: WOUNGLOW 0478

OUR ADVICE BUREAU COUPON

This coupon is available until December 30th, 1939, and must be attached to all letters containing queries, together with 3 penny stamps. A stamped addressed envelope must also be enclosed.

PRACTICAL MECHANICS, DEC., 1939.

MICROSCOPY—Continued

"THE MICROSCOPE AND ENTOMOLOGICAL MONTHLY."—The premier journal for all students of nature. 1/-, from newsgagents, or 1/1 from Microscope, 20/21 Took's Court, London, E.C.4.

MODELS

PERFECT USED MODEL TRAIN BARGAINS. Popular makes. Send ¼d. for our catalogue and save money.—Below.

FOR TRIX RAILWAYS. Some special 4-4-0T locomotives and wooden coaches; particulars 1½d. Exchanges.—Georges', 11 Friars Street, Ipswich.

MODEL AIRCRAFT

PETROL ENGINES complete, £215s. 6d. or ready machined assembly kit, 30s. 6d. Timers, propellers, gas and rubber kits. List 1½d.—Lowe, 10 Lindbergh Road, Bournemouth.

MUSICAL INSTRUMENTS

BAND GUIDE. Hints on the Bugle, Drum, Flute, Staff Parade formation, etc. Free, post paid.—Potter's (Manufacturers), West Street, London, W.C.2.

PHOTOGRAPHY

PHOTOGRAPHIC MATERIALS. Plates, films, mounts, chemicals. Interesting money-saving lists free.—"Kimber's," 105 Queens Road, Brighton.

SITUATIONS VACANT

G.P.O. ENGINEERING DEPT. (no experience required). Commencing £9/13/0 per week. Age 18-23. Excellent prospects. Free details of Entrance Exam. from B.I.E.T. (Dept. 579), 17-19 Stratford Place, London, W.1.

WATCHMAKING

WATCH & CLOCK REPAIRERS. Send 3d. for complete list of material and tools.—Blakiston & Co., Ainsdale, Southport.

3½ in. WINFIELD FOR VALUE AND RELIABILITY



As illustrated £10-10-0
or by 12 monthly payments of 18/4
3 in. B.G.S.C. Lathes from £4-10-0
The Winfield Mfg. Co. College St. Works LONG EATON

CUT THIS OUT

Practical Pen Coupon Value 3d.

Send five of these coupons with only 3/- (and 2d. stamp) direct to the Fleet Pen Co., 115, Fleet Street, E.C.4. By return you will receive a handsome lever self-filling FLEET S.F. PEN with solid gold nib (fine, medium, or broad), usually 10/6. Fleet price 4/3, or with 5 coupons only 3/-. De Luxe Model. FLEET SELF-FILLER, 2/- extra.



WIRELESS

HEAR AMERICA, AUSTRALIA, JAPAN.—Receivers 19/8. List, W. Buckle, 63 Avenue Approach, Bury St. Edmunds.

MISCELLANEOUS

BE TALLER!! Extra inches count!! Details 6d. stamp.—Malcolm Ross, Height Specialist, Scarborough.

CASTING MOULDS for Lead Soldiers, Indians, Animals, etc. Sample mould, 2/9. Catalogue stamp.—Industries 2, Waldegrave Park, Twickenham.

TELESCOPES, MICROSCOPES, Scientific Instruments, etc. Send for lists. Sale or Exchange.—C. V. Bolton, F.S.M.C., 49a Leigh Road, Leigh, Lancs.

PATENTS AND INVENTIONS

WE SUCCESSFULLY SELL inventions, patented and unpatented. Write for proof, and tell us what you have for sale.—Chartered Institute of American Inventors, Dept. 16-C, Washington, D.C., U.S.A.

NEW RECEIVERS

"STAND-BY" Crystal Set (See August issue "P.M."). A useful and good Receiver. Aerial coil 2/3. Detector 2/3. Complete kit of parts to build 10/3. 45 ft. copper spiral aerials 1/3.—Thompson, 176, Greenwich High Road, Greenwich, S.E.10.

TOOLS

MYFORD LATHES have no equal for sturdiness and value. Lists free. Delivery anywhere. Terms still available.—Nuttall's, 20, Albert Street, Mansfield.

A GOOD PIANIST IS ALWAYS WELCOME



There is a way to become a really FINE PIANIST and SIGHT READER. I will teach YOU quickly and enjoyably BY POST, from ordinary music (no freakish methods) enabling you to read and play at sight any standard musical composition so that you shall give delight wherever you go. No practice drudgery, but simple, interesting training a child could follow. A teacher by your side always, not for merely half an hour weekly. I have taught over 51,000 adult pupils during 35 years and I CAN TEACH YOU, even if you do not know a note. *Proof—Advanced 49171. Age 36: "I have progressed far beyond the bounds of my imagination."* Send for free booklet "Mind, Muscle and Keyboard," and form for free advice. Say if Advanced, Moderate, Elementary or Beginner.

Mr. H. BECKER
(British by Birth and Descent)

(Dept. 258), 69, Fleet St., London, E.C.4



MINIATURE PETROL ENGINES for Aeroplanes and Speed Boats. 1 to 15 c.c. Send 3d. for particulars

castings made from our castings 12/6 per set. Complete Engines ready to run from £315s.

J. HALLAM & SON
Upton, Poole,
Dorset

MAKE MORE MONEY

£3 to £6 weekly can be earned at home in a wonderful business of your own. No matter where you live you can commence to make money in your spare or whole time. No risk, canvassing or experience required. A wonderful opportunity for anyone wishing to add pounds to their income. Particulars, stamp.

BALLARD, York House, 12 Hambrook Road, LONDON, S.E.25.

Ideal Christmas Gifts at Bargain Prices



GAMAGES

32 Page Christmas Gifts List Sent Post Free on Request

BRITAIN'S BIGGEST VALUE IN TOOL CHESTS

AN EVER-POPULAR GIFT



Carriage (outside our extensive delivery area) 3/- extra England and Wales.

61 SHEFFIELD MADE TOOLS **84/-**
IN CHEST FOR ONLY

Contains an extremely comprehensive range of fine quality tools—suitable for practically all woodworking jobs. Chest stained and polished Walnut colour. Size: 27 in. by 11 in. by 7 1/2 in. Fitted with fixed compartments for small articles, and movable tray with 24 spring clips to hold chisels, bits, etc. Contents: 1 Skew-back Handsaw, 22 in.; 1 Tenon Saw, 12 in.; 1 Set 3 Blade Compass Saws; 1 Pad Saw and Handle; 1 Smoothing Plane, 2 in. double iron; 1 Joiner's Hammer, No. 2; 1 Claw Hammer, No. 1; Joiner's Mallet, 5 in.; All-Steel Hatchet, No. 1; 1 Cased Oilstone, 8 in.; 1 Joiner's Square, 6 in.; 1 Sliding Bevel; 1 Spirit Level, 6 in.; 1 Spoke-shave, 2 1/2 in.; 1 Marking Gauge; 1 Cabinet Turncrew, each 4 in., 6 in., 1 pair, Pincers, 6 in.; 1 Handled Chisel, each 2 1/2 in., 3 in., 4 in., 1 in.; Handled Gouge 1/2 in.; 1 Joiner's Plain Brace, 9 in.; 1 Centre Bit, each 1/2 in., 3/4 in., 1 in.; 1 Special Auger Bit, each 1/2 in., 3/4 in., 1 in.; 1 Boxwood Rule, 2 ft.; 1 pair Combination Pliers; 1 Putty Knife; 1 Paint Scraper; 1 Mitre Block 9 in.; 2 Gimlets; 2 Bradaws; 1 Glue Pot; 1 Cold Chisel, 6 in. by 1/2 in.; 1 Tack Hammer; 1 6 in. Half-round File and Handle; 1 4 in. Saw File and Handle; 1 Centre Punch; 1 Nail Punch; 1 Packet of 12 Sheffield Twist Drills; 1 Pencil.

Or DELIVERED on FIRST of SIX MONTHLY PAYMENTS of **15/6**

2 1/8" PLAIN GAP BED LATHES

Will stand the hardest usage by hand or power. Possess many refinements usually found in larger or more expensive tools. Length between centres 10 in. Face-plate 3 1/2 in. diam. Height of centres from Gap 2 1/2 in. Slide Rest with Vee Slide, Square Thread Lead Screw. The Headstock Hollow Mandrel is bored 1/2 in. Mandrel nose 1/2 in. x 16 in. threads and bored No. 0 Morse Taper. Cone Pulleys 2 1/2 in. and 1 1/2 in. inside and 2 1/2 in. and 1 1/2 in. outside. Lead Screw 1/2 in. Square thread, 12 threads. Weight of Lathe 18 lb. Carriage (outside our extensive delivery area) 2/- England or Wales.



Foot Motor, 18/6; Countershaft, 15/6; Set of 8 Tools, 3/-; 3-Jaw Dog Chuck, 6/6; Belt, 2/- . All above carriage extra if ordered separately.

37/6

1 5/8" PLAIN GAP BED LATHE

with Compound Slide Rest

Overall length, 12 1/2 in. Length of bed, 8 in. Maximum distance between centres, 6 1/2 in. Height of centres from gap, 2 in. The nose of the solid mandrel is 3/4 in. x 20 in. threads. Bearings adjustable for wear. Compound slide rest has vee slides with gibbs and adjusting screws. Tailstock is of the sliding barrel type, and is held in position by a set screw. Driver plate 1 1/2 in. dia. Cone pulleys 1 1/2 in. x 1 1/2 in. dia. for 3/4 in. or 1/2 in. round belt. Weight 8 lb.



Carriage (outside our extensive delivery area) 1/6 England or Wales. Accessories as for 37/6 lathe on left.

21/-

Exceptional Value in GEARED MINIATURE A.C. MOTORS (50 cycles)

Will work through any suitable transformer. Rating 12 to 14 volts continuous to two minutes at 24 volts. Incorporating bi-metal thermal cut-out and automatic clutch to avoid breakage under sudden stoppage. Reversing switch, self-lubricating bearings. Rotor speed (no load) 2,000 r.p.m. Output spindle speed 58 r.p.m. All brand new, and remarkable value. Post 6d. Illustration is approx. one-third actual size.

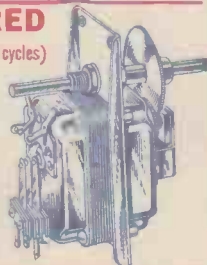

7/6

BOXES OF TWELVE



ASSORTED FILES

The best and cheapest way to buy Files. British made and excellent quality. Sizes 6 to 12 inches.

12 for 4/6

Post 6d. Also sizes 4 to 8 ins. 12 for 2/11. Post 6d.

High-Grade BENCH GRINDERS

Hand driven, fitted 4 in. x 3/4 in. wheel and with tool rest. Strongly made throughout, it will give years of service. Offered at about half the price you would expect to pay. Post 7d.



3/6

1/6 h.p. CAPACITOR START MOTORS

by a Prominent British Manufacturer Originally listed at 4 gns.

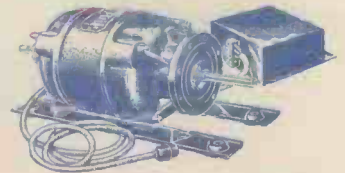

25/-

Can be run off ordinary electric light point. Will drive up to a 3 in. lathe, drilling machine, water pump for garden fountain, or any type of light machinery. These motors have had only a small amount of use, and will give long and trouble free service. 1/6 h.p. single phase, 1,425 r.p.m. For A.C. mains only, 200/250 volts 50 cycles. Carriage 1/6 England or Wales.

FIRST QUALITY HEAVYWEIGHT 3 in. SCREWCUTTING LATHES (BACK GEARED, GAP BED), SLIDING, MILLING, SURFACING

An opportunity to secure a high-grade lathe at a remarkably low price. Be advised and order now while stocks are available.

SPECIFICATION

Exceptionally strong headstock with adjustable bearings. Heavy, solid bed ensures accurate work. Machine cut change wheels for all English threads. Saddle and slide have large bearing surfaces, and the tailstock is of rigid design. Swing, over saddle 4 1/2 in., over bed 6 in., over gap 8 in. Diameter of mandrel 3/4 in., mandrel nose 3/4 in. x 12 threads. Mandrel and tailstock bored 3/4 in. clear. Centres No. 1 Morse taper, leadscrew 3/4 in. x 8 T.P.I. Cone pulleys 3 1/2 in., 3 3/4 in., 2 3/4 in. x 1 1/2 in. Back gear ratio 30 to 20 distance between centres 12 in., overall length 27 in., weight 52 lb. Complete with face plate and ten change wheels.

79/6

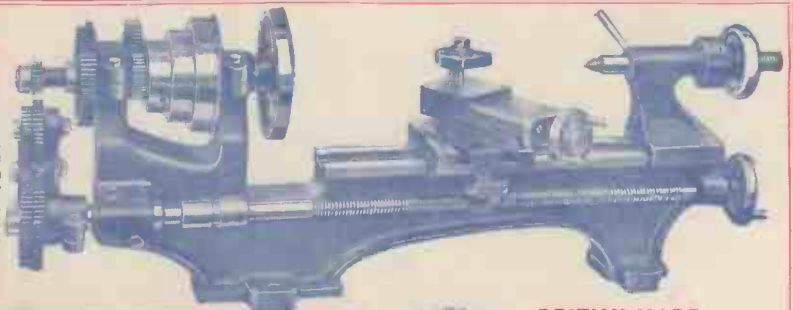

BRITISH MADE THROUGHOUT

Or DELIVERED on FIRST of SIX MONTHLY PAYMENTS of **14/9**

Carriage (outside our extensive delivery area) 3/6 extra England and Wales.

GAMAGES, HOLBORN, LONDON, E.C.1

Phone your order: HOLborn 8484

City Branch: 107 Cheapside, E.C.2

Published about the 30th of each month by GEORGE NEWNES, LIMITED, Tower House, Southampton Street, Strand, London, W.C.2., and Printed in England by THE SUN ENGRAVING CO., LTD., London and Watford, Herts. Sole Agents for Australia and New Zealand—Gordon & Gotch, Ltd. Sole Agents for South Africa—Central News Agency, Ltd. Subscription Rates: Inland and Abroad, 7s. 6d. per annum. Canada, 7s. per annum. Registered at the G.P.O. for transmission by Canadian Magazine Post.