

Practical *MECHANICS*

1'6

FEB - 1962



*Listening
to Space*

**IMPROVING
YOUR LATHE**

**POWER FROM
THE WIND**

Make a photographic print dryer



Screwdrivers

* PRECISION BUILT FOR CRAFTSMEN

Manufactured to exacting standards by Moore & Wright (Sheffield) Ltd. world famous for precision and hand tools.



WRITE FOR OUR
LEAFLET NOW

Please send me details of your
SCREWDRIVERS.

NAME

ADDRESS

MOORE & WRIGHT (Sheffield) LTD.
Handsworth Road, Sheffield, 13.

MW 69 PM



Ex-M.O.S.

PRECISION TOOLS

14 DAYS
FREE
TRIAL



TOOLROOM CLINOMETERS (Micrometer Bubble Type)

35/-

An Engineer's Clinometer of great precision. Main scale is divided 0-20 deg. in 1 deg. divisions and angles to within $\frac{1}{2}$ minute can be read speedily on the micrometer thimble. For their original military purpose a clip was fitted to the base but this clip can be easily removed in the Machine Shop. Net weight 22 oz. Length of base 3 $\frac{1}{2}$ in.

Ex-M.O.S. WALTHAM STOP WATCHES

A high quality $\frac{1}{2}$ second recorder with minute recorder reading 0-30 minutes. Offered at fraction of cost. £3.15.0.

OPTICAL TEST SET

Containing 30 carefully graded lenses of Crown glass. Focal lengths from 4 in. to 120 in. Dia. 47 mm. 42/- All in the new Vu-File transparent pack.

CHRONOMETERS. We are disposing of our collection of chronometers, recognised as being one of the finest in the world. Full details on request.

CHARLES FRANK LTD

67-75 SALTMARKET, GLASGOW, C.1

Phone: BELL 2106/7 Established 1907

Britain's greatest stocks of new, used and Ex-Govt. Optical and Scientific Equipment. Send for illustrated catalogue.

Leytool

ADAPTABILITY

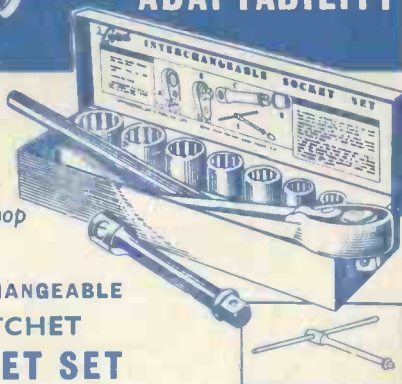

See it
at your
Tool Shop

INTERCHANGEABLE RATCHET SOCKET SET

The Leytool $\frac{1}{2}$ -in. Reversible Ratchet spanner with Extension Piece for long reach, a 9-in. Tommy Bar and 7 Interchangeable Sockets. offers unbeatable value. Everything a set of this kind should do can be done more quickly and easily with the handy Leytool Kit.

92/- complete
FREE

Write for illustrated
catalogue of complete
range of "Leytools"

LEYTONSTONE JIG & TOOL CO. LTD.
LEYTOOL WORKS, CROWHURST ROAD, HOLLINGBURY
ESTATE, Nr. BRIGHTON, SUSSEX

Also at LEYTON, LONDON

Telephone: BRIGHTON 57011



YOUR THIRD HAND

THAT HOLDS ON

WITH HANDS OFF

Nowadays, Handymen, Housewives, Engineers, Motorists and the like have an opportunity to use the Mole Wrench as their 'third hand'. This tool, world famous for its versatility, locks on to work and remains there, with hands off, until the release lever is touched. A hand vice, clamp, super-pliers, and so on, are but a few of its uses for the inevitable repairs and maintenance jobs in home, workshop, garage and garden. Two sizes: 7", 12/6 and 10", 15/-.

Make sure you get a genuine Mole Wrench—look for the name on it.

If in any difficulty write to:

M. MOLE & SON LTD., BIRMINGHAM, 3.

THE MOLE
TRADE MARK
SELF-GRIP WRENCH

FROM IRONMONGERS,
MOTOR AND MOTOR
CYCLE ACCESSORY
DEALERS

Make Your Ability PAY



UNLIMITED OPPORTUNITIES exist today for "getting on" . . . but only for the fully trained man. Let I.C.S. develop your talents and help you to succeed.

IT'S MUCH EASIER to study under expert guidance. An I.C.S. course directs your efforts and helps you along, step by step, until your goal is reached—and you're a fully trained man.

WITH I.C.S., the largest and most successful correspondence school in the world, you get the most thorough postal training possible. Printed manuals, fully illustrated, make study easy and progress sure. Moderate fees include all books.

Take the right course NOW!

- ADVERTISING**
Copywriting
Layout & Typography
Market Research
- ART**
Oil & Water Colour
Commercial Illustrating
Recreational Art
Showcard Design
- BUILDING**
Architecture, Clerk of Works, Building Construction, Bricklaying
Quantity Surveying
Builders' Clerks'
Heating & Ventilation
Carpentry & Joinery
- CIVIL ENGINEERING**
Highway Engineering
Structural Engineering
Concrete Engineering
- COMMERCE**
Book-Keeping, Accountancy,
Office Training, Costing
Business Correspondence
Report Writing, Secretaryship
Shorthand & Typewriting
Computer Programming
Storekeeping
- DRAUGHTSMANSHIP**
Architectural, Mechanical
Drawing Office Practice
Structural Drawing
- ELECTRONICS**
Industrial Electronics
Computers & Maintenance
- FARMING**
Arable & Livestock
Farm Machinery Maintenance
Pig & Poultry Keeping
Market Gardening
- FIRE ENGINEERING**
I.F.E. Examinations
Fire Service Promotion Examinations
- GENERAL EDUCATION**
G.C.E. Subjects at Ordinary or Advanced Level
Good English
Foreign Languages
- HORTICULTURE**
Complete Gardening
Flower and Vegetable Growing
Fruit Growing
- MANAGEMENT**
Business Management
Hotel Management
Office Management
Industrial Management
Personnel Management
Work Study, Foremanship
- MECHANICAL & MOTOR ENGINEERING**
Engineering Mathematics
Diesel Engines, Fitting & Turning
Maths. & Machine Drawing
Inspection, Workshop Practice
Welding
Refrigeration & Air Conditioning
Motor Mechanics
Running & Maintenance (many other subjects)
- PHOTOGRAPHY**
Practical Photography
P.D.A. Examination
- POLICE**
Entrance Examination
- RADIO T.V. & ELECTRICAL**
Servicing & Engineering
Electrical Contractors'
Radio Construction (with kits)
Electricians'
Householders' Electrical
- SELLING**
Company Representatives'
Sales Management, Retail Selling
- WRITING FOR PROFIT**
Short Story Writing
Free-Lance Journalism
- MANY OTHER SUBJECTS INCLUDING**
Industrial Instrumentation
Chemical Engineering
Petroleum Production
Textile Technology, Dressmaking
Flower Arranging

INTENSIVE COACHING for all principal examinations including C.I.S., A.C.C.A., I.C.W.A., B.I.M., A.M.I.Mech.E., Brit.I.R.E., I.Q.S., City and Guilds, R.H.S. General.

Examination students are coached until successful
INTERNATIONAL CORRESPONDENCE SCHOOLS
(Dept. 168)

Intertext House, Parkgate Road, London, S.W.11

Please send FREE book on _____

Name _____

Address _____

Block Capitals _____

Occupation _____ Age _____ 2.62

INTERNATIONAL CORRESPONDENCE SCHOOLS



DE-LUXE TAPE RECORDER CABINET
29/9

Beautifully made Tape Recorder Cabinet. Size: 13" x 10 1/2" x 7". Two-tone red line covering. Stylish design. Carrying/detachable lid. Easily adapted to Record Player Cabinet. Exceptional value. P. & P. 5/-.



RECORD PLAYER CABINET
29/9

P.L.5

Petite Portable player cabinet in smart 2-tone colours. Size 12" x 10 1/2" x 6". Carr. 5/-.

DUKE & CO. (London) LTD. 621/3 Romford Road
Manor Park, E.12
Send for Latest Free Catalogue Ilford 6001/3

BRASS, COPPER, BRONZE, ALUMINIUM, LIGHT ALLOYS
Rod, Bar, Sheet, Tube, Strip, Wire
3,000 Standard Stock Sizes.
NO QUANTITY TOO SMALL.
List on application.

H. ROLLET & CO. LTD.
6 CHESHAM PLACE, LONDON, S.W.1
Also at BELGRAVIA 4300
LIVERPOOL, LEEDS, MANCHESTER, BIRMINGHAM

PROJECTORS, 2 x 2. See the best of the rest, then see ours, and make your own for about 25-26. Quality and definition inferior to none. 330 w. results from 100w. lamp. 15ft. candles on a 3ft. screen guaranteed. Plan 2/- per set. See our list for details

ASTRO TELESCOPE. 6" Reflector. 80-400X on Equatorial or Altazimuth mount, geared drives and circles. £45. Complete. Carr. extra. Or in kit form at approx. £30. Components available separately. Plans 2/6.

EXTRA WIDE-ANGLE EYEPIECES. The world's best. 74 degree angle of view. 1", 1 1/2" and 1 1/4" in focusing mounts, as new, 25 ea. Cost over £30.

ORTHO SCOPIC EYEPIECES. 1/2" wide-angle 50 degree field. Push-in. New, 35/-, or with R.A.S. thread £2/6. 1" 56 degree field R.A.S. thread 37/6. 2" 42 degree field 30/- Variable power 1/2"-1" R.A.S. thread, for draw-tube focusing, only £4.5.0. Keplar eyepiece. 1 1/2" in focusing mount, 8/6.

ASTRO MIRRORS. 6" x 48" parabolic 1/4th wave £9.5.0. 4" x 31" £3.3.0. 4" x 40" 35/-, 6" x 40" 55/-. Aluminium flats, 1" x 1 1/2" 4/-, 1 1/2" x 2 1/2" 6/-. 2" x 3" 8/6. Equal to the best at only a fraction of the price, but rectangular and unground edges.

PRISMS. First grade. 1" 10/6. 1" 12/6. 1" x 1 1/2" faces 17/6. 1 1/2" 25/-, 2" 35/-.

OBJECT LENSES. 3" x 36" £6.10.0. 4" x 48" £19. 2 1/2" x 25" £3. Others from 12/6. All guaranteed first grade.

EQUATORIAL OR ALTAZIMUTH TELESCOPE MOUNTINGS. Geared drives with circles. Ex-Gov. Cost about £80 ea. Our Price £6.10.0. Suitable for telescope up to 10wt. Carr. £1. extra.

MIRROR TYPE VIEWERS. The ONLY perfect viewer obtainable today. Will reveal detail in your slides you did not know were there. Make your own for £2.5.0. Plans 1/-.

SCOUT 3-DRAW TERRESTRIAL TELESCOPES. 25X. 2" O.G. Brand new leather covered, with leather case, £9. Ditto oracicle finish, £9.10.0. Near new with case, £7.10.0. Fair condition, optically perfect. No case, £6.10.0. 50X eyepieces to fit, 37/6. 75X. 50/- Astro-Terrestrial adaptors to give 40X and 60X with normal eyepiece, 50/-.

7 x 21X VARIABLE POWER TELESCOPES, 2" O.G. Weight approx. 10 lbs. £6.10.0 ea. in case.

See our lists for other types. Over 40 various types of telescopes in stock, also Binoculars. Any item gladly demonstrated to callers, comparisons welcomed. Lists free for S.A.E. Booklets How to Use Ex-Gov. Lenses and Prisms. Nos. 1 and 2. 2/6 each.

H. W. ENGLISH

469 RAYLEIGH ROAD, HUTTON, BRENTWOOD, ESSEX

VALTOCK AUTOMATIC ALL PURPOSE BLOWLAMPS
BURNS ONLY PURE METHYLATED SPIRIT

	The "2000." Ideal for model makers, hobbyists and service engineers for fine delicate work, soft soldering, glass bending, etc. PRICE 14/7		The "Major." A larger version of the "2000" fitted with flame shield to give large flame: for most big soldering jobs about the house. PRICE 30/-
	The "No. 3." The D.I.Y. man's best friend. Full size, powerful. For paint stripping, heavy soldering and all big plumbing jobs. PRICE 63/-		Soldering iron attachment. Fits the "Major" and "2000". Gives you a soldering iron anywhere—away from electrical supplies. PRICE 5/-

SLOTGRIP TORSION SCREWDRIVER

Holds screws on the end of the blade

		For putting screws in awkward places. Automatic action. Push-it grip. Pull—it's released. PRICE 5' 7/6 10' 12/-
---	---	---

See them at your usual suppliers or send for details to:

VALTOCK LTD

REGENCY HOUSE, 14 WARWICK STREET, LONDON, W.1. Telephone: GERrard 1667

The First "Practical Mechanics" HOW-TO-MAKE-IT BOOK

Edited by F. J. Camm

A book for the man who likes to make things for himself, compiled from the columns of "Practical Mechanics". Everything herein described has been designed, built and tested in the "Practical Mechanics" workshop.

... it shows you how to construct ...

Tape Recorder; Electronic Organ; Electric Washing Machine; Hand Vacuum Cleaner; Electrically-operated Garage doors; Bagatelle Table; Reflecting Telescope Stand; Harmonograph; "Designograph"; 15-in. Four-heddle Hand-loom; Potter's Wheel; Pottery Kiln; Electric Oven; Westminster Tubular Door Chimes; Cycle Trailer; Pedal-cycle Sidecar; Portable Air Compressor; Water Softener; Spanish Hawaiian Guitar; Steel-stringed Ukelele; Double-seater Canoe; Radio Deaf-aid Unit; Garden Pool; Vertical Enlarger; Photo-electric Exposure Meter; Synchronised Flashgun; Combined Printing Box and Safelight; Diascopes and Episcopes; Steam-driven Motor Boat; Electric Wall Bracket; Inexpensive House Telephones; Electric Gas-lighter; Adjustable Drawing Table; Toboggan.





224 pages, 320 "how-to-do-it" Illustrations, 2nd edition.

15s. FROM ALL BOOKSELLERS

... or in case of difficulty 16s. 3d. by post from GEORGE NEWNES LTD., Tower House, Southampton Street, London, W.C.2.

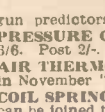
NEWNES

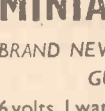
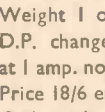
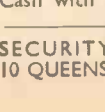
WATSON'S SPECIAL OFFERS

	LIGHTWEIGHT CHARGING SETS. 12/15v., 80w. Extremely neat and compact and UNUSED. £10.10.0. Carr. 15/-.
	TANK COMMANDERS' PERISCOPES. 11in. long with large wide angle object lens. A very fine quality instrument with binocular vision. 15/6. Post 3/-.
	CLOCKWORK MOTORS. Well made, in heavy brass, double spring motors taken from gun predictors. 37/6. Post 3/6.
	PRESSURE GAUGES. 2 1/2in. diam., 0-24 Pressure, 0-6 Vacuum. 6/6. Post 2/-.
	AIR THERMOMETERS. 5D/938 as used in FROST SENTINEL in November "P.M." 4/6. Post 1/6.
	COIL SPRING BELTS. 4 x 12in. extends to 15in. Any number can be joined together. 20 for 4/6. Post 1/-.
	SMALL COMPRESSORS by HYMATIC. Two stage units. Capacity 1.2 CFM. Max. Press. 450 P.S.I. Size 8 x 5 x 4in. 45/-, Post 3/6. Hundreds of other Bargains. Send 8d. Stamp for Illustrated List

EASTERN MOTORS, ALDEBURGH, SUFFOLK. Phone 51

MINIATURE RELAYS

BRAND NEW—
GUARANTEED
6 volts, 1 watt, D.C. Coil
Weight 1 oz. Contacts
D.P. changeover rated
at 1 amp. non-inductive.
Price 18/6 ea. Post Paid.
Cash with order only.

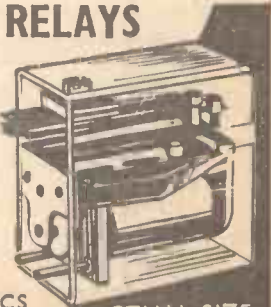

SECURITY ELECTRICS 10 QUEENS RD. COVENTRY ACTUAL SIZE

*When
Buying
Paint*



BUY JUST WHAT YOU NEED—
tinslets 9d. each from
F. W. WOOLWORTHS Stores, HALFORDS
CURRYS and HOBBY & HANDICRAFT
SHOPS.
EXTRA-ECONOMICAL 2 oz. tin 1/6 each.

**Which of
these
properties
matters
most
to you?**

- Dry in 1 hour
- Super smooth gloss
- Extreme hiding powers
- Leaves no brushmarks
- Easy flow
- Lead free and Non-toxic
- Largest colour range
- Matt or metallic finishes
- Economical sizes of tin
- All colours intermixable
- Durable, withstands wear and tear
- Suitable for any surface

Tick off those qualities you think important. If necessary tick them all—They're all points to consider before you buy your next tin of paint. And there's only one paint with all these advantages—

HUMBROL
PLASTIC ENAMEL

Humbrol is also available in 22 radiant decor colours. Extra economical 2 oz. tins 1/6, 1/2 pint tins 3/3, 1/4 pint tins at 5/6 each and 1 pint tins at 10/3. From Paint Shops and Hardware Stores everywhere

THE HUMBER OIL CO. LTD. MARFLEET, HULL

FOR A SENSE OF ACHIEVEMENT !



JOHNSON: DO-IT-YOURSELF OUTFIT

See your own work come to life with a Johnson Do-it-yourself Outfit! At last a range of easy-to-use photographic outfits for the keen photographer who wants to develop and print his own films. There are outfits for beginners and for the more advanced enthusiast. Each outfit has everything you need, including full, easy-to-follow instructions. Johnsons make a wide range of photographic equipment and chemicals, stocked by all photographic dealers. Price from £1.17.6 to £5.12.6.



FOR CONFIDENCE IN PHOTOGRAPHY



**DESIGNED BY "L.B.S.C."
CASTINGS BY**

A. J. REEVES

Reeves castings for small steam locomotives set the standard by which other castings are judged, and enjoy a world wide reputation. Use Reeves castings for your "Evening Star," and prove for yourself that they are indeed the "Choice of Experience."

Send a 1/- stamp NOW for a copy of our latest lists with details of blueprints, castings and fittings for many small steam locomotives designed by "L.B.S.C." and other leading designers.

We also list a wide range of workshop equipment, including the famous MYFORD range of lathes, FOBCO drilling machines, and many more recommended Power Tools too numerous to mention here. Small tools also are well represented—WARRIOR taps and dies—DORMER drills—ECLIPSE tools—MOORE AND WRIGHT precision instruments, and many more.

WORKSHOP EQUIPMENT IS AVAILABLE ON THE MOST REASONABLE OUT-OF-INCOME TERMS—we shall be happy to quote quite free of obligation.

"THE CHOICE OF EXPERIENCE"

A. J. REEVES & CO. (Birmingham) LTD.
(Dept. E.S.) 416 MOSELEY RD., BIRMINGHAM, 12

Phone: CALthorpe 2554

VALUABLE NEW HANDBOOK FREE TO AMBITIOUS ENGINEERS

Have you had *your* copy of "Engineering Opportunities"?

The new edition of "ENGINEERING OPPORTUNITIES" is now available—without charge—to all who are anxious for a worth-while post in Engineering. Frank, informative and completely up to date, the new "ENGINEERING OPPORTUNITIES" should be in the hands of every person engaged in any branch of the Engineering industry, irrespective of age, experience or training.

**We definitely Guarantee
"NO PASS—NO FEE"**

This remarkable book gives details of examinations and courses in every branch of Engineering, Building, etc., outlines the openings available and describes our Special Appointments Department.

WHICH OF THESE IS YOUR PET SUBJECT?

MECH. ENGINEERING
Gen. Mech. Eng.—Maintenance Eng.—Diesel Eng.—Press Tool Design—Sheet Metal Work—Welding—Eng. Pattern Making—Inspection—Draughtsmanship—Metallurgy—Production Eng.

RADIO ENGINEERING
General Radio—Radio & TV Servicing—TV Eng.—Telecommunications—Electronics—Sound Recording—Automation—Practical Radio—Radio Amateurs' Exam.

CIVIL ENGINEERING
General Civil Eng.—Municipal Eng.—Structural Eng.—Sanitary Eng.—Road Eng.—Hydraulics—Mining—Water Supply—Petroleum Tech.

WE HAVE A WIDE RANGE OF COURSES IN OTHER SUBJECTS INCLUDING CHEMICAL ENG., AERO ENG., MANAGEMENT, INSTRUMENT TECHNOLOGY, WORK STUDY, MATHEMATICS, ETC.

Which qualification would increase your earning power?
A.M.I.Mech.E., A.M.S.E., A.M.I.C.E., A.M.Brit.I.R.E., A.F.R.A.S., B.Sc., A.M.I.P.E., A.M.I.M.I., A.R.I.B.A., A.I.O.B., A.M.I.Chem.E., A.R.I.C.S., M.R.S.H., A.M.I.E.D., A.M.Mun.E., CITY & GUILDS, GEN. CERT. OF EDUCATION, ETC.

BRITISH INSTITUTE OF ENGINEERING TECHNOLOGY
410A COLLEGE HOUSE, 29-31 WRIGHT'S LANE, W.8

ELEC. ENGINEERING
General Electrical Eng.—Installations—Draughtsmanship—Illuminating Eng.—Refrigeration—Elem. Elec. Science—Elec. Supply—Mining Elec. Eng.

AUTO ENGINEERING
General Auto. Eng.—Auto. Maintenance—Repairs—Auto. Diesel Maintenance—Auto. Electrical Equipment—Garage Management.

BUILDING
General Building—Heating & Ventilation—Plumbing—Architecture—Carpentry—Painting & Decorating—Specifications & Quantities—Surveying—Architectural Draughtsmanship.

THIS BOOK TELLS YOU

- ★ HOW to get a better paid—more interesting job.
- ★ HOW to qualify for rapid promotion.
- ★ HOW to put some letters after your name and become a "key-man" . . . quickly and easily.
- ★ HOW to benefit from our free Advisory and Appointments Depts.
- ★ HOW you can take advantage of the chances you are now missing.
- ★ HOW—irrespective of your age—education or experience—YOU can succeed in any branch of Engineering.

**156 PAGES OF EXPERT
CAREER - GUIDANCE**

You are bound to benefit from reading "ENGINEERING OPPORTUNITIES," and if you are earning less than £25 a week you should send for your copy now—FREE and without obligation.



POST NOW!

TO: B.I.E.T., 410A, COLLEGE
HOUSE, 29-31 WRIGHT'S
LANE, W.8.

2d. stamp
if posted in
an unsealed
envelope.

Please send me a FREE copy of "ENGINEERING OPPORTUNITIES." I am interested in (state subject, exam., or career).

NAME _____

ADDRESS _____

WRITE IF YOU PREFER NOT TO CUT THIS PAGE

THE "B.I.E.T. IS THE LEADING INSTITUTE OF ITS KIND IN THE WORLD

Practical

MECHANICS

Vol. XXIX

February, 1962

No. 334

Editorial and Advertisement
Offices

"PRACTICAL MECHANICS"

George Newnes Ltd., Tower
House, Southampton Street,
Strand, W.C.2.

© George Newnes Ltd., 1962

Phone: Temple Bar 4363

Telegrams:
Newnes, Rand, London

SUBSCRIPTION RATES

including postage for one year

Inland - - - 22s. per annum

Abroad - - - 20s. 6d. per annum

Canada - - - 19s. per annum

Copyright in all drawings, photographs and articles, published in "Practical Mechanics" is specially reserved throughout the countries signatory to the Berne Convention and the U.S.A. Reproduction or imitations of any of these are therefore expressly forbidden.

CONTENTS

Fair Comment	197
A New Space Communication System	198
An Electric Pin-Table	199
A Lunar Hole Digger	201
Evening Star	202
Camera Lens Testing	206
Wind Power	208
A Photographic Print Dryer	211
Puff Football	213
Find the Light Answer	214
Giant Telescope	216
A Mechanical Designing Device	219
Science Notes	221
Lathe Gadgets	222
Copying with the Enlarger	224
Magic Sand Buckets	226
Transparency Projector	229
Trade Notes	233
Letters To The Editor	234
Your Queries Answered	237

CONTRIBUTIONS

The Editor will be pleased to consider articles of a practical nature suitable for publication in "Practical Mechanics." Such articles should be written on one side of the paper only, and should include the name and address of the sender. Whilst the Editor does not hold himself responsible for manuscripts, every effort will be made to return them if a stamped and addressed envelope is enclosed. All correspondence intended for the Editor, should be addressed: The Editor, "Practical Mechanics," George Newnes, Ltd., Tower House, Southampton Street, Strand, London, W.C.2.

FAIR COMMENT

COAL SURPLUS

AS Britain feels her way uneasily through yet another economic crisis, the need for a further expansion in our industrial output is clearly of paramount importance. In this modern age of mechanisation, this must depend above all upon abundant supplies of suitable fuels, at competitive prices.

As recently as five years ago, such a requirement was by no means easy to fulfil. In 1956 not only Britain but Western Europe and many other parts of the world anticipated a continued shortage of coal in the face of rapidly rising demand. Forecasts of the probable position in 1960, 1965 and subsequent years took account of continued expansion in the use of heat and energy and compared this with the feasible increase in supplies of coal, oil and other fuels. By universal consent, the main burden of a steadily growing consumption could only be met in the near future through the efforts of the oil industry—in the longer term, it was hoped, rapid development of nuclear power would provide some easement of the situation.

It was largely in the light of such prognostications that the oil industry made its plans for raising production and increasing its transport, refining and distribution facilities. These took full account of the amazing flexibility of the industry, which allows a far more rapid development than could possibly be achieved by the coal industry.

At this precise juncture, a quite unexpected transformation took place in the world's fuel supply position. In particular there was a sudden pause in the growth in industrial output which in previous years has been proceeding smoothly and rapidly, virtually simultaneously with this there occurred a check, even a decline—in the fuel requirements of many industries, as a result of the introduction of new equipment and other economies which were expressly designed to reduce fuel consumption and assist the supply position.

This situation was experienced in full measure in Britain. In 1956, the demand for coal had reached a post-war peak with a total of 214 million tons. This accounted for more than 90% of all our energy requirements, as compared with some 7% derived from oil and small contributions from other sources. To assist the hard-pressed coal miners the Government encouraged an increase in the use of oil in various ways—including the generation of electricity—and the oil companies responded by making additional supplies available at prices comparable to those charged for coal.

In the United Kingdom, as elsewhere, however, the years from 1957 to 1959 were marked by little or no increase in industrial activity. Furthermore there occurred a series of comparatively mild winters (in marked contrast to that of earlier years when fuel rationing was a necessity). Thus the demand on the coal industry was suddenly eased.

Meantime, the demand for oil continued to grow and, in an unbelievably short time, the familiar coal shortage became transformed into a surplus—not only in Britain but in Western Europe and many other parts of the world also.

The March 1962, issue will be published on Feb. 28th, 1962. Order it now!

A New Space Communication System

NOW that man has entered space, the tremendous distances involved in space travel and research will bring communication problems.

One way in which messages can be transmitted across space is by electro-optical system which is currently being developed by Electro-Optical Systems Inc., under a contract from the Wright Air Development Division.

There are many advantages which are obtained by the use of optical wavelengths for space communications where atmospheric scattering and absorption do not take place.

Other advantages include the long distance transmission which is possible, considerable freedom from jamming and also the difficulty of interception of the messages due to the narrow bandwidths possible. Such systems also promise to be more reliable in difficult space operating systems and a high signal to noise ratio can be obtained.

Working Principle

In this apparatus the rays of the sun are collected by a mirror antenna system and then passed through a modulating device which puts the required message into the light signals. They are then passed out through a second mirror system into space.

After travelling the required distance to the receiver, which may extend up to ten million miles or more the light signal is picked up by the receiving mirror system.

The optical message is passed through a photo-multiplier, fed to signal processing equipment and finally read by the receiving space traveller.

Double mirrors have been used for both the mirror system which picks up the rays of the sun and the system which transmits the message into space. Here one mirror reflects the signal back through a hole in the centre of the first mirror and permits the collection of the solar radiation from a wide angle.

The second double mirror system is used for transmitting the message. It allows solar radiation to be picked up from one direction and then be re-radiated in another direction.

At the message receiving end of the system the signal is picked up either by a double mirror system when the detector is fitted behind the primary mirror or else a parabolic collecting mirror can be used with the detector mounted at the focus of the mirror.

Detectors being used at the present time are photo-multipliers. They are preferred because of their low internal noise, high quantum efficiency over the solar wavelengths and noise-free amplification.

Shutter Modulation

To interrupt or modulate the light beam, so cutting the coded message into the signals, a stressed plate shutter has been developed.

This consists essentially of a plate of glass mounted between pairs of rigid beams. Placed at either end of the beams are stacks of piezoelectric drivers. When a voltage is applied to these stacks they are caused to expand or contract according to their polarity. This movement is imparted to the rigid beams and to the glass plate. Strain induced in the glass causes temporary double refraction so changing the state of polarisation of the light beam passing through the glass.

When this shutter plate is placed between a pair of crossed or parallel polarisers and a modulation voltage is applied to the piezoelectric drivers the light beam passing through the glass will be modulated from a full open to a full close position.

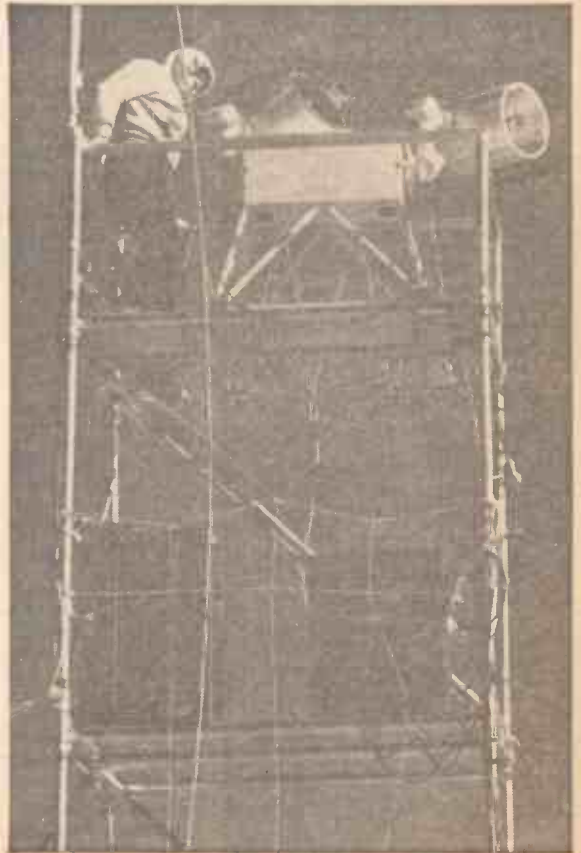

Experimental SOCOM transmitter on 30ft tower during tests.

An Electric Pin-table

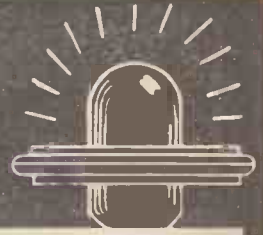

by Jameson Erroll

Part 2. - Concluding Constructional Details

THE electrical contacts are the next consideration. They consist of two copper foil plates $1\text{ in.} \times \frac{1}{2}\text{ in.}$ in each division and are attached to the hardboard with $\frac{1}{4}\text{ in.}$ 8B.A. brass nuts and bolts. The heads should be counter-sunk as should the holes in the table drilled to receive them. By far the best way to make the holes in the copper foil is to use a hollow punch; this will leave a natural counter-sink and will also make a very clean hole; attempts to drill thin copper foil are usually futile as the foil rides up the flutes of the drill and either breaks or twists. The B.A. bolts should be tightened up so that they scarcely ride above the surface of the foil. To the ends of these B.A. bolts will later be fastened the electrical wiring. The first copper plate is fixed with its near edge about $\frac{1}{8}\text{ in.}$ from the foil on the dividing bar, and the edge of the second plate about $\frac{1}{2}\text{ in.}$ from the front edge of the first. Thus, there is no contact between the foil on the bar and the plates, nor between

the two plates, until a ball or balls enter the channel; then the first ball contacts the bar and rests on the plate and thus completes the circuit, and the second ball, should there be one, rests against the first one and the second plate and makes a further contact thus lighting the second lamp.

coloured Cellophane, a sheet of glass. Fig. 7 (last month's issue) shows the lay-out.

The actual divisions are made similar to those of the dividing beads. Ex. $2\text{ in.} \times 1\frac{1}{2}\text{ in.}$ softwood is used, the main bar being $15\frac{1}{2}\text{ in.}$ long and the dividers 4 in. long and positioned at 3 in. intervals. One small angle plate is sufficient to fasten the assembly to the hardboard table.

$\frac{1}{8}\text{ in.}$ holes are drilled in the table to receive the bulb holders which are of the M.E.S. type (Miniature Edison Screw) similar to those found in torches, etc. Their centres are 1 in. apart, the front one being $1\frac{1}{2}\text{ in.}$ from the cross bar; they are, of course, placed centrally across each division. Fasten them to the hardboard by means of $\frac{1}{2}\text{ in.}$ 8B.A. brass cheese-head bolts passing through the board and the upper tag—the one on top of the fibre washer—and tighten with a nut. Note that this tag is underneath the hardboard, the holder itself protruding through the $\frac{1}{8}\text{ in.}$ hole made in the table. Fig. 8, shows this connection quite plainly.

The large indicating numbers through which the lights will shine, are cut out—stencil fashion—on a piece of fairly thick cardboard and, like the bulbs, are centred 3 in. apart so that the centre of each number falls immediately over the bulbs. This card is attached to the wood divisions with glue. Over it is laid a piece of coloured Cellophane $15\frac{1}{2}\text{ in.} \times 4\frac{1}{2}\text{ in.}$ and over this, a sheet of clear or frosted glass of the same size; this latter is kept in position with two mirror clips.

The Number Indicator

This part of the apparatus comprises five divisions, ten bulbs, cut-out numbers on a sheet of white card, a strip of

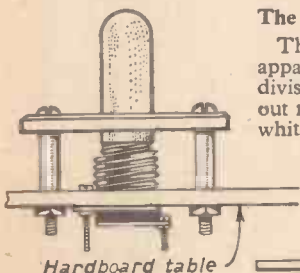
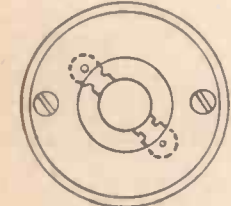

Fig. 8 (Above).—Plan and section of flashing bulb and protector assembly.

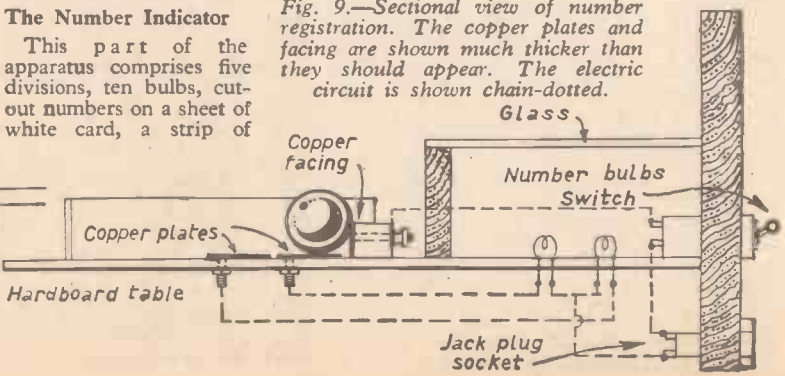

Fig. 9.—Sectional view of number registration. The copper plates and facing are shown much thicker than they should appear. The electric circuit is shown chain-dotted.

The Hazards

These, as set out by the author, are clearly seen in Fig. 7 (Jan. issue). Their arrangement and the form they take is entirely at the option of the constructor; there may be more or fewer of them, and they can be arranged to offer impedance as and where required. The lay-out shown offers plenty of variety, apparatus of differing re-action, and sufficient obstacles to maintain the necessary degree of uncertainty. They can be obtained from Philip Shefras (Sales) Ltd. of Hollybush Place, Bethnal Green, London, E.2., who were most helpful and are prepared to supply large or small quantities of their products. They are suppliers of all kinds of apparatus used in automatic machines.

The particular gadgets used by the author and supplied by the above firm are listed below together with the firm's own reference number:—

- Pifco flashing bulbs 6V No. 1626.
- 6V Clear lamps M.E.S. No. E129.
- M.E.S. Lamp holders. No. E143.
- Posts (bumpers in the text). No. G818a.
- Post rubber rings. No. G696.
- 2in. Rubber rings. No. G692.
- 1in. Steel balls. No. G570.
- Oval springs. No. S736.
- Transformer, 6 taps 0/30V. No. E168.

The posts—referred to in the text and drawings as bumpers—are of plastic with rubber rings fitted near the top. These cause the ball to rebound and thus deflect it. They are shown in Fig. 7. Two posts set 5½in. apart as also shown can have a 2in. rubber ring between them; the ball rebounds and changes direction according to the position at which it strikes the rubber band. The oval springs produce a somewhat similar re-action when struck and, like the two posts can be positioned to impel the ball in something approaching the desired direction.

The posts (or bumpers) should be fixed by means of raised-head chrome 4B.A. bolts passing through their centre hole (already drilled) and the table, and tightened with washer and nut. The oval springs, on the other hand, have a serrated shank and are primarily intended for a hammered fit into wood; but it is quite easy to thread them 2B.A. and fasten with a washer and nut. If this is found to be impracticable, the hardboard should be reinforced with a block of wood suitably bored and the shank force-fitted.

The other hazards shown in Fig. 7 are homemade. The blocks are self-explanatory; the spiral spring was from an old clock and is suspended about ½in. above the table top with a bolt and nut which also passes through the hardboard. The spring deflector prevents the ball rolling straight down the side and resembles the blocks in action, except that the path of the ball is less certain.

The flashing bulbs and protectors require some explanation as to their use and construction. They are purely a decorative and varying feature in that they have no connection with the numbers scored. Their constant flashing in-and-out is quite attractive, and prevents the current being left on

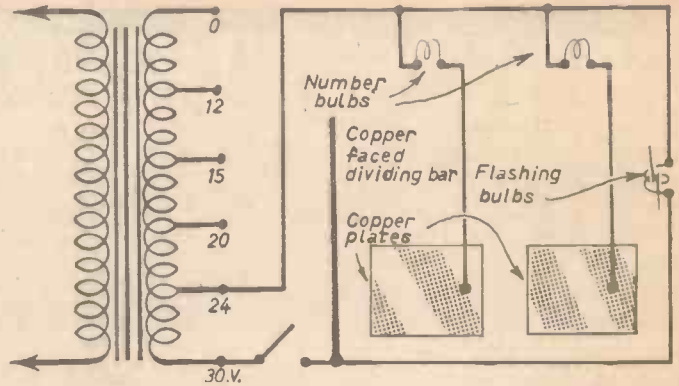

Fig. 10.—The electric circuit using mains transformer giving 6V secondary supply.

accidentally. Since they project about 1½in. above the table it is necessary to provide some form of protection against the fast-moving and somewhat heavy steel balls. The idea shown in Fig. 8 was accordingly adopted. It offers adequate protection and at the same time furnishes a further hazard. The washers are ½in. bright steel having an external diameter of 1½in. and are ¼in. thick with a bevelled edge. Two ⅜in. holes are drilled in them as shown, and they are raised from the table with two ½in. lengths of brass tubing of an inside diameter to clear 4B.A. The bulb protrudes through the hole in the washer, and electrical connections are made under the hardboard as with the numbering bulbs.

The Electric Circuit

The complete circuit is shown in Fig. 19, while Fig. 9 shows the numbering circuit.

Power is obtained through a tapped transformer although, of course, a battery could be used. The type bought from Philip Shefras has six secondary tapings—0, 12, 15, 20, 24 and 30V and from this a multiple of voltages can be obtained from 3V to 30V, almost in steps of 1V at a time. Thus, the transformer can be used for other purposes *ad lib* and is a worth while investment. It has been boxed up as an entirely separate unit with the main terminals *inside* the box for safety. A jack plug and socket connects it with the pin-table circuit.

Referring to both Figs. 9 and 10 in turn it will be seen that one terminal of the jack goes to the switch and nowhere else. The other switch connection is to the copper-faced dividing bar and to one tag on each of the flashing bulbs. The other jack terminal runs to *all* the bulbs. The remaining tags on the number bulbs are connected to their respective copper plates. None of the wiring is visible above the table so there is no need to be over particular as to lay-out except to make all runs as short as possible. Soldered connections are strongly recommended, they stay put and are necessarily clean and therefore offer the minimum resistance. Use light, rubber-covered single flex for all these connections, and ordinary lighting flex between the jack plug and the 24V and 30V tapings on the transformer, thus obtaining an output of 6V. From mains to transformer primary use ordinary flex.

(Continued on page 207)

A LUNAR HOLE DIGGER

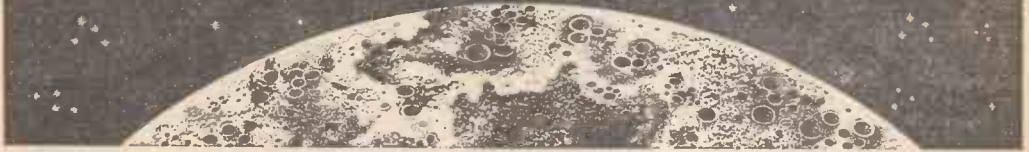

By D. S. Fraser

WITH a voyage to the moon—more or less around the corner—a group of American scientists are wondering, and saying: "Going our way? Because our way is moonway! We want to find out if the moon is actually made of green cheese. And, what's more, we aim to find out."

With this in mind, they have arranged with some engineers, to develop a device which will drill a hole in the moon.

Engineers at the Garrett Corporation, in California, led by Frederick H. Green, chief of preliminary design, have designed, engineered and already partially tested a Lunar Drilling Rig, a drill that will bore a hole in the surface of the moon, televise the contents of the hole, and report its findings back to earth.

The Lunar Drill came about in answer to a plea from the aerospace industry, a number of months ago, to devise a means of determining the exact composition of the moon's surface, so that astronaut-carrying space vehicles can be properly designed for a successful moon landing.

In spite of centuries of observation, relatively little is known about the moon's surface. For example, it may be covered with dust, but is it a layer three inches or thirty feet deep? The configuration of a space ship, and an astronaut's suit, depend on the answers to this, and many other questions.

The drilling rig stands about 10 feet tall, weighs 300 pounds on earth, but only 50 pounds on the

moon. This is due to the fact that moon's gravity is only one sixth that of the earth's.

This lack of weight, and therefore thrust, posed the first of many problems for a drilling rig. Fifty pounds were not considered heavy enough to force an auger through hard rock surfaces that might be encountered. The weight would be enough, however, to force a half-inch, diamond-headed drill, operating without lubricants, into the surface, no matter how hard.

Once the preliminary drilling is completed, a two-bladed reamer, with the cutting edges retracted along its shank, would automatically drop into the hole. When the tool rotated, centrifugal force would extend the blades which would then ream out the hole from the bottom up. And so the force of the reamer itself would be holding the drilling rig to the surface of the moon.

After reaming, an auger drill, similar to a wood-cutting tool, would bring to the surface the chips left behind by the reamer.

All this would go on under the watchful eye of a television camera, which would televise close-ups of the surface, and sub-surface, and relay pictures back to earth.

Other tests to measure the surface include a scraping device which is inserted in the hole and withdrawn to determine the hardness of the sub-soil by the amount of resistance to the scraper blades. Also, gamma-rays will be emitted from the probe lowered into the hole. By measuring the

(Continued on page 215)



L.B.S.C.'s 3½ in. Gauge

EVENING STAR

PART 12

Radius rod and lifting link

A piece of $\frac{1}{4}$ in. x $\frac{1}{4}$ in. mild steel 5½ in. long, will be needed for each radius rod. Mark off as shown in Fig. 77, taking great care to get the offsets right. Then drill the holes and cut the slots; use No. 32 drill for all three holes. Although the slots are offset, there is no difference between the right and left-hand sides, as the R.H. rod will fit the L.H. side if turned over, and vice-versa. The rods can be milled to shape by any of the methods described for the coupling-rods, clamping to a supporting bar with a cramp at each end, when milling the sides. When one side is done, and the rod turned over, only one end will rest on the supporting bar when the rod is set level for milling the opposite side; so put a suitable strip of packing between rod and supporting bar, and clamp the rod down tightly to it. Beginners note that all work to be milled needs to be fixed so that there is no chance of it shifting while the job is in progress. The push exerted by even a small milling-cutter is far greater than they would imagine.

After milling to shape, ream the hole in the short fork only; those in the long fork are left as drilled, as the pins at that end are press-fitted. The superfluous metal at each end can then be sawn off, and the ends rounded as shown in Fig. 77.

The lifting link is a simple job, being just a piece of $\frac{1}{4}$ in. x $\frac{1}{4}$ in. mild steel 1½ in. long, milled or filed to the outline shown on Fig. 73. Note the little blob at the side of the bottom boss. This forms the oil box for lubricating the lifting pin on the full-sized engine, and if it isn't present on the little one, our old friend Inspector Meticulous will be getting his notebook out. Drill a No 55 countersunk oil hole in it, also in the top projection, reaming the pin holes last of all.

Expansion links

Careful work is required to make the expansion links; the job isn't difficult, but requires patience. They are the most vital part of the valve gear, and if they aren't right, the valve setting will be incorrect, and the efficiency of the engine will suffer. The best material for the links is the fine grade of cast steel used in gauge and tool making, known in the trade as "ground flat stock." I always use it. If mild steel is used, it must be case-hardened, to avoid slackness developing between the die-block and link slot. Cast steel links can be hardened right out and last indefinitely. The die-blocks must also be hardened.

Each link will need a piece of steel 2½ in. long, $\frac{1}{4}$ in. wide and $\frac{1}{8}$ in. thick. Coat with marking-out fluid, and be mighty careful to mark out correctly as per Fig. 75. Cut the curved slot first. If a

beginner makes an apple-pie of it, he can easily make another start on a fresh piece of metal; but if he gets the outline right, and then messes up the slot, there will probably be a few words to add to the dictionary of railroad Esperanto, besides waste of precious time. The slot can be milled out.

Very many years ago, in my notes in another journal, I described a special gadget to guide the link while milling the slot with an endmill in the chuck, and was amused to see it recently resurrected by somebody else—truly, there's nothing new under the sun! However, it isn't worth the trouble of making it for just two links, when the slots can be cut by hand in a quarter of the time. Just drill a series of $\frac{1}{8}$ in. holes as close together as possible, along the centre-line of the slot. File away the metal between the holes with a rat-tail file, then finish to outline with a small fish-back file, or a half-round file will do. Use a bit of $\frac{1}{8}$ in. round silver-steel as a gauge, and use the file very carefully until the steel will slide easily from end to end of the slot, without appreciable shake. Anybody with the average amount of care and patience can do the job perfectly, and in less time than might be imagined; you can take that as gospel from one who has done the job scores of times.

About $\frac{1}{32}$ in. at each end of the slot should be made slightly over width, so that there is no chance of the dieblock forming a minute step at each end of its extremes of movement; but that job can be done when the block is made and fitted to the link. File the link to given outline (Fig. 75), then drill the hole in the tail for the pin with No. 32 drill; use No. 55 for the oil hole, counterboring it with No. 32, and ream the pin hole $\frac{1}{4}$ in. The die-block can then be sawn and filed from a bit of the same kind of steel as used for the link, drilled No. 32 and reamed $\frac{1}{4}$ in. The hole must go through

Fig. 74.—Front view of Expansion Link erected.

Fig. 73.
Lifting Link.

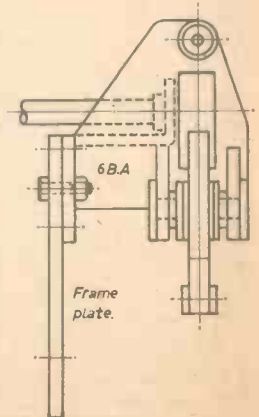
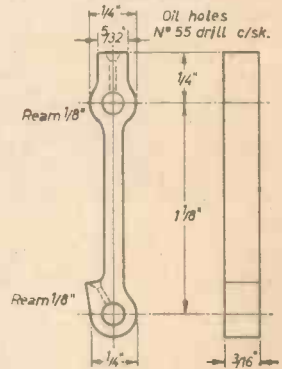

dead square. After the ends of the slot have been slightly relieved as mentioned above, the block should slide easily from end to end, without the slightest sign of shake, and can then be hardened.

The trunnion blocks at either side of the link can be made from mild steel, $\frac{1}{8}$ in. thick. Offcuts from the frame would do. Some close work is called for here, but there is nothing to cause beginners any anxiety. Saw two pieces about $\frac{3}{4}$ in. square, and mark one off to the outline of the trunnion block, shown attached to the link in Fig. 75. Drill the hole for the trunnion pin with No. 23 drill, and the rivet holes with No. 53. Use the drilled piece as a jig to drill the trunnion hole in the second piece, but don't drill the rivet holes in it. Put a bit of $\frac{3}{32}$ in. rod in the trunnion holes, to keep the pieces of metal in line while you file them both to shape at one fell swoop.

One side of each trunnion block has to be cut away $\frac{1}{8}$ in. to a depth of $\frac{3}{8}$ in. Hold the block in a machine-vice on the miller table or lathe saddle, and run it under a side-and-face cutter; adjust so that the cutter is $\frac{1}{8}$ in. from the edge of the block. If no cutter is available, the block can be made in two parts, each $\frac{1}{2}$ in. thick. One part is made to the shape of the block, as shown in Fig. 74. The other piece, which forms a spacer between block and link, is as shown to the right of the dotted line in the same illustration. Another way is to turn the trunnion-pin and block in one piece from $\frac{3}{4}$ in. round mild steel. Chuck a short length, face the end, and turn $\frac{1}{8}$ in. length to $\frac{1}{8}$ in. dia. Part off at a full $\frac{1}{8}$ in. from shoulder. Reverse in chuck, and face the head to exactly $\frac{1}{8}$ in. thickness. Coat the side with the pin on it, with marking-out fluid; mark out very carefully, locating from the pin, and file to outline. Finally cut the rebate.

It is vitally essential that the trunnion blocks are fitted to the links with both pins dead in line, and also in line with the curved slot. They must also be in the middle of the length of the slot. That sounds a tall order, but there is nothing to it if the job is carried out in the same way as I do it. Open out the pin holes in the trunnion blocks with No. 13 drill, which is $\frac{1}{8}$ in. driving fit size, and slightly countersink the holes on the outsides of the blocks. Chuck a piece of $\frac{1}{8}$ in. round silver-steel, face the end, slightly chamfer it (just sufficiently to take off the sharp edge). Part off at a full $\frac{1}{2}$ in. from the end, reverse in chuck and chamfer the other end likewise. Squeeze this through one of the trunnion blocks from the countersunk side, until there is only $\frac{1}{8}$ in. left projecting. Poke the rod through the slot in the link, and squeeze the other trunnion block on the other side of the link, keeping the two blocks in line. If the trunnion blocks have milled rebates, the wide end of each should now be hard up against the side of the link. If two-piece trunnion blocks are used, put the spacers between the larger pieces and the link.

Adjust the blocks until the pin is exactly in the middle of the slot, and the blocks are in the position shown in Fig. 75. Clamp the lot tightly with a toolmaker's clamp, run a No. 53 drill through the rivet holes already in one trunnion block, and carry on right through the link and the other block. Slightly countersink the holes, and

rivet the lot together, using pieces of $\frac{1}{8}$ in. round steel for rivets; hammer the ends tightly into the countersinks, and file flush as shown in the section. Next—watch your step here—cut out the unwanted middle part of the pin by putting a thin hacksaw down the space between link and trunnion block, filing the cut part smooth on the inside of the block, with a thin file such as used by key cutters.

The final job is to braze the pins, and that is easy. Put a smear of wet flux around each pin. Bend up two $\frac{1}{8}$ in. rings of $\frac{3}{32}$ in. brass wire, and put one over each pin, close to the trunnion block, in the flux. Lay them on some broken-up coke in a small tray (a large tin lid would do) heat until the brass wire melts and flows into the countersinks, which it will do at a bright red heat, then before the redness has all died away, plunge into clean cold water. This will harden both links and pins, and wear will be negligible. If mild steel is used for the links, they should be heated and rolled in case-hardened powder, but not quenched, before the trunnion blocks are fitted. Scrape off any traces of burnt flux, and clean up with fine emery cloth or similar abrasive.

No brazing will, of course, be needed if the pins are turned solid with the blocks, but great care must be taken to have the pins in line before riveting the trunnions to the links. After clamping the trunnions to the link, test by setting a couple of vee-blocks $\frac{1}{8}$ in. apart, lined up to a steel rule. If the link is exactly vertical with the trunnion pins resting in the vees, the pins are in

Fig. 75.—Expansion Link.

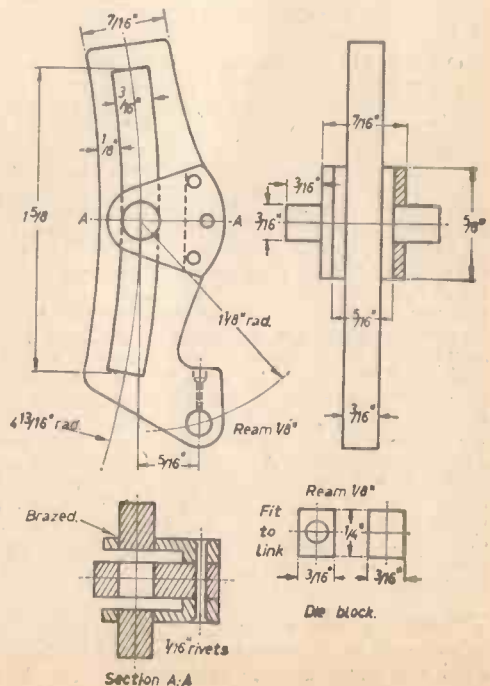

line. See that the clamp is tight before drilling the rivet holes—if anything shifts, you've had it!

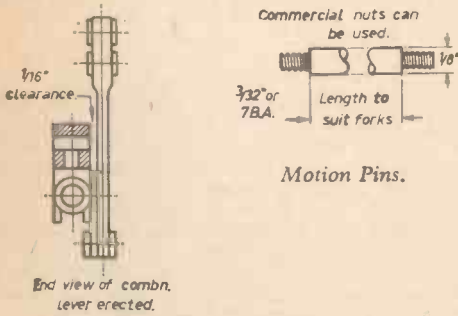

Motion Pins.

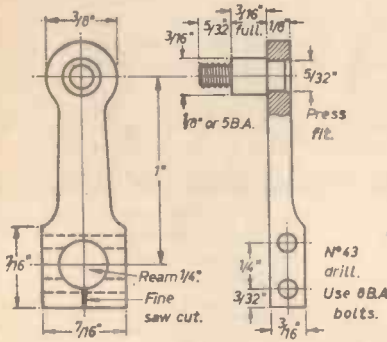

Fig. 76.—Return Crank.

On the full-size engine, the brackets carrying the expansion links and reversing screw are fabricated, the parts being assembled on a jig, and the points welded. This cannot be done on the little one, the parts being too small to be held in a jig; and without it, the bits would come unstuck. I therefore had to scheme out a simpler arrangement, the pieces of which could be brazed together at one heat. Even this requires care and patience, so if castings are available for both brackets, as I think they will be, I strongly recommend their use, as much work will be saved. However, for those good folk who would prefer to build up the brackets, the following instructions show how the job can be done.

Each bracket consists of a side plate, bracket frame, two lugs for carrying the expansion link bearings, and an angle plate in which the bush for the weighbar shaft, or reversing shaft, is fitted. The side plates for both right and left-hand brackets are identical, and are made from pieces of mild steel plate, 1½ in. long, 1½ in. wide and ½ in. thick. Mark one out as shown in Fig. 75, drill the screwholes, use it as a jig to drill the second one, then temporarily rivet the pieces together, and saw and file to outline.

The Bracket Frames

These are made from 1/8 in. sheet steel. The left-hand one needs a piece approximately 5 in. long,

the right-hand one 2½ in. long, both 1-13/16 in. wide. Bend these to the shape shown in the side view drawing, Figs. 74 and 75 which are reproduced full size, and therefore show the exact locations and angles of the bends. The upper part of the left-hand bracket is cut to the shape shown, but leave the top overlength. Drill the hole for the front bush ¼ in. and the back one ⅜ in. being careful to have them both in line. The 1 in. x ⅜ in. clearance hole for the expansion link must be exactly in line with the hole for the bush. Both bushes should be made from steel rod, as there is a risk of melting bronze or gunmetal when brazing up the bracket. The front bush has a 7/8 in. step turned on it, to fit tightly into the hole in the bracket; the back one is just a ¼ in. slice of ⅜ in. round rod with a ¼ in. x 40 tapped hole through it.

The lugs for carrying the expansion link bearings are sawn and filed from 1/8 in. mild steel, all four being similar. To hold them in position during the brazing operation, mark out their location on the front of each bracket, and drill a No. 51 hole right in the middle of each marked space. Hold the lug in position, and poke the end of a bent scriber through the hole, to make a mark on the end of the lug where it butts up against the bracket. Centrepop the mark, drill it No. 55, and tap 7/8 in. or 10BA. A steel screw to match will hold the lug to the bracket tight enough to prevent shifting while the brazing business is going on. Note—the holes for the bushes should not be drilled full size until after brazing. Drill them 3/8 in. when making the lugs, so that they can be lined up with a piece of 3/8 in. rod when assembling.

Angle Plates

Each angle plate is made from 3/8 in. mild steel. The left-hand one is a full angle, the upper part fitting between the ends of the bracket frame, as shown in Fig. 74. The vertical part of the right-hand one has a shaped top, seen in Fig. 75. The horizontal part of each angle plate is level with the top of the side plate, as shown in the sections. Don't drill the bush holes full size right away. First cut out the pieces of steel, and bend up the angles, which can easily be done in the bench vice, as 3/8 in. mild steel-sheet is very ductile. Mark off and centrepop the location of the bush holes, but before drilling, put each angle plate temporarily in position on the bracket, and check off the centrepops with the centres of the holes in the lugs which will carry the expansion links. The vertical distance should be 1 1/8 in. and the horizontal ditto 1 1/8 in. for both right and left-hand brackets. If O.K. drill each centrepop 3/8 in.

Assembling and Brazing the Brackets

This job requires care and patience, but isn't so difficult. Incidentally, wasn't it Job, of Bible history, who was renowned for his patience? Although he never brazed up a bracket assembly, his good virtue is worth emulation! The difficulty is, to prevent the parts from shifting while the operation is in progress. In full size, the jig on which the parts are assembled, securely holds the lot while each joint is separately welded. What we have to do, is fix up some arrangement to hold the pieces so that the lot can be done at one go. Ordinary toolmakers' cramps aren't of much use, as

they would allow the thin bracket frames to slip, unless screwed up very tightly; and the pressure exerted on the thin metal would cause it to buckle and distort as soon as it became red hot. Besides, the cramps would just about be ruined by the heat of the operation. However, where there's a will, there's a way, as the old saw puts it, and the solution is quite simple.

When I have awkward bits to hold in place while brazing or silver-soldering, I usually knock up rough cramps to suit the job in hand. They only take a few minutes, but save endless time and trouble. In the present instance, bend a rough cramp from a bit of $\frac{1}{4}$ in. x $\frac{1}{2}$ in. steel rod. Drill and tap one end of it for a $\frac{1}{4}$ in. screw. Make a sleeve about $\frac{1}{2}$ in. long, from $\frac{1}{8}$ in. round steel, one end of which is drilled No. 30 for about $\frac{1}{16}$ in. depth. The other end has a slot milled or filed across it, a full $\frac{1}{8}$ in. wide and about $\frac{1}{4}$ in. deep. Two will be required to hold the bracket frame securely against the side plate. If the angle plate is made a tight fit between the sides of the bracket frame, it should stay put during the brazing operation; but anybody who is doubtful, can easily make a rough cramp of the ordinary tool-makers' type, from two bits of $\frac{1}{4}$ in. square steel, with $\frac{3}{8}$ in. stove screws for adjusting, placed over the vertical part of the angle plate, and the side plate, it will hold them securely without excessive tightening of the screws.

Once the assembly is completed, the brazing operation is simplicity itself. Follow the same procedure as described for the crossheads. Cover the joints with wet flux, lay the whole bag of tricks in a pan of small coke or blacksmiths' breeze, heat to bright red with a blowlamp or gas blowpipe, and touch the joints with a piece of $\frac{1}{8}$ in. brass wire, or Sifbronze wire, or other good brand of brazing wire. If the heat is right, the end of the wire will melt and run into the joint like water, leaving a little smooth fillet. Naturally the cramps will become red hot, too, but that doesn't matter an Aswan as long as you don't get any brazing material on them, and stick them to the job. Let the lot cool to black, then quench in clean cold water. Remove the cramps, scrape off any burnt flux that may be sticking to the brackets, and clean up. A flat stick of wood with a wedge-shaped end having a piece of fine emerycloth or similar abrasive glued over the wedge, is very handy for getting into the corners. The upper edges of the left-hand bracket, left overlength for drilling the bush holes and fitting the bushes, can now be trimmed down to the dimensions shown in the front view, the corner is rounded off flush with the bush.

Fitting the Bushes

It is essential that the bushes in which the trunnions of the expansion links work, should be exactly in line, so put a piece of $\frac{1}{8}$ in. rod through the holes in the lugs, and check to make sure that it is square with the bracket. If not, correct the holes with a round file, put a $\frac{1}{4}$ in. drill through them, and recheck with a bit of $\frac{1}{4}$ in. rod. When OK open them up with a $\frac{3}{16}$ in. drill, and put a $\frac{1}{4}$ in. parallel reamer through the pair of them. Check off the position of the hole in the angle plate, and if all right open it out and ream it likewise. Take all the sharp edges off the holes by a touch with a $\frac{1}{2}$ in. drill.

The bushes should be turned from good hard bronze, either cast or drawn. Don't use commercial brass rod, which wears away very quickly. Draw bronze rod $\frac{1}{4}$ in. diameter is available from our advertisers, or from any metal merchants. If cast stick is used, it should be $\frac{1}{2}$ in. in diameter. Chuck a short length in the three-jaw, and if cast, turn about $\frac{1}{2}$ in. length to $\frac{1}{4}$ in. diameter. Face the end, centre, and drill to $\frac{3}{8}$ in. depth using No. 14 drill for the link bushes, and $\frac{1}{4}$ in. drill for the reversing-shaft bushes. For the link bushes, turn down $\frac{3}{8}$ in. length to $\frac{1}{4}$ in. diameter, a nice push fit in the reamed holes in the lugs. For the reversing-shaft bushes, turn similarly, but to $\frac{1}{2}$ in. length. Part off at a full $\frac{1}{8}$ in. from the shoulder, reverse in chuck, and take a facing skim over the flange to true it up. Countersink the flange side of the link bushes to $\frac{3}{16}$ in. depth, either with a big centre-drill, or an ordinary $\frac{1}{8}$ in. drill. Put a $\frac{1}{4}$ in. parallel reamer through the reversing-shaft bushes, after facing the flange, holding it in the tailstock chuck.

Drilling the Bush Flanges

To drill the screwholes in the bush flanges, make a jig from a steel washer, same as used for drilling the screwholes in the cylinder covers. Get a washer $\frac{1}{4}$ in. diameter, chuck it, and bore out the hole until it just slips over the bushes without shake. Set out the four screw-holes on it, and drill them No. 48.

Put it on each bush, holding it to the flange with a cramp, and run the No. 48 drill through the flange, using those in the washer as guides. Countersink the holes in the reversing shaft bushes with No. 21 drill. Put the link bushes in the holes in the lugs, hold with a cramp, run the No. 48 drill through the screwhole, making countersinks on the lugs, follow through with No. 53 drill, tap 9BA and put round head steel screw in. Ditto repeat with the reversing shaft bushes, but use countersunk screws. Finally, poke a $\frac{1}{8}$ in. parallel reamer through each pair of link bushes while they are in place in the bracket, which will make certain that the holes are dead in line. Put a small centre-dot at the top of each flange, so that when removed to insert the links, they can be replaced in exactly the same position.

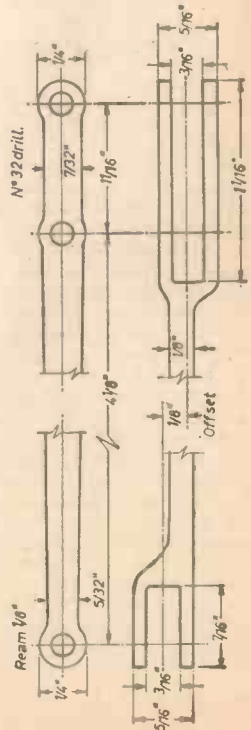

Fig. 77.—Radius rod and lifting link.

WHILE it is sufficient to examine an enlargement of an ordinary photograph when the camera is to be used only for general applications, any specialised work must usually be performed to a much higher standard. Therefore, in the latter case, it is helpful to have a fairly precise indication of the lens performance.

The first essential is that the lens must focus accurately when set by either the engraved scale, the coupled rangefinder or the reflex screen. It is extremely difficult to determine the exact point of sharp focus on an enlargement of an ordinary subject. Far more satisfactory is the provision of a special set of targets, as these will show up errors of focus beyond possible doubt.

The depth of field given by any lens is smallest at short ranges and large apertures, and the following test should be conducted at the closest distance to which the lens will focus and at all scale markings up to, say, 10ft. Beyond that, small errors of



CAMERA LENS *Testing*

BY A. E. BENSUSAN

focus are unlikely to be apparent under all but exceptional conditions.

Three targets are made from sections of printed matter glued to stiff card which is strutted to stand upright. The cards should be marked -3 in., 0 and $+3$ in. respectively. The "zero" target is set up at the point of focus determined from the scale, or by using the coupled rangefinder or reflex screen, with the "minus" target 3in. nearer to the camera and slightly to one side. The "plus" target is set up 3in. behind the "zero" one and to the other side (Fig. 1). For positive results, the extreme edges of the field of view of the camera should not be utilised.

With the camera firmly held on the tripod, and the lens wide open, the shutter is released with a cable. The exposure given should be the minimum, for any excess will affect definition. Examination of the result will show whether the focus was correct, over or under. Repetition at the other distances provides a complete pattern of scale, reflex or rangefinder accuracy, and adjustments may be made accordingly.

The ability to resolve clearly is an indication of the quality of a lens. A good objective on a precision 35mm. camera, closed down two stops below the maximum aperture, should resolve 100 lines per millimetre at the centre of the field, and at least half that number at the edges. These standards may be relaxed, in linear proportion to the size of larger negatives when related to the 24×36 mm. frame of the miniature camera. The controlling factor is the degree of enlargement required to bring both negatives to the same print size regardless of differences in the shapes of the respective frames.

A test chart should be made by ruling indian ink lines across white paper. The section giving 100 lines per millimetre on the negative should have 50 lines of $\frac{1}{2}$ mm. thickness per inch of width, while that for 50 lines per millimetre should have 25 lines of $\frac{1}{2}$ mm. thickness per inch. If other standards of

resolution are required, they will be proportionate to those given above.

Small parts of the ruled chart should be stuck to a dark card background so that they will appear on the negative at all four sides, in the corners and at the centre of the field (Fig. 2). The result will, thus, give performance figures for all points. The range for photographing the chart is 53 times the focal length of the lens, whatever that may be, and the subject should fill the frame as fully as possible.

The lens is carefully focused on the chart, either by scale, rangefinder or viewing screen. Both the camera and the subject should be rigidly supported, as any trace of movement will give a false result. The chart must be square with the camera for similar reasons. One way to achieve this is to knot a piece of string near both ends so that one knot touches the centre of the lens, or a cap over it, and the other makes contact with a corner of the chart when the string is stretched tight (Fig. 3). If the chart is square with the camera, the knot at the free end will just touch all four corners while the other one stays at the centre of the lens.

Fig. 1.—Target Cards.



A fine grain film of about 40 A.S.A. will be found most satisfactory for resolution testing. Process films of high contrast are unnecessary while, at the other extreme, fast films have a resolving power of only 40 to 60 lines per millimetre and this is less than the lens of a good miniature should resolve. The exposure should be the minimum which will give sufficient density in the ruled areas of the chart. Over-exposure is a prime cause of loss of quality and must be avoided.

Development should be in a normal fine grain formula. Ordinary M.Q. developers produce insufficiently fine grain, while superfine grain types often contain a silver solvent which improves grain structure but at the cost of image diffusion. Protracted development causes the emulsion to swell and, like over-exposure, results in poor quality.



Fig. 2.—Ruled Test Chart.



Fig. 3.—Camera is square to chart.

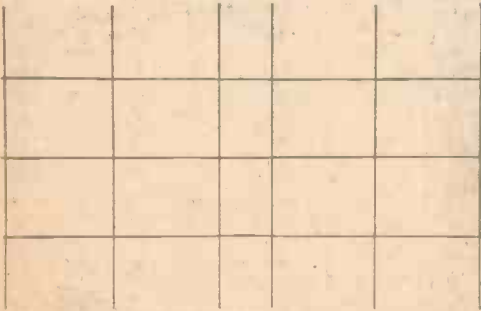

Fig. 4.—Chart reproduced with slight spherical aberration.

The negative may be examined under a high-power magnifier, or enlarged through a high-class lens. If there is any doubt as to the performance of the enlarging lens, print the negative one third at a time, in each case using the centre section of the field produced through the lens and stopping the aperture down well.

If the lines on the test chart negative, or an enlarged print made from it, are reproduced distinctly, the lens is capable of resolving up to that standard. Lack of resolution will produce fuzzy-edged lines without full density. Repeating the test for the full range of apertures providing a continuous account of improvement as the lens is progressively stopped down.

Most lenses suffer from some degree of spherical aberration, that is a tendency to reproduce straight lines as curves. In normal use this passes unnoticed, but it may well be important for technical work. In general, the larger the lens aperture employed and the further the straight line is from the optical axis, the more curved will it appear.

The amount by which this occurs in any lens can be determined by photographing a ruled sheet of white paper or card. Provided that the lines are straight, they can be sited on any spacing over the picture area. Set up the test ruling at a convenient distance and photograph it with a progressive series of apertures. A ruler laid along the lines of each negative will show any deviations from the mean. A specimen photograph taken at an aperture of $f3.5$ is shown in Fig. 4.

Electric Pin Table

(Continued from page 200)

Finish

A gay, high-gloss finish is essential if the apparatus is to attract the eye; plenty of bright colours and contrasts. Each division, for example, can be of a different colour according to the number it carries. The smaller numbers (two of each) are not painted on as might be supposed; they came from Decorette transfers which are easy to apply and admirably suited to the smooth surface of the painted table top. Numbers of varying sizes are obtainable; those used are $\frac{3}{4}$ in. high. Similarly, the coloured Cellophane placed over the large stencilled numbers need not be confined to one colour; it could well correspond with that given to the divisions bearing the same numbers.

The back should be covered with a large sheet of thick strawboard or hardboard and be screwed on—not nailed—to admit easy access for repairing or changing the wiring. Four rubber feet should be fixed at each corner to prevent scratching the table on which the machine is operated.

Operation

Six balls normally constitute a game but there is no reason why twelve balls should not be used or that the scores should not be accumulative.

Note that the balls must be kept clean and as free from grease as possible since they have to complete a low-voltage circuit. *En passant*, these balls can be bought from $\frac{1}{2}$ in. up to $1\frac{1}{2}$ in. in diameter, mostly in steps of $\frac{1}{8}$ in. The author bought 1 in. but would, if occasion arose to buy more, favour $1\frac{1}{8}$ in., they would travel more determinedly and their extra weight would assist electrical contact.

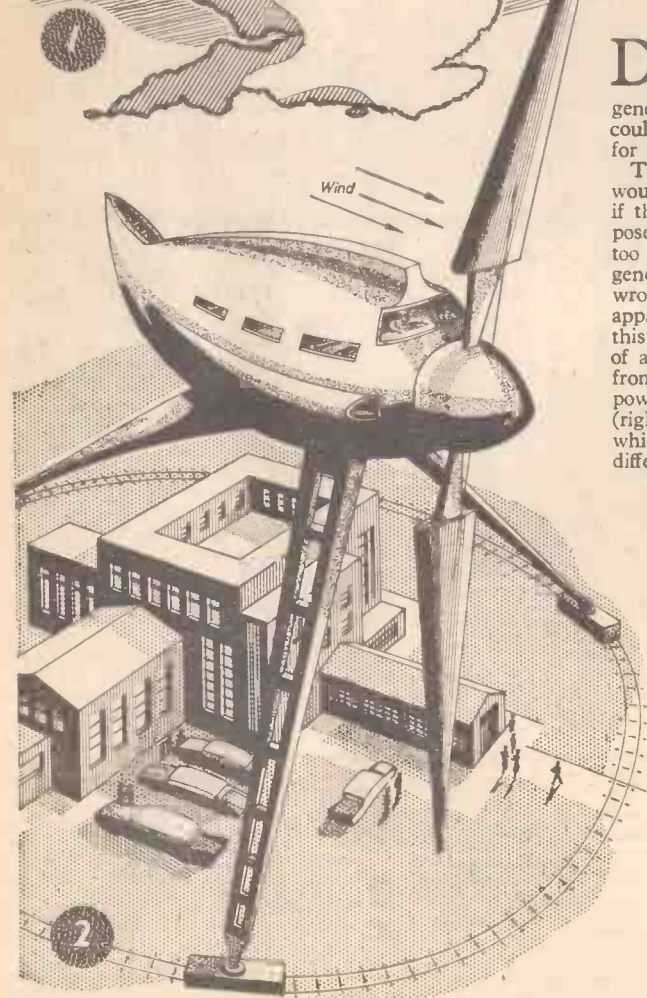

DO you live in any of the shaded areas in the map (Fig. 1) and in a reasonably exposed location? If you do you could generate electricity from the wind, which could be used for power, warming water, or for central heating.

The generation of power from the wind would seem to be an excellent idea, especially if this power is to be used for heating purposes where the problem of storage is not too difficult. Yet there are few wind driven generators in the British Isles, so what is wrong, why is so little use made of this apparently free source of power? To answer this question it is perhaps best to look first of all at how much power can be extracted from the wind. The most widely used wind power machine is the windmill, and the table (right) gives typical figures of the power which can be obtained using windmills of different diameter.

It can be seen from the table that the amount of power which can be extracted increases rapidly with the wind speed. In fact a given windmill will produce eight times as much power if the wind speed is doubled! It is therefore very desirable to choose a really windy site if maximum efficiency is to be obtained for a wind driven generator. Generally it is hardly worth while building a wind power machine in a location where the average annual wind speed is less than 12m.p.h.; for this reason the shaded areas on the map represent the places where at least this speed can be obtained. Of course there are many places where the average wind speed is much greater, many locations in the West of Ireland, North of Scotland, and West Wales, have speeds of 20 to 30m.p.h. These sites are especially suitable for wind power generation.

Fig. 1.—Shaded areas show where the wind speeds are high enough to make windmills economical.

Fig. 2.—An Aerogenerator.

Power in kilowatts from a windmill for different propeller diameters.

Wind Speed m.p.h.	12.5ft	25ft	50ft	100ft	200ft
10	0.4	1.5	6	24	96
20	3	12	49	196	784
30	10.5	42	166	666	2664
40	24.5	99	394	1574	6296
50	48.0	192	771	3085	12340
60	83.0	333	1331	5325	21300

Types of Machine

Next it is appropriate to examine the types of machine which could be used for wind power generation. Of the hundreds of proposals which have been put forward for wind power machines, only two seem to offer any real possibility, and these are the wind rotor and the windmill. The wind rotor is shown in Fig. 4 and as can be seen it is of very simple construction, which can easily be made from sheet material. The wind rotor is not as efficient as the windmill, but on the other hand its simple construction makes it a possibility for small domestic applications. Little research work has been done on the wind rotor, and so it offers the amateur a lot of scope for development. One possible line of development would be to investigate the possibility of making an inflatable wind rotor, which could simply be taken to the site and pumped up. This might lead to a very cheap form of construction.

The other possibility for wind powered machines is the windmill. This machine has been used for many hundreds of years, and efficient designs can now be produced. It seems probable that if very large wind generators are ever to be built, they will be of the windmill type. There are three sizes of windmill which offer scope for development. At the bottom of the scale are the small domestic generators of up to 3kW capacity, similar to the one shown in Fig 5. If these sets were used simply for water or space heating, they could be quite attractive, but more will be said later on this subject when costs are considered. However this type of generator is not economical for electric light as the storage batteries which are required to maintain a constant supply, are very expensive.

The next size of windmill for which there is a definite need, is one with blade diameters of about 70ft. This size of windmill would have a rated output of about 50kW in a 20m.p.h. wind. Such machines would have wide applications in remote islands, where transport costs made fuel oil expensive. The electricity generated would be sufficient to serve a small community with both power and light. The light would be available at all times with the help of a certain amount of battery storage, but the power would be

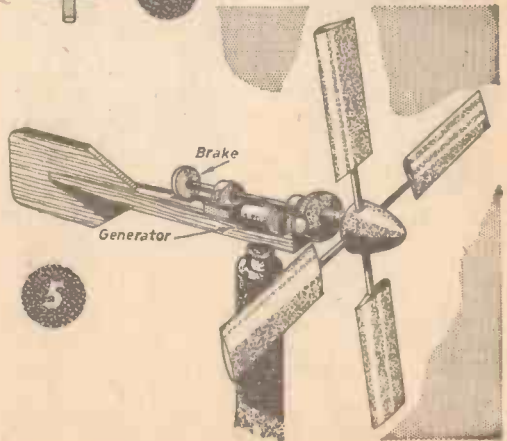
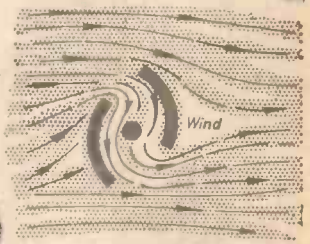

Fig. 3.—Intermediate size wind generator.

Fig. 4.—The wind rotor.

Fig. 5. — Wind generator suitable for home construction.

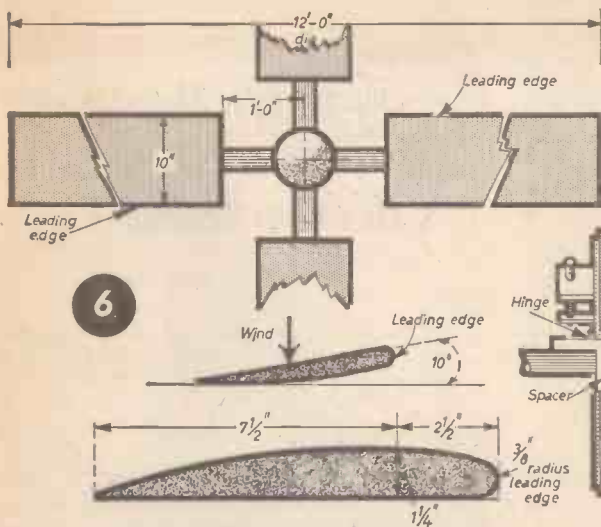

Fig. 6.—Leading dimensions of blades of windmill shown in Fig. 5.

available only when there was adequate wind. This actually would only be a small inconvenience, as places such as the Orkney Islands have more or less continuous wind. Such a windmill is shown in Fig. 3.

Aerogenerators

The third and largest size of windmill would be one with the blades of at least 200ft in diameter. This type of machine is usually referred to as an aerogenerator and unlike the other smaller machines, its purpose would be to supply power to the national grid, which would save coal and oil fuel in the power stations. It has been calculated that such an aerogenerator could supply current for about half the cost of a conventional power station. An illustration of an aerogenerator is shown in Fig. 2. The site for such a large machine would have to be chosen very carefully to ensure a high average wind speed. However as already stated there are some excellent wind power sites in the British Isles. About 10% of all power requirements could be supplied by aerogenerators, while still leaving sufficient conventional generating capacity to cope with calm periods. Serious study is being given to the building of aerogenerators in several countries.

The Cost

So far it has been shown that the generation of power from the wind is possible and practical, which brings back the question why is more use not made of this source of free power? The answer of course is that while the source of power, which is the wind, is indeed free, it costs money to build machines to extract this power. The interest and depreciation on the capital used to build the machine will have to be paid for by the user of the electricity. If the cost to the user is more per kilowatt hour from a wind generator than from the grid or diesel generator, then he will not be interested. As has been mentioned the cost of power

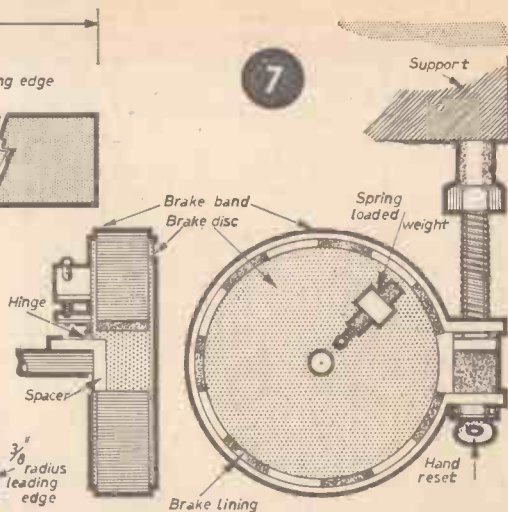

Fig. 7.—Details of a suitable brake.

from any aerogenerator is about half that of power from the grid, and for this reason there is every hope that such machines will be built in the future. The cost of power from an intermediate size windmill is about equal to the cost from the grid. Because of this there is little incentive to build such machines except in locations where the grid is not available. However there are many isolated places in the world where the grid is not available, and so there is scope for the intermediate size of machine.

It is with the smaller domestic machine that it becomes difficult to justify the cost. Small sets are manufactured for use on isolated farms, but the cost of these machines are too high to make the power generated attractive if an alternative supply is available. However this price limitation does not apply to a home constructed windmill, as the handyman may be able to make one very cheaply. It is therefore worth while considering what is the most that a home generator could cost while still making the project worth while.

To take an example assume that it is proposed to drive a generator of 1.5kW with wind power. To do this would require a 12ft windmill working in a 16 m.p.h. wind. Then the maximum which can be spent on the project to produce power at 0.5d. per kWh (grid price about 1.0d. per kWh) is £20. This price must include the cost of the generator, blades, supporting tower etc. The figures quoted assume (a) that the rated wind blows for at least a fifth of the year (b) that the interest on the capital invested plus depreciation is equal to 20%. If the handyman can build his own wind generator for this price, and uses the power for heating purposes, then he will save money.

To see what is involved in building a wind generator refer to Fig. 6. This shows the chief dimensions of the machine illustrated in Fig. 3. Exact details are not given because the materials available to each constructor will not be the same. Similarly details of the generator are not given as

(Continued on page 228)

A Photographic Print Dryer

A GOOD sized print dryer can be an expensive item, but the 24in. x 18in. dryer described here can be made, complete with thermostat control, for as little as 45s.

The materials required are:

- 1 piece of Hard Asbestos size 24in. x 18in.
- 1 piece of Hard Asbestos size 22in. x 16in.
- 2 sheets of 22 gauge tin size 25in. x 22in.
- 1 piece of Calico Material size 25in. sq.
- 2 $\frac{1}{4}$ in. rods—25in. long.
- 4 3in. x $\frac{1}{2}$ in. metal strips.
- 2 $\frac{1}{2}$ in. dia. light springs $\frac{1}{2}$ in. long.
- 1 3-pin 5 amp plug.
- 1 500W spiral heating element.
- 3yds. 3-core 5 Amp flex.
- 13 4B.A. copper nuts and bolts.
- 36 $\frac{1}{2}$ in. flat top self-tapping screws.
- 1 thermostat variable from 80° to 100°F.

By A. L. Marshall

for the thermostat and also the adjusting spindle. The thermostat should be placed in the centre and as near the top of the dryer as possible. Now make the right-angle bend, on each of the two ends.

The Legs

Make the four legs as follows. Cut four pieces of tin as per Fig. 2. Bend at right angles lengthways and bend in the $\frac{1}{2}$ in. section. Taking the large sized sheet of asbestos, mark off holes to correspond with the holes on the four sides. Drill and bolt these into position, with the asbestos on the inside of the bend. Fix with self-tapping screws the four legs, using four screws to each leg. Using two of the metal strips, drill a $\frac{1}{2}$ in. hole in the end and bend $\frac{1}{2}$ in. of the end with the hole at right-angles. Next drill two holes for the self-tapping screws, fix

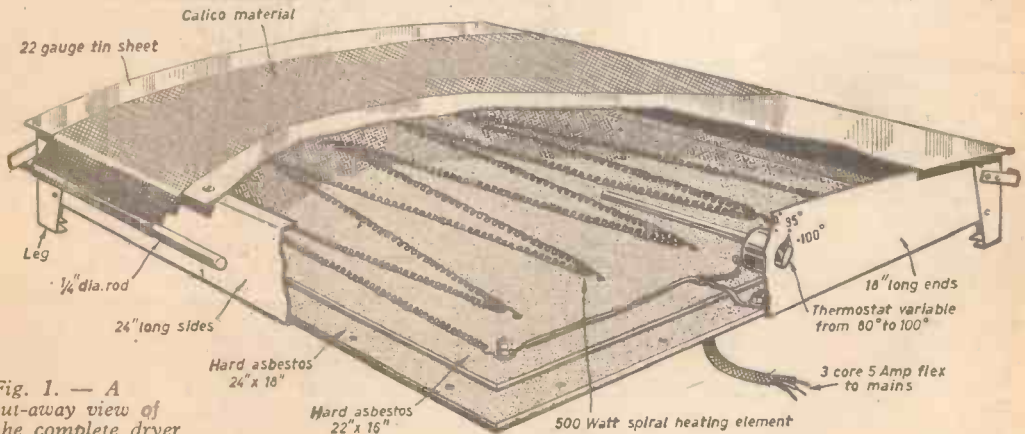

Fig. 1. — A cut-away view of the complete dryer.

The method of construction is as follows. From one of the sheets of tin, cut two lengths, each 24in. long and 4 $\frac{1}{2}$ in. wide, mark for bending and drill five $\frac{1}{2}$ in. holes as per Fig. 2. These have to be bent to take the asbestos and the top of the dryer. A good tip for bending is to get a length of wood, 24in. x 3in. x $\frac{1}{2}$ in. Clamp the strip of tin on to this, and bend on to the wood, to give two right-angle bends. This will ensure the strip does not warp, and the distance between the bends will be 3in. wide from end to end.

From the same piece of tin, cut the ends of the dryer 18in. long, 4in. wide at the ends and 5in. wide at the centre. Mark for bending and drill four $\frac{1}{2}$ in. holes as per Fig. 2. In one of the ends, mark off and drill the holes to take the fixing screws

one at each end of the dryer as per Fig. 2. The other two strips are drilled and screwed to the opposite side, without the angle bend or hole.

Fixing the Element

Now comes the heating side of the dryer. Take the asbestos sheet. Drill $\frac{1}{2}$ in. holes opposite each other at one end and two holes opposite each other on the sides; these are for fixing the two sheets together in the dryer. Now drill a $\frac{1}{2}$ in. hole, centre of the two holes to take the electric cable. Place in the bolts, in the end holes, complete with washers and double nuts and tighten finger tight. Take the element and stretch to the fullest extent. This has to be fixed to the asbestos sheet as shown in Fig. 3. This is now ready to be bolted in position. Place

in the centre of the dryer, mark off the three holes, drill and bolt in position. Make sure that the element ends are at the same end that is to carry the thermostat, now fix this in and bolt to the holes previously drilled and wire as follows.

Wiring

Strip sufficient cable to allow separate wires to run from the 1/2 in. hole to the sides of the dryer. Slot the cable through from the underneath and fix the black lead to one of the element screws; the red lead goes to one of the connections on the thermostat. Take a spare length of red cable and connect the other thermostat connection to the other end of the element. Fix the green cable to one of the bolts on the frame of the dryer to act as an earth. Wire up the three-pin plug, making sure the red lead is to the live side of the plug.

The heating side can now be tested; if found satisfactory, proceed with the fixing of the top of the dryer.

Measure the large sheet of tin and cut this to 24 1/2 in. x 20 1/2 in. Using 6 self-tapping screws to

each side, allow a 1/2 in. overlap at the ends and screw into position.

The Apron

To make the apron, cut the piece of Calico to 24 in. x 25 in. Sew a 1/2 in. hem along the 24 in. side, cut one of the rods to 24 in. and slot into the hem. Solder the two springs, one at each end of the rod. Place the material on the dryer and fix the ends of the springs into the holed angle brackets. Smooth the calico over the convex top and using the other rod as a straight edge, place on top of the material but under the end brackets, pull the material tight and pencil a line where the rod holds the calico.

Disconnect the springs and sew in a 1/2 in. hem, folding the material along the pencil line, slot in the rod and reconnect the springs. When this is clipped into position on the front of the dryer, it will hold the glazing or drying plate and prints down firmly on to the convex surface.

The dryer must now be calibrated to give heats between 80° and 100° F. This can be done by

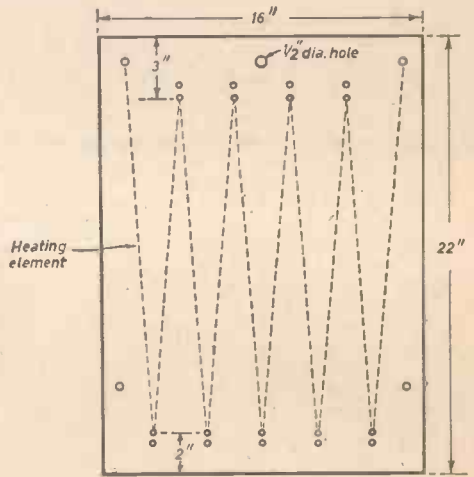
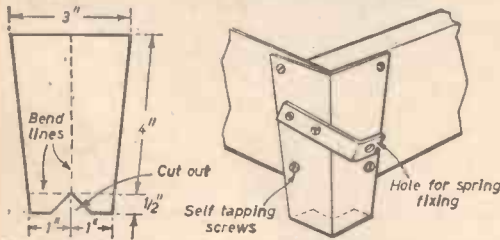
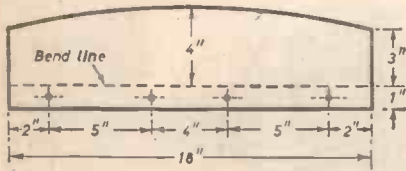
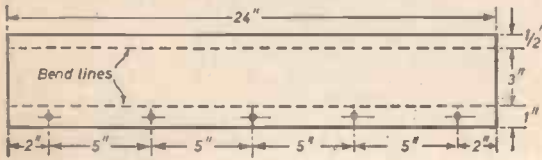

adjusting the thermostat and using a thermometer under the calico, and marking the control knob in steps of 5°.

Fig. 2 (Above left).—Details of the sides and legs.

Fig. 3 (Above).—The heating element mounted.

PUFF FOOTBALL

(Continued from page 213.)

with 8 in. crossbar. Fix the crossbar between the uprights with small woodscrews, then screw the foot of each goal post to the inner edge of the gap in the 2 in. x 1/2 in. edging strips. A single screw is used to secure the uprights thus allowing the goal frame to swivel flat when storing the playboard after use. For added realism, you may like to mark out the pitch with white poster paint, which can also be used for the goals.

Save or collect several empty Polythene containers—those about 6 in. tall and 2 in. diameter will

be found to give the best hand grip and the strongest "puff" The hole at the top of the container may need enlarging slightly with any sharp metal point in order to give a strong enough airjet to push the ball. The object of the game (following the general rules of football as far as possible) is to propel the ball towards and into the opponent's goal only by sharply squeezing the "puffer". The ball is not pushed or touched by hand except at "kick-off" or "goal kick" etc. The opponent defends his own goal or attacks in the same way. Fig. 2 shows the suggested positions for 2, 4 or 6 players. The numbers of players likely to use the board regularly will also help you to decide upon its final size.

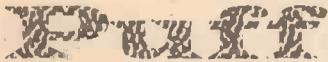
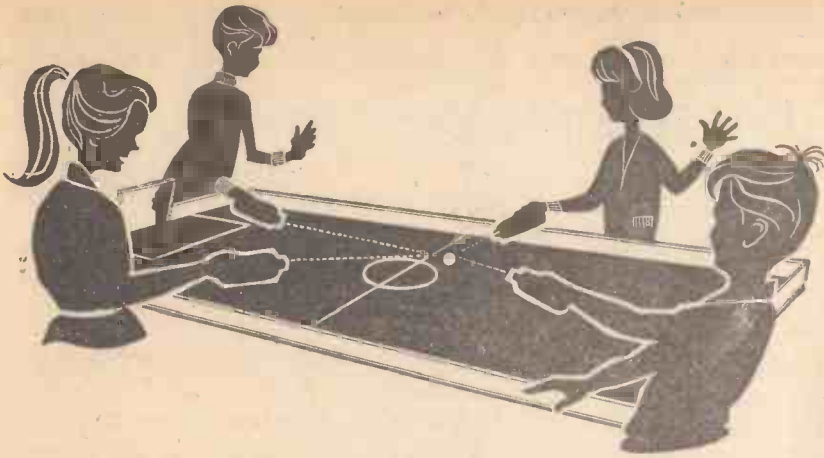

Football

THIS is an easy-to-make indoor game, which can give some hours of fun to all members of the family—a game for two to six players.

Materials and accessories required are simply:

- One sheet of hardboard.
- Several lengths of 2in. x 1/2in. softwood
- A few pieces of 1/2in. square wood strips.
- One table tennis ball, and for each player, an empty Polythene squeeze container (the kind in which several brands of washing-up detergent are now supplied).

The playing "pitch", cut from hardboard, can be any convenient size up to say 6ft x 3ft according to whether it is to be used on the floor or on a table top. Fig. 1 shows how the hardboard, smooth side up, is edged with

Fig. 1.—Details of the table.

the 2in. x 1/2in. wood "rail". This is either pinned and glued with contact adhesive, or screwed in at 8in. or 12in. intervals using 1/2in. c'sk woodscrews (from beneath the base board). A gap of about 8in. or so is left at the centre of each end piece to accommodate the goals.

Make the goal posts and crossbars from the 1/2in. x 1/2in. strips of a size roughly in proportion to the chosen area of the pitch, say 5in.-6in. uprights

(Continued on previous page)

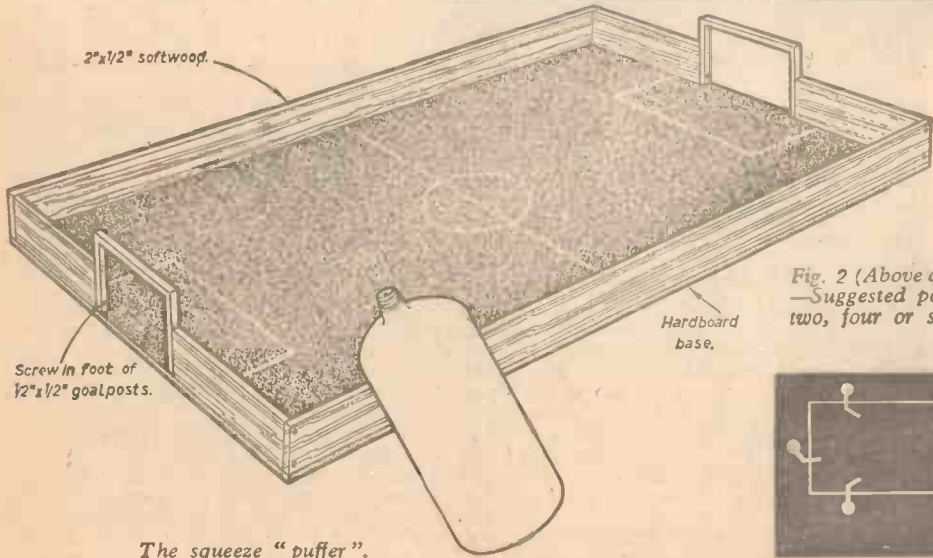
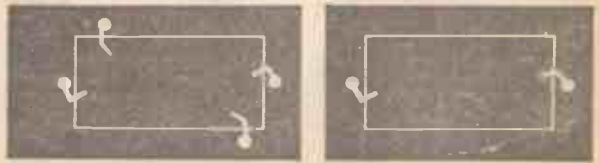
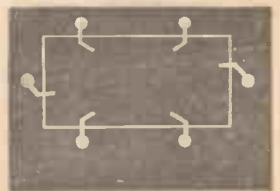

Fig. 2 (Above and Below).—Suggested positions for two, four or six players.



Find the LIGHT answer



Construct this simple to make

multiboard — *THE CIRCUIT*

- (A) $4\frac{1}{2}$ V. Torch battery
- (B) Torch bulb
- (C) Test prods
- (D) Studs linked by insulated wire

by Schoolmaster

Schoolmaster

THE multiboard, as I call this gadget, enables children to learn their multiplication tables and simple division based on each individual table.

The multiboard was primarily designed for low I.Q. children in Secondary Modern schools. It was found that the normal means of teaching was of little or no use and that this type of child resented the normal infant type approach to the tables, and in fact counting in general. After all, weren't they twelve to fifteen years of age and quite grown-up! The multiboard was then introduced with amazing success.

Resentment as regards teaching approach disappeared, interest and therefore learning took its place. To them it was a game with a flashing light as a reward. By playing, something stuck in their minds and, what is more important, made them think.

Later the game was modified by timing with a stop-watch. This "competition" consisted of the "contestant" running through a table in the quickest time he could muster. Until the novelty wore off, as it always does, the educative results were beyond expectations. After this point had been reached, the method was just accepted.

The multiboard was then tried with normal or slow seven to nine-year-olds. The result was equally interesting: tables being learned far more quickly than they would normally. It was a job sometimes to tear the child away from the board.



(A) The multiboard in use; (B) The wiring and layout of the board.

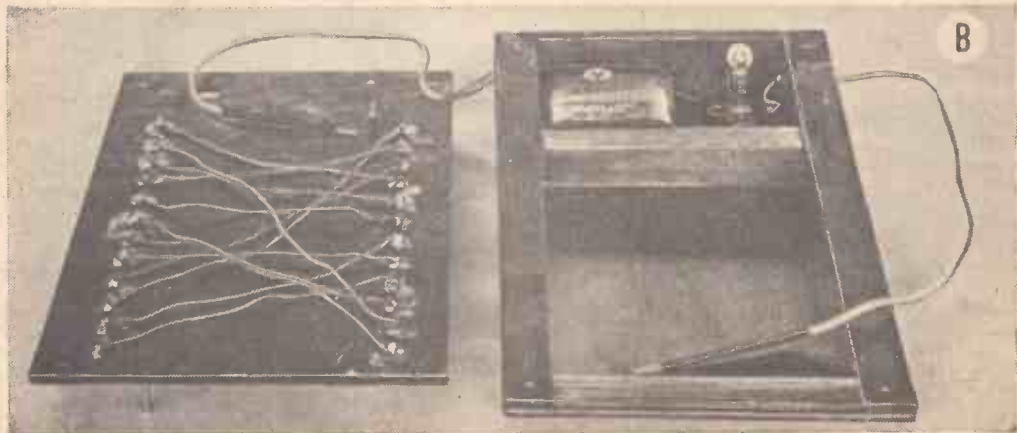

Educational

Instructive

Entertaining

Restriction of Use

The multiboard cannot be used for mass instruction. In fact, it is not meant to be used for such a purpose but only for the individual, or working in pairs using a question-and-answer technique.

The operation is quite simple. Two brass prods attached to flexible leads are connected to a battery and bulb in series. If the two prods are touched together, the bulb will light up. Similarly the bulb will light up if the ends of a piece of wire are touched with the prods, as this completes the circuit.

This principle is used in the multiboard. There are twelve sets of studs down each side of the board which are joined up in pairs. Therefore, if one prod touches a stud on the left hand column and the other prod touches the paired stud on the right hand side, then the bulb will light. If, however, any of the other eleven studs are touched, nothing happens.

The left hand studs are numbered consecutively from one to twelve and are permanently fixed in position. The right hand studs are numbered in such a way that the numbers are not consecutive and the numbers of each table are on removable sheets. The sheets being held in position by pegs are detachable in order that different tables may be attempted.

Constructional Details

The construction is quite simple and need not be the elaborate affair shown in the photographs. A sheet of cardboard may be used, pierced by studs or drawing pins. The studs being brass paper fasteners are joined together with insulated copper wire soldered into them. If drawing pins are used,

then the wire is looped round the pin and when hammered flat, the wire is held in position by the flattened pin. In this case no solder is required. In fact, this method was used with success by ten-year-old boys in a handiwork class.

Trouble might be experienced with the prods skidding on the paper fastener heads. This can be eliminated either by flattening the head with a hammer or punching a dent into the head centre with a steel centrepunch.

If a cardboard base is used, then the battery (a 4½ volt flat torch battery) can be clipped on top along with the bulb in a small torch type bulb holder.

If the prods are $\frac{3}{8}$ in. in diameter then a length of ordinary bicycle valve rubber tubing will cover them tightly. This will electrically insulate the prods and also give them a better working grip while in use.

The sheets in the model shown in the photographs were made of strip aluminium with the numbers printed on. This made it possible to wipe down the instrument with a damp cloth when required. Paper strips can be used but they have to be renewed occasionally when they become too soiled.

(C) The numbered face and test prods.

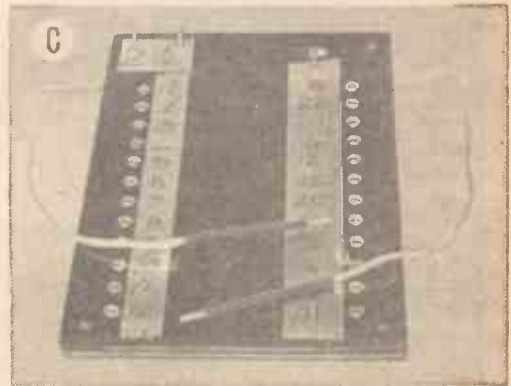

LUNAR HOLE DIGGER

(Continued from page 201)

wave lengths of the rays which bounce back to the probe, the molecular weight and type of material under the moon's surface can be determined.

To power the apparatus, it has been suggested, solar energy from the sun will be converted into electrical energy to drive the drill, operate the geophysical probe and television camera, and transmit the information to monitoring stations on earth.

Use of solar energy, however, poses some problems, too. Any one part of the moon's surface facing the sun is exposed for only 14 out of 28 days. So the drilling operation must be completed in two weeks before the equipment becomes powerless.

Once the Lunar Drill had completed its work, it would be left on the moon. In all probability several lunar drillings would be made to ensure comprehensive knowledge of the moon's surface.

In theory, this lunar drilling sounds practical enough. However, it must be remembered that all this mechanical operation must operate in a vacuum-like atmosphere containing neither hydrogen nor water, and in violent temperatures which range from minus 243 to plus 212 degrees F.

Fantastic? It may sound so, but five years ago who would have seriously believed we would be on the verge of shooting an astronaut into space in a Mercury capsule? Or, for that matter, 50 years ago how many people thought the moon just might be made of green cheese? It's doubting Thomases like those old folks that have made scientists what they are today. Oh well . . .

Giant new telescopes



will listen to outer space

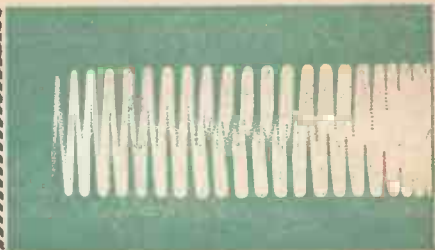

By Richard J. Salter, B.Sc. (Eng). Hons., A.M.I.C.E., A.M.I.Mun.E.

THE tremendous radio telescopes now being built in many parts of the world all owe their origin to a faint hiss heard by Karl Jansky in his radio apparatus some thirty years ago.

He had been investigating the effect of thunderstorms on telephone communications. As well as the crackle from the thunderstorms there was also a faint hiss, curiosity led him to find where it came from and the result was astonishing. For he discovered the source of the radio signals was in a region of the Milky Way.

It was left to an amateur radio enthusiast called Reber to follow up this discovery and using a parabolic radio wave reflector in his back garden he was able to detect radio waves which were reaching the earth after travelling for twenty-five million miles through space.

Today radio astronomy is being carried out in every scientifically minded country in the world providing the mileposts and direction signs for the space travellers of tomorrow.

Radio Stars

Stars studied by the radio astronomer are quite different from those seen by eye in the night sky. Instead of being visible points of light in the sky radio stars are often rapidly moving clouds of gas in the Milky Way, or galaxies of stars separated by vast distance of space from our own.

Radio waves are only part of the electro-magnetic radiation travelling across outer space with the speed of light. Other kinds of radiation which differ from radio waves only in their wavelengths are X and Gamma Rays, Visible Light Rays and Radiant Heat Rays.

These radio waves can be intercepted on earth by a curved metal reflector of sheet metal or wire mesh which focuses the waves on to a dipole or feed connected to the receiver. The power of the telescopes to distinguish radio stars which are close together in distant space, known as the resolving power, depends upon the diameter of the reflector.

Radio Telescopes

This is the reason why radio telescopes are such tremendous structures. The great steerable Jodrell Bank construction was a magnificent feat of science and engineering.

An even larger radio telescope than this however is now being built at Sugar Grove, West Virginia, for the United States Navy. It will have a huge moving reflector dish with a diameter of 600ft which will be supported high above the valley floor by two towering structures very much like Ferris wheels. At its highest point it will be 665ft above the valley floor, a height which will allow the reflector to follow any celestial object from horizon to horizon.

As well as being able to tilt to any angle of elevation from zero to 90° the entire structure will revolve on a circular railway track.

An aluminium wire screen will reflect the radio waves received from space to the focus. It will be very important for the reflecting surface not to deviate more than one inch from a true paraboloid and an elaborate servo mechanism will be installed to maintain this accuracy in spite of temperature expansion and contraction and the force of the strongest gale.

In addition to being used as a receiver of radio waves the new 600ft telescope may also transmit radio signals. With its great power gain and high resolution it should be possible to obtain echoes fairly easily from the Moon, Venus, Mars and perhaps Jupiter. Measurement of the travel time of these waves will help to fix solar distances more exactly, an important factor in any space travel programme.

Large as the 600ft diameter radio telescope at Sugar Grove is, it is minute when compared with the resolving power of a large optical telescope.

This is because light waves have a wavelength in the region of a 50,000th. of an inch long so that a 200in. optical telescope has an aperture 10 million times the length of a light wave. Because radio waves from space have a considerably longer wavelength it would need a radio telescope with a diameter of at least a thousand miles to achieve this same resolving power for the waves emitted by cool hydrogen.

An artists' impression of how the giant new telescope being built for the U.S. Navy will look when it is completed. (Official U.S. Navy photograph).

Giant new telescopes will Listen to outer space

Fixed Reflector

Some of the difficulties and expenses of building very large radio telescopes have been overcome by constructing a fixed instead of a movable reflector.

In this way natural ravines and valleys have been used to support the reflecting surface. The Arecibo radio telescope in Puerto Rico is being built in this manner. With a diameter of 1,000ft it is considered that when it is completed it will be the largest radio telescope in the world.

Unlike most of the other radio telescopes the Arecibo reflector will be a segment of a sphere of the normal paraboloid shape. This change in the shape of the reflector together with specially designed equipment will allow the telescope to pick up radiation from a wide areas of the sky even though the reflector is not moveable.

Radio waves reflected by the hemispherical dish will be picked up by a feed mechanism suspended high in the air at the focus of the instrument by three towers, two of which will have a height of 250ft and the third, a height of 365ft.

Covering an area of more than 18 acres, the new telescope is expected to have important defence uses in detecting the effect of nuclear explosions on the ionosphere. *(Continued on page 238)*



Nestling in the hills of Puerto Rico the Arecibo Radio Telescope will form a huge saucer in the ground. (Official U.S. Air Force photograph).

(Right). — Still another radio telescope with a different kind of reflector. The parabolic-cylindrical reflector of wire mesh focuses the radio waves on to the feed which is suspended high in the air on four wood towers.

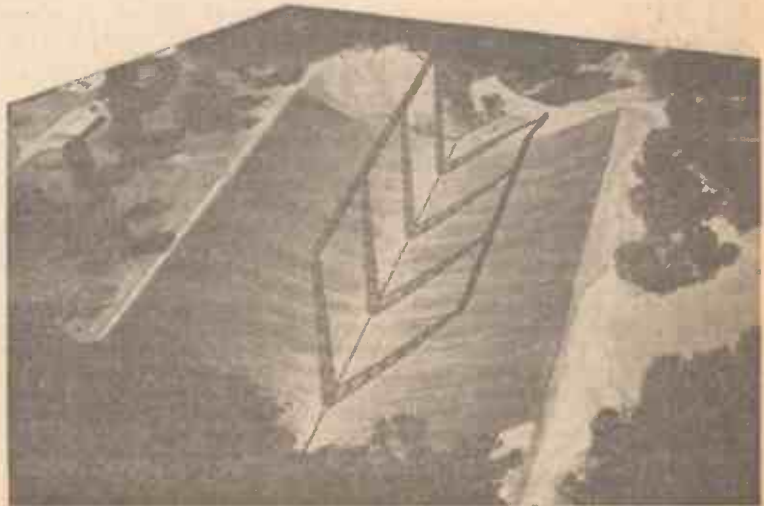

By JAMESON ERROLL

A MECHANICAL DESIGNING DEVICE

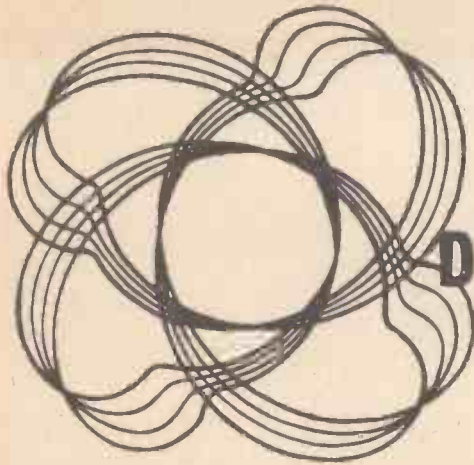

THIS piece of apparatus, sometimes referred to as a Designograph, is primarily intended for amusement; it will provide children and adults with countless hours of quiet pleasure. It can, however, be used for intricate design work when practice has made perfect.

As will be seen from Fig. 2, it consists of a revolving table on which a circular piece of paper is placed, an eccentric block (also revolving), a pencil or pen holder, a guide bar to position the guide rod, and a hand-turned pulley. This latter controls the revolving table and eccentric block, and as the handle is turned, a varying but consistent design is imprinted on the paper. Since both revolve at different speeds, the design traced is a multiple one and, by altering the positions of the guide rod on the eccentric block and the pen-holder along the rod, can be made endless in its variety.

Measurements

Its measurements are extremely elastic and all components can be sized by material available. The pulley wheels, in particular, can be of any diameter within reason, and the author has used two similar ones on the eccentric block and the handle, the one on the handle differing in diameter. All were picked up on a junk stall. For descriptive purposes it has been necessary to adhere to the measurements shown, but constructors will naturally alter them to comply with those used.

The baseboard is of $\frac{3}{8}$ in. plywood, 14 in. \times 12 in., and Fig. 1 shows the positions on the board of the various components. Both the table and the eccentric block revolve on $\frac{1}{2}$ in. bolts which are a fixture on the baseboard, and note that neither of these bolts protrude above the top of their respective components. The handle pulley, however, is mounted on a $\frac{1}{2}$ in. hexagon-headed bolt which threads through the baseboard and is locked by a nut underneath.

The Table

This is circular with a working surface 8 in. in diameter and is of $\frac{3}{8}$ in. plywood. It can be cut from a square piece but mark the circle with compasses so that its centre is established. This is most important since the table must revolve evenly; if the circle

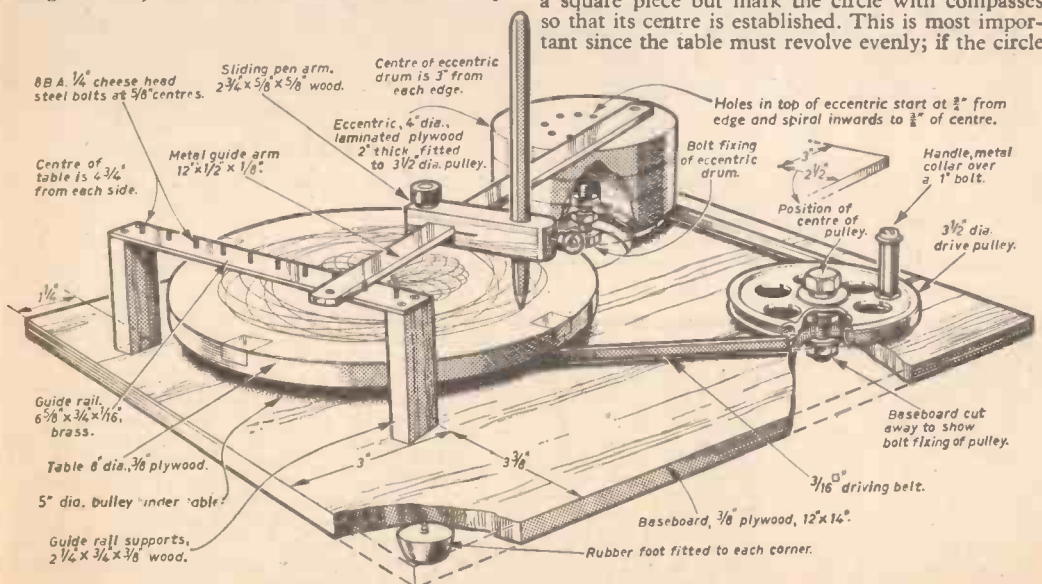

were cut first, its true centre would be somewhat difficult to locate. After cutting with a fretsaw, glasspaper perfectly smooth and then drill a $\frac{1}{8}$ in. hole through the centre. Pass a short length of silver steel through this centre and through the 5 in. grooved pulley and screw both together with No. 4 wood screws. When this is done, remove the silver steel and cover the top of the table with a piece of thick, white cardboard. This completes the table.

The Eccentric Block

This consists of a solid block 4 in. in diameter and 2 in. thick. It is best built up from four pieces of $\frac{1}{2}$ in. plywood glued together under pressure. Round them as for the table and through the centre, to a depth of about $1\frac{1}{2}$ in. drill a $\frac{1}{8}$ in. hole and screw the $3\frac{1}{2}$ in. pulley to the underside as with the table. The drilling of the $\frac{3}{8}$ in. holes in the top to carry the 4 B.A. bolt on the guide rod calls for some care, and Fig. 1 illustrates how the centres are arrived at. It is best to prepare a template of cardboard, pinpoint the holes in it, and transfer them to the eccentric block. A series of circles, from $\frac{1}{2}$ in. radius increasing by eighths to $1\frac{1}{2}$ in. radius, is drawn and the circles then cut by eight straight lines passing through the centre each 45deg. to its adjacent line. Where these lines cut each succeeding circle gives the position for the eight holes. The holes should be drilled about 1 in. deep and very slightly counter-sunk to ease entry of the guide pin.

The Pulley Wheel

As can be seen in Fig. 1 this may be any grooved pulley with a $\frac{1}{2}$ in. to $\frac{3}{8}$ in. centre hole. A bolt with a hexagon head is passed through the top and a locknut threaded underneath; this is tightened only sufficiently to allow the pulley to revolve freely but without wobble. The handle is made up of a $1\frac{1}{2}$ in. B.A. round-head bolt over which is passed a 1 in. length of tubing of an internal diameter to give an easily revolving fit; this is locked on with two nuts as shown. These three items may now be mounted on the baseboard; they should align perfectly about $\frac{1}{2}$ in. or so above it.

The drive consists of a length of $\frac{1}{2}$ in. square catapult elastic, an ideal medium since it is self-tensioning; about a yard will be required. Pass it round the three pulleys and, stretching it slightly and allowing $1\frac{1}{2}$ in. overlap, cut it to the proper length. With a razor blade or sharp knife slice a long, narrow wedge-shaped piece off each end (from opposite sides) and join the two with a rubber adhesive and then bind tightly with a layer of Sellotape. This will result in a firm joint entirely free from any "bump", and should ride evenly over the grooved pulleys.

The Drawing Mechanism

This embodies three components, viz. a guide rod, a guide rail, and a pen-holder.

The first is not illustrated since it consists only of a 12 in. length of $\frac{1}{2}$ in. \times $\frac{1}{8}$ in. mild steel or brass at a $\frac{1}{2}$ in. from one end of which a 1 in. 4 B.A. countersunk bolt is fitted. Drill a hole with a No. 32 or $\frac{3}{32}$ in. drill, counter-sink it slightly, and tap 4 B.A. Screw the bolt in and tighten as much as possible without stripping the thread.

The guide rail shown in Fig. 1 is composed of a 6 $\frac{1}{2}$ in. length of $\frac{1}{2}$ in. \times $\frac{1}{16}$ in. brass or mild steel and two supports of hardwood 2 $\frac{1}{2}$ in. \times $\frac{1}{2}$ in. \times $\frac{1}{2}$ in. Drill ten holes with a No. 50 or $\frac{1}{16}$ in. drill and tap 8 B.A. Into these holes are



Fig. 2.—The designing device in operation.

threaded $\frac{1}{2}$ in. 8 B.A. cheese-head bolts. At each end drill two holes to accommodate No. 4 wood screws and counter-sink them; these are for fastening to the supports. These latter are then screwed to the baseboard from the underside with 1 in. No. 6 wood screws in the position indicated.

The pen-holder is made from a piece of good quality softwood 2 $\frac{1}{2}$ in. long \times $\frac{1}{2}$ in. \times $\frac{1}{2}$ in. With a centre $\frac{1}{2}$ in. from one end, bore a $\frac{1}{2}$ in. hole to accommodate the ballpoint pen, pencil or other instrument; round this end to give a nice finish. A $\frac{1}{2}$ in. from the other end bore a $\frac{3}{8}$ in. hole to clear a $\frac{1}{2}$ in. 4 B.A. bolt with a round, milled head, and, on the underside, cut a hexagon recess to hold the lock-nut flush. From this same end, but at right angles to the hole, make a saw cut down the centre for a distance of $1\frac{1}{2}$ in. With a file increase the width of the cut, $\frac{1}{2}$ in. from the end and $\frac{1}{2}$ in. wide, so that the guide rod is a reasonably tight but sliding fit. This enables the pen-holder to slide along the rod to any desired position when it can be firmly locked by rotation of the milled bolt which brings the two saw-cut edges together. Returning now to the other end, bore a $\frac{3}{8}$ in. hole lengthwise from the rounded end to the $\frac{1}{2}$ in. hole and force-thread a $\frac{1}{2}$ in. 4 B.A. thumb-bolt into it; this, when tightened, locks the pen in position. If difficulty is experienced in obtaining this bolt, a practicable adaptation can be made up from a cheesehead bolt into the slot of which is soldered a $\frac{1}{2}$ in. \times $\frac{1}{2}$ in. \times $\frac{1}{2}$ in. piece of brass; alternatively, a suitable washer will be quite effective.

The apparatus is now ready for action.

Operation

The designing medium used will depend much on the skill of the operator and whether designs are intended to be permanent, for reproduction, or just for amusement. An easy-flowing ballpoint pen is a very good medium for ordinary work, but it is advisable to commence with a pencil until a certain degree of proficiency has been attained. An Indian ink drawing pen gives excellent results for reproduction purposes but calls for care and a certain amount of skill in operation.

A number of circular pieces of white paper, 7 $\frac{1}{2}$ in. in diameter, should first be prepared and one mounted on the table with three short pieces of Sellotape running over the edge of the table. Insert a pencil in the holder so that its point—which

(Continued on page 238)

SCIENCE NOTES

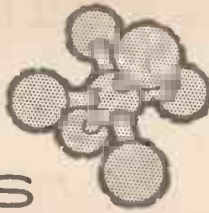

X-15 Reaches Design Maximum Speed

A MAXIMUM speed flight in the X-15 research airplane has been completed by Major Robert M. White, U.S.A.F., whose exploits with this machine were previously reported in PRACTICAL MECHANICS. Major White is one of the prime research pilots in the United States X-15 programme. The flight, which was at first announced as 4070 miles an hour, based on preliminary radar data, has been corrected to 4093m.p.h., following examination of instruments in the aircraft.

Major White made the unofficial record on Thursday, 9th November, 1961, following launch from a B-52 carrier at 45,000ft over Mud Lake, Nevada. This was his eleventh powered flight in the X-15. He landed on Rogers Dry Lake, at Edwards, California, about 200 miles away.

He attained a speed of Mach 6.04 at 95,800ft. Highest altitude attained was 101,600ft, and highest temperature, due to aerodynamic heating, 1,147°F on the wing leading edge. The rocket engine burned at maximum throttle for 36 seconds. Total flight time was 10 minutes. The aircraft speed brakes (flaps) were not used during the speed run.

Engineers of the National Aeronautics and Space Administration's Flight Research Centre at Edwards programmed the flight based on numerous practice runs in the X-15 simulator and on experience with a long series of flights at lower speeds. Primary objectives were to obtain maximum speed and evaluate handling qualities of the airplane with its stability augmentation system inoperative. Some cracking occurred in the right outer panel of the windshield during descent, the cause of which is being studied by engineers and scientists.

The X-15, a joint U.S.A.F.-Navy-N.A.S.A. programme, is being flown to obtain scientific information on many factors including aerodynamics heating, stability and control, and structures and operating problems, in the supersonic and hypersonic speed ranges. The design altitude objective—about 50 miles—is under consideration for an early attempt. The research programme will be continued for many months with three X-15 aircraft and a staff of research pilots.

The Russell 'Hi-Tip' Lifting and Tipping Machine

THE increasing rate of mechanisation of industrial processes is constantly giving rise to the need for more rapid handling of materials and the manufacturers of mechanical handling equipment are keeping pace with modern develop-

ments by eliminating the need for the manhandling of all types of substances. Many kinds of appliances in a more or less elaborate form are available for transporting, lifting, stacking and in fact for performing any kind of handling operation swiftly and economically.

In order to fulfil the need for a simple and reliable machine for lifting and emptying all types of containers, Russell Constructors Limited, have developed a unit which will lift any kind of container weighing up to 10cwt, and will tip it so as to empty the contents into a hopper, truck, mixer or other receptacle. This machine, known as the "Hi-Tip" has a minimum height of lift of 4ft 6in. An interesting feature is the fact that vertical sections can be added to increase this dimension to any height desired.

It is fabricated of $\frac{1}{2}$ in. mild steel of all-welded construction and consists of a base, a top unit and centre sections. The base, which for the standard machine occupies an area of only 3ft x 4ft 6in., houses the electrical equipment, control mechanism, main drive and chain compensating device, all the mechanical parts being adequately protected.

The top unit contains the actuating cam guides for the tipping action and the centre sections, which can be added or removed to alter the height of lift, include the appropriate lengths of guide rails. The machine is powered by an electric motor with a self-contained braking unit and the carriage is elevated by means of twin Renold lifting chains and sprockets. Automatic stop devices are fitted at loading and tipping positions and an overload switch is used to protect the motor.

The start and return operations are actuated manually but automatic sequence control can be provided if required, the emptying time being controlled by a variable time switch. The speed of lift is 30ft per minute and the standard tipping angle is 30° from the vertical. The cradle can be adapted to take any particular type of containers such as drums, barrels, kegs, skips, trolleys, vats, bowls, sacks, etc., the chute being shaped to suit the material being handled.

The Russell "Hi-Tip" is suitable for continuous 24-hour operation. It requires virtually no maintenance and is fool proof in use. It can be provided in a portable form if required and is finished to any specified colour.

Further details may be obtained from the manufacturers at Russell House, Adam Street, London W.C.2.

Giant Lathe for Turbine Parts

THE Kharkov Turbine Works has just completed the assembly of the biggest Soviet-made vertical turning lathe.

It occupies an area of some 9,700sq. ft and is higher than a six-storey building. Its weight is 1,400 tons.

The faceplate is big enough to handle parts weighing up to 400 tons and over 65ft in diameter.

The lathe is operated by one operator who simply pushes a button on a central control panel. All the auxiliary processes are automated.

The huge machine-tool can be fitted with a support for milling, drilling and boring operations, and with various devices for a number of other uses.

LATHE GADGETS

Part 2

TOOL HEIGHT GAUGE AND CENTRE EXTRACTOR

By L. C. MASON

HAVING the lathe equipped with a toolpost quickly adjusted for height, such as that recently described, there is little excuse for a tool setting of only approximately the right height, as the exact position is as easily fixed as any other.

Given that any position is quickly fixed, what is obviously required to match is a method equally quick and simple of finding the exact centre height for a variety of different tools. This need is completely filled by the gauge shown. It consists of a metal strip—the material is not important—having a series of notches cut in one edge to indicate tool heights. The one shown is made from a short length of 1 in. by $\frac{1}{4}$ in. dural strip; it could equally well be brass or steel.

The various notches all indicate centre height, but come in different positions along the edge of the strip because they indicate this measurement when the gauge is stood end up on different parts of the lathe. Thus what would appear to be the highest one shows centre height when the gauge is up-ended on the bed, this being the part of the lathe furthest below the tool point in use. The next longest is centre height with the gauge located on the saddle, while the next shows it measured from the top surface of the cross-slide. One could be provided to indicate height from the top-slide, but as the tool end will generally overhang this, it would be very infrequently used.

The point in having all these various heights shown is that the tool can be set to correct height wherever it may happen to be in relation to the bed. With a long job mounted between centres for instance, tool height can be accurately set without disturbing the job to check the tool point with a fitted centre, using whichever base for measurement is the most convenient for the tool position. On switching tools for screwcutting, say, the same check is very quickly applied, again without disturbing anything.

To make the gauge, select the strip of material to be used and square off one end reasonably truly for the base end. The top can be rounded, drilled with a hole for hanging up near the lathe, or finished in any way fancy dictates. For the calibrations, fit the

tail centre in the barrel and move the tailstock up the bed till the centre point comes over the saddle. Stand the gauge strip upright on the various surfaces, in each case moving it across the centre point so that the centre scribes a short light line on the strip, square to the edge.

Saw out a small triangular notch at each station below the line, leaving the line just showing. Clean up the gap with a triangular file so as to just take out the line. Dimensions for the various locations have not been given, as these are best fixed by reference to the lathe with which it will be used. The same procedure for making the gauge can be applied in respect of lathes of different make and widely varying size.

A nice finishing touch is provided by stamping against each mark an indication of where the measurement is taken from. Metal letter punches of $\frac{1}{16}$ in. or $\frac{3}{32}$ in. are very suitable for this.

Mention was made above of long jobs being turned between centres. One after-effect of such jobs where the turning has taken a fair amount of time or involved heavy cuts, is that the centres will be very firmly seated in their sockets. The same thing results from the use of the tailstock drill chuck, where the use of the larger drills will seat the arbor of the chuck very tightly. It is not always easy to remove a centre or the drill chuck without bruising or damaging either in any way, particularly with the head centre which is unhardened. Twisting with pliers or a clamp to free it is a procedure not to be recommended, owing to the danger of scoring the seating, where all possible steps should be taken to preserve its finish and accuracy. The safest way is to jar it out with some sort of soft drift. However, to do this satisfactorily you really need three hands; one to present the drift, another to administer the tap, and a third to catch the expelled centre and prevent it diving on to the bed and damaging the point.

The gadget shown does this very nicely, quite safely, and using only the normal number of hands. It consists of a length of rod of a diameter to slide easily down the head or tailstock, and reduced at one end to leave a step where the diameter changes.

The larger diameter end is provided with a soft insert—dural or brass—where it contacts the centre. The reduced end carries a sliding weight, drilled an easy fit on the rod (Photo 2).

In use, the weight is moved to the extreme end of the rod, the rod inserted in the head or tailstock to touch the end of the centre, and the weight slid briskly along the rod to bump the step. Quite a gentle tap given in this way direct on the end of the centre will free a really tight one. This is quite simply done with one hand, while the other restrains the centre.

The whole thing can be made in a very short time, the dimensions shown (Fig. 2) applying to one made for use with an ML7. Proportions can obviously be varied to suit other sizes of lathes, and no dimensions are critical in the slightest. As a longer swing is taken with a larger hammer to deliver a heavier blow, so an extractor with a much larger weight should have a proportionately increased length of travel for the weight.

All the turning on the rod can be done in the three-jaw chuck, even if this is not dead true, as it is not essential that the two diameters should be truly

NEWNES ENGINEER'S REFERENCE BOOK

By F. J. Camm

£5, plus 2s. 6d. Postage

Geo. Newnes Ltd., Tower House, Southampton St., Strand, W.C.2.

concentric. Drill the business end of the rod before turning the end pad, then the spigot of the pad can be turned a light press fit in the hole.

The weight can be finished off to any fancy shape, turning a series of shallow grooves round it for finger grip, or knurling, whichever is preferred or possible with available equipment. There is an equally wide choice of ways of retaining the weight on the rod; a groove round the rod with a spring wire circlip, a plain split pin through a cross hole, or a tapped hole in the end for a screw and large washer, to mention just three. The latter method was chosen for the one shown, mainly on the score of neatness and the fact that the necessary bits were available from the junk box.

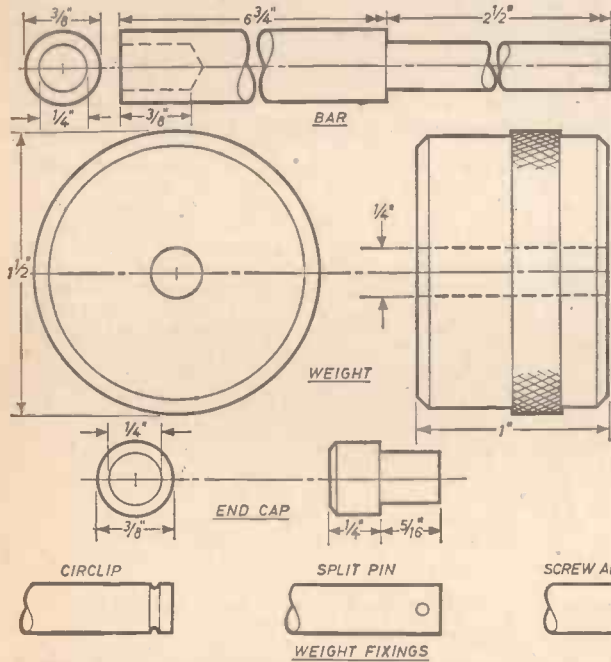

Fig. 2. (Left).—
Lathe centre
extractor details.

(Right).—Lathe
tool height
gauge.

(Below).—Lathe
centre extractor
assembled for
use.



Copying with the Enlarger

By PHOTOGRAPHER

MANY amateur photographers now own enlargers, either commercially produced models or equipment they have constructed for themselves. Very few seem to realise that the enlarger can be used also as a highly accurate and efficient copying camera, without requiring any structural alterations to enable it to perform the additional function. However, several thicknesses of black paper or cloth are needed to wrap around the negative stage and exclude all light.

The baseboard, on which the original subject to be copied is supported, the lens panel and the negative carrier, which holds the copying film, are always parallel with each other. This eliminates the usual problem of ensuring that the camera is square in all planes to the original. The only adjustment required is that necessary to fill the negative frame area with the image of the subject. Following the routine outlined below makes copying an almost automatic process.

Setting-up

First, the enlarger should be set up as though for normal use, but with a ruled focusing negative emulsion side down in the negative carrier. If a standard, professionally made, ruled negative is not available, one can be made by drawing a pattern on blank film with black indian ink and a draughtsman's ruling pen. When the ink does not flow smoothly and take well, the addition of a little gum can help. The design should, of course, be drawn on the emulsion side of the film, that is the duller side.

The enlarger head must be adjusted vertically on the column so that the image of the focusing negative is not only perfectly sharply defined, but also dimensionally correct to almost fill a sheet of white paper the same size as the original subject for copying (Fig. 1). A small safety margin, say $\frac{1}{8}$ in. on all sides, is a wise precaution.

The position of the blank paper on the baseboard can be marked with a pencil, or by sticking on small patches of coloured adhesive tape to indicate the locations of the paper edges. The paper is then removed and replaced by the original (Fig. 2) which, if it is at all inclined to curl, should be held down by the slightly overlapping heads of drawing pins. Alternatively, if it is not considered desirable to stick pins into the baseboard, coins can be arranged so that their edges just hold the corners of the original flat.

Working Conditions

Subsequent operations must be carried out under darkroom conditions, using a safelight of a colour to suit the film on which the copy is to be made. The table gives a list of film types appropriate to various copying projects, and the safelights which

can be employed for general illumination without risk of fogging the film are always indicated on the cartons. In all cases, the safelight should be at least three feet from any place where film is handled, and the naked film should be covered up when not actually being used. An additional precaution is to have the safelight directed at a white wall or ceiling, so that only reflected light strikes the film. To avoid accidentally switching on the enlarger light, disconnect the plug.

Users of 35mm. equipment have a comprehensive selection of different films available, but the choice of rollfilms is not so wide. In that case, sheet films will prove more satisfactory both for ease of handling, since they do not curl as cut rollfilm does, and for the excellent range of films obtainable.

A film is loaded, emulsion down, into the negative carrier of the enlarger, and covered with a piece of black paper. The carrier is then slid into the negative stage (Fig. 3), and the light-tight wrappings bound round and secured. If a condenser mount is usually lowered on to the negative strip in the enlarger to keep it flat, it should also be lowered to keep the copying film in a true plane.

Since the enlarger has no shutter to regulate the duration of the exposure, this has to be done by switching on the copying light. An ordinary 60W. pearl bulb provides ample illumination, and is easier to handle with good effect than a high-powered photographic type. Half the exposure is given with the light to one side of the original, at an angle of approximately 45° and a distance of 2ft (Fig. 4). The light is then switched off before moving it, and the procedure repeated on the other side.

An average exposure, using the conditions mentioned above, no reflector on the light, a film of 20A.S.A. speed and the enlarger lens at f16, would be two seconds on each side. A film of double that speed (i.e. 40A.S.A.) would require half that exposure, and so on. When the exposing light has been switched off, the film can be removed from the carrier and processed in the usual way.

Avoiding Glare

A point to watch is that a shiny surfaced original, for example a glossy photograph, does not reflect light into the enlarger lens. If the 45° lighting angle and subject flatness are maintained, there should be little chance of this. The absence of a reflector also helps to avoid glare, and generally softens the light to prevent excessive contrast.

While it is always desirable to use the appropriate film types listed in the table, it is possible to produce quite good work with only one kind of material. To cover all forms of copying, a panchromatic film of about 65A.S.A., such as Ilford FP3, could be stocked. It will, however, require additional development to provide enough contrast for line originals such as typewritten and printed documents, and ink drawings.



Fig. 1. Adjusting the enlarger head for focus and size of image.

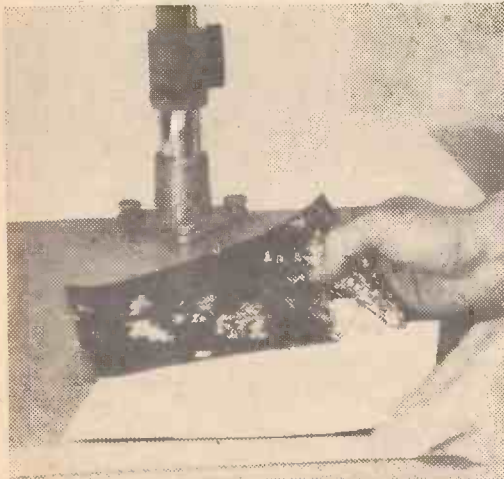

Fig. 2. Replacing the blank paper with the original.



Fig. 3. The carrier holding the copying film covered with black paper, is inserted in the enlarger.

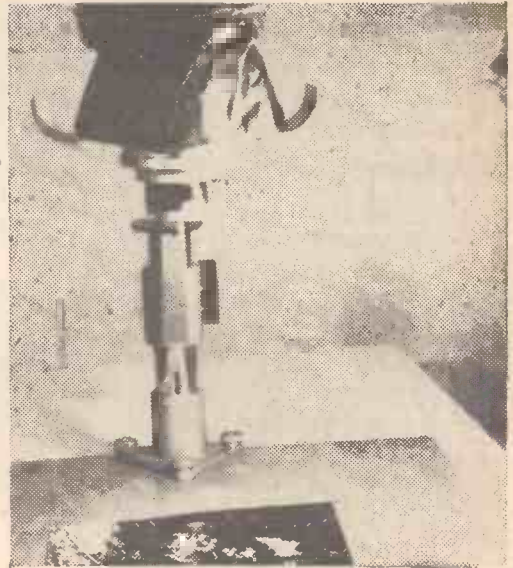

Fig. 4. Making the Exposure.

Subject	Type of film	Speed
Typing, letterpress and ink diagrams	Process	Slow
Black and white photographs or printed pictures of soft contrast	Panchromatic or ordinary	Slow
Black and white photographs or printed pictures of normal contrast	Panchromatic or ordinary	Medium
Black and white photographs or printed pictures of excessive contrast	Panchromatic or ordinary	Fast
Colour photographs or printed pictures	Panchromatic	Medium



by Eric Hawkesworth

Magic* Sand Buckets

COINS are plucked magically from mid air and tossed into a pair of seaside sand pails until both buckets are seemingly half-full of chinking money. Only an elementary sleight-of-hand manipulation is required to repeatedly catch a single coin which is then apparently thrown into one of the buckets; other coin loads are delivered automatically into the hands via the mechanical action of the built-in-bucket loaders.

The coin catching routine starts with single coins being taken from thin air, coat lapels and ears, etc., and finishes with cascades of coins being grabbed

from here, there and everywhere. Total cost of the two pails with secret mechanisms is less than 5s. and either ordinary copper pennies or plated discs can be used to load the magazine and clip, four dozen such coins being needed.

Coin Magazine Bucket

Two seaside buckets measuring 6in. dia. across the top and 6in. high are modified to take the secret coin load as follows: Three 1½in. dia. holes are cut in the bottom of the first pail after first marking out the bucket bottom centre and

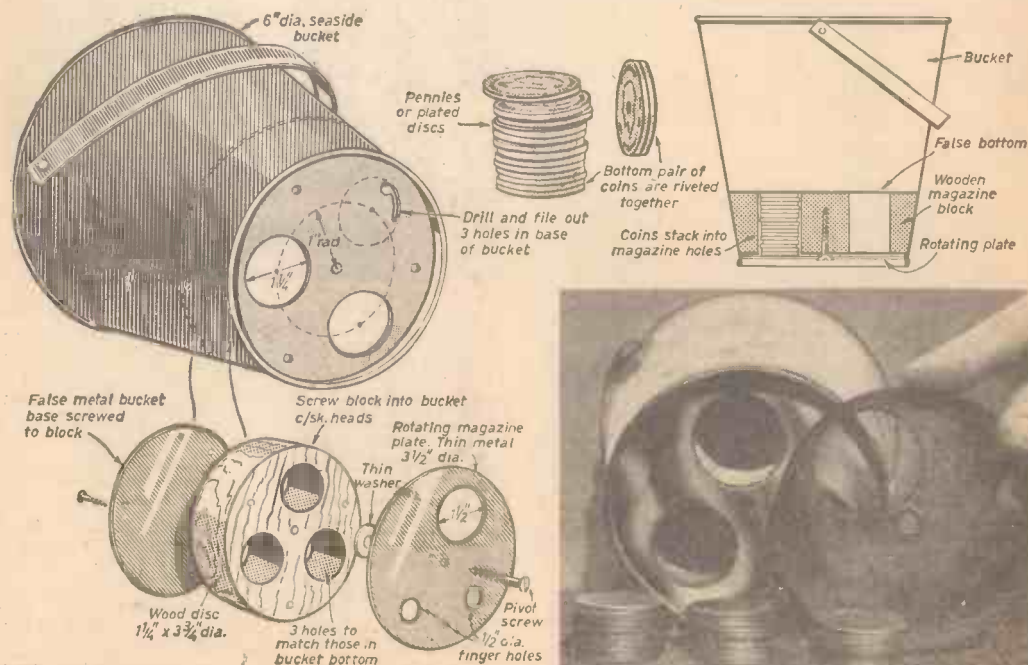

Fig. 1.—The coin magazine bucket.

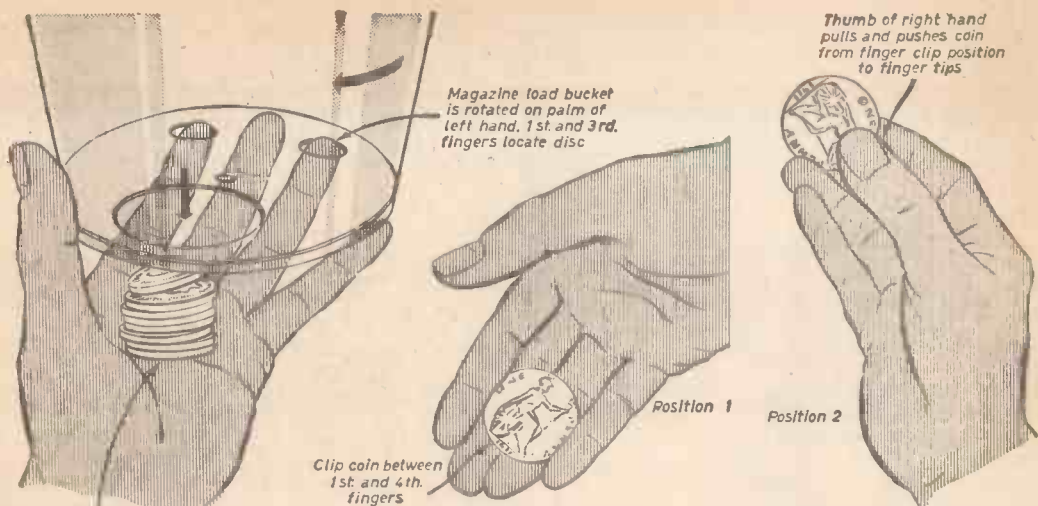

Fig. 2.—The operation of the bucket.

Fig. 3.—Two positions of coin manipulation.

scribing a 2in. dia. circle. Step off the 1in. radius round the circle and then mark the three coin magazine holes from alternate points. Fig. 1.

Remove the metal discs by drilling a start hole and filing round with a small warding file. Make the magazine block from a 1½in. thick wood disc shaped to be a good fit inside the pail. Mark off the three coin holes from those in the base and drill right through the block. Secure the block into the bucket with three c'sk. woodscrews put flush between the magazine holes.

Make a false floor for the bucket from a disc of thin sheet metal and screw this down over the wood disc block. The rotating magazine plate is another disc of 20 gauge mild steel sheet and this has one large hole 1½in. dia, and two ½in. holes drilled through. A central pivot screw secures the rotating plate to the bucket base with a thin steel washer between. The large hole must line up with the coin magazine wells as it is turned. The two small holes are best marked after holding the bucket in the working position and noting where the tips of first and third fingers touch the disc when the large hole is immediately over the palm of the holding hand.

The purpose of the small holes is to locate and hold the rotating disc in the left hand while the right hand turns the pail. As each chamber of coins lines up with the plate hole, the coins are deposited neatly and secretly into the palm of the left hand. To ensure a jam-free action between rotating plate and the holes, the bottom pair of coins are riveted together with a single central copper rivet hammered flush into countersunk settings. This extra-thick coin at the bottom of each of the three loads prevents any possible sticking by a single coin sliding between plate and bucket base.

Construction of the "Chinking" Bucket

Second sand pail has a coin-holding clip and a flipper lever built into the base. The lever end protrudes through a slot in the bucket side and is

flicked with the thumb to make a chinking sound as the right hand apparently "throws" a coin into the pail. The sound of the flipper lever simulates the falling coin and completes the illusion of a coin hitting the base of the bucket. Later, the coins in the clip are shaken from the holder and are poured into the other bucket.

Bend the clip from a piece of aluminium sheet having two small fixing lugs turned up at right-angles as shown in Fig. 2. Bolt the clip against the bucket side, taking care there is enough clearance for the coins to flip free when required. With 12 coins in the holder it should be possible to manipulate the bucket without them rattling about.

The flipper lever is a 3in. length of brass valance curtain rail. File the ends round and fit into the bucket with an angle piece and fairly loose split rivet for the pivot. A light tension spring attached to lever and bucket wall provides the flipper action.

Method of Working

Both sand pails are loaded with the four dozen coins and are placed on the table with chinking bucket upright and magazine pail on its side showing interior to audience. A single coin is held in the fingers of the right hand in the clip position between first and little finger. This is shown in Fig. 3, Position 1. The hand is held naturally at the side, taking care that the coin is not revealed to the audience.

The chinking bucket is taken up and held in the left hand with the thumb ready on the flipper lever. Pretend to "catch" a coin by reaching out the right-hand and pushing the hidden coin from the clip position to finger tips with the thumb (Fig. 3, Position 2). Bring the coin to the bucket and dip the fingers into the pail. At the same time, operate the flipper lever and retract the coin into the finger-clip position by drawing back the thumb. This illusion is very effective if the movements are co-ordinated with a little practice.

You can apparently take coins from everywhere and drop them one at a time into the pail. Simply

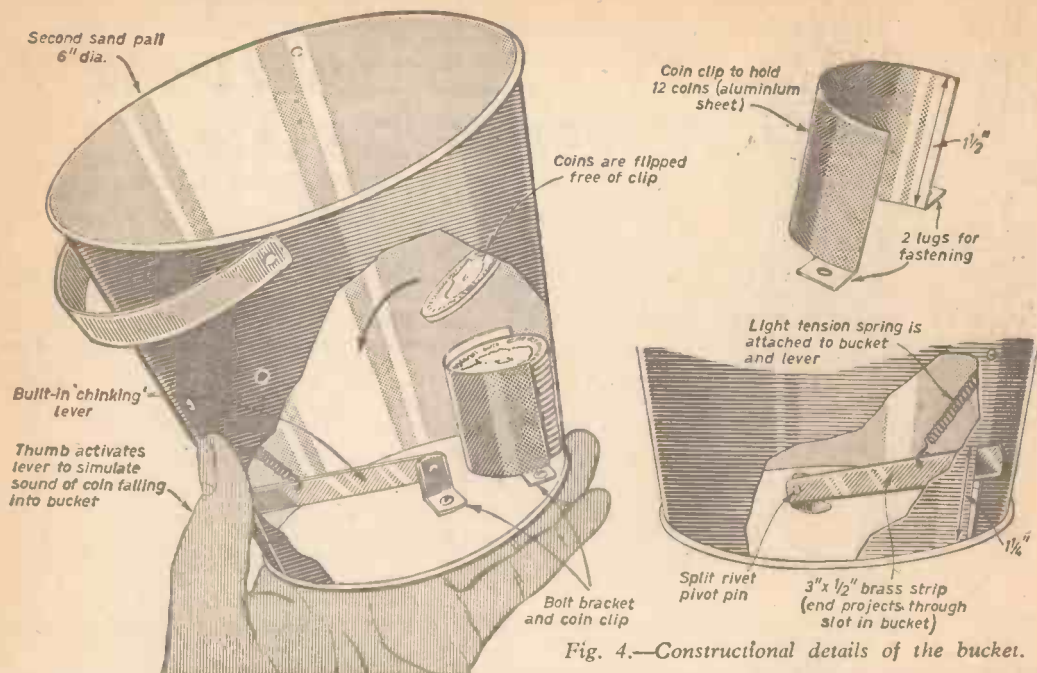

Fig. 4.—Constructional details of the bucket.

pull the flipper lever down and release to produce the chinking sound each time a coin is "thrown" into the bucket. Repeat this single coin catch move about a dozen times then flip the coins out of the holder by jerking the bucket upwards. Rattle the now loose coins about and pour them into the other pail.

The first bucket is placed on the table and the coin magazine bucket placed on the left palm in the position indicated in Fig. 4. Large hole of the rotating disc is midway between two of the coin loads at first but the bucket is then turned until the first load drops into the palm as shown. The performer tells his audience that he is coming where all the money really is . . . in their pockets!

Down in the audience, the performer transfers the bucket to his right hand and then plunges his left hand, with the palmful of coins, into someone's pocket. These coins are produced and cascaded

into the bucket. Again the bucket is placed on the left hand and another coin load is obtained by turning the pail. This time the left hand squeezes somebody's nose while the right hand holds the bucket beneath to produce the coins!

Obtain the third load of coins then reach up and apparently catch this final handful as you return to the platform. Throw the coins into the pail then pour the money from bucket to bucket making as much noise as possible to bring the "Miser's Dream" to a rattling conclusion.

Both bucket interiors should be painted bright yellow to match in the false floor of the magazine pail and the flipper lever and clip of the other bucket. Bright palming coins can be purchased from the conjuring shops or a set of pennies could be cleaned and silvered to produce the effect of halfcrowns.

WIND POWER

(Continued from page 210)

the success of the project depends on the constructor being able to obtain one cheaply. The main design features of the windmill are as follows:—

Blade diameter	12ft
Number of blades	4
Wind speed at which rotation starts	8m.p.h.
Design wind speed	16m.p.h.
Design Power	1.5kW
Design speed of rotation	120r.p.m.

The drive from the propeller shaft to the generator should be by gears, though a belt drive would do if it was well protected from the weather. As this wind power machine is primarily intended for heating purposes either an A.C. or D.C. generator could be used. The power cable from the generator can be taken direct by cable, which would have to be untwisted every few months.

A Brake

To protect the wind generator from over speeding in high winds it is necessary to fit a brake which will automatically bring it to rest in an emergency. A suitable type of brake is shown in Fig. 7. This brake is operated by a weight tripping the catch of the brake band, the spring supplying the necessary force. The brake has to be reset by hand when high winds have died down.

The supporting structure for the wind generator should be sufficiently high to avoid interference from near objects. However the machine should not be mounted on a roof as air currents are likely to be turbulent, and also damage may be done to the roof. Where conditions permit a straight pole or lattice tower supported by guy wires would be the best.

**a full
size**

TRANSPARENCY PROJECTOR

By L. R. REPAGE

THE projector shown in the photograph and illustrations was constructed by the author using mostly simple materials. Yet there are several interesting features about the design which not only adds to the efficiency of the projector but will give the amateur some very interesting constructive work.

There are several components which must be purchased but this will be money well spent and is quite a bit cheaper than buying a commercial instrument.

The components are the projector lamp, a pre-focus 150-watt lamp, a pre-focus lamp holder, a 4in. condenser lens, twin-type complete in housing, and chance glass strips to cover 3in. x 3in. This, incidentally, is the most expensive item. If omitted the slides may warm up and will give shorter duration of projection. The projector shown was made for 2½ x 2½ slides but will cover almost complete area of 3¼ x 3¼ standard-slides if a suitable slide carrier is also made up.

The author was fortunate in having one of those old standard lanterns, the complete lens in its housing was ideal therefore for the 2½in. square slides to be projected. Many of these old "magic lanterns" can still be seen about second-hand shops and can often be had for a £1 or so. These contain very solid brass face plates which can be utilised in the construction.

For the lamp house proper a radio casing was cut down from an old service receiver. These are solidly constructed of good gauge metal. The rectangular box form is not difficult to construct using good XX tinplate.

For the cutting of metal small piercing saw blades were used. These will cut metal of reasonable gauge. Care is needed for obvious reasons as these blades are very sharp.

For the outer casing, slide carrier, vent panels, good gauge aluminium sheet was chosen for lightness. For the chance glass panel sheet, brass or copper should be used, as soldering the glass holder and guides is necessary. In much of the other construction the brass curtain channel section has been used owing to its good strength and

soldering possibilities.

Construction

The lamp house should be made first, if not already available. This is attached by 2B.A. studding to the surrounding rails of the curtain channel. The bend at the corners should be done in a frame and the job will be more likely to be successful if the webbing is cut at the point of bend. If too sudden or bent cold the channel will snap off. Four lengths of curtain channel form the slide carrier track and these are slotted and spaced with washers on the front 2B.A. studding.

The surrounding rails mentioned form the skeleton for mounting the slide track, chance glass panel and condenser housing in its frame. This frame is adjustable both vertically and horizontally, as also is the chance glass panel. Ample ventilation is afforded as the top of the lamphouse has three large holes cut, also a large rectangle in the bottom. Although not shown in the photograph, a liberal number of holes were later drilled in both sides when the final position of the lamp was found by adjustment. These holes should be on a level with the lamp each side.

The projector lamp is also fully adjustable, the special GEC porcelain pre-focus lamp holder is mounted on a frame made from short lengths of brass curtain channel. These are cut, drilled and fixed with set screws, and when squared up can then be heated and soldered. Elongated slots allow the holder to move forward and backwards and similar shorter slots allow the platform itself to move laterally across the lamp-house. Four lengths of a B.A. studding fixed to the base of the lamp-house hold the platform and with nuts and washers the platform can also be adjusted to get the filament of the lamp exactly to its correct height.

The condenser cradle is made from ½in. planed hardwood, obtainable from most craftsmen's shops. These are screwed and glued to form a rectangular frame and each member has a small arc cut out to seat the condenser housing. Two side channels have nuts soldered near each corner and short lengths of studding fix the whole condenser

Before casing is fitted.

The complete projector.

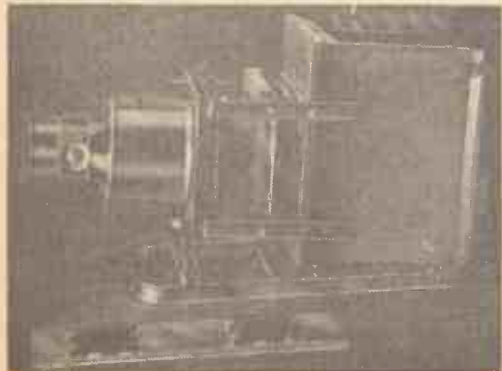

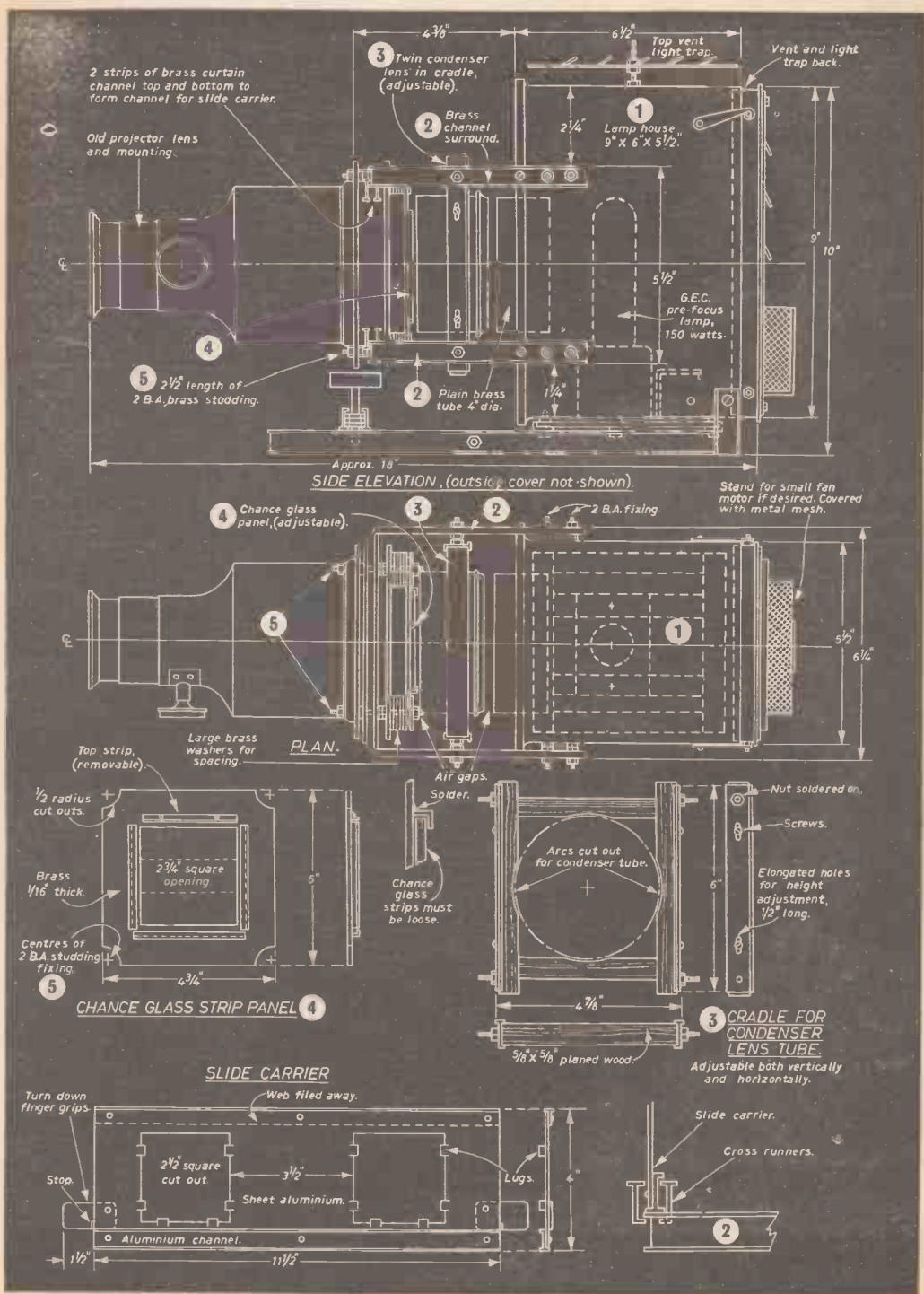

FRONT PANEL.

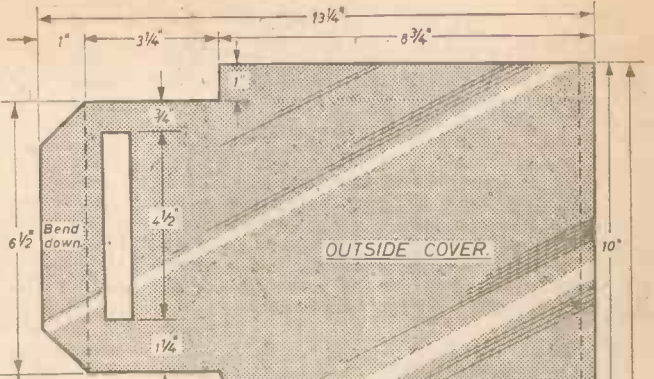
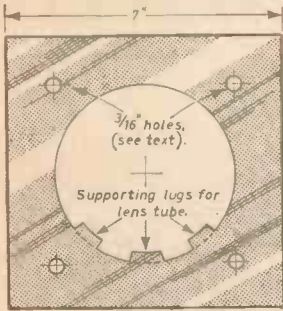

OUTSIDE COVER

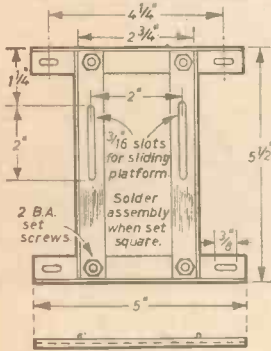

PLATFORM FOR PRE-FOCUS LAMP HOLDER.

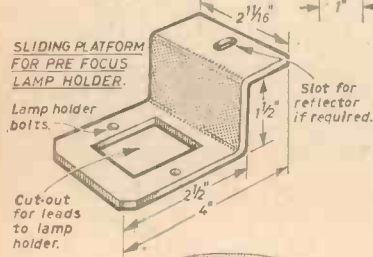
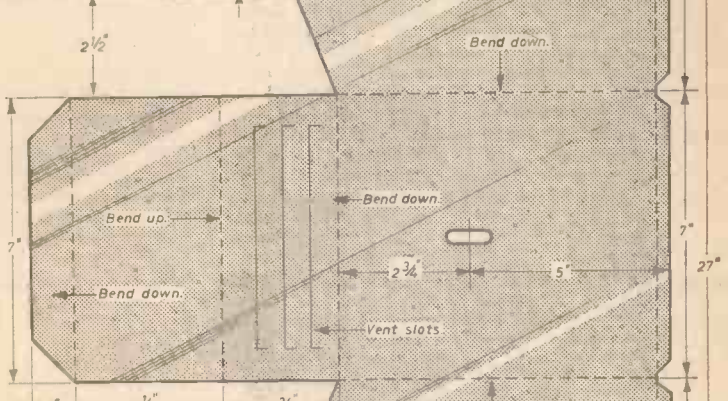

SLIDING PLATFORM FOR PRE FOCUS LAMP HOLDER.

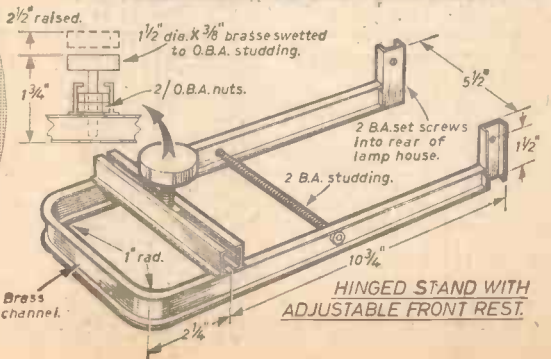
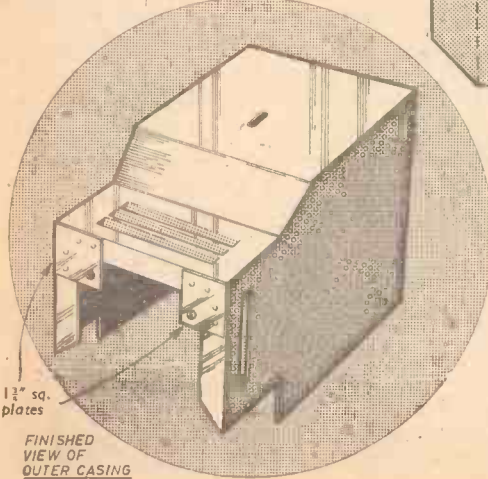

assembly to the surround. After its position (side-ways and vertically) has been adjusted, nuts lock the cradle firmly into position. A firm but not too tight sliding fit to the condenser housing is preferable—this allows slight distance adjustment of the condenser tube.

A cut out circle is made in the front end of the lamp and a short plain tube fixed—its purpose to stop stray light from escaping. However, with the outer casing or cover, which was a later luxury fitted by the author, it may well be found unnecessary. A short gap between this tube and that of the condenser lens assembly tube is preferable to allow heat to escape and prevent condenser heat from contact with the lamp house.

Ventilation

There is adequate ventilation as the outer casing is spaced about $\frac{1}{2}$ in. away from sides of lamp-house. Also the sloping front allows heat around the condenser assembly to escape along the top.

The panel to take the chance glass strips should be cut from good gauge brass or copper sheet (an old copper etching plate is suitable for this purpose); the cutting can be done with the piercing saw in a fretwork frame. Do not try to hurry this work as a good loose seating for the strips of chance glass is essential to allow for expansion. The seating is formed by cutting short angle sections from brass curtain channel and soldering (heating the whole plate first) to the plate, thus forming a three-sided cage. A detachable strip with two very small set screws is fitted to the top, just clear of the strips of chance glass after these have been inserted, to prevent the latter dropping out should the panel be accidentally inverted. The glass strips are valuable, so care in this panel construction is time well spent. The whole panel is attached to the chassis by the 4 main lengths of brass 2B.A. studding and can be adjusted over a short distance to correct height and also laterally. Exact positioning of the chance glass aperture is thus obtained. This is the purpose of the arc cut outs at the corner of the plate. Large washers front and back allow (with end nuts) the whole plate to be fixed. The point that this plate must be a good rigid one is emphasised again. The platform for the whole

lamp assembly is also made of brass curtain channel. Make a pencil plan first as guide, then bend the front curves in a blowlamp. Cut off to length of base, drill both sides for 2B.A. studding tie bar. When this is fixed, the top cross strips can be soldered again by use of the blowlamp, also the small end attaching strips forming the back hinge of the platform. The reader may prefer to fit side lugs allowing the platform to be screwed down firmly to a baseboard of say $\frac{1}{2}$ in. ply or good hardwood. The platform is, of course, hinged to the back of the lamp-house and this can then be raised or lowered by the front brass turntable which itself rests under the front panel plate holding the lens system.

The slide holder, which runs between the two slots formed by the top and bottom brass curtain channels was made from stout sheet aluminium and the curtain channels top and bottom were riveted to the aluminium with miniature rivets. Countersink these rivets to prevent any jamming of the slide. It may be found necessary to file away part of the webbing of the top channel to afford smooth entry and removal of the slides during projection.

The outer cover was made from moderately stout gauge aluminium sheet and full dimensions have been given for making from one piece. If any variation has been made in the lamp-housing and general construction, then the sizes given will not be correct and it will be necessary to modify. The cover is fixed by the top 2B.A. studding and by two 2B.A. set screws to the rear of the lamp-house body. The front aluminium face plate is made last and the hole should be sufficient to pass the plate over the lens barrel. To correctly drill the fixing holes touch each. 2B.A. studding with ink and press the plate against them. The holes can then be accurately drilled.

The top of the casing should be drilled all over with small $\frac{1}{16}$ in. holes for ventilation. Black the inside of the case with hard drying matt paint. Blackboard paint is ideal for this purpose.

The black vent box was made from a frame of the curtain channel with an aluminium panel with vent slits cut therein. Make a good cable connection, preferably with 3-core cable and use the earth lead connected to the metal casing.

BACK VENT BOX FOR PROJECTOR

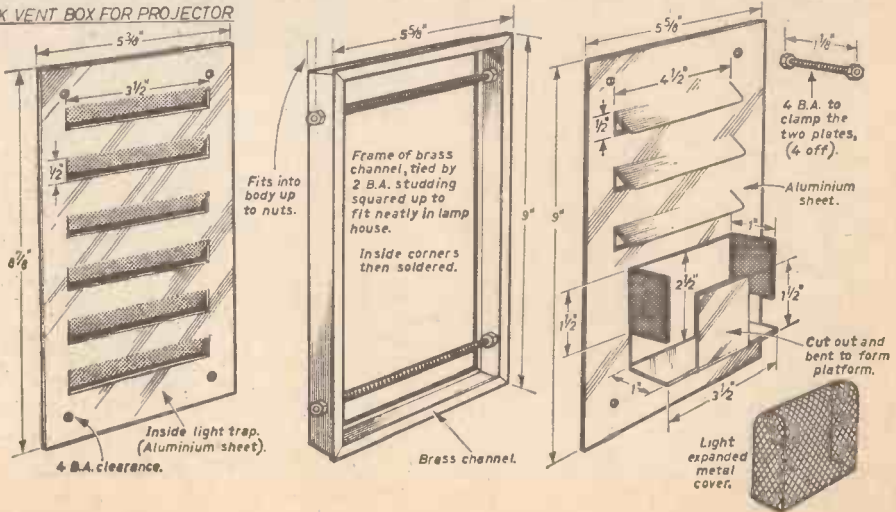

TRADE NOTES

A REVIEW OF NEW
TOOLS, EQUIPMENT,
ETC..

Oryx Soldering Irons

THE Oryx range of soldering instruments previously only used by Electronics and Radio Component Manufacturers are now available to the "do-it-yourself" enthusiasts. In addition to the original range of low voltage models as used by industry, these instruments are now also available for mains use without the need for a transformer.

Distributors are:—W. Greenwood Electronic Ltd., 677 Finchley Road, London, NW2.

Presto B.A. Tap Index Set

WITH particular appeal to the engineer's workshop a range of taps in B.A. sizes is now available in a strong metal index container. The sizes are from 0-10, each size includes three taps (taper, second, and bottoming).

The set can be supplied with either carbon steel cut thread or high speed ground thread taps.

The containers are produced in a high quality stove enamel finish and the hinged interior keeps each tap individually stored when not in use.

The makers are Easterbrook Allcard & Co. Ltd., Penistone Road, Sheffield.

Safeti-Kit

FOR the handyman who needs to wire up his garage or workshop to give a supply for lighting, power tools, battery charger, heating, etc., a complete kit of all the necessary parts can now be obtained.

Simple instructions for doing the work are supplied, and these have been compiled in accordance with the local electricity boards requirements with regard to safety, the makers have in fact already made, and tested, many of the important connections.

The Safeti-Kit is obtainable for 15 or 13 amp power supply and costs £6 9s. 6d. Distributors are:—J. B. Potter Ltd., 3a Lodge Street, Leeds 1.



The Safeti-Kit.

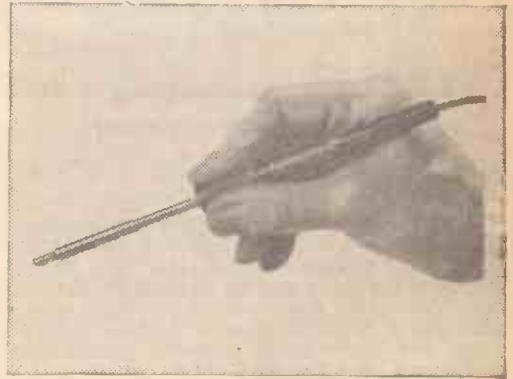

Oryx Soldering Irons.



Presto
B.A.
Tap
Index
Set.

Electroplating Kit

A NEW kit for the handyman no bigger than the size of a pencil torch, brings silver, chromium and gold-plating into the home. It can be used on any metal which conducts electricity.

The kit, of American origin, works off a torch battery and consists of a special brush containing an electrical contact, a second contact is clipped to the object to be coated. When a special plating fluid is applied, the tiny electric current breaks it down leaving a deposit on the surface of the metal.

The kit costs 36s. for chromium, 40s. for silver and 57s. 6d. for gold.

They are available from A. W. Gamage Ltd., Holborn, E.C.1.

LETTERS TO *The Editor*



The Editor does not necessarily agree with the opinions expressed by correspondents

A Useful Scriber

SIR,—This scriber can be used on metals and plastics, etc. It is made out of a discarded ball point pen. Remove the ink tube from the ball point also the part where the ball is fixed, these will come away quite easily with pliers. Next, insert a gramophone needle in place of the ball top, tap it home and insert it back into the plastic holder (see sketch on left). This can be carried out by replacing the plastic top with a pocket clip.—L. Roberts (Birmingham 32).

The Scriber.

Remove ball point tip.

Remove ink tube.

Insert gramophone needle here.

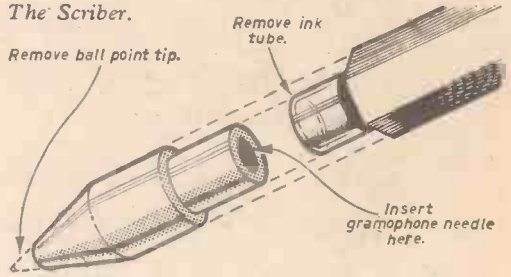

“Anti-Gravity”

SIR,—With regard to the article entitled “Anti-gravity” which appeared in your October, 1961 issue, the author’s knowledge of fundamentals is impressive but he is let down by the experiment in diamagnetism. Aluminium is unfortunately paramagnetic (atomic susceptibility +0.00002) and the experiment actually demonstrates a Leng’s Law response to an impulsive change of flux. The magni-

tude of true diamagnetic force is given by $KH \frac{dH}{dx}$ per unit volume and K for bismuth is -0.000013 (minus sign indicates repulsion).

As one who has observed this diamagnetic force in bismuth, I assure readers that space travel along the planetary lines of force, using this type of reaction, is quite impossible.—D. S. Armstrong, B.Sc. (Eng.).

The Hover-Rail Article

SIR,—Re the article in the December 1961 issue of PRACTICAL MECHANICS on the hover train. Perhaps it will interest your readers to know this idea is by no means a new thing. In fact way back before the 1918 war (I think it was 1911 or 1912) an American demonstrated in a hall in London, a rail car that floated on repulsive magnetism. The speed was something terrific. When the power was switched on the car travelled so fast that sight couldn’t follow it. It simply disappeared and reappeared at the end of the track. The inventor claimed that there were no limits to the speed possible, 1,000m.p.h. and upwards.

I suppose most people with a scientific turn of mind know that an electro magnet repulses aluminium. This was the basis of the invention. All along the track were electro magnetics. The car being made of aluminium was lifted off the rails. Along the sides of the car were bands of iron. There were horseshoe shaped erections from one side of the track to the other, through which the car passed. These were magnetic and attracted the

iron bars.

The action demonstrated was the car at rest at one end of the track. An electric circuit was switched on controlling the magnets in the track and the car rose off the rails into the air where it was held in position by the magnetic force of the horseshoe. The forward switch was pressed and the car immediately leaped forward. As the car passed each magnet the power was switched off that magnet on to the next. The inventor contended that this magnetic attraction was progressive, and was only slowed by air resistance. There was talk at the time that the Post Office intended to make a 20 mile track to test it but I don’t think it came to anything. I remember that public interest was very keen. Even the Prince of Wales went to see it.

Of course there was the usual opposition. Which there always is to anything new. One eminent person said, “what would happen if it went off the track?” forgetting that it was always off the track. Pity the poor inventor.

Club News

Ramsgate and District Model Club, hon. secretary Mr. E. Church, 103 Pegwell Road, Ramsgate.

Annual Film Show to be held at 7 p.m. on the 17th February, at the Royal Hotel, Harbour Street, Ramsgate.

A Refresher Course in Mathematics By F. J. CAMM

5th Edition 8s. 6d.

By Post 10s.

NOW!
YOU can MASTER ELECTRONICS!

BRITAIN'S MOST COMPREHENSIVE PRACTICAL COURSE IN RADIO • ELECTRONICS TELEVISION!

THESE SPECIAL TRAINING KITS — YOURS TO KEEP



Multi-Range TEST METER



CATHODE RAY OSCILLOSCOPE



AM and VHF/FM LUXURY RECEIVER



SIGNAL GENERATOR



Complete set of Picture Way books and Experimental Manuals

LEARN BY BUILDING NOW for your **CAREER • HOBBY OWN BUSINESS**

YOU RECEIVE

- Complete kits of equipment as illustrated.
- Complete set of experimental manuals.
- Complete set of "picture-way" theory books.
- Modern test-yourself examination sheets.
- Study programme.
- Unlimited consultation with Tutors.

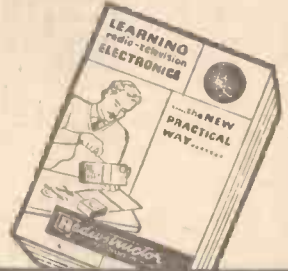

FREE BROCHURE NOW

RADIOSTRUCTOR

TO RADIOSTRUCTOR (DEPT. M108) READING, BERKS.

Name _____ **BLOCK**

Address _____ **CAPS**

_____ **PLEASE**

(We do not employ representatives) 2/62

NEW POCKET MANUAL "PRACTICAL STEAM TRAPPING"

New unique guide to correct selection and installation of steam traps for mains drainage, heating systems, process steam units of all kinds; including best condensate-lifting installations. Concise directions; clear illustrations. Copies free on request to:

SPIRAX-SARCO LTD.

(TECHNICAL DEPT.) Cheltenham, Glos.

CAR BATTERY CHARGERS

For normal 220-250v. A.C. mains. Ready for use with mains and output leads. 12 months' guarantee.

6/12v. 1a	29/9
6/12v. 2a	38/9
6/12v. 2a. with meter	49/9
6/12v. 4a. with meter and variable charge rate selector as illustrated	89/9 or Dep. 13/3 and 5 monthly payments 13/3.

Terms C.W.O. or C.O.D. Carr. 4/6. Callers welcome. Trade supplied. R.S.C. (Manchester) LTD., Dept. 'S, County (Mecca) Arcade, LEEDS 1; 54-56 Morley Street, BRADFORD; 8-10 Brown Street, MANCHESTER 2; 73 Dale Street, LIVERPOOL 2.

GENERAL CERT. OF EDUCATION

THE KEY TO SUCCESS & SECURITY
Essential to success in any walk of life! Whatever your age, you can now prepare at home for the important new General Cert. of Education Exam, on "NO PASS—NO FEE" terms. You choose your own subjects—Educational, Commercial or Technical. Recently announced big extension of subjects gives everyone the chance to get this valuable Certificate.

SEND FOR FREE 136 PAGE BOOK
Full details of how you can obtain the General Cert. are given in our 136-page Guide—Free and without obligation. Personal advice on request.
Write today, School of Careers, Dept. 160 29-31, Wright's Lane, London, W.8.

The School of Careers

FOR PRACTICE
OR PLEASURE

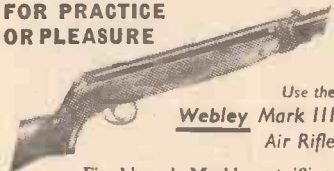

Use the
Webley Mark III
Air Rifle

Fixed barrel. Machine cut rifling. Two models — .22 Sports and .177 Club Target.

Write for descriptive Catalogue.

WEBLEY & SCOTT LTD.
28 PARK LANE, HANDSWORTH
BIRMINGHAM, 21

2000 Hand Reamers, sizes 5/16", 3/8", 7/16", 3/8" each. Also 5/8", 11/16", 4/9 each.

1,000 High Speed Side and Face Cutters, 2 1/2" dia., 1" hole, 3/8", 1/2" thick, 15/- each. 3" dia., 1" hole, 1/2", 5/8" thick, 20/- each. 3 1/2" dia., 1" hole, 3/8", 3/4", thick, 25/- each.

500 Sets Hex. Die Nuts. Sizes 1/4", 5/16", 3/8", 7/16" and 1/3" Whit., B.S.F. American Car thread or 26 brass thread. These sets are in a neat case. Present day value over 30/- per set, to clear 15/- per set any thread. Two sets 28/6, four sets 55/-. Also 5/8" and 3/4" in Whit., and B.S.F. only. 5/8" 5/- each; 3/4", 6 each. 10/- per pair.

20,000 Metal Sighting Saws, 1-3/4" dia., 5/8" hole, .015" to .080" thick. 6 asstd. 8/9, dozen 15/-. Still cheap at double this price.

5,000 Hardened and Ground H.S. Tool Bits, 1/4" square, 2-1/2" long, 15/- doz. 5/16" square, 3" long, 20/- doz. 3/8" square, 3" long, 25/- doz. 7/16" square, 3-1/2" long, 30/- doz.

3,000 H.S. Straight Shank End Mills, approx. 3/32"-1/2" dia., outstanding value, 8 assorted, £1 the lot.

3,000 Circular Split Dies, 1" dia. cutting 1/4", 5/16", 3/8", 7/16", 1/2" Whit., B.S.F., also brass thread, 26 thread and all sizes and American N.P. 12/- per set of 5 sizes. 2 sets 22/6; 4 sets 42/6. Taps to suit 12/6 per set, either taper or second or plug 1" dia. stocks 6/- each.

Six Tons Precision Ground Silver Steel, 36" lengths: 1/4", 9/32", 3/8", 1/2" dia., 10/9 lot. Also 13" lengths 1/16" to 1/50" dia., doz. assorted, 5/8.

H.S. Parting Tool Blades, 3/32" x 3/4" x 5", 5/- each.

£2 ORDERS POST PAID

J. M. BURKE

192 Baslow Road, Tottle, Sheffield

TRANSISTOR POCKET RADIOS

BULK PURCHASE ENABLES US TO MAKE THIS FANTASTIC OFFER AND WITH MONEY BACK GUARANTEE! The "BAN REMO" ... so tuned that it brings the voices of star entertainers and vocalists dramatically to life—in your home, office, etc. ... Only 4 1/2 x 2 x 1 1/2 in. fits easily into your pocket or handbag. Works for months off 8d. battery. Should last a lifetime. Anyone can assemble it in an hour or two with our easy plan. Complete set of parts including miniature speaker, carrying case—everything only 32/6 plus 2/6 P. & P. C.O.D. 2/6 extra. (Parts can be bought separately.) Limited period—so order before it's too late.

ONLY 32/6
No more to pay

DEMONSTRATIONS DAILY
CONCORD ELECTRONICS (Dept. B12/1)
210 CHURCH ROAD : HOVE : SUSSEX

INTRODUCING A NEW PORTASS LATHE

33" x 16" B.G.S.C. bench lathe complete with faceplate, catchplate and backplate, changewheels, etc., flat or vee drive. Complete satisfaction or remittance refunded in full. Ex-works write:

CHARLES PORTASS & SON
Buttermere Works, Sheffield 8
Est. 1889 Cash or terms

ROGERS 31/33 NELSON ST. SOUTHPORT

Fibre Washers, 144 Assorted	3/6
Motor Rectifiers, A.C. to D.C.	3/9
Sell Tap Screws, 100 Assorted	3/-
Rectifiers, 6/12 v. at 6 amps.	18/-
Winker Units, 6 or 12 volt	6/6
Motorised Water Pumps	75/-
Instrument Cases, 12in. x 8in. x 6in. New 7/3	
Telephones, New, Modern	18/-
Races, Belts, Valves, Pulleys, Pumps, Brass Steel, Aluminium, etc.	
10 PAGE LIST FREE. STAMP PLEASE	

Practical assistance to students, teachers, engineers and designers...

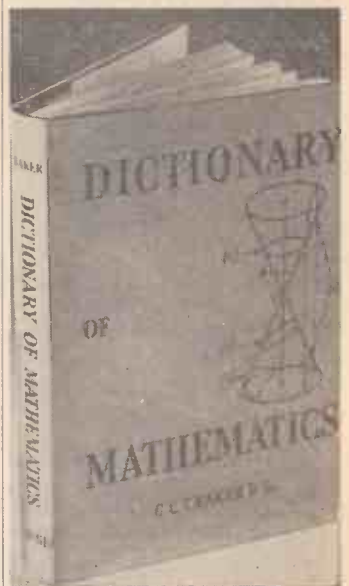

DICTIONARY OF MATHEMATICS

By C. C. T. BAKER, B.Sc.

This concise dictionary provides immediate explanatory reference to hundreds of the most commonly used mathematical terms, theorems, tables, processes and derivations employed in algebra, arithmetic, geometry, trigonometry, co-ordinate geometry and the calculus.

35s. FROM ALL BOOKSELLERS

... or in case of difficulty 36s. 3d. by post from GEORGE NEWNES LTD., Tower House, Southampton Street, London, W.C.2.

NEWNES

SURPLUS BARGAINS

Telephone Handsets. Two in series with battery give two-way intercom. 35/- per pair, post 2/3; Mains Motors from 25/-, post 3/-; Low Voltage Motors from 12/6, post 1/6; Battery Charging Transformers, 15v. and 9v, 1 1/2 Amp., 16/-, post 1/9; Rectifiers to suit above for 12v and 6v Batteries, 6/6, post 1/-; Water Pumps, 17/6, post 2/-. Send 3d. stamp for illus. list of interesting bargains. Money back guarantee.

MILLIGAN'S
2 HARFORD STREET,
LIVERPOOL, 3.

YOUR *Queries* ANSWERED

Making a Kaleidoscope

I WISH to make a kaleidoscope, I have some idea of the principle but do not know the most suitable length and angles.—E. V. Brown (Liverpool).

THE most simple form to give a kaleidoscope is that of an equilateral triangle with three strips of mirror glass, all of equal width and fitting closely together in a tin or cardboard tube, which should be parallel. The ends should be cut square. At the end opposite to that which you look into there should be two pieces of plain clear glass with a space between them. In this space are placed a number of oddly-shaped fragments of coloured glass.

When the tube is rotated the coloured fragments are reflected in all three mirrors and produce very beautiful symmetrical patterns. The degree of beauty and colour effects are dependent upon the shapes and choice of colour in the glass fragments. The principle can be very much elaborated by making the kaleidoscope larger and increasing the number of mirrors. It is also possible to have double sets of coloured fragments.

THE P.M. BLUEPRINT SERVICE

- 12 FT. ALL WOOD CANOE. New Series. No. 1, 4s.*
 COMPRESSED-AIR MODEL AERO ENGINE. New Series. No. 3, 5s. 6d.*
 AIR RESERVOIR FOR COMPRESSED-AIR AERO ENGINE. New Series. No. 3a, 1s. 6d†
 "SPORTS" PEDAL CAR. New Series. No. 4, 5s. 6d.*
 F. J. CAMM'S FLASH STEAM-PLANT. New Series. No. 5, 5s. 6d.††
 SYNCHRONOUS ELECTRIC CLOCK. New Series. No. 6, 5s. 6d.*
 ELECTRIC DOOR-CHIME. No. 7, 4s.*
 ASTRONOMICAL TELESCOPE. New Series. Refractor. Object glass 3in. diam. Magnification x 80. No. 8 (2 sheets), 7s. 6d.*
 CANVAS CANOE. New Series. No. 9, 4s.*
 DIASCOPE. New Series. No. 10, 4s.*
 EPISCOPE. New Series. No. 11, 4s.*
 PANTOGRAPH. New Series. No. 12, 2s.*
 COMPRESSED-AIR PAINT SPRAYING PLANT. New Series. No. 13, 8s.*
 MASTER BATTERY CLOCK.* Blueprints (2 sheets), 4s. Art board dial for above clock, 1s. 6d.
 OUTBOARD SPEEDBOAT. 11s. per set of three sheets.
 P.M. TRAILER CARAVAN.* Complete set, 11s.
 P.M. BATTERY SLAVE CLOCK. 2s. 6d.
 P.M. CABIN HIGHWING MONOPLANE, 1s. 6d.
 THE MECHANIKART, 15s.*

The above blueprints are obtainable, post free from Messrs. George Newnes, Ltd., Tower House, Southampton Street, Strand, W.C.2.

*denotes constructional details are available free with the blueprints

RULES

Our Panel of Experts will answer your Query only if you comply with the rules given below

A stamped addressed envelope, a sixpenny crossed postal order, and the query coupon from the current issue which appears at the foot of this page, must be enclosed with every letter containing a query. Every query and drawing which is sent must bear the name and address of the reader. Send your queries to the Editor, PRACTICAL MECHANICS, Geo. Newnes, Ltd., Tower House, Southampton Street, Strand, London, W.C.2.

The Burning Properties of Peat

COULD you please tell me whether peat has good heating qualities and also does it need other fuel to start it burning and to keep it alight? Is it slow burning?—C. Adams (Cheshire).

PEAT or turf is a rapid-burning material and burns with a glow rather than with a large flame. It gives out plenty of heat, but produces a large amount of voluminous ash, which renders it a "dirty", and an uneconomic fuel for industrial use. The peat lights readily enough by the ordinary methods, using paper and wood to start it. A peat fire is recognised as being a hot one, provided the grate admits adequate air. There are, of course, different grades of peat, just as there are different grades of coal. All peats contain, in addition to woody and fibrous matters, small amounts of bituminous oils, tarry matters and lignite materials which aid the combustion of the fuel.

Removing Tin Deposit

COULD you please tell me how to remove the tin deposit from old copper cooking utensils so that they can be polished for interior decorating purposes.—C. Brown (Liverpool).

TREAT the tinned surface with diluted hydrochloric acid (spirits of salts). This must be done with care for the acid attacks both tin and copper, but its reaction with tin is speedier than that with copper.

Iron Window Frames

MY house is fitted with iron window frames and am troubled with paint peeling off due to rust. Can you advise me how to treat the iron and what kind of paint to use to prevent this trouble in future?—W. Lenning (Glasgow).

YOUR trouble seems to be due either to the use of a very poor quality paint or to the painting over of badly rusted metal frames. It is clear that the rust is proceeding actively underneath the paint layer. There is only one way to stop the trouble. Remove all the paint by scraping and remove all the underlying rust also. This will have to be done by

"Practical Mechanics" Advice Bureau. **COUPON.** This coupon is available until February 31st, 1962, and must be attached to all letters containing queries, together with 6d. Postal Order. A stamped addressed envelope must also be enclosed. Practical Mechanics, February, 1962

patient sandpapering. Having exposed the bare, clean metal, give the latter a coat of priming paint—a red oxide paint will do, but better still would be a coat of a metallic lead paint, which you should be able to obtain from any good paint store. The metallic lead has a powerful inhibitory effect on the rusting of the iron. Having given a coat of the priming paint, allow it to set hard, then repeat the coat. Finally, apply two separate coats of the finishing paint of your choice. All coats of paint should be put on thinly, since, in all probability, the window frames will not close properly if the paint coats add too great a thickness.

Silica Gel

CAN you please answer the following: What is silica gel? What are its applications? When does it require reactivation and how is it reactivated—F. Holden (Lancs).

SILICA gel is an amorphous form of hydrated silica. It is produced by the electrolysis of sodium silicate solution or by the treatment of such solution with acid. In this water, a colloidal form of hydrated silica is obtained, which latter polymerises to give a "gel" or a jelly-like substance. This is the "silica gel". When freshly prepared, it appears as a gelatinous mass but, on standing, it sets to a solid mass which (when it contains less than 75% of water) is very friable or powderable and can thus readily be ground or pulverised. Usually the material is carefully heat-treated in order to dehydrate it completely. It is then pulverised and graded according to its particle size.

The uses of silica gel follow from its extraordinary activity as an absorbing agent. The gel will not only absorb fumes and gases, but it will also absorb impurities from liquids. Still more, it will rapidly absorb moisture from air and other substances. It has been estimated that one part of silica gel will often absorb about 300 parts of moisture or other contaminating impurity from its surroundings. When

the gel has acquired its full complement of absorbed material it must be "reactivated". This, in some cases, is effected by dissolving out the impurities but, more ordinarily and especially in the case of absorbed moisture, the reactivation of the gel is carried out merely by heating it so as to drive the moisture off.

Principle of a Stereoscope

COULD you please let me know the principle of a stereoscope and how I could make a simple one?—F. Perks (London, E.S.1).

THE principle of the stereoscope lies in the fact that two photographs are taken of the same subject from viewpoints separated by a distance of from 2½ in. to 3½ in. When the prints from the negatives are mounted side by side and placed in the stereoscope they are looked at with both eyes simultaneously; the left eye sees one picture and the right eye the other, and the effect is that of looking at the same relief and distance as was seen by the photographer's eyes when he took the picture of the actual subject.

To make a stereoscope, the first thing to do is to obtain a pair of lenses, double convex, of approximately 6 in. focus with a diameter of 1½ in. These are mounted in holes cut in a plywood panel 2½ in. apart, centre to centre. Below these holes and midway between them a gap is cut to accommodate the nose of the observer. From this panel another piece of plywood, at right-angles to it, extends backwards from about 8 in. and on this a suitable stage is made to slide. This stage is merely a support for the stereoscopic pictures and must be capable of holding the pictures in an upright position and parallel with the lenses in the first panel. The sliding of the stage is necessary in order to meet differences in the focus of the eyes of various observers. Underneath the horizontal strips of plywood a handle may be fitted for holding.

A Mechanical Designing Device

(Continued from page 220)

should be fine—rests firmly on the table but, as a precaution, place a small piece of scrap paper under the point so that movement when locking it in position does not mark the sheet on which the design is to be produced.

It will probably be found necessary to exert slight pressure on the pen-holder with one hand while turning the handle with the other. Aim for a smooth, even rotation rather than a speedy one; in fact, too much speeds put an unnecessary strain on the pen and may result in an unsymmetrical delineation.

Until one becomes thoroughly acquainted with the almost unlimited compass of the machine, it is a good idea to keep specimen copies of the designs produced with the guide rod in various eccentric holes and guide rail divisions. Do not forget, too, that the pen can be moved along the rod. Thus, the number of designs and their combinations can be considered as practically infinite.

Giant Telescope

(Continued from page 218)

Yet another kind of radio telescope has been built for the University of Illinois. Once again it has a fixed reflector, this time in the shape of a parabolic-cylinder. By using this shape of reflector and adjustable receiving apparatus it will be possible to receive radio signals from a large area of the sky.

To build the telescope a small valley was found near Danville, Illinois, and by digging away some of the valley the shape for the 400ft by 600ft reflector was carved out ready for the wire mesh which concentrates the radio signals on to the feed system.

As at Arecibo this feed system is high in the air above the reflector. It is hung beneath a 425ft wooden beam which is itself supported by four 153ft high wood towers. Wood was used because it did not scatter as many of the radio waves, even the bolts were made of plastic impregnated wood.

Chief task of this instrument will be the mapping of the faint radio sources far out beyond our own galaxy. It is a vital task if the radio astronomer is to penetrate far into the depths of space.

SALES AND WANTS

The pre-paid charge for small advertisements is 9d. per word, with box number 1/6 extra (minimum order 9/-). Advertisements, together with remittance, should be sent to the Advertisement Director, PRACTICAL MECHANICS, Tower House, Southampton Street, London, W.C.2

MISCELLANEOUS

AQUALUNG AND COMPRESSOR Equipment, Ballraces and Miscellaneous items. Lists 3d. DRYCOE, 157 Malden Road, Cheam, Surrey.

VENNER TIME SWITCHES reconditioned 14 days. 25/-. For Car Lights, Fish Tanks, Charging. **BATCHELORS**, 4 Park Road, Bromley, Kent.

Protect your house with "LITON" Photoelectric Burglar Alarm

Easy to build, Safe, Foolproof. Kit of parts, £4.12.6; built, £5.10.0. Battery model: Kit, 65/-; built, 72/6. Also Garage Door Opener, Light Saver, Customer Announcer etc. Send Is. stamp for new 12-page CONSTRUCTION MANUAL to "ST. JOHN'S RADIO", 3 Jews Row, London, S.W.18

FOR SALE

HYPODERMIC SYRINGES, brand new 2cc. Sima, excellent for oiling etc., 4/9 each. Also needles, sizes 12, 17 and 18 at 4/- per dozen. **G. ROGER SMITH**, 16 Clyde Street, Liverpool 20.

8mm. double run film, 25ft., lengths fast pan (29° sch) or slow pan (27° sch) not process paid, not spooled, 6/8 each. 16mm. ex-government film manufacture date 1965/59, 300ft., tins containing 6 x 50ft. rolls, 30/- each plus 1/6 post. This film is slow pan and can be successfully reversed. Single rolls of 50ft. ditto 6/- ea. plus 6d. post. Brand new Dallmeier 4in. projection lenses especially designed for 35mm. transparency projectors, but will cover up to 2 1/2in. square, original price 27, only 23, post 1/6. 2in. Bi-Convex Glass Condensers, 2/6 each, post 6d. Episcopes from 2/0 each.

Brand new Avominor moving coil Multirange A.O./D.E. Test Meters (ex.M.O.S.) solid hide case with shoulder strap, leads and test leads, in original tropical packing list over £11, price £5, post 2/6. Brand new Kodak (ex Admittal) 7 x 50 Prismatic Telescopes, focusing in fitted wooden case with binocular eyepiece, fitted filters, cost over £50 due to another huge purchase, lower than ever price, 64.10s each, carriage 5/-.

Brand new (ex A.M.) 12 volt 25 amp batteries. These are R.A.F. general purpose lead acid accumulators, and are similar in construction to normal car battery. Very suitable for cars and vans, will start any vehicle. Never been filled and in original tropical packing. First charge instructions included, cost about £10, only £2.10.0. each, carriage 5/-.

Ex Admiralty brand new Pocket Stopwatches by Waltham and Smiths. Fully jewelled movement, 1/5th second, 60 seconds per rev., 30 minute recorder dial, winding button start, stop and re-set, value £8, 45/-, post 2/-. Ditto, tarnished cases, but brand new 37/6. plus 2/- post.

Ex Admiralty brand new Pocket Stopwatches. Waltham 6 seconds per rev., no recorder dial, accuracy greater than 1/10th second, jewelled movement, in original box, winding button start, stop and re-set, cost over £12, 10s. 6d., post 2/-.

Ex R.A.F. Aerial Film. 9 1/2in. x 300ft. Pho. £3. 10/6. 35/-, 5 1/2in. x 275, 8s. 2d. 5/6. Ideal for cutting to smaller sizes. Perfect condition. Post 1/6.

Ex A.M. OGS Mark 3 Recorder Camera. 16mm. made by Specto. Latest model with three shutter speeds, 2 or 16 f.p.s. bloomed 1 1/2in. lens F1.9 with iris to F.16, 24 volt, 50ft. magazine loading, complete with magazine in original tropical packing, absolutely brand new, only £5, post 2/6. Ditto used £3.10s., post 2/6.

All goods supplied on 14 day money back guarantee.

R. SANKEY, Regal Cinema, **ATHERSTONE** **WARWICKS.** Tel.: Atherstone 2220/8210.

Ex A.M. G.45 Gun Camera. 24 volt, 2in. fixed focus lens 50ft. magazine loading, complete with magazine, new £2.15.0., ditto used £2. Both post 2/6.

FOR SALE

(continued)

ALUMINIUM LADDERS/STEPS. Gigantic offer. 400 models.—**SANCO LTD.**, 17 (PM) Boundary Road, Hove.

ASTRO TELESCOPE making. Standard Ramsden Push-in. Eye-pieces, 1 1/2in., 1 1/4in., 1 1/8in., focus, 35/-; with R.A.S. thread, 42/6 each. S.A.E. lists, Object Glasses, Newtonian Mirrors, Diagonal Mounts, Focusing Mounts, Tripods, Mountings and Terrestrial Telescopes. **W. BURNETT**, Grand Sluice, Boston, Lincs.

- ★ CHEMISTRY SETS ... 15/-
 - ★ CHEMICAL PACKS ... 6/-
 - ★ APPARATUS PACKS ... 7/6
- All Post Free

Send Stamp for Leaflet—
H. STORER (Dept. P.M.)
67 CLOPTON ROAD
SHELDON, BIRMINGHAM 33

WATZA BOBPAK?? It's a 1/-'s worth of almost any nut, screw, washer or bolt etc. Send for list of approx. 3,000 Bobpaks. **K. R. WHISTON** (Dept. BPM), New Mills, Stockport.

HOBBIES

CATALOGUE NO. 14. Government Surplus and Model Radio Control. over 500 illustrated items, 2/6 (refunded on purchase). **ARTHUR SALLIS RADIO CONTROL**, North Road, Brighton.

NEWTONIAN TELESCOPE making. 6in., 8 1/2in., 1 1/2in. Glass discs, Grinding Kits, Plano-convex lenses, Optical flats, Ramsden eye-pieces, Barlow lenses. S.A.E. for lists. **L. J. MAYS**, 20 Clover Rd., Timperley, Altrincham, Cheshire.

NEW CHEMISTRY sets for Boys, harmless, entertaining, instructive, 15/- post free. **STORER (Dept P.M.)**, 67 Clopton Road, Sheldon, B'ham.

HANDICRAFTS

MARQUETRY VENEERS, twelve assorted 5/-, post free. Send 3d. for list. **FRANK COLES (VENEERS)**, 78 Rivington Street, E.C.2.

WOODWORKING

SAWBENCHES — 6in. to 30in. from £9. Motorised £16, Petrol Portable £29, Bandsaws £14, Loggin Benches, Bundlers, Splitters, Planers, Lathes, Spindle Assemblies, Motors, Engines. Deferred Terms. Send 2/-, returnable for 40 page Catalogue and Bargain offers. List Free. **BEVERLEY PRODUCTS**, South Thoresby VSC, Alford, Lincs.

SIX-INCH SAWPLANE £16/10/-, write for brochure from: **EAST ANGLIAN TRADING CO.**, 5 Guardian Road, Norwich.

HOME BOAT BUILDING

FULLY PREFABRICATED Kits to Assemble a Boat at Home, for two-berth Cabin Cruisers, fast runabouts, canoes, prams, Enterprise sailing dinghies. Leaflets from: **WYVERN BOATS (WESSEX) LTD.**, Milborne Port, Sherborne.

BROMLEY BOATS, Kits, Mahogany, Silver Spruce, American Boat plans, 3d. list. Southlands Road, Bromley, Kent.

TOOLS

JUST RELEASED — EX-W.D. SETS. Ten A/F Sockets, 9/32in. Drive. 3/16in. to 7/16in. Five accessories. Special Metal Box. Fits most B.A. and smaller Metrics. New unused. Refund guarantee. Details on request. £2 each, post free.

A.C.R. SUPPLIES

5 Queen Street, Manchester 2,

SAVE POUNDS

AT OUR NEW

TOOL BAR

AN EXTRA HAND



10" adjustable grip wrench with an automatic self locking tension release. Leaves both hands free. Makes so many OUR PRICE awkward jobs easier. High 7/6 2/- grade—heavy duty tool.

Set of Chrome Vanadium RING SPANNERS



fits 6 nut and bolt sizes 1"-1 1/4" Whitworth and six nut and bolt sizes 3/16"-7/16" B.S.F. (also available in A/F and Metric). Worth 25/- OUR PRICE 10/6 2/-.

WRENCHES 3 FOR THE PRICE OF ONE



Set of first-class adjustable Wrenches—4", 6" & 8" sizes. Today's value 37/6. 17/6 p.&p. OUR PRICE 1/6.

Lists of all our tools are available on request.

J.D. SWAIN

(Dept. PMC 1)
47 Goldhawk Road, London, W.12

TOOLS

(continued)

BRAND NEW TOOLS

EX-GOVT. & SURPLUS BARGAINS

- 50 Ace Drill Chucks $\frac{1}{8}$ " capacity, No. 1 Morse Taper Shank. Price 7/-.
- 25 Knurling Tools, 2-Wheel Floating Head. Price 25/-.
- 50 Thread Gauges Whitworth/B.S.F., 23 Blades, 4-52 Threads. Price 3/6. 1,000 Precision Needle Files, 6 assorted. Price 4/6.
- 500 4" Hand Files, 6 assorted. Price 5/-.
- 75 Sets Left Hand B.S.F. Tap and Die. Each size $\frac{1}{16}$, $\frac{1}{8}$, $\frac{3}{16}$, $\frac{1}{2}$ ". Price 16/-.
- 50 Model Makers Rotary Files, sets of 12 in Plastic Case. Price 12/-.
- 25 Pairs Vee-Blocks 3" x 1" x 2". Price 20/- pair.
- 300 H.S.S. Slitting Saws, 2" dia., 1" bore, 4 assorted. Price 9/-.
- 100 Sets Circular Standard Split Dies B.S.F. or Whitworth, one each, size $\frac{1}{16}$ ", $\frac{1}{8}$ ", $\frac{3}{16}$ ", $\frac{1}{2}$ ". Price 30/- per set.
- Torque Wrenches, $\frac{1}{2}$ " sq. drive 0-100 ft./lb. Price 65/-.
- 200 H.S.S. Centre Drills one each size $\frac{1}{16}$ ", $\frac{1}{8}$ ", $\frac{3}{16}$ ", $\frac{1}{2}$ " and $\frac{3}{4}$ ". Standard Types. Price 10/-.
- 50 Precision Pliers 4" Box Joint. Ideal for Model Work. Flat Nose 9/3. Snipe Nose 9/3. Round Nose 9/3. Diagonal Side Cutters 11/6. Top Cutting 13/-. 100 Die-stock 1". Price 7/-.
- 150 Super H.S.S. Parting Tool Blades, height $\frac{1}{8}$ ", width $\frac{3}{16}$ " or $\frac{1}{2}$ ", length 6". Price 5/- each.
- 144 Super H.S.S. sq. x 2" Tool Bits. Ground ALL SIDES. Price 2/6 each. P.S. Stubbs Silver Steel. Round x 13" lengths. Parcel one each size $\frac{1}{16}$ ", $\frac{3}{16}$ ", $\frac{1}{2}$ ", $\frac{3}{4}$ ". $\frac{1}{16}$ " x $\frac{1}{16}$ ", $\frac{3}{16}$ " x $\frac{1}{16}$ ". Price 15/- a parcel. All Tools supplied on Approval against Cash with Order.

Please add 1/6 on Orders under 40/- towards postage.

A. E. KING

152 HALFWAY STREET, SIDCUP, Kent

WATCHMAKERS

NEW WATCHES, watch movements, Watchmakers' tools and materials, Instructional books, etc., at unbeatable prices. Also watch repairs undertaken. Send 1/- for Bumper Bargain Catalogue. The Watchmakers Supply Company, "Time House", Carterton, Oxford.

WATCH PARTS

FOR ALL makes of Watches, Tools, Instructional Books, etc., Special Kits for Beginners send 6d. for "Super Bargain Catalogue". T. G. LOADER (Dept. B.), Watchmakers' Mail Order Service, Milestone Road, Carterton, Oxford.

FOR WATCH and Clock materials, Bracelets, Straps and Watches, try J. J. LAWSON, 95 Godwin Street, Bradford 1. (Tel.: 32075.) Free lists on request.

PHOTOGRAPHY

BELLOWS, CAMERA, Enlarger, Process, Industrial Collapsible Machine Guards. BEERS, 4 St. Cuthbert's Road, Derby. (Tel.: 41263.)

PROJECTORS. Home Assembly Kits all types and sizes and Stereo from £6/2/6. Fan Base Kit £3/7/6. Opticals, Screens, S.A.E. MARSHALL SMITH LTD., 64 Norwich Avenue, Bournemouth.

ELECTRICAL

SMALL ELECTRIC CIRCULATING PUMPS

Suitable for Washing Machines, Pot Washers, Fish Tank Aerating, Garden Fountain or Waterfalls, etc. Comprising 120 watt shaded pole A.C. motor coupled to centrifugal pump. Maximum delivery, 250 g.p.h. Maximum head, six feet. Suitable for continuous running on 200/240 volts. Silent running. New, not surplus. Price £3, postage 3/-. H. Middleton, 639 Abbeydale Road, Sheffield 7.

ALL TYPES of Electrical Goods at extremely competitive prices, e.g., 5 amp Twin Cable, 35/- 100 yards; Lampholders 7/- doz; 5ft Batters 49/-. Quality and immediate dispatch guaranteed. Request list, J.G. FLOW SUPPLIES, 93 Fairholme Road, London N16. (Tel.: Stamford Hill 4384.)

SPECIAL OFFER OF ELECTRIC MOTORS

$\frac{3}{4}$ h.p., 2,850 r.p.m., single phase, 220-240 v., standard foot mounting, $\frac{1}{2}$ in. diam. shaft, ideal for driving up to a 10in. circular saw, latest type well known make, fully guaranteed, makers list price £12.40. Huge purchases and profit slashing allow us to offer at the bargain price of £8.10.0. Money back guarantee. S.A.E. for lists.

P. BLOOD & CO. (Dept. E.M.)
ARCH STREET, RUGELEY, STAFFS.

Cut your Cost of Living

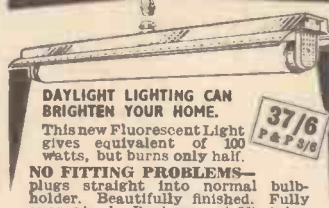

J.D. SWAIN Ltd

Dept. PMC2, 47 Goldhawk Road, London, W.12.

RADIO

RADIO, TELEVISION Service Sheets. All types valves. S.A.E. list. JOHN GILBERT RADIO, 20 Extension Shepherd's Bush Market, London W12. SHE 3052.

PATENTS

PATENTING SERVICES, Advice Qualified agent. C. L. BROWNE, 114 Greenhayes Avenue, Banstead, Surrey.

SITUATIONS VACANT

A.M.I.Mech.E., A.M.Brit.I.A.E., City and Guilds, G.C.E., etc., bring high pay and security. "No pass — no fee" terms. Over 95% successes. For details of exams and courses in all branches of Engineering, Building, Electronics, etc., write for 148-page handbook free. B.I.E.T. (Dept. 967B), London W.8.

EDUCATIONAL

"HOW AND WHY" of Radio and Electronics made easy by a new, non-maths, practical way. Postal instructions based on hosts of experiments and equipment building carried out at home. New courses bring enjoyment as well as knowledge of this fascinating subject. Free brochure from Dept 12 P.M., RADIOSTRUCTOR, Reading.

POSTAL TUITION in Technical Drawing, tracing and blueprint reading, Drawing and Design in wood or metal work for handicraft Teachers' Examinations. Details from C. PANNELL, 145 The Crossway, Portchester, Hants.

ELECTRONICS!

Key to YOUR Future?

An exciting career—a new Hobby—
Your own spare or full-time BUSINESS?



New experimental course includes big kits for building test gear and complete AM/VHF receiver.

FREE BROCHURE FROM
RADIOSTRUCTOR
DEPT. E80, READING, BERKS.

3-TRANSISTOR
POCKET RADIO

WITH MINIATURE LOUDSPEAKER
ABSOLUTELY NO SOLDERING REQUIRED

UNIQUE DESIGN

39/6 Superb appearance.

Simple instructions—
Built in an evening.
No drilling, no soldering. Complete in every detail. Receives entire broadcast

band. Aerial required certain areas—
Pocket size $4\frac{1}{2}$ x $2\frac{1}{2}$ x $1\frac{1}{2}$ in.

Or the more powerful
SAVOY SUPER 3. 55/6
Three transistors and two diodes in a five-stage reflex circuit. Dimensions as above.

ALL PARTS SOLD SEPARATELY
Battery 1/- extra. P. & P. 2/-

SAVOY ELECTRONICS LTD.
15 Maiden Lane, Strand, London, W.C.2
(Back of Adelphi Theatre).

Automatic (Time) Switches

New and reconditioned 15 day clockwork and electric switches

from 35/-

Send S.A.E. for illustrated details to:

DONOHUE (TIMERS)
1 & 2 UPPER NORFOLK ST., NORTH
SHIELDS, NORTHUMBRLAND

SPECIAL HEAT RESISTING GRADE P.V.C. HEATING CORDS, Nylon centre, Copper/Nickel conductor, woven glass braided. For soil warming, under-carpet heating, frost-free pipes, etc., etc. Supplied in 12, 15, 25 and 30 ohms/yard. Price 1/- per yard, post free.



NEON ILLUMINATED INDICATOR SWITCH 2 amps, 240 v. A.C. 10/6 each, post free.
FIT THIS TO YOUR ELECTRIC BLANKET AND BRING IT UP TO DATE

THERMOSTATS. BW/1, 5 amps, 15/6. Post 8d. SN/40 1/2 amp., 5/6. Post 6d. C.S. Convector Thermostat, 15 amps, 25/- . Post 10d. Model MB for Immersion Heaters, 15 amp. £2. Post 2/-. PF Room Thermostat, 15 amps, £2. Post 1/-. M.L. Greenhouse Thermostat, 10 amps, 35/- . Post 1/-. P.J. Miniature Thermostat for Hotplates, 5 amps, 9/3. Post 9d.

REPLACEMENT ELEMENTS for electric fires, irons, toasters, kettles, convect. heaters, washboilers, etc.

TELEVISION SUPPRESSOR KIT, for appliances up to 1 amp., 3/6. Post Free.

BI-METAL. Hi-Flex 45 3/16 in. x .010, 6d. per foot. Standard 1 1/2 in. x 3/16 in. x .036, 6d. Plus postage.

MAGNETS. Sintered Bar Magnets of great power and stability 1/2 in. x 3/16 in. x 1/16 in., 9d. each. 8/- doz. Post 9d.

CAR HEATER ELEMENT, 6 in. x 1 1/2 in. 200/250 v. 100 w. 6/- each.

THE TECHNICAL SERVICES COMPANY, Banstead, Surrey
 We can list only a few items in this space. Send 6d. in stamps for Catalogue and S.A.E. for enquiries.

GAMAGES

NEW AND ENLARGED TOOL DEPT.

The Gamage "16" Electric ARC WELDER

Suitable for garage and maintenance work, agricultural machinery, heating engineers, ornamental iron or blacksmith's work, handicrafts or the home workshop

For joining Ferrous Metals not less than 16 gauge (or 1/16 in.) thick, and if necessary, up to 1/2 in. thick by repeat runs after preparation. Robustly constructed throughout. Air cooled, Dimensions approx. 10 x 13 x 8 in. Weight approx. 50lb. Incorporates a heavy-duty transformer and is complete with cables, welder's equipment, electrodes and instructions.



Will not weld thinner than 1/16 in. For 190/250v. single-phase A.C. 10 to 15 amps domestic supply. Runs 16 S.W.G. rods continuously.

BARGAIN PRICE £15/10/0

Or 12 Monthly Payments of **27/3**

If outside our extensive van delivery area Part Carr. and Pkg. 7/6 in Gt. Britain.

A COMBINED ARC WELDING AND BRAZING MACHINE
 New and improved model. Brazes light sheet down to 26 S.W.G.—invaluable for work on car bodies. Even a novice can operate this carbon brazing contact method.

£25 Or 12 Monthly Payments of **43/9**
 Carr. Paid in G.B.

Tool and Car Accessory List Free

GAMAGES, HOLBORN, LONDON, E.C.1.—HOL 8484

every door tight shut!

- SIMPLE TO FIX—NO WOODWORKING ALTERATIONS
- PERMANENT IN POWER—WILL NOT FATIGUE OR FALL
- SELF-ALIGNING FLOATING MAGNET
- NO WORKING PARTS TO OIL OR SERVICE
- ALUMINIUM CASING & PLATED KEEPER AVOID RUST

No. 870 For use on kitchen or bathroom cabinets & cupboard doors

No. 871 For use on heavier hinged or sliding doors



Eclipse Magnetic DOOR CATCH

Made by James Neill & Co. (Sheffield) Ltd.
 and obtainable from all tool distributors

PM61

THE "ULMIA" MITRE SAW

Cuts with precision, Mitres, Half Mitres, Quarter Mitres and Squares

A real necessity for accurate picture framing

- ★ CUTS RIGHT AND LEFT HAND
- ★ SPRING LOADED STOP AT ALL ANGLES

No. 1 cuts up to 2" x 2" - £6 0 0
 No. 2 cuts up to 4" x 4" - £11 11 0
 No. 3 cuts up to 6" x 6" - £16 5 0

Carriage Paid

JUST OUT
 Our new folder of "Zyts" Toolkits Free and post free Get your copy now

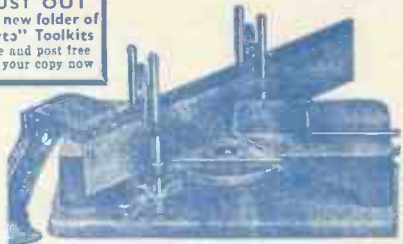

Send P.C. for illustrated folder on "Tools for Mitring"

S. Tyzack & Son Ltd

ONLY LONDON ADDRESS

341-345 OLD STREET, LONDON, E.C.1

★ Telephone: Shoreditch 8301 (10 lines)

Free Guide — SUCCESS IN ENGINEERING

One of the following Courses taken quietly at home in your spare time can be the means of securing substantial well-paid promotion in your present calling, or entry into a more congenial career with better prospects.

132-PAGE BOOK FREE! SEND FOR YOUR COPY

ENGINEERING, RADIO, AERO, ETC.

Aero. Draughtsmanship	Elec. Draughtsmanship
Jig & Tool Design	Machine " "
Press Tool & Die Design	Automobile " "
Sheet Metalwork	Structural " "
Automobile Repairs	R/F Concrete " "
Garage Management	Structural Engineering
Works M'gmt. & Admin.	Mathematics (all stages)
Practical Foremanship	Radio Technology
Ratefixing & Estimating	Telecommunications
Time & Motion Study	Wiring & Installation
Engineering Inspection	Television
Metalurgy	Radio Servicing
Refrigeration	Gen. Elec. Engineering
Welding (all branches)	Generators & Motors
Maintenance Engineering	Generation & Supply
Steam Engine Technology	Aircraft Mainten. Licences
I.C. Engine Technology	Aerodynamics
Diesel Engine Technology	Electrical Design
	Ordnance Survey Dr'ship

BUILDING AND STRUCTURAL

L.I.O.B.	A.I.A.S.	A.R.S.H.	M.R.S.H.
A.M.I.P.H.E.	A.A.L.P.A.	A.R.S.	A.R.I.C.S.
Building Construction	Builders' Quantities		
Costs & Accounts	Carpentry & Joinery		
Surveying & Levelling	Building Inspector		
Clerk of Works	Building Draughtsmanship		
Quantity Surveying	Heating and Ventilating		

GENERAL, LOCAL GOVERNMENT, ETC.

Gen. Cert of Education	Common. Prelim. Exam.
Book-keeping (all stages)	A.C.I.S., A.C.C.S.
College of Preceptors	A.C.W.A. (Costing)
Woodwork Teacher	School Attendance Officer
Metalwork Teacher	Health Inspector
Housing Manager (A.I.H.Sg.)	Civil Service Exams.

BECOME A DRAUGHTSMAN — LEARN AT HOME AND EARN BIG MONEY

Men and Youths urgently wanted for well paid positions as Draughtsmen, Inspectors, etc., in Aero, Jig and Tool, Press Tool, Electrical, Mechanical and other Branches of Engineering. Practical experience is unnecessary for those who are willing to learn—our Guaranteed "Home Study" courses will get you in. Those already engaged in the General Drawing Office should study some specialised Branch such as Jig and Tool or Press Tool Work and so considerably increase their scope and earning capacity.



★ OVER SEVENTY YEARS OF CONTINUOUS SUCCESS ★

NATIONAL INSTITUTE OF ENGINEERING

(In association with CHAMBERS COLLEGE—Founded 1885)

(Dept. 29)

148, HOLBORN, LONDON, E.C.1

SOUTH AFRICA: E.C.S.A., P.O. BOX NO. 8417, JOHANNESBURG
AUSTRALIA: P.O. BOX NO. 4570, MELBOURNE

This remarkable FREE GUIDE explains:

- ★ Openings, prospects, salaries, etc., in Draughtsmanship and in all other branches of Engineering and Building.
- ★ How to obtain money-making technical qualifications through special RAPID FULLY-GUARANTEED COURSES.

MANY INTERESTING COURSES TO SELECT FROM!

A.M.I.Mech.E., A.M.I.M.I.,
A.M.Brit.I.R.E., A.M.I.P.E.,
A.M.I.C.E., A.M.I.Struct.E.,
A.M.I.Mun.E., M.R.S.H.,
A.M.I.E.D., A.F.R.Ae.S.,
London B.Sc., Degrees.

Fully guaranteed postal courses for all the above and many other examinations and careers. Fully described in the New Free Guide.



THE ACID TEST OF TUTORIAL EFFICIENCY SUCCESS—OR NO FEE

We definitely guarantee that if you fail to pass the examination for which you are preparing under our guidance, or if you are not satisfied in every way with our tutorial service—then your Tuition Fee will be returned in full and without question. This is surely the acid test of tutorial efficiency.

If you have ambition you must investigate the Tutorial and Employment services we offer. Founded in 1885, our success record is unapproachable.

ALL TEXTBOOKS ARE SUPPLIED FREE
PROMPT TUTORIAL SERVICE GUARANTEED
NO AGENTS OR TRAVELLERS EMPLOYED



Free Coupon

To: NATIONAL INSTITUTE OF ENGINEERING
(Dept. 29), 148-150, Holborn, London, E.C.1

Please Forward your Free Guide to

NAME

ADDRESS

My general interest is in: (1) ENGINEERING
(2) AERO (3) RADIO (4) BUILDING
(5) MUNICIPAL WORK

(Place a cross against the branches in which you are interested.)

The subject of examination in which I am especially interested is

To be filled in where you already have a special preference.
(2d. stamp only required if unsealed envelope used.)

SEND OFF THIS COUPON NOW AND BE ALL SET FOR SUCCESS

FOUNDED 1885 - FOREMOST TODAY