

97. Baloo Lane

PRACTICAL MECHANICS AND SCIENCE

DEC 1962

2/-

AIR CUSHION TRANSPORT



Also Inside

POWER MODEL AIRCRAFT
HOW SPACE SHIPS ARE TESTED
TOOLS FROM FILES

SAVE MONEY AND
ENJOY YOURSELF

Heathkit
DAYSTROM

BUILDING ANY
OF OUR MODELS

Even if you are an absolute beginner,
you can build any Heathkit model!

We guarantee that NO electronic or soldering experience is necessary. Our simple well illustrated manual guides you step-by-step.



S-33

6 W. STEREO AMPLIFIER. Model S-33. A versatile, high-quality, self-contained STEREO/MONAUERAL Amplifier. 3 watts per channel. 0.3% Distortion at 2.5 w. per Channel. Inputs for Radio (or Tape). Gram ... £13.76

AUDIO SIGNAL GENERATOR. Model AG-9U. 10 c/s-100 kc/s, switch selected. Distortion less than 0.1%. 10 v. sine wave output metered in volts and dB's ... £21.96

VALVE VOLTMETER. Model V-7A. Measures volts to 1,500 (D.C. and R.M.S.) and 4,000 pk to pk. Res. 0.1Ω-1,000 MΩ. D.C. impedance, 11 MΩ, with test prods, leads and standardising battery ... £13.18.6

TELEPHONE AMPLIFIER. Model TTA-1. "Free-hand" operation; portable and self-contained. 9 v. battery. Elegant ivory toned cabinet ... £7.96

5in. OSCILLOSCOPE. Model O-12U. Wideband amplifiers ideal for TV servicing. F.M. alignment, etc. Vertical frequency response 3 c/s-5 Mc/s without extra switching. T/B covers 10 c/s to 500 kc/s. ... £38.10.0

PORTABLE SERVICE SCOPE. Model OS-1. A compact, portable oscilloscope, ideal for servicing and general laboratory work. Uses printed board circuitry. 2 1/2 in. CRT. Size 5 x 8 x 1 1/4 in. long. £19.19.0

SHORTWAVE TRANSISTOR PORTABLE. Model RSW-1. Two short bands, crawler and medium. £22.8.0

SINGLE CHANNEL AMPLIFIER. Model MA-12. 10-12 watt Hi-Fi amplifier. Extremely low distortion and wide frequency range ... £11.9.6

HI-FI AM/FM TUNER. Tuning range: FM:89-103 Mc/s. AM: 16-50, 200-550, 900-2,000 m. Tuning heart (£5.5.6 incl. P.T.) and I.F. amplifier (£20.13.0) sold separately. Printed circuit board ... Total £25.18.6

HI-FI 18W STEREO AMPLIFIER. Model S.99. 9 w. per channel, Ganged controls. Stereo/Monaural, Gram, Radio, and Tape Recorder inputs. Push-button selection. Grey metal cabinet. Printed circuit construction ... £27.19.6

TAPE RECORDING/PLAYBACK AMPLIFIER
Stereo (TA-IS) £24.10.0 Monaural (TA-1M) £19.2.6

6-TRANSISTOR PORTABLE
Model UXR-1. Pre-aligned I.F. Transformer, printed circuit and a 7 x 4in. high flux speaker. Covers both Med. and Long Wavebands. Has attractive leather case with gold relief. Can be assembled in 4 to 6 hours ... £14.3.0



UXR-1

THE "MOHICAN" GENERAL COVERAGE RECEIVER. Model GC-1U. Fully Transistorised. Frequency 580 kc/s min., 30 Mc/s max. in 5 bands ... £39.17.6

AMATEUR TRANSMITTER. Model DX-40U. From 80-10 M. Crystal controlled. Power input 75 W. C.W., 60 W. peak, controlled carrier, phone. Output 40 W. to aerial ... £33.19.0

SINGLE SIDE BAND ADAPTOR. Model SB-10U. May be used with most A.M. Transmitters with certain provisions ... £39.5.0

HI-FI F.M. TUNER. Model FM-4U. Available in two units which for your convenience are sold separately. Tuner unit, FMT-4U £3.2.0. Amplifier and P.S. FMA-4U £11.11.0. ... Total £15.8.0

ELECTRONIC WORKSHOP KIT. Model EW-1. Will help your child to understand electronics, by making at least 20 exciting experiments, including Transistor Radios, Intercom, Burglar Alarm, etc. ... £7.18.0

VARIABLE FREQUENCY OSCILLATOR. Model VF-1U. Calibrated 160-10 m. Output on 160 and 40 m. ... £11.17.6

TRANSISTOR INTERCOM. Models XI-1U and XIR-1U. Ideal for office or home. Each Master operates up to 5 remotes. 9 v. battery operated. ... £10.19.6

Model XI-1U (Master) ... £4.7.6

Model XIR-1U (Remote) ... £11.5.0

HI-FI SPEAKER SYSTEM. Model SSU-1. Easily assembled. Twin speakers and balance control in a ducted port reflex cabinet, suitable for STEREO or MONO. (Legs 1 1/4 optional extra). ... £11.5.0

STEREO CONTROL UNIT USC-1. Luxury model with inputs to suit any pick-up ... £19.10.0



TTA-1



O-12U



S-99



AM/FM Tuner



TA-11



MALVERN

Assembled models also available - prices on request.
Deferred terms available over £10. Free Delivery U.K.

HI-FI EQUIPMENT CABINETS. Range available to meet various needs. Details on request. (MALVERN equipment cabinet illustrated on the left) from £11.12.6 to £18.10.0.

STEREO HEAD PREAMPLIFIER USP-1. Ideal for boosting tape-head output and low output pick-ups (e.g. Decca fss) ... £7.7.6

AUDIO & DO-IT-YOURSELF
accessories also available

"COTSWOLD" HI-FI SPEAKER SYSTEM. Acoustically designed enclosure "in the white" 26 x 23 x 15 1/2 in. 12in. bass speaker with 2in. speech coil, elliptical middle speaker. Complete with cross-over unit, level control, etc.
COTSWOLD MFS SPEAKER SYSTEM. A minimum floor space model. Size: 36in. high x 16 1/2 in. wide x 14 1/2 in. deep, with performance similar to the standard model. Specially designed for small rooms. Either model ... £23.4.0



COTSWOLD

FREE BRITISH HEATHKIT CATALOGUE

Please send me FREE CATALOGUE (Yes/No) _____

Full details of model(s) _____

NAME _____

ADDRESS _____

PM-12

DAYSTROM LTD.

Dept. PM.12, GLOUCESTER, ENGLAND

A member of the Daystrom Group, manufacturers of the
WORLD'S LARGEST-SELLING ELECTRONIC KITS



**IN THE DARK
ABOUT
DEVELOPING?**

It is much easier than you think to develop your own films and this new UNIVERSAL tank from Johnsons makes it easier still. You only have to load the film in the dark, the rest of the job—developing, fixing and washing—is carried out in the light. Everything has been designed for ease of manipulation and the tank is adjustable for several widths of film—120/620, 127, 35 mm./828 or 16 mm. (5 feet.) With fully illustrated instruction book. At your dealers' now, 32/6.

JOHNSONS
OF HENDON LTD

Used by famous model loco builders
Myford

*the lowest priced and finest
precision metal-working
lathes in their class*



Send for details of the **ML7 & Super 7** and the full range of accessories:

3- & 4-Jaw Chucks
Fixed and Travelling
Steadies

Dividing Attachment
Quick Change Gearbox
TRI-LEVA Speed Selector, etc.



Myford
LIMITED





BEESTON NOTTINGHAM
TELEPHONE
NOTTINGHAM 254222



Screwdrivers

* PRECISION BUILT FOR CRAFTSMEN

Manufactured to exacting standards by Moore & Wright (Sheffield) Ltd. world famous for precision and hand tools.



WRITE FOR OUR
LEAFLET NOW

Please send me details of your
SCREWDRIVERS.

NAME _____

ADDRESS _____

MOORE & WRIGHT (Sheffield) LTD.
Handsworth Road, Sheffield; 13.
MW68 PM

VALUABLE NEW HANDBOOK FREE TO AMBITIOUS ENGINEERS

Have you had *your* copy of "Engineering Opportunities"?

The new edition of "ENGINEERING OPPORTUNITIES" is now available—without charge—to all who are anxious for a worthwhile post in Engineering. Frank, informative and completely up to date, the new "ENGINEERING OPPORTUNITIES" should be in the hands of every person engaged in any branch of the Engineering industry, irrespective of age, experience or training.

**We definitely Guarantee
"NO PASS—NO FEE"**

This remarkable book gives details of examinations and courses in every branch of Engineering, Building, etc., outlines the openings available and describes our Special Appointments Department.

WHICH OF THESE IS YOUR PET SUBJECT?

MECH. ENGINEERING
Gen. Mech. Eng.—Maintenance Eng.— Diesel Eng.— Press Tool Design — Sheet Metal Work — Welding — Eng. Pattern Making — Inspection - Draughtsmanship — Metallurgy — Production Eng.

RADIO ENGINEERING
General Radio — Radio & TV Servicing — TV Eng. — Telecommunications — Electronics—Sound Recording—Automation—Practical Radio —Radio Amateurs' Exam.

CIVIL ENGINEERING
General Civil Eng. — Municipal Eng. — Structural Eng. — Sanitary Eng. — Road Eng. — Hydraulics—Mining—Water Supply — Petroleum Tech.

ELEC. ENGINEERING
General Electrical Eng. — Installations—Draughtsmanship — Illuminating Eng. — Refrigeration — Elem. Elec. Science — Elec. Supply — Mining Elec. Eng.

AUTO ENGINEERING
General Auto. Eng. — Auto. Maintenance — Repair — Auto. Diesel Maintenance — Auto. Electrical Equipment—Garage Management.

BUILDING
General Building — Heating & Ventilation — Plumbing — Architecture — Carpentry — Painting — Decorating — Specifications & Quantities — Surveying — Architectural Draughtsmanship.

WE HAVE A WIDE RANGE OF COURSES IN OTHER SUBJECTS INCLUDING CHEMICAL ENG., AERO ENG., MANAGEMENT, INSTRUMENT TECHNOLOGY WORK STUDY, MATHEMATICS, ETC.

Which qualification would increase your earning power? A.M.I.Mech.E., A.M.S.E., A.M.I.C.E., A.M.Bric.I.R.E., A.F.R.Ae.S., B.Sc., A.M.I.P.E., A.M.I.M.I., A.R.I.B.A., A.I.O.B., A.M.I.Chem.E., A.R.I.C.S., M.R.S.H., A.M.I.E.D., A.M.Mun.E., CITY & GUILDS, GEN. CERT. OF EDUCATION, ETC.

BRITISH INSTITUTE OF ENGINEERING TECHNOLOGY
410A COLLEGE HOUSE, 29-31 WRIGHT'S LANE, W.8

THIS BOOK TELLS YOU

- ★ HOW to get a better paid, more interesting job.
- ★ HOW to qualify for rapid promotion.
- ★ HOW to put some letters after your name and become a "key-man" . . . quickly and easily.
- ★ HOW to benefit from our free Advisory and Appointments Depts.
- ★ HOW you can take advantage of the chances you are now missing.
- ★ HOW, irrespective of your age, education or experience, YOU can succeed in any branch of Engineering.

156 PAGES OF EXPERT CAREER - GUIDANCE



You are bound to benefit from reading "ENGINEERING OPPORTUNITIES," and if you are earning less than £25 a week you should send for your copy now—FREE and without obligation.

POST NOW!

TO B.I.E.T. 410A, COLLEGE HOUSE, 29-31 WRIGHT'S LANE, W.8.

2d. stamp if posted in an unsealed envelope.

Please send me a FREE copy of "ENGINEERING OPPORTUNITIES." I am interested in (state subject, exam., or career).

NAME _____

ADDRESS _____

WRITE IF YOU PREFER NOT TO CUT THIS PAGE

THE B.I.E.T. IS THE LEADING INSTITUTE OF ITS KIND IN THE WORLD

PRACTICAL MECHANICS AND SCIENCE

Vol. XXX

December, 1962

No. 344

TALKING POINT

Editorial and Advertisement
Offices
**"PRACTICAL MECHANICS
AND SCIENCE"**
George Newnes Ltd., Tower
House, Southampton, Street,
Strand, W.C.2.
© George Newnes Ltd., 1962
Phone: Temple Bar 4363
Telegrams:
Newnes, Rand, London

SUBSCRIPTION RATES
including postage for one year
Inland - - - £1 8s. per annum
Abroad - - - £1 6s. 6d. per annum
Canada - - - £1 5s. per annum

Copyright in all drawings, photographs and articles published in "Practical Mechanics and Science" is specially reserved throughout the countries signatory to the Berne Convention and the U.S.A. Reproduction or imitations of any of these are therefore expressly forbidden.

CONTENTS

Talking point	99
How space ships are tested ...	100
Panning for gold the modern way	102
Lathe gadgets	103
Air cushion transport	105
Amateur climatological station	107
Picture news	112
Sun gazing underground	114
Easily made magnetic actuators	116
"Fritz" power model aircraft	119
Sheet metal detail work	123
The mechanics of early cars	124
A head pre-amp for crystal microphones	127
A pair of step ladders	129
L.B.S.C.'s "Evening Star"	132
Trade news	135
Easily made door chimes	136
New tools from old files	138
New highway safety device... ..	142

CONTRIBUTIONS

The Editor will be pleased to consider articles of a practical nature suitable for publication in "Practical Mechanics and Science". Such articles should be written on one side of the paper only, and should include the name and address of the sender. Whilst the Editor does not hold himself responsible for manuscripts, every effort will be made to return them if a stamped and addressed envelope is enclosed. All correspondence intended for the Editor, should be addressed: The Editor, "Practical Mechanics and Science", George Newnes, Ltd., Tower House, Southampton Street, Strand, London, W.C.2.

The Law about Patents

FROM time to time a request for guidance concerning patents comes from a reader. This is not in the least surprising. The fact that PRACTICAL MECHANICS AND SCIENCE pleases him, shows an interest above the ordinary in mechanical devices. Subsequently, while thinking over the manner in which they accomplish their tasks, a sudden illuminating idea may come. This could be the seed of an invention, a way of producing a specified result more easily, more cheaply, more speedily. It may well justify the trouble and expense of obtaining the grant of a patent.

One cannot patent the idea, new and very valuable though it is; one can, however, patent its embodiment in "a manner of new manufacture". This is how Section 101 of the governing statute, the Patents Act 1949, defines an invention.

"Patent" is used for "letter patent", that is an open letter. This declares to all that the state has granted a privilege: for a period, he alone is to have the right to make, use, exercise and vend a manufacture new within the realm. The patentee, as the privileged person is called, has a temporary monopoly, the duration of which in the U.K. is normally sixteen years, but when the patentee is able to show that the sixteen-year period has given him no adequate reward, the period may be extended, even (but very rarely) up to ten years more. For this privilege granted in the letter patent is in fact the state's reward to the patentee, not for his invention, but for letting others know of it.

The grant is made by the Comptroller General of the Patent Office, but only after the applicant submits on Patent Form 3 (stamped £4) a complete specification of his invention: such as to "contain a full and detailed description of the invention, of such a nature that the invention could be carried into practical effect by a competent workman from the directions of the document alone". Moreover, drawings are required to accompany a complete specification "in all cases where they are necessary to a clear and ready understanding of the invention described and claimed". When the monopoly period is over, all are free to use the invention as they will.

Whether the greatest inventor is in the records we do not know. The invention he made still awaits disclosure. For he may have kept his discovery to himself, dreading that it would be a menace to mankind. Some inventors disclose their inventions without seeking the statutory reward of a patent. We must note too that what seemed a success in the laboratory often does not reach the factory or is then a failure. Many a patentee, his high hopes shattered, has likened his patent to the white elephant that impoverishes its owner. To read the report of the National Research Development Corporation recently published is a sobering experience. Set up eleven years ago to develop projects needing money, including private inventions, it was expected to build up such a fund of royalties from patents as would balance outgoings, but there now appears no chance of doing so.

This cautionary note is necessary lest any reader of PRACTICAL MECHANICS AND SCIENCE should lightly commit himself to spending much in quest of a patent.

The Jan. 1963 issue will be published on Dec. 28th, 1962. Order it now!

HOW SPACE SHIPS ARE TESTED

described by our science correspondent

WITH a landing on the moon expected within the next year or so, more and more attention is being given to the planets. Already space probes are attempting to discover their secrets. Before long the first manned space craft will be steered towards them in epic voyages of conquest. To reach even our nearest neighbours in the solar system quite long voyages will be required to cover the tremendous distances involved. During the weeks of space travel the spaceships themselves will be subjected to temperatures and stresses almost unknown on earth.

Just as a black ball would absorb more heat in space than a white ball so the temperature of the spacecraft in flight depends upon its colour and finish and also on its shape. If it were made of material which was a poor conductor of heat, only the side facing the sun would be hot, whilst the other would be icy cold. Hot and cold spots on a spacecraft can cause a great many complications for electronic components can freeze or bake in the sun. Since even a single space shot costs a fantastic amount of money scientists and engineers have had to discover ways of testing spacecraft right here on earth.

They do this with what is known as a space environmental simulator. The largest simulator of its kind in the United States has recently been built at the California Institute of Technology Jet Propulsion Laboratory. To make sure that failures cannot happen when a space-man's life is at stake, the space simulator has been built large enough to test a complete spacecraft. The vital part of this device is a cylindrical tower 80 ft high and 27 ft in diameter. Contained within the lower part of this great structure is a stainless steel vacuum chamber whilst above it is a solar unit from which the scorching heat of the sun in space can be beamed on to the spaceship under test.

During the several months long space flights to even the nearest planets, space-men will have to travel through a perfect vacuum where temperature, as it is known here on earth, does not exist unless there is some object to intercept the radiant heat from the sun. For the space simulator to be

any use at all, it must be able to duplicate all the visible and invisible rays of the sun within as perfect a vacuum as possible. What is more the inner walls of the simulator chamber must not emit heat or absorb any more of the heat and light reflected off the spacecraft, just as would be the case in outer space. To make the inside of the chamber similar to space it was covered with an aluminium screen made up of 200 dull black aluminium plates. These are cooled by pumping liquid nitrogen through small tubes which run along the screen. A 28,000 gallon storage tank for the liquid nitrogen, which boils at minus 320° Fahrenheit, ensures a ready supply of cooling liquid however hot conditions may be inside the simulator.

The actual amount of heat beamed onto the spaceship depends on its destination. A ship designed to travel to Venus would have to withstand twice the heat received on earth from the sun. On a trip to Mars however, the spaceship would be much farther away from the sun than we are here on earth and would receive much less

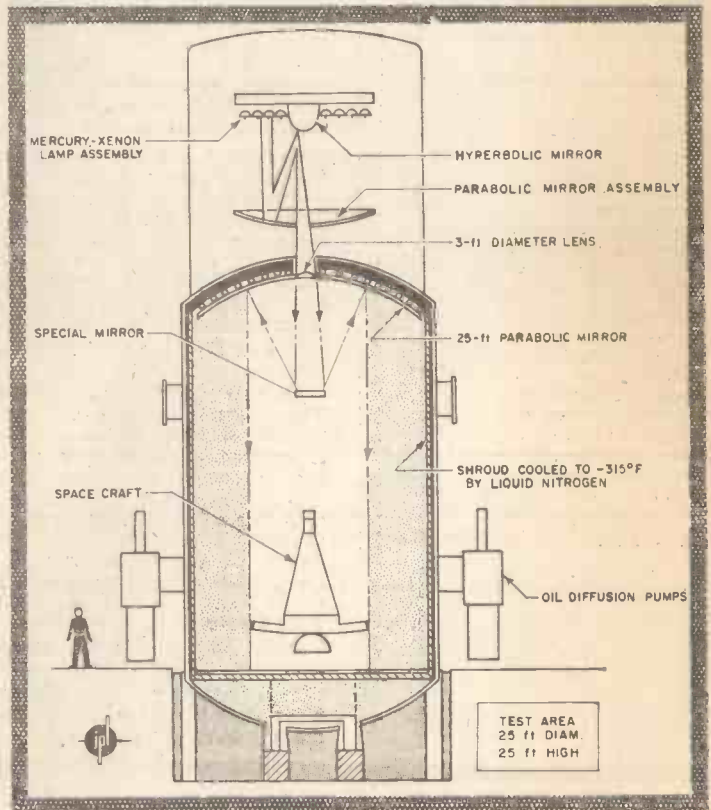

solar heat. The artificial sun heat is created in the simulator by an intricate optical system which uses 131 compact-arc mercury/xenon lamps, each one of $2\frac{1}{2}$ kilowatt rating and fitted with a 16 in. diameter reflector. At first it was planned to place the artificial sun system within the vacuum chamber, but because of cooling problems it was finally placed on top and the light beamed into the vacuum chamber through a 3 ft diameter lens. The light does not shine straight down into the vacuum chamber. First of all the lamps shine downwards onto a parabolic mirror from which the light is reflected upwards in a concentrated beam to a hyperbolic mirror. From here it is reflected downwards once more and then passes through the lens into the vacuum chamber. Once inside the chamber, the 3 ft light-beam has to be widened to about 12 ft. This is done by a 30 in. diameter mirror which once more reflects the light-beam to a 25 ft diameter parabolic mirror at the top of the vacuum chamber. From here it shines down again in a parallel beam. Thus it falls on the spaceship just as sunshine would do in outer space.

To create on earth the conditions of vacuum which are met in space three different kinds of pumps are used. First of all seven compressors, which normally are used in a wind tunnel at the laboratory, suck out most of the air in the simulator. Next three vacuum pumps remove all but a fraction of the remaining air. Last of all, ten oil-diffusion vacuum pumps take over to produce a pressure within the simulation chamber which is only one billionth of atmospheric pressure at sea level.

In the future it is hoped to completely copy conditions in space by fitting a vibration unit in the chamber. Then the scientists and engineers of the Jet Propulsion Laboratory will be able to see how their spacecraft behave when the guidance rockets are fired far out in space.

Building the simulator was expensive, it had to be when one considers its size and complexity. But the spacemen think the 4 million dollars spent on its construction will have been well spent if it prevents tragic accidents far out in space where rescue is impossible.

Workmen in the new space simulation chamber at The National Aeronautics & Space Administration Jet Propulsion Laboratory, California. Measuring 47ft high by 27ft in diameter, the stainless steel vacuum chamber is used to test space vehicles under flight conditions. The temperature in the chamber can be lowered to 310°F below freezing. The diagram on the facing page shows the optical heating system.

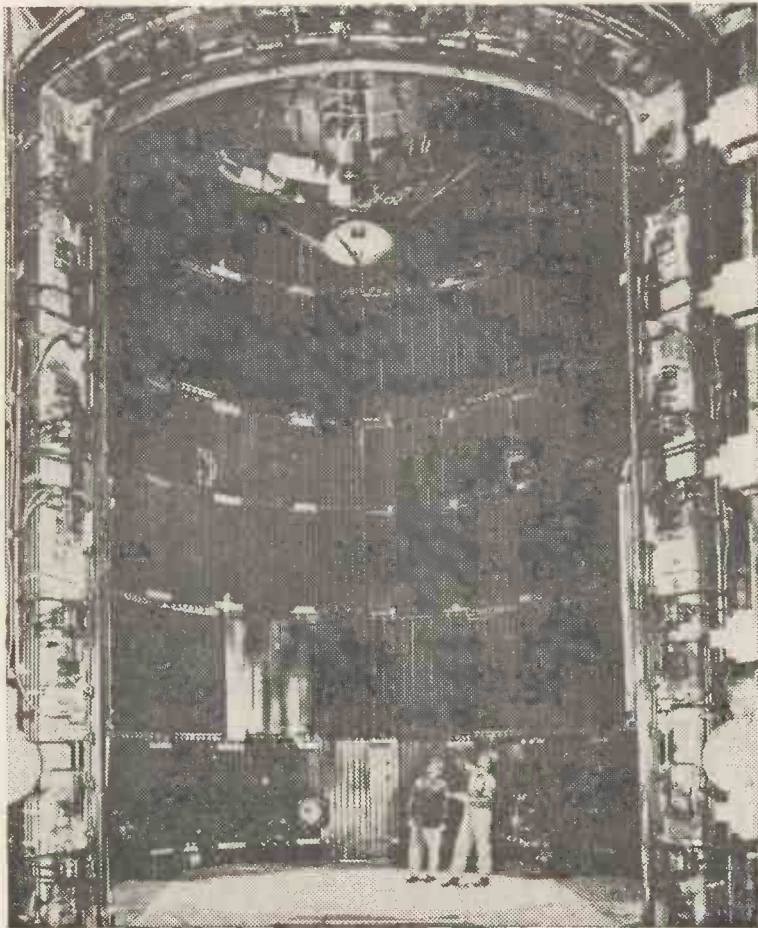

Panning for gold

THE MODERN WAY

By R. J. Salter

THE old timers who panned for gold with their battered tin plates in the rivers of California, South Africa and Australia would stare in surprise at a gold panning machine which has just been produced. Extracting gold from river sand is a process known as alluvial mining. The miner tries to recover granulated gold which has been deposited in the river by separating it from the sand in the river bed. After scooping up the river sand in his flat pan the miner span the pan round so that the light river sand was swilled away whilst the heavier particles of gold sank to the bottom. If he had been lucky a quick glance soon revealed the sparkle of gold in the bottom of the pan. More scientifically minded miners crushed the gold bearing rock deposits in a bronze mortar. To the crushed rock was added mercury which unites with the gold particles to form an Amalgam. This liquid compound of gold and mercury was then heated so that the mercury evaporated, leaving the pure gold.

Whichever method they used, not many of them made a fortune. For whilst the particles of gold were not too difficult to find, separating enough to make it worthwhile was a back-breaking job. Prospectors

who buy a new mechanised gold panning machine, put on the market by a Texas engineering firm, will not find gold panning quite such hard work. The new machine, said to do the work of 30 men panning by hand, has a motor-driven vibrating sieve. As the river sand is washed across this sieve, large stones are vibrated off the end and finer material passes through the sieve into a space beneath. Here the gold particles settle to the bottom and the fine sand is washed away. The trough which catches the gold can hold several pounds of it, a rich reward for the mechanised gold prospector.



This is the mechanical gold panning machine. The vibrating sieve onto which the river sand is thrown can be seen on the right of the picture.

(Photo by courtesy Link-Belt Company)



LATHE GADGETS

by L. C. MASON

Part 12

D.T.I. Fixtures I.

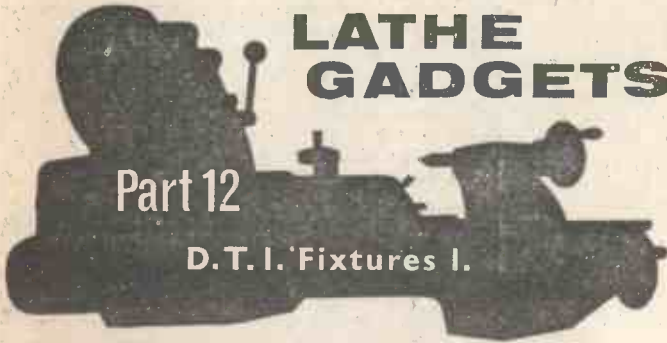

MANY lathe owners will no doubt have discovered for themselves the extreme usefulness of the Dial Test Indicator—or “clock”—as it is familiarly called. This device has numerous applications in lathe work and probably the most frequent use to which it is put is in setting up work to run truly in the four-jaw

chuck. Most types of D.T.I. have a lug of some kind on the case, by which they can be held in some sort of stand. The stand can be placed on the cross slide and the plunger of the indicator brought to bear on the job.

However, there are several advantages in being able to mount the indicator in the toolpost. The main ones are that it is much less liable to damage through being knocked over, it can be used to set the top slide accurately at an angle when using a pattern—as in copying the Morse taper on a centre—and that it can be used to set the top slide accurately for really parallel turning.

The indicator shown is a standard Baty model, having the mounting lug on the case. However, the toolpost holder is much more adaptable if it holds the indicator by the short neck carrying the plunger. This it does by the grip of a shaped clamp, the two halves of which are pinched together with a knurled finger nut. Amongst other things this makes for much easier fixing and release than a nut on a screw fitting through the lug.

The holder is merely an L-shaped bracket shaped up from 1/4 in. mild steel plate, the short arm holding the indicator and the long one being gripped in the toolpost. By having the clamp at right-angles to the toolpost arm the indicator can be presented to work in the chuck without disturbing the toolpost position. The clamp consists of a small pad of the same 1/4 in. material located on top of the short arm by a threaded stud, the hole for the neck of the indicator being drilled on the joint line of the two pieces.

Dimensions for the holder will obviously vary according to the make and type of indicator used, so that sizes shown will probably serve as little more than a guide to suitable proportions. None of the dimensions are at all critical.

The sketches and photographs should be self-explanatory and making the holder is a straightforward shaping and drilling job. Measure the diameter of the indicator neck and mark the centre of the hole for it across the short arm. Mark also a line either side of the centre line indicating the diameter of the hole. From the inner one of these the position of the clamp stud can be located, drilled and tapped 2B.A. This now gives the overall length of the top piece forming the other half of the clamp, which can be cut to length, drilled 1/8 in. and temporarily screwed to the arm. When drilling the hole for the indicator neck hold the two pieces tightly together in the machine vice so that they cannot move during drilling. Drill



Using the D.T.I. fixture on an interior bore.



D.T.I. in holder with parts of lever attachment.

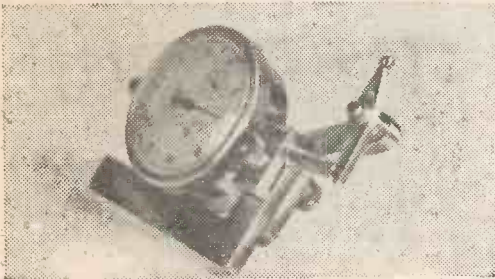

Complete assembly for interior work.

the hole with its centre on the joint line. Remove the top piece and file back the under surface $\frac{1}{16}$ in., leaving an untouched ridge $\frac{1}{16}$ in. wide across the inner end. This provides a heel, enabling the pad to act like a holding dog, clipping the indicator neck when the finger nut is tightened down. If the indicator is chromium plated it may be found that this hard, polished surface makes it difficult to hold securely without excessive pressure by the nut. Should this be so, wrap one layer of Sellotape round the neck, which will give ample grip.

For facing in the lathe, the toolpost is generally turned through 90 degrees so that the normal turning tool is set parallel to the lathe axis. In setting up work for facing or boring a hole square to a truly set-up face, the indicator can replace the tool just as before—again without altering the toolpost position. In this case the grip nut is slacked off and the indicator turned over in its holder to bring the dial on top when the short arm is pointing away from the operator.

It will be seen that a stud is provided on the holder on both sides, although the clamp only requires one. The second stud—or rather the other end of the same one—is for the attachment of a small additional piece carrying a small lever which bears on the tip of the plunger. This extra attachment enables the indicator to be used for setting-up work by reference to a bored hole. A large bush, for instance, might be held in the chuck and the outside turned as far as the chuck jaws. The bush could then be finish bored right through. It can then be reversed in the chuck, being held by the turned part, and can be set up again truly by using the D.T.I. on the inside bore for turning the remainder of the outside. This cuts out the bother of making a mandrel for turning the outside.

The lever attachment is again a straightforward job, the dimensions being arranged so that the plunger has travelled a small distance—say, $\frac{1}{16}$ in.—when the lever is at right-angles to the plunger. The lever can be made from a scrap of $\frac{1}{4}$ in. mild steel, facing it back to half thickness in the four-jaw chuck to leave a round boss for the bearing bush. When faced back to size in the chuck, drill and ream the boss $\frac{1}{16}$ in. to take the bush. In this instance the bush is stationary, the lever turning on the outside of it, which gives larger bearing surfaces and makes it easier to ensure that the lever swings exactly square to its arm. The bush can be turned from a scrap of brass rod of a diameter and length under the flange to give a free but shakeless fit to the lever. Drill the bush $\frac{1}{16}$ in. for a $\frac{1}{16}$ in. Whitworth or S.B.A. fixing screw. The ball end of the lever is merely a $\frac{1}{16}$ in. ball bearing soft soldered in a slight depression in the end of the lever.

The lever supporting arm is proportioned to bring the lever into the right position to work the indicator, again depending on the indicator. A $\frac{1}{4}$ in. dowel pin tapped into the support arm engages a hole in the short arm of the clock holder to position the two exactly.

The stud holding both clamp and lever attachment is most easily made from a short length of $\frac{1}{8}$ in. mild steel rod threaded 2 B.A. Two or three light centre punch marks in that part of the thread which will be in the holder bracket will distort the

(Continued on page 141)

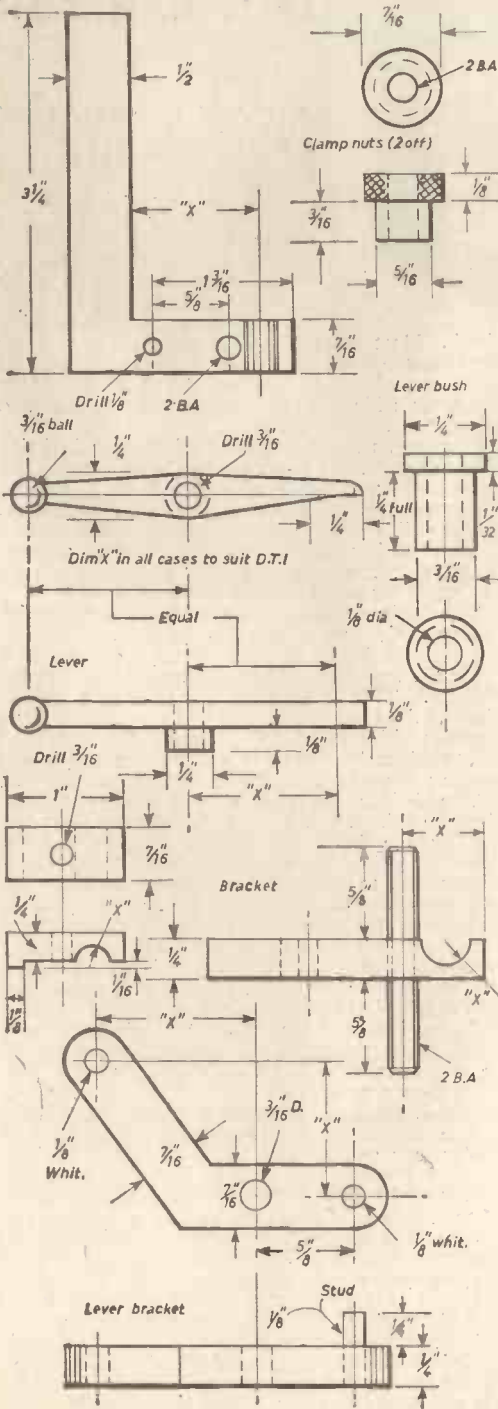

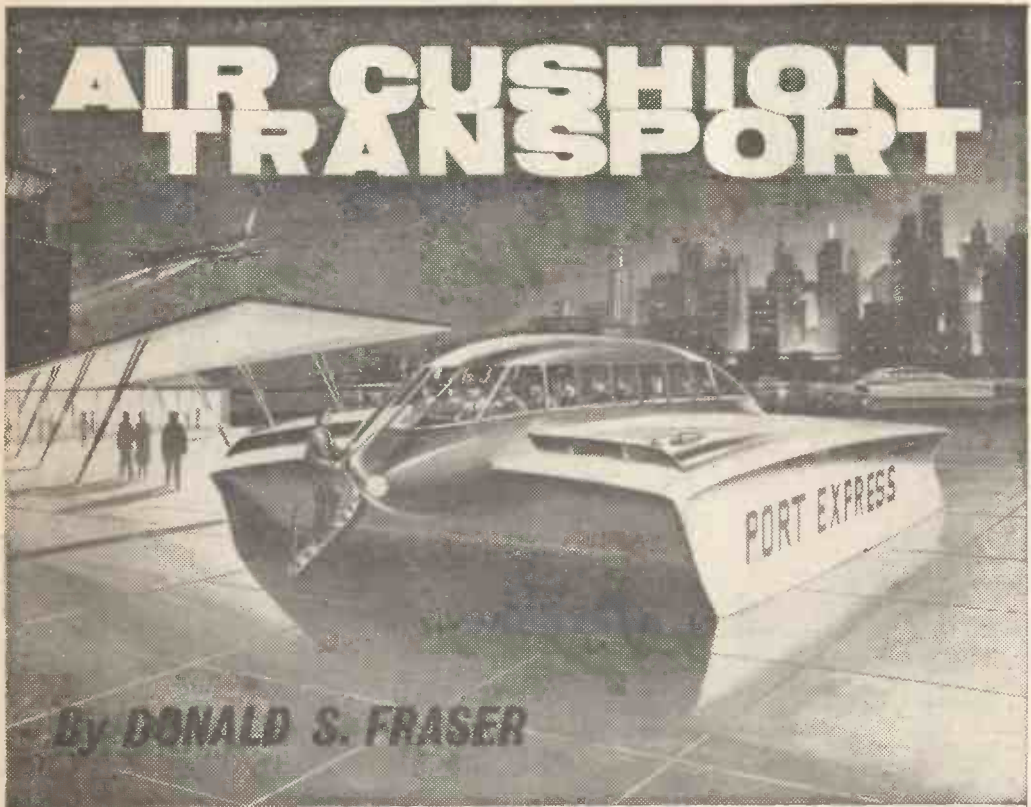

THE first air cushion vehicle ever licensed for operation on a public highway has "passed its tests". The craft, one of a number developed by Bell Aerosystems Company in the United States, is an experimental vehicle that scoots over ground or water on a cushion of air.

The air cushion vehicle (ACV) was recently demonstrated in the City of Buffalo, in the State of New York. Bell personnel performed precision manoeuvres with the boat-like craft, putting it through its paces about 3 inches above the ground.

They displayed the craft's extreme manoeuvrability by gliding the 18-ft long ACV sideways into spaces that would defy the driver of a conventional motor car. They pivoted the craft about in its own length, showed its ability to hover above the ground, and also performed conventional forward, backward and turning movements. A special New York State licence plate, bearing the letters "ACV", was attached to the vehicle.

The 2,000 pound ACV resembles a streamlined motorboat. It is powered by a 65 horsepower motor car engine driving a fan, mounted horizontally, amidships. The fan drives air under the vehicle where it forms a pressure pocket to lift the ACV from the ground. It is controlled by metal "flippers" which rim the vehicle's lower sides and regulate the escape of air from beneath

the craft. Once airborne, the ACV is capable of 15 miles-an-hour ground speed at present, while carrying three passengers. Future ACV's with greater power will, of course, be developed. This particular vehicle has been developed as a research tool to study the air cushion principle and to experiment with control techniques.

The Bell company envisage air cushion vehicles serving a variety of specialised uses, and their development programme includes much diversification. Among the wide range of applications for ACV's that the company is investigating, are passenger ferries between water-bound airports and metropolitan centres such as New York or Washington; they could also be used as emergency vehicles for seaports, providing rapid transport for medical teams, and fire fighting apparatus to disaster scenes; and they might be developed as large ocean spanning vessels that would ride over water at high speeds unaffected by wave action. While most of these vehicles would be designed primarily for cruising over water, they would also be able to operate over land.

A versatile naval craft, designed and built by Bell for the U.S. Bureau of Ships, is one of the new family of air cushioned vehicles named hydro-skimmers. It is 18 feet long with an eight-foot beam and weighs 2,300 pounds. The hull is made of fire-retardant polyester resin reinforced with fibreglass. A large fan, fixed horizontally amid-



One of the air cushion vehicles being developed in England, "Hovercraft" as we call them, is the Vickers Armstrong (South Marston) Ltd. VA-3. First shown to the public on April 11th this year, it can carry 24 passengers plus a crew of two at a cruising speed of 60 knots. The main structure comprises a buoyancy tank and the ducting system, and supports the propulsion units and superstructure.



This 2,000-pound experimental air cushion craft scoots over ground or water. It is powered by a 65 horsepower motor car engine which drives a fan amidships. It operates about three inches above the ground. The craft is the first air cushion vehicle to be licensed for operation on public highways. Note the New York State licence plate—bearing the letters ACV—on the bow.

Another experimental air cushion craft which has been developed for the U.S. Navy is a "hydroskimmer." It has the same body design and midships mounted horizontal fan as the land vehicle ACV top right.

An emergency fire fighting vehicle of the future patterned after an air cushion vehicle. This vehicle, which would travel over land and water, would be well suited for emergency applications at sea or air ports.

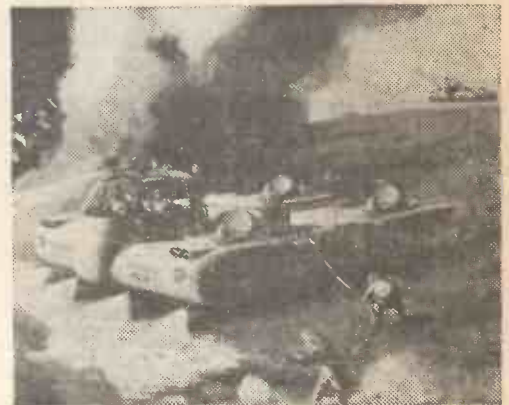
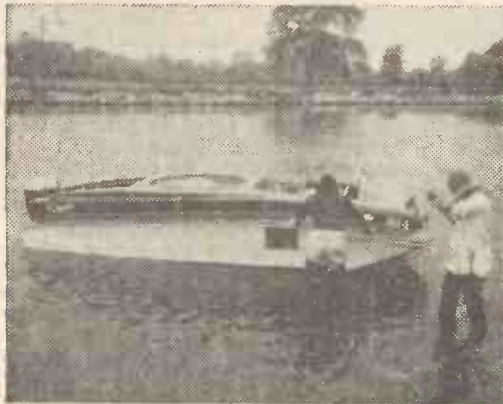

ships and driven by a small but powerful motor drives air under the hull. Air can escape from the bow and stern only. Two fins which run the length of the hull help to trap the air and provide the air cushion. An outboard motor propels the craft forward. Hydroskimmers will have a variety of military uses with obvious application to anti-submarine warfare, amphibious assault, logistics and utility operations. Such craft are capable of high speed with relatively low horsepower since they operate above the water surface with resulting reduction in wave and frictional drag.

The largest air cushion vehicle to be constructed in the United States is a 22-ton, 62-foot Hydro-

skimmer, for the U.S. Navy Bureau of Ships, by Bell Aerosystems. It is part of the Navy's programme to develop the technology necessary to design ocean-going vessels of this type. It will be used to develop an understanding of rough weather control problems and provide design criteria for the construction of future vessels of this type. The craft is expected to be ready for testing by mid-1963 and is the subject of our cover picture.

This unique vehicle will skim over the water on a cushion of air at speeds in excess of 70 knots. The craft will also be able to operate over land.

The aluminium-hulled Hydroskimmer will be

(Continued on page 141)

Amateur Climatological Station

Part Four

CONSTRUCTING A SENSITIVE SEISMOGRAPH

By A. Crawfoot

ALTHOUGH a seismograph is not a normal instrument in a climatological station it is a fascinating piece of equipment for its own sake. The author used his in Australia for the detection and tracking of tropical revolving storms, but it is also a first-class earthquake recording instrument and has been commended by Dr. Owen A. Jones, director of the University of Queensland Seismological Station, Australia, in the following words: "Having seen records of some recent earthquakes made by Mr. Crawfoot's instrument and compared them with the records made by our own Milne-Shaw seismographs I can confidently state that an instrument carefully made after Mr. Crawfoot's plans will give very satisfactory and useful records." Dr. Owen further says: "I must emphasise at the outset that the primary job of a seismological station is to obtain good and continuous records. A record may be difficult to interpret, or mistakes may be made in its interpretation, but as long as a good record is obtained and preserved it can be re-examined and re-interpreted by yourself or other people as often as is necessary. A weekly letter and our monthly bulletin setting out the recordings at the University of Queensland station will be forwarded on application (to the university). I would also be glad to help you in interpretation and suggest that if you have any difficulties that you post your seismograph record to me and I will return it together with my interpretation. I would also be glad to receive copies of your readings regularly, say each month. These may be helpful in interpreting our own records. Acknowledgement would be made in our bulletin."

The making of the seismograph entails work that demands great attention to detail. Most of the sizes given can be changed to suit the materials in hand; as long as the overall design is adhered to it will make no difference. The first thing that must be made is the pier to take the instrument. This must be built in the room that you have already prepared in your station. It should be built at one end, furthest from the door, a little over to the corner. The pier is of solid concrete and should go down through the floor, with a clearance of 2in. all round which should be filled with sand. If possible take it down to solid rock, but if this is any more than 3ft down don't trouble. Three feet is quite enough. The pier should be about 24in. x 30in. and should be lined up with the 30in. dimension either true north or true east. A table height of about 2ft 6in. is suitable. Inscribe the N-S or E-W line in the concrete whilst it is still

wet. It will make the setting up of the instrument much simpler. When using a magnetic compass to mark this line do not forget to allow for declination and variation. Also ensure that no iron nearby deflects the compass. The prism (if used) and the recorder tables can be ordinary wooden tables which, when all is set up, must be fixed to the floor. As the instrument will take some little time to build the concrete will have a good chance to dry out and settle before going into use. By the way, use no steel in the concrete. It may affect the instrument. Good concrete of about a four-to-one mix will give perfect results.

The base of the instrument is constructed from two pieces of *very dry* hardwood. You can use 2in. angle brass if you wish but I had no trouble with wood. The corner must be carefully halved together, glued, screwed and bolted through the centre with a 2½in. x ¼ in. bolt, the end of which has been pointed. This forms the fixed support. One inch from each end is an adjusting bolt of the same size as the central one but with a clearance hole through the wood and a nut fixed flush underneath. A B.S.F. thread is quite suitable but if you can get bolts with an instrument thread, which is much finer, do so. The pillar is made from 1in. diameter brass rod 16½in. long, threaded at the bottom, with two half nuts to clamp it very firmly to the base. A small strip of ¼in. thick brass should be soldered to the top, in line with the side member of the base. This strip should be drilled to take a small eyebolt ½in. out from the pillar. This should be adjustable up and down by at least ½in. A small countersink should be made 3in. up from the base to take a jewel bearing from a clock balance wheel. This should be fixed in with Bostik or a similar compound. Three brass base blocks, countersunk to take the levelling bolts, should be made to stand the frame and pillar on.

The pendulum should be made from a 20in. length of ¼in. diameter brass rod, tapered down to ¼in. at the end. The large end should be drilled to take a steel gramophone needle. This should be a firm fit but not too tight as the needle will need renewing from time to time. A small tank, made from shim brass, about 1in. x 1in. x 1in., should be soldered to the outer end. This is to drive the magnifier. A lead mass, weight about 4oz., should be fitted to the pendulum not more than 6in. from

the large end. This should be carefully balanced side-ways and fitted with a sling made from a piece of 0.029in. copper wire. This should be fitted into two holes drilled in the side of the mass. A damping vane is fitted 10in. from the large end. This should be a piece of shim brass 3in. x 1/4in. soldered to a piece of 0.029in. wire about 2in. long. The vane should be curved to a 10in. radius. A tank 4 1/2in. x 1in. x 1in. should be mounted on a block standing on the pier at such a height as to enclose the vane. The pendulum should be suspended by a very fine wire from the sling on the mass to the eyebolt at the top of the pillar. This wire should be as fine as possible whilst still holding the weight. It should be flexible without any springiness. Before trying the pendulum lower the period adjustment end of the base as far as possible. Place the needle on the pendulum into the jewel bearing and, the sling and wire being fixed to the pendulum mass, fasten the top end of the suspension wire to the eyebolt so that the pendulum hangs a little low at the outer end. Release the pendulum and, if it swings over to one side, adjust the tilt bolt so that it lies square with the base. A preliminary test of the instrument can now be made. Set the pendulum gently swinging. It will probably have a short period of swing

of about two seconds—that is, for a complete swing from one side, over to the other, and back again. Screw up the period adjustment end of the base and you will find that the period will lengthen. The period depends on the angle BC makes to the vertical, not to AC. It will be found that if BC reaches vertical the pendulum will become unstable and collapse. The best period I have found to be six seconds. It is as well to make up two stops from wood blocks with a wire up from each. Place one on each side of the pendulum so that it can be either locked or allowed a small amount of movement as required. The tank for the damping vane can now be placed into position with the bottom about 1/4in. clear of the vane. The tank should be filled with a light household oil to cover the vane. You will probably have to add a heavier oil later when the instrument is finally damped. Let the instrument stand whilst you make up the magnifying gear. This will allow it to settle down and also allow the suspension wire to stretch. This can be taken up later.

The movement of the pendulum in relation to the ground is only a fraction of a thousandth of an inch. It is obvious therefore that to be of any use this movement must be magnified. There are

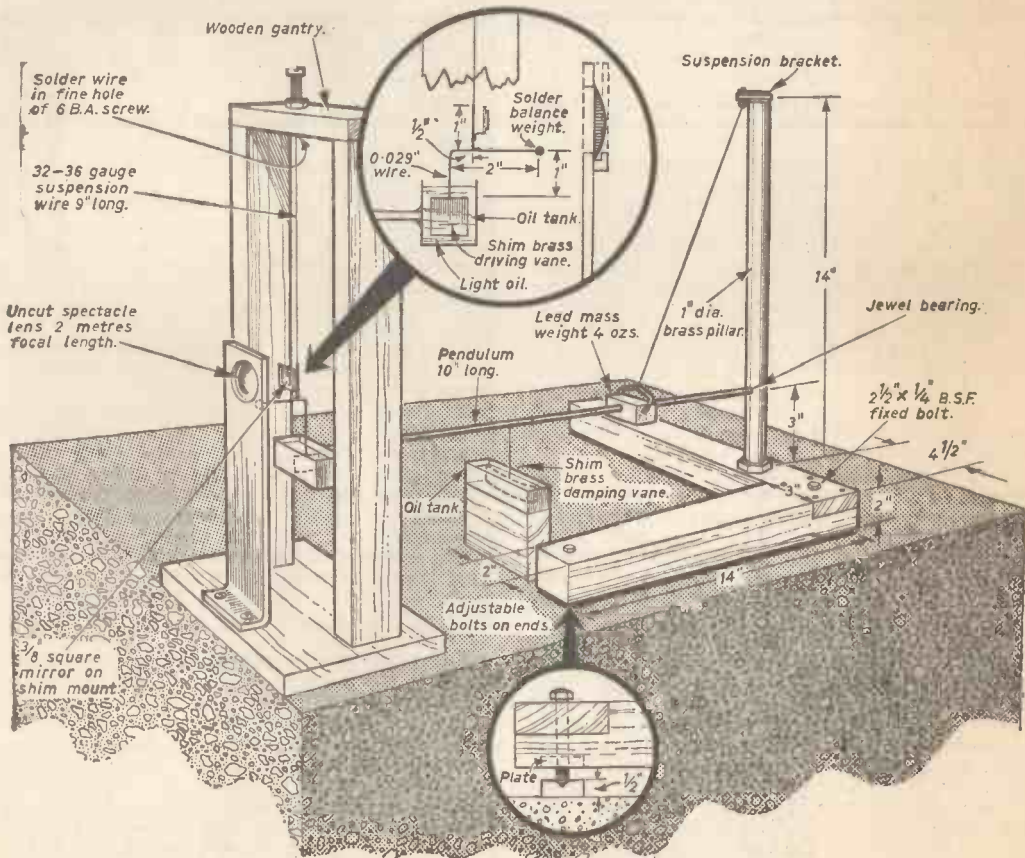

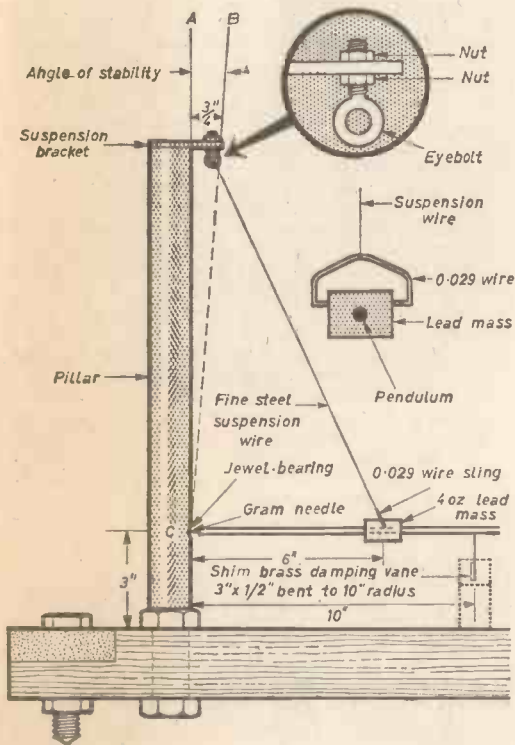

several ways of doing this. With an amateur operated instrument the oil-driven magnifier described is certainly the best. It allows for any tilt of the ground to be smoothed out. In my case the instrument was situated on a small peninsula. With direct coupling the light spot would drift right off the record due to the tilt of the ground under the influence of the tides. With oil coupling it remained perfectly stable. A piece of 0.029in. wire should be bent into an L shape 1in. x 2in. At the end of the 1in. length a piece of shim brass $\frac{1}{4}$ in. square should be soldered. This should be set in the same plane as the L. Solder a 1in. length of the same wire $\frac{1}{4}$ in. in from the corner of the long end. This forms the vertical hanger and carries the mirror. The mirror should be mounted on a small piece of wire soldered to the wire just mentioned and bent up so that it is clear of the main wire. A piece of shim brass $\frac{1}{4}$ in. square should be soldered to this at right-angles to the driving vane. Cut a $\frac{1}{4}$ in. square piece of mirror from a lady's handbag mirror. This is usually very thin and with care a flat piece can be cut out. Do not use any piece that has any distortion as it might affect the movement of the light on the record, thus giving a false reading. The mirror should be fixed to the brass backing with Bostik or a similar adhesive compound. To balance the unit suspend it by a piece of 32 gauge wire fixed above the mirror. Add a little solder to the end of the 2in. leg of the L until it rests horizontally. Check the

vertical wire to make sure that it is dead in line with the suspension wire. Next make up a solid frame (wood will do if it is dry and seasoned) from which to hang the magnifier permanently. It should be of a height that will allow about 9in. of 32 gauge suspension wire. This height may have to be altered as the working of this magnifier depends on the torsion of the wire to hold the mirror stable against a slow drift of the pendulum. With ground movements of up to 20-second period the oil acts as a solid and drives the vane and the mirror with it, but with slower motions the torsion of the magnifier suspension wire holds the vane steady in the oil. Provision must be made for turning the unit. This is done simply by hanging the wire from a small bolt with a nut to lift or lower it. The whole bolt is turned to position the mirror in the desired direction. It should be noted that this unit is very light and delicate and should be handled with tweezers. The final adjustment of the mirror angle can only be made when the whole instrument and recorder is finished, so no attempt should be made at this stage.

The whole instrument—with the magnifier—must be enclosed in a case so that no air can displace the pendulum in any way. It is advisable to use a soft building board such as Celotex or Caneite for this purpose as this materially assists in temperature control. In front of the mirror cut a hole about 1in. diameter. In front of this, on the outside, arrange a rebated frame to take an uncut spectacle lens of 2 metres focal length. This just drops into position and if the grooves are a little slack the lens can be adjusted either vertically or horizontally. The frame and lens must remain in position when the cover is removed.

Next comes the recorder. This is very much the same as the wind direction recorder except that the drum traverses sideways instead of the pen. This is achieved by having the axle threaded on one side, the number of threads being four to the inch. The drum is, of course, larger, the size given in the sketch being the minimum. If you can get one of, say, 12in. diameter do so; it will give better results. To offset that, the photographic paper will be larger and obviously cost more. You must work that out yourself but do not go any smaller than the 7in. shown. The supports for the drum are much the same as in your other recorder with the exception that the slots are filed to a knife edge at the bottom. In the case of the support that takes the threaded end of the spindle the knife edge should be filed at a slight angle to fit into the thread groove. The driving motor can be the same as before. An alarm clock is very satisfactory. Mine worked for two years without any trouble at all. The driving arms should, of course, be longer to allow for an 8in. traverse. Always allow for an over-run of some hours. In front of the drum and level with the axle is fitted a long cylindrical lens mounted on two supports which should not be screwed to the base until the correct position can be determined. The lens itself is made from a length of Perspex rod 1in. in diameter, 7in. long. Cut it in half right down the middle and file the flat side smooth. Finally polish it so that it is quite clear. An easy-to-obtain polishing agent is ordinary toothpaste. It is quite smooth and leaves no marks of any kind. The rounded side of the lens should be placed next to the drum. There is less likelihood of the paper

catching that way. The whole recorder unit must be fitted into a lightproof box which should have a lifting lid so that the drum can be removed to renew the paper. Allow enough room at the motor end so that this can be wound up without trouble.

A slot about 1in. wide should be cut in front of the lens. Two pieces of thin metal of any sort should be screwed over this so that a thin slit is left in the middle. The space should be gauged with two razor blades. One strip should be fixed with screws slotted so that the slit can be adjusted to pass more light to the paper if needed, but always keep the slit as fine as the sensitivity of the paper will allow.

Use two elastic bands to hold the paper in position at each end of the drum. Make sure when you load the drum that the paper will trail past the lens and that the bands are fully on the paper. I mention that because some time ago I was following a very severe cyclone down the Queensland coast, the microseisms getting larger each day, and it became obvious that it would pass within a few miles of my station. In my eagerness to get a good record of it and thinking of the possibility of not being able to get back in time to change the record I kept the bands too close to the edges of the paper. The next day the eye of the cyclone passed within 30-40 miles of the station, probably the closest that a seismograph had ever been to this type of disturbance. One band slipped off, the paper caught on the lens and the result was no record. It was a bitter experience.

Next the light source. A 12-volt, 30-watt straight filament lamp should be used. It is mounted with the filament vertical inside a tin or box that is well ventilated but which will allow no light to escape except through a vertical slit about $\frac{1}{8}$ in. wide.

This light source should be placed as near as possible dead under the centre of the light slit of the recorder. Great care must be taken that no light can fall on this slit except that which is wanted. The beam is directed on to the mirror of the seismograph, through the lens, and is reflected back out through the lens and on to the light slit of the recorder. Here it should be a very fine line, being at the focal point of the lens. A very small spot of light is thus able to reach the cylindrical lens and is focused by this to a very tiny and intense spot of light on the paper. It is best to paint the whole of the recorder cover, both inside and out, a dead black, with the exception of the outside of the slit, which should be painted a dull white. This allows the light beam to be focused and centred properly. The sketch shows the light beam going through a prism, but if you have the space do

not do this. It makes the setting up 100% more difficult and also absorbs a fair amount of light, which means that the slit on the recorder must be more open, making it more difficult to get a sharp trace. By using the prism, however, a lot of floor space can be saved and you must use the system that is suited to the size of your station.

It will take a lot of time and care to get the light beam set up perfectly. The mirror must first be adjusted for angle. Bend the wire support in or out in the vertical plane. The other way just twist it. Remember that the driving vane in the oil must be in line with the pendulum. The oil in the tank is light household oil. It must cover the vane completely. The spectacle lens will also need slight adjustment. This is done with a little putty at the back or front to throw the beam where needed. The beam should finish centrally on the light slit of the recorder.

With all set the next adjustment is the damping of the instrument. Remove the instrument cover and when it has settled down again press one finger firmly on the concrete pier. It will be seen that the light beam on the recorder will move over a considerable distance. Let it settle down again, then mark the position of the light beam on the slit. Depress the pier again so that the beam moves about 2in. Watch it return and if it is under-damped it will move past the starting point and then swing back and forth until it settles. If it is over-damped it will stop anywhere between the limit of the movement and the starting point. If under-damped add some thicker oil to the tank, making sure that it is well mixed with the thin oil.

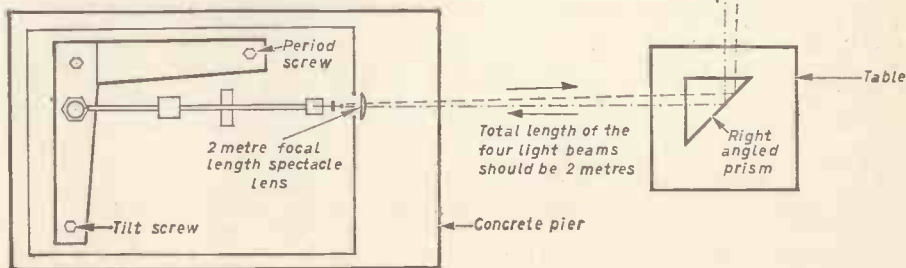
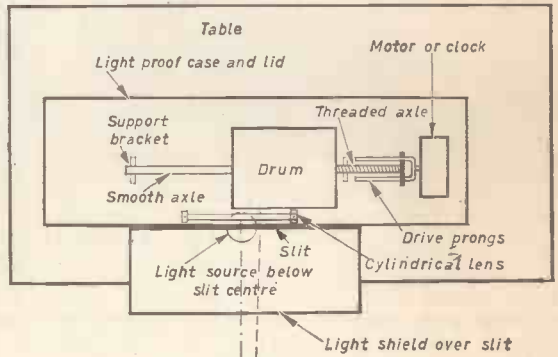

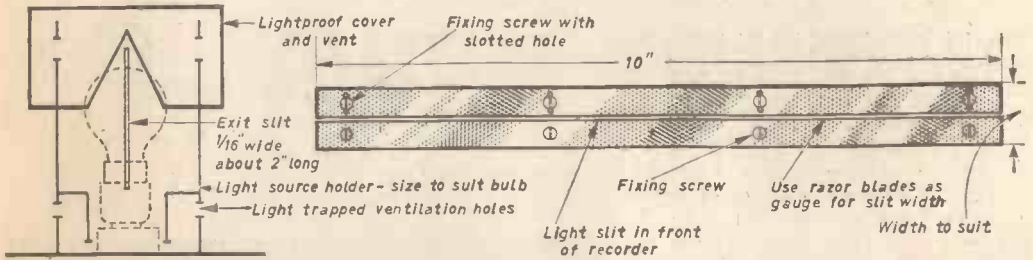

Keep testing and adding oil until the light returns once only to the starting point and then stays there. If the instrument is over-damped you must cut a little off the shim brass vane until it is a little under-damped, then proceed as above. Pay a lot of attention to the damping as you will not get a true record of the ground movement otherwise. Make a few trial runs for a few days as it will take quite a time for the whole instrument to settle. You are then ready to start work with it.

When putting on the paper, mark it with the date and time when started and the direction of the line on the paper. For storm tracking work no further timing is needed. One length of trace on the paper is one hour, give and take a few minutes. For seismological work much more accurate timing must be shown on the record. As these articles are primarily meteorological I won't take up too much time and space to describe how this is done. I used a Sangamo contactor clock and set the points so that they were "off" for about three seconds every minute and then placed it in the lamp circuit.

This switched the light off for that period once every minute. This clock was timed very carefully against the "pips" of a time signal every day and the error noted.

As regards the paper used, I obtained some ex-Government surplus paper 1,000ft by 8in. wide. It was quite cheap and, being a positive paper, quite satisfactory. It was a little thick, but that was only a minor fault. The developer I used was D19b with ordinary hypo for fixing. I mixed a half-gallon at a time, which lasted well over two weeks.

Unfortunately there is not room in this article to go into the subject of seismology and the interpretation of readings. A good book on the subject is "Earthquakes", by Milne and Lee, published by Kegan, Paul, Trench, Trubner and Co. Ltd., 1939. Other books on the subject also exist. An essential book for the interpretation of results is "Travel Time-tables", by Jeffrey and Bullen, published by the British Association for the Advancement of Science, Burlington House, London, W.1.

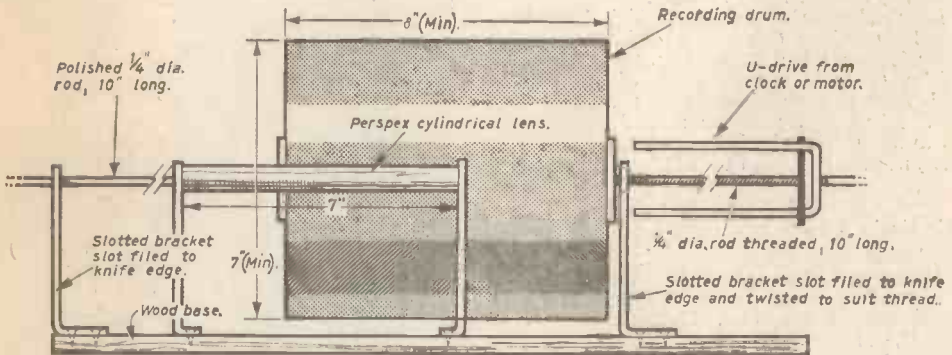

PRACTICAL TELEVISION and PRACTICAL WIRELESS

Price 2s. plus 5d. postage

Price 2s. plus 5d. postage

Obtainable from your local newsagents, or direct from:

GEO. NEWNES LTD., Tower House, Southampton Street, London, W.C.2.

PICTURE NEWS

FROM THE WORLD OF SCIENCE



Photograph shows:—“The Ark” a pressure lifting vehicle capable of carrying a load of 1 ton over water being demonstrated recently.

A large selection of vehicles which have been designed by British Companies and the Fighting Vehicles Research and Development Establishment especially to meet the demands of the British Armed Forces were demonstrated at Chertsey, Surrey. The vehicles shown ranged from motor cycles to 30-ton-six-wheeled tractors, light wheeled vehicles, tracked armoured vehicles and heavy tanks.

Atomic clocks

THE first atomic clock devised in the United States used the vibrations of the ammonia molecule to measure time. This clock, built by scientists at the U.S. National Bureau of Standards, is stable to within one part of 100,000,000. Because of its nature, the molecule performs as an electronic filter to reject all frequencies except the sharply defined one of 23,870,000,000 cycles per second, which is then employed to keep an electric current alternating at a definite fraction of the same number and, in turn, to regulate a quartz crystal clock. It is the continual vibrations within molecules and atoms that measure time for atomic clocks.

In time, atomic clocks will replace the earth's rotation as a standard, and will establish a precise standard for units of time, such as the second. For scientists, who sometimes have to deal with researches into events that take place in millionths, or even billionths, of a second, the precision timing of atomic clocks will be of inestimable value.

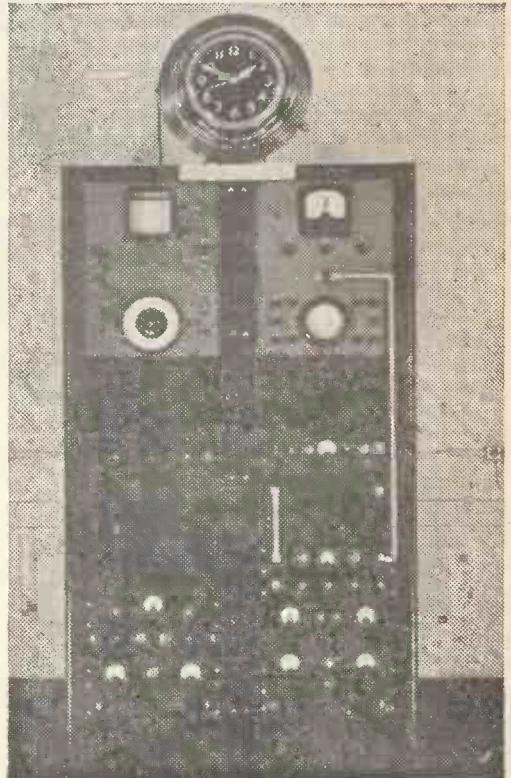



Land-Rover cushion craft

FOR over ten years the Land-Rover has enjoyed a well-earned reputation for rugged versatility under rigorous conditions of service. Now Vickers-Armstrongs (South Marston) Ltd. have applied the air cushion principle to a standard Land-Rover and have produced a vehicle that can traverse even more difficult terrain. The air cushion is provided by two centrifugal fans driven by V-belts from a second Land-Rover engine. An additional aluminium superstructure, fitted round the normal vehicle body and engine, acts as an envelope and ducting for the air cushion which is contained within a flexible synthetic-rubber skirt attached to the lower edge of the envelope. Unlike the Hovercraft which has no contact with the ground, the air cushion truck is an ordinary vehicle whose wheels maintain contact with the ground and provide traction in the normal way. The pressurised air gives an additional form of suspension and over sodden land, which would otherwise be impassable, the air cushion reduces the wheel loading to enable traction to be maintained. The position of the flexible skirt can be adjusted at varying distances above the ground and the vehicle can be driven over dry firm surfaces without hindrance. It is thought that air cushion trucks of this type will have important applications in agriculture, notably for crop spraying and spreading of liquid fertilisers, but their use is also envisaged by rough country vehicle operators in all parts of the world.



Soft moon landing

THE United States Air Force, when dropping heavy equipment to the earth's surface, use a device containing pneumatic decelerators. These soften the the parachute landing when the equipment hits the ground.

Similar decelerators have now been proposed for the time when soft landings are to be made on the moon or other planets.

In the artist's conception, a space vehicle approaches the moon's surface with vernier rockets controlling the landing speed. At the proper distance from the surface, the laminated decelerator is extended below the vehicle, braced and inflated.

Feasibility of the device, to prevent bounce or upset of the spacecraft, has been proved through a series of tests and computer studies conducted in Arizona.



BEFORE and AFTER:

This double exposure photograph demonstrates a device that simulates the way a tyre cord pantographs—or changes angle—when a tyre is moulded.

At right, the device is in the drum shape of a tyre before moulding. At left, it has assumed the shape of a finished tyre. The device was made to help explain tyre construction to motor car engineers.

Sun Gazing Underground

NEW SOLAR TELESCOPE AT KITT PEAK, U.S.A.

BY D. FRAZER

THE march of science is incessant. Nothing can slow down the pace of scientific discovery—especially in the field of astronomy. The chief reason for this is that astronomers throughout the world co-operate, as there is no one nation from which the entire sphere of the sky can be seen.

In 1962, or early 1963, astronomers from all over the world will be going underground to study the sun. Strange as this may seem, it is the latest method of obtaining more revealing solar observations than have ever been possible before. The major instrument in this new project will be the world's largest solar telescope, which is now nearing completion at the Kitt Peak National Observatory, Arizona, in the United States. The telescope will be available to all professional astronomers.

During the construction of the telescope a 300-foot long tunnel had to be dug into the summit of Kitt Peak, a mountain some 40 miles south-west of Tucson. The tunnel, which slopes at an angle of 32 degrees to the horizontal, looked more like a mine shaft than an astronomical research facility. Nearby, and rising 110 feet above the ground, is a column of steel and concrete, which will support a motor-driven flat mirror, known as a heliostat.

The heliostat will form the top of the giant telescope, heading a 500-foot inclined tube, partly above and partly below ground. The heliostat's 80-inch mirror will track the sun all day, every day of the year, rotated at the earth's rotational speed by a delicate clockwork mechanism controlled by light-sensitive devices. The mirror will reflect the sun's image down the inclined shaft to a smaller mirror 480ft away, then upward 280ft to a third mirror, and from there 20ft into an underground observation room where the image will be photographed or directed to spectroscopic devices. The heliostat will be retractable and will be kept beneath a cover at night, or in stormy weather. The second mirror may be moved up and down the inclined shaft according to the type of image required. The mirror mount weighs 50 tons and was manufactured by Westinghouse,

This artist's impression shows the layout and optical system of the big telescope. About three-fifths of the structure will be underground. The 200-foot long water-cooled section above ground is supported at its upper end by a concrete tower, topped by the sun-following heliostat mirror.

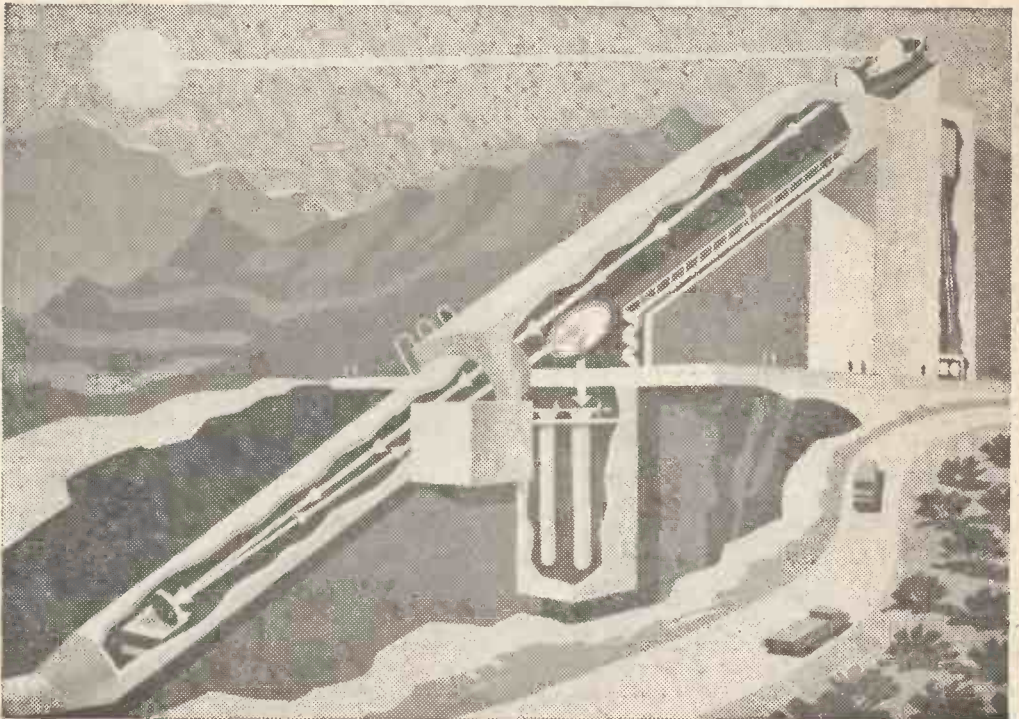

who also completed the work on the mounts for the two smaller mirrors that go into the telescope structure. The solar telescope will be capable of photographing 500-mile areas 93 million miles away on the sun. To achieve this accuracy the heliostat must not move as much as 1/1000 of an inch in a 25-mile-an-hour wind.

A unique feature of this project, is a water-cooling system that will keep the exposed portion of the tunnel at a constant temperature. This will prevent what astronomers call "poor seeing", which is caused by warm air rising from the ground and causing a shimmering, haze effect which distorts good viewing.

The grinding of the mirror was accomplished by a new process called "sagging", which is said to be an improvement on earlier methods. Most mirror blanks in the past were made by melting glass and lading the molten material into a mould. The new process involves melting or "sagging" glass directly onto a mould. This is a delicate operation, but it is less complex and costly than lading. It is also more precise, and reduces the risk of bubbles in glass.

The new telescope will form an image of the sun, larger and more detailed than is possible with any other instrument on earth. This will permit scientists to conduct spectrographic analyses of the sun's surface that will contribute valuable information to atomic research meteorology

and communications. The telescope may also make it possible to learn how the sun and stars are formed, and how the sun fits into the life span of a star.

The sun, 93 million miles away from the earth and with a core registering 27 million degrees Fahrenheit, is of great interest to scientists. Its "averageness", i.e. the fact that it is average in brightness, surface temperature, size, mass and age amongst the stars, will enable astrophysicists to apply knowledge gained from solar studies to distant stars both bigger and smaller. In addition to spectral investigations, the giant telescope will be used for research efforts on sun spots and solar flare. It will, undoubtedly, substantially increase man's meagre knowledge of the star that keeps our planet alive. This solar telescope is one of several major instruments in use, or under construction, at the new National Research Centre of Optical Astronomy at Kitt Peak.

The Association of Universities for Research in Astronomy (AURA), a non-profit corporation, designed and will operate the observatory under a contract with the U.S. National Science Foundation. AURA's board of directors is composed of astronomers and business representatives from ten American universities: California, Chicago, Texas, Harvard, Indiana, Michigan, Ohio State, Princeton, Wisconsin and Yale.

View showing the construction of the world's largest solar telescope at Kitt Peak, Arizona. The large hole in the foreground now houses the observing room. The tower on the left will cradle the heliostat.



EASILY MADE

MAGNETIC ACTUATORS

IT is sometimes necessary to have a rotary action initiated by a single pulse, such as would be received from a bell push or similar switch, which will continue for some time after the initiating pulse has ceased. The action, of course recommencing each time the pulse is received. These requirements are met by the arrangement shown in Fig. 1. The press switch connects the motor to the supply and the motor drives the cam and any other mechanism connected to it. When the cam turns far enough, the lobe lifts the microswitch arm which opens the circuit and stops the motor. The action can be started again by pressing the switch. The cam should be driven through gears and by using a suitable gear ratio the running period may be hours or seconds. The shape of the cam lobe is important, the motor does not stop instantly when switched off and if the cam speed is high it will over-run the microswitch roller, thus switching the motor on immediately after it has been switched off. A flat topped cam lobe will prevent this. In general, the cam speed should be kept as low as possible.

Only motors that require no starter can be used with the device, but this is the case with many fractional H.P. mains motors. Many low voltage model motors also require no starter. However even with the battery operated motor, and especially when it has to start under a heavy load, direct switching can be hard on the windings. To avoid to some extent the rush of current to the stationary motor, a resistance is included in the push circuit. The value of the resistance depends upon the current taken by the motor and this

BY B. C. MACDONALD

varies in battery operated model motors from about $\frac{1}{4}$ to $1\frac{1}{2}$ amps. If we divide the voltage by the current we have the motor resistance and, as a very rough guide, about half of this would be a suitable value for the press circuit resistance.

In Fig. 2 we have a solenoid mechanism that gives a very powerful upward striking action. When the circuit is closed the iron rod rises rapidly, well out of the top of the coil, then falls back to be held in the coil so long as current flows. On breaking the circuit the rod falls back on to the stop. For maximum effect the rod should be half way in the coil in the rest position.

Fig. 3 shows a simple arrangement of one or two magnets to give a sideways thrust which can be used to operate the push of a counting mechanism or to give a stepped rotary motion by means of a clock escapement wheel and pawl as shown. The amount of movement between the arm and the magnet is small but can be proportionally increased by lengthening the vertical part of the operating arm.

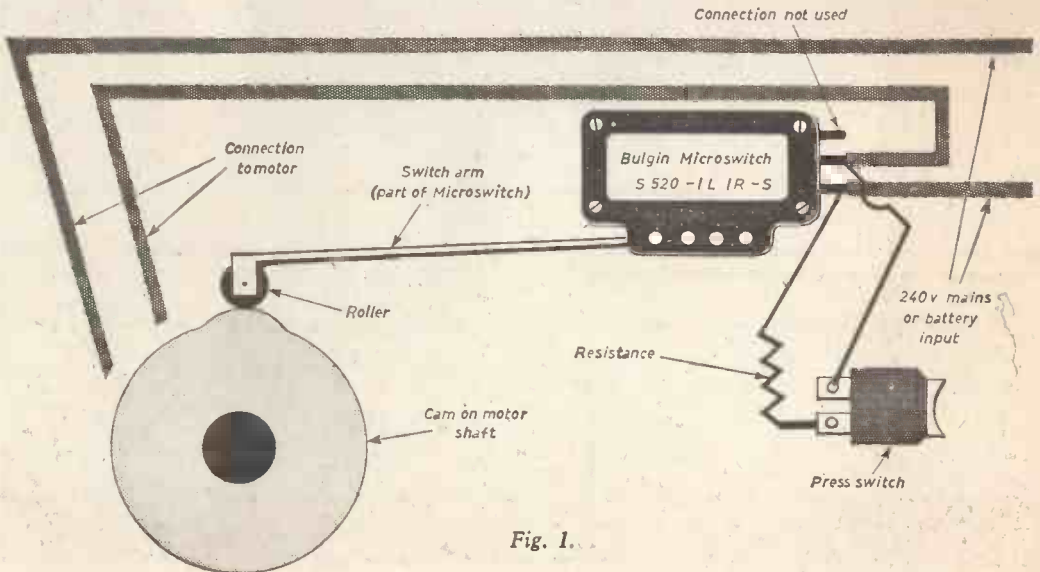

Fig. 1.

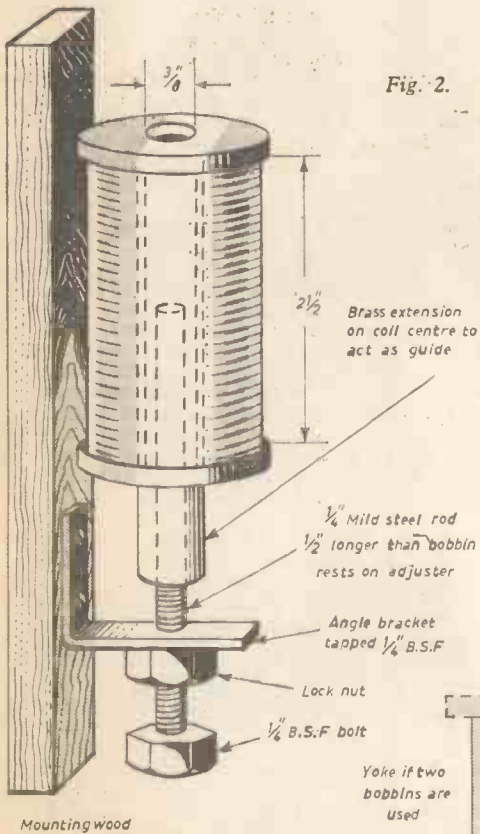

Fig. 2.

Pull magnets are often needed to operate camera shutters and other mechanisms at a distance, and they can be made to give quite a powerful pull, especially in the larger sizes. Fig. 4 illustrates such an arrangement. The top of the bolt, after the head has been cut off, should be slotted with a hacksaw so that after it has been inserted into the bobbin through the upper part of the yoke it can be screwed into position. The brass bracket is necessary to act as a guide for the moving part of the magnet. The iron washer can either be soldered on to the moving rod, or if the hole in the washer is very slightly smaller in diameter than the rod, the latter may be driven into the washer. A suitable support should be used to prevent the washer becoming distorted.

If we require an actuator that will give a push instead of, or as well as, a pull this may be achieved by means of the pot type magnet shown in Fig. 5. In fact the arrangement is the same in principle as that of Fig. 4, the magnet coil in this case being completely surrounded by an iron tube. This gives a better magnetic circuit and results in a more powerful magnet. The larger diameter brass tube and its top provide a guide for the moving rod. The hole in the 1/4 in. iron rod, to take the 1/4 in. brass rod, should be accurately drilled in the centre. The brass rod is soldered in position. The iron tube through which the brass rod passes should be of 1/4 in. diameter and screwed B.S.F. for about half an inch at one end to take the adjusting nut. The

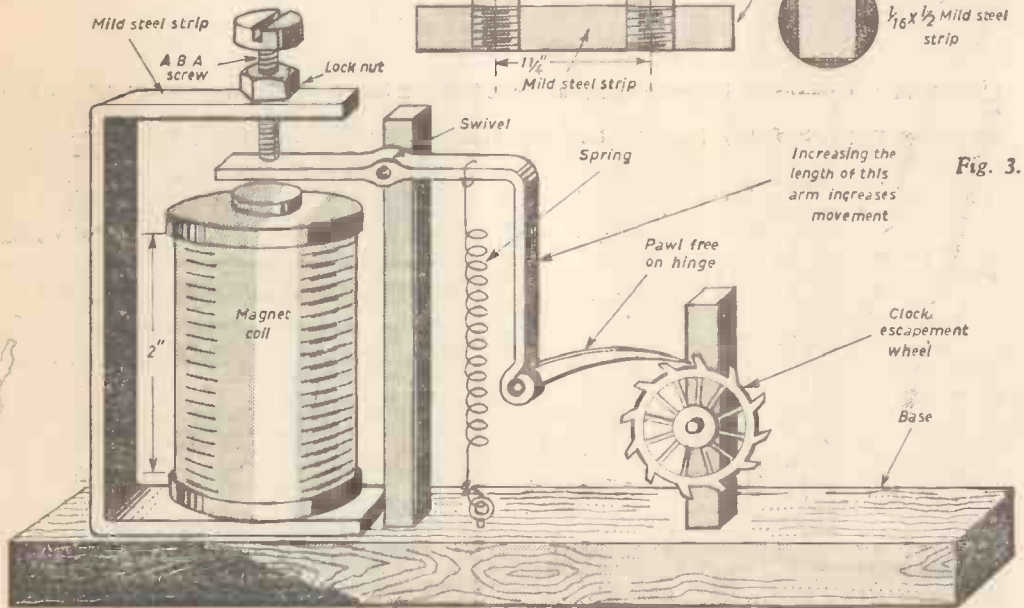
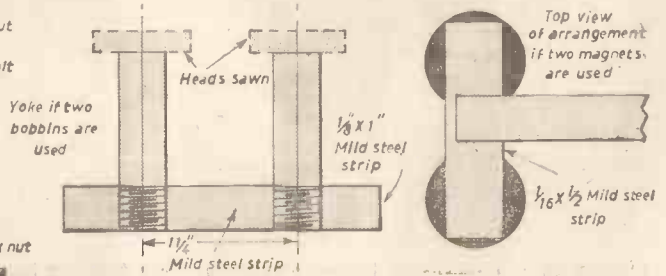
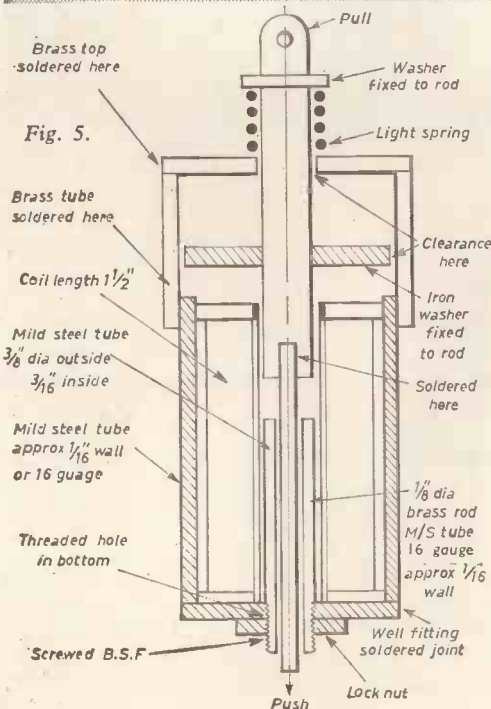
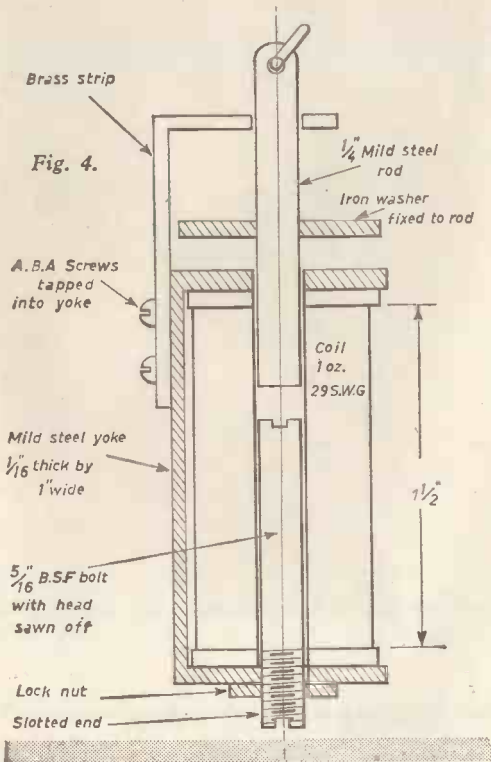

Fig. 3.



wall thickness of the tube should be $\frac{3}{32}$ in. and the brass rod should be of $\frac{1}{8}$ in. dia. to give clearance between rod and tube of $\frac{1}{16}$ in. In fact these measurements are not critical and the reader may vary them a little to suit the material at his disposal, but it is important to allow plenty of clearance for the moving parts, or they will tend to stick when the magnet operates. Sticking is also likely to occur if the surface of the metal is rough.

The coils will all take 0.75 amps at 4.5v, 1 amp at 6v, 1.3 amps at 8v and 2 amps at 12v. The solenoid of the striker, Fig. 2, will work with a.c. or d.c. as will the pull magnets. The magnets of Fig. 3 will work with d.c. only. The wire used for winding the coils may be either D.C.C. (double cotton covered) or enamelled. The D.C.C. wire takes up rather more space, and because of this only the lengths of the bobbins are given. It is best to wind the coils before the rest of the mechanism is made, since the width of the windings settles some of the dimensions. The bobbins can be made with thin brass or copper sheet. Form the centre by wrapping a piece of the sheet round a suitable former and soldering the overlapped joint. The ends of the bobbin can then be soldered on to this. The winding space should be lined with paper, pasted on to the bobbin, to prevent the wire touching the metal.

The striker bobbin, Fig 2, is extended at the lower end of the coil to act as a guide, as shown, and in this case $1\frac{1}{2}$ oz No. 28s.w.g. wire should be wound on the $2\frac{1}{2}$ in. long bobbin. The bobbins of Fig. 3 may be made of card, they are 2in. long and wound with $1\frac{1}{2}$ oz of No. 26s.w.g. wire per coil. If only one coil is used, this is wound with 1oz of No. 29s.w.g. The yoke is made from $\frac{1}{16}$ in. x 1 in. mild steel strip, suitably shaped by bending in a vice. The coil of the pull magnet shown in Fig. 4 is $1\frac{1}{2}$ in. long and wound with 1oz of No. 29s.w.g. wire. The yoke is made from mild steel strip $\frac{1}{16}$ in. thick by 1 in. wide. The clearances for the moving rod should not be too tight, to prevent sticking. The pot magnet, Fig. 5, gives a pull at one end and a push at the other. The coil is exactly the same as that for Fig. 4, it should be a fairly tight fit on the bottom rod so that it will stay in position. This fit can be obtained by paper packing. The upper, moving rod, must of course be quite free to move in the bobbin. After assembling the coil, the brass cap may be fixed by soldering at four points only. Too much heat, it should be remembered, may damage the wire of the coil.

DIRECTION FINDING RECEIVER

We regret that a number of printing errors escaped notice in this article in the September and October issues. The following are the correct descriptions of various parts wrongly quoted in the parts list and text.

I.F. transformers

1. XT26 (Repanco) blue spot
2. XT26 (Repanco) blue spot
3. XT27 (Repanco) green spot

Oscillator coil (L3 Fig. 10.)

XO28 (Repanco) black spot

B.F.O. coil (L4 Fig. 10.)

XO28 (Repanco) black spot

Ferrite slab aerial

FS30 (Repanco) 5 1/2 in. long

We apologise for any inconvenience these errors may have caused to constructors of this equipment.

Fritz

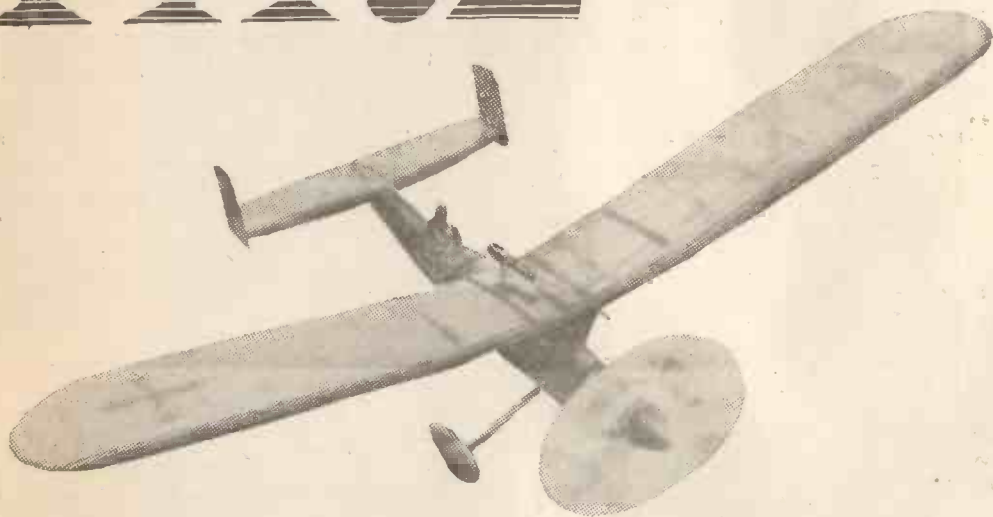

A SPORTS POWER MODEL by COLIN READ

FRITZ was designed as a sports model with scale lines and yet with sufficient wing area and power to be an all-weather flier. This enables the model to be flown all the year round and not in calm weather only, as is usually specified for scale models. Several features such as cowled-in engine fairings, open cockpit, armament and the Iron Cross markings of German 1940-44 fighters result in an attractive semi-scale sports model. It is not known whether in fact there was a fighter with these lines, but perhaps some pre-war prototypes bear a little resemblance.

Construction is first commenced by building the fuselage, this being a straightforward structure of all-balsa covering. Cut the sides from $\frac{1}{16}$ in. sheet and formers 4-9 from $\frac{3}{32}$ in. sheet. Former 3 is $\frac{1}{16}$ in. ply. The undercarriage should be firmly fixed to this former, as shown, before the basic fuselage is assembled.

Before fixing former F2 in position the choice of power plant should be made. The original was a Cox Baby Bee 0-049 mounted as shown. The new D/C 049 Quickstart Bantam with tank would also be a very suitable choice. Any engine of similar size can be used, however. Neither is it essential to mount the engine as a sidewinder if some other method is preferred. Fix the engine bolts by means of a piece of wire soldered across the heads to prevent the bolt heads turning when the engine is finally bolted in place. The bolt

heads can now be firmly cemented in place. Former 2 can now be cemented in place on the basic fuselage.

Cover the top from nose to cockpit, F6a-F7, with $\frac{1}{16}$ in. sheet in strips $\frac{1}{16}$ in. x $\frac{1}{16}$ in., and from F7 to F9 with $\frac{1}{16}$ in. strips tapering from $\frac{1}{16}$ in. wide to $\frac{1}{16}$ in.

The pylon sides should be cut from $\frac{3}{32}$ in. sheet with hardwood $\frac{1}{16}$ in. x $\frac{3}{32}$ in. strips cemented in place as shown. The side view on the drawing is the full projected view and, when fitted, the wing fits perfectly on top. Sand the pylon sides to shape and cement in place firmly, using Britfix cement. The hardwood strips pass through the fuselage covering and a small slot should be cut for this purpose. When set, the underside of the fuselage can be covered with $\frac{1}{16}$ in. cross-grained sheet. Temporarily fit the engine to assist in carving the cowl from $\frac{1}{16}$ in. sheet. This should be fuel-proofed three or four times with dope to prevent fuel soakage.

Bolt the engine in place permanently, noting that sufficient downthrust and sidethrust is incorporated as shown, then firmly cement the cowl in position. Add ply former F1 and finally sand to shape. The cowl fairing blocks should be carved and sanded to shape, then the holes for the cylinder head and needle valve can be cut out and shaped. When mounting the Cox Baby Bee 049, or the Golden Bee 049, with the cylinder horizontal, or in fact any similarly mounted engine with incorporated fuel

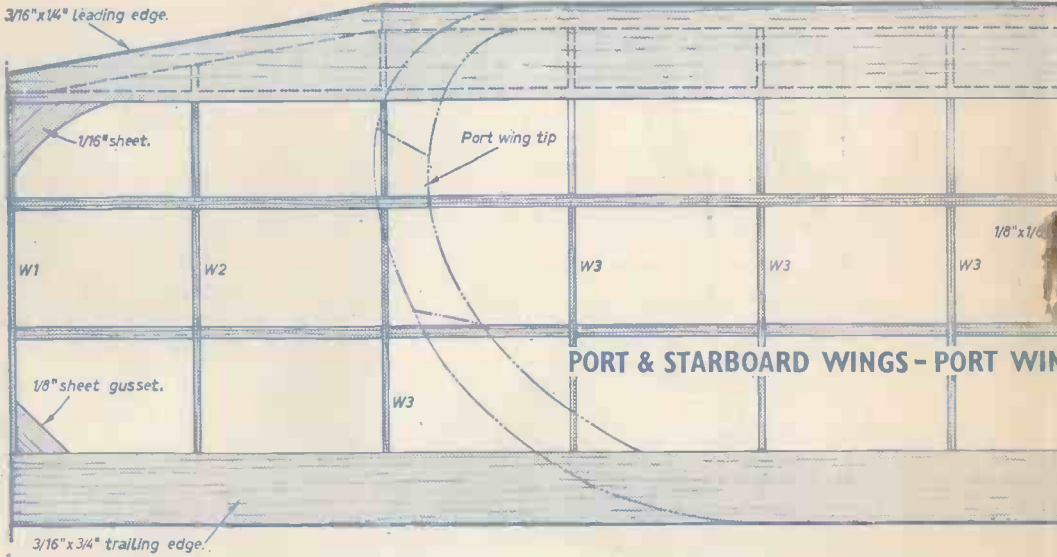

PORT & STARBOARD WINGS - PORT WING

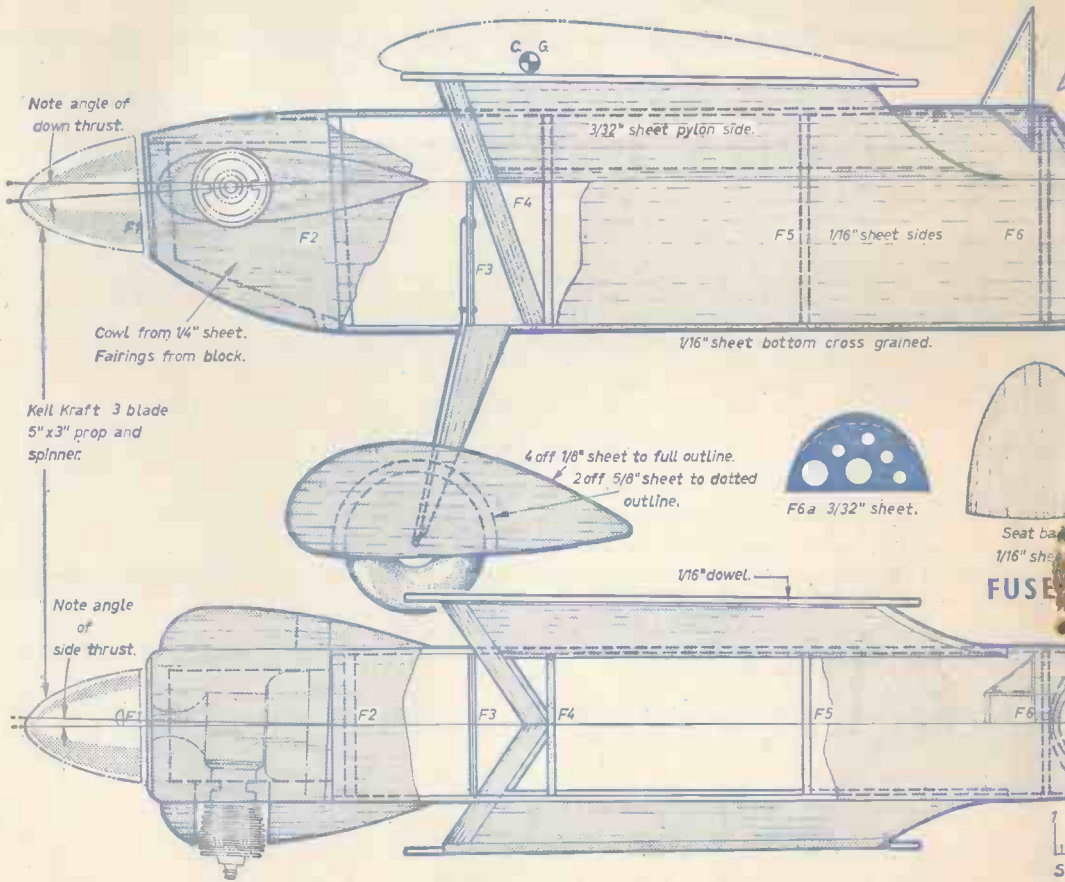

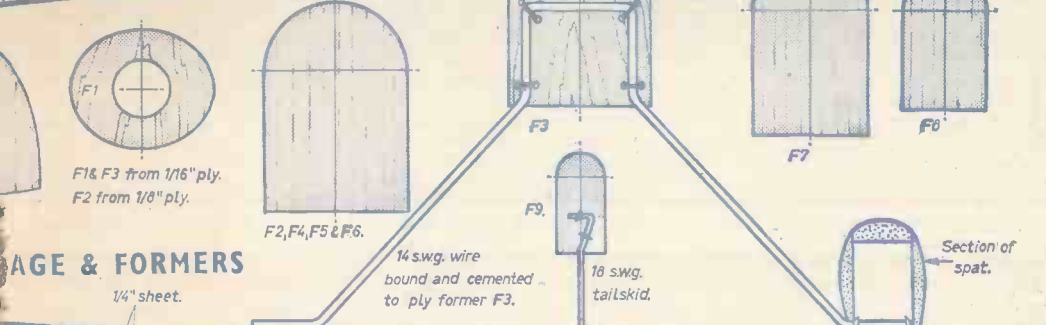
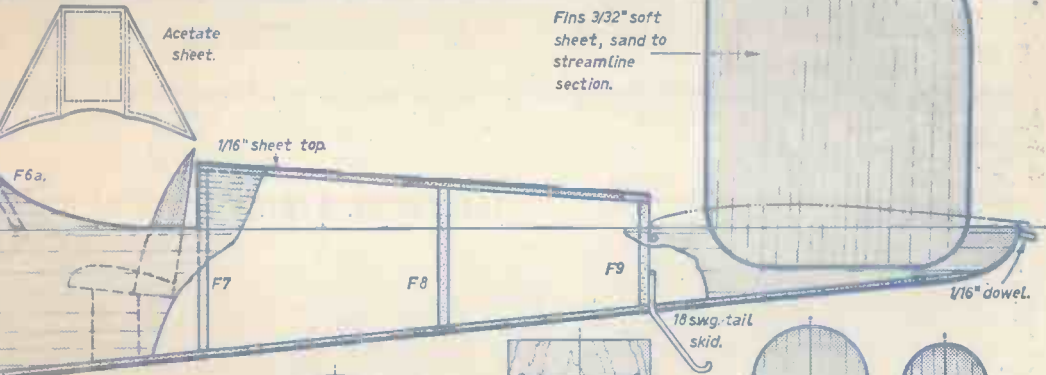
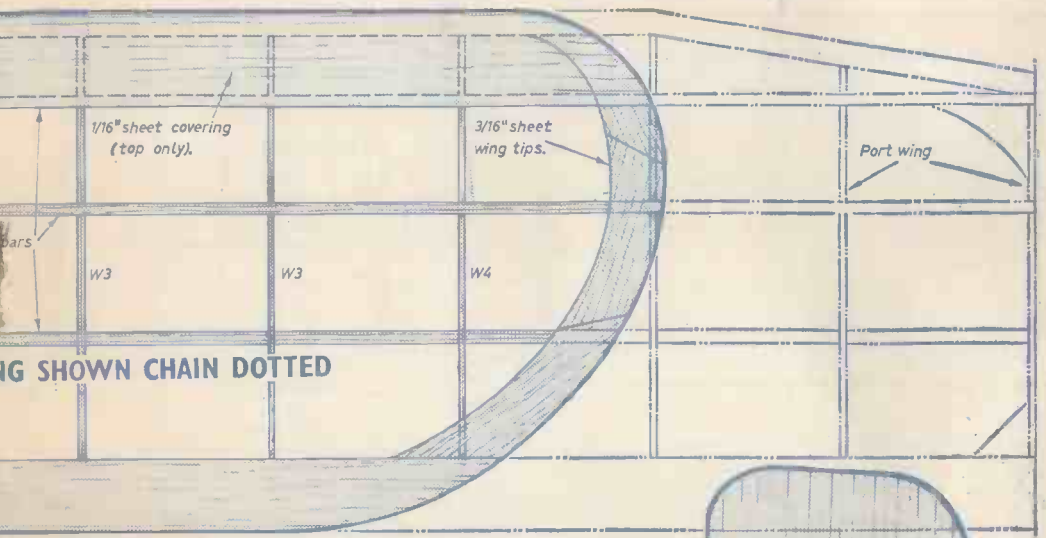

All materials balsa unless otherwise stated.

Material List

Balsa Sheet

- 2. 1/4 in. x 3 in. x 36 in.
- 1. 3/8 in. x 3 in. x 36 in.
- 1. 1/2 in. x 3 in. x 12 in.
- 1. 1/2 in. x 3 in. x 18 in.
- 1. 1/2 in. x 3 in. x 12 in.

Ply

- 1. 1/8 in. x 2 in. x 6 in.
- 1. 1/8 in. x 2 in. x 3 in.

Balsa Strip

- 3. 1/4 in. x 1/4 in. x 36 in.
- 1. 1/4 in. x 1/4 in. x 12 in.
- 1. 1/4 in. x 1/4 in. x 12 in.

Trailing Edge Balsa

- 1. 1/4 in. x 1/4 in. x 12 in.
- 1. 1/4 in. x 1/4 in. x 36 in.
- 1. 1/4 in. x 3/8 in. x 12 in.
- 1. 1/4 in. x 3/8 in. x 36 in.

18 in. 14 s.w.g. piano wire; small piece 18 s.w.g. piano wire; 1 pr. 1 1/2 in. sorbo balloon wheels; 5 x 3 Keil-Kraft 3-bladed nylon prop and spinner; 3 sheets Jap tissue; acetate; cement; dope, etc.

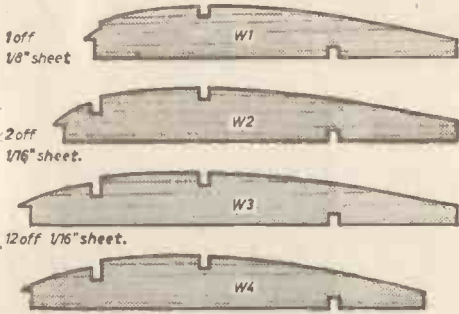
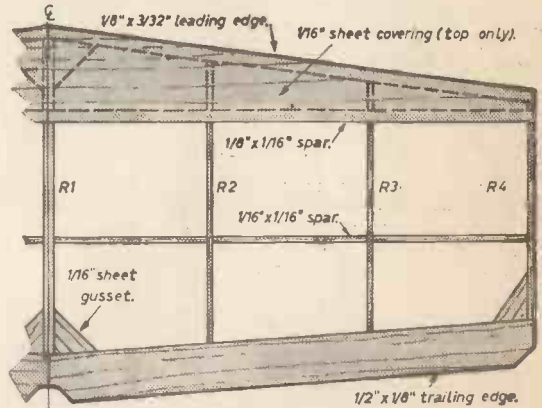

WING RIBS

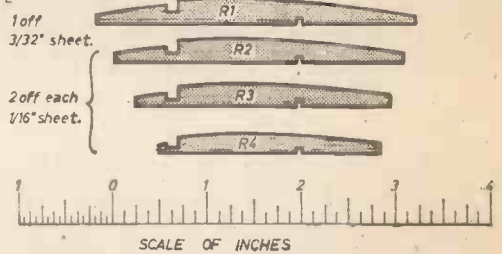

All materials balsa unless otherwise stated.

TAILPLANE & RIBS

tank, remove the fuel tank and re-position with the fuel feed at the bottom so that the needle assembly is horizontal but on the opposite side to the cylinder. This will enable flights of reasonable power duration to be made as it will be noticed that after filling the tank only the lower half will contain fuel. This is sufficient for a 20-second power run. I use this method on all my Cox powered sports models and find it quite easy to judge runs of 10-20 seconds. With glow-plug engines the cylinder head must be exposed to allow connection with the starting battery.

The U/C fairings are built up from 1/4 in. and 1/8 in. sheet, well cemented in place. I find Britfix cement unbeatable for this type of work and particularly for engine cowl joints. For a final scale touch use the Keil-Kraft nylon 5 x 3 prop complete with spinner.

The wings should be built flat on the drawing, all ribs being cut out as indicated from 1/16 in. and 1/8 in. sheet balsa. A good quality wood should be chosen for the trailing edge and spars as it is not advisable to have an overweight structure. After building the wing halves they should be joined together at the centre and 1/16 in. ply braces added to give 3 in. dihedral at each tip. The 1/8 in. sheet top covering can now be added and all gussets cemented in place. Finally sand the wing tips and leading edge to shape.

The tailplane is very straightforward and can be built flat on the drawing. Cut the fins from soft 1/16 in. sheet and sand to a streamline section.

The whole framework should now be sanded to

a smooth finish, doped several times all over and sanded again until a really smooth surface results. This method is used before covering on all my concours and exhibition models and definitely improves the looks of the model when using coloured tissue. For covering Fritz use coloured Jap tissue and attach to the framework with thinned dope. Dope the tissue three or four times, adding tissue strips if required, after the second coat of clear dope. The clear dope should not be too thick; always add a little thinners before using.

The entire model, fuselage, cowl, spats etc. should be covered in a basic colour tissue, say orange, with trim strips (black) as shown in the illustrations, doped on. Finish with a coat of fuel proofer, preferably H.M.G. as this gives a really fuel proof finish. For a final touch add a pilot, windscreen and machine gun, and markings.

Test flights should be carried out in reasonably calm weather, and provided the c/g is correct a trouble-free first flight should result, even if only gliding. A gentle right-hand gliding turn is the ideal to aim at, together with wide left turn under power. This ensures freedom from trimming problems, as with a right-hand power turn and a right-hand glide the model could, and possibly would, spin in fast and catastrophically.

Gradually increase the engine power during trials and a left-handed spiral climb will result. Fast enough to match a 1/2 A contest model in fact, but unfortunately not gliding quite like one, although satisfactorily long flights can be made on a 10-20 second engine run.

Sheet Metal Detail Work

by Benchman

IN the August issue an exercise in sheet metal fitting was described. This exercise dealt with the method employed to calculate the exact amount of material needed to construct a right angle bracket from 16 s.w.g. material. It was a straightforward exercise which could be carried out using simple calculations. By this method a fitting could also be made without fear of possible fracture or waste of metal.

Suppose that it is necessary to construct a similar fitting with an increased bend. This will result in the external surface being subjected to increased tension, and the internal surface to increased compression. Another type of basic exercise gives the solution of the length of material required for the job. A right-angled triangle (Fig. 1) is a triangle containing one right angle. It has special characteristics which it is as well to know when working out dimensions, with or without tables. In the first place, without knowing any angles and without the use of tables, the third side can be found when the other two are known. This is Pythagorus' Theorem. $A^2=B^2+C^2$, $B^2=A^2-C^2$, $C^2=A^2-B^2$. Thus A can be found by taking the square root of B^2+C^2 and so on.

However, in some cases, where two sides are not known it is necessary to know only one side and one angle. The other dimensions can then be found by simple trigonometry. Trigonometrical tables are to be found in many handbooks. Before attempting to solve any problem however, the descriptions of the sides of a triangle must be correctly defined. If the known angle in Fig. 1 is α , then the names of the sides are: A, Hypotenuse, the sloping side opposite the right angle; B, Opposite, the side opposite the known angle; C, Adjacent, the third side, next to the known angle. The three basic trigonometrical functions are derived from these three sides and the angle, as follows:

$$\text{sine } \alpha = \frac{\text{OPP}}{\text{HYP}} \quad \text{cosine } \alpha = \frac{\text{ADJ}}{\text{HYP}} \quad \text{tangent } \alpha = \frac{\text{OPP}}{\text{ADJ}}$$

The one we are interested in, in this exercise, is $\tan \alpha$.

Referring to Fig. 2, the method of constructing a sheet metal fitting with an internal angle of 70°

with 1 in. sides, in 16 s.w.g. material, and with a radius of twice the gauge thickness, is as follows.

$$\begin{aligned} EA &= AB - BE \quad \text{but } BE = \frac{EF}{\tan 35^\circ} = \frac{0.128'' + 0.064''}{0.700} \\ &= \frac{0.192}{0.700} = 0.274'' \quad \therefore EA = 1 - 0.274 = 0.726'' \end{aligned}$$

$$\begin{aligned} \text{Similarly } CD &= CB - BD \quad \text{but } BD = \frac{DF}{\tan 35^\circ} = \\ &= \frac{0.128'' + 0.064''}{0.700} = 0.274'' \quad \therefore CD = 1 - 0.274 = 0.726'' \end{aligned}$$

$$\begin{aligned} DE \text{ (the bending allowance)} &= \frac{2\pi(R + \frac{1}{2} \text{ gauge}) 110}{360} \\ &= \frac{6.283 \times 0.160 \times 110}{360} = 0.307'' \end{aligned}$$

Thus the total length of material required =
 $EA + CD + DE = 0.726 + 0.726 + 0.307 = 1.759''$

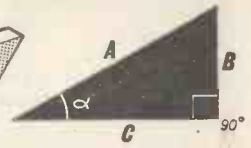

Fig. 1.

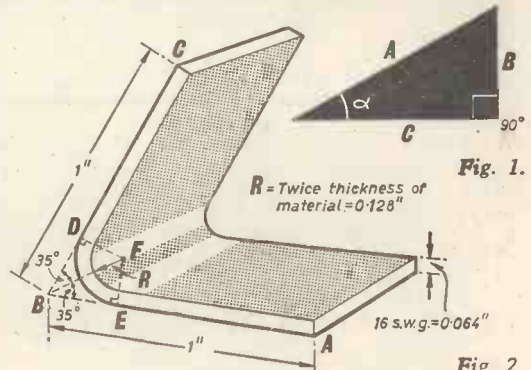

Fig. 2.



THE P.M. BLUEPRINT SERVICE

- 12 FT. ALL WOOD CANOE. New Series. No. 1, 4s.*
- COMPRESSED-AIR MODEL AERO ENGINE. New Series. No. 3, 5s. 6d.*
- AIR RESERVOIR FOR COMPRESSED-AIR AERO ENGINE. New Series. No. 3a, 1s. 6d.
- "SPORTS" PEDAL CAR. New Series. No. 4, 5s. 6d.*
- F. J. CAMM'S FLASH STEAM-PLANT. New Series. No. 5, 5s. 6d.*
- SYNCHRONOUS ELECTRIC CLOCK. New Series. No. 6, 5s. 6d.*
- ELECTRIC DOOR-CHIME. No. 7, 4s.*
- ASTRONOMICAL TELESCOPE. New Series. Refractor. Object glass 3in. diam. Magnification x 80. No. 8 (2 sheets), 7s. 6d.*

- CANVAS CANOE. New Series. No. 9, 4s.*
- DIASCOPE. New Series. No. 10, 4s.*
- EPISCOPE. New Series. No. 11, 4s.*
- PANTOGRAPH. New Series. No. 12, 2s.*
- COMPRESSED-AIR PAINT SPRAYING PLANT. New Series. No. 13, 8s.*
- MASTER BATTERY CLOCK.* Blueprints (2 sheets), 4s. Art board dial for above clock, 1s. 6d.
- OUTBOARD SPEEDBOAT. 11s. per set of three sheets.
- P.M. TRAILER CARAVAN.* Complete set, 11s.
- P.M. BATTERY SLAVE CLOCK, 2s. 6d.
- P.M. CABIN HIGHWING MONOPLANE, 1s. 6d.
- THE MECHANIKART, 15s.*

Post free from Messrs. George Newnes, Ltd., Tower House, Southampton Street, Strand, W.C.2.

*denotes constructional details are available free with the blueprints.

THE MECHANICS OF EARLY CARS

We take a look at practical mechanics in action

Where can you get a replacement crankshaft for an 1896 car? Make It Yourself is the answer for most owners of veteran cars. Many of them are first-class practical engineers who have beautifully restored their vehicles, often found as wrecks under piles of rubbish—or worse! Those of our readers who delight in craftsmanship will, we are sure, enjoy these pictures from this year's Brighton Run as much as we enjoyed taking them.

This 1902 Hanzer was discovered in a Reading scrap yard during the war and is believed to be the only one in existence. When found the original body had been removed and substituted by a clumsy wooden milk float. Mr. Dennis Field, editor of *V.C.C. Gazette*, bought the car and restored it in 1945 to what he estimated to be original condition, although he had no data from which to work. An advertisement was later found in *The Autocar* of July 5th, 1902, offering the car for sale at £165. The advertisement contained a clear photograph and described the car as the "Speedwell Parisien—Fast and good hill climber, absolutely vibrationless". Its present owner, Mr. E. Baker has restored the mechanical parts, and this is the third time he's driven it to Brighton.

The engine is a French "Aster" and its single cylinder produces five horse power,



Photographs
by
Norman Kirby

The Quadrant Cycle Co. of Birmingham turned their attention to motor tricycles. They were responsible for this three-wheeler incorporating two entirely independent engines, in 1903, and they subsequently made cars.



In 1896 Messrs. Walter Arnold and Sons imported and sold Beny cars. They also built or modified some twelve cars of the Beny design, fitted engines of their own manufacture, and sold them as Arnold Motor Carriages. The engine is a single cylinder mounted horizontally, it has an exposed crankshaft on which is mounted a huge cast-iron flywheel coupled with a belt drive to the rear wheels.



This light car, the Clement-Panhard, was designed by Commandant Krebs, a director of Panhard-Levassor, late in 1898, it was later sold in this country as the Stirling-Panhard.

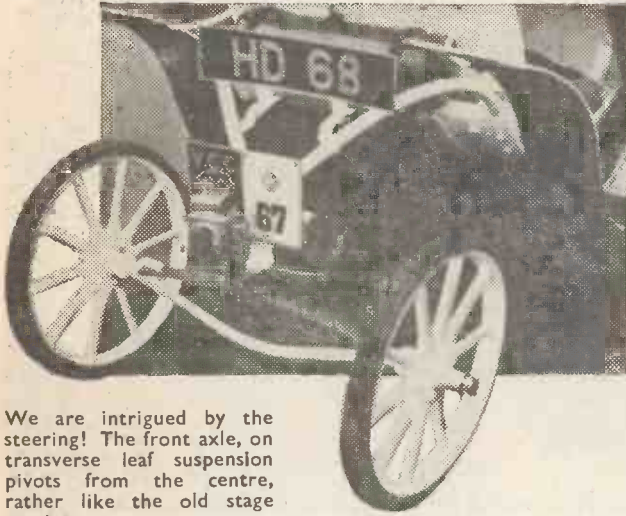

We are intrigued by the steering! The front axle, on transverse leaf suspension pivots from the centre, rather like the old stage coaches.



This Dechamps Tricycle looks fairly modern, but was in fact made in 1899 by a Belgian firm which started in the motor business making tricycles and later turned their attention to cars.



1904 Rolls-Royce engine.

In 1904 Sir Henry Royce designed and built three 10 H.P. twin-cylinder "Royce" cars, and by the end of the same year production of the first batch of similar models, by then Rolls-Royce, had begun. Not more than twenty twin-cylinder cars were made, of which only three are known to have survived.



An entry by The Royal College of Science, a 1911 Dennis fire engine.

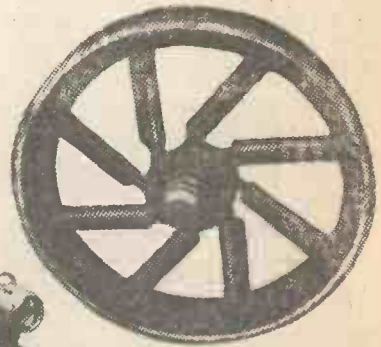

The wheels of this Renault had hydraulic spokes. This must have been the earliest type of independent suspension on all four wheels.

The well-known French firm made this 1903 Renault. Their early cars were fitted with De Dion engines, and later designs had the radiator placed between the engine and the dashboard and by using a vaned flywheel and an airtight bonnet, efficient cooling was ensured.



Gardner-Serpollet Steamer. M. Leon Serpollet was one of the pioneers of steam road vehicles in France; he built his first steam tricycle in 1887. His partner, Gardner, was an American who financed the concern. These cars were marketed from 1900 onwards.



The Gillet-Forest was the product of another early French concern, the first model having a large horizontal single-cylinder engine surmounted by a curious cage of gilled tubes which formed the cooling system. Only a single example of the make survives in this country today.



The De Dion Bouton cars formed the biggest entry in the run. This famous French concern was founded by an association between the Comte de Dion and a certain Monsieur Bouton. Their early vehicles were steam driven. Later petrol driven tricycles were made and by 1901 the first front engine petrol driven car was produced.

A Head Pre-amp for Crystal Microphones



Fig. 1.

SOME types of crystal microphones provide quite a low output voltage, and their high impedance makes it difficult to ensure a good signal-to-noise ratio when connecting leads of any length are used. When extreme sensitivity is required, the problem is that much worse.

One way out of the difficulty is to use a "head" pre-amplifier such as the one described here. The circuit is quite standard (Fig. 2), employing two stages of valve amplification. Built-in batteries are used to provide the power, and the close proximity of the pre-amp to the microphone ensures that mains hum will not be amplified with the signal. Figs. 3, 4 and 5 show the construction of the unit. While no radical miniaturisation has been attempted, the small size of the valves allows quite a compact unit to be made, handy either for fitting directly to the mike, or for inserting into its lead.

Construction

The circuit is built up on a strip of insulating material; Perspex or similar material makes an attractive job. The resistors and capacitors are held in place by their connecting leads which are pushed through holes previously drilled or punched in the strip. Fig. 5 shows the layout of the panel. The components are fitted to the front of the panel as shown in Fig. 5; their projecting leads then being interconnected as Fig. 3 and soldered in place. Only where two leads cross will it be necessary to use insulating sleeving. When the wiring is complete, the large "decoupling" capacitor C4 can be folded over the front of the panel and the two valves can likewise be folded over, to lie along

the rear face, producing a compact block.

One suggested method of enclosing the pre-amp is shown in Fig. 1, by using a large i.f. can. In this case, pin sockets were used for the microphone and a co-axial socket for its cable. Just as easily, the unit could be inserted into the microphone lead by mounting a suitable socket at each end.

Circuit details

About the only unconventional feature of the circuit is the manner in which it is connected to the main amplifier. Because a separate source of supply is used, it is quite immaterial whether the negative or positive lines of the circuit are earthed. The circuit as shown is, in fact, "inverted". The screened cable to the main amplifier input is connected to Out and B+, i.e., across the load resistor of "V2", and the positive pole of the battery is earthed. This arrangement obviates the need for

Fig. 2.

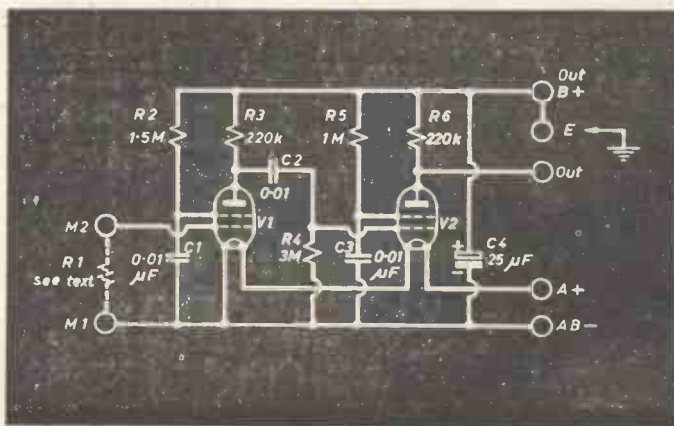

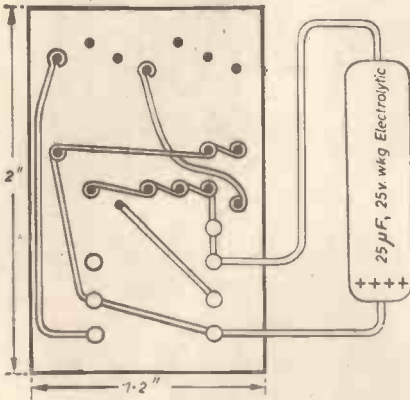

Fig. 3.

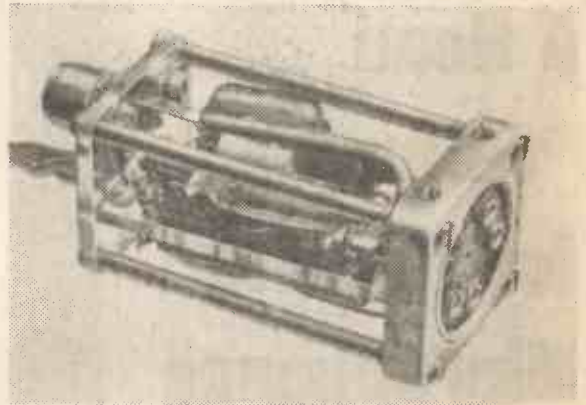

Fig. 4

a second interstage-coupling capacitor. It has no effect whatsoever on the behaviour of the circuit as a microphone pre-amp. However, if the unit is used for other purposes it should be remembered that the input is floating 20 volts "below" earth (although it is effectively earthed as far as signal voltages are concerned).

If the circuit is built into a metal case, this should preferably be connected to "B+" or "E", thus avoiding the danger of the h.t. battery being shorted if the pre-amp and main amplifier casings happen to touch.

Batteries

Power for the pre-amp is derived from a 22½v battery (as used in deaf aids, flashguns etc.) together with a 1.4v dry cell. Alternatively, if some loss of gain can be tolerated, a 9v grid-bias battery can serve both purposes. In the first case, the negative (or "0") poles of battery and cell are connected to AB-, the 22½v positive is connected to B+ and the positive pole of the 1.4v cell to A+. In the second case, the -9v socket of the grid bias battery is taken to AB-, the + or 0 socket to B+ and the -7½v socket to A+. *Be careful, a mistake here can easily burn out the valves.*

Input resistor R1

If it is intended to use the unit as a general-purpose pre-amplifier, or where an input capacitor is used in the microphone circuit, a further resistor R1 will be required to provide the input resistance that would otherwise be provided by the microphone itself. A value of 1.5MΩ should be suitable.

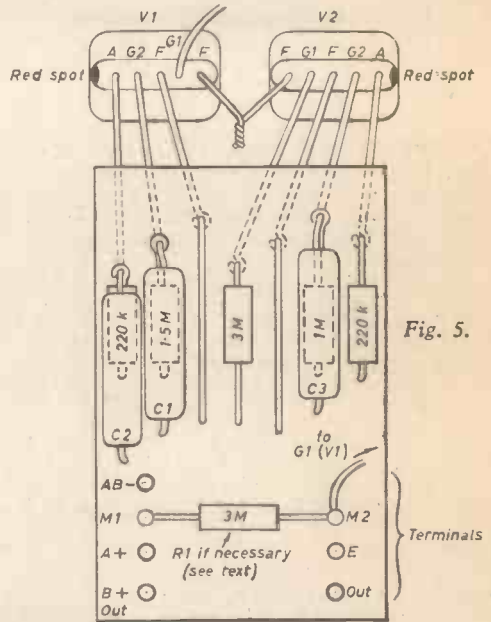

Fig. 5.

SEND A "PRACTICAL" CHRISTMAS GIFT!

You must have friends who would enjoy PRACTICAL MECHANICS AND SCIENCE, too! Why not send them a year's subscription for this invaluable magazine? It's a present you know they'll appreciate—whether they're beginners or experts. Each issue will be a renewal of your best wishes, too, every month of the year! Send friends' names and addresses, together with your own, and remittance to cover each subscription, to The Subscription Manager (G.3), "Practical Mechanics and Science," Tower House, Southampton Street, London, W.C.2. We will despatch first copies to arrive before Christmas, and send an attractive Christmas Greetings Card in your name to announce each gift.

RATES (INCLUDING POSTAGE) FOR ONE YEAR (12 ISSUES): U.K. 28s., OVERSEAS 26s. 6d., CANADA 25s.

COMPONENTS LIST

- | | |
|--------------|-----------------------|
| R1 see text. | C1 0.01μF. |
| R2 1.5MΩ. | C2 0.01μF. |
| R3 220kΩ. | C3 0.01μF. |
| R4 3MΩ. | C4 25μF 25v. wkg. |
| R5 1MΩ. | V1 } Raytheon CK505AX |
| R6 220kΩ. | V2 } |
- All resistors ¼ watt or smaller, 20% tolerance.
- or, Mullard DF66,
or, Hivak XFW40,
or, Hivak XFW30.



Fig. 1.

MOST commercial step ladders are much too flimsy and a long period of continued use soon causes them to become rickety and dangerous. Although tightening of the screws has the effect of ensuring they do at least stand correctly on a reasonably flat surface, they soon go back to their former condition, which makes painting or decorating difficult and dangerous. The main factor which causes steps to wobble soon after they are purchased is keeping them in a hot dry place to dry out and shrink. This undoubtedly tends to loosen the screws, but in addition if many bought steps are examined carefully the sections of timber from which they are constructed will be seen to be obviously far too small, and are therefore liable to crack as the wood begins to dry. The design shown in Fig. 1 is not by any means new, but in addition to reducing the number of small pieces of timber to a minimum, it possesses a degree of rigidity seldom experienced in purchased step ladders. Also the use of substantial metal

A PAIR OF STEP LADDERS

A "better than bought"
workshop project
described by
John Waller

hinges instead of the flat variety, which are more in keeping with doors of cabinets, gives the user a comfortable feel that the assembly will not collapse before he has reached the second tread.

Most step ladders are made from soft wood because this is cheapest. However, for constructors who wish to make an article which will give many years' service, a hard wood is essential and well worth the extra slight initial cost. A visit to the local timber yard should bring to light some suitable lengths of material other than oak. As such wood is generally free from knots and shakes a much more pleasing piece of equipment results from your efforts. There is no point in buying unplaned timber when making these step ladders, as the small cost of running the material through the yard planing machines saves some hours of manual labour.

The first operation is to mark off and cut the various lengths, ensuring that each piece is exactly the correct dimension. Cut off the top corner of 'A' as shown at Fig. 2 to create a pleasing radius and angle the feet as shown. A series of lines should next be scribed across each member where the treads etc. will eventually fit. Most readers will adopt the technique of sawing along the tread lines for a depth of about $\frac{1}{8}$ in. and then cutting away the remaining material with the aid of a chisel. To avoid splitting the timber as the tool emerges from the opposite side, work from both sides until a clean flat groove has been produced. A rise of about 8 in. is adequate and each tread should fit tightly into its respective groove. Use either a tread, or a piece of scrap timber from which they were cut, as a gauge and saw inside the lines when first cutting the wood.

A somewhat similar method is used when making the rear legs 'B'. Although the actual legs should be hardwood as they must naturally undergo severe usage in service, the cross struts can be either hard or good quality soft timber. The position of the top cross bar is determined when the front and rear members are put together, as it supports the top platform, and this must naturally be perfectly level. A slope of as little as $\frac{1}{8}$ in. can be annoying because screwdrivers and similar tools will have the usual habit of rolling off at just the wrong moment.

The ladders shown in the drawings were constructed with steps tapering from 12 in. to 20 in.

Fig 2

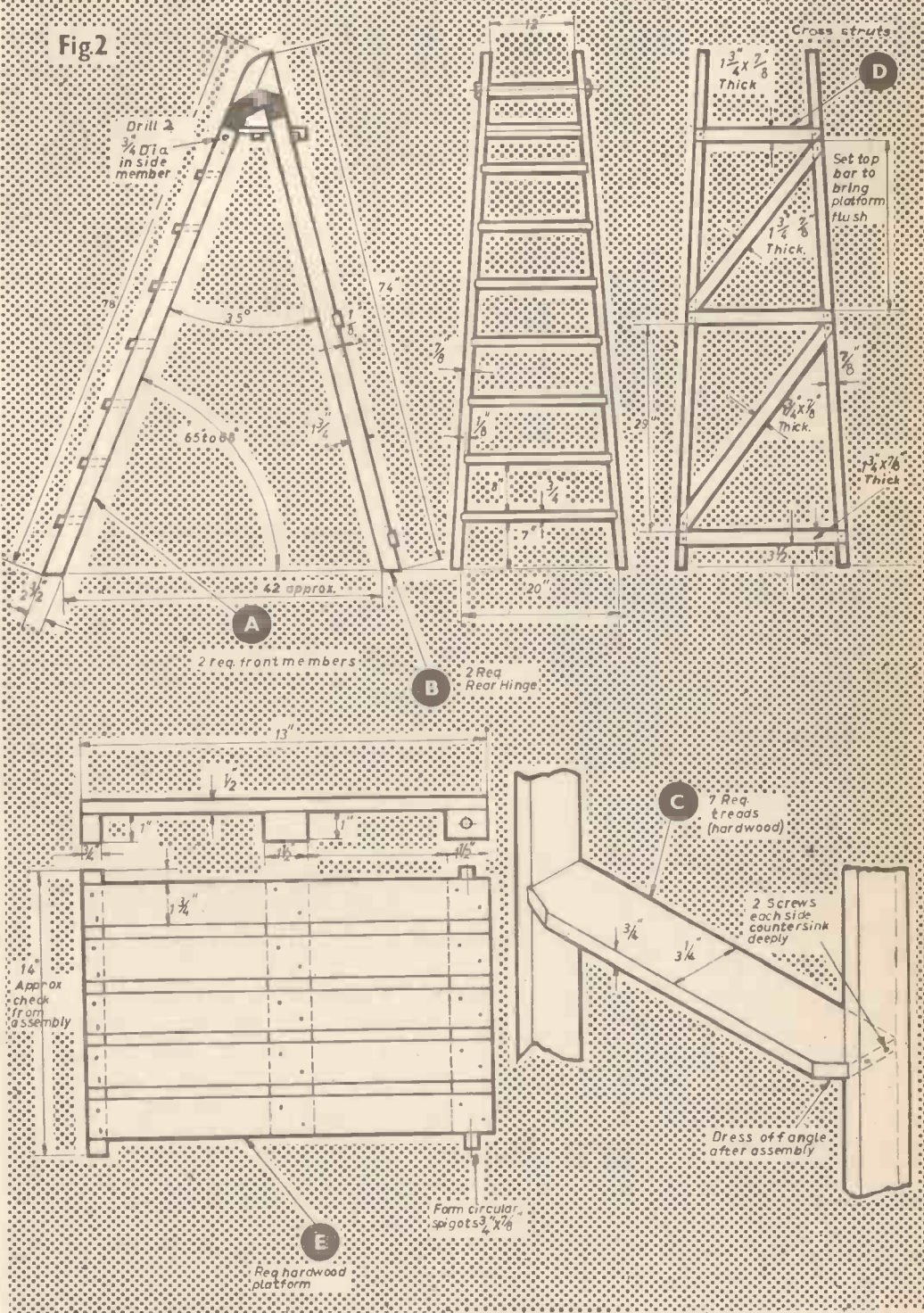

between the two sides pieces, but these dimensions could perhaps be improved by making them slightly wider to allow sitting on the platform when carrying out awkward painting jobs or fixing lighting fittings. Some care is, however, essential in the choice of dimensions, as the steps will become heavy and cumbersome to carry about if made too wide. If a greater width is preferred—the dimensions given are adequate for most work—then thicker treads will be necessary and $\frac{3}{8}$ in. finished timber should be used.

The platform 'E' performs a dual function because it permits standing for those occasional high jobs whilst the provision of a ledge, which drops over the top bar of the rear member, prevents the steps from spreading. Again hardwood is preferable as the platform often has to support a considerable weight, and it should be made with a substantial cross bar underneath to add to the strength of the assembly.

Two hinges are necessary and these are illustrated in Fig. 3. Sheet brass is an ideal material as it does not rust. Every article of this nature becomes scratched soon after the initial painting—and if this metal is used the steps always have a nicer appearance and never show large areas of rusted metal which detract from their good looks. Thin brass is easily bent, and as hardwood is specified for the side members this acts as an excellent former over which to bend the edges. Use a mallet for this operation after temporarily securing the hinges

with two wood screws. Remember that the hinges are "handed", but if each is bent in this way you will not make the usual mistake which occurs when such a situation arises and finish up with two left handed hinges! A brass tube or piece of gas pipe is another feature well worth incorporating as this detail makes a rigid hinge assembly. A length of rod—again brass for preference—together with nuts and washers, completes the hinge.

Most commercial step ladders are made with wood screws of inadequate length and these either become loose as the timber dries or simply drop out because the holes into which they are fitted are too large. For these step ladders, screws $1\frac{1}{2}$ in. long are considered necessary, except for those holding the treads of the platform and the hinges. Do not be tempted to use old screws smaller than No. 8's just because they happen to be available. Drill holes and countersink them where necessary and use these as a guide for the holes to receive the threaded portion, but again do not drill these too large. Tighten each screw hard and you can fill the deeply recessed head with putty or similar material if you intend to paint the ladders. However, as these items of equipment are meant for every day use and not as a decorative feature, paint of any description will soon cover the legs and treads. Despite a resolution to wipe off spots as soon as they appear, a host of different hues gives the impression the equipment is amply repaying the time spend on its construction.

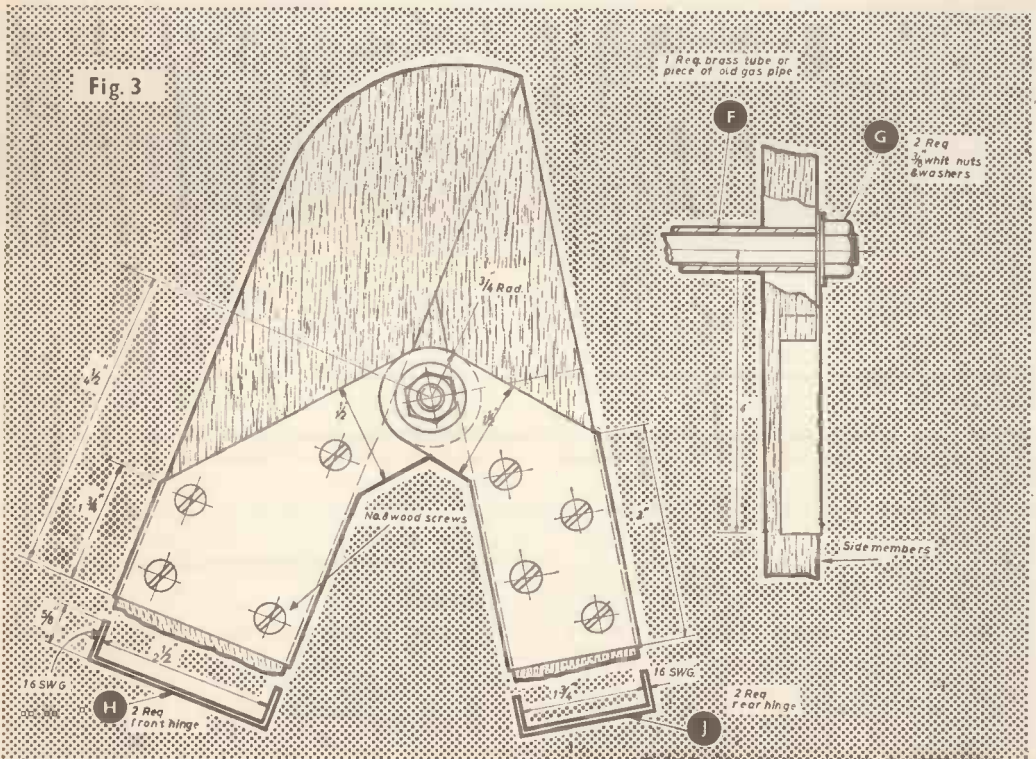

L.B.S.C.'s 3½ in. Gauge

PART 22.

EVENING STAR

BOILER CONSTRUCTION
(continued)

BEFORE removing the tubes from the lathe, clean the ends with coarse emerycloth or similar abrasive, and slightly bevel the ends by holding a second-cut flat file against them while still revolving.

Experienced coppersmiths should have no difficulty in silversoldering the whole nest of tubes into the combustion-chamber tubeplate at one go, but tyros should make a two-stage job of it, doing the four flues and top row of tubes at the first shot, then completing the rest at the second. In the first case, smear plenty of wet flux over the tubeplate before fitting the tube ends. For best-grade silversolder, use powdered borax mixed to a creamy paste with water. For Easyflo, use the special flux sold for use with it, mixed likewise. Put the tubes through the holes so that a bare ⅛ in. projects inside. Put the smokebox tubeplate on the outer ends, with the tubes coming through about ¼ in. or so; it won't slip down, friction will prevent it. Line up the tubes so that they are parallel with the combustion-chamber. Novices follow the same procedure, but put in the four flues and top row of small tubes only.

Stand the assembly in the brazing pan with the tubes pointing skywards, and put on some more flux, pushing it between the tubes with a brush. If doing the lot at once, either cut some sheet silversolder into ¼ in. squares, and drop them among the tube ends, or put a ring of silversolder wire around each tube. This must, naturally, be done before putting on the smokebox tubeplate. Two-stagers need not bother about this, as all the ends are accessible. First play the blowlamp flame on the combustion-chamber, and keep it away from the tubes until the tubeplate starts to glow red. Then play on both the tubeplate and tube ends until the whole bag of tricks becomes medium red. When this stage is reached, the bits of silversolder, or rings, as the case may be, will melt and flow all around each tube, making a perfect seal. The blowlamp flame should not be kept playing on the same place, but moved right around the whole nest of tubes, which gives it a chance to get between the tube ends and do the needful to all of them.

Two-stagers go to work in much the same way, heating the combustion-chamber tubeplate first before playing the flame on the tubes; but here, a word of warning. Don't let the flame play on the uncovered holes in the tubeplate for too long, otherwise you'll suddenly find one big ragged hole in place of a lot of little round ones—and that will mean sawing off the tubeplate from the end of the chamber, making and fitting a fresh one, and fitting longer tubes. When tubes and tubeplate glow medium red, apply a strip of best-grade silversolder, or Easyflo wire, to each one. The end will melt off, and run around the tube like water, forming a nice even fillet.

The smokebox ends of the tubes must be softened, so if the lot have been done at one operation, carefully pull off the smokebox tubeplate, and

heat the free ends of the tubes to medium red for about 1 in. down. Then put the assembly in the pickle bath for about 15 minutes, after which it should be well washed in running water. Two-stagers should put the job in the pickle-bath without removing the smokebox tubeplate. After washing off, insert the rest of the tubes through the holes in the smokebox tubeplate, fitting the inner ends into the combustion-chamber tubeplate as before. Put plenty of wet flux around them, and repeat the silversoldering operation, as previously described. The second heating won't have the slightest effect on the first, so beginners need have no apprehension whatever. When a fillet of silversolder has run around each tube, remove the smokebox tubeplate, soften the free ends of the tubes as before-mentioned, pickle for 15 minutes, and wash off.

Fitting firebox assembly to boiler shell

Clean the inside of the firebox wrapper, and the lower edge of the throatplate between flanges, with coarse emerycloth or similar abrasive. Next, fit the front section of the foundation ring, which isn't a ring at all, says Pat, but is made in four sections, from ¼ in. square copper rod. Cut a piece to fit tightly between the flanges of the throatplate, slightly rounding the corners on the contact side; clean it well, and jam it in place. With the boiler shell upside-down on the bench, slide the firebox-and-tube assembly into it, until the front of the firebox comes up hard against the pieces of square rod. Set the firebox midway between the wrapper sides, so that the spaces on each side of it are equal, then put a clamp over the lot, to keep the fire box in place, see Fig. 134, while riveting the crown stays.

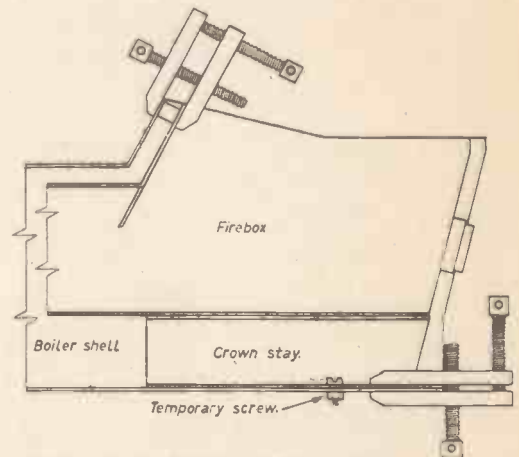

FITTING FIREBOX ASSEMBLY TO BOILER SHELL.

Fig. 134.

The flanges of the crown stays should be in full-length contact with the top of the firebox wrapper. Put a cramp over each, as shown in Fig. 134, then drill a couple of No. 41 holes through wrapper and each flange, at $1\frac{1}{2}$ in. from the edge of the wrapper, and central with the flanges. Put a $\frac{3}{8}$ in. screw through each, from the inside of the wrapper, and put a nut on each on the outside, screwing up tightly. These screws will keep the flanges in position when the cramps are removed, and the flanges can then be permanently riveted to the wrapper. Drill through wrapper and flange with No. 41 drill, at $\frac{1}{2}$ in. spacing, keeping the holes in a straight line along the middle of the flange. Scrape off any burring, then put $\frac{3}{8}$ in. x $\frac{1}{2}$ in. copper rivets through from the inside. To do this easily, I use a strip of 16-gauge steel about $\frac{1}{4}$ in. wide, with a notch in the end like a distant signal. The rivet is

one side. To prevent it slipping while the riveting is under way, I always remove one of the hard steel insets from the vice jaws, and rest the bar on the ledge which supports the inset.

Hold the shank of the rivet, put the boiler over the bar so that the rivet head rests on it, snip off the rivet shank about $\frac{1}{8}$ in. from the wrapper, then hammer down the projecting bit to form a head. Don't waste valuable time forming fancy heads, as they are completely hidden when the outer cladding sheet is fitted to the boiler. Repeat operations on each flange, so that there will be four rows of rivets showing through the wrapper. Finally, take out the temporary screws, and put rivets through the holes.

The front section of the foundation ring can then be riveted in. Drill a row of holes with No. 41 drill, at $\frac{1}{2}$ in. spacing, and about $\frac{1}{2}$ in. from the bottom of the throatplate, right through the outer throatplate, the piece of $\frac{1}{2}$ in. copper bar, and the firebox throatplate. Scrape off any burring inside the firebox, slightly countersink the holes on the outside, and put in $\frac{3}{8}$ in. x $\frac{1}{2}$ in. roundhead copper rivets, hammering the shanks well down into the countersinks.

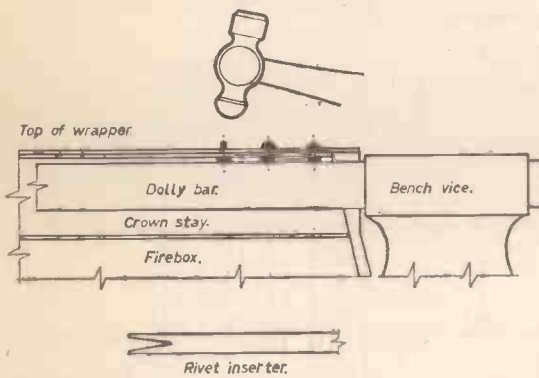

RIVETING CROWNSTAY FLANGES TO WRAPPER.

Fig. 135.

jammed in the notch, and is held tight enough to allow the rivet to be poked through the hole from the inside; the projecting shank can then be held on the outside, the notched rod pulled away, and the head of the rivet rested on a dolly. This is a piece of iron bar, about 1 in. x $\frac{1}{2}$ in. section, gripped in the bench vice with about 6 in. projecting from

Fitting the smokebox tubeplate

Clean the inside of the end of the barrel, and insert the smokebox tubeplate, flange first, taking care it is exactly vertical. Tap it in evenly until it barely touches the ends of the tubes. If they line up with the holes, it will be another miracle, but they can easily be coaxied into position by aid of a wooden meat skewer or knitting needle, or even a blacklead pencil, as the silversoldering job makes them ductile. However, when lining up, be mighty careful to avoid distorting the ends, or they won't go through the holes. When they are all nicely lined up, carefully tap the tubeplate right home, so that the tubes stand out a bare $\frac{1}{8}$ in. from the tubeplate, and the distance from the tubeplate to the end of the barrel is the same all the way around.

The ends of the tubes have now to be expanded into the holes. This is done with a taper drift; the taper shank of a worn-out or broken drill is just the tool for the job. Grease it, insert it into the tube end, and hit gently with a hammer until the tube is forced tightly against the hole. If the drift sticks, and doesn't want to come out, a sideways tap will teach it good manners.

The next brazing job

Smear some wet flux all around the joint between barrel and tubeplate flange, around the tube ends, and along the four crownstay flanges. Get a tray of some sort about 1 ft square or round—the lid of a biscuit tin would do—and cut a hole in it $4\frac{1}{2}$ in. dia. to fit over the boiler barrel. Stand the boiler on end, and put the tray over it, about 3 in. from the top, propping it up with a couple of bricks, or something similar, to prevent it from slipping down while the job is under way. Pile some small coke or breeze in the tray, all around the barrel, to the level of the tubeplate, and get the blowlamp going good and strong.

Use either easy-running brazing-strip or coarse-grade silversolder for the circumferential joint. Play the flame all over the tubeplate and barrel end until they are well heated, then concentrate on that part of the joint farthest away from the tubes. As soon as it glows bright red—the coke will help—apply the strip, and when it melts and flows in, work your

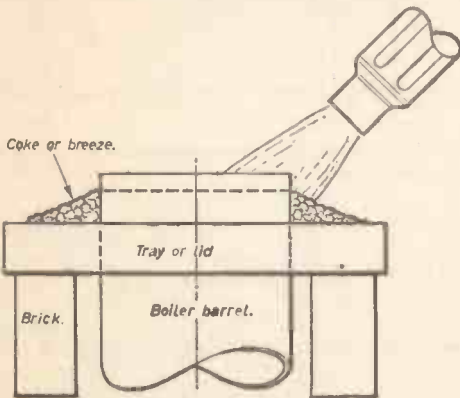

BRAZING SMOKEBOX TUBEPLATE.

Fig. 136.

way steadily right around the barrel, directing the flame partly inside and partly outside, until you get a nice even fillet between barrel and tubeplate. Next direct the flame on the tube ends (watch your step here, to avoid burning them) and when they and the surrounding metal becomes medium red, apply a strip of best-grade silversolder, or Easyflo, to each. As this melts at low temperature it will "flash" around each tube, filling the countersink and making a perfect seal.

on until the melted metal has sweated full length between flanges and wrapper.
 If possible, enlist the services of an assistant with another blowlamp (2½-pint size would do) on this job. The assistant should play the flame on the outside of the wrapper, while the operator directs his flame on the inside, along the flanges. Literally caught between two fires, the metal will rapidly heat to the required temperature, and the silversolder will melt and

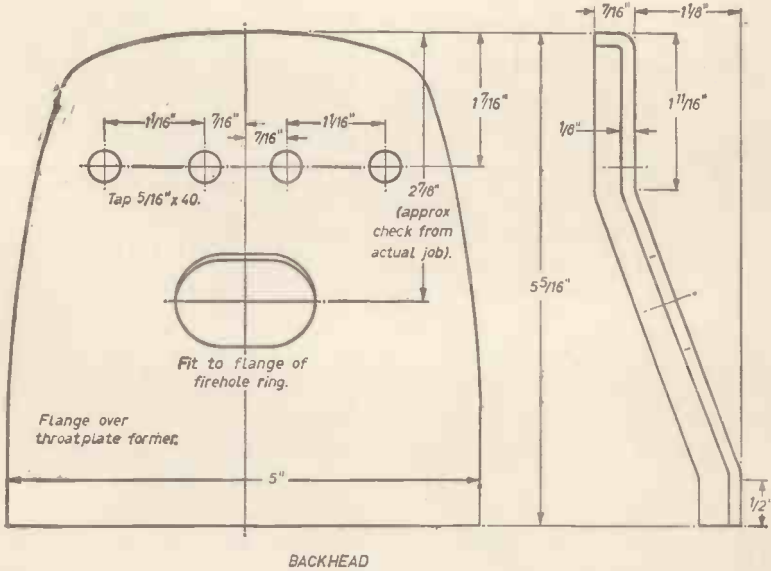
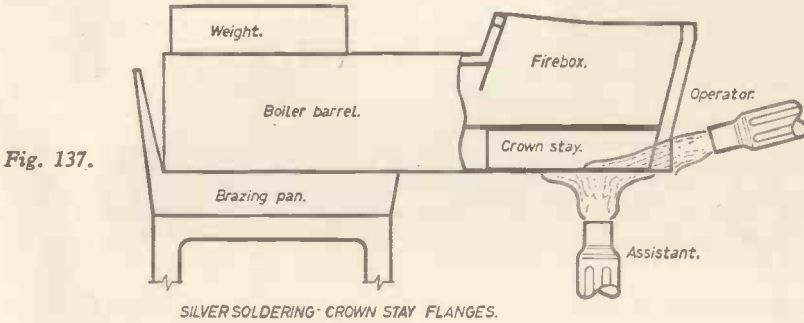

Now, some quick action is called for. Take the tray off the barrel, grip the boiler with the big tongs, holding by the throatplate—mind it doesn't slip!—and lay it in the brazing pan with the firebox overhanging the edge (Fig. 137). Put a brick or something else fairly heavy, on the barrel, to prevent the whole issue from tipping over. Play the blowlamp flame on the firebox wrapper from the underneath, until it glows red, then blow on the crownstay flanges inside the wrapper, until the whole back end of the boiler is red. Then feed in a strip of best-grade silversolder, or Easyflo, the full length of each crownstay-flange, and keep the heat

penetrate in fine style, sealing all the rivets. When the redness dies away, put the boiler in the pickle bath again, but stand well clear of the splashes and fumes. What I do is to use the tongs to stand the hot boiler beside the pickle bath, then get the garden rake to lift it in. The handle of the rake is long enough to enable me to keep a safe distance! Let the job soak for the usual 15 minutes or so, then it can be fished out with the tongs, the acid pickle drained out, and the boiler well washed in running water. Rub up the outside with a handful of steel wool, or some scouring powder, ready to handle for the final stage of assembly.

TRADE NEWS

A handy tool for hobby and household

A NEW tool, the "8 in 1" consists of an unbreakable imitation amber handle with a chuck to take a set of implements for seven applications. They are a saw, a hammer with a nail claw, a Philips screwdriver, two normal screwdrivers and an awl. The screwdrivers and awl fit inside the handle when not in use.

Price 10/6 post free available from F. W. Lee (Industrial Equipment) Ltd., 23a Bond Street, Ealing, London W5.

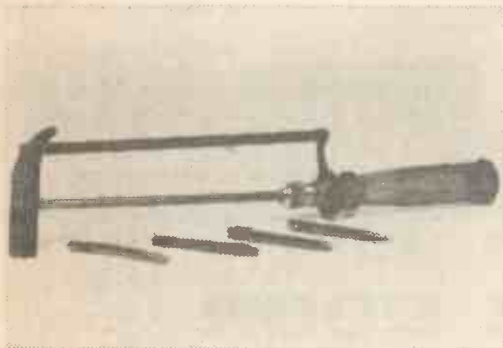

New method of solder packaging

MULTICORE Solders Ltd. have introduced a completely new Solder Dispenser.

The contents of the new dispenser are 16 feet of 18 s.w.g. Ersin Multicore Savbit alloy, the solder alloy containing a precise quantity of copper which in controlled tests on manufacturers' production lines, has supported the claim that it makes soldering iron bits last 10 times longer. It is the first time that this particular alloy has been made available to the home constructor and handyman in a 2/6d. pack.



New Wolf bench grinder

WOLF have introduced a new 6" Bench Grinder in their Grand Prix range; it is to be known as Type GPG6.

The unit will be found ideal for grinding and touching up small lathe tools, chisels, drills, etc., and for light toolroom work. With a wire brush or calico mop fitted it is suitable for light buffing and polishing jobs.

The $\frac{1}{2}$ h.p. motor is of the totally enclosed induction type, and is available for use on AC single phase 200/240 voltage.

One of the main features of this new machine is its modern design and low retail price of only £18. 15s. 0d., complete with two 6" grinding wheels (one coarse and one fine), wheel guards, tool rests and 5 ft. cable.



Pneumatic saw

PORTABLE cutting of sheet material can present a problem when small shaped sections are involved. The LESTO PW/HS 1A1 Pneumatic Jig Saw, weight only $4\frac{1}{2}$ lbs. will cut out panels leaving no burr. A similar Jig Saw Machine is available to work from standard electricity supply.

The machine illustrated, is fitted with a container which provides a drip feed coolant on to the blade. This gives the blade considerably longer life than could otherwise be obtained. Metal from $\frac{1}{4}$ - $\frac{1}{2}$ " thick can be cut with this tool. Blades are available to cut wood, metal, plastics and fibre boards. For best performance 80 lbs. per square inch pressure is needed.

The price of the machine, complete with coolant feed container is £22. 4s. 0d.



paper, cut to the width of the coil, wrapped round and glued. This is to prevent the wire unwinding. The outer wire end of the coil must be securely held by the paper. The pieces of cardboard tube protruding from the bobbin ends should now be cut off with a sharp knife, flush with the surface of the hardboard ends. When this has been done, the wood dowel, which should have remained in the bobbin up till now, should be removed.

Two pieces of paxolin with $\frac{1}{16}$ in. holes as shown in the drawing, are now glued to the ends of the bobbin. First, however, make sure that the holes will freely take the rod from which the striker will be made, so that this will move quite freely. If necessary they may be eased out with a small round file or a piece of fine glass paper made into a roll. Often one side of the paxolin sheet is rough, and this is the side that should be glued. If both sides are smooth, one should be roughened with glass paper to give a "key" for the glue. The coil is now complete.

The striker

This is a composite brass and iron rod, as shown in the drawing. It is an advantage to use tubing to make this, if a suitable size can be obtained. Such tubing is a little lighter and is easier to work with. If the pieces of iron and brass tube have, say, a $\frac{1}{8}$ in. hole through them they may be easily and accurately joined by means of a brass plug inserted so that half is in one tube and half in the other

EASILY MADE DOOR CHIMES

BY B. C. MACDONALD

THESE chimes are quite easy to make and have a very good appearance. The materials needed are all readily obtainable and in fact the amateur mechanic may already have some of them. The first part to make is the coil.

The coil

The coil is wound on a cardboard former, and this can be made by wrapping a piece of thin card round a piece of quarter-inch wooden dowelling. Leave an overlap of about $\frac{1}{8}$ in. and glue this down, temporarily winding on some string to hold the card firmly in place until the glue dries. In this way make a cardboard tube about four inches long. This requires ends to make a bobbin. These ends are made from hardboard, each measuring $1\frac{1}{2}$ in. x 1 in. In each of them drill a $\frac{1}{8}$ in. hole. The holes should be enlarged with a file, or by inserting a scissors blade and turning it until the ends are a tight fit on the tube. Force the hardboard ends onto the tube, and glue them in position two inches apart. Retain the dowel rod in position until the coil has been completed. When the glue is dry, wind on 1 oz of No. 28 S.W.G. double cotton covered (D.C.C.) wire. It would be very nice to have this wound on in even layers, each turn close to the next, but as this is a rather tedious exercise, it is sufficient if the wire is simply wound on to the bobbin as evenly as possible. There is no reason why enamelled wire of the same gauge should not be used. This wire takes up slightly less room than the cotton covered wire. When the winding is completed it should be covered with a piece of

when the tubes are pushed together. Final soldering is still required, of course. However, brass and steel rod may be used, but the two parts must be accurately joined and the joint must be flush and smooth or the striker will not work properly. The washer soldered to the end of the striker is to retain the spring, and should be as light as possible. As shown in the illustration, solder is run onto each end of the striker to make them convex. This is not essential, but these soft ends give a softer and more pleasant note.

The mounting board

The mounting board is a piece of plywood, $\frac{3}{8}$ in. thick. It is cut to size and smoothed all over with glass paper. If it is now painted with black enamel, this will be partially absorbed by the wood to give a satin finish, quite suitable for the purpose. On the rear of the board near each corner, knock in a rubber headed tack, to act as a wall rest. Two mirror plates should also be fitted for hanging the chimes. It may be necessary to bend these towards the wall a little. If so this should be done before they are finally fitted, and it should be checked that the board will hang properly on the wall, seating on all four rubbers.

The hangers for the tubes are made from brass strip, but in fact metal strip of any kind will do. The V-notch may be cut with a pair of tin snips or an old pair of scissors and the strip bent into the L shape in a vice or with a pair of pliers. Finally, the hangers are screwed into position as shown.

The top is made from a piece of $\frac{3}{8}$ in. thick paxolin. Two corners are rounded off as shown. The radius of the curve is not important but it should, of course, be the same on both corners and should correspond to the curve of the cover. Two 4 B.A. brass terminals are fitted, as shown, to facilitate connection to the push and battery (or transformer). The top is screwed to the edge of the mounting board with small brass screws, the holes being countersunk to bring the screw heads flush with the surface. Take care to drill the holes in the paxolin so that the screws enter the centre of the plywood. If too near the edge they will break out.

The coil may now be glued in position, using the wood blocks in the manner shown in the drawing. The polished surface of the paxolin on the bobbin end should be roughened with glass paper to enable the glue to obtain a grip. This applies also to the painted wood mounting board at the points where the glue is to be applied.

Each of the two wires from the coil is fixed to one of the terminals, on the underside of the top. If D.C.C. wire is used the cotton must be removed from the ends of the wire. In the case of enamelled wire, the enamel must be thoroughly scraped away from the ends of the wire; otherwise the wire will remain insulated from the terminals although connected to them.

The tubes

The tubes are of brass, either one inch or seven eighths of an inch outside diameter. One should be 36 in. long and the other 33 in. long. These lengths can be varied slightly but this difference should be maintained. Heavier gauge tubing (thicker wall) gives rather a better tone than thinner gauge; no exact gauge is specified because there is plenty of latitude here. Two small holes should be drilled directly opposite each other in each tube, about a quarter of an inch down from the top. The tubes should be polished, and may then be lacquered if desired. Two split pins (cotter pins) should be opened out, the ends of each pin being turned over in the shape of small hooks. The pins are inserted in the tubes so that the hooked ends engage with the holes provided. The tubes are suspended by means of a loop of wire passing through the eye of the split pin and seating in the V cut out in the hanger.

Before the striker is inserted in the coil it must be fitted with a light spring, as indicated in the drawing. If difficulty is experienced in obtaining a suitable spring, one can be made by winding a single strand of a Bowden cable (cycle brake cable) tightly on an $\frac{1}{8}$ in. diameter rod. About four or five turns should be right, but some experimenting will be required to find the best length for the spring.

The cover

This may be made from tinplate, which can be obtained quite cheaply from any tinsmith, although

(Continued on page 142)

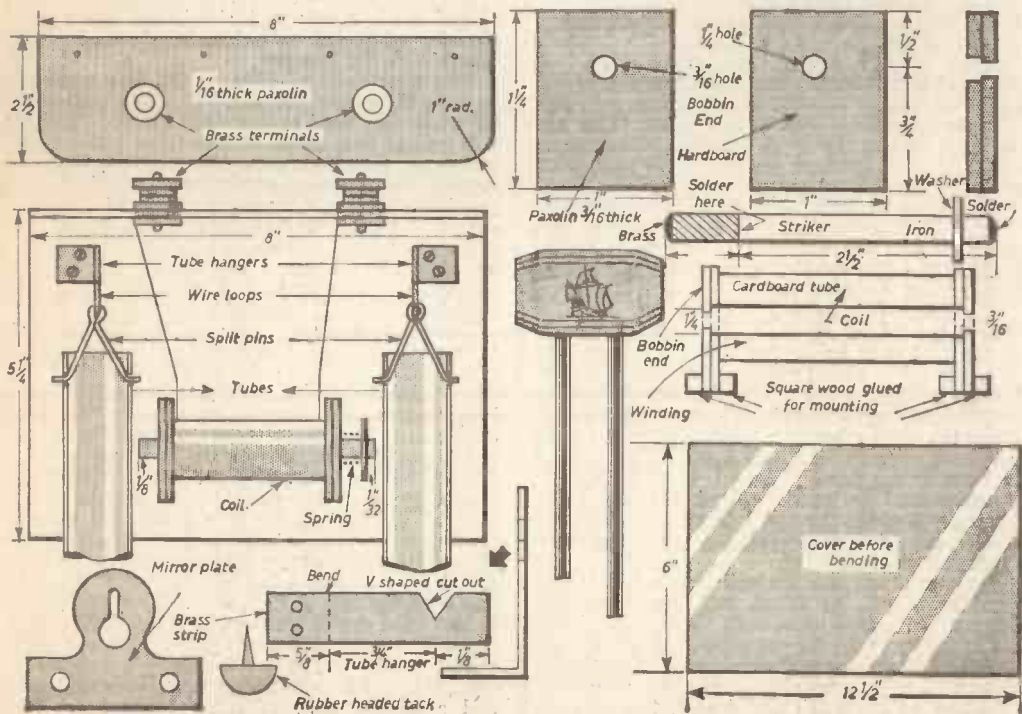

New Tools from Old Files

by S. Seager

IT is common knowledge that files can be recut. In the hope of making this economy come true many old files are given a corner of their own and left to rest and rust. Frequently the pile gets upset and causes more trouble than it is worth.

Having from time to time made the odd tool from my pile of discarded files I finally decided to clear away the whole lot in this manner. The value of the tools I now have is far in excess of any saving that would be made by having the files recut. A few of the tools are shown in the illustrations. They are:

1. Three cold chisels from 12in. and 8in. flat files and an 8in. square file.
2. Two plugging chisels for breaking into brickwork from 14in. files.
3. Three firmer wood chisels, two with tangs, one for hammering. Made from 12in., 8in. and 6in. files.
4. Four scrapers from 10in. flat, 8in. flat, 8in. half-round and 8in. three-square files.
5. Two centre pops from the tang ends of 10in. round files.
6. Hedge-laying tool from a 12in. half-round file.
7. Screwdriver from a 10in. flat file.
8. A flat-point drill from an 8in. rat-tail file.

Annealing

This is the first step. Heat the file to cherry red, or more accurately 820-850°F., and allow it to cool buried in hot ashes, lime or dry sand. The rule is to let it cool as slowly as possible. Care should be taken not to overheat the file or to heat it too quickly, which may cause it to crack and also causes the formation of heavy mill scale with resulting pitting. The same cautions apply when later heating the tool for rehardening. To guard against distortion the files should lay on a flat bed during heating.

Shaping

If the tool is to be shorter than the original file it is worth while to cut the file before annealing it. This can be done without laborious hacksawing by first grinding a shallow nick all round with a grindstone at the point where the file is to be cut. Clamp the wanted part of the file in a vice with the nick just outside the jaws. Wrap a cloth round the protruding end to guard against possible flying splinters and strike the end a sharp blow with the side of a 2lb hammer. Before using the remainder inspect the end for cracks.

After annealing, the file can be shaped in any normal way such as filing, grinding, sawing or forging as it is now quite soft. If the shaping is done at the forge (as for the ends of the two upper scrapers at 4) this should only be done at bright-red heat. The volume of the hot file is very small in relation to the anvil and it will lose its heat

quickly. The hammer blows should be struck as rapidly as possible and the workpiece must be reheated as soon as it becomes dull. After forging leave the work near the hearth to cool normally. This procedure will prevent cracks forming in the work.

The wood chisels were made from hand flats and the toothed side was filed flat, parallel to the safe edge. Owing to the fact that these files taper in thickness toward the end one face had to be made into a flat plane to use it as a chisel. This was done by clamping the annealed file in the vice with the tapered portion protruding. Careful tapping with a hammer then straightened one surface. This was then surface ground to a perfectly flat plane. To avoid bowing the work when it was placed on the magnetic chuck of the grinder the tapered end was carefully packed up with shims. Lastly the bevel was ground and the tool hardened and tempered as described later.

The cold chisels (1) were filed to shape after annealing. The angle of the cutting edge is governed by the materials to be cut with the chisel. It should be from 65° for cast steel to 30° for aluminium. All the chisels had the file teeth removed on the grindstone. The head of the chisel should be left soft and should be given a 30° chamfer all round to reduce mushrooming when struck with the hammer.

The tang ends of 10in. round files were used to make the centre punches. The ends were broken off while still hard as described earlier. The tang was ground to a round section taper and a v-point was ground at the end. Although the tapers are ground with the tang parallel with the shaft of the grinding wheel the actual point should be ground with the tang at right-angles to the shaft. This gives a stronger point which is more resistant to cracking. For a smart appearance the file teeth should also be ground away at the head and a 30° chamfer ground all round.

The spade drill (8) is very useful when long holes have to be drilled and can be knocked up very quickly if a particular size of drill is not to hand when wanted. Given fair working conditions with lower speeds and plenty of good "suds" the spade drill is capable of doing some very useful work. The end should be forged roughly to shape and then finished by grinding and filing. The included angle should be 60°. The clearance angle is best incorporated by filing. Since the smooth tang-end portion of the file will fit in the drill chuck, care should be taken not to damage this end. If the drill is to cut accurately the point must be dead in line with the axis of the shank. This type of drill is also very useful when making small grindstones from broken or discarded stones. After chipping the stone to a roughly circular shape the centre hole can be drilled with this bit, using a very slow speed and a copious flow of cutting lubricant. After

PARKER'S SHEET METAL FOLDING MACHINES
NEW BENCH MODEL



Capacity 36 in. wide x 18-gauge mild steel. Forms channels and angles down to 45 deg., which can be flattened to give safe edge. Depth of fold according to height of bench. Will form flanges. Weight approx. 2 cwt. Also the well-known vice models of:

36 in. x 18-gauge capacity ...	£11 10 0	} Carriage free
24 in. x 12-gauge capacity ...	£6 15 0	
18 in. x 16-gauge capacity ...	£6 15 0	

One year's guarantee: money refunded without question if not satisfied. Send for details:

A. B. PARKER, Wheatcroft Works
WELLINGTON STREET, BATLEY, YORKS. Tel: 426

Know what's happening with...
"ADVANCES IN SPACE TECHNOLOGY"

A new book by acknowledged experts. Covers: A Survey of Present Developments—Satellite Dynamics—Space Navigation Problems—Space Satellites for Telecommunications—The Re-entry Problem—New Materials for Space—Structural Design Aspects of Space Vehicles—Human aspects of Space Flight. Contains an extensive bibliography together with sources of information on space flight as well as a table recording all known space-vehicle launchings. 230 pages. 70 diagrams, 16 plates. 45s. from all booksellers or, in case of difficulty, 46s. 3d. by post from **GEORGE NEWNES LTD., Tower House, Southamton Street, London, W.C.2.**

NEWNES

SURPLUS BARGAINS

Low Speed Motors. Low Voltage Motors and Gearbox, with Two output shafts giving approx. 4 r.p.m., and 16 r.p.m. at 12 v. DC and 6 r.p.m. and 24 r.p.m. at 24 v. DC. Dimensions approx. 7 1/4" x 5" x 3" overall. Each 25/-, post 1/9.

Telephone Handsets. Two in series with battery give two-way intercom, 35/- pair, post 2/3. Mains Motors from 25/-, post 3/-. Low Voltage Motors from 12/6, post 1/6. Battery Charger Transformers 15v. and 9v., 1 1/2 amp., 16/-, post 1/9. Rectifiers to suit above for 6 and 12v. Charging, 6/6, post 1/-. Send 3d. stamp for illus. list of interesting bargains. Money Back Guarantee.

MILLIGAN'S

2 HARFORD ST., LIVERPOOL, 3

Handy Taper Pin Reamers. 3/32" to 1/4" dia., 4 assorted 12/8, actual value nearly £2.
20,000 Metal Slitting Saws 1 1/2" dia., 5/8" hole, 0.013" to 0.060" thick, 6 asstd. 8/9, dozen 15/-. Still cheap at double this price.
5,000 Hardened and Ground H.S. Tool Bits, 1 1/4" square, 2 1/2" long, 16/- doz., 5/18" square, 3" long, 20/- doz., 3/8" square, 3" long, 25/- doz., 7/16" square, 3 1/2" long, 30/- doz.
3,000 H.S. Straight Shank End Mills, approx. 3/32"-1/2" dia. outstanding value, 8 assorted, £1 the lot.
3,000 Ball Races, 3/16" bore 2/-; 3/8" 2/6 each.
3,000 Circular Split Dies, 1" dia. cutting 1/4", 5/16", 3/8", 7/16", 1/2" Whit. B.S.F., and American N.F., 12/- per set of 5 sizes, 2 sets 22/6. Taps to suit 12/6 per set, either taper or second or plug, 1" dia. stocks 8/- each.
Hexagon Die-Nuts in Case, sizes, etc., as above, 15/- set, three sets 42/8. Brand new, £2 orders P.P. except abroad.

J. BURKE,

182 BASLOW ROAD, TOTLEY, SHEFFIELD

FREE CORRESPONDENCE COURSES IN STEAM

TWO COURSES: (1) A *Simplified Course* for the practical man in need of basic information about steam and steam applications. (2) An *Advanced Course* for those with a background of technical training. There is no charge or obligation. Details on request to:

SPIRAX-SARCO LTD.
(TECHNICAL DEPT.), Cheltenham, Glos.

FOR

- .. Your Career
- .. Your Own Business
- .. An Absorbing Hobby

A NEW-PRACTICAL WAY of UNDERSTANDING

RADIO • TELEVISION • ELECTRONICS

Including: Transistors; VHF/FM; Hi-Fi equipment; Computers; Servo-mechs; Test instruments; Photo-electrics; Nucleonics, etc.

Radiostrutor—an organisation specialising in electronic training systems—offers a new self-instructional method using specially designed equipment on a "do-it-yourself" basis.

You learn by building actual equipment with the big kits of components which we send you. You advance by simple steps performing a whole series of interesting and instructive experiments—with no complicated mathematics! Instructional manuals employ the latest techniques for showing the full story of electronics in a practical and interesting way—in fact, you really have fun whilst learning!

POST NOW

To-RADIOSTRUTOR (Dept. G28) READING, BERKS. Please send brochure, without obligation, to:—

*Name _____

*Address _____

12/62

(We do not employ representatives) *Block Caps Please

RADIOSTRUTOR
LEADS THE WORLD
IN ELECTRONICS TRAINING

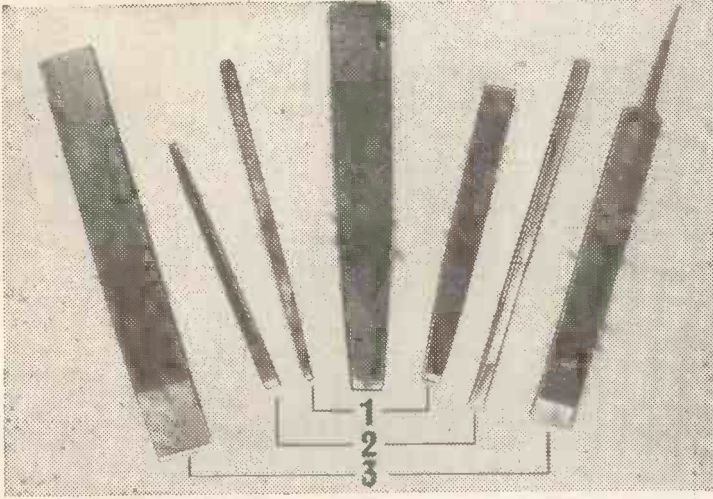

drilling the hole the stone can be mounted on an arbor and dressed to shape.

The two flat scrapers at 4 were made from 10in. and 8in. flat files. The ends were forged to shape, turning the file over at each reheat to produce a gradual, even taper for about 2in. from the cutting edge. At the cutting edge the scraper should be slightly splayed out as shown and should be about $\frac{3}{16}$ in. thick. The edge should be ground to an angle of 75-80° on the grindstone and the scraper should then be hardened and tempered. Final sharpening should be carried out on the oilstone, followed by "hand stropping" to produce a razor-sharp edge. To stone the scraper hold the handle in the right hand with the elbow on the bench carrying the stone. Incline the scraper at the correct angle and gently rock the tool sideways with the left hand.

The half-round scraper at 4 was shaped by grinding. About 4in. of the flat side of the file tip was ground concave by using the curved edge of the grindstone. Then the plan shape shown in the illustration was produced by grinding away the edges of the file and rounding them off. This could be done equally well by filing. The purpose of this is to relieve discomfort to the hands when pressure is applied to the handle in using the scraper. The edges of the tip were ground to a cutting angle of about 40°. The scraper was next heated to an even red colour along the whole cutting end and carefully pressed on the anvil to give it a smooth and gentle upward curve. Finally the whole 4in. cutting end was hardened and tempered.

The last scraper illustrated at 4 is for scraping bearings. A three-square file was used and first the teeth were removed by grinding. The sides

were ground concave on the grindstone to produce three cutting edges. The whole tool was then hardened and tempered. The cutting edge of this scraper should be sharpened with a rounded-edge oilstone slip.

The two plugging chisels (2) are shown in edge view. They are used for plugging brickwork or for breaking holes through a wall. 14in. flat files were used for these and the tang ends were cut off at 45° to form the cutting edge. In the one at the left the original file was tapered and this thus provided the necessary clearance along the sides. The file on the right had no taper and had to be ground to provide this.

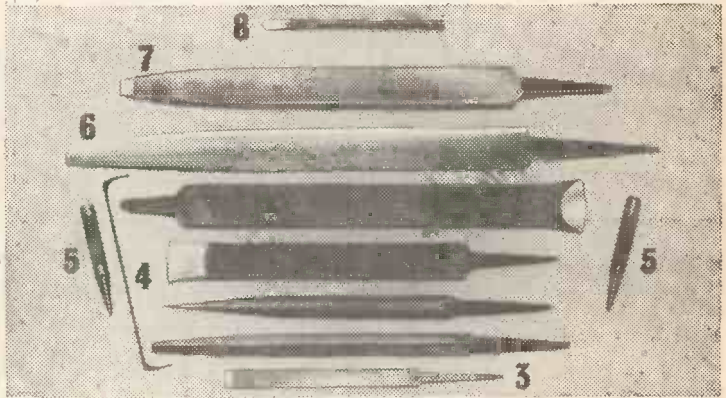

At 6 is shown a tool made from a 12in. half-round file, for camping or hedge-laying. The lower edge was ground to a sharp cutting edge for light chopping work whilst the part of the upper edge nearest the handle was ground to a more robust angle for heavier stick or branch chopping. Because this tool can easily "fly off the handle" the tang should be ground to a round section and threaded $\frac{1}{8}$ B.S.W. A suitable handle should now be drilled right through and the tang secured with a nut and washer at the end. For safety the tang should be peened over the nut as well.

The screwdriver (7) was made from a 10in. flat file ground to shape. If only used as a screwdriver no heat treatment is necessary but nevertheless it is advisable to anneal it and only re-harden the tip. Screwdrivers nearly always get used as levers at some time or other and to use the untreated tool in this way might be disastrous.

Hardening and tempering

When hardening tools two important points should be remembered. The correct hardening

temperature varies according to the carbon content of the steel. File steel usually contains about 1.1% carbon and a temperature of 800-850°F is correct. As you probably have no means of measuring such temperatures, heating to cherry red is accurate enough. Avoid exceeding this temperature and take care not to heat the work up too rapidly. It is better to quench the work in oil or soapy water than in plain water, to avoid too drastic a cooling action. The tongs should grip the work away from the hot cutting edge and should be positioned so that the work can be plunged vertically into the coolant. Stir the work as it cools to prevent the bubbles from running up the tool. They may delay the cooling in places and give uneven hardness.

The tempering temperatures do not depend on the carbon content of the steel but only on the use to which the tool is to be put. It is obvious that the force on the cutting edge of a scraper is very different from that on a cold chisel. The art of tempering lies in knowing the colour at which to quench the work. This sometimes causes confusion and although several very clearly coloured charts can be obtained it is not always realised that the white is the fully hard colour before the tempering heat is applied. The colours then run through the straw colours to the purple which is the hottest colour and also the softest temper. All too often the beginner imagines that the purple is the blackness of unpolished fully hard metal and the white is white heat. If any doubt exists take a strip of bright, hard iron, steel or silver steel, or even a bright 6in. nail and gently heat the centre in a gas or blow lamp flame. The colours will be seen to flow out from the flame with the straw colours outermost in the coolest parts and purple nearest the flame. When the colours near the ends of the metal, quench it and keep it for future reference.

Before tempering any of the tools described above, the black scale left after hardening must be removed with emery paper, polishing the cutting ends to a clean bright surface. Cautiously apply a gentle flame to the tool, about 1½in. from the cutting edge and watch as the colours flow towards it. At the right moment quench in cold salt water. Always apply the heat gently or the colours will develop too fast and you will not be able to catch the cutting edge at the right colour.

The correct colours for the tools described in this article are as follows. Cold chisels (1), purple (530°F); plugging chisels (2), dark straw (500°F); scrapers (3), light yellow (425°F); centre pops (5), dark straw (500°F); screwdrivers (6), blue (570°F); hedging tool (7), blue (570°F); spade drill (8), dark straw (500°F).

LATHE GADGETS

(Continued from page 104)

thread sufficiently to make it a tight fit, so that when screwed into position with a couple of lock-nuts it will be fixed stiffly enough to stay put when using the finger nuts.

Note that when setting up a job with the indicator bearing in a hole the readings of the indicator will be reversed owing to the action of the lever. A touch on the plunger end of the lever sufficient to move the needle will serve to check which way the job should be moved over in the chuck.

As a safety-first measure it is advisable when mounting the holder in the toolpost to leave the tool clamp screws or nut only finger tight. This will provide ample grip for all purposes as only a very small force is required to depress the plunger. Should the amount of eccentricity of the job have been badly misjudged, with the result that the plunger receives much too long a thrust, the light grip on the holder allows the indicator to be pushed away with no damage resulting.

AIR CUSHION TRANSPORT

(Continued from page 106)

27 feet wide and have an overall height of 21 feet. It will carry a crew of three. An open cargo deck at the aft end of the Hydroskimmer will provide space for approximately five tons of payload. The craft will operate at full power for two hours. Four cushion fans, mounted horizontally in the vehicle's hull, provide the lift needed to raise it from the surface. It will hover at a height of slightly more than two feet.

Two propellers, mounted in ducts on the craft's after deck, supply thrust to drive it over the surface. Aerodynamic rudders located in the slip stream of the propellers provide yaw (turning) control.

Four 1,080-horsepower Solar Saturn marine gas turbine engines are mounted in the hull and power both the cushion fans and the drive propellers.

A number of companies will assist Bell as subcontractors in the fabrication and development programme. Initial commitments include Electric Boat Division of General Dynamics Corporation, which will consult on naval architecture and furnish the lift fans; Steel Products Engineering Co. a division of Kelsey, Hayes Steel Company, which will build the transmission system. The U.S. Navy David Taylor Model Basin, Washington, will build and test the aerodynamic model and the Stevens Institute of Technology, Hoboken, N.J., will build the hydrodynamic model.

A Refresher Course in Mathematics

By F. J. Cunn

5th Edition 8s. 6d.

By Post 10s.

"Practical Mechanics and Science" Advice Bureau. COUPON

This coupon is available until December 31st, 1962, and must be attached to all letters containing queries, together with 6d. Postal Order. A stamped addressed envelope must also be enclosed.

Practical Mechanics and Science. Dec. 1962

A NEW HIGHWAY SAFETY DEVICE

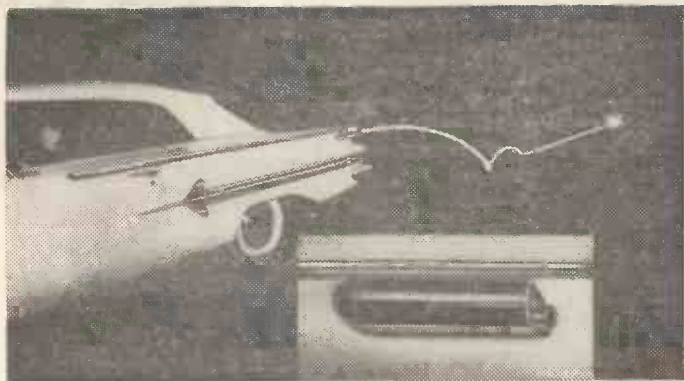

By R. J. SALTER

A NEW safety device has recently been introduced in the United States which may greatly reduce the number of collisions between broken down and moving vehicles.

One of the greatest dangers on high speed highways is the vehicle which suddenly breaks down on the highway either from mechanical failure or from a puncture. To prevent such accidents an emergency flare holder has been manufactured to form a permanent fitment beneath the rear bumper of the car. Alternatively one or more of these chromium-plated flare holders can be incorporated into the rear bodywork of the car. The flares are wired into the electrical system of the vehicle and

a button is fitted on the dashboard. Should the vehicle be involved in an accident or a breakdown and becomes stuck on the highway all the driver has to do is to press the button on the dashboard. This ignites the flare and projects it out of the holder at the rear of the vehicle, for a distance of about 25 ft. The shape of the flare prevents it rolling off the highway, where it burns with a red glow which can be seen for a considerable distance for about a quarter of an hour.

Police patrol cars have already been fitted with this device in America and they find them excellent for giving a warning signal when they arrive at the scene of an accident.

EASILY MADE DOOR CHIMES

(Continued from page 137)

aluminium sheet is a better material. The sheet should be pressed over some round object to give the curves at the ends, and these curves should match the curves on the paxolin top piece so that when the cover is placed in position a good tight fit results. When suitable curves have been obtained the sheet is covered with good quality leathercloth, using an adhesive of the kind sold for fixing rubber soles to shoes, or Boscotex. The galleon is obtainable as a transfer, as are the two lines top and bottom. The sheet could be covered with real ornamented leather, possibly surmounted by some antique metallic motif, and this line of thought would offer great scope to those with the necessary ability. The cover could also be made with a flat surface and could then be covered with a picture in marquetry.

Before fitting the cover make sure that the chimes are working by testing them on the wall in their final position. Some adjustment will be necessary to obtain the best results, and the position of the tubes in relation to the striker can easily be altered as necessary, simply by bending the tube hangers sideways in the direction required. When all is well, dismount the tubes and remove the chimes before fitting the cover, which should be fixed to the sides of the mounting board with three

screws each side. To make a professional job, use an upholstery washer on each screw. It is not difficult to re-hook the tubes when the cover has been fitted and the chime is in position on the wall.

Wiring

Use twin plastic-covered lighting flex for wiring. The voltage required is about 9 to 12 volts. Two No. 126 batteries connected in series will give 9 volts. Connect the terminal marked + on one battery to the terminal marked - on the other battery with a piece of wire. If two No. 996 lantern batteries are used, to give 12 volts, connect the centre spring on one battery to the brass strip on the other. The connecting wire should be soldered. Connect the bared ends of the flex at one end of the wire to the terminals on the chimes, connect the remaining two ends to the bell push. The batteries may now be connected at any point in the flex by cutting *one* wire and connecting the bared ends to the battery. Connect each end to one of the free terminals in the No. 126 battery combination, or one to the unconnected spring and one to the unconnected brass strip in the No. 996 battery combination. The length of wire used should be as short as possible, very long lengths of wire would considerably reduce the voltage. A transformer may be used instead of batteries provided it can supply at least 8 volts and a current of about 1 amp. Many bell transformers do not meet these requirements so care is required when choosing one.

SALES AND WANTS

The prepaid charge for small advertisements is 9d. per word, with box number 1/6 extra (minimum order 9/-). Advertisements, together with remittance, should be sent to the Advertisement Director, PRACTICAL MECHANICS AND SCIENCE, Tower House, Southampton Street, London, W.C.2.

PERSONAL

INVENTORUS LIMITED

Our team of consulting experts is available to advise and assist you in all technical and commercial phases of the successful development of your inventions.

Write to:

The Commercial Director
INVENTORUS LIMITED
 278/282 High Holborn, W.C.1.

FOR SALE

SCREWS, NUTS, Washers. Grand assortment brass and steel. Mainly B.A. few B.S.F. and Whit. 3lb 10/-, 6lb 18/-, in storage tins. R. G. McCLELLAND, Dept. P.M., 1 Beulah Road, Epping.

WASHING MACHINE Spares, new and second-hand. J. AND D. ELLISON, Barkerhouse Road, Nelson.

ASTRO TELESCOPE making. Standard Ramsden pshn eye-pieces, 1 1/2", 1 1/4", 1 1/8", 3/4", 5/8", 1/2", 3/8", 1/4", 1/8". R.A.S. thread 42/6 each. S.A.E. list. Object Glasses. Newtonian Mirrors, Diagonal Mounts, Focusing Mounts, Altazimuth Mountings and Tripods for Refractors and Reflectors. W. BURNET, 99a West St., Boston. Lincs.

Make your own 2in. Sq. Slide Projector, Leech 3in. lens with Focusing Mount £2.15.0, post 1/6. Pre-Focus Lampholder 5/-, post 6d. Double Condenser Assembly with Carrier 15/-, post 1/-, Lamphouse with Mirror 10/-, post 1/6.

All the above parts are removed from Brand New Ex-Government Ellis & Newton 35mm. Strip Projector. The projector complete lens lamp, containing all the above parts and many more can be purchased for £4.15.0. Post 4/-.

Similar but Heavier Built Strip Projector Adolscope by Metalair, 3 Element Condenser system, Beck 3 1/2in. lens, Lighting by 110 volts, 200 watt pre-focus lamp, inbuilt in construction to normal car battery, 60 volts A.C. in wooden carrying case, used but good condition. £5.15.0, plus 5/- carriage (spare lamps, 8/- ea, plus 1/- post).

Ex A.M. G45 Gun Camera. 24 volt, 2in. fixed focus lens 50 ft. magazine loading, complete with magazine, new £2.15.0, ditto used £2. Both post 2/6.

Brand new Kodak (ex Admiralty) 7 x 50 Prismatic Telescope, focusing in fixed wooden case with binocular eyepiece, fitted filters, cost over £50; due to another huge purchase lower than ever price £4.10s. each, carriage 5/-.

Brand new (ex A.M.) 12 volt 25 amp. batteries. These are R.A.F. general purpose lead acid accumulators, and are similar in construction to normal car batteries. Very suitable for cars and vans, will start any vehicle. Never been filled and in original tropical packing. First charge instructions included, cost about £10, only £2.10.0 each, carriage 5/-.

All Metal Projector Stands. Lightweight, fold flat when not in use. Model 1, Height 3ft. Table 30 x 13in. Grade 1 24. Grade 2 £2.10.0. Both plus 7/6 carr. Model 2. As above but height variable between 2ft. 9in. and 2ft. 3in. Platform 21 x 13in. Grade 1 25. Grade 2 23. Both carr. 7/6. All are in good condition, used but paintwork is very good on Grade 1 models.

Ex R.A.F. Aerial Film, 9 1/2in. x 300ft. Pan, £3. 160ft. 35f, 6 1/2in. x 47 1/2in. 8f, 24ft. 5f. Ideal for cutting to smaller sizes. Perfect condition. Post 1/6.

Ex A.M. G95 Mark 3 Recorder Camera, 16mm. made by Specto. Latest model with three shutter speeds, 2 or 16 f.p.s. bloomed 1 1/2in. lens F1.9 with iris to F16, 24 volt 50ft. magazine loading, complete with magazine in original tropical packing, absolutely brand new, only £5, post 2/6. Ditto used £3.10.0, post 2/6.

All goods supplied on 14-day money back guarantee.

R. SANKEY Royal Cinema, ATHERSTONE
 WARWICKS. Tel.: Atherstone 2220, 3210

FOR SALE

(continued)

OXY-ACETYLENE Home Welder. Build your own, instruction 2/6. **DRESDEENA**, The Harrow Way, Basingstoke, Hants.

BLACKSMITH'S PORTABLE FORGES !!! Brand new Government from £5/15/- carriage paid. Thousand bargains, catalogue free. **GREENS**, 893 Albert Street, Lytham.

PROJECTOR SCREENS. Matt white plastic, 26in. x 24in. Ideal for making miniature screens. Clear brilliant pictures, 4/6 each, 1/6 p. and p.; two for 10/- post free. R. G. McCLELLAND, Dept. P.M., 1 Beulah Road, Epping.

CATALOGUE NO. 44. About 5,000 items. Materials, Electrical and Mechanical Gear. Very interesting. **K. R. WHISTON** (Dept. P.M.S.), New Mills, Stockport.

MAINS ELECTRIC FURNACES. Muffle 7in. x 4in. x 3in. open ends, 900 degree C; 39/8 Hardening; Inclination; Analysis. **PAYTOX ENGINEERING**, 169 May Lane, Birmingham 14.

CIRCULAR GLASS Discs for grinding Astronomical Mirrors. Smoothed and edged per pair with Abrasive Pitch Rouge, 6in. x 1in. £2/15/-; 8in. x 1in. £3/15/-; 8in. x 1 1/2in. £4/15/- post paid. Cash refund guaranteed. **H. GIBBS**, 75 Portmanmore Road, Cardiff, S. Wales.

LATEST from USA—Large 14oz "Aerosol" Sprayer with "separate" detachable glass Container for Paints, Cellulose, Insecticides etc. Large and fast coverage with your "own" liquids by simply pressing the button, giving professional results. 38/6 posted. Extra. power units and Containers available. Also New Car Ramses 95/- pair. S.A.E. for literature. **BELLANGERS**, 306 Holloway Road, London N7, North 4117.

MISCELLANEOUS

AQUALUNG AND COMPRESSOR Equipment. Ballraces and Miscellaneous items. Lists 3d. **FRYCE**, 157 Malden Road, Cheam Surrey.

PHOTOGRAPHY

PROJECTORS. Home Assembly Kits, all types and sizes and stereo from £6/2/6. Fan Base Kit £3/7/6. Opticals, Screens, S.A.E., **MARSHALL SMITH LTD.**, 64 Norwich Avenue, Bournemouth.

RADIO

RADIO, TELEVISION Service Sheets. All types Valves. S.A.E. list, **JOHN GILBERT TELEVISION**, 15 Shepherd's Bush Road, London W8. SHE 8441.

MATCHBOX Size Crystal Sets. All parts, instructions, 3/3. **BAILEYS**, 23 Fir Lane, Oldham.

MODEL PARTS

"EVENING STAR" in 3 1/2" G.

"Wilwau" is completely up to date with the castings for L.B.S.C.'s fine loco. S.A.E. with enquiries appreciated.

W. K. Waugh, 31 Hillfoot Drive, Bearsden, Nr. Glasgow. Bea 2985

HOBBIES

NEWTONIAN TELESCOPE making 6in., 8 1/2in., 11 1/2in. Glass discs. Grinding Kits, Aluminised Parabolic Mirrors, Optical Flats, Ramsden Eye-pieces, Barlow Lenses. S.A.E. for list. **L. J. MAYS**, 20 Clover Road, Timperley, Altrincham, Cheshire.

CATALOGUE NO. 15. Government surplus Electrical and Radio equipment. Hundreds of items at Bargain Prices for the Experimenter and Research Engineer, 2/6 post free, Catalogue cost refunded on purchase of 50/-. **ARTHUR SALLIS RADIO CONTROL LTD.**, 93 North Road, Brighton.

HANDICRAFTS

MARQUETRY VENEERS 12 assorted 6/- post free. List 3d. **FRANK COLES (VENEERS) LTD.**, 76 Rivington Street, EC2.

JEWELLERY SIMPLY MADE. Rings, Brooches. Catalogue free. **WEBBS**, 105 Upminster Road, Hornchurch.

WATCHMAKERS

NEW WATCHES, watch movements, Watchmakers' tools and materials. Instructional books, etc. at unbeatable prices. Also watch repairs undertaken. Send 1/- for Bumper Bargain Catalogue. **THE WATCHMAKERS' SUPPLY COMPANY**, "Time House", Carterton, Oxford.

WATCH PARTS

FOR ALL makes of Watches, Tools, Instructional Books, etc., Special Kits for beginners, send 6d. for "Super Bargain Catalogue" **T. G. LOADER**, (Dept. B), **WATCHMAKERS' MAIL ORDER SERVICE**, Milestone Road, Carterton, Oxford.

SITUATIONS VACANT

A.M.I. Mech.E., A.M.Brit.I.A.E., City and Guilds, G.O.E., etc. bring high pay and security. "No pass—no fee" terms. Over 95% success. For details of exams and courses in all branches of Engineering, Building, Electronics, etc., write for 148-page handbook, free. **B.I.E.T.** (Dept. 967B) London W8.

SKILLED PRACTICAL Engineers and Craftsmen are eligible for associate membership of **THE INSTITUTE OF ENGINEERS, PRACTICAL**, 118 Westwood Park, London SE23. Write for details.

OFFICIAL APPOINTMENTS

LBO Central School of Arts and Crafts, Southampton Row, WC1. Assistant Lecturer (Grade B) required as soon as possible for metal workshop in the Industrial Design Department. Duties include instruction of full and part-time students in the metal work aspects of model making and prototype production. Applicants should have had a sound relevant practical experience. Sheet metal working a **bi**lly would be an advantage. £915-£1,410 with additions for qualifications and training, point of entry dependent on experience. Forms, from the Secretary (HE.4/C/2556/12) returnable within 14 days.

**CHESHIRE EDUCATION COMMITTEE
CHESHIRE COUNTY TRAINING COLLEGE,
ALSAGER,
STOKE-ON-TRENT**

At the request of the Ministry of Education, the Cheshire Education Committee proposes to hold the following course commencing in September, 1963, at the above College:—

One Year Course of Teacher Training for Craftsmen

It is proposed to hold a one-year course designed to give skilled Craftsmen training which will enable them to take up posts as teachers of Handicrafts in secondary schools.

Applications are therefore invited for admission to this course from men who already possess appropriate qualifications, such as a Full Technological Certificate of the City and Guilds of London Institute, or a Higher National Certificate or Higher National Diploma, and who wished to be trained as teachers.

The particular academic requirements of individual students and the application of their craft skills to the needs of schools will be specially studied. The year of training will include periods of teaching in schools.

The basic salary scale for qualified assistant teachers is £570 per annum rising by sixteen annual increments to a maximum of £1,170 per annum. Additions to the basic scale are given in respect of recognised periods of training and university degrees. Certain other qualifications are also recognised as being equivalent to a degree. In determining the commencing salary, an allowance up to a maximum of twelve increments may be granted in respect of approved industrial experience.

Anyone needing further advice about the course, the qualifications required, and grants available to students while attending the course, and the teaching prospects available at the end of the course, should communicate with the Principal. Applications for admission to the course should also be made to the Principal. Early application advised.

JOHN G. KELLETT

Director of Education,
County Hall, Chester.

PATENTS

PATENTING SERVICES. Advice qualified Agent. **C. L. BROWNE,** 14 Greenhayes Avenue, Banstead, Surrey.

PLANS

FULL-SIZE BOAT Plans by Morris Johnson and over 60 easy-to-build craft by world's leading designers. Send for new Catalogue, 5/- to: **FAREHAM BOAT PLANS, 88** Portchester Road, Fareham, Hants.

HOME BOAT BUILDING

FULLY PREFABRICATED Kits to assemble a boat at home, for two-berth Cabin Cruisers, fast Runabouts, Canoes, Frams, Enterprise Signet Sailing Dinghies. Leaflets from: **WYVERN BOATS (WBSSEX) LTD.,** Milborne Port, Sherborne.

BROMLEY BOATS, KIts, Mahogany, Silver Spruce, American Boat plans. 3d. list. Southlands Road, Bromley, Kent.

WOODWORKING

ANGLIAN RANGE Saw Spindles, 10in. R/F Sawbenches, 6in. and 8in. Planers, 6in. Sawplanes and Woodworking Lathes. Send 6d. postage for brochures and price list to: **THE EAST ANGLIAN TRADING COMPANY, 5** Guardian Road, Norwich, Norfolk, NOR55A.

ELECTRICAL

ALL TYPES of Electrical Goods at extremely competitive prices, e.g.: 5-amp Twin Cable, 35/- 100 yd; Lampholders, 7/- doz.; 5ft Battens, 49/-. Quality and immediate dispatch guaranteed. Request list, **JAYLOW SUPPLIES, 93** Fairholt Road, London N.16. (Tel.: Stamford Hill 4384.)

SMALL ELECTRIC CIRCULATING PUMP for hot or cold water, fish tanks, ornamental fountains, waterfalls, milk cooling, greenhouse watering, pot washers, etc., comprising 120 watt unshrouded type, shaded pole, A.C. motor, coupled to centrifugal die-cast pump. Output 250 g.p.h. Maximum head 6 feet, 220/250 volts. Silent continuous running.

New Price £3.3.0. Post paid.
H. MIDDLETON, 639 ABBEYDALE RD., SHEFFIELD, 7.

12 VOLTS CONVERTER to 250 VOLTS Run all your mains a.c.—d.c. equipment from your car battery, shavers, record players, radios, etc. New type vibrator, low battery drain, not to be confused with heavy battery drain Rotary transformers. Spare fuses, Vibrator, battery clips, etc. 12 volts to 250 at 100 m.a.

BRAND NEW tested, in water-proofed cartons, ONLY 32/6, carr. 7/6 (few only)
(DEPT. F), J. T. SUPPLY,
309 Meanwood Road, Leeds, 7.



EDUCATIONAL

"HOW AND WHY" of Radio and Electronics made easy by a new non-maths practical way. Postal instructions based on hosts of experiments and equipment building carried out at home. New courses bring enjoyment as well as knowledge of this fascinating subject. Free brochure from Dept. 12, P.M., **RADIOSTRUCTOR, Reading.**

POSTAL TUITION in Technical Drawing, tracing and blueprint reading. Drawing and design in wood or metalwork for Handicraft Teachers Examinations. Details from: **C. PANNELL, 145** The Crossway, Portchester, Hants.

ENGINEERING DRAWINGS. Learn how to prepare and read them by simplified postal tuition. No previous technical education required. Complete course £2. Single lesson 10/-. Write for free prospectus to: **SPEEDY-CRAFT, 2** Norwood High Street, London, SE27.

G.C.E. in Geometrical Drawing— Postal tuition to "O" level. **C. PANNELL, 145** The Crossway, Portchester, Hants.

f's MADE

By repairing Radio and TV Sets as a job or as a spare time business. Our practical course will show you the way. No previous experience is required.

SEND FOR FREE BOOK TO-DAY

RADIOSTRUCTOR

Dept. G.80 READING, BERKS.

Please mention
PRACTICAL MECHANICS AND SCIENCE
when replying to advertisers

ROGERS 31/83 NELSON ST. SOUTHPORT

Fibre Washers, 144 Assorted	..	3/6
Meter Rectifiers, A.C. to D.C.	..	3/9
Self Tap Screws, 100 Assorted	..	3/-
Rectifiers 6 1/2 v. at 5 amps	..	18/-
Winker Units, 6 or 12 volt.	..	6/6
Motorised Water Pumps	..	95/-
Instrument Cases, 12in. x 8in. x 6in. New	7/3	
Thread Gauges	..	4/8
Races, Belts, Valves, Pulleys, Pumps, Brass, Steel, Aluminium, etc.		

10 PAGE LIST FREE. STAMP PLEASE

THE "ADEPT" BENCH HAND SHAPER
Length of stroke of ram 3 1/2in.; or No. 2 B.H. model, 6 1/2in. stroke. Also for Power-drive extra.

Ask your dealer
Manufactured by

"EX WORKS". The "Adept" 2 1/2in. B.S.F. 4-jaw independent chuck, reversible jaws.

F. W. PORTASS MACHINE TOOLS LTD.
Adept Works, 141a Nicholson Road, Heeley, Sheffield, 8.



The "SUPER-ADEPT" LATHE
1 1/2in. centres
6in. between centres.
A good range of accessories is available.

For your "EVENING STAR" use Reeves castings. Castings which have long set the standard by which other castings are judged. Used and approved by "L.B.S.C." Our comprehensive lists (1/- stamp, please), list blueprints, castings and fittings for many "L.B.S.C." designed small steam locomotives; workshop equipment, etc.

MYFORD SUPER SEVEN LATHES £102.7.6.

Deposit £10.7.6 and 24 monthly payments of £4.9.8.

MYFORD M.L.7 LATHES, £70.15.0. Deposit £7.2.0

and 24 monthly payments of £3.2.1.

A. J. REEVES & CO (BIRMINGHAM) LTD

416, MOSELEY ROAD, BIRMINGHAM 12

CAIthorpe 2554

WE WILL SUBMIT—ON APPROVAL

Ex-M.O.S. HARDENED CHESTERMAN COMBINATION SET No. 92, with 12" rule. Brand new condition £6.15.0

TOOLROOM CLINOMETERS (Micrometer Bubble Type) 35/-

The NEW RUSSIAN MICROSCOPE. Worth £70. £47.10.0

Ex-R.A.F. ILLUMINATED MAGNIFIERS with 3" diam. lens. 38/6

GERMAN DRAWING INSTRUMENT SETS: Brand new in velvet lined case. £2.19.6

CHARLES FRANK LTD.

Phone: BELL 2000

67/75 SALTMARKET, GLASGOW, C.I. Est. 1907
Britain's greatest stocks of new, used and Ex-Government Optical and Scientific Equipment. Send for Illustrated Catalogue.

The FLAKE with the FLAVOUR



4'9½
PER OZ

THIS BOOK IS FREE!

G.C.E. "How to get your G.C.E." AN AUTHORITATIVE GUIDE

A complete up-to-the-minute guide—all you want to know about G.C.E. How, when and where to apply. Subjects & Syllabuses at all levels. Exemptions, Career Requirements. 'No Pass—No Fee' Home Study Courses . . . how you can get the G.C.E. and choose your own subjects. Send for this unique book today—FREE! School of Careers, Dept. 160, College House, London, W.8.

"NO PASS—NO FEE!"

DO IT YOURSELF THE EASY WAY

NO SOLDERING OR DRILLING MEDIUM & LONG WAVE INTERNAL AERIAL KITS COMPLETE WITH ASSEMBLY TOOL

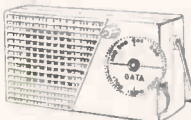

DATA 427
4 TRANSISTORS
2 DIODES
7 STAGES
MOVING COIL SPEAKER

75/- P.P. 2/9 extra.
Battery 2/3 extra.

Also DATA 328. 3 Transistors, 2 Diodes, 6 Stages. Personal Earpiece. 4 1/2 x 2 1/2 x 1 1/2. 49/6. P.P. 2/-.
Batt. 1/- extra. All Parts Supplied Separately.

DATA ELECTRONICS LTD.
6 HILLSIDE GARDENS, EDGWARE, MIDDLESEX

HIGHSTONE UTILITIES

58 NEW WANSTEAD, LONDON, E.11

Hand Microphones, with switch in handle and lead. 5/6. Tannoy. 7/-. Similar Instruments, moving coil. 3/6. All post 1/6. Mask type with switch. 3/6, post 6d. Throat Mikes. 5/-, post 7d. Mike Buttons (carbon). 2/- Moving coil. 3/6, post 6d. Accumulators, 2-volts, unspillable. 7" x 4" x 2". brand new. 5/6, post 2/-, 3 for 15/-, post 3/6, 6 for 28/6, post 5/-.

Ex-R.A.F. 2-valve (2 volt) Microphone Amplifiers, as used in 'plane intercom. In self-contained metal case; can be used to make up a dead aid outfit, intercommunication system, or with crystal set, complete with valves and fitting instructions. 20/-, post 3/6.

Meters, 20 amp. 2in. m.c. 3/6; 3.5 amp. 2in. T.C. 6/-; 100 mA 2in. m.c. 7/6, all post extra.

Meter (L. & R.) containing 2-500 micro-amp movements. 9/-, post 1/6.

Bell Transformers.—These guaranteed transformers work from any A.C. mains giving 3, 5 or 8 volts output at 1 amp. operate bulb, buzzer or bell. Will supply light in bedroom or larder, etc. 9/-, post 1/-.

Similar Transformer but output of 4, 8 or 12 volts. 20/-, post 1/3. BUZZERS for use with above or batteries. 4/6, post 5d.

G.P.O. Telephone Hand Comb. Sets, 12/6, post 1/6. Telephone Hand Generator, 3/6, post 2/6. Telephone Bell, 3/6, post 9d. S.B.C. Neon Indicator Lamps, for use on mains to show "live" side of switches, etc. 2/-, post 4d.

Diodes, 1/6. 0005 Variable Condensers, 2/6, post 9d. Headphones in Good Order, 3/-, Better Quality, 7/6 and 10/-.

Balanced Armature Type (very sensitive). 13/6. All post 1/6. New Single Earpieces, 3/6. Bal. armature type. 4/6, can be used as transistor set loudspeaker. Two of these will make an intercom. set. Ex R.A.F. earpiece, 2/6, all post 6d. Headphone Cords, 1/6. Post 6d. Headbands, 1/6. Post 9d.

Money refunded if not completely satisfied. Full illustrated list sent on request with 3d. stamp and S.A.E. Letters only.

NYLON · P.T.F.E.

ROD, BAR, SHEET, TUBE, STRIP, WIRE

No quantity too small List on application

BRASS · COPPER LIGHT ALLOYS ALUMINIUM · BRONZE

H. ROLLET & CO. LTD.

6 CHESHAM PLACE, LONDON S.W.1. BELgravia 4300

Also at Liverpool, Leeds, Manchester, Birmingham

INTRODUCING A NEW PORTASS LATHE

3 1/2" x 16 1/2" B.G.S.C. bench lathe complete with faceplate, catchplate and backplate. changewheels, etc., flat or vee drive. Complete satisfaction or verittance refunded in full. Ex-works write:

CHARLES PORTASS & SON
Buttermere Works, Sheffield 8
Est. 1889 Cash or terms

EARN

There's plenty of room at the top for technically trained men—room for YOU if you want quick promotion or a better-paid more interesting career. N.I.E. can quickly give you a *guaranteed* spare-time Postal Training, in the comfort of your own home and open up a whole new world of opportunity for you.

Find out, as thousands of others have done, how easy it is to learn at home with N.I.E. Send for *Success in Engineering*—136 pages of information you can use—and details of pay-winning Courses in all branches of Engineering, Building, Local Government, etc. Get your copy today—FREE!



FREE GUIDE!

One of the following Courses taken quietly at home in your spare time can be the means of securing substantial well-paid promotion in your present employment, or entry into a more congenial career with better prospects.

MORE

This remarkable FREE GUIDE explains:

- * Openings, prospects, salaries, etc., in Draughtsmanship and in all other branches of Engineering and Building.
- * How to obtain money-making technical qualifications through special RAPID FULLY-GUARANTEED COURSES.

A.M.I.Mech.E., A.M.I.M.I., A.M.Brit.I.R.E., A.M.I.Prod.E. A.M.I.C.E., A.M.I.Struct.E., A.M.I.Mun.E., M.R.S.H., A.M.I.E.D., A.F.R.Ae.S., London B.Sc., Degrees.

Fully guaranteed postal courses for all the above and many other examinations and careers. Fully described in the *New Free Guide*.

SOON

We definitely guarantee that if you fail to pass the examination for which you are preparing under our guidance, or if you are not satisfied in every way with our tutorial service—then your Tuition Fee will be returned in full and without question. This is surely the acid test of tutorial efficiency.

If you have ambition you must investigate the Tutorial and Employment services we offer. Founded in 1885, our success record is unapproachable.

**ALL TEXTBOOKS ARE SUPPLIED FREE
PROMPT TUTORIAL SERVICE GUARANTEED
NO AGENTS OR TRAVELLERS EMPLOYED**



BECOME A DRAUGHTSMAN - EARN BIG MONEY

Men and Youths urgently wanted for well paid positions as Draughtsmen, etc., in all Branches of Engineering. Our Guaranteed "Home Study" courses will get you in. Those engaged in the General Drawing Office should study some specialised Branch, and so increase their earning capacity.



**NATIONAL INSTITUTE
OF ENGINEERING**

THE GATEWAY TO BETTER LIVING

A.I POSTAL COURSES

ENGINEERING, RADIO, AERO, ETC.

Aero, Draughtsmanship	Elec. Draughtsmanship
Jig & Tool Design	Machine ..
Press Tool & Die Design	Automobile ..
Sheet Metalwork	Structural ..
Automobile Repairs	R/F Concrete ..
Garage Management	Structural Engineering
Works M'gmt. & Admin.	Mathematics (all stages)
Practical Foremanship	Radio Technology
Ratefixing & Estimating	Telecommunications
Time & Motion Study	Wiring & Installation
Engineering Inspection	Television
Metallurgy	Radio Servicing
Refrigeration	Gen. Elec. Engineering
Welding (all branches)	Generation & Supply
Maintenance Engineering	Aircraft Mainten. Licences
Auto Engine Technology	Aerodynamics
Diesel Engine Technology	Electrical Design

BUILDING AND STRUCTURAL

A.I.O.B.	A.I.A.S.	M.R.S.H.
A.M.I.P.H.E.	A.A.L.P.A.	A.I.Q.S. A.R.I.C.S.
Building Construction	Builders' Quantities	Carpentry & Joinery
Costs & Accounts	Building Inspector	Building Draughtsmanship
Surveying & Levelling	Building Inspector	Heating & Ventilating
Clerk of Works		
Quantity Surveying		

GENERAL, LOCAL GOVERNMENT, ETC.

Gen. Cert of Education	A.C.I.S., A.C.C.S.
Book-keeping (all stages)	A.C.W.A. (Costing)
College of Preceptors	School Attendance Officer
Woodwork Teacher	Health Inspector
Metalwork Teacher	Civil Service Exams.
	Housing Manager (A.I.Hsg.)

POST COUPON FOR FREE BOOK

Please send me a FREE copy of "Success in Engineering".

NAME

ADDRESS

Subject or exam of interest

NATIONAL INSTITUTE OF ENGINEERING
(Dept. 29) 148-150 Holborn London EC1