

94 June

PRACTICAL MECHANICS AND SCIENCE

APR 1963

2/-



BUILD YOUR
OWN AEROPLANE

Also inside

**BUILDING IN CIRCLES
FAULT FINDING WITH A VOLTMETER
AN ELECTRIC LAWNMOWER**

SAVE MONEY AND
ENJOY YOURSELF



BUILDING ANY
OF OUR MODELS

There are kits which You can build without help, previous experience, or special equipment!

We guarantee that NO electronic or soldering experience is necessary. Our simple well illustrated Manual guides you step-by-step.



S-33

6 W. STEREO AMPLIFIER. Model S-33. A versatile, high-quality, self-contained STEREO/MONAUURAL Amplifier. 3 watts per channel. 0.3% Distortion at 2.5 w. per Channel. Inputs for Radio (or Tape) Gram ... £13.7.6

HI-FI MONAUURAL AMPLIFIER. Model MA-5. A 5 W. Amplifier with inputs for gram., radio. Presentation similar to S-33 ... £10.19.6

VALVE VOLTMETER. Model V-7A. Measures volts to 1,500 (D.C. and R.M.S.) and 4,000 pk to pk. Res. 0.1Ω-1,000 MΩ. D.C. impedance. 11 MΩ, with test prods, leads and standardising battery ... £13.18.6

TELEPHONE AMPLIFIER. Model TTA-1. "Free-hand" operation; portable and self-contained. 9 v. battery. Elegant ivory-toned cabinet ... £7.9.6

5in. OSCILLOSCOPE. Model O-12U. Wideband amplifiers ideal for TV servicing. F.M. alignment, etc. Vertical frequency response 3 c/s-5 Mc/s, sensitivity 10mV/cm. T/B covers 10 c/s to 500 kc/s. ... £38.10.0

PORTABLE SERVICE 'SCOPE. Model OS-1 A compact, portable oscilloscope, ideal for servicing and general laboratory work. Uses printed board circuitry. 2½in. CRT. Size 5 x 8 x 14½in. long. £19.19.0

SHORTWAVE TRANSISTOR PORTABLE. Model RS-W-1. Two short bands, trawler and medium. £19.17.6

SINGLE CHANNEL AMPLIFIER. Model MA-12. 10-12 watt Hi-Fi amplifier. Extremely low distortion and wide frequency range ... £11.9.6

HI-FI AM/FM TUNER. Tuning range: FM:88-108 Mc/s. AM: 16-50, 200-550, 900-2,000 m. Tuning heart (£4.13.6 incl. P.T.) and I.F. amplifier (£20.13.0) sold separately. Printed circuit board. ... Total £25.6.6

HI-FI 18W STEREO AMPLIFIER. Model S.99. 9 w. per channel, Ganged controls. Stereo-Monaural. Gram, Radio, and Tape Recorder inputs. Push-button selection. Grey metal cabinet. Printed circuit construction ... £27.19.6

TAPE RECORDING/PLAYBACK AMPLIFIER Stereo (TA-1S) £24.10.0 Monaural (TA-1M) £19.2.6

6-TRANSISTOR PORTABLE Model UXR-1. Pre-aligned I.F. Transformer, printed circuit and a 7 x 4in. high flux speaker. Covers both Med. and Long Wavebands. Has attractive leather case with gold relief. Can be assembled in 4 to 6 hours ... £12.11.0



UXR-1

THE "MOHICAN" GENERAL COVERAGE RECEIVER. Model GC-1U. Fully Transistorised. Frequency coverage. 580 kc/s min., 30 Mc/s max., in 5 bands ... £39.17.6



TTA-1



O-12U



S-99



AM/FM Tuner



TA-1S

ELECTRICITY MAINS EXTENSION KIT. Model PUE-1. Completely safe, conforms to IEE Regulations, ideal for supplying light and power to out-buildings (or for soil-heating). Complete with sockets, cables, switches lampholder, junction box, etc. Full details on request ... £4.15.6

PRINTED CIRCUIT AMPLIFIER. Model PCA-1. A 0.5 watt transistor Amplifier. Suitable for gram conversion, baby alarm, intercom, etc. 3 ohm output, 9-volt operation. ... £3.9.0

HI-FI F.M. TUNER. Model FM-4U. Available in two units which for your convenience are sold separately. Tuner unit, FMT-4U £2.15.0. Amplifier and P.S. FMA-4U £12.6.0 ... Total £15.1.0

ELECTRONIC WORKSHOP KIT. Model EW-1. Will help your child to understand electronics, by making at least 20 exciting experiments, including Transistor Radios, Intercom, Burglar Alarm, etc. £7.13.6

BATTERY ELIMINATOR KIT. Model UBE-1. Designed to supply 9 V. or 12 V. D.C. to transistor radios, intercoms, etc. Size as PP9. Battery. £2.17.6

TRANSISTOR INTERCOM. Models XI-IU and XIR-IU. Ideal for office or home. Each Master operates up to 5 remotes. 9 v. battery operated. ... £10.19.6

Model XI-IU (Master) ... £10.19.6
Model XIR-IU (Remote) ... £4.7.6

HI-FI SPEAKER SYSTEM. Model SSU-1. Easily assembled. Two speakers and balance control in a ducted port reflex cabinet, suitable for STEREO or MONO. (Legs 14/6 optional extra). ... £10.17.6

STEREO CONTROL UNIT USC-1. Luxury model with inputs to suit any pick-up ... £19.10.0

Assembled models also available — prices on request.
Deferred terms available over £10. Free Delivery U.K.



MALVERN

HI-FI EQUIPMENT CABINETS. Range available to meet various needs. Details on request. (MALVERN equipment cabinet illustrated on the left) from £6.19.6 to £29.8.0.

STEREO HEAD PREAMPLIFIER USP-1. Ideal for boosting tape-head output and low output pick-ups (e.g. Decca ffs) £7.7.6

AUDIO & DO-IT-YOURSELF accessories also available

"COTSWOLD" HI-FI SPEAKER SYSTEM. Acoustically designed enclosure "in the white" 26 x 23 x 15½in. 12in. bass speaker with 2in. speech coil, elliptical middle speaker. Complete with cross-over unit, level control, etc.

COTSWOLD MFS SPEAKER SYSTEM. A minimum floor space model. Size: 36in. high x 16½in. wide x 14½in. deep, with performance similar to the standard model. Specially designed for small rooms. Either model ... £23.4.0



COTSWOLD

FREE BRITISH HEATHKIT CATALOGUE

Please send me FREE CATALOGUE (Yes/No).....
Full details of model(s).....
NAME.....
ADDRESS.....
PM-4

DAYSTROM LTD.

Dept. PM.4, GLOUCESTER, ENGLAND

A member of the Daystrom Group, manufacturers of the
WORLD'S LARGEST-SELLING ELECTRONIC KITS

YOU NEED SPACE

WE SAVE IT FOR YOU WITH STEEL SHELVING



Hundreds of sizes available and as many shelves as you require. Details in catalogue free on request

Illustration shows 73" x 34" x 9" with six shelves adjustable every inch. Each shelf will carry 400 lb. distributed weight!

£3-7-6 per bay

Delivery free on mainland

"STOWAY" steel carries our guarantee of satisfaction

N. C. BROWN LTD.

DEPT D122 . EAGLE STEELWORKS . HEYWOOD . LANCAS
Tel. 69018 (6 lines)

LONDON . 25 NEWTON STREET . KINGSWAY . WC2
Tel. HOL 7931

The MONODEX, a small handy tool is a vast improvement on the ordinary tinsmith's shears—entirely new upward cutting action effortlessly shears through mild steel up to 20 s.w.g. and aluminium, alloy, brass and copper to 18 s.w.g. without distortion, leaving a good clean edge.

CUTS SHEET METAL
without distortion

Obtainable from Hardware and Tool Shops

39/6

EACH
SPARE BLADES 6/- EACH



MONODEX
REGD

SHEET METAL CUTTER

Patentools Ltd., Mitre Hse., Western Rd., Brighton Tel: Brighton 25117

PHOTOGRAPHERS!

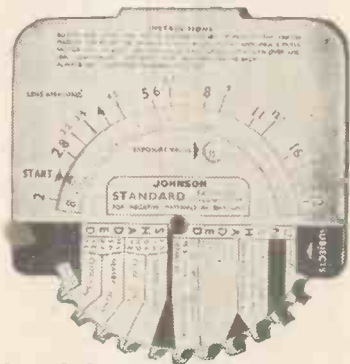

Get the right exposure every time!

Do your pictures ever come out over-exposed or under-exposed? You need a Johnson Standard Daylight Exposure Calculator! It's only 5/- . With this calculator, you just 'dial' for the correct exposure. It's easy! You 'dial' the sort of subject you are photographing, the light conditions, the weather, and the speed of the film you are using—then read off the exposure details. Other calculators for colour cine, artificial light, and flash are also available. Ask your local photographic shop about Johnson calculators.

JOHNSONS
OF HENDON LTD

VALUABLE NEW HANDBOOK FREE TO AMBITIOUS ENGINEERS

Have you had your copy of "Engineering Opportunities"?

The new edition of "ENGINEERING OPPORTUNITIES" is now available—without charge—to all who are anxious for a worthwhile post in Engineering. Frank, informative and completely up to date, the new "ENGINEERING OPPORTUNITIES" should be in the hands of every person engaged in any branch of the Engineering industry, irrespective of age, experience or training.

**We definitely Guarantee
"NO PASS—NO FEE"**

This remarkable book gives details of examinations and courses in every branch of Engineering, Building, etc., outlines the openings available and describes our Special Appointments Department.

WHICH OF THESE IS YOUR PET SUBJECT?

MECH. ENGINEERING
Gen. Mech. Eng.—Maintenance Eng.—Diesel Eng.—Press Tool Design—Sheet Metal Work—Welding—Eng. Pattern Making—Inspection—Draughtsmanship—Metallurgy—Production Eng.

RADIO ENGINEERING
General Radio—Radio & TV Servicing—TV Eng.—Telecommunications—Electronics—Sound Recording—Automation—Practical Radio—Radio Amateurs' Exam.

CIVIL ENGINEERING
General Civil Eng.—Municipal Eng.—Structural Eng.—Sanitary Eng.—Road Eng.—Hydraulics—Mining—Water Supply—Petroleum Tech.

ELEC. ENGINEERING
General Electrical Eng.—Installations—Draughtsmanship—Illuminating Eng.—Refrigeration—Elem. Elec. Science—Elec. Supply—Mining Elec. Eng.

AUTO ENGINEERING
General Auto. Eng.—Auto. Maintenance—Repair—Auto. Diesel Maintenance—Auto. Electrical Equipment—Garage Management.

BUILDING
General Building—Heating & Ventilation—Plumbing—Architecture—Carpentry—Painting & Decorating—Specifications & Quantities—Surveying—Architectural Draughtsmanship.

WE HAVE A WIDE RANGE OF COURSES IN OTHER SUBJECTS INCLUDING CHEMICAL ENG., AERO ENG., MANAGEMENT, INSTRUMENT TECHNOLOGY WORK STUDY, MATHEMATICS, ETC.

Which qualification would increase your earning power? A.M.I.Mech.E., A.M.S.E., A.M.I.C.E., A.M.Brit.I.R.E., A.F.R.Ae.S., B.Sc., A.M.I.P.E., A.M.I.M.I., A.R.I.B.A., A.I.O.B., A.M.I.Chem.E., A.R.I.C.S., M.R.S.H., A.M.I.E.D., A.M.Mun.E., CITY & GUILDS, GEN. CERT. OF EDUCATION, ETC.

BRITISH INSTITUTE OF ENGINEERING TECHNOLOGY
410A COLLEGE HOUSE, 29-31 WRIGHT'S LANE, W.8

THIS BOOK TELLS YOU

- ★ HOW to get a better paid, more interesting job.
- ★ HOW to qualify for rapid promotion.
- ★ HOW to put some letters after your name and become a "key-man" . . . quickly and easily.
- ★ HOW to benefit from our free Advisory and Appointments Depts.
- ★ HOW you can take advantage of the chances you are now missing.
- ★ HOW, irrespective of your age, education or experience, YOU can succeed in any branch of Engineering.

156 PAGES OF EXPERT
CAREER - GUIDANCE



You are bound to benefit from reading "ENGINEERING OPPORTUNITIES," and if you are earning less than £25 a week you should send for your copy now—FREE and without obligation.

POST NOW!

TO B.I.E.T. 410A, COLLEGE HOUSE, 29-31 WRIGHT'S LANE, W.8.

2d. stamp if posted in an unsealed envelope.

Please send me a FREE copy of "ENGINEERING OPPORTUNITIES." I am interested in (state subject, exam., or career).

NAME _____

ADDRESS _____

WRITE IF YOU PREFER NOT TO CUT THIS PAGE

THE B.I.E.T. IS THE LEADING INSTITUTE OF ITS KIND IN THE WORLD

PRACTICAL MECHANICS AND SCIENCE

Vol. XXX

April, 1963

No. 348

TALKING POINT

Editorial and Advertisement
Offices
"PRACTICAL MECHANICS
AND SCIENCE"

George Newnes Ltd., Tower
House, Southampton Street,
Strand, W.C.2.

© George Newnes Ltd., 1963
Phone: Temple Bar 4363
Telegrams
Newnes, Rand, London

SUBSCRIPTION RATES
including postage for one year
Inland - - - £1 8s. per annum
Abroad - - - £1 6s. 6d. per annum
Canada - - - £1 5s. per annum

Copyright in all drawings, photographs and articles published in "Practical Mechanics and Science" is specially reserved throughout the countries signatory to the Berne Convention and the U.S.A. Reproduction or imitations of any of these are therefore expressly forbidden.

CONTENTS

Talking point	291
High frequency Tesla coil ...	292
Lathe Gadgets	297
Space telescope	299
Fault finding with a volt meter	301
A weed drag	303
Picture news	304
Building in circles	306
Super telephoto Lens	308
The Luton Major	310
An electric lawn mower	315
Napier's bones	318
A novel electrical game	320
A simple armillary	322
Wonder gas of the space age ...	324
Trade news	327
Soil blocking tool	328
Recondition that faulty tap... ..	330
Buying a meter	332
Shako	334

CONTRIBUTIONS

The Editor will be pleased to consider articles of a practical nature suitable for publication in "Practical Mechanics and Science". Such articles should be written on one side of the paper only, and should include the name and address of the sender. Whilst the Editor does not hold himself responsible for manuscripts, every effort will be made to return them if a stamped and addressed envelope is enclosed. All correspondence intended for the Editor, should be addressed: The Editor, "Practical Mechanics and Science", George Newnes, Ltd., Tower House, Southampton Street, Strand, London, W.C.2.

New discoveries

"MOST of the scientists that the world has ever known are alive and working today. Despite that, the vast stretches of the unknown and the unanswered and the unfinished still far outstrip our collective comprehension."

Recorded here are some of today's scientific discoveries:

A portable pneumatic pump unit—named the "Iron Heart"—that resuscitates the heart by external pressure on the chest has been perfected. The new device presses down against the breast bone of the patient with a rhythmic force, actually pumping blood by alternately compressing gas without requiring any electric power.

Sea water could be a better fuel than petrol if science learns how to harness thermo-nuclear reaction. Deuterium, or "heavy" hydrogen, in ordinary water packs more energy than you could obtain in the equivalent volume of petrol.

Where is the North Magnetic Pole now? Contrary to what many people think, it moves. Since 1950 it has been moving north at the rate of about five miles a year. Scientists are to again check its whereabouts this year.

Why put a man on the moon when electronic instruments could provide the same data? Because, says a famous scientist, "the human brain is still infinitely superior to the most complex computer. No bigger than a grapefruit, and operating on the equivalent of a tenth of a volt of electricity, it has some ten billion tiny, individual message relay centres linked together which can digest incoming data, analyse, compare and evaluate it and initiate appropriate action in a fraction of a second. The brain has 10,000 times the memory storage capacity of the biggest computer."

A Finnish scientist claims to have found a way to rid the human body of strontium, one of the dangerous elements absorbed into the body through radioactive fallout. His method is to inject a drug known as pilocarpine nitrate, which stimulates the salivary glands and induces the strontium to flow out of the body with sweat and saliva. To prevent reabsorption back into the body an ointment is spread over the body that renders the strontium insoluble in water and can be washed off. The new technique has been successfully tested on animals and two humans.

A gyroscope has been perfected that "does the twist". It bears little resemblance to a conventional gyroscope. It consists of a solid thin-walled hollow cylinder, pressed from ceramic powder and suspended between its two open ends. A lengthwise twist developed by the cylinder is what makes it useful as a gyro. This twist arises for the same physical reason that body twists develop in a "twister" doing a popular dance.

A U.S. scientist has discovered, through a new X-ray technique, that a meteorite that fell to earth some 90 years ago contained diamonds. Now we know what the space race is all about!

That's a good idea!

This is the proposed title of a new regular feature which we hope to commence in the May issue. It will be made up entirely from ideas contributed by readers.

These "hints" or "tips" can apply to the workshop, in the home or garden, and should include either a drawing or photograph and a description, kept as brief as possible.

For all ideas which are published the contributor will receive half or one guinea according to the merit of the idea.

The May 1963 issue will be published on April 30th, 1963. Order it now!

A TESLA coil is a device which produces very high voltages (over 100Kv) alternating at radio frequencies. For the electrical experimenter it is an intriguing piece of apparatus, yet perfectly safe in use, despite the dramatic effects it gives.

With the coil described here, long blue streamer-like sparks may be drawn from either electrode ball to the hands. If a neon lamp is held in the hand it will light up with no apparent connections, even when four or five inches from either electrode. "Sparks" may also be made to pass through glass without puncturing it. If an ordinary lamp bulb is held by the metal cap and the glass placed $\frac{1}{4}$ in. from one of the electrodes, blue sparks will pass through the glass and continue through the vacuum or gas inside to the filament.

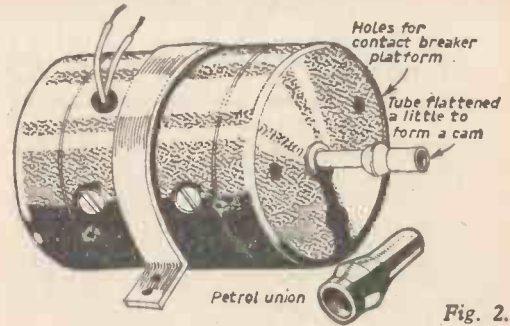

Fig. 2.

A novel high frequency tesla coil

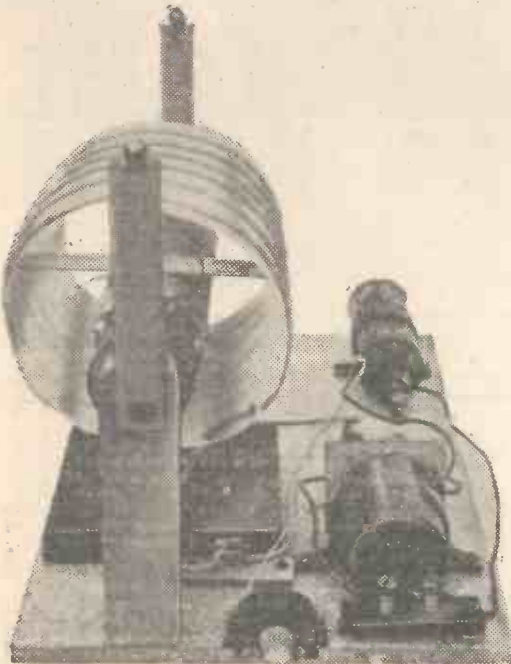

Fig. 1.—The complete high-frequency Tesla coil, showing the arrangement of the components.

Making the Tesla coil

The coil can be made in many forms, the layout is not very critical, and the only parts requiring special care are the condensers and coils. These must be to specification or much time will be wasted in getting optimum results.

The complete circuit is shown in Fig. 5. A 12 volt supply from a car battery or good model train set d.c. supply (3 to 4 amps is required) is stepped-up by using a 6v car ignition coil. This stepped-up voltage is fed into a condenser C_2 via a small spark gap G_2 . When the condenser C_2 is almost fully charged it discharges through the larger gap G_3 via a coil consisting of a few turns of heavy wire (L_2). This coil is the large outer

Fig. 3.—The contact breaker assembly.

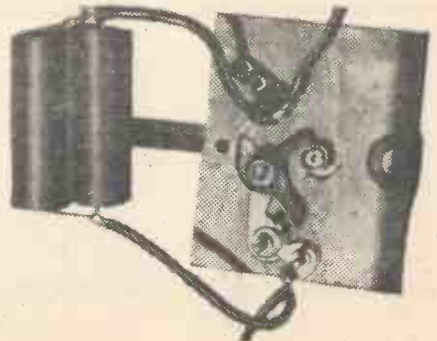

PARTS REQUIRED

1. 6v car ignition coil.
 1. 12v d.c. motor of sufficient power to drive a cam to work contact breaker. One prototype used a landing lamp motor obtained from Messrs. Milligans, 2 Harford St., Liverpool. The model illustrated used a surplus Hoover motor from H. W. English, Rayleigh Rd., Brentwood, Essex.
 1. Base board about 12in. x 18in. x 2in., say chipboard.
 1. 10 ohm variable resistance or lamp dimmer (Milligans).
 1. 0.5 or 1.0 Mfd paper condenser (C1).
 12. Black Polytiles, S & S, 6in. square.
 6. 1in. strips of Polytile, S & S. (These tiles are pure plastic, and any tile having a china or brick-like backing is not suitable. The correct tiles are obtainable from Edwin Jones Ltd., Southampton.)
 1. Roll of aluminium cooking foil.
 1. Polythene bottle about 6½ in. in diameter.
 - 4yd. 16g. copper wire, heavily insulated with PLASTIC covering.
 - 1 lb. 28g., S.C.C., or better still S.S.C., copper wire.
 - 1 tin. Radiospares insulating cement.
 1. Cardboard tube, 2in. dia., 12in. long.
 2. Corks or wooden plugs to fit.
- Nuts, bolts, washers, cored solder, etc. (soldering flux must not be used).

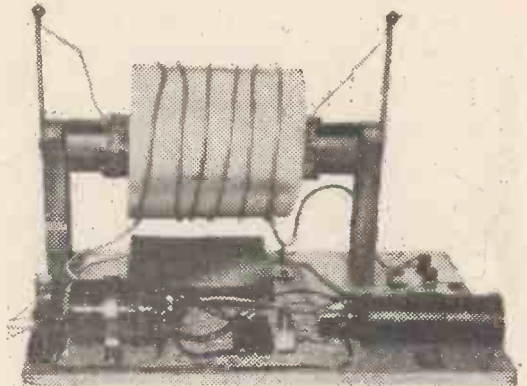

Fig. 4.—Front view of the coil.

spindle. The union should be squashed slightly flat in a vice to form a cam. The general idea and a suitable motor mounting is shown in Fig. 2. Two terminals should be fitted near the motor which should be temporarily wired up in series with the speed control R_2 and tested on the d.c. supply (car battery). If the motor will not run slowly, introduce a small length of electric fire spiral into the circuit R_1 .

The contact breaker

Obtain a car contact breaker set of similar type to Fig. 3. Mount the contacts on a small board fixed to the motor so that the moving contacts are operated by the motor cam. Care is required to

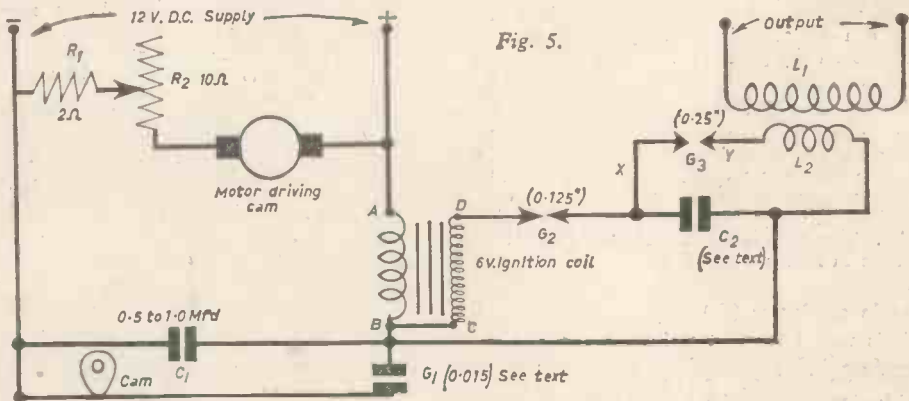

Fig. 5.

coil in the photographs. The magnetic field round L_2 influences the long, highly insulated coil L_1 which has many turns. A high voltage is induced by transformer action and in this design the coil also oscillates as part of a tuned circuit. Extremely high voltages are thus produced at the output electrode balls.

The motor and cam

A petrol pipe union should be obtained from a garage, of a suitable size to fit tightly on the motor

keep the board from fouling the motor spindle in any way (spacing washers may help here). Make sure there is a fibre washer keeping the moving contacts from touching the fixed contacts (as indeed is the case in a motor car).

To enable the position of the fixed contacts to be adjusted the fixing holes should be slotted. Adjust the gap to a maximum of 12 to 15 thousandths of an inch, but make sure that the contacts close as the cam is manually rotated. Try the motor out again and slightly grease the cam.

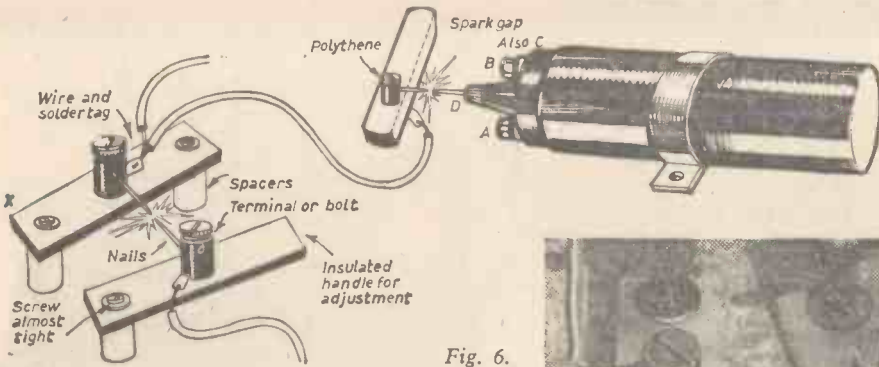

Fig. 6.

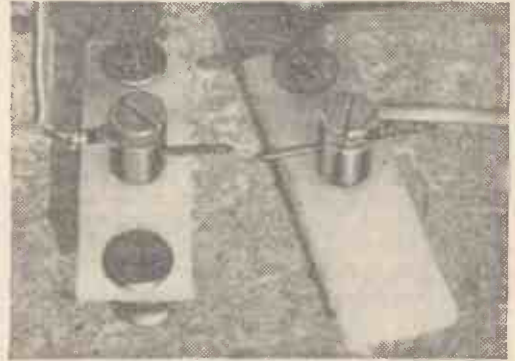

Fig. 7.

Wiring the ignition coil

Fix the ignition coil to the baseboard and wire up all the circuit on the left of spark gap G_1 in Fig. 5. The coil should be a 6 volt type although it is to be overrun on 12 volts (experiment has shown that most will easily stand up to this for years). Note that terminal B of the coil should be attached to the static contact with a solder tag and suitable wire and the moving contact to the negative terminal. Obtain a 0.5 or 1Mfd 400 volt working, paper condenser C_1 and wire it across the contacts.

Attach a heavily insulated H.T. lead to the large coil terminal D and hold the spare end near the coil casing or terminals A or B. Note that C is joined to B internally by the coil manufacturers. Run the motor and $\frac{1}{2}$ in. sparks should jump the gap. However, if all is well do not run like this for long or the coil will be damaged. It is wise to try a slightly larger or smaller condenser across the contacts to obtain the best spark at the gap and the least arcing across the contact breaker points. Two 0.5Mfd can be seen in Fig. 3, which gave the best results on the prototype.

The first spark gap (G_2)

This is made from two needles, one being inserted in the large coil terminal D instead of the H.T. cable used for testing. The other should be held in a terminal screw, or drilled bolt, mounted on a piece of polythene or Perspex (Polytile is suitable). The gap is adjustable, the general idea being seen in Fig. 6.

The main condenser (C_2)

This is very important and represents the most difficult part of the apparatus to make. Nine pieces of aluminium, lead, or tin foil, as shown in Fig. 9, should be interleaved with flat black Polytile sheets. These sheets are the correct thickness, have the correct dielectric constant and are easily worked. (No other type but "Polytile", should be used). Each alternate tin foil sheet should be turned round so that the final result is as shown in Fig. 9. No foil must come within one inch of the edge of the Polytiles except the lugs, and no dirt must be present on them. Two holes should be drilled through all the Polytile plates, near the extreme edges as shown. The sheets may be drilled separately if preferred. The condenser should be mounted as shown in Fig. 9 and the photographs. Wood screws can be used, preferably brass.

Two terminals (nuts and bolts with washers will do) should be mounted on Perspex, polythene or Polytile strips as shown in Fig. 9. There must be no electrical connection between these two terminals. The complete condenser may then be covered *thinly* with insulating cement.

The second spark gap (G_3)

A couple of pieces of insulating material, as above, should be mounted as in Figs. 6 and 7. Two needles should be mounted in terminals or drilled bolts. Solder tags should be fitted and a handle to be used for adjusting the gap.

We can now test out the condenser previously made. Wire up according to Fig. 5 using heavy motorcar type L.T. wire with a polythene cover, otherwise use motorcycle H.T. cable. Rubber cable as used for ordinary lighting is not suitable. As we have not yet made the Tesla coil omit this item from the circuit and connect direct from Y to the condenser.

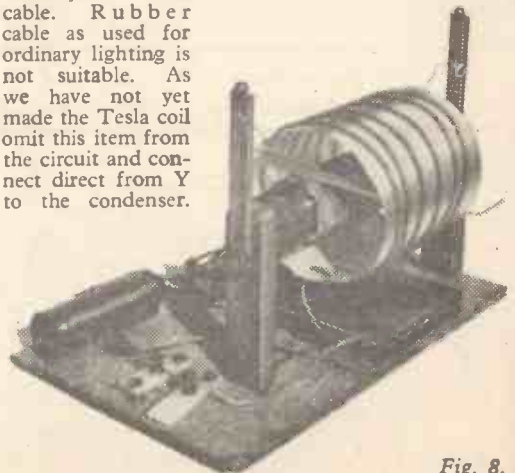

Fig. 8.

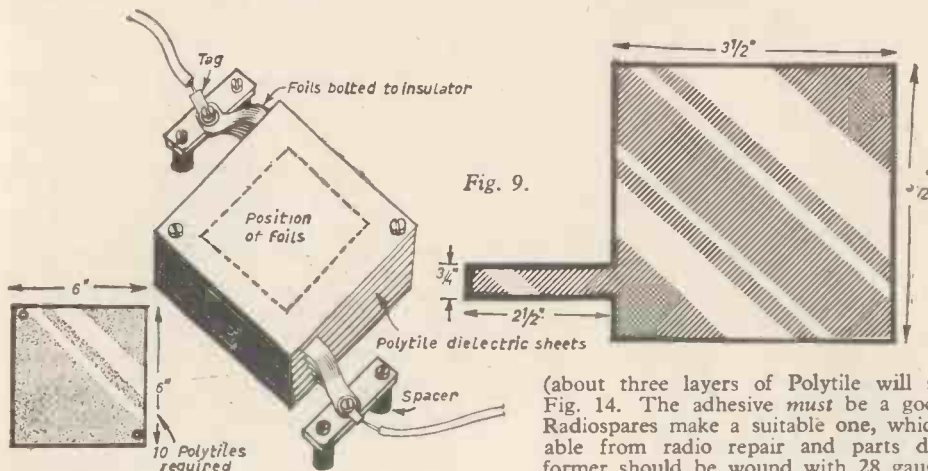

Fig. 9.

(about three layers of Polytile will serve) as in Fig. 14. The adhesive must be a good insulator. Radiospares make a suitable one, which is obtainable from radio repair and parts dealers. The former should be wound with 28 gauge wire in a single, tightly wound layer. No turn must overlap any adjacent turn. The coil should then be literally flooded with insulating cement. Connect the ends of the winding to two large ball bearings stuck on Polytile strips. Corks should be fitted in the ends

At this stage set G_2 to $\frac{1}{8}$ in. and G_3 to $\frac{1}{4}$ in. and run the motor fairly slowly. A continuous train of small blue sparks should jump across G_2 , but only about five per second of really fat white sparks across G_3 . These will make a cracking sound, and care should be exercised not to get near them. They will probably jump more than $\frac{1}{2}$ in. so keep your fingers out!

Making the primary Tesla coil

The former for this is made from a polythene bottle which must have the dimensions shown in Fig. 11. It should be wound with six turns of really heavy gauge, plastic covered wire (Fig. 10).

Making the secondary Tesla coil

The cotton or silk covered wire should be wound on a polythene former between $2\frac{1}{2}$ in. and $2\frac{3}{4}$ in. diameter. Since it must be at least 12 in. long it may not be easy to obtain. The author used a cardboard tube (Fig. 13) and stuck to it strips of polythene

Fig. 10.

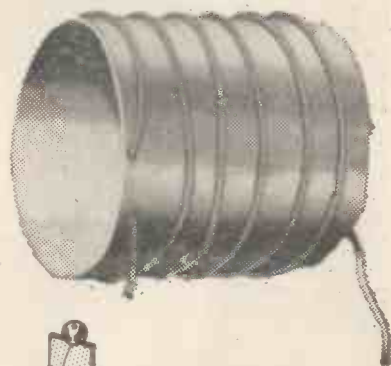
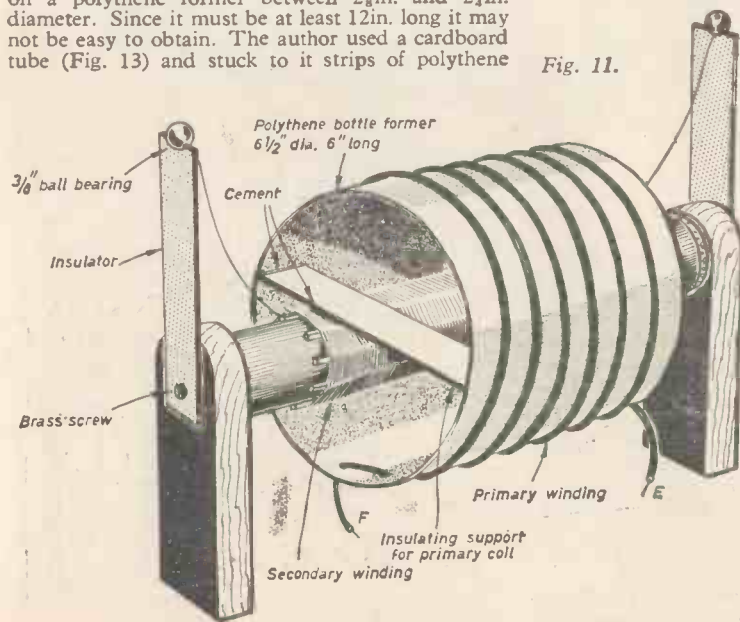

Fig. 11.



of the former and wooden supports made for the coil as in Figs. 11 and 14.

Finally, two or more Polytile strips should be cemented across the long coil and the larger one rested thereon (Figs. 11 and 13).

Trying out the Tesla coil

Wire the Tesla coil into the circuit as in Fig. 5. The wire from the adjustable contact "Y" should go to the large coil instead of back to C on the ignition coil. The contact X should remain connected to the condenser and small spark gap. The other end of

Fig. 12.

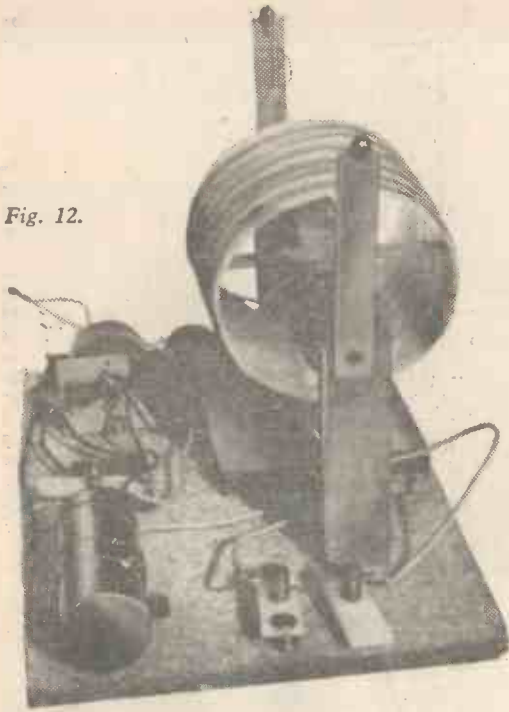

capacitance relationship of L_2 and C_2 . This is modified by the inductance of L_1 , which is tuned so that the whole system oscillates. The two electrode balls represent voltage antinodes and a small neon on a stick, held between the coils, will light towards each end, but should go out in the centre. If more than two antinodes are present the lamp will light at various places along the coils and the system is not resonating under optimum conditions.

The author took considerable trouble in determining the dimensions of the two coils and condenser C_2 , and if readers keep to these their unit should resonate correctly. Those who wish to experiment may add or remove condenser plates and use different length of coils. Always make sure however, that only two antinodes are present along the secondary Tesla coil. Longer coils may lead to unsolved insulation difficulties—these Tesla type h.p. currents and voltages travel quite nicely even over clean glass surfaces.

Warning

While a simple Tesla coil of this type is not considered dangerous it can have unpleasant, frightening effects, especially to young children and very old people. It should therefore be used with discretion.



Fig. 13.—The secondary Tesla coil and mountings for the primary coil.

the coil should be connected to the other side of the condenser.

Run the motor and hold a finger near one electrode ball. A tingling sensation should be felt and sparks at least 1 in. long should jump to the finger. In the dark a blue glow will be seen to fill the space between the ball and the finger. Hold an ordinary beehive type neon lamp near the ball and it will glow very brightly. Using this as a gauge, measure how far from the electrode it will light up. Now try adjusting the motor speed, and the various gaps, for optimum results. Do not set G_2 to too large a gap as no good purpose is achieved and the coil will be damaged.

Additional information

The correct functioning of the coil as a high-frequency oscillator depends on the inductance/

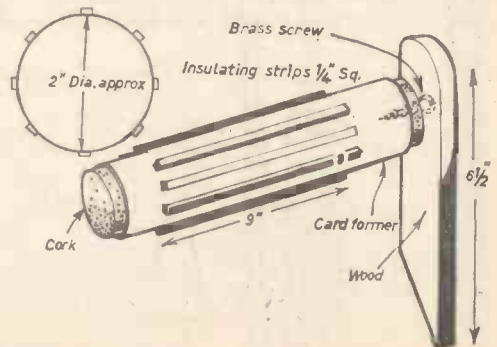

Fig. 14.

LATHE GADGETS

Part 16

RADIUS TURNING TOOL

By L. C. MASON

THE odd job crops up from time to time in which a shape is required that can't be easily or accurately produced by the normal tools. Such a shape is a true hemi-spherical depression. This could be needed in the cylinder head of a model o.h.v. engine with inclined valves or perhaps in parts of a universal joint embracing a ball. Some pistons have a similar depression in the crown. This concave shape has also been needed for a former plate for dishing a piece of sheet copper.

The tool shown will machine such a surface by means of a swinging cutter bit in a holder. The tool is mounted on the top slide as for facing, in line with the lathe centre line, and the cut applied

The length of the body bars allows them to be swung on the faceplate to face the inside surface of the gap and finish the hole for the cutter holder at the same setting. First square off the gap end of the lower bar and centre pop the position for the cutter holder bearing hole. Drill through $\frac{1}{8}$ in. diameter at this point. Mark out the end of the bar for the step forming part of the gap and rough-saw out the waste piece, leaving a reasonable machining allowance inside the lines. Insert a short end of $\frac{1}{8}$ in. rod in the hole and grip this in a tailstock chuck. Bring the bar, suspended on its rod, up to the faceplate and clamp it to the faceplate. With the clamps little more than finger tight remove the tailstock chuck, leaving the rod in the hole, and turn the lathe by hand to check the trueness of the setting. Adjust as required, remove the rod and balance up the faceplate with appropriate weights opposite the tail of the bar. Face back the surface of the step to the marked lines and bore out the hole with a small boring tool to just under $\frac{1}{4}$ in. diameter. Open up to size with a $\frac{1}{8}$ in. reamer or D-bit. The top bar should be treated similarly except that, as the step is much shallower, all the metal can be removed by machining without troubling to saw any away.

With the two gap faces completely machined mark out the positions for the clamp screws on the top bar and drill $\frac{1}{8}$ in. Slip a piece of true $\frac{1}{8}$ in. rod through the two bearing holes (silver steel or the shank of a drill) and clamp the two bars together,

(Right).—The completely assembled radius turning tool. In this picture it is shown without a cutter bit in the tool holder.

(Below).—The radius turning tool dismantled to show the component parts.

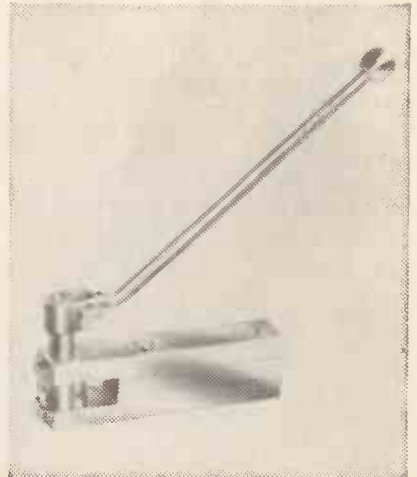
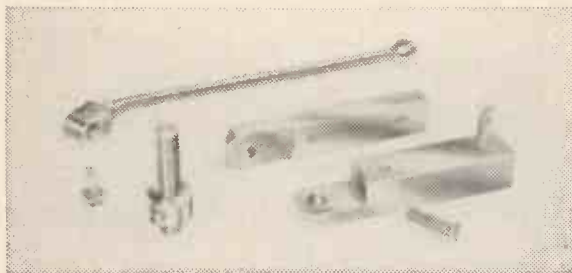

by hand by swinging the cutter bit in its holder with the long handle. The depth of cut is regulated by the saddle position and the radius of cut by the amount the cutter projects from the holder. The proportions of the holder fix the range of sizes it is possible to machine with it; as shown the smallest size is about $\frac{1}{4}$ in. diameter and $\frac{1}{8}$ in. deep.

The tool is quite simple to make, the body consisting merely of two flat bars shaped at one end to accommodate the cutter holder and clamped together with a pair of countersunk screws. Make the body first, then the cutter holder can be machined to a good fit in its gap between the bars.

adjusting their position so that the rod turns without binding. Spot through the holes in the upper bar for the screw holes in the lower one, separate the bars and drill and tap the holes in the lower one. Countersink the top of the holes in the upper bar fairly deeply. Screw the bars together temporarily to act as a gauge for the size of the cutter holder and chamfer off any angles at the business end of the body likely to prevent its close approach to a small depression.

The cutter holder is a plain turning job from $\frac{1}{8}$ in. round rod. To ensure that the two $\frac{1}{8}$ in. ends are truly in line it could well be turned between

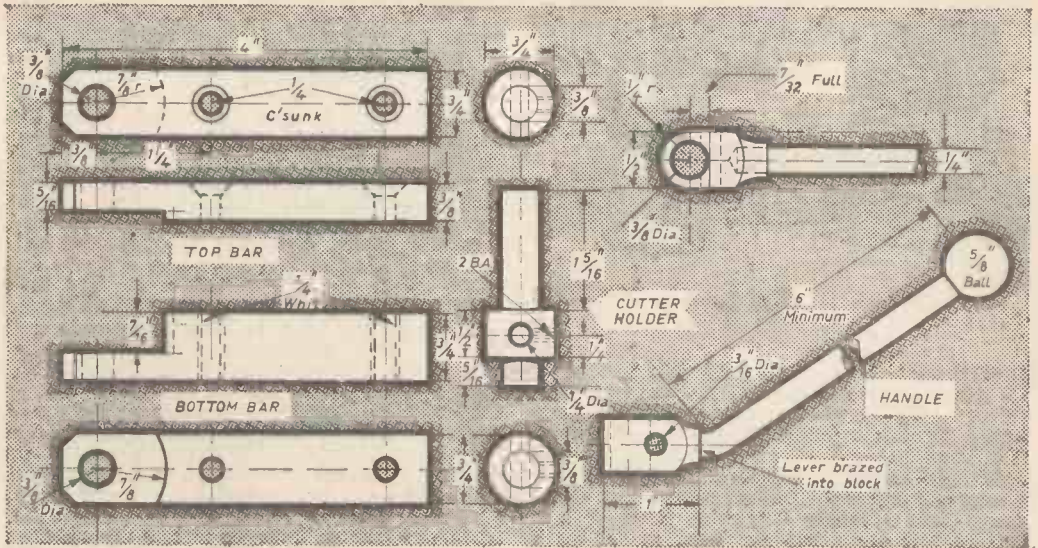

centres. If the nominal $\frac{3}{8}$ in. diameter of the bar is much off size it will pay to turn the whole thing from slightly larger stock. A true $\frac{3}{8}$ in. diameter holder is a great help in setting up the tool for use, as will be seen.

With the holder completely turned and a close fit in the gap in the body, drill the $\frac{1}{4}$ in. hole through the holder for the cutter bit. Here again care in getting the hole true and squarely across the middle will pay dividends. Lastly drill and tap for the 2B.A. Allen set screw to hold the cutter.

The cutter bit itself is a short length of $\frac{1}{4}$ in. round silver steel rod, hardened and tempered in the usual way. The ML7 topslide tool surface is $\frac{3}{8}$ in. below centre height; the proportions of the radius turning tool bring the lathe centre height threequarters of the way up the $\frac{1}{4}$ in. diameter of the cutter. The cutter point should therefore be shaped accordingly. The length of the cutter is determined by the radius of cut required, light cuts only being taken if the tool point is well extended.

While on the subject of heights relating to the ML7 lathe, it will be noted that the total thickness of this tool is $1\frac{1}{4}$ in. If the normal turning tool used in the lathe is, say, $\frac{3}{8}$ in. square, it will save time when mounting the radius turning tool in place of the normal turning tool to slip a short end of $\frac{3}{8}$ in. square bar under the jack screw of the lathe tool clamp. By doing this the setting of the jack screw need not be disturbed, the clamp plate and screw merely being raised complete to a new position $\frac{1}{4}$ in. higher.

The cutter operating handle can be of any style you happen to prefer, the example shown being as suitable as any. It is a length of $\frac{1}{4}$ in. round rod brazed or screwed into a clamp block which fits on the cutter holder spindle. A tight grip on the spindle is provided by a notched cotter through the drilled hole and firmly tightened up the nut. Then drill the spindle hole which will notch the cotter as required at the same time. Remove the cotter and cut off the bolt head, which allows the nut to draw the cotter through the hole so that the notch grips the spindle. The outer end of the handle looks more "finished" with the addition of a plastic knob or one made from a softened ball bearing.

(Continued on page 333)

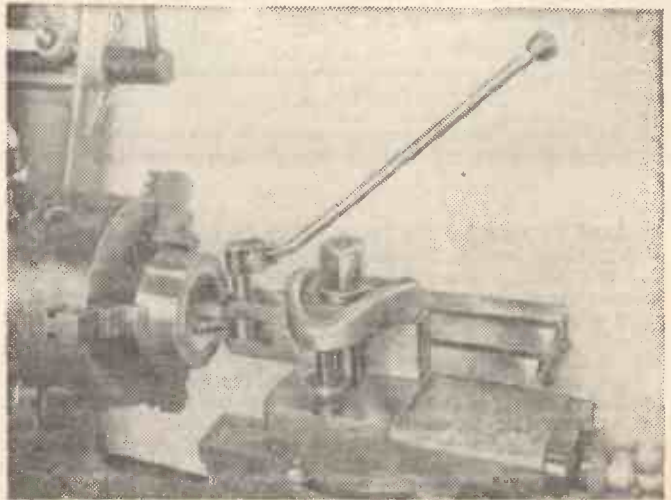

Machining a spherical depression with the radius turning tool.

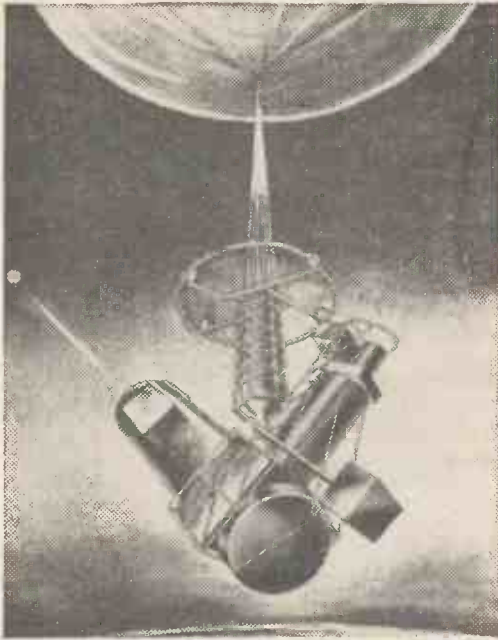

An artist's impression of Stratoscope II, 80,000ft above the earth with its 36in. remote-controlled telescope focused on a distant star.

SPACE TELESCOPE LOOKS AT THE STARS

BY R. J. SALTER

IT has never been possible to see the planets really clearly from a telescope on earth because the view is blurred by the atmosphere surrounding our world.

All this is being changed by the use of a telescope carried up above the atmosphere to an altitude of 80,000ft, by a helium filled balloon. Known as the Stratoscope II the telescope is of the reflecting type using as its primary mirror a 36in. diameter fused quartz reflector. It is believed to have the most finely ground paraboloid surface ever made, with an accuracy of one millionth of an inch. Such precision was necessary to take advantage of the clear seeing possible from above the atmosphere. This relatively small telescope will give astronomers clearer vision even than with the 200in. telescope on Mount Palomar in California. Stratoscope II is a development of an earlier balloon-supported telescope with a 12in. diameter mirror. Several years ago this Stratoscope I obtained very clear photographs of sunspots.

Two balloons are being used to lift the telescope; a small one and a larger one. The purpose of the small balloon is to lift the larger one into the air before take off and then at the instant of take off the larger balloon is released from its container. In the photograph the Stratoscope II balloon is being tested in flight. It was particularly important that it should be made with a fabric which was extremely strong and which would not tear easily and so a revolutionary new material was developed by research scientists.

Not only was the material of which the balloon was made new. The idea of using a small launch balloon above a large main balloon is an important development in high altitude craft. The small launch balloon is large enough to hold at ground level all the helium required to lift the record three-

ton payload to an altitude of 80,000ft. This means that during the inflation of the launch balloon, the main balloon can remain in a sheath which prevents it being blown about in the wind. In this way the balloons can be controlled on the ground before the launch, even though a wind is blowing. With this development, scientists will not need to wait for a calm day before sending the telescope aloft. As the tandem balloons begin to rise the helium expands in the thinning air and then moves down from the upper into the lower balloon through a transfer valve. As the main balloon expands, its containing sheath splits open.

All this time the balloons are kept under control by a 1,050ft main anchor line attached to a winch waggon some 900ft away upwind. Finally when the launch balloon is some 600ft in the air and the main balloon in its sheath has left its package the main anchor line is released from the launch balloon and floats slowly to the ground by parachute. As the balloons and the telescope ascend the main balloon expands until at 80,000ft above the ground it has extended to a diameter of just over 200ft.

To orientate the telescope a wide-angle television camera is incorporated, whilst the actual image being recorded by the film in the telescope can be seen from another television camera built into the telescope optical system. Using the pictures received on earth from the wide-angle television camera the astronomers will be able to direct the telescope to the particular part of the heavens which they are studying and then accurately focus the image on the film, using the second camera. Operation of these controls and the other electronic apparatus in the telescope is being carried out by a 70-station command channel.

During normal operation the telescope remains supported by its two balloons about 16 miles above



The balloon being filled through three inflation tubes. The main balloon can be seen furlled beneath the launch balloon.

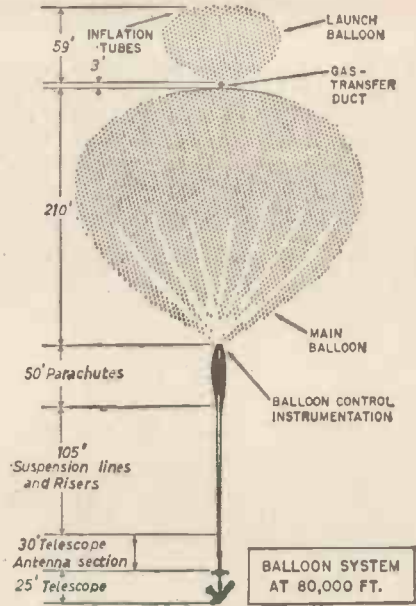

LAUNCH BALLOON	
MATERIAL:	S-12 .5 MIL MYLAR DACRON SCRIM (4 x 6 STRANDS / INCH) TENSILE STRENGTH 40 LBS. / INCH
TYPE BALLOON:	FULL SUPERPRESSURE CYLINDER
VOLUME:	305,000 FT. ³
MAIN BALLOON	
MATERIAL:	S-11 .35 MIL MYLAR DACRON SCRIM (4 x 6 STRANDS / INCH)
TYPE BALLOON:	TAILORED NATURAL SHAPE
VOLUME:	5,250,000 FT. ³
LENGTH OVERALL	
AT LAUNCH:	660 FT.
AT 80,000 FT.:	480 FT.
WEIGHT	
PAYLOAD:	6300 LBS.
OVERALL:	13,250 LBS.
GROSS LIFT: 14,875 LBS.	
FREE LIFT: 1325 LBS.	

First success reported

As this article was being prepared for publication, Stratoscope II made its first, and highly successful, flight. During this it observed the star Sirius and the infra-red spectrum of the planet Mars to discover its carbon dioxide and water vapour content. The results were a death blow to theories of Martian canals and life, as they revealed that the water vapour level is only a fraction of 1%. The planet must thus be a vast, waterless desert.

The 12 hour flight reached a height of 77,000ft after a "beautiful launch" and covered 500 miles from the launch point at Palestine, Texas. The observations of Mars were at the request of the United States Space Agency, to assist in the design of next year's Mariner probe to Mars. The only trouble experienced was an unexpected drift into bad weather which necessitated bringing the telescope down by parachute from 44,000ft instead of landing as planned. The telescope is believed to be undamaged and is expected to fly again in a few weeks, to observe Jupiter or Saturn.

the earth for approximately eight hours during the night. When dawn comes the telescope is brought back to earth by releasing helium from the balloons. This is done by radio control from tracking aircraft which follow the balloons down to earth. As the telescope lands the shock of the impact is taken by a crash pad fitted beneath the load.

Scientists using this latest telescope hope to learn more of the surface of the moon for even the exact nature of the surface of this our nearest space neighbour is still not known. The telescope will also be focused upon Venus, Jupiter and Mars to try and discover more of their secrets which are hidden from astronomers on the earth.

STRATOSCOPE II LAUNCH CONFIGURATION

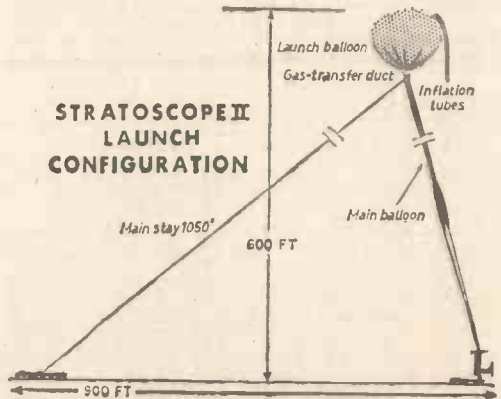

Fault Finding with a VOLTMETER

BY G. A. W. PARTRIDGE

ELECTRICAL appliances and wiring break down from time to time. The two most common faults are open circuits and short circuits. A break in the electrical circuit is known as an open circuit. When electricity flows where it is not wanted, usually due to damaged insulation, a short circuit is said to have taken place.

An open circuit is indicated by the appliance or part of the wiring becoming "dead". A short circuit usually "blows" the fuses or automatically switches off the circuit breaker if one is fitted, and there is sometimes a burning smell caused by overheating.

A simple voltmeter used intelligently can go a long way in tracing such faults. There are several kinds on the market, but an instrument that can operate on alternating current (a.c.) and direct current (d.c.) with ranges from 0 to 300 volts is the most suitable. There is usually a switch for changing the meter from a.c. to d.c. operation and vice-versa.

The main advantage of voltmeter testing is that no disconnecting is necessary which is more often than not the case when using an ammeter. The voltmeter is simply connected directly to the circuit, either with test-prods or clips.

Let us assume that a wall or ceiling light has ceased to function. All other lights are working so obviously no fuses have "blown". Therefore the fault must be in the lamp itself, its switch, or the wiring. There is little point in using a voltmeter on the lamp because changing the bulb will show up any fault here quickly enough.

Now test the switch by removing the cover and connecting the voltmeter to one of the terminals and also to a cold water pipe or the household earthing system (Fig. 1). Long test leads will be necessary. They can be made from about 4 yards of lighting flex and fitted with test-prods that are designed to have test-clips attached to them (Fig. 2). Check that the switch contacts are not burnt as this might be the cause of the trouble. If there is a reading on both terminals when the switch is ON it indicates that there is a break in the switch wire or black return wire (Fig. 1). On the other hand if no reading is indicated at the switch it means that the fault lies in the red supply wire, or in the junction box. In the first case remove the lamp bulb and with the switch ON touch the two connecting pins in turn.

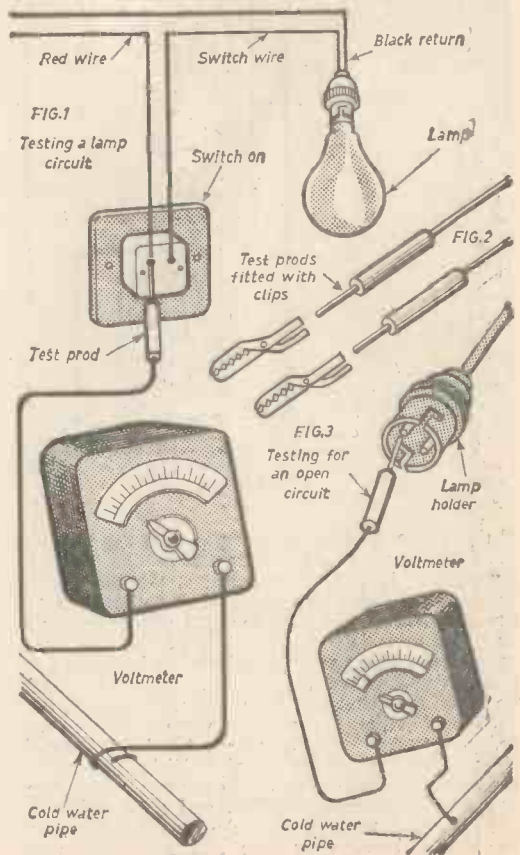

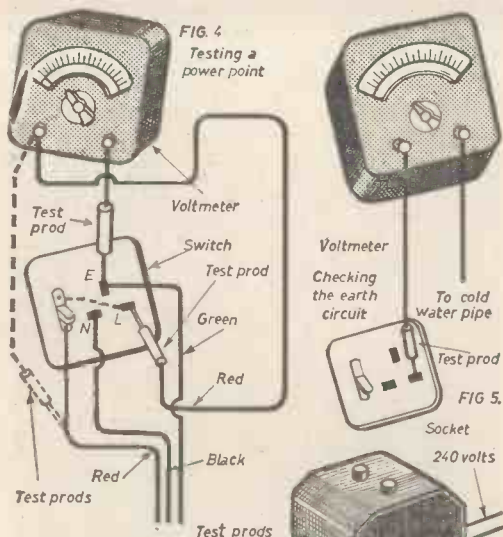

FIG. 4 Testing a power point

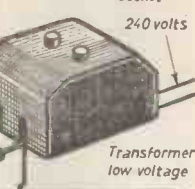
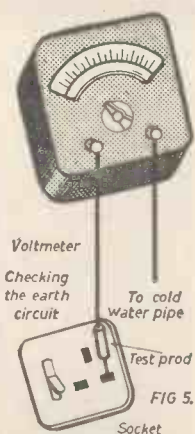
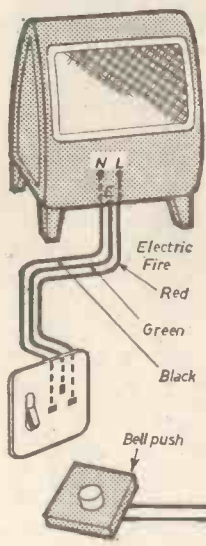

FIG. 5 Checking the earth circuit



If there is a reading on one pin then the break is in the black return circuit or in the junction box, which is usually mounted above the ceiling.

When several lights cease to function and the fuses or circuit breakers are still unblown or set, then the fault lies in the main part of the lighting circuit. Here again, the junction box and connections to the fuses or the circuit breaker should be carefully examined with the main switch OFF.

Short circuits are easier to trace due to the fuse "blowing" or the circuit breaker automatically switching off the supply. First turn off all switches, replace the fuse or reset the circuit breaker as the case may be, and then switch on each light on the circuit one after the other, until the circuit breaker or fuse suddenly disconnects

the supply. The last lamp turned on is in the part of the circuit that contains the short. Careful inspection of the switch, lamp, and wiring should reveal the fault. Damaged insulation will probably be the cause.

If the fuse or circuit breaker disconnects the power before any lights are turned on, the fault will be between the lighting switches and the distribution board. Here again, the junction box should be opened up and examined.

When power points develop trouble it is usually either in the switches or sockets rather than the wiring. Such faults can often be found by inspection. A break in the wiring, however, can be detected with the voltmeter as shown in Fig. 4. With the switch ON, a reading should be obtained with the voltmeter connected to the "E" (earth) and "L" (live) terminals of the socket. No reading shows that the switch may be faulty. (Remember that a switch with bad contacts may pass sufficient current to operate the voltmeter and not the appliance, so it should be carefully inspected). If a reading is obtained when the voltmeter is connected to "E" and directly to the red wire (Fig. 4) then the switch or its connection to the "L" socket is faulty. No reading indicates a break in the red wire or bad connections at the main switch and fuses. It must not be overlooked that this test may be showing up a broken earth circuit, which should be verified by transferring the test lead to a cold water tap (Fig. 5). If a reading now appears then the earthing system is faulty and should be put right as soon as possible. If the "L" socket is alive but there is no reading when the meter is connected across the "L" and "N" sockets then the "N" (black) wire is either broken or disconnected.

Faults on portable appliances are usually found in their connecting cords. Fig. 6 shows how an appliance such as an electric fire can be quickly tested. First, test between the "N" and "L" terminals in the plug with the switch ON. If there is a reading then test between the red and black wires at the electric fire. If there is no reading then the cord is broken and should be replaced. Faults in the appliance itself can usually be found by inspection.

Low voltage equipment can be tested in much the same way except that a lower voltmeter range is selected. A transformer operated electric bell that ceases to function should first have its fuses checked, which will probably be in the step-down transformer. If they are intact check the low voltage side which may be from 4 to 12 volts, depending upon the type of bell in use (Fig. 7). If all is well connect the meter across the bell and get someone to press the bell push. No reading shows that the wiring or push is at fault. A reading indicates that the bell is not working.

Some bells operate on batteries, so in this case the voltmeter must be switched to d.c. and a suitable range chosen. Test the battery by connecting the meter across the terminals and take a reading when the bell push is pressed. If the voltage drops to almost zero then the batteries are exhausted.

Short circuits on low voltage equipment are shown up by "blown" fuses, if fitted, a damaged battery or transformer, and burnt insulation at the point where the short has taken place. Sometimes the fuse operates before any burning occurs. A bell that rings continuously indicates a short circuit between the bell push wires.

A WEED DRAG

Although designed for a specific purpose this could also be used for clearing ponds and streams, or assisting yachtsmen in finding lost moorings.

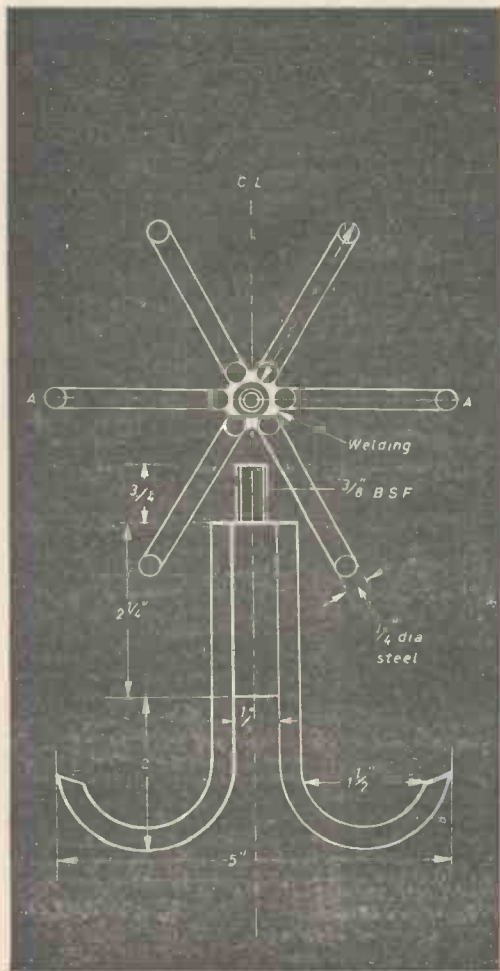

By S. A. Seager

THIS piece of equipment was devised to take samples of water weed near to or away from the banks of any water in which it happened to be growing. Although this particular one was made with the help of welding tackle and a lathe, alternative methods of construction are described later.

The basic parts are the hooks, six of which are required, and the body to which the hooks are welded. A 3in. length of 1/2in. diameter mild steel should be used for the body. The hooks should be made from 1/2in. round steel, either silver steel or bright drawn mild steel being strong enough. The advantage of the two latter steels is that they both have a fine finish which can be blued. Otherwise, common black round steel can be used.

Silver steel can be bought from good tool shops in 13in. lengths. It does not of course contain silver, the term refers to the bright finish of this material. Three pieces cut in half will provide six hooks. Shape the hooks with the aid of a 1 1/2in. round former and a mechanic's vice. A soft vice jaw should be used to prevent damage to the outer side of the hook being bent. Blows should be delivered with a hide faced hammer otherwise damage will result from this source as well. The body should be made by turning the 1/2in. rod to 1/2in. diameter for a length of 3/4in., threading this portion 1/2in. B.S.F. which is the thread size of most landing net handles. The drag can thus be fitted to your existing landing net handle. Before assembly, all the hooks should be cut to the same lengths and the points filed back as shown to give a neat finish. Roughly position the six hooks around the body and secure with the aid of a hose clip. Space the hooks evenly around the body and finally tighten the clip. The position of the clip should allow for the weld metal to be run above and below it. Before welding check that all six hooks seat firmly against the body.

To prevent the formation of rust, the drag can be blued in the fire by laying it in freshly heated coke. The usual heat colours will be seen to form, and when a blue colour is reached quench out in oil.

The scope of the drag can be increased by attaching an eyenut with a 1/2in. B.S.F. thread. If one cannot be found, an old ballbearing outer cage about 1/2in. wide can be used. Soften it by heating to redness in the fire and leave there overnight. Then drill it 1/8in. and tap this hole 1/2in. B.S.F.

An alternative method of making the drag without using the lathe is by using a 2 1/2in. x 1/2in. B.S.F. set bolt (threaded right up to the head) and half a dozen hexagon nuts to fit. The first nut should be screwed down tightly to the head of the bolt, but keeping the faces of the bolt head and the nut in alignment. Repeat with the other five nuts leaving a portion of the bolt projecting to screw into the eyebolt or handle. The hose clip should now be placed in position and the assembly welded. This method has the advantage over the lathe method of allowing for a more accurate positioning of the hooks which abut against the faces of the nuts. If no welding tackle is available then soldering must be resorted to. Should soldering be used then the operation of bluing must be done before assembly.

PICTURE NEWS

FROM THE WORLD OF SCIENCE

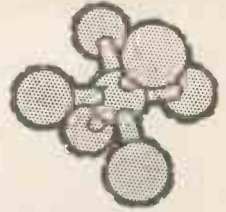

Engine thermometer $\frac{1}{8}$ -inch-long measures temperatures up to 1,000° C

ROYAL Dutch/Shell companies all over the world can now provide engineering firms with small $\frac{1}{8}$ in. screws which measure temperatures of up to 1,000° C—ten times that of boiling water. These screws are called Templugs and can be inserted into many mechanical components to help research engineers develop more efficient machinery.

Templugs are used by "Shell" Research Limited, at Thornton Research Centre, Cheshire, in the quest for improved fuels and lubricants.

Heat is a form of energy, and the heat dissipated by, say, a motor car's radiator represents wasted power. If an engine can be built to run at higher temperatures, it will do more work on a gallon of fuel. This in turn means that for a given horse power, a car can be fitted with a smaller, lighter and more economical engine.

Engineers are therefore constantly trying to operate new engines at ever higher pressures and temperatures as design knowledge increases. To do this, they must know exactly how hot each part of every component in a prototype engine becomes under operating conditions. Too high a temperature at one point may result for example in distortion and failure. The problem is to select for each part both the most suitable material and the most effective design.

Many metal alloys become permanently harder or softer when heated, and their final degree of hardness will depend on both the temperature reached and the duration of exposure to it. Hardness can be measured very accurately, and if the time of exposure is known, the temperatures reached may be directly calculated.

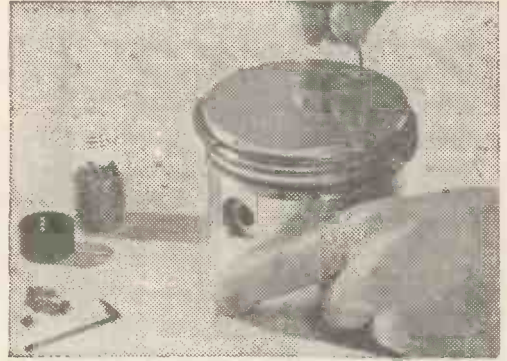

This metallurgical technique has been recognised for some time, and avoids all the problems of using devices like thermo-couples and fusible plugs on fast-moving engine parts. It is very difficult, for example, to connect a thermo-couple to a piston which is reciprocating at high speed, and fusible plugs tend to foul working surfaces when they melt.

These Templugs are simple to install, do not damage the part under test, and their use allows any number of repeat tests to be made with the same component. Made in the form of $\frac{1}{8}$ in.-long grubscrews, they can be inserted into small holes drilled almost anywhere in a piston head, a connecting rod, or perhaps the propeller shaft bearing of a ship; and they are capable of indicating the temperature reached at each of these points to within plus or minus one per cent.



NEW YORK CITY now has its first electronic and automatic underground railway train. It runs between Times Square and the Grand Central Railway terminal and shuttles back and forth between those two stations. The electronic devices, shown at the lower right of the photograph, control the train's speed as it approaches the passenger platforms. On underground trains that are not automated the operator sits in a small compartment at the front similar to London's underground trains.

Nike-Zeus target track radar

RADAR equipment in all of the U.S. Army's Nike-Zeus "anti-missile missile" tracking stations are protected by huge bubble-shaped radomes. The stations have been erected at key points in the United States and in the Atlantic and Pacific oceans.

In designing the Nike-Zeus system it was specified that radomes for protecting target track radar antennae must allow the radar to operate at maximum efficiency. To meet these requirements the radomes, which are nearly 50ft in diameter, are constructed without overlapping seams, source of much distortion, and a uniform thickness. They are made of a rubberised nylon with staggered butt splices in body and crown.

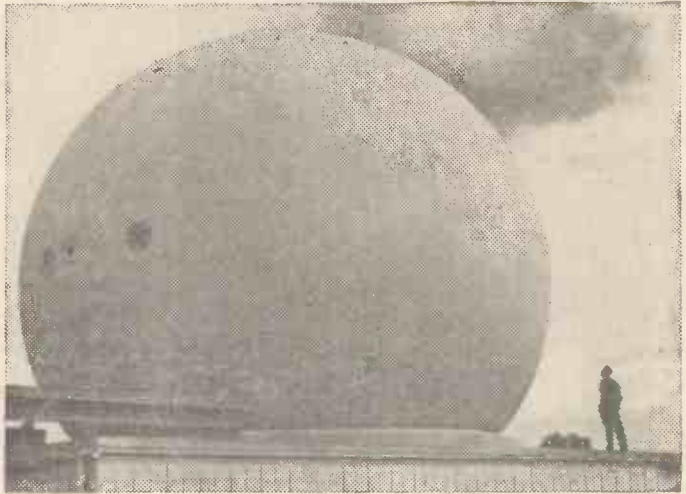

AN atomic clock has no resemblance to an ordinary clock and does not operate in the same manner. The device shown here, for instance, is one of many types which have now been perfected. It is used to find the age of any object. A sample of the object is placed in a cylinder which contains a Geiger counter. This counter is so sensitive that it reveals even a minute particle of radioactivity. The exact age can then be computed because radioactivity dies out at a definite rate as an object grows older.

WORLD'S FIRST AIRCRAFT COOLING LABORATORY

ANEW cooling systems laboratory designed to improve air passenger comfort and safety was officially opened at the Royal Aircraft Establishment, Farnborough, Hants. First of its kind in the world, the laboratory can simulate flight temperatures and pressure variations at speeds up to 2,500 m.p.h. and altitudes up to 80,000ft. In such conditions aircraft skin temperatures may be raised to 350°C, although the outside air will be about -60°C, and pressures will range from 15lb per square inch at ground level to less than 0.5lb per square inch. The unit will facilitate at an early stage design of an aircraft's various conditioning systems and enable environmental conditions within to be accurately forecast.





Marina City under construction. The central service cores pass through circular floors; here partly built.

THE scientific approach is considered essential in all branches of industry as well as in the professions. Take the construction industry for instance, and the architects who plan and prepare the structures to be built. Science has found the way to short-cut many building techniques and to lower constructional costs and maintenance expenses.

Today, architects in the United States are increasingly using circular patterns for various types of buildings. Round buildings are often more economical to construct than rectilinear forms, and more practical and convenient to use. Though they are never likely to become as common as straight-walled, rectangular structures, they are finding growing acceptance in special situations. Many architects also turn to the circle

(Bottom left). A circular design was chosen for this branch of the American Trust Company in San Francisco. The circular pattern fitted in well to the irregularly shaped site. The building is constructed of glass and brick. (Bottom right). A living room of a flat in Marina City. Focal point of the rooms in the wedge-shaped flats is the outside wall, which is glass from floor to ceiling to take advantage of the dramatic view.



building

for relief from the monotony of straight lines and severe rectangular shapes.

According to a recent bulletin, the most spectacular example of circular design is provided by two 60-storey buildings in the Marina City project now nearing completion in Chicago. They are reputed to be the world's highest block of flats, and comprise two cylindrical towers of reinforced concrete which rise 588 feet to dominate the skyline. The first 19 floors of each building are devoted to spiral parking ramps for cars. Laundry facilities are on the 20th floor. On the top 40 floors, far above the noise and dust of the city, are the residential units, each with a private balcony. These twin towers overlooking the Chicago River are being built to provide housing for middle-income families. Together, they will contain a total of 896 flats and parking facilities for 900 cars.

Architect Bertrand Goldberg, designer of the revolutionary project, says the circular design, and the construction techniques this made possible, have lowered the cost at least 15 per cent. He claims that the round shape gives the highest ratio of usable floor space to exterior wall area—a big economy because a building's outside skin forms a large part of the total construction. In each tower the wedge-shaped flats fan out from a central core containing lifts, stairwells, plumbing and electrical connections. Mr. Goldberg says these centralised utilities require less pipes, cables and installation labour than utilities in a conventional building.

An unusual feature of the project's construction is the use of plastic forms for casting concrete.



in circles

by Donald S. Fraser

These forms can be moulded into any shape, which made them especially suitable for the circular towers. They were used to cast the central core, supporting columns and floor tiers. Another feature contributing to speedy erection is the use of two Linden climbing cranes imported from Denmark. These cranes, which are raised floor by floor as construction progresses, can reach any point in a 200-foot circle.

Circular construction is finding favour with school boards, too. When the round Hereford Township elementary school in rural Pennsylvania was completed in 1958 it attracted nation-wide attention. The school has one-third less corridor space than conventional school structures and cost \$100,000 less than a nearby school of similar capacity. It is constructed of curved concrete blocks, and has wedge-shaped classrooms with windows along the outside wall. The building's core is a dome-roofed, round area used as a school dining room and auditorium.

The Vista Mar elementary school in Daly City, California, completed the same year, also stresses compactness, an inward-directed plan, skilful technology and low cost. It is built in the form of a large ring surrounding a landscaped play area. The ring, of glass and concrete, contains thirteen classrooms and two kindergartens.

In Wheaton, Maryland, a three-storey round school has been designed to make maximum use of a small site. Though it is estimated the cost will be little different from that of a conventional structure, the circular design will bring libraries, conference rooms and other common facilities within easy reach of all classrooms.

Shown here is a Standard Oil Company of California service station at Los Angeles International Airport. The canopy reflects the circular lines of other buildings in the new jet-age airport complex. This type of round building, as can be seen from its lack of structural walls, is more economical than a conventional structure and offers a higher proportion of usable space. It can also afford a relief from straight lines and rectangular shapes.

A number of hospitals in the United States, as well as in some other countries, are adopting the circular principle for nursing units. Proponents of circular nursing wings say that a nurse stationed in the centre of the wing can easily see patients in the surrounding rooms and has only a comparatively short distance to walk to reach their bedsides. Some controversy has arisen however, as to whether these advantages remain in large nursing units, where there are from 40 to 50 beds, unless some variation is made in the circular design. Such variation might include, for instance, the use of segments of circles for intensive nursing care, in integral combination with rectangular forms for patients requiring intermediate care.

In 1957, the Mayo Clinic in Rochester, Minnesota, opened a 12-bed circular unit for patients requiring intensive nursing care. The experimental unit proved successful. The architects, Ellerbe and Company, of St Paul, Minnesota, have since incorporated circular nursing wings into 11 hospitals now under construction, or completed, in Minnesota, Missouri, Pennsylvania, Texas, Canada and Mexico. Among other architectural firms using the circular plan is Charles Luckman Associates of Los Angeles. This firm has designed circular hospitals and nursing wings, with rectangular surgery units, for towns in California.

The American Trust Company used a round design for its branch building on Market Street in San Francisco. The circular pattern, chosen to fit an irregular site, attracted attention to the glass and brick building and brought the bank many new customers. Another eye-catching, circular business structure is the Capitol Records Building in Hollywood, California.

Buckminster Fuller's geodesic domes have further increased the circle's usefulness. Spheroids built on structural principles he established are serving in numerous forms: auditoriums, exhibition halls, restaurants, barns, greenhouses, helicopter hangars, railway repair shops, warehouses and dwellings.

Circles also form the basis of Architect Orville Bauer's design for his own home. The site he selected was a wooded knoll overlooking the

(Continued on page 329)



A SUPER - TELEPHOTO LENS FOR YOUR 35 mm CAMERA

By M. L. Michaelis, M.A.

PHOTOGRAPHY enthusiasts who prefer the 35mm format will sooner or later purchase a good camera with interchangeable lenses, if they take their hobby at all seriously. The common "trio" of lenses for such a camera is the "normal" lens of 5cm focal length, a short-focus wide-angle lens of about 3.5cm focal length, and a telephoto lens of moderate power, with 13.5cm focal length. The present short article is intended for the owners of this trio, and may even encourage others who are still making up their minds about purchasing such equipment.

The enthusiast possessing this trio of lenses sooner or later toys with the idea of purchasing a long-distance lens of really long focal length, 40cm or more. He is usually put off by the tremendous price of such items, which normally run at about a hundred pounds or more. This was, in fact, the case for the author, and to solve the problem he hit upon the idea of combining the lenses of his existing trio, to make a very good super-telephoto lens. All that was required was the design and construction of a couple of simple intermediary-rings of suitable diameter, to enable the lenses to be screwed together at the correct distances from each other. This involved nothing more than sixpenceworth of aluminium piping, and a few hours work on a metalwork lathe—and saved a hundred pounds!

Principle

The principle of the method is as simple as it is cheap. The ordinary 13.5cm telephoto lens is used as the objective of a telescope arrangement to produce an image of distant objects in space, 13.5cm behind its principal plane. The wide-angle lens of 3.5cm focus, in combination with ordinary extension tubes, is used as an "eyepiece" to take an extreme-close-up photograph of the image produced by the telephoto lens. This arrangement multiplies the focal length of the telephoto lens by the magnification factor of the wide-angle arrangement. A factor of 4 is easily achievable, giving a final focal length in the region of 50cm.

This simple combination of telephoto and wide-angle lenses would limit the field of view to a small circle appearing in the centre of the final image on the film—i.e., the complete negative-area would not be utilised. The standard method of combating such "vignetting" in other optical instruments proved satisfactory here—namely, to place a suitable converging lens at the position of the space-image formed by the telephoto lens. This is called a "field lens" and must have such a focal length that it forms an image of the diaphragm of the telephoto lens at the same place as the diaphragm of the wide-angle lens. It need not be optically corrected as it contributes nothing to the actual

image formation. However, it is desirable to use a complex lens having no actual glass surface at the principal plane to avoid in-focus magnification of any dust particles or blemishes on that surface.

Upon making the calculations to determine the necessary focal length for this field lens the author came to the surprising result that 5cm is just about right, and this happens to be the focal length of the still unused "normal" lens! A practical trial thoroughly confirmed the truth of these calculations. Furthermore, the definition of the final super-telephoto images on the film is surprisingly good, and the final effective aperture was also found to be surprisingly high—i.e., the loss of light in



passing through the many glass elements of all three lenses in succession was found to be smaller than might be thought.

The *theoretical* aperture of the final combination is given by the stop number set on the telephoto lens multiplied by the multiplication factor achieved with the wide-angle lens. Thus, using the telephoto lens at $f/4$ and a multiplication factor of 4, the theoretical final aperture is $f/16$. The actual effective aperture obtained was $f/18.5$ —i.e., a loss of less than one stop number.

It will be seen that for snapshot work with this arrangement a film of high speed is indicated, particularly if stopping down to achieve better definition or depth of focus. A few experiments will soon show the individual reader the best method of working.

Viewfinder

Nothing other than a true single lens reflex camera is likely to prove usable as only this type of camera throws the actual image formed through the lens system on to a ground-glass screen. The angle of view of this long-focus system is so narrow that any other form of viewfinder is likely to be much too inaccurate. Probably something utterly different from what was seen in such a viewfinder will actually have been photographed! Cameras with only partially interchangeable lenses—i.e., front cell only, are unsuitable. The lens must be *totally* removable and replaceable by a complete other lens.

The single lens reflex camera is also the only practical solution to the problem of focusing with this arrangement. Although efforts should be made to dimension the rings so that the existing distance scale on the front telephoto lens still holds true, as will be shown below, one should not rely on this. Accurate focusing is necessary, viewing the reflex image through the (normally) built-in magnifying glass.

Using the lens

Any arrangement with very long focal length is prone to give pictures blurred by movement of the camera if exposures longer than, at the most, a two-hundredth of a second are attempted without a firm tripod. A really good tripod naturally allows good results for any length of exposure and thus permits even night work with this arrangement.

If blurred pictures result with this arrangement these are more likely to be due to camera shake than

poor performance of the combination. It may help to fit a tripod socket on one of the rings or tubes to get closer to the centre of gravity. This will be dependent upon the relative weights of the lenses and the camera body.

The wide-angle lens, next to the camera, should be set at "infinity" and operated at full aperture at all times (this must be at least $f/4.5$). The normal lens used as the field lens must also be operated at full aperture, which in this case must be not less than $f/2.8$, and should be set to infinity, too. The aperture control on the telephoto lens should be used for setting the actual effective stop number and the focusing should be carried out with the distance setting ring on the telephoto lens. The existing calibrations should be quite accurate still, though the effective stop will be the actual stop set on the telephoto, times the magnification factor of the wide-angle set-up.

Maximum aperture of the field lens

The diagonal of a 35mm negative is 5cm. If M is the magnification factor used, then the diagonal of the effective part of the first image, which will fall on the stop of the field lens, is $5/M$ cm. But by definition, the stop diameter of an aperture of f /number S of a lens of focal length 5cm is also given by $5/S$. Thus the f /number of the field lens dictates the smallest magnification usable without shading off parts of the film negative area. Thus for a magnification of 4, as here proposed, the field lens could at a pinch be operated at $f/4$. But this was found to cut matters too close. Although detail was still present in the corners of the negative the light intensity had fallen considerably. The next largest stop, $f/2.8$, gave good results even when a magnification factor of only 3 was used, giving a final focal length of about 33cm and an effective final aperture of $f/11$ at maximum aperture on the telephoto.

The author uses a Praktika FX2 camera and the following lenses: Meyer Primagon 1:4.5/35, Zeiss Tessar 1:2.8/50, Zeiss Sonnar 1:4/13.5cm.

Making the rings

Two standard 5cm extension tubes, having suitable threads to match the camera and lenses to be used, should be fitted directly to the camera body. The wide-angle lens should be screwed directly into these. The "normal" lens, to be used as field lens, should then be held in a suitable

(Continued on page 329)

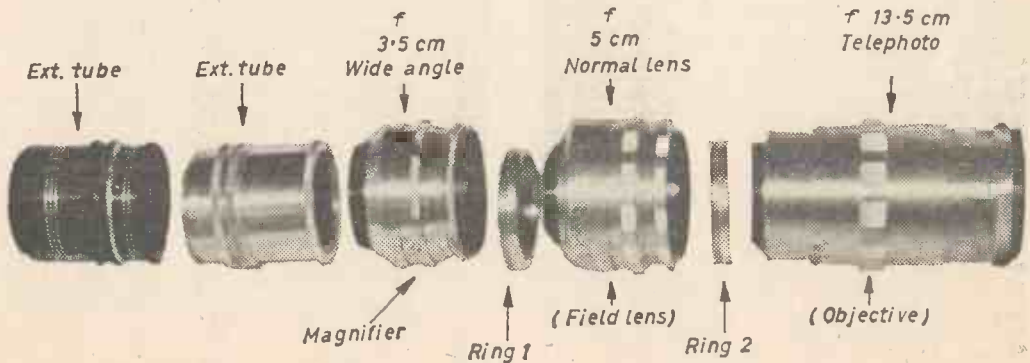



DURING the years 1935-39, Luton Aircraft Ltd. designed and built no less than five types of light aircraft. The company having developed from the Dunstable Sailplane Co. it was perhaps natural that the first aircraft should have been evolved from the high-efficiency sailplane formula: the Luton "Buzzard" had tapered wings of very high aspect ratio (10.9), an oval stressed-skin fuselage and pusher airscrew, the engine being mounted behind the pilot's cockpit. Split landing flaps—a novel feature in 1935—were also incorporated. The later Mark II "Buzzard" coupe had the span shortened from 40 to 35½ft and the pilot was housed in an enclosed cabin.

The Luton "Minor", which first flew in 1936—just 26 years ago—was an immediate success and during the next two or three years examples were built by amateurs all over the world. In one instance an enthusiast taught himself to fly with a Luton "Minor" of his own construction—a procedure, however, that is illegal and certainly not to be recommended! PRACTICAL MECHANICS published a series of articles containing plans and details of construction and it is of interest to note that some building continued through and after the war with the aid of these articles.

As readers of PRACTICAL MECHANICS are aware, the design of the Luton "Minor" was brought up-to-date by Phoenix Aircraft Ltd., successors to Luton Aircraft Ltd., and the design was featured in these pages from Sept. 1959 to August 1960. The "Minor" is now accredited as one of the finest single-seat amateur aeroplanes in Europe and the easiest to build.

The "Major"

The successful advent of the pre-war "Minor" led to a demand for a two-seater, having similar flying and safety characteristics. Thus the Luton "Major" was produced to fulfil the requirements of private owners, flying cubs and the Civil Air Guard. The "Major", a high-wing monoplane, was provided with an enclosed cabin, full dual control and folding wings: the power unit chosen was the Walter Mikron II of 62 h.p., although the prototype had a Mikron I of only 55 h.p. installed.

The first flight of the Luton "Major" took place at Denham Aerodrome early in 1939, piloted by Sqdn. Ldr. (now Group Capt. ret.) E. L. Mole, of the R.A.F. Staff College. In writing to congratulate the makers shortly afterwards, S./L. Mole said "It's really remarkably clever to have it just right at its first trials." The report on the initial performance and handling trials is of considerable interest and is given on the next page.

The R.A.F. 48 aerofoil section, used on the "Minor", was again chosen for its high maximum lift coefficient (low landing speed) and particularly for the smooth top to the lift curve, which results in gentle stalling characteristics. By retaining the chord of the "Minor" wing (5ft 3in.) and obtaining the additional wing area by an increase of span, a higher aspect ratio resulted, with a reduction of induced drag and improved performance. The "Minor" wing-tip plan shape, also chosen for good behaviour at the stall, was repeated on the "Major". Shrouded ailerons (now modified to slotted) with differential control, provided additional improved features.

The wings are of conventional two-spar type, the front spar being a simple built-up 'T' beam, with a ply shear web supporting upper and lower pairs of spruce booms. The rear spar, of broad 'U' section, employs single spruce boom members top and bottom. The leading-edge of the wing is plywood covered, both for increased aerodynamic efficiency and for increased stiffness, the whole wing being fabric covered. Each half wing is supported by two streamline-section lift struts, which come together at the lower end to form a 'V', the struts being supported at mid-length by small vertical struts to the main spars together with a light connecting member. This shortening of the effective strut lengths permits the use of much lighter tubing, besides giving rigidity to the whole unit. Each wing hinges about the rear spar attachment

point and the lift strut apex, there being a slight rise to the trailing-edge over the inboard section to allow the wing to pass over the top of the fuselage. Wing folding is achieved by withdrawal of a locking pin at the root end of each front spar, enabling the "Major" to be housed in a large garage. Alternatively, removal of three bolts allows each wing to be dismantled.

The tail unit is of simple construction and incorporates an elevator trimming tab which is adjustable in flight. The undercarriage is of the split-axle type, allowing the wheels to splay outward as well as upward under landing loads, each half axle being provided with special shock-absorbing and rebound compression rubbers, housed in a neat fairing. Brakes may be incorporated in the main wheels and a steerable, sprung tail-wheel is fitted.

PERFORMANCE TRIALS

DENHAM AERODROME

Maximum speed	101 at 2,600 r.p.m.*	} 200 ft above aerodrome
Speed at cruising r.p.m.	97 m.p.h. at 2,550 r.p.m.	
Climb from ground level	0-1,000 ft 1 min 35 sec	} at 60 m.p.h., full throttle, 2,300 r.p.m.
	0-2,000 ft 4 min 5 sec	
	0-3,000 ft 6 min 35 sec	
	40 m.p.h. indicated.	
Stalling speed	(a) Normal: 50°C.	
Oil temperature	(b) After 6½ min. climb at full throttle, 55°C.	
Aileron control	Light and effective, but pilot's control movement might be reduced for comfort.	
Elevator control	Light and sensitive. Excellent feel.	
Rudder control	Very effective.	
Synchronisation of controls	Aileron and elevator about equally light: rudder rather heavier—advantageous.	
Take-off and initial climb	Excellent: quite surprising for such a low-powered engine.	
Behaviour at stall	Viceless: aircraft sinks on even keel. No tendency to drop a wing.	
Flight stability	Unusually good. The aircraft flew 'hands and feet off' quite easily and quickly regained level flight after any air disturbance.	
Vibration	Very slight. Cabin reasonably quiet.	
Visibility	(a) Taxiing: excellent, except directly forward with tail down.	
	(b) In flight: excellent in all directions: a remarkably good feature.	
General	The aircraft is extremely easy to fly and takes off and lands remarkably slowly. It is very comfortable in flight and possesses unusually good visibility, which makes navigation easy and should create great confidence and a feeling of safety to pilots.	

* Note: Maximum engine speed is 2,800 r.p.m. If the airscrew pitch was slightly modified to allow full engine power to be used, the top speed would be in the neighbourhood of 105 m.p.h.

LUTON MAJOR

SPECIFICATION

Span	35 ft 2 in.
Span, folded	11 ft 8 in.
Length	23 ft 9 in.
Wing area	163 sq. ft
Weight, empty	600 lb
Weight, all-up	1100 lb
Useful load	480 lb
Fuel capacity	11 gal

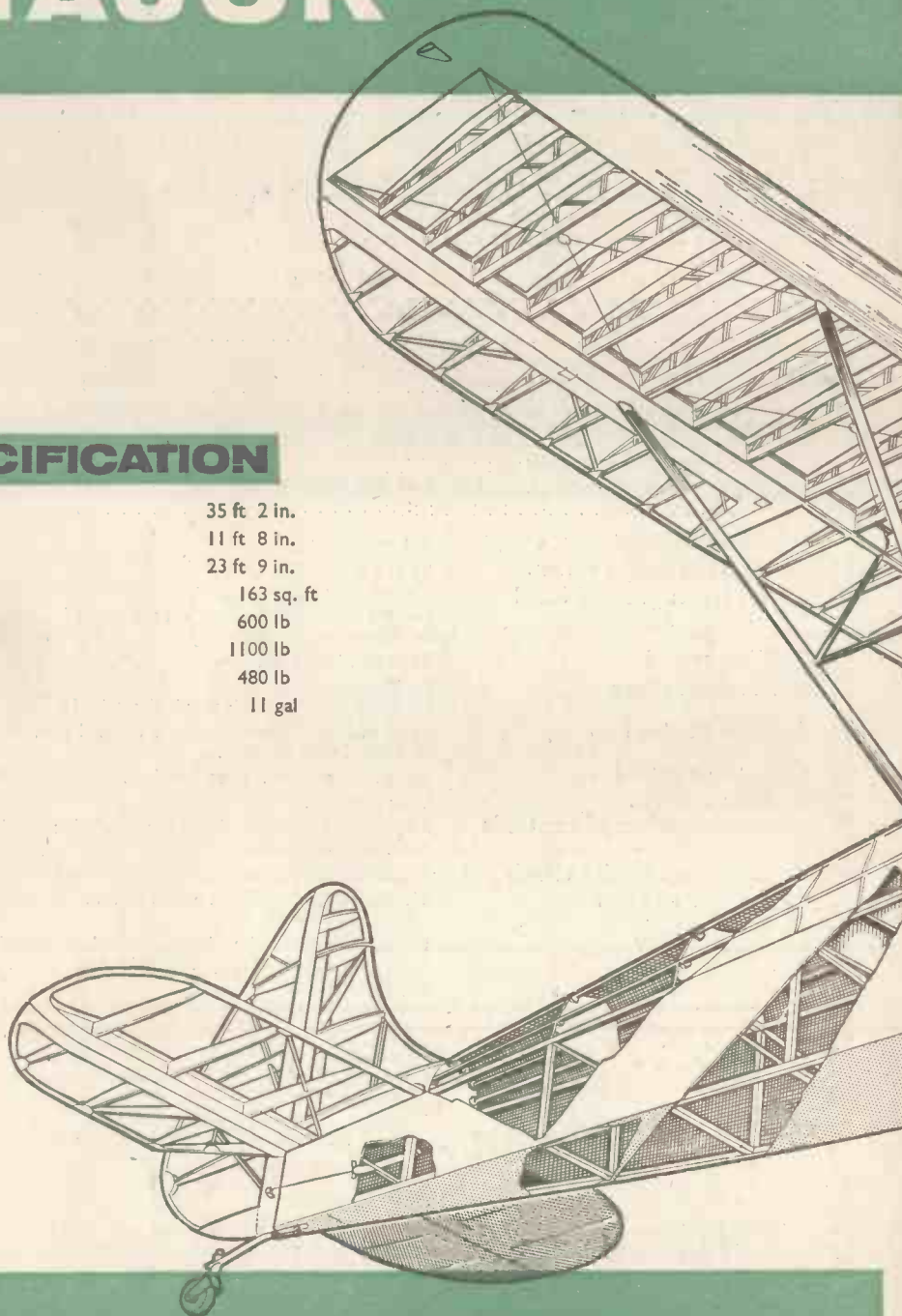



by Phoenix Aircraft Limited

PERFORMANCE

	60 h.p.	80 h.p.		60 h.p.	80 h.p.
Max. speed	105	115 m.p.h.	Distance to 50ft screen	720	560 yd
Cruising speed	95	104 m.p.h.	Range, still air	300	300 miles
Stalling speed	35	35 m.p.h.	Take-off run	87	68 yd
Initial climb	700	1,240 ft/min	Landing run	50	50 yd

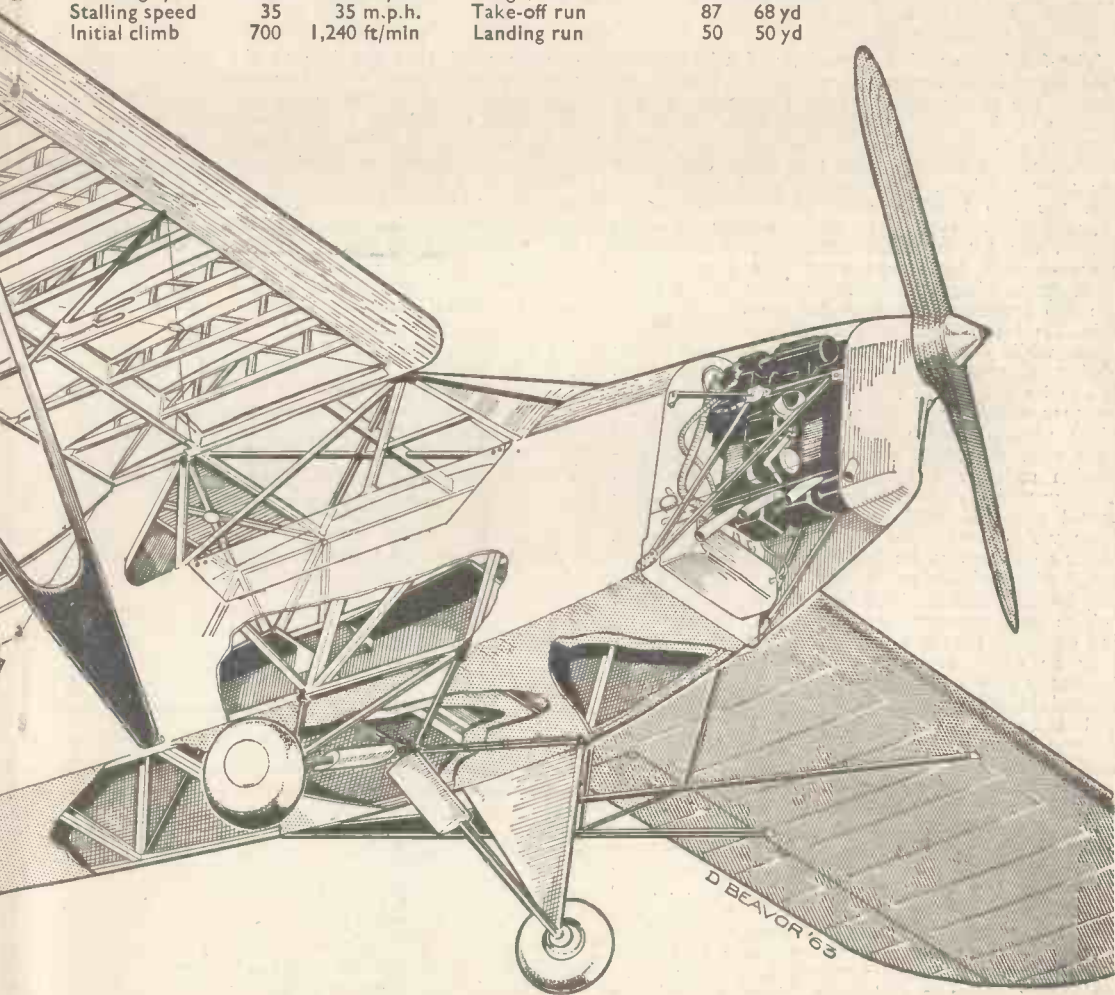

The range can be increased by fitting overload tanks in the wing. The excellent short-field performance enables use to be made of small fields for take-off and landing.



The fuselage consists essentially of a box structure comprising longerons and cross bracing in spruce, the whole being plywood covered. In the vicinity of the cabin the fuselage sides extend to wing height, finishing off at the rear with a neat fairing, which merges with the turtle deck over the after fuselage. Five simple steel cross tubes link the two fuselage sides at points of stress concentration, viz, the undercarriage pick-up points, the lift strut attachments and the cabin centre-section front and rear spar attachments. Split doors, hinged horizontally and meeting along the top longeron, are provided on the starboard side, the lower door opening outward and downward, while the upper door hinges upward to the horizontal position, immediately under the wing. It can be clipped in this position for flight in hot weather conditions. Glazing consists of a one-piece wrap-around windscreen and is continued back over the cabin top to the rear spar centre-section member and also along the cabin sides. This provides excellent visibility through a horizontal angle of 320° and also vertically, as was favourably commented upon in the test report. Draw curtains may be fitted to avoid sun-glare. A small direct-vision panel, for bad weather flying and landing, can be fitted in the port side window.

The seat supports together with the main flying controls, take the form of a single box, which may be easily removed as a unit for servicing. Normally flown solo from the front seat, the dual controls enable the "Major" to be used for club and instructional work, whilst the rear control column is removable for joy-riding and touring if desired.

The flight characteristics are covered in the test pilot's report and may perhaps be summed up by the account given in "Flight" after a trial flight by their pilot. "The maker's object in providing good flying qualities rather than sheer performance has certainly been achieved . . . the behaviour at the stall is completely without vice and, unless the machine is pulled up sharply from a reasonable speed, it is not possible to stall it fully. At an indicated airspeed between 40 and 45 m.p.h., there is still some lateral control and there is absolutely no tendency for a wing to drop: the machine simply sits squarely in the sky and does not even drop its nose to any marked extent. The take-off is remarkably good and, remembering the good stalling characteristics, the machine can be made to fly just as soon as the elevators

can be used to force it into the air. The all-round view is good: there is plenty of head room. The ailerons are differentially operated and consequently very little rudder correction is necessary, even when using full lateral control. With ample rudder area a sideslip can be held quite steeply at a reasonably slow speed". In another test, the "Major" was flown throttled right back at about 40 m.p.h., hands off, and it was found that although a certain amount of wallowing took place at this slow speed, the aeroplane could be flown almost indefinitely and continued harmlessly on its course, free from dangerous tendencies.

Perhaps one further pre-war incident, illustrating the "Major's" docile flying qualities, may be related. Mr. A. J. Payne had attended a flying display at Bristol and, due to a mishap, one of the aileron control levers was severed, thus putting the circuit out of action. Heedless of sound advice, the pilot decided to risk the return journey to Denham, devoid aileron control! He covered the

(Continued on page 323)

A nearly complete Luton "Major" cockpit built by Mr. W. G. Cooper of Weybridge.



An electric LAWNMOWER

BY E. R. EVANS

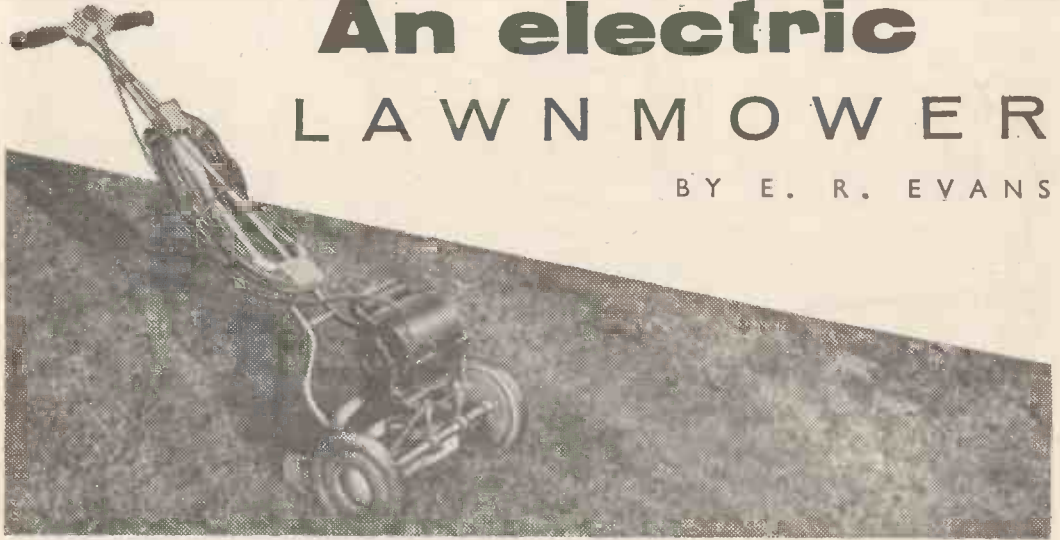

AROUND many homes one of the most time consuming of the chores that eat into the leisure hours of the male member of the household is undoubtedly mowing the lawn. With a hand mower this task can in many instances take a whole afternoon to carry out. The fitting of an electric motor suitably attached to the mower will eliminate a lot of the hard work and at the same time produce a better finish and a considerable saving of time.

In a recent issue of *PRACTICAL MECHANICS* details were given for converting a roller-type mower to power drive. But this article shows how the slightly poorer relation, the side-wheel mower, can at a modest cost and with a little trouble, be similarly powered. The details given are applicable to the Qualcast B1 model but there is no reason why other makes and models could not be similarly adapted. In order to illustrate the advantages and capabilities of the power assisted mower a test was recently carried out in which the grass was first allowed to grow to a height of 2-3in. Selecting a day when ground conditions were quite wet, and amid protests from the head gardener (the missus), the lawn was mown without leaving any trace of surface damage whatsoever.

Before starting the modifications the reader is advised to inspect the cutting cylinder and sole plate and decide whether or not sharpening would be beneficial. Also check the phosphor bronze shaft bushes for wear and renew if necessary. Being satisfied on these points, proceed to dismantle the mower. Remove the handles and prise off the hub caps with a screwdriver. Remove the split pins and withdraw the side wheels. The small pinions and driving dogs now exposed are not used in the converted mower and should be removed and discarded. The removal of the bolts at each end of the sole plate and round tie bar then allows the mower to be completely dismantled.

The motor

The most suitable type of motor to power the mower is one having a rating of $\frac{1}{4}$ or $\frac{1}{2}$ h.p. and running at 1,425 r.p.m., turning anti-clockwise

when viewed from the shaft end. With the size of pulleys specified the cutting cylinder revolves at approximately 700 r.p.m., which is about 50% faster than the speed usually obtained by hand mowing. Several advertisers offer suitable motors for as little as £3 each. The writer uses a motor that also powers a combination lathe and circular saw unit between times, the changeover from one to another only taking about ten minutes as the motor mount was designed specially with this in mind.

Constructional details

With all the necessary materials at hand commence with the modifications to the cutting cylinder. Select the end where the spider lugs are bent inwards, i.e. away from the face to which the pulley will be fixed, thus providing a flat mounting surface, and using a hacksaw, preferably fitted with a high-speed blade, cut off the projecting blades flush with the spider plate. Start sawing from the inner edge of the blade and saw to within $\frac{1}{8}$ in. of the cutting edge, then grip the projecting end with a pair of pliers and break it off. File off all saw marks and rough edges, using a fine carborundum stone on the hardened cutting edges.

Mount the 4in. pulley in the lathe three-jaw chuck and machine off the boss flush with the pulley disc. Bore out the centre to $1\frac{1}{4}$ in. diameter to clear the side plate bush housings. Before removing the pulley from the chuck scribe a $\frac{1}{8}$ in. radius circle with a pointed tool and divide into three equal parts. Drill $\frac{1}{4}$ in. diameter countersunk holes in these positions (Figs. 1 and 2) for the fixing bolts. To ensure smooth running it is essential that the pulley is fitted concentrically with the spindle. To achieve this a hollow cylinder should be turned in metal or hardwood to be a sliding fit over the spindle and inside the hole in the pulley. Hold the pulley in position against the spider plate with a G clamp, drill one $\frac{1}{4}$ in. diameter hole through and lightly bolt up. The remaining bolt holes can now be drilled. Metal spacers or washers should be fitted between the pulley and the spider to prevent distortion of the pulley rim

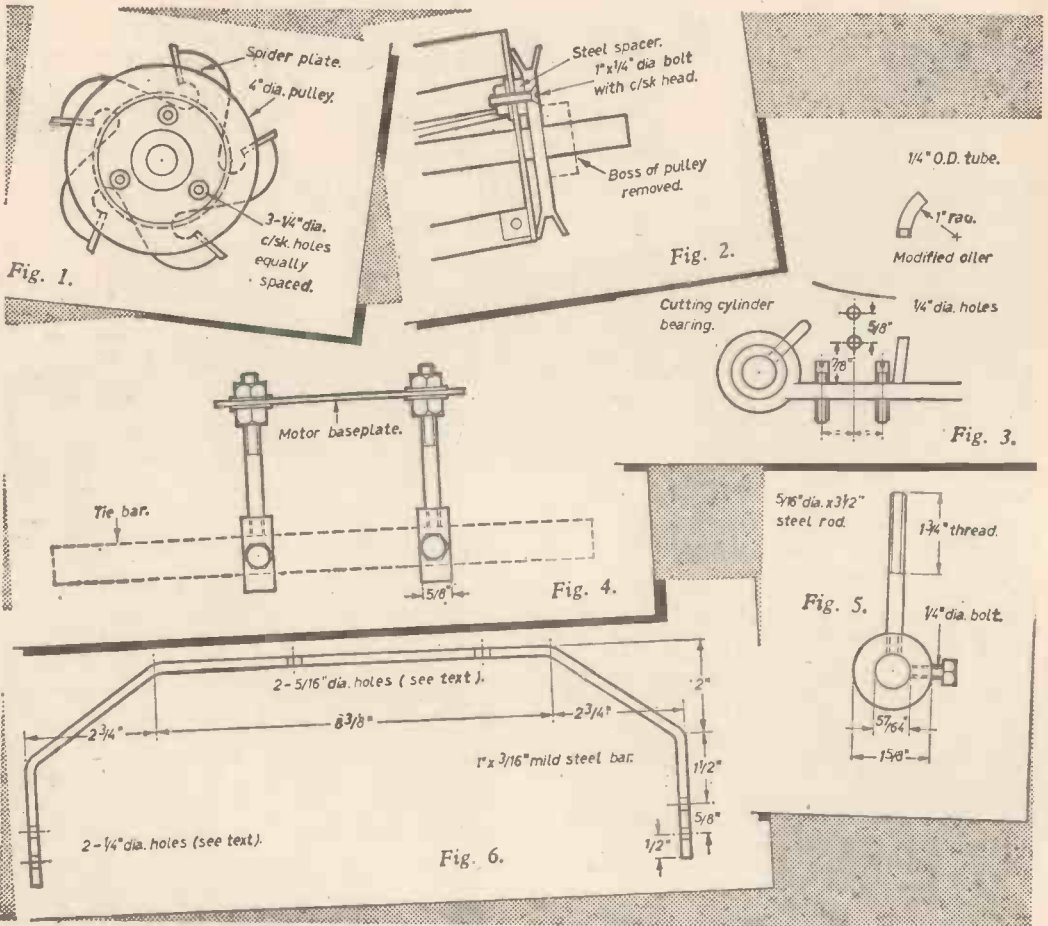

when the fixing bolts are finally tightened and to make sure the pulley is in alignment. Check that the pulley runs truly.

Drill two 1/4 in. diameter holes through each side plate on a line passing centrally between the adjusting screws as shown in Fig. 3. These are for fixing the rear motor support bracket. The reader is advised to construct the improved lubricator shown in Fig. 3 which consists of a 3/8 in. length of 1/4 in. diameter o.d. bent metal tube threaded into a hole tapped through the original oil hole. This arrangement ensures an adequate supply of lubricating oil to the phosphor bronze bushes. This is important as the cylinder will be turning faster.

The front supports for the motor should be made from two 3/8 in. bore mild steel shaft collars, reamed or bored out to approximately 1 1/8 in. to fit the tubular tie bar. Substitute hexagon-head bolts for the original grub screws and drill and tap an additional hole in each for the 1/8 in. diameter motor support rods shown in Figs. 4 and 5. Alternatively the collars can be turned up on the lathe from a length of 1 1/4 in. diameter mild steel bar.

The 1/8 in. diameter threaded motor support rods could well be made from 3 1/2 in. lengths of mild steel studding, in which case a locknut must be provided at the collar ends. Each rod should be fitted with

two nuts and washers to provide height adjustment of the motor. The rear motor support bracket should be made from a 1 in. x 8 1/2 in. length of 1 in. x 1/8 in. mild steel flat bar bent to the dimensions shown in Fig. 6. Drill one 1/4 in. diameter hole each

MATERIALS REQUIRED

- 1/4 or 3/8 h.p. 1,425 r.p.m. single-phase motor, clockwise rotation.
- 2 in. and 4 in. "Picador" pulleys or similar.
- A25 rubber Vee-belt.
- Two 3/8 in. bore mild steel shaft collars.
- Two 3 1/2 in. x 1/8 in. diameter threaded rods or studding, nuts and washers.
- Three c/sk bolts 1 in. x 1/4 in., nuts and washers.
- Two 1 1/2 in. x 1/8 in. hexagon bolts, nuts and washers.
- 5 in. x 3 1/2 in. x 1/8 in. aluminium alloy sheet.
- 20 1/2 in. of 1 in. x 1 in. x 1/4 in. alloy angle.
- Length of 7/029 three-core rubber or p.v.c. covered cable.
- Three-pin 5A double-pole switch socket and plug.

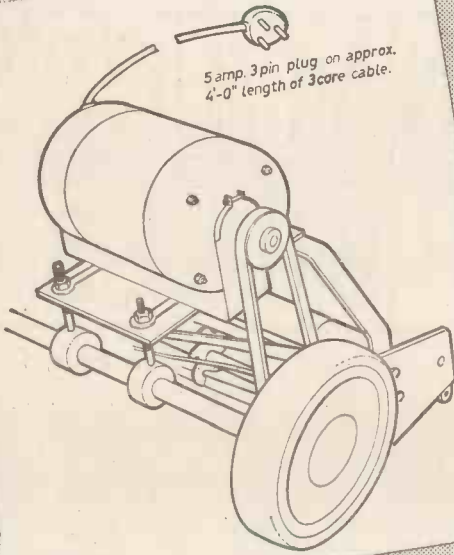

Fig. 7.

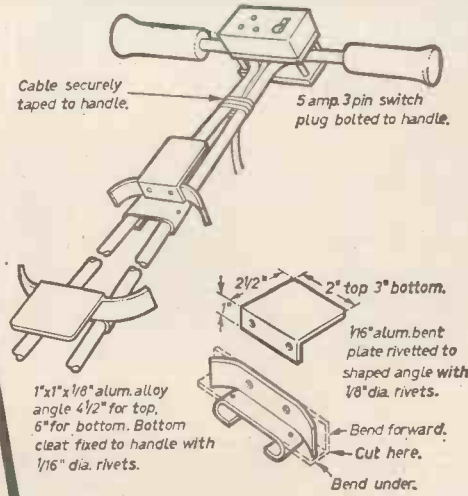

Fig. 8.

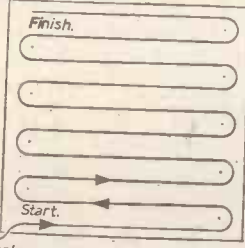

Fig. 9.

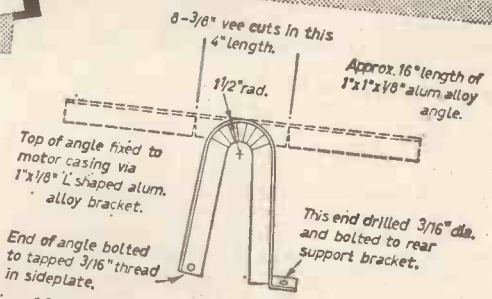

Fig. 10.

side, located 1 1/2 in. from the ends. The remaining holes are drilled later.

The mower should now be reassembled as shown in Fig. 7, not forgetting to slip the Vee-belt over the 4 in. pulley before fitting the adjacent sideplate! Also it may be found necessary to fit one or two steel washers over the spindle to provide clearance between the pulley and bearing adjustment screws. A similar thickness of washers must then be interposed between the sole plate and the side plate before inserting the fixing bolt.

With the additional parts lightly bolted in position sit the motor in place, slip the Vee-belt over the 2 in. pulley and bring the two pulleys into alignment. At the same time adjust the front and rear motor supports so that the driving belt clears all parts of the mower.

When everything appears to be shipshape mark the positions for the rear motor holding-down bolts. Remove the motor, drill two 1/2 in. diameter holes to take the bolts and drill the second 1/2 in. diameter hole at the bottom of each support bracket. A belt guard should be made from a piece of 1 in. x 1 in. x 1/2 in. aluminium alloy angle approximately 16 in. long. It should be attached to the motor with L-shaped metal brackets and to the side plate and rear support bracket as shown in Fig. 10. The

dimension will vary with the type of motor used.

With the mechanical work now complete it is worth while considering dismantling the main parts and applying a protective coat or two of paint.

Electrical details

The reader is urged to use good quality electrical fittings and cable in the interests of safety. ON NO ACCOUNT SHOULD A TWO-WIRE SYSTEM BE USED, A PROPERLY EARTHED CONNECTION IS ESSENTIAL.

The mains lead should be 7/029 three-core rubber or p.v.c. covered cable in one length sufficient to reach to the furthestmost point of the grass without splices or connectors. It should be fitted with a three-pin plug to suit the power supply point, whilst the mower end should terminate in a three-pin 5A double-pole switch socket bolted to the handle as Fig. 8. The switch socket used by the writer was provided with fixing holes in diagonally opposite corners. Two pieces of 1/2 in. thick bakelite were cut to the same size as the switch. Long bolts were passed through the switch fixing holes and through corresponding holes in the bakelite plates. Shorter countersunk head bolts were passed through holes in the other two corners

(Continued on page 333)



By J. F. Rowlands, Ph.C.

JOHAN NAPIER, Laird of Murduston, lived in the reign of James I some three centuries ago—an age when crossing the Atlantic presented the same hazard as crossing space to the moon does to us today. A fairly satisfactory method of astro-navigation had been perfected but the chief difficulty was that many practical sailors had not the education to cope with the mathematical calculations and usually relied on instincts and experience to guide them—so often with disastrous results. In fact the only people with any education as we know it were the wealthy, and many of them confined their learning to ecclesiastical matters and not to the pressing material problems of the time. Napier, however, although intended to enter the ministry, became involved with more down-to-earth problems in the running of his estate and his attention was drawn to the complete lack of arith-metical knowledge amongst those who in their work needed it most. As a result of his application to the problem he devised four methods of making calculation simpler and less liable to error.

First the Chequerboard, then his "Bones" and later an elaboration of these, and finally the Logarithm Tables. Only the last seems to have survived and it is difficult to see how we could manage without them today, although the calculator could possibly have replaced them.

The "Bones" or Rods, as Napier called them, are not difficult to make and are extremely interesting and in a limited way quite useful. All that is needed is about 4ft of $\frac{3}{8}$ in. square wood (I used balsa, but hardwood would be better), a sheet of drawing paper 7in. x $7\frac{1}{2}$ in., glue, ink and if possible, access to a drawing board and T square.

Cut ten pieces of $\frac{3}{8}$ in. square wood into $3\frac{1}{2}$ in. lengths, preferably using a mitre block and gauge to make them neat and square. Next mark off the drawing paper as shown, taking great care to keep it truly square at all angles. Use waterproof ink and a ruling pen set for broad lines for the dark lines and set at fine for the others. Rule off as shown into $\frac{3}{8}$ in. squares (you could use $\frac{1}{2}$ in. squared graph paper if you wish to save trouble—most stationers stock it in foolscap size) and then draw in the diagonals as shown and the numbers exactly as in the diagram. Starting with the four columns in the top left-hand corner headed 0, 1, 9, 8 fill in the numbers as shown in Fig. 1. You will observe that these numbers are a multiplication table starting at two times and ending at nine times, the

unit figure being in the bottom right and the tens figure in the top left of each small square.

Having completed all the diagrams in a similar manner by writing in the appropriate multiplication tables it is necessary to cut the sheet into ten rectangles each $1\frac{1}{2}$ in. x $3\frac{1}{2}$ in. (Fig. 3). I use a steel rule and a sharp knife; scissors could be used but not so neatly. Fold each piece along the vertical lines and glue them round the $3\frac{1}{2}$ in. lengths of wood. Use the adhesive sparingly but right up to the edge and press them down, using a piece of clean paper to avoid marking them with your fingers. One or two coats of thin size and a coat of cellulose lacquer would improve the final product.

A tray to hold the rods is needed. This is simply a piece of thin plywood or thick cardboard, $3\frac{1}{2}$ in. x $4\frac{3}{8}$ in., with pieces

		0	1	9	8
2 X →	0	0	2	1	8
3 X →	0	0	3	2	7
4 X →	0	0	4	3	6
5 X →	0	0	5	4	5
6 X →	0	0	6	5	4
7 X →	0	0	7	6	3
8 X →	0	0	8	7	2
9 X →	0	0	9	8	1

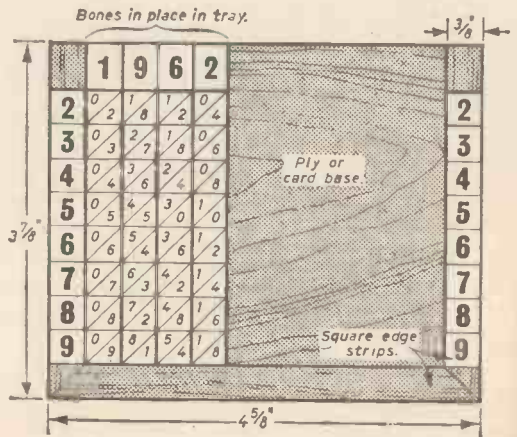

of $\frac{1}{2}$ in. square material glued to three sides as shown. The side numbers are written on a piece of ruled paper and glued to the side pieces.

Suppose that we want to multiply 1962 by 365, quite a formidable sum to one not used to arithmetic! First remove all the rods except the four bearing at the top the numbers 1, 9, 6 and 2. It helps in selection to remember that opposite sides of the rods always add up to 9, so if you see a 4 you know that 5 is on the back. Arrange these as shown in Fig. 2 and now concentrate on the numbers in the horizontal line opposite 3 on the tray edge.

Starting with the extreme right-hand figure, which is 6, write this down on a piece of paper. Now mentally add the figure in the top left half of the square (0 in fact) to the figure in the bottom right of the next square (8) and write down the sum of the two to the left of the 6. Then continue adding top left to bottom right and writing down the totals till the left-hand rod is reached.

$$\begin{array}{cccc} 5 & 8 & 8 & 6 \\ (3+2) & (7+1) & (8+0) & \end{array}$$

Now write down the figure on the extreme right of row 6, the second figure of the number we are multiplying by, not under the 6 of 5886 but one space to the right. Add top left to bottom right all the way along as before and write down the sums (the figures in brackets are only inserted here to make the working clear and need not be put down when actually working the sum).

$$\begin{array}{cccccc} 5 & 8 & 8 & 6 & & \\ 1 & 1 & 7 & 7 & 2 & \\ & (6+5) & (3+4) & (1+6) & & \end{array}$$

Note that 6+5 in the last diagonal addition=11, so write down 1 and carry 1 into the next column.

Repeat the procedure along row 5, again starting one place to the right of the number above.

You should now have:

$$\begin{array}{r} 5886 \\ \text{add } 11772 \\ \hline 9810 \end{array}$$

716130 the answer!

I find that I can compete favourably, but with much more ease and accuracy, with someone who multiplies it out by the normal method. Mainly because I have no need to know the multiplication tables and until the final addition, I never have to carry more than 1. The two great pitfalls in large multiplication are thus removed.

Quite astronomical numbers can be handled, as the only limitation with this set of "Bones" is that the smaller number must not exceed ten figures (nine thousand million) and must not have the same figure more than three times. A larger set could handle even larger numbers if needed! The size of the larger number is limited only by the size of paper on hand since these figures are taken one at a time from the sides of the tray.

The apparatus has little practical application these days except that, as Napier remarked, it might stimulate an interest in subjects mathematical. In its day, when there was no competition from mechanical and electronic devices, few people had the advantages of even the most primitive schooling, and it was a definite step forward in the direction of accuracy. Few people today have heard of "Napier's Bones", so called, I presume, because the first models were made of ivory or bone, and fewer still know exactly what they were.

Fig. 1 (Left).—One bone "unfolded". Note that each column is the multiplication table for the figure in the top rectangle.

Fig. 2 (Bottom left).—The bones in their tray, set up for the example worked in the text.

Fig. 3 (Right).—The complete grid for making a set of Napier's Bones. This should be cut where shown to make ten bones.

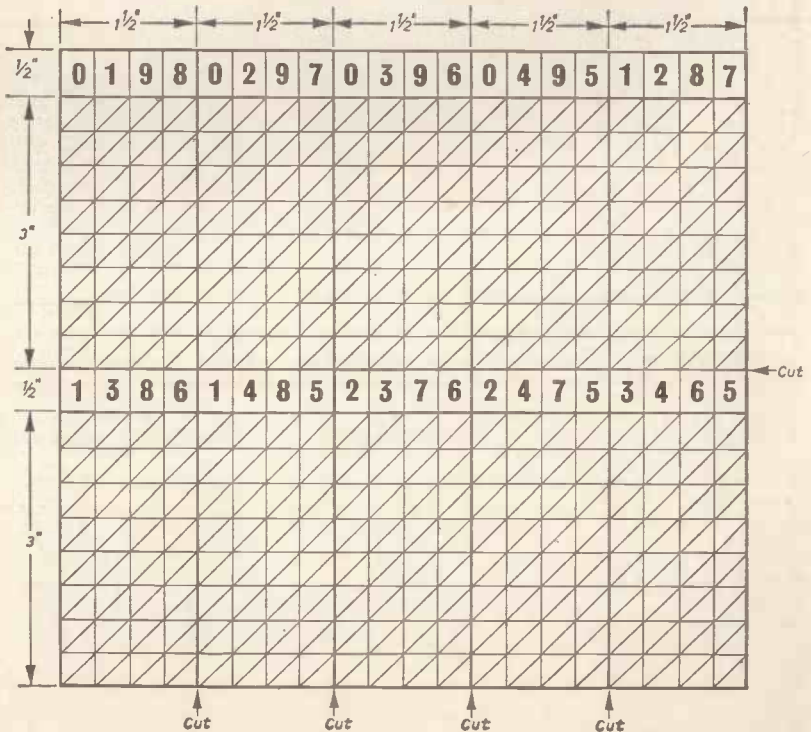

Novel Electrical Game

THIS game is a combination of chance and skill and is for two players. At first sight there may seem to be little opportunity for the exercise of skill, but it will become apparent that the course of the game is in fact considerably influenced by the individual player's placing of score flags and by his subsequent moves in getting these back to score.

The board upon which the game is played should be square with the two players at right-angles to each other at the South and West sides as in Fig. 1. Each player has a control board equipped with three switches which can be closed by slight pressure. These should be held so that neither player can see his opponent's switches or know in advance which switch is depressed.

The board has nine bulbs, wired as in Fig. 2, current being supplied by a 1.5V dry cell. South can complete the circuit to the sections running vertically from him marked 1, 2 and 3 in Fig. 1. In the same way West can select any line of bulbs running at right-angles to those connected to South's control board. The lamps are so wired that the one which lights is that where the section selected by South crosses that selected by West. For example, if South presses his centre switch and West his left switch, lamp 2 lights (that is, the lamp where South section 2 and West section 1 cross). Similarly West section 2 switch and South section 2 switch would light bulb 5. West 3 and South 1 would light bulb 7 and so on. The lamps do not light until both switches are depressed. If South plays first, West does not know which of his sections South has chosen until he (West) depresses his own switch. Similarly when West plays first, South does not know in advance which section West has chosen.

Each player has nine flags with scores as shown in Fig. 3. Each places one flag on each of the nine squares of the board, positioning them so that his opponent cannot observe the score or wording. After placing the flags on the board the players make their moves alternately. Assume South presses his centre switch (section 2) and West also decides to press his centre switch (section 2), then bulb 5 lights. The wording on both flags on this square is then shown and the player winning the move takes both flags. This continues until the board is cleared, when each player totals up the flags in his possession. The higher score wins or a total can be made over a number of games.

The scores obtained at each move will depend on the placing of the flags. For example, if South's land mine should destroy West's general headquarters South will have increased his own score by 50, but if South's land mine only took West's sniper only 5 would be gained. Again, if West's fuel dump were situated in the same square as

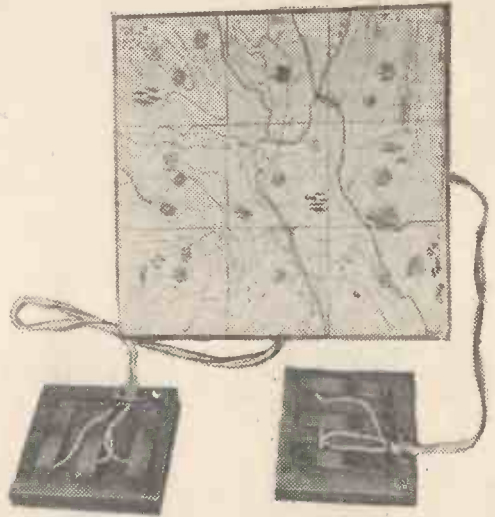

The completed board.

South's spy hideout West would gain 40 (25 plus 15) on that move, but if the fuel dump were located with the enemy's important signals station South would gain 55 (30 plus 25) on the move. If flags of the same score occupy a square the first player of that particular move takes both. For example, if West selects section 1 and South then selects section 3, lamp 3 will light, and if both snipers occupy square 3 it is assumed West's sniper was first, so West gains 10 (5 plus 5).

Individual choice is exercised in setting out the flags. For example, if South places his land mine, sniper and anti-personnel bomb along the three squares of his section 1 it is apparent that he can choose this section at any time with a good chance of gaining a score or only losing insignificantly. As some flags are removed it will also become apparent what opponent's flags are left on the board.

Construction

The actual size of the board is of little importance but a board about 9in. x 9in. is convenient. This can be hardboard or three-ply with 1in. strips as sides to clear wiring and leave accommodation for the dry battery, which should be held by a metal clip. A section of an old, unwanted map should be cut to suit the board or a map can be drawn for this purpose. A sheet of any thin transparent material over the top will avoid fingermarks.

Holders are not required for the bulbs, which should be of 2.5V, 0.3A rating (ordinary torch bulbs), and are a push fit in holes in the board. Fig. 4 shows the underside. To join the screw caps and hold the bulbs securely 20s.w.g. or similar bare wire should be twisted tightly round them. Soldering is not necessary here. The wires to the tips of the bulbs must be soldered on, however. Thin flex, such as flexible bell wire, should be used for the cables between the game board and control boards. The flex should be twisted to make a four-way cable and passed through the holes at the South and West edges of the board. Fig. 5 shows one control switch board; two are necessary. As regards working there is nothing to choose between using ready-made push switches or making simple contacts from scrap metal as shown. Fig. 2 shows the complete wiring of the board.

The flags can each be about 1in. square. Each set should be painted a distinctive colour so that

they can be quickly sorted at the end of a game. Various possible ways of making the flags are shown in Fig. 6. The simplest type can be cut from cardboard. Better flags can be made from thin wood, coloured perspex or similar material. The metal flags are readily cut from thin aluminium and should be slightly curved so that they stand upright. The pin-type flags can be quickly made from thin card and wire.

As current is only drawn intermittently the dry battery will have a long life. It is worth testing each bulb with the battery before fitting it. If 3.5V bulbs are to hand a 3V (two-cell) battery can be used. All the bulbs should be of the same current rating, such as 0.3A, or others along the same row will tend to glow. If a bulb is defective it will remain out while others along the rows selected light dimly. Provided the battery voltage is lower than that of the bulbs they should last almost indefinitely.

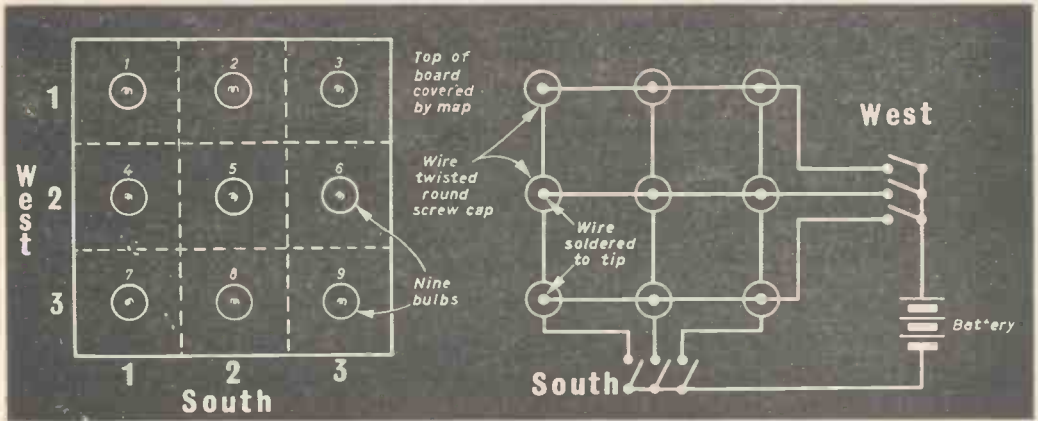

Fig. 1.

Fig. 2.

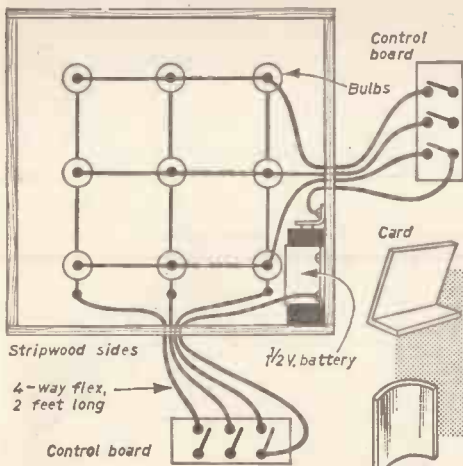

Fig. 4.

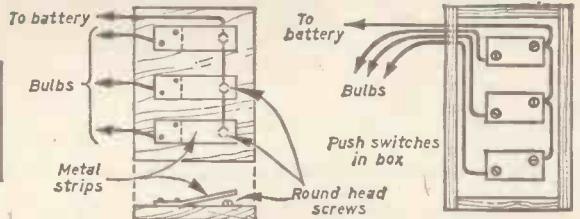

Fig. 5.

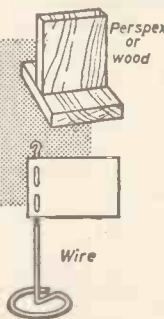

Fig. 6.

LAND MINE TAKE OPPONENT SCORE	SNIPER 5	FUEL DUMP 25
SPY HIDEOUT 15	GENERAL H. A. 50	ANTI- PERSONNEL BOMB TAKE 5, 10, 15. LOSE 15.
VEHICLE SPARES 10	REPAIR DEPOT 20	IMPORTANT SIGNALS STATION. 30

Fig. 3.



Fig. 1.

A COMPLETE armillary is a form of sundial consisting of ten concentric rings, secured together to form a hollow sphere. The rings represent the equator, the meridian, the tropics, etc., as on a globe of the world. For a simple armillary to indicate sun time, only two intersecting rings at right angles and a rod to act as gnomon are essential.

A photograph of a simple armillary is shown in Fig. 1. To lay out the hours on the hour ring draw a circle A (see Fig. 2) with a diameter equal to that of the gnomon. Draw another concentric circle, B, equal to the inside diameter of the hour ring. Draw a vertical line at the left of A and tangential to it. Where the line touches circle B is 12 midnight. With this as starting point, by means of compasses divide the circle into 15° divisions. These represent the hours and should be numbered in a clockwise direction. Draw the diameter CD.

Place the actual hour ring on the circle B and carefully transfer the hour lines from, say, 6 a.m. to 8 p.m., onto the inside of the ring. Transfer also the ends of diameter CD onto the outside of the ring, and make them reasonably permanent by scribing them. They will be used later for levelling the ring. Make $\frac{1}{8}$ in. hacksaw cuts in the inner surface of the ring at the hours, across the full width.

In a similar manner mark two diameters at right angles on the outer surface of the other ring. Drill a hole at each end of one diameter to take the gnomon. The holes should be exactly at mid-width of the ring. In a true simple armillary the gnomon and its ring should lie in the True N-S direction when set. To simplify setting, this ring was turned through 90° when securing it to the hour ring.

If the external diameter of the hour ring is equal to the internal diameter of the gnomon ring, one will fit inside the other and can be pinned or otherwise secured in place. In the example illustrated these diameters were not equal. It was considered best to cut the gnomon ring and secure the halves (allowing for the width of the hour ring) by solder-

A Simple ARMILLARY

By Sidney D. Scorer

ing. As the gnomon must pass through the centre of both circles, the axes of the two circles must be at right angles.

The gnomon must be set at an angle to the horizontal equal to the latitude of the place where the armillary is fixed. In the present instance it was 53° 20'; a figure obtained from the latitude scale at the side of the



Fig. 2.

Fig. 3.

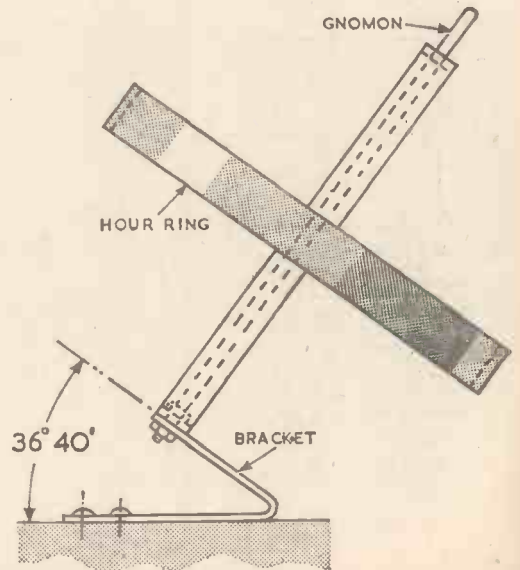

Ordnance Survey map for the locality. By securing the gnomon ring at 90° to its true position its lower face when set would be at an angle of ($90^\circ - 53^\circ 20'$) i.e. $36^\circ 40'$ to the horizontal (see Fig. 3). The tangent of that angle is 0.7445. Thus, draw a base line 10in. long and at one end erect a perpendicular line 7.445in. long. If the ends of the lines are joined the inclined line makes the requisite angle with the base line.

Now take a strip of suitable metal for a support bracket. Carefully scribe the longitudinal centre-line along each side of the strip. Bend the strip until one length lies on the base line and the other along the line inclined at $36^\circ 40'$. Drill a hole in the centreline of the inclined part, near the end, and large enough to take the gnomon. Drill two holes, large enough to take securing screws, on the centreline of the horizontal length.

Screw one end of the gnomon for a distance sufficient to take two nuts and the combined thickness of the gnomon ring and the bracket. When the gnomon ring is secured to the bracket, the inclination of the gnomon automatically becomes $53^\circ 20'$, when the base of the bracket is placed on a horizontal surface.

The gnomon must also point in the True N-S direction (not Magnetic N-S). In the present instance a small pillar of stone with a square portion of an old, faced gravestone were used to make a pedestal. The top slab was cemented to the pillar and trued by means of a spirit level. At the same time, one of the diagonals was set approximately in the True N-S direction.

When the mount has been prepared, a hole for the bracket securing screw should be drilled on the diagonal line about one third of the length along. A suitably-sized piece of projecting rod (not iron) should be dropped into the hole and the notched end of a marching compass placed against it. In my district the magnetic variation is about 8° (see local Ordnance Survey map for yours), and True N was thus this amount away from N as indicated by the compass. Reference to the diagram on the Ordnance Survey map will make this clear. The position of True North was then marked on the slab. The positioning rod was removed and a pencil line through the N mark and the centre of the hole gave the True N-S direction. It was practically on the diagonal.

The slab hole should now be Rawlplugged and the bracket secured with a screw. The centrelines previously scribed on the bracket should be lined up to the N-S line on the slab, and a pilot hole drilled into the slab through the other screw hole in the bracket. Remove the bracket, drill the slab hole to a suitable size, Rawlplug it and secure the bracket firmly with two screws. At the same time keep the bracket lines accurately in line with the N-S line. Secure the rings to the bracket by the gnomon and its nuts. The correct angular position of the hour lines can be checked by using a scribing block to ensure that the scribed lines at each end of the diameter CD are exactly the same height from the slab surface. The gnomon nuts should then be tightened hard, and the scribing block used again to check that the ring has not moved.

The armillary illustrated was made from material to hand, which happened to be $6\frac{1}{2}$ in. diameter x $\frac{1}{4}$ in. stainless-steel piping. The gnomon was a $\frac{1}{4}$ in. diameter stainless-steel welding rod and the bracket was made from a stainless-steel weld test specimen. The securing screws were chromium plated brass.

The positioning of the gnomon ring 90° from its theoretically correct setting was a risk, but it has only had the effect of partially obscuring the gnomon shadow early in the morning and in the early evening. This method greatly simplified setting problems as the stainless steel was rather hard for drilling and it was not thought to be wise to grip it in a vice after soldering.

In reading the time the western side of the gnomon shadow is always used. Morning hours show on the western side of the hour ring; afternoon hours on the east side. Noon is, of course, the line at the bottom. This armillary appears to be accurate to within 10 minutes of clock time. As it was also intended to be a garden ornament, the result is considered to be satisfactory.

THE LUTON "MAJOR"

(Continued from page 314)

120 miles without incident and made his approach at very high speed, since, as he stated "I could not bank". Missing a hangar by what seemed only a few inches, and to the amazement of onlookers, the "Major" came to rest with no damage to pilot or aircraft.

The post-war Luton "Major"

Following the resurgence of the "Minor", Phoenix Aircraft Ltd. undertook the revision of the "Major" drawings for amateur construction and already a number of this type are being built in this country and Australia, where the enormous distances between townships offer great scope for two seater light aircraft. Incidentally, the Luton "Minor" was the first ultra-light aircraft to receive full approval by the Director-General of Civil Aviation in Australia. The Luton "Major" is the only British-designed two-seater aeroplane available to amateurs for home building.

The "Major" was originally designed by Mr. C. H. Latimer-Needham to Air Ministry requirements, as laid down in A.P. 1208, but it has recently been re-stressed to current A.R.B. requirements. The opportunity was taken to increase the permitted engine power to 85 h.p. and the gross weight to 1,100lb. Available power units now include the Mikron II and III of 62 h.p.; the Continental A65 and C85; the Porsche 678/1, of 65 h.p.; the Agusta GA70/0, of 74 h.p.; and the 55 h.p. Lycoming. These units are available, either new or rebuilt at prices varying between £200 and £500.

The materials for building the airframe cost about £250, so that the "Major" can be built for as little as £500, assuming that the constructor does all the work himself. However, all the metal parts and other components may be obtained in the finished state, if desired. The machine operates on "permit to fly", costing ten shillings a year and third-party insurance costs between £15 and £20 per annum. The complete set of 47 constructional drawings may be purchased from Phoenix Aircraft Limited, Cranleigh, Surrey, for £20.

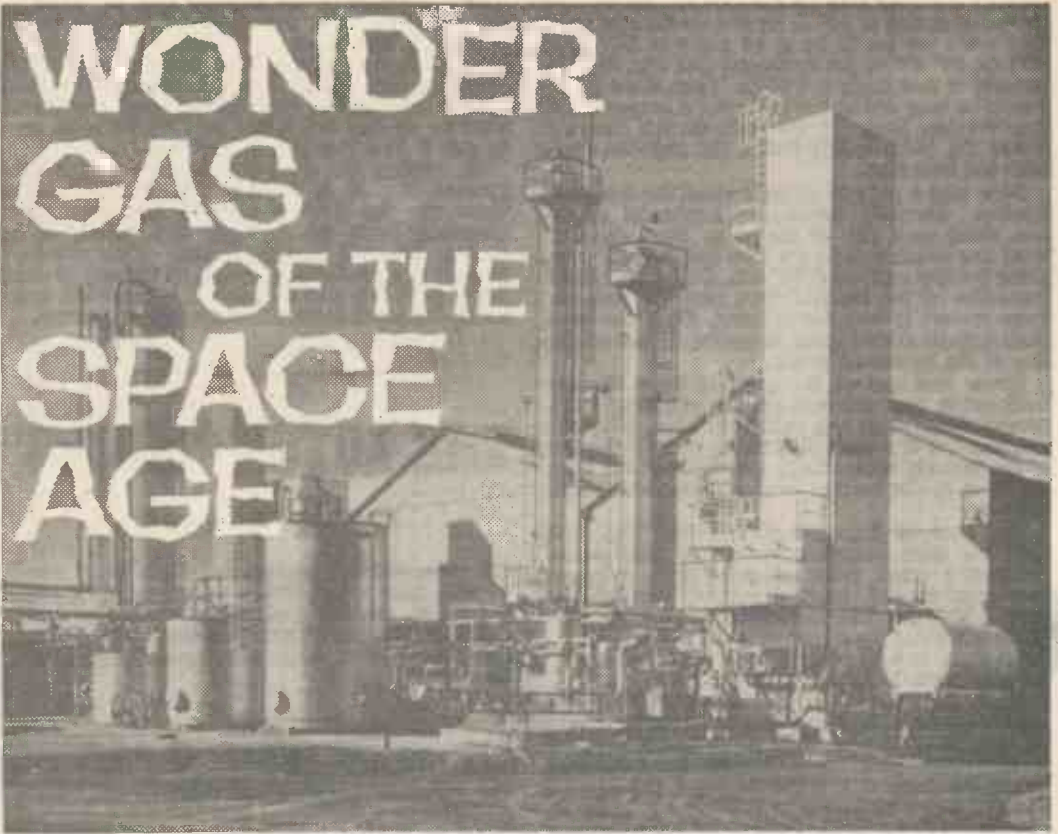

WONDER GAS OF THE SPACE AGE

By PAUL BROCK

WORLD consumption of helium, gas with the space age future, has been increasing by about 20% annually over the past ten years, until today world usage is about 600,000,000 cubic feet. Of this only 3,500,000 cubic feet are used outside the United States, mainly because helium has been virtually a U.S. monopoly since it was first extracted commercially at the end of World War I. Only small amounts are exported, and these are exclusively for research and medical purposes.

A new company, however, has just been formed to develop Canadian helium for sale on world markets. Named Canadian Helium Ltd. this new source of supply might break the long-standing U.S. monopoly. The Canadian-based company is owned by British, Canadian and French interests and will extract and sell helium from the prolific Wilhelm Field in the province of Saskatchewan, nine miles north of Swift Current. The field contains large reserves of recoverable helium in a mixture of approximately 96 per cent nitrogen, two per cent helium, and two per cent other gases and covers an area of 170,040 acres. The original well was drilled while geologists were prospecting for oil and its value might never have been realised if a curious laboratory technician had not subjected the incombustible gas to a spectroscopic analysis. Initial plans call for the extraction of 12,000,000 cubic feet of helium

annually, and the plant is scheduled to start producing this month (April, 1963).

Helium's "wonder" characteristics have long intrigued scientists, and the gas is rapidly becoming one of the workhorse elements of the Space Age. It is colourless, odourless, tasteless, non-inflammable, and chemically inert. It never combined with any other substances in nature and so cannot be manufactured by any chemical process. It accounts for only about 5 parts in 1,000,000 of air, and the principal commercial source until now has been from natural gas in Texas which, in some cases, contains as much as 7 per cent helium. Its extraction from other gases is made possible because it remains a gas at a lower temperature than any other substance.

Helium is the second lightest element, about twice as heavy as the lightest of all—hydrogen. Modern science uses it in the construction, testing and operation of space vehicles, in the harnessing of atomic power in gas-cooled reactors, in medicine, metallurgy, electronics, welding, leak detection, optics, illuminated signs, and for research into cryogenics (the study of methods for producing extreme cold). Recently it has been proposed for use in ion propulsion motors for future spacecraft.

One of its less sophisticated yet most valuable qualities is that when it is mixed with oxygen it enables sufferers from asthma or other respiratory

diseases, to breathe more oxygen through restricted passages with less muscular effort. This is because helium is lighter than nitrogen and more easily penetrates such passages. It is also used to replace the nitrogen of the atmosphere for deep-sea divers and caisson workers. This is because its comparative insolubility in the blood reduces liability to the bends—the release of small bubbles of nitrogen in the blood which can cause agonizing paralysis and death. Until helium-oxygen mixtures were used, divers could not operate at a greater depth than 300 feet. Now they can work at 600 feet. Another important use of the gas is in the welding of light metals derived from magnesium. By projecting a protective mantle of helium around the arc during welding, oxygen is excluded and oxidation prevented.

Prior to World War II helium's principal use was for inflating airships and balloons. Although twice as heavy as hydrogen its lifting power is 92% as great, and its chemical inertia eliminates the danger of fire or explosion from sparks or incendiary bullets. This was precisely the reason why the government first took over control of all helium production in the U.S., reserving to itself the gas as a munition of war. Not until 1937 when development of heavier-than-air machines appeared to render airships obsolete as offensive weapons, did Congress pass legislation permitting the sale of surplus helium to any U.S. industry requiring it. Exports abroad, however, remained under strict control. Following the destruction of the airship "Hindenburg" by fire at Lakehurst, New Jersey, in 1937, the German government requested permission to purchase helium from the U.S. for inflating airships. This was flatly refused on the grounds that the gas might be used for military purposes.

In tracing the story of this unique gas, one meets with quite a few highlights in the progress of science. Unwittingly, Henry Cavendish—that English experimenter who turned the London

mansions he owned into laboratories crammed with glassware, and had a backstairs entry built so that he would not have to endure the sight of females in his eccentric man's world—provided the first clue to the existence of helium 178 years ago. In experiments in which he passed electric sparks through air to burn up the oxygen and then absorbed the nitrogen in alkali, Cavendish found himself left with a bubble of residual gas. It was to prove, 150 years later, a veritable bubble of fortune, for it contained argon, neon and helium, later to be used in the electric lamps and illuminated signs of the twentieth century. Cavendish was baffled by this bubble. He described it carefully in his journals, but for over 100 years his experiment was ignored or forgotten.

Then, in 1893, British scientist Lord Rayleigh described before the Royal Society how he had discovered that one litre of nitrogen from air weighs a definite fraction more than a litre prepared from nitrogen compounds. He invited suggestions from scientists to explain this phenomenon, but as with the Cavendish experiment there was no response. So Rayleigh, using a big milk and butter dairy on his estate as a laboratory, repeated the Cavendish experiment on a large scale. Vats intended to be filled with cream held caustic soda. A telephone was rigged near his apparatus and connected with his library, so that an assistant could tell him whether the electric arc he was passing through air in a glass vessel was still functioning. He wanted to be sure that the fixation of the nitrogen was progressing satisfactorily and continuously while he got some rest.

In this way Rayleigh was left with a substantial quantity of inert gas, or rather a mixture of gases, which he described as "egoists among chemical elements, drones which form no compounds or association with others." Rayleigh named his end-product "argon" from the Greek for "idle". He did not realise that one of the gases comprising it was helium, but in any case it was present in such a small proportion that it could only be



Photo shows a number of heli-wound copper tube exchangers for low temperature gas separation equipment.

identified and separated by other means in later years.

The eventual isolation and identification of helium is often described as one of the greatest romances of science, for helium was actually found in the sun before its existence on earth was even suspected! During the solar eclipse of August 18, 1868, the French astronomer Pierre Janssen, making spectroscopic observations of sunspots, found a line in the spectrum which corresponded with no known element. At the same time a similar discovery was made by Sir Joseph Lockyer and Sir Edward Frankland in England. The unrecognised substance was named helium from the Greek *helios*, "the sun". It was evident that helium existed in or near the sun in enormous quantities.

Nothing more was discovered about the gas, however, until in 1895, Sir William Ramsay took a specimen of the mineral cleveite, heated it with sulphuric acid, and collected a gas which when incandescent was found to give an identical spectrum with that of solar helium. Before this, the gas given off by cleveite when it was boiled with weak sulphuric acid had been thought to be nitrogen. It was a great discovery, and since that time helium has been found in a large number of minerals.

It is especially found in connection with compounds of uranium, thorium and the rare earths, and a very remarkable thing about it is that it is produced by the spontaneous disintegration of radium. Before the discovery of radio-activity this presence of helium in ores of uranium and thorium could not be accounted for. Then it was suggested by Sir Ernest Rutherford that helium was one of the integral products of radio-active change. Later investigations confirmed the fact that the alpha emanation of radioactive disintegration consists of helium atoms, each with a double positive charge.

Another unique thing about helium is that it is the most difficult of all gases to liquefy. In 1908, however, helium was successfully reduced to the liquid state, its boiling point being established at about 268 degrees below zero Centigrade, more than 16 degrees Centigrade lower than that of hydrogen. Helium is also impossible to solidify at normal atmospheric pressures. Such properties make liquid helium extremely useful as a refrigerant in producing temperatures close to absolute zero, thought to be the lowest temperature that can ever be produced.

When liquid helium is cooled at normal pressures, it is transformed into Helium II, a liquid with fantastic physical properties. It has no freezing point, has little or no internal friction, and passes readily through minute cracks and the tiniest of holes with the greatest of ease. This is what makes it invaluable in detecting leaks in rocket and space ship hardware. This strange liquid can flow up the walls of a container and over the lip. If a bottle is dipped halfway into liquid helium the liquid will flow up the outside of the bottle and into the top until the levels are the same inside and out. Its heat conductivity is nearly a million times that of ordinary liquids, so that when heated strongly it does not boil, but evaporates quietly from an undisturbed surface.

Economical transportation of commercial helium over long distances is one of the chief obstacles confronting the new producers in Saskatchewan. One plan being considered is mass conversion of

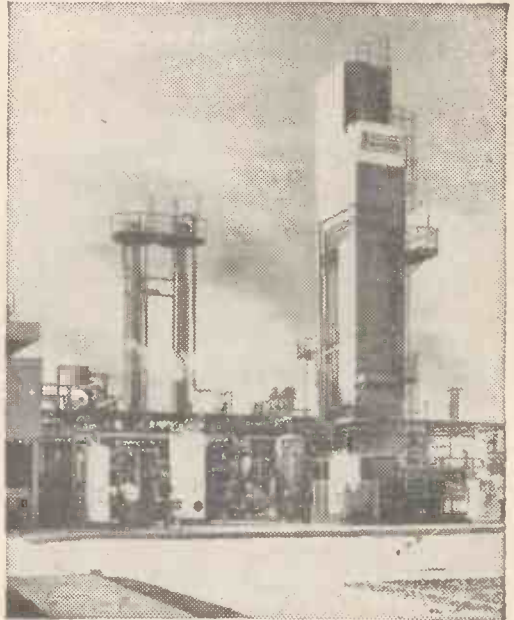

A low temperature separation plant.

the helium gas to liquid form, and transportation of this in special high-pressure metal cylinders. Substantial storage facilities will also have to be built by the countries planning to exploit the new sources of space age gas—principally the countries of Western Europe, Japan and Australia.

THE P.M. BLUEPRINT SERVICE

- 12 FT. ALL WOOD CANOE. New Series. No. 1, 4s.*
- COMPRESSED-AIR MODEL AERO ENGINE. New Series. No. 3, 5s. 6d.*
- AIR RESERVOIR FOR COMPRESSED-AIR AERO ENGINE. New Series. No. 3a, 1s. 6d.
- "SPORTS" PEDAL CAR. New Series. No. 4, 5s. 6d.*
- F. J. CAMM'S FLASH STEAM-PLANT. New Series. No. 5, 5s. 6d.
- SYNCHRONOUS ELECTRIC CLOCK. New Series. No. 6, 5s. 6d.*
- ELECTRIC DOOR-CHIME. No. 7, 4s.*
- ASTRONOMICAL TELESCOPE. New Series. Refractor. Object glass 3in. diam. Magnification x 80. No. 8 (2 sheets), 7s. 6d.*
- CANVAS CANOE. New Series. No. 9, 4s.*
- DIASCOPE. New Series. No. 10, 4s.*
- EPISCOPE. New Series. No. 11, 4s.*
- PANTOGRAPH. New Series. No. 12, 2s.*
- COMPRESSED-AIR PAINT SPRAYING PLANT. New Series. No. 13, 8s.*
- MASTER BATTERY CLOCK.* Blueprints (2 sheets), 4s. Art board dial for above clock, 1s. 6d.
- OUTBOARD SPEEDBOAT. 11s. per set of three sheets.
- P.M. TRAILER CARAVAN.* Complete set, 11s.
- P.M. BATTERY SLAVE CLOCK, 2s. 6d.
- P.M. CABIN HIGHWING MONOPLANE, 1s. 6d.
- THE MECHANIKART, 15s.*

The above blueprints are obtainable, post free from Messrs. George Newnes, Ltd., Tower House, Southampton Street, Strand, W.C.2.

*denotes constructional details are available free with the blueprints

TRADE NEWS

NEW to the Stanley "Jobmaster" range of hammers are bell-faced claw hammers. These have a new swept neck design which makes for better appearance and balance.

The new series has all the features of other Stanley hammers, including the exclusive "Ever-tite" handles which are pre-shrunk and triple wedged to prevent the heads becoming loose.

Two sizes are initially available—the 20oz retailing at 16/- and the 16oz retailing at 15/-.

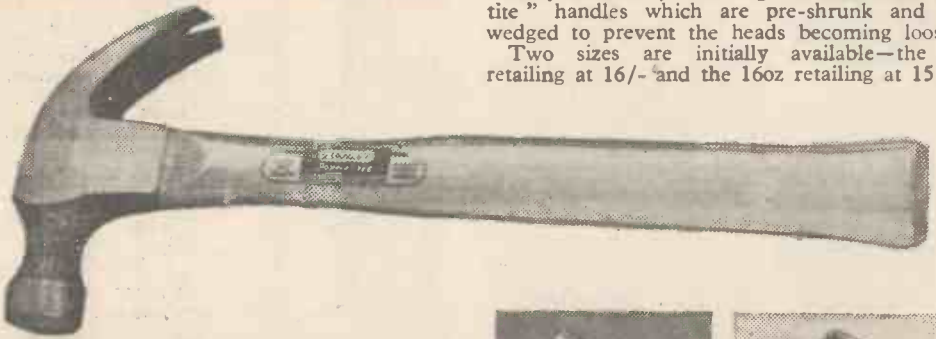

Bahco flexible socket spanner

THIS type of spanner, known as the Bahco "L" Series is a development from the high quality range of Bahco bihexagon sockets and tools.

The bihexagon socket ends have the outstanding features of all Bahco sockets, that is strength, durability, thin walls and perfect rings. Strength and durability are assured because only the finest selected steels are used. Thin walls and perfect rings ensure that sockets will operate in restricted spaces.

The sockets are attached to the handle with a Phillips head screw, thus worn sockets can be replaced easily. A spring lock washer between the handle and socket holds the socket wherever the operator sets it. The handle is light and comfortable, but designed so that exceptional strength is developed in the direction of pull.

This socket spanner can be used like a screwdriver for "easy" nuts or like a speeder brace on "tight" ones. It requires the minimum vertical working space, giving the operator both versatility and speed.

These "L" Spanners are available in Whitworth, A/F and metric ranges.

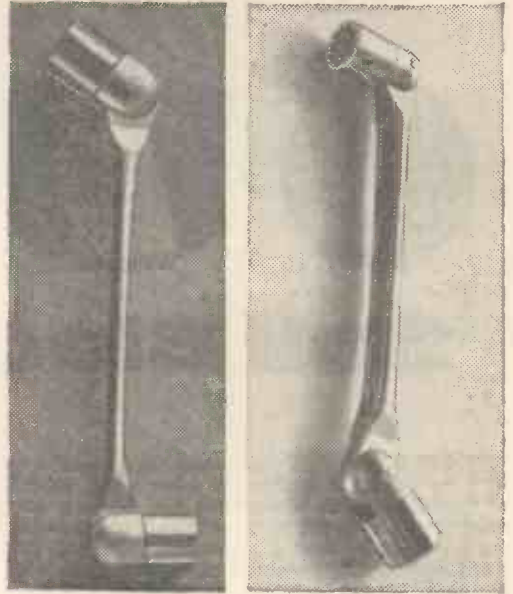

Spring dress for "Eezit"

THREE-WAY Eezit—original and best-known of all rust penetrants—will appear in a slightly different can this year. The familiar colours—red, black and white—are retained, but a striking new design has been substituted for the old.

The first rust penetrant, "Eezit" has been used all over the world for more than 30 years, as an infallible releasant for seized or rust-bound metal parts, and was further developed a year ago, to provide a three-way action—rust penetrant, rust preventative and light lubricant in one.

It is obtainable from all good ironmongers, hardware dealers, do-it-yourself suppliers and garages.

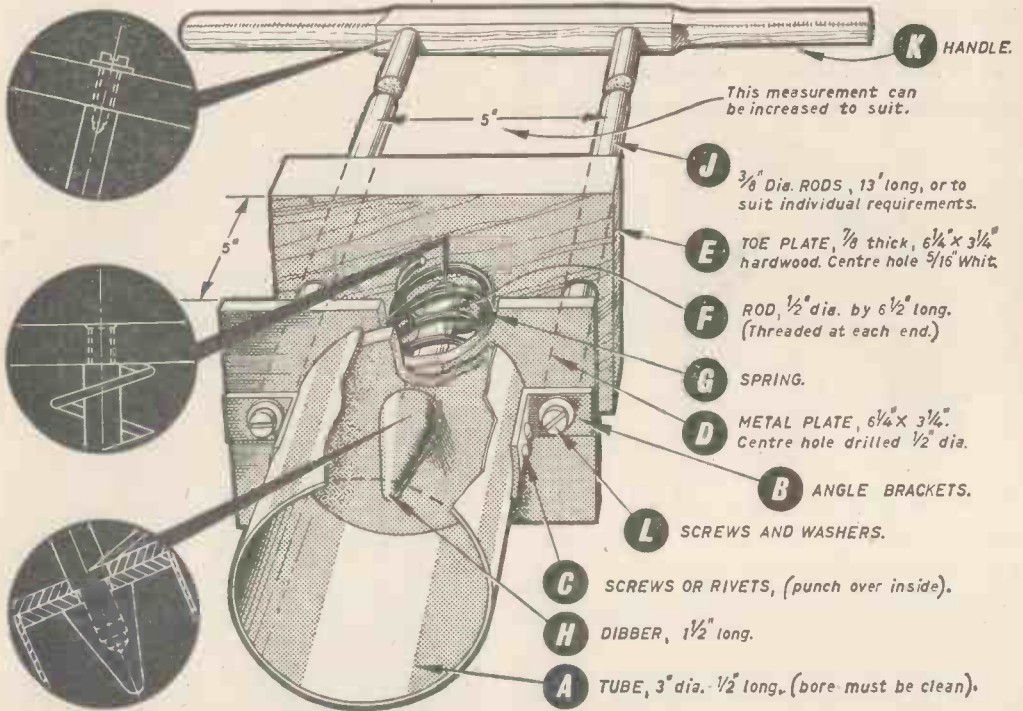

Soil Blocking Tool

BY J. WALLER

ENTHUSIASTIC gardeners or owners of horticultural businesses among the readers of PRACTICAL MECHANICS AND SCIENCE have used scores of flower pots for raising and growing-on seedlings in their greenhouses. Although pots have undoubtedly given fine service over the years, the modern idea of raising young plants with compressed soil formed into a block means that the root system is not disturbed when the seedling is transferred to more permanent quarters. To this is coupled a saving in cost as replacement of broken pots is no longer necessary. The device for producing soil blocks shown here, has been used by the author for a number of years and will repay the time spent on its construction in a single year.

Tube "A" should first be cut to a suitable length. The dimensions of this tool are elastic and can be modified to suit material in hand or individual requirements. To this member a pair of brackets "B" should be attached with rivets or by screws. If screws are the only items available, these should be punched or filed down inside to ensure that a flush surface is left.

Next a cover plate "D" should be made from steel or brass, to compress the soil. It should be drilled to be a loose fit round rod "F". Above this plate is another plate, "E", for the foot to press on. This should have the same shape and similar drillings as the plate "D", but a piece of hardwood

can be used if preferred. A pair of long rods "J" and a handle "K" are necessary, but it is suggested that some thought is given to the length of these rods before cutting them as the position in which the tool is to be used will effect the dimensions. For use at floor level long rods are advisable as this means less back bending, while for bench use shorter rods are more comfortable to use. An inner rod "F", spring "G" and dibber "H" with its backing disc, which can be a very loose fit in the tube, complete the tool. It should be emphasised that when cutting the thread these must be made tight, to avoid subsequent loosening as the tool is used. Leave the die slightly open when threading the shafts to ensure that the resulting thread is oversize to an extent of perhaps a thousandth of an inch. This will be sufficient to hold the parts tenaciously and prevent them from loosening.

In use, operate the tool as follows. Prepare a mound of soil; the texture of this material is important and it should be rather peaty and tend to adhere when compressed by the hands. Push the tool into the heap until the tube is buried beneath the surface. The soil will rise inside the tube and when pressure is put on the handle "K" this will have the effect of compressing the soil into a cylinder. The toe of the boot should now be applied to the plate "E" still pressing on the handle. This causes the rod "F" to

slide downwards and so force the dibber "H" into the earth; at the same time this compresses the soil further leaving it reasonably compact and ready for ejection. The toe should not be applied hard enough to force the soil block out of the tool however.

The tool should now be withdrawn from the mound and held over the usual shallow seed box. Again exert pressure on the plate "E" to push the block from the tube into the tray. A clean bore is essential in the tube—rust or any protrusion will naturally prevent the clean ejection of the block and could, in bad cases tend to break the edges sufficiently to render it unusable. The secret of these soil block tools lies in the mixing of the earth to give the desired adhering qualities, and it is suggested that readers should go easy with the watering can until satisfied that blocks are ejected that can be picked up without disintegrating.

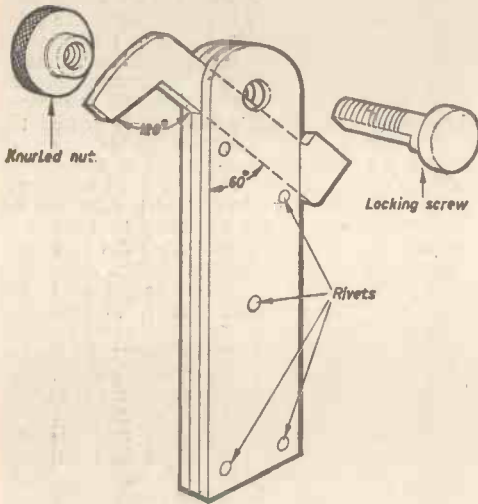

Aid to better drill grinding

THE drawing shows a handy gauge for use when grinding twist drills by hand. The body is composed of three strips of metal, the inner strip forming a 60° guide for the slide. This is locked in position by a clamping action, and the flat of the clamp screw also locks it against the guide face by tending to turn. The nut should be a fairly tight fit on the thread and the flat should be less than half the screw diameter. The turned up end of the slide prevents it being pulled right out. The apex of the gauge is set by rule to half the diameter of the drill (the sliding member can be graduated if desired). The drill is placed alongside the gauge, then given half a turn to check if both cutting edges fit perfectly. The edges of the drill must be ground until this is achieved.

BUILDING IN CIRCLES

(Continued from page 307)

Maumee River valley in Toledo, Ohio. Wishing to make the panoramic view an integral part of the design, Mr Bauer devised a plan of two circles—a large circle, and a smaller one attached to it—with walls of glass around the perimeter of each to give a feeling of space in every room. The larger circle nestles into the rounded bank of hillside. It contains the main family rooms and is connected with the second circle by a short corridor. The smaller circle, suspended on slender steel columns for a "tree-house" effect, is the living room. Here, the views provided by the glass walls are used to dramatic advantage.

So, in a round-about way, scientific research has come to the aid of the architectural profession and the building industry. There is always some other way of doing everything and, for better or worse, scientists can usually be relied upon to find that way.

A SUPER-TELEPHOTO LENS

(Continued from page 309)

mounting, accurately aligned, and set to infinity and the smallest size stop. It should then be moved until the image of the stop ring is sharply in focus on the ground-glass screen in the viewfinder. The distance between the wide-angle lens rim and the normal lens back should be measured accurately with callipers and a suitable ring machined from aluminium tubing to hold the two lenses securely in these relative positions when screwed together. The ring should have an external thread to mate with the internal filter thread on the front rim of the wide-angle lens casing and an internal thread to take the normal lens. (If any of the lenses have a front rim without a filter thread a clamp-on arrangement with a positive locating ridge will be needed instead of the external thread.)

Having completed this ring the normal lens should be coupled to the wide-angle lens with it. The telephoto lens should now be set to infinity and its largest stop and mounted in front as before. It should be moved until a very distant object (a house or tree at least 200yd distant) appears sharply in focus on the viewfinder. The distance between the front of the normal lens and the back of the telephoto lens is then measured with callipers and a corresponding ring machined from aluminium tubing.

The procedure can be completed by repeating for various lengths of initial extension tubes to give various final focal lengths if desired.

Recondition that faulty Tap

says P. G. Tucker

The domestic water tap is so simple in design that complete failure is almost impossible. Yet how often one is discarded and replaced when a little time spent will give equal service.



THERE are few things more annoying than a dripping tap, particularly when it is in the kitchen. In many cases, renewal of the washer will effect a cure but unfortunately this is not always the case.

When the tap has been removed and dismantled (the water supply will, of course, have been turned off), the seating on which the washer rests should be carefully examined. If it appears to be quite flat and level then a new washer is all that is necessary, but it may be found that the seating has become rough and may even have grooves in it. In view of the fact that it is this seating which decides whether or not the tap will perform its correct function, it is surprising that no provision is made for the ready renewal of this most essential part, despite the amount of work that goes into the making of a tap. The seating is usually made of brass and the best method of repair would be to remove the old seating and insert a new one. This however, is not easy to do, so other means must be found if one is not to go to the expense of buying a new tap.

There are two fairly easy ways of giving the tap a new lease of life and perhaps the easiest, although somewhat tedious, is to grind the seating, following a similar procedure to that adopted when grinding-in the valves of a car engine. The essential tool required is a hand drill, although if a power drill or lathe are available these would obviously be used in preference.

Obtain a cork of such a size that it will just enter the body of the tap, and screw into it a wood screw with the head removed (Fig. 1). Mount the wood-screw in the chuck of the drill and apply some grinding paste to the end of the cork. With the tap held securely, in a vice or by other means, insert the cork into the body of the tap and revolve it, keeping it as square as possible to the seating and applying pressure. Repeated application of grinding paste may be necessary and the time taken will depend on how badly the seating is defaced. Grinding must be continued until the seating is seen to be bright and even all over. It is surprising how small a defect of the seating will allow water under pressure to leak by.

A second and somewhat quicker method of reconditioning a tap is to fit a new seating. First clean up the seating with emery cloth and a wire brush, ensuring that any depressions are also cleaned out. Hold the tap in a gas jet by some convenient means, until solder applied to the seating melts and flows freely over it. Then apply Fluxite or some other flux to the seating and use cored solder if available. Having thoroughly coated the seating obtain a washer, preferably of brass or bronze, of a size roughly equivalent to the area of the seating. Enlarge the centre hole if necessary. Rub the washer on a sheet of emery cloth laid on a flat surface such as a sheet of glass until it is bright and flat. Do this to both sides and then cover one side only with solder. When doing this take care not to allow the solder to get on to the other side as the untinned side is to form the seating (Fig. 2).

Again holding the tap securely, insert the washer with the solder side down and centralise the washer on the seating. All that is now necessary is to heat up the tap with the gas jet and watch until it is seen that the washer drops slightly as the solder flows into a level surface. Then allow the tap to cool down without disturbing the new seating. This completes the repair and with a new washer such a tap will not only give good service but is one which can be reconditioned at any future time in a few minutes.

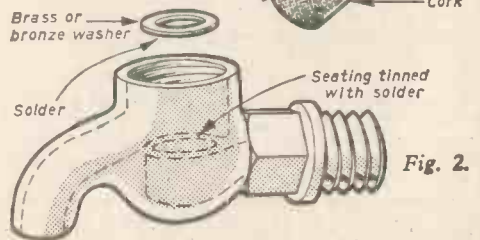

PARKER'S SHEET METAL FOLDING MACHINES
NEW BENCH MODEL



Capacity 36in. wide x 18-gauge mild steel. Forms channels and angles down to 45 deg. which can be flattened to give safe edge. Depth of fold according to height of bench. Will form flanges.

Price £23/0/0, carr. free. Also the well-known vice models of:
36 in. x 18-gauge capacity ... £11 10 0
24 in. x 18-gauge capacity ... £6 15 0
18 in. x 16-gauge capacity ... £6 15 0

Weight approx. 2 cwt.
Carriage free

One year's guarantee: money refunded without question if not satisfied. Send for details:

A. B. PARKER, Wheatcroft Works
WELLINGTON STREET, BATLEY, YORKS. Tel. 426

WE WILL SUBMIT—ON APPROVAL

- PROJECTION MICROSCOPE. An amazing new instrument designed by Charles Frank.....£23.10.0
- EX-M.O.S. HARDENED CHESTERMAN COMBINATION SET No. 92, with 12" rule. Brand new cond. £6.15.0
- TOOLROOM CLINOMETERS (Micrometer Bubble Type) Ex-M.O.S.....35/-
- THE NEW RUSSIAN MICROSCOPE. Worth £70. £47.10.0
- EX-R.A.F. ILLUMINATED MAGNIFIERS with 3" diam. lens.....38/6
- GERMAN DRAWING INSTRUMENT SETS: Brand new in velvet lined case.....£2.19.6

CHARLES FRANK LTD. Phone: BELL 2000
67/75 SALTMARKET, GLASGOW, C.1. Est. 1907
Britain's greatest stocks of new, used and Ex-Government Optical and Scientific Equipment. Send for Illustrated Catalogue.

THE FAMOUS HARRIS ELECTRIC WELDER and Complete Kit

For Welding, Soldering, Brazing and metal construction & repairs in the home, on the car or cycle. Instant heat 6,000°F. Works from 6v or 12v car battery or transformer from A.C. mains. Complete kit of Welding Tool, 9ft. cable, cltp, carbons, cleansing fluid, fluxes, filler rods, goggles, instructions. Blasts thousands in daily use. As supplied to Depts. of H.M. Government, L.C.I., Standard Telephones, etc. Welds all Metals up to one-eighth inch. C.O.D. IP REQUIRED. Obtainable only from: Post & Pkg., 3/6.

57/6

HARRIS ENGINEERING CO.
(Dept. P.M.50) 289 KINGSLAND ROAD LONDON, E.2.

INTRODUCING A NEW PORTASS LATHE

3 1/2" x 16 1/2" B.G.S.C. bench lathe complete with faceplate, catchplate and backplate, changewheels, etc. flat or vee drive. Complete satisfaction or remittance refunded in full. Ex-works write:

CHARLES PORTASS & SON
Buttermere Works, Sheffield 8
Est. 1889 Cash or terms

ROGERS 31/33 NELSON ST. SOUTHPORT.

Fibre Washers, 144 Assorted	3/6
Mercury Switches	8/6
Timer Motors, 1 h.p.m.	26/-
Rectifiers 6/22 v. at 6 amps.	17/-
Transistors, G.T.I.I. Branded	2/6
MotORIZED Water Pumps	95/-
Instrument Cases, 12in. x 8in. x 6in. New	7/3
Thread Gauges	4/9
Races, Belts, Valves, Pulleys, Pumps, Brass, Steel, Aluminium, etc.	

10 PAGE LIST FREE. STAMP PLEASE

FREE INFORMATION SHEETS

TITLES include "Condensation Rates": "Steam Distribution": "Condensate Return": "Boiler Feed Tank": "Direct Steam Injection": "Flash Steam Recovery": "Air in Steam Plant": "Oil Burning Installations": "Steam Heated Calorifiers": "Compressed Air". Copies and full list free of charge or obligation.

SPIRAX-SARCO LTD.
(TECHNICAL DEPT.) Cheltenham, Glos.

FREE THIS BOOK WILL INTEREST YOU!

LEARNING the PRACTICAL WAY

FOR

- .. Your Career
- .. Your Own Business
- .. An Absorbing Hobby

RADIOSTRUCTOR EQUIPMENT-COURSES

A NEW-PRACTICAL WAY of UNDERSTANDING

RADIO • TELEVISION • ELECTRONICS

Including: Transistors; VHF/FM; Hi-Fi equipment; Computers; Servo-mechs; Test instruments; Photo-electrics; Nucleonics, etc.

Radiostructor—an organisation specialising in electronic training systems—offers a new self-instructional method using specially designed equipment on a "do-it-yourself" basis. You learn by building actual equipment with the big kits of components which we send you. You advance by simple steps performing a whole series of interesting and instructive experiments—with no complicated mathematics! Instructional manuals employ the latest techniques for showing the full story of electronics in a practical and interesting way—in fact, you really have fun whilst learning!

RADIOSTRUCTOR

LEADS THE WORLD IN ELECTRONICS TRAINING

POST NOW

To RADIOSTRUCTOR (Dept. G28) READING, BERKS. Please send brochure, without obligation, to:—

*Name.....

*Address.....

4/63

(We do not employ representatives) *Block Caps Please

P.M. and S. test report

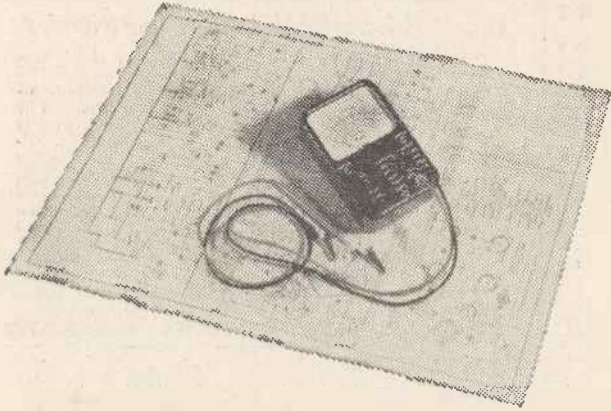

BUYING A METER?

ANYONE who is even moderately interested in radio, electronics or electrical work will have early on felt a desire to own a multi-range testmeter. But when the pocket is at last deep enough which should the prospective purchaser choose? If his interest is solely in house wiring, electric motors and such equipment, any meter with a good selection of a.c. and d.c. ranges will be satisfactory. For these purposes there is no advantage in buying expensive meters with resistances of 10,000 to 30,000 ohms per volt. However, if measurements are to be made on radio or electronic apparatus this factor is of vital importance. This is because all voltmeters of this type draw at least a small current from the circuit to which they are connected. In the case of house wiring and similar circuits this current is available without any effect on the circuit. In a high-resistance radio circuit, however, the working current may only be a milliampere or so. The connection of a voltmeter requiring, say, 1mA (1,000 ohms per volt) would therefore draw an abnormally high current from the circuit. By acting as a shunt it would thus cause the voltage being measured to drop considerably. For this type of work a resistance of at least 10,000 ohms per volt is necessary. Although meters having resistances up to 100,000 ohms per volt are available it is a good plan to choose one of 20,000 ohms for general purposes. This is because

the voltages quoted in manufacturers' data are nearly always obtained with a meter of this sensitivity and the use of other meters can lead to false interpretations.

Generally a pocket-sized meter will be chosen as these are cheaper than bench models and are easier to carry around. There is still a wide range to choose from, however. If cheapness is the overriding factor there are available quite serviceable imported meters having a sensitivity of 20,000 ohms per volt. Cheapness, however, can bring its own disadvantages. In order to reduce the number of resistors necessary, complicated scales are sometimes used in which readings have to be traced across several staggered scales. These are infuriatingly difficult to read and errors are all too easy. In some cheaper models a number of alternative test lead sockets are used to simplify the range switch. This can easily lead to fatal errors. The writer will not forget in a hurry the expensive blue flash and stench of burnt rectifier that followed such a mistake when trying out a colleague's brand new meter! This showed up another snag in that being an imported model the meter could not be sent to the maker for repair.

For some months PRACTICAL MECHANICS AND SCIENCE has been using a meter that comes near to

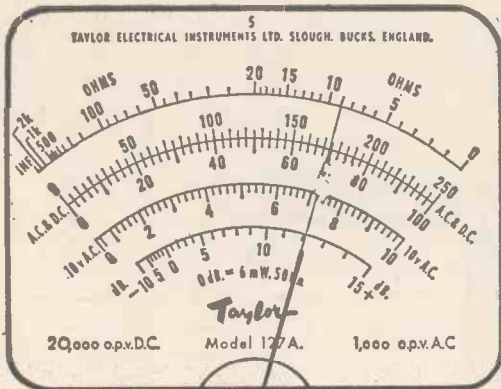



being ideal. This is the new version of the Taylor Multimeter, Model 127A. The previous version was well known to us and well liked but the new one is even better. Various detail changes have improved the appearance, functioning and already excellent readability of the meter, but the most important is an alteration of the function of one of the test lead sockets. External shunts can now be plugged in to measure d.c. currents up to 10A.

The meter movement is of the advanced centre pole type developed by Taylor Instruments Ltd.

Instead of the usual "horseshoe" magnet this movement utilises ring magnets. This greatly reduces the size and weight needed to produce any given sensitivity. The same type of instrument is used in all Taylor moving-coil meters and made possible their 100,000 ohms per volt multimeter, Model 100A, the most sensitive in the world. This movement also reduces the effects of external magnetic fields and permits larger clearances round the coil. The use of shock-absorbing jewelled bearings and pivots of nearly twice the normal diameter, yet with minimum friction, make this an unusually robust movement.

The 127A multimeter is truly pocket sized, has a resistance of 20,000 ohms per volt on d.c. and what must be one of the most easy to read sets of scales on any multimeter. It covers 30 ranges, including current ranges from 50 μ A to 100mA, 0.3V to 1,000V d.c., 10V to 1,000V a.c. and resistances from 1Ω to 20M Ω as well as output and decibel ranges. An external adaptor enables e.h.t. voltages up to 25kV to be measured and three shunts cover d.c. currents to 10A.

All in all we think that at £10 10s. complete with test leads and prods this meter represents fine value for money. Even if it means waiting a little while to own this meter its purchase will never be regretted. A really solid leather carrying case costs 45s., the 25kV adaptor £5 5s., 1A d.c. shunt 9s. 6d., 5A d.c. shunt 15s., 10A d.c. shunt 18s. 6d.

AN ELECTRIC LAWNMOWER

(Continued from page 317)

of the bakelite plates only. The whole assembly should be bolted up around the handle as shown. Connect approximately 4ft of the three-core cable to the motor terminals with the earth wire *securely* clamped under an adjacent bolt on the motor casing, preferably using a cable termination specially made for the job. A 5A three-pin plug should be used to connect the motor cable to the switch socket. This method was adopted for two reasons, firstly the motor can be quickly detached for use elsewhere and secondly should something get jammed in the works or adjustment need to be done the plug can be withdrawn for perfect safety. Furthermore, the mains cable can be easily detached for use as an extension lead for an electric drill, etc. A method of storing the cable when not in use is shown in Fig. 8.

Method of use

At first it may appear that trailing a cable behind a lawnmower might make life exciting and the reader may have visions of a lawn strewn with bits of chopped-up cable! On the contrary, provided the following method is used there is no problem. Always start mowing from the side or corner nearest to the supply (see Fig. 9) and at the end of each cut step over the cable as you turn to make the next cut. After a short time one tends to do this automatically.

One final point. Lubricate the bearings frequently and at least once every time the mower is used.

LATHE GADGETS

(Continued from page 298)

Incidentally it is worth while saving the handles from discarded rubber stamps for such purposes as this and they also make good file handles for small needle files.

In setting up for turning, the centre point of the tool's swing must be centred. This can be set quite simply and very exactly as follows. Fit the three-jaw chuck and grip in it a short length of exactly $\frac{1}{4}$ in. diameter rod. Clamp the radius turning tool on the top slide and advance it with the cross slide until the cutter holder touches the rod in the chuck. The vertical centreline through the cutter holder — i.e., the swing axis of the cutter — will now be on the nearside of the lathe centreline by a distance equal to the radius of the rod plus that of the holder — viz., $\frac{1}{8} + \frac{1}{8} = \frac{1}{4}$ in. So remove the rod, feed the cross slide in $\frac{1}{4}$ in. by the feedscrew dial and the tool will be exactly set. Lock the cross slide if possible. The cutter should project for the full finished radius required right from the start and the depth of cut should be achieved by moving the saddle towards the job along the bed.

"Practical Mechanics and Science" Advice Bureau. **COUPON**

This coupon is available until April 30th, 1963, and must be attached to all letters containing queries, together with 6d. Postal Order. A stamped and addressed envelope must also be enclosed.

Practical Mechanics and Science. Apr. 1963

Shake-O

A steadiness of hand tester

by J. B. Dalby

THIS device, as part of our skill and knowledge corner, has been the source of considerable amusement and profit at our three annual bazaars. It consists basically of a bent wire "F" along which is passed a wire ring "G" attached to a handle. When the hand wavers, the ring comes in contact with the bent wire, completes the circuit and the buzzer "D" rings.

The baseboard "A" is a piece of $4\frac{1}{2}$ in. x $\frac{1}{2}$ in. board 50 in. long. The two upright pillars "B" should be made from two lengths of broom handle $6\frac{1}{2}$ in. long and spaced 42 in. apart. They should be let into the baseboard to a depth of $\frac{1}{4}$ in. and attached to the board by means of wood screws, screwed from the underside of the board. They could, of course, be glued into position.

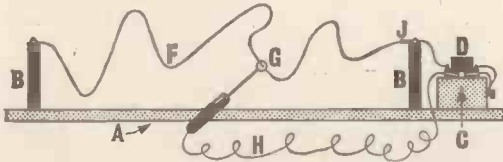

The bent wire "F" should be made up from a length of $\frac{3}{16}$ in. diameter galvanized wire, bent to form a series of hills and valleys. At each end of the wire form a ring so that the wire can be screwed to the tops of the pillars. Remember to slot ring "G" on the wire before screwing it to the pillars.

The ring "G" should be made from $\frac{1}{16}$ in. copper wire 8 in. long, bent round a piece of $\frac{1}{4}$ in. diameter dowel and soldered. The remaining straight portion of the wire should be threaded through a drilled bradawl handle and the end bent over. The trailing lead wire "H" should be slotted into this bent-over end, and both ends pulled into the handle. The battery box "C" should be made to fit a standard bell battery.

A morse-type buzzer screwed to the top of the battery box completes the equipment. A buzzer was used in this instance because one happened to be available. A bell could be used equally well, although it may be a bit too noisy. For times of non-use some insulating tape should be wound round the bent wire at "J" and the ring "G" rested on it. The unit should be wired with red plastic covered copper wire as shown in the plan.

A large size variation of this system was seen recently and consisted of a wire stretched between two posts above head level with a correspondingly larger ring.



JUST OUT!
MAKE SURE OF YOUR COPY!

PRACTICAL HOUSEHOLDER ANNUAL 1963

A complete guide to home improvements

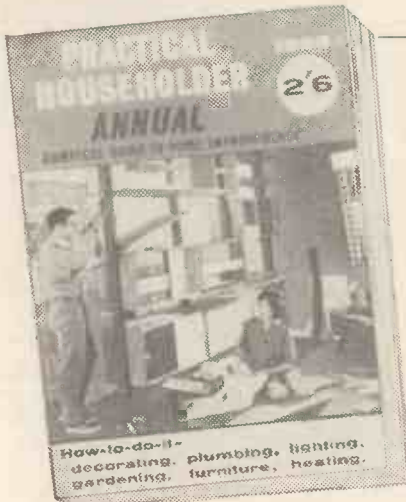

TOOLS AND METHODS Building a tool kit—joints and fastenings—dictionary of tools.

DECORATING The right paints and tools—decorating indoors and out—wallpapering—ceilings—doors and windows.

HOUSE AND GARDEN Building sun porch, pool, garden furniture—laying foundations—draining a lawn.

PLUMBING AND HEATING Basic principles of central heating systems—boiler installation and operation.

ELECTRICITY Converting to ring main system—installing immersion heaters, electric cookers—underfloor heating.

POWER TOOLS Types to buy and how to use them—modern equipment described—electric saw use and maintenance.

FURNITURE, WOODWORKING Built-in furniture—re-upholstering—modern floor coverings—room divider—children's playgym.

KITCHENS Building cupboards and storage units—constructing kitchen cabinets with refrigerator space.

5-YEAR PLAN Detailed plan showing how to decorate and maintain your home progressively, indoors and out.

2/6 from all Newsagents and Bookstalls.

BIG DEMAND! Hurry for yours now!

SALES AND WANTS

The prepaid charge for small advertisements is 9d. per word, with box number 1/6 extra (minimum order 9/-). Advertisements, together with remittance, should be sent to the Advertisement Director, PRACTICAL MECHANICS AND SCIENCE, Tower House, Southampton Street, London, W.C.2.

PERSONAL

WANTED: INVENTIONS:

We are seeking ideas and inventions for technical and commercial development. Send us particulars for advice by our team of consulting experts.

The Commercial Director
INVENTORUS LIMITED
278/282 High Holborn, W.C.1.

PATENTS

PATENTING SERVICES. Advice qualified Agent. C. L. BROWNE, 114 Greenhays Avenue, Banstead, Surrey.

WOODWORKING

ANGLIAN RANGE Saw Spindles, 10in. R/F Sawbenches, 6in. and 8in. Planers, 6in. Sawplanes and Woodworking Lathes. Send 6d. postage for brochures and price list to: THE EAST ANGLIAN TRADING COMPANY, 5 Guardian Road, Norwich, Norfolk. NOR55A.

ELECTRICAL

SMALL ELECTRIC CIRCULATING PUMP for hot or cold water, fish tanks, ornamental fountains, waterfalls, milk cooling, greenhouse watering, pot washers, etc., comprising 120 watt unshrouded type, shaded pole. A.C. motor, coupled to centrifugal die-cast pump. Output 250 g.p.h. Maximum head 6 feet. 220/250 volts. Silent continuous running.
New Price £3.10.0. Post paid.

H.MIDDLETON, 639 ABBEYDALE RD., SHEFFIELD, 7.

ALL TYPES of Electrical Goods at extremely competitive prices, e.g. 5-amp Twin Cable. 35/- 100yd; Lampholders, 7/- doz.; 5ft Battens, 49/-. Quality and immediate dispatch guaranteed. Request list. JAYLON SUPPLIES, 93 Fairholt Road, London N16. (Tel.: Stamford Hill 4384.)

BRAND NEW

BROOK ELECTRIC MOTORS

Single Phase, 1/2 h.p.	1,500 r.p.m.	£7 13 9	
1/2 h.p.	1,500 r.p.m.	£10 7 6	
H.P. TERMS	3/4 h.p.	3,000 r.p.m.	£10 7 6
AVAILABLE	1/2 h.p.	1,500 r.p.m.	£11 16 9
	1 h.p.	3,000 r.p.m.	£11 16 9

Fully guaranteed by makers, approval against cash. Carriage paid mainland. State voltage.

P. BLOOD & CO.

ARCH STREET, RUGELEY, STAFFS.

HOBBIES

CATALOGUE NO. 15. Government surplus Electrical and Radio Equipment. Hundreds of items at Bargain Prices for the Experimenter and Catalogue cost refunded on purchases. Research Engineer, 2/6 post free of 50/- ARTHUR SALLIS RADIO CONTROL LTD., 93 North Road, Brighton.

PICTURE MAKING. Lovely coloured prints up to 22 x 24, fancy mouldings and accessories. Photographic mount list and printers' fancy card lists: RADOFOTE (M.), 13 Bridge Street, Southport.

HANDICRAFTS

MARQUETRY VENEERS, 12 assorted 6/- post free. List 3d. FRANK COLES (VENEERS) LTD., 76 Rivington Street, EC2.

PHOTOGRAPHY

10% DISCOUNT secures a high class camera at WALLACE HEATON, 64 Cheapside, London EC2. Write for Free Lists.

PROJECTORS, Home Assembly Kits, all types and sizes and stereo from £8/2/6. Fan Base Kit £3/7/6. Opticals, Screens, S.A.E., MARSHALL SMITH LTD., 64 Norwich Avenue, Bournemouth.

RADIO

RADIO, TELEVISION Service Sheets. All types Valves. S.A.E. list. JOHN GILBERT TELEVISION, 1b Shepherd's Bush Road, London W6. SEE 6441.

MATCHBOX SIZE Crystal Sets, all parts, instructions 3/3. BAILEYS (P.M.), 23 Fir Lane, Royton, Lancs.

WATCHMAKERS

NEW WATCHES, watch movements. Watchmakers' tools and materials, instructional books, etc. at unbeatable prices. Also watch repairs undertaken. Send 1/- for Bumper Bargain Catalogue. THE WATCHMAKERS' SUPPLY COMPANY, "Time House", Carterton, Oxford.

WATCH REPAIRERS. Send 9d. for Catalogue of Watch parts and New Watches at lowest Wholesale prices, also Used Movements, Instructional Books, Special Kit for Beginners, T. G. LOADER & CO. (Dept. B), 36 Milestone Road, Carterton, Oxford.

FOR SALE

FOOD FOR SERIOUS THOUGHT IF IT WILL RUST IT NEEDS V.P.I. IF IT HAS V.P.I. IT WON'T RUST
See the sign of the "TWO OWLS" below

ASTRO TELESCOPE making. Standard Ramsden push-in eye-pieces, 1in., 1 1/2in., 2in. focus 35/-; with R.A.S. thread 42/6 each. S.A.E. list. Object Glasses, Newtonian Mirrors, Diagonal Mounts, Focusing Mounts, Altazimuth Mountings and Tripods for Reflectors and Refractors. W. BURNET, 99a West St., Boston, Lincs.

WASHING MACHINE Spares, new and second-hand. J. AND D. ELLISON, Barkerhouse Road, Nelson.

RUST PREVENTION WITHOUT CONTACT

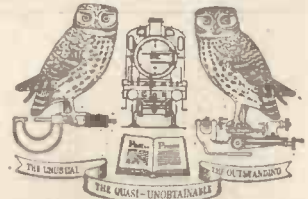

MODEL ENGINEER SERVICES. Lathes, Micrometers, Tools, Scientific Instruments, Saws, Chisels, Watches, Fire Arms, Mowers, Marine Craft, Cycles, Sewing Machines, Nuts, Bolts, Screws, Nails and 1001 ferrous items are constantly menaced—frequently ruined by the engineer's old and persistent enemy—RUST. RUST CANNOT FORM WITHIN 18" OF RUST V.P.I. INHIBITOR PAPER

Small packs now available for: Practical mechanic, engineer, garage, workshop, laboratory, marine craft, sportsman and domestic use and for all with unsolved rust problems.

A Strip under lathes, machine, mower, cycle, model, behind tools in rack, instrument drawer or tool cupboard, engine room or garage, or amongst screws and nails and they will behave as stainless steel indefinitely. Just wipe and put away. No wrapping, oil, paint, or lacquer, no brush, no wasted time—NO RUST. FOOL PROOF: FOUL PROOF: RUST PROOF yet neat, clean, tidy and 100% effective.

Neutralises oxidising effect of Oil Stoves. Essential for winter storage of summer things and winter things in summer. As tested and recommended by Practical Mechanics, Model Engineer, Model Railway News, etc. UNBELIEVABLE

A trial pack will prove V.P.I. a MUST for all workshops, homes and all with ferrous problems. POST ORDERS ONLY (Prices include UK P. & P.)

Why not join with friends and save postage! to: C. D. ELLIOTT OWLES, 8 Bosula, Westerton, Chichester, Sussex, England.

Please send me V.P.I. as ticked below.
Large sheets, 10ins. x 20ins. at 1/6 each
Economy Wallets (2 sheets) 6/-
2 Wallets at 11/- 3 Wallets at 18/-
4 Wallets at 21/- Wallets at 5/- each.
I enclose cheque/P.O. £..... (5 or more 6/- each)

NAME
ADDRESS.....

(Continued overleaf)

1/10 h.p. Motors 3000 revs. with mounting feet
30/- Post 3/-
Dept. 46, WHEELHOUSE
13 Bell Road, Hounslow HOU. 3501

FOR SALE (continued)

COMPRESSORS

Twin Cylinder 2½ cu. ft. 150 lbs.
Base mounting with Vee Pulley

£2-5-0d. 12/- Carriage

Also Safety Valves, Gauges, Tanks, Hose, etc. - S. A. E. Illustrated List.

Dept. 32, WHEELHOUSE 13 BELL ROAD, HOUNSLOW. HOU 3501

HOME ARC-WELDER, uses No. 8, 10, 12 electrodes. From 47/6. Send S.A.E. for details. Also, Oxy-acetylene welder building instructions 2/6. "DRESDEENA", The Harrow Way, Basingstoke, Hants.

BRASS BAR and Rod 1in. x 4in. Bar at 15/- per ft; ¼in. diameter Rod at 6/- per ft. Carr. 2/6. J P LOUDON, 44 Gargour Road, Lesmahagow, Lanark.

EX. A.M. Remote Contactor Unit. 24V. but 12V adequate. Precision made, impulse-driven, one-step motor incorporating make/break switch with indicating manual reset. Modifiable for many timing sequences. 13/- p. and p. 2/-. H. DUCKWORTH, 37 Carr Gate, Cleveleys, Lancs.

NUTS, BOLTS, Washers, Split-pins, Mill-pins, Rivets, Self-tapping Screws and Washers, 1,000 items in all. 12/6 C.W.O. New Delco ¼ h.p. Motors. 220/250V 1 P.H. Endmount. £2/17/6; Footmount £3/7/6. Crompton 220V ¼ h.p. F.M. £3; E.M. £2/10/-. M.A.C., New Building, Troy Road, Morley, near Leeds.

Make your own 2in. Slide Projector. Leech 3in. Lens with Focusing Mount £2.15.0, post 1/6. Pre-Focus Lampholder 5/-, post 6d. Double Condenser Assembly with Carrier 15/-, post 1/-. Lampouse with Mirror 10/-, post 1/6.

All the above parts are removed from Brand New Ex-Government Ellis & Newton 65mm. Strip Projector. The projector complete less lamp, containing all the above parts and many more can be purchased for £4.15.0. Post 4/-.

Similar but Heavier Build Strip Projector Adioscope by Metallair. 3 Element Condenser system. Beck 3½in. lens, Lighting by 110 volts, 200 watt pre-focus lamp, inbuilt transformer to convert 200-250 volt A.C. in wooden carrying case, used but good condition. £5.15.0, plus 5/- carriage (spare lamps 8/- ea. plus 1/- post).

EX A.M. G45 Gun Camera. 24 volt, 21L. fixed focus lens 50 ft. magazine loading complete with magazine, new £2.15.0, ditto used £2. Both post 2/6. Brand new Kodak (Admiralty) 7 x 50 Prism Telescopes, focusing in fitted wooden case with binocular eyepiece, fitted filters, cost over £50; due to another huge purchase lower than ever price £4.10s. each, carriage 5/-.

Brand new (ex A.M.) 12 volt 25 amp. batteries. These are R.A.F. general purpose lead acid accumulators, and are similar in construction to normal car battery. Very suitable for cars and vans, will start any vehicle. Never been filled and in original tropical packing. First charge instructions included, cost about £11, only £2.10.0 each, carriage 5/-.

All Metal Projector Stands, Lightweight, fold flat when not in use, various heights available between 2 ft. and 3 ft. 10 in. Table approximately 40 x 13in. Grade 1 £4, Grade 2 £2.10.0, both carriage 7/6. All are in good condition, used, but paintwork is very good on Grade 1 models.

Ex R.A.F. Aerial Film. 9½in. x 300 ft. Pan, £3. 160ft. 35/-, 5½in. x 47ft. 8/-, 24ft. 5/-. Ideal for cutting to smaller sizes. Perfect condition. Post 1/6. Ex A.M. G45 Mark 3 Recorder Camera. 16 mm. made by Specto. Latest model with three shutter speeds, 2 or 16 f.p.s. bloomed 1½in. lens F1.9 with iris to F.16, 24 volt 50ft. magazine loading, complete with magazine in original tropical packing, absolutely brand new, only £5, post 2/6. Ditto used £3.10.0, post 2/6.

All goods supplied on 14-day money back guarantee. R. SANKEY Regal Cinema, ATHERSTONE
WARWICKS. Tel.: Athertons 2220, 3210

SPEAKERS 7/9d. 7 x 4in. or 6in. Salvage guaranteed. Transistors, new, 2/- Tape Cabinets, 19/6d. 'LISTS', 621, Romford Road, Manor Park Broadway. ILFORD 6001.

ALUMINIUM, BRASS, Copper and Bronze in sheet, rod, strip, tube, also Stainless Steel sheet. Any size cut. Complete price list 1/-. SLATER METALS (N.F.) LTD., 17 Slater Street, Liverpool 1.

CLUB, CAR and Lapel Badges at realistic prices from: TESTER HATCHER & CO. LTD., Cliffe, Rochester, Kent.

UNOWOT WHISTON SELLS, S.A.E. 5,000 item Catalogue, 200 useful mixtures. WHISTON (Dept. PMU), New Mills, Stockport.

TUBES 15/-, 15in., 14in., 12in. Guaranteed. Postage 5/-, 623 Romford Road, E12. ILFORD 6001.

EDUCATIONAL

POSTAL TUITION in Technical Drawing, Tracing and Blueprint Reading. Drawing and design in Wood or Metalwork for Handicraft Teachers Examinations. Details from: O. PANNELL, 145 The Crossway, Portchester, Hants.

G.C.E. in Geometrical Drawing. Postal tuition to "O" level. O. PANNELL, 145 The Crossway, Portchester, Hants.

"HOW AND WHY" of Radio and Electronics made easy by a new non-maths practical way. Postal instructions based on hosts of experiments and equipment building carried out at home. New Courses bring enjoyment as well as knowledge of this fascinating subject. Free brochure from: Dept. 12, P.M. RADIOSTRUCTOR, Reading.



'S MADE

By repairing Radio and TV Sets as a job or as a spare time business. Our practical course will show you the way. No previous experience is required. SEND FOR FREE BOOK TODAY!

RADIOSTRUCTOR

Dept. G80

READING, BERKS

MISCELLANEOUS

AQUALUNG AND COMPRESSOR Equipment, Ballraces and Miscellaneous Items. Lists 3d. PRYCE, 157 Malden Road, Cheam, Surrey.

TOOLS

LARGEST STOCKS of Bargain new Cutting Tools. Send for free list. ENGINEERING TOOLS LTD., 313 New North Road, London N1. Phone: Canonbury 9977. Cables: Gepetra Londondri.

HOME BOAT BUILDING

BROMLEY BOATS, Kits, Mahogany, Silver Spruce, American Boat plans, 3d. list. Southlands Road, Bromley, Kent.

FULLY PREFABRICATED Kits to assemble a boat at home for two-berth Cabin Cruisers, fast Runabouts, Canoes, Frams, Enterprise Signet Sailing Dinghies. Leaflets from WYVERN BOATS (WESSEX) LTD., Milborne Port, Sherborne.

SITUATIONS VACANT

A.M.I. Mech.E., A.M. Brit. I.A.E., City and Guilds, G.C.E., etc. bring high pay and security. "No pass—no fee" terms. Over 95% success. For details of exams and courses in all branches of Engineering, Building, Electronics, etc., write for 148-page handbook, free. B.I.E.T. (Dept. 967B) London W8.

NYLON · P.T.F.E.

ROD, BAR, SHEET,
TUBE, STRIP, WIRE

No quantity too small List on application

BRASS · COPPER
LIGHT ALLOYS
ALUMINIUM · BRONZE

H. ROLLET & CO. LTD.

6 CHESHAM PLACE, LONDON
S.W.1. BELgravia 4300Also at Liverpool, Leeds, Manchester,
Birmingham

GAMAGES

STRONG HEAVYWEIGHT ALL STEEL TOOL BOXES

First quality, British made boxes in 20 gauge sheet steel, stove enamelled in a blue finish. Universal barn-top boxes with lift-out sliding tray and swivel handles on hinged lid.

Size 14in. x 8in. x 7in. Approximate weight 6½lb. Part Carriage & Pkg. 3/6. **21/9**

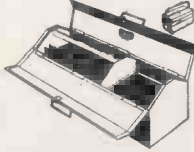

Size 18in. x 7in. x 7in. Approx. wght. 9½lb. Part Carr. & Pkg. 4/-. **34/6**

Size 24in. x 8in. x 8½in. Approx. wght. 13½lb. Part Carr. & Pkg. 4/9. **39/6**

'CANTILEVER' ALL STEEL TOOL BOXES

FIRST QUALITY, BRITISH MADE
Automatically opened or closed by pulling or pushing on handle. Provision for padlock on all boxes.

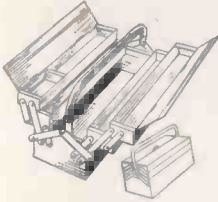

Size 18in. x 8in. x 8in. with 5 trays. Weight 14½ lbs. approx. **55/6**

Size 22in. x 8in. x 8in. with 5 trays. Weight 17½ lbs. approx. **68/9**

If outside our Van area part Carr. & Pkg. 4/9.

GAMAGES, HOLBORN, LONDON, E.C.1. HOLborn 8484

The FLAKE with the FLAVOUR



4'9½
PER OZ

GEAR TRAINS. 10 gears with governor and 3 take offs and cam operated switch. 6in. x 3in. 6/6 ea.

BRASS SLIDE MOVEMENTS. 12in. long x 2in. x 2in. Runs on channel in 5 ball races. 8/6 ea. Post 1/6.

PILOTS' MICROPHONES. Magnetic with switch. 3/6 ea. Carbon throat mikes, 5/- pair or 2/6 ea. Magnetic throat mikes. New inserts. Will pick up from any vibrating surface, 2/6 ea, 18/- doz.

DOWTY PRESSURE SEQUENCE VALVES. Type D1290 Mk. F, adjustable for most pressures. New, £1 ea.

RELAYS. Siemens H.S. 2000 ohm, 8/6. Ditto 145 ohm in waterproof case, 8/6.

H.S. RELAY. 175 ohm Plat S.P.C.O. Fully adj. Will work from ½ v. at 1 mA, 6/6.

LATCHING RELAY. 230 v. A.C., 8/6.

LOXEX RELAY. 12 v., 10 a, C O., 6/6.

THERMAL HOT WIRE RELAYS. Adjustable contacts to work on 50-250 v. A.C. or D.C., 6/6.

THERMOSTATS. Bimetal, adjustable from zero upwards, 8/6 ea.

ELECTRO MAGNETS. 900 ohm with small lever movement. Useful for latching device, 3/- ea. 24/- doz. 12 assorted used and soiled relays for experimenters, 30/-.

UNSELECTORS. 8B, 25 w. New, 6/3; Ex New equip., 50/-; Used need checking, 10/- 6B, 25 w. New, £2.10.0. Ex New, £2. 4b, 25 w. New, £2.0.0; Ex New, 30/-.

TOGGLE SWITCH. Heavy Duty. 4 B. C.O. Centre off. Ideal motor control, single or three phase, 230-400 v. 5 a, for stop, start and reverse. New, 3/6 ea., 30/- doz.

TOGGLE SWITCHES. On-Off. Bak., 1/-; Metal, 1/6; Two-way, 2/6; Used assorted, 9/- doz.

MINIATURE HIGH SPEED MOTORS. 24 v. with speed governor, coupled to gyro mirror, fitted electric magnetic system for deflection control, 25/- ea. Post 4/-.

ROTARY VANE VACUUM PUMPS. Ex R.A.F., 30/- Smaller type with 24 v. motor, Brand New, £3. R.A.F. piston type compressors, 100 lb., 30/-.

ACTUATORS. 24 v. motor drives 6in. arm through 90 degrees with automatic reverse switchgear. Brand new 17/6 ea. Post 4/-.

MERCURY VAPOUR LAMPS. 200-250 v., 125 w., 12/6 ea.

POINTOLITE. 100-250, 500 w., 10/-.

PHOTO CELLS. Osram CM G8, New, 5/- ea. 12/6 matched prs Cad-Sulph. differentiating pr. 17/6.

MINIATURE GEARED MOTORS. 6 v. D.C. motor fitted res. for 24 v. with ELECTRO-MAGNETIC CLUTCH. Speed one R.P.M. Automatic speed control. Seven ball races in gear box. Worm gears throughout. Torque 15 lb. Brand new in the cast case with relay and micro switches. £2 ea. Cost £30. Motor only, 35/-.

Small Motors, fitted fans, 24 v., 12/6. Ditto with blower housing, 27/6. Suit projectors.

SYNCHRONOUS MOTORS. 230 v. A.C. One rev. per 24 hours, 35/- Ditto 20 rev. per hour, fitted switchgear, 12/6. Ditto fitted numerous gears with low final speeds, 8/6 ea. Post 1/6.

TIME SWITCHES. 230 v. A.C. fitted automatic Solar Dial. 45/- ea.

HAND GENERATORS. Will charge 2, 6, 12 or 24 v. batteries at 2 amps., 30/- ea. Carr. paid.

INFRA RED MONOCULARS. For the detection of infra-red light sources. Tested O.K., 35/-.

ZAMBONI PILES. 1500 v. Checked O.K., 17/6 ea. Not guaranteed, two for 10/- Gels checked O.K., 17/6.

FAULTY I.B. MONOCULARS. 3 for 30/-

INFRA RED OPTICAL SYSTEMS with cells sealed in perspex. Brand New, 12/6 ea.

CAMERA SHUTTERS. VARIO, with Iris, flash contacts, finger and cable release sockets. Brand new with fitting ring, 8/6 ea.

SCHMIDT TYPE PROJECTION SYSTEM. Mirror, flat and correcting plate in one unit. 7in. dia. mirror, Brand New, 70/-.

BURGLAR TROUBLE? Large TWIN GONG BELLS, 230 v. A.C. will wake the dead, 35/- ea. Camera and photo flood on same circuit will take picture of thieves or number of van. Cost—under £10 for D.I.Y. kit, including camera. Cameras only, 16 mm. Cine, FI-9, New, £5. Used F4, £3.10.0.

For the latest and best
NEW and EX GOVMT. BINOCULARS and TELESCOPES
See our lists or call and inspect. Over 100 different types of instruments to choose from, also Dumpy Levels, Theodolites, Microscopes, Periscopes, Stereoscopes, Rifle sights, Projectors and Enlargers. KITS, Lenses, Filters, Prisms of all types, Eyepieces, Tubes, Geared Heads, Mountings, Finders, Clinos, Lamps, Oscilloscopes, Motors, Pumps, Blowers, Converters, you name it, we usually have it.
For testing telescopes and binoculars we have a 20-mile view of beautiful Essex countryside so that YOU can SEE for YOURSELF the difference between the wide choice we have to offer. Choose a fine day for a run in the country and pay us a visit.
Booklets, "How to use Ex-Govt. Lenses and Prisms", Nos. 1 and 2, 2/6 ea. Lists Free for S.A.E.
FOR OPTICAL EQUIPMENT DESIGNED BY EXPERTS AT PRICES YOU CAN AFFORD, CONSULT
H. W. ENGLISH, 469 RAYLEIGH ROAD, HUTTON, BRENTWOOD, ESSEX. Brent. 1685.

EARN

There's plenty of room at the top for technically trained men—room for YOU if you want quick promotion or a better-paid more interesting career. N.I.E. can quickly give you a *guaranteed* spare-time Postal Training, in the comfort of your own home and open up a whole new world of opportunity for you.

Find out, as thousands of others have done, how *easy* it is to learn at home with N.I.E. Send for *Success in Engineering*—136 pages of information you can use—and details of pay-winning Courses in all branches of Engineering, Building, Local Government, etc. Get your copy today—FREE!

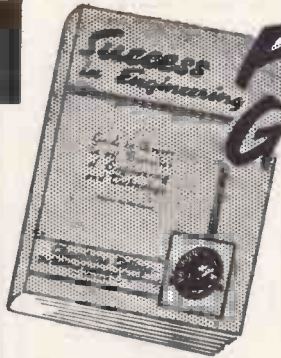

FREE GUIDE!

One of the following Courses taken quietly at home in your spare time can be the means of securing substantial well-paid promotion in your present employment, or entry into a more congenial career with better prospects.

MORE

This remarkable FREE GUIDE explains:

- Openings, prospects, salaries, etc., in Draughtsmanship and in all other branches of Engineering and Building.
- How to obtain money-making technical qualifications through special RAPID FULLY-GUARANTEED COURSES.

A.M.I.Mech.E., A.M.I.M.I., A.M.Brit.I.R.E., A.M.I.Prod.E., A.M.I.C.E., A.M.I.Struct.E., A.M.I.Mun.E., M.R.S.H., A.M.I.E.D., A.F.R.Ae.S., London B.Sc., Degrees.

Fully guaranteed postal courses for all the above and many other examinations and careers. Fully described in the New Free Guide

SOON

We definitely guarantee that if you fail to pass the examination for which you are preparing under our guidance, or if you are not satisfied in every way with our tutorial service—then your Tuition Fee will be returned in full and without question. This is surely the acid test of tutorial efficiency.

If you have ambition you must investigate the Tutorial and Employment services we offer. Founded in 1885, our success record is unapproachable.

**ALL TEXTBOOKS ARE SUPPLIED FREE
PROMPT TUTORIAL SERVICE GUARANTEED
NO AGENTS OR TRAVELLERS EMPLOYED**



BECOME A DRAUGHTSMAN - EARN BIG MONEY

Men and Youths urgently wanted for well paid positions as Draughtsmen, etc., in all Branches of Engineering. Our Guaranteed "Home Study" courses will get you in. Those engaged in the General Drawing Office should study some specialised Branch, and so increase their earning capacity.



NATIONAL INSTITUTE OF ENGINEERING

A.I POSTAL COURSES

ENGINEERING, RADIO, AERO, ETC.

- | | |
|--------------------------|----------------------------|
| Aero, Draughtsmanship | Elec. Draughtsmanship |
| Jig & Tool Design | Machine " " |
| Press Tool & Die Design | Automobile " " |
| Sheet Metalwork | Structural " " |
| Automobile Repairs | R/F Concrete " " |
| Garage Management | Structural Engineering |
| Works M'gmt. & Admin. | Mathematics (all stages) |
| Practical Foremanship | Radio Technology |
| Ratefixing & Estimating | Telecommunications |
| Time & Motion Study | Wiring & Installation |
| Engineering Inspection | Television |
| Metallurgy | Radio Servicing |
| Refrigeration | Gen. Elec. Engineering |
| Welding (all branches) | Generation & Supply |
| Maintenance Engineering | Aircraft Mainten. Licences |
| Auto Engine Technology | Aerodynamics |
| Diesel Engine Technology | Electrical Design |

BUILDING AND STRUCTURAL

- | | | |
|-----------------------|------------|--------------------------|
| A.I.O.B. | A.I.A.S. | M.R.S.H. |
| A.M.I.P.H.E. | A.A.L.P.A. | A.I.Q.S. |
| Building Construction | A.R.L.C.S. | Builders' Quantities |
| Costs & Accounts | | Carpentry & Joinery |
| Surveying & Levelling | | Building Inspector |
| Clerk of Works | | Building Draughtsmanship |
| Quantity Surveying | | Heating & Ventilating |

GENERAL, LOCAL GOVERNMENT, ETC.

- | | |
|---------------------------|----------------------------|
| Gen. Cert of Education | A.C.I.S., A.C.C.S. |
| Book-keeping (all stages) | A.C.W.A. (Costing) |
| College of Preceptors | School Attendance Officer |
| Woodwork Teacher | Health Inspector |
| Metalwork Teacher | Civil Service Exams. |
| | Housing Manager (A.I.Hsg.) |

POST COUPON FOR FREE BOOK

Please send me a FREE copy of "Success in Engineering".

NAME

ADDRESS

.....

Subject or exam of interest

NATIONAL INSTITUTE OF ENGINEERING
(Dept. 29) 148-150 Holborn London EC1