

Improving the Superhet — See Page 158

A
NEWNES
PUBLICATION

Edited by
F.J. CAMM
Vol. 15. No. 372.

Practical Wireless and

3!

EVERY
WEDNESDAY

Nov. 4th, 1939.

★ PRACTICAL TELEVISION ★

Contents

Making 465 kc/s I.F. Transformers

D.C. High-tension Eliminators

Fading and A.V.C. on the Short Waves

Thermion's Commentary

A Novel Volume Control Circuit

Practical Television

Improving the Superhet

Pilot and Dial Lamps

Readers' Letters

Practical Hints

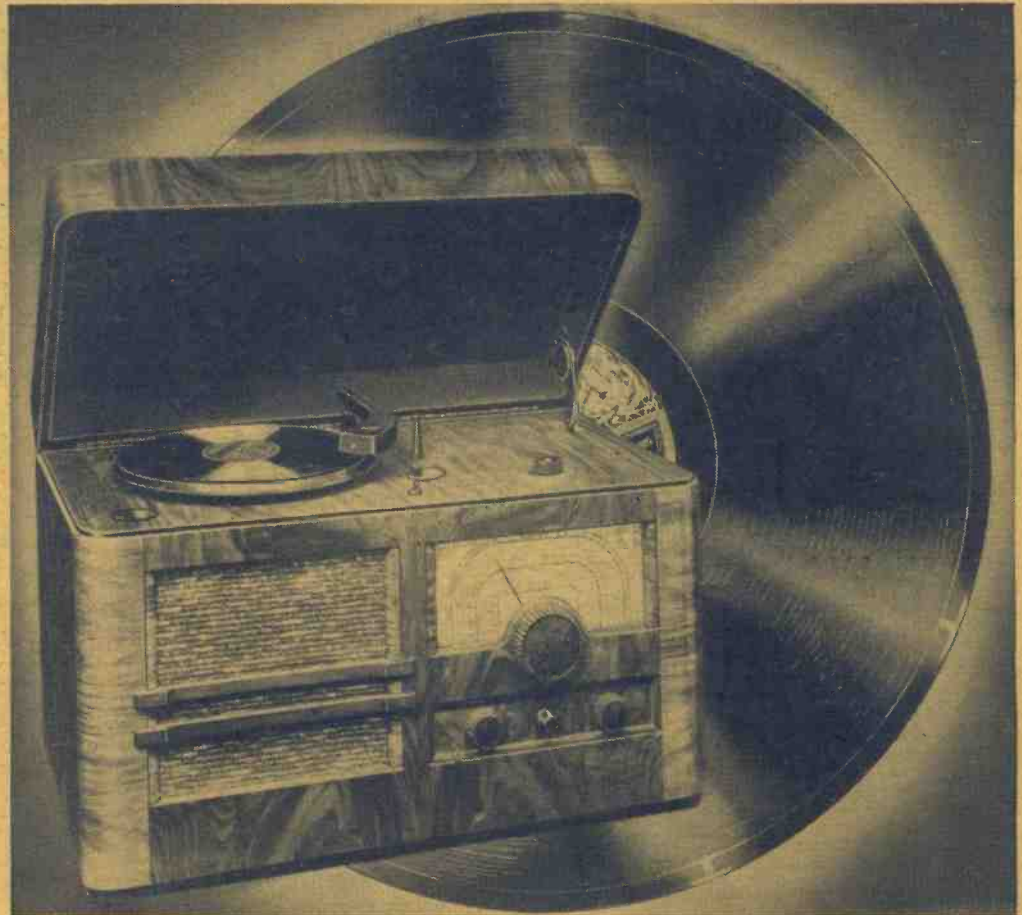

POINTS ABOUT PICK-UPS

Everything the Enthusiast Wants to Know in

THE WIRELESS CONSTRUCTOR'S ENCYCLOPEDIA

By F. J. CAMM.

PROFUSELY ILLUSTRATED.

A Complete Guide, in Alphabetical Order, to the Construction, Operation, Repair, and Overhaul of all types of Wireless Receivers and Components, including Definitions of all Terms and Units.

From all Booksellers or by post 5/6 from the Publishers, GEORGE NEWNES, LTD. (Book Dept.), Tower House, Southampton St., Strand, London, W.C.2

5!

NET

STIRRING NEW WAR WEEKLY

No. 1 Out To-day

DIFFERENT FROM ANYTHING YOU HAVE SEEN BEFORE, AND BETTER!

"THE WAR WEEKLY" is the most important publication since the outbreak of hostilities. Carefully planned and conceived, it provides each week a dramatic record in picture and narrative of the progress of the conflict on all fronts.

World-famous writers contribute to its pages—and they tell you the things you want to know. Skilled artists supply diagrams and maps, and large reconstructed pictures which illustrate graphically what is really happening; while a big supplement of striking photographs from the Western Front and Neutral sources is printed by the lifelike photogravure process.

"THE WAR WEEKLY" is an authoritative and unforgettable record for every home in the land—a record of the bravery and devotion of the men and women engaged in the struggle to save civilization from Nazi domination.

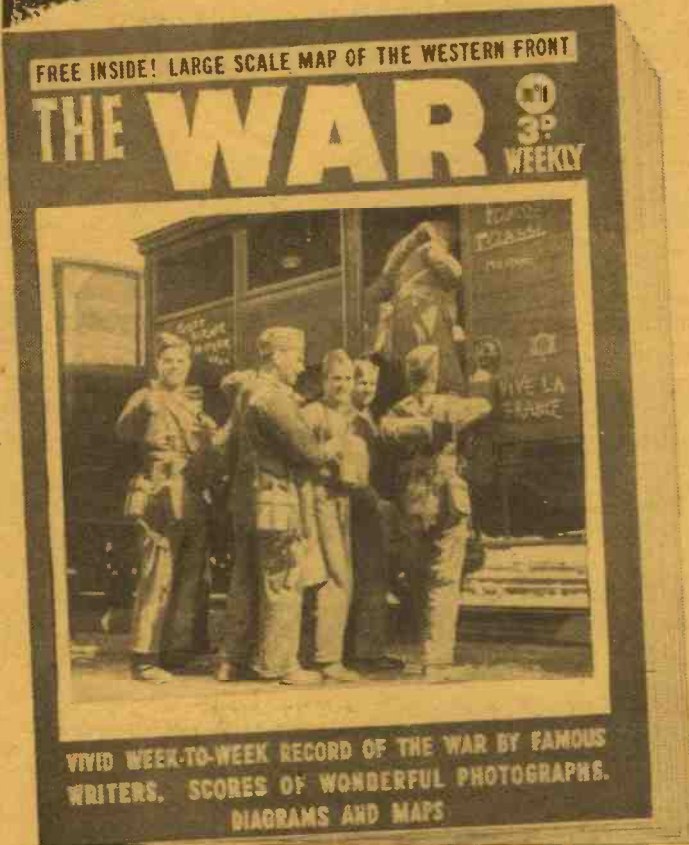

WORLD-FAMOUS AUTHORITIES
who contribute to
"THE WAR WEEKLY" No. 1

SIR HUBERT GOUGH, G.C.B.

Commander of the valiant Fifth Army in the last war. He writes in No. 1 on "Hitler's Lost Horizon—The Baltic."

RT. HON. A. DUFF COOPER, M.P.

One of the most outspoken opponents of the Nazi regime. His contribution to No. 1 is "The Man who will slay the Nazi Dragon."

MADAME TABOUIS

Europe's greatest political writer—the one woman Hitler fears. She deals in No. 1 with Germany's Russian Gamble.

MAJOR-GEN. A. C. TEMPERLEY, C.B., C.M.G., D.S.O.

The celebrated writer on military affairs who has held many staff appointments. "Can we smash through the Siegfried Line?" he asks in No. 1 of "The War Weekly."

ELLEN WILKINSON, M.P.

A. G. MACDONELL, etc.

FREE
Inside Every Copy



THE WAR WEEKLY

3D EVERY FRIDAY Get No. 1 from your Newsagent to-day

Practical and Wireless

★ PRACTICAL TELEVISION ★

EVERY WEDNESDAY

Vol. XV. No. 372. Nov. 4th, 1939.

EDITED BY
F. J. CAMMStaff:
W. J. DELANEY, FRANK PRESTON,
H. J. BARTON CHAPPLE, B.Sc.

ROUND THE WORLD OF WIRELESS

Pick-up Factors

THE use of a gramophone pick-up is often accompanied by complaints that the gramophone records are worn out more quickly than when a standard acoustic gramophone is employed. This, of course, indicates that the pick-up is being wrongly used, as the electrical pick-up has the needle held more or less freely so that it does not wear the sides of the record. On the other hand, a standard sound-box has a fairly stiff mica or metal diaphragm which holds the needle rigidly and it accordingly exercises more wear and tear than the electrical reproducers. It is, however, essential to see that the pick-up is so mounted that the correct tracking angle is followed and also that other factors are followed—according to the makers' instructions. Any broadcast receiver which gives reasonable quality of reproduction will also give reasonable reproduction with a pick-up, but in many cases better quality will be obtained from records than from radio. There is a right and a wrong way of using a pick-up, and in this issue we give some further details on this interesting topic. Remember always, however, that the set makers' and the pick-up makers' instructions must be followed if the best is to be obtained from their respective products.

B.B.C. Symphony Orchestra

THE B.B.C. announces that the Symphony Orchestra is to visit the Colston Hall, Bristol, weekly on Wednesday beginning November 1st. The concerts start at 7 p.m. and finish at 9 p.m. Prices will be popular and full details of pro-

grammes and solo artists will be announced shortly. The first concert (November 1st) is being conducted by Sir Adrian Boult.

Television Teaser

FEAR that he might go suddenly mad is bothering Wilfred Guenther, co-ordinator of facsimile, television and short-wave at American station WLW. Guenther's dog recently engaged in a scrap with a neighbour's dog. It developed that the neighbour's dog had rabies. After the fight, Guenther picked up his dog and, although the pet is inoculated against rabies, thinks that some of the poisonous saliva from the mad dog might have been on his dog's hair when he picked it up. "If I start frothing at the mouth—scram, and scam fast," Guenther has advised his fellow workers.

"The People of France"

FOLLOWING up the success of the recent broadcast of "The Spirit of Poland," Moray McLaren, Assistant Director of Features and Drama, is arranging a programme on the theme of France. This is entitled "The People of France," and will be heard on November 4th.

The subject being much too vast to be treated as a whole in one programme, McLaren plans to take some small part of France—some little town perhaps—as a sort of microcosm of the whole country and show how its people represent the qualities of the whole. He hopes to get the collaboration of Frenchmen who will come to the microphone and also lovers of France. "The People of France" will not be so much a dramatic programme as a descriptive and evocative one. Moray McLaren will handle production.

Baird Bomb Detector

BAIRD TELEVISION have been turning their scientific abilities to war-time use, and it is announced that they have succeeded in developing a sensitive photo-electric detector for indicating the presence of incendiary bombs and fires. The apparatus is so sensitive that it will operate from the flare from 10 grains of

magnesium flash powder ignited 260 feet distant.

Red and Blue Networks

THOUSANDS of eyes in Greater Cincinnati were attracted to brilliant red and blue lights on the top of Carew Tower, the city's tallest building, recently. Putting them there was the idea of Cecil Carmichael, press relations director of WLW, to call attention to the fact that the N.B.C. Red and Blue network programmes were now to be heard exclusively on WLW and its sister station WSAI.

Wireless Register

THE British Institution of Radio Engineers (Duke Street House, Duke Street, London, W.1), after consultation with the authorities, has arranged to compile a register of its members and others who are anxious to take some part in the National Service Work where their radio training and experience can be utilised.



A Frances Day Penny Fund, for providing gifts for members of the fighting services, was recently inaugurated. Above is Miss Frances Day and Capt. E. B. Hambro, of the 15th Hussars, counting some of the initial collection. £15 in coppers is in the "glass."

Editorial and Advertisement Offices: "Practical Wireless," George Newnes, Ltd., Tower House, Southampton Street, Strand, W.C.2. Phone: Temple Bar 4363.

Telegrams: Newnes, Rand, London. Registered at the G.P.O. as a newspaper and for transmission by Canadian Magazine Post.

The Editor will be pleased to consider articles of a practical nature suitable for publication in PRACTICAL WIRELESS. Such articles should be written on one side of the paper only, and should contain the name and address of the sender. Whilst the Editor does not hold himself responsible for manuscripts, every effort will be made to return them if a stamped and addressed envelope is enclosed. All correspondence intended for the Editor should be addressed: The Editor, PRACTICAL WIRELESS, George Newnes, Ltd., Tower House, Southampton Street, Strand, W.C.2.

Owing to the rapid progress in the design of wireless apparatus and to our efforts to keep our readers in touch with the latest developments, we give no warranty that apparatus described in our columns is not the subject of letters patent.

Copyright in all drawings, photographs and articles published in PRACTICAL WIRELESS is specifically reserved throughout the countries signatory to the Berne Convention and the U.S.A. Reproductions or imitations of any of these are therefore expressly forbidden. PRACTICAL WIRELESS incorporates "Amateur Wireless."

Making 465 Kc/s I.F. Transformers

Complete Winding Data and Details for Constructing Three Different Types of Variable-selectivity Transformer

SOME time ago we published constructional data of coils and I.F. transformers of different kinds, and many of the issues describing these components are now out of print. We have received, however, many requests for constructional data of I.F. transformers suitable for use in modern superhets, and as the majority of modern coils are designed for an I.F. of 465 kc/s, the 465 transformer must be used. We are therefore giving below a reprint of the main constructional details of transformers of this type. Fig. 1 shows the constructional details from which it will be seen that the primary and secondary coils are wound on ribbed ebonite formers, and these are tightly fitted on to a length of wooden dowel rod arranged inside a screening box. A transformer to tune to 465 kc/s—which approximates to an equivalent wavelength of 650 metres—can be made by using 120 turns of 36-gauge d.c.c. or enamelled wire for primary and for secondary. This is the total number of turns on each former, although they are split into sections to minimise self-capacity.

Connections

The transformer can be used as shown in the circuit in Fig. 2, by connecting a .0003-mfd. pre-set condenser across each winding for trimming purposes. Incidentally, it is better to employ one of the new types of trimmer on steatite or similar bases, such as are made by Polar, Bulgin and others. These condensers, besides being somewhat more efficient than older types, have a lower minimum capacity and are considerably more compact.

By following the form of construction shown in Fig. 1, it is easily possible to alter the coupling between primary and secondary and thus to vary the bandwidth covered; in other words, to obtain variable selectivity, which is a valuable asset in many modern superhets. The only objection is that the selectivity cannot be varied by means of an external control, and is therefore only pre-set, being adjustable only after removing the screening can and probing inside the set.

"Top-capacity" Variable Selectivity

There are, however, various methods of providing an external adjustment, one of the simplest being by using a .0001-mfd.

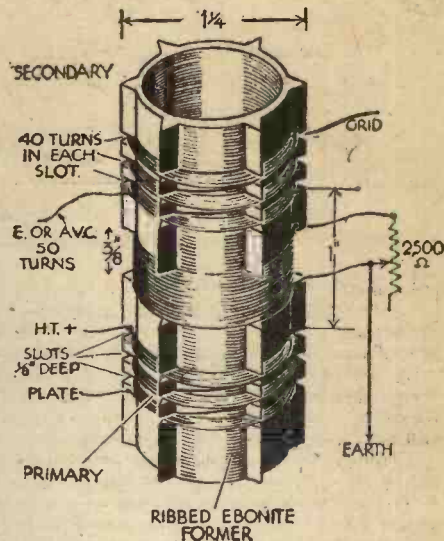

Fig. 5.—How to connect a variable resistance for varying the selectivity.

found that the coils must be well separated, for otherwise the coupling will be too great.

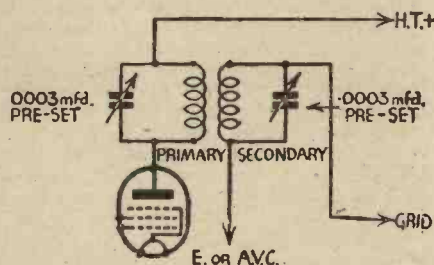

Fig. 2.—Connections for the transformer shown in Fig. 1.

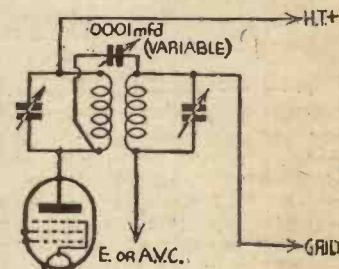

Fig. 3.—How to obtain variable selectivity, by means of a small variable condenser.

variable condenser to provide "top-capacity" band-pass coupling. It is wired between the high-potential ends of the windings, as shown in Fig. 3—between the anode terminal of the primary and the grid terminal of the secondary. When using this system the I.F. transformer should be mounted near to the panel control so that extremely short leads can be used between the condenser and the transformer. Still further to assist in eliminating unwanted "pick-up" and coupling, it is often an advantage to screen the leads. With the arrangement described, preliminary adjustment can be made by varying the distance between the two coils, the variable condenser being used only when the set is tuned to a signal. In general, it will be

Moving Coil

Another arrangement is to mount the two coils so that one of them can be rotated—in rather the same manner as one of the windings of the once-popular variometer could be moved. The idea is shown in Fig. 4, where it will be seen that the secondary winding is mounted on a length of screwed brass rod passing through the

(Continued on page 164)

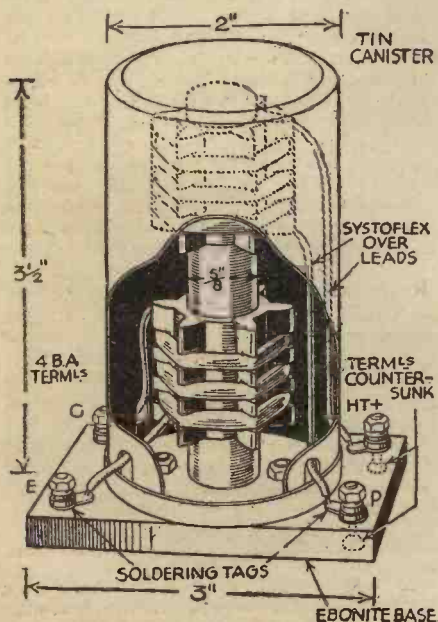

Fig. 1.—The simplest form of home-made I.F. transformer—for which an ordinary cylindrical screen may be used.

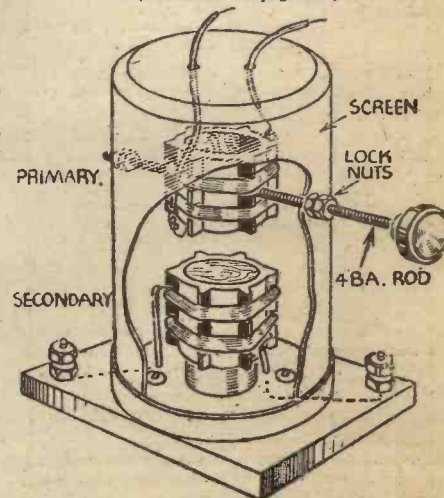
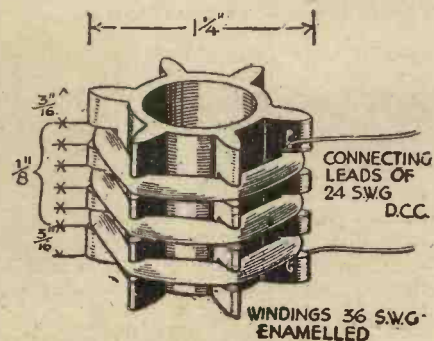

Fig. 4.—An alternative variable selectivity scheme.

D.C. HIGH-TENSION ELIMINATORS AND L.T. CHARGERS

Technical and Practical Details Relating to Direct Current Operated Equipment

By L. O. SPARKS

IN spite of the progress which has been made by the various electricity supply companies with the changing over of direct current supplies to alternating, there are still many towns and districts using D.C., and consequently there is always a steady demand for eliminators and L.T. chargers suitable for such supplies.

Although D.C. can provide a very handy source of voltage and unlimited current, so far as the average constructor is concerned there are many who bemoan the fact that their electricity supply is not A.C.

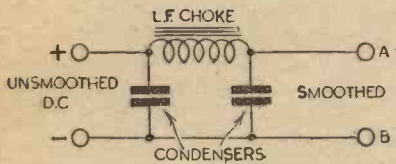

Fig. 1.—The essentials of a smoothing circuit. The condensers can be 4 mfd. or 8 mfd.

While admitting that D.C. voltages cannot be stepped up so conveniently as A.C., it must be realised that it does offer definite advantages in other directions. For example, it is well known that an A.C. supply can be stepped up or down by making use of a suitable type of transformer, a component, which, by reason of the ratio of its primary winding to its secondary winding, will increase or decrease the initial applied voltage.

This characteristic of A.C. is certainly very handy, but it does not alter the fact that one is still dealing with alternating current, which in its natural state is totally unsuited as a source of H.T.; therefore, one has to employ some form of rectifier, either valve or metal rectifier, to convert it to direct current. Unfortunately, the complete conversion does not end there, owing to the fact that no rectifier is perfect, and a very pronounced ripple, which would manifest itself aurally as a violent hum, would still be present in the rectified current. To overcome this, it becomes necessary to make additions to the circuit in the form of a suitable smoothing choke and at least two large capacity condensers, these having the effect of smoothing out practically all ripple and thus rendering the current suitable for use as high tension for a receiver or amplifier.

It will be appreciated that the components mentioned above naturally make the cost of the mains equipment something to be considered, and it is in this direction that a D.C. supply scores, as it does not call for any transformer or rectifier, while its smoothing section need not be as elaborate or make use of such high-voltage condensers.

Against this, however, there is the snag, if it does really amount to such, that the initial supply cannot be stepped up in such a simple manner as A.C. if voltages higher than those of the supply are required. In the early days of radio this was much more serious than it is to-day. With the development of the modern valves and the

introduction of negative feed-back, to mention but two main items, it is now possible to get all the power and quality usually required for normal use, so the question of limited voltages does not, therefore, become such a detrimental factor as it would at first appear.

High-tension Eliminator

For the reason which will be explained later, it is not possible to give a definite design for an eliminator, as, apart from other considerations, it is very doubtful if any two constructors will have identical requirements as regards the number of H.T. feeds and the values of the voltages desired. In view of this, the details given in this article must be taken as the basis for each constructor to use to develop a finished unit which will satisfy his own particular demands, and, provided the essential features are embodied, there is no reason why a highly satisfactory eliminator should not be made.

Assuming that the electricity supply mains have a voltage between 200 and 250, which is the standard of most supply companies, the first problem to be tackled is the elimination of any ripple which might be present, as it must not be overlooked that in spite of the fact that the supply is D.C., it does not mean that it is "pure" enough for such purposes as we have in mind.

A simple and almost universal smoothing arrangement can be formed with a good make of L.F. choke in conjunction with two fixed condensers, each having a capacity of, say, 4 or 8 mfd. The manner

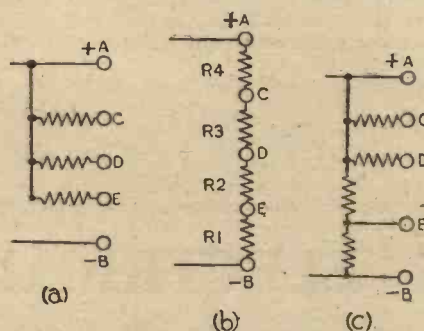

Fig. 3.—Three resistance networks suitable for voltage dropping and dividing.

in which these are connected is shown in Fig. 1, where it will be noted that the L.F. choke is in series with the positive side of the supply, and the condensers are in parallel with or across the mains, one on each side of the choke.

The condensers must have a voltage rating in excess of the voltage of the supply, for example, 350 volt working, and those having a rating below 250 volts D.C. should certainly not be used. In this direction, there is also another point to observe. It is now quite common practice to use electrolytic condensers when large capacities are required, but owing to the fact that the

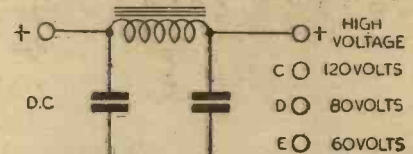

Fig. 2.—Indicates possible voltageappings required for an average installation.

connections of these types have to be made with due regard to the positive and negative side of the circuit, particular care must be taken if such condensers are embodied in the design to see that the connections to the mains are correct as regards polarity, otherwise, serious harm can be done to the condensers. Ordinary fixed condensers of the Mansbridge type do not, of course, necessitate such considerations.

The L.F. choke should be selected with care. For efficient smoothing it is necessary for it to have an inductance of 20 to 25 henries at, say, 50 mAs for average requirements, although, if the receiver or amplifier has a higher current consumption than this, then one having the same inductance value at the higher current must be obtained.

Voltage Dividing and Dropping

So far, according to Fig. 1, the voltage across the points A B will be slightly less than that of the mains, as soon as any current is flowing in the circuit. The reason for this will be obvious a little later. While this value might be suitable for the output stage, if a suitable valve is in use, it is very unlikely that it will do for other parts of a normal battery-operated receiver, so some means must be incorporated for providing lower voltages to suit individual circuit requirements.

From Ohm's Law, which, as every constructor should know, states that for a D.C. circuit "the current (I) flowing equals the voltage (E) divided by the resistance (R) of the circuit," it will be seen that before any arrangements can be made for voltage dividing or dropping, two factors must be known. Let us consider Fig. 2, which is intended to represent possible voltages which might be required, and as the voltage (Fig. 1) will have to be reduced by resistances to the lower values, it will be appreciated that the current consumption of the circuits which will be connected to the points C, D and E must be known, either by measurement or calculation, before the necessary resistance values can be determined. For example, supposing that the voltage at A is 200 volts, and that the current flowing in C, D and E is 10 mAs, 5 mAs and 2 mAs respectively. How does one calculate the resistance values?

Resistance Networks

An examination of Fig. 3 will reveal three resistance networks, all of which can be used to produce the required results. The system shown on the left is nothing more than simple series resistances, whose values are selected according to the current flowing in each circuit and the voltage required, and can, therefore, be calculated in the following manner.

Ohm's Law can be rearranged thus: $R \text{ (Resistance)} = \frac{E \text{ (Volts)}}{I \text{ (Current)}}$, but when deal-

ing with current values usually associated with the H.T. side of a receiver, we must

(Continued on page 164.)

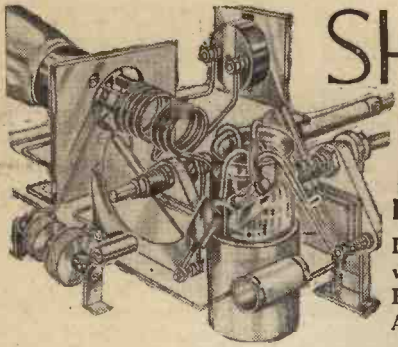

SHORT-WAVE SECTION

FADING AND A.V.C. ON SHORT WAVES

In This Article the Writer Suggests that Short-wave Fading Cannot be Compensated for Any Existing Means, and Gives Reasons for His Assertions. You May or May Not Agree with the Conclusions Drawn.

THE serious bugbear of fading has been practically eliminated on the medium- and long-wave bands, due to the application of various improved and modified systems of automatic volume control, but the same cannot be said of the short waves, unfortunately. As a matter of fact, the question of compensating for fading on short waves is an important one, and is surrounded by many difficulties, many of which cannot be appreciated until experiments are taken in hand.

High- and Low-speed Fading

Before considering possible solutions of the problem let us consider the type of fading which takes place on short-wave signals, for without a knowledge of this the matter cannot be studied seriously. In the first place it must be remembered that there are two entirely different kinds of fading with which we have to contend; sometimes one particular kind is manifest, sometimes the other, and frequently both together. Normal slow fading, such as occurs on the medium waves, is not always very troublesome when use is made of a modern and highly-sensitive receiver, but high-speed fading is not only difficult to cope with, but is just as troublesome no matter what kind of receiver is employed.

Slow fading is, of course, more pronounced on short waves than on broadcast frequencies, and the strength of signals varies to a far greater extent. In fact, in many cases signal strength varies from full loudspeaker volume to inaudibility, even when using a well-designed superhet. And since all normal forms of A.V.C. function by virtue of the fact that they cause the sensitivity of the high-frequency or intermediate-frequency valves to be reduced as signal strength increases it is evident that they can have no effect on a signal which has become particularly weak. This is a point which is frequently overlooked, despite the fact that the principle is fundamental.

Why A.V.C. is Ineffective

It can be appreciated from this that A.V.C. can never ensure anything approaching uniform signal strength on short-wave signals until, and unless, we find a means of obtaining an almost unlimited degree of H.F. amplification. There is another important point, which is that fading on short-waves appears to differ from that on other

wavebands in that the wavelength of the signal varies slightly, or that fading is more pronounced on one sideband than on the other—in making this statement it is being assumed that there are such things as sidebands, although a few eminent scientists tell us that there are not. Whichever of these two effects actually applies it is a fact that signal distortion takes place at the same time as the signals fade; most short-wave enthusiasts will have observed this.



The new Invicta 5-valve all-wave A.C. superhet, with push-button and spin-wheel manual tuning.

Make These Tests

We are not considering the technical reasons for fading at the moment, so it is not proposed to go more deeply into this

question from the theoretical aspect, but it is suggested that readers tune to a signal that is subject to considerable fading and observe the effect of slightly modifying the tuning when fading commences. If band-spread tuning is employed, and if the low-capacity tuning condenser is provided with an accurate slow-motion control, it will generally be found that the degree of fading can be reduced by "following" the signal with the tuning control.

If the receiver is provided with a tone control it will also prove interesting to observe the difference which this makes at varying signal intensities. There is ample scope for experiment along these lines, and it is quite likely that some reader may evolve a system of fading compensation if he is sufficiently interested to pursue experiments in this direction.

From what has been stated above it should not be concluded that A.V.C. is always completely useless on short waves, but it should be borne in mind that it cannot be as effective as might be desired. Special circuits, and, indeed, special receivers, have been introduced in an endeavour to overcome the trouble.

Rapid Fading

High-speed fading, in the experience of the writer, is not reduced at all by the use of A.V.C. On the other hand, it has often been found that the trouble is accentuated, especially if there is an appreciable "time lag" in the circuit due to the incorrect choice of decoupling condensers and resistances. As a result of this, the correcting bias voltage is often applied to the controlled valves just at the moment when the signal has attained a lower intensity, the result being a partial paralysing of the set. In other words, the fading is doubled in effect, and signal strength may easily fall to zero. It is because of this that even a well-arranged system of A.V.C. often renders reception much worse than that obtained when A.V.C. is not employed.

It has not been the intention in this article to condemn automatic volume control, but merely to show its ineffectiveness for short-wave reception. There may be readers who disagree with some of the above statements, and there may be some who will claim to have found A.V.C. the system definitely worth while. If there are any such it would be interesting to learn of their views, since the conclusions drawn and stated above are not the result of theoretical philanderings with the subject, but have been drawn from experiments extending over the past few years.

ELECTRICAL ZOOMING

ONE of the advantages associated with the image dissector form of electron camera is the ease with which the electrical focus can be changed so as to produce close-up pictures of any selected section of a scene, without in any way making adjustments to the optical focus. Either by manipulating a series of switches, or using a single knob rotation, enlargements can be made rapidly, and this avoids either camera movement or quick alterations to the lenses. Many have wondered whether the storage type of camera using the photo-electric mosaic can be employed in a similar manner. The answer is in the affirmative, by the simple expedient of reducing the size of the electron beam scan. A great reduction in scan, however, is found to give

poor sensitivity and reduced resolution, while if this state is prolonged to fit in with certain sections of the production, then the tube becomes marked, and when the normal scanning size limits are resumed, a rectangular shadow will be in evidence over the area where the reduction had occurred.

Super Emitron Cameras

On the other hand, with the super emitron cameras in which the photo-electric and secondary emissive actions are separated, and take place in distinct planes, this effect does not occur, so that if the occasion warrants it electrical zooming may be resorted to without altering optical focus.

ON YOUR WAVELENGTH



Come Into My Office

WHEN important matters have to be discussed the Editor calls his staff into his office. This week I want readers to imagine that I have called them into my office because I have a message to impart from the Editor, and which he has asked me specially to pass along to you. Make yourself comfortable in the chairs around, help yourself to my cigarettes, and hark unto me. Ready? Right!

You are a loyal reader of this paper, and because of that I know that you want to go on reading it. In normal times we are able to supply every newsagent with a sufficient number of copies to supply ordinary needs. This means that we have to print a surplus number of copies. Now, in peace-time, when there is a plentiful supply of raw material, all publishers are able to print these surplus copies. If the newsagent does not sell all of the copies which he orders in excess of those for which he has a regular demand he is able to return the remainder and to obtain a credit note for them.

That condition does not hold in war-time. I do not know how many of you can remember the last war, but paper was severely rationed then, as it is now, and it was necessary to cut out the sale or return basis on which newspapers and periodicals are supplied to newsagents, and also to supply periodicals only against standing orders. This means that your newsagent will not order copies from us unless he has an order from you. You cannot blame him for that, for the copy would be left on his hands and he would have to pay for it. So many members of the public are moving from their district, or going into one of the various Forces, that a newsagent to-day is uncertain as to where his customers may be next week. I repeat that he will not take copies unless he has a standing order for them. Now all publishers have inserted in their periodicals an order form which readers merely have to fill in and hand to the newsagent. We have endeavoured to save our readers the trouble of having to write a letter to the newsagent by printing such a form in recent issues of this journal. There are still many readers who have failed to fill in that form and perform that small task which helps us and the newsagents as well as the readers.

As you are all in my office, I am able to convey this information to you, and I hope impress upon you the need, if you have not already done so, of filling in that form to-day and handing it to your newsagent. If you do not, the issue of your favourite wireless journal, which is now the only weekly journal available for amateurs, may not be cheerfully reposing upon the newsagent's counter next Wednesday morning. If it is it will be for someone else who has had the wisdom of reserving it each week.

I do hope that every reader who has not been able to come to this office for this chat, and who reads this report of the interview, will similarly take the friendly hint and sign that form to-day.

Readers on Service

I HAVE received a letter from one of our readers, Mr. J. E. Bowden, who is

By Thermion

B.L.D.L.C. member 6186 AA, call-sign 2AYQ. It is one of the most friendly letters I have yet received. This reader, who is on active service, has had the bad luck to lose an arm through an army lorry crash. Serving with him is Bill Watson (G6JL), of Torquay; Bert Tupman (G3ID), of Dawlish; Les Dymond (G3HW), of Teignmouth; and Iran Taylor (2FPJ), of Salisbury. Not a bad crowd of hams in one unit. Notwithstanding the fact that Mr. Bowden is in hospital he was able with one hand to write me a most interesting letter. He has lost his left arm, and officers say that he will be able to operate with his right hand only: of course; only for Home Service. Every reader of this journal will wish Mr. Bowden a speedy recovery. I am certain that he would welcome a few words from other readers, and B.L.D.L.C. readers. I am unable to give you his official address, but his private address is: 28, Coombe Road, Preston, Paignton, Devon.

The Home Service

THE restriction of our broadcasting to a single station or wavelength has led to the publication in these pages of some receivers referred to as "Home-broadcast" or "A.R.P." sets. In my journeys amongst many representative classes of listener I find that a very large number now only listen to this one station, and the receiver is kept permanently tuned to it and only switched on and off as desired. The original enthusiastic listening which was indulged in, in order to hear news from various countries has now been forgotten, and the majority appear to be content to listen to the home service only. I was therefore interested to see recently a receiver advertised by a very large firm specifically for this purpose. It was apparently a four-valve mains set, provided with only one knob—a combined on-off and volume control. The set had a fixed tuned circuit, with a permeability device to enable a slight variation to be made if desired, but this was an internal adjustment. The output was given as 4 watts, and it would appear that a really good receiver could be made up on these lines, although ideas for quality receivers are, unfortunately, not of much use under the present system. Quality alone is not sufficient to justify the construction of a special local quality set, and on several occasions I have found that volume has also varied appreciably over a period of

listening. This appears to be due to the line switching adopted at the new B.B.C. headquarters, rather than to effects on the radiated signal.

St. Dunstan's War Aims

MEN and women of the Army, Navy, and Air Force, and members of the Regular Fire Brigades and Police Forces who may be blinded in the present war, will be cared for by St. Dunstan's. This was arranged before the War in a series of conferences, including representatives of the Fighting Services, the Ministries of Pensions and Health, and St. Dunstan's.

It was agreed that St. Dunstan's should establish a War Hospital for serious eye cases and other incidental wounds as an integral part of its organisation, and that the authorities concerned would concentrate the cases there as soon as they could be moved. Great importance is attached to early training of the newly blinded.

St. Dunstan's was founded by the late Sir Arthur Pearson in the early days of the Great War, and under his magnificent leadership, and largely through his personal example—for he had himself gone blind shortly before the war—developed into an outstanding and universally-known organisation for the care of the war-blinded. Officers and men, and a few women, from all the Empire countries, were eligible for assistance, and ninety-five per cent of all of them came under and are still under its care. Modern conditions of war suggest that the proportion of young service women requiring St. Dunstan's help may be considerably increased.

H.M. Governments will provide life pensions for those blinded in the war, but these must be supplemented by earnings to ensure a full life. Moreover, man cannot live by bread alone, and so the Government has entrusted St. Dunstan's with the duty of bringing to the aid of these young men its tradition, experience and method of re-creating their lives. St. Dunstan's will remain a voluntary agency, supported by the goodwill of the British peoples and this goodwill will be called upon by public appeal, which will take many forms. To help start a War Fund, ten per cent of the net proceeds of the forthcoming Poppy Day will be allocated to St. Dunstan's.

Plans are in hand as the need arises to extend the hospital and to enlarge the present school so that all the young blinded men may learn to read with their fingers, to typewrite, to look after themselves and walk alone, to learn as little children do the first lessons of life. The blinded men of the Great War will hold out a helping hand to the young fellows who will join their ranks, and where possible will take an active part as lecturers and teachers. There will be workshops and lecture rooms where trades, handicrafts and professions will be taught. Some occupations for the blind are out-of-date—new ones will have to be found.

The new St. Dunstan's may be different in many details from its familiar prototype of a quarter of a century ago, but the spirit will be the same, and "Victory over Blindness" will be the watchword.

Comment, Chat and Criticism

Absolute and Programme Music

Some Further Considerations on this Interesting Phase of Music are Given by Our Music Critic, MAURICE REEVE

WITH a few exceptions, it may be taken as a rule that works written in the classic "sonata" form, i.e., all sonatas, symphonies, and chamber music, are absolute, and that compositions in the smaller forms such as the "rondo," are, when complete in themselves, programme music. As the latter half of this statement needs much more elaboration than the former, we will deal with first things first. I will single out those few symphonies by the great symphonic masters which were definitely written to a programme, but which most listeners prefer to regard subjectively, and free from all external associations.

Beethoven's Pastoral

First of them all is Beethoven's sixth, the Pastoral. I will not repeat its programme here, as I described it in a former article. I will just mention that, unlike the Moonlight Sonata, it was definitely planned by Beethoven to a programme, and the title is Beethoven's own. Another which may be looked upon as programme music, but which, I expect, would be more accurately classed as impressionistic, is Dvořák's celebrated fifth, "From the New World." This work was written when the composer was serving as a professor of music in, I think, Chicago, and was built round some native Indian themes collected and given to him by pupils and friends. Although both these works are very akin in this respect (though worlds apart in character), I class them differently because, in the one case, Beethoven has deliberately named each of his movements after the scene he painted. Dvořák merely gave his work a general title, leaving the listener's imagination much freer to form its own picture. In listening to the Beethoven we must not wander from the picture he specifically tells us he is painting. But in listening to the Dvořák, the composer seems to say: "Here are my impressions of America, the new world, I wonder if you agree with me." And these last two sentences can serve to divide programme music into two divisions: that which sets out to tell a definite story or paint a definite picture, and that which merely gives an impression of something or sets a train of thought working.

Vaughan Williams' "London" Symphony

Another splendid "programme symphony" (I don't know whether I have coined a phrase of any value there) is Vaughan Williams' "London" symphony. By the introduction of such tunes as "Cherry Ripe," and "Sweet Lavender," and Big Ben fail to imagine is a typical London fog, so striking through what nobody can shadowy and nebulous is the scoring, Vaughan Williams has drawn a memorable picture of our famous capital metropolitan city.

The symphony is used very seldom as a means for illustrating a programme, and I cannot think, off-hand, of any other examples worth mentioning. Instances such as Haydn's "Clock," "Drum Roll," etc., are not programme music at all, but merely take their titles from a figure introduced into one of the movements to illustrate those effects.

Beethoven wrote one of his thirty-two piano sonatas to a programme—the one known as "Les Adieux." Its three movements are styled "Les Adieux," "L'Absence," and "Le Retour" respectively, and the whole work forms a beautiful and realistic picture of the composer's emotions at having to bid farewell to his beloved young friend and patron, the Archduke Rudolph, and of his joy at his return. The clatter of his horses' hoofs, the postilion's horn, and his sadness whilst alone, are faithfully portrayed.

Many other works have titles such as the "Archduke" Trio, the "Emperor" concerto, or the "Military" symphony, which were given them usually by publishers or as nicknames by which they can be easily recognized when talked about. They are in no way connected with a programme as such.

Couperin and Rameau

That class of music which merely sets out to imitate something such as a coucou, a musical box, or chimes, can be dismissed in very few words. They are not programme music as we have defined that term in these articles, but merely salon trifles. Such examples of imitative impressions are usually of little musical value, and are more often than not mere rubbish, though, when handled by masters, such as the early seventeenth century French writers Couperin and Rameau, can become classics.

But my strong advice is, listen to most of this music as if it was absolute, divorce it from, at any rate, the silliest of its trappings, and concentrate on the material of which it is made. Of course, one has a perfect right to look out for certain things that we are told are there, such as the brook and the thunderstorm in the Beethoven, or "Cherry Ripe" and Big Ben in the Vaughan Williams. Not only should we be less than human not to, but we must, as critics. The composer has made it part of his job to paint a picture of the countryside, or of London, and we must find out whether he has done his job satisfactorily—he expects us to do so. But what I mean is this, when you have

found out all about those things, place them right at the back of your mind and give yourself over to the music, just as if you had never been told it had any story attached to it.

Comparisons

One might make the comparison of eating a Christmas pudding. Do we seek every ingredient as we place each mouthful in our mouth? I hardly think so. We know from the taste of the first one whether it is a good pudding or not. If good, then we know just what is in it and we don't have to ferret with our palates for this or that ingredient. And the same applies to any piece of music, even such an obviously vivid one as "1812." I think you will get much more satisfaction from it, listening to it that way. The harmony, the form, the counterpoint, etc., they are the important things really, much more important than whether the representation of a fountain or a streak of lightning is as realistic as it might be. There are exceptions, of course. And if a piece sets out to do nothing more than to represent the splashing of ornamental water, then it must stand or fall thereby. But the fact that the three birds in the "Pastoral" are not authentic replicas of the original has never yet prevented anyone wallowing in a wondrous piece of music, whereas, if that was all that a listener was on the look-out for, they would. What he would miss thereby, only those who listen as musicians could say.

I trust that these notes will help in the listening of those of my readers who go in for the better items in B.B.C. programmes, and more especially those who try to cull as much as they can from good music, but who feel they miss something in the process. There is no good reason for the many good programmes that are given us to be dismissed as "highbrow" and "dull." They should be enjoyed at least as much as anything else. It is only a question of sorting things out and looking at the problem in a less haphazard way than so many people do when the "next item on the programme" happens to be a symphony concert.

TELEVISION AND AEROPLANES

QUITE a lot has been said recently concerning the application of television in one form or another in connection with aeroplanes. It is quite common knowledge that the reception of television signals in an aeroplane while in flight, even when at a high altitude, is not a difficult matter. Over five years ago 180 line pictures radiated from the station at Crystal Palace were shown in a machine while flying forty miles away, and three years ago, during the Radiolympia Exhibition, the experiment was again repeated before a party of newspaper press men using the standard Alexandra Palace transmissions. On various occasions it has been suggested that since there are but few difficulties of reception, schemes could be devised whereby the principles of television could be made to guide the pilot of a machine when the approach

to his ground objective is obscured by fog. If this could be undertaken successfully there is no doubt that it would prove a boon to blind flying, but so far no equipment seems to have been put into practical service on a commercial basis, although there is every hope that it will eventually materialise. Of more recent date, however, a discussion has been going on concerning the possibility of installing actual television transmitting apparatus in aeroplanes with the idea of transmitting aerial views direct to one or more ground stations. A few weeks ago due prominence was given in a leading American paper to the fact that a squadron of Italian machines had been fitted out in this way, and that a satisfactory signal range up to 100 miles had been achieved successfully. The main problem would undoubtedly be the reduction of weight.

A Novel Volume Control Circuit

CIRCUITS have already been proposed in which the adjustment of a volume control potentiometer feeding the grid of a valve automatically introduces negative feedback, so that as the control is adjusted so as to reduce volume, negative feedback is introduced to an increasing extent. This has the advantage that the "law" of the potentiometer can be easily modified and fidelity is improved on loud signals by reason of the feedback introduced when the gain is decreased to a low value.

The accompanying illustration shows an improved circuit developed in the Laboratories of the General Electric Co. of America of this type which has the advantage that positive feedback can be set up when the potentiometer is adjusted to the position of maximum gain, thus further extending the range of the volume control. The circuit shows a conventional diode detector 1 feeding an amplifier stage 10 and an output stage 17. The only unusual feature is the feedback circuit from the output transformer to the input circuit of valve 10. This circuit consists of the conductors 23 which are connected to the upper ends of the resistances 4 and 8.

Wheatstone Bridge System

It will be seen that the two paths 3, 4 and 6, 7 and 8 constitute a Wheatstone Bridge, the resistances 3 and 4 being the ordinary diode load, and having impressed thereon the rectified signal electromotive force, which may be the ordinary audio voltages produced in the diode circuit of a radio receiver. The two conductors 23 are connected at diagonally opposite corners of the bridge, and the cathode of the discharge device 10 is connected through resistance 12 and earth to a third diagonally opposite corner of the bridge which is likewise connected to the cathode of the diode 1. The grid of discharge device 10 is connected to a tap 9 on potentiometer 7 whereby this connection may be moved along resistance 7. When it is in its lower position a small portion of the voltage produced by the diode 1 is supplied to the discharge device, but a maximum amount of the voltage supplied by the feedback conductors 23 is supplied to the grid of the discharge device. As the contact 9 is moved upward the portion of the voltage produced by the diode which is supplied to the grid of the discharge device is decreased. The arms of the bridge may be so proportioned that when the contact 9 is in its extreme upper position the bridge is exactly balanced. The system is then adjusted for maximum transmission of signal energies produced by the diode 1 and for zero feedback. Since the voltage produced by the conductors 23 is supplied to the bridge in phase to produce degeneration it will be observed that in this position of the contact 9 the system has maximum sensitivity.

Degenerative Feedback

Degenerative feedback systems as used in audio amplifiers are extremely important by reason of their improvement of the frequency characteristics of the amplifier to which they are applied, their reduction of hum, and their correction of distortion. Since the degeneration, however, has the effect of reducing the sensitivity of the amplifier, or of reducing the amplification

Utilising Positive Feedback, as Well as Negative Feedback as a Means of Volume Control

of the discharge device, it is important that the degeneration be completely removed when maximum amplification is required as upon reception of extremely weak signals in the radio receiver. At such times the contact 9 is moved to its upper position in order that all of the audio signal electromotive force available may be supplied to the discharge device. In accordance with this system, in which the diode load 3, 4 and the potentiometer circuits 6, 7, 8 are connected with respect to the diode, and to the feedback circuit in bridge relation, this feedback voltage may be reduced to

generative voltage is reduced until such point is reached where it is zero. Upon further movement of the contact 9 upward the degenerative voltage is reversed in phase and becomes regenerative so that it tends to increase the amplification of the amplifier by reason of regeneration. Such increased amplification which occurs at adjustments of the contact on the potentiometer utilised only upon reception of weak signals is, of course, valuable. In such an arrangement resistance 3 may be of 3,900,000 ohms, resistance 4 of 220 ohms, resistance 7 of 2,000,000 ohms, and resistance 8 of 22 ohms.

It will be seen that these results are secured without any appreciable complication of the circuits. The only extra resistance required is the resistance 4 which may be of 10 ohms; that is, a

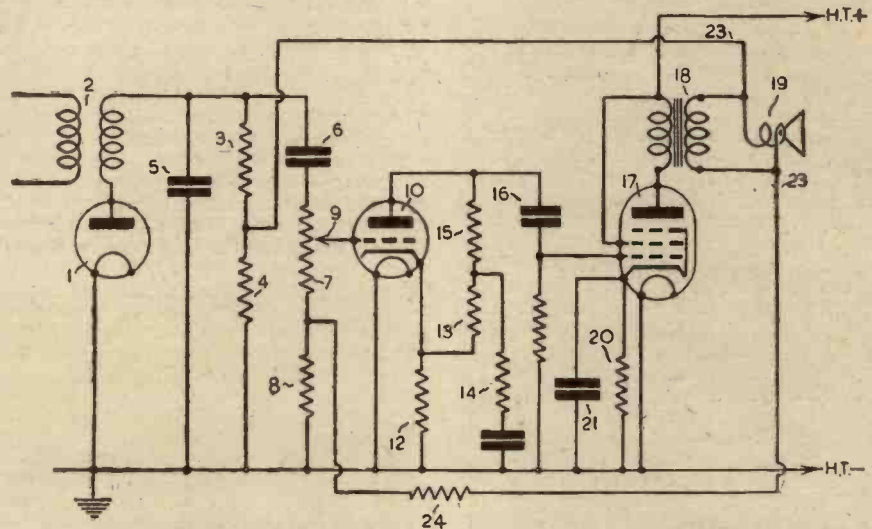

Circuit showing how the features described in this article may be employed.

zero when maximum amplification is required.

In fact, it has been found that by properly proportioning the bridge, the point of contact 9 upon resistance 7 where zero feedback voltage is supplied to the grid, may be adjusted to a point short of the top of the resistor; that is, to a point intermediate the ends of the resistor. In this way, as contact 9 is moved upward from the bottom of the resistor, a de-

10-ohm resistor can be utilised in this position in a system where resistance 3 was one of 200,000 ohms, resistance 7 of 2,000,000 ohms, and resistance 8 of 100 ohms for exact balance on top of potentiometer 7.

The magnitude of resistance 24, of course, determines the amount of feedback voltage. While this resistance may be variable it is commonly fixed and a value of 220 ohms is satisfactory.

LINE PAIRING

THE picture definition of a television receiving set is very seriously impaired when the interlacing of the odd and even frames is not being undertaken satisfactorily. Quite low percentage displacements are visible at normal viewing distances, and complete line pairing is even worse than watching a picture of half-line definition. It is for this reason that set makers devote so much attention to the time base generator, and selector circuits to ensure that a perfect interlace becomes possible, and the full quality of the picture thereby revealed, if it is assumed that all other possible defects have been eradicated. One possible cause of the trouble is the incomplete separation of the frame and line synchronising signals which are present in the received carrier. Many

schemes have been proposed to make this possible, and in one of these it is suggested that separation would be easier in the receiver if the line synchronising signals were suppressed for a very short period just prior, and immediately after, each frame pulse. To carry this into effect it is necessary at the transmitting end to use a valve prior to the mixing stage which can periodically be rendered non-conductive. This would be controlled by the frame pulse generator and would eliminate the line pulses for the periods desired.

PRACTICAL WIRELESS SERVICE MANUAL

By F. J. CAMM.

From all booksellers 5/- net, or by post 5/6 direct from the Publishers, George Newnes, Ltd. (Book Dept.), Tower House, Southampton St., Strand, London, W.C.2.

PRACTICAL TELEVISION

November 4th, 1939.

Vol. 4.

No. 175.

A New Application

IT cannot be too often emphasised that the science of television has many important applications quite apart from the fairly obvious one of entertainment. The development of television allied to the telephone so that subscribers can see as well as hear one another has already been made possible on the Continent, while America has tried out equipment of a similar character. The visual interpretation of police messages in lieu of written or verbal instructions is another; the replacement of relatively slow moving tape machines in city offices by a good size message screen, worked from a central transmitting source; the guidance of aeroplanes in fog, or at night time, when visibility is at a discount, are but a few uses that can be readily called to mind. It was interesting to learn recently, therefore, that an important foreign technical institute which carried out important research had found a way to apply television for the sole purpose of keeping its doors closed to undesirable visitors. This was revealed by a visitor who succeeded in obtaining admittance. The door bell was pressed in the usual manner, and after a short wait on the steps of the building the door appeared to open without human agency. On entering, the head of the institute came forward to exchange formal greetings. Seeing the rather amazed look on the visitor's face it was explained that the operation of the front door "bell" push brought into action a television camera cunningly concealed but capable of transmitting pictures of those at the front door to a receiving screen at the principal's desk. If it is desired to give admission to those outside, then another button is pressed and the doors are opened electrically. What a number of commercial applications could be conjured up for this device, and one can picture the elusive "Thermion" making good use of it to keep away callers who may have been upset by some of his trenchant but nevertheless interesting remarks.

An A.R.P. Device

IT has always been said that necessity is the mother of invention, and it does not really need a war to prove the truth of this statement. The possibility of attack from the air, however, has set in motion many ideas which are designed to combat, as far as possible, the effects of bombs, or alternatively, give warnings from sections of buildings that are rather remote. As an example of this it is quite possible that an incendiary bomb may penetrate the roof, and stop in rafters of the loft. To give warning that something is amiss a device has been marketed which makes use of a photo-electric cell. As soon as any additional light reaches the cell such as would be provided by the initial efforts of an incendiary bomb, the cell current increases, and a relay is brought into action which rings an alarm, or gives any other form of indication which may be desired in a convenient

section of the house. Steps can at once be taken to prevent the spreading of the damage, and there is the added advantage that if by chance any part of the equipment should fail or the current fail, then the alarm is brought into circuit so that the defect can be remedied, and the device thereby maintained in proper working order.

Cathode-ray Tube Manufacture

THE modern form of cathode-ray tube assumed a high degree of importance in many scientific directions, and there is no doubt that a marked impetus was given to the perfection of the device as a result of the stringent requirements imposed by television receiver design. No modern laboratory is completely equipped without one or more C.R. tubes capable of being employed for both qualitative and quantitative work, and the degree of reliability

can be seen sometimes in window glass. All satisfactory bulbs are then very thoroughly scoured and washed chemically inside so as to remove all trace of impurity and dirt, otherwise the quality of the fluorescent screen would be impaired. When clean and dry the screen is then sprayed on while the tube is revolved so as to give a powder layer of uniform thickness. Depending on the particular use of the tube, so the chemical constitution of the powder ingredients is varied, while the form of fixative used must be capable of preventing the screen from flaking. Proper baking assists in this process, and then the bulb with its tubular neck is covered internally with a thin metal coating which forms part of the anode to which is applied the high accelerating potential. In another section of the factory the glass pinches are made up and these contain the anode, modulator and indirectly-heated cathode for electro-magnetic working, with the addition of deflector plates, and other anodes if electrostatic focusing and deflection is to be employed. A pinch is sealed into place at the end of each tube neck, taking care to keep axial alignment correct and the tube is then complete except for pumping and testing. Each tube is then put on a pump, and surrounded by an oven cylinder. This is seen quite clearly in the accompanying illustration which shows a section of this part of the operation. Held vertically in a form of retort with screen uppermost, the pumping, to remove every possible trace of gas, baking and activating is carried out under careful supervision. The pumps are seen below



A section of a modern cathode-ray tube factory where the baking and pumping process is undertaken.

which can be placed on their performance is attributable to the care taken in manufacture, and the whole series of tests which must be passed before the tube is finally regarded as satisfactory. Quite naturally, different firms use somewhat different manufacturing methods, but in general terms the line of action followed commences with a careful examination of the glass bulbs to see if there are any flaws apparent, after the bulbs have been subjected to a high pressure test of the order of three atmospheres. There must be no evidence of cracks, while the screen face must be quite smooth and exhibit no trace of "stones"—small impurities such as

the bench and when this operation is completed satisfactorily the tube is sealed off. Now comes a whole series of stringent tests to ensure that the vacuum is up to standard, the characteristic of the tube is taken to see that it will modulate within the voltage limits required, the filament constants and electronic emission of the cathode are measured. The quality and colour of the screen next come under review, for there must be uniformity of brightness over the scanned area when no modulating signal is applied and no traces of colour patches to indicate that impurities have got into the screen powder. If the tube passes

(Continued in column 1, page 168).

Practical Hints

A Stand-by Crystal Unit

HAVING a worn-out four-pin valve and a few odd parts, I made the simple crystal unit shown in the accompanying sketch. First breaking the glass envelope of the valve, I removed all parts—glass, grid, plate, etc. I then drilled two holes facing

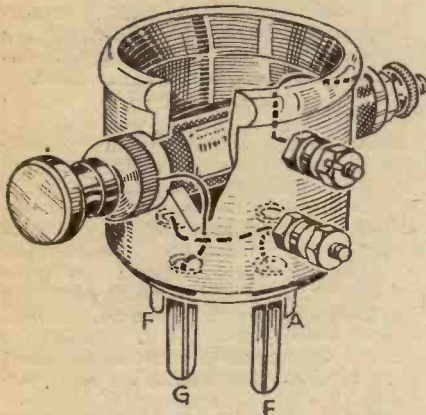

A compact stand-by crystal unit utilising an old valve base.

each other, half-way up the base, in which I fitted a semi-permanent crystal detector. Two more holes were drilled in one side to take two small terminals. Connections were then made as shown. It will be noticed that an earth wire is connected to both filament pins, since various sets have different sides earthed.

The complete unit can be plugged in the first valveholder of almost any battery receiver, first removing connection to batteries. Headphones are connected to terminals on the unit, while tuning condensers, coil, etc., already in the set, are made use of. The unit can be used for emergencies, such as when batteries are run down, etc.—R. BARKWAY (Leigh-on-Sea).

Improving a Rectifier's Efficiency

OBSERVING that damp climatic conditions had an adverse effect on a permanent detector by considerably reducing the volume of a crystal set, I hit upon the following cure.

I took a small tin and mounted the permanent detector in this, as shown in the sketch. Inside the tin I placed a small quantity of calcium chloride, which has the property of absorbing moisture from the atmosphere. It was then found that, however damp the air conditions prevailing

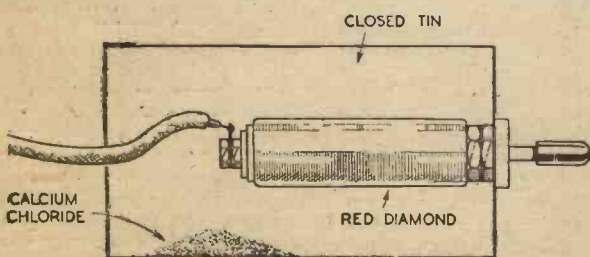

A simple method of keeping a crystal detector dry.

THAT DODGE OF YOURS!

Every Reader of "PRACTICAL WIRELESS" must have originated some little dodge which would interest other readers. Why not pass it on to us? We pay £1-10-0 for the best hint submitted, and for every other item published on this page we will pay half-a-guinea. Turn that idea of yours to account by sending it in to us addressed to the Editor, "PRACTICAL WIRELESS," George Newnes, Ltd., Tower House, Southampton Street, Strand, W.C.2. Put your name and address on every item. Please note that every notion sent in must be original. Mark envelopes "Practical Hints." DO NOT enclose Queries with your hints.

SPECIAL NOTICE

All hints must be accompanied by the coupon cut from page 164.

inside the tin, and consequently the air in contact with the crystal points, the latter were always dry. This has stepped up the volume considerably at all times.—WM. NIMMONS (Belfast).

An Efficient Earthing Clamp

ON my bench I have been using a heavy gauge copper wire as an earth, and also for the negative high and low tension. I found, however, that crocodile clips were a source of trouble, as the contact became oxidised and formed a high-resistance joint. I solved the problem by constructing the

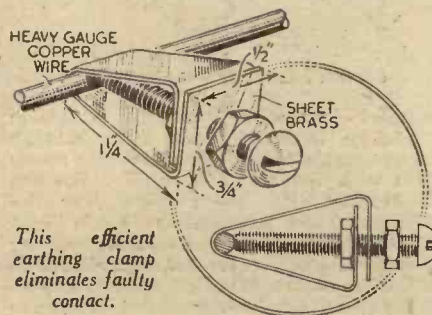

accompanying screw clamp from some sheet brass and a 2BA screw with two nuts. The effect of screwing the bolt against the copper wire forms a clean low-resistance joint. The second nut is for clamping the lead from the set. With this device all trace of crackle has disappeared.—D. R. STEWART (Newport, Mon).

An Improved Lamp-shade

I HAVE just fitted up an improvised lamp-shade in an out-house, and find it works well. I took a burnt-out L.F. transformer and removed the bottom and inside. Next I bored two holes in the top, one in the centre and one to one side. I fitted an M.E.S. batten holder in the centre hole and used the other hole for a wire. The light is well shielded except in a downward direction.—B. W. COOPER (Wellingboro').

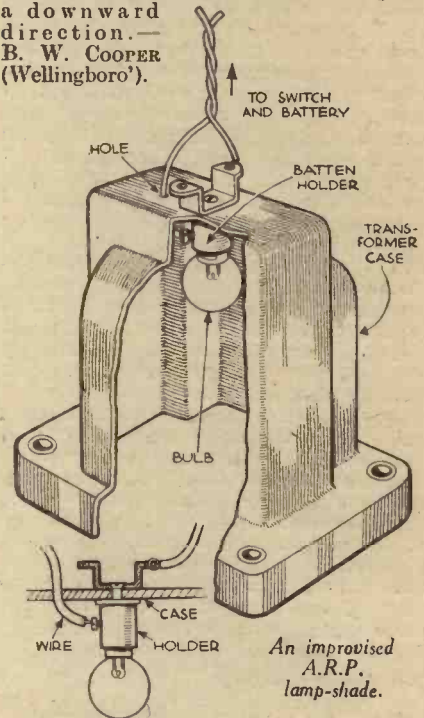

Cutting a Thread

WHEN mounting some components on wood or thick metal chassis, it is often found difficult to mount the holding-down nut in an accessible position. The difficulty of mounting the component may be overcome by using a tapped hole for the component, and if a suitable tap is not available a substitute may be made by filing three flats on a threaded bolt and driving this into a clearance hole drilled in the metal or wood. The same procedure may be adopted when it is desired to open out a hole in a component or other item. The flats are, of course, for clearance purposes, and care is necessary to avoid spoiling the thread whilst filing the bolt.—G. READ (Malling).

A COMPLETE LIBRARY OF STANDARD WORKS

By F. J. CAMM

- WIRELESS CONSTRUCTOR'S ENCYCLOPÆDIA 5/-, by post 5/6.
- EVERYMAN'S WIRELESS BOOK 5/-, by post 5/6.
- TELEVISION and SHORT-WAVE HANDBOOK 5/-, by post 5/6.
- SIXTY TESTED WIRELESS CIRCUITS 2/6, by post 2/10.
- WIRELESS COILS, CHOKES and TRANSFORMERS and HOW TO MAKE THEM 2/6, by post 2/10.
- PRACTICAL WIRELESS SERVICE MANUAL 5/-, by post 5/6.
- WORKSHOP CALCULATIONS, TABLES and FORMULÆ 3/6, by post 3/10.
- PRACTICAL MECHANICS HANDBOOK 6/-, by post 6/6.

All obtainable from or through Newsagents or from GEORGE NEWNES, LTD., Tower House, Southampton St., Strand, W.C.2.

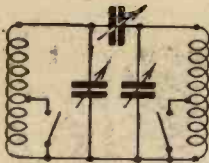

Fig. 1.—The standard bandpass tuning circuit.

IMPROVING THE SUPERHET

How to Obtain Better Selectivity at the Minimum of Cost and How to Fit a Visual Tuning Indicator.

By W. J. DELANEY

MANY listeners are using simple types of superhet which they have obtained on account of the improved selectivity which this type of receiver gives compared with a "straight" receiver. It is often found, however, that although looked upon as the most selective type of receiver, a superhet does not, in its simpler form, come up to expectations. For all normal purposes it will suffice, but when it is desired to hear stations working very close to each other, an improvement may be looked for. A really good commercial superhet will, of course, not have any failings in this direction, but it is the simpler types, and consequently the lower-priced models, with which we are mainly now concerned. This type of receiver will in general consist of a combined mixer and oscillator as the first valve, followed by one I.F. stage feeding a detector. The question of A.V.C. does not at the moment arise, although owing to the use of multiple valves it is a common practice to use a double-diode-triode valve as the second detector and thus obtain the necessary A.V.C. with little additional cost. It is obvious, therefore, that the simplest way of obtaining improved selectivity is by the inclusion of a further tuned circuit, and this brings to mind at once a further valve stage in the form of an H.F. amplifier preceding the mixer or frequency-changing stage.

Bandpass Tuning

It is a well-known fact that if two tuned circuits are coupled in a certain manner, what is known as a bandpass effect will be obtained (Fig. 1). This arrangement is common in straight receivers, but is not often fitted to simple superhets. Therefore, a further tuning coil and condenser may be coupled to the input circuit in such a case, and a small condenser used to couple the two together and we have a bandpass input circuit. In addition to an improvement in selectivity such an addition will also often have another important advantage—namely the elimination of second-channel interference, or whistles. The coil should, of course, cover a similar range to that covered by the existing aerial coil and the condenser should have a similar maximum capacity (Fig. 2). It will not be possible to gang the tuning condensers owing to the lack of exact matching between circuits, but the extra coil and condenser may be made up in the form of a small unit (preferably in a screened box) and mounted outside the cabinet. A small variable condenser with a maximum capacity not exceeding .0003 mfd. should be used to couple the new circuit to the aerial terminal of the superhet, provided no condenser is already included in the receiver between the aerial terminal and the tuning circuit. If there should be alternative aerial terminals, select that one

which does not include the aerial-series condenser. The new condenser is operated as if it were a wave-trap, keeping it in step as far as possible with the existing tuning controls.

H.F. Stage

By using the same coil and condenser and connecting these to an H.F. pentode we may make up an H.F. stage, generally, in the case of a superhet referred to as a "Pre-selector." The exact connections, that is, the provision of the necessary operating voltages, etc., will depend upon

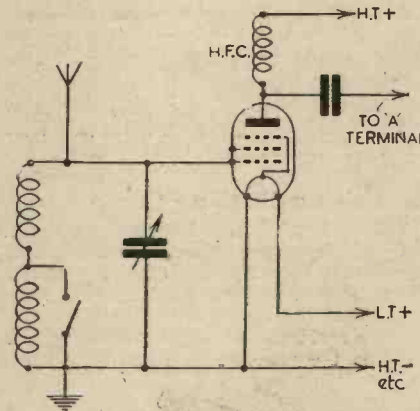

Fig. 3.—An H.F. or pre-selector stage for addition to a standard superhet circuit.

whether the receiver is a battery or mains model, and in the latter case it will probably be preferable to include a separate mains unit with the stage to avoid difficulties in tapping off those supplies from the receiver. The main circuit is given in Fig. 3 and the valve makers' instructions regarding screen voltage, bias control, etc., should be followed. Such a pre-selector stage may be made up as a small compact unit, or in some receivers it may be possible to incorporate all the parts, including the valve inside the cabinet, mounting the tuning condenser on the panel or side of the cabinet. It is often possible to employ two stages of pre-selection, but instability may arise if the gain of each stage is kept too high. The

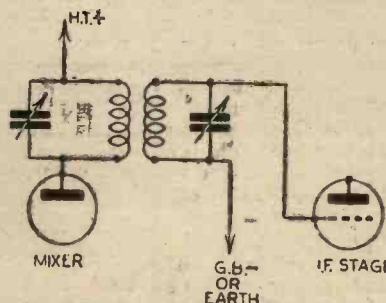

Fig. 4.—Standard I.F. coupling system as used in the superhet.

reduction which is sometimes necessary to obtain stability may be such that the overall gain of the two stages is no greater than that given by one good stage and therefore this point should be borne in mind.

Bandpass I.F.'s

Reference has been made to bandpass circuits, and it should be remembered that it is possible to employ this feature in the I.F. stages of a superhet. To do so, a further I.F. transformer of the same frequency as the existing components should be obtained, together with a small air-dielectric variable with a maximum capacity not greater than .0001 mfd. This is used to couple the two I.F. transformers together, the new transformer being added, preferably, to the first I.F. transformer—that is, between frequency changer and I.F. stage. The circuit is shown in Fig. 5 and it will be seen that the lower end of the secondary of the existing transformer and the lower end of the primary of the new transformer are both connected to earth. The small variable is connected at the "tops" of the coils, and to enable maximum signal strength to be obtained (bearing in mind that increased selectivity results in decreased signal strength), one tip of a moving vane on the condenser should be bent slightly so that the condenser is short-circuited in the maximum capacity position. When the condenser is at minimum capacity, selectivity is highest. The condenser may be mounted on a bracket fitted to one of the I.F. transformers, or on the baseboard, and it may be controlled from the panel by means of an extension rod control outfit. A numbered dial will enable exact settings to be repeated for various degrees of selectivity.

It will, of course, be necessary to gang the transformers very accurately and at least one of them should be of the air-cored type so that tuning is relatively flat, otherwise ganging may not hold for all settings of the small coupling condenser.

Visual Tuning Indicator

Finally, when improving selectivity difficulty may be experienced in obtaining accuracy.

(Continued on page 164.)

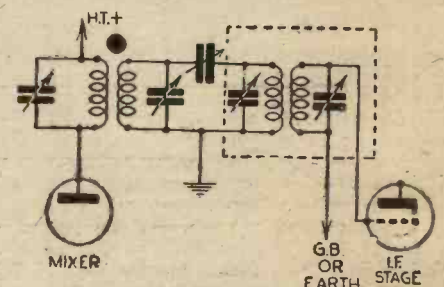

Fig. 5.—Adding another I.F. transformer to increase selectivity.

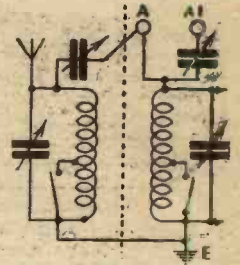
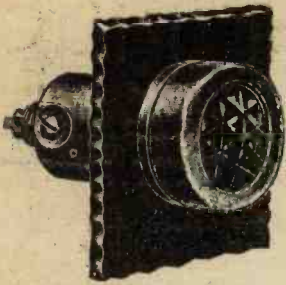

Fig. 2.—How to add a second coil to the input circuit to make use of bandpass coupling.



A Bulgin dial light fixing with ruby window.

PILOT AND DIAL LAMPS

Although Seldom Given Much Attention, Light Indicators on Sets Need to be Watched for Several Reasons, as this Brief Survey Shows

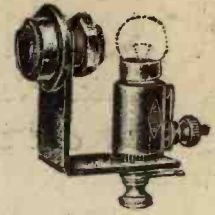

A simplified signal lamp fitting for battery or mains apparatus.

ALTHOUGH one seldom sees a radio receiver to-day which is not fitted with a dial light, such lights have only been standard accessories on family sets for a comparatively few seasons. Actually, dial lights were introduced with the more general adoption of all-mains receivers, and were only later applied to battery sets.

Obviously, and as its name implies, a dial light is intended primarily to illuminate the tuning dial. Usually a semi-transparent dial is fitted, with the light behind it, so that the tuning pointer, whether moving or stationary, stands out in bold relief. Other possible variants include again a semi-transparent scale, with an opaque shutter behind it and rotating with the tuning condenser, an aperture in the shutter permitting a beam of light in the form of a spot or arrow, to fall upon the scale and thus to indicate the station or wavelength to which the set is tuned. A point to be kept in mind in this connection is that a dial light as such is really required only when the set is being tuned. In the interest of economy in low tension current, therefore, some battery sets are fitted with a switch or push-button, whereby the dial lamp is rendered incandescent only when it is desired to examine the dial for re-tuning, and so forth.

Unfortunately, this practice stultifies a secondary but very useful function of the dial lamp, namely, to serve as a pilot to warn the owner that the set is still switched on.

Further Uses

Other uses of pilot lamps are to indicate the position of wavechange switch and radiogramophone switch, and the settings of other controls. This is sometimes done by the use of several lamps either switched on by the controls themselves or covered and uncovered by shutters operated with the controls. The use of several lamps, however, is only permissible in sets operated from the mains, but for battery sets and others where economy is essential it can usually be arranged that a single lamp shall illuminate the dial, and all other indications, by means of shutters actuated by the controls and thus masking or revealing suitably worded tablets or windows on the scale.

Small flash-light bulbs are commonly used as fuses in battery sets, to obviate the risk of burned-out valve filaments in the event of accidental contact between the H.T. positive line and the low tension circuits. In most "universal" sets, the pilot lamp or lamps are wired in series with the filament or heater circuit of the valves, and thus serve as an indication that the valve heaters are intact and that the mains are "on," as well as for the illumination of the dial. Incidentally, a set having pilot lamps connected in this way will, of course, be inoperative should the lamp itself fail.

Inspection Purposes

Before leaving the uses of pilot lamps a few words might be written about possible uses which are seldom, if ever, exploited. How many times does it occur that the innermost recesses of a set or a radiogram are so congested and obscure, that it is impossible to examine them or to undertake any normal service work? And what is easier or cheaper than to arrange a permanent miniature lamp to illuminate these dark corners, or to provide a small movable inspection lamp of similar type? In the case of a battery set, the low-tension accumulator can be used as the supply for the inspection lamp, the connections being taken to the battery side of the on-off switch so that inspection can be done when the set is switched off. For mains sets it would be best to use a flash-lamp battery for the interior inspection lamp, and not the low tension circuit of the set, since it is especially important not to open up or to undertake any internal adjustments to a mains set while the receiver is switched on.

Many experimenters have quite a number of different units which they use in combination from time to time, each of which

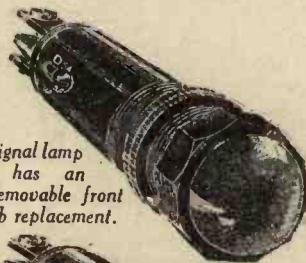

A new signal lamp which has an easily removable front for bulb replacement.

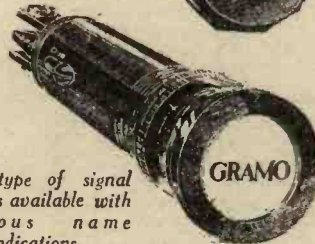

This type of signal lamp is available with various name indications.

should be fitted with its own pilot lamp to avoid the risk of any one part being inadvertently left on circuit for lengthy periods. A recent visit to a particularly well-arranged amateur's laboratory revealed just such a scheme; the main power unit, a speaker energising unit, several alternative radio units, microphone and power amplifiers, etc., each having a small, red-glazed window through which a pilot lamp glowed its warning so long as that particular unit was on circuit.

Ratings

Dealing first with battery sets, dial lights should, of course, be wired on the side of the on-off switch remote from the accumulator. With regard to the rating of the bulb, it is first of all necessary to

point out that inexpensive "flash-lamp" bulbs should never be employed in any type of set, as they are rated only for intermittent service, and their life on continuous duty is usually very unsatisfactory, even if they are considerably under-run. Next, it should be noted that reliable lamps are available rated for 2-volt, 4-volt and 6-volt circuits, and taking currents ranging from 0.06 ampere to 0.5 ampere in each range. Although only a 2-volt accumulator is used in battery sets, even the 2-volt 0.06 ampere rating lamp may be too great a drain on the battery from the point of view of economy, especially where the accumulator is already on the small side. Such a lamp is equivalent to adding an extra load equal to about half of an extra valve. It is not a bad plan, therefore, to fit two dial lamps in series, one as the dial lamp proper, and the other merely as a resistance to reduce the overall consumption but fitted with a push-button to short-circuit the resistance lamp and thus to give full illumination during tuning. The two lights running in series during normal running of the set will give just sufficient illumination to remind the listener that the set is still switched on.

Bulbs for A.C. Use

The 4-volt range of lamps is suitable for use with A.C. sets, but in the interest of lamp life no bulb taking less than 0.2 ampere should be used on a mains set. Lamps of this rating, if not over-volted, will have a life of the order of 300 burning hours, but a 0.5 ampere lamp may be expected to last for at least 1,000 burning hours. In order to ensure long life some users employ 6-volt bulbs on the 4-volt A.C. low-tension supply; but although life certainly is prolonged, the illumination so obtained is not brilliant and is, in fact, somewhat depressing.

Turning now to direct current and to universal sets, where the pilot lamp or lamps are wired in series with the valve filaments, the voltage ratings of the lamps are usually of little consequence. What does matter, however, is the current rating which must be identical with that of the valve heaters—usually 0.2 ampere. Too low a current rating would cause a lamp to fail prematurely, and too high a rating will produce insufficient light. Other points in connection with direct current and universal sets are first, that if provision is made for pilot lamps, then those lamps must be in position or else the set will not operate; and second, if the set fails to function and the pilot lamp is not illuminated, the fault may be one of three things: (a) pilot lamp fused; (b) valve heater or line resistance open-circuited; or (c) mains disconnected either through the blowing of a fuse, or because a switch or plug is not "on."

Finally, it must be suggested that in view of the annoyance caused by failure of lamp bulbs, whether used as pilots or as fuses, it is an excellent plan to keep a spare of each size used, ready for any emergency.

POINTS ABOUT PICK-UPS

Practical Notes on the Correct Use of a Pick-up, on Tracing and Curing Radiogram Faults, and on Mechanical Aspects of the Pick-up Itself. By FRANK PRESTON

THERE have been few receivers made during the past few years which have not had provision for connecting a gramophone pick-up, whilst the home constructor can very easily fit appropriate terminals to any set he makes. But in many instances little use has been made of the "Gram" equipment until recently, when black-out conditions have rendered it necessary to provide increased entertainment in the home. In consequence, there are probably many readers who are using a pick-up for the first time.

There is seldom any difficulty in doing this, nor in obtaining satisfactory reproduction right from the start. Sometimes, however, faults do arise which might puzzle the user who has not had much previous experience. I am not going to deal here with the methods of connecting a pick-up, and with the methods of providing the bias required when the detector valve is used as an L.F. amplifier in conjunction with the pick-up, since full instructions have previously been given in these pages and back numbers are available for those who require them. What I do propose to explain is the correct procedure to be followed when minor troubles arise.

Disappointing Reproduction

For example, those who connect a pick-up for the first time may be disappointed with the quality of reproduction. Assuming that there is no fault in the receiver—and if there was it would generally show itself on radio—it will often be found that the output of the pick-up is so great that the detector valve, now used as a first L.F. amplifier, is being overloaded. This is almost bound to be the case when using a pick-up which is not fitted with a volume control. The distortion will take the form of "blasting" on loud passages, and of "cracking" on high notes. The correct course is to insert a volume control potentiometer between the pick-up and the pick-up terminals, as shown in Fig. 1. Theoretically, the value of this should be governed by the characteristics of the pick-up and of the valve into which it feeds, but in most cases a resistance of 50,000 ohms will serve. Should the resistance be higher than this it might sometimes be found desirable to connect a fixed resistor of about 100,000 ohms in parallel with the pick-up leads as indicated by broken lines in Fig. 1.

Modifying the Tone

Another slight modification which is worth trying is that of wiring a fixed condenser between the slider terminal of the potentiometer and the end terminal. This also is shown by broken lines in Fig. 1. The value of the condenser can usually be about .001 mfd., but it is a good plan to try a few alternative values, or to replace the fixed component by a pre-set one with a maximum value between .002 and .005 mfd. The condenser is especially valuable when the volume control specified and used is of high resistance; the condenser prevents loss of high-note response at low volume settings.

Although it should not be necessary,

and should be avoided whenever possible, reproduction can be made more "mellow" by connecting a fixed condenser right across the pick-up leads. Broken lines in Fig. 1 show this condenser, which can have a value up to .001 mfd. Always use the lowest capacity which is satisfactory, because the condenser is sure to "cut" the higher frequencies. Apart from the volume control, the modifications mentioned are in the nature of palliatives and their use is in the nature of a "cure," rather than a "prevention"; the latter is bound up with receiver and pick-up design, and introduces far too wide a subject for treatment here.

A Scratch Filter

Quite apart from the use of these resistors and condensers as a means of correcting the quality of reproduction, it is often found that there is a certain amount of "hiss" which results mainly from needle scratch. This can be overcome by fitting a simple parallel circuit which by-passes the very high frequencies of which the "hiss" is comprised. So-called scratch filters can be bought for as little as 3s. 6d., and their two terminals are connected between the pick-up leads. A scratch filter consists of a form of H.F. choke in series with a fixed condenser, and can be made up from an H.F. choke having an inductance

and this is especially useful when it is not practicable to reduce the length of the leads. It is to screen them by running them through a length of screening braid, or by cutting them off short and connecting them to a length of twin-braided cable. The shielding braid must, of course, be effectively earthed by soldering a short piece of wire to it and connecting this to the earth terminal. When the pick-up or its carrier arm is metal, it might be desirable also to run an earth-lead to this.

In the case of many pick-ups made during the past few years, it will be found that the leads are already provided with screening-braid and that there are three leads instead of the expected two. One of these is for earth connection, and it is generally black, or at least coloured differently from the other two for easy identification. When this connection is provided, there is, of course, no need to provide any additional screening. Another point about the connecting cable is that it should not run close to the gramophone motor. If it does, connect the screening-braid to the motor frame—which will, or should be, already earthed.

Mechanical Aspects

The points so far dealt with are purely electrical, or electro-magnetic, in character. There are various mechanical items which

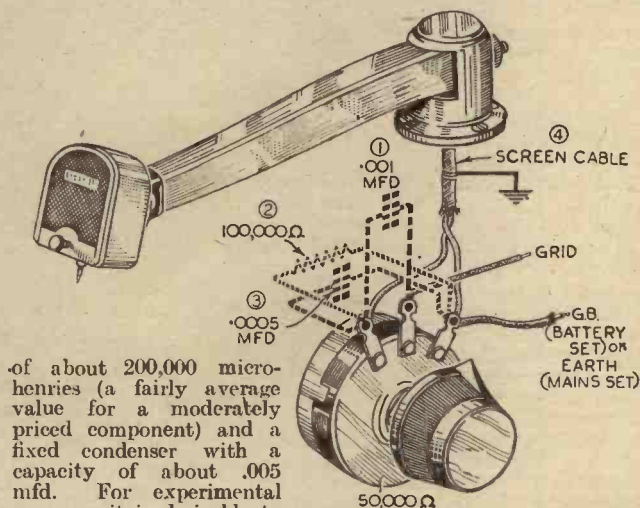

Fig. 1.—The connections of a potentiometer volume control. Broken lines show experimental modifications mentioned in the text. They are: (1) a fixed condenser in parallel with that portion of the potentiometer which is in series with one pick-up lead; (2) a fixed shunt resistor; (3) a shunt condenser for "mellowing" the tone; (4) earthed screening braid for the pick-up cable.

of about 200,000 microhenries (a fairly average value for a moderately priced component) and a fixed condenser with a capacity of about .005 mfd. For experimental purposes it is desirable to try a few alternative condensers, or two or more condensers in parallel to make up the total capacity, or to use a pre-set condenser instead of a fixed one.

Screen the Leads

It is sometimes found, when a pick-up is connected to the receiver for the first time, that there is a high-pitched "tizzing" noise if the set is battery operated, or a pronounced hum or similar noise when the set is mains operated. In almost every case this is due, not to any fault in the pick-up or receiver, but to a form of interaction between the pick-up leads and some other part of the receiver circuit. Sometimes it can be eliminated by the simple process of shortening the pick-up leads, but there is a still more effective method—

call for attention when trouble is experienced due to unsatisfactory reproduction. For example, reproduction can well be ruined if the pick-up arm moves stiffly about its pivot. It is seldom that there is any particular fault with the pivot itself, but if there is, a spot of oil will probably overcome it. Sometimes, however, free movement might be restricted by the method of leading the cable from the arm; it might be pulled tight, for example, so that the arm tends to stick at one point. If that happens, the needle will be pressed toward one side of the record groove instead of riding smoothly down the centre of the groove. Quality might also be lost if the pivot is excessively loose so that the arm and pick-up are allowed to tilt. Should this happen the needle will also be

tilted, so that it rubs on the side of the groove.

Alignment

Correct positioning of the pick-up arm in relation to the turntable is of importance, but there cannot be any fault in this respect if the template generally supplied with the arm is employed when mounting the unit on the motor board. Should a template not be available, the position will be correct when the point of the needle is about 1/4 in. beyond the turntable spindle; its track across the record will then be a shallow curve, which is the nearest approximation to the theoretically-correct radial line. This correct tracking can be properly allowed for only when the turntable is at the correct height. This is obtained when the needle is upright when viewed from the front. When checked from the side the needle should make an angle of approximately 50 degrees with the record surface; this might be described as the angle of drag.

precise, since there are so many varying methods of armature suspension and damping. Careful examination of the unit while dismantling will generally suffice to make the arrangement quite clear. If you are in any doubt concerning the exact method of procedure, it is better to return the unit to the makers' service department than to run any risk of causing damage which would be costly to repair later. If the magnet or coil is to be removed, take care that the fine-wire leads from the winding are not damaged.

Adjustments

After renewing the buffers, or while making any examination or adjustment, it is important that the armature should be centralised. If it is not centred between the pole-pieces it will probably touch one of them on loud passages, thus causing rattle. This will also occur if it is too lightly damped. On the other hand, excessive

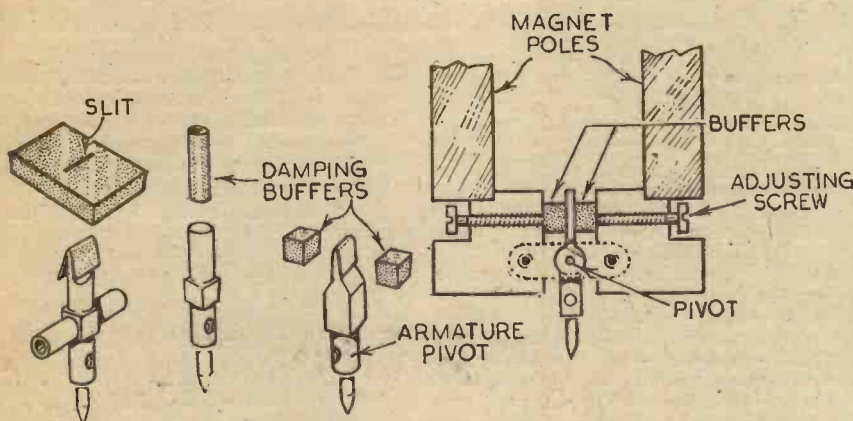

Fig. 2.—Some of the many forms of rubber buffers used for damping the movement of the armature in different pick-ups.

Another fault which might be experienced is that of "needle-chatter" or rattle. Sometimes this is due to nothing more serious than the presence of dirt or small metal particles between the armature (which carries the needle) and the pole pieces of the magnet which is inside the pick-up case. Should this fault be suspected, the cover of the pick-up can be removed by removing the two or three screws, according to design, used to hold it and carefully pressing a strip of plasticine against the ends of the pole pieces. Alternatively, it might be possible to remove any dirt with a fine paint-brush.

Armature Damping

Rattle can also be caused by perishing of the rubber buffers used to damp the movement of the stylus bar, armature or needle-carrier (these names are used to describe the same thing). Buffers of various types are fitted, and some of them are illustrated in simple form in Fig. 2. It may be seen that in one of the systems illustrated the pressure of the rubber buffers can be varied by means of two grub screws. These are recessed in the case and can be turned by means of a very small screwdriver or bradawl. When the rubber is perished and hard, in any type, the buffers must be replaced. If new parts cannot conveniently be obtained from the makers of the pick-up, they can be cut from a pencil-eraser, from a strip of motor-car inner tube, or from a piece of catapult elastic. It is not possible to be more

damping—due to over-tightening the buffers or to the use of buffers which are too hard or large—will result in the unit lacking sensitivity and also in poor bass-note response.

IMPORTANT NOTICE

Owing to the restriction of paper supplies in war-time, readers may find it impossible to get "Practical Wireless" each week unless they give their newsagent a regular order for their favourite paper now.

Wastage of surplus copies in the shops must be avoided, and readers can be of the very greatest help if they will fill up the Order Form given on page 168 and deliver it to their usual newsagent or bookstall. An order of this sort ensures regular delivery during war-time, and the Editor asks every reader to help in this way.

PLEASE ORDER "PRACTICAL WIRELESS" NOW AND USE THE ORDER FORM ON PAGE 168

BARGAINS!

N.T.S. Amazing Offers! Send for Complete Lists

FREE VALVES, S.G.3 Kit for all-wave operation on 9 to 2,000 metres. Available less coils to accommodate those already possessing B.T.S. or N.T.S. One-Shot types. Simple to assemble and an amazing performer on all bands. Two S.G. and Pentode output stages. Complete Kit with metal chassis, transformer, etc., and 3 FREE valves and building instructions. Bargain. Cash or C.O.D., 32/6. If required, complete set of 10 coils (two for each band), 27/-.

SHORT-WAVE 4 Kit, Valves FREE. New bandspread tuning model. S.G. stage and Pentode output, for loudspeaker or 'phone reception of the world's war news, propaganda talks and fascinating short-wave transmissions always on the air. Kit comprises all parts, coils for 12 to 94 metres and 4 FREE valves. Bargain, 55/-.

COMMUNICATIONS Receiver. Famous-name 5-valve model illustrated in N.T.S. advertisement last week. Wave-range 10-550 metres continuous. Bandsread tuning and special tuning features which ensure all-world reception. Built-in speaker 'Phone socket. Fully tested and ready for use on A.C. supplies, 200/250 v. Bargain, £9. Full specification on request. Terms, £2 deposit and four monthly payments of 38/6.

A.C. ALL-WAVE 4 CHASSIS. Now's the time to fit this chassis in your present radio or radiogram cabinet. Powerful 4-valve S.G. Pentode output circuit. Wave range 18 to 2,000 metres. Pleasing station name dial. Output 3 watts. P.U. sockets. Size of chassis, 11 1/2 in. w., 9 in. h., 8 1/2 in. deep. Fully tested and complete with all valves. Bargain 79/6. Limited new stock of matched 2,500 ohm field speakers, 25/-.

VALUABLE RADIO PARCELS. Our new offer comprises variable condensers, coil, fixed resistances and condensers, useful control knobs and a brand new universally drilled cadmium-plated steel chassis. Amazing BARGAIN—only 5/-, plus 1/- for special packing and postage.

BARGAIN PARTS. Parcel of 4 assorted screened and unscreened coils for experimenting and replacement purposes, 2/-, post 6d. Special offer of 2-volt 1-amp. Trickle Chargers employing metal rectifier. Brand new and ready for charging your L.T. on A.C. mains 200/250 volts. Bargain, 12/6, postage 6d.

VALVES. Special offer: set of 3 2-volt battery types 1A6E, 1B4E and 2101, brand-new in makers' cartons, complete with valveholders, data and useful circuit diagrams. Bargain, 7/6 the lot, post free.

NEW TIMES SALES CO.
56 (Pr.W.9), LUDGATE HILL, LONDON, E.C.4

LISTS FREE

"Nowadays," said that knowing chap Hughes,
"One can't risk ever missing the news.
So to keep my new set
On the job, you can bet—
For the wiring it's
FLUXITE I choose!"

See that FLUXITE is always by you—in the house—garage—workshop—wherever speedy soldering is needed. Used for 30 years in government works and by leading engineers and manufacturers. Of Ironmongers—in tins, 4d., 8d., 1/4 and 2/8.

Ask to see the FLUXITE SMALL-SPACE SOLDERING SET—compact but substantial—complete with full instructions, 7/6.

Write for Free Book on the art of "soft" soldering and ask for Leaflet on CASE-HARDENING STEEL and TEMPERING TOOLS with FLUXITE.

TO CYCLISTS! Your wheels will NOT keep round and true, unless the spokes are tied with fine wire at the crossings AND SOLDERED. This makes a much stronger wheel. It's simple—with FLUXITE—but IMPORTANT.

THE FLUXITE GUN

is always ready to put Fluxite on the soldering job instantly. A little pressure places the right quantity on the right spot and one charging lasts for ages. Price 1/6, or filled 2/6.



ALL MECHANICS WILL HAVE

FLUXITE

IT SIMPLIFIES ALL SOLDERING

FLUXITE LTD. (Dept. W.P.) DRAGON WORKS, BERMONDSEY STREET, S.E.1.

LATEST PATENT NEWS

Group Abridgments can be obtained from the Patent Office, 25, Southampton Buildings, London, W.C.2, either sheet by sheet as issued on payment of a subscription of 5s. per Group Volume or in bound volumes, price 2s. each.

Abstracts Published.

PLIERS.—Will, H. No. 502936.



Fig. 1.

Radio pliers comprise two jaw members with narrow tapering jaws 2, 6 (Fig. 1), and curved cutting edges 9 formed on lugs 8. The pivot pin 7 is flattened on opposite sides and engages a round hole in one jaw member and an elongated keyhole slot 11 in the other member so that the jaw space is adjustable, the two jaw members being in other respects of entirely similar form.

TRANSFORMERS.—Kolster-Brandes, Ltd., and Newman, L. G. No. 508692.

A radio-frequency transformer comprises two relatively movable coils L1, L2 (Fig. 2), so arranged that in any position their axes are not contained in parallel planes and do not intersect. The coils L1, L2 may be mounted on members 2, 3 secured to a resilient strip 4 one on each side of a fold 7 therein, the angle between the portions of the strip 4 on which the members 2, 3 are mounted being varied by a screw 8 through gearing 10. The screw 8 may contact the strip 4 at the fold 7 as shown, or may be applied to the strip 4 at P, the strip being held by a stop or other device at O. The apparatus may be arranged in a screening container 1.

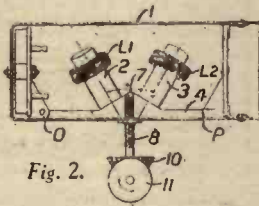

Fig. 2.

MECHANICAL SWITCHES WITHOUT QUICK ACTION.—Murphy Radio, Ltd., Boyd, J. D. A., and Fisher, L. No. 507346.

In a multiple change-over switch for radio receivers, insulating annular discs carrying radially disposed wiping contacts are arranged to be removable from the assembly without the necessity of complete dismantling. Each annular stator disc 7 (Fig. 3), carries contacts 8 which wipe over contact plates 10 on an insulating rotor disc 9 (Fig. 4), which is held between the contacts 8 and contact plates 11, which have connecting lugs 12, on the other side of the stator 7, contact being made between plates 10 and 11 by rivets passing through the rotor 9. Each stator 7 has two notches 17, 18, one radial and one tangential, or both

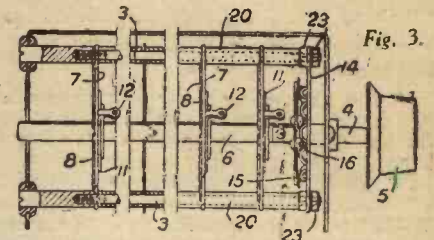

Fig. 3.

tangential which enable it to be sprung on or off rods 3 by loosening nuts 23 but without removing the other discs 7 and spacers 20. A flat strip 6 is threaded through the rotors 9 and screws into a post 4 on an operating handle 5, and it can be removed without disturbing the assembly. Balls 16 on a spring annulus 15 carried by the strip 6, engage with corrugations on a fixed disc 14, to locate the switch.

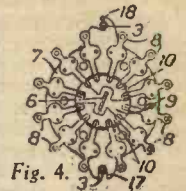

Fig. 4.

NEW PATENTS

These particulars of New Patents of interest to readers have been selected from the Official Journal of Patents and are published by permission of the Controller of H.M. Stationery Office. The Official Journal of Patents can be obtained from the Patent Office, 25, Southampton Buildings, London, W.C.2, price 1s. weekly (annual subscription, £2 10s.).

Latest Patent Applications.

- 27454.—Boehm, H.—Wireless receivers. October 7th.
 27377.—Ducati, A. C.—Radio aerial. October 6th.
 27378.—Ducati, A. C.—Radio aerial. (Cognate with 27377.) October 6th.
 27677.—Longo, G.—Radio transmitters. October 11th.
 27370.—Standard Telephones and Cables, Ltd., Beatty, W. A., and Scully, C. T.—Remote control of radio transmitters and receivers. October 6th.

Specifications Published.

- 513155.—General Electric Co., Ltd., and Graig, R. H.—Cathode-ray tubes.
 513251.—General Electric Co., Ltd., and Peters, W. H.—Tuning devices for wireless receivers.
 513205.—Faudell, C. L., Spencer, R. E., and James, I. J. P.—Television systems.
 513157.—Klemperer, O., and Wright, W. D.—Electron lenses. (Addition to 480857.)
 513136.—Kolster-Brandes, Ltd., Smith, K. G., and Tiller, P. A.—Indicating devices for radio receivers.

Printed copies of the full Published Specifications may be obtained from the Patent Office, 25, Southampton Buildings, London, W.C.2, at the uniform price of 1s. each.

Notes from the Test Bench

Foil On Baseboard

A SPECIAL precaution may be mentioned regarding the use of foil on a baseboard for earthing purposes. If this is sufficiently thick it will be quite in order to solder leads to it and to employ it for screening purposes. A case was recently investigated, however, where a metal cased coil unit had been screwed to a baseboard covered with very thin aluminium foil, and owing to the sharp edges of the coil unit and the undue force used when the screws were tightened, the foil was cut cleanly out to the outline of the coil base. Consequently, the continuity of the screen as an earth medium was broken and the coil unit was not earthed permanently. The poor contact made by the edges of the coil gave intermittent earthing and erratic tuning effects.

Oscillator Note

WHEN using a simple valve oscillator circuit for morse-code practice, it is common to use a standard L.F. transformer as the coupling medium. This transformer will control the frequency of the note, and by modifying the size of the core the pitch of the note may be controlled. If the core is removed entirely, the note will be totally different from that obtained when the core is intact, and therefore an interesting form of test device may be made up with such a circuit, provision being made for sliding a portion of the core in and out. It should be locked up by some means and mounted on a small sliding base, preferably provided with markings or graduations so that pre-arranged settings may easily be obtained.

Separate G.B. Battery

SOME commercial receivers are provided with a combined H.T. and G.B. battery, and readers have experienced difficulty in obtaining replacement of these. Separate H.T. and G.B. batteries are, however, more easily obtainable, and it

should be remembered that these may be used, provided that a lead is added to the battery cable for the G.B. positive connection. This is, of course, automatically provided in the combined battery, being common with the H.T.—socket. Therefore, when using the separate batteries a short lead must be attached to the H.T.—lead and a plug provided for insertion in the G.B. positive socket.

THE WIRELESS CONSTRUCTOR'S ENCYCLOPÆDIA

By F. J. CAMM 6th Edition 5/- net.
 (Editor of "Practical Wireless")

Wireless Construction, Terms, and Definitions explained and illustrated in concise, clear language.

From all Booksellers, or by post 5/6 from George Neumes, Ltd., Tower House, Southampton Street, Strand, London, W.C.2.

ELECTRADIX OFFERS—

DETECT ENEMY FIRE BOMBS with a photo-cell night watchman. You can make one yourself to indicate in the A.R.P. room. Battery or mains. RAY DETECTOR. Complete Kit. Battery model with Relay £3/17/6. A.C. Mains Set £5/10. D.C. Mains Set £4/15. **PHOTO CELLS.** R.C.A. Caesium Silver Vacuum £5 list. for 25/-. Electro-Photonic photo-cells generate E.M.F. under light 1 1/4 in. by 1 in. 22/6. Few only left. **DISC SELENIUM CELLS** light to dark resistance ratio. mounted in bakelite case 8/6. In brass housings, Superior model 10/6.

RELAYS. Ultra-sensitive Moving Coil Relay 1,000 ohm coil closes circuit on 50 microamps 60/- 2,000 ohm 6 m.a. Lightweight magnetic Relay 10/6.

RAID BELLS. ALARM BELLS. Mains, battery or magneto waterproof types. Large selection. Priority for A.R.P. 2/6 to 4/0/-.



POCKET HEADPHONES. W.D. all leather headband strap and cords, 3/6 pair. Wireless type, with aluminium headband, 3/9. 4,000 ohms, 4/6.

LISTENING MIKES, steel-clad Electradix indestructible, are ears outside your dug-out.

CABINET AND COMPONENTS FOR "P.W. 30/- THREE"



Tudor Oak Cabinet 13 1/2 in. by 7 in. by 7 in. Fitted .0005 Slow Motion Condenser dial window, vernier microphone, 3-way switch, chassis valveholders, wiring clips, three fixed condensers and 10 terminal panel strip. 12/6.

Complete as detailed. ONLY 10/- to callers. or 12/6 Post and Packing Free.

DUG-OUT CRYSTAL SETS. Model B. Pol. Mah. case 9 in.—10 in. 2 tuning condensers, plug-in coils. Permanent Detector, 7/6. Small Boudoir Model 5/6.

THE MORSE CODE. You must learn it. **MORSE PRACTICE SETS** are cheap. No. 1 Sound. Key and Buzzer on base, 3/- No. 2 Light. Key and Bulb on base, 2/- No. 3. Combination Set for Sound and Light key, buzzer and bulb on base, 7/-.

BUZZERS, BUZZERS, BUZZERS for all purposes. The well-known robust Model D. For Morse Practice or Signals. Adjustable note. Worth 5/- For 1/- only. **KEYS FOR MORSE.** Well balanced Morse keys, plated brass bar, bakelite base and terminals, etc. 4/6. Massive Buzzer, 1/- With these and your pocket battery you can signal distant to pair of 3/9 Sullivan phones.

Superior Model Keys, 7/6. A few Government long-lever Keys, used spares for transmitting, 10/6. No. 1, R.A.F. Signal Keys, massive balanced bar with adjustments, wood base, Khaki finish, 12/6. Fuller Army Keys 15/- Brown's Patrol Keys 42/-.

MORSE RECORDING. These service paper tape inkers record messages. Magnificent British work, mahogany drawer containing tape reel, Standard G.P.O. Type £6/10. Portable enclosed Field Service type, completely fitted with meter and key, unused, £7-10-0.

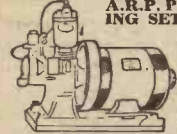

A.R.P. PETROL ELECTRIC GENERATING SETS for Lighting and Charging.

Half h.p. DIRECT COUPLED.

150 watts D.C. 1,300 r.p.m.

2-stroke water-cooled 1-cyl. Engine, magneto ignition.

On bedplate with 30 volts 5 amps.

Dynamo, £12-90 Larger size 1 kW. Petrol Electric sets

500 watts, 2-stroke water-cooled

1 h.p. 1 cyl. engine on bed plate direct-coupled to 50/70 volts 10 amps. D.C. Dynamo, magneto ignition, fuel and oil tank, £16. See review page 145, Oct. 28 issue.

A.R.P. EDISON HIGH CAPACITY STEEL CELLS at quarter list price.

CABLE. Lightweight twin weld cable, unbreakable Army steel reinforced, 55/- mile. Heavier types, 65/- and 70/-.

ARMY SIGNALS. Day and Night Lucas and Aldis Hooded Army Signal lamps, telescopes, rights, hand or tripod. For Fire Brigades and Police, 60/- Hellos on tripod for signals.

SHELTER, A.R.P. Ventilation and Air Conditioning. A.C. or D.C. mains, 80 watts; 9 in. Blower, 20 cub. ft. fresh air per min., 25/-.

ELECTRIC PUMPS, for A.C. or D.C. 12 v. to 230 v. Centrifugal all-bronze pump, throws 120 gals. per hour. 6ft. Caravans, Bungalows and Boats, 72/6. Larger pumps for draining shelters, dug-outs, etc. £6-17-6.

FOR DARK NIGHTS AT HOME. SOUND RECORDING at low cost. The FEIGH RECORDER fits any diagram, positive drive, worm gear and rack. Complete, ready for use, only 37/6. Super Feigh Fidelity Set, 42/6. Tracking Gear only, 21/- Either 3/3 doz. metal blanks can be used for the glass-coated simplices. 1 in., 3/- each. Pre-amplifiers for Recording Mikes, 1-valve Battery Model in cabinet, 25/- A.C. Mains pre-amplifiers, with valve rectifier, steel-cad model, 30/-.

5/- EMERGENCY PARCELS of useful Experimental electrical and radio repair material and apparatus, 10lbs. for 5/- Post Free.

Don't forget to send now for our Barstain List "N."

ELECTRADIX RADIOS

218, Upper Thames Street, London, E.C.4

Telephone: Central 4611



FREE ADVICE BUREAU COUPON

This coupon is available until November 11th, 1939, and must accompany all Queries and Hints.

PRACTICAL WIRELESS, 4/11/39.

IMPROVING THE SUPERHET

(Continued from page 158).

ate tuning settings which will be imperative in view of the risk of distortion due to side-band cutting when the set is slightly "off-tune." A visual tuning indicator will assist in finding the accurate setting point, provided that A.V.C. is fitted in the receiver. The small "magic-eye" or cathode-ray tuning indicators are obtainable separately and may be added to such a receiver by adopting a circuit recommended by the makers of the Osram indicator. It will be seen that it is fed from the last I.F. stage and the A.V.C. line, and the necessary valve-holder should be mounted on a bracket so that the top of the valve is facing the panel. A hole will have to be cut to permit the top of the valve to be seen and the tuning indications thereby read. A small escutcheon may be mounted if desired. Again it is necessary to adhere to the values recommended by the makers of the particular tuning indicator which is obtained and instructional leaflets are supplied by the manufacturers for this purpose.

D.C. and H.T. ELIMINATORS

(Continued from page 151).

remember that *milliamps* are invariably used and not amperes; therefore, in the above formula R would equal $\frac{E \times 1,000}{I}$

If this is applied to the point C of the first network, and taking the voltage and current values given previously, then

$$R1 = \frac{80 \times 1,000}{10} \text{ which in turn equals}$$

8,000 which, as it denotes the value of the resistance, will naturally be in ohms.

In case anyone is wondering where the 80 comes from, it should be realised that one is concerned with dropping a certain voltage to arrive at the required figure of 120 volts, for the point in question. The figure 80, therefore, represents the difference between the supply available, namely, 200 volts at B and the 120 volts at C. *Don't overlook this little essential detail.* Always remember that the purpose of the resistance is to drop the *surplus voltage*.

The other resistances' values for the first network can be calculated in the same way, provided one remembers the change in current value and the difference in the voltage to be dropped. To make it quite clear, the values for D and E respectively should be written in the following manner:

$$R(D) = \frac{(200 - 80) \times 1,000}{5} \text{ and}$$

$$R(E) = \frac{(200 - 60) \times 1,000}{2} \text{ or, 24,000 ohms}$$

and 70,000 ohms. It will be noticed that E in the two above examples (the difference between the maximum voltage and that required at the two points) has been shown in detail for the sake of clearness.

From the above it will be appreciated that particular care must be taken when measuring the current which will be flowing in the circuits fed by the various tapplings, otherwise a considerable variation in voltages will result. In this direction it is advisable to remember that the meters used for such work must be accurate and, in the case of voltmeters, have a high resistance. Many readers use a low-resistance voltmeter for checking the voltages supplied by an eliminator and, owing to the current consumed by the meter, due to its low internal resistance, false readings are obtained.

MAKING 465 KC/S I.F. TRANSFORMERS

(Continued from page 150)

screening can. Nuts and lock-nuts are placed on the rod at the two points where it emerges from the screen, to prevent lateral movement, and these can be tightened so that there is sufficient stiffness to rotation to prevent the coil turning on its own. An ordinary knob is fixed to the end of the rod, and this provides the operation. It should be noticed that the flexible leads from the moving coil are brought out through the top of the screen (which can be made from a thin tinfoil canister or obtained from an old component), whilst those from the fixed coil are brought out at the base. In doing this it will be found convenient to mount one of the pre-set trimming condensers on top of the case or, better still, inside it and beneath a hole giving access to the adjusting screw.

Those with mechanical inclinations will appreciate that this simple form of construction is far from ideal, and will prefer to fit brass bushes in the screen to take the spindle. Another point worthy of mention is that a pair of transformers can easily be ganged by fitting a metal sleeve between the spindles of two transformers placed in a line.

Adjustable Coupling

There is another form of variable coupling available to the constructor, and one which offers many advantages, chief of which is that it does not depend for its successful operation on any mechanical devices. The system referred to consists of placing a third coil (which is not connected to any part of the circuit) between the primary and secondary windings. The form of construction referred to is illustrated in Fig. 5, and it can be seen that primary and secondary windings of 120 turns each are wound in three sections on a 1 1/4 in. (overall) diameter ribbed ebonite former. Each winding is divided into three sections 1/4 in. apart, and there is a space of 1 in. between primary and secondary. In this space are wound 50 turns of 36-gauge enamelled wire, the ends of the winding being connected to two terminals of a variable resistance having a value of about 2,500 ohms—the exact resistance is not very critical.

When the resistance is set to its maximum value the coil provides a fair degree of coupling between the primary and secondary, but when it is moved to zero the coupling is appreciably reduced. Thus, the degree of selectivity is increased, as is required when listening to distant stations or when interference is experienced. This electrical system of selectivity control has been found very satisfactory, although it is worth while to experiment with different sizes of coupling winding.

It will be understood, of course, that with any of the forms of I.F. transformer described it is necessary to include the .0003-mfd. pre-set condensers in parallel with the two windings for trimming purposes. These can be adjusted by trial when the transformers are put into use. It might be thought that the capacity suggested is rather high, but it is preferable to have a fair range of adjustment, especially when using home-made coils which cannot be calibrated as are factory-produced coils.

PATENTS AND TRADE MARKS

Any of our readers requiring information and advice respecting Patents, Trade Marks or Designs, should apply to Messrs. Rayner and Co., Patent Agents, of Bank Chambers, 29, Southampton Buildings, London, W.C.2, who will give free advice to readers mentioning this paper.

Open to Discussion

The Editor does not necessarily agree with the opinions expressed by his correspondents. All letters must be accompanied by the name and address of the sender (not necessarily for publication).

A Reader's Den

SIR,—I enclose a photograph of part of my den which may be of interest to readers.

On the right may be seen the master mains control board, and immediately below this an 0-v-0 short-wave receiver which feeds into the D.D.T. and pentode section of the six-valve broadcast receiver beneath. Under this is the speaker and a compartment for batteries.

The panels on the left contain an electric clock, mains distribution switches, and amplifying equipment. I am particularly interested in your articles on servicing.

Wishing PRACTICAL WIRELESS continued success.—M. S. CROTHALL (Folkestone).

Contacting S. African Amateurs

SIR,—I would very much like to exchange my S.W.L. cards with any S.W.L., A.A., or fully licenced amateur anywhere on the globe.

Might I add that the postal authorities here will get all mail through, regardless of the international situation.

My correspondents tell me that they have not been able to contact very many S.A. hams. If hams or S.W.L.s therefore wish to work more S.A. hams they should communicate with the S.A.R.R.L. Address: P.O. Box 3037, Cape Town, S. Africa.

In conclusion, I wish to compliment you on the new PRACTICAL WIRELESS magazine.—JACK LEVIN (Salt River, Cape Town).

Exchanging QSL Cards

SIR,—It may interest QSL exchangers to know that I have started a QSL "Swapping Service" for PRACTICAL WIRELESS readers. To avoid congestion, I have a number of lists of QRA's of 100 per cent. QSL'ers. All these addresses were made through PRACTICAL WIRELESS. Lists will be sent free to all readers genuinely interested, and as postage cost at this end will be high, a stamp would be appreciated.—JOHN R. TYZACK, 197, So. Eldon Street, South Shields, Co. Durham.

SIR,—In order to keep alive the "contact" spirit of ham radio during the war, I shall be pleased to exchange my QSL card with any of your readers at home or abroad, and all cards will be acknowledged with my own QSL card, bearing my personal photograph and call-sign, G5LP.—L. F. S. PARKER (G5LP), 22, Second Avenue, Wellingborough, Northants.

A 14 mc/s Log from Westgate: Correspondents Wanted

SIR,—I have been interested in the DX logs published in your paper for some time, and so am enclosing my 14 mc/s log from October 1st-18th.

Phone: EA1L; EK1AF; ES1E, 5C, D; HA2T, 3B, 8C; I1RE; UK3AA; W1AA, DES, JFG, KSG, YIB, BC, HF, 2ANL, 3EOZ, GJH, SPR, 6VB, 8FCQ, AKW, 9CBX; and XE1FG.

CW: ARIAF; CT1CX; D4BUF; EA5A; EK1AR; ES2G; 5D, 8D; HA2L, G, 3F, 7L; I1KN, MK, EC; PL, AX; KAILZ; LU4BH; OZ3IK; OXZ2X; PK1IJ, XZ; PY2DV, KT; UIAD, 3AV, AH, CU, 4AM, GQ; U2AH,



A corner of Mr. M. S. Crothall's wireless den.

Prize Problems

PROBLEM No. 372.

SEEING a moving-coil loudspeaker offered for sale at a very low price, Smithers purchased it to use in his receiver in place of an old moving-iron component. He took it home and connected it to his receiver, but volume was very weak, signals being almost inaudible. He thought perhaps it was defective, and took it back to the dealer, who connected it to a test receiver which he had working and convinced Smithers that the speaker was perfectly in order. Again Smithers tried it on his set, but again could only obtain very weak signals. What was wrong? Three books will be awarded for the first three correct solutions opened. Entries should be addressed to The Editor, PRACTICAL WIRELESS, George Newnes, Ltd., Tower House, Southampton Street, Strand, London, W.C.2. Envelopes must be marked Problem No. 372 in the top left-hand corner and must be posted to reach this office not later than the first post on Monday, November 6th, 1939.

Solution to Problem No. 371.

The coils which Jackson obtained were not matched and thus his matched ganged condenser would not be capable of tracking properly throughout the waverange. The following three readers successfully solved Problem No. 370 and books have accordingly been forwarded to them: W. C. Pracy, 3, Stanham Terrace, Strait Road, Romford; T. Kitching, 2, Railway Crescent, Withernsea, E. Yorks; A. T. Jackson, 31, Schneider Road, Barrow-in-Furness.

NE, UG, GOJ; U5YS, KA; W1KH KNH, DMX, KHE, LZ, 2KYO, PZ, LTI 3TOV, 4IOW, 7OSL, 8DPH & XU7G A? YI6ZC; YR5AE; YU7XU, and LP.

My receiver is an 0-v-2 (battery), and the aerial a 50ft. inverted-L. All reception was on 'phones.

I would be pleased to get in touch with any S.W.L.s in the Folkestone district, as I am shortly moving there.—PETER A. LOVELOCK, Strathmore, Minster Road, Westgate, Kent.

Station TGWA

SIR,—I have been a regular reader of PRACTICAL WIRELESS for the past two years and must compliment you on the high standard of its contents. The other day I received a pound of Guatemalan coffee from station TGWA as a prize in one of their DX contests. If any readers would like to correspond with me and send S.W.L. cards I will endeavour to reply by return of post to each. Wishing your paper every success.—K. I. PROCTER, Beechleigh, 63, Thackeray's Lane, Woodthorpe, Nottingham.

The British Short-Wave League

SIR,—May I add a little further information to that supplied by reader R. W. Ibull in the October 21st issue, regarding the activities of the British Short-Wave League.

I have just received a card from the secretary, Mr. F. A. Beane, stating that an eight-page "Review" will be brought out at the end of this month. He asks me to pass this news on to all friends and members, as there are countless B.L.D.L.C. members who are also B.S.W. Leaguers.—R. T. PARSONS (Brighton).

Correspondent Wanted

SIR,—As a member of the B.L.D.L.C., and being intensely interested in short and medium-wave radio, I would like to correspond with any listener or amateur in any part of the world, preferably one who is well up in amateur transmitting.

All letters will be answered by return. My interest lies mainly in collecting QSL cards, and transmitting subjects.

Wishing your journal every success.—J. WOAD, 15, Bradbury Street, Ravensthorpe, Dewsbury, Yorks.

Join Newnes' Practical Group!

PRACTICAL MOTORIST

The owner-driver's journal which tells you how to repair, overhaul and obtain the best performance from your car.

3d.—Every Friday.

PRACTICAL MECHANICS

The only English journal of its type. It deals with every branch of Science, Mechanics, Invention, Model-making, Chemistry, Astronomy, Photography.

6d.—Every month.

THE CYCLIST

The leading weekly for every Cyclist, Clubman, Utility Cyclist or Tourist. Join "The Cyclist" Road Club and also take advantage of the FREE Insurance.

2d.—Every Wednesday.

Practical Wireless BLUEPRINT SERVICE

These Blueprints are drawn full size. Copies of appropriate issues containing descriptions of these sets can in some cases be supplied at the following prices, which are additional to the cost of the Blueprint. A dash before the Blueprint Number indicates that the issue is out of print.

Issues of Practical Wireless... 4d. Post Paid
Amateur Wireless... 4d. " "
Wireless Magazine... 1/3 " "

The Index letters which precede the Blueprint Number indicate the periodical in which the description appears: Thus P.W. refers to PRACTICAL WIRELESS, A.W. to Amateur Wireless, W.M. to Wireless Magazine.

Send (preferably) a postal order to cover the cost of the Blueprint and the issue (stamps over 6d. unacceptable) to PRACTICAL WIRELESS Blueprint Dept., George Newnes, Ltd., Tower House, Southampton Street, Strand, W.C.2.

PRACTICAL WIRELESS		No. of	Universal Hall-Mark (HF Pen, D,	
Date of Issue.		Blueprint.	Push-Pull)	PW47
CRYSTAL SETS.				
Blueprints, 6d. each.				
1937 Crystal Receiver		PW71		
The "Junior" Crystal Set	27.8.38	PW94	A.C. All-Wave Corona Four	6.11.37 PW81
STRAIGHT SETS. Battery Operated.				
One-valve: Blueprints, 1s. each.				
All-Wave Unipen (Pentode)		PW31A		
Beginners' One-valver	19.2.38	PW95		
The "Pyramid" One-valver (HF Pen)	27.8.38	PW93		
Two-valve: Blueprints, 1s. each.				
Four-range Super Mag Two (D, Pen)		PW36B		
The Signet Two (D & LF)	24.9.38	PW76		
Three-valve: Blueprints, 1s. each.				
Selectone Battery Three (D, 2 LF (Trans))		PW10		
Sixty Shilling Three (D, 2 LF (RC & Trans))		PW34A		
Leader Three (SG, D, Pow)	22.5.37	PW35		
Summit Three (HF Pen, D, Pen)		PW37		
All Pentode Three (HF Pen, D (Pen), Pen)	29.5.37	PW39		
Hall-Mark Three (SG, D, Pow)	12.9.37	PW41		
Hall-Mark Cadet (D, LF, Pen (RC))	16.3.35	PW48		
F. J. Camm's Silver Souvenir (HF Pen, D (Pen), Pen) (All-Wave Three)	13.4.35	PW49		
Cameo Midget Three (D, 2 LF (Trans))		PW51		
1936 Sonotone Three-Four (HF Pen, HF Pen, Westcor, Pen)		PW53		
Battery All-Wave Three (D, 2 LF (RC))		PW55		
The Monitor (HF Pen D, Pen)	21.3.36	PW61		
The Tutor Three (HF Pen, D, Pen)	14.8.37	PW62		
The Centaur Three (SG, D, P)		PW64		
F. J. Camm's Record All-Wave Three (HF Pen, D, Pen)	31.10.36	PW69		
The "Coit" All-Wave Three (D, 2 LF (RC & Trans))	18.2.39	PW72		
The "Rapido" Straight 3 (D, 2 LF (RC & Trans))	4.12.37	PW82		
F. J. Camm's Oracle All-Wave Three (HF, Det., Pen)	28.8.37	PW78		
1938 "Triband" All-Wave Three (HF Pen, D, Pen)	22.1.33	PW84		
F. J. Camm's "Sprite" Three (HF Pen, D, Tet)	26.3.38	PW87		
The "Hurricane" All-Wave Three (SG, D (Pen), Pen)	30.4.38	PW89		
F. J. Camm's "Push-Button" Three (HF Pen, D (Pen), Tet)	3.9.38	PW92		
Four-valve: Blueprints, 1s. each.				
Sonotone Four (SG, D, LF, P)	1.5.37	PW4		
Fury Four (2 SG, D, Pen)	8.5.37	PW11		
Beta Universal Four (SG, D, LF, Cl. B)		PW17		
Nucleon Class B Four (SG, D (SG), LF, Cl. B)		PW34B		
Fury Four Super (SG, SG, D, Pen)		PW34C		
Battery Hall-Mark 4 (HF Pen, D, Push-Pull)		PW46		
F. J. Camm's "Limit" All-Wave Four (HF Pen, D, LF, P)	26.9.36	PW67		
All-Wave "Corona" 4 (HF, Pen D, LF, Pow)	9.10.37	PW79		
"Acme" All-Wave 4 (HF Pen, D (Pen), LF, Cl. B)	12.2.38	PW83		
The "Admiral" Four (HF Pen, HF Pen, D, Pen (RC))	3.9.38	PW90		
Mains Operated.				
Two-valve: Blueprints, 1s. each.				
A.C. Twin (D (Pen), Pen)		PW18		
A.C.-D.C. Two (SG, Pow)		PW31		
Selectone A.C. Radiogram Two (D, Pow)		PW19		
Three-valve: Blueprints, 1s. each.				
Double-Diode-Triode Three (HF Pen DDT, Pen)		PW23		
D.C. Ace (SG, D, Pen)		PW25		
A.C. Three (SG, D, Pen)		PW29		
A.C. Leader (HF Pen, D, Pow)	7.1.39	PW35C		
B.C. Premier (HF Pen, D, Pen)		PW35B		
Ubique (HF Pen, D, (Pen), Pen)	28.7.34	PW36A		
Armada Mains Three (HF Pen, D, Pen)		PW38		
F. J. Camm's A.C. All-Wave Silver Souvenir Three (HF Pen, D, Pen)	11.5.35	PW50		
"All-Wave" A.C. Three (D, 2 LF (RC))		PW54		
A.C. 1936 Sonotone (HF Pen, HF Pen, Westcor, Pen)		PW56		
Mains Record All-Wave 3 (HF Pen, D, Pen)		PW70		
All-World Ace (HF Pen, D, Pen)	28.8.37	PW80		
Four-valve: Blueprints, 1s. each.				
A.C. Fury Four (SG, SG, D, Pen)		PW20		
A.C. Fury Four Super (SG, SG, D, Pen)		PW34D		
A.C. Hall-Mark (HF Pen, D, Push-Pull)	24.7.37	PW45		
SUPERNETS.				
Battery Sets: Blueprints, 1s. each.				
£5 Superhet (Three-valve)	5.6.37	PW40		
F. J. Camm's 2-valve Superhet		PW52		
F. J. Camm's "Vitesse" All-Waver (5-valver)	27.2.37	PW75		
Mains Sets: Blueprints, 1s. each.				
A.C. £5 Superhet (Three-valve)		PW43		
D.C. £5 Superhet (Three-valve)	1.12.34	PW42		
Universal £5 Superhet (Three-valve)		PW44		
F. J. Camm's A.C. £4 Superhet 4	31.7.37	PW59		
F. J. Camm's Universal £4 Superhet 4		PW60		
"Qualitone" Universal Four	16.1.37	PW73		
Four-valve: Double-sided Blueprint, 1s. 6d.				
Push-Button 4, Battery Model	22.10.38	PW95		
Push-Button 4, A.C. Mains Model				
SHORT-WAVE SETS. (Battery Operated.)				
One-valve: Blueprint, 1s.				
Simple S.W. One-valver	9.4.38	PW88		
Two-valve: Blueprints, 1s. each.				
Midget Short-wave Two (D, Pen)		PW38A		
The "Mect" Short-wave Two (D (HF Pen), Pen)	27.8.33	PW91		
Three-valve: Blueprints, 1s. each.				
Experimenter's Short-wave Three (SG, D, Pow)	30.7.38	PW30A		
The Prefect 3 (D, 2 LF (RC and Trans))		PW68		
The Band-Spread S.W. Three (HF Pen, D (Pen), Pen)	1.10.38	PW68		
PORTABLES.				
Three-valve: Blueprints, 1s. each.				
F. J. Camm's ELF Three-valve Portable (HF Pen, D, Pen)		PW65		
Parvo Lightweight Midget Portable (SG, D, Pen)	3.6.39	PW77		
Four-valve: Blueprint, 1s.				
"Imp" Portable 4 (D, LF, LF, (Pen))	40.3.38	PW86		
MISCELLANEOUS.				
S.W. Converter-Adapter (1 valve)		PW48A		
AMATEUR WIRELESS AND WIRELESS MAGAZINE				
CRYSTAL SETS.				
Blueprints, 6d. each.				
Four-station Crystal Set	23.7.38	AW427		
1934 Crystal Set		AW444		
150-mile Crystal Set		AW450		
STRAIGHT SETS. Battery Operated				
One-valve: Blueprint, 1s.				
B.B.C. Special One-valver		AW387		
Two-valve: Blueprints, 1s. each.				
Melody Hanger Two (D, Trans)		AW388		
Full-volume Two (SG det, Pen)		AW392		
Lucerne Minor (D, Pen)		AW426		
A Modern Two-valver		WM409		
Three-valve: Blueprints, 1s. each.				
Class B Three (D, Trans, Class B)		AW386		
£5 5s. S.G. 3 (SG, D, Trans)	2.12.33	AW412		
Lucerne Ranger (SG, D, Trans)		AW422		
£5 5s. Three: De Luxe Version (SG, D, Trans)	19.5.34	AW435		
Lucerne Straight Three (D, RC, Trans)		AW437		
Transportable Three (SG, D, Pen)		WM271		
Simple-Tune Three (SG, D, Pen)	June '33	WM327		
Economy-Pentode Three (SG, D, Pen)	Oct. '33	WM337		
"W.M." 1934 Standard Three (SG, D, Pen)		WM351		
£3 3s. Three (SG, D, Trans)	Mar. '34	WM354		
1935 £6 6s. Battery Three (SG, D, Pen)		WM371		
PTP Three (Pen, D, Pen)		WM389		
Certainty Three (SG, D, Pen)		WM393		
Minutube Three (SG, D, Trans)	Oct. '35	WM396		
All-Wave Winning Three (SG, D, Pen)		WM400		
Four-valve: Blueprints, 1s. 6d. each.				
65s. Four (SG, D, RC, Trans)		AW370		
2HF Four (2 SG, D, Pen)		AW421		
Self-contained Four (SG, D, LF, Class B)	Aug. '33	WM331		
Lucerne Straight Four (SG, D, LF, Trans)		WM350		
£5 5s. Battery Four (HF, D, 2 LF)	Feb. '35	WM381		
The H.K. Four (SG, SG, D, Pen)	Mar. '35	WM384		
The Auto Straight Four (HF Pen, HF Pen, DDT, Pen)	Apr. '36	WM404		
Five-valve: Blueprints, 1s. 6d. each.				
Super-quality Five (2 HF, D, RC, Trans)		WM320		
Class B Quadradyne (2 SG, D, LF, Class B)		WM344		
New Class B Five (2 SG, D, LF, Class B)		WM340		
Mains Operated.				
Two-valve: Blueprints, 1s. each.				
Two-valve Mains Short-wave (D, Pen) A.C.		AW453		
"W.M." Long-wave Converter		WM380		
Three-valve: Blueprint, 1s.				
Emigrator (SG, D, Pen) A.C.		WM352		
Four-valve: Blueprint, 1s. 6d.				
Standard Four-valve A.C. Short-wave (SG, D, RC, Trans)	Aug. '35	WM391		
MISCELLANEOUS.				
S.W. One-valve Converter (Price 6d.)		AW320		
Enthusiast's Power Amplifier (1/6)		WM387		
Listener's 5-watt A.C. Amplifier (1/6)		WM392		
Radio Unit (2v.) for WM392 (1/-)	Nov. '35	WM398		
Harris Kleogram battery amplifier (1/-)		WM399		
De Luxe Concert A.C. Electro-gram (1/-)	Mar. '36	WM403		
New Style Short-wave Adapter (1/-)		WM388		
Trickle Charger (6d.)	Jan. 5, '35	AW462		
Short-wave Adapter (1/-)		AW456		
Superhet Converter (1/-)		AW457		
B.L.D.L.C. Short-wave Converter (1/-)	May '36	WM405		
Wilson Tone Master (1/-)	June '36	WM406		
The W.M. A.C. Short-wave Converter (1/-)		WM408		

In reply to your letter

Aerial Lead

"I am erecting a new aerial, outdoors this time, as my previous aerials have been indoors. I have to drill through a metal framed window to lead the wire in and I wonder if there is any detriment in this, as the metal frame will be obviously earthed through the walls, etc. Could you advise regarding this point, or suggest any better alternative?"—J. C. (Canonbury, N.1).

IN normal cases there is no objection to taking the lead through the metal frame. The lead will run at right angles to the actual metal work and thus only a very small capacity effect will be provided. If a well-insulated wire is used or, better still, if a proper lead-in insulator is fitted, there will be no noticeable loss. One idea to avoid drilling the metal frame has been suggested, namely, to attach the end of the lead-in to a disc of metal—about 4 ins. in diameter, and to cement this to the actual glass window pane. A similar disc should then be attached immediately behind the glass, that is, inside the room, and attached to the aerial terminal. This provides a series aerial condenser.

Valve Connections

"I have a mains triode with top cap but with 8-pin base, and I am unable to find the connections to this particular valve. I wonder if you could assist me in this; the type number of the valve is HL.133."—P. V. (Coventry).

THE base is provided with a "keyed" plug, and holding the valve with pins facing you and with the key at the bottom, the pins may be numbered from 1 to 8, starting with the pin on the immediate left of the key. The connections are then 1 and 8 heater; 2 cathode; 3 anode; 4, 5 and 7 are blank and 6 is the metallising. The grid is joined to the top cap.

Hum-bucking Coil

"In looking through some back numbers I came across a reference to a 'hum-bucking' coil, but I am sorry that I have been unable to find any trace as to what this means. I wonder if you would enlighten me in this connection or direct me to any source of information."—G. R. T. (Barnsley).

THE term is applied to a small coil wound on a loudspeaker of the field-energised type. The coil is overwound on the field winding and it is connected in series with the speech coil, but so arranged that it is out of phase with the speech coil. Thus any hum introduced into the latter is balanced out, or bucked.

Meter Connections

"I am building up a more or less comprehensive five-valve with two H.F. stages, and have two or three milliammeters on hand. I should like to fit these to the

receiver as permanent fittings on the lines of a good transmitter, but am in some doubt as to the most suitable places in which to put them. Could you suggest how I might best make use of them in this connection?"—W. B. N. (Portsmouth).

THE only really effective place in such a circuit as that mentioned, provided A.V.C. is not employed, is in the detector stage with, perhaps, a high reading meter in the common H.T. negative lead to see the total H.T. consumption. A meter could be included in the anode circuit of the output valve to indicate overloading, but probably the best plan is to keep to the transmitter idea and fit closed-circuit

RULES

We wish to draw the reader's attention to the fact that the Queries Service is intended only for the solution of problems or difficulties arising from the construction of receivers described in our pages, from articles appearing in our pages, or on general wireless matters. We regret that we cannot, for obvious reasons—

- (1) Supply circuit diagrams of complete multi-valve receivers.
- (2) Suggest alterations or modifications of receivers described in our contemporaries.
- (3) Suggest alterations or modifications to commercial receivers.
- (4) Answer queries over the telephone.
- (5) Grant interviews to querists.

A stamped addressed envelope must be enclosed for the reply. All sketches and drawings which are sent to us should bear the name and address of the sender.

Requests for Blueprints must not be enclosed with queries as they are dealt with by a separate department.

Send your queries to the Editor, PRACTICAL WIRELESS, George Newnes, Ltd., Tower House, Southampton Street, Strand, London, W.C.2. The Coupon must be enclosed with every query.

jacks in every anode and screen circuit so that a suitable meter may be plugged in as desired. By using a low reading meter and fitting shunts across the various jacks so that the necessary scale multiplication is obtained, one meter will serve for all readings.

Self-contained A.V.C. Unit

"I have just read the interesting article on the above subject in your issue dated October 21st, but note that you refer to an H.F. choke whereas your circuits indicate an L.F. choke. I wonder if you will tell me exactly what type of choke is needed as I should like to make up the unit."—M. C. (Merthyr).

IN the second paragraph of the article in question it states that the choke may be "any standard broadcast component, but best results will be obtained with an iron-cored component." The circuits and text therefore agree, as the diagrams indicate the iron-cored type of choke. The letters L.F. in Fig. 5 indicate the L.F. coupling to which that point is joined. A suitable iron-cored choke is the Wearite type H.F.O. or Varley Nicore, type BP.26.

Inductance Measurements

"I am interested in the making of chokes and transformers, but the main difficulty is that when I have wound them I am unable to ascertain the inductance value. As I am anxious to carry out some rather detailed tests I should like to be able to measure the inductance and wonder whether you can tell me how to make a suitable instrument for the purpose. Have you ever described, for instance, an inductance bridge which would do the trick?"—D. E. R. (S.E.4).

A SIMPLE instrument which may be made from spares was described in our issue dated May 6th last.

Ultra-short Wave Adapter

"Although amateur activities have ceased I have heard some interesting ultra-short wave signals on a friend's television receiver and I understand that it is possible to get such signals on a standard set by means of an add-on unit. If this is so, could you give me instructions for making one which I could use with my Hall-mark Four, battery version?"—P. S. (Perranporth).

AN adapter is generally satisfactory, although a converter can be constructed. With a four-valve, however, you are probably concerned with H.T. and L.T. consumption, and therefore an adapter would probably be of greater use to you. This is used in place of the existing detector stage, and the H.F. stage is thus cut out. An experimental adapter was described in our issue dated April 8th last, and this may be used in your case. By using the Eddystone type of plug-in ultra-short wave coil you can cover various wave-ranges.

REPLIES IN BRIEF

The following replies to queries are given in abbreviated form either because of non-compliance with our rules, or because the point raised is not of general interest.

L. V. (Brondebury). The unit is obviously damaged and although only the transformer may need replacing, you may find that the choke and/or condensers are also damaged.

P. E. R. (Mythe). The coil is obsolete, but could be used for an "A.R.P." type of receiver.

J. H. (Chelmsford). The larger condenser would give less control, owing to the spread of the stations.

W. E. A. (Cardiff). The transformer is for Class B working. It differs from a standard condenser by virtue of the special design of the secondary winding.

H. Y. (Coventry). We regret that we could not give constructional details in the form of a reply to a query. The subject would need two or three complete articles.

P. T. (Aldershot). The set is ideal for the purpose, but we would suggest a modification to use a standard output stage instead of the Q.P.P. This would result in lower H.T. consumption.

B. R. (St. Yarmouth). The band is not now in use. You will find several commercial stations and some broadcast stations now working there.

M. D. (Hornsey). The aerial should prove satisfactory but it may be worth while to try a much thicker gauge—preferably the special 7/22 stranded wire.

H. E. (Perth). We are unable now to give constructional data. All transmitters have been confiscated for the duration of the War.

H. H. (Glasgow). The firm is no longer in business. We have no data for the component referred to.

S. D. E. (N.W.11). The club has ceased activities but they inform us that they will make an announcement when they recommence.

H. R. T. (Lincoln). The component is of American origin but could be used in the set referred to. The same connections will hold good.

The coupon on page 164 must be attached to every query.

PRACTICAL TELEVISION

(Continued from page 156).

all these tests without being rejected it is then placed in a tank, and subjected to a high external pressure test, to ensure that it is immune from any risk of implosion while in normal use. The whole manufacturing process is a long one, highly skilled labour has to be employed and expensive plant and materials, and this accounts for the relatively high cost of each individual tube, but, no doubt as commercial demand increases economies will be effected, and prices will drop to a lower level.

Differentiation by Polarisation

EVERY nation that is considering the coverage of the whole country with ultra-short-wave television signals is confronted with a difficult problem, due to the relatively small number of adequate band widths of frequencies within the compass of the total width allocated by international convention to this purpose. Assuming that a large number of individual stations will have to be erected in carefully selected areas so as to give the maximum possible service, it is obvious that certain of these stations will be forced into using common carrier frequencies, just as is done with present-day broadcasting when the stations are sufficiently remote from one another to prevent mutual interference. A national coverage as distinct from an international one is quite another matter, however, and it is felt that there may be extensive fringe areas where television pictures from different stations working on identical carrier frequencies may be seen on the same set, so that the result observed on the cathode-ray tube screen would be unintelligible. It is known that the transmitted carrier wave can be either vertically or horizontally polarised—the former has been used in most European countries, while America has pinned its faith to the latter—so it has been put forward that one possible solution may be the use of differing polarisation by those stations compelled to share the same carrier frequency. Opinions still differ as to the practical feasibility of this idea, and it is as yet too early to be dogmatic in accepting or rejecting the idea. With the existing forms of transmitting aerial assemblies, however, which purport to be polarised in either the vertical or horizontal directions, a tilting of the wavefront has been observed and actual measurements have shown that this may be the extent of twenty degrees. This would of course prevent satisfactory differentiation of stations whose signals are mutually receivable in fringe areas. On the other hand, it is felt that insufficient attention has as yet been given to this problem, and schemes may be devised to overcome this defect by suitable adaptations of both transmitting and receiving aerial arrays. Even for ordinary reception conditions in the United States, quite elaborate aerial systems have had to be employed in certain districts, and the accumulation of data on "mutilation" of the radiated wave form in the ultra-short-wave region, even if this mutilation only takes the form of a tilted wavefront, may be instrumental in providing ideas to meet this problem, which is certainly likely to become acute when any national service develops.

NEWNES' TELEVISION AND SHORT-WAVE HANDBOOK

5/-, or 5/6 by post from
 GEORGE NEWNES, Ltd., Tower House,
 Southampton Street, Strand, London, W.C.2.

PREMIER

★ RADIO ★
 —AS USUAL

PREMIER SHORT-WAVE KITS for OVERSEAS NEWS

Incorporating the Premier 3-Band S.W. Coll. 11-86 Metres without coil changing. Each Kit is complete with all components, diagrams and 2-volt valves. 3-Band S.W. 1 Valve Kit, 14/9. 3-Band S.W. 2 Valve Kit, 22/6.

DE LUXE S.W. KITS

Complete to the last detail, including all Valves and coils, wiring diagrams and lucid instructions for building and working. Each Kit is supplied with a steel Chassis and Panel and uses plug-in Coils to tune from 13 to 170 metres.

- 1 Valve Short-Wave Receiver or Adaptor Kit 20/-
- 1 Valve Short-Wave Superhet Converter Kit 23/-
- 1 Valve Short-Wave A.C. Superhet Converter Kit 26/3
- 2 Valve Short-Wave Receiver Kit 29/-
- 3 Valve Short-Wave Screen Grid and Pentode Kit 68/-

REPLACEMENT VALVES FOR ALL SETS

EUROPA MAINS VALVES 4 v., A.C. Types, A.C./H.L., A.C./L., A.C./S.G., A.C./V.M.S.G., A.C./H.P., A.C./V.H.P., all 5/3 each. A.C./Pens. I.H., 6/6; A.C./P.X.4, 7/3; Oct. Freq. Changers, 8/6; Double Diode Triodes, 7/6; 3i-watt D.H. Triode, 7/8; 350 v. F.W. Rect., 5/6; 500 v. F.W. Rect., 6/6; 13 v. 2 amps. Gen. Purpose Triodes, 5/6; H.F. Pens. and Var.-Mu. H.F. Pen., Double Diode Triodes, Oct. Freq. Changers, 7/6 each. Full and Half-wave Rectifiers, 6/6 each. Triad high-grade U.S.A. valves, all types in stock. Standard tubes, 5/6 each. Octal Base tubes, 6/8 each. 210 and 250, 8/6 each.

PREMIER BATTERY CHARGERS for A.C. Mains. Westinghouse Rectification complete and ready for use. To charge 2 volts at 1 amp., 11/9; 6 volts at 1 amp., 19/-; 6 volts at 1 amp., 22/6; 12 volts at 1 amp., 24/6; 6 volts at 2 amps., 37/6.

Huge Purchase of U.S.A. Mains Transformers at Pre-War Prices. Manufacturers' surplus. All brand new and Guaranteed.

Input 110 v. and 220 v. A.C. Output 325-325 v., 120 m.a., 6-3 v., 2-3 amps., 5 v. 2 amps. C.T., 7/6 each. Input 230 v. A.C. Output 325-325 v., 75 m.a., 5 v. 2 amps., 6-3 v. 2-3 amps. C.T., 6/6 each. Special Offer Mains Transformers, manufacturers' surplus, 250-250 v. 60 m.a., 4 v. 2 a., 13 v. 1 a., 3/6; 300-300 v. 60 m.a. 4 v. 5 a. C.T., 4 v. 1 a., 6/11.

Clearance Offer U.S.A. Valves, 24, 30, 41, 39/44, 35/51, 55, 56, 57, 58, 71, 77, 78, 85, 2A5, 2A6, 2A7, 2B7, 6A7, 12Z3, 210, 250, all 2 for 3/-.

PREMIER SHORT-WAVE COILS, 4- and 6-pin types, 13-26, 22-47, 41-49, 78-170 metres, 2/- each, with circuit. Special set of S.W. Coils, 14-450 metres, 4/9 set, with circuit. Premier 3-band S.W. coil, 11-25, 19-43, 38-86 metres. Suitable any type circuit, 2/11. 3 Gang Condensers, fully screened, 1/6 each. Orders 5/- and over sent Post Free. Under 5/- please add 6d. postage.

Full Range of Components, etc., available from Stock Full Postal and Counter Services maintained as usual.

YOU MUST HAVE A

PREMIER 1940 CATALOGUE

111 PAGES - - - PRICE 6d.

Over 20 Pages of British and U.S.A. Valve Data, Receivers, Amplifiers, Components. GET YOUR COPY TO-DAY!

ALL POST ORDERS TO: Jubilee Works, 167, Lower Clapton Road, London, E.5. Amherst 4723

CALLERS TO: Jubilee Works, or our NEW PREMISES, 169, FLEET STREET, E.C.4.

Central 2833 or 50, High Street, Clapham, S.W.4. Macaulay 2381

MISCELLANEOUS

THERE'S MONEY IN RADIO!—If you understand radio you can make substantial profits in spare time. For hints and ideas get MONEY-MAKING MADE EASY, by L. Harvey Wood. Available from all booksellers, 2/6 net. or by post, 2/10, from the Publisher, C. Arthur Pearson, Ltd., Tower House, Southampton Street, London, W.C.2.

THE PRACTICAL MOTORIST'S ENCYCLOPEDIA, by F. J. Camm, 3s. 6d. net. A lucid exposition of the principles, upkeep and repair of every part of the car. 442 illustrations. From booksellers everywhere, or by post 4s. from George Newnes, Ltd. (Book Dept.), Tower House, Southampton Street, Strand, London, W.C.2.

Classified Advertisements

Advertisements are accepted for these columns at the rate of 2d. per word. Words in black face and/or capitals are charged double this rate (minimum charge 2/- per paragraph). Display lines are charged at 4/- per line. All advertisements must be prepaid. All communications should be addressed to the Advertisement Manager, "Practical Wireless," Tower House, Southampton Street, Strand, London, W.C.2.

RECEIVERS, COMPONENTS AND ACCESSORIES

SOUTHERN RADIO'S Bargains.

ALL Articles Fully Guaranteed. Postage extra.

5/-—Parcel of useful components, comprising condensers, resistances, volume controls, coils, wire, circuits, etc., etc., value 25/- 5/- per parcel.

10/-—Parcel of useful components, comprising 100 articles, including electrolytics, valveholders, etc., etc., value 55/- 10/- per parcel.

21/-—Small traders' parcel of components, comprising at least 150 articles, including 24 assorted tubular condensers, 24 valveholders, 36 resistances, 12 Mainsbridge type condensers, 6 electrolytics, etc., etc., value 85/- 21/- per parcel.

5/-—Twelve Mainsbridge type condensers, 1-2-4 mfd.; 5/- per dozen.

7/6—24 assorted tubular condensers, up to 2 mfd., 7/6 for 24; Telsen 3-range meters (volts and milliamps), 4/-; Morse tappers, 2/11.

BUZZERS, 1/6; crystal detectors, 2/-; crystal sets, 5/6; crystals, 6d.

2/6—Ormond loudspeaker units, 2/6; A.C. eliminators, with trickle charger, 37/6.

IN Spite of Increased Costs of Production, whilst our present stock lasts no increase will be made in prices. It is, however, advisable to buy now. Thousands of bargains for callers.

SOUTHERN RADIO, 46, Lisic Street, London, W.C. Gerrard 6053.

Vauxhall.—All goods previously advertised are still available; send now for latest price list, free.—Vauxhall Utilities, 163a, Strand, W.C.2.

5/- Bargain Parcel comprising Speaker Cabinet, Drilled steel chassis, condensers, resistances and many other useful components. Worth 22. Limited number. Postage 1/-.—Bakers Selhurst Radio, 75, Sussex Rd., South Croydon.

BANKRUPT BARGAINS. Brand new 1935-9 models, makers' sealed cartons, with guarantees, at less 40% below listed prices. Also Portables and Midget Radio. Send 14d. stamp for lists.—Radio Bargains, Dept. A.W., 261-3, Lichfield Road, Aston, Birmingham.

WAR-TIME RESTRICTION OF PAPER SUPPLIES

ORDER FORM

For Reader's use to Newsagent or Bookstall

To.....
 (Name of Newsagent or Bookstall)

Please deliver or reserve for me a copy of each issue of "PRACTICAL WIRELESS" until further notice.

Signed

Address

N.B. This Order Form if sent to the Reader's usual Newsagent or Bookstall will ensure regular delivery of this paper during war-time. Paper supplies have been rationed to all publishers and the wastage of unsold copies in the shops must be avoided. Please help both publisher and retailer by ordering NOW.

LOUDSPEAKER REPAIRS

L OUDSPEAKER repairs, British, American, any make. 24-hour service, moderate prices.—Sinclair Speakers, Pulteney Terrace, Copenhagen Street, London, N.1.

L.S. REPAIR AND REWINDING SERVICE: 24-hour service. See below:—

R EPAIRS to moving coil speakers a speciality. New cone assemblies fitted. Speech coils and fields wound or altered. Mains transformers, chokes, eliminators and vacuumis repaired, prices quoted. Speaker transformers, Class "B" L.F. transformers and pick ups rewound at 4s. each, post free. Discount trade. Estimates free. Guaranteed satisfaction. **L.S. Repair Service, 5, Balham Grove, London, S.W.12.** Phone: Battersea 1321.

NEW LOUDSPEAKERS

3,000 SPEAKERS from 6/6 each, P.M. and energised 4in. to 14in. including several Epoch 18in.—Sinclair Speakers, Pulteney Terrace, Copenhagen Street, London, N.1.

CABINETS

A CABINET for Every Radio Purpose.

C ONVERT Your Set into a Radiogram at Minimum Cost; surplus cabinets from noted makers under cost of manufacture (undrilled), 30/- upwards; motors at wholesale price.

U NDRILLED table, console and loudspeaker cabinets from 4/6.

I NSPECTION Invited; photos loaned to country customers.

H. L. SMITH and Co., Ltd., 289, Edgware Road, W.2. Tel.: Pad. 5891.

MORSE EQUIPMENT

F ULL range of Transmitting Keys, Practice Sets, Oscillators, Recorders and other Radio Telegraph Apparatus, designed and manufactured by T. R. McElroy, World Champion Telegraphist. Absolutely first-class construction. Send 2d. for 60-page general catalogue.—Webb's Radio, 14, Soho Street, London, W.1. Phone: Gerrard 2089.

COMMUNICATION RECEIVERS

F INEST selection in the country. Sole Agents for famous HALLICRAFTERS Receivers, ranging in price from £10 to £150. Attractive easy terms. Demonstrations at our London Showrooms, 60-page Catalogue post free 2d.—Webb's Radio, 14, Soho Street, London, W.1. Phone: Gerrard 2089.

TECHNICAL LITERATURE

T ECHNICAL BOOKS for the enthusiast. Radio Handbook—600 pages. Hundreds of constructional theoretical circuits short-wave equipment. Radio Society of Great Britain Handbook 2/6 Post Free. R.C.A. American Receiving Valve Manual, 1/6 Post Free.—Webb's Radio, 14, Soho Street, London, W.1. Phone: Gerrard 2089.

RADIO MAP AND GLOBE

W EBB'S RADIO MAP of the World enables you to locate any station heard. Size 40" by 30". 2-colour heavy Art Paper, 4/6. Limited supply on Linen, 10/6. **WEBB'S RADIO GLOBE**—superb 12" full-colour model. Radio prefixes, zones, etc. Heavy oxydised mount. Post Paid, 27/6.—Webb's Radio, 14, Soho Street, London, W.1. Phone: Gerrard 2089.

LOUDSPEAKER CONVERSIONS

B AKERS' Triple Cone Conversions Will Immensely Improve Reproduction of Your Present Speaker. Enables you to bring your speaker right up to date and obtain really realistic reproduction at the cost of a few shillings; free descriptive leaflet from the Pioneer Manufacturers of Moving Coil Speakers since 1925.—Bakers Selhurst Radio, 75, Sussex Rd., South Croydon

RECEIVERS, COMPONENTS AND ACCESSORIES

G ALPIN'S ELECTRICAL STORES offer as follows: Shunt wound charging or lighting dynamos, 220v-10a., £4/10/-; 100v.-45a., £7; 100v.-10a., 450 r.p.m., £5; 50/75v.-25a., £3/10/-; 50/75v.-15a., £4/10/-; 50v.-4a., 35/-; 20v.-8a., 32/6; Shunt regulators or charging resistances, 7/6 to 15/-; volt-meters, large size, 7/6 to 15/-; amp-meters, large size, all readings, 7/6 to 15/-; milliamp meters by Turner or Weston, 2in. dia., moving-coil movements for recalibration 17/6 each; moving-coil movements for recalibration into multirange meters, complete in case, 5/-; large size, 5in. scale, 7/-; X-ray transformers, 120/150v. input, 50-cycle single phase, 70,000v. output, 3 KVA, £10; also other sizes; H.T. transformers, mains input, 5/7,000v. out, 8/-; 10,000v. out, 10/-; G.P.O. multi contact relays, single coil, 3/6; twin coil, 4/6; triple coil, 5/6; all separate working, various resistances; wire, single 23 s.w.g. enam. and heavy cotton covered, approx. 300yd. coils, 3/6 per coil; ditto twin, approx. 150yd. coils, 4/6 per coil; 18 s.w.g. single, approx. 250yd. coils, 6/- per coil; push back wire, standard telephone approx. 250yd. coils, 10/- per coil; all above wire is new; double output hand-driven generators, 800v. and 6v., 25/-; T.C.C. electrolytic condensers, 2,000mf., 50v. working, new, 5/6; large mains transformers, 250-0-250, 300 m/a, three 4v. windings and a 50v. winding, new, 12/6; 1/2 h.p. A.C. motor for rewinding, ball bearing, D.E. shaft, induction type, 17/6; also large stocks of electrical goods too numerous to mention. Please write stating requirements. All goods guaranteed; all goods three days approval from date of delivery. Terms strictly cash with order or C.O.D. (C.O.D. is post only and charges extra).

G ALPIN'S ELECTRICAL STORES, 75, Lee High Rd., Lewisham, London, S.E.13.

"S TAND-BY" Crystal Set. Specified coil 2s., case 9d., or complete kit of parts, 10s. 3d., post free.—T. W. Thompson and Co., 176, Greenwich High Road, S.E.10.

MISCELLANEOUS

C RYSTAL with silver cats-whisker, 6d. Complete detector parts, 1/- Glass tube detector on ebonite base, 1/6. Postage 1d.—Post Radio Supplies, 323, Upper Street, London, N.1.

H EADPHONES. Reconditioned and guaranteed. 4,000 ohms. Brown, G.E.C., B.T.H., Sterling, Western Electric, Siemens, Brandes. 5/- per pair. Other reliable makes, 2/6 pair. Postage 6d. Telefunken, lightweight, adjustable, 7/6 per pair. Western Electric, single earpieces, 2,000 ohms, 2/- Postage 3d.

B E TALLER !! Extra Inches Count!! Details 6d. stamp.—Malcolm Ross, Height-Specialist, Scarborough.

L.R.S.

intend carrying on the good work of supplying Quality Radio Equipment.

ARMSTRONG CHASSIS

PORTABLE A.R.P. RECEIVERS and other reliable radio apparatus are available as usual on our very **CONVENIENT TERMS.**

Write for quotation and full details.

PLEASE NOTE OUR TEMPORARY ADDRESS LONDON RADIO SUPPLY COMPANY "DENWYN," OXENDEN WOOD RD., CHELSEFIELD, KENT

OUR STUDENTS GET GOOD JOBS

You can qualify for a well-paid technical post, or learn to earn money in your spare time. Send now for details of our modern Home-study Radio Courses

T. & C. RADIO COLLEGE
FAIRFAX HOUSE, HIGH HOLBORN, W.C.1

RECEIVERS, COMPONENTS AND ACCESSORIES

F ILMAMENT Transformers, input 200-250 volts, output 4volts 4 amp., 4 volts 6 amp. 4/11 each

M AINS Transformers, American windings, input 200-250 v. tapped, output 250-0-350 100 mA., 5 volts 2 amp., 6.3 volts 5 amp. 8/6 each

G.E.C. Mains Transformers, American windings, 350-0-350 v. 65 mA., 5 volt 2 amp., 6.3 volt 2.5 amp. Suitable for replacements in G.E.C. models, 5/6 each
Auto Transformers, 100-230 volt 6/3 each
24 Mfd. Can Type Electrolytics, 450 volts working. 1/6 each

T.C.C. 8 mfd. Can Type Wet Electrolytics, 450 v. working. 1/3 each

P RESS BUTTON UNITS with 6 press buttons, ready for wiring into set, with circuit 6/11 each

B ULGIN 20 ohms Wire-wound Pots 1/- each
Stranded Push-Back Wire, 1d. per yard, 12 yards 10d.
Chassis Mounting Valve Holders, American, 4-, 5-, 6- and 7-pin. 4d. each
Octal, 5d. each. Loctal, 10d. each. 7-pin English type, 3d. each.

R OTHERMEL Piezo Crystal Speakers, 7 1/2in. Cone. List 55/-. Our price 10/6 each

C RYSTAL Pick-up, high-grade American Bronze finish, complete with arm £1/5/- each

P O LAR N.S.F. 1-watt Resistances, All sizes up to 2 meg. 4d. each, 3/9 doz.

W EARITE MAINS TRANSFORMERS, made to strict electrical standards, wire-end type, all windings centre-tapped, screened primaries, tapped inputs 200-250 volts, screw adjustment.

T YPE R.C.2, 350-0-350, 120 mA.; 4 volts 2.5 amp., 4 volts 5 amp. 11/- each

T YPE R.C.4, 500-0-500, 150 mA.; 4 volts, 4.5 amp., 4 volts 2.5 amp., 4 volts 2 amp., 4 volts 2 amp. 21/- each

T YPE R.C.2. Drop-through type, capped.

T YPE R.C.4. Upright mounting type, fully shrouded, **A** MERICAN C.T.S. Volume Controls, finest made, divided spindles, length 2 1/2in., with switch, 2,000, 5,000, 10,000, 25,000, 50,000, 100,000 2/6 each

Less switch, 50,000, 100,000, 500,000 1/9 each

W ire Wound, 5 watt (less switch), 2,000, 10,000, 25,000, 50,000 2/- each

B RAOLEY OHM Wire-wound Volume Controls, with switch, 600,000 ohms 1/- each

W EARITE H.F. CHOKES 1/6 each

P ENTOOE Speech Transformers 2/- each

P LESSEY DRY ELECTROLYTICS. **CAN TYPE:**

12 x 6 mfd. 500 v. wkg. 1/6 each

12 x 16 " 350 v. " 1/6 "

12 x 8 " 500 v. " 1/6 "

16 x 8 " 475 v. " 1/6 "

8 x 6 " 500 v. " 1/6 "

12 mfd. " 450 v. " 1/6 "

8 x 8 x 8 mfd. 500 v. " 2/11 "

16 x 8 x 4 x 4 mfd. 500 v. wkg. 2/11 "

12 x 8 x 8 x 8 " 500 v. " 2/11 "

16 mfd. 450 v. wkg. 1/3 "

16 x 10 mfd. 350 v. wkg. 1/6 "

T.C.C. Cardboard Electrolytics wire-end type, 500 volt wkg. 600 volt surge. 8 mfd. Type "Minor" 1/9 each

8 x 8 mfd. 4 lead type. "Minor" 2/9 each

8 mfd. midget Tubular wire-end, 500 volt working, 600 v. surge 1/9 each

Blas wire-end type 25 mfd. 50 volt 1/6 each

50 mfd. 12 volt 1/3 each

50 " 25 " 1/9 each

25 " 25 " 1/6 each

Tubular wire-end non-inductive paper, all sizes up to 0.1, 5d. each; 4/9 doz.

Metal case 1 hole fixing electrolytic condensers, 500 volt working, 600 volt surge, 8 mfd. 2/6 each

S TANDARD TELEPHONE HEADPHONES resistance 2,000 and 4,000 ohms. 6/11 per pair

V olume Controls 1,000 and 5,000 ohms only with switch 1/3 each

.0005 3-gang tuning condenser units, with trimmers 2/11 each

P LESSEY P.M. 8in. Moving Coil Speakers with Pen. Trans. 11/6 each

Less Pen Trans. 9/6 each

P LESSEY Energised Speakers, 1,000, 1,500, 2,500 ohms field. 8in. with Trans. 7/11 each

10in. 2,000 & 1,000 ohms field with transformer 12/6 each

6in. 1,500, 2,500 5/11 each

R UBBER GROMMETS 4d. per doz.

S PECIAL OFFER. **R** AYTHEON No. 76 VALVES, 2/- each

S.P.D.T. Switches 1/1 each

D.P.D.T. Twist Switches 1/3 each

R AYTHEON First-grade valves, largest stockists, all types in stock, including Glass Series, Glass Octal Series, Metal Series, Bantam Series, Single-ended Metal Series, and Resistance Tubes; all at most competitive prices; send for lists.

All Orders Must Include Sufficient Postage to Cover. Hours of business, 9 a.m.-6 p.m., Saturdays, 9 a.m.-1 p.m.

R A D I O C L E A R A N C E , L T D . , 6 3 , H i g h H o l b o r n , L o n d o n W.C.1. Telephone, HOLBORN 4631.

In the Popular Pocket Size

London Opinion

**NO. 1
Just
Out**



KEEPS THE
FLAG OF
HUMOUR
FLYING

TO-DAY the famous monthly LONDON OPINION appears in the popular pocket size, full of brilliant features and highly topical. In its new form it is convenient to handle, and easy to post to those on active service—you slip it into an envelope . . . the man who receives it slips it into his pocket . . . it's as simple as that.

LONDON OPINION was privileged to play its part in the last war. Its leading cartoonist was Bert Thomas—"Arf a Mo', Kaiser!"—and once again LONDON OPINION will keep the flag of humour flying; reflecting the courage and optimism of those men and women now engaged in the service of their country—on the home front, in the A.R.P. and abroad.

WE INVITE YOU to get a copy of this new LONDON OPINION. We feel you will enjoy everything in it—for it is planned to amuse you for hours. **BUY IT AT ONCE, WHILE COPIES ARE STILL TO BE HAD!**

PUT IT IN YOUR POCKET TO-DAY 6p MONTHLY

Of all Newsagents and Bookstalls, or by post 7d. from the Publisher, George Newnes, Ltd., Tower House, Southampton Street, Strand, London, W.C.2.

George Newnes, Ltd.

Practical and Wireless

★ PRACTICAL TELEVISION ★

EVERY WEDNESDAY

Vol. XV. No. 373. Nov. 11th, 1939.

EDITED BY
F. J. C. AMM

Staff:

W. J. DELANEY, FRANK PRESTON,
H. J. BARTON CHAPPLE, B.Sc.

ROUND THE WORLD OF WIRELESS

Midget Portables

THE introduction, some time ago, of midget parts for the construction of midget receivers resulted in the production of many novel portable receivers, but their popularity seems to have waned. The probable reason for this is the fact that many of the parts were more or less non-standard, that is, they were produced specially for midget sets and accordingly were not readily obtainable. There is no doubt, however, that midget receivers are popular, and in America there is a very wide range of small mains sets no larger than a normal mantel-type clock. A midget receiver which can be built from standard parts is, however, an interesting proposition, not only from the point of view of design, but in its utility for general use. In these days of A.R.P. work, a small set which can very conveniently be carried into the air-raid shelter or which may be taken from room to room, even if it is only for headphone use, will certainly be popular, and in this issue we describe such a receiver incorporating standard parts and using two valves. With quite a short aerial, such as could be erected inside or just outside a shelter, very good headphone signals should be obtainable in any part of the country, and we make this contribution to our recent range of emergency and spare-parts designs.

British Amateur Call-signs

WE understand that the last British call-sign issued prior to the outbreak of war was G4QS. One or two call-signs bearing later references than this were, however, issued previously, but were out of sequence.

Editorial and Advertisement Offices:
"Practical Wireless," George Newnes, Ltd.,
Tower House, Southampton Street, Strand,
W.C.2. Phone: Temple Bar 4363.
Telegrams: Newnes, Rand, London.
Registered at the G.P.O. as a newspaper and
for transmission by Canadian Magazine Post.

The Editor will be pleased to consider articles of a practical nature suitable for publication in PRACTICAL WIRELESS. Such articles should be written on one side of the paper only, and should contain the name and address of the sender. Whilst the Editor does not hold himself responsible for manuscripts, every effort will be made to return them if a stamped and addressed envelope is enclosed. All correspondence intended for the Editor should be addressed: The Editor, PRACTICAL WIRELESS, George Newnes, Ltd., Tower House, Southampton Street, Strand, W.C.2.

Owing to the rapid progress in the design of wireless apparatus and to our efforts to keep our readers in touch with the latest developments, we give no warranty that apparatus described in our columns is not the subject of letters patent.

Copyright in all drawings, photographs and articles published in PRACTICAL WIRELESS is specifically reserved throughout the countries signatory to the Berne Convention and the U.S.A. Reproductions or imitations of any of these are therefore expressly forbidden. PRACTICAL WIRELESS incorporates "Amateur Wireless."

Good Marksman, Bad Sights

BILL GUENTHER, who is in charge of B short-wave activities allied with WLW, found out to his dismay recently that the sights on a rifle have an awful lot to do with where the bullet goes.

Guenther, along with four other WLW men, took part in a muzzle-loading rifle contest staged by the Ohio Valley Coon Dog Association at Dillsboro, Indiana. After the tournament ended and Guenther discovered he was fifth in a field of five, his consternation turned to utter disgust—as he considers himself an expert marksman. It was then that the farmers who lent him the gun informed him that the sights were crooked, so he needn't feel quite so bad.

Ed Mason, WLW announcer, won first prize and was awarded the Boss Johnston trophy. His hit 26 bulls-eyes out of a possible 30. George Biggar, programme director, was second; Scotty Wiseman, of Lulu Belle and Scotty, third, and Barton Reese Pogue, fourth.

Scots Reception Complaints

THE problems arising from a single programme transmission have already been mentioned, and we now understand that dealers in some parts of Scotland are complaining that they can only get the Home Service transmission with great difficulty. Unfortunately, conditions of National safety necessitate the present broadcast system, and there is at the moment nothing which can be done to alleviate matters in those localities where reception is not up to standard.

British Sets in Egypt

A RECENT report by the Commercial Secretary of H.M. Embassy at Cairo reveals that the total imports of radio sets rose from 15,267 units to 20,080 units in 1937, but decreased to 17,633 units during 1938. The percentage of British receivers is, however, increasing and was 15 per cent. in 1938 as compared with 13 per cent. in 1937, and 11 per cent. in 1936.

Radio Licences

THE preliminary figures received from the Post Office in respect of September licences shows an increase of 41,383 (free licences showing a decrease of 60). A total of 679,964 were issued and 638,581 expired. The free licences issued to the blind totalled 3,404 and 3,464 expired. The total number of licences and their sub-division is as follows:

	Paid Licences	Free to Blind
England & Wales ..	8,125,000	47,050
Scotland ..	781,000	5,800
Northern Ireland ..	125,000	1,200
	9,031,000	54,050

Sound Effects Man in Cymbalist Act

VISITORS to the WLW studios are always intrigued with that part of the tour that takes them through the "gadget department;" more properly, the sound effects rooms. But sometimes, according to Byron Winget, sound technician, members of that department get funny duties.

A recent "Salute to the Cities" script contained a short dramatisation calling for sound. Winget made his appearance at the rehearsal, stayed with the cast two hours until air time, and went on the air as per schedule. Half-way through the script he performed his task. It consisted of slamming a door—once! That was all. "You've heard about the cymbalist who practised the symphony score by himself," says Winget. "Well—"

No Valve Price Increase

IT is stated that at present the members of the British Radio Valve Manufacturers Association have no intention of increasing list prices of radio valves, and that the many rumours to the contrary are quite incorrect.



Mr. Irwin Dash, the famous music publisher and song writer, whose songs are being sung by the troops in England and France, and being broadcast by all leading bands and broadcasting artists.

D.C. HIGH-TENSION ELIMINATORS AND L.T. CHARGERS-2

Some Further Considerations and Calculations Connected with Resistance Networks for Voltage Dividing

By L. O. SPARKS

WE proceed with the network indicated by "b" in Fig. 3 and assume that the same current and voltage conditions exist as in the previous examples given last week.

It will be understood that the resistances R1, R2, R3 and R4 are actually in series with each other but in parallel or across the total H.T. supply. The arrangement could consist of a single resistance tapped at suitable points or four separate resistances joined together to produce the same effect. Whichever system is used, the arrangement forms what is known as a potentiometer, similar as regards effect to the small component having the same name but provided, usually, with one variable tapping point. This is widely used in radio apparatus for controls which depend for their operation on varying applied voltages.

If one compares this form of network with the simple individual series resistances of "a" (Fig. 3) it will be realised that, according to Ohm's Law, a current will flow continuously through the network and create a definite consumption so long as the supply is connected. If, therefore, such an arrangement is used—for example, in battery-operated apparatus—care must always be taken to see that the H.T. supply is broken when the receiver or amplifier is

switched off, otherwise the continual current drain through the resistances will shorten the life of the battery. Although this item does not have to be considered in the same sense with D.C. mains equipment, as one naturally switches off the mains, it does introduce another factor which must be considered when calculating the voltages at the various tapping points and even the maximum voltage at "A," as will be seen later.

Although many constructors can calculate resistance values for ordinary series connections, quite a number trip up when it comes to a potentiometer network, and it would seem that the snag is the following.

Calculating R1

The resistances R4, R3 and R2 can be calculated, but the question of R1 presents something of a problem, as there is no definite factor to govern its value. It can be considered, therefore, as the unknown quantity in the calculation.

It is known that different current values will be present in each section of the potentiometer, according to the current requirements of each tapping point, but it must also be remembered that an additional current will be flowing through all the resistances due to their total effect across the

H.T. supply. This additional current will be ultimately regulated by the value of R1, so, as both are intimately related, how does one determine the actual resistance of R1?

If the circuits of well-designed power packs, especially those producing high voltages, are examined, it will usually be found that a "bleeder" resistance is embodied across the H.T. supply. The purpose of this resistance is to prevent the smoothing condensers from retaining a high voltage charge when the apparatus is switched off, as such might cause nasty shocks to the operator when making any alterations. It is usual to select a value for the "bleeder" resistance which will allow a current to pass of, say, 10 per cent. of the full load current. For example, if one is considering a power pack delivering

the total value of R1, plus R2, plus R3, plus R4, so now the individual values can be calculated in the following way.

The resistance R4 will be carrying the current required by all tapping points plus the bleeder current, namely, 10 mA's plus 5 mA's plus 2 mA's plus 2 mA's (bleeder current) which equals 19 mA's. To produce the required voltage drop for the first tapping point, i.e., 200 - 120, or 80 volts, R4 must therefore, be equal to $\frac{80 \times 1,000}{19} = 4,210$ ohms.

The next resistance R3 has to carry only the current required by D, plus that required by E, and the bleeder current, which equals 5 plus 2 plus 2, or 9 mA's. R3, therefore, equals $\frac{120 - 80 \times 1,000}{9}$ which, in turn = 4,444 ohms.

R2 has to carry only 2 mA's, the current required by E plus 2 mA's for the bleeder, so the value of this resistance becomes $R2 = \frac{20 \times 1,000}{4} = 5,000$.

If the total value of these resistances is taken, it will be found that it amounts to 13,654 ohms which, if subtracted from the value of the bleeder resistance, i.e., 100,000 ohms, will give the value of R1. This figure, therefore, comes out at 86,346 ohms.

Voltage Differences

To avoid any misunderstanding arising concerning the calculations for R2 and R3, the following might be stressed with advantage. It will be noted that the voltage to be dropped, in the case of R3, is only 40 volts, this being the difference between the voltage required at D and that available at C. Particular note should be made of this. Many might think that the voltage to be dropped should be 200 - 80, but they must remember that the maximum voltage of 200 volts has already been reduced to 120 volts at the junction of the resistances R4 and R3 by R4. The same applies to the next step, that of R2, the difference to be dropped being only that which exists between D and E, namely, 20 volts.

Wattage Rating

When selecting resistances for use in voltage dividers or droppers, it is absolutely essential to pay particular attention to their rating as regards their ability to dissipate the wattage concerned. Wattage, as every constructor should know, is the product of voltage multiplied by current, the latter being in amperes. When we speak of wattage dissipation, however, we are referring to electrical power, i.e., watts, which are lost through some characteristic of the circuit and, in the case in question, it is the resistances which have been purposely introduced to bring about a voltage drop. The power which is lost expends itself by producing heat, and if due care is not taken, too much heat can be created in a given resistance, and such excessive rise in temperature might cause a breakdown of the component.

(Continued on page 184.)

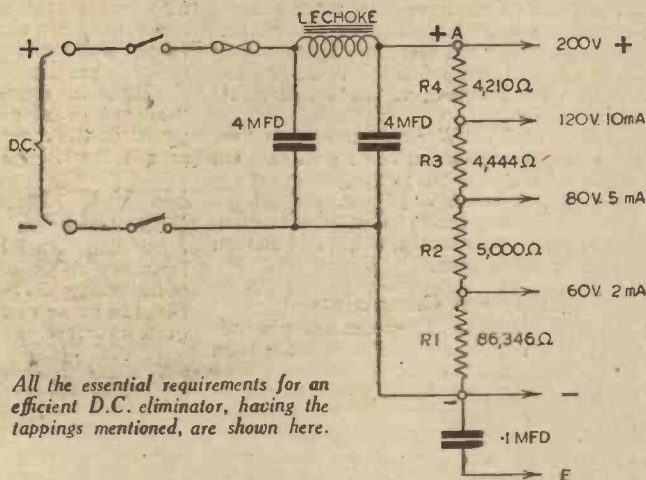

All the essential requirements for an efficient D.C. eliminator, having the tappings mentioned, are shown here.

500 volts at 120 mA's, then a suitable value for the bleeder would be:

$$10 \text{ per cent. of } 120 \text{ mA's} = 12 \text{ mA's, therefore}$$

$$R \text{ (bleeder)} = \frac{500 \times 1,000}{12}$$

or, in other words, 41,666 ohms, say 42,000 ohms.

Bearing in mind the above, it will be understood that the bleeder resistance could be replaced with the network forming the potentiometer we are concerned with in our original calculations and, if we do this, then it is a definite step towards finding the value of the unknown resistance R1.

To use the voltage and current figures previously mentioned, let us work out an actual example.

Assume the supply to be 200 volts, and we want tappings of 120 volts at 10 mA's at C, 80 volts at 5 mA's at D and 60 volts at 2 mA's at E.

Bleeder Current

Firstly, determine the value of a suitable bleeder. The total current consumption of our requirements is 17 mA's. Ten per cent. of that is 1.7 mA's, say, for easy calculation purposes, 2 mA's. R (bleeder)

$$\text{will then equal } \frac{200 \times 1,000}{2} \text{ which equals}$$

$$100,000 \text{ ohms. This then will represent}$$

THE "MITE" TWO

Preliminary Constructional Details of a Simple Two-valve Midget Receiver Constructed from Standard Components

PORTABLE receivers are normally a summer-time feature, but the recent prominence of Air-Raid Precautions schemes has led to a demand for small receivers which may be used in shelters, dug-outs, or similar quarters. There are many receiver designs which are suitable for such purposes, but a specially designed midget receiver obviously will possess merits which will make it more useful. Midget receivers may be made up from the special midget components which have been produced for the purpose, but these are not so readily accessible as standard components. Furthermore, the latter are often standing by as spare parts, and thus every constructor may build a receiver of the type illustrated on this page, which is a two-valver using all standard parts and valves, and which is designed for operation from a standard or throw-out aerial. The use of a frame aerial was not justified in a simple type of receiver on the lines followed, owing to the absence of adequate H.F. amplification, and it is generally found that the poorest throw-out aerial will pick up more energy than the best self-contained frame. No difficulty should be experienced in erecting a suitable aerial, and this subject will be dealt with next week.

The Circuit

As may be seen from the theoretical diagram on this page, a triode detector followed by a pentode, transformer coupled, is employed, with a single screened coil of the H.F. transformer type. This provides adequate selectivity and signal strength by virtue of the primary winding and the coupling provided therein, whilst if desired a series aerial condenser may be used. This is indicated in the circuit, but was not actually incorporated in the original model. If, however, a fairly large aerial is used, or you are situated close to a main station, there may be insufficient selectivity if this condenser is not included. Normal reaction control is provided and bakelite

dielectric condensers are used for both tuning and reaction purposes. A small type unscreened L.F. transformer is employed, and to ensure good quality 'phone signals, a fixed tone corrector is included in the output stage. It is, of course, quite possible that in many cases a loud-speaker could be operated satisfactorily from this circuit, but it has been designed primarily for headphones, and three or four pairs may be operated comfortably. To enable a single H.T. tapping to be employed, the first valve is decoupled and the decoupling resistance acts also as the necessary voltage-dropper. The two switches on the front of the cabinet, which, by the way, is home-made, are for wave-changing and on/off purposes, and the chassis is accommodated in the upper part of the cabinet, with the necessary batteries in the lower section. A wiring diagram and full constructional details will be given next week.



A view of the finished receiver.

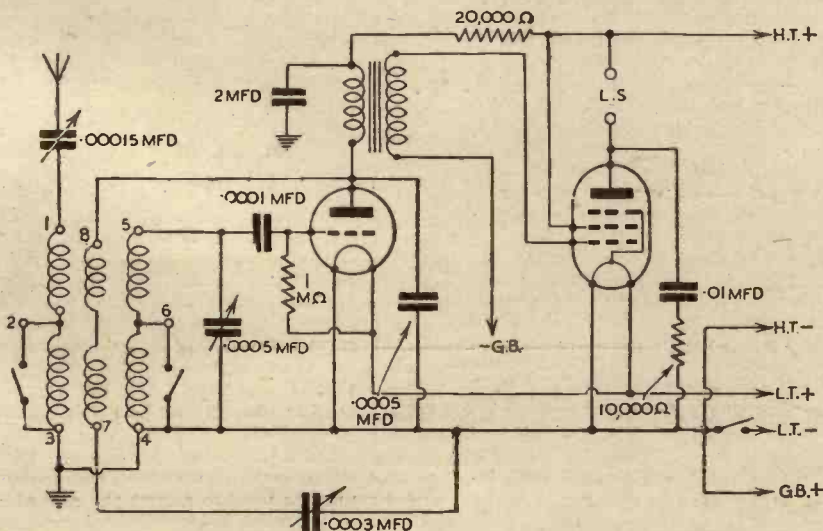

Theoretical circuit of the "Mite" Two.

LIST OF COMPONENTS

- One coil, type B.P.80 (Varley).
- One .0005 mfd. Compax condenser (Polar).
- One .0003 mfd. Compax condenser (Polar).
- One .0001 mfd. tubular condenser, type 33, (T.C.C.).
- One .0005 mfd. tubular condenser, type 33, (T.C.C.).
- One .01 mfd. tubular condenser, type 33, (T.C.C.).
- One 2 mfd. tubular condenser, type FT (T.C.C.).
- One 1 megohm ½ watt resistance (Dubilier).
- One 20,000 ohm ½ watt resistance (Dubilier).
- One 10,000 ohm ½ watt resistance (Dubilier).
- One L.F. transformer, type L.F. 53 (Bulgin).
- One on/off push-pull switch, type S.22 (Bulgin).
- One 3-point push-pull switch, type S.36 (Bulgin).
- Two dials, type I.P.8 (Bulgin).
- One 4-pin chassis type valveholder (Clix).
- One 5-pin chassis type valveholder (Clix).
- One A.E. socket strip (Clix).
- One L.S. socket strip (Clix).
- One 210 DET valve (Cossor).
- One 220HPT valve (Cossor).
- Connecting wire, flex, plugs, etc.

A SIMPLIFIED ELECTRON MULTIPLIER

Details of a New Form of Electron Device Evolved from the Zworykin Multiplier

IN a conventional magnetic electron multiplier the electrodes are supported in two parallel planes by means of mica plates. In one plane are arranged the photo-cathode and the multiplying electrodes, and opposite to them in the other plane are the accelerating or field plates. A uniform transverse magnetic field is used to direct the electrons from each multiplying plate to the next.

In the arrangement shown in Fig. 1, each accelerating plate A is rigidly connected by means of conducting side pieces S to the secondary emitting plate M of the next multiplying stage. An accelerating plate A and multiplying plate M are made together as one unit. In order to prevent lateral spreading of the beams, the multiplying plate M carries side flaps F which form

shows the electron optical arrangement of a photo-cell with one stage of multiplication. This design combines a large cathode surface with general compactness and ease of assembly.

The electrode arrangement in the device is shown in cross section. It consists of a photo-cathode C, a secondary emitting electrode M, and an anode A, all made of thin metal sheet. The cathode is a rectangular box having a slot in one side. Light is admitted to the surface of the cathode through a grid G of very fine wires. The inside of the wall opposite to the grid is the sensitive surface. All of the electrons emitted from C are drawn through the slot between the pieces P and Q by the field of the anode A, which is maintained at some hundreds of volts positive

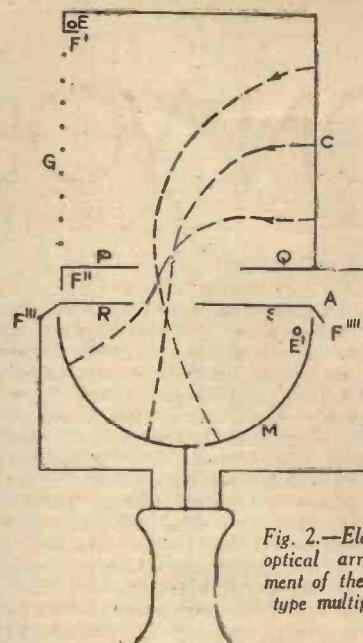

Fig. 2.—Electron optical arrangement of the new type multiplier.

arranged that all of the primaries are intercepted, and is maintained at a potential intermediate between those of C and A. The secondary emitter M may conveniently be semi-cylindrical in shape. The part S of the anode can be allowed to overlap the cathode slot to some extent without interfering with the primary current. By this means an increase of the field strength at the cathode slot is obtained. R must be somewhat shorter than P. The paths of three representative primary electrons are shown in the diagram. Experiments indicate that the shapes and relative dimensions of the electrodes can be varied within fairly wide limits without loss of multiplication. It may be noted that the number of electrodes (three) is the minimum for a single stage multiplier.

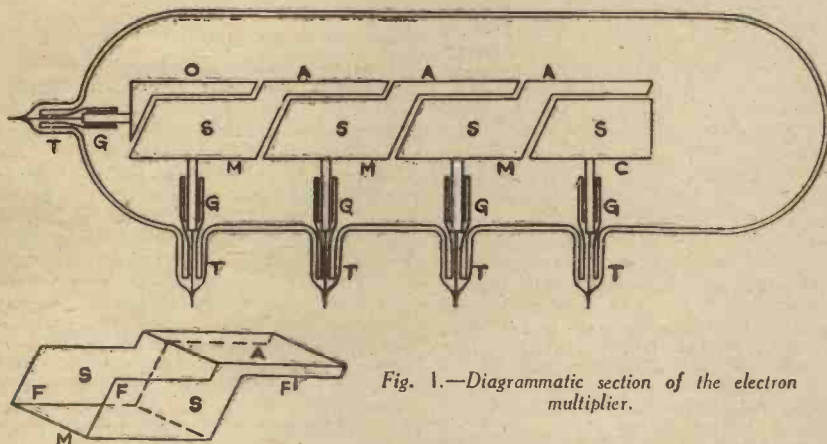

Fig. 1.—Diagrammatic section of the electron multiplier.

part of the connection between A and M. Smaller flaps F' are attached to A to give it the necessary mechanical rigidity. By mounting the electrode units in the glass envelope, as shown, the leakage path can be made very large indeed. Each of the multiplying plates M is carried on a rigid bar which is welded to some suitable sealing in wire, the latter being fused into the glass. In order to get the assembly correctly mounted in the tube, the electrode units are held together inside the tube in a suitable jig, and the mounting rods are inserted through the ends of the side tubes T so as to fit into eyelets fixed to the plates M. Connection between the rods and the eyelets may be established by welding or screwing together. The metal to glass seals are then completed, and the jig removed. Electrical leakage can be further reduced by fitting glass sleeves G on to the rods, as shown. The sleeves are fused to the glass at their lower ends. The photo-cathode C and the output plate O are mounted in a similar manner. The first accelerating plate A opposite to the photo-cathode is a grid of very fine wires to permit illumination of the cathode C.

with respect to C. The slot is cut in a face of the cathode box which is adjacent to the photo-sensitive face. The anode A is a flat sheet parallel to P and Q. A slot is also cut in the plane anode A so that the primary electrons pass through and strike the secondary emitter M, which is so

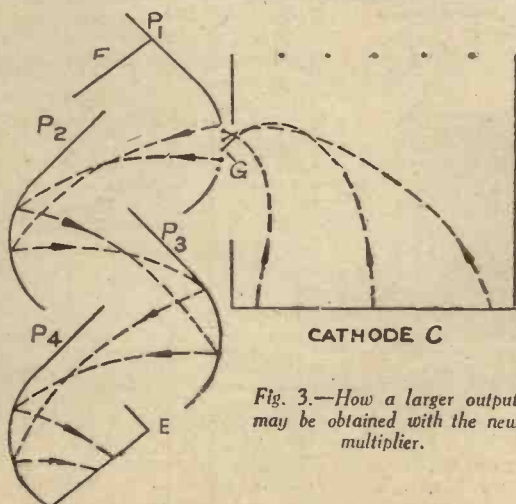

Fig. 3.—How a larger output may be obtained with the new multiplier.

Screened Cathode

Each of the electrodes should have a depth (perpendicular to the plane of the diagram) not less than the length of a side of the square cathode C. The cathode is preferably closed with metal sheet at the top and bottom to avoid the disturbing effects of wall charges. Multipliers constructed to this design have a high ratio of collector current to cathode current, indicating that all, or nearly all of the primary electrons strike the secondary emitting surface and are not intercepted directly by the collector. Actually, less than 5 per cent. of the cathode emission fails to reach the secondary emitter.

This type of photo-cell multiplier is particularly well adapted for use with surfaces that must be deposited by evaporation in vacuo before activation. Two evaporators E and E' are indicated in the diagram. E provides the cathode surface and E' the secondary emitting layer. Shields F', F'', F''', F'''' prevent the evaporation of the metal on to the glass envelope.

Glass or other ceramic or mica supports with suitable spacing devices may be used to mount the assembly in its correct geometrical form.

(Continued on page 186)

Two New Photo-cells

The accompanying illustration, Fig. 2,

ON YOUR WAVELENGTH



The Patent Position

BUDDING inventors should note that during war-time enemy patents, designs, trademarks and copyrights, are available to British subjects, and a copy of the list can be obtained for threepence at Post Offices and Inland Revenue Offices. Any person may make applications to use one or more of these patents on payment of a fee of £2, the procedure to be adopted being decided by the Comptroller-General of Patents, at the Patent Office, Chancery Lane, W.C.2. He has power to grant a licence to an applicant for the residue of the life of the patent, registration or copyright, or for any less period. The list covers a wide field, and includes textiles, wireless, motor-cars, bicycles, and aircraft. It is probable that many of these foreign patents are valuable but have not been exploited owing to want of capital, and it is quite likely that a number of ingenious products of German and Austrian designers and inventors are now available for use to British subjects who by working them may do so with profit not only to themselves but also to our Exchequer.

Gilbert and Sullivan on the Air

AFTER many years of effort on the part of the B.B.C. to come to arrangements with the owners of the rights in the Gilbert and Sullivan operas, some of them are to be broadcast. I believe I am correct in saying that since the war most, if not all, of the D'Oyly Carte Gilbert and Sullivan touring companies have been withdrawn. The owners of the rights have evidently relented from their previous attitude, and so Gilbert and Sullivan fans will still be able to hear the famous tunes which age does not wither nor custom stale.

Valve Prices

THE Secretary of the British Radio Valve Manufacturers Association states that the rumour that there is an intention to increase the list prices of valves is without foundation. It is equally untrue to say that there is likely to be a reduction. At any rate, for the present, prices will remain static. They will only be increased should the costs of production rise.

The Battery Racket

I AM not referring to the manufacturers, but to the dealers when I classify the present battery position as a glorified racket. Many dealers are adopting the reprehensible practice, knowing that batteries are as scarce as the dodo, of refusing to supply unless the customer will also buy the complete torch. Now, I have been in touch with several of the battery manufacturers, who affirm what I already knew, that the output has been increased to cope with the present demand. They mildly suggest that there will be no real shortage. Some of the dealers are splitting up 4½-volt cells into three 1½-volt cells and charging 4d. each.

In spite of the demand for H.T. batteries there seems to be a delay in delivery. Who said that the battery set was dead?

By Thermion

"Aeronautics"

ANY reader who has relations or friends in the Royal Air Force can be certain that a copy of *Aeronautics*—the authoritative monthly magazine—will be a welcome gift. *Aeronautics* will interest everyone interested in aviation, but it has a special value to those now training for the "first line of attack and the last line of defence." It is a review of every aspect of military and civil development in the air, and for those who care to preserve each copy it provides a permanent record of the war in the air.

Another valuable feature which is being much commented upon is the series of "Aircraft Recognition" diagrams and descriptions. These are of particular interest to members of the Observer Corps.

Aeronautics will be welcomed in every R.A.F. mess and training camp, but in common with all other magazines and periodicals, it is now necessary to order a copy in advance from newsagent or bookstall.

Licence Figures

THE increase in the number of licences during September was 41,383, and a total of 679,964 were issued. The total number of licences in force is now 9,085,050. What a vast army the B.B.C. has to upset!

B.B.C. Pedantry

I AM all in favour of somebody setting up standard spellings and pronunciations of words. There are far too many different spellings and different pronunciations. At present anyone can compile a dictionary and invent his own spellings. It is impossible to believe that a compiler of a dictionary does not make mistakes, or that there are not misprints in a dictionary. Thus, a mistake becomes a standard word.

The B.B.C. has a committee which decides on pronunciations. I do not agree with their decision. I refuse to pronounce *combat* as *cumbat*. There are many other words which the B.B.C. pronounces in a comic way. If we are going to have a committee to examine the English language, it should be composed entirely of Englishmen; and Welshmen, Scotsmen, and Irishmen, who, after all, merely speak dialect English, should not be invited to serve on such a committee. Their racial instinct is bound to influence their decision. A Scotsman particularly thinks that the Scot pronounces English better than an Englishman. I remember a Scottish editor some

years ago telling his friends in a worldly-wise way how he had once edited a manuscript and altered the word *commence* to *begin*. That man was not an editor. There are some who think that the best writing consists of simple words. Such a doctrine is usually held by those of poor vocabulary. In any case, if the argument is correct, writing is brought down to the level of a ten-year-old scholar. I like words to scintillate and sparkle. I have no time for the quackery and nonsense which is spoken about journalism by those anxious to impress writers with their editorial wisdom. If I were a publisher, and an editor of mine altered *commence* to *begin* I would sack him for wasting his time.

Let us have less B.B.C. pedantry on the question of pronunciation. The public will never use the word *cumbat* and we must not permit the B.B.C. to be a law unto itself.

Black-out-built Sets

JUDGING from the sales of our blueprints and our technical books, particularly "Sixty Tested Wireless Circuits," enormous numbers of receivers are being built during the black-out. The demand seems to be for the cheaper styles of receivers, and that for battery and mains blueprints seem to be in equal quantities. This is the only weekly journal now devoted to wireless, and it is our intention to carry on. The one remaining link between the constructor and his hobby is this journal, which leads me, once again, to the reminder that it is now necessary to order your copies, for newsagents are not permitted to return unsold copies. He will merely order from us the copies for which he has received orders from the public. I am sorry to have to keep rubbing this in, but there are many remiss readers who have failed to take my advice, and then write to me to know what I am going to do about it when they are unable to obtain their copies. I cannot do anything about it because we only print the copies which the newsagents order from us.

The Queen's Broadcast

I HAVE just received the announcement that her Majesty the Queen will broadcast a Message to the Women of the Empire at 9.0 p.m., B.S.T., on Armistice Day (Saturday, November 11th). Since she became Queen, Her Majesty has broadcast on four occasions, namely, in June, 1938 (speech at the Paris Banquet); September, 1938 (launch of liner *Queen Elizabeth*); May, 1939 (laying of Foundation Stone of Supreme Court Building, Ottawa); and June, 1939 (farewell speech at the end of the Royal Tour of Canada, from Halifax, Nova Scotia). On two of these occasions, that is, in September, 1938, and June, 1939, Her Majesty's words were relayed by the B.B.C. As Duchess of York, she broadcast ten times between September, 1927, and December, 1936.

Overseas listeners will be able to hear the speech in the form of electrical recordings at various times.

Comment, Chat and Criticism

Choosing Gramophone Records

Our Music Critic, Maurice Reeve, Explains Why Certain Favourite Compositions Make Unsatisfactory Records

MUCH has been written on this subject and much more is doubtless forthcoming. Although I have not read it all, I have read several good articles on the subject. But never have I come across a certain side of the question adequately treated—a side which is probably as important as any other, and which, if studied carefully, would save countless disappointments among the record-buying public. I will base my article this week on this question—why do certain favourite compositions make unsatisfactory records?

Gramophone records are expensive luxuries to most of us, and the purchase of a symphony or an opera is a matter of much thought and careful saving. Consequently, most collections are made up of the famous works such as instrumental solos, songs, or overtures which are complete on one disc—certainly not more than two. These collections, again, more or less, come about—and are seldom evolved from a plan or system—something after this style: A thoroughly musical and intelligent person has his favourite pieces. Typical examples are the works of Chopin, and things like Liszt's "Liebestraume" and Schubert's songs. As he hears them or learns them, so he pops into the gramophone store and buys them. Even if he has them played over for him in the shop I doubt whether he more than very rarely notices the point I am aiming at. But after he has owned it a short while and played it twenty or thirty times, dissatisfaction with it frequently comes over him. I've grown tired of that thing, he'll say, or I don't know why that doesn't sound like it did when I heard so-and-so play it. I have known many people actually make these remarks to me. I have been in their houses listening to some of their records. They'll ask me if I like this or that, adding, "although I'm very fond of it I'm afraid I have a very poor recording of it." When they play the record to me the reason is only too obvious.

Rushed Recordings

A ten-inch record plays for three and a half minutes, and a twelve-inch for four and a half. Now, hundreds of world-famous pieces, like those I have mentioned, can only be got on to one side of a disc if played to the clock. Consequently, large numbers of them are rushed and their performance stripped of the poetic and interpretative qualities we get from artists performing in the concert room. But several, I regret to say, are also cut. To anyone who knows the work intimately, this is an outrage and quite unforgivable. The result of all this must necessarily be an unsatisfactory recording. I have often been bitterly disappointed with records of such celebrated and universally favourite pieces as Chopin's "Ballade in A Flat" for these reasons. And knowing the work backwards and forwards, as well as inside and out, I can vouch for the reasons for my disappointment. Some works of this type have recently been done as a double-sided record. And when played by a renowned artist, make splendid recordings.

Piano Works

But piano works in particular want to be very carefully chosen. There are many pitfalls into which they can fall, and not the least of them is the question of finding the right spot for the break, when it is a double-sided affair. Some compositions are of such a delicate and ethereal texture, and the imagery and illusion so subtle, that they cannot suffer being broken into at all. In fact, to do so seems as unwarranted as to intrude on a person's private meditation. When we hear this type of record broadcast, we are easily deceived, because we forget that it is being played in duplicate on a double-disc machine, with all such interruptions eliminated.

Symphonies

Symphonies, with few exceptions, are easily recorded. It is fairly simple to find a spot to break off for each disc without offending one's susceptibilities too much. There are repeat bars and full stops in plenty, and only a little thought and care are required to land in one of these each time. Schubert's "Unfinished" is a notable exception, but what music is there in the whole wide world that ought to remain so inviolable? The breaks for turning and changing the discs seem a sacrilege, and infuriate me every time. But it can rightly be argued, half a loaf is better than no bread, and who would refuse a glass of champagne because the right glass for it was not handy? Certainly not your humble contributor.

Sonatas, and all chamber music, are much less suitable for recording than symphonies. Although written to the same pattern, their texture is so much more delicate both as to the score and the pattern, that, here again, interruption, one feels, is only committed at one's peril.

Overtures and Strauss Waltzes

My personal opinion is that overtures, operatic arias and selections, songs and things like Strauss waltzes, make the ideal record. I have heard some magnificent recordings of works such as Weber's "Oberon" and "Freischütz" overtures and Strauss's "Fledermaus" and "Artist's Life." Sir Thomas Beecham's recording of a Rossini overture is a marvel of vitality and nervous tension, and the reproduction seems so faithful that the very individuality of the man and the orchestra are given to us just as if we were under their influences in the concert hall. Many of the concert transcriptions of Wagnerian excerpts are excellent, but the "Ride of the Valkyries" is a travesty, on one side of a disc. I suppose all the classic symphonies are now preserved for posterity on gramophone records, and all that I have ever heard are excellent in every way. Many of the most popular have so many recordings that one sometimes has a choice of five or six orchestras and conductors to pick from. Occasionally, as I pointed out, the break at the end of a disc is exasperating and calculated to fray the most carefully controlled nerves.

Concerto Recordings

There are some splendid concerto recordings, and Cortot's rendering of César Franck's "Symphonic Variations" should be in every musician's collection. Kreisler's, too, are perfect, and the great violinist's personality is brought vividly before us on each one. This must surely mark the high water of perfect recording—the preservation of the artist's individuality and interpretation—and not the mere rendering of sounds however complicated and multifarious. Otherwise there would be no object served in having two recordings of the same work. We would merely have to walk in to the shop and ask for so and so, and the rest would be only a case of "don't shoot the pianist, he's doing his best."

C.R. TUBE PERFORMANCE CHARACTERISTICS

THE performance characteristics of a modern cathode-ray tube are expressed in different ways according to the particular purpose to which any one tube is to be placed. In this connection there is one item which has to be watched carefully, and this is known as pattern distortion. Under normal circumstances the beam of electrons in its passage from the accelerating and focusing equipment to the front fluorescing screen, is subjected to the influence of deflecting fields either of the electrostatic or electromagnetic types. These should be mutually at right angles, and unless this happens there is a departure from the rectangular pattern which would otherwise be formed, and this is generally expressed in terms of the distance a given point on the pattern is from its true position. For example, any distortion due to an incorrect relative orientation of the pairs of deflector plates or deflecting coils may be checked by applying a linear scanning

potential to the vertical and horizontal deflecting systems in turn, and measuring the angle between the lines formed on the tube's screen. Then, again, distortion may arise due to non-parallelism of the plates or coils of a single pair, whether horizontal or vertical. This can be checked by observing and measuring the degree of trapezoidal distortion traced on the screen assuming that a symmetrical deflecting potential is applied. It is only by tests of this or a similar nature that it can be assured that each tube will function in the required manner when used either for qualitative or quantitative work.

PATENTS AND TRADE MARKS.

Any of our readers requiring information and advice respecting Patents, Trade Marks or Designs, should apply to Messrs. Rayner and Co., Patent Agents, of Bank Chambers, 29, Southampton Buildings, London, W.C.2, who will give free advice to readers mentioning this paper.

TRACKING DOWN STATIC

An Explanation of a Few Simple Methods of Tracking Down the Cause of Man-made Static and Other Noises

ALTHOUGH a great deal of interference trouble has been removed now that outside electric signs are not in use at night, there are still many sources from which such trouble may come, and many listeners have found that the new tuning point on the scale has resulted in interference being experienced which was not noticeable at the tuning setting originally used for their local station.

Much has been written concerning the remedies to apply in order to overcome electrical interference, but the first difficulty encountered by the amateur is almost invariably that of finding the cause—and source of the trouble. It would be a waste of time to fit an interference-free aerial system if the crackles were being conveyed to the receiver through the mains-supply leads. The first step should thus be to decide the reason for the impaired reception, and although the Post Office engineers are always very helpful in this respect when their services are requested, the average enthusiast would prefer to carry out a little "detective" work on his own before asking for outside assistance.

Pick-up or Wire-conveyed

In the first place, it is evident that if the set is battery operated the interference must be picked up by the aerial or by the connecting leads used with it. For this reason it is a good plan where a mains-operated set is used to arrange with a fellow amateur to compare the results obtained with his set with those provided by the mains receiver in the location in which the

trouble is observed. This will generally give an immediate clue to the type of interference—mains-borne or direct pick-up. When the interference is fed into the receiver by means of the mains leads it is evident that a choke-condenser filter is required. A certain amount of experiment may be required in order to determine the most suitable values of condensers and chokes, but the procedure will be comparatively straightforward.

If it is definitely determined that the trouble is due to pick-up, the next step should be to remove the aerial lead-in at the point where it enters the house and note whether this makes any difference. If it does, a screened down-lead might prove effective and should certainly be tried. Should this make very little difference, however, the effect of altering the position of the leads to the speaker (where it is external to the set) should be tried, whilst it should be observed whether an alteration in position of the batteries and their leads makes any difference.

Bad Contacts

If none of these changes has any pronounced effect, it will often be indicated that the interference is due to a bad or intermittent contact to some piece of electrical apparatus in the house. A small motor, a vacuum cleaner, an electric-light switch or an electric bulb which is loose in its holder might be at the root of the trouble. If any of these is suspected it will probably be a fairly easy matter to confirm the suspicion by switching off the particular item. In

this respect it should be mentioned that a switch having contacts which are worn, and across which sparking or arcing takes place can be the cause of a mysterious form of trouble which is intermittent in character. In the same manner a loose electric lamp bulb can produce interference due to slight arcing between the bulb and holder.

Direction Finding

Should it be found impossible to locate the source of trouble by trial-and-error methods it is often possible to arrange a direct system of location by the use of a frame aerial in conjunction with a battery set. A portable receiver is most convenient for the purpose, but where this is not available a simple frame aerial consisting of about 75ft. of 26-gauge cotton-covered or enamelled wire wound round the lid of a cardboard box and connected to a battery set (preferably one having a "straight" circuit) may be used almost equally well. In the latter case the grid lead from the aerial coil should be disconnected and the frame wired in its place.

When the frame aerial has been connected it should be found that the interference is most pronounced with the edge of the frame pointing in one particular direction.

The frame aerial should thus be rotated until the strength of the interference attains a maximum, after which the volume control, where fitted, should be turned down until the crackles are only just audible in a pair of 'phones connected to the speaker terminals. The next step is to move the set and frame first in one and then in the other direction of the frame, carefully observing whether the interference increases or diminishes. It is almost sure to become more pronounced when the outfit is moved in one direction, and the frame should therefore be moved as far as possible in that direction, the frame occasionally being rotated slightly so as to keep the interference as loud as possible.

OPERATING MAINS SET FROM BATTERIES.

(Continued from previous page.)

their positive supply from a tapping on the accumulator.

One method of operating the set without altering the G.B. arrangements would be by using two separate accumulators. This would seldom be a practical proposition unless using batteries from a car having a 12-volt system in which two individual 6-volt batteries are joined in series when on the car. In every case it would, naturally, be necessary to take a positive tapping from a 6- or 12-volt car battery unless a series resistor were used to drop the voltage. Such a resistor would have to be a "hefty" one, wound with heavy gauge resistance wire, because the wattage dissipation would be comparatively high.

Another minor difficulty would arise when the set incorporated an energised moving-coil speaker. The only satisfactory course would then be to replace this by one of the moving-coil type, for there would be insufficient "spare" current to energise the field.

A Vibrator H.T. Unit

It is possible to carry out a more ambitious scheme than that outlined above, by obtaining the H.T. supply from a self-rectifying vibrator unit of the type used in car-radio installations. A complete

supply unit could be built—not including any smoothing system—and this would then be used to replace the mains transformer and rectifier. In other words, the L.T. and H.T. negative connections would be as mentioned above, but the H.T. positive lead would be taken to the "rectifier" side of the smoothing system; thus, use would still be made of the smoothing choke and condensers in the set. Moreover, as the battery-operated H.T. supply unit

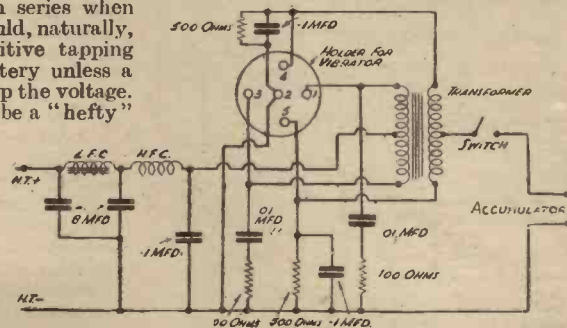

Fig. 3—Theoretical circuit of the unit shown in Fig. 2.

would provide a maximum output in the region of 250 volts at 60 mA, the average receiver would operate almost exactly as it did when fed from the A.C. mains.

Figs. 2 and 3 show an H.T. supply unit incorporating a Bulgin self-rectifying vibrator, and the associated transformer. A smoothing arrangement is also shown in these two illustrations, but the choke and

the two 8-mfd. condensers would be omitted in most cases, the H.T. + connection to the set being taken from the H.F. choke, which is inserted in the output to prevent instability due to the possible presence of H.F. in the H.T. supply.

The diagrams are almost self-explanatory, but it should be added that for operation from a 6-volt accumulator the vibrator unit should be a type H.T. V.1, and the transformer a type M.T.5. When the supply is from a 4-volt accumulator the correct vibrator is type H.T.V.3 and the transformer an M.T.10, and for 12-volt operation type H.T.V.4 vibrator and M.T.10 transformer are required. Incidentally, the M.T.10 transformer can be used with any of the rectifiers mentioned, since the primary is tapped for 4- 6- and 12-volt operation; the output is 250 volts (250.0-250 volts strictly, for the secondary winding is centre-tapped) at 60 mA.

Important Points

In constructing a power unit including a vibrator unit it is important that all leads be kept short and that a really good earth connection be employed. If the earth is poor there may be a danger of hum. For best results, the unit should be enclosed in an iron box, soundly earthed, but this is not essential when the receiver is well screened and if the parts are arranged compactly. The coded flexible leads from the transformer are the same for all models, which means that the wiring indicated in Figs. 2 and 3 applies to a unit, for any of the input voltages mentioned.

A Neon Lamp Tester

Checking Components, Resistances and Condensers by Means of an A.R.P. Lamp

MANY readers have acquired special lamps for the black-out necessitated by A.R.P. rules, and of these the majority are of the beehive type. These, as most readers will gather from the customary orange glow, are of the neon gas-filled type, and it may be pointed out that this particular type of lamp offers facilities for radio component test purposes.

Continuity and insulation tests, condenser tests, and the determination of the values of resistances are all possible with the aid of one of these useful gadgets.

Before carrying out any work with the lamp it is just as well to mount it in a holder on a small wooden base. A small "charging" board as used for accumulator charging from D.C. mains will answer the purpose very well. Such a board is illustrated in Fig. 1 and the wiring underneath is given in Fig. 2.

A Flashing Sign

The usual application of the lamp by the radio constructor is as a circuit tester, and

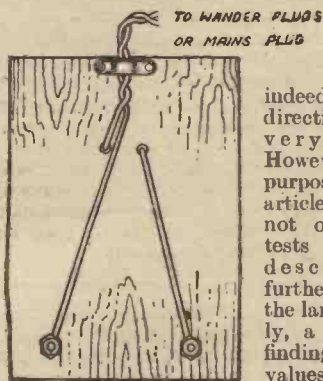

Fig. 2.—The simple wiring below the test board.

the lamp will give a series of intermittent flashes, the speed of the flashes determining the value of the resistances under test. Besides being a very interesting experiment in itself—it provides quite a novel "flashing sign" without any mechanical mechanism—it is an easy method of checking just those resistances which are usually most difficult to measure, namely, very high ones. With ordinary meters accurate results are very difficult to secure owing to the small readings obtainable.

The neon lamp does not, of course, replace meters, but may be looked upon as supplementary to the ordinary moving-iron instruments. It must be admitted that the method to be described is one of substitution, but by drawing a simple graph many different values can be determined from two or three "known" resistances.

Useful Tests

Before going into details of the "flashing sign" tests here are some of the more common applications of the lamp.

By fitting two insulated test prods to the ends of a length of twin flex taken from the terminals on the lamp board, the lamp may be quickly connected to any part of the circuit or component under test without fear of the conductivity of the constructor's hands upsetting the results. The prods can be bought or are easily made from pieces of vulcanite rod with the flex passing through the centre and connecting with metal contacts sticking from the end of the prod. A couple of old fountain pens will make excellent prods. A hole should be drilled in the top of each for the flex to pass through while the original tip will do as the contact. The wire is soldered to the tip before it is screwed on. (Fig. 3).

To make the lamp glow it will have to be either connected to an H.T. battery or

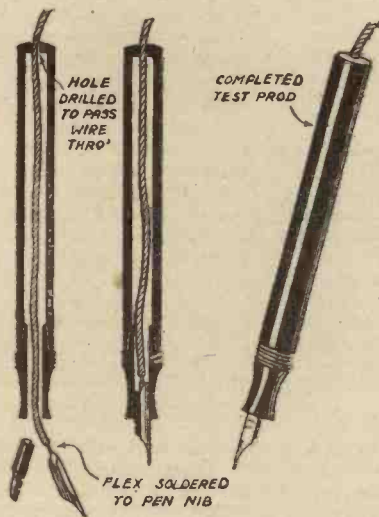

Fig. 3.—A method of making a test prod from an old fountain pen.

plugged into D.C. mains. When buying the lamp the voltage required should be stated. On touching the two prods together the circuit will be completed and the lamp will glow.

Testing Condensers

Owing to the comparatively high voltages used, the lamp will provide a very stringent test of insulation, and is therefore particularly

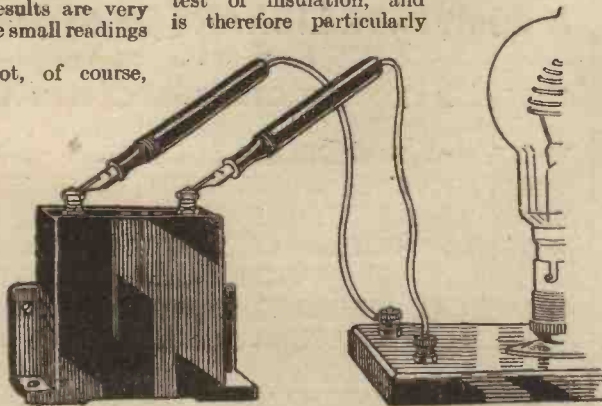

Fig. 4.—Testing the insulation of a fixed condenser by means of the neon lamp.



Fig. 1.—The completed neon lamp tester.

useful in testing condensers. The test prods are held in contact with the terminals of the condenser for a minute or two as in Fig. 4. If the condenser is leaky a series of flashes will occur in the lamp, that is to say, that after a short time it will glow momentarily and then go out again immediately, and then after a similar period of time it will suddenly flash again. If this only occurs at long and regular intervals, say once every minute, the condenser may be considered as O.K., although, of course, a perfect condenser would give no flashes at all. However, in a test of this sort allowance has to be made for any slight leakage in the lampholder, wiring, and test-prods, which would give the same effect as leakage in the condenser, so that an occasional flash does not mean the condenser is a "dud." In fact, this test is so searching that a flash every minute or half-minute represents a leakage resistance of not less than several million ohms. It is when the flashes occur several times per minute or when they gradually increase in frequency that the insulation may be taken as very poor or broken down. This test may be applied equally well to fixed or variable condensers but cannot, of course, be used for the electrolytic type.

A multitude of other insulation tests may be carried out by placing the prods across the suspected part. For instance, the insulation between the sockets of a valveholder can be tried by placing the prods in the sockets themselves, or again, the insulation between the windings of a transformer may be checked by connecting one prod to one of the primary terminals and the other to one of the secondary terminals.

Continuity Tests

To test for breaks in the wiring of coils, transformers, etc., the prods should be connected across the terminals of the component in the same way as with a condenser. A continuous glow indicates that there is no break in the wire, but erratic glowing or no light at all means there is respectively only a partial connection or else a complete break.

Another use for the neon tester is in determining whether a variable resistance or potentiometer is working properly. If the two terminals of the variable resistance or, in the case of a potentiometer, the terminal joined to the slider and one of the other two are connected to the lamp and the slider is moved slowly round, then any place where there is a faulty contact will

(Continued on next page)

A NEON LAMP TESTER

(Continued from previous page)

be indicated by the lamp going out at that point. If the instrument has a fairly high resistance, such as 5,000 ohms or more, then the glow of the lamp should steadily increase or decrease as the knob is turned first one way and then the other. If it flickers it means the slider is not making proper contact at the point where the flickering occurs.

In testing a variable resistance or potentiometer in this way we get a very good idea of how the lamp will behave when resistances of various values are connected in series with it, for in moving the slider we vary the resistance from zero to the full value of the instrument. Now if we look at the lamp we shall see that the glow does not gradually get paler as the resistance is increased, but rather does it diminish in area. First of all the whole of the beehive-shaped electrode or the disc glows (according to the direction of the current), and then the glow becomes smaller until only a small point is illuminated. Instead of the variable resistance

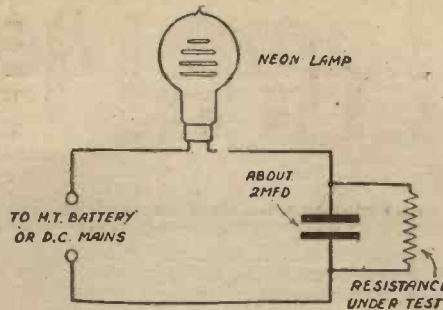

Fig. 5.—The circuit used when testing resistances by the method described in the text.

be used, and when the current is switched on there should be no glow or flashes from the lamp until the resistance is connected up. On placing a resistance in position the lamp will start flashing at regular intervals. There may be five, ten, twenty or more flashes per minute until the lower values are reached, when the flashes become too fast to count, or else merge into one continuous glow.

Now in order to test a range of different resistances it is best to make a simple graph as in Fig. 7. By placing three or four different resistances of known value across the fixed condenser in turn a table such as the following may be compiled.

Resistance	Flashes per minute
3 megohms	14
2 " "	20
1 " "	26
1/2 " "	33

From this it is a very simple matter to make the graph. For the benefit of those readers who may not be familiar with plotting graphs I will describe how this one is made. The results tabulated above were those actually obtained with an "Osglim" neon lamp and several good-quality resistances. You will see that the resistances chosen vary from 1/2 megohm to 3 megohms, therefore we divide the graph vertically into equal increments of resistance to cover this range. Along the base we mark the number of flashes per minute from 0 upwards. Now, taking the first figures in the table, we see that a resistance of 3 megohms gave 14 flashes. We run a pencil along the horizontal line marked 3 megs. and one along the vertical line marked 14. Where they intersect at A we put a small cross. We carry out the same procedure for the other points, thus 2 megs.

meets 20 at point B, and so on. The points A, B, C and D are then joined up with a line as shown.

Once the graph is complete we can read off the value of any unknown resistance within the limits of the graph. Suppose, for instance, that we placed an unmarked resistance across the terminals of the condenser and the lamp flashed 30 times per minute. Following up from the 30 line on the graph we see that it meets the curve at the same point as the horizontal line marked 1/2 meg. The value of the resistance is therefore 1/2 meg. In the same way a resistance giving 17 flashes would be approximately 2 1/2 megohms.

The accuracy of these results depends to a large extent on getting the lamp to flash at regular and easily countable intervals. To ensure this, a little care in the adjustment of the voltage and the capacity may be required. If the flashes occur too quickly

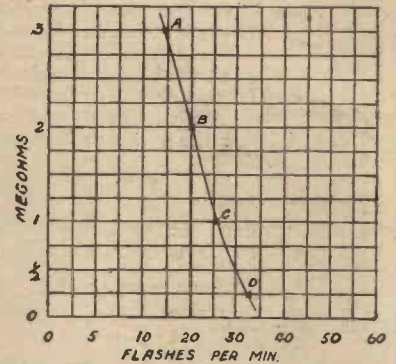

Fig. 7.—The curve used for finding the values of resistances.

to count, then a larger condenser—say 4 mfd.—should be used. This will slow up the flashes considerably. Keeping the voltage of the supply as low as possible will also help, although naturally it must not be reduced so much that the lamp will not glow at all.

There is one peculiarity in connection with neon lamps which must be mentioned here, as it is possible for it to cause slightly erratic results, and that is there is sometimes a time lag between the flash and the voltage producing it. This means that although the upper critical voltage necessary for producing a discharge is reached, yet the discharge does not immediately take place. This is due to insufficient ionisation within the lamp itself. However, it may be overcome by having a bright light, or another neon lamp, glowing in the near vicinity of the test lamp, when the work is in progress.

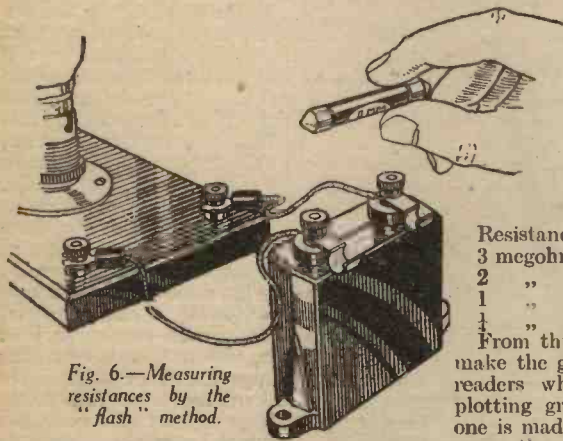

Fig. 6.—Measuring resistances by the "flash" method.

several fixed resistances may be tried. It will be noticed that each one will give a different amount of glow according to its value. This in itself will provide a rough means of finding out the value of an unknown resistance. As an example we may find that a grid leak of two megohms makes the lamp just glow, whereas a half-megohm leak makes about a quarter of the total area of the electrodes light up. If a leak of unknown value is then submitted to the test and found to give a glow area smaller than that of the half-megohm leak but more than that of the two-megohm one, then we may fairly safely assume its value to be in the region of one megohm.

Obviously this method gives only approximate results, and has the drawback that a large number of known resistances is needed in order to be able to determine the value of any unknown one. A far more accurate and reliable method is that mentioned earlier, namely, the "flash" method.

Measuring Resistances

The circuit necessary is shown in Fig. 5. It consists simply of a large fixed condenser in series with the lamp and an H.T. battery or other direct current source, while the resistance under test is placed across the condenser. A good idea is to discard the prods and connect the condenser with two wires to the lamp as in Fig. 6. Grid-leak clips or stiff wires can be fitted to the condenser terminals to facilitate the quick attachment and removal of the resistances. A good quality condenser if about 2 mfd. capacity should

A COMPLETE LIBRARY OF STANDARD WORKS

By F. J. CAMM.

- WIRELESS CONSTRUCTOR'S ENCYCLOPÆDIA 5/-, by post 5/6.
- EVERYMAN'S WIRELESS BOOK 5/-, by post 5/6.
- TELEVISION and SHORT-WAVE HANDBOOK 5/-, by post 5/6.
- SIXTY TESTED WIRELESS CIRCUITS 2/6, by post 2/10.
- WIRELESS COILS, CHOKES and TRANSFORMERS and HOW TO MAKE THEM 2/6, by post 2/10.
- PRACTICAL WIRELESS SERVICE MANUAL 5/-, by post 5/6.
- WORKSHOP CALCULATIONS, TABLES & FORMULÆ 3/6, by post, 3/10.
- PRACTICAL MECHANICS HANDBOOK 6/-, by post 6/6.

All obtainable from or through Newsagents or from Geo. Newnes, Ltd., Tower House, Southampton St., Strand, W.C.2

Practical Hints

Accumulator Charge Indicator

HAVING two accumulators, one of which was fitted with a charge indicator, I hit on the following idea for an indicator for the second accumulator.

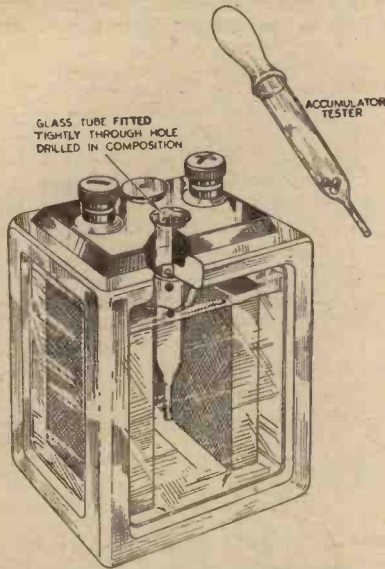

A simple method of providing a charge indicator for an accumulator.

I purchased an accumulator tester of the 3-bead type and removed the rubber bulb. I then drilled a hole in the top of the accumulator so that the glass tube of the tester fitted tightly; this was then pushed down into the accumulator until the top was flush, as shown in the sketch.

The acid filled the tube in which the beads floated or sank according to the state of charge of the accumulator. In order to stop undue evaporation, a small rubber bung with a hole drilled through it was placed in the top of the tube.—F. J. HAWOD (Folkestone).

Former Mounting Strips

AS I am compiling some data sheets on coil winding, it was necessary for me to originate a scheme so that coils and

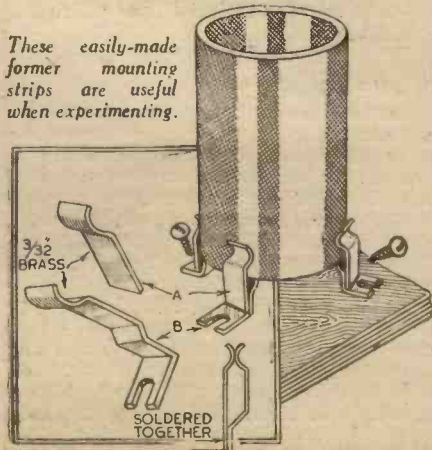

These easily-made former mounting strips are useful when experimenting.

THAT DODGE OF YOURS!

Every Reader of "PRACTICAL WIRELESS" must have originated some little dodge which would interest other readers. Why not pass it on to us? We pay £1-10-0 for the best hint submitted, and for every other item published on this page we will pay half-a-guinea. Turn that idea of yours to account by sending it in to us addressed to the Editor, "PRACTICAL WIRELESS," George Newnes, Ltd., Tower House, Southampton Street, Strand, W.C.2. Put your name and address on every item. Please note that every notion sent in must be original. Mark envelopes "Practical Hints." DO NOT enclose Queries with your hints.

SPECIAL NOTICE

All hints must be accompanied by the coupon cut from page iii of cover.

formers could be mounted conveniently, regardless of their different diameters.

At first I used crocodile clips, but the arrangement proved more awkward than it was worth, so discarding this method I made up a number of the clips depicted in the accompanying sketches. Each clip is made up with two pieces of sheet-brass, so bent that the jaws are springy and strong after soldering together. An elongated $\frac{9}{16}$ in. hole provides means for mounting on the wooden test board, and I find that three of these clips are usually all that are required for rigidly holding comparative extremes in former sizes.—R. L. SHALE (Surbiton).

S.W. Coil Improvement

RECENTLY, being tired of adjusting the aerial condenser on my short-wave set every time I changed the coil, I devised the following method of over-

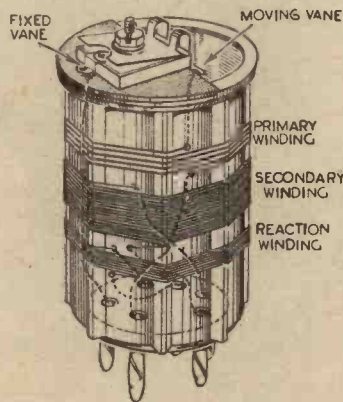

A method of incorporating an aerial condenser with a plug-in coil.

coming the trouble. As will be seen from the illustration, a semicircular sheet of paxolin was cut to cover the top of a six-pin coil, and glued in position. On this was mounted a small mica-dielectric pre-set condenser. The beginning of the primary winding was removed from its pin and soldered to the moving plate of

the condenser. A wire was then brought from the fixed vanes of the pre-set, through the paxolin strip, and soldered to the vacant pin.

The coil is now placed in the set, and the trimmer adjusted by means of a slip of wood. The set of coils may be so fitted, and once the condensers on each coil are adjusted, aerial adjustments are capably taken care of.—WILSON CAIRNS (Newtownards).

A Handy Battery-housing Box

HAVING a wooden chassis which I had discarded recently, it occurred to me that this chassis could again be put to useful purpose in the form of a compact battery-housing box, thus making it more convenient for moving the H.T., L.T. and G.B. about when testing. From the illustration, it will be seen that the modification consists simply of a thick plywood top, cut out to hold the batteries, reinforcement being provided by a cross-member as depicted; an additional plywood base.

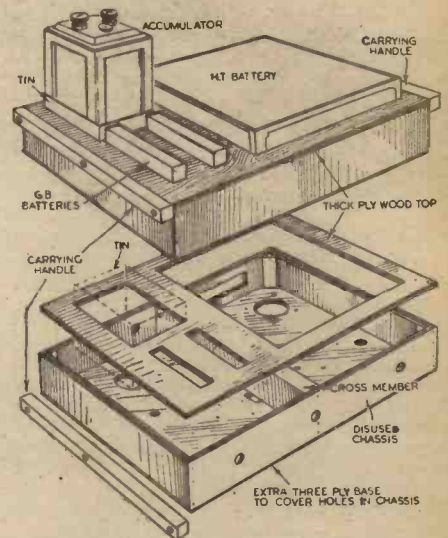

A novel battery-housing box contrived from an old wooden chassis.

and two strip-carrying handles cut from a piece of American white wood.

To afford some protection against the accumulator acid creeping, I made a tin container, and permanently fitted this into the accumulator section, screwing it to the chassis base; this is shown by the pictorial, and the dotted lines in the lower illustration. Facilities of this nature make the construction well worth while.—J. E. FELLOWS (Durham).

PRACTICAL MECHANICS HANDBOOK

By F. J. CAMM

6/- or 6/6 by post from George Newnes, Ltd., Tower House, Southampton Street, W.C.2.

FRAME AERIAL DESIGN

A Frame Aerial will Often Prove of Value Either in Removing Interference or in Improving Selectivity. Details of Design are Given in This Article

By W. J. DELANEY

MANY amateurs regard the frame aerial as a makeshift substitute for the normal outdoor aerial, and consider that any old framework with odd wire wound round it will answer for the purpose. As a matter of fact, a frame aerial is just as scientific in its design and application as the special types of reflector or directional aerial such as are employed by amateur transmitters, and their construction and use may be applied in a

cast purposes, that the sides of a square frame aerial should not be less than 12ins. in length, or in the case of a round frame a diameter of at least 12in. should be aimed at. The turns of wire may be laid side by side or spaced slightly, the latter arrangement reducing self-capacity and accordingly permitting more turns with a consequent increase in inductance. This point must not be overdone, however, and normally a space equivalent to the thickness of the wire should be found most suitable.

A round frame aerial may very conveniently be made up by using small wooden hoops such as used by children or large embroidery hoops such as may be obtained at needlework accessory or haberdashery shops. The hoops, of which two are required, should be spaced and held apart by small strips of wood, cane or insulating material, and in this connection a point will be mentioned later when dealing with spaced windings. A rectangular frame may be made with a minimum of material by mounting two strips of wood at right-angles and then winding the frame across the ends of the strips. As an alternative pegs or similar supports may be driven into a flat surface, but one of the most valuable features of the frame aerial is that it is directional and therefore must be moved so that it is in the plane of the received signal-waves in order to obtain maximum induction. Therefore, a readily-moved assembly is desirable, although if pegs or similar supports are mounted on a flat surface this may be made part of a receiver cabinet—as witness the popular portable type of receiver. Here the entire cabinet or just the back may be moved to obtain the directive effect.

The Round Aerial

As already mentioned, hoops may be used for the round aerial, and a foot may be mounted on one of the distance-pieces. If the aerial is needed for medium waves only a single winding may be employed, but for the medium and long waves, with

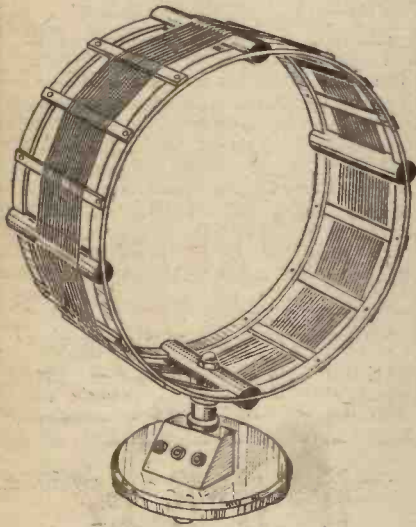

Fig. 1.—How to make a frame aerial with embroidery or similar hoops.

similar manner. For the benefit of those who are anxious to go into the subject of the frame aerial fully, it may be mentioned that the voltage received by a frame aerial may be calculated by a formula, this being $E = (2\pi FAN/\lambda) \cos \theta$ volts.

- where A = frame area in square metres,
- F = field strength in volts per metre,
- N = number of turns,
- λ = wavelength in metres,
- θ = angle between the plane of the frame and the direction of the loop.

This formula applies to loops or frames of all shapes, provided that the loop is small compared with the wavelength. The exact expression is

$$E = 2FHN \sin((\pi W/\lambda) \cos \theta)$$

- where H = height of the frame in metres,
- W = width of the frame in metres.

Frame Design

Thus it will be seen that a frame aerial is every bit as important in design as other parts of a modern radio receiver, and some care expended in design and building will undoubtedly be repaid in the results obtained. In normal cases a round or square frame is found most satisfactory, and from the details given in the above formulae it is obvious that the size is of some importance. It may be taken as a general rule, for normal domestic broad-

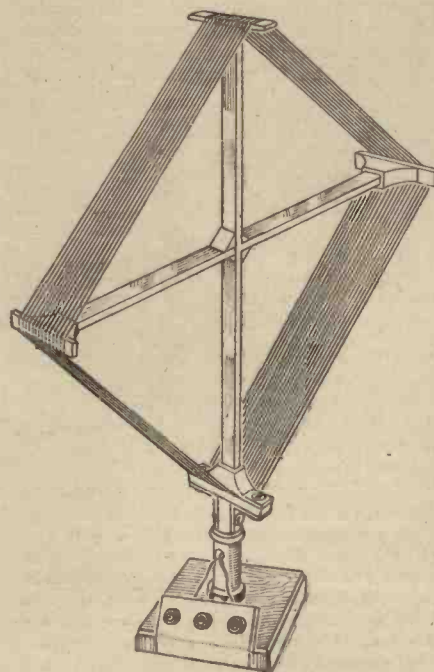

Fig. 2.—A rectangular home-made frame aerial.

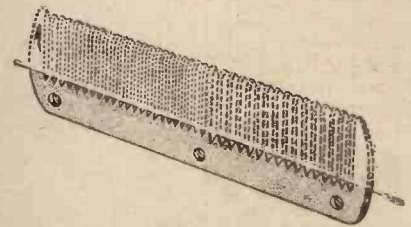

Fig. 3.—Details of a cut-down comb to act as wire spacer and support.

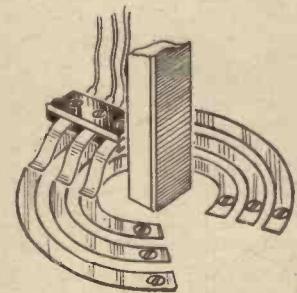

Fig. 4.—How to arrange for wiping contacts on a continuously rotating frame.

wave-change switching, it is desirable to wind the medium-wave section with turns slightly spaced, and to use a much finer gauge of wire with turns touching for the long-wave loading section. To enable the respective turns of wire to be maintained in position, the distance-pieces between the hoops may be cut with a saw or grooved as desired. One good plan is to use ordinary combs of the type having two sets of teeth, one close-spaced and one wide-spaced, and to cut down the teeth to about $\frac{1}{4}$ in. in length. These may be screwed to the distance-pieces to avoid difficulties of cementing the celluloid or other material from which the combs are made.

Square Frames

At the ends of the cross strips used for a rectangular frame similar supporting strips may be attached and again the comb idea may be adopted. Alternatively, spade-shaped pieces of ebonite may be cut and saw-cuts made to carry the aerial windings. To enable the frame to be rotated the ends of the winding must be firmly anchored to the frame and flexible leads taken down to terminals mounted on an insulating strip fitted to the base. A stop must be provided in this case, however, as if the frame is given a full rotation the wires will be twisted and may be fractured. A very good idea if a really good job is being made

(Continued on page 184.)

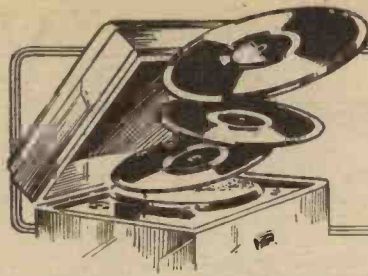

Impressions on the Wax

A REVIEW OF THE LATEST GRAMOPHONE RECORDS

Decca

ALTHOUGH each day brings some new topical song—each of which is ardently hoped will be a new "Tipperary"—the recording-people are fighting shy of the majority of them until they get a line on what the public and fighting forces want to hear and sing.

One or two tunes seem to be in the public eye, however, and "The Siegfried Line" is one of them. By a curious coincidence two teams of composers hit on the same idea at the same time. One team chose "I'm Sending you the Siegfried Line to Hang Your Washing On" as a title, while the other thought of "We're Gonna Hang out our Washing on the Siegfried Line." Both of these tunes have been recorded on *Decca F 7245*, played by Ambrose and his Orchestra. Ambrose has also recorded two other topical numbers. These are "Adolf," a gay marching-tune composed by Annette Mills, who wrote "Booms-a-Daisy," and "Kiss Me Good Night, Sergeant-Major" on *Decca F 7244*.

One Hitler-inspired song that has been recorded is Tommy Handley's "Who is That Man That Looks Like Charlie Chaplin?" Coupled with it is Max Kester's love ditty: "The Night We Met in a Black-out"—*Decca F 7246*.

One of the many good things that the B.B.C. had scheduled for listeners before the war was a special programme by Ambrose and his Orchestra. This was to have been called "Reminiscing with Ambrose," and consisted of a survey of the many tunes that he and his band have made famous. Listeners who were disappointed over the cancellation of this programme will be pleased to know that Decca have arranged the highlights of the programme in a special album release. "Reminiscing with Ambrose" on six records is a survey of the most fascinating tunes of recent years and includes such favourites as "Body and Soul," "The Continental," "Organ Grinder's Swing," "Top Hat," etc. In each case the vocal is sung by the Ambrose star who made the number popular. *Decca (Album No. 10) F 7202/7*.

A Remarkable Instrument

ARTHUR YOUNG'S first record on the Novachord has proved so popular that Decca have released another one by him at the keyboard of this unique instrument, a description of which I give below.

The Novachord is the invention of Laurens Hammond who also devised the Hammond Organ, and it can simulate an extraordinary number of other instruments such as the piano, harpsichord, violin, trumpet, cello, steel guitar and French horn. It has the appearance of a piano, but produces its mystifying variety of tones electrically by means of radio valves.

On one side of *Decca 7201* is Bach's "Prelude in D," while the reverse contains Alec Templeton's brilliant swing impression of a Bach Fugue called "Bach Goes to Town."

Mr. and Mrs. Jack Doyle made their first record together during last month. Mrs. Doyle—who is better known as Movita, the Mexican film-star—sings "South of the Border," whilst on the reverse Jack Doyle sings "When Irish Eyes are Smiling"—*Decca F 7199*.

Other vocal records you should hear include two by Rudy Vallee from his film "Second Fiddle." The fact that they are all from the pen of Irving Berlin is an added attraction. On *Decca F 7210* he sings "I'm Sorry for Myself" and "An Old-fashioned Tune is Always New," and on *Decca F 7211* he has coupled "When Winter Comes" with "I Poured My Heart Into a Song."

Brunswick

ONE of the most outstanding features of popular music during recent years has been the revival of Hawaiian music. This is particularly noticeable in America where many of the hotels have established Hawaiian rooms. Bing Crosby is very fond of this music—you will remember the film in which he introduced "Sweet Leilani." This month he has recorded two new songs about the colourful islands. Accompanied by Lani McIntyre and his Hawaiians, he sings "When you Dream about Hawaii" and "Sail Along Silvery Moon"—*Brunswick 02826*.

Frances Langford also has the craze. Her new record contains "Echoes of Hawaii" and "The Man With the Mandolin"—*Brunswick 02829*. Incidentally, you must hear the first record of a young Danish vocalist named Fin Olsen. This is on *Decca F 7212*. Olsen's tones in "I Never Knew Heaven Could Speak" are amazingly like Miss Langford's. The coupling is "Fuzzy Wuzzy."

Fans will want to hear the latest thing in swing bands. This has been formed by Glenn Miller. Miller will be remembered as the trombonist in many Brunswick records by Red Nichols and his Five Pennies. He plays "How Am I to Know?" and "Moonlight Bay"—*Brunswick 02831*.

Paul Whiteman introduces a novelty in his "Sax Socktette" on *Brunswick 02834*. Nine saxophones swing out in "After You've Gone" and "I Kiss Your Hand, Madame." For his second solo-piano record, Count Basie turns to a twelve-year-old number called "The Dirty Dozens"—*Brunswick 02825*. A quite sensational record by Connie Boswell and the Lyn Murray Singers is "Memory Lane" and "Silver Threads Among the Gold," on *Brunswick 02828*.

For beauty of melody and tunefulness the Frank Bridge "Suite for String Orchestras" is hard to beat. It is delightful music from beginning to end. The "Suite" was composed 30 years ago and has now been recorded by Decca. A grand performance of it is given by The Boyd-Neel String Orchestra, conducted by Boyd-Neel, on *Decca X 250/2*, supplied in album with a descriptive note by Alex Robertson.

BARGAINS!

N. T. S. Amazing Offers! Order NOW before Prices Rise

FREE VALVES. S.G.3 Kit for all-wave operation on 9 to 2,000 metres. Available in less coils to accommodate those already possessing B.T.S. or N.T.S. One-Shot types. Simple to assemble and an amazing performer on all bands. Two S.G. and Pentode output stages. Complete Kit with metal chassis, transformer, etc., and 3 FREE valves and building instructions. Bargain, Cash or C.O.D., 32/6. If required, complete set of 10 coils (two for each band), 27/-.

CLASS B 4-VALVE CHASSIS. New limited supply. Suitable for fitting in your present cabinet or for emergency use. Wave-range 200 to 2,000 metres. Selective and sensitive. Volume equal to a mains set. Fully tested chassis (size 11 in. x 9 in. x 8 in. high), complete with all valves, cash with order, only 61/6. Impossible to repeat once present stock is cleared.

COMMUNICATIONS Receiver. Famous-name 5-valve model 115td. in previous N.T.S. advertisements. Wave-range 10-550 metres continuous. Band-spread tuning and special tuning features which ensure all-world reception. Built-in speaker. 'Phone socket. Fully tested and ready for use on A.C. supplies, 200/250 v. Bargain, 29. Full specification on request. Terms, £2 deposit and four monthly payments of 38/6.

A.C. ALL-WAVE 4 CHASSIS. Now's the time to fit this chassis in your present radio or radiogram cabinet. Powerful 4-valve S.G. Pentode output circuit. Wave-range 18 to 2,000 metres. Pleasing station name dial. Output 3 watts. F.U. sockets. Size of chassis, 11 in. w. 9 in. h., 8 in. deep. Fully tested and complete with all valves. Bargain, 78/6. Limited new stock of matched 2,500 ohm field speakers, 25/-.

VALUABLE RADIO PARCELS. Our new offer comprises variable condensers, coil, fixed resistances and condensers, useful control knobs and a brand new universally drilled cadmium-plated steel chassis. Amazing BARGAIN. Only 5/-, plus 1/- for special packing and postage.

BARGAIN PARTS. Parcel of 4 assorted screened and unscreened coils for experimenting and replacement purposes, 2/-, post 6d. Special offer of 2-volt 1-amp. Trickle Chargers employing metal rectifier. Brand new and ready for charging your L.T. on A.C. mains 200/250 volts. Bargain, 12/6, postage 6d.

HEADPHONES. Lightweight and extremely sensitive, 5/6 pair, postage 6d.
VALVES. Special offer: set of 3 2-volt battery types 1A4E, 1B4E and 2101. Brand-new in makers' cartons, complete with valveholders, data and useful circuit diagrams. Bargain, 7/6 the lot. post free. Est. 1924.

NEW TIMES SALES CO.
56 (10 PW), LUDGATE HILL, LONDON, E.C.4
LISTS FREE

CLIX

FLEXIPIN Self-Adjusting PLUGS

If your radio **CRACKLES** when you touch the plug which connects your set to the wall socket, it is because the plug-pins are not making proper contact with the socket-tubes.

The CLIX plug has been specially designed to eliminate this trouble and its self-centering, expanding pins will fit and make perfect contact in any make of BSS Socket.



CLIX
5 amp 2-pin
"M" type
plug as used
by all the
leading radio
manufacturers
Costs **4¹/₂**
only

A full range of 2 and 3 pin BSS types in 2, 5 and 15 ampere sizes is available from all good Radio and Electrical Dealers.

If in difficulty write to the makers:—

British Mechanical Productions Ltd.
1, Church Road, Leatherhead, Surrey.
FIT "CLIX" and CUT THE CRACKLE

ASTOUNDING STATEMENTS

Why not make some historic records at home, of present-day news as broadcast in English from enemy stations? Better still, record your own Christmas messages for relatives and friends in England—or record any song or music which has a special interest for you.

Home Sound Recording is Not Expensive

when you buy and use **A FEIGH RECORDER**
Fits any Radiogram, positive drive, worm gear and rack. Complete, ready for use, only 37/6. Super Feigh Fidelity Set, 42/6. Tracking Gear only, 21/-. Either 3/3 doz. metal blanks can be used for the glass-coated simples, 1-pin, 3/- each. Pre-amplifiers for Recording Mikes, 1-valve Battery Model in cabinet, 25/-. A.C. Mains pre-amplifiers, with valve rectifier, steel-cased model, 60/-.

CODE. Learn how to Send and Read Morse.

MORSE PRACTICE SETS are cheap. No. 1 Sound. Key and Buzzer on base, 3/-. No. 2 Light. Key and Bulb on base, 2/-. No. 3. Combination Set for Sound and Light key, buzzer and bulb on base, 7/-.

KEYS for MORSE. Well-balanced Morse keys, plated brass bar, bakelite base and terminals, etc., 4/6. Massive Buzzer, 1/- With these and your pocket battery you can signal distant line to pair of 3, 9 Sullivan 'phones. Superior Model Keys, 7/6. A few Government long-lever Keys, used spares for transmitting, 10/6. No. 1. R.A.F. Signal Keys, massive balanced bar with adjustments, wood base, khaki finish, 12/6.

Enclosed Army type. Key W., unused. For heavy work, 14/6. Brown's Key, highest possible grade, police patrol type. Few only, 42/-.

POCKET HEADPHONES. W.D. all leather headband strap and cords, 3/6 pair. Wireless type, with aluminium headbands, 3/9. 4,000 ohms, 4/8, 6/6 and 8/6.

LISTENING MIKES, steel-cased Electradix indestructible; are ears outside your dug-out.

MORSE RECORDING OF WIRELESS SIGNALS. These well-known service paper tape inkers record messages on any wavelength at speed. Recorders add enormously to interest. Magnificent British work, mahogany drawer containing tape reel. Standard G.P.O. type, £8/10/4. Portable enclosed Field Service type, complete, fitted with meter and key, unused, £7/10/0.

THE P.W. 30/- THREE. Fitted Cabinet with varia. Condensers and wiring, 10/6 to callers, or 12/6 post and packing free.

DETECT ENEMY FIRE BOMBS with a photo-cell night watchman. You can make one yourself to indicate in the A.R.P. room. Battery or mains. **RAY DETECTOR.** Complete Kit. Battery model with Relay £3/17/6. A.C. Mains Set £5/10. D.C. Mains Set £4/15.

PHOTO CELLS. R.C.A. Cassium Silver Vacuum. £5 list, for 25/-. Electro-Photonic photo-cells generate E.M.F. under light 11in. by 1in. 22/6. Few only left.

DISC SELENIUM CELLS light to dark resistance ratio mounted in bakelite case 10/-. In brass housing. Superior model 15/-.

RELAYS. Ultra-sensitive Moving Coil Relay 1,000 ohm coil closes circuit on 50 microamps 60/-, 2,000 ohm 5 m.a. Lightweight magnetic Relay 10/6.

RAID BELLS, ALARM BELLS. Mains, battery or magneto waterproof types. Large selection, 2/6 to 40/-.

A.R.P. EDISON HIGH CAPACITY STEEL CELLS at quarter list price.

CABLE. Lightweight field cable, unbreakable Army steel reinforced, 65/- mile. Heavier type, 75/-, Twin lightweight cable 55, and heavy twin type 27 per mile.

ARMY SIGNALS. Day and Night Lucas and Aldis Hooded Army Signal lamps, telescopic sights, hand or tripod. For Fire Brigades and Police, 60/- Helios on tripod.

SHELTER, A.R.P. Ventilation and Air Conditioning. A.C. or D.C. mains, 80 watts; 9in. Blower, 20 cub. ft. fresh air per min., 25/-.

ELECTRIC PUMPS. for A.C. or D.C., 12 v. to 230 v. Centrifugal all-bronze pump, throws 120 gals. per hour, 6ft. Caravans, Bungalows and Boats, 72/6. Larger pumps for draining shelters, dug-outs, etc., £6/17/6.

BATTERY CHARGING ON A.C. Mains. The A.C. NIINDAY will keep your battery fit without attention.

Model N/A6, 100/250 volts A.C. and D.C. 6/8 volts 1 amp., 15/- Model N/B6, 100/250 volts to D.C. 6/8 volts 1 amp., 25/- Model N/C6, 100/250 volts to D.C. 6/8 volts 2 amps., 35/- Model N/D12, 100/250 volts to 12 volts 1 amp., 32/- Ditto, 12 volts 2 amps., with 6-volt tap, 55/- 5 amp., 24/10/0.

5- EMERGENCY PARCELS of useful stand-by electrical and radio repair material and apparatus, 10lbs. for 5/- Post Free.

Send now for our Bargain List "N."



ELECTRADIX RADIOS

218, Upper Thames Street, London, E.C.4

Telephone: Central 4611

LATEST PATENT NEWS

Group Abridgments can be obtained from the Patent Office, 25, Southampton Buildings, London, W.C.2, either sheet by sheet as issued on payment of a subscription of 5s. per Group Volume or in bound volumes, price 2s. each.

Abstracts Published

TELEVISION RECEIVERS; KINEMATOGRAPH APPARATUS; DEVELOPING APPARATUS.—Marconi's Wireless Telegraph Co., Ltd., and Banks, G. B. No. 508695.

In an intermediate-film type television receiver, the film is moved forward in the gate 5, Fig. 1, in a series of steps, being left stationary in the gate and exposed through the lens

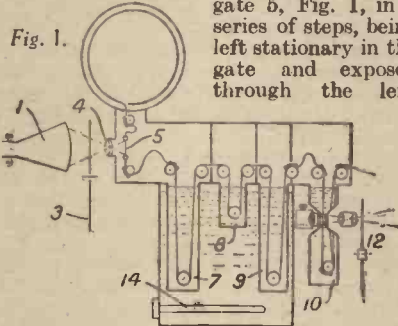

system 4 to a picture on reproducer 1 during one picture period, but during the following picture period is moved forward by one frame during which time it is not exposed to the picture. The reproducer 1 may be made inoperative or the shutter 3 may interrupt the light during this period. The film is immediately processed by passing through a developing tank 7, a fixing tank 9, and washing tanks 8, 10. These tanks are heated to any desired temperature by heater 14. The cine-projection may be under water and the projector is provided with a flicker disc 12, Fig. 2, comprising spaced sectors, a, b, c which increase the flicker frequency beyond the noticeable frequency.

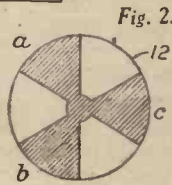

WIRELESS RECEIVING SYSTEMS; CABLES.—Disney, A. L., and Belling and Lee, Ltd. No. 508949.
A cable 15, 11, 16, Fig. 3, for connecting an aerial to a receiver is provided with a common overall waterproof covering 12 of rubber, gutta-percha, etc., which surrounds the three sections 15, 11, 16 and matching transformers 14 therebetween. The cover-



Fig. 3.

ing may be of greater diameter at the places 13 where the transformers occur or of greater thickness therebetween. The line may be provided throughout with a braided wire screen and the assembly may be provided with integrally moulded lugs, terminals, etc.

VALVE AMPLIFYING CIRCUITS.—Ellis, H. D. M. No. 508697.

In an arrangement in which a pair of valves are coupled in push-pull to the output through a transformer, the cathodes are connected together and through a common impedance to the negative high-tension source. The input to one valve is between the grid and a point on the common impedance, while the grid of the second valve is connected to a point of the common impedance such that the potentials across the impedance are applied to the input of the valve. Fig. 4 shows an arrangement

in which the common impedance comprises resistances 8, 16 and bias is applied through resistances 15, 18 and the grid of the valve 4 is connected through condenser 17 to the negative high tension terminal 9. In a modification, resistance 16 is dispensed with and the grid of the second valve connected directly to the

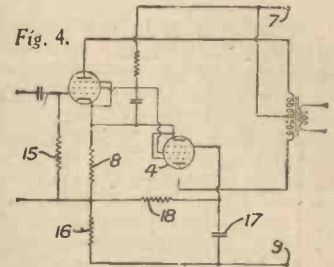

negative high tension terminal. The input to the first valve may be directly between the grid and the cathode, and the input to the second valve may include a resistance in the common anode circuit.

NEW PATENTS

These particulars of New Patents of interest to readers have been selected from the Official Journal of Patents and are published by permission of the Controller of H.M. Stationery Office. The Official Journal of Patents can be obtained from the Patent Office, 25, Southampton Buildings, London, W.C.2, price 1s. weekly (annual subscription £2 10s.).

Latest Patent Applications

- 28028.—Baird Television, Ltd., and Baird, J. L.—Methods of transmitting signals. October 17th.
- 27766.—Hazeltine Corporation.—Tunable selector of uniform band width. October 12th.
- 28077.—Magyar Wolframlampa Gyar Kremenezky Janos Reszvenytarsasag.—Method of reducing noise disturbance in radio reception. October 17th.
- 27930.—Philips Lamps, Ltd.—Adjustable electric condensers. October 14th.
- 27991.—Philips Lamps, Ltd.—Adjustable electric condensers. October 16th.

Printed copies of the full Published Specifications may be obtained from the Patent Office, 25, Southampton Buildings, London, W.C.2, at the uniform price of 1s. each.

THE WIRELESS CONSTRUCTOR'S ENCYCLOPEDIA

By F. J. CAMM | 6th Edition

(Editor of "Practical Wireless") | 5/- Net

Wireless Construction, Terms, and Definitions explained and illustrated in concise, clear language

From all Booksellers or by post 5/6 from George Newnes Ltd., Tower House, Southampton Street, Strand, London, W.C.2.

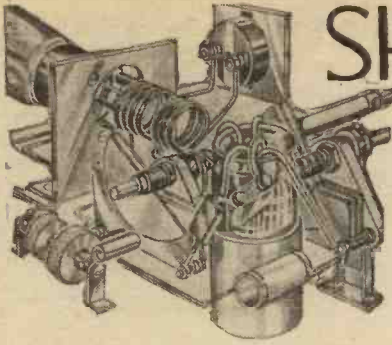

SHORT-WAVE SECTION

FROM "SHORT WAVES" TO "ALL WAVES."

How to modify a standard short-wave receiver.

NUMEROUS articles have been published on the subject of converting a broadcast receiver for short-wave reception, but little has been said regarding the modification of a short-waver in order to make it suitable for medium- and long-wave use. It might be argued that nobody wishes to make a conversion in this "direction," but it is evident that many constructors who own an experimental short-wave set as well as a normal broadcast instrument would find it an advantage to make the former capable of reception of broadcasting—probably because the standard broadcast set is "family" property.

Coils in Series

Fortunately, it is generally a perfectly simple matter to make the alteration, largely because a short-wave receiver is fundamentally of an efficient type, designed on low-loss principles. The easiest method to carry out the alteration would be to arrange for a broadcast coil to be included in series with the normal tuning coil, as shown in Fig. 1. In this case the switch marked A is used to short-circuit the broadcast coil when listening on short waves, and that marked B (and probably built into the coil) is for effecting the change-over from medium to long waves. The tuning range on the broadcast bands would generally be rather restricted when using this arrangement, due to the fact that the tuning condenser probably has a maximum capacity of only .00016-mfd., or thereabouts. But despite this, a wavelength coverage of about 280 to 400 metres could generally be obtained, the exact range depending partly upon the size of the short-wave coil in use, since the

inductance of this is added to that of the new tuner.

This slight difficulty can be overcome by connecting a .0003-mfd. tuning condenser in parallel with the broadcast coil, and

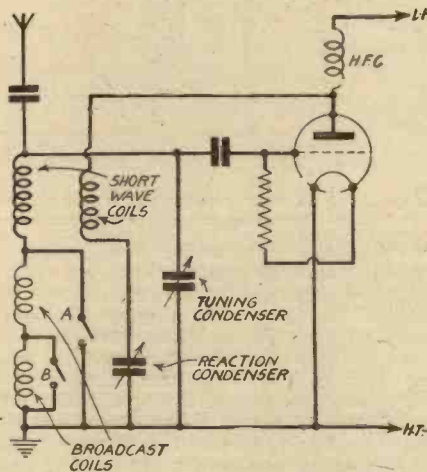

Fig. 1.—A simple method of adding a broadcast coil to a short-wave set, both coils being in series.

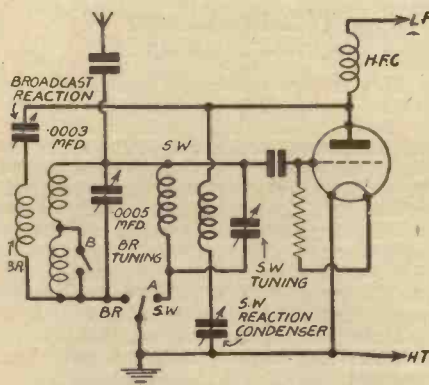

Fig. 2.—This arrangement is an improvement on that shown in Fig. 1, since the reaction can be used on all wavelengths. The broadcast reaction condenser must be set to zero when working on short waves.

using this in conjunction with the smaller component used for short-wave tuning. It is quite permissible to use a condenser with a plain disc dial because final, or vernier, tuning can be carried out on the short-wave condenser which permits of very accurate adjustments being made. The new components can be mounted in almost any convenient position on the chassis, since the coil will no doubt be of the screened type, and both this and the condenser are completely short-circuited for short-wave reception.

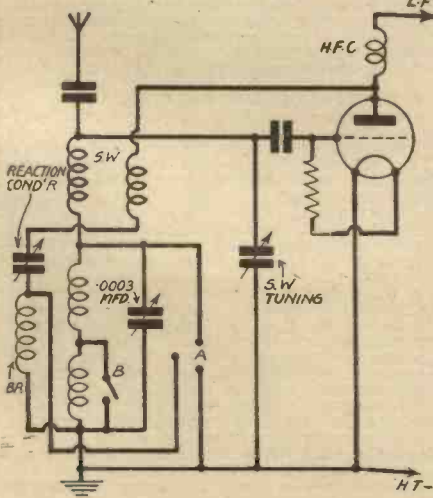

Fig. 3.—A variation of the circuit shown in Fig. 1, where reaction is used on all wavebands.

Waveband Switching

An alternative arrangement which is possible with certain types of coils is shown in Fig. 2, where it will be seen that a change-over switch is used to bring either the short-wave or broadcast coil into circuit. In this case the larger coil has a .0005-mfd. tuning condenser in parallel with it, and the smaller condenser is cut out of circuit except when working on short waves. Another difference between this circuit and the first one mentioned is that a separate reaction circuit is used for broadcast reception, this comprising the usual reaction winding and .0003-mfd. bakelite-dielectric variable condenser. This reaction circuit is not definitely broken when working on short waves, but as there is no connection to earth, it will generally be found that short-wave reception is not impaired.

When using the circuit shown in Fig. 1, it might often be found that the detector valve cannot be made to oscillate on broadcast wavelengths due to the small reaction winding which is in circuit, but this trouble, should it exist, can be eliminated by using the connections indicated in Fig. 3, where it will be seen that the two reaction windings are joined in series, a three-point switch short-circuiting both windings of the broadcast coil on short waves.

A Different Method

There are cases in which none of the arrangements so far described could be used successfully. For example, if the aerial were coupled to the short-wave coil through a separate aerial winding, the degree of coupling would be so slight on broadcast wavelengths that signal strength would be reduced to a serious extent. In such instances, a more complicated switching system becomes necessary, and one suitable method of switching is shown in Fig. 4, where it is assumed that both tuners are provided with separate aerial windings. A two-pole change-over switch is employed, and one pole serves to make the earth-return connection to the appropriate coil while the other is used to transfer the aerial lead to one coil or the other. The switch shown is purely diagrammatic, but one of the anti-capacity type (Wearite, for instance) is most suitable, although a Q.M.B. component can generally be used with complete success. The chief point to watch is that the leads to the switch, especially those in the aerial circuit, must be short and direct.

This general scheme lends itself to various modifications which can be introduced according to the particular types of coils

(Continued overleaf)

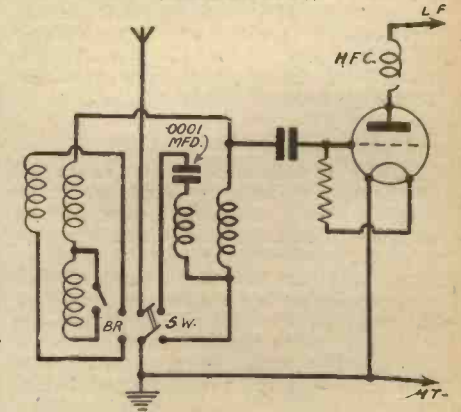

Fig. 4.—This circuit shows connections which can be used when both S.W. and broadcast coils have separate aerial windings. Tuning condensers and reaction circuits are omitted for simplicity.

SHORT-WAVE SECTION

(Continued from previous page)

employed. In every case, however, it is important that the switching system should be as simple as possible, for complicated switching frequently leads to various capacity losses.

H.F. Receivers and Superhets

The circuits considered above are shown as applying to the simple type of Det.-L.F. receiver, but all are applicable to sets in which an H.F. stage is used; all that is then necessary is to duplicate one of the systems, so that the change-over is effective on both the aerial and inter-valve tuning circuits. The aerial coil, of course, will not have a reaction winding, and the corresponding connections should, therefore, be omitted.

The ideas are also applicable, after slight modification, to many superhet receivers, although it will then be necessary to use a separate gang condenser for broadcast tuning. Besides, the condenser must be of the superhet type and designed to provide the frequency difference for which the I.F. transformers are intended. The simplest type of conversion is shown diagrammatically in Fig. 5, this circuit being on the assumption that a pentagrid frequency-changer is employed, and that

band-pass tuning is not considered necessary. Except when an intermediate frequency of 465 kc/s is used, however, band-pass is desirable, and thus a slight modification of the switching for the input circuit would be necessary.

It should be added that when the short-wave set is modified for all-wave working

the short-wave H. F. chokes, where used, should be replaced by others of the universal or all-wave pattern. This is not always essential, but it is generally desirable because reaction would often be difficult to obtain, or to control, on broadcast wavelengths due to the insufficient inductance of the short-wave chokes.

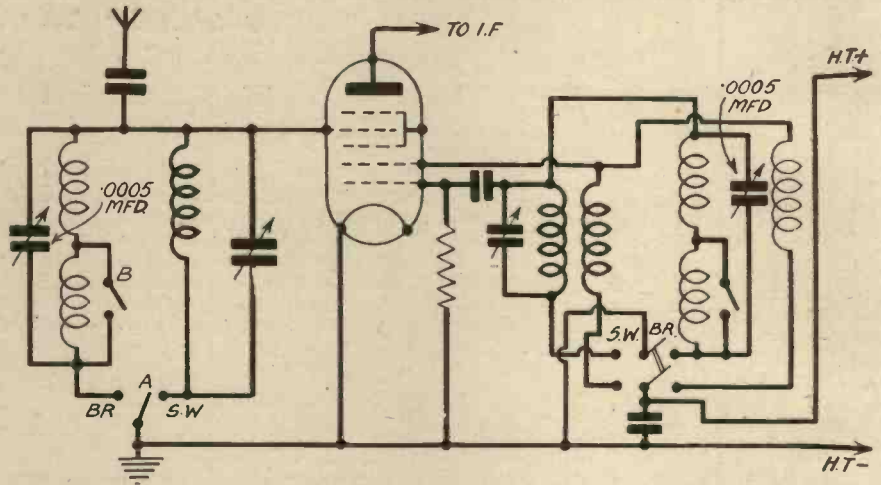

Fig. 5.—This circuit incorporates a simple switching arrangement for use with a simple superhet.

FRAME AERIAL DESIGN

(Continued from page 180.)

is to terminate the ends of the winding in small spring plungers or other types of brush and to mount collecting rings on the base. In this case the frame may be rotated continuously. It is essential, however, to see that the collecting rings are kept perfectly clean and oil or other insulating material must not be placed on them. A reaction winding may, of course, be used in conjunction with the frame and this should preferably be placed in between the medium- and long-wave sections of the frame with a slight space separating them. To enable a single winding to give good reaction control on both bands, a reaction winding large enough to give good reaction on the long should be placed close to the long-wave section. It must, of course, then be spaced well away from the medium-wave section or it will be found too large for the medium waves. The splitting of the medium- and long-wave sections does not produce any ill-effects. An elaboration of this idea is to place the reaction winding on secondary supports inside the frame, again so placing it in relation to the medium- and long-wave sections that the one winding will give good control on both bands. Unfortunately, there is no rule or formula which may be applied to this type of winding and experiment is necessary to find the desired position.

Frame Aerial Sizes

Finally, the size of the frame aerial and the number of turns are obviously inter-related. The only rule which may be given for the size of the frame is that approximately 75ft. of wire is needed to cover the normal medium-wave band when a .0005 mfd. condenser is used for tuning. For the long waves a total of 150 to 200ft. is needed, of which the 75ft. mentioned will obviously be a part. The on/off wavechange switch is connected across the additional wire so that only the 75ft. is in circuit on medium waves. This rule, however, is merely a "rule of thumb" and will form the basis of any experiments which are being carried out. Remember that the frame aerial takes the place of the first

tuned circuit in a receiver and it is not added to an existing set as in the case of a standard aerial. If, therefore, a frame is being used with an existing set the first coil and variable condenser must be disconnected, or the condenser may be left in circuit and the coil alone disconnected. If, however, a ganged tuning circuit is in use it will be found almost impossible to gang the tuning section if a frame is employed as the inductance value will not match a normal broadcast coil, and a separate condenser is therefore an essential part of the frame aerial circuit.

D.C. ELIMINATORS

(Continued from page 170)

The wattage which will be dissipated by a circuit including resistance can be calculated from the simple formula $W=I^2 \times R$, but, as mentioned before, one must not forget that the current I must be expressed as amperes. For example, take the case of $R4$. This has a resistance of 4,210 ohms and is carrying a total current of 19 mAs. What wattage rating should it have?

$W=I^2 \times R = .019 \times .019 \times 4,210$
which equals $.000361 \times 4,210 = 1.519$ watts,
or for practical purposes, say, 2 watts.

It will be noted that the current, 19 mAs, has been expressed as its decimal part of an ampere.

The same calculation must be made to determine the rating of the other resistances, and when the value comes out at some odd decimal part or fraction of a watt, then the nearest standard size above should be taken.

PRACTICAL WIRELESS SERVICE MANUAL

By F. J. CAMM.

From all Booksellers 5/- net, or by post 5/6 direct from the Publishers, George Newnes, Ltd. (Book Dept.), Tower House, Southampton Street, Strand, London, W.C.2.

RADIO CLUBS & SOCIETIES

Club Reports should not exceed 200 words in length and should be received First Post each Monday morning for publication in the following week's issue.

SLOUGH AND DISTRICT SHORT-WAVE CLUB

Hon. Sec.: K. A. Sly (G4MR), 16, Buckland Avenue, Slough.

Headquarters: Toc H Headquarters, William Street, Slough.

Meetings: Alternate Thursdays at 7.30 p.m.

At the last meeting, held on October 26th, 1939, the chief item of interest was the discussion on 28 mc/s conditions; a brief review of conditions this year was given, and members compared notes on the dates when the band had been active. A further series of logs were handed to the research group for examination, and this group has decided that it shall devote its time mainly to 28 mc/s listening. Morse practice took place as usual.

The next meeting, to be held on November 9th, 1939, will include all the usual features such as Morse practice, discussion on conditions, short talks by members of the research group, and query corner.

New members will always be welcome at any of our meetings, and we have room for many more. The subscription is 2s. 6d. a year, an extra 3d. being payable at each meeting for the hire of the room.

THE CROYDON RADIO SOCIETY

Hon. Publicity Sec.: E. L. Cumbers, 14, Campden Road, South Croydon.

THE Croydon Radio Society has the greatest pleasure in announcing that it is recommending activities on Wednesday, November 8th, at 8 p.m., in St. Peter's Hut, Ledbury Road, S. Croydon, which temporary headquarters adjoins St. Peter's Hall. The subject will be a discussion led by Mr. Stuart Davis on "High-quality Reproduction." Demonstrations will take place on his latest quality receiver, and such items as microphones, home-recording, records and new experiments in hnm avoidance are all to be dealt with. When dealing with home-recording, Mr. Davis' own recording of the Davis Theatre Organ is likely to be of considerable interest.

As regards the future, meetings will probably be on a monthly basis, but it is safe to say that the enthusiasm of members and friends at the opening meeting will be the chief guide for subsequent activities. We feel sure that PRACTICAL WIRELESS readers in Croydon will find in the society not only a pleasant way of spending winter evenings but an abundance of friendly spirit. It should be mentioned that as lecturers may well find it difficult to come from any distance, the society will have to rely even more upon local talent, and in particular upon its own members for programmes. In conclusion, let it be said that the subscription is being reduced, so that nothing now stands in the way of an enjoyable session.

PRACTICAL TELEVISION

November 11th, 1939.

Vol. 4.

No. 176.

Field Strength

THE sensitivity of television receiving sets has improved considerably during the last two years, for whereas the first commercial model on an average required a signal input from the aerial of about 250 microvolts to produce a satisfactory picture, this figure has now been reduced to 100 microvolts, or lower, in those areas where external interference is negligible. Various improvements in design have been instrumental in bringing about this state of affairs, but when it comes to the question of expressing the sensitivity of any radio receiver in terms of so many units there are many who fail to understand exactly what is implied. This is not always made easier by a reference to a text book, for it will be found that an electric field is defined as "the space in the neighbourhood of charges where forces of attraction and repulsion are exerted on other charges." Again, in the same book a reader is told that the strength of an electric field can be measured by the force which would be exerted on a unit charge placed there, or in other words the field strength is the force in dynes per unit charge. Unless one is well versed in units and the early theory of wireless, expressions such as these are apt to be a little confusing, and it is, therefore, better to try and secure a physical conception of what is actually happening when the receiving aerial is affected by the broadcast station's transmitted signals. The actual modulating currents in the transmitting aerial array have the effect of producing electromagnetic waves which are radiated into space on somewhat analogous lines to the disturbance on a pond's surface when a pebble is thrown in. Whereas in the case of the pond we are only concerned with the result of a single impact, in the case of the transmitting aerial, since the modulating currents are maintained, there is a continuous radiated wave whose amplitude is modulated. This wave is really an electric field which, if evident to the eye, would show as lines of force like those produced by sprinkling iron filings on a paper covering a bar magnet.

Volts per Metre

WHEN these lines of force in their passage through space are made to cut across a conductor, a voltage or potential difference is introduced and the magnitude of this naturally depends on the strength of the field at that point. Hence we find the field strength expressed as so many microvolts or millivolts, and the ease with which a radio set responds to this induced voltage is, therefore, referred to as the sensitivity. In many cases, however, the electrostatic field strength is expressed as so many volts per metre or a sub-multiple of this. At the point of reception it is assumed that the field strength is uniform, and by the use of mathematics it can be proved that field strength can be expressed as the rate of change of potential difference

along a line of flux. This leads to the practical unit of field strength, the volt per cm., that is to say, the field strength is such that the potential difference between two points one cm. apart on a line of flux is one volt. Now since one electrostatic unit of potential difference is 300 volts we have the expression that one E.S.U. of field strength is the same as 300 volts per cm. As readers will know the electrostatic field strength at a receiving aerial is generally quoted as a sub-multiple of this unit, that is, millivolts per metre or microvolts per metre, and although the foregoing explanation is rather brief since the mathematical proofs have been omitted, it will no doubt enable the problem to be somewhat better understood.

Experimental Equipment

AS usual, Thermion, in a recent issue, hit the nail on the head when he spoke of fresh fields for the experimenter to conquer and drew attention to the possibility of building up a closed circuit

out in their respective positions for easy adjustment, and it will be noted that two cathode-ray tubes of 7in. diameter are employed. That on the left is for producing the scanning field which acts in reality as a light-spot scanner. Immediately to the right of this is the case containing a single photo-electric cell and amplifier, resistance capacity coupled and capable of giving a satisfactory frequency response up to the limit of definition for which the apparatus is designed. The full scanning field of this cathode-ray tube is focused by means of the lens on to a strip of ordinary 35 mm. talking film. The variations of light passing through this film negative during the rapid movement of the point of fluorescence on the screen are made to activate the cathode surface of a simple photo-electric cell. The resulting fluctuating current produced is then amplified and fed directly to the modulator electrode of the receiving tube seen mounted on the wooden stand to the right of the illustration.

Avoiding Synchronising Difficulties

IN the case of the apparatus illustrated the two tubes were operated electrostatically both for focusing and deflection, but the same or even better results can be secured with C.R. tubes functioning electromagnetically. By working in a closed circuit all the synchronising difficulties are eliminated, for the deflecting currents of both tubes are derived from a common time-base generator, seen on the extreme right of the table. Picture width, picture height, frame speed and line speed are all adjustable, so that the frame speed at which observable flicker vanishes can be

The separate units of a closed circuit television transmitter and receiver laid out to permit easy adjustment.

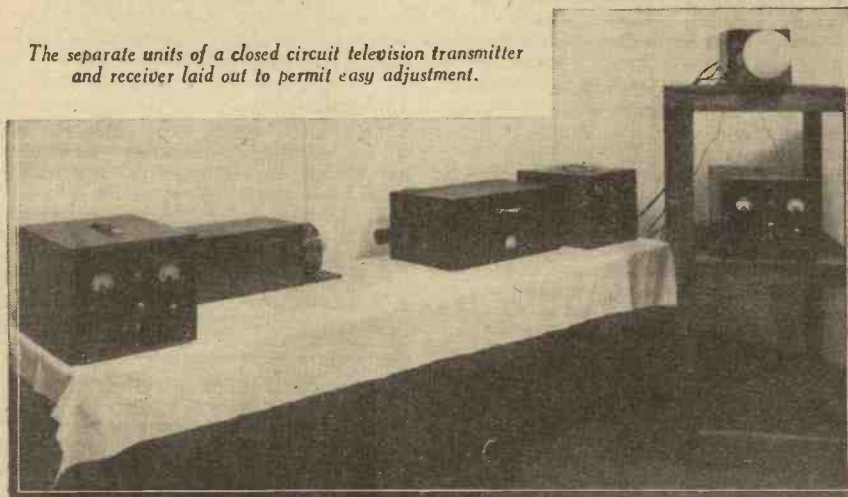

transmitter and receiver for television work. Apparatus of this nature is of inestimable value for understanding the principles of television, and can be demonstrated to show exactly how a cathode-ray tube works, what the process of scanning entails, and finally build up pictures on the tube screen of visual transparencies or the shadow outlines of solid objects. Equipment of this type has been used on many occasions at technical colleges when the curriculum embraces the subject of television, and as an example of actual practical apparatus and as a guide to the experimenter who is seriously thinking of using his spare time to indulge in this hobby, reference should be made to the accompanying illustration which portrays apparatus built up for this purpose. As may be seen in the picture the various separate units of the complete ensemble are laid

determined and the dependence of this factor on picture brightness noted. Then, again, by interposing switches, the building up of a picture from a stationary unmodulated spot can be demonstrated by closing the line and frame circuits in turn and then combining them. On introducing a transparency, a modulating signal is produced and the picture observed on the receiver screen. It is also instructive to vary the number of scanning lines per picture and so trace the improvement in definition as the lines increase. The only other units that have to be built up are the appropriate power packs for the tubes, time-base generator and amplifier, and by using multi-pin plugs and sockets with interconnecting leads of appropriate length, the whole apparatus can be set up in a short space of time, and in separate rooms if desired.

Open to Discussion

The Editor does not necessarily agree with the opinions expressed by his correspondents. All letters must be accompanied by the name and address of the sender (not necessarily for publication).

Home Recording

SIR,—I noticed with interest a letter published in the October 28th issue from Mr. Hebron (Manchester), in which he suggests articles on home recording.

Although my pet hobby is wireless, I am also very keen on cinematography, and have often seriously considered using home recording for use in conjunction with the films I make. At the moment, however, ignorance of that subject deters me from "taking the plunge," so that I, for another, would be glad to see a good instructional article, or articles, appear in my favourite weekly dealing with sound on disc.—**J. W. JACKSON** (Worcester).

SIR,—I have read the letter from Mr. Hebron in the issue dated October 28th and I, too, would appreciate a series of articles on home recording. I consider the series should be on the following lines:

First Article: Home recording with entirely home-made apparatus. How to convert pick-up into cutting-head.

Second Article: Types of suitable amplifiers, for mains and battery operation. Power output required.

Third Article: Home recording with commercial apparatus. Difficulties and points to watch for in home recording.

Perhaps other readers will have different ideas on the subject.—**J. B. RUDKIN** (Bebington).

Quality Reproduction: Correspondent Wanted

SIR,—I have been a reader of PRACTICAL WIRELESS for years, and I think it deserves the position it holds in the radio world, because it caters for the humble, as well as the well-off "ham." I think the new cover is a definite improvement.

Could we have a series of articles on "Quality" reproduction, or an article on "Radio in Other Lands"? I mean the kind of sets that other people use, and the transmitters in use in radio clubs.

And, finally, I would like to get in touch with a reader on the subject of quality reproduction of gramophone records.—**D. BRAINES**, 1, Sidney Crescent, Ashford, Middx.

Radio Signal Survey League

SIR,—May I inform readers who are interested in short-wave work that particulars of joining the Radio Signal Survey League may be obtained by sending their name and address to the undersigned. I will also gladly exchange my card with anybody.—**A. V. OGLESBY**, 81, Stockton Lane, York.

Proposed Club for Parham, Suffolk

SIR,—I am starting a club for short-wave fans, like myself. I am calling it "The British Short-Wave Correspondent Club," and I would be very pleased if readers who would like to join would write to me for details enclosing a stamp for a membership form. Membership is free, and the club is also open to short-wave

fans abroad.—**N. E. Hodgson**, Silverlace Green, Parham, Woodbridge, Suffolk.

Exchanging S.W.L. Cards

SIR,—I should like to exchange my S.W.L. card with hams throughout the world, and will also be pleased to exchange correspondence with YL's anywhere. S.W.L.'s wishing to exchange cards with Norman E. Whiton, of Greenwood, Mass., U.S.A., may send their cards via me; these will be replied to as soon as I receive another batch from him. Wishing your fine paper every success.—**ARTHUR F. WALTON**, 212, Intake Road, Fagley, Bradford, Yorks, England.

SIR,—I should be glad to exchange my A.A. card with any S.W.L., A.A., or G., and will Q.S.L. 100 per cent.

I also enclose my 14 mc/s log of stations received between the hours of 7 and 11 p.m., October 8th to October 12th. Fone.

WIADM, IDQ, DIC, NU, BIC; W2DH, IKV, ITD; W3DOZ; W4DSY; W9FNH, NMH; W8OKU; YV5AK, 5ABE; EK1AF, ES5D.

CW: W3GQG, YR5EF, HA3L.

I would also like to correspond with anyone interested in short-wave beam antennae.—**R. Nugent**, Field House, Windmill Hill, Nr. Hailsham, Sussex.

10-Metre Logs

SIR,—With the 10-metre amateur band opening up again, some very interesting DX is to be heard, and conditions seem to be quite favourable.

Prize Problems

PROBLEM No. 373.

ROGERS made up a four-valve battery set from spare parts and when the wiring had been checked he connected it to his nominal aerial and earth system and switched on. Signals came in at once, but he could only get the local station accompanied by very severe distortion. After one or two tests he connected a short length of wire to the aerial terminal in place of the ordinary aerial and then signals were clear and undistorted. What did this indicate? Three books will be awarded for the first three correct solutions opened. Entries must be addressed to The Editor, PRACTICAL WIRELESS, Geo. Newnes Ltd., Tower House, Southampton Street, Strand, London, W.C.2. Envelopes must be marked Problem No. 373 in the top left-hand corner and must be posted to reach this office not later than the first post on Monday, November 13th, 1939.

Solution to Problem No. 372.

The speaker which Smithers purchased was of the low-resistance type, that is, it had only a speech coil of low resistance and no input transformer. Accordingly he should have obtained an output transformer in order to use it in his set. The dealer knew this and connected it to the low-resistance output sockets on his test receiver.

The following three readers successfully solved Problem No. 371 and books have accordingly been forwarded to them: **J. Hardaway**, 48B, Ordnance Street, Chatham, Kent; **M. East**, 23, Eversholt Street, Euston, N.W.1; **W. C. Young**, 432, Emmadale Road, Weymouth, Dorset.

The difficulty, in the present situation, seems to lie in comparing logs with other S.W.L.'s, which is always interesting and helpful, but practically impossible at the moment.

In order to get over this obstacle, I am willing, if sufficient interest is shown, to collect together all 10-metre logs sent to me and re-issue them in the form of a leaflet giving details of all the best DX heard on that band. B.L.D.L.C. and B.W.S.L. members are especially invited to co-operate, but all keen S.W.L.'s may be sure that their help will be appreciated.

Logs should be accompanied by details of the receiver in use, antennae, and any interesting U.S.W. news, together with a stamped addressed envelope.—**L. Singletary**, Boyces Lane, Wisbech, Cambs.

Gramo. Amplifier for D.C. Mains

SIR,—I would like to get in touch with any reader who has constructed a gramophone amplifier for D.C. mains. That is, the motor pick-up, amplifier and loudspeaker in one cabinet, as apart from a radiogram. Perhaps a reader living in a district now gone over to A.C. may have one for disposal.—**C. A. WOAD**, 160A, London Road, Northwich.

A SIMPLIFIED ELECTRON MULTIPLIER

(Continued from page 172.)

Dealing with Large Output

If the quantity of light available is fairly great but, in spite of this, advantage can be derived from secondary emission multiplication, the electrostatic multiplier of Fig. 3 affords a convenient means of obtaining large output currents. The design is a modified version of the curved plate type of electron multiplier described by Zworykin (Zworykin and Rajchman, Electronics, July, 1938, page 12). The cathode C is similar to that of the single stage multiplier of Fig. 2. and is arranged as shown in relation to the other electrodes. Electrons from the photo-electrically active surface of the cathode are drawn off by the field of the first multiplying plate P₁, and travel along the paths indicated. They impinge on a secondary emitting gauze G which forms part of the first curved plate. The stream of secondary electrons from the gauze is accelerated towards electrode P₂ and there liberates further secondaries which move towards electrode P₃ and so on. Any number of multiplying stages can be used. An output electrode E collects the current from the last multiplying stage. This electrode E and the flap F on the first multiplying plate are so shaped that the field in the space between the curved plates is the same as that which would be produced by an infinitely long series of plates similar to P₁, P₂ and P₃. The voltages applied to the electrodes are as follows:—

Cathode—0 volts, P₁—V volts, P₂—2v volts, etc.

V can be conveniently fixed at some value between 150 and 300 volts. If Ag-Ag, Cs₂O—Cs layers are used as secondary emitters a multiplication at 300 volts of about 2 can be obtained at the gauze if this has about 67 per cent. interception of the primary electrons from the cathode. The succeeding stages can be made practically 100 per cent. efficient so that gains of 7 per stage at 300 volts per stage are easily achieved. Thus, a four-stage multiplier of this type might have an overall multiplication of about

$$2 \times 7^3 (=700) \text{ times.}$$

In reply to your letter

Two-valve B.F.O. Unit

"Could the B.F.O. described in current issues be used as a wavemeter? I also query the connection from one end of coil 1 to grid condenser C4, which does not appear to be shown in the wiring diagram."—R. H. (Rowlands Castle).

THE apparatus in question has quite a number of other uses and we shall shortly publish a supplementary article covering some of the uses to which it may be put. We regret the omission of the lead in question, but if you wire from the theoretical circuit given in issue dated October 21st you will find everything in order. As you will appreciate, the wiring is rather complicated to show clearly in view of the unusual construction of this piece of apparatus.

Making H.T. Batteries

"I wonder if you can tell me how to make up H.T. batteries at home? I believe there is a firm who sell the parts and give instructions for making these units—at least, I remember seeing their advertisement in one of the papers."—L. D. (Hove) and others.

THE firm you refer to is no longer in business, and we are unable to trace any other firm carrying on this type of business. The making of H.T. batteries is not an economical proposition as the cost of the separate chemicals—especially now that there is a war on—will result in the batteries costing much more than the commercial product. The wet type of H.T. battery also appears to have disappeared from the market and the small jars and other parts are no longer available.

Taking up Servicing

"Could you please advise me as to the best way that I could learn to test and overhaul wireless sets, tracing faults and testing valves? I have a slight knowledge of electricity."—J. A. (Gosport).

WE would suggest that you carry out as much practical work as possible and augment the experience thus gained by a careful perusal of our latest handbook, the "Practical Wireless Service Manual," in which are many valuable service hints. It would also be advisable to get in touch with your local Technical Institute and see if they are offering courses connected with such work, as it is always advisable to combine practical and technical experience.

Quality Reproduction

"I have been reading the article on the above subject as a preliminary to choosing my output stage. Unfortunately, I do not see any reference to the output tetrode or beam-power tetrode. Before I decide on one of these could you give me a rough idea as to how the reproduction compares with the triode and pentode?"—A. C. (Hale).

THE tetrode may be regarded much in the same light as a pentode, and valve-makers can supply full technical details concerning output, loading, etc. We shall publish another article shortly on the subject in which features of the tetrode are described.

Mains Transformers

"Can any type of mains transformer be used on D.C. mains for any purpose, i.e. bells, wireless, models, etc.? If they can, why are they not used on A.C./D.C. sets? Your answer will settle an argument. I am building a three-valve A.C. set with a D.H. rectifier, and the set valves are I.H. Which is the best way to switch on?"—H. A. W. (Tottenham).

ON no account should mains transformers be used on D.C. supplies, as they are not suitable for such mains and will only result in a short-circuit across the mains supply. With regard to your switching problem, we suggest that you arrange the

RULES

We wish to draw the reader's attention to the fact that the Queries Service is intended only for the solution of problems or difficulties arising from the construction of receivers described in our pages, from articles appearing in our pages, or on general wireless matters. We regret that we cannot, for obvious reasons—

- (1) Supply circuit diagrams of complete multi-valve receivers.
- (2) Suggest alterations or modifications of receivers described in our contemporaries.
- (3) Suggest alterations or modifications to commercial receivers.
- (4) Answer queries over the telephone.
- (5) Grant interviews to querists.

A stamped addressed envelope must be enclosed for the reply. All sketches and drawings which are sent to us should bear the name and address of the sender.

Requests for Blueprints must not be enclosed with queries as they are dealt with by a separate department.

Send your queries to the Editor, PRACTICAL WIRELESS, George Newnes, Ltd., Tower House, Southampton Street, Strand, London, W.C.2. The Coupon must be enclosed with every query.

switching so that the heaters of all valves, including the rectifier, are brought into circuit first and then, when they have had time to warm up, use another switch to complete the H.T. circuit from the rectifier to the receiver.

Eliminator Tests

"I have an H.T. eliminator the tapings of which are marked Neg., S.G., 80 and 120-150. On testing them I find the following: Neg., S.G. and 80 both about 25 volts and the 120-150 about 75 volts. On opening it and trying the rectifier I find only 75 volts there. I tried different adjustments on the mains panel but they had no effect. Could you please tell me where the fault is and if I could put it right?"—A. H. P. (Broughton-in-Furness).

THE low readings you obtain when measuring the output of the eliminator are no doubt entirely due to the use of a low-resistance voltmeter. Therefore, if it is possible for you to employ a good make of voltmeter having a high internal resistance, you will no doubt find that the tapings are approximately the voltage specified by the makers.

The coupon on page iii of cover must be attached to every query.

ARMSTRONG

apologise for delay in delivery of some models. This has been unavoidable owing to the difficulty in obtaining materials. However, customers may rest assured that we are doing our utmost to expedite all outstanding orders. In these difficult times we shall be grateful if customers will allow us as much notice as possible when ordering.

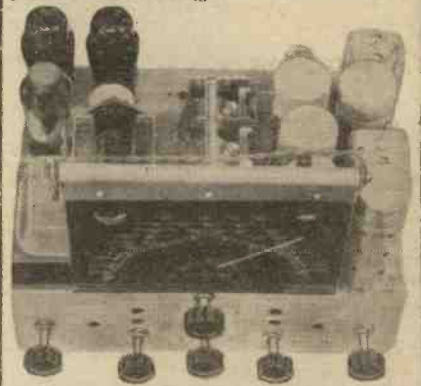

MODEL SS10
"SUPERHET-STRAIGHT" 10-valve High Fidelity Radiogram chassis. All-wave, incorporating 2 independent circuits, Superheterodyne and Straight, having R.F. pre-amplifier, R.C. coupled push-pull Triode output capable of handling 8 watts.

PRICE £12 : 12 : 0

MODEL AW38 8-valve All-wave Superheterodyne chassis. This All-wave Radiogram chassis has resistance capacity coupled push-pull output capable of handling 8 watts, and gives good quality reproduction on both radio and gramophone, for an economical price of 8 gns.

Armstrong Push-pull Speaker to match AW38 Chassis, £1 : 1 : 0.
We suggest Model AW38 together with matched speaker at £9 : 9 : 0 complete, represents the most outstanding value on the market to-day.

ILLUSTRATED ART CATALOGUE ON REQUEST
ALL CHASSIS SENT ON 7 DAYS' APPROVAL
ARMSTRONG MANFG. CO.
WALTERS ROAD, HOLLOWAY, LONDON, N.7.
(Adjoining Holloway Arcade)
Phone NORTH 3213

L.R.S

intend carrying on the good work of supplying Quality Radio Equipment.

ARMSTRONG CHASSIS

PORTABLE A.R.P. RECEIVERS and other reliable radio apparatus are available as usual on our very CONVENIENT TERMS.

Write for quotation and full details.

PLEASE NOTE OUR TEMPORARY ADDRESS
LONDON RADIO SUPPLY COMPANY
"DEN WYN," OXENDEN WOOD RD., CHELSFIELD, KENT

This book will keep you cheerful for hours!

WRITTEN FOR FUN

By LEONARD CROCOMBE

Chockful of the 'most hilarious jokes ever put together in one volume. The author, an acknowledged expert, has searched the world for jokes, and has selected here 600 of the best.

3/6 From all Booksellers, or by post 3/10 from the Publishers

GEORGE NEWNES, LTD.
(Book Dept.),
TOWER HOUSE, SOUTHAMPTON ST., LONDON, W.C.2

Practical Wireless BLUEPRINT SERVICE

PRACTICAL WIRELESS Date of Issue.	No. of Blueprint.	Universal Hall-Mark (HF Pen, D, Push-Pull)	
1937 Crystal Receiver	PW71	—	PW47
The "Junior" Crystal Set	PW94	6.11.37	PW81
CRYSTAL SETS.			
STRAIGHT SETS. Battery Operated.			
One-valve: Blueprints, 1s. each.			
All-Wave Unipen (Pentode)	—	PW31A	
Beginners' One-valver	19.2.33	PW95	
The "Pyramid" One-valver (HF Pen)	27.8.33	PW93	
Two-valve: Blueprints, 1s. each.			
Four-range Super Mag Two (D, Pen)	—	PW36B	
The Signet Two (D & LF)	24.9.33	PW76	
Three-valve: Blueprints, 1s. each.			
Selectone Battery Three (D, 2 LF (Trans))	—	PW10	
Sixty Shilling Three (D, 2 LF (RC & Trans))	—	PW34A	
Leader Three (SG, D, Pow)	22.5.37	PW35	
Summit Three (HF Pen, D, Pen)	—	PW37	
All Pentode Three (HF Pen, D (Pen), Pen)	29.5.37	PW39	
Hall-Mark Three (SG, D, Pow)	12.6.37	PW41	
Hall-Mark Cadet (D, LF, Pen (RC))	16.3.35	PW48	
F. J. Camm's Silver Souvenir (HF Pen, D (Pen), Pen) (All-Wave Three)	13.4.35	PW49	
Cameo Midget Three (D, 2 LF (Trans))	—	PW51	
1936 Sonotone Three-Four (HF Pen, HF Pen, Westector, Pen)	—	PW53	
Battery All-Wave Three (D, 2 LF (RC))	—	PW55	
The Monitor (HF Pen, D, Pen)	—	PW61	
The Tutor Three (HF Pen, D, Pen)	21.3.36	PW62	
The Centaur Three (SG, D, P)	14.8.37	PW64	
F. J. Camm's Record All-Wave Three (HF Pen, D, Pen)	31.10.36	PW69	
The "Colt" All-Wave Three (D, 2 LF (RC & Trans))	18.2.39	PW72	
The "Rapide" Straight 3 (D, 2 LF (RC & Trans))	14.2.37	PW82	
F. J. Camm's Oracle All-Wave Three (HF, Det., Pen)	28.8.37	PW78	
1938 "Triband" All-Wave Three (HF Pen, D, Pen)	22.1.33	PW84	
F. J. Camm's "Sprite" Three (HF Pen, D, Tet)	26.3.33	PW87	
The "Hurricane" All-Wave Three (SG, D (Pen), Pen)	30.4.33	PW89	
F. J. Camm's "Push-Button" Three (HF Pen, D (Pen), Tet)	3.9.33	PW92	
Four-valve: Blueprints, 1s. each.			
Sonotone Four (SG, D, LF, P)	1.5.37	PW4	
Fury Four (2 SG, D, Pen)	8.5.37	PW11	
Beta Universal Four (SG, D, LF, Cl. B)	—	PW17	
Nucleon Class B Four (SG, D (SG), LF, Cl. B)	—	PW34B	
Fury Four Super (SG, SG, D, Pen)	—	PW34C	
Battery Hall-Mark 4 (HF Pen, D, Push-Pull)	—	PW46	
F. J. Camm's "Limit" All-Wave Four (HF Pen, D, LF, P)	26.9.36	PW67	
All-Wave "Corona" 4 (HF, Pen, D, LF, Pow)	9.10.37	PW79	
"Acme" All-Wave 4 (HF Pen, D (Pen), LF, Cl. B)	12.2.38	PW83	
The "Admiral" Four (HF Pen, HF Pen, D, Pen (RC))	3.9.33	PW90	
Mains Operated.			
Two-valve: Blueprints, 1s. each.			
A.C. Twin (D (Pen), Pen)	—	PW18	
A.C.-D.C. Two (SG, Pow)	—	PW31	
Selectone A.C. Radiogram Two (D, Pow)	—	PW19	
Three-valve: Blueprints, 1s. each.			
Double-Diode-Triode Three (HF Pen DDT, Pen)	—	PW23	
D.C. Ace (SG, D, Pen)	—	PW25	
A.C. Three (SG, D, Pen)	—	PW29	
A.C. Leader (HF Pen, D, Pow)	7.1.39	PW35C	
D.C. Premier (HF Pen, D, Pen)	—	PW35B	
Ubique (HF Pen, D, Pen), Pen)	28.7.34	PW36A	
Armada Mains Three (HF Pen, D, Pen)	—	PW38	
F. J. Camm's A.C. All-Wave Silver Souvenir Three (HF Pen, D)	11.5.35	PW50	
"All-Wave" A.C. Three (D, 2 LF (RC))	—	PW54	
A.C. 1936 Sonotone (HF Pen, HF Pen, Westector, Pen)	—	PW56	
Mains Record All-Wave 3 (HF Pen, D, Pen)	—	PW70	
All-World Ace (HF Pen, D, Pen)	28.8.37	PW80	
Four-valve: Blueprints, 1s. each.			
A.C. Fury Four (SG, SG, D, Pen)	—	PW20	
A.C. Fury Four Super (SG, SG, D, Pen)	—	PW34D	
A.C. Hall-Mark (HF Pen, D, Push-Pull)	24.7.37	PW45	
Universal Hall-Mark (HF Pen, D, Push-Pull)			
A.C. All-Wave Corona Four	6.11.37		PW81
SUPERHETS.			
Battery Sets: Blueprints, 1s. each.			
£5 Superhet (Three-valve)	5.6.37	PW40	
F. J. Camm's 2-valve Superhet	—	PW52	
F. J. Camm's "Vitesse" All-Waver (5-valver)	27.2.37	PW75	
Mains Sets: Blueprints, 1s. each.			
A.C. £5 Superhet (Three-valve)	—	PW43	
D.C. £5 Superhet (Three-valve)	1.12.34	PW42	
Universal £5 Superhet (Three-valve)	—	PW44	
F. J. Camm's A.C. £4 Superhet 4	31.7.37	PW59	
F. J. Camm's Universal £4 Superhet 4	—	PW60	
"Qualitone" Universal Four	16.1.37	PW73	
Four-valve: Double-sided Blueprint, 1s. 6d.			
Push-Button 4, Battery Model	—		PW95
Push-Button 4, A.C. Mains Model	22.10.38		PW95
SHORT-WAVE SETS. (Battery Operated.)			
One-valve: Blueprint, 1s.			
Simple S.W. One-valver	9.4.38	PW88	
Two-valve: Blueprints, 1s. each.			
Midget Short-wave Two (D, Pen)	—	PW38A	
The "Fleet" Short-wave Two (D (HF Pen), Pen)	27.8.38	PW91	
Three-valve: Blueprints, 1s. each.			
Experimenter's Short-wave Three (SG, D, Pow)	30.7.38	PW30A	
The Prefect 3 (D, 2 LF (RC and Trans))	—	PW63	
The Band-Spread S.W. Three (HF Pen, D (Pen), Pen)	1.10.38	PW68	
PORTABLES.			
Three-valve: Blueprints, 1s. each.			
F. J. Camm's ELF Three-valve Portable (HF Pen, D, Pen)	—	PW65	

These Blueprints are drawn full size. Copies of appropriate issues containing descriptions of these sets can in some cases be supplied at the following prices, which are additional to the cost of the Blueprint. A dash before the Blueprint Number indicates that the issue is out of print.

Issues of Practical Wireless ... 4d. Post Paid
 Amateur Wireless ... 4d. " "
 Wireless Magazine ... 1/3 " "
 The Index letters which precede the Blueprint Number indicate the periodical in which the description appears: Thus P.W. refers to PRACTICAL WIRELESS, A.W. to Amateur Wireless, W.M. to Wireless Magazine.

Send (preferably) a postal order to cover the cost of the blueprint and the issue (stamps over 6d. unacceptable) to PRACTICAL WIRELESS Blueprint Dept., George Newnes, Ltd., Tower House, Southampton Street, Strand, W.C.2.

Parvo Flyweight Midget Portable (SG, D, Pen)	3.8.39	PW77
Four-valve: Blueprint, 1s.		
"Imp." Portable 4 (D, LF, LF, (Pen))	19.3.33	PW86
MISCELLANEOUS.		
S.W. Converter-Adapter (1 valve)	—	PW48A
AMATEUR WIRELESS AND WIRELESS MAGAZINE		
CRYSTAL SETS.		
Blueprints, 6d. each.		
Four-station Crystal Set	23.7.33	AW427
1934 Crystal Set	—	AW444
150-mile Crystal Set	—	AW450

STRAIGHT SETS. Battery Operated		
One-valve: Blueprint, 1s.		
B.B.C. Special One-valver	—	AW387
Two-valve: Blueprints, 1s. each.		
Melody Ranger Two (D, Trans)	—	AW388
Full-volume Two (SG det, Pen)	—	AW392
Lucerne Minor (D, Pen)	—	AW426
A Modern Two-valver	—	WM409
Three-valve: Blueprints, 1s. each.		
Class B Three (D, Trans, Class B)	—	AW386
£5 Ss. S.G. 3 (SG, D, Trans)	2.12.33	AW412
Lucerne Ranger (SG, D, Trans)	—	AW422
£5 Ss. Three: De Luxe Version (SG, D, Trans)	19.5.34	AW435
Lucerne Straight Three (D, RC, Trans)	—	AW437
Transportable Three (SG, D, Pen)	—	WM271
Simple-Tune Three (SG, D, Pen)	June '33	WM327
Economy-Pentode Three (SG, D, Pen)	Oct. '33	WM337
"W.M." 1934 Standard Three (SG, D, Pen)	—	WM351
£3 Ss. Three (SG, D, Trans)	Mar. '34	WM354
1935 £6 Gs. Battery Three (SG, D, Pen)	—	WM371
PTP Three (Pen, D, Pen)	—	WM389
Certainty Three (SG, D, Pen)	—	WM393
Minutube Three (SG, D, Trans)	Oct. '35	WM396
All-Wave Winning Three (SG, D, Pen)	—	WM400

RECEIVERS, COMPONENTS AND ACCESSORIES

SOUTHERN RADIO'S Bargains.

ALL Articles Fully Guaranteed. Postage extra.

5/-—Parcel of useful components, comprising condensers, resistances, volume controls, coils, wire, circuits, etc., etc., value 25/-. 5/- per parcel.

10/-—Parcel of useful components, comprising 100 articles, including electrolytics, valveholders, etc., etc., value 55/-. 10/- per parcel.

15/-—Service man's component kit. Comprising electrolytic condensers, volume controls, tubular condensers, resistances, valveholders, wire, mica and Mainsbridge condensers, etc., etc. 120 articles contained in strong carrying case 9" x 7" x 7", value 65/-. 15/- the complete kit.

21/-—Small traders' parcel of components, comprising at least 150 articles, including 24 assorted tubular condensers, 24 valveholders, 36 resistances, 12 Mainsbridge type condensers, 6 electrolytics, etc., etc., value 85/-. 21/- per parcel.

5/-—Twelve Mainsbridge type condensers, 1-2-4 mfd.; 5/- per dozen.

7/6—24 assorted tubular condensers, up to 2 mfd., 7/6 for 24; Telsen 3-range meters (volts and milliamperes), 4/-; Morse tappers, 2/11.

BUZZERS, 1/6; crystal detectors, 2/-; crystal sets, 5/6; crystals, 6d.

2/6—Ormond loudspeaker units, 2/6; A.C. eliminators, with trickle charger, 3/76.

SOUTHERN RADIO, 46, Jisle Street, London, S.W.C. Gerrard 6653.

HEADPHONES. Reconditioned and guaranteed. Brown, G.E.C., B.T.H., Sterling, Nesper, Brunet, Western Electric, Siemens, Brandes, 4,000 ohms, 5/- pair. Telefunken, lightweight, adjustable, 4,000 ohms, 7/6.

CRYSTAL with silver cat's-whisker, 6d. Complete detector parts, 1/-. Glass tube detector on ebonite base, 1/6. Sensitive permanent detector, 1/6. Postage 1d.—Post Radio Supplies, 328, Upper Street, London, N.1.

BANKRUPT BARGAINS. Twelve-valve A.C./D.C. push-pull superhets, 9 gns. Also A.C. 10-valve. Regentone 6v. A.C./D.C. all-wave transportables, £6/17/6. Decca A.C./D.C. superhet 2-band transportables, 1940, £6/5/-. Crosley 1939 10v. A.C./D.C. 4-band push-pull superhet, £7/10/-. Portadyne 1940 4 battery superhet portables, £6/10/-. Truphone 1939, 10½ gns. A.C./D.C. all-wave 5v., 8 gns. Components, valves, all at keenest prices. State requirements for quotation. All new goods.—Butlin, 6, Stanford Avenue, Brighton.

VAUXHALL. Rola 8in. P.M. speakers, 14s. 9d.; Magnavox 6½in. P.M., 10s. 6d. complete with input transformers.

VAUXHALL. Collaro A.C. gramophone motors, boxed, 29s. Flat sheet aluminium, 12in. by 12in., 3s.; 12in. x 18in., 4s.

VAUXHALL. TCC aluminium containers, 8 mfd., 500 v., 2s. 9d.; TCC cardboard containers, 8 mfd., 600 v., 2s.; 8 and 8 mfd., 3s. 6d.

VAUXHALL. Volume controls, 2s.; with switch, 3s. Tubular condensers, 0.1 mfd., 3d.; 0.25 mfd., 4d. Resistors, 1 watt, 4d.

VAUXHALL UTILITIES. 163a. Strand, London, W.C.2. Post paid over 2s. 6d. Write for free list.

CONVERSION UNITS for operating D.C. Receivers from A.C. Mains, 100 watts output, £2/10/0.—150-watt Model for operating Radiogramophones, £3/10/0. Send for lists.—Chas. F. Ward, 46, Farringdon Street, London, E.C.4. Tel: Holborn 9703.

LOUDSPEAKER REPAIRS

LOUNDSPEAKER repairs, British, American, any make. 24-hour service, moderate prices.—Sinclair Speakers, Putney Terrace, Copenhagen Street, London, N.1.

L.S. REPAIR AND REWINDING SERVICE: 24-hour service. See below.

REPAIRS to moving coil speakers a speciality. New cone assemblies fitted. Speech coils and fields wound or altered. Mains transformers, chokes, eliminators and vacuum repaired, prices quoted. Speaker transformers, Class "B" L.F. transformers and pick ups rewound at 4s. each, Post free. Discount trade. Estimates free. Guaranteed satisfaction.

L.S. Repair Service, 5, Balham Grove, London, S.W.12. Phone: Battersea 1321.

CABINETS

ACABINET for Every Radio Purpose.

CONVERT Your Set into a Radiogram at Minimum Cost; surplus cabinets from noted makers under cost of manufacture (undrilled), 30/- upwards; motors at wholesale price.

UNDRILLED table, console and loudspeaker cabinets from 4/6.

INSPECTION Invited: photos loaned to country customers.

H. I. SMITH and Co., Ltd., 289, Edgware Road, W.2. Tel.: Pad. 5891.

Practical Wireless

★ PRACTICAL TELEVISION ★

EVERY WEDNESDAY

Vol. XV. No. 374. Nov. 18th, 1939.

EDITED BY
F. J. C. AMM

Staff:

W. J. DELANEY, FRANK PRESTON,
H. J. BARTON CHAPPLÉ, B.Sc.

ROUND THE WORLD OF WIRELESS

Repairing Loudspeakers

A LOUDSPEAKER is a delicate piece of apparatus, and should be used with care, but in spite of this it may become damaged, due either to overload or some accident. A badly repaired speaker will give bad results, evident either by distorted signals or by noise due to a speech coil rubbing the sides of the air gap. It may even give good results but at greatly reduced strength. Fortunately, it is not a difficult matter to repair a speaker quite satisfactorily if proper steps are taken and the work is undertaken in a workman-like manner. Special gauges are available for centring a speech coil, and spare cones may be purchased or made up. The texture of the cone will of course, affect the tone of reproduction, and this is one interesting field of research for those who are anxious to adopt some line of experiment which is both simple and interesting. The transformer which is associated with the speaker may also be regarded as part of the speaker, and should be treated accordingly. An interesting article on this subject will be found on page 195.

Relay Difficulties

ALTHOUGH the Government have stated that all relay licences will expire in December, 1939, an offensive against relays has been started by Nottingham retailers, and Cardiff, Cheltenham and Chesterfield are considering relay applications. Eastbourne has already turned down relay working.

Television Loss

DUE to the suspension of the television broadcasts, the loss to industry is stated to be approaching £1,250,000. About 22,000 receivers were in use worth over £750,000. It is estimated that retailers have £70,000 worth of receivers on their hands, assuming each retailer only has one such set. Over 15,000 receivers were in stages of assembly and are accordingly "wasted."

The Geography of the War

PROFESSOR A. G. OGILVIE, of Edinburgh University, who is broadcasting to schools every week the Senior Geography lessons on the geography of the war, reaches on November 16th an

A tale of heroism in the wastes of Northern Canada, it is aptly called "Unflinching." It has been devised by Betty Dew Roberts and will be produced by T. Rowland Hughes.

A Modern Morality Play

D. G. BRIDSON'S reputation as a poet is already considerable, but it will be greatly enhanced by the modern morality play, "Aaron's Field," which he has written for broadcasting on November 16th. It is the story in verse of a man who buys a small field in the country simply for the pleasure of owning an unspoiled corner of the land; only to find that the possession brings with it the unwelcome attentions of hosts of busybodies who wish to encroach



A terrific reception was accorded these well-known entertainers when they gave a free show to members of the Royal Air Force "somewhere in England." From left to right they are Stainless Stephen, Eve Beck, Eddie Pola, Rene Houston, Donald Stuart, Shirley Houston and Frank Baron.

important lesson when he begins to deal with the Western boundaries of Germany. On this day he is to describe Germany's boundary with France, where all the fighting is taking place between the Maginot and Siegfried Lines.

"Unflinching"

THE courage that allowed Captain Scott, on his expedition to the South Pole, to set down his experiences clearly and unemotionally while awaiting a lingering and lonely death, was almost equalled in 1927 by a boy of eighteen years. This story, not so well known, will be the subject of a broadcast on November 15th.

on his preserves. There is scope for some grand character-acting in the play, which is very amusing. The part of Aaron will be played by Ivor Barnard and others who will appear in the cast include Wilfred Pickles and Fred Fairclough.

"Mystery Under Hatches"

ANOTHER radio play from the pen of A. L. du Garde Peach is always pleasant news for followers of radio drama. In this new play, "Mystery Under Hatches," to be broadcast on November 18th, Mr. du Garde Peach has chosen an excellent theme for the creation of a mystery story—a South Sea voyage of a tramp steamer.

Editorial and Advertisement Offices:
"Practical Wireless," George Newnes, Ltd.,
Tower House, Southampton Street, Strand,
W.C.2. Phone: Temple Bar 4363.
Telegrams: Newnes, Rand, London.
Registered at the G.P.O. as a newspaper and
for transmission by Canadian Magazine Post.

The Editor will be pleased to consider articles of a practical nature suitable for publication in PRACTICAL WIRELESS. Such articles should be written on one side of the paper only, and should contain the name and address of the sender. Whilst the Editor does not hold himself responsible for manuscripts, every effort will be made to return them if a stamped and addressed envelope is enclosed. All correspondence intended for the Editor should be addressed: The Editor, PRACTICAL WIRELESS, George Newnes, Ltd., Tower House, Southampton Street, Strand, W.C.2.

Owing to the rapid progress in the design of wireless apparatus and to our efforts to keep our readers in touch with the latest developments, we give no warranty that apparatus described in our columns is not the subject of letters patent. Copyright in all drawings, photographs and articles published in PRACTICAL WIRELESS is specifically reserved throughout the countries signatory to the Berne Convention and the U.S.A. Reproductions or imitations of any of these are therefore expressly forbidden. PRACTICAL WIRELESS incorporates "Amateur Wireless."

D.C. HIGH-TENSION ELIMINATORS AND L.T. CHARGERS—3

Final Details Concerning the Design of H.T. Supplies are Given in this Article, Together with Information about Suitable Charging Circuits for D.C. By L. O. SPARKS

AS the third arrangement for voltage dropping, as shown at "C" in Fig. 3, page 151, is nothing more than a simple combination of the two preceding systems and, as these have been dealt with in detail, it is hardly necessary to work out actual examples. The formulæ given in the two previous articles can be applied to their appropriate calculations, and providing one remembers that the current is being expressed as milliamps, and that the voltage to be dropped is the difference between the maximum and the value required, no difficulties should be experienced.

The fundamental circuit of a D.C. eliminator, page 170, can be taken as depicting the general design of such units, but, whether the system of voltage dividing shown is embodied, or whether the other methods are used, will depend on the constructor and his requirements. Similarly, the smoothing arrangements, using two fixed condensers and one L.F. choke, is, in the majority of cases, quite satisfactory, but it is possible to come across mains supplies which are particularly troublesome as regards hum or ripple and in such instances it sometimes is necessary to increase the efficiency of the smoothing by including a similar L.F. choke in the negative side of the circuit. If this has to be done, the choke should be connected between the two fixed condensers in the same manner as the one in the positive line but, of course, in the negative lead.

In the previous calculations, the resistance of the choke was purposely ignored but, in practice, it must be appreciated that that component will produce a certain voltage drop so the value of that drop must be subtracted from the value of the supply mains before one can determine the exact maximum voltage available on the smoothed side of the eliminator.

This consideration makes it very necessary for one to select chokes having the lowest D.C. resistance, consistent with the inductance required, and an examination of various makers' catalogues will reveal that such values can vary widely.

Earth Connections

When using D.C. eliminators of receivers designed for use on such supplies, it is absolutely essential to avoid making direct connection between the common negative line of the apparatus and the actual earth. With battery or A.C. mains operated receivers, the common negative side of the circuit is always connected to the earth terminal, but with D.C. equipment one must not overlook the fact that, as direct electrical continuity is employed between the mains and the associated circuit and, as one side of the mains is always earthed on the supply side, a dead short-circuit could be produced if, as it does sometimes happen, the connecting plug was put in the wrong way round, assuming the negative side of the supply to be earthed or, if by chance the receiver is connected properly, but the positive side of the mains was earthed.

To avoid anything of this nature, and, incidentally, to eliminate the possibility of nasty shocks, it is only necessary to make the earth connection between the receiver or apparatus and earth through a fixed condenser, having a value of, say, .05 mfd. to .1 mfd. The connections are quite simple. One side of the condenser is connected to the earth terminal of the receiver and the other to the actual earth connection.

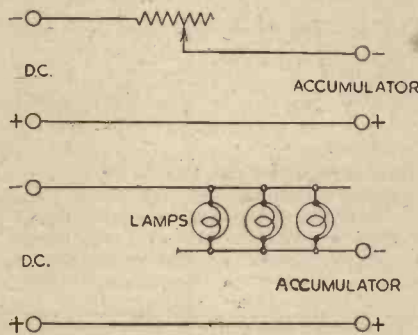

Fig. 4.—Two arrangements for limiting the current flowing in the accumulator circuit.

In actual practice, it is *always* advisable to include a small fixed condenser in the aerial lead as well, as aerials have been known to come down and make contact with the earth, and experimenters have already proved—quite fluently—that shocks can be received between the aerial and damp ground when using D.C. supplies.

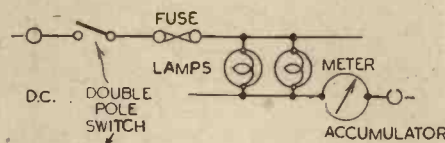

Fig. 5.—A complete circuit for a D.C. L.T. charger using lamps for current control.

L.T. Accumulator Charging

For L.T. charging purposes, D.C. mains offer very definite advantages when compared with A.C. supplies. They provide a ready-made source of direct current whose output is such that no limitations are imposed so far as current requirements are concerned, speaking, of course, of the average constructor's likely demands.

Unlike A.C. mains, no elaborate rectifiers are required; the charging capacity of

the equipment is not governed by the installation and consequently the whole system is more flexible and less costly.

When considering L.T. accumulator charging, the main essentials are a steady source of reasonably good D.C. voltage at a current which can be regulated by the cells to be charged or the charging rate required. Many constructors are under the impression that the value of the applied voltage is a vital item, and they endeavour to set up apparatus to reduce, say, the mains voltage to 2 volts, if a 2-volt cell is under consideration. This view is very misleading; what one is more concerned with, in actual practice, is the regulation of the current flowing in the charging circuit.

For example, supposing a cell having a charging rate of half an ampere has to be charged from D.C. mains having a voltage of 200 volts, if the circuit can be arranged with some form of resistance in series to limit the current to the required value, then that is all that is required.

Circuit Details

That statement is fundamentally correct but, as most general statements are, it is a little bald and therefore calls for a little elaboration. For instance, what type of resistance should be used; how does one check the current flowing and what safety precautions are necessary?

The resistance can be of the wire-wound type and have either a fixed or variable value or, on the other hand, it can take the form of ordinary mains-operated lamps, preferably of the carbon filament type.

The two arrangements are shown in Fig. 4, where it will be seen that the resistance is wired in series with one of the supply leads, whilst the lamps are connected in what is known as a series-parallel arrangement.

With the former, the resistance is varied until the correct current charging rate is reached; if the same current output is to be required always, then it would be permissible to use a fixed resistance, once the exact value has been determined. When the lamp system is employed, the charging rate can be controlled in definite steps, above a certain minimum value, by inserting more lamps in circuit which allows more current to flow in the circuit.

To determine the amount of current flowing, it is really essential to incorporate in the circuit an ammeter in series with one of the leads, as such will give a visual indication of what is happening and allow the number of hours required for a full charge to be calculated. When it is likely that the current output will be changed from time to time, it is practically essential for a meter to be used, and even with a fixed predetermined output, it is wise to make a meter check when the charger is first put into commission, just to prove that all is well.

A more complete charging circuit, using lamps, is shown in Fig. 5, and a table giving the current passed for various types of carbon-filament lamps is included on this page.

(Continued on page 203)

Carbon Filament. 200-250 volt.	Wattage.	Current Amps
8 candle power	36	.18 to .15
16 " " " " " " " " " "	66	.33 to .27
32 " " " " " " " " " "	136	.68 to .56
Other lamps' voltage according to supply :		
40 at 200 volts2
60 " 200 " " " " " " " " "		.3
75 " 200 " " " " " " " " "		.35
100 " 200 " " " " " " " " "		.5

PADDERS AND TRIMMERS

The Importance Of and the Difference Between the Two Methods of Obtaining Correct Oscillator Tracking in the Superhet. By W. J. DELANEY

PRACTICALLY every amateur knows that the superhet in the majority of cases makes use of a special type of ganged condensers, in which one section has plates of a special shape. They also know that this is known as the oscillator tracking section, but the reason for the special shape of the plates is not often understood. This type of condenser is, however, not essential in a superhet, and it is possible to make use of a standard type of ganged condenser in which all plates are of the same shape. If this is done, however,

from these figures that in the signal frequency stages there is a different ratio of change over the entire range, and thus it is essential to modify either the inductance or the condenser to obtain this desired ratio consistently through the medium waveband.

Inductance Values

It would appear at first sight, therefore, that by making the inductance smaller so that at minimum settings of a standard condenser the frequency is 1,950 we should be able to obtain the desired results, but in practice the maximum setting will give us 715 kc/s instead of 1,000. Therefore it is obvious that the range covered by the condenser must be restricted. It is for this purpose that the padders and trimmers are employed, and it should be remembered here that the trimmers are capacities included in parallel with the tuning condenser or coil, whilst the padders are series connected condensers. We have seen that the capacity range of the condenser must be restricted to obtain our desired 1,000 kc/s and if we connect condensers in series we obtain a lower capacity than when using one alone. If the value of such a series condenser is made sufficiently large it will have little effect on the minimum setting of our circuit, but there is a drawback

to the use of a condenser in series alone. That is, although we can obtain a value which will give us correct tuning settings at each end of the tuning scale, all intermediate settings will not be in step with those obtained in the signal frequency circuits.

If, however, we use a smaller inductance for the oscillator coil, and then connect a large capacity condenser in parallel with it, this will also affect the total circuit capacity, and with a suitable value of both trimmer and padder we can obtain a more or less

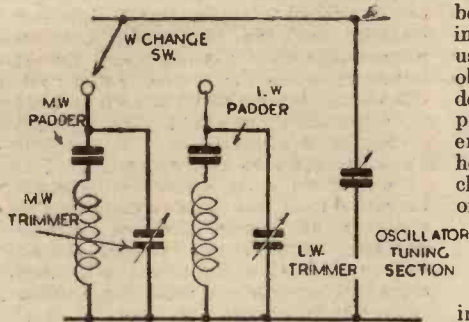

Fig. 1.—A normal arrangement of padders and trimmers in a superhet for medium and long-wave reception.

then special steps have to be taken to ensure that the same result is obtained as would be present were the shaped type of condenser used. In order that the reason may be made clear, it is first necessary to see why the oscillator section is different from the normal tuning circuit such as is found in every type of modern receiver. (For the purpose of this discussion the permeability type of tuner is ignored.)

Intermediate Frequency

The most important feature of the superhet is its very high degree of selectivity, and this is obtained by using many tuned circuits and by adopting a frequency-changing principle. In this the signals are changed from their normal frequency to a totally different one, and subsequent amplification is carried out at the new frequency. This is known as the Intermediate Frequency, and the transformers used in coupling the subsequent stages are known as Intermediate Frequency transformers. These are fixed tuned to a frequency in modern receivers of approximately 450 kc/s. It is necessary to think in terms of kilocycles rather than metres in order to follow the working of the superhet, and the normal medium-wave band of most present-day sets is from 550 to 1,500 kc/s. The aerial circuit or any other signal frequency stages will, therefore, cover that band, and to do so a given inductance value (157 microhenries) is used in conjunction with a tuning condenser having a maximum capacity of .0005 mfd. If, now, we have an intermediate frequency of 450 kc/s then the frequency-changing stage must employ an oscillator circuit in which the tuning will range from 550 plus 450 to 1,500 plus 450 kc/s, or in other words from 1,000 to 1,950 kc/s. It is now obvious

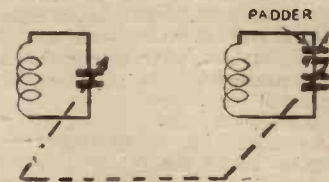

Fig. 2.—An alternative padder arrangement.

perfect balance throughout the entire tuning range with a standard shape tuning condenser.

Circuit Design

Even when a shaped oscillator section is employed it is generally essential to make use of these padders and trimmers owing to the fact that the receivers are designed to cover more than one waveband, and to ensure perfect tracking each waveband has to be separately adjusted. In Fig. 1 we show the usual form which the oscillator circuit takes, the padders generally being fixed values ascertained by the makers during design, and the trimmers being adjustable (pre-sets) so that circuit wiring and similar stray capacities may be balanced out with the particular inductance value which is employed. There is, however, an alternative method of obtaining a similar result, whereby the padding condenser is included in series with the oscillator tuning condenser, but as different values have to be used for each waveband, this method is not generally adopted. In this circuit also, the padding condenser must have a large capacity in relation to the tuning condenser in order that at lower settings of the latter it will have little effect.

We are often asked to advise regarding the capacities of padders and/or trimmers to enable readers to use old coils and tuning condensers in the construction of a superhet, but it must be pointed out that this cannot as a rule be done, as, for the reasons already stated, it is essential that the oscillator coil has an inductance lower than the signal frequency coils, and therefore to make use of old coils it will first be necessary to strip down such coils so that the desired lower inductance value is obtained. In view of the difficulty of arriving at any exact knowledge as to the inductance value of a coil so modified, it is not possible to give exact data regarding suitable condensers. It may be mentioned, however, that the normal inductance of oscillator coils used with shaped vanes is 126.9 uH. compared with the 157 uH. inductance of the signal-frequency coils.

AN APPRECIATION FROM THE TRADE

"Dear Mr. Cumm,

"I would like to place on record the appreciation of my clients and this agency for the House of Neunes, having decided to carry on with the weekly publication of your well-established journal PRACTICAL WIRELESS.

"At the present time it is the only British weekly journal catering for thousands of the public, young and old, whose interests lie in the realms of radio construction and experimental work at home.

"It was, I am sure, a pleasant surprise for your readers to know that by placing an order with their newsgents, they could still secure their copies each week, and also that they do not have to pay an increased price for them.

"As this agency specialises in radio publicity, we have since the very first issue of PRACTICAL WIRELESS placed advertising contracts with you for various of our clients. Both they and we are glad to retain the opportunity of keeping your readers advised of the variety of radio apparatus they continue to supply.

"I trust you will continue to secure a good measure of support from all those radio companies who have increased their business as a result of the sustained efforts which PRACTICAL WIRELESS has made and is still making to popularise receiver construction.

"Yours sincerely,

"H. Freeman (Managing Director),
"PARRS ADVERTISING LTD."

Anti-interference Aerials

A LISTENER often buys an all-wave set, has it sent home and proceeds to connect the usual aerial, earth and mains leads. Results—probably excellent on medium and long waves. Turning over to short waves, a number of stations are picked up after a preliminary skirmish with the fine tuning control, and also the ignition noises from every car in the vicinity. A few evenings juggling with the controls, the same troubles recur and, in consequence, receiver is tuned to the locals and a few medium-wave foreign stations ever afterwards.

The same tale is often true of the short-wave unit (or receiver) except for the proviso that in this case the listener may have provided himself with the short-wave aerial system more suited to the wave-ranges to be covered. In the latter instance it is possible that the better matching of the aerial system to the short-wave aerial coupling coil is providing increased signal strength, and therefore a higher signal to interference ratio.

Reception under the latter conditions is certain to be more tolerable, although complete freedom from man-made static can only be achieved by paying close attention to the several vulnerable points of noise entry to the set, and providing a noise-proof aerial system.

We are concerned for the moment, however, with the real problem of providing an aerial system which is not only substantially electrically static proof, but equally efficient over ultra-short, short, and both medium and long waves. In fact, the horizontal aerial section and the download together must perform equally well on all wavebands without necessitating mechanical or physical changes. Allowing for such modifications at the receiver end of the download which is accessible, the requirements are nevertheless exacting.

Separate Aerial Systems

One obvious course is to erect two separate aerial systems, the first for medium and long waves only, and the second for all short-wave ranges. Without question the separation of the two aerials is technically the most happy solution. Each aerial can be arranged in a manner likely to provide maximum signal pick-up, and the downloads can be individually treated to afford the greatest relief to man-made static.

The download from the aerial for medium and long-wave reception can consist of a large diameter low-loss screened conductor, or a small screened conductor acting as a transmission line with impedance matching devices at each end. Where the download length does not exceed, say, 50ft., the low-loss screened conductor is best, owing to the small signal attenuation and avoidance of complications. At the most, the signal loss should not exceed 20 per cent—not a heavy price to pay for static-free reception! By using a low aerial tapping or a small primary winding on the coil in the set the loss will be less or, alternatively, the attenuation will be proportionately lower if the download is less than 50ft. in length. Owners of commercially made receivers should note the latter point, because it is obviously impracticable to interfere with the "interior" to achieve technical perfection.

A Discussion of the Problems of Devising a Static- and Noise-proof Aerial for All-wave Receivers

Transmission Line Systems

Where the M.W. and L.W. horizontal aerial must be erected at some considerable distance from the receiver in order to avoid electrical static radiation, it becomes impracticable to employ a low-loss screened download, and here the transmission line system comes to our aid. There are several reliable makes on the market and while each system possesses its own technical merits, yet fundamentally they all operate on the same principle. A step-down matching transformer is mounted on or near the horizontal aerial and another of the step-up type near, or on the set.

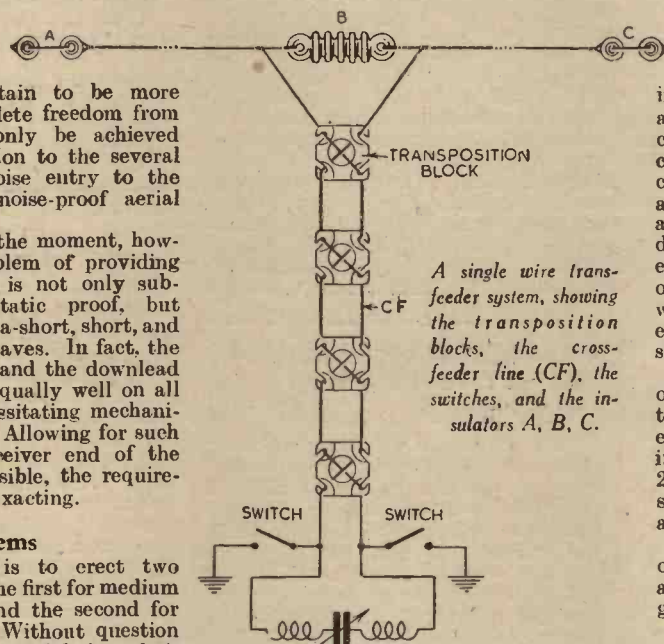

A single wire trans-feeder system, showing the transposition blocks, the cross-feeder line (CF), the switches, and the insulators A, B, C.

The advantages of each system are numerous, not the least of which is that the screened small diameter transmission line (or download) can vary between, say, 50 and 400 feet in length, and additionally, is loss-free in that the lead can be buried, tacked to fences, walls, or run under floors or in walls. One word of warning to would-be users—whenever possible, the outdoor cable should advisedly be purchased with insulation over the outer metal braid, as atmospheric conditions can play havoc with the usual exposed screening.

The Short-wave Aerial

With regard to the short-wave aerial, there seems to be no defined opinion among technicians as to the ideal arrangement. Certainly the writer was brought severely to task in the correspondence columns of this journal once for daring to declare, in effect, that the well-known cross-over feeder principle was in itself not completely proof against man-made static. The opportunity now presents itself of clarifying the position.

This download consists of two "feeders"

each attached to dipole horizontal aerials, end to end and insulated from each other. At regular intervals, the "feeder" downloads cross over on special insulated separators, while at the receiver the cables are normally joined to the ends of a coupling coil, either direct or via resistances, the latter devices being intended to make the complete aerial system aperiodic, to cover a band of wavelengths. Usually the dipoles have a natural wavelength response, according to their length, but this obviously only makes for maximum efficiency at one point.

If a centre earthed point is provided on the coupling coil, theoretically, all electrical static extraneous capacitance and inductive effects on the "feeders" are cancelled out and taken to earth. That this effect is partially achieved in practice has been proved, although it is contended that the improvement in the matching due to the downloads between aerial and set is equally responsible for the higher signal to interference ratio.

However, in the estimation of the writer, an even greater improvement in noise reduction can be effected by avoiding all possibilities of capacity coupling between the feeder coupling coil, and the coil in the set. Stray capacity couplings will pass noise voltages, and these will nullify to some extent the advantages accruing from the special download. By simply interposing an electrostatic metal foil screen as a single open-circuited earthed turn between the windings, the desired effect is obtained, even at the possible expense of the available signal.

Similar results are procurable by the use of a special flex feeder cable, comprising two twisted conductors, well insulated and embedded in rubber; and with a surge impedance of 120 to 150 ohms at about 20 metres; other parts of the aerial system remaining the same, and as advocated.

There is no doubt that by employing one of each aerial arrangement mentioned, an all-wave receiver can be expected to give an improved noise-free performance.

Downloads

Both downloads can pass to the set at a common leading-in point, consisting of a hole through the wood framework of a window or a bushed hole in a glass pane, or even a large diameter plain ebonite tube. It is of vital importance that the downloads are not broken by means of special fittings, as the exposed points are then capable of picking up noises from the "blanket" of electrical static which surrounds a building. As already mentioned, the matched transmission line download for broadcast wavebands can be treated like an electric cable, but slightly more careful treatment is necessary for the low-loss type. This should be fixed to extension brackets attached to the outside wall in order to relieve the horizontal aerial of the weight, and to prevent high winds and rain causing disintegration of the protected foil screening.

The short-wave aerial feeder cable, on the other hand, must be treated like a normal download and be brought in preferably at an angle to the building, and not less than 15ft. from it for its major length.

ON YOUR WAVELENGTH



By Thermion

Bad Luck for Baird's

IT is with regret that I learn that as a result of the position in which the Baird Television Company has been placed through the suspension of television transmissions, they are no longer able to finance the carrying on of the company's business, and as a result the trustees for the loan stock have informed the Board that it is their intention to apply to the court for the appointment of a receiver. The company announce that the reasons leading up to this position are that on the Friday evening of September 1st it was announced by the B.B.C. that under regulations made by the Government television transmissions from the Alexandra Palace would cease. This delivered a knock-out blow and completely stopped the activities of the company.

This cessation happened at a difficult time, for it occurred during Radiolympia, the zenith of the year's working, when the capital invested in stocks was at its maximum. These sets which had received great approval and interest prior to and at the Show are consequently left on the company's hands as stock unsaleable until television transmissions recommence. The company had already become busily engaged in the manufacture and supply of large screen television receivers for theatres. They had received a contract for such work, which would have kept a portion of the works fully occupied for the next eighteen months. No further deliveries under this contract are possible.

Everyone will appreciate what a staggering blow this has been to the company when they were turning the corner, and had in sight the reward for which they had so long and assiduously worked.

The Television Advisory Committee had shown such confidence in the expansion of television that they had recommended to the Postmaster-General and to the Government that work should be commenced immediately for new stations at Birmingham and Manchester.

I am of the opinion that the cessation of the television programme was just one of the many pieces of panic legislation introduced at the start of the war. It is most important that the morale of the people should be maintained, and anything which tends during the gloomy evenings to entertain people in their homes should have been maintained. Television would, during the war, come into its own. I am aware that the transmissions from Alexandra Palace could be used by the enemy for D.F. purposes, but I am certain that times could have been selected during the day when this risk could have been reduced to a minimum. I am still hopeful that the transmissions will be resumed at an early date, for I am not one of those who think that the war will be of long duration.

H.T. Batteries for Torches

I MENTIONED last week that some dishonest dealers, anxious to profit out of the present shortage of torch batteries, are breaking up high-tension batteries for the purpose. The public should refuse to buy such batteries, which

are made for a comparatively low current discharge, whereas the average torch takes anything up to half an ampere. The maximum safe current from one of the cells of a high-tension battery is but a few milliamps.

The Programmes

THE programmes have been improving, but only in patches. Just about the time when I am able to listen in each evening there is usually some mournful music or a religious service. I don't want either, and I do not think the public wants it. We have managed to get some brighter Sunday programmes, and I do not think that the miserable music which has been pushed out of those Sunday programmes should be interlarded with the weekly programmes. We are promised some Gilbert and Sullivan, but what about broadcasting some of the old musical comedies again, such as "The Marriage Market," "The Merry Widow," "The Geisha," "Mousme," "The Cingalee," "The Country Girl," "The Count of Luxembourg," "The Chocolate Soldier," "The Earl and the Girl," "Irene," "The Waltz Dream," "The Gypsy Princess," "Florodora," and so on? We do not want miserable music during the war—we will not have it!

Pocket Sets

ANOTHER indication that the country is at war is in the demand for midget sets of the sort which can be accommodated in a cigar box. Many of our readers on active service have written for details of such a set. Obviously, a midget is only suitable for headphones, but my readers are prepared to sacrifice some quality, provided that they can listen-in to the news and to the evening programmes. These readers are away from their files of copies, and so I believe it is the intention to republish in these pages details of some of the pocket sets which we have described in the past.

Radio in the East Indies

RADIO appears to be something of a novelty in far-away Malaya, and at present there are only two broadcasting centres in the locality. In Singapore, the British Malaya Broadcasting Corporation, which is a private enterprise, operates two transmitters.

One of these radiates on medium waves and provides a high-quality local service

for listeners living on Singapore island and in South Johore. The other operates on short waves, and is heard quite well over a very large part of the peninsula.

In Penang, the local amateur radio society operates a small short-wave transmitter, which also covers a wide area.

An interesting feature in the sale of receivers in Malay is the preference which the public of all races has for expensive sets. This seems to be largely due to the fact that before the home stations were built reception of overseas short-wave transmissions was only possible with highly sensitive receivers.

Nowadays, relatively inexpensive sets costing the equivalent of around £10 to £12 are capable of providing good entertainment from the "locals," but the majority of sales still fall in the £14 to £30 class.

The first Malayan all-radio exhibition was held in Singapore early this summer. The site was a Chinese amusement park, which provided many entertainments in addition to displaying radio equipment of all kinds. Visitors had the choice of various forms of amusement from a skating rink to a Malay theatre, and from cinemas to open-air restaurants.

The public were initiated into the secrets of broadcasting through an exhibit by the B.M.B.C., which consisted of an open studio from which actual transmissions were broadcast.

A Broadcast Thriller

A VICTORIAN thriller called "Gas Light," which will be broadcast on November 24th, is by Patrick Hamilton and was successfully presented on the London stage where it ran for nearly a year. It has the strong atmosphere of a thriller, which it retains to the end.

The author admits that, in writing his plays for the stage, he also has in mind the question of radio presentation. The version of "Gas Light" which listeners will hear has been specially adapted by the author, and although it was given its première on the stage, it might virtually be termed a radio play. It will be produced by Barbara Burnham.

Patrick Hamilton is also the author of "Rope," "Money with Menaces" and "To the Public Danger."

Hallé Concert

THE Hallé Concert Society is now well established in its war-time home at the Paramount Theatre, Manchester, and listeners are to hear another Hallé broadcast from there on November 19th. Sir Thomas Beecham, President of the Society, is again conducting and the two works to be broadcast are Tone Poem "En Saga," by Sibelius, and Concerto in D, for violin and orchestra, by Sibelius. The violinist for the concerto will be Henry Holst.

Holst, who succeeded Arthur Catterall as professor of the violin at the Royal Manchester College of Music, has a great Continental reputation. He studied in Copenhagen and also in Berlin, where he became leader of the Berlin Philharmonic Orchestra.

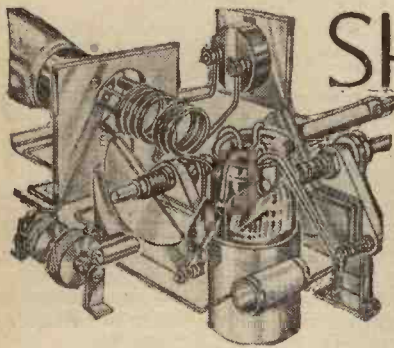

SHORT-WAVE SECTION

ULTRA SHORT-WAVE OSCILLATORS

Two Types of Unit Which May Be Used for Experimental Purposes.

After a few stations have been logged, and when the wavelengths are known (they are generally announced), the oscillator may be calibrated so that it may later be used as a wavemeter. There are, of course, "direct" methods of calibration, but these call for a fair amount of skill and a certain amount of apparatus; in any case, the average amateur does not wish to go to the trouble of calibrating in this manner.

Another Type of Oscillator

Those who prefer to use a more conventional type of oscillator may employ the circuit given in Fig. 2, which is that of a modified Hartley arrangement in which a pair of 4-turn coils are used in conjunction with a .00015 mfd. (max.) pre-set reaction condenser and a 35 mmfd. or 40 mmfd. tuning condenser. Here again, an H.F. or H.L. valve is employed, and is fed from an H.T. battery giving up to 60 volts. In this case, the output is not modulated and can therefore be picked up only when the receiver is in an oscillating condition. For this reason the "squeak" is heard at two points on the tuning scale, and there is a "silent point" between them; it is the latter which indicates the wavelength to which the set is tuned when the oscillator is calibrated. An advantage of this type of oscillator is that it can be used as part of a super-regenerative receiver when desired without having to make any alterations to the main connections or components.

The "Feigh" Recorder

MANY listeners are now taking up home recording as an interesting radio side-line, and one of the main difficulties is the acquisition of a suitable tracking device. It is known, of course, that the pick-up or cutting head must be traversed across the recording blank at a suitable speed to obtain the desired spiral track on the disc, and most blanks used for home-recording are merely plain discs of aluminium or synthetic bakelite or other material. A tracking gear is therefore essential and the majority are very elaborate machine-cut devices which are not inexpensive. Furthermore, they are generally part of a complete recording equipment in which the turntable is a vital part, being heavily weighted and driven by a special motor.

Messrs. Electradix can supply a very inexpensive tracking device, however, which, when suitably operated will prove very effective in cutting a perfect spiral track in any type of home-recording blank. The device consists of a small metal support which clips over the motor spindle, on top of the blank. A flat metal strip with a rack edge is passed through a slot in the upper part of the support and the teeth mesh with a spiral cut track on top of the support. Two lengths of the rack are obtainable, to suit the various sizes of blank which may be used. A small hole at the end of the rack is engaged on a pin fitted to the cutting head, and Messrs. Electradix can supply a suitable pick-up ready fitted with this pin. The rack should be given a copious smearing of vaseline or similar grease—not too thick—and the surface of an aluminium blank should also be greased before cutting. The device works very well indeed, and the tracking mechanism alone costs 21s., whilst the cost of the complete outfit is 37s. 6d. If desired a special super fidelity set may be obtained and the cost then is 42s. 6d.

ONE of the first difficulties encountered when experiments in ultra-short-wave reception are first taken in hand is that of knowing whether or not the receiver is functioning correctly. To those who have not yet "gone down" below 10 metres this may seem rather a peculiar state of affairs, but if it is found that signals cannot be received the set may be at fault, or the reason may simply be that there are no transmissions being sent out at the time which are within range.

Despite this handicap experiment on these below-10-metre waves can be very interesting, and it certainly offers some diversion to the enthusiast who has a suitable oscillator.

An Electron-coupled Oscillator

A "wavemeter" of the oscillator type can be made very cheaply, and by using standard receiver components throughout. A circuit for a suitable electron-coupled arrangement, using an ordinary triode valve of the H.F. or H.L. type is shown in Fig. 1, from which it will be seen that the valve is wired rather like a leaky-grid detector, but with important variations. The first of these concerns the tapped coil, of which one portion is in the grid-filament circuit and the other in the filament-anode circuit—through the .005 mfd. fixed condenser. It can also be seen that the H.F. choke, instead of being in the high-tension lead to the valve is in the low-tension circuit. The general principles of the electron-coupled oscillator circuit have been described in these pages before, so there is no need to go into the theory of the arrangement here. In passing, however, it should be pointed out that it is customary to employ a screen-grid type of valve for electron-coupled circuits, but that the simple triode has been found to be perfectly satisfactory on the ultra-short waves.

Suitable Components

The correct type of coil should consist of about five turns $\frac{3}{16}$ in. in diameter, and the Eddystone No. 1,050 is very suitable. This is a component which has been introduced for the present season, and it is mounted on a special steatite-type baseplate. The tapping for the filament lead should be approximately two turns from the lower end of the winding, and can be made by means of a tapping clip, since the coil is not actually provided with a tapping. The tuning condenser may be a standard component of 35 or 40 mmfd., and this will cover a range of about 4.5 to 7 or 8 metres, according to the exact capacity of the condenser. It will be evident that the ultra-short-wave H.F. choke must be of an efficient type having a low D.C. resistance, and at the same time it must be capable of carrying the .1 amp. required by the valve filament. Values are assigned to the grid condenser and leak, these

being different from those employed in a normal detector circuit. The grid leak acts as an automatic bias control since the potential developed across it varies according to the grid current and thus according to the intensity of the oscillation. The values of grid condenser and leak also govern very largely the pitch of the note which is "transmitted," and if unsuitable components were used there would be a danger of the note being above audibility or being of such a low pitch that the valve oscillated intermittently.

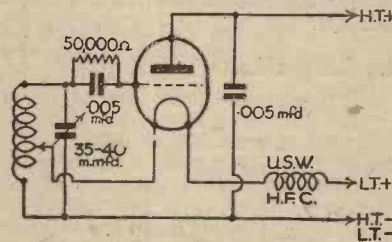

Fig. 1.—Circuit of the electron-coupled modulated oscillator described in the text.

Using the Oscillator

In using the oscillator in conjunction with a receiver it should be connected to a 60-volt H.T. battery and 2-volt accumulator and placed a short distance away from the set. It is then tuned to about 6 metres by setting the tuning condenser to its midway position, and the receiver is tuned until a note is heard in the 'phones. After this has been arranged it is best to move the oscillator as far away from the set as possible so that the received note is only

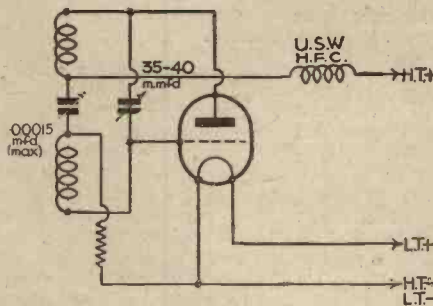

Fig. 2.—Circuit diagram of a conventional ultra-short-wave oscillator.

just audible. The effect of any alterations to the receiver can then be checked by observing if the note increases in loudness or becomes inaudible. A good deal of useful experimental data can be compiled in this manner, and it can be ascertained that the receiver functions correctly before wasting time in trying to pick up real signals from amateur stations or from commercial transmitters.

Some Loudspeaker Faults and Remedies

THE loudspeaker itself so rarely develops a fault that when it does the experimenter might overlook it, spending much unnecessary time tracing through the receiver circuit. Nevertheless, faults do sometimes arise, and they can be divided into three main categories: those which render the speaker "dead," those which cause a reduction in output volume level, and those which produce "scratching" noises and "rattle."

When the speaker becomes suspect there are various simple tests which may be applied. These will be more apparent if a glance is taken at the semi-theoretical arrangement shown in Fig. 1. This is for a permanent-magnet moving-coil type of unit, although the arrangement is sensibly the same when the speaker is of the energised type; the only important difference is that the permanent magnet is replaced by an iron "pot" which carries a winding consisting of several thousands of turns of wire. The main points at which a fault causes a cessation of output are indicated in Fig. 1, and it will be seen that the built-in transformer is just as likely to be the cause of trouble as is the speaker unit itself; actually, faults are even more usual in the transformer than the speaker.

The Speaker Transformer

The first point which should receive attention is the continuity of the primary winding of the transformer. It is this which normally carries the anode current for the output valve, and it might become open-circuited. This fault is frequently referred to as a burnt-out transformer, although in practice it is very rare for the winding to be fused due to the passage of an excessive current. More usually, the turns of fine wire break, due to vibration, corrosion, or a combination of the two. If a milliammeter is available, continuity of the winding can easily be checked. The method is to wire the meter, along with a G.B. battery, as shown in Fig. 2. An average resistance value is 300 ohms, which means that if the winding were intact a meter reading of about 5 mA would be shown when using a battery voltage of 1.5. If the resistance were greatly in excess of the normal value the current indicated would be much lower; if the winding were severed the meter would not give a reading at all.

In some instances, the reading might be noticeably higher than that anticipated; this would generally show that a section of the winding was short-circuited due to

a fault in the transformer. Such a fault, however, would seldom result in the speaker being absolutely "dead," although output would be reduced. The extent of this would depend upon the proportion of the total number of turns which had become shorted.

How to Trace the Cause of Speaker "Noises," Lack of Sensitivity or Failure to Operate, and How to Carry Out the Necessary Repairs. These are of Two Main Kinds—Electrical and Mechanical.

By FRANK PRESTON

The "Soak" Test

When making the test for continuity it is often desirable to leave the meter and battery in circuit for several minutes,

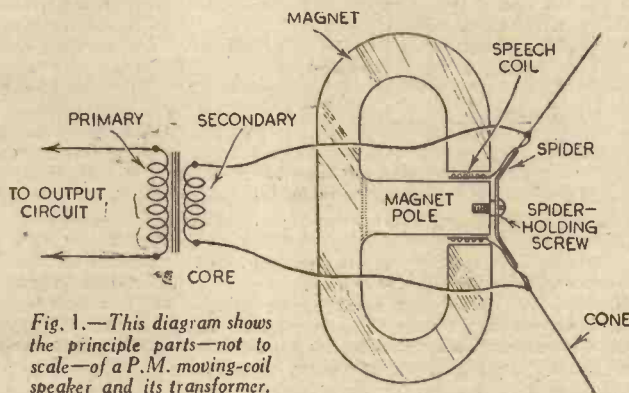

Fig. 1.—This diagram shows the principle parts—not to scale—of a P.M. moving-coil speaker and its transformer.

watching the meter needle meanwhile. The reason for this is that the two sides of the fracture might just touch each other and make fairly good contact for a certain length of time. Even this test is not ideal, for the transformer generally carries a considerably heavier current than 5 mA. In carrying that current, heating of the wire takes place, and expansion follows the rise in temperature. Expansion of the complete winding will often cause the two ends of the broken wire to separate—as they would when the speaker was in normal use. For this reason it is often desirable to wire a suitable milliammeter (that is, one capable of carrying the full anode current of the output valve) between the speaker and H.T.+, as shown in Fig. 3. It should be remembered that the receiver will often operate inefficiently when the meter is connected in this way, because of the increased resistance in the anode circuit. Nevertheless, should the meter give a constant reading for a

period of, say, 15 minutes, it will be unlikely that the winding is broken.

When a milliammeter is not available the battery test can be made by using a pair of phones in place of the meter. There should be a pronounced "plonk" as the circuit is made and broken by inserting and removing the wander plug attached to a battery lead. Unfortunately, however, this is by no means as satisfactory as the "soak" test mentioned above.

Broken Speech-coil Connections

Should it be found that the transformer winding is defective it is generally cheapest to have the transformer re-wound, although in some instances it might be less expensive to obtain a new transformer.

If the transformer winding proves to be intact and yet the speaker remains "dead," there is a possibility of a break in the secondary circuit. The transformer secondary winding will very rarely be responsible, for it consists of relatively few turns of fairly heavy-gauge wire. It is in the flexible lead from one of the secondary terminals to the speech coil that the fault will most likely be found. With the usual arrangement of built-in transformer two short flexible leads are taken to two contact "pips" on the cone; these are connected directly to the ends of the speech coil. Occasionally one of the flexible leads breaks or comes adrift from the contacts; re-connection is often a rather delicate operation, but it is straight-

(Continued on the next page)

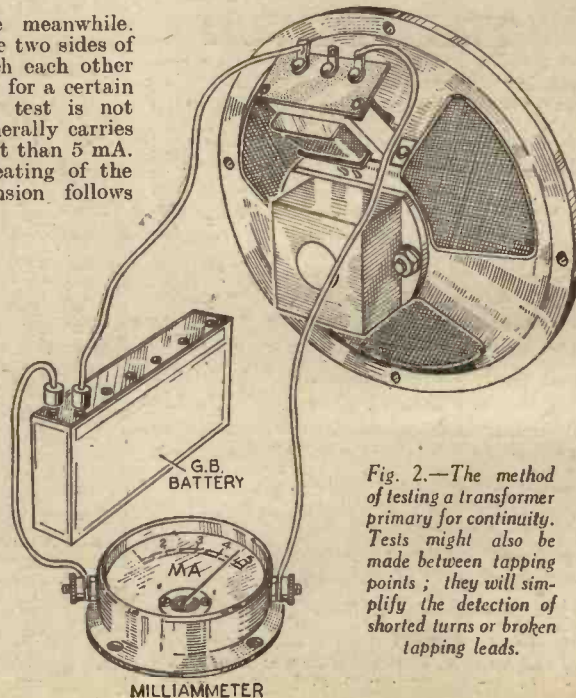

Fig. 2.—The method of testing a transformer primary for continuity. Tests might also be made between tapping points; they will simplify the detection of shorted turns or broken tapping leads.

SOME LOUDSPEAKER FAULTS

(Continued from the previous page)

forward enough. The fault just referred to, by the way, sometimes causes a peculiar crackling noise or even a "fizzling" sound.

Loss of Magnetism

If the output level is low, without there being any other fault (such as distortion, crackling or "cracking" on certain notes), the fault will generally be traced to weakening of the permanent magnet, with a P.M. speaker, or to short-circuiting of some of the turns of the field winding in an energised type of speaker. The latter, incidentally, is almost sure to be accompanied by overheating of the field coil. Short-circuiting can be tested for by measuring the resistance of the field with a milliammeter and dry battery. In this case, the nominal resistance will probably be in the region of 2,500 ohms, so it will be necessary to apply 10 volts to obtain a reading of 4 mA.

Permanent magnets retain their magnetism for many years in normal conditions, but many of the earlier types of P.M. speaker were inferior to present-day units in this respect. A weak magnet can be dealt with satisfactorily only by the makers or by a firm specialising in magnets. The makers will also undertake to test the magnet and give an estimate if the speaker is sent to their service department. A very rough test of magnet strength can be made if a similar speaker in good condition is available. The method is to see what weight the magnet will support, using cast-iron weights of the type supplied with domestic scales. Do not dismantle the speaker for the test but apply the weights to an exposed portion, taking care to test on the corresponding portion of both magnets. It should be understood that this is not an ideal test and that it is not necessary if every other part of the speaker has been checked.

Mechanical Faults

Mention has already been made of various electrical defects which can give rise to crackling and other background noises. There are also several mechanical faults

which may produce a similar result. For example, if the transformer is not securely clamped to the frame of the speaker it will vibrate and cause a buzzing noise or, possibly, resonate at a particular frequency, so giving the effect of "cracked" notes. Similarly, loose transformer stampings will give this effect. If they are loose it might be possible to clamp them by tightening the assembly bolts, when used, by inserting a wooden wedge between the stampings and the holding clamp, or by pinching up the sheet-metal clamp with a large pair of pliers. Another method which is simple and often effective is to brush shellac

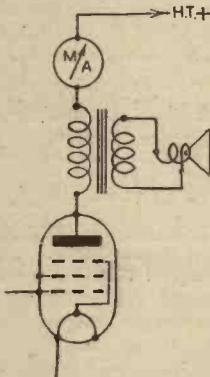

Fig. 3.—In many respects it is better to test the transformer primary for continuity while it is connected in the anode-circuit of the output valve.

varnish very freely over the edges of the stampings so that a fair amount runs down between them; when that sets the laminations will be quite rigid.

When looking for the cause of vibration the mounting of the speaker unit on the baffle-board should not be overlooked, since a loose screw or washer could easily be responsible. But when looking for this possibility do not overlook the fact that legitimate speaker vibration may be transferred to components in the set itself, or even to connecting wires which run alongside components.

Damaged Speaker Cone

Another possibility of inferior reproduction—and possibly of "noises off" as

well—is a damaged speaker cone. Unfortunately, it is seldom possible to effect a completely satisfactory repair without replacing the cone as a whole. Sometimes, however, a piece of thin, gummed paper can be attached to the damaged part of the cone. It should be well pressed down so that there are no loose edges to the tear. When the damage is more extensive it is sometimes better to cut a definite circular hole in the cone and to glue a circle of similar paper over this. For best results, the edges of both the hole and circle should be thinned off so that the thickness of the repaired cone is practically uniform. In the case of a speaker used with a "quality" receiver it is generally essential to have the cone replaced, since repair would not be likely to prove satisfactory.

Speech-coil Centring

A fairly common cause of "scratchy" reproduction, often accompanied by a lack of speaker sensitivity, is due to the speech coil not being correctly centred over the magnet pole. Centring can be carried out fairly easily by slackening the centre-screw which passes through the mounting spider and into the centre of the pole piece, and then inserting three strips of paper or thin card, tightening the screw and finally removing the strips. Unless a set of centring strips (specially made for the purpose and supplied in threes of varying thickness) is available it might be necessary to try a number of pieces of thin card to find a thickness which will just permit of the coil being centred. When the three strips are in place they should be a fairly tight sliding fit, without, however, causing the coil to bulge.

An effect similar to that of an eccentric speech coil can result from the accumulation in the air gap, between the coil and the magnet of dust and metallic particles. Sometimes it is possible to remove them with a vacuum cleaner of the type fitted with a flexible pipe; sometimes it is necessary to remove the cone and "collect" the particles by pressing a strip of plasticine into the air gap.

NOTES FROM THE TEST BENCH

Baring Wires

WHEN making connections of a soldered type to the ends of wires, absolute cleanliness is essential. Scraping with a pen-knife is the usual method adopted, but this may lead to trouble due to the wire being partially cut through. A better plan is to use a small piece of worn emery folded over and to draw the end of the wire through this, holding it between the finger and thumb. Cotton-covered wire may often be bared satisfactorily by burning, but the wire should not be held in contact with the flame too long, and the cleaning process must be repeated afterwards to remove the oxidised surface.

Easier Control

IN experimental apparatus it is often found desirable to provide an accurate slow movement of a control, but a slow-motion drive is not justified. A good plan to obtain such control is to use one of the old-pattern large-diameter control knobs

(3 or 4 inches across), and by holding the large-diameter and not the centre control knob a much more exact movement may be obtained. In this way the single knob

may be used quite satisfactorily as a two-speed drive, using the centre knob for preliminary setting and the outer edge as a vernier.

A VOLTMETER DIODE

THE G.E.C. have recently introduced a new diode designed especially for use in high-frequency peak voltmeters. This has a small top cap for the anode in place of an anode lead wire, as formerly provided in early models. This diode is provided with a 1.8 volt filament consuming 1.6 amps and the total emission is 3 mA. The diagram shows how it should be employed, C1 and C2 being .001 mfd. for any radio frequency. R is a 100-ohm centre-tapped potentiometer or resistance, and V is an electrostatic voltmeter or equivalent instrument. The leakage resistance between filament and earth should not be less than 500 megohms, and the filament battery or filament transformer secondary should therefore be well insulated from earth. At frequencies up to 100 megacycles and voltages over 100, a direct reading of the peak H.F. voltage is obtained without calibration

to an accuracy of a few per cent. For voltages below about 100, the instrument requires calibration for accurate measurements, on account of the effects of leakage and of initial electron velocities. The calibration may be carried out with a 50-cycle supply, in which case the two condensers should be increased to .1 mfd. At frequencies over 300 megacycles the readings are only approximate owing to the effect of the voltmeter connecting leads, which cause the instruments to read high. These leads should, therefore, always be kept as short as possible. The price of the valve is £3.

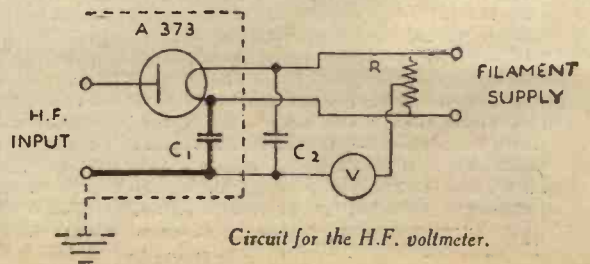

Practical Hints

An Electro-magnetic Switch

THE accompanying sketches give details of a simple electro-magnetic switch I have been using for the past year or so. It has been working in a cupboard which has to have the light extinguished when the door is closed but must be put on by hand. The advantage of its design lies in the fact that the "off" magnet circuit is broken when the switch is put off, thus allow-

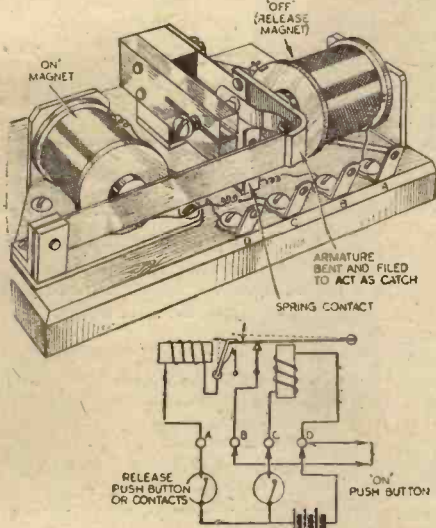

Perspective view and circuit diagram of a simple electro-magnetic switch.

ing plain contacts on the door. With an ordinary electro-magnetic switch worked by push-button, the magnet circuit controlling the "off" mechanism can still be operated even when the switch is off, so that some form of intermittent contact would be necessary. With this ordinary "make-shut," "break-open" action will suffice.

There are many other applications for this switch, such as remote control of wireless receivers, etc.—P. A. SHEARS (Horsham).

A Small Testing Rack

THE accompanying sketch illustrates the general construction of a testing rack which I have designed to facilitate home servicing a receiver chassis, and the multitude of different tests which I have been able to effect by reason of the rack's adjustability have certainly justified the efforts I have put into the design and construction.

Tests can easily be arranged if the small test panel circuit is carefully worked out and wired up neatly with adequate precaution by way of insulation so far as the mains voltage is concerned. All that I use is a small neon lamp for continuity and leakage tests, a 0.30 milliammeter for resistance and condenser tests and flashes, provision being made for differential readings by parallel and series meter resistances and under the control of two push-buttons "A" and "B." The mains control switching is effected by two S.P.D.T. telephone key switches, the two poles of the mains

THAT DODGE OF YOURS!

Every Reader of "PRACTICAL WIRELESS" must have originated some little dodge which would interest other readers. Why not pass it on to us? We pay £1-10-0 for the best hint submitted, and for every other item published on this page we will pay half-a-guinea. Turn that idea of yours to account by sending it in to us addressed to the Editor, "PRACTICAL WIRELESS," George Newnes, Ltd., Tower House, Southampton Street, Strand, W.C.2. Put your name and address on every item. Please note that every notion sent in must be original. Mark envelopes "Practical Hints." DO NOT enclose Queries with your hints.

SPECIAL NOTICE

All hints must be accompanied by the coupon cut from page iii of cover.

being individually controlled, and again the metal fittings of the panel are at earth potential.

All supply leads from the receiver (if of

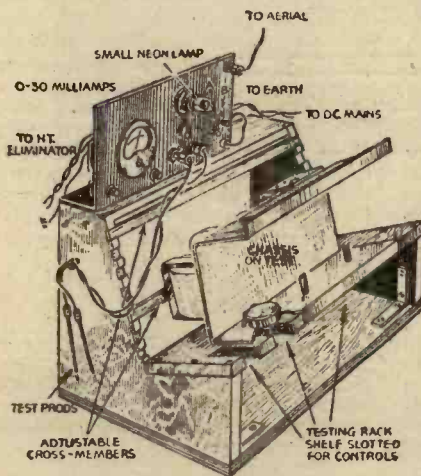

A compact testing rack.

the battery type) go to the eliminator and accumulator, whilst for D.C. mains working the leads are accessible for immediate use. A.C. mains working is in my case effected by means of a rotary converter, the supply leads of which are interchangeable with the D.C. input leads on the test panel.—O. G. WENTWOOD (London, E.7).

An Improved Unit H.T. Battery Assembly

I STILL employ the old method of building up one's H.T. supply from 4.5 volt torch batteries, since I find it most convenient financially, and admirable for short-wave work. I find, however, that the detrimental effect of accelerated corrosion caused through tightly packing the batteries without individually separating them called for a new method of

assembly, and in employing the idea illustrated I have appreciably lengthened the normal life of my H.T. battery, since corrosion is retarded by the employment of the glass separators. I can recommend this

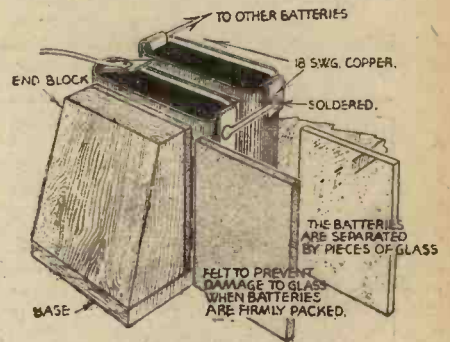

A method of assembling flash-lamp batteries for forming an H.T. unit.

simple improvement for the new life it gives to the battery, and also its portability.—N. J. E. SMYTHE (Liverpool).

Drilling Glass

WE are continually receiving requests from readers who wish to employ a glass panel for a glass cabinet for housing their receivers, and to such readers the following information may prove useful.

It should be remembered that glass may be drilled just as easily as ebonite, provided the right drill and lubricant is employed. The broken-off point of a triangular file makes a very good drill, and it should be turned slowly, without undue pressure, and at the same time lubricated with copious supplies of ordinary turpentine. When through, turn the glass over and finish from the opposite side.

An Aerial-earth Jack-switch

REQUIRING a better method than the usual knife switch of isolating the wireless set from the aerial when not in use, I obtained a closed-circuit jack and jack-plug. I then connected them as shown in the accompanying diagram. It will be seen that when the jack plug is inserted, the aerial and earth are connected to the set, but when the plug is withdrawn the jack closes the circuit between aerial and earth thus eliminating any risk of damage by lightning.—D. DUNN (Bristol).

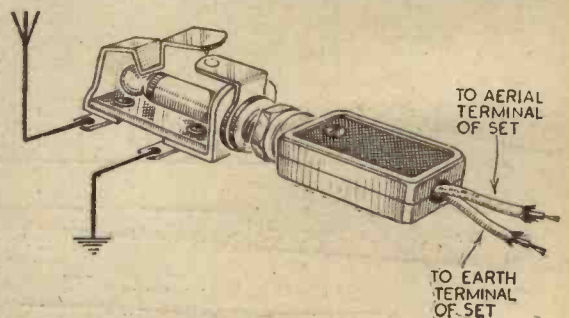

General view of a simple electro-magnetic switch.

A 2-Valve Beat-frequency

THIS useful piece of apparatus has undoubtedly a great appeal to serious engineers and experimenters alike for both radio and audio-frequency measurements. The instrument is useful for accurate checking and matching of any straight-gang condenser, and also for comparing any low- or medium-value fixed capacity condensers, i.e., .000001 to .0005 mfd. Last, but not least, it can be used as an electronic musical instrument suitable for solo performance.

Additional Accessories

For the above purposes it is advisable to make small additions to the original instrument, and to make up a few simple accessories.

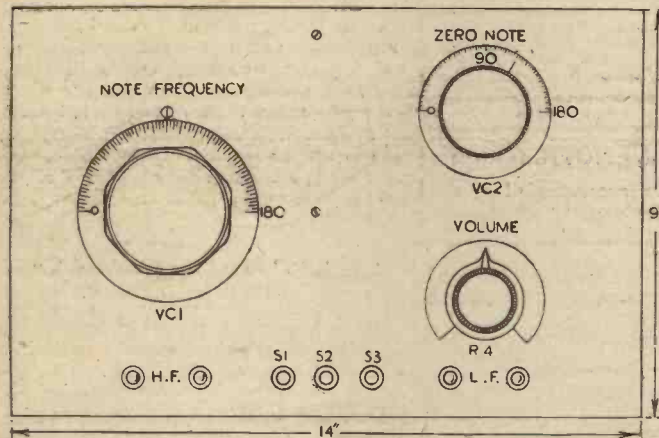

Fig. 1.—The front of panel, showing the three additional sockets.

The additions take the form of three standard type of sockets, which are fixed to the panel as indicated in Fig. 1. The centre one can take the place of the lowest nut and bolt which hold the centre screen, as it has to be earthed. Next, sockets No. 1 and 3 should be fixed to and insulated by bushes from the front panel at a distance of 1in. either side of No. 2 socket. Now, turning to condenser VC2, the value (.00025 mfd.) was found to be on the large side for the purposes of this article, and was accordingly reduced to .000025, and incidentally it should not be of the square

law or log type of condenser, but of the old type with semi-circular vanes. If this is built from standard type plates, two fixed at $\frac{1}{8}$ in. spacing and one moving vane will give the approximate capacity required. It must here be emphasised that this reduction in no way affects the performance of the instrument. The next thing is to connect sockets Nos. 1 and 3 to C4 and C9 respectively (Fig. 2). We must now pay a little extra attention to the coils; whereas for the original purpose alone, accurate matching was not

essential, this now becomes necessary, so first see that all former dimensions are absolutely identical in both cases. Next, so arrange the windings that it is possible to move a turn or two at one end of each former. Then see that all wiring, with the exception of flex battery leads, is kept as rigid as possible. The last thing to do before refitting to the container is to see that the dial of VC2 is exactly at 90 degrees with vanes, also 90 degrees engaged; if there is any overlap at ends it should be equally divided. This concludes the modifications to the existing instrument, but it should not be permanently fixed to its container as the coil matching operation is to follow later.

Amplifier

Now for the external accessories required. These comprise: a simple one-valve amplifier (see circuit diagram, Fig. 3), one .0005 variable condenser and container for same, two terminals and crocodile clip

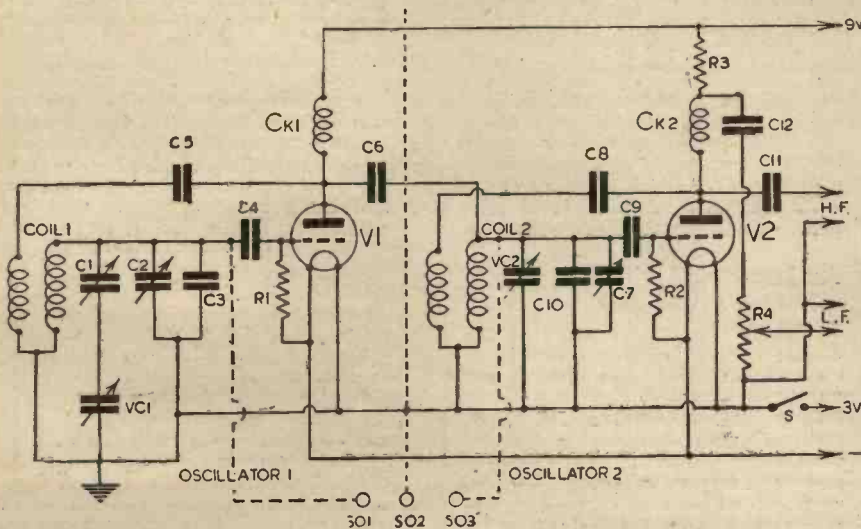

Fig. 2.—Theoretical circuit of the modified B.F.O. unit, the additional connections being shown by dotted lines.

Further Particulars of
Under the Above Head
October 14th

(Fig. 4), and a set of leads, which should be made up as in Fig. 5

Obtain two lengths of screened flex, 12ins. long, strip back and cut off the screening braid to within 1in. of one end of each piece. Then securely attach a

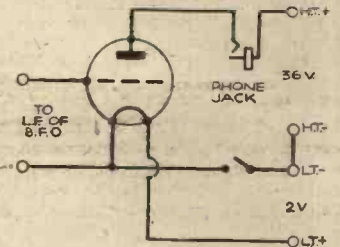

Fig. 3.—Circuit diagram of the one-valve amplifier, which should be constructed to match the B.F.O. unit. In operation four 9v. grid-bias batteries form the H.T. supply.

crocodile clip to each, to retain the frayed ends of screening. To make a neat job it is advisable to either bind the ends, or slip on a 1in. length of cycle valve tubing. Untwine the screening to a length of 3ins. from each of the other ends, double back along itself, and then either bind or slip another 1in. length of valve tube over the

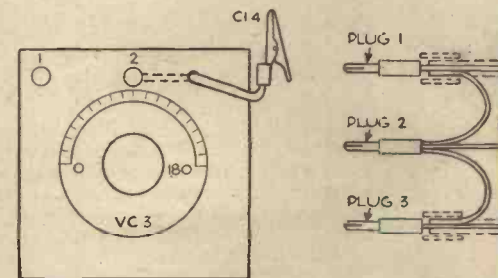

Fig. 4.—Details of condenser panel and crocodile clip. Moving vane are connected to terminal 2, and fixed vane

ends. Cut off flex to within 1in. from end of screening and attach a standard plug to each. Make up a length of ordinary flex to same length with a clip at one end. Now make up final plugs with the ordinary flex, and also the two ends of screening from other leads. The most important thing in this operation is that the length of the screened leads should be identical, and also the screening should not be inadvertently left loose on the flex, as this will cause capacity variations to which this instrument is peculiarly sensitive.

Operating Details

To use the unit, insert Pl.1, Pl.2, Pl.3 into S1, S2, S3 respectively, clip the crocodile clips on to a small piece of ebonite, dry wood, or other insulating material in their respective order, and approximately 1½ins. apart. Connect the amplifier to instrument, plug in a pair of phones, and switch on. If previous

Frequency Oscillator

The Apparatus Described
in the Issues for
and 21st, 1939

adjustments have been carried out, it will now give a good note in the phones. On turning VC1, however, it is now necessary to readjust slightly, and this is done as follows: set VC1 to Min. and VC2 to exactly 90°; now adjust C2 and C7 until zero beat is obtained. The next part of the adjustment is coil matching, and this is done as follows: Take an ordinary straight-ganged condenser (2- or 3-gang) and connect clip 1 to one set of fixed vanes, clip 2 to chassis, and clip 3 to another set of fixed vanes. Turn the condenser to about two-thirds of maximum value, when the note in phones will probably go up the scale considerably, or may even disappear. Now adjust the dial of VC2 until note is heard; note reading and pitch of note. Next, reverse the two screened leads on condenser, being careful not to disturb its setting. The same pitch of note should now be heard at exactly the same number of degrees from centres on the opposite side of dial on VC2. If this is not so, it indicates that the coils are out of match. To rectify this, proceed as follows:—Taking 90° on V.C.2 as zero, if zero beat on second reading is nearer to dial zero than the first, slightly space the end turns on coil No. 2. If the opposite is the case, then repeat operation with coil No. 1; next remove condenser

Checking Capacities

To use this instrument for checking and comparing fixed values of capacity, if previous instructions have been carried out carefully, small fixed condensers may be checked by the aid of direct reading on VC2 as follows: Set VC2 at 180° and reduce beat to zero in phones by increasing VC1. Clip the small-value condenser to be checked between clip Nos. 1 and 2, and any value between 1 mmfd. and 25 mmfd. can be read by zero beat on the dial of VC2. If the dial is

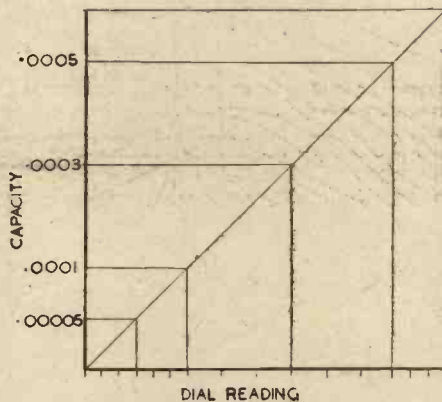

Fig. 6.—A graph of condenser readings.

graduated in 180°, then every 7.2° from maximum=1 mmfd., and if marked in 100 divisions then every four divisions=1 mmfd. from maximum to minimum.

Plotting Condenser Values

For larger values the third accessory (Fig. 4) is brought into use. Clip No. 1 is clipped on to terminal No. 1. Place No. 2 clip on terminal No. 2; set VC1 to 0°, and VC3 to 0°; reduce beat to zero by VC2. It will be most advantageous to make a small graph of condenser VC3 readings as in Fig. 6 and attach same to the container. It is also a good plan to obtain a small number of accurate fixed condensers to use as masters (Belgian

silver mica, .00005, .0001, .0003 and .0005 mfd.). By clipping these in turn between clip 3 on the instrument and clip 4 on the condenser and rotating same until zero beat is obtained, a graph can be plotted and intermediate values determined.

As a Musical Instrument

Now for the last and most novel use of the unit, that of a musical instrument, which affords plenty of scope for the amateur virtuoso. The only additions required for this purpose are an old morse tapper, and an extension handle for condenser VC1. In the writer's case this was made from a piece of plywood, as in Fig. 7, and attached to knob of VC1 by a fibre band secured by a nut and bolt.

The morse tapper was connected in the reverse way, that is the rear contact was used, and the circuit broken as the key is pressed. It was then clipped to Nos. 2 and 3, and the key pressed and zero adjusted by VC2.

The output from B.F.O. was then taken to P.U. terminals of the receiver. To strike a note, press key, and vary pitch

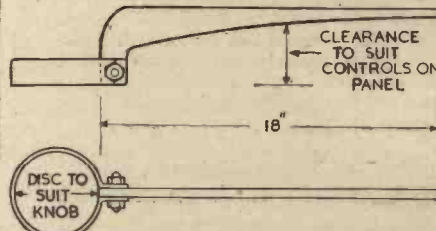
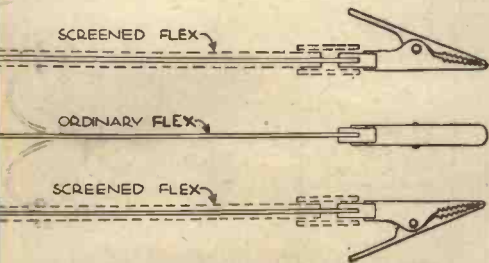

Fig. 7.—Details of extension handle for condenser.

of note by moving extension handle on VC1. With this long handle it will be found that the full musical scale can be brought under the operator's control quite easily, and some very interesting results obtained.



The flex and Fig. 5.—Details of screened flex leads with plugs and clips.

and replace clips on insulator as before. It will now be found that zero has drifted considerably, so return VC2 to 90°, and reset zero by the aid of C2 and C7. This operation should be repeated from the start, only this time the condenser under test should be set to minimum and zero balance by its own trimmers. It should be turned at approximately 10° steps for its full length of travel, and at each step zero checked by VC2. The zero beat should always be at 90° on dial. If this is not so, slightly bend the split end vanes at the ends of each section until the required results are obtained. Having done this, it is advisable to reverse the leads again at maximum to ensure accurate matching, and then dope the coils to prevent shift, and fix permanently to the container. If these instructions are carefully observed, matching accuracy of the order of .5 per cent. at minimum and 2 per cent. at maximum can be obtained.

NOW READY!
WORKSHOP CALCULATIONS
TABLES AND FORMULÆ
By F. J. CANN
3/6, by post 3/10, from George Newnes, Ltd.,
Tower House, Southampton St., London, W.C.2.

LIST OF COMPONENTS FOR THE TWO-VALVE BEAT-FREQUENCY OSCILLATOR	
Condensers:	
C1, pre-set type, .00001-.0002 mfd. Series condenser.	
C2, pre-set type, .00001-.0003 mfd. Osc. 1 trimmer.	
C3, fixed tubular, .0003 mfd. Osc. 1 tank tuner.	
C4, fixed tubular, .0001 mfd. Osc. 1 grid condenser.	
C5, fixed tubular, .0003 mfd. Osc. 1 reaction condenser.	
C7, pre-set type, .00001-.0003 mfd. Osc. 2 trimmer.	
C8, fixed tubular, .0003 mfd. Osc. 2 reaction condenser.	
C9, fixed tubular, .0001 mfd. Osc. 2 grid condenser.	
C10, fixed tubular, .0003 mfd. Osc. tank tuner.	
C12, fixed tubular, .1 mfd. Osc. 2 L.F. coupling.	
VC1, variable slow-motion tuning condenser, dial marked in degrees, .0005 mfd.	
VC2, variable tuning condenser of small capacity, dial marked in degrees, .00025 mfd.	
Resistances:	
R1, 3 megohms. Osc. 1 grid leak.	
R2, 3 megohms. Osc. 2 grid leak.	
R3, 10,000 ohms. Osc. 1 coupling res.	
R4, 50,000 ohms. Osc. 1 volume control and on/off switch.	
V1, Mullard PM1HL valve. Metallised.	
V2, Mullard PM1HL valve. Metallised.	
1 piece of sheet aluminium, thick gauge, 14in. by 9in.	
1 piece of sheet aluminium, thick gauge, 8in. by 6 in. with a 3in. flange.	
Wire for connecting.	
36 d.s.c. wire for winding the coils.	
2 baseboard mounting valveholders.	
1 9-volt grid-bias battery.	
6 wander plugs and flex.	
7 insulated type sockets with screened lead wire and plugs.	
4 crocodile clips.	
1 wooden case, 14in. by 9in. by 6-7in. and tinfoil for covering inside of same.	
2 ebonite coil formers 2in. long by 2 1/2in. diameter, ribbed.	
Quantity of nuts and bolts, wood, and small metal strips.	
2 H.F. screened chokes.	

BUILDING THE "MITE" TWO

Making Up the Cabinet and Panel, and Wiring This New Midget Two-valve Battery Receiver

THE panel and cabinet for this receiver may be made from ordinary plywood, but to preserve a neat front appearance the panel is preferably cut from $\frac{1}{4}$ in. material, whilst the remainder may be $\frac{3}{8}$ in. or $\frac{1}{2}$ in. ply. The front should also be kept to $\frac{1}{4}$ in. to ensure that the components may be mounted by means of their standard one-hole fixing bushes, a thicker panel preventing these from locking securely. The details of all wood parts are clearly shown in the accompanying illustrations, and the panel and containing case should be made together to ensure that the front will fit cleanly over the case. Next the small baseboard should be cut, noting that this is only $6\frac{1}{4}$ in. wide (or slightly less) so that it will slip inside the case. To keep all rigid the baseboard may be attached to a wide strip of wood screwed or glued to the front, or alternatively small screws may be driven through the front and into the thickness of the base, and small side runners may be placed inside the case so that the base rests on these when pushed home. Mount the two condensers and switches on the front and put this on one side whilst the base is completed.

Mounting the Components

Drill the two clearance holes for the valveholders 1 in. in diameter and two $\frac{1}{4}$ in. holes for each of the sockets on the socket

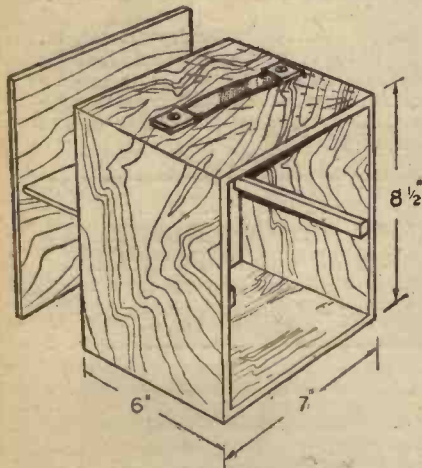

This gives a general idea of the cabinet and panel assembly. Note fillets for supporting base-board.

strips. The remaining small holes through which connecting leads are passed are drilled to $\frac{1}{4}$ in. and this will just clear the wires with standard insulated sleeving over them. Screw down the valveholders, socket strips and coil, but leave the small transformer until last to avoid any risk of damage in view of the rather frail nature of this particular component. Wire up as much of the set as possible before mounting this base, as this is more convenient to handle before the panel is fitted. Leads from the coil to the panel-mounted components may then be attached, cutting them off to length after the panel and base are screwed together. Battery leads and the fixed condensers and resistances should all

be attached to the baseboard before mounting and then the two parts may be screwed together. Complete the wiring to the variable condensers and switches, and then attach the transformer and make the necessary connections to the four coloured leads, taking great care to follow correctly the colour code for these leads. When the

wiring has been completed it should be carefully checked before connecting batteries and valves, and if found to be quite in order a preliminary test may be carried out.

Battery Supplies

It will be noted that the amount of space available in the bottom of the containing case is limited and a standard H.T. battery cannot be accommodated. Accordingly, a small battery supply consisting of standard 9-volt grid bias batteries should be made up, connecting these in series. A further similar battery is needed for grid bias,

(Continued on opposite page)

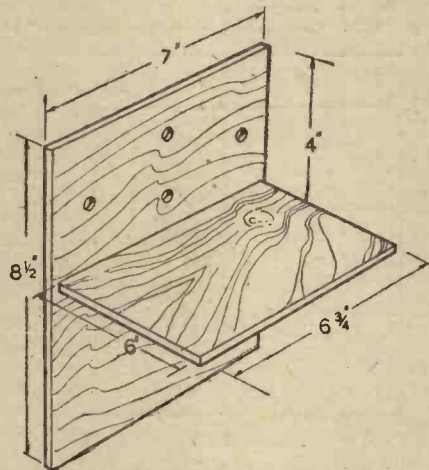

The panel with baseboard fixed in position. All essential cutting measurements for these two items are shown.

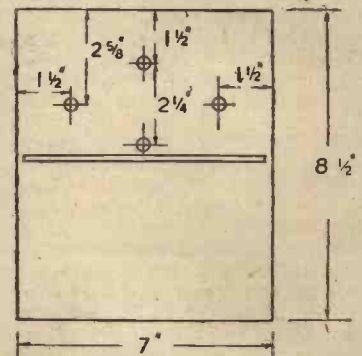

Showing all dimensions for drilling and location of panel components.

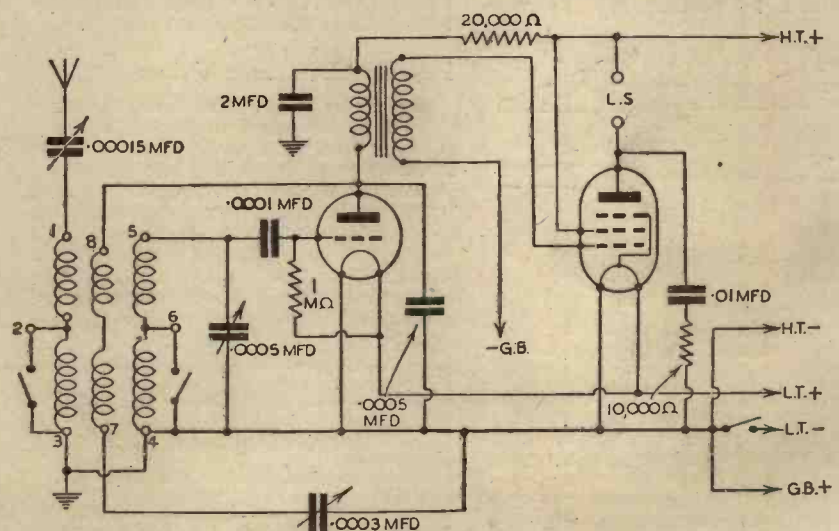

Theoretical circuit of the "Mite" Two.

LIST OF COMPONENTS

- | | |
|--|---|
| One coil, type B.P.80 (Varley). | One L.F. transformer, type L.F. 53 (Bulgin). |
| One .0005 mfd. Compax condenser (Polar). | One on-off push-pull switch, type S.22 (Bulgin). |
| One .0003 mfd. Compax condenser (Polar). | One 3-point push-pull switch, type S.36 (Bulgin). |
| One .0001 mfd. tubular condenser, type 33, (T.C.C.). | Two dials, type I.P.8 (Bulgin). |
| One .0005 mfd. tubular condenser, type 33, (T.C.C.). | One 4-pin chassis type valveholder (Clix). |
| One .01 mfd. tubular condenser, type 3, (T.C.C.). | One 5-pin chassis type valveholder (Clix). |
| One 2 mfd. tubular condenser, type FT (T.C.C.). | One A.E. socket strip (Clix). |
| One 1 megohm $\frac{1}{2}$ watt resistance (Dubilier). | One L.S. socket strip (Clix). |
| One 20,000 ohm $\frac{1}{2}$ watt resistance (Dubilier). | One 210 DET valve (Cossor). |
| One 10,000 ohm $\frac{1}{2}$ watt resistance (Dubilier). | One 220HPT valve (Cossor). |
| | Connecting wire, flex, plugs, etc. |

BUILDING THE "MITE" TWO

(Continued from previous page)

although only a small bias voltage is required in view of the limited H.T. applied

to the output valve. For L.T. there are several small accumulators available, and the particular choice will depend upon the amount of H.T. which it is decided to apply. If exceptionally powerful results are desired—for instance, to operate a loud-speaker—then an external H.T. battery of standard type should be used, but as the receiver is designed primarily for head-phones use the small self-contained battery will be found to give adequate results with a short throw-out aerial. This should preferably be of thin flex such as is obtainable at the popular stores with a silk finish, and it should be about 15 to 20ft. long. It should be attached to the aerial socket and then wrapped round a flat strip of cardboard to keep it free from kinks and to assist in rapid use when desired. It should be thrown out over a fence if the set is used in the open air, or hooked up on a picture rail if used in the home. An earth is not essential but will assist in improving signal strength. As mentioned last week, if it is used very close to a powerful station some additional selectivity may be desired, and for this purpose a small variable or preset condenser may be connected between the aerial and the aerial socket. It should be adjusted to provide the desired degree of selectivity and if desired a shorting switch may be fitted across the condenser, so that it may be eliminated when required.

WIRING DIAGRAM OF THE "MITE" TWO

GB- LT+ LJ- GB+HT- HT+

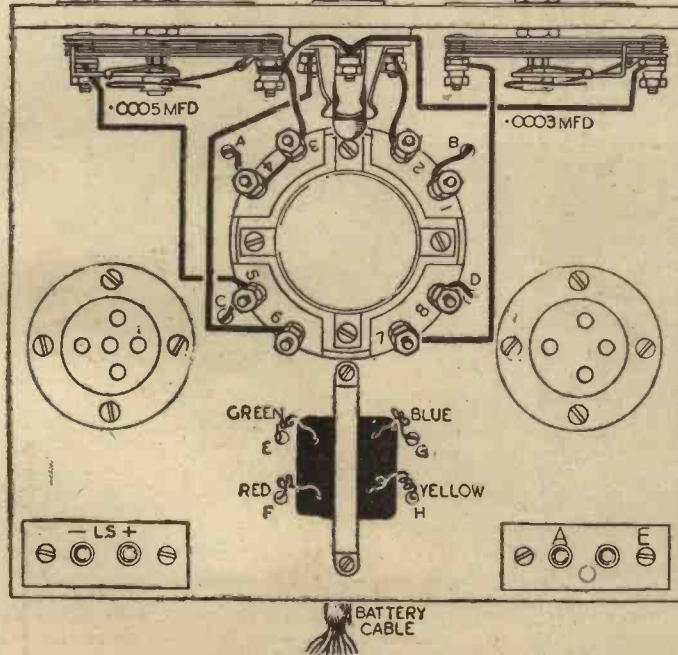
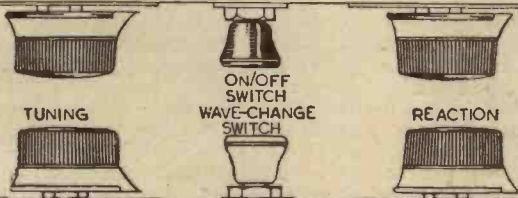
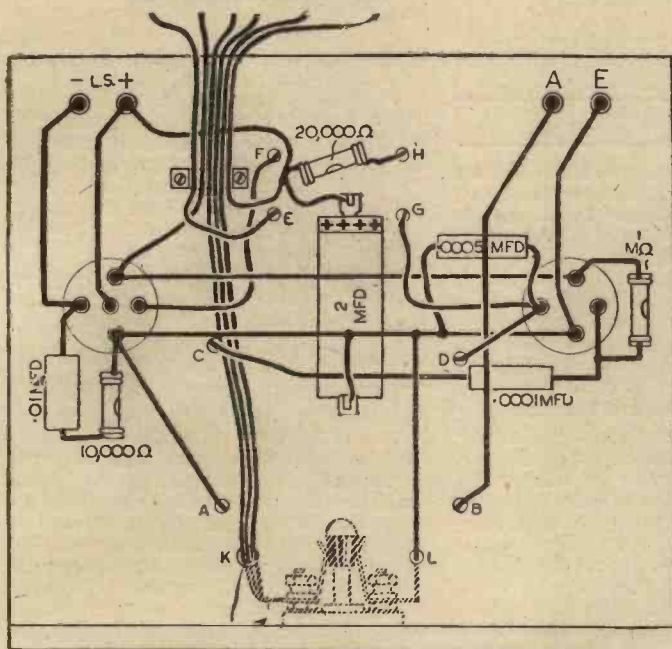

A COMPLETE LIBRARY OF STANDARD WORKS

By F. J. CAMM

WIRELESS CONSTRUCTOR'S ENCYCLO-PEDIA, 5/-, by post, 5/6.

EVERYMAN'S WIRELESS BOOK, 5/-, by post, 5/6.

TELEVISION and SHORT-WAVE HANDBOOK, 5/-, by post, 5/6.

SIXTY TESTED WIRELESS CIRCUITS, 2/6, by post, 2/10.

WIRELESS COILS, CHOKES and TRANSFORMERS and HOW TO MAKE THEM, 2/6, by post, 2/10.

All obtainable from or through Newsagents, or from Geo. Newnes, Ltd., Tower House, Southampton St., Strand, W.C.2

N.T.S. BARGAINS
Secure Yours Now

VALUABLE RADIO PARCELS. Our new offer comprises variable condensers, coil, fixed resistances and condensers, useful control knobs and a brand new universally drilled cadmium-plated steel chassis. Amazing BARGAIN only 5/-, plus 1/- for special packing and postage.

5-v. BATTERY SHET CHASSIS. Amazing bargain in replacement chassis. Employs highly efficient 5-valve superhet circuit, seven stages in all, economical H.T. consumption provided by the use of Class B output. Wave-range, 200-2,000 metres, station and metre-calibrated scale. Chassis size 12ins. wide, 8ins. high, 9ins. deep. Supplied complete with all valves, fully tested and ready for use. BARGAIN 72/6. Carriage paid.

B.T.S. SHORT-WAVE CONVERTER. Famous "Adaband" unit for use with your present battery receiver. Merely stand your set on top with simple external connections. Switched coil units for 13 to 74 metres. Handsome walnut cabinet. Complete with valves and ready for use. BARGAIN 47/6. Original price 5 gns.

CLASS B. 4-VALVE CHASSIS. New limited supply. Suitable for fitting in your present cabinet or for emergency use. Wave-range 200 to 2,000 metres. Selective and sensitive. Volume equal to a mains set. Fully tested chassis (size 11 1/4 in. x 9 in. x 8 1/2 in. high), complete with all valves. Cash with order, only 61/6. Impossible to repeat once present stock is cleared.

BARGAIN PARTS. Parcel of 4 assorted screened and unscreened coils for experimenting and replacement purposes. 2/-, post 6d.

CHASSIS-A.C. ALL-WAVE MODEL. For your radio or radiogram. 18 to 2,000 metres. Pleasing coloured station-name dial. Powerful all-world station-getter. Output 3-watts. P.U. Sockets. Size 11 1/4 in. x 8 1/2 in. high x 9 in. deep. Fully tested, complete with 4 valves. BARGAIN £3 19/6. Carriage paid.

MOVING-COIL SPEAKERS. Special offer mains energised models, 2,000 ohms. Suitable for above mains chassis. BARGAIN, 17/6, carriage and packing, 1/-.

FREE VALVES. S.G.3 Kit for all-wave operation on 9 to 2,000 metres. Available less coils to accommodate those already possessing B.T.S. or N.T.S. One-Shot types. Simple to assemble and an amazing performer on all bands. Two S.G. and Pentode output stages. Complete Kit with metal chassis, transformer, etc., and 3 FREE valves and building instructions. Bargain. Cash or C.O.D., 32/6. If required, complete set of 10 coils (two for each band), 27/-.

HEADPHONES. Lightweight and extremely sensitive. 5/6 pair, postage 6d.

VALVES. Special offer: set of 3 2-volt battery types 1A4E, 1B4E and 2101, brand-new in makers' cartons, complete with valveholders, data and useful circuit diagrams. Bargain. 7/6 the lot, post free.

NEW TIMES SALES CO. 56 (Pr. W.11), LUDGATE HILL, LONDON, E.C.4. 'Phone: City 5516. Est. 1924.

CLIX

SAFEWAYS ADAPTORS

You can use your Radio and other electrical appliances in any room and secure their full benefit throughout your home by fitting a SAFEWAYS Adaptor in your existing lamp-holder.

To nullify the depressing effects of the "Black-out" fit a SAFEWAYS Adaptor with a low-wattage lamp in the branch outlet and the usual lamp in the other. You can then enjoy normal lighting knowing that, should it be necessary, dimmed lighting can be switched on at a moment's notice.

This particular arrangement can also be used as a nightlight for children or invalids, but is merely one of many ways in which SAFEWAYS can increase the convenience of your electrical installation—quickly, cheaply and safely.

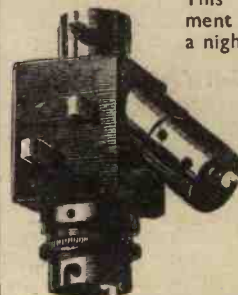

ASK YOUR DEALER FOR

"SAFEWAYS"

Single Switch, 1/10; Double Switch, 2/3; Cord Control 2/6 each.

A CLIX product made by:—**BRITISH MECHANICAL PRODUCTIONS LTD.**

1, Church Road, Leatherhead, Surrey.

PRACTICAL TELEVISION

November 18th, 1939.

Vol. 4.

No. 177.

Japan to the Fore

LIKE the Americans, the Japanese are apparently taking advantage of the lull in British television development and are making strides to catch up in various aspects of the science. Although burdened with a war in China, technical work does not seem to be neglected, according to accounts which reach this country. Important tests under conditions of outside broadcasts are being made with cameras of the storage type, while it is understood that even two-way television and telephone experiments are being conducted. The Japanese authorities have been intensely interested in the subject of television for a considerable period and have repeatedly sent investigators to this country to inquire into the progress made and learn the latest facts. It may come as a surprise to some readers to know that over ten years ago Baird was giving demonstrations to the Japanese. As evidence of this, it is interesting to refer to the illustration below, which shows a Japanese engineer sitting before the scanner in use at that time. The two boxes, each containing a pair of not too sensitive photo electric cells, can be seen on the right, being placed above and below the wall aperture through which passed the scanning beam. Notice also the white background screen to emphasise the head outline (only head and shoulder pictures could be shown with any degree of clarity in those days), together with the dark centre pattern before which the sitter had to place his head in order to keep within the limits of scan of the spot light beam. The inclined mirror above the top cell box enabled the person being televised to check his position periodically, for undue movement was not possible without spoiling the effect of the observed picture. When this pioneer outfit is compared with modern high-definition equipment it serves as a striking example of the enormous strides made in that period of ten years, but every scientific invention has to begin at some point in the ladder of progress.

A Useful P.E. Cell Application

THE extreme versatility of the photoelectric cell is likely to become even more apparent under the present conditions of national emergency, for it is realised that the cell's normal function can be utilised in schemes of attack and defence. An example of the former has recently come to light in America where it is proposed to operate a torpedo photo-electrically. In the top section of the torpedo is located the cell so that when travelling at a good depth below the surface of the water, the cathode surface of the cell is influenced by the daylight filtering through the water. This energising of the cathode is sufficient to keep a relay circuit closed, and the torpedo keeps to a horizontal path towards the ship at which it has been fired. As soon

as the torpedo passes under the bottom of the ship, however, the light is cut off by the shadow of the ship. This opens the relay and mechanism is brought into instant operation for directing the path of the torpedo upwardly against the bottom of the ship, and for making the torpedo explode after a given lapse of time against the underside of the boat where it will cause most harm.

Conditions of Phosphorescence

IN order to be of some assistance during the enforced black-out periods, all sorts of devices are now on sale which claim to give a measure of glow so that a person wearing them can give an indication of his or her position without in any way contravening the lighting regulations. Then, again, certain cinemas and other buildings have taken steps to coat pillars and path guides for pedestrians with a form of paint which glows when flooded with special ultra-violet lamps. This is not visible from the air, yet the combination is of value in drawing public attention to entertainment activities which a blacked-out building front would fail to do. All these schemes are a practical evidence of chemical ingenuity to meet a current demand, and after all are based on the established phenomenon of the transformation of energy of particular forms into radiant energy, a process which is rather generally described by the term luminescence. As is to be expected, the nature of the luminescence depends on the physical condition

and chemical constitution of the material together with the manner of excitation. Incandescence is one well-known example; then we have fluorescence, where the emission of light, as a general rule, ceases with the cessation of excitation, whether this is derived from a fast-moving stream of electrons or some form of light. In connection with this A.R.P. work, however, the section is the phosphorescent one, as this implies that light continues to be emitted for a time after the incidence of the particular radiation has finished. In the case of the majority of the luminous paints, or buttons, it is generally sufficient to subject the surface to a bright light first of all, and after this it will exhibit the phosphorescence for quite a long period. It may be necessary to periodically renew the activating agency if it is desired to keep the badge active for a long time, but this is quite a simple matter.

Various Types

THE chemical constitution of the various powders used for these purposes determine both the colour, intensity and duration of the phosphorescence, while the presence of impurities even in very small quantities can make a material difference to the results obtained. Then, again, it is found that phosphorescence is affected by temperature, for warming a surface covered with luminous paint increases its luminescence, while cooling it has the reverse effect. There are many methods now employed for the preparation of phosphorus, as the chemical is termed, and one of the most popular is called "sidot blende" or "phosphorescent zinc sulphide." It is prepared by adding magnesium chloride and sodium chloride to pure zinc ammonium sulphate dissolved in water. The precipitate with hydrogen sulphide is then dried without being washed, and the zinc sulphide in yellow crystalline form which remains after heating is found to be highly phosphorescent. When this substance is intensely excited a strong violet light is emitted for a fraction of a second, and after this a greenish coloured



The Japanese have always evinced great interest in television and this illustration shows a demonstration being given by Baird several years ago.

PRACTICAL TELEVISION

(Continued from previous page.)

light is noticed, and this under favourable conditions can last for a few hours.

Another Interesting Experiment

THE production of the deflecting voltages and currents which have to be fed to the cathode-ray tube under normal working conditions is often imperfectly understood, and the present period of tele-

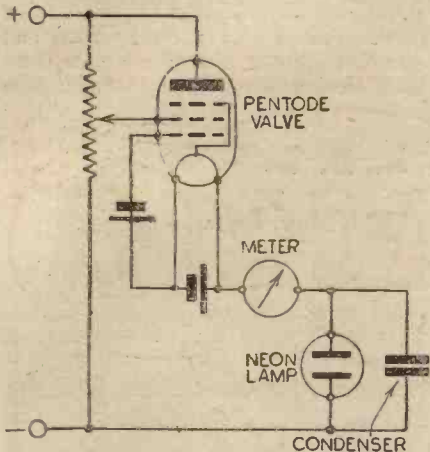

Fig. 2.—A simple circuit for demonstrating the essential principles of a time-base generator unit.

vision inactivity in so far as actual transmissions are concerned provides an excel-

D.C.—H.T. ELIMINATORS AND L.T. CHARGERS

(Continued from page 190)

Safety Precautions

As with D.C. eliminators, always remember the possibility of getting a shock between one side of the mains and earth, so never connect or disconnect the accumulator or touch any bare conductors until the supply has been switched off.

Always use a double-pole switch in the supply circuit and include, at least, one suitable fuse, the value of which will depend on the charging rate.

Don't charge at a current rate above that specified for the cell or cells under charge, and always see that the electrolyte is maintained at its correct level, usually about $\frac{1}{4}$ in. above the plates. Pure distilled water should be used for topping up the cells, and periodical tests made with a hydrometer to see if the specific gravity of the electrolyte is correct.

Finally, if any doubt exists as to which is positive or negative of the mains, and it is absolutely essential to know this for all D.C. equipment, carry out the following test, and then mark the mains socket and connector so that no mistakes will be made in the future.

With a lamp of the correct mains voltage in series with one of the leads from the mains, insert the bare ends of the leads in a porcelain, china or glass vessel containing

lent opportunity for the keen reader to gain an insight at least into the basic principles underlying the time-base generator action. No expensive apparatus is necessary and if desired the components can be assembled on a baseboard to serve later as a piece of demonstration equipment. Dealing broadly with the device it is generally appreciated that action of the cathode-ray beam deflecting circuit depends on charging a condenser through a constant current device so that the rise of voltage is linear with time, and then discharging the condenser rapidly when it has reached some predetermined value dependent on the volts required to sweep the scanning spot across the tube screen face. Now the commercial equipment used for this purpose embodies many refinements to ensure that the conditions of linearity are fulfilled, but with the simple experimental apparatus this is not an important criterion. The constant current charging device can conveniently be a pentode valve, for it is known by reference to the anode current anode volts characteristics that for quite a reasonable anode voltage change the anode current remains sensibly constant. To discharge the condenser a gas-filled relay (thyatron) or a neon lamp can be used, and since the experimenter is more likely to have the latter handy, or alternatively the outlay for same is very small, it will be assumed that this is used. A reference to Fig. 2 will show the essential circuit details, and as far as the pentode valve is concerned the connections will vary with battery or mains valves.

a solution of salt and water. The bare ends must be kept a few inches apart and it will be noticed, when the mains are switched on, that bubbles are produced around one of the leads. These indicate that that lead is the negative. It is essential for the mains lamp to be in series, in case the two bare ends are brought into contact with each other; similarly, it is equally vital for the tester to avoid making contact with the salt water or the bare ends of the mains leads.



Here is Fred Hartley (of the famous Sextet) with his sternest critic—Mrs. Fred Hartley, of course. Together they judge one of his latest recordings on their Ekco radiogram.

ARMSTRONG

apologise for delay in delivery of some models. This has been unavoidable owing to the difficulty in obtaining materials. However, customers may rest assured that we are doing our utmost to expedite all outstanding orders. In these difficult times we shall be grateful if customers will allow us as much notice as possible when ordering.

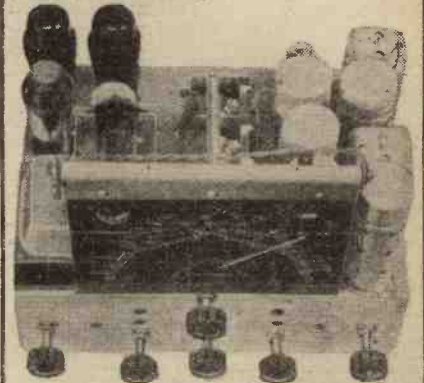

MODEL SS10
"SUPERHET-STRAIGHT" 10-valve High Fidelity Radiogram chassis. All-wave, incorporating 2 independent circuits Superheterodyne and Straight, having R.F. pre-amplifier B.C. coupled push-pull Triode output capable of handling 8 watts.
PRICE £12 : 12 : 0
MODEL AW38 8-valve All-wave Superheterodyne chassis. This All-wave Radiogram chassis has resistance capacity coupled push-pull output capable of handling 6 watts, and gives good quality reproduction on both radio and gramophone, for an economical price of 8 gns.
Armstrong Push-pull Speaker to match AW38 Chassis, £1 : 1 : 0.
We suggest Model AW38 together with matched speaker at £9 : 9 : 0 complete, represents the most outstanding value on the market to-day.

ILLUSTRATED ART CATALOGUE ON REQUEST ALL CHASSIS SENT ON 7 DAYS' APPROVAL
ARMSTRONG MANFG. CO.
WALTERS ROAD, HOLLOWAY, LONDON, N.7.
(Adjoining Holloway Arcade)
Phone NORTH 3213

L.R.S

intend carrying on the good work of supplying Quality Radio Equipment.

ARMSTRONG CHASSIS

PORTABLE A.R.P. RECEIVERS and other reliable radio apparatus are available as usual on our very **CONVENIENT TERMS.**

Write for quotation and full details
PLEASE NOTE OUR TEMPORARY ADDRESS
LONDON RADIO SUPPLY COMPANY
"DENWYN," OKENDEN WOOD RD., CHELSFIELD, KENT

ENGINEERING OPPORTUNITIES



268 PAGES
This unique Handbook shows the easy way to secure
A.M.I.C.E., A.M.I.Mech.E., A.M.I.E.E., A.M.I.A.E., A.M.I.W.T., A.M.I.E.E., and similar qualifications. **WE GUARANTEE—"NO PASS—NO FEE."** Details are given of over 150 Diploma Courses in all branches of Civil, Mech., Elec., Motor, Aero, Radio and Television Engineering, Building, Government Employment, etc. Write for this enlightening Handbook to-day **FREE** and post free.

British Institute of Engineering Technology,
409, Shakespeare House, 17, 18, 19, Stratford Pl., W.1

ELECTRADIX HOME SOUND RECORDING IS NOT EXPENSIVE

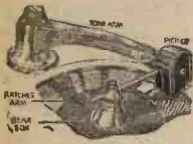

when you buy and use
A FEIGH RECORDER

Fits any Radiogram, positive drive, worm gear and rack. Complete, ready for use, only 37/6. Super Feigh Fidelity Set, 42/6. Tracking Gear only, 21/-. Either 3/3 doz. metal blanks can be used or the glass-coated 10" Simulat discs, 3/- each. Pre-amplifiers for Recording Mikes, 1-valve Battery Model in cabinet, 25/-. A.C. Mains pre-amplifiers, with valve rectifier, steel-cased model, 60/-. (See report on the Feigh, page 194, this issue.)

ACOUSTIC RECORDERS. Great Fun. Lasting Interest. Cost is low. New **MIVOICE** acoustic sets, complete outfits in carton de luxe, 16/-. No. 2 Mivoice, 10/6. Junior, 5/6.

MORSE RECORDING OF WIRELESS SIGNALS. These well-known service paper tape inkers record messages on any wavelength at speed. Recorders add enormously to interest. Magnificent British work, mahogany drawer containing tape reel. Standard G.P.O. type, £5. Portable enclosed Field Service type, complete, fitted with meter and key, unused, £5.

THE P.W. 30/- THREE. Fitted Cabinet, with varia. Condensers and Wiring, 10/6 to callers, or 12/6 post and packing free.

CRYSTAL SETS. Model B, Pol. Mahog. case, 9in. by 10in., 2 tuning condensers, plug-in coils, Permanent Detector, 7/6. 4,000 ohms phones, 4/6.

CRYSTALS, RECEIVING. Enclosed 2-crystal permanent Detector, 2/-. Carborundum Marconi Army Detector, 2/6. Galena point Detector, mounted, 1/6. Galena and Neutron Crystals, 4d., 6d., and Perikon, 1/-. Carborundum mounted, 8d.

LEARN HOW TO SEND AND READ MORSE MORSE PRACTICE SETS are cheap. No. 1 Sound-Key and Buzzer on base, 3/-. No. 2 Light Key and Bulb on base, 2/-. No. 3. Combination Set for Sound and Light key, buzzer and bulb on base, 7/-.
KEYS FOR MORSE. Well-balanced Morse keys, plated brass bar, bakelite base and terminals, etc., 4/6. Massive Buzzer, 1/-. With these and your pocket battery you can signal distant line to pair of 3/9 Sullivan phones. Superior Model Keys, 7/6. A few Government long-lever keys, used spares for transmitting, 10/6. No. 1, R.A.F. Signal Keys, massive balanced bar with adjustments, wood base, 12/6. Fuller Trans Keys, 10/6.

Enclosed Army type, Key W., unused. For heavy work, 14/6. Brown's Key, highest possible grade, police patrol type. Few only, 42/-.
POCKET HEADPHONES. W.D., all leather headband and strap, 3/6 pair. Wireless type, with aluminium headbands, 3/6. 4,000 ohms, 4/6. 6/6 and 8/6.

LISTENING MIKES. steel-clad Electradix indestructible; are ears outside your dug-out.

ELECTRIC SOLDERING IRONS. Heavy workshop type, 125 watts, 220/250 volts, 6/6.

BELLS. G.P.O. type trembler Circular Desk Bell, with movement in gong, 1/6. Wall Bells, trembler, 2/6. Ditto, large size, 7/6. Large metal 12-volt single stroke Bells, 10/-.
MAINS BELLS. A.R.P. 220-volt Ironclad Trembler Alarm Bells, with 10-in. gong, outdoor type, listed, 80/- Sale, 37/6.
Single Bell Wire, 1/- 100 yards. Twin Bell Wire, 3/- 100 yards. Hooters, 6 and 12 volts, 4/6. Bell Transformers for A.C. 100 volts, 2/6. 230 volts, 5/6 and 15/-.
PHOTO-CELLS. R.C.A. caesium silver vacuum, £5 list, for 25/-. Electro-Photonic photo cells generate E.M.F. under light 1 1/2 in. x 1 in., 22/6. Few only left.
DISC SELENIUM CELLS light to dark resistance, ratio mounted in bakelite case, 3/6; in brass housings, superior model, 10/6.
RELAYS. Ultra sensitive moving-coil relay 1,000 ohm coil, closes circuit on 50 micro-amps., 60/-. 2,000 ohm 5 m.A. lightweight magnetic relay, 10/6.
EMERGENCY PARCELS of useful stand-by electrical and radio repair material and apparatus, 10lbs. for 5/-. Post Free.

Send now for our Bargain List "N."

ELECTRADIX RADIOS
218, Upper Thames Street, London, E.C.4
Telephone: Central 4611

OUR STUDENTS GET GOOD JOBS
You can qualify for a well-paid technical post, or learn to earn money in your spare time. Send now for details of our modern Home-study Radio Courses

T. & C. RADIO COLLEGE
FAIRFAX HOUSE, HIGH HOLBORN, W.C.1

B.L.D.L.C. The British Long-Distance Listeners' Club

A VERY large number of our members will no doubt raise a hearty cheer when they see the illustration in these columns of the new A.C.R. certificate. While admitting a certain delay has been experienced in releasing these, we feel sure that all of those who have already submitted their veris for this award will appreciate that existing conditions have been to blame and that the delay has been unavoidable.

Within many days now, some hundreds of amateur shacks and dens will be decorated with a replica of the illustration, which is printed in two colours on a good quality board, approximately 7in. by 5in.

To those who have not already qualified for the A.C.R. we would mention that they should submit verification cards, issued by transmitting stations in the five continents, to prove that they have actually contacted all continents.

To avoid unnecessary correspondence, it should be noted that certificates will now be forwarded as quickly as possible to those who have already submitted their claims, so if by chance you do not receive yours immediately, please do not write.

Curtailed Activities

Many of us have had our normal listening periods considerably upset by fresh and more important claims on our spare time, but there is no need to drop all interest in



A reduced replica of the handsome A.C.R. Certificate which is printed in two colours.

our hobby; in fact, it is very advisable to turn to it as often as possible for relaxation.

Although the amateur transmitter in this country has had to sign off for duration, it does not mean that all amateurs overseas are inoperative. With the local ether less congested, it is an opportunity for the keen listener to reach out for the more distant transmissions and, in other words, put his receiver, and, incidentally, his own capabilities, through a real test.

THE BEST WAR ATLAS

Do you know where Emden is? Do you know how many flying miles from Wilhelmshaven to Scapa Flow? Do you realise the depth of the Siegfried Zone? Do you really know how much easier it is to follow the daily war news with the aid of a really good map? **NEWNES COMPREHENSIVE WAR ATLAS**, which has just been published at the modest price of 1s. 6d., is the finest Atlas of its kind. It is absolutely up to date, and gives eight pages of maps covering all the countries affected by the present conflict and those bordering upon them. There is a special double-page map of the Western Front showing the Siegfried and Maginot Zones, and a number of statistical facts relating to the comparative strengths of the Naval, Military and Air Arms of the belligerent countries. Particularly interesting is a chart showing the distances by air between various strategical points in Europe.

These maps are, without a doubt, absolutely ideal for the home. No wall space is required and they can be referred to instantly and in comfort while reading the paper, for the print is large and clear and the Atlas is the handy size of 12in. by 9 1/2in.

NEWNES COMPREHENSIVE WAR ATLAS is obtainable through all Bookstalls and Newsagents or by post, 1s. 9d., from the Publishers, Tower House, Southampton Street, Strand, London, W.C.2.

PERSONAL PARAGRAPHS

Following the resignation of Mr. A. Scott from the management of the Ediswan Belfast Office, Mr. C. W. W. Torrance has been appointed in his place.

Henry Carlisle, late manager of Jays, for Wireless (Stratford branch) and late of British and Overseas Agencies, has joined H.S.L. (Electric) as outside representative for the London area.

M. Rosenthal has resigned his directorship of Aren Radio and Television, Ltd., and has no further connection with this company.

PRACTICAL MECHANICS HANDBOOK

By F. J. CAMM

6/- or 6/6 by post from George Newnes, Ltd., Tower House, Southampton Street, W.C.2.

Open to Discussion

The Editor does not necessarily agree with the opinions expressed by his correspondents. All letters must be accompanied by the name and address of the sender (not necessarily for publication).

Hamburg on a Crystal Set

SIR,—With reference to C. G. Willson Pepper's letter, published in PRACTICAL WIRELESS, it may interest you to know that I also have heard, on a crystal set, the station mentioned. The station came in, on the bottom end of the band, about R5, with no background from the local station. The programme was announced as being radiated from "Hamburg, Cologne and DJA (on 31-metre band)." The time of listening was approximately between 8 and 9 p.m., and the date was some time about the beginning of October—the 8th, I think.—J. W. DAVISON.

A 14 mc/s Log from Penarth

SIR,—I append my 14 mc/s log which may be of interest to other readers. The set is a 1-v-1, with an indoor aerial.

Times: 21.30-23.00.

Sept. 12th: W2ABL, GW, TP, CD, PD; W3ANJ, W4DSY, W8BNP.

Sept. 15th: W1AKY, JFG, QN; W2GR, LKN; W3EZQ, W4EEE, DCR; W5XCD, W8RL, LFE, CNA; W9ZGO, PCJ; and K4FKC.

Sept. 18th: W1CCZ, ERG, EI, MUZ; W2ACK, W3DZC and W4DCR.

Sept. 23rd: W1AHJ, W2ETI, KC, FYL, FMY; W4KZ, W6PSH, W8QXT.

Sept. 29th: W1BUZ, JDG, DQ, JFG, DIC; W2JWW, GMR, CSS; W3ANO, AIF; W5GPG, W8DBC, DST, RGA, TZL, SPH; and W9ASO.

Oct. 8th: W1LTS, BRO, FGX, OTX, RCJ, CIW, TQ; W2EPD, HCM, KFJ, BZ, DLO, DN, BRI; W3CAB, CEL; W5EEK, W8BNP, CFA, CFI, CMA, CUO; and K4FKO.

I wonder if any reader having a callbook to dispose of would drop me a post-card. Here's wishing the new PRACTICAL WIRELESS a long and successful life.—H. VENNING, 44, Windsor Road, Penarth, Glam.

"Home Service" Broadcasting: A Double-detector Circuit

SIR,—I have received requests through the post for further particulars of the double-detector system. I therefore append the detector circuit of the set used by me, and beg to offer the following remarks, which appear to be essential for a proper understanding of the matter.

(1) It can be used after an H.F. stage and using a three-gang tuning condenser. An H.F. transformer will be suitable in the H.F. stage and in detector 1, and if a set of three-gang H.F. transformer coils are employed the primary of detector 2-coil can be used for reaction purposes.

(2) As there is necessarily interaction between the two detectors, two reaction condensers are not necessary, and fixed reaction can be used if desired.

(3) The value of the resistances in the anode circuit of each detector valve can be varied to suit the type of valve used and the H.T. voltage applied. If the values given are used with H.L. valves, a low value of H.T. must be tried at first in order to prevent oscillation, or a decrease in the

volume of output when reaction is applied. To overcome this, it is suggested that higher values of resistances R4, R5 and R6 be used, and also (experimentally) the input can be taken to the top of each coil. For a first try-out of the circuit, the H.T. to the detectors should be started at about 60-80 volts, and gradually increased as stability is proved. After one has under-

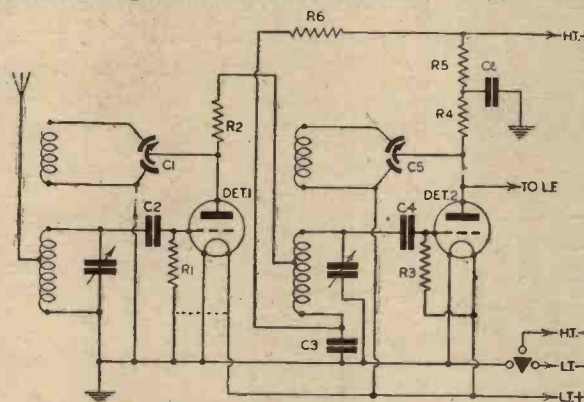

Mr. D'Arcy Ford's Double-detector Circuit. Component values: C1, .0003 mfd.; C2, .0001 mfd.; C3, 1 mfd.; C4, .0005 mfd.; C5, .0003 mfd.; C6, 2 mfd.; R1, 2 megohms; R2, 100 ohms; R3, 1 megohm; R4, 70,000 ohms; R5, 20,000 ohms; R6, 100,000 ohms.

stood the correct principles of operation, the set will be found to be quite stable and simple to use. The 100 ohms resistance R2 was placed there to prevent self-oscillation—but

whether it did so has not been proved. Try the results without this resistance.

(4) It has been found that the grid condenser of detector 2 in different sets has given better reproduction when of the value of .0005 mfd.

(5) The coils which are used in my set are of the highly selective type, so selective that the makers recommend them to be followed by a tone-correcting low-frequency transformer. Although I have not used this, there is still a fair high-note reproduction, so the double-detector system must act as a tone-corrector under conditions of high selectivity.

(6) The system can be adapted to the "second detector" of a superheterodyne. If A.V.C. is used it would be preferable to take it from detector 2, as this carries an amplified voltage.

(7) Detector 1 will probably stand overloading, but if overloading occurs it should be dealt with first in detector 2, probably by lowering the value of its grid-leak. I have altered the grid-leak of detector 2 in my set to 2 megohms, owing to the weak input. The grid-leak to detector 1 can also be tried taken to L.T. positive.

(8) Any L.F. stage can be employed after the two detectors, which in practice act as one stage.

(9) Any kind of crystal (preferably of the semi-permanent type) or metal rectifier can be used with the crystal detector circuit—but it is hardly worth while using crystals after or before a valve stage. When testing the crystal circuit, place the headphones first across the L.F. transformer, and adjust the first crystal for maximum sensitivity. After the headphones are in the final position, the second crystal can be adjusted. A condenser across the 'phones can be tried to see if reproduction is improved.

(10) Any method of detection, including diode, can be used in a double-detector circuit. If greater amplification is required, an S.G. or R.F. pentode valve can be used as detector 1, followed by a triode or diode. Or two multiple-grid valves, provided they are suitable for use as single detectors, can be used in the double-detector system.—D'ARCY FORD (Exeter).

Prize Problems

Problem No. 374

AFTER building a three-valve battery set, Jackson was not satisfied with the tone of reproduction and decided to fit a tone control. For this purpose he used a variable resistance which he had in his spares box, and which had a total value of 25,000 ohms. He joined this across the loudspeaker, but found that instead of varying the tone it affected the volume and even cut signals right out in one position. What was wrong? Three books will be awarded for the first three correct solutions opened. Entries should be addressed to the Editor, PRACTICAL WIRELESS, Geo. Newnes, Ltd., Tower House, Southampton Street, Strand, London, W.C.2. Envelopes must be marked Problem No. 374 in the top left-hand corner and must be posted to reach this office not later than the first post on Monday, November 20th, 1939.

Solution to Problem No. 373

The four-valve set which Rogers made should have been provided with some form of volume control, as the input signal was so great that overloading took place and consequently signals were distorted. When he connected the short length of wire to the aerial terminal he reduced the input and the detector was thus able to pass on a suitable signal to load the output stage fully without distortion.

The following three readers successfully solved Problem No. 372 and books have accordingly been forwarded to them: H. A. Phillips, 176, Pine Road, Bournemouth; T. Bridwell, 61, Goring Road, Colechester, Essex; P. G. Ridgmount, X10, Queens' College, Cambridge.

A 10-metre DX Log

SIR,—I wish to submit my DX log for 28 mc/s (10 metres). All stations were logged between 13.00 and 19.00. B.S.T., and were heard on the loudspeaker of my set. My Rx is a four-valve made from different circuits which have appeared in PRACTICAL WIRELESS. My antenna is a half-wave doublet running N. to S., 34ft. high, and the valve combination is Osram Z21, Mazda HL2 and P220. I have heard 78 countries on 'phone, and 99 on 'phone and C.W.

28 mc/s phone: W1LEU, W2DH, W2VH, W2MES, W3FIL, W4LMS, W5HLO, W5GZK, W5DZK, W8AGU, W8JLW, W9KVB, W9ZHB. All were heard at R9 QSAS on October 29th.

I also would like to exchange my S.W.L. card with anybody interested. I wish PRACTICAL WIRELESS all the success through these trying times, as it is still the best book on radio.—"ENTHUSIAST" (Maidenhead).

Practical Wireless

BLUEPRINT SERVICE

These Blueprints are drawn full size. Copies of appropriate issues containing descriptions of these sets can in some cases be supplied at the following prices, which are additional to the cost of the Blueprint. A dash before the Blueprint Number indicates that the issue is out of print.

Issues of Practical Wireless ... 4d. Post Paid
 Amateur Wireless ... 4d. " "
 Wireless Magazine ... 1/3 " "

The Index letters which precede the Blueprint Number indicate the periodical in which the description appears: Thus P.W. refers to PRACTICAL WIRELESS, A.W. to Amateur Wireless, W.M. to Wireless Magazine.

Send (preferably) a postal order to cover the cost of the blueprint and the issue (stamps over 6d. unacceptable) to PRACTICAL WIRELESS Blueprint Dept., George Newnes, Ltd., Tower House, Southampton Street, Strand, W.C.2.

PRACTICAL WIRELESS Date of Issue.	No. of Blueprint.	Universal Hall-Mark (HF Pen, D, Push-Pull)		
CRYSTAL SETS.				
Blueprints, 6d. each				
1937 Crystal Receiver	PW71			
The "Junior" Crystal Set	PW94	6.11.37	PW81	
STRAIGHT SETS. Battery Operated.				
One-valve: Blueprints, 1s. each.				
All-Wave Unipen (Pentode)	PW31A			
Beginners' One-valver	PW85	10.2.38		
The "Pyramid" One-valver (HF Pen)	PW93	27.8.38		
Two-valve: Blueprints, 1s. each.				
Four-range Super Mag Two (D, Pen) The Signet Two (D & LF)	PW36B PW76	24.9.38		
Three-valve: Blueprints, 1s. each.				
Sixtone Battery Three (D, 2 LF (Trans))				
Sixty Shilling Three (D, 2 LF (RC & Trans))				
Leader Three (SG, D, Pow)	PW34A	22.5.37	PW35	
Summit Three (HF Pen, D, Pen)	PW37			
All Pentode Three (HF Pen, D (Pen), Pen)	PW39	20.5.37	PW41	
Hall-Mark Three (SG, D, Pow)	PW41	12.6.37	PW48	
Hall-Mark Cadet (D, LF, Pen (RC))	PW48	16.3.35		
F. J. Camm's Silver Souvenir (HF Pen, D (Pen), Pen) (All-Wave Three)	PW49	13.4.35		
Cameo Midget Three (D, 2 LF (Trans))	PW51			
1936 Sonotone Three-Four (HF Pen, HF Pen, Westcor, Pen)	PW53			
Battery All-Wave Three (D, 2 LF (RC))	PW55			
The Monitor (HF Pen, D, Pen)	PW61			
The Tutor Three (HF Pen, D, Pen)	PW62	21.3.36		
The Centaur Three (SG, D, P)	PW64	14.8.37		
F. J. Camm's Record All-Wave Three (HF Pen, D, Pen)	PW69	31.10.36		
The "Colt" All-Wave Three (D, 2 LF (RC & Trans))	PW72	18.2.39		
The "Rapid" Straight 3 (D, 2 LF (RC & Trans))	PW82	4.12.37		
F. J. Camm's Oracle All-Wave Three (HF, Det., Pen)	PW78	28.8.37		
1933 "Triband" All-Wave Three (HF Pen, D, Pen)	PW84	22.1.38		
F. J. Camm's "Sprite" Three (HF Pen, D, Tet)	PW87	26.3.38		
The "Hurricane" All-Wave Three (SG, D (Pen), Pen)	PW89	30.4.38		
F. J. Camm's "Push-Button" Three (HF Pen, D (Pen), Tet)	PW92	3.9.38		
Four-valve: Blueprints, 1s. each.				
Sonotone Four (SG, D, LF, P)	PW4	1.5.37		
Fury Four (2 SG, D, Pen)	PW11	8.5.37		
Beta Universal Four (SG, D, LF, Cl. B)	PW17			
Nucleon Class B Four (SG, D (SG), LF, Cl. B)	PW34B			
Fury Four Super (SG, SG, D, Pen)	PW34C			
Battery Hall-Mark 4 (HF Pen, D, Push-Pull)	PW46			
F. J. Camm's "Limit" All-Wave Four (HF Pen, D, LF, P)	PW67	26.9.36		
All-Wave "Corona" 4 (HF, Pen D, LF, Pow)	PW79	9.10.37		
"Acme" All-Wave 4 (HF Pen, D Pen), LF, Cl. B)	PW83	12.2.38		
The "Admiral" Four (HF Pen, HF Pen, D, Pen (RC))	PW90	3.9.38		
Mains Operated.				
Two-valve: Blueprints, 1s. each.				
A.C. Twin (D (Pen), Pen)	PW18			
A.C.-D.C. Two (SG, Pow)	PW31			
Selectone A.C. Radiogram Two (D, Pow)	PW19			
Three-valve: Blueprints, 1s. each.				
Double-Diode-Triode Three (HF Pen DDT, Pen)	PW23			
D.C. Ace (SG, D, Pen)	PW25			
A.C. Three (SG, D, Pen)	PW29			
A.C. Leader (HF Pen, D, Pow)	PW35C	7.1.30		
D.C. Premier (HF Pen, D, Pen)	PW35B			
Ubique (HF Pen, D, (Pen), Pen)	PW36A	28.7.34		
Armada Mains Three (HF Pen, D, Pen)	PW38			
F. J. Camm's A.C. All-Wave Silver Souvenir Three (HF Pen, D, Pen) "All-Wave" A.C. Three (D, 2 LF (RC))	PW54			
A.C. 1936 Sonotone (HF Pen, HF Pen, Westcor, Pen)	PW56			
Mains Record All-Wave 3 (HF Pen, D, Pen)	PW70			
All-World Ace (HF Pen, D, Pen)	PW80	28.8.37		
Four-valve: Blueprints, 1s. each.				
A.C. Fury Four (SG, SG, D, Pen)	PW20			
A.C. Fury Four Super (SG, SG, D, Pen)	PW34D			
A.C. Hall-Mark (HF Pen, D, Push-Pull)	PW45	24.7.37		

CRYSTAL SETS.				
STRAIGHT SETS. Battery Operated.				
One-valve: Blueprints, 1s. each.				
£5 Superhet (Three-valve)		5.6.37	PW40	
F. J. Camm's 2-valve Superhet			PW52	
F. J. Camm's "Vitesse" All-Wave (5-valver)		27.2.37	PW75	
Mains Sets: Blueprints, 1s. each.				
A.C. £5 Superhet (Three-valve)			PW43	
D.C. £5 Superhet (Three-valve)		1.12.34	PW42	
Universal £5 Superhet (Three-valve)			PW44	
F. J. Camm's A.C. Superhet 4		31.7.37	PW59	
F. J. Camm's Universal £4 Superhet 4			PW60	
"Qualitone" Universal Four		16.1.37	PW73	
Four-valve: Double-sided Blueprint, 1s. 6d.				
Push-Button 4, Battery Model		22.10.38	PW95	
Push-Button, 4, A.C. Mains Model				
SHORT-WAVE SETS. (Battery Operated.)				
One-valve: Blueprint, 1s.				
Simple S.W. One-valver		9.4.38	PW88	
Two-valve: Blueprints, 1s. each.				
Midget Short-wave Two (D, Pen)			PW38A	
The "Fleet" Short-wave Two (D (HF Pen), Pen)		27.8.38	PW91	
Three-valve: Blueprints, 1s. each.				
Experimenter's Short-Wave Three (SG, D, Pow)		30.7.38	PW30A	
The Perfect 3 (D, 2 LF (RC and Trans))			PW63	
The Band-Spread S.W. Three (HF Pen, D (Pen), Pen)		1.10.38	PW68	
PORTABLES.				
Three-valve: Blueprints, 1s. each.				
F. J. Camm's E.L.F. Three-valve Portable (HF Pen, D, Pen)			PW65	
Parvo Flyweight Midget Portable (SG, D, Pen)		3.6.39	PW77	
Four-valve: Blueprint, 1s.				
"Imp" Portable 4 (D, LF, LF, (Pen))		10.3.38	PW86	
MISCELLANEOUS.				
S.W. Converter-Adapter (1 valve)			PW48A	
AMATEUR WIRELESS AND WIRELESS MAGAZINE				
CRYSTAL SETS.				
Blueprints, 6d. each.				
Four-station Crystal Set		23.7.38	AW427	
1934 Crystal Set			AW444	
150-mile Crystal Set			AW450	
STRAIGHT SETS. Battery Operated.				
One-valve: Blueprint, 1s.				
B.B.C. Special One-valver			AW387	
Two-valve: Blueprints, 1s. each.				
Melody Ranger Two (D, Trans)			AW388	
Full-volume Two (SG det, Pen)			AW392	
Lucerne Minor (D, Pen)			AW426	
A Modern Two-valver			WM409	
Three-valve: Blueprints, 1s. each.				
Class B Three (D, Trans, Class B)			AW386	
£5 6s. S.G.3 (SG, D, Trans)		2.12.33	AW412	
Lucerne Ranger (SG, D, Trans)			AW422	
£5 5s. Three: De Luxe Version (SG, D, Trans)		10.5.34	AW435	
Lucerne Straight Three (D, RC, Trans)			AW437	
Transportable Three (SG, D, Pen)			WM271	
Simple-Tune Three (SG, D, Pen)		June '33	WM327	
Economy-Pentode Three (SG, D, Pen)		Oct. '33	WM337	
"W.M." 1934 Standard Three (SG, D, Pen)			WM351	
£3 3s. Three (SG, D, Trans)		Mar. '34	WM354	
1935 £6 6s. Battery Three (SG, D, Pen)			WM371	
PTP Three (Pen, D, Pen)			WM389	
Certainty Three (SG, D, Pen)			WM393	
Minute Three (SG, D, Trans)		Oct. '35	WM396	
All-Wave Winning Three (SG, D, Pen)			WM400	
Four-valve: Blueprints, 1s. 6d. each.				
65s. Four (SG, D, RC, Trans)			AW370	
2HF Four (2 SG, D, Pen)			AW421	
Self-contained Four (SG, D, LF, Class B)		Aug. '33	WM331	
Lucerne Straight Four (SG, D, LF, Trans)			WM350	
£5 6s. Battery Four (HF, D, 2 LF)		Feb. '35	WM381	
The H.K. Four (SG, SG, D, Pen)		Mar. '35	WM384	
The Auto Straight Four (HF Pen, HF Pen, DDT, Pen)		Apr. '36	WM404	
Five-valve: Blueprints, 1s. 6d. each.				
Super-quality Five (2 HF, D, RC, Trans)			WM320	
Class B Quadradyne (2 SG, D, LF, Class B)			WM344	
New Class B-Five (2 SG, D, LF, Class B)			WM340	

Mains Operated.				
Two-valve: Blueprints, 1s. each.				
Consoelectric Two (D, Pen) A.C.			AW403	
Economy A.C. Two (D, Trans) A.C.			WM286	
Unicorn A.C.-D.C. Two (D, Pen)			WM324	
Three-valve: Blueprints, 1s. each.				
Home Lover's New All-electric Three (SG, D, Trans) A.C.			AW383	
Mantovani A.C. Three (HF, Pen, D, Pen)			WM374	
£15 15s. 1936 A.C. Radiogram (HF, D, Pen)		Jan. '36	WM401	
Four-valve: Blueprints, 1s. 6d. each.				
All Metal Four (2 SG, D, Pen)		July '33	WM329	
Harris' Jubilee Radiogram (HF, Pen, D, LF, P)		May '35	WM386	

SUPERHETS.				
Battery Sets: Blueprints, 1s. 6d. each.				
Modern Super Senior			WM375	
Varsity Four		Oct. '35	WM395	
The Request All-Waver		June '36	WM407	
1935 Super-Five Battery (Superhet)			WM379	
Mains Sets: Blueprints, 1s. 6d. each.				
Heptode Super Three A.C.		May '34	WM359	
"W.M." Radiogram Super A.C.			WM360	

PORTABLES.				
Four-valve: Blueprints, 1s. 6d. each.				
Holiday Portable (SG, D, LF, Class B)				AW393
Family Portable (HF, D, RC, Trans)				AW447
Two H.F. Portable (2 SG., D, QP21)				WM363
Tyers Portable (SG, D, 2 Trans)				WM367
SHORT-WAVE SETS—Battery Operated				
One-valve: Blueprints, 1s. each.				
S.W. One-valver for America		15.10.38	AW429	
Rome Short-Waver			AW452	
Two-valve: Blueprints, 1s. each.				
Ultra-short Battery Two (SG, det, Pen)		Feb. '36	WM402	
Home-made Coil Two (D, Pen)			AW449	
Three-valve: Blueprints, 1s. each.				
World-ranger Short-wave 3 (D, RC, Trans)			AW355	
Experimenter's 5-metre Set (D, Trans, Super-regen)		30.6.34	AW433	
The Carrier Short-waver (SG, D, P)		July '35	WM390	
Four-valve: Blueprints, 1s. 6d. each.				
A.W. Short-wave World-beater (HF Pen, D, RC, Trans)			AW436	
Empire Short-waver (SG, D, RC, Trans)			WM313	
Standard Four-valver Short-waver (SG, D, LF, P)		22.7.39	WM383	
Superhet: Blueprint, 1s. 6d.				
Simplified Short-wave Super		Nov. '36	WM397	
Mains Operated.				
Two-valve: Blueprints, 1s. each.				
Two-valve Mains Short-waver (D, Pen) A.C.			AW453	
"W.M." Long-wave Converter			WM380	
Three-valve: Blueprint, 1s.				
Emigrator (SG, D, Pen) A.C.			WM352	
Four-valve: Blueprint, 1s. 6d.				
Standard Four-valve A.C. Short-waver (SG, D, RC, Trans)		Aug. '35	WM391	

MISCELLANEOUS.				
S.W. One-valve Converter (Price 6d.)				
Enthusiast's Power Amplifier (1/6)			AW320	
Listener's 5-watt A.C. Amplifier (1/6)			WM387	
Radio Unit (2v.) for WM392 (1/-)			WM392	
Harris Electrogram battery amplifier (1/-)			WM399	
De Luxe Concert A.C. Electrogram (1/-)		Mar. '36	WM403	
New Style Short-wave Adapter (1/-)			WM388	
Trickle Charger (6d.)		Jan. 5, '35	AW462	
Short-wave Adapter (1/-)			AW456	
Superhet Converter (1/-)			AW457	
B.L.D.L.C. Short-wave Converter (1/-)		May '36	WM405	
Wilson Tone Master (1/-)		June '36	WM406	
The W.M. A.C. Short-wave Converter (1/-)			WM408	

In reply to your letter

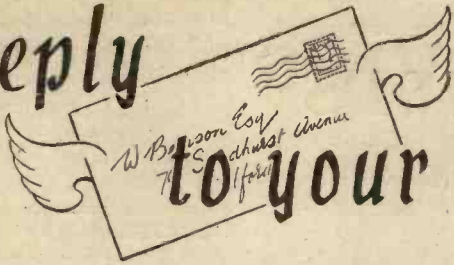

Condensers in Parallel

"I am building a mains unit for a friend which must have an 8 mfd. paper type condenser. He is in possession of two 4 mfd. paper type condensers at the right voltage. Can I join these in parallel in the place of the 8 mfd., and will they serve the same purpose as that which is marked in the circuit as a reservoir condenser?"—W. M. (Buckfastleigh).

CONDENSERS connected in parallel are additive and, therefore, two 4 mfd. condensers in parallel will give a total capacity of 8 mfd. and your idea is, therefore, quite in order.

Extension Speaker

"I have a commercial set which has extension speaker sockets. I am not certain, however, what type of speaker must be used with this particular set and I wonder if you can tell me how to find out in the easiest manner. Incidentally, I have two spare speakers which I should like to use."—H. T. (Keith).

UNFORTUNATELY there is no standardisation in the method of taking out extension speaker connections. In some receivers the built-in speaker transformer is used as a choke and the extension speaker is thus choke-fed, calling for a high resistance type of speaker. In others the extension sockets are connected to the speech coil circuit of the built-in speaker and thus a low-resistance speaker must be used. To preserve the matching there is not a great deal of latitude in the range of resistance which may be used in the latter case and, therefore, if the information is not printed on a slip fitted to the cabinet you should communicate with the makers and obtain exact data.

Pick-up Matching

"I should be much obliged if you could tell me why my B.T.H. pick-up, which has worked well with a Pye set and also with the S.T. 300, will only give weak signals with my new Cossor set."—B. R. P. A. (N.8).

THE trouble you are experiencing with the pick-up might be due to unsatisfactory matching between the pick-up and the input of the particular set, or to insufficient amplification being provided when the pick-up is switched into the new circuit. We note that it is a commercial receiver and we therefore suggest you communicate with the makers and obtain their opinion regarding the amplification which is provided in this particular model.

A.R.P. One

"I would be much obliged if you could send me the address of the makers and also the price of the coil for your 'A.R.P. One', which I propose to build."—P. R. (Wellington College).

THE makers are T. W. Thompson, 176, Greenwich High Road, S.E.10, and the price is 2s. 6d. post paid.

Resistances in Parallel

"What is the formula for working out the value of resistances when several resistances are in parallel?"—E. M. (Denton, Manchester).

THE formula is: Total resistance equals the Reciprocal of the Sum of the reciprocals. This may be written down thus:

$$\text{Total resistance} = \frac{1}{\frac{1}{R_1} + \frac{1}{R_2} + \frac{1}{R_3}} \text{ etc.}$$

RULES

We wish to draw the reader's attention to the fact that the Queries Service is intended only for the solution of problems or difficulties arising from the construction of receivers described in our pages, from articles appearing in our pages, or on general wireless matters. We regret that we cannot, for obvious reasons—

- (1) Supply circuit diagrams of complete multi-valve receivers.
- (2) Suggest alterations or modifications of receivers described in our contemporaries.
- (3) Suggest alterations or modifications to commercial receivers.
- (4) Answer queries over the telephone.
- (5) Grant interviews to querists.

A stamped addressed envelope must be enclosed for the reply. All sketches and drawings which are sent to us should bear the name and address of the sender.

Requests for Blueprints must not be enclosed with queries as they are dealt with by a separate department.

Send your queries to the Editor, PRACTICAL WIRELESS, George Newnes, Ltd., Tower House, Southampton Street, Strand, London, W.C.2. The Coupon must be enclosed with every query.

Receiving Amateurs

"I have an all-wave 5-valve superhet, which gives very good amateur reception on 40 metres. Although commercial stations near and on 20 metres are received very well I find that I can get no amateurs on 20 either on C. W. or 'phone, whatever times I listen. Could you tell me why this is?"—P. A. L. (Westgate-on-Sea).

THE reason why you cannot hear amateurs is that since the outbreak of war, all amateur transmitting licences so far as The British Isles and British possessions are concerned, were withdrawn. Amateur activity on the part of European amateurs has also been curtailed and, generally speaking, the Americans are the only satisfactory amateurs working regularly, and you will find best reception of these on the 10-metre band.

Using Headphones

"I should be glad if you could tell me of any commercial set which is produced, but which has provision for 'phone connections for the deaf. I wish to use an all-electric receiver with an extension speaker to another room and an attachment for myself for 'phones."—W. H. F. (Southgate).

ORDINARY headphones may sometimes be used at extension speaker sockets, but the resistance of the 'phones is important, and also the question of the volume. There may be too much for comfortable headphone use, even with a person who is partially deaf. A trial should

enable this to be ascertained, however. We do not know of any firm making a special receiver with headphone provisions on the lines indicated in your letter.

Gramophone and Hum

"I have added a pick-up and motor to my set to reproduce records, but experience very bad hum. Is it possible that the pick-up leads will introduce this trouble, and if so, how does one overcome it?"—R. W. (Shrewsbury).

THE pick-up leads should certainly be screened, with the screening earthed. The motor unit should also be earthed to avoid hum being picked up by any leads in the receiver. You may, however, have wrongly connected your pick-up or otherwise have modified the circuit wiring of the receiver and this may be introducing the trouble.

REPLIES IN BRIEF

The following replies to queries are given in abbreviated form either because of non-compliance with our rules, or because the point raised is not of general interest.

A. R. (Liverpool, 6). We have published the details on many occasions. The aerial should be joined to either 1 or 2. A 3-point switch should be joined to 3, 4 and earth. Six and 7 should be joined to earth, and 5 to the reaction condenser. Eight is the grid terminal and the tuning condenser is joined across 8 and 6.

P. B. (Blackpool). We described an 18-watt amplifier in our issue dated Dec. 31st, 1938, and this should meet your requirements.

W. A. J. (Hove, 3). It is not clear what details you require. In any case, we cannot give details of various foreign broadcasts.

A. A. H. (Buckingham). So far as we are aware there is no such article manufactured.

J. McL. (Paisley). We regret that we cannot give coil-winding data in the form of a reply and we refer you to our book on the subject, "Coils, Chokes and Transformers."

L. H. B. (Derby). We suggest that you cut out one of the band-pass coils in the H.F. coupling. This will improve volume. You may be able to connect the .0003 mfd. condenser direct to the grid of the second valve. The bias arrangement should work satisfactorily.

R. J. B. (Manchester, 14). As the set is a commercial model we suggest you communicate with the makers regarding the details mentioned in your letter.

H. P. B. (Cambridge). The two resistances should be joined in series, the first acting as the load resistance and the second as a decoupler. The fixed condenser is joined from anode to one side of the primary of the transformer, the other side of which is earthed. The secondary is then joined between grid and grid bias. A 2 mfd. condenser should also be joined between earth and the junction of the two resistances.

C. S. (Rabat). We regret that we are unable to give instructions for a conversion of the type mentioned, and in any case, think it would be extremely difficult to make a satisfactory job in such a case.

J. P. (Hull). The set in question is for battery operation. We are not clear concerning your reference to 5-pin valves. The valves used in the original model are all 4-pin.

M. F. W. (Scarborough). We regret that we have no details of reception conditions in your locality at the present time and, therefore, cannot advise you. Your local radio dealer should be able to assist you in this connection. The Junior receiver is more elaborate than the Stand-by, but results would be about the same.

G. L. (Mumbles). You could use the condensers mentioned, but tuning would be extremely difficult on the short waves with such a large tuning capacity.

D. H. A. B. (Luton). As long waves are working it is obvious that the coil is in order, and we therefore suggest a careful examination of the switch and switch connections.

R. H. A. (Nottingham). We cannot give details, as transmitting activities have been suspended by the authorities.

C. F. C. (Barrow-in-Furness). If the set did not employ a step-up mains transformer the mains can, theoretically, be connected to the smoothing circuit.

S. G. McA. (Collin). Write to the V.G. Mfg. Co., of Gorst Road, Park Royal, N.W.10, and the Electradix Company whose advert. appears in this issue. See the details on the Feigh Recorder in this issue.

The coupon on page iii of cover must be attached to every query.

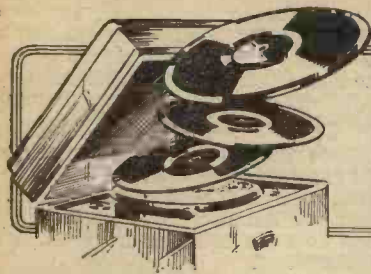

Impressions on the Wax

A REVIEW OF THE LATEST GRAMOPHONE RECORDS

RICHARD TAUBER has chosen two well-known ballads for his latest recording on *Parlophone RO 20453*. They are "For You Alone," sung in English with the composer conducting the orchestral accompaniment, and "Good-Night," which is also sung in English. Coming down to the other end of the vocal scale we have a recording by Oscar Natzke (bass), who, with organ accompaniment, sings "The Song of Hybras the Cretan" coupled with "Hear Me Ye Winds and Waves" on *Parlophone E 11426*.

Millicent Phillips, the young girl soprano, who is rapidly making a name for herself, records two songs on *Parlophone R 2712*—"Waltz Song" and "Spring's Awakening."

Orchestral

OF the orchestral records I choose a waltz medley in two parts on *Parlophone R 2714* called "In Old Time Austria" played by the Orchestre Mascotte and a record by Herman Darewski and his Orchestra which has been recorded at the Spa Royal Hall, Bridlington. It features "Sanctuary of the Heart" and "The Voice of the Sea"—*Parlophone F 1559*.

"That Man Again!"

AS is to be expected, Ronald Frankau pokes fun at that Nazi man with "Heil! Hitler! Ja! Ja! Ja!" and couples it with "The French Girls Have Got Something" on *Parlophone R 2715*. He is accompanied by Monte Crick at the piano.

A Dramatic Recording

A RECORD that I can specially recommend is *Parlophone F 1561*, which gives a vivid and thrilling reconstruction of the sinking of the S.S. *Kensington Court* by a German-submarine, with the ultimate rescue of the crew by R.A.F. flying boats. The episode is reconstructed by Capt. J. Schofield and company. On the reverse side is featured "Wings Over the Navy" which introduces a short speech of thanks by Capt. J. Schofield. The tune is played by that popular combination, The Organ, The Dance Band and Mc, which reminds me that this combination have also made "I'm Sending You the Siegfried Line" and "Kiss Me Good-night, Sergeant Major," on *Parlophone F 1550* and "Old Bill and Young Bert's Medley of Wartime Songs" on *Parlophone F 1551*. This record introduces "Tipperary," "Beer Barrel Polka," "If You Were the Only Girl in the World," "South of the Border," "Mademoiselle from Armentières" and "Booms-a-Daisy."

Leslie A. Hutchinson (Hutch) has made two more records this month. They are "Moon Love" coupled with "Begone" on *Parlophone F 1555* and "The Day We Meet Again" with "The Man and His Dream" from the film "The Star Maker" as the coupling on *Parlophone F 1556*.

Dance Music

HARRY ROY and his Orchestra have two new recordings introducing the popular war song of the moment, "We're Gonna Hang Out the Washing on the Siegfried Line," coupled with "The Daughter of Mademoiselle from Armentières" on *Parlophone F 1547*, and "We Won't Be Long Out There" and "How Ashamed I Was" on *Parlophone F 1548*. In strict dance tempo and with no vocals we have Victor Silvester and his Ballroom Orchestra playing "Love Never Grows Old" (waltz) and "In the Middle of a Dream" (quick step) on *Parlophone F 1553*; also "We'll Meet Again" (slow foxtrot) and "Yours for a Song" (quick step) on *Parlophone F 1554*.

Rex

THE Rex list has the highest proportion of topicalities. Billy Cotton's band plays "I'm Sending You the Siegfried Line" and "Adolf" on *Rex 9634*. On *Rex 9633* he has coupled "The Girl Who Loves a Soldier" with "Run, Rabbit, Run," while on *Rex 9632* he has made a first-rate "wax" of the new patriotic song, "There'll Always be an England." This is backed by "Wish Me Good Luck" from the new Gracie Fields picture. Mention of Gracie Fields brings to mind her latest record of songs of the last war which she has called "Old Soldiers Never Die," and it takes up both sides of *Rex 8618*.

Re-creating a Record

ALTHOUGH there are many readers who have no doubt purchased a re-recording of an H.M.V. Caruso record, how many have ever thought how it is accomplished? Up to the present, only Caruso's records have lent themselves to the process of re-recording, since his voice alone gave forth such a full and steady flow of tone equal in all its registers. Others have been tried but they have proved unsuccessful.

During the years that Caruso made gramophone records the system of recording remained practically unchanged. The voice acted directly on a diaphragm, to which was attached a cutter bearing on a revolving disc of wax. The singer sang into the diaphragm and the actual sound energy he produced was used to drive the stylus cutting the wax disc. This process favoured the human voice, but gave poor, weak orchestral results.

Once the new electrical method, with all its advantages, was in use, the happy idea was hit upon of having a modern opera orchestra accompany a Caruso record, masking the weak orchestral accompaniment (i.e., submerging it) and recording the resulting merged performance. Thus the best of each recording method was utilised.

Classified Advertisements

Advertisements are accepted for these columns at the rate of 2d. per word. Words in black face and/or capitals are charged double this rate (minimum charge 2/- per paragraph). Display lines are charged at 4/- per line. All advertisements must be prepaid. All communications should be addressed to the Advertisement Manager, "Practical Wireless," Tower House, Southampton Street, Strand, London, W.C.2.

RECEIVERS, COMPONENTS AND ACCESSORIES

SOUTHERN RADIO'S Bargains.

ALL Articles Fully Guaranteed. Postage extra.

5/- Parcel of useful components, comprising condensers, resistances, volume controls, coils, wire, circuits, etc., etc., value 25/- 5/- per parcel.

10/- Parcel of useful components, comprising 100 articles, including electrolytics, valveholders, etc., etc., value 55/- 10/- per parcel.

15/- Service man's component kit. Comprising electrolytic condensers, volume controls, tubular condensers, resistances, valveholders, wire, mica and Mainsbridge condensers, etc., etc. 120 articles contained in strong carrying case 9" x 7" x 7" value 65/- 15/- the complete kit.

21/- Small traders' parcel of components, comprising at least 150 articles, including 24 assorted tubular condensers, 24 valveholders, 36 resistances, 12 Mainsbridge type condensers, 6 electrolytics, etc., etc., value 85/- 21/- per parcel.

5/- Twelve Mainsbridge type condensers, 1-2-4 mfd.; 5/- per dozen.

7/6 7/6 for 24; Telseu 3-range meters (volts and milliamps), 4/-; Morse tappers, 2/11.

BUZZERS, 1/6; crystal detectors, 2/-; crystal sets, 5/6; crystals, 6d.

2/6 Ormond loudspeaker units, 2/6.

2/- Tool or instrument carrying cases ex-

-Government stock. Wood 9" x 7" x 7", 2/- each.

SOUTHERN RADIO, 46, Liste Street, London, W.C. Gerrard 6653.

VAUXHALL.—All goods previously advertised are still available; send now for latest price list, free.—Vauxhall Utilities, 163a, Strand, W.C.2.

GALPIN'S ELECTRICAL STORES offer as follows:

Shunt wound charging or lighting dynamos, 220v-10a., £4/10/-; 100v-45a., £7; 100v-10a., 450 r.p.m., £5; 50/75v.-25a., £5/10/-; 50/75v.-15a., £4/10/-; 50v.-4a., 35/-; 20v.-8a., 32/6; Shunt regulators or charging resistances, 7/6 to 15/-; volt-meters, large size, 7/6 to 15/-; amp-meters, large size, all readings, 7/6 to 15/-; milliamp meters by Turner or Weston, 2in. dia., moving coil, sizes 0.5 m/a., 0.50 m/a, etc., 17/8 each; moving-coil movements for recalibration into multirange meters, complete in case, 5/-; large size, 5in. scale, 7/-; H.T. transformers, mains input, 5/7,000v. out, 6/-; 10,000v. out, 10/-; G.P.O. multi contact relays, single coil, 3/6; twin coil, 4/6; triple coil, 5/6; all separate working, various resistances; double output hand-driven generators, 800v. and 6v., 25/-; wire, single 23 s.w.g. enam. and heavy cotton covered, approx. 300yd. coils, 3/6 per coil; ditto twin, approx. 150yd. coils, 4/6 per coil; 18 s.w.g. single, approx. 250yd. coils, 6/- per coil; push back wire, standard telephone approx. 250yd. coils, 10/- per coil; all above wire is new; T.C.C. electrolytic condensers, 2,000mf., 50v. working, new, 5/6; X-ray transformers, 120/150v. input, 50-cycle single phase, 70,000v. output, 3 KVA, £10; also other sizes; large mains transformers, 250-0-250, 200 m/a, three 4v. windings and a 50v. winding, new, 12/8; ½ h.p. A.C. motor for rewinding, ball bearing, D.E. shaft, induction type, 17/6; also large stocks of electrical goods too numerous to mention. Please write stating requirements. All goods guaranteed; all goods three days' approval from date of delivery. Terms strictly cash with order or C.O.D. (C.O.D. is post only and charges extra.)

GALPIN'S ELECTRICAL STORES, 75, Lee High Rd., Lewisham, London, S.E.13.

"STAND-BY" Crystal Set. Specially coil 2s. case 9d., or complete kit of parts, 10s. 3d. post free.—T. W. Thompson and Co., 176, Greenwich High Road, S.E.10.

5/- Bargain Parcel comprising Speaker Cabinet, Drilled steel Chassis, condensers, resistances and many other useful components. Worth £2. Limited number. Postage 1/6.—Bakers Sellhurst Radio, 75, Sussex-Rd., South Croydon

HEADPHONES. Reconditioned and guaranteed. Brown, G.E.C. B.T.H., Sterling, Nipper, Brunet, Western Electric, Siemens, Brandaes, 4,000 ohms, 5/- pair. Telefunken, lightweight, adjustable, 4,000 ohms, 7/6.

CRYSTAL with silver cat's-whisker, 6d. Complete detector parts, 1/-. Glass tube detector on ebonite base, 1/6. Sensitive permanent detector, 1/6. Postage 1d.—Post Radio Supplies, 329, Upper Street, London, N.1.

Practical and Wireless

★ PRACTICAL TELEVISION ★

EVERY WEDNESDAY

Vol. XV. No. 375. Nov. 25th, 1939.

EDITED BY
F. J. CAMM

Staff:

W. J. DELANEY, FRANK PRESTON
H. J. BARTON CHAPPLE, B.Sc.

ROUND THE WORLD OF WIRELESS

Simplified Tuning

THE difficulty of tuning short-wave stations accurately is one which besets every beginner to short-wave work. Unfortunately, it is found that in the majority of cases the listener does not appreciate the sharpness of tuning which may be experienced on the short waves, and accordingly he tries to make do with large capacity tuning condensers and inferior slow-motion dials. The result is that few stations are received and short-wave reception is given up as worthless. When, however, proper tuning adjustments are made there is a tremendous field of interest on the short waves, and in these days of foreign news broadcasts in English it is worth while delving into the short waves, if only to compare the various news items which are heard. All tuning difficulties may be removed with proper tuning facilities, and of these the bandspread arrangement is undoubtedly the most satisfactory. There is no need to obtain special components, and standard parts properly arranged may be used for the purpose. The main features and hints on this subject will be found on page 211 in this issue.

Physical Jerks by B.B.C.

REPEATED efforts have been made by various bodies to induce the B.B.C. to introduce early morning physical exercises, but again it has taken a war to obtain the desired end. These broadcasts will commence on Monday, December 4th, and each broadcast will be of ten minutes' duration, starting at 7.35 every morning

except Sunday. The series will be conducted by experts and will be divided into two sections. On Monday, Wednesday and Friday, a male instructor will direct the exercises at the microphone for men, while on Tuesday, Thursday and Saturday, a woman instructor will broadcast exercises suitable for women listeners. In each case the exercises will be designed for listeners aged under forty years. If the experiment proves successful, it is possible that a series of broadcasts for the "over-forties" will be introduced later on.

Ferranti and Pool Licence

THE British Licensing Pool have announced that manufacturers will now be able to make use of patents controlled by the Ferranti Company under the normal A5 licence, without payment of additional royalty.

War-time in the West Highlands

MISS HELEN MACLEAN, daughter of the Very Rev. Dr. Norman Maclean, lately minister of St. Cuthbert's Church, Edinburgh, will speak on November 24th on "War-time in the West Highlands." She will have stories to tell of the courage and humour with which the Highland people have greeted yet another war which means much hardship to them. Miss Maclean has been for the past two years organiser for the National Labour Party in Scotland.

For Good Music on the Air

A NATIONAL referendum has been organised by the Italian Broadcasting Company (E.I.A.R.) to ascertain what changes in the programmes and in the hours of transmission listeners throughout the country would prefer. All set owners in Italy receiving the circular are asked to fill in the form conscientiously and return it to the Company to ensure a maximum of requests for *Good Music*. They are asked to remember that the selection of future programmes will greatly

depend on the public response to the referendum. Valuable prizes, amounting to a total of 700,000 lire (first prize, 100,000 lire) are being distributed to those who send in their reply before January 31st, 1940.

"Victorian Negative"

WHEN Stephen Potter originally wrote this Samuel Butler programme called "Victorian Negative," a book was selling in fairly large numbers, entitled "Victorian Portrait," which gave a portrait of the golden age. It suggested to Potter the title of his programme about Butler, who was a great anti-Victorian. "Victorian Negative" was the first programme written by Stephen Potter for listeners in this country, and the original version was produced by M. H. Allen. Following this broadcast he was appointed to the B.B.C. staff, and many successful productions have since come from his pen.

Plastic Cabinets

CABINETS in plastic material are increasing in popularity in the

Editorial and Advertisement Offices:
"Practical Wireless," George Newnes, Ltd.,
Tower House, Southampton Street, Strand,
W.C.2. Phone: Temple Bar 4363.
Telegrams: Newnes, Rand, London.
Registered at the G.P.O. as a newspaper and
for transmission by Canadian Magazine Post.

The Editor will be pleased to consider articles of a practical nature suitable for publication in PRACTICAL WIRELESS. Such articles should be written on one side of the paper only, and should contain the name and address of the sender. Whilst the Editor does not hold himself responsible for manuscripts, every effort will be made to return them if a stamped and addressed envelope is enclosed. All correspondence intended for the Editor should be addressed: The Editor, PRACTICAL WIRELESS, George Newnes, Ltd., Tower House, Southampton Street, Strand, W.C.2.

Owing to the rapid progress in the design of wireless apparatus and to our efforts to keep our readers in touch with the latest developments, we give no warranty that apparatus described in our columns is not the subject of letters patent.

Copyright in all drawings, photographs and articles published in PRACTICAL WIRELESS is specifically reserved throughout the countries signatory to the Berne Convention and the U.S.A. Reproductions or imitations of any of these are therefore expressly forbidden. PRACTICAL WIRELESS incorporates "Amateur Wireless."



Arthur Askey (right), "Stinker" Murdoch and Phyllis Calvert in an amusing scene from their new film "Charley's Aunt."

U.S.A. There is a tendency to larger sizes of cabinet in this material and the weight of a recently introduced model exceeds the average plastic cabinet by five times. It is stated that the finish is gained through clever application of decalcomania over the plastic to furnish an exact reproduction of costly burl and rich sliced walnut.

BIASING PROBLEMS

Many Beginners Experience Difficulty with the Practical Arrangements Necessary for Various Biasing Circuits. Some Useful Information on the Subject is Given in This Article
By L. O. SPARKS

As vital as is a suitable source of high-tension to apparatus using modern thermionic valves, it must be appreciated that unless full consideration is given to the essential provision of adequate bias, the efficiency and life of the valves concerned will be most seriously affected.

An examination of the characteristic curves of valves will indicate how closely the potential of the control grid is associated with the correct operation of them and, if comparisons are made, it will also be obvious that the value of the grid potential varies greatly according to the type of characteristic of the valve. For example, a super-power output valve of the L.F. type will require more applied grid bias than a steep-slope output pentode having a high magnification factor and, similarly, the grid of a modern wide base H.F. pentode will usually demand a higher potential than certain types of screen-grid valves.

To enable a beginner to understand more fully the theoretical considerations of bias and valve operation, reference should be made to past articles dealing with these aspects and, at the same time, study, as frequently as possible, the characteristic curves published by the valve manufacturers. All circuit diagrams should also be examined and all grid circuits traced, so that one becomes eventually familiar with the numerous biasing arrangements and systems employed.

former and, with the second method, through the grid leak which always forms part of an R.C. coupling.

As one is solely concerned with maintaining the grid at a certain negative potential with respect to the filament of, in the case of indirectly heated valves, the cathode, when applying grid bias, the source of negative voltage can be obtained from a small dry battery, usually having a total

flowing. This can be expressed in formula as: $R = \frac{E \times 1,000}{I}$ when we are concerned, as we are in this instance, with finding the value of R, as the other two values are known. E will be representing the value of the bias voltage required and I the total current consumption of the circuit in milliamps.

By virtue of the voltage drop produced by this method, the end of the resistance nearest the H.T. negative side will, therefore, become so many volts negative with respect to the L.T. negative and earth line, so it is to that end of the resistance must be connected the lead supplying the bias to the grid concerned. To prevent any undesirable interaction, it is always advisable to by-pass the resistance with a fixed condenser which can have a value between 2 mfd and 25 mfd.

So far, the above only provides bias for one circuit, but the same method can be used for two or more demands, in which case the arrangement shown in Fig. 3 is used. For the sake of clearness, only two bias supplies have been indicated.

The resistance R can now be formed from two separate resistances r.1 and r.2, or it can be of the type which will allow a suitable tapping point to be obtained. The value required to give the bias voltage for G.B.-2 (the higher voltage of the two requirements), is calculated as mentioned above, and, as an example, we will say that it has to be 500 ohms.

The value of the resistance to produce the required voltage for G.B.-1 is then calculated, and we will say that that is 300 ohms. From this, then, we see that r.1 has to be 300 ohms and that r.1 plus r.2 has to be 500 ohms, thus giving r.2 a value of 200 ohms. As in the previous example, it should be noted that each supply is by-passed to earth through its own by-pass condenser.

At first glance, it might seem that this method is a way of getting something for nothing but, on due consideration, it will be realised that the voltages so developed for bias purposes must come from somewhere and, in point of fact, they have to be subtracted from the maximum value of the H.T. supply. If the H.T. supply is normally 120 volts, and the total bias voltages are, say, 12 volts, then the effective H.T. voltage is reduced to 108 volts.

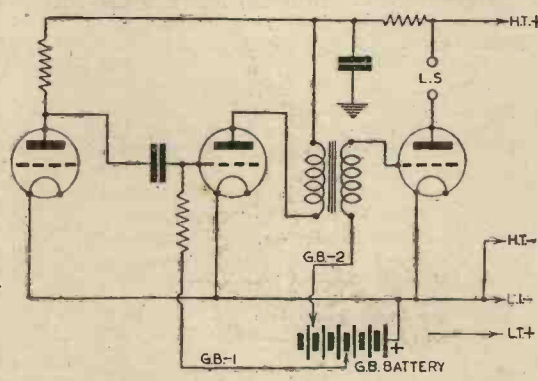

Fig. 1.—A normal L.F. circuit showing how the bias is applied to the grids of battery-operated valves.

value of 9 volts but provided with sockets at every 1½ volts, which has its positive end connected to the L.T. negative side of the circuit. The most simple arrangement is shown in Fig. 1.

It is possible, however, to dispense with an external battery and secure the required voltages by means of voltages dropped across a resistance connected in such a manner that the total current consumed by the circuit provides the required values. This method is usually known as "automatic biasing" and is applicable to battery and mains-operated receivers.

Automatic Biasing

The diagram shown in Fig. 2, depicts the L.F. and output valves of a normal battery-operated receiver. It will be noted that the H.T. negative is not directly connected to the L.T. negative as is usual in a circuit of normal design. The direct connection has been broken and a resistance inserted which we will call R.

As this point represents the connection between the H.T. supply and the negative side of the filament, it will be realised that it also completes the anode circuits of the valves as regards the D.C. current flowing therein. This can be proved by inserting, in place of the resistance, a suitable milliammeter which will register the total current consumption of the receiver.

In previous articles, the most recent of which are those on D.C. H.T. Eliminators and L.T. Chargers, complete details are given of the effect produced by a current flowing through a resistance. It has been explained that such conditions produce a voltage drop across the resistance, the value of the voltage depending on the value of the resistance and the current

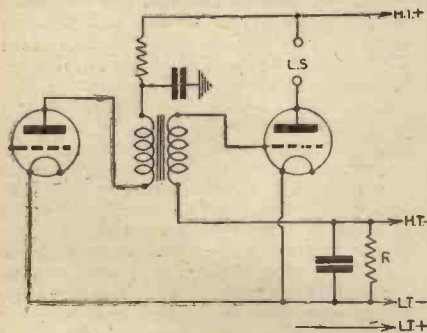

Fig. 2.—The fundamental arrangement for automatic grid bias when only one G.B. supply is required.

L.F. Circuits

The simple type of detector and L.F. circuit offers a very easy-to-follow biasing arrangement, as the grid circuits of the L.F. valves can usually be followed straight through to the source of negative bias, namely, the G.B. battery. It does not matter whether transformer or resistance-capacity coupling is used between the valves, a direct electrical D.C. path must exist to allow the grid to receive its correct bias. With the former method, it receives it through the secondary of the L.F. trans-

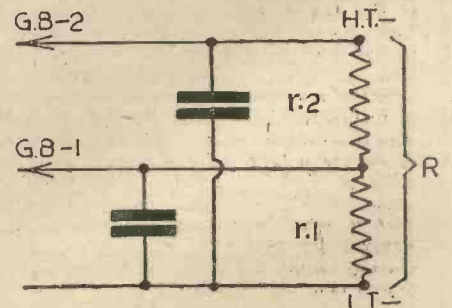

Fig. 3.—Shows how the resistance R has to be tapped to allow more than one G.B. supply to be obtained.

More Light on Bandspreading

Bandsread Tuning Provides Simplified Methods of Station Location. How to Select a Suitable System is Explained in this Article — By W. J. DELANEY

MOST amateurs who are interested in short-wave work have heard of bandspread tuning, but there are still many to whom the actual system is a bit of a mystery, especially when it is noted that some receivers are advertised as having "Electrical Bandspreading," whilst others have "Mechanical Bandspreading." The term itself should be self-explanatory—namely, the band (by which is meant the tuning band) is spread out over a much greater length of scale than is normally

very much lower maximum capacity than the normal tuning condenser. This in turn is provided with its own tuning dial and thus two dials have to be read together. There are, however, several methods of incorporating electrical bandspreading and it is this which gives rise to the doubts and difficulties of the newcomer. In its simplest form it consists of a second condenser in parallel with the normal one, as shown in Fig. 1. A typical combination is found in the special Eddystone range of components where the main condenser, now known as the "bandsetter" is provided with a special

have any direct relation to the dial divisions of the main condenser and thus it will not be possible to progress evenly from one end of the scale to the other for searching purposes. Tuning is certainly simplified by this scheme, however, and tuning settings may be exactly repeated as desired by following both dial indications. A home-made device suitable for this form of bandspreading may be made as shown in Fig. 4.

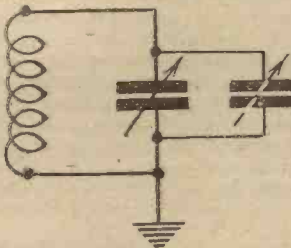

Fig. 1.—The normal bandspread arrangement.

obtained. In a standard type of receiver a single tuning knob or device is employed and thus the band width of the coil in use is covered by a full movement of the tuning scale which is fitted. This will probably occupy an effective length of about 6in. or 7in. Over perhaps $\frac{1}{2}$ in. of this scale there may be 10 or more stations, more being found on the short-wave bands. It is obvious that if that half-inch of scale may by some means be separately brought out so that a pointer will traverse another 6in., the selection of the individual stations will be simplified. This is, in effect, what is done by all bandspread devices. Its utility is obviously mainly of use in short or ultrashort wave apparatus, as on the broadcast band such crowding is not normally experienced. It may, of course, be applied to broadcast receivers and the various methods operate as follows:

Mechanical Bandspreading

A mechanical bandspread device is merely an elaborated slow-motion tuning dial in which, in place of a single pointer, a dual pointer arrangement is provided. These two pointers may be mounted on a common centre point or may be on separate dials, but they are both operated from a single control knob. This knob is provided with some form of gearing whereby one pointer makes several revolutions of a scale whilst the second pointer travels with the vanes of the condenser. A typical instance is the B.T.S. dial illustrated in Fig. 3. The centre pointer makes 8 revolutions to the outer pointer's single revolution and thus by reading both pointer indications together very accurate tuning settings may be instantly reproduced. Furthermore, the very fine tuning which is provided by reason of the low gearing enables very fine tuning settings of the condenser vanes to be obtained. The advantage of this system is that it may be instantly added to any receiver by replacing the existing slow-motion tuning device. It takes up slightly more room, but that is all.

Electrical Bandspreading

The other method of bandspreading makes use of a second condenser, having a

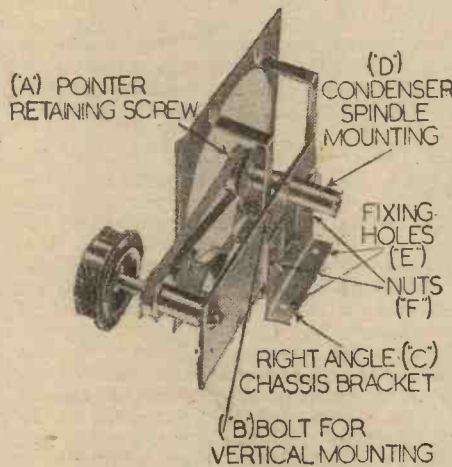

Fig. 3.—The B.T.S. mechanical bandspread device. This costs 17/6 complete.

stop-plate device divided into 10 sections. The maximum capacity of the smaller or bandspreading condenser has a range approximately equal to one-tenth of the bandsetter and thus by moving this condenser in steps and rotating the bandspreader a full scale at a time the tuning is subdivided into 100 sections. By the incorporation of a geared slow-motion drive (9 to 1) the subdivision is in effect still further split up giving an effective splitting up or gearing of 90 to 1. Any small capacity variable may be used for a similar form of bandspreading, although the coverage of the condenser used may not

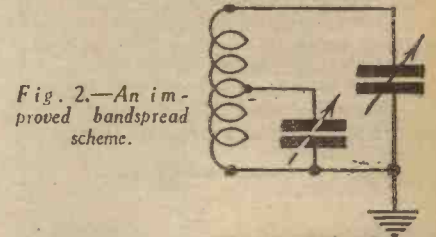

Fig. 2.—An improved bandspread scheme.

A plate is mounted on the supporting or dividing plate of a standard ganged condenser and a small moving plate mounted on a spindle so that a single plate is in each section of the condenser.

For the Amateur Bands

An alternative method of electrical bandspreading which is found in a number of special "communications" receivers is adopted to enable the amateur bands to be spread as desired. That is to say, if a given coil and condenser are employed they will cover, say, from 35 to 50 metres. By arranging the bandsread condenser across only a portion of this coil it will be possible to make the 40-metre amateur band spread exactly over the full range of capacity of the bandsread condenser and in this way the receiver may be used for normal purposes, but when searching for an amateur on the 40-metre band the main condenser is put to a given setting and then the amateur band will be made to cover exactly the bandsread dial, thus simplifying calibration and tuning of the many amateurs which are, in normal times, found on that band. This form of tuning is, perhaps, most effective on the very low wavelengths such as the 10 and 20-metre bands, but it may be tried by amateurs who wish to adopt this method of tuning on other bands. The exact position of the tap across which the condenser is fitted will, of course, depend upon the inductance of the coil and the capacity of both bandsetting and bandspreading condensers, and it is thus best found by experiment.

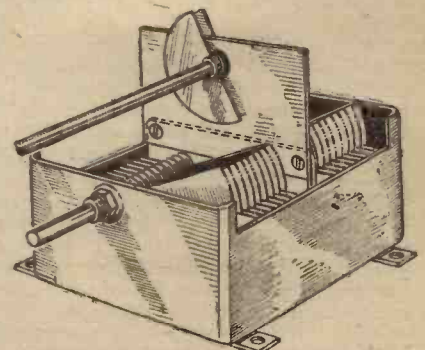

Fig. 4.—Modified gang condenser for bandspreading. This is fitted to certain Peto-Scott instruments.

WORKSHOP CALCULATIONS TABLES AND FORMULÆ

By F. J. CAMM

3/6

or by post 3/10 from
GEORGE NEWNES, LTD.,
Tower House, Southampton St.,
London, W.C.2

"Brushing Up" Your Morse

Details of Different Types of Morse Practice Sets, and of a Simple Receiver for 10-metre Reception

IMMEDIATELY prior to the start of the war many readers were learning morse, partly to enable them to listen to amateur transmissions and more particularly with a view to making application for a transmitting licence. Plans have had to be changed now that British amateurs are, for the time being, "off the air," and because transmitting licences are not now being issued. After the war, there is no doubt that licences for transmitting will be granted as in the past, so it would be a mistake to discontinue morse practice. It does not take long to lose touch with the code once its use is discontinued, and if only a few minutes a week are given to it,

more experienced experimenter—it can be adjusted to give a very high-pitched note by careful adjustment of the contact-breaker screw. This should be turned down as far as possible without allowing the armature to stick against the end of the solenoid core. Sometimes an old buzzer

by The Experimenters

can be improved by replacing the vibrator spring with a stronger one. But the insertion of the .005-mfd. fixed condenser in series with one output lead, as shown, will be of some assistance in raising the pitch as heard through the 'phones.

condenser, whilst a 1-megohm series resistor is included in series to limit the current from the D.C. supply. There is also a load-resistor of 50,000 ohms, and an output-feed consisting of the key and a .005-mfd. fixed condenser. When the condenser in parallel with the neon has a capacity of .0005-mfd. the frequency of oscillation is about 1,000 cycles per second. Consequently, the pitch of the note can be varied by adjustment of the pre-set.

With this arrangement the closed circuit consisting of the neon, load resistor, series resistor and D.C. supply is always in oscillation. But the output is supplied to the 'phones or pick-up terminals only when the key contacts are closed. Since there is no electrical connection between the two output leads from the oscillator, a grid leak—the value is unimportant—should also be connected between the pick-up terminals.

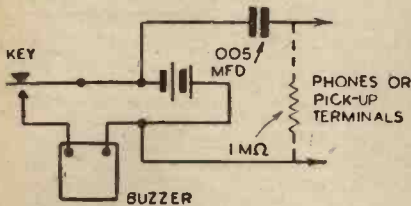

Fig. 1.—Circuit of a simple morse practice unit, using a high-note buzzer.

past experience will not be wasted. In addition, of course, there are many enthusiastic amateurs who hope that eventually they will be able to make use of their radio experience in one branch of the Services.

Down to 10 Metres

Those who were previously accustomed to listen to British amateurs working in code on the 20- and 40-metre bands will now find that there are none to be heard on these wavelengths, except American and a few Continental amateurs, using "fone." But if you go down to 10 metres you will generally find some of the "key punchers"—and their transmissions are nearly always interesting.

Morse Practice

Even if there are no transmissions to be heard there are many ways of keeping in touch with morse, especially if practice is carried out along with a friend. The old method of learning the code is by rigging up a little unit consisting of a high-note buzzer, a tapping key and a dry battery, as shown in Fig. 1. This has the disadvantage that the note is vastly different from that produced by a C.W. transmitter; a low, droning buzz replaces the more pleasing "peep." There is also the objection that listening is done directly, instead of through a pair of 'phones—and this does make a difference. This particular trouble can be overcome by mounting the buzzer inside a padded box, so that it is fairly well sound-insulated, and then connecting the unit to a pair of 'phones, as indicated in Fig. 1. If preferred, the amplifier portion of a broadcast receiver can be used instead of 'phones by making connection to the pick-up terminals.

"Tuning" the Buzzer

Provided that the buzzer is a good one—very cheap ones are not of much use to the

A Neon Oscillator

A far better method is to use an oscillator, of which there are various types. The best-known arrangement employs a valve, but there are certain objections to this. One is that it must be well screened if the oscillator is to be prevented from radiating. Another is that of cost—both initial and running.

For these reasons, it is in many respects better to employ a neon-tube oscillator. As readers know, if a potential is applied across a neon tube, the tube glows due to the gas between the two electrodes becoming ionised and acting as a conductor. It is also known that if a potential is applied to a condenser, the condenser becomes charged. When the terminals are bridged, the condenser is discharged. It is by making use of a combination of these effects that a neon oscillator can easily be made. The idea is that a condenser is joined in parallel with the neon tube. The application of a potential causes the condenser to charge up; when it is charged, the potential is automatically applied to the neon; when the potential builds up to a sufficiently high value the gas is ionised and a discharge takes place. And as soon as the neon becomes a conductor it short-circuits, and therefore discharges, the condenser.

Circuit Details

By choosing a suitable value of condenser the rate of charge and discharge can be of audible frequency. The simple circuit for a neon oscillator is shown in Fig 2, where the neon tube is the Bulgin midget neon. It is in parallel with a .001-mfd. pre-set

Operating Voltage

The D.C. voltage required to operate the neon is 180 to 200, and this might present a difficult problem when the receiver is battery operated, or fed from A.C. It

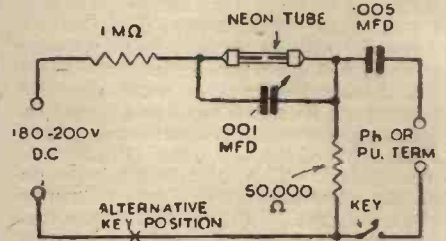

Fig. 2.—Circuit diagram of a morse practice unit incorporating a neon oscillator.

should be remembered, however, that the current passed is so infinitesimally small that it is often possible to use a couple of run-down H.T. batteries of nominal voltage between 100 and 120 each. Alternatively, a lead can be taken to the upper D.C. terminal in the diagram to an H.T. + point in an A.C. receiver; the negative connection is made through the pick-up terminal. Should this method be employed the voltage will probably be in excess of 200, and therefore the 1-megohm series resistor should be replaced by one of 5 megohms. When using a high voltage such as this, take care that all terminals and wiring on

(Continued on page 222)

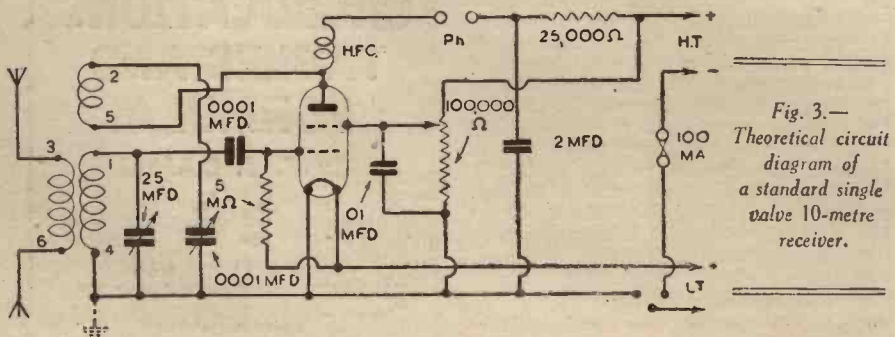

Fig. 3.—Theoretical circuit diagram of a standard single valve 10-metre receiver.

ON YOUR WAVELENGTH

Announcers and Their Names

SO announcers are to be permitted a little publicity. You are to be told the name of the announcer. The move has not gone too far for it to be stopped, and I hope that the arrangement will be withdrawn. The job of an announcer is an over-rated one where little thinking, brains, or ability are required. The only qualification seems to be an Empah voice, and a knowledge of the mis-pronunciations of words which the B.B.C. committee have decided upon. Now all that an announcer has to do is to read a type-written document prepared by some other B.B.C. department. I presume that these documents are typed out with doubtful words spelt phonetically, for I am sure that no announcer would take the risk of committing the heinous offence of pronouncing such a word as *combat* in the manner prescribed by all dictionaries. They might forget that the B.B.C. language commands that it should be pronounced *cumbat*.

However, I cannot see that anyone wants to know, or ought to want to know, the name of an individual retained at a good salary to read a cold-blooded document. I suggest that it is a job which could be dispensed with altogether. The announcements could be recorded on a steel tape and broadcast in the usual way. Too much is being made of this announcing business. It is not the announcer, but the announcement which should interest listeners. I do not care two hoots who reads it, and neither should you, for it is not original matter, and therefore the enunciator matters not. I see in this latest move an effort to place announcing on the same level as crooning. If you have not a voice, but can make burbling sounds in a microphone, you are a crooner, and large sums will be paid to you to keep trained singers out of work. If you are unable to do anything original you can become an announcer. In other words, if you cannot even croon, you read a typewritten announcement. It will be tragic if a man is now regarded as a famous announcer. We all are taught to read, but nothing has nauseated me so much in recent years as the artificial drawing-room manner of many of our announcers. If you meet them in ordinary life their pronunciation, I can assure you, is quite different. The B.B.C. should not allow them to pander to their vanity by permitting them, after the manner of the shining-faced schoolboy, proud of the fact that he has won a prize for regular attendance at Sunday School, to say that it is Bill Brown speaking. Once again I repeat that it is a job which could be done by any intelligent schoolboy, the matter they read is not original, and therefore, the ability required is merely that of being able to read. I cannot think that the question of the pronunciation of words is left to them in view of the chaotic terminological position created by the B.B.C. interference in matters upon which lexicographers have been working for centuries.

We are no more interested in an announcer than in the person who processes a gramophone record or who sets the type



By *Thermion*

from which this journal is printed, not from a public point of view at any rate. Stop the nonsense! No one wants to know the names of the reporters who provide us with our printed news.

Readers on Active Service

PRIVATE A. G. HOBSON, who is somewhere in Hants, was formerly 2AGH. He has now lost his transmitter, his licence, and his friends, and has been conscripted under the militia scheme. Also, he is in an isolated spot, 200 miles from home. He has a little time on his hands and would like to correspond with any SWL in England or Overseas. Any letters sent will be forwarded.

Another reader somewhat similarly placed is Mr. G. Hazelwood. Each of these readers has this journal sent on to him each week. Mr. Hazelwood is also interested in transmitting and receiving. He is at present constructing a crystal receiver for emergency use. Here also I shall be glad to forward on letters.

B.B.C. English

APROPOS my first paragraph it seems that our schools will have to teach B.B.C. as well as A.B.C. Torch thinks

that the B.B.C. Committee consists mainly of Scots, Welsh and Irish—none the less honourable on that account. He gives an imaginary conversation in the train:

My deah fellah! *Combat*? You simplah caunt mean thet! A men like you ought to know bettah. Have yew no thawt for the Empar?

Come raound heah and we'll let you have a luk at some of owah buks.

And when youah gayein heaome in the trectain you ken take thet oppahtunitah to perfect youah pronunciation by repeating ovah and ovah again:

You caunt do thet theah heah!

Let us have a respit from you. It is We whose propah function it is to decide how the English Language shall be spoken.

English—As She is Broadcast

Why should "Spoken English" be
At the mercy of those three—
Sandy, Taffay, Jovial Pat;
But not we English, tell me that?
'Tis because the B.B.C.
Strange complexes has you see,
Which, when we begin to sift,
Seem to start in more "Uplift,"
Self-elected "Bettah Clauses"
Out to "Educate" the "Messes."
So we hear, with inward groan
"Heoam" must now describe our Home
And when they describe a fight
"Combat" is what they indite;
Oh! that we might answer back
Don't be daft, the word's "Combat."
Affectation's in your swank,
Rank pedantry, childish prank,
Till with rage you set us roaring
"What d— nonsense! Oh, how boring!"
"Culshaw" carried to excess
Serves us up a frightful mess,
Strange to palate, throat, and tongue
This "New" English seems quite wrong.
We demand in future—note
English like our fathers spoke;
That Taffay, Pat, and pawky Sandy
In future be a bit less handy
Leaving we English folk to gauge
The way we speak "Our Own Language."
"Torch."

The Wireless Clubs

I AM glad to note that several of our clubs intend to keep going. The Croydon Radio Society held its first war-time meeting, and there was a full attendance of members. Enthusiastic Hon. Sec., E. L. Cumbers, tells me that a number of new members includes many readers of this journal. There is much which clubs can do to keep interest alive. Haphazard clubs are bound to be skittled over by the war, but clubs of the standing of the Croydon Radio Society have become rather more than local institutions, and it is their duty to keep going.



H. M. The Queen seated at the desk in Buckingham Palace from which she broadcast a message to the world on November 11th, 1939.

PRACTICAL TELEVISION

November 25th, 1939.

Vol. 4.

No. 178.

American Television Developments
DEVELOPMENTS of a very far-reaching character are foreshadowed by an item of news which has just come to hand from America. It was to the effect that patent licence agreements, by which each party has the right to use the invention of the other in television and other electronic

co-operation of the American R.M.A. in an important matter of this nature and there has been a measure of non-agreement on some of the standards that were recommended for the initiation of the service.

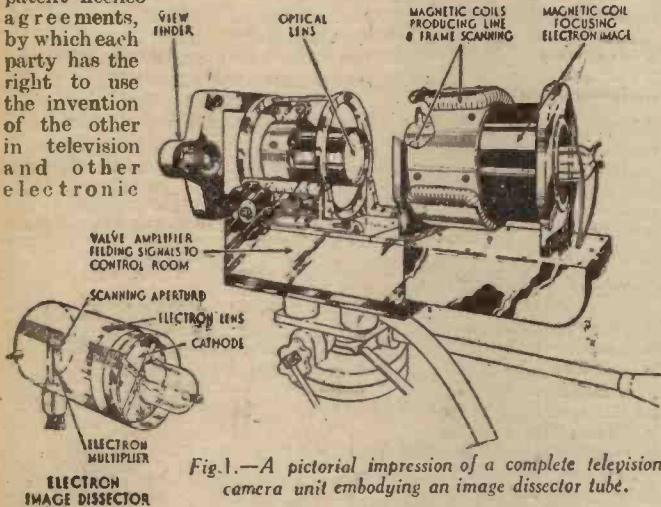

Fig. 1.—A pictorial impression of a complete television camera unit embodying an image dissector tube.

The Latest Type
FOLLOWING on the news contained in the previous paragraph, concerning a pooling of patent resources between Farnsworth and the R.C.A., comes information concerning the latest type of image dissector tube built by the former. The basic principles of operation are similar to the earlier types, but there are many details of refinement which make it admirable for film television purposes. The tube, of course,

fields, have been signed by the Radio Corporation of America and the Farnsworth Television and Radio Corporation. These two firms are the leading ones in the American television field, the former being known best for its Iconoscope developments, and the latter for the image dissector tube. It is agreed by impartial observers that whereas the iconoscope, or storage tube, is capable of producing the best television pictures of either studio or outside scenes, the image dissector tube, due to its absence of flares on sudden light changes, is by far the better device when talking films have to be televised. An agreement of this nature therefore brings about a combination which should ultimately sweep the American market and expedite the progress of television in the United States very materially. At the present moment the industry in that continent is still suffering from delays of a character which resemble very much those which occurred in the early days of the service in this country. Two months ago a committee of the Federal Communications Commission should have presented their report, but there have been the usual delays in completely correlating all the data in regard to the transmission of signals on the channels allocated to television. The magnitude of the service areas has still to be settled, and there is still a good deal of conservatism, as was the case with the B.B.C., as to the distances over which wholly satisfactory results can be expected. Until these facts are brought to light on lines similar to that achieved by the publication of the R.M.A. television service area map a few months ago, the extension of television to cities outside New York is sure to be held up. It is obvious that the F.C.C. must seek the

derives its name from the fact that the electron image produced by the cathode as a result of the influence of the optical image, is dissected into the thousands of elemental picture areas which, taken in their correct sequence, comprise the television signal, which, after amplification, is made to modulate the radiated ultra-short-wave carrier. These tubes are not mass produced, but are treated as separate units, and the individual characteristics taken so that the maximum efficiency is derived from the complete camera. The cylindrical Pyrex glass tube has the caesium silver-oxide cathode mounted in disc form at one end, and the anode which accelerates the electron image towards the target aperture is an internal cylinder of nickel. This is evaporated into position and completely closes the front end except for a rectangular window through which the lens focuses the optical image on to the back cathode. The whole assembly will be made clear by a reference to the pictorial drawing, Fig. 1, which illustrates one of these tubes built up into a camera assembly with sections cut away to show how the parts are related one to

the other. The tube alone is seen in the bottom left-hand corner.

Advantages

THE photo-electric sensitivity, according to the latest American measurements, are of the order of 30 to 45 microamps per lumen, and it is therefore necessary to magnify this signal before passing it to the first valve amplifier stage. In the small metal target which has the scanning aperture, therefore, is mounted a secondary emission electron multiplier, and this is now said to be of the electrostatic type. The modern tube has an eleven-stage multiplier built up from monel metal electro-plated with silver. To maintain a proper potential distribution a fine wire-mesh screen covers the opening to each section of the impact metal, and at the usual voltage working level the overall multiplier gain is found to be over 40,000. Now, since the signal which is derived from the cathode surface consists entirely of photo-electrons and is in no way dependent upon capacity effects or secondary emission, as in a storage tube mosaic plate, the final signal is completely free from shading effects, and in consequence there is no necessity to incorporate correcting circuits and the equipment is simplified. Furthermore, it is quite an easy matter to ensure that the average illumination is included in the television signal (D.C. component) without the necessity for a separate photo-electric integrating device. Although rather limited in its initial sensitivity, therefore, the signal-to-noise ratio is most satisfactory, and the freedom from shadows and the ready availability of background information as a D.C. component render the image dissector tube an admirable device for televising scenes

(Continued on page 216)

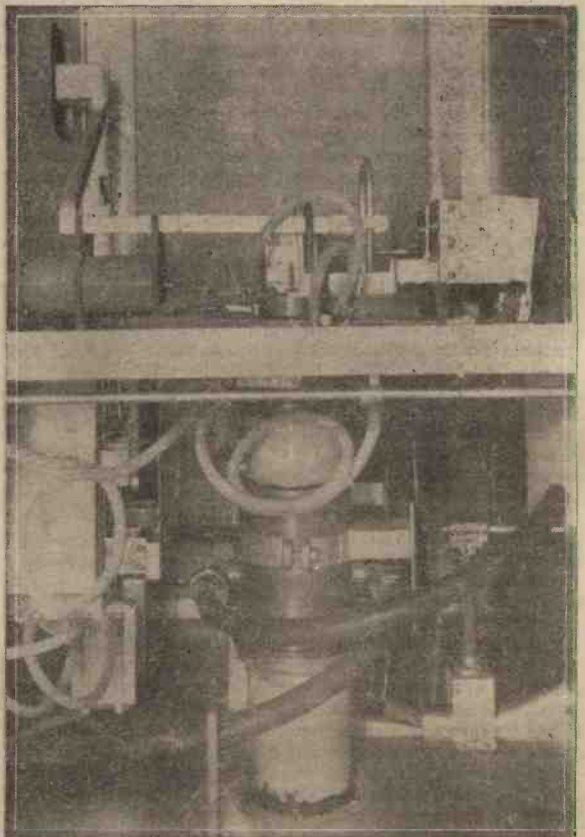

Fig. 2.—An example of a water-cooled tetrode for high-power ultra-short-wave radio transmitting.

SHORT-WAVE SECTION

(Continued from previous page)

Tuning Coil

The following constructional data for building the resonance tuning stage should be adhered to: 1.1 in. diameter six-ribbed ebonite coil former, slotted and wound for 26 turns of 22-gauge tinned copper wire; eighth inch spacing between turns; tuning condenser .0001 mfd. fitted with slow motion dial.

The coil former should be mounted on Raymart lin. type porcelain insulators in a horizontal position. Fig. 4 shows the complete assembly.

Rigid mounting is, of course, essential; a 6 1/2 in. length of former will be suitable, and will allow sufficient space for insulator mounting. The ends of windings are taken to the insulator terminals, and soldering tags mounted on the terminals for the connecting leads.

Operating Details

With regard to the operating of the complete receiver. First, we have an additional tuning control, and one which, if misused, will complicate tuning procedure.

Under these circumstances it is best, therefore, to run the initial tests using aerial input A2 and switch which cuts the

aerial resonance tuner out of circuit. Thus the receiver is operated as a conventional straight three, and by following this procedure the operator is enabled to locate the various band positions on the dial, as covered by the individual coils.

Later, terminal A2 as associated with the aerial resonance tuner should be used. As stated by the writer in a previous article aerial tuner stages of this type, if correctly used, are an asset.

The most satisfactory method of operation is to set the tuner condenser at zero and affix the tapping clip to the centre of its associated coil.

Assume, for example, that the six-pin type coil used in the receiver covers, amongst others, the 31-metre band, and we desire to receive a transmission on this band. The first step is to tune in the desired station to maximum volume and then tune the aerial tuner unit condenser and, in addition, adjust the tapping clip, trying various positions along the coil until a combination of tapping clip and condenser tuning is found to provide the maximum of further increased signal gain.

Correct adjustment will ensure freedom from instability. It will, of course, be necessary to carry out a slight adjustment of the detector stage tuning condenser and reaction. Once these positions and adjust-

ments are found and noted, the operator will automatically carry them out, and changing from one frequency to the next will be as easy as in the case of a tuned H.F. stage receiver.

The foregoing procedure applies to all wave-bands, but it is important to note all adjustments until the operator has become familiar with the operating of the receiver as a whole.

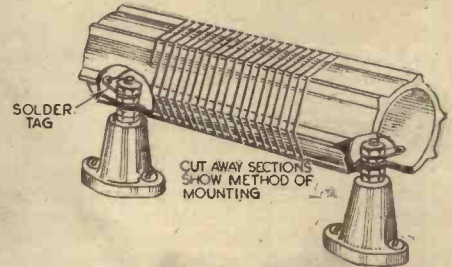

Fig. 4.—Showing the method of mounting the tuning coil.

Final Notes

With regard to the use of headphones on two valves, an important point is the consideration of signal ratio. A two-valve headphones output is an asset due to the fact that searching is facilitated, as an extremely and comparatively low background accompanies all signals.

In addition, the experimenter, and especially those new to short waves and receivers, who carry out initial tests using the headphones, will gain a much better idea as to operating procedure, sensitivity and overall efficiency.

A receiver built on the lines suggested will tune from 15 metres up to 170 metres, and if careful attention to detail in construction is given will function down to ten metres, when suitable coils are available.

After the initial tests and band location have been carried out, the operator should take in hand the complete calibration of all bands, such calibrations to include dial readings and tapped-coil tapping positions.

Apart from the tapped coil, standard six-pin coils of the Eddystone, B.T.S., Raymart and Premier types are quite suitable for use with this receiver, and the same applies to tuning condensers and H.F. chokes as listed by these firms. In the latter instance, however, such chokes should function efficiently with entire freedom from resonance peaks throughout the full tuning range.

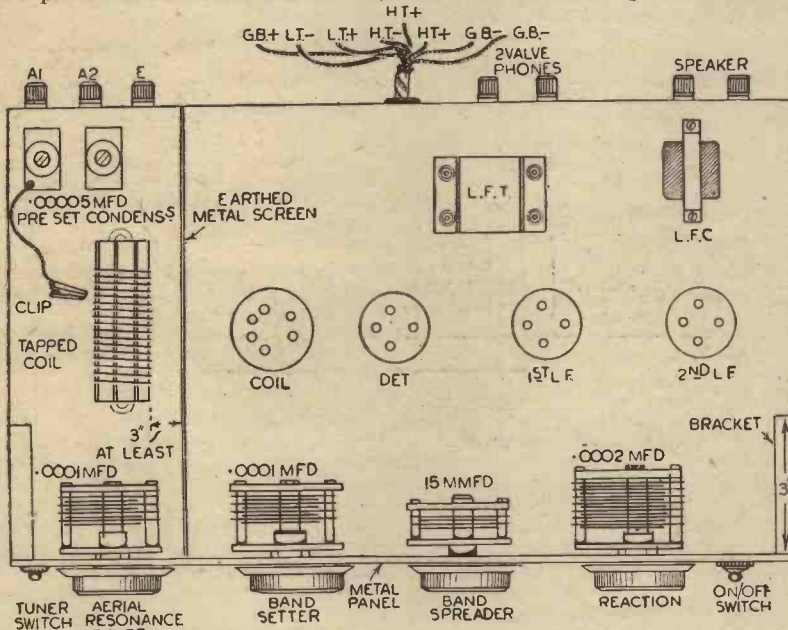

Fig. 3.—The layout of components for the three-valve receiver described in the text.

PRACTICAL TELEVISION

(Continued from page 214)

where the varying contrast pictures are projected on to the cathode in rapid succession, as is the case with talking films.

High Powers at Ultra-high Frequencies

THE rapid development of ultra-high carrier frequencies for radio communication purposes has necessitated a considerable amount of research work being devoted to schemes for satisfactorily generating and controlling these high frequencies with a view to employing high powers. Some years ago it was thought impossible to erect stations with a rated power exceeding a few watts, but on the advent of high-definition television with its stringent demands for service range and band width, a closer study of the whole

problem was made. According to the latest details of high-powered ultra-short-wave transmitters—that is to say, powers of 20 kilowatts and above—many designers favour the use of tetrodes for the output stage. One of the reasons advanced for this is because of the relatively small grid-plate capacity, a feature which in many designs avoids the necessity for neutralising. This is always a difficult problem and, furthermore, the number of possible parasitic oscillations is reduced. In some cases preference is given for demountable water-cooled tetrodes which are continuously evacuated. An actual example of one of these valves complete with water cooling circuits and auxiliary equipment is shown in Fig. 2. Many advantages are claimed for this scheme, quite apart from their extreme stability at the high carrier frequencies employed. Originally this scheme represented a radical departure from past practice in the somewhat virgin field of ultra-short-wave technique, and in

the event of filament failure it is possible to effect repairs in a relatively short space of time. By the use of specially designed water cooling circuits it is possible to make the transmitter handle very large-frequency band widths without upsetting performance, and the pipes for this purpose can be seen in Fig. 2. There is no doubt that with the anticipated increased use of this end of the frequency spectrum for divers commercial and other purposes, many material improvements will be undertaken, and the earlier restriction of service range for satisfactory signals will be extended far beyond the theoretical limits thought possible.

PATENTS AND TRADE MARKS

Any of our readers requiring information and advice respecting Patents, Trade Marks or Designs, should apply to Messrs. Rayner and Co., Patent Agents, of Bank Chambers, 29, Southampton Buildings, London, W.C.2, who will give free advice to readers mentioning this paper.

Practical Hints

A Novel Tune:

SOME time ago I found it necessary to use some type of "tuning" device in the aerial, grid, and reaction coils of a simple S.W. set. I had only one pair of plug-in coil mounts, but I eventually thought of an idea to incorporate these successfully.

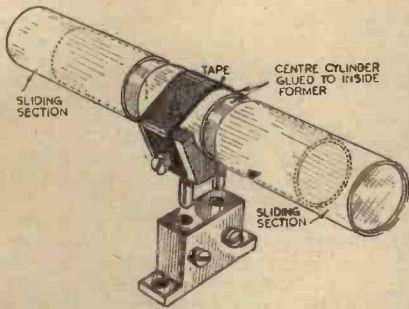

A simple plug-in tuner.

I had in my possession a thin cardboard container about 1 1/2 in. in diameter and about 1 ft. long. I cut this into sections (as shown in the sketch) wound my coils, and mounted them on the plug-in mounts with a strip of insulation tape. The inside cylinder or "bearing" for the two outside formers was glued to the centre piece. When this was finished, the outside coils could be "tuned" by sliding them on the fixed tube, leaving them when the best position was found.—R. A. Palmer (Claydon).

A Duplex Slow-motion Drive

NEEDING a two-ratio slow-motion drive recently, I constructed the device shown in the accompanying sketch. The condenser, or other driven member, is driven by a gear wheel 2 which is driven by the worm drive 3 on the shaft 4 mounted in bearings 5 which are screwed to the baseboard. Shaft 4 is driven by bevel wheels 6 and 7, the main control knob being indicated at 9. This main control knob gives a slow-motion turning effect. A bearing 10 permits shaft 11 to rotate freely, and also allows it to be tilted slightly. When shaft 11 is horizontal a worm-drive 14 engages with

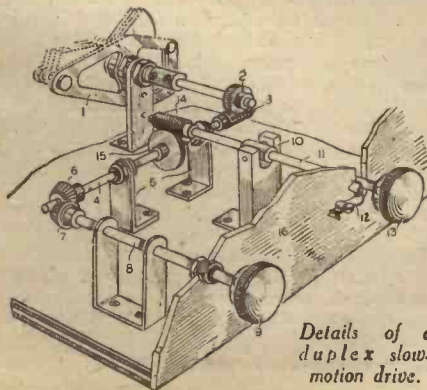

Details of a duplex slow-motion drive.

THAT DODGE OF YOURS!

Every Reader of "PRACTICAL WIRELESS" must have originated some little dodge which would interest other readers. Why not pass it on to us? We pay £1-10-0 for the best hint submitted, and for every other item published on this page we will pay half-a-guinea. Turn that idea of yours to account by sending it in to us addressed to the Editor, "PRACTICAL WIRELESS," George Newnes, Ltd., Tower House, Southampton Street, Strand, W.C.2. Put your name and address on every item. Please note that every notion sent in must be original. Mark envelopes "Practical Hints." DO NOT enclose Queries with your hints.

SPECIAL NOTICE

All hints must be accompanied by the coupon cut from page 228.

a gear wheel 15 centrally situated on the shaft 4. This drive gives a very slow-motion effect when the secondary control knob 13 is turned. As the main control-knob 9 could not

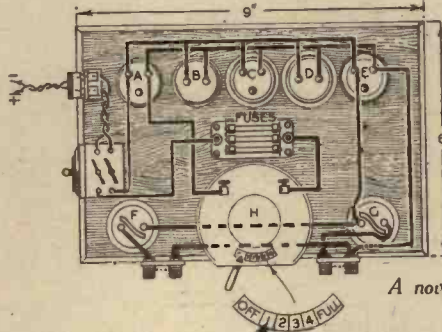

A novel test panel.

be turned whilst 14 is engaging with 15, a small slot is provided in the panel where shaft 11 goes through and a spring catch 12 is placed in such a position that when knob 13 is pulled down it engages with it, and this holds the worm clear of gear 15 to permit of the main control 9 being used.

All the necessary parts for this device were taken from a well-known constructional set, and I have found that the apparatus gives a firm drive with only a vestige of slip on the slowest motion drive, but this

could obviously be eliminated by using close-fitting worm drives and gears.—L. H. BANNISTER (Bath).

Unique Test Panel

IN order to expedite experimental radio work I made up the following idea, illustrated in the accompanying drawing. I had a switch, a regulator and a number of plug sockets available and with a few more components I made up a panel as shown. Both lampholders are wired in series, with a shorting strip across a pair of terminals so that either can be used as a series test lead. The three fuse-holders are mounted on a single base and soldered together, so that practically any desired rating of fuse may be obtained by combination methods. The switch is a safety precaution and is of the double-pole type.—R. H. CORNELIUS (Ely).

A Spring-bladed Screwdriver

THE simple tool illustrated will be found useful for holding and driving screws in inaccessible places.

Take a piece of rod and slot the end about 1/2 in. deep. Into this slot two pieces of steel cut from an old clock-spring are pressed. These pieces are about 1/2 in. wide and about 1/2 in. long. They are made so that the lever bends outward when not in use. When they are squeezed together and put into the slot of a small screw they grip it tightly, so that it may be put into position with ease. The device is rigid enough to act as a screw-driver. To fix the steel blades in the slot the rod is drilled and a pin put through.—THOMAS KELLETT (Swindon).

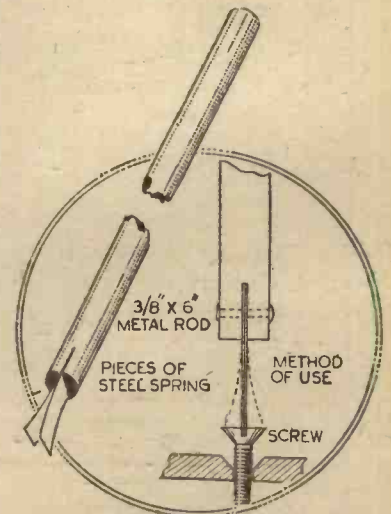

A useful tool for holding and driving screws in awkward corners.

THE WIRELESS CONSTRUCTOR'S ENCYCLOPÆDIA

By F. J. CAMM : 6th Edition
5/- Net

Wireless Construction. Terms and Definitions explained and illustrated in concise, clear language

From all Booksellers or by post 5/6 from George Newnes Ltd., Tower House, Southampton Street, Strand, London, W.C.2.

A CATHODE-RAY TUBE

Constructional Details of a Cathode-Ray Tube for Use as a Monitor on

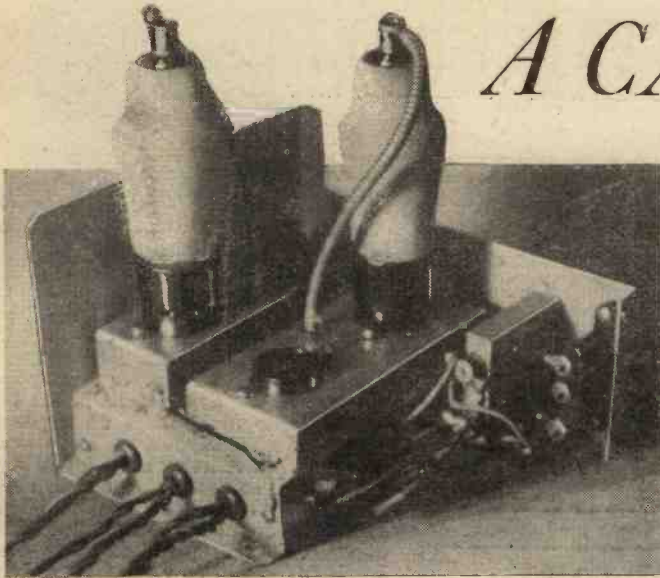

Fig. 8.—General view of the experimental time-base chassis.

THE use of a cathode-ray tube for monitoring purposes is well known to service-men and keen experimenters, but so far we have not published any constructional data for this type of apparatus. The following details will

finished effect is well worth the time spent on it. It is also a good idea gently to slope out the cut at the face of the panel, as in Fig. 3.

When the space has been cut and the two variable resistors fitted, screw the panel on to the baseboard temporarily so as to line up the monitor-tube, which is held in

rests with a pencil. The tube can then be withdrawn and the rests fixed in position with wooden screws from the underside. After sliding back the tube, the panel can then be fixed back on to the baseboard.

After fixing the mains transformer,

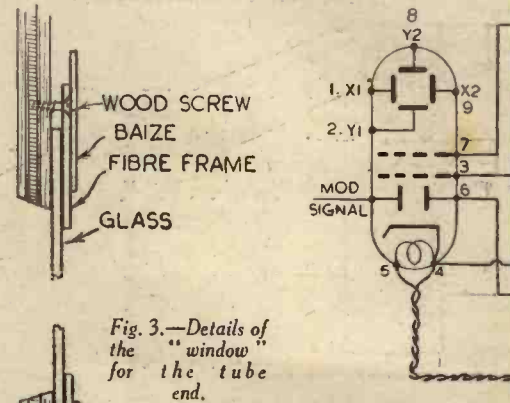

Fig. 3.—Details of the "window" for the tube end.

Fig. 10.—Theoretical

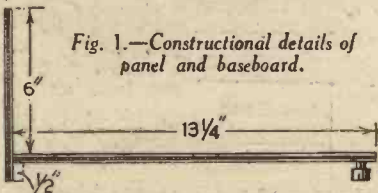
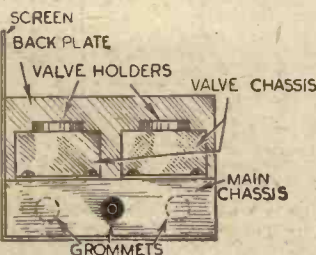
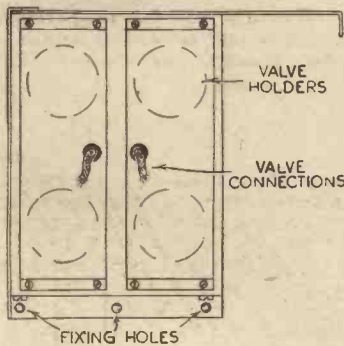

Fig. 1.—Constructional details of panel and baseboard.

enable such a device to be constructed, although this only deals with the assembly and construction of the cathode-ray section—not the time base. This will be given at a later date.

Tube Power-pack

For the base use a piece of thick ply-



Figs. 6 and 7.—General details of the time-base unit.

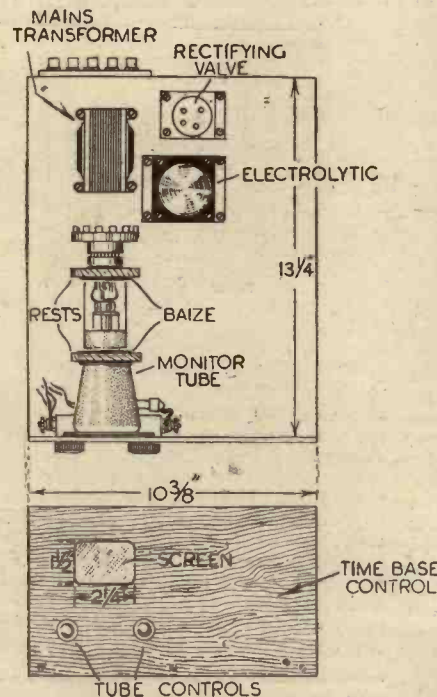

Fig. 2.—Plan of the monitor chassis and front panel details, with dimensions.

position with two plywood frames (as clearly shown in Fig. 2). The tube resting holes are cut oversize to accommodate a strip of baize which is glued on to protect the tube from jars, etc. Make sure that the tube slides freely in the rests, as any stress is dangerous to the tube.

The best plan is to first slide the rests on to the tube in their respective places, hold these down on to the baseboard in the correct position, and then mark around the

arrange the rectifying valve and the electrolytic as near to this as possible, allowing space for wiring and leads. The transformer must lie with the core in line with the monitor-tube; otherwise there will be considerable magnetic interference on the deflected ray when the tube is working.

One other point regarding the picture-space in the panel. The cut edge should be blackened with a dull finish paint to throw the screen into relief, and it is a safety-point to fix a piece of glass between the panel and the tube screen to protect the latter. There is also a piece of baize around the picture space for the tube to butt on to.

FILM STUDIO

YET another ramification of television has become evident by the Continental suggestion that film studios should be able to use electron camera equipment at the same time as the film camera. The idea put forward is that the television and film cameras should be mounted together on the same dolly truck, and by means of matched lenses, or a similar optical device, the two cameras would view the same scene under identical conditions. The signals from the television camera could be fed to receiving sets in remote viewing rooms, and so enable the producers to have an instantaneous monitor of what is being recorded in the film studio. The advantage does not stop here, however, for by using modern big screen receiving equipment the director would have thrown on to the screen pictures which in size would resemble that seen in the average cinema. The sound level could be raised to suit the large picture conditions, and in this way convey to those responsible for directing and producing the picture a far better impression

TUBE MONITOR

Cathode-ray Tube Assembly for Other Test Purposes

The rectifying-valve is mounted on an aluminium bracket, whilst the electrolytic is mounted (by the single-hole fixing nut), on to a piece of ebonite or fibre which in turn is supported by two aluminium brackets.

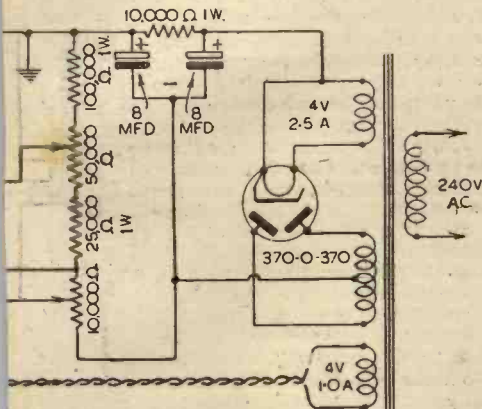

al circuit of the monitor tube and power-pack unit.

Push the nine-pin base on to the monitor-tube pins, taking care not to strain the glass envelope, and the power-pack is ready to wire up.

Wiring

A terminal strip is provided at the rear of the baseboard to accommodate terminals X1, X2, Y1, Y2 and earth. The appearance is greatly enhanced if the strip is engraved in white, and this also applies to the controls on the panel face.

Fixed resistors can be supported by their own wire ends if these are stiff enough, thus saving the expense of clips.

The best way to avoid muddles when wiring is to use coloured flexes, and to keep

a notebook recording the different colour combinations which may be used for certain of the components.

For example: the four leads to X1, X2, Y1 and Y2 could be, say, yellow, red, blue and black respectively. This will be found a great help, especially when wiring the dual time-base unit. A record should also be kept of coloured flexes leading from the time-base valve mountings, as these are in turn mounted on to a main chassis. Rubber grommets should be used for all external connections where these pass through the metal chassis.

Note carefully that H.T. positive is earthed to the power-pack chassis or material between the holder and the chassis, when fixing, to prevent the possibility of a "short."

Dual Time-base Unit

As the writer's own time-base unit is not,

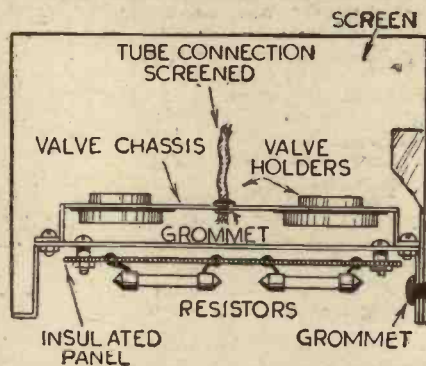

Fig. 5.—Further details of the metal chassis and assembly of parts.

as yet, completed, the performance of same cannot be commented upon; but a few notes concerning this will not come amiss.

The metal chassis is built, as shown in Figs. 5 to 7, aluminium being used. Where paint is used on the chassis, care must be taken to ensure that the various metal parts make good contact, as the chassis is earthed to H.T. negative.

Where base-board mounting valve holders are used for chassis mounting (by reversing the screw contacts), make sure that the latter are well countersunk, and place a piece of insulating

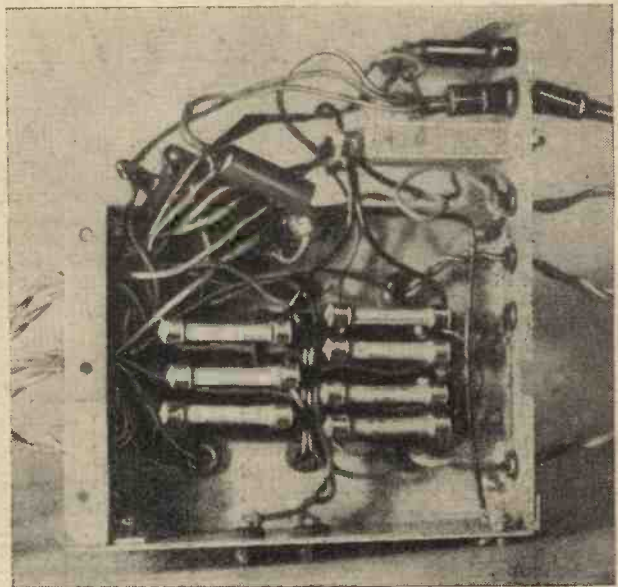

Fig. 4.—Underside of time-base chassis, showing resistor panel.

Notes

H.T. positive on the monitor-tube power-pack unit is connected to H.T. negative on the time-base unit. This is done simply by looping a wire between the two respective chassis.

As gas-filled delay valves are expensive, there are circuits available utilising "hard" valves.

If you have some electrolytics which are "shorted" on one "side," don't forget that these can be utilised by cutting off the "dud" ends and connecting the two negative leads together. In the case of the screening cans not being isolated but are negative, the two condensers should be mounted on to a common chassis, but only in the time-base unit. As the H.T. positive from the monitor-tube power-pack is earthed to the chassis, the above tip cannot be used, unless this particular chassis is isolated from the main chassis.

A list of components is not given as the parts may be identified from the theoretical diagram and the illustrations.

TELEVISION

than that secured in the large, brilliantly lit, studio, when viewing the stage set directly, and listening to the sound on headphones. If desired, the whole of the film camera operator's movements could be controlled from this remote monitor room, and so avoid the confusion of noises which exists when a scene is being shot. Again, the dual advantage of television and film working together in this way would also manifest itself when it is necessary to film timid animals, or birds, in their natural surroundings, for with a remote control of this type, and a continuous observation of the field encompassed by the camera lens, there would be no sound disturbance likely to upset production as a result of the animals becoming startled. The scheme certainly seems to be one worthy of the closest examination, and furnishes yet further evidence of the necessity for film and television interests to work together in the closest collaboration for their common interest even under the present conditions.

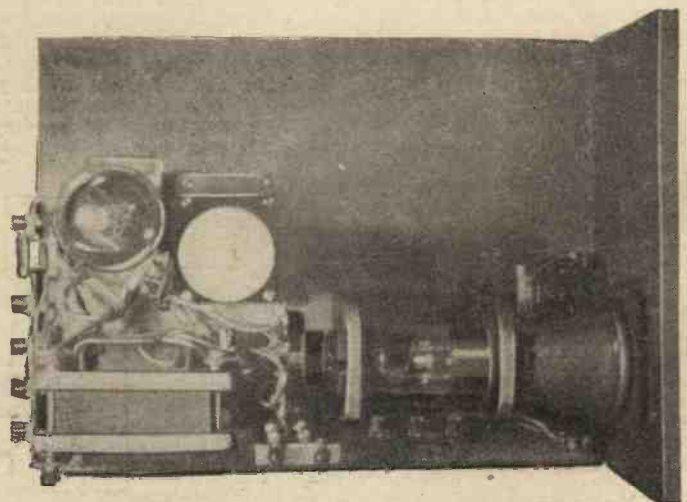

Fig. 9.—Plan view of the C.R. tube assembly with power pack.

RESONANT CIRCUITS

An Explanation of Acceptor and Rejector Circuits, and their Application to Modern Radio Practice

THE phenomenon of "resonance" is perhaps the most important of all the electrical effects which are exploited in both radio transmission and reception; in fact, it is not too much to say that if such things as resonant circuits were unknown radio would be quite impossible of achievement. A circuit is said to be "resonant" to a particular frequency when it is particularly sensitive to that frequency, and less sensitive to all other frequencies. This may need a little further explanation, which is furnished by the statement that a coil or inductance offers an opposition to changes of current, and that this opposition, or "impedance" as it is called, becomes greater as the frequency increases, while a condenser offers an opposition to changes in voltage; this opposition, which is now called "reactance" or "reactive impedance," being smaller as the frequency rises.

Two Kinds

The effect of an inductance is to cause the alternations of current in an A.C. circuit to lag behind the alternations of voltage,

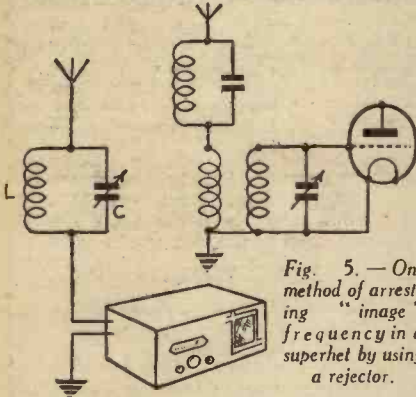

Fig. 5. — One method of arresting "image" frequency in a superhet by using a rejector.

Fig. 4. — A simple rejector wavetraps for eliminating a powerful interference.

while the effect of a condenser is the reverse, making the current alternations tend to lead the voltage alternations. For any combination of inductance and capacity in a circuit there is one particular frequency at which the net result of impedance and reactance is most marked, and the peculiar properties of circuits tuned to resonance with signals—either "wanted" or "unwanted"—are of the greatest value in radio engineering.

Broadly speaking, there are two kinds of resonant circuit—that in which the inductance is in series with the capacity, as in Fig. 1, and that in which the inductance is in parallel with the condenser, as in Fig. 2. It is these two types of circuit which are called "acceptor" and "rejector" circuits respectively, and as these two terms are frequently employed in radio articles, and as the circuits themselves have such wide uses and important effects in receiving equipments, it is necessary to learn something about their properties.

The Acceptor

Consider first the series resonant circuit, or "acceptor" of Fig. 1. Since the effect of

the inductance is to make the current lag, and of the condenser to make the current lead, it is clear that their respective effects are in opposition to one another. Actually the net impedance of such a circuit is equal

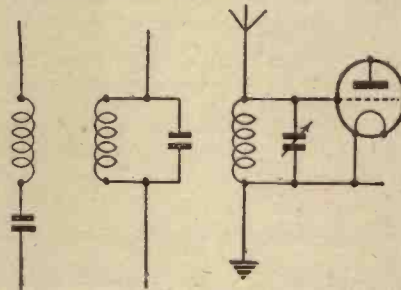

Figs. 1, 2 and 3. — A series tuned, or acceptor, circuit; a parallel tuned, or rejector, circuit; and an ordinary tuning circuit respectively.

to the difference between the impedance of the coil and the reactance of the condenser. Now since the impedance of the coil rises with the frequency and that of the condenser decreases with the frequency, obviously there must be one frequency at which the two quantities are exactly equal, and therefore cancel each other out. In other words, the impedance of an acceptor circuit at resonant frequency is zero. This means, in effect, that a theoretically perfect acceptor circuit would offer no opposition at all to currents having a frequency equal to the critical or natural frequency to which the circuit is tuned, but would offer some impedance to currents of all other frequencies, this impedance being greater as the frequency of the applied impulses differed in increasing amount from the resonant frequency.

The Rejector

The parallel tuned circuit, or rejector, Fig. 2, on the other hand, has entirely different properties, as the currents in the two branches of such a circuit are in opposite phase—that in the inductive arm lagging approximately a quarter of a period behind the voltage alternation, and that in the condenser arm leading the voltage by approximately a quarter of a period, a very curious effect takes place. If we consider a current as a stream of electrons it is possible to secure a very clear idea of what takes place. Imagine the electrons arriving at the top end of the rejector

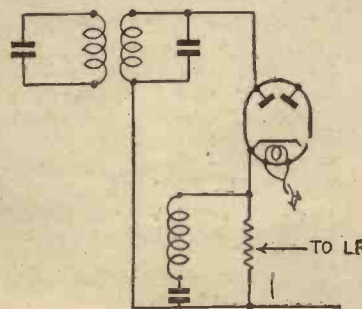

Fig. 8. — An I.F. by-pass to diode load in the second detector circuit of a superhet.

circuit at one particular instant. Owing to the opposition to changes of current offered by the inductance, the electrons will rush into the condenser and charge it up, but at the end of the first quarter period, when the voltage wave has reached its maximum, and is beginning to decrease, the condenser commences to discharge through the inductance, and the electrons now pass into the condenser from the bottom end, and charge it in the opposite direction. At one particular frequency, the "resonant" frequency of the circuit which depends upon the values of the inductance and the capacity, the interchange of current between the condenser and the inductance will occur at a rate exactly equal to the frequency of the incoming impulses, with the result that the current will continually circulate in the resonant circuit. In a perfect resonant circuit, therefore, a very high oscillating voltage is built up at resonance. Such a circuit would have an infinitely great impedance at resonant frequency.

It will now be seen why the terms "acceptor" and "rejector" are applied to these two kinds of circuit. A series tuned

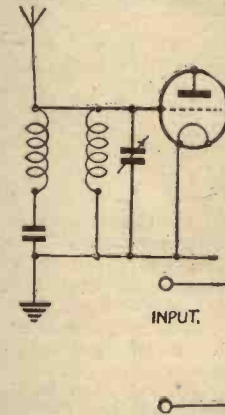

Fig. 6. — An alternative method to Fig. 5, using in this case an acceptor.

Fig. 7 (below). — Tone corrector filter in the form of an acceptor to give a sharp cut-off above a certain frequency.

circuit allows currents of resonant frequency to pass through it—"accepts" such currents, in other words; while a parallel tuned circuit permits very little current at resonant frequency to pass or, in other words, "rejects" such currents.

Examples

The ordinary radio tuner is, of course, a familiar and simple example of a rejector circuit. It is shown in basic form in Fig. 3, and owing to its high impedance to signals of the frequency to which it is tuned, a much greater voltage at that frequency is developed across it, for application to the grid of the first valve, than is developed for signals of other frequencies.

A rejector is also useful as a wave-trap to cut out or reduce the signal from a particularly strong unwanted station. A simple wave-trap is shown at L.C. in Fig. 4, this circuit being connected in series with the aerial and tuned to the unwanted signal. By offering a high impedance to the interfering frequency, the unwanted signal is very greatly reduced. A wave-trap of this kind is not often necessary with a modern receiver, which should be sufficiently selective for all normal purposes, but in the case of simple straight sets with only

two tuned circuits, used within the "swamp area" of a powerful station like Droitwich, a trap is often useful for eliminating the local station when foreign listening is required.

In superhet receivers, there is a possibility of interference from signals of a frequency equal to the intermediate frequency, and this is commonly avoided by the use of what are, in effect, wave-traps of either the acceptor or rejector type tuned to the intermediate frequency. A rejector could be connected in series with the aerial coil as in Fig. 5 and would act as a stopper, or an acceptor circuit would be connected in parallel with the aerial coil as shown in Fig. 6 and form a kind of short circuit for the interfering signal which

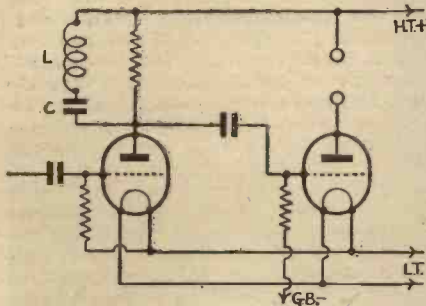

Fig. 9.—L.C. is an acceptor tuned to 5000/6000 cycles for use as a heterodyne whistle filter.

would be bypassed to earth. Another interesting use of an acceptor circuit, tuned to the intermediate frequency of a superhet, is shown in Fig. 8, where the acceptor is connected in parallel with the diode detector load to bypass the intermediate frequency and prevent it being impressed on the following low-frequency stages.

An Annoying Effect

One of the minor annoyances experienced by the users of fairly simple and unselective straight receivers such as the popular H.F.-detector-output combination, is the presence of heterodyne whistles, due to two stations of only slightly differing wavelength "beating" together to produce a high-pitched note usually in the region of 5,000 or 6,000 cycles. It is not possible to prevent the production of such whistles in a receiver of this type, but it is a comparatively easy matter to prevent them from being reproduced in the loudspeaker. All that is required is an acceptor circuit, tuned to about 5,000 cycles connected in parallel with one of the components carrying the low-frequency signal, such as the anode resistance in an R.C. amplifying stage. This will act as a virtual short-circuit for the whistles, with the result that no voltage corresponding to their frequency will be developed for transfer to the grid of the following valve. A whistle-filter circuit is indicated in Fig. 9, and appropriate values for the choke and condenser are 0.5 henry and .001-mfd., respectively

Tone Correction

Closely related to the whistle filter is the tone-corrector filter which is used in various guises in different parts of certain receivers in order to give a reproduction more nearly approaching the original microphone performance than would otherwise be possible, or to modify the results of unequal frequency response in some other part of the circuit. A crude form is a condenser and resistance in series, connected across, say, a loudspeaker to short-circuit part of the upper register and thus

give a more mellow tone, but this is not a true acceptor circuit, and its effect increases with the frequency. If, however, it is desired to make a fairly sharp cut-off above a certain frequency, a form of acceptor circuit similar to that shown in Fig. 7, is often used. It will be noted that the output is taken across the condenser only, and the principle is that if a condenser alone and no inductance were employed, the voltage developed across the condenser would be high for low-frequencies and small for high-frequencies, the drop being uniform. Since the action of the choke is, however, in opposition to that of the condenser, a substantially constant response is obtained to all frequencies up to the resonant frequency, above which the whole of the audio-frequency energy is diverted through the condenser and thus a clearly defined cut-off is obtained.

It is well known that in using an ordinary potentiometer volume-control, there is serious attenuation at both the upper and lower ends of the musical scale at small volume levels. This can be overcome to a large extent by a tone-compensated volume-control such as that shown in Fig. 10, in which an acceptor circuit, roughly tuned to 1,000 cycles, is shunted across a portion of the potentiometer, thus reducing the response for the middle frequencies and maintaining the normal tonal balance. The design of a satisfactory control of this type offers scope for interesting experiment.

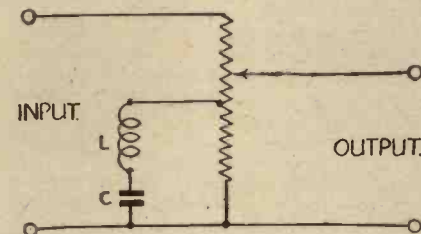

Fig. 10.—Tone-compensated volume control giving uniform frequency response. L.C. is an acceptor tuned broadly to 1000 cycles.

A condenser of 0.5 mfd. and a choke of 50 micro-henries may be taken as approximate values, and the best position for tapping them across the volume-control could be found by trial.

Join Newnes' Practical Group!

PRACTICAL MOTORIST
The owner-driver's journal which tells you how to repair, overhaul and obtain the best performance from your car.
3d.—Every Friday.

PRACTICAL MECHANICS
The only English journal of its type. It deals with every branch of Science, Mechanics, Invention, Model-making, Chemistry, Astronomy, Photography.
6d.—Every month.

THE CYCLIST
The leading weekly for every Cyclist, Clubman, Utility Cyclist or Tourist. Join "The Cyclist" Road Club and also take advantage of the FREE Insurance.
3d.—Every Wednesday.

AROUND the SALES

INFORMATION that SAVES you MONEY!

Really amazing bargains sums up the offers below... Pre-Christmas opportunities—every one of them—which you are advised not to miss. **ORDER NOW.**
ALL-WAVE CHASSIS. See illustration and description further down and secure yours while stocks hold good. S.T.900 users or those possessing any of the well-known B.T.S. One Shot Coils (self-locating types) should invest NOW in a new N.T.S. Emergency All-Wave (3-2,000 metres) Kit. This Kit receiver, with steel chassis, transformer, condensers, S/M dial and S.G., S.G. Det., and Pentode valves will cost you only 32/6 (plus 1/3 for Post and Packing), the finest Kit value for "Pr. Wireless" readers. Coils available: 9 to 27 metres, 5/6 the pair; 24 to 70, 5/6; 15 to 43, 5/6; 900 to 2,000, 7/-; 130 to 550, 6/- a pair. **OR THE COMPLETE KIT**, with all 10 Coils costs only 59/6, plus 1/3 for packing and postage.
AMPLIFIERS. A.C. model giving 7 watts output, employing 4 valves with two in push-pull. This is an amazing bargain at 77/6 complete, and you can use it for announcements or reproduction of gramophone records. Then there is the 4-watts battery model—designed on similar lines and for the same uses—which costs only 59/6, complete with 4 valves, fully tested. Runs off an ordinary 120 to 150v. H.T. battery and 2-volt accumulator. Useful for boosting up battery sets.
CONSTRUCTORS. Secure one or more of a new N.T.S. component parcels going at 5/-. Postage and pack-

TO-DAY'S FINEST CHASSIS "BUY" All Wave

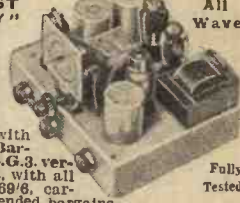

Powerful A.C. All-Wave Model. 4 valves. Station scale. Wave-range 18 to 2,000 metres. 3 watts output. P.U. sockets. Size 12ins. x 8 1/2 ins. x 9 1/2 ins. deep. Complete with 4 valves, fully tested. **Bargain, 79/6.** Battery S.G.3 version, pentode output, with all valves, fully tested, 69/6, carriage paid. Recommended bargains. Fully Tested

ing is charged extra 1/-. The parcel contains variable condensers, a coil, fixed resistances and condensers, a number of control knobs and a usefully-drilled cadmium-plated steel chassis (alone worth 10/- or more). Put this 5/- item first on your shopping list and advise your friends.

HEADPHONES. Lightweight and sensitive pair of 'phones which every radio man should have by him. The pair cost only 5/6, post 6d. Also a 1-amp L.T. Trickle Charger employing metal rectifier, for A.C. mains, 12/6.

SEND NOW

Only from N.T.S. can you obtain these wonderful bargains. Stocks are rapidly clearing and prices may rise, so post your order right away.

NEW TIMES SALES CO.,
56 (Pr.W12), LUDGATE HILL, LONDON, E.C.4.
Phone: City 5516 Est. 1924

CLIX
FLEXIPIN Self-Adjusting PLUGS

If your radio **CRACKLES** when you touch the plug which connects your set to the wall socket, it is because the plug-pins are not making proper contact with the socket-tubes.

The CLIX plug has been specially designed to eliminate this trouble and its self-centering, expanding pins will fit and make perfect contact in any make of BSS Socket.



CLIX
5 amp 2-pin "M" type plug as used by all the leading radio manufacturers
Costs only **4 1/2**.

A full range of 2 and 3 pin BSS types in 2, 5 and 15 ampere sizes is available from all good Radio and Electrical Dealers.

If in difficulty write to the makers:—
British Mechanical Productions Ltd.
 1, Church Road, Leatherhead, Surrey.
FIT "CLIX" and CUT THE CRACKLE

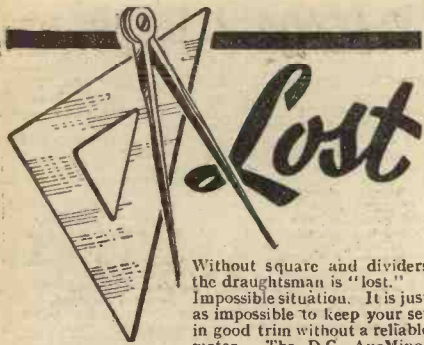

Without square and dividers the draughtsman is "lost," impossible situation. It is just as impossible to keep your set in good trim without a reliable meter. The D.C. AvoMinor tells you all you want to know; troubles are instantly traced; falling-off in performance is immediately checked. Complete in case with instruction booklet, leads, interchangeable test probes and crocodile clips.



BRITISH MADE

Voltage	
0-6 volts	0-240 volts
0-12 volts	0-300 volts
0-120 volts	0-500 volts
Current	
0-6 m/amps.	
0-30 m/amps.	
0-120 m/amps.	
Resistance	
0-10,000 ohms	
0-10,000 ohms	
0-1,200,000 "	
0-5 megohms	

The D.C.

AVOMINOR

Regd. Trade Mark
ELECTRICAL MEASURING INSTRUMENT

Write for fully descriptive leaflet

Sole Proprietors & Manufacturers—
Automat'c Coil Winder & Electrical Equipment Co., Ltd.,
Winder House, Douglas St., London, S.W.1. Phone: Victoria 3404/7

HAVE YOU HEARD THE RUMOUR

That Winston Has Sunk The German Fleet Single-handed?

It's in

Reginald Arkell's WAR RUMOURS

Everybody is talking about WAR RUMOURS, the new book of hilarious war rumours in verse. It tells how Hitler was arrested by a special constable; what happened when Mr. Chamberlain was dropped behind the German lines, and how Winston Churchill won the war—by himself!

WAR RUMOURS is written in Reginald Arkell's inimitable style, and the illustrations by Edgar Norfield capture the real "rumour" spirit. Read it—enjoy it—and recite its amusing verses to your friends. It is a priceless wartime "possession."

From all booksellers 1/- net, or by post 1/2 from the publishers, C. Arthur Pearson, Ltd., (Book Dept.), Tower House, Southampton Street, Strand, London, W.C.2.

THE TROPHY SIX

An A.C. Mains 6-valve Set of the Communications Type

WE have already reported on the range of Trophy receivers produced by Messrs. Peto-Scott, and have now had the pleasure of testing the 6-valve model, an illustration of which appears below. This receiver is designed on similar lines to the other models, with several refinements, amongst which may be mentioned the bandspread tuning system. Here two separate controls are provided, a small double-section condenser being mounted on a standard gang condenser, and the two separate sections controlled by separate knobs. These are the two large central knobs. The main condenser section is provided with the large silver dial seen on the left, and this carries four separate calibration markings—in kilo- and megacycles. A transparent indicator with hair-line is rigidly fixed above this dial and the four bands are marked from 1 to 4, the wave-setting switch below the dial also carrying these four figures. The bandspread spindle is provided with a small circular calibrated dial positioned behind the glass window seen in the centre of the panel, and this is floodlit. Tuning is thus not only exceedingly simple to carry out but the velvety action of the controls and the well-marked dials facilitate the operation of obtaining a station which has once been located.

The Circuit

The valve combination in this receiver is a triode-hexode frequency-changer, pentode I.F. amplifier, double-diode-triode second detector, A.V.C. and 1st L.F. stage, triode beat-frequency oscillator and pentode output stage. A full-wave rectifier is included in the mains section. The controls reading from left to right along the bottom of the panel are Send/Receive switch, band switch, B.F.O. on/off switch, A.F. gain, A.V.C. on/off switch, pitch control

and 'phone jack. The latter is included in the speech-coil circuit and silences the speaker when 'phones are plugged in. The wave-range covered is from 6.5 to 545 metres, divided up into the following sections: Band 1, 14 to 45 mc/s; Band 2, 5.5 to 16 mc/s; Band 3, 1.6 to 5 mc/s, and Band 4, 550 to 1,600 kc/s.

The receiver was tested on a normal outdoor aerial and also on a small dipole, separate sockets being provided for these two forms of aerial. The sensitivity is high, and on Band 1 a surprisingly large number of stations were heard during our test. The overall short-wave performance is fully up to the standard to be expected



The Trophy Six receiver.

from a circuit of the type which is employed, and the bandspread tuner was found most satisfactory in use. The volume is ample for all normal purposes, and when receiving very powerful stations the usual microphone trouble to be expected with a built-in speaker is experienced. Obviously the A.F. gain-control must be judiciously handled, but this is the normal method of handling a receiver of this type.

The receiver may be taken as a very good sample of a modern communications receiver, and at 9½ guineas it represents very good value. The cabinet and chassis are of steel, both finished in the modern black crystalline surface, and the overall dimensions are 17½in. wide by 10in. high and 9in. deep.

"BRUSHING UP" YOUR MORSE

(Continued from page 212)

the "D.C." side of the neon are adequately insulated and protected so that they cannot accidentally be touched. Also, if the alternative key position indicated by a cross is used, care must be taken that this is insulated and the metal bar shrouded if there is any chance of parts of the positive side of the circuit being touched.

Simple 10-metre Receiver

So much for morse practice. If a 10-metre receiver is to be built, it may in the first place be of very simple type, since a good range is possible without using an elaborate circuit. It is generally maintained that transmissions on wavelengths up to 10

metres are limited to the "visual" range, but this has often been disproved. On 10 metres it might be found that reception conditions are variable, but transatlantic reception on this wavelength is not unusual. A fairly standard circuit arrangement is shown in Fig. 3. Only a single valve is shown, but it is better to use this before an L.F. amplifier, although the single valve is often sufficient.

The connections shown are for a six-pin coil, such as the Eddystone type 6BB, which has a wavelength range of about 9 to 11 metres with the tuning condenser shown. Naturally, other wavelength ranges can be covered by changing the coil, since there are types (in various makes; B.T.S. coils are popular with readers) to cover all the short-wave bands.

RADIO CLUBS & SOCIETIES

Club Reports should not exceed 200 words in length and should be received First Post each Monday morning for publication in the following week's issue.

THE CROYDON RADIO SOCIETY

Hon. Sec.: E. L. Cumbers, 14, Campden Road, South Croydon.

THE Croydon Radio Society held its first war-time meeting on Wednesday, November 8th, in St. Peter's Hut, Ledbury Road, South Croydon. Mr. G. A. Hoskin presided, and introduced Mr. Stuart Davis with his improved high quality apparatus. Mr. Davis, indeed, welcomed this opportunity of being with quality enthusiasts, for various reasons. One was that if any of his technical improvements had been worth while, then his audience would appreciate them. Another was that members' questions and criticisms could not fail to be of great help to him. Above all, however, was the fact that he was glad to be instrumental in re-commencing activities, as the society's friendly meetings filled a gap in long winter evenings. His new amplifier had a 50-watt output. Class AB amplification for the receiver was used, and a fixed grid bias of 25 volts was one new feature. Another was the incorporation of two rectifiers for anode and screen voltages, as he had one control valve for screen voltage when last visiting the society. The Tone Control unit was fully explained, as also the contrast expansion apparatus. Here, of course, practical demonstration made his remarks very clear, and he soon came to his home recording. His records of the Davis Theatre Organ, and Sir Thomas Beecham conducting the London Philharmonic Orchestra were distinctly fascinating. Finally the deep voice of the chairman were recorded as well as the B.B.C. Symphony Orchestra that evening on the Home Service programme. Both these important recordings were played back in half a minute. The next meeting is on Wednesday, December 6th, and meanwhile the publicity secretary would welcome the views of PRACTICAL WIRELESS readers as to meetings being held more often than once a month.

EDGWARE SHORT-WAVE SOCIETY

Hon. Sec.: F. Bell 118, Colin Crescent, Hendon, N.W.9.

Meetings: Are now held at G3HT, 4, Gainsborough Gardens, Edgware.

A GOOD number of members are still meeting, and three new members have joined since the war. Total membership is now 52.

It has been decided to run the annual dinner on November 25th. Nearly 45 people are expected, including many well-known amateurs.

After dinner all will visit the Palladium.

The vote for the "Enthusiasts" Cup will take place at the two meetings held before the dinner.

Many letters have been received from members serving with the Forces from their "somewhere" radio bases.

At the meetings held now oscilloscope experiments with receivers and amplifiers are being carried out. Future meetings include a visit to the local cinema

to see the Ham radio picture, "Grand Jury Secrets," discussion on microphones with experiments, testing of a new communication receiver, and members' apparatus built during the war.

THE SURREY RADIO CONTACT CLUB

Hon. Sec.: S. A. Morley, 22, Old Farleigh Road, Selsdon, Surrey.

THE club held its November meeting at the Café Royal, Croydon, on Sunday, November 5th, at 3.30 p.m., when a very interesting talk was given by Mr. L. C. B. Blanchard, BRS 3003, about the 28 mc/s amateur band. He gave a general outline of some of the chief events which had taken place in the past, and gave a forecast as to what he thought conditions would probably be like in the future; he also tried to impress upon those present that the band did not only consist of one station from the U.S.A., but also many other countries could be heard, both on fone and c.w., from many other parts of the world, providing the listening was done intelligently.

As already mentioned in last month's report, the club is now publishing its own monthly magazine, entitled "Q.R.X." (price threepence). As the November number was exhausted within a few days of its publication, those desirous of securing a copy should make an early application to the secretary so as to avoid disappointment. The December number will be ready towards the end of the current month.

The club have decided, as in past years, to hold a "Hamfest," which will be held at the Café Royal, North End, Croydon, on Friday, December 15th next, at 7.30 p.m. Lady guests are particularly welcome.

EASTBOURNE AND DISTRICT RADIO SOCIETY

Hon. Sec.: T. G. R. Dowsett, 48, Grove Road, Eastbourne, Sussex.

AT the society's meeting held on Tuesday, October 31st, Mr. R. Bridgeland, 2FYP, gave a lecture on "Coils."

First of all he explained the theory of coils, following this by formulae for reactance, frequency, etc. Resonance curves were then dealt with, and various tuning methods. He then went on to inefficiencies of coils, application of reaction, and the effect of input impedance of valves on tuning circuits. Next he dealt with matching the aerial to the tuning coil, the use of transformers, and a certain type of filter called "Collin's Coupler."

He finished on frame aerials, ultra-high frequency coils of the neighbourhood of 10 cms., and band-pass coils.

CLAYESMORE RADIO CLUB

Hon. Sec.: I. H. Gordon, Clayesmore School, Iwerne Minster, Blandford, Dorset.

BEING a school club, we are carrying on as usual during the war. The first meeting of the winter session was held on October 1st. Black-out and electricity rationing systems were put into action, the latter now having been withdrawn.

On November 7th, at 7 p.m., there were two talks. The secretary, I. H. Gordon, spoke on "The Modern Talkie Cinema." He dealt with the radio side of the subject, first giving a short, historical account of the talkie and then went on to the sound-on-film system. With the aid of diagrams the photo-electric cell and the sound head unit were fully explained. Afterwards there was a demonstration with a Gaumont-British talkie projector.

A. W. G. Wilson then spoke on "Electrical Sound Recording." He dealt with home and commercial disc recording, describing fully how the vibrations were produced and then played back. With the aid of the club's recording gear the actual cutting was demonstrated. Finally, records were examined under a low-power microscope. Arrangements are now being made for the recording of the troop's concert shows.

Preserving Leads

WHEN taking out flex leads through a hole in a metal chassis, it is highly desirable to provide some form of protection to prevent the sharp edges of the hole from cutting through the insulation with consequent risk of short-circuits and perhaps serious damage to a component. A simple way of providing such protection is by slipping large diameter insulated sleeving over the leads where they pass through the hole and making the latter of such a diameter that the sleeving wedges tightly in the hole. A much more elaborate and preferable idea is, of course, to use the special rubber grommets supplied for the purpose. They may be obtained for 4d. per dozen.

READ
"THE CYCLIST"
3d. Every Wednesday

ARMSTRONG

apologise for delay in delivery of some models. This has been unavoidable owing to the difficulty in obtaining materials. However, customers may rest assured that we are doing our utmost to expedite all outstanding orders. In these difficult times we shall be grateful if customers will allow us as much notice as possible when ordering.

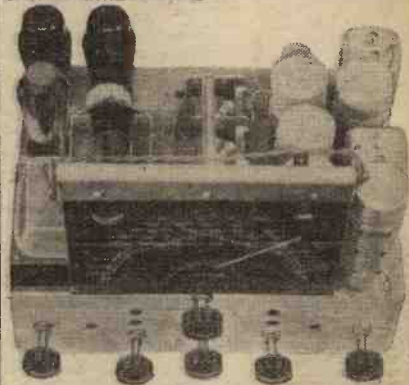

MODEL 8s10

"SUPERHET-STRAIGHT" 10-valve High Fidelity Radiogram chassis. All-wave, incorporating 2 independent circuits, Superheterodyne and Straight, having R.F. pre-amplifier, R.C. coupled push-pull Triode output capable of handling 8 watts.

PRICE £12 : 12 : 0

MODEL AW38. 8-valve All-wave Superheterodyne chassis. This All-wave Radiogram chassis has resistance capacity coupled push-pull output capable of handling 6 watts, and gives good quality reproduction on both radio and gramophone, for an economical price of 8 5s.

Armstrong Push-pull Speaker to match AW38 Chassis, £1 : 1 : 0.

We suggest Model AW38 together with matched speaker at £9 : 9 : 0 complete, represents the most outstanding value on the market to-day.

ILLUSTRATED ART CATALOGUE ON REQUEST ALL CHASSIS SENT ON 7 DAYS' APPROVAL

ARMSTRONG MANFG. CO.

WARLTERS ROAD, HOLLOWAY, LONDON, N.7.

(Adjoining Holloway Arcade)

Phone NORth 3213

L.R.S.

intend carrying on the good work of supplying Quality Radio Equipment.

ARMSTRONG CHASSIS

PORTABLE A.R.P. RECEIVERS and other reliable radio apparatus are available as usual on our very CONVENIENT TERMS.

Write for quotation and full details

PLEASE NOTE OUR TEMPORARY ADDRESS
LONDON RADIO SUPPLY COMPANY
"DENWYN," OXENDEEN WOOD RD., CHELSFIELD, KENT

WARTIME ELECTRIC SUPPLY

An Independent Emergency or Stand-by Set may be of great value to you. Can be transported on any car. All these sets are in first-class order and straight from reserve Stores, an opportunity for a low price purchase that certainly cannot be repeated.

A.R.P. PETROL ELECTRIC GENERATING SETS

FOR LIGHTING AND CHARGING FOR £16 ONLY.

A 500-watt, single cyl., 2-stroke, water-cooled, self-oiling Stuart Turner engine; mag. inn. coupled to 50/70 volts, 10 amps. shunt dynamo, 1,000 r.p.m., £16. No increase in price, these are £40 sets, ready for immediate delivery.

FOR £12. A 150-watt engine and dynamo on similar lines but coupled to 25/30 volts, 6 amps. dynamo. Half Kilowatt and other sizes; all ready for immediate delivery.

ELECTRADIX RADIOS,
218, Upper Thames Street, London, E.C.4.

Notes from the Test Bench

Chassis and Screws

IT is often recommended that steel or iron screws should not be used in radio set construction, but there is one important point to bear in mind when mounting components on a wooden-chassis or baseboard—especially if hard wood is employed. If a suitable clearance hole is not first made in the wood, when a thin brass screw is driven in there is a danger of the top half of the screw turning off, leaving a portion of the screw in the hole in such a position that a fresh screw cannot be used without moving the component. Therefore make certain that a suitable clearance hole is first drilled when using thin brass screws.

ELECTRADIX

WAR EQUIPMENT FOR SIGNAL WORK.

SERVICE TYPESIGNALLERS
DOUBLE HEADPHONES, with flat leather headbands for steel helmet wear, 120 ohms. by S.T. Co., 3/6. 4ft. cords 6d. Single 60 ohm. phones with cord D111, 1/6. **FIELD Telephone Exchanges**, 5-line and 20-line portable. Twin and single cable.

RAID SIGNAL PHONES. Complete sets with 5 and 20 line exchanges.

PORTABLE WARDENS' PHONES, etc. State wants. **HEADPHONES**. Wireless type, with aluminum headbands, 3/9. 4,000 ohms. 4/6. 6/8 and 8/6.

LISTENING MIKES, steel-clad Electradix. Indestructible; are ears outside your dug-out.

MORSE KEYS. Few Ex WD Keys reserved for Services. New Keys now in production for training code users. First-class at low prices.

A good small key on moulded base is the TX pivot arm and excellent for learners, 3/6. Full size, well finished key, all brass, solid pivot bar, adjustable tension, etc. B. 2. 7/6. Superior Type P.F., fully adjustable, nickel finish, 9/6. High Grade Type IV, plated fittings, polished wood base, a fine key, 10/6. Special Key on 3-switch box for buzzer and 2 lamps, C.A.V., 6/6.

BUZZERS, small type, with cover, 1/6. **Power Buzzers**, with screw contact and adjustable spring armature, 2/6. **Heavy Buzzer** in Bakelite case, 3/6. **Siemens Morse Transmitters**, with key and brass-cased Power Buzzer, 17/6. **Magneto Exploders**, 25/-.

SIGNAL LAMPS by Lucas and Aldis, hooded for night and day use, telescope sights, key and discs; for tripod or hand use. Heliographs, Mark V, with spare mirrors in leather case, with mahogany tripod.

MORSE RECORDING, G.P.O. type inkers, on mahogany base with tape reel under, in first-class order, 5/6. **Lightweight French Army Field Morse Inkers**, fold up into wood case, 27/10/-.

Field H.Q. Morse Inker, brand new, entirely enclosed and fitted every refinement, current indicator, key, tape container, etc., 2/8. **Mahogany Tape Container**, G.P.O., 4/6. **Morse Paper Reels**, 8d.

CRYSTAL SETS, Boudoir, 6/6. **B.M. Table**, 7/6. **LEARNERS' MORSE PRACTICE SET**, Sound Type No. 10, with Key and Buzzer on base, 3/-.

Visual Type No. 2A with Key and Lamp on base, No. 3A Duplex with Key and Buzzer and Lamp for sound and visual, line plug is on base, 7/-.

Siemens Service Set, 17/6.

CHARGERS.

YOU MUST KEEP YOUR BATTERY PREPARED !! Battery Charging on A.C. Mains. The A.C. NIT-NDAY will keep your battery fit without attention. Model N/A 6, 250 volts A.C. and D.C. 98 volts 1 amp. 15/-.

Model N/B 12, 250 volts D.C., 6/8 volts 2 amps., 35/-.

Model N/D 12, 250 volts to 12 volts 1 amp., 32/-.

Ditto, 12 volts 2 amps., with 6-volt tap, 55/-, 5 amp., 24/10/-.

And many others. **SHELTER CHARGERS**, with automatic switchgear for large batteries.

A.R.P. ACCUMULATORS for stand-by H.T. at 6d. per volt; 3 amp. hours. In 24-volt unit crates, glass cells, 12/- each. Can be parallel charged off 12 volts.

Furry Dug-outs or ill-ventilated shelters must be kept fresh.

A.R.P. SHELTER Ventilation and Air Conditioning. Compact unit, drive off A.C. or D.C. mains, 80 watts; 9in. Blower, 20 cub. ft. fresh air per min. 25/- is a bargain price.

WET WEATHER ELECTRIC PUMPS, for A.C. or D.C. 12 v. to 230 v. Centrifugal all-bronze pump, throws 120 gals. per hour. 72/6. **Type R pumps**, Twin piston type for draining shelters, dug-outs, etc., 26/17/6. Auto. float switch, 45/-.

ELECTRIC IMMERSION HEATERS. Save coal. Armoured bath or tank type with flex, 1,000 watts 230 volts, 25/-.

SIGNAL BELLS—FIRE ALARM BELLS. Waterproof mains, Battery or Hand magneto Buzzers.

BELLS. G.P.O. type trembler Circular Desk Bell, with movement in case, 1/6. Wall Bells, trembler, 2/6. Ditto, large size, 7/6. Signal Bells, large, metal, 12-volt single stroke Bells, 10/-.

OF GREAT INTEREST IN DARK WAR EVENINGS.

LOW COST Home Recording with the all-gear **FEIGH Electric Recorder**, Ball Bearing centre gear box and traverse rod. Is the lowest priced electric home recorder that will fit any grammo. The set with Tracking Gear, Pick-up and tone arm with diamond, 37/6. Gear only, 21/6.

ACOUSTIC RECORDERS. Cost is low. New **MIVOC** acoustic sets, complete outfits in carton de luxe, 16/-.

No. 2 Mivoc, 10/8. Junior, 5/6.

FIELD SERVICE TESTERS.

DIX-MIPANTA VEST POCKET TESTER. A versatile moving-iron multi-range meter for service on A.C. or D.C. THREE ranges of volts: 0-7.5, 0-150, 0-300. Black bakelite case, 2 1/2in. x 2 1/2in., with pair of test leads and plugs. 19/6.

FLEHOTT BATTERY TESTERS. Govt. Model 108. Mov. Coil Ammeter and graded theo., 37/6.

LINESMAN'S DETECTORS, Q. and I. Galvo. In leather Case, 15/-.

HORIZONTAL BRASS-CASED GALVOS, 7/6.

CELL TESTERS, Megger 3-0-3 v. mov. coil, Aluminium Case, 25/-.

5- **EMERGENCY PARCELS** of useful stand-by electrical and radio repair material and apparatus, 7 lbs. for 5/-. Post Free.

ELECTRADIX RADIOS

218, Upper Thames Street, London, E.C.4

Telephone: Central 4611

LATEST PATENT NEWS

Group Abridgments can be obtained from the Patent Office, 25, Southampton Buildings, London, W.C.2, either sheet by sheet as issued on payment of a subscription of 5s. per Group Volume or in bound volumes, price 2s. each.

Abstracts Published.

ELECTRIC SIGNALING SYSTEMS.—Cole, Ltd. E. K. Martin, A. W. and Jarvis, H. G. No. 497774.

In a motor-operated press-button tuned wireless receiver the wave-change switch is adjusted if necessary when a station-selecting button is operated, the adjustment being effected by an electric motor which may be the same motor as that used for tuning the receiver. Fig. 1 shows an embodiment using the tuning motor and a magnetic clutch but an embodiment using a dog clutch is also described. In the position of the apparatus indicated a long-wave station selected by button L has been

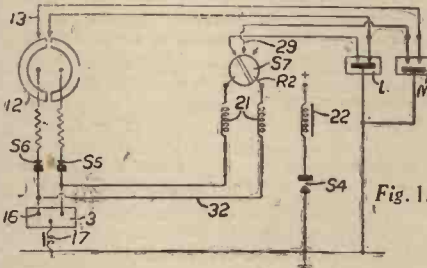

selected. If now a medium-wave station button, of which one only M is indicated, is operated, the motor 3 is energized over 17, 16, 32, R2, 29, M, and relay 21 is operated to open contacts S5, S6 and close contact S4 so that the magnetic clutch 22 is energized to couple the wave-change switch with motor 3 to move the switch in the correct direction. When the wave-change switch is set wiper 29 engages the insulated segment on the switch member S7 and relay 21 releases to de-clutch the switch and connect the motor to button M over disc 12. The motor now runs in the usual way until wiper 13, connected to button M, engages the insulated segment. An embodiment using a relay with a single winding only and in which the motor always drives the wave-change switch in the same direction is also described.

ADJUSTING WIRELESS APPARATUS.—Electric and Musical Industries, Ltd. No. 500111.

The tuning element of a wireless receiver is actuated from the control spindle through gearing, the ratio of which is automatically altered by a voltage derived from the incoming signal when the receiver is approaching exact tune therewith. The tuning condenser 2 (Fig. 2) is driven from the tuning knob 4 through spindles 12, 11 separated by a friction clutch 13, 14 and planetary gears comprising a sun wheel 10, planet wheel 1 and a freely mounted wheel 3. A normally inoperative auxiliary gear train comprises the wheel 6 frictionally coupled to pinion 5 on the control spindle and driving a pinion 7, also frictionally associated with the wheel 3. The gear ratio 10, 1, 3 is such as to give a rapid or coarse adjustment of tuning until the desired signal reaches a pre-determined strength, e.g. about 250 cycles from the exact in-

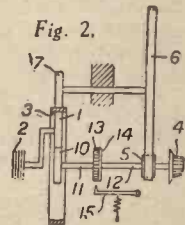

tune position, when a control voltage actuates an electromagnet device 15 which engages the toothed periphery of clutch member 13 thereby arresting shaft 11 and the sun wheel 10. Continued rotation of knob 4 now drives the condenser 2 through the gear train 6, 7, 3, 1 the ratio of which may be ten times that of the other planetary system. The wheels 7 and 1 may both engage the inner surface of the wheel 3.

NEW PATENTS

These particulars of New Patents of interest to readers have been selected from the Official Journal of Patents and are published by permission of the Controller of H.M. Stationery Office and the Official Journal of Patents can be obtained from the Patent Office, 25, Southampton Buildings, London, W.C.2, price 1/- weekly (annual subscription £2 10s.).

Latest Patent Applications

- 29086.—Akt.-Ges. Brown, Boveri, and Cie.—Amplifiers with negative feedback. Oct. 31st.
- 28768.—Aktiebolaget Elektrod.—Device for voltage indication. Oct. 26th.
- 29020.—Davis, E. A.—Automatic clock control for radio push-button receivers. Oct. 31st.
- 28884.—Walton, G. W.—Thermionic valves. Oct. 28th.

Specifications Published

- 513940.—Thornton, A. A. (Philco Radio and Television Corporation).—Horn-type loudspeakers.
- 513878.—Fernseh Akt.-Ges.—Scanning oscillators for use in television and like systems.
- 514059.—Standard Telephones and Cables, Ltd., Jacobsen, B. B. and Roche, A. H.—Thermionic amplifiers.
- 514060.—Plessey Co., Ltd., Packman, P. J., and Morrison, P. H.—Adjusting or selecting mechanism for the tuning-controls of wireless apparatus.
- 513961.—Pye, Ltd., Smith, W. A. St. C., and Dalglish, J. W.—Loop aerials and the like.
- 513965.—Murphy Radio, Ltd., Baker, G. B., and Boyd, J. D. A.—Pre-set tuning of radio-receivers.
- 514065.—Blumlein, A. D.—Thermionic valve circuits.
- 513970.—Marconi's Wireless Telegraph Co., Ltd.—Electrical tuned circuits.
- 514026.—Crosley Radio Corporation.—Push-button tuning devices for radio receiving. (Cognate Applications, 27836/38, and 27837/38).
- 513983.—Hazeltine Corporation. Television scanning systems.

Printed copies of the full Published Specifications may be obtained from the Patent Office, 25, Southampton Buildings, London, W.C.2, at the uniform price of 1s. each.

PRACTICAL WIRELESS SERVICE MANUAL

By F. J. CAMM.

From all Booksellers 5/- net, or by post 5/6 direct from the Publishers, George Newnes, Ltd. (Book Dept.), Tower House, Southampton St., Strand, London, W.C.2.

Comment, Chat and Criticism

The Music of Chopin

Our Music Critic, Maurice Reeve, Discusses the Music of Poland's Famous Composer

THE tragic fate that has overtaken Poland naturally causes music-lovers' thoughts to turn towards Chopin—by far the greatest musician she ever produced. In fact, it is no exaggeration to say that he is the only Polish composer who can be considered of any real quality—Paderewski possibly excepted.

Chopin, who was born near Warsaw in 1810, and died in Paris only thirty-nine years later, is an unique character in music from several aspects. A worker in small media and for one instrument only—a few unimportant pieces excepted—he cannot claim the genius or the universal vision and outlook of the great masters. Yet, recognising his limitation, he is great nevertheless. What he did accomplish was supremely great; his stature is limited by the narrowness of the horizon that hemmed him in. He never wrote a symphony, an opera, a quartet or other piece of chamber music; and the orchestration of his two beautiful pianoforte concertos is extremely poor. Excepting three piano sonatas (two of which are first class), and a sonata for piano and 'cello, Chopin wrote exclusively in the media of concert pieces. In these forms—the Scherzo, Ballade, The Polonaise, Impromptu and various other single works and collections of works like the Etudes and Preludes, he remains and is likely to remain, the incomparable master. Alike in the perfection of their form, including balance and poise, and their masterly writing for the instrument, they remain without a peer in their own sphere.

A Master Craftsman

His output was very small, judged from any standing. When compared with men like Mozart and Schubert, who died at an even earlier age, it is microscopic. But like Flaubert or Benvenuto Cellini, he was a master craftsman. Perfection was always his standard.

I doubt if either Beethoven or Schubert are better loved by the mass of musical people; certainly no other writer can rival him in the affections of the multitude. In exactly ten years' time we shall be celebrating the centenary of his death. For one hundred years his music has been the best loved of any in the pianist's repertoire. Just as the Beethoven Symphonies have been the biggest draw for more than a century in the orchestral world, so has a "Chopin recital" been in the pianistic. The fifth generation of Chopin players is now living, and some of them have inherited the master's tradition—himself a great pianist—direct from his senior pupils, such as Klindworth and Xcharwenka. No other composer has founded such a dynasty, nor one which seems more likely to be perpetuated by the master's faithful heirs and successors. A hundred years is more than sufficient to prove that the loyalty and constancy we give him are what they claim to be, and not mere fashionable crazes that many third and fourth-rate composers enjoy for a brief period. So let us conclude the article with a concise

examination of the reasons for the supreme place Chopin's music occupies in so many hearts.

First, and without question foremost, must come the fact that Chopin and Schubert were the most wonderful melodists in all music. And so far as purely instrumental music is concerned, he is easily first. A Chopin melody transports one into another world. There is a sensuous, yet at the same time an ethereal, quality in it which leaves behind it a haunting memory that is unique in music. They are never simple enough (with a few exceptions like the trio from the Funeral March) to enable one to memorise them quickly, yet they are not so abstruse as to drive one off feeling shy of them, as if they were beyond our limited capacities for thinking musically. They are perfect of their kind.

The "Chopin Ornament"

Scarcely second in importance is that unique thing, the "Chopin Ornament." Its like cannot be found in any other composer's music, except Liszt's, and his are often of a different character. They so often form an integral part of the melody that they are frequently difficult to separate from the context like the ordinary trills or appoggiaturas in others' music. It is for this reason that I said his ornaments were of scarcely less importance than his melodies—they are often one and the same thing.

Thirdly comes his subtle and exquisite harmonisation, which is always pungent and "Chopinesque," even though written in the modes fashionable in his day. Never so daring or given to such violent splashes and contrasts of colour as Liszt, he is for this reason, perhaps, the better loved of the two. Chopin can claim to have discovered the full possibilities for beautiful harmonisation in the chromatic scale, hitherto used only sparingly, even by the mighty Beethoven. He exploited its possibilities in a series of daring experiments (see the first book of Etudes, Op. 10) which opened the way for Liszt's torrential outbursts. No such lengthy "sentences" without a resolution had been heard before, and they set the standard for all future writers. Even though others exploited his discoveries far beyond what he probably considered possible or practicable, he was the George Stevenson who gave the romantic school of music an impetus which has not yet shown signs of slackening. He founded a school of pianoforte writers of which Debussy and Albeniz, in our own day are the direct descendants.

Rhythm

Fourthly is his employment of rhythm. It is his masterly handling of the two national dances, the Mazurka and the Polonaise, which give his music their unmistakably Polish flavour. Not only did he write two collections of masterly works in these rhythms, but the rhythms themselves pervade almost everything he wrote. No matter how slight the flavouring may be, it is almost bound to be there. In the

great Polonaise Fantasia, he left us a supreme example of how a long work can be built up on classical lines with a dance measure as its inspiring motive. Modern writers, striving in vain after ballroom steps in classical frameworks, would do well to study this beautiful composition.

But I leave to the last what must rank as Chopin's most endearing and lasting quality. He was, above all things, music's supreme poet. His collected works are comparable to the works of Keats or Shelley. Even in his grandest and most impassioned moments, he was the poet first and the musical architect after. This is all the more remarkable as, unlike Schubert and other great melodists, he never called in the word poet to his aid. Consequently, whether roaring like the lion or cooing like the dove, his work is saturated with an ineffable sweetness and a romantic fervour. The soul of a patriot in exile is struggling in many of his major pieces, and the incurably romantic pervades his entire output. Although he never wrote a more divine paean of love than the Moonlight Sonata, he sang the song far more often than did the greatest of all tone poets.

Chopin Players

Chopin was never followed by a Polish composer of comparable distinction to himself, but he founded a dynasty of truly great pianists. And if anyone doubts whether nationalism can be adequately expressed through music, and Poland through Chopin's music in particular, one only has to hear a Polish pianist play Chopin, and compare it with others. No other race of pianists can distill the essence from these flowers in quite the same way, although almost all countries have produced some magnificent Chopin players. The names of these players, even the Polish ones, are far too many to enumerate here, but they form a remarkable line which shows no signs of decreasing fecundity. Paderewski, Godowsky, Pachmann and Horowitz, may be cited as the century's most distinguished Chopin players in the direct line of succession.

Although a Pole to his finger-tips, let us not forget—to his credit—that Poland was non-existent then, as to-day; and that Chopin was an exile throughout his life. Whatever our views may be on the political side of this vexed question, we cannot help but feel sad at the thought that the home of such a beloved genius, and of such a cultured people, suffers so cruelly at fate's hands. Chopin's name will forever be a beacon for Polish exiles to flame their patriotism by, and for all musicians to whom their art symbolises beauty and perfection as ideals. Chopin's figure may not tower with music's giants, but he was one of music's geniuses, and an unique one in many ways, and his grave in Père Lachaise will know many devoted pilgrims during these days of his country's martyrdom as, indeed, it always has. May he rest in peace, and the world continue to honour his unique music.

Open to Discussion

The Editor does not necessarily agree with the opinions expressed by his correspondents. All letters must be accompanied by the name and address of the sender (not necessarily for publication).

A Reader's Trouble Solved

SIR,—Many thanks for all the trouble you have taken in answering my many queries. I am now on the right road, and daily my knowledge of practical wireless is increasing. The "solenoid" chokes shall be made, and I hope they prove effective.

I am glad you have at last removed the dragon of Graham Farish's "snap" choke from my poor old head. I puzzled a lot over that "snap."—**HOWARD SOMERVILLE** (London, S.W.).

Correspondents Wanted

SIR,—I have been a short-wave fan for the last two years and was just going to apply for an A.A. licence when the war broke out and stopped me.

I would like to correspond with any S.W. fan anywhere in the world or in England, and would also be glad to get in touch with a S.W. listener in Leeds or district. My interest mainly lies in S.W. transmitting and receiving. As a regular reader of your splendid wireless journal I wish it continued success.—**FRANK STORK** (1, Brudenell View, Hyde Park, Leeds, 6).

SIR,—I have been a reader of your excellent paper for about six months but have recently become a member of the B.L.D.L.C. I would like to correspond with any S.W.L. in the world, particularly with those interested in amateur listening.—**H. POKLEWSKI** (48, Abbey Road, St. John's Wood, London, N.W.8).

SIR,—I have been interested in short-wave reception for about two years, and I would like to correspond with readers anywhere who are also interested in short waves, and who are about seventeen years of age.—**F. G. H. ELPICK**, 11A, The Broadway, Southall, Middlesex.

Double-crystal Detector Circuits

SIR,—I was pleased to find someone else interested in crystal sets, namely, Mr. D'Arcy Ford, whose letter I read in your October 23rd issue.

Mr. D'Arcy Ford includes an L.F. transformer in his circuit but omits to give the connections for linking this up. This is very awkward for anyone like myself—I have had only about six months' interest in wireless, and my knowledge has been picked up from PRACTICAL WIRELESS. I am only just beginning to understand the theoretical circuit diagrams which you publish.

If anyone at about the same elementary stage as myself would care to communicate with me with a view to mutual assistance I shall be very pleased.—**(MASTER) ARNOLD S. LONG** (29, Hopwood Bank, Horsforth, near Leeds).

A Four-valve Portable

SIR,—As a reader of your interesting paper from No. 1, I am very interested in your last few battery sets and intend making them up as I have several good parts and valves by me. But I would like to suggest that in all battery sets you employ auto grid-bias, as I think it would make the sets more compact, especially in view of the battery shortage. If a certain valve requires, say, 4½ v. G.B. when using battery,

why not show the alternative way of making it automatic so that builders can use the method which they prefer and so avoid battery replacements? I think if these things were shown for 1 or 2 G.B. tappings it would be a very great advantage. I wonder what other readers think on this subject?

I am greatly interested in portables, and in view of the Home Service Broadcast with war news at midnight, I should like to see a 4-valve portable that one could take upstairs when bedtime comes, to listen there.



The latest radio nightmare as experienced by our reader, Howard Somerville.

I think a set with 2 S.G., D. and output using ordinary-size valves and components would meet the case.—**FRANK CLARKE** (Prestwich).

Exchanging S.W.L. Cards

SIR,—I would be very pleased to exchange my S.W.L. card with any other S.W.L., A.A., or fully-licensed hams in the British Isles.

I will also correspond or forward lists of American QRAs to any reader interested. All correspondence will be answered by return. In closing, I should like to say that I think the new issue of PRACTICAL WIRELESS is very fine indeed.—**J. C. MENZIES** (174, Peckham Rye, East Dulwich, London, S.E.22).

A 56-mc/s Report

SIR,—Reading in the issue of PRACTICAL WIRELESS dated October 21st, 1939, about the lack of 56 mc/s reports, perhaps it might interest Mr. L. Hudson, Leeds 9, that I hold QSLs, all 100 per cent., from the following hams for 56 mc/s 'phone reception: W2JCY, verification of 8 contacts; W2IIQ, 2IPH, and W1EER; two from VK2NO (different dates); also G6JQ and G6WJ.

Finally, let me congratulate you upon the present style of the production of PRACTICAL WIRELESS; there's nothing like it in this country.—**C. MELLANBY** (Pwllheli, N. Wales).

International Radio Monitors

SIR,—May I bring to the notice of your readers the International Radio Monitors (I.R.M.), which has its headquarters in

the U.S.A. All activities in this country are managed by a British representative, and every member receives a copy of the I.R.M. bulletin monthly. Any reader interested may obtain further details of this society by sending his name and address to the undersigned.—**T. KNIGHT** (50, Scott Street, Barrow-in-Furness, Lancs).

YOUR WAR-TIME MUSIC

COMPOSERS, authors and music publishers may expect to receive in December as usual the fees due to them for the performance in public of their works registered with the Performing Right Society, according to an official statement issued by the Society recently.

While the amount to be distributed will obviously be reduced, there is good reason to hope, says the Society, that the loss will not be overwhelming.

The first of a series of "Emergency Bulletins" to be issued by the Society gives an interesting account of the steps taken by the Society to meet its war-time problems.

The Performing Right Society, as is well known, looks after the fees due to composers, authors, and music publishers for the performance in public of their copyright works. In addition to recording the time and place of every performance, it has to analyse the hundreds of thousands of programmes it receives every year in order to allocate to the individual composer his fair share, according to the number of times his work has been performed, from the licences paid into its coffers by hotels, restaurants, bands, cinemas, municipalities, and all the other "users" of music.

That work is now going on, not on so detailed a basis as before, but sufficiently accurately for the Society to be able to guarantee that each of its members shall receive his dues next pay-day.

Prize Problems

Problem No. 375.

ROBERTS had a simple three-valve set of very old design and he saw some guaranteed new L.F. Transformers advertised at a very low price and accordingly he obtained one. When he put this in place of his existing transformer, however, he failed to obtain any results. There was a complete absence of signals in the speaker. What was wrong? Three books will be awarded for the first three correct solutions opened. Entries should be addressed to the Editor, PRACTICAL WIRELESS, Geo. Newnes, Ltd., Tower House, Southampton Street, Strand, London, W.C.2. Envelopes must be marked "Problem No. 375," and must be posted to reach this office not later than the first post on Monday, November 27th, 1939.

Solution to Problem No. 374.

Jackson overlooked the fact that a fixed condenser was necessary to complete the tone control circuit, and as a result of Jackson's arrangement the speaker was short-circuited.

The following three readers successfully solved Problem No. 373, and books have accordingly been forwarded to them:

J. R. Russell, 33, Cheylesmore Terrace nr. Friars Road, Coventry.
G. A. Collings, 27, Lowfield Road, Acton, W.3.
J. E. Toogood, Croft House, Nautical College, Pangbourne, Reading.

In reply to your letter

Avoiding Overloading

"I recently built a two-valve amplifier but the output is so great that it leads to overloading. You say in your article that the output from the set should be controlled. I find that I can see no way of doing this; my set is a two-valver. Can you please explain what to do?"—N. L. (Leicester).

PROBABLY your best plan is to replace the coupling in your two-valver so that a variable grid leak is used. This will mean changing your coupling, if transformer coupling is employed, to R.C.C. Alternatively a volume control of .25 megohms should be shunted across the secondary of the L.F. transformer, connecting the grid of your second valve to the arm of the volume control.

Hum

"Since reading various articles on hum in your paper I have been looking round my set and am rather puzzled by a difficulty in it. When I switch on there is a fairly loud hum in the speaker. As the valves heat up, however, this hum dies away and when the signals come through there is practically no hum audible, even in "silent" periods in the programme. Is this hum a sign of a fault or is it usual with A.C. sets?"—R. P. (Reading).

WE think you will find that the hum is due to the fact that the output valve is directly-heated, whilst the remaining valves in the receiver are indirectly-heated. Alternatively, your output stage may make use of a directly-heated valve and this, with the directly-heated rectifier, means that almost as soon as the set is switched on the output stage is fully alive, but is receiving an excessive voltage. Consequently hum is audible in the speaker, but as the remaining valves heat up and take their share of current, the output stage is released from part of its load and the output voltage delivered by the mains section is also lowered—remembering that the voltage and current are directly related. A thermal-delay switch would appear to be advisable in a set of this type.

Bias Resistor

"I am building a mains set in which you specify an indirectly-heated output stage. I have a spare directly-heated valve which I intend to use and am not building exactly to your specification as I am introducing one or two ideas of my own. I am uncertain, however, how I should apply bias

RULES

We wish to draw the reader's attention to the fact that the Queries Service is intended only for the solution of problems or difficulties arising from the construction of receivers described in our pages, from articles appearing in our pages, or on general wireless matters. We regret that we cannot, for obvious reasons—

- (1) Supply circuit diagrams of complete multi-valve receivers.
- (2) Suggest alterations or modifications of receivers described in our contemporaries.
- (3) Suggest alterations or modifications to commercial receivers.
- (4) Answer queries over the telephone.
- (5) Grant interviews to querists.

A stamped addressed envelope must be enclosed for the reply. All sketches and drawings which are sent to us should bear the name and address of the sender.

Requests for Blueprints must not be enclosed with queries as they are dealt with by a separate department.

Send your queries to the Editor, PRACTICAL WIRELESS, George Newnes, Ltd., Tower House, Southampton Street, Strand, London, W.C.2. The Coupon must be enclosed with every query.

to this output stage and wonder if you can assist me in this connection."—P. N. R. (Cleethorpes).

YOU should use a separate transformer winding for the heater of the directly-heated output valve and then connect the bias resistor between the centre tap of that winding and H.T. negative (or earth line). The grid return, that is, the lower end of the transformer secondary or the grid leak, should be connected to the H.T. negative or earth line. The usual by-pass condenser should be included across the resistor. If the transformer winding is not centre-tapped, then a humdinger or centre-tapped resistor should be put across the winding and the arm of this component regarded as the winding centre-tap.

Valve Characteristics

"I have obtained an American valve, but regret that I have no details as to its type or characteristics. I cannot find it in any of my books and should be glad if you could let me know what it is, and, if possible, its English equivalent. The Number is 6E6."—L. B. (Harrow).

THE valve is listed as a Dual Triode Power Amplifier and is of the A.C.-D.C. type. It has a 6.3 volt heater and takes up to 27.5 volts grid bias at 250 volts H.T. The plate current at this rating is 18 mA., the impedance 3,500 ohms and the output 1.6 watts per pair of triodes. The recommended load resistance is 14,000 ohms. We cannot trace any English equivalent of this particular valve.

Speaker Data

"I have got hold of an old speaker from a friend and this has the name Epoch stamped on it with the letters D3. I should be glad if you could tell me what this is rated at and the speech coil impedance. There is no transformer fitted."—K. F. (Bath).

THE standard D3 model was rated with a 15-ohm speech coil and would handle up to 10 watts. There is, however, always the risk that the model was not standard and therefore no exact guarantee can be given regarding the speech coil.

Fitting a Suppressor

"The electric cleaner which we use is causing some annoyance as it gives rise to a background of rushing sounds in the speaker when the set is on. I understand that this may be prevented by fitting a suppressor, but I do not know the exact type, nor exactly where to fit it on the cleaner. Should I dismantle the motor and fit across the brushes, or would you advise me to have it done by the makers?"—G. R. (S.E.7).

YOU can fit a suppressor without interfering with the mechanism of the cleaner and for this purpose special flex adaptors are made. All that is necessary is to cut the leads to the cleaner and fit the suppressor in the lead. Two and three-wire units are available, according to the type of wiring fitted to the cleaner. These suppressors may be obtained from Messrs Belling-Lee, of Cambridge Arterial Road, Enfield, Middlesex.

The coupon on page 228 must be attached to every query.

TROPHYs Now Installed at "Radio Royal"

Europe's Largest Press Listening Post depends on TROPHY for All-World Reception

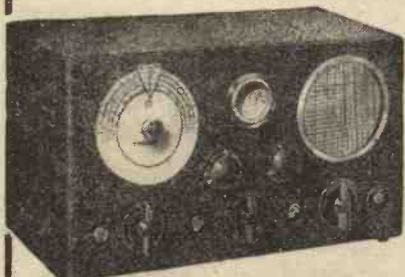

● TROPHYs from £6:6:6. Send for Lists.

At official centres, too, you will find TROPHYs installed... exactly the same models as offered to PRACTICAL WIRELESS readers, for listening to the World's News, entertaining programmes and B.E.C. transmissions. Keep abreast with important topical events, enjoy Radio's biggest thrill, invest in a TROPHY, there's a model to suit you.

TROPHY 6. This 6-valve A.C. model is illustrated on left. Continuous wave-range 6.5 to 615 metres. Separate dial electrical bandspread tuning. An amazing performer on all bands. Built-in speaker and provision for alternate use of 'phones. For ordinary aerial or doublet aerial use. Ready to play on A.C. 200 to 250 v. supplies. Fully guaranteed. **£10 : 19 : 6**

TROPHY 8. The Super 8-valve model of the TROPHY range. 5 bands, continuous wave-range 7 to 550 metres, R.F. on all bands. Bandspread tuning and refinements of the communication type receiver. Ready for operation on A.C. 200/250 v. supplies. TROPHY P.M. Speaker in cabinet. **£13 : 17 : 3** to match. 48/3 extra. Easy terms.

77 (P.W.12), City Rd., London, E.C.1. Tel: Chisold 9875.

PETO-SCOTT CO. LTD.,

WEST END LONDON DEMONSTRATIONS. 41, High Holborn. Tel: Hol. 3248. and R.E.M. Ltd., 70, Wigmore St.

RADIOGRAM CHASSIS

6-Stage All-Wave Superhet

Complete Cash with Valves C.O.D. **£5:19:6**

Here is a splendid opportunity to replace that old Radio chassis. Modern 5-valve 6-stage chassis providing all-world reception on 18 to 2,000 metres and perfect speaker reproduction. A.V.C. Tone and Volume controls. Metre and station-named illuminated dial. 3 watts output. P.U. sockets. Size 11 1/2 in. wide, 9 1/2 in. high, 8 1/2 in. deep. Fully guaranteed. Ready for use on I.A.C. or D.C. 200/250 volts. Matched energised speaker, £1 7s. 6d. extra.

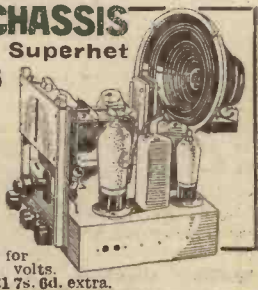

Practical Wireless BLUEPRINT SERVICE

PRACTICAL WIRELESS CRYSTAL SETS.	Date of Issue.	No. of Blueprint.
Blueprints, 6d. each		
1937 Crystal Receiver	27.8.38	PW71
The "Junior" Crystal Set	27.8.38	PW94
STRAIGHT SETS. Battery Operated.		
One-valve: Blueprints, 1s. each.		
All-Wave Unipen (Pentode)	19.2.38	PW31A
Beginners' One-valver	19.2.38	PW85
The "Pyramid" One-valver (HF Pen)	27.8.38	PW93
Two-valve: Blueprints, 1s. each.		
Four-range Super Mag Two (D, Pen)	24.9.38	PW30B
The Signet Two (D & LF)	24.9.38	PW76
Three-valve: Blueprints, 1s. each.		
Selectone Battery Three (D, 2 LF (Trans))		PW10
Sixty Shilling Three (D, 2 LF (RC & Trans))		PW34A
Leader Three (SG, D, Pow)	22.5.37	PW35
Summit Three (HF Pen, D, Pen)		PW37
All Pentode Three (HF Pen, D (Pen), Pen)	29.5.37	PW39
Hall-Mark Three (SG, D, Pow)	12.4.37	PW41
Hall-Mark Cadet (D, LF, Pen (RC))	16.3.35	PW48
F. J. Camm's Silver Souvenir (HF Pen, D (Pen), Pen) (All-Wave Three)	13.4.35	PW40
Cameo Midget Three (D, 2 LF (Trans))		PW51
1936 Sonotone Three-Four (HF Pen, HF Pen, Westector, Pen)		PW53
Battery All-Wave Three (D 2 LF (RC))		PW55
The Monitor (HF Pen D, Pen)		PW61
The Tutor Three (HF Pen, D, Pen)	21.3.36	PW62
The Centaur Three (SG, D, P)	14.8.37	PW64
F. J. Camm's Record All-Wave Three (HF Pen, D, Pen)	31.10.36	PW69
The "Colt" All-Wave Three (D, 2 LF (RC & Trans))	18.2.39	PW72
The "Rapido" Straight 3 (D, 2 LF (RC & Trans))	4.12.37	PW82
F. J. Camm's Oracle All-Wave Three (HF, Det., Pen)	28.8.37	PW78
1933 "Triband" All-Wave Three (HF Pen, D, Pen)	22.1.38	PW84
F. J. Camm's "Sprite" Three (HF Pen, D, Tet)	26.3.38	PW37
The "Hurricane" All-Wave Three (SG, D (Pen), Pen)	30.4.38	PW80
F. J. Camm's "Push-Button" Three (HF Pen, D (Pen), Tet)	3.9.38	PW92
Four-valve: Blueprints, 1s. each.		
Sonotone Four (SG, D, LF, P)	1.5.37	PW4
Fury Four (2 SG, D, Pen)	8.5.37	PW11
Beta Universal Four (SG, D, LF, Cl. B)		PW17
Nucleon Class B Four (SG, D (SG), LF, Cl. B)		PW34B
Fury Four Super (SG, SG, D, Pen)		PW34C
Battery Hall-Mark 4 (HF Pen, D, Push-Pull)		PW40
F. J. Camm's "Limit" All-Wave Four (HF Pen, D, LF, P)	26.9.36	PW67
All-Wave "Corona" 4 (HF, Pen, D, LF, Pow)	9.10.37	PW79
"Acme" All-Wave 4 (HF Pen, D (Pen), LF, Cl. B)	12.2.38	PW83
The "Admiral" Four (HF Pen, HF Pen, D, Pen (RC))	3.9.38	PW90
Mains Operated.		
Two-valve: Blueprints, 1s. each.		
A.C. Twin (D (Pen), Pen)		PW18
A.C.-D.C. Two (SG, Pow)		PW31
Selectone A.C. Radiogram Two (D, Pow)		PW10
Three-valve: Blueprints, 1s. each.		
Double-Diode-Triode Three (HF Pen DDT, Pen)		PW23
D.C. Ace (SG, D, Pen)		PW25
A.C. Three (SG, D, Pen)		PW29
A.C. Leader (HF Pen, D, Pow)	7.1.30	PW35C
D.C. Premier (HF Pen, D, Pen)		PW35B
Ubique (HF Pen, D, (Pen), Pen)	28.7.34	PW36A
Armada Mains Three (HF Pen, D, Pen)		PW33
F. J. Camm's A.C. All-Wave Silver Souvenir Three (HF Pen, D, Pen)	11.5.35	PW50
"All-Wave" A.C. Three (D, 2 LF (RC))		PW54
A.C. 1936 Sonotone (HF Pen, HF Pen, Westector, Pen)		PW56
Mains Record All-Wave 3 (HF Pen, D, Pen)		PW70
All-World Ace (HF Pen, D, Pen)	28.8.37	PW80

Four-valve: Blueprints, 1s. each.		
A.C. Fury Four (SG, SG, D, Pen)		PW20
A.C. Fury Four Super (SG, SG, D, Pen)		PW34D
A.C. Hall-Mark (HF Pen, D, Push-Pull)	24.7.37	PW45
Universal Hall-Mark (HF Pen, D, Push-Pull)		PW47
A.C. All-Wave Corona Four	6.11.37	PW81
SUPERHETS.		
Battery Sets: Blueprints, 1s. each.		
£5 Superhet (Three-valve)	5.6.37	PW40
F. J. Camm's 2-valve Superhet		PW52
F. J. Camm's "Vitesse" All-Waver (5-valver)	27.2.37	PW75
Mains Sets: Blueprints, 1s. each.		
A.C. £5 Superhet (Three-valve)		PW43
D.C. £5 Superhet (Three-valve)	1.12.34	PW42
Universal £5 Superhet (Three-valve)		PW44
F. J. Camm's A.C. Superhet 4	31.7.37	PW59
F. J. Camm's Universal £4 Superhet 4		PW60
"Qualitone" Universal Four	16.1.37	PW73
Four-valve: Double-sided Blueprint, 1s. 6d.		
Push-Button 4, Battery Model	22.10.38	PW95
Push-Button 4, A.C. Mains Model		
SHORT-WAVE SETS. (Battery Operated.)		
One-valve: Blueprint, 1s.		
Simple S.W. One-valver	9.4.33	PW38
Two-valve: Blueprints, 1s. each.		
Midget Short-wave Two (D, Pen)		PW38A
The "Fleet" Short-wave Two (D (HF Pen), Pen)	27.8.38	PW91
Three-valve: Blueprints, 1s. each.		
Experimenter's Short-Wave Three (SG, D, Pow)	30.7.38	PW30A
The Prefect 3 (D, 2 LF (RC and Trans))		PW63
The Band-Spread S.W. Three (HF Pen, D (Pen), Pen)	1.10.38	PW68
PORTABLES.		
Three-valve: Blueprints, 1s. each.		
F. J. Camm's ELF Three-valve Portable (HF Pen, D, Pen)		PW65
Parvo Flywing Midget Portable (SG, D, Pen)	3.6.39	PW77

These Blueprints are drawn full size. Copies of appropriate issues containing descriptions of these sets can in some cases be supplied at the following prices, which are additional to the cost of the Blueprint. A dash before the Blueprint Number indicates that the issue is out of print.

Issues of Practical Wireless ... 4d. Post Paid

Amateur Wireless ... 1d. " "
Wireless Magazine ... 4s. " "

The Index letters which precede the Blueprint Number indicate the periodical in which the description appears: Thus P.W. refers to PRACTICAL WIRELESS, A.W. to Amateur Wireless, W.M. to Wireless Magazine.

Send (preferably) a postal order to cover the cost of the blueprint and the issue (stamps over 6d. unacceptable) to PRACTICAL WIRELESS Blueprint Dept., George Neaves Ltd., Tower House, Southampton Street, Strand, W.C.2.

Four-valve: Blueprint, 1s.		
"Imp" Portable 4 (D, LF, LF, (Pen))	19.3.38	PW86
MISCELLANEOUS.		
S.W. Converter-Adapter (1 valve)		PW48A
AMATEUR WIRELESS AND WIRELESS MAGAZINE CRYSTAL SETS.		
Blueprints, 6d. each.		
Four-station Crystal Set	23.7.38	AW427
1034 Crystal Set		AW444
150-mile Crystal Set		AW450
STRAIGHT SETS. Battery Operated.		
One-valve: Blueprint, 1s.		
B.B.C. Special One-valver		AW387
Two-valve: Blueprints, 1s. each.		
Melody Ranger Two (D, Traus)		AW388
Full-volume Two (SG det, Pen)		AW392
Lucerne Minor (D, Pen)		AW426
A Modern Two-valver		WM409
Three-valve: Blueprints, 1s. each.		
Class B Three (D, Trans, Class B)		AW386
£5 5s. S.G.3 (SG, D, Trans)	2.12.38	AW412
Lucerne Ranger (SG, D, Trans)		AW422
£5 5s. Three: De Luxe Version (SG, D, Trans)	19.5.34	AW435
Lucerne Straight Three (D, RC, Trans)		AW437
Transportable Three (SG, D, Pen)		WM271
Simple-Tune Three (SG, D, Pen)	June '33	WM327
Economy-Pentode Three (SG, D, Pen)	Oct. '33	WM337
"W.M." 1934 Standard Three (SG, D, Pen)		WM351
£3 3s. Three (SG, D, Trans)	Mar. '34	WM354
1935 £6 6s. Battery Three (SG, D, Pen)		WM371
PTP Three (Pen, D, Pen)		WM389
Certainty Three (SG, D, Pen)		WM393
Minitube Three (SG, D, Trans)	Oct. '35	WM396
All-Wave Winning Three (SG, D, Pen)		WM400

Classified Advertisements

RECEIVERS, COMPONENTS AND ACCESSORIES

SOUTHERN RADIO'S Bargains.
ALL Articles Fully Guaranteed. Postage extra.

5/- Parcel of useful components, comprising condensers, resistances, volume controls, coils, wire, circuits, etc., value 25/- 5/- per parcel.

10/- Parcel of useful components, comprising 100 articles, including electrolytics, valveholders, etc., etc., value 55/- 10/- per parcel.

15/- Service man's component kit. Comprising electrolytic condensers, volume controls, tubular condensers, resistances, valveholders, wire, mica and Mainsbridge condensers, etc., etc. 120 articles contained in strong carrying case 9" x 7" x 7", value 65/- 15/- the complete kit.

21/- Small traders' parcel of components, comprising at least 150 articles, including 24 assorted tubular condensers, 24 valveholders, 36 resistances, 12 Mainsbridge type condensers, 6 electrolytics, etc., etc., value 85/- 21/- per parcel.

5/- Twelve Mainsbridge type condensers, 1-2-4 mfd.; 5/- per dozen.

7/6 24 assorted tubular condensers, up to 2 mfd., 7/6 for 24; Telsen 3-range meters (volts and millamps), 4/-; Morse tappers, 2/11.

BUZZERS, 1/6; crystal detectors, 2/-; crystal sets, 5/6; crystals, 6d.

2/6 Ormond loudspeaker units, 2/6.

2/- Tool or instrument carrying cases ex-Government stock. Wood 9" x 7" x 7", 2/- each.

SOUTHERN RADIO, 46, Lisie Street, London, W.C. Gerrard 0653.

HEADPHONES. Reconditioned and guaranteed. Brown, G.E.C., B.T.H., Sterling, Nesper, Brunet, Western Electric, Siemens, Brandes, 4,000 ohms, 5/- pair. Telefunken, lightweight, adjustable, 4,000 ohms, 7/6.

CRYSTAL with silver cat's-whisker, 6d. Complete detector parts, 1/- Glass tube detector on ebonite base, 1/6. Sensitive permanent detector, 1/6. Postage 1d.—Post Radio Supplies, 328, Upper Street, London, N.1.

VAUXHALL. Rola 8in. P.M. speakers, 14s. 9d.; Magnavox 6in. P.M., 10s. 6d. complete with input transformers.

VAUXHALL. Collaro A.C. gramophone motors, boxed, 29s. Flat sheet aluminium, 12in. by 12in., 3s.; 12in. x 18in., 4s.

VAUXHALL. TCC aluminium containers, 8 mfd., 500 v., 3s.; TCC cardboard containers 8 mfd., 600 v., 2s.; 8 and 8 mfd., 3s. 6d.

VAUXHALL. Volume controls, 2s.; with switch, 3s. Tubular condensers, 0.1 mfd., 3d.; 0.25 mfd., 4d. Resistors, 1 watt, 4d.

VAUXHALL UTILITIES, 163a, Strand, London, W.C.2. Post paid over 2s. 6d. Write for free list.

BANKRUPT BARGAINS. Brand new 1938-9 models, makers' sealed cartons, with guarantees, at less 40 per cent. below listed prices; also Midgets, portables, car radio. Send 1d. stamp for lists. Radio Bargains, Dept. P.W., 261-3, Lichfield Road, Aston, Birmingham.

BANKRUPT BARGAINS. List free. Good stock of receivers up to 12 valves. Portables, battery and mains. Full stock valves of all types. Service goods. Portadynes superhet battery portables, 6 gms. Mains superhets, all-wave, £6 17s. 6d. Battery all-wave superhets, £6. All new goods. Please state requirements, as my list has been subject to price changes. I will quote per return.—Butlin, 6, Stamford Avenue, Brighton.

LOUDSPEAKER REPAIRS

LOUDSPEAKER repairs, British, American, any L make. 24-hour service, moderate prices.—Sinclair Speakers, Pulteney Terrace, Copenhagen Street, London, N.1.

L.S. REPAIR AND REWINDING SERVICE: 24-hour service. See below:—

REPAIRS to moving coil speakers a speciality. New cone assemblies fitted. Sneece coils and fields wound or altered. Mains transformers, chokes, eliminators and vacuums repaired, prices quoted. Speaker transformers, Class "B" L.F. transformers and pick-ups rewound at 4s. each, post free. Discount trade. Estimates free. Guaranteed satisfaction.

L.S. Repair Service, 5, Balham Grove, London, S.W.12. Phone: Battersea 3321.

NEW LOUDSPEAKERS

3,000 SPEAKERS from 6/6 each, P.M. and energised 4in. to 14in. including several Epoch 18in.—Sinclair Speakers, Pulteney Terrace, Copenhagen Street, London, N.1.

FREE ADVICE BUREAU COUPON

This coupon is available until December 2nd, 1939, and must accompany all queries and hints.

PRACTICAL WIRELESS, 25/11/39