

# PLANNING YOUR RECEIVING STATION — See page 189

A  
NEWNES  
PUBLICATION

Edited by  
**F. J. CAMM**

Vol. 17. No. 417.

# Practical Wireless and

# 6<sup>d</sup>

EVERY  
MONTH

March, 1941.

## ★ PRACTICAL TELEVISION ★

### Contents

- New Uses for Old Components
- ◆
- Amateur Receiver Design
- ◆
- Factory Production Methods
- ◆
- Thermion's Commentary
- ◆
- Practical Hints
- ◆
- Novel Automatic Tuning Unit
- ◆
- Using Obsolescent Coils
- ◆
- Class "B" Feed-back Amplifier
- ◆
- Service Engineer's Log
- ◆
- Queries and Enquiries



F. J. CAMM'S ALL-DRY SUPERHET PORTABLE

—Radio Engineers are at a premium to-day! Equip yourself for a good job by studying this new book—

## PRACTICAL WIRELESS SERVICE MANUAL

By  
**F. J. CAMM.**

A Complete, Practical and Up-to-date Work on the Testing of all Types of Wireless Receivers, 288 PAGES and OVER 220 PHOTOGRAPHS, DIAGRAMS and PLANS.

From all Booksellers 6/- net, or by post 6/6 direct from George Newnes, Ltd. (Book Dept.), Tower House, Southampton Street, London, W.C.2.

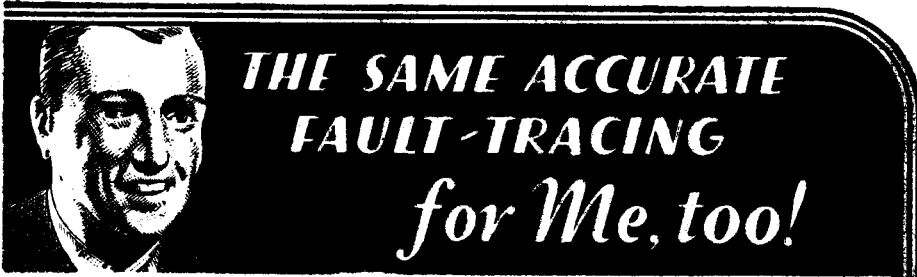

● The Universal AvoMinor and D.C. AvoMinor provide the serious amateur with testing facilities comparable in accuracy with those of the famous "AvoMeter" on which service engineers and manufacturers rely for precision testing.

Trouble-tracking with the AvoMinor is reduced to its simplest terms, enabling amateur and expert alike to locate faults with ease and rapidity.

**AVO**  
*Regd. Trade Mark*  
**ELECTRICAL MEASURING INSTRUMENTS**

Sole Proprietors and Manufacturers:  
**AUTOMATIC COIL WINDER & ELECTRICAL EQUIPMENT CO., LTD.**  
 Winder House, Douglas Street, London, S.W.1. Phone: Victoria 3404-7

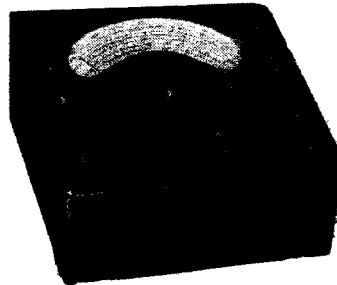

**THE UNIVERSAL AVOMINOR**

ELECTRICAL MEASURING INSTRUMENT  
 22 Ranges of Direct Readings

D.C. Volts	A.C. Volts	D.C. Milliamps
0- 75 millivolts	0- 5 volts	0- 2.5 milliamps
0- 5 volts	0- 25 "	0- 5 "
0- 25 "	0-100 "	0- 25 "
0-100 "	0-250 "	0-100 "
0-250 "	0-500 "	0-500 "
0-500 "		

**RESISTANCE**

0- 20,000 ohms	0- 2 megohms
0-100,000 "	0- 5 "
0-500,000 "	0-10 "

Complete with instruction booklet, leads, interchangeable crocodile clips and testing prods.

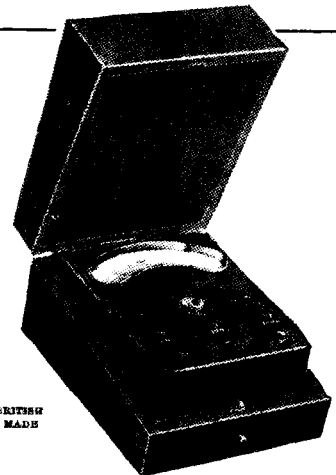

BRITISH MADE

**THE D.C. AVOMINOR**

ELECTRICAL MEASURING INSTRUMENT  
 13 Meters in ONE

Current milliamps	Voltage volts	Resistance ohms $\cdot 1$
0- 6	0- 6	0- 10,000
0- 30	0- 12	0- 60,000
0-120	0-120	0-1,200,000
	0-240	megohms
	0-300	0-3
	0-600	

In case, complete with instruction booklet, leads, interchangeable crocodile clips and testing prods.

● Write for fully descriptive pamphlets and current prices.

# NOISE SILENCER Applications

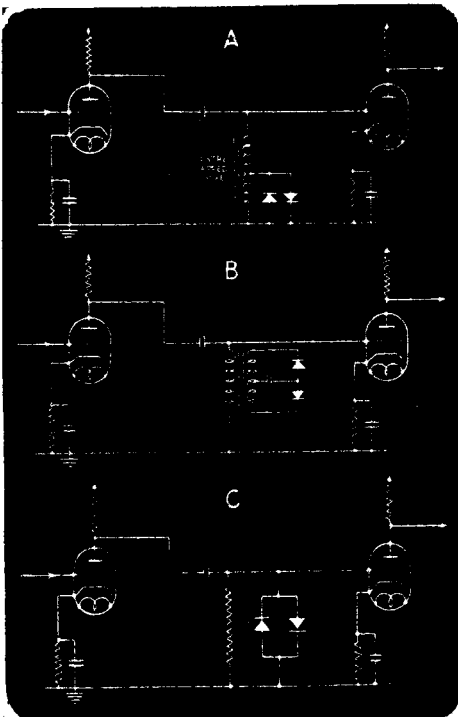

Westinghouse Metal Rectifiers may be used for the reduction of static interference, their operation in such circuits being entirely automatic, and dependent solely upon the property that their resistance decreases as the current passing increases. The rectifiers are connected to give a non-linear characteristic in both directions, the circuit being arranged that the normal maximum audio voltage across them does not raise the operating point on to the straight portion of the rectifier characteristic curve. Noise peaks cause the rectifiers to work on the straight portion and act as a short-circuit across the output for the duration of the peak.

- (A) This is the most simple circuit and uses "H" type units.
- (B) A more elaborate circuit using two W.6 Westectors and allowing the "cut-off" point to be varied to suit different conditions.
- (C) A circuit using two W.X.6 Westectors for use in an early low-frequency stage.

## WESTINGHOUSE METAL RECTIFIERS

### COUPON

To Westinghouse Brake & Signal Co., Ltd.,  
 Pew Hill House, Chippenham, Wilts.

I enclose 3d. in stamps.  
 Please send me a copy of  
 "The All Metal Way" giving  
 details of noise silencer  
 applications.

Name.....  
 Address.....

.....PRA. 341

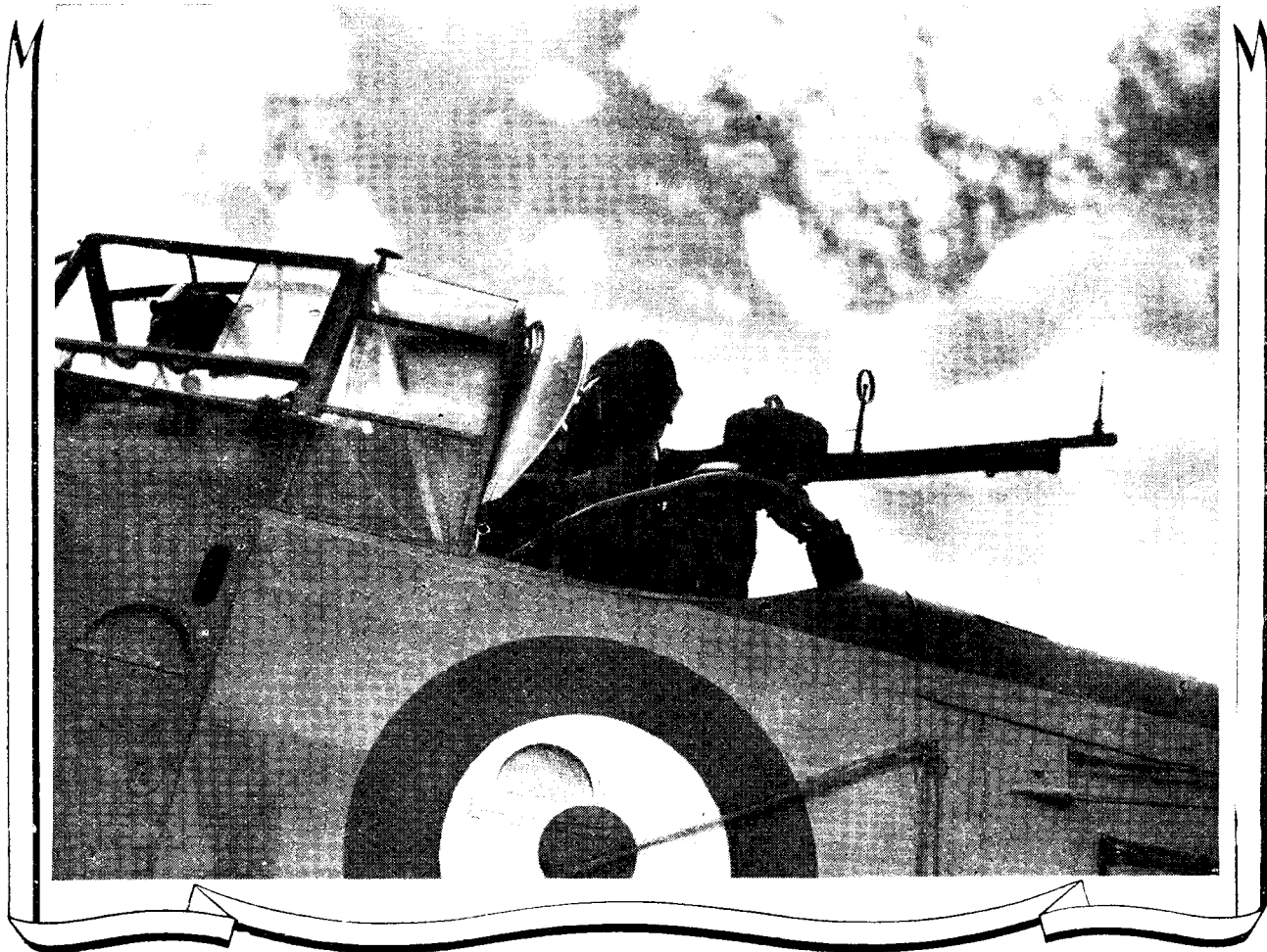

## UP IN THE CLOUDS MAYBE—BUT THEY MEAN BUSINESS

Maybe we're up in the clouds ourselves sometimes. Even idealistic, if you like, about our trading principles and our loyalty to those with whom we do business. But we cannot help feeling, as we look back on our many happy associations with some of the most important concerns in the country, that no one has lost by our upholding those principles. We're idealistic, yes ; but when it comes to doing a job we can safely say—"we mean business".

# DUBILIER



DUBILIER CONDENSER CO. (1925) LTD., DUCON WORKS, VICTORIA ROAD, NORTH ACTON, LONDON, W.3.  
C. R. Casson 153

# PREMIER RADIO

## PREMIER SMOOTHING CHOKES

Type	Current	Henrys	Res.	Price
C.40/1500	40 mA.	20-34 H.	500Ω	5/3
C.60/180	60 "	8 H.	180Ω	5/3
C.60/400	60 "	25-34 H.	400Ω	7/6
C.60/500	60 "	18-30 H.	500Ω	5/3
C.100/400	100 "	20-34 H.	400Ω	9/6
C.150/1185	150 "	20-34 H.	185Ω	13/6
C.200/145	200 "	20-34 H.	145Ω	15/9
C.250/120	250 "	25 H.	120Ω	17/6
C.60/2500	60 "	Speaker Field Replacement	2500Ω	7/6

## PREMIER 1941 HIGH FIDELITY AMPLIFIER KITS

Each Kit is complete with ready drilled chassis, selected components, specially matched valves and full diagrams and instructions.

	Kit of Parts with Valves	Completely Wired and Tested
4-watt A.C. Amplifier	£2 14 0	£3 11 6
4-watt A.C./D.C. "	£2 0 0	£3 17 6
6-watt A.C. "	£6 16 6	£7 13 6
8-10-watt A.C./D.C. "	£6 11 6	£7 9 0
15-watt A.C. "	£7 18 9	£9 8 0

Black Crackle Steel Cabinet 17/6 extra.

## MAINS TRANSFORMERS

Wire-ends. All L.T. Windings Centre-Tapped

SP. 250	250-0-250 v. 60 m.a.	4 v. 1-2 a, 4 v. 2-3 a, 4 v. 2-3 a	11/9
SP. 300	300-0-300 v. 60 m.a.	4 v. 2-3 a, 4 v. 2-3 a	11/9
SP. 301	300-300 v. 150 m.a.	4 v. 2-3 a, 4 v. 2-3 a, 4 v. 1 a	15/-
SP. 350A	350-350 v. 100 m.a.	5 v. 2 a (not C.T.), 6.3 v. 2-3 a	14/-
SP. 350B	350-350 v. 100 m.a.	4 v. 2-3 a, 4 v. 2-3 a	14/-
SP. 351	350-350 v. 150 m.a.	4 v. 1-2 a, 4 v. 2-3 a, 4 v. 3-4 a	15/-
SP. 352	350-350 v. 150 m.a.	5 v. 2 a, 6.3 v. 2 a, 6.3 v. 2 a	15/9

Auto Transformers. Step up or down. 100-125 v. to 200, 230 or 250 v. A.C., 60 watts, 9/11; 125 watts, 13/6; 250 watts, 18/6.

L.T. Transformers, all C.T.

4 v. 2-3 a	9/11	6.3 v. 2-3 a	9/11
2.5 v. 5 a	9/11	7.5 v. 3 a	9/11
5 v. 2-3 a	9/11	12 v. 3-4 a	15/-

Push-Pull Driver Transformers ... 6/6

Universal Output Transformers. 11 Ratios. Single or Push-Pull ... 6/6

## MATCHMAKER UNIVERSAL OUTPUT TRANSFORMERS

Will match any output valves to any speaker impedance.

11 ratios from 13 : 1 to 80 : 1, 5-7 watts, 15/9, 10-15 watts, 20/6, 20-30 watts, 35/-.

**ELECTROLYTIC CONDENSERS.** Cardboard cases. 500 v. working, 4 mfd. and 8 mfd., 1/9 each. 8 : 8 3/16, 4+4, 2/8, 8+4, 3/3, 4+4+1 3/9, 4+4+4 4/3, 16 : 8 4/1, 16 : 16, 5/-, 25 mfd. 25 volt, 1/2, 50 mfd. 12 volt, 1/2, 50 mfd. 50 volt, 2/-, 15 mfd. 100 volt, 1/3. Mansbridge type, 1 mfd. 250 volt, 1/-, 2 mfd. 250 volt, 1/9, 4 mfd. 500 volt, 4/8.

## PREMIER MICROPHONES

Transverse Current Mike. High grade large output unit. Response 45-7,500 cycles. Low hiss level, 23/-.

## "LEARNING MORSE"

Premier Morse Practice Key on Bakelite Base and Brass Movement	3/3
General Purpose Morse Key	5/10
Heavy Duty TX Key on Cast Base	10/-
Bakelite Buzzers	2/-
3 Henry Chokes	7/6
Complete Kit of Parts for Valve Oscillator as described in W.W. "Learning Morse"	25/-

## NEW PREMIER S.W. A.C. RECEIVER

In response to many requests we have now produced an A.C. version of the popular Premier Short Wave SG3 Kit. Circuit: Pentode H.F. Stage, Pentode Detector, Beam Power Output, and F.W. Rectifier. 200-250 v. A.C. Operation. Built-in Power Pack. Hum-free operation. For use with Phones or P.M. Speaker.

Complete Kit of Parts with drilled chassis, all components. Plug-in Coils covering 13-170 metres, 4 valves and full instructions and circuits.

£4 - 10 - 0

Battery Version also available Kit £3 8 0 Extra Coils 9-15, 200-2,000 m. also supplied.

★ "The Wireless World" said they were "very much impressed" ★

See full Test Report, pp. 492-3 December Issue. Send for full details

## Premier Pick-ups.

Heads will fit any tone-arm	7/6
Premier Pick-up with Volume Control	12/6
Premier de Luxe, 6,000 ohms	17/6

## ANOTHER SPECIAL OFFER

Rothermel Brush Piezo Crystal Pick-ups. New Junior P.U. with arm, 24/6. Standard, S.8 Model with arm, 34/9. P.U. head only. De Luxe Model, 24/6.

## MOVING COIL SPEAKERS

All complete with transformer. Rola 6 in. 15/-; 8 in. P.M.s, 17/6; 10 in. P.M.s, 22/6.

## ENERGISED MODELS

Plessey 8 in., 175 ohm field, 7/6; G. 12 energised, 2,500 field, 63/-; 10 in. B.T.H. 1,600 ohm field, less transformer, 11/6.

## PREMIER BATTERY CHARGERS for A.C. MAINS

Westinghouse Rectification complete and ready for use

To Charge:	6 volts at 1 amp.	22/6	
2 volts at 1/2 amp.	11/9	12 volts at 1 amp.	24/6
6 volts at 1/2 amp.	19/-	6 volts at 2 amps.	37/6

Moving Coil Mike. Permanent magnet model requiring no energising. Response 90-5,200 cycles. Output .25 volt average. Excellent reproduction of speech and music. 49/-.

## PREMIER SHORT-WAVE KITS for OVERSEAS NEWS

Incorporating the Premier 3-Band S.W. Coil, 11-86 Metres without coil changing. Each Kit is complete with all components, diagrams and 2-volt valves. 3-Band S.W. 1-Valve Kit, 14/9. 3-Band S.W. 2-Valve Kit, 22/6.

## DE LUXE S.W. KITS

Complete Kit, including all Valves, coils, wiring diagrams and lucid instructions for building and working. Each Kit supplied with a steel Chassis, Panel and plug-in coils to tune from 13 to 170 metres.

1 Valve Short-Wave Receiver or Adaptor Kit	20/-
1 Valve Short-Wave Superhet Converter Kit	23/-
1 Valve Short-Wave A.C. Superhet Converter Kit	26/3
2 Valve Short-Wave Receiver Kit	29/-

## SHORT-WAVE GEAR

Short-Wave Coils. 4- and 6-pin types, 13-26, 22-47, 41-94, 78-170 metres, 2/- each, with circuit. Premier 3-Band S.W. Coil, 11-25, 19-43, 38-86 metres. Suitable any type circuit, 2/11.

4-pin or 6-pin Coil Formers. Plain or Threaded, 1/2 each.

Utility Micro Cursor Dials, Direct and 100 : 1 Ratios, 4/3.

Bakelite Dielectric Variable Condensers. .0005 mf. Suitable Tuning or Reaction, 1/6 each. Short-Wave H.F. Chokes. 10-100 m., 10 1/2 d. each.

Lissen Dual Range Screened Coils. Medium and Long Waves, 2/9 each.

## AMERICAN VALVES

We hold stocks of all types at competitive prices.

## SHORT-WAVE CONDENSERS

Trolitic Insulation. Certified superior to ceramic. All-brass construction. Easily ganged.

15 m.mfd.	1/9	100 m.mfd.	2/3
25 m.mfd.	2/-	160 m.mfd.	2/6
40 m.mfd.	2/-	250 m.mfd.	2/11

## REPLACEMENT VALVES FOR ALL SETS

Europa Mains Valves, 5-pin, 4 v. A.C. Types A.C./H.L., A.C./L., A.C./S.G., A.C./V.M.S.G., A.C./H.P., A.C./V.H.P., A.C.P., all 5/6 each. A.C./H.P., A.C./V.H.P., 7-pin, 11/5. A.C./Pens, I.H., 10/6; A.C./P.X.4, 9/-; Oct. Freq. Changers, 9/6; Double Diode Triodes, 9/9; 3 1/2-watt D.H. Triode, 12/-; 350 v. F.W. Rect., 10/8; 13 v. 2 amp. Gen. Purpose Triodes, 5/6; H.F. Pens. and Var-Mu. H.F. Pen., Double Diode Triodes, Oct. Freq. Changers, 8/6 each. Full and Half-wave Rectifiers, 9/- each.

WRITE FOR LATEST LISTS.

ALL TYPES OF BATTERY VALVES AT COMPETITIVE PRICES.

Microphone Transformers Suitable for all mikes. Tapped secondaries. A, 20 and 40 : 1; B, 30 and 60 : 1; C, 50 and 100 : 1. 6/6 each. Microphone Stands. Bakelite table stand, 9 in. ring, 7/6 each.

ALL ENQUIRIES MUST BE ACCOMPANIED BY 2 1/2 d. STAMP.

# PREMIER RADIO CO.

ALL POST ORDERS to: JUBILEE WORKS, 167, LOWER CLAPTON ROAD, LONDON, E.5 (Amherst 4723).

CALLERS to: Jubilee Works, or 169, Fleet Street, E.C.4 (Central 2833), or 50, High Street, Clapham, S.W.4 (Macculay 2381).

# Practical Wireless

and

## PRACTICAL TELEVISION

EVERY MONTH.

Vol. XVII. No. 417. March, 1941.

EDITED BY  
F. J. C. AMM

Staff:  
FRANK PRESTON,  
L. O. SPARKS.

## COMMENTS OF THE MONTH

By THE EDITOR

### Opportunities in the Air Force

THE Air Ministry has asked us to announce that vacancies still exist in the R.A.F. for technical officers for employment on engineering, armament and signals duties. Naturally, our readers will be most interested in the signals section, and the qualifications required are: applicants must be holders of electrical engineering or science degrees with experience of wireless, or holders of technical college or approved institution diplomas and two years' experience in tele-communications engineering, preferably on the radio side. A number of posts is also available for candidates possessing a sound theoretical knowledge of elementary electricity and magnetism, of the principles of wireless telegraphic and telephonic communications, and of transmitter circuits, modern wireless receiving apparatus, and apparatus for the measurement of high-frequency potentials and currents. Some practical experience in addition is desirable, and specialised knowledge in one or more of the practical aspects of tele-communications would be an asset. Commissions in the R.A.F.V.R. will be granted for the duration of hostilities to suitable applicants between the ages of 21 and 50 years, possessing the requisite personal and technical qualifications.

Candidates should apply in writing to the Air Ministry, S.7(e)1, Adastral House, Kingsway, London, W.C.2, giving full particulars of qualifications, training and experience. Those who are engaged on the production of aircraft, engines or accessories, or on other important national work, should not submit qualifications without first consulting their employers as to the possibility of their being spared for R.A.F. duty. Candidates who have previously applied are requested not to renew their applications.

The Services have already paid

tribute to our efforts in helping to provide and to train personnel for the wireless sections of the Services, and many hundreds of our readers are already in the Services. All of those who write to us state that they have obtained their training and experience as a result of being regular readers of this journal and the books we publish in connection with it. Additionally, members of our staff are in the Services helping to train the new recruits. They have stepped out of the pages of this journal into active service, and have replaced the printed for the spoken word at the time of the nation's need. We have received a large number of letters from readers who have made their acquaintance. Many other readers write to say that wherever they are in the Services they are able to find readers of this journal, and quickly to make friends with kindred interests.

### Our Technical Books

BOOKS which are finding favour in the Services are: "The Practical Wireless Encyclopædia," the "Radio Engineer's Vest Pocket

Book," the "Superhet Manual," "Newnes' Short-wave Manual," "Sixty Tested Wireless Circuits," "Wireless Coils, Chokes and Transformers," "Wireless Transmission," "Practical Wireless Service Manual," and "Everyman's Wireless Book." A catalogue giving the full list of books we publish is available from the Book Department, George Newnes, Ltd., Tower House, Southampton Street, London, W.C.2.

Not all of our readers, however, are engaged in the wireless branch of the Services. Many of them are in the Royal Air Force, and they will find our "Aeroplane Maintenance and Operation" series of great value, for they cover practically every branch of the subject. The practical men are using our "Practical Mechanics Handbook," "Engineers' Manual," "Workshop Calculations, Tables and Formulæ," whilst instrument makers are finding our new volume, "Watches: Adjustment and Repair," of value. Those in charge of Diesel engines are buying "Diesel Vehicles: Operation, Maintenance and Repair."

### Our All-dry Portable

RESPONDING to a popular demand, this month we give constructional details for an all-dry battery-operated portable superhet. As will be seen, it is most compact, very easily built, and it has an excellent performance. Those engaged on A.R.P. or shelter work, men in the Services, and those remote from home and accumulator charging facilities, will welcome the publication of this design which, of course, carries the PRACTICAL WIRELESS guarantee; which is that, provided the components specified are used, we undertake to service it, free of charge, if carriage is paid, should the receiver fail to function in the manner claimed.

Editorial and Advertisement Offices:  
"Practical Wireless," George Newnes, Ltd.,  
Tower House, Southampton Street, Strand,  
W.C.2. Phone: Temple Bar 4363.

Telegrams: Newnes, Rand, London.  
Registered at the G.P.O. for transmission by  
Canadian Magazine Post.

The Editor will be pleased to consider articles of a practical nature suitable for publication in PRACTICAL WIRELESS. Such articles should be written on one side of the paper only, and should contain the name and address of the sender. Whilst the Editor does not hold himself responsible for manuscripts, every effort will be made to return them if a stamped and addressed envelope is enclosed. All correspondence intended for the Editor should be addressed: The Editor, PRACTICAL WIRELESS, George Newnes, Ltd., Tower House, Southampton Street, Strand, W.C.2.

Owing to the rapid progress in the design of wireless apparatus and to our efforts to keep our readers in touch with the latest developments, we give no warranty that apparatus described in our columns is not the subject of letters patent.

Copyright in all drawings, photographs and articles published in PRACTICAL WIRELESS is specifically reserved throughout the countries signatory to the Berne Convention and the U.S.A. Reproductions or imitations of any of these are therefore expressly forbidden. PRACTICAL WIRELESS incorporates "Amateur Wireless."

# New Uses for Old Components

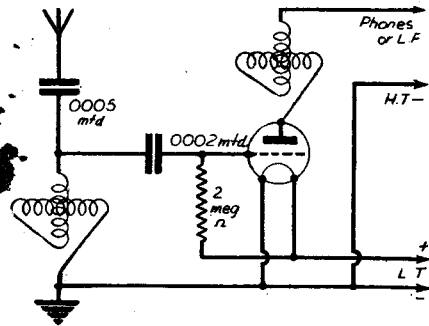

Fig. 1.—How two variometers may be used in a regenerative detector stage. It might be found necessary to shunt the anode-circuit variometer by a .0003 mfd. fixed condenser to bring it into tune with the aerial tuner.

THE use of old components—probably relegated to the junk box years ago—is an evergreen topic. To-day, when new parts cannot always be bought as readily as before the war, and when economy must be our watchword, it is of more than usual interest. We are often asked if such-and-such an old part could be used in a PRACTICAL WIRELESS receiver; that is, in a receiver of which full details are published. We are nearly always compelled to answer in the negative, since PRACTICAL WIRELESS designs are always carefully worked out for one set of components, and one only.

When building a simple set to his own design, however, the constructor can well try the effect of using odd parts, and he will often be successful, since his set will probably not be planned with quite the same thoroughness that must be followed in our laboratories. The experimenter has still more scope, because he is primarily interested in testing and experimenting with all kinds of circuit arrangements. A circuit which is rather outside the usual channel will often interest him far more than will one of more stereotyped pattern.

## Variometer Tuning and Reaction

One of the oldest components still to be found in many spares boxes is a variometer. You may say: "Yes, but that died a natural death nearly 20 years ago." Perhaps it did, but that is no reason why it should not be tried in conjunction with modern valves. Many readers will remember that the variometer was used largely because of its efficiency; it does not require any added variable capacity for tuning, and since no tappings are taken from the windings, there are no "dead-end" losses. Its use was very largely confined to crystal sets, for which it made an excellent aerial tuner in the days when a high degree of selectivity was not essential.

One method in which a couple of similar variometers can be used in a single-valve or Det.-L.F. receiver is shown diagrammatically in Fig. 1. It will be seen that one is in the aerial circuit, while the other replaces the reaction winding in the anode circuit. The "reaction" variometer serves as a reaction control operating in conjunction with the self-capacity of the detector valve, for which a small power or L.F. type is most satisfactory for the circuit illustrated. When the anode circuit is tuned to the same frequency as the aerial circuit, feedback takes place through the inter-electrode capacity of the valve. The valve then

In This Article the Experimenters Show How Many Old Components Can be Used Successfully, and How Some of Them Can be Modified so that they are Brought More Up to Date

oscillates just as it does when using "swinging-coil" or capacity-controlled reaction. Incidentally, reaction increases the selectivity of the set to a marked degree.

## Another Reaction Circuit

If you have only one variometer, you can modify the circuit shown in Fig. 1 to that given in Fig. 2. In this case the anode circuit component is replaced by a couple of similar coils, one of which is made to move in relation to the other. The coils may be made by winding about 250 turns on two flat bobbins, as shown in Fig. 3; the bobbins can be made by using a few discs of shellacked cardboard or fibre clamped together by means of a screw and

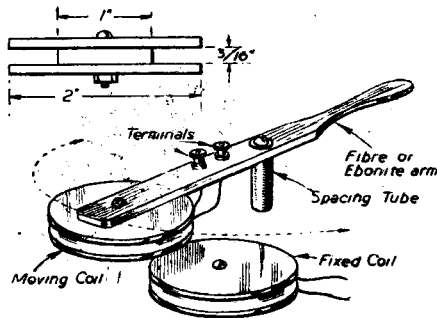

Fig. 3.—A convenient form of construction for the reaction coils shown in Fig. 2.

nut. One of the coils is mounted rigidly on the chassis or baseboard, while the other is carried on a fibre, bakelite or wooden arm so that it can be moved over the other one. It is important that the connections to these two coils should be in the correct "sense," so if you cannot obtain any reaction when the set is first tried, reverse the leads of one of the coils—it does not matter which.

Should you find it too much trouble to

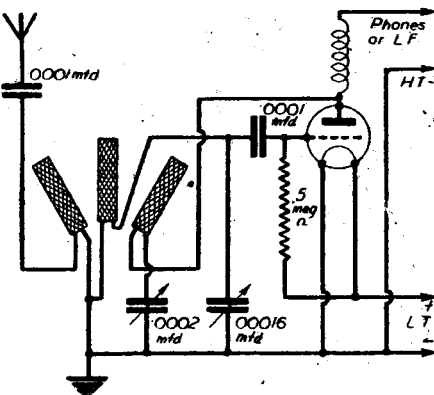

Fig. 4.—A good short-wave receiver can be made by using a three-coil holder in the circuit given here. The coils will have to be rewound if they are of suitable size for medium and long-wave reception.

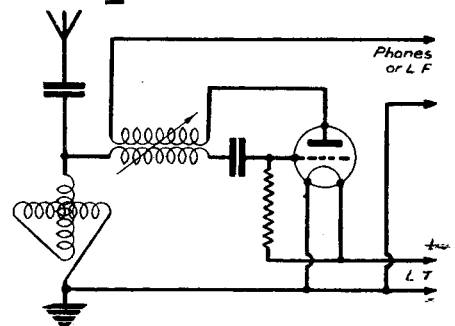

Fig. 2.—In this circuit a variometer is used for aerial tuning, while reaction is provided by means of a swinging coil coupled to a fixed coil in the grid circuit. Component values may be the same as those shown in Fig. 1.

make bobbins for the coils, wind the turns (cotton-covered wire between 30 and 36 gauge is suitable, whatever the form of construction), round three fingers, bind the turns together with thread, form the hank into an approximate circle and mount the two windings in a manner similar to that shown in Fig. 3.

## "Swinging" Coils

Plug-in two-pin coils and "swinging" coil holders are not very widely used nowadays, but they can quite well be pressed into service, especially for short-wave receivers. Thus, if you have a three-coil holder (centre one fixed, the other two movable), you could use it very well in a circuit of the type shown in Fig. 4. The left-hand coil is an aperiodic aerial coil, the centre one is the grid tuner and the right-hand coil is for reaction. Since the use of a swinging coil alone is not sufficiently precise for short-wave reaction control, a .0002-mfd. (capacity not very critical) condenser is used in addition. This is operated in the usual manner after finding the best position for the reaction coil. Movement of the aerial coil serves to vary the degree of aerial coupling and therefore the degree of selectivity. It also has an effect on reaction coupling, and when set to its optimum position for any particular waveband, both selectivity and sensitivity will be at maximum, and smooth control of reaction should be possible. Should there be a "dead-spot" in the tuning range—that is, a part of the condenser scale over which oscillation cannot be obtained—a small movement of the aerial coil should remove it.

## Rewinding Two-pin Coils

With regard to the size of the coils, it will generally be found that the reaction coil should be slightly larger than the grid coil, and the aerial coil about two-thirds the size of the grid coil. It is probable that the only coils available will be for the medium-wave range (numbers between 35 and 75) or long-wave range (100 to 250). In that case, the windings can be stripped and new windings put on. Assuming that the coil former has a diameter of about 2in., the approximately correct numbers of turns for the 20, 31 and 49-metre bands, using the .00016-mfd. tuning condenser shown, will be 8, 12 and 16. The wire should be about 22 gauge for the smallest coil, but may be as fine as 26 gauge for the largest of those mentioned and still finer for any larger coils. The aim should be to accommodate the required number of turns side by side.

When a fair number of coils is available they can all be rewound to form a complete set tuning from, say, 19 to 80 metres. All can be used in any of the coil holders, bearing in mind the general rules with regard to relative sizes that we mentioned above.

**Use for a Neutralising Condenser**

Another component which many will find in the junk box—especially those whose wireless days go back to the '20s—is a neutralising condenser. This was used originally for neutralising the internal electrode capacity of valves used for H.F. amplification, before the time of the S.G. and V.M. The maximum capacity is generally in the region of 15 mmfd., which is ideal in series with the aerial lead to a short-wave receiver working on wavelengths below about 20 metres. These condensers are of the variable type, and the capacity can generally be varied very gradually from minimum to maximum due to the mounting of the moving "vane," generally an alumi-

nium tube on a threaded spindle; this tube is moved into and out of a larger tube which forms the fixed "vane."

**Renovating Valves**

Here is a hint which we give with a good deal of reserve, because it does not always work. Very often an old triode valve of the dull-emitter type (not the bright emitters which many readers have almost forgotten, and many others probably never seen) can be given a new lease of life by subjecting it to the brutal treatment of connecting an H.T. battery across its filament. Actually, a start should be made by tapping off about 24 volts from the H.T. battery, connecting one lead to one of the filament pins and very quickly "flicking" the other against the second filament pin. With the old type of dull emitter this often has the effect of producing a new electron-emitting coating on the surface of the filament. This is because the older D.E. valves had filaments coated with a so-called rare earth; after

continued use of the valve, and if the filament did not burn out in the meantime, this coating was shed off, leaving the valve in a practically useless condition, although the filament would still glow. Remember that the treatment described is applicable only to old-type valves, and also that it will often have the effect of burning out the filament instead of improving its emitting qualities. Remember also that these old valves were far from efficient as compared with modern standards and cannot be made to perform as well as those we buy to-day.

**A Use for a Damaged Transformer**

Burnt-out L.F. transformers can often be used satisfactorily as L.F. chokes in the anode circuit of the detector valve. It is always the primary which burns out, and the secondary is generally quite sound. It is this winding, therefore, that is used by connecting it as shown in Fig. 5. The choke, it will be noted, takes the place of the anode resistance in an R.C.C. stage, and is in some respects better than a resistance because it does not cut down the H.T. voltage to such a marked extent.

While referring to the detector anode circuit it might be mentioned that a large two-pin plug-in coil (size 500 upward) can be used as a good H.F. choke in a medium-wave receiver. One of 1,000 upward is suitable in a medium- and long-wave set, and a 75 or 100 can be used efficiently in a short-wave receiver down to about 50 metres; below that wavelength a still smaller coil is suitable. It should not be placed close to the aerial coil, to which it should be at right angles.

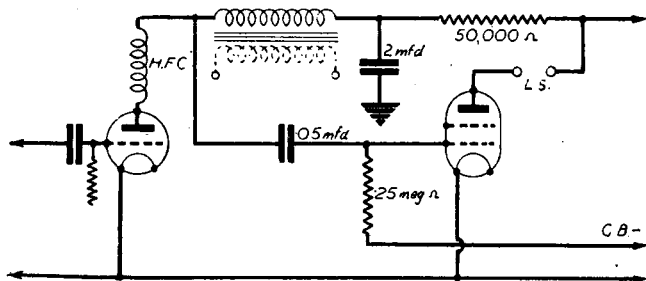

Fig. 5.—The secondary of an old L.F. transformer with burnt out primary makes a good L.F. choke for use in the detector anode circuit. The primary winding—shown in broken line—is not used.

**ITEMS OF INTEREST**

**A Ticklish Repair Job**

A JOB for which there are few competitors, if any, was performed recently by James Baysore, Mason, Ohio, "cloud specialist" for station WLW, Cincinnati, U.S.A. Clinging to a perch on top of Carew Tower, 644 feet high, he repaired a short-wave aerial which had torn loose in the high wind.

He ascended the pole, which rises above the observation platform of the skyscraper, 48 stories above the street, by means of metal steps clamped to the flag mast. The aerial, consisting of a network of copper wires, picks up broadcasts from WLW's mobile unit. The short-wave impulses are caught by the aerial, transferred over a ground wire to WLW's master control room five miles away, then relayed to the transmitter and tower at Mason, Ohio, 20 miles north of Cincinnati.

Repairs were necessary on the aerial after it had been loosened by wind. Also on the flag pole is the Crosley Corporation's television aerial. Baysore handles all of WLW's "high altitude" work both in Cincinnati and Mason. For his flag-pole job he was dressed like an Arctic explorer, with four layers of clothing wrapped around him. The hardest job, he says, is to keep his face warm. His safety depends on a life-belt, and a safety catch on each step of the pole.

**Listening Posts**

A NEW feature inspired by the inconsistencies of German propaganda broadcasts has been introduced by the B.B.C. in its overseas transmissions.

At 5 a.m. B.S.T. in the North-American transmission, each night of the week except Friday and Saturday, a résumé will

be presented of the statements made in the previous twenty-four hours on the German short-wave stations; these will be compared with what was said on Germany's medium wavelengths, and the notable differences between the stories told to the home audience and to the world at large will be demonstrated. The feature will also reveal the striking disparities between the different short-wave transmissions;

one version is prepared for the United States, another for Latin America and yet another for the Near East. These varying accounts of the German point of view will be translated and broadcast by the B.B.C. without comment.

The feature, under the title "Listening Post," incidentally demonstrates to the world one result of the work of the B.B.C.'s monitoring service which, throughout the twenty-four hours, listens to, and when necessary, makes recordings of, the transmissions from enemy stations.



The training of wireless operators for the R.A.F. still proceeds apace, and in the illustration wireless operators are seen leaving an aeroplane after a practice flight.

# Problems of Amateur Receiver Design—7

The Coils and I.F. Transformers Required for Superhet Receivers : All-wave Working with "Straight" and Superhet Circuits  
By FRANK PRESTON

**L**AST month I referred to the principal types of tuning coil used in the aerial and inter-valve circuits of "straight" receivers, pointing out the chief advantages of the different coil arrangements. To some degree, all of the points raised in that article are applicable to the initial stages of a superhet., especially when it incorporates one or two stages of H.F. amplification—prior to the frequency-changer. The differences occur in respect of the oscillator and intermediate-frequency amplifier stages, since the requirements here are entirely different from those relating to tuning circuits which have to cover the ranges of signal frequencies.

### Tuning the Oscillator

In the first place we can consider the oscillator-tuning circuit. As most readers are aware, this must always be tuned to a frequency higher than that of the signal by an amount equal to the I.F. Thus, if the aerial and other tuning circuits preceding the frequency-changer were tuned to

constructor and not necessarily to the student. But the explanation will help the constructor to appreciate the importance of choosing the oscillator coil, not only to suit the I.F. transformers to be used, but also to suit the gang tuning condenser. It would, for example, be futile to obtain a 110 kc/s oscillator coil to match the other tuners if the superhet.-type gang condenser were designed for a 465 kc/s oscillator coil. Similarly, if both coil and condenser were correct for 110 kc/s they could not be used in conjunction with 465 kc/s I.F. transformers. The practical importance of this comes into prominence when buying components from dismantled commercial receivers; when this is done, care should be taken to obtain the full set of tuning components from the same receiver. It is, of course, far better to buy proper components designed and made for constructor use, but this is not always easy at the present time when component factories are busily engaged in fulfilling Service contracts.

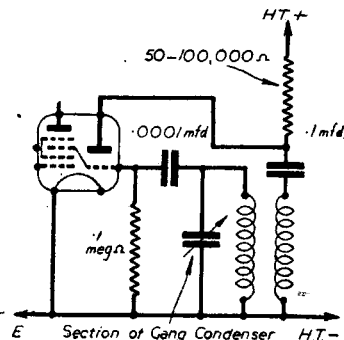
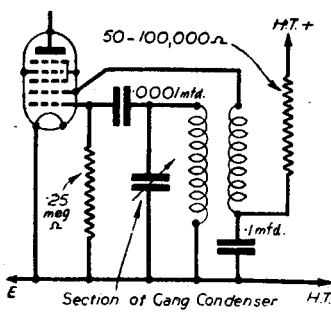

Fig. 1 (left).—The usual connections for an oscillator coil used with a pentagrid frequency-changer.  
Fig. 2 (right).—In the case of a triode-hexode valve it is generally better to parallel-feed the oscillator anode. In both this Fig. and Fig. 1 wave-change switching is omitted for clarity.

1,000 kc/s the oscillator should be tuned to 1,465 kc/s, assuming the generally-used I.F. of 465 kc/s. Because of this, the oscillator tuning circuit is different in two respects from any signal-frequency circuit: the tuned winding of the coil has fewer turns, and the section of the gang condenser used with the tuner has a lower maximum capacity than have the other condenser sections. Additionally, the vanes of the condenser section used for oscillator tuning are differently shaped from the others—in the majority of cases—in order that the resonant frequency of the oscillator circuit may change in such a manner that it shall always differ from that of the input tuning circuits by the same amount. This is a point which is often misunderstood, so it may be worth while to go into it a little more fully.

If the receiver is to cover a wavelength range of 200 to 600 metres, the signal-frequency tuning circuits must cover the frequency range of 1,500 to 500 kc/s, whilst the oscillator must tune from 1,965 to 965 kc/s. It will be seen that whilst the frequency of the S.F. circuits is varied in the ratio of three to one, the ratio of the oscillator circuit is varied only in the ratio of approximately two to one.

### Choice of Oscillator Coil

The above explanation is rather by the way, because this series of articles is intended primarily to be of interest to the

Another point which should be borne in mind in the same respect is that certain oscillator coils are designed for use with standard (not superhet.-type) gang condensers. These coils generally have built-in fixed padding condensers wired in series with the tuned windings and, therefore, with the condenser section used with the coil. The fixed series condensers have the effect of reducing the effective capacity of the tuning-condenser section and of ensuring that the rate of change of frequency is correct. It is still of the utmost importance, however, that the coils are used in conjunction with the appropriate I.F. transformers.

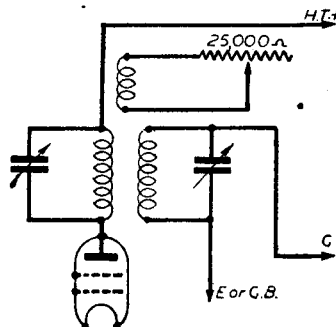

Fig. 4.—A variable-selectivity I.F. transformer of the type having a tertiary winding.

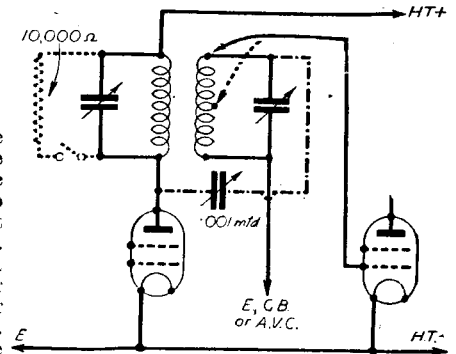

Fig. 3.—An I.F. transformer (in full lines with modified connections shown by broken and chain lines.

### Oscillator Connections

The usual method of connecting the oscillator coil (which consists of a tuning and reaction winding) is as shown in Fig. 1, where it will be seen that the tuned winding is in the grid circuit of the oscillator, the untuned or reaction winding being in series between the oscillator anode and H.T. +, generally with a decoupling and voltage-dropping resistor in circuit. A pentagrid valve is shown, but the same general arrangement would be followed when using an octode or a triode-pentode. When using a triode-hexode, however, it is found better to use slightly modified connections, as shown in Fig. 2. Here it will be noticed that H.T. is supplied to the oscillator anode through a parallel-feed circuit, the reaction winding being isolated electrically by means of a fixed condenser, which also serves as a decoupling condenser along with the decoupling resistor. Another modification which is sometimes found desirable, consists of including the tuned winding in the oscillator anode circuit, with the reaction winding in the grid circuit. This is often found to be better than using the connections shown in Fig. 2, and in the case of a semi-experimental receiver it is well worth while to try the effect of reversing the positions of the windings shown in Fig. 2.

### Resistor Values

In both Fig. 1 and Fig. 2 the oscillator-anode decoupling resistors are given a value between 50,000 and 100,000 ohms. These are average, but the optimum value is, naturally, dependent upon the voltage of the H.T. supply and the particular frequency-changer in use, and it is therefore best to work to the figures supplied by the valve makers, using the simple resistor-calculation formulæ given in a previous article of this series. The value of the grid leak also varies in some measure according to the particular valve employed, although in many instances it is found that results are not affected by altering the value outside the range of 50,000 to 250,000 ohms. Valve makers generally give some guidance on this point in the instructions provided with the valve.

### The I.F. Coils

Having settled the main questions concerning the oscillator, we can turn to the I.F. stages. As we have seen, the I.F. transformers must be chosen to match the intermediate frequency provided by the oscillator. Knowing that, however, we have a wide field from which to choose



our transformers. In most cases they may be of the simplest possible type, consisting of two plain windings, placed adjacent to each other and each semi-tuned by means of a built-in pre-set condenser. The connections are shown in full lines in Fig. 3.

When additional selectivity is required there are two main methods of securing it: by moving the primary and secondary windings of one or all of the transformers so that they are further apart; by using a centre-tapped secondary, as shown by a broken line in Fig. 3. The former method is convenient when the windings are on separate spools carried on a central pillar and when the screening can be removable, but it is not always a practical proposition. On the other hand, by using the centre-tapping there is sometimes a greater loss of efficiency. This loss may be offset by the reduced damping on the secondary, however, especially when using a double-diode second detector. It would then probably be most satisfactory to make connection to the end of the secondary of all transformers except that immediately preceding the second detector.

It should be mentioned in passing that if the windings are moved apart it will probably be necessary to re-set the trimming condensers after each experimental movement.

### Increasing the Band-width

In some instances it might be found that tuning is too sharp, with the result that quality suffers. The windings of one of the transformers (probably the first) may then be placed a little closer together. A simple alternative method, which is not to be strongly recommended, is to connect a fixed resistor in parallel with the primary winding of the first I.F. transformer. This resistor is also useful when difficulty is experienced in keeping the receiver completely stable, but again the method is not recommended except in extreme cases, since it must cause a certain loss of efficiency. The parallel-resistor method is more often used in conjunction with a switch, as shown in Fig. 3, so that it can be brought into circuit on long waves (when the instability is generally most troublesome, if it occurs at all) and switched out on medium waves. The on-off switch can be mounted so that it is ganged with the ordinary wave-change switch.

### Variable-selectivity I.F.'s

In nearly every case it is better to have a form of variable selectivity than to make the tuning extremely sharp or unduly flat. There are various types of variable-selectivity transformer on the market, in the simplest of which one of the windings is mounted on a rotor so that it can be turned in respect of the other to give variable coupling. Another arrangement which is convenient, and which can be applied to ordinary transformers, is to connect a variable or pre-set condenser between the high-potential (grid and anode) ends of the windings; this is indicated by means of chain lines in Fig. 3. Coupling is increased by increasing the capacity of the condenser, so it is desirable in the first place to set the windings fairly well apart. This is especially important if the pre-set condenser used has a comparatively high minimum capacity. It is often better, however, to use a variable condenser—one of the solid-dielectric type is convenient—of one-half the capacity indicated in Fig. 3.

Another excellent method of obtaining variable selectivity is by using an I.F. transformer with an extra tertiary or damping winding, as shown in Fig. 4.

The winding is generally placed between the other two and is connected only to a variable resistor. As the value of the resistor is reduced the damping effect of the "floating" winding is increased, and vice-versa. The value of the variable resistor shown is not necessarily that which is most suitable in all cases, and the recommendation of the component manufacturer should be followed.

When variable selectivity is employed

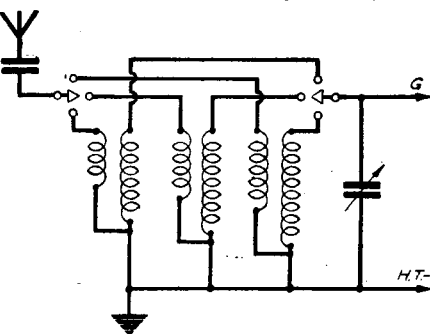

Fig. 5.—The customary arrangement of separate coils in an all-wave tuner. The two rotary switches shown would be ganged together, and also ganged with similar switches for other tuners in the receiver.

## Review of Broadcasting in 1940

IN reviewing broadcasting during the year 1940 the tremendous part it is playing in the country's war effort inevitably overshadows all the other activities of the B.B.C. And yet, despite war-time difficulties, the B.B.C. has continued to provide manifold services for an audience which listens more attentively than it did in peace-time and which has grown considerably despite war-time difficulties of reception. But, naturally, it is in foreign broadcasting that the biggest strides have been made, and to-day listeners in every Continent tune in to "The Voice of Britain" as it reaches them in an ever-growing variety of tongues.

### Day and Night Transmissions

In 1940 the B.B.C.'s Home and Overseas services involved ceaseless transmissions day and night throughout the twenty-four hours. Before the end of the year the B.B.C. was broadcasting in thirty-two languages—seventy-five separate news bulletins (a quarter of a million words) were being radiated every day, apart from the many other programmes devised purely for listeners overseas. News editors and programme builders with special knowledge of foreign countries, and linguists of thirty different nationalities, were numbered in the B.B.C.'s war-time staff.

Summed up, the year 1940 represents an accumulation of broadcasting resources in terms of personnel and equipment that is still growing and is not even yet within sight of its peak.

Democracy demands that the British people should be taken into the confidence of their leaders, and by the time Mr. Churchill became Prime Minister listeners had already learned to look to him for his realistic statements on the war and the problems with which the nation is confronted. He gave ten broadcasts during the year—six as the nation's Prime Minister, which were relayed to the world. Lord Halifax, Mr. Attlee, Mr. Ernest Bevin, Mr. Herbert Morrison, and other members

of the Cabinet also broadcast during 1940; while Mr. Duff Cooper, Minister of Information, spoke on a number of occasions. Lord Woolton, Minister of Food, has also become a well-known microphone personality.

### All-wave Tuning

Mention has not been made of all-wave tuning so far, but this does not call for very much attention here, since the arrangement of windings will be similar to the arrangements already discussed. The most usual method, and nearly always the best, is to have what amounts to a set of coils, each complete in itself, although all are mounted in one unit, and a rotary switching system for bringing into circuit whichever is required for the waveband to be covered. Thus, we have the connections shown in Fig. 5, where an aerial tuner is indicated. Precisely the same arrangement would hold good for inter-valve coils and for oscillator coils, and the various rotary switches employed would be ganged together by mounting them on a common spindle. This is the method adopted by manufacturers of all-range tuners and all-range coil assemblies, and it is far more effective than the older-fashioned method of using a single coil suitably tapped.

### Crisis in France

During the crisis in France in June, broadcasting became an essential means of communication from this country to the Polish and Czech armies fighting in France. The facilities of the B.B.C.'s European broadcasts were at once made available to the Polish Commander-in-Chief and to the Czech military administrations in London. Messages were transmitted instructing Polish and Czech soldiers to keep in touch with the British Command. General Sikorski himself spoke in the Polish and French services on June 19th. Czech pilots in France were told to fly their machines to Britain, and those in North Africa were advised to report to the nearest British post. Broadcasts of similar importance in the conduct of the war were made from time to time for the purpose of communicating with Allied merchant ships on the high seas. How many sea captains steered their ships to British ports as a result of messages broadcast by the B.B.C. may never be known, but the high percentage of the merchant fleets of enemy-occupied countries now serving in the Allied cause is proof of the value of these broadcasts.

At the request of the Polish Ambassador, the B.B.C. introduced a series of broadcast messages during the invasion of Poland by which refugees were able to convey news of their safety and whereabouts to friends and relatives.

The North American service was also one of the year's big developments and there are now daily transmissions of six hours, including news bulletins, variety and feature programmes and the "Britain Speaks" series by such well-known broadcasters as Vernon Bartlett, J. B. Priestley and Leslie Howard.

### The King's Broadcasts

The King broadcast on two occasions during the year. On Empire Day, at a time when the fate of the B.E.F. in France and Belgium was still in doubt, he spoke grave words of encouragement to the people in the British Commonwealth. The institution of the "George Cross" and the "George Medal" was the occasion of the King's second broadcast on September 23rd. In the course of it the sirens were heard sounding the "raiders passed."

The Queen broadcast on April 13th, on the occasion of the eighty-fifth anniversary of the founding of the Y.W.C.A. On June 14th, the day that Paris fell, Her Majesty broadcast in French to the women of France, conveying the sympathy and

admiration of the women of this country.

The most memorable day in the year's broadcasts to children was on Sunday, October 13th, when Princess Elizabeth broadcast a message in the Children's Hour to the children of the Empire. Princess Margaret, who was standing at her sister's side, also made her maiden speech over the air by bidding their listeners "Good-night."

### Programme for the Forces

One of the B.B.C.'s earliest war-time innovations was a special programme for the Forces, and during the winter of 1939-40 it was the greatest boon to our men on the Western Front. Since the Battle for Britain began, its popularity is perhaps even

more enhanced, and it is so much the Services own programme that they themselves often provide much of the material.

With all the rapid expansion in these other directions, there has been no diminution in the quality of Home Service programmes. Listeners have been kept informed of the march of events by experts who give the background to the news and explain the significance of moves in the domestic, the diplomatic and the military spheres. For instance, the Sunday-night postscripts by J. B. Priestley and the War Commentaries by Air-Marshal Sir Philip Joubert became outstanding events.

This brief outline gives some idea of how the B.B.C. did "go to it" in 1940—a year of abnormal and strenuous activities.

## COMPETITION RESULT

### "How the War has Affected my Radio Hobby"

**S**PACE prevents us from publishing all the winning essays in complete form, so we are giving below extracts of those whose writers have already been awarded book prizes.

**G. N. Green**, of Ruislip, describes how during his work of national importance, radio helps him to secure a welcome break. He says: "As an A.R.P. worker, I find very little time for the practical side of wireless, but I am able to devote more time to the reading and studying of technical matters. When my duties at my A.R.P. post allow, I read PRACTICAL WIRELESS and I am pleased to note that my colleagues are also becoming more and more interested in wireless since they have had the opportunity of reading my copy of PRACTICAL WIRELESS."

"For my part, I am very interested in short-waves and I intend to try out a number of circuits, selected from back numbers of PRACTICAL WIRELESS, when we have won this war. I have read about and enjoyed making scores of sets from the time when your journal first appeared. I have been interested in wireless since the age of eighteen years, and I am now forty-one years. Am I tired of it? Indeed not; in fact, I am more interested and am looking forward to the days of peace when I shall be able to return to my wireless den again and carry on with the good work."

**A Scottish reader**, Arthur McCaig, of Drymen, uses a theme which applies, we imagine, to many constructors.

"War has had a curious effect on my radio hobby, as it was about the time when the last one ended that a friend and I built a set which brought us nothing more than Morse and a lot of trouble. However, we were keen, so at a later date we built a set which brought in 2LO, and Rugby. Like many other enthusiasts, my interest waned with the passage of time, chiefly on account of the mystery with which radio was surrounded by early journals. The advent of PRACTICAL WIRELESS renewed my zeal and, by a combination of circumstances, my hobby again occupies much of my time and thought. Recently, we had electricity installed in the home, so straight away I built an A.C. trickle-charger from a design in PRACTICAL WIRELESS of March, 1936. With an eliminator already at hand, I now have the nearest thing to the all-mains which is to be my future set."

An entry from a reader in the R.A.F., **A. F. Light** (L.A.C.), N. Wales, describes the thrill he is anticipating. He explains: "In an old copy of PRACTICAL WIRELESS I came across a suggested circuit using a pair

of Lissen four-range coils. The idea appealed to me as being sound, and I assembled, rather roughly I must admit, the circuit just to see if my estimation was correct. Well, the results obtained—on all four wavebands—surprised both myself and my friends, and the only fault I had to find was connected with the type of slow-motion dial I used. I managed, however, to obtain a pair of G.E.C. slow-motion variable condensers and set about assembling and wiring the set as my main receiver. War broke out. I was robbed of the thrill of testing my new set, but I now picture it already waiting for me to put it through its paces when my leave comes. I have fancied several circuits which you have published, and I am keeping them together, with all the notes and information you have given, ready for use at a later date, but if the set I have gives me the results I expect, I wonder whether I shall leave it alone or shall I see and build something which you might have or will publish that will offer even greater appeal to me."

**H. T. Betteridge**, now serving with the R.A., strikes a most interesting note. "The war has given me radio as a hobby. Since as a schoolboy I played with crystal sets my career and outdoor interests have prevented radio from attracting my attention. The war placed me in a wireless branch of the services and from Ohm's Law I have progressed to quite advanced technical literature. Now, from being part of my duty, it has become the absorbing interest of my spare time. I have joined the R.S.G.B., and am a regular reader of PRACTICAL WIRELESS, which whets my appetite for the practical side of the subject. But up to the present my interest has, perforce, been theoretical; lack of facilities for construction have so far prevented me from building the short-wave portable equipment on which I have set my heart."

"After the war I hope to be able to build myself a set that will give me world-wide reception on all wavelengths from 10 to 600 metres."

"The Birth of a Business" would be a good sub-title for the entry received from Lawrence McGee, of Bristol.

"When war commenced, I was a relay station operator, but later I obtained a position as a radio service engineer. Unfortunately, the firm had to close down owing to the shortage of trained men. My friend and I were devoting our spare time to experimental work and, occasionally, to a certain amount of radio servicing, but as

time went on we found that we had more work than we could cope with. The increase demanded more space and better facilities, so we decided to rent a roomy workshop which we happened to know was vacant. We carried out all the work, black-out fittings, construction of benches and shelves, etc., ourselves, and recently we have been able to add a writing-desk and lino for the floor. After the war, we have decided to build a transmitter in our workshop, and to construct a receiver-amplifier of the rack type which we have designed."

Another reader in the R.A.F. explains how the training he has received since being in uniform has opened up fresh ground for him; his name is **W. E. Austin**, Brightlingsea.

"Before the war I was an ardent short-wave enthusiast, spending most of my leisure hours experimenting and listening. Now that we are at war, those pleasures have been denied me, to some extent."

"I am now nearing the completion of my course, which I have found extremely interesting and instructive. Before I joined up, my listening was restricted to radio telephony, as I had no knowledge of Morse. But now that I am able to operate with Morse I realise how much I have missed in the past. After the war, I am hoping to obtain a transmitting licence and join the grand band of British 'hams' in their experiments. With the help of PRACTICAL WIRELESS, I hope to design and build my own apparatus, such as transmitters, receivers and the other gear necessary for an amateur station."

**G. R. Neville**, of Greenwich, looks ahead, and seeks respite and enjoyment in anticipation of what the future holds for the radio enthusiasts.

"My radio activities have been somewhat curtailed by the war, but I still follow with keen interest, through the medium of PRACTICAL WIRELESS, a hobby that has been mine since the days of crystal and reflex circuits. The monthly appearance of PRACTICAL WIRELESS is certainly well worth waiting for; a real achievement when one appreciates the difficulties of production. Until quite recently, I have been carrying out some very interesting experimental work connected with L.F. amplifiers for record reproduction. An occasional spot of DX listening on the short-waves is, I find, a very good tonic."

"What shall I build after the war? Shall we find any big developments, when once again we are able to spare more time for our radio activities? Also, what will the manufacturers offer us? What an opportunity there should be for manufacturers to change over from war work to that of producing good components for constructors."

# ON YOUR WAVELENGTH



## The B.B.C. Accent

WHAT a welter, what a miasma of correspondence has descended on me over my comments on the B.B.C. accent. Playful letters, satirical letters, letters interlarded with sophistry, letters containing the rapier thrust of acrimony, letters agreeing with me, letters pointing the minatory finger, threatening letters and, of course, the inevitable batch of anonymous letters, which have found one of the two places reserved for anonymous letters—usually the wastepaper basket!

But I see that I am not alone in criticising, however mildly, the B.B.C. for daring to take upon itself the rôle of national lexicographer and flaunting such authorities as the Oxford dictionary. Here is one gem from the *Daily Mail*: "The B.B.C. are certainly carrying on a wonderful job; the pronunciation of the announcers is perfect." I presume here that the critic is referring to accent rather than to pronunciation. However, this quotation is from a letter sent by a lady.

A fair young lady at Cleadon resides.  
After hearing them speak the lady decides  
That it's just perfect English the way they announce,  
Quite free from all swank or suggestion of bounce.  
Having publicly stated she thinks them just fine,  
Perhaps she's hoping they'll call round and see her  
some time!

This is a comment by Torch. However, interwoven with the question of B.B.C. accent is that of the Northern accent, which I gently jibed last month, and Torch further comments thus:

What ails thee, Thermion, owd bird?  
As tha duzzent like Lankysshire foak,  
Nor Yorkshire, noather, it seems,  
An't way as eaur English is spoke.  
We'n allus thought well o' thee,  
Us radio fans in't North,  
An' we buy thi yellow-backed un,  
Cos we know it's good money's worth.

So theau shouldn't torn ageanst us  
Cos we dorned speak same as thee:  
We're beaund to tell thi summat,  
An' we hoap as tha'll agree.

We know as there's gradely foak in't North,  
Ay, an' many a lot in't South,  
But thi canna judge oather on 'em  
By t'speech as cooms caut o' their mouth.

It's their deeds as counts, an' they're Britons aw.  
An' together they stand in't breach,  
An' they won't forget as they're brothers  
In spite o' their different speech.

Well, we dunnot bear thee no malice, owd lad,  
Or we'd tell thee so to thi faace:  
An' we still think eaur Thermion's a gradely chap.  
If eaur dialect's a bit caut o' plaace!

## A Critic from Dorking

I HAVE received a number of postcards from W. R. C., of Dorking, who always omits to include his address. This critic sends suggestions for articles he would like to see in this journal. Had he included his address I should have been able to indicate to him that all of his suggestions have formed the subject of articles in previous issues. One of his suggestions was that we should tell him how to make a series aerial condenser!

## The Purchase Tax and Repairs

HIS Majesty's Customs and Excise Department have removed the wrinkles from the brows of many dealers on the question of Purchase Tax and repair work. Manufacture of wireless apparatus

## By Thermion

is defined as making goods or performing any process in the course of making goods. It does not cover repairing or reconditioning an article, provided that the operations performed are not so extensive as to involve the making of what is virtually a fresh article. Therefore, liability to register as a manufacturer does not arise from reconditioning and repair work. Liability to register as a wholesaler may occur if the reconditioned or repaired goods, being the property of the repairers, are intended for resale to retailers, but not if intended for resale to consumers. Sales by registered persons are not exempt from tax on the ground that the goods are second-hand or reconditioned, but no tax is chargeable on sales of such goods where transactions are between retailers and their customers, and the same applies if a registered firm is dealing with the goods in its capacity as a retailer.

## A.G.M. of the R.M.A.

AT the annual general meeting of the R.M.A., the following firms were elected to the council: Messrs. Belling and Lec, Plessey, Bulgin, Westinghouse, Bush, Cossor, G.E.C., Marconi, Murphy, Pyc, Ultra.

## That Intransitive Verb

I HAVE received an interesting letter from G. W. S., of Ickenham, and this is what he says:

"Since the inception of PRACTICAL WIRELESS, I have seldom, if ever, failed to gain much pleasure in the perusal of 'On Your Wavelength,' and in reflecting on the forceful personality so well expressed in those gems of satire which sparkle among the more general items of topical interest for the radio fan.

"My December issue of PRACTICAL WIRELESS reached me, unfortunately, rather late, the delay being doubtless due to the exigencies of the transport system in the Christmas rush. Picture my delight on turning to page seventy-nine to read, in paragraph one, another of those satirical cameo criticisms of the

B.B.C.—this time with our old friend 'Thermion' in a new rôle—that of 'grammatic' critic to the announcing fraternity. A fair damsel, it is, who wilts under his withering fire, and I am here, in writing, to temper justice with mercy for the victim.

"Now, I wholeheartedly agree, Thermion, that the unique position of the B.B.C. announcers necessitates that their grammar should, at all times, be exemplary. But I am going to submit that, though the example instanced in this particular indictment, viz.: 'I will play you "So and So"' is incorrect, when judged by rigid grammatical standards, it conforms with conventional expressions of the type:

"I will pay you two shillings  
or I will send you PRACTICAL WIRELESS  
or I will buy you a fur coat.

"As a parallel to your introductory comments it may be argued: One does not pay *you*, nor does one send *you*, neither does one buy *you*. Construed according to strict laws of grammar, the foregoing should, of course, read, respectively:

"I will pay to you the sum of two shillings.

"I will send to you the publication PRACTICAL WIRELESS.

"I will buy for you a fur coat.

"Moreover, Thermion, I cannot agree that the verb 'to play,' even though used in the specified sense, is intransitive.

"My own conclusion on the incident is that the good lady in question allowed herself to lapse into loose or conventional grammar, which, I hope you will agree, is not quite the same as committing a grammatical error. So much for B.B.C. grammar. May the day soon dawn when those evil things we fight against are utterly and completely destroyed, and we can look forward to an era full of promise of discoveries and developments in our own particular branch of science. Then, also, we shall see our desires realised in the fulfilment of your promise that PRACTICAL WIRELESS will revert to weekly publication, with our old friend, to whom I have the honour of addressing this note, sporting his inimitable style in 'On Your Wavelength.'"

## Flying Without Wings

MAGIC lanterns and darkened rooms are used for the ground training of R.A.F. bomber crews in the "Cubicle Trainer."

The screen is hung on one side of a large room. On the opposite side stands a row of half-a-dozen glass-fronted cubicles—hence the name. Each cubicle contains a pilot, a navigator, and a wireless operator. Outside the cubicle sits the instructor, who is in touch with the half-dozen crews by wireless only. By sending them on a "flight" to, say, Milan, he gives them an exercise in navigation. Every few minutes a slide of an aerial photograph showing landmarks over which they would pass if in actual flight is thrown upon the screen. They see the slide through the glass front of their cubicles.

Before entering the cubicles the crews are "briefed," just as bombing crews are "briefed" at an operational station before going on a real raid. They are given their objective, and the instructor decides the route which they are to follow. From the moment of "taking off" the navigators begin to plot their course on a chart.

Not all the pictures on the slides are easily recognised, and the crews would soon be "lost" if the wireless operator were not there to pick up a bearing from the "ground"—that is, from the instructor outside. Sometimes slides of towns or landmarks which are just off the route are deliberately shown. If the navigator recognises them he will know from his maps just how far he has been carried by wind drift from his correct course. If he fails to recognise them he will again need the wireless operator to get a "fix" from the "ground" and to establish his position.

## Our Roll of Merit

Our Readers on Active Service—Twelfth List.

- E. Thomas (Pte.),  
Chepatow.
- A. Warner (Signalman),  
Home Forces.
- J. N. Harris (Driver, R.A.S.C.),  
Home Forces.
- J. C. Holland (Sub. Lt., R.N.),  
C/o G.P.O.
- R. M. Nielson (Sgt.),  
Shetlands.
- F. G. Stanley (Pte.),  
Lancs.
- Doughty (Armourer L/Cpl., R.A.O.C.),  
Cheshire.
- G. R. Hughes (Sgt. R.A.M.C.),  
Leominster.

# The History of the Radio Valve : 1900-1916

Dr. de Forest Reviews His Early Adventures During His Development of the Vacuum Valve

**T**HE evolution of the radio or "audion" valve as it was known, is a very interesting story, and one that is not at all well known. Most radio men assume that it was accomplished through a fling of inspiration. But this is not true. It came about through hard work.

Just over forty years ago, I entered into the development of wireless telegraphy, and knowing at that time what Marconi had been using, there were many unnecessary complications. I didn't have a clue, but I went to the library in Chicago at night, and finally came across an observation which a German physicist had recorded, and that gave me an idea of what could be developed into a wireless detector. I worked in my room at night and spent my days in the Western Electric Telephone laboratory. In my room was a little spark coil with which I generated my electric waves. One night, when I made this coil spark, I noticed the light of the Welsbach gas burner on the wall dimmed very perceptibly. It occurred to me that the electric waves were acting upon the incandescent gases surrounding the gas mantle.

## Gas Detector

In 1903, I had a chance to get into laboratory work and investigate the gas detector, as I called it. I used the Bunsen burner in these experiments, and proved that heated gases were actually responsive to electric waves.

By 1905 I had advanced to the point where I was using a carbon filament to heat the attenuated gases in a glass tube. In connection with this bulb, I used, as I had always used in my gas-flame experiments, a telephone receiver with an H.T. battery connected between the plate and the filament in the bulb. The device was not a rectifier, but a genuine relay detector whereby the electric waves produced marked changes in the battery current which was flowing through the tube.

## The Third Electrode

In 1906 I removed the antenna connection from the plate electrode and connected it to a simple piece of tinfoil wrapped around the cylindrical tube. This proved to be a great improvement over my preceding arrangement. I next placed this controlled electrode within the tube in the form of another plate on the opposite side of the filament from the first plate. This third electrode within the tube was a marked improvement, and I decided that I could still further improve the device if I worked it between the filament and the anode electrode.

At this time I had in mind a telephone repeater, or relay, and took out a broad patent on the three-electrode valve thus used. In addition to the filament battery, and the plate or H.T. battery, I used a G.B. battery in series with the controlled electrode. My patent was that I used this battery to bias "negatively" the

controlled electrode, but I did not claim this arrangement in my patent. As the result of this omission on the part of my patent attorney, Mr. Lowenstein later secured a patent on the negative grid-bias which for years was a controlling patent in radio litigation. The negatively-charged controlled electrode was of much more value when audion was used as a telephone relay, than as a wireless detector. From



Dr. Lee de Forest.

my earliest experiments I continued to use a blocking condenser in a series within the controlled electrode.

Although my first valves were low vacuum, they were nevertheless quite gaseous, and permitted me to use only 22 volts on the plate. Gradually I began to exhaust my valve to a higher vacuum, so that I could apply higher potentials to the plate, thereby increasing the power which could be used.

In 1908 I changed from the cylindrical to the spherical type of tube. In 1907/8 I began to use two filaments in parallel. One of these was a spare. The free end of the filament was brought out of the bulb, and when the first filament burned out the second one could be used simply by winding a spare wire around the base of the bulb. In 1906 the name "Audion" was applied to the device by my assistant, Mr. Babcock.

## "Double Audions"

In 1909, in order to increase the conductivity of the valve and to enable the use of larger energy, we used two plates and two grids, usually connected in parallel. We called these "double audions," and sold them at a higher price than those using the single plate and grid.

In 1909 I first used the grid-leak, for when I began to get a really high vacuum I found that the audion would block, provided that a good condenser was used in the grid connection. To avoid this, I used a high-resistance grid-leak. Our panels were of hard rubber in those days,

and my first grid leak was simply a pencil mark in the panel connecting the grid and filament binding posts. With this device, the "audion" became very popular in 1909.

## A Two-valve Amplifier

In 1911 I moved to San Francisco as Research Engineer for the Federal Telephone Company. In 1912 that Company was establishing long-distance telephone calls from San Francisco to Honolulu. They used a buzzer and tickler system, but it was not very sensitive. They could barely read the messages from Honolulu, so they asked me what I could do in the developing of an amplifier. I again went to work on my baby. From New York I got a supply of "audions." I now got the amplifier to work without much difficulty, first singly, and then two audions in cascade. The greatest voltage I could use was 50 to 60 volts because the vacuum was not sufficiently high at that time. So I took all of the valves to San Francisco to a maker of X-ray tubes. He re-tubulated them and got a much higher vacuum. I could then easily use 200 volts of H.T. battery. I always used individual H.T. batteries, one for each amplifier stage. As a result of those experiments, I developed the cascade amplifier into what later became an invaluable device. On one occasion, after breaking my last but one good "audion," I tried to make one audion do the work of two, feeding the output energy back into the grid circuit. This set up a terrific howl in my headphones. That was the first feed-back circuit in radio history. At that time, instead of using the transformer, I tried the auto-transformer, or choke-coil, and found that I could couple the second audion with the first in that manner.

## Tungsten Filament

In 1913 I got back to my own laboratory in New York. One of the first improvements thereafter was made by Dr. Hudson. He experimented with the tungsten filament, wrapped a fine tantalum wire around the tungsten, and found it increased emission; called it the "Hudson X" filament. The "hams" clamoured for these audions. In the same year, in my own laboratory, I began to develop the feed-back circuit for use both as a receiver and as a transmitter. I also began to make these valves in my own plant, but I encountered plenty of trouble in mastering this complex art in those early days.

## Transmitter Valves

The next step was towards the type of transmitter valves we see to-day. About that time, in 1915, the Western Electric Company adopted the same design for their transmitter valves. The chief difference was that they used oxide-coated filaments. The Western Electric Company erected a transmitter in connection with the first Naval wireless station at Washington, and were soon able to telephone the Eiffel Tower, in Paris. From that point progress in valve construction became a matter of engineering design. The entry of America in the World War increased the demand for enormous quantities of these valves, and during this time the General Electric Company, as well as Westinghouse, began to make them.

The history of the radio valve for the last twenty-four years is too well known to bear repetition.—*Radio News*.

**Everyman's Wireless Book**

5/-, or by post 5/6 from George Newnes, Ltd., Tower House, Southampton St., London, W.C.2.

# Modern Factory Production Methods—6

Factory Inspection Technique is Explained in This Article. By "SERVICE"

IT could well be imagined that the start of full production would mean the end to all the worries of the many engineers who, as we have seen, have been so deeply immersed in their work of getting the new receiver on to the assembly line. This, however, is not so, and the real troubles only commence when the assembly line has got into full swing. Any hitch that slows down production at this critical stage will entail a definite, and perhaps serious, monetary loss on the production, and as an insurance against these losses factory managements will not hesitate to maintain a large staff of experienced inspectors.

Readers will realise the importance attached to inspection by the many vacancies which may be seen for experienced inspectors in the employment columns of newspapers and journals, and at the present time the factories and the Services cannot obtain enough qualified men for their needs. It has been the writer's endeavour throughout this series of articles to impress upon the reader the reason behind many of the rather misunderstood features of modern factory production methods.

Readers who aspire to senior jobs in large factories, but whose horizon has been bounded by the four walls of a small service workshop will be completely "at sea" when applying for such situations, unless they have an underlying knowledge of factory procedure, especially inspecting.

To be an inspector who cannot only criticise the material or article he is examining, but who can also appreciate why it is not up to the standard he demands, a thorough insight into factory methods as outlined in this series is essential. It is, of course, no good demanding a standard of such excellence that only hand-made articles produced in single units at high cost can satisfy the quality desired, when the job has evidently been given over to mass production because of the factory's ability to produce a large quantity of an article in a short time at a low cost, and to a fair standard.

## Inspection Points

However, we have already dealt with this question, and will proceed to investigate the whole matter of inspection as it affects the large factory. The importance of inspection will be better appreciated from the following list of inspection points in a large manufacturing concern.

(1) At the goods inwards department an inspection will take place of all component parts or material being delivered to the factory to see that they comply with the specification laid down by the purchasing department, who have, of course, prepared their specification from the designer's instructions. In many cases the goods inwards department will forward the material and components to the various stores allocated to receive them, and these stores carry out the actual inspection.

(2) The assembly floor will inspect the material they draw from the main stores into their own smaller stores from which the assembly line is fed.

(3) Any sub-assemblies, as described in the fourth article in this series, made up from parts drawn from the assembly floor stores will be passed to the inspector before

they are handed on to the girls on the actual assembly line for incorporation into the receiver chassis.

(4) There will be various stages of inspection along the assembly line to cover those operations or assemblies which cannot be properly examined at the end of the assembly line.

(5) The chassis will be inspected as it comes from the assembly line for wiring and mechanical faults so that the chassis is a perfect working unit before it is handed over to the operator who puts it into its cabinet.

(6) The cabinet will be inspected before it is accepted by the assembly floor.

(7) The complete receiver will be finally inspected immediately prior to packing, and after it has had its final performance test to see that there are no faults such as knobs scraping on the front of the cabinet, scratches on the woodwork, omission of instruction leaflets, etc.

condenser drives, soldered joints, etc., a square for cabinet inspection, and so on.

Very small items, such as pick-up coils, cannot be stamped in this way, and often a spot of paint is used to indicate the inspection stage, the colour being used to identify the operator concerned.

Final tests on a complete model immediately before packing for transit are generally recorded by the tester putting his stamp on a label which is tied to the receiver or inserted into the instruction book. If any complaint is made when the set is delivered the label should be sent back to the factory to enable investigations to be made.

## Cross-checks

Many readers of PRACTICAL WIRELESS who have in the past been service engineers, working more or less on their own, may find themselves in jobs in mass-production factories where the above-mentioned

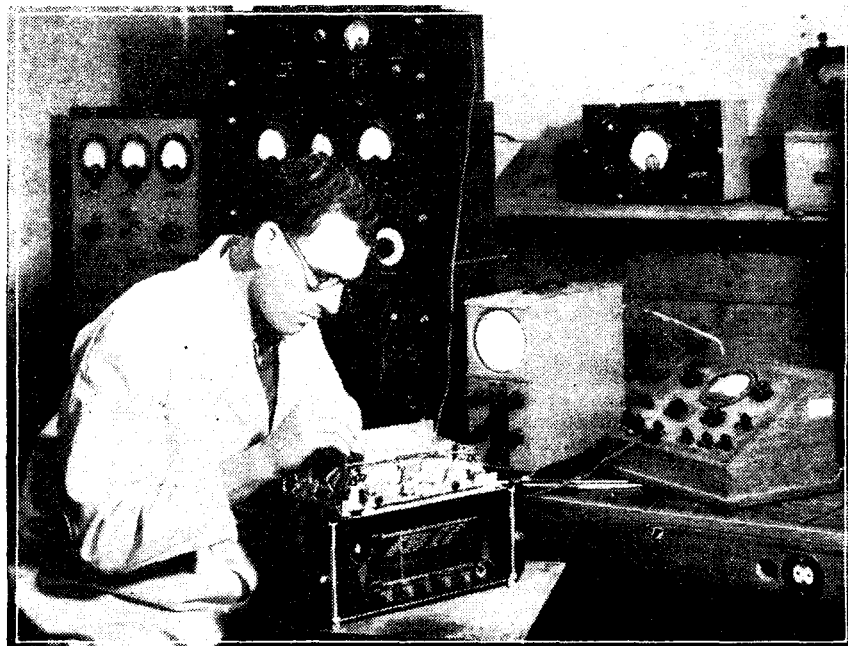

Checks and tests at all stages of production are essential for a steady output. Modern test equipment such as is being used by this engineer in the works of A. C. Cossor, Ltd., speeds up fault diagnosis.

## Identification Methods

With all the above inspection stages to be maintained at a high standard it will be appreciated that an important item in factory production is the identity of work done, with the inspectors doing it. Every component, chassis and complete receiver that has been examined must bear a stamp or label indicating that the unit has been through the inspection stage, and that so-and-so inspector passed it. The indication may take the form of a rubber stamp which leaves an impression on the unit which may be readily distinguished at a later date. Often a circle with a number inside is used, the number being registered as referring to a particular operator. Various shapes of stamps may be used to indicate different operations. A circle may mean performance test, a triangle the mechanical examination of

checks and cross-checks are in operation. They must not take these precautions in the wrong spirit, and think that they are being constantly spied upon; the system is as much for their benefit as for the factory authorities. It safeguards the conscientious worker against the slacker, so that instead of a whole group of operatives being condemned as inefficient because of the large percentage of rejects in their production, the actual operatives responsible can be identified and suitable action taken.

By "suitable action" it does not always mean the dismissal of the employee. It may be found that it is impossible to carry out an inspection as thoroughly as it would be desirable. Certain parts of the component or chassis may be inaccessible or invisible to visual inspection while electrical tests give an O.K. result.

For example, an inspector may pass a

chassis as being up to standard with regard to sensitivity after trimming, and put his stamp on the chassis after it has passed through the test gear satisfactorily. If, however, after a lapse of a day or two, while the chassis is proceeding through the stages of mechanical inspection, fitting to the cabinet, and final check, it is found to be down on general performance it is no good suspecting the sensitivity inspector of careless work before looking into other things. It may be found upon investigation that the type of trimmers used in the receiver shift under the rather rough treatment they go through on a factory floor. Although correctly set by the operators ganging the receiver and passed by the inspector, who may have handled the chassis immediately afterwards, before it received any rough treatment, the trimmers may shift during subsequent stages and so cause the receiver to be rejected at the final test.

It will be seen, therefore, that a good inspector must stick up for himself if he feels confident that he can do the inspection expected of him no matter what may be the opinion of the designer or production engineer on the subject. That is why in a large factory the inspectors are controlled entirely by a management presided over by the chief inspector, to whom they are responsible, and to no one else. Although working on a production floor they do not come under the authority of the men in charge of the production, whose main object, naturally, is to deliver from the floor as many receivers or components as possible. If this were not so, impartial criticism and investigations would be difficult to maintain, and the quality of the product would certainly deteriorate.

### Meeting of Inspectors

It is usual to hold a meeting of inspectors periodically—say, once a week—where complaints, suggestions, etc., can be talked over. By means of the rubber stamp impressions on the chassis or labels, any complaints can be brought to the attention of the inspector concerned, and he can give his reasons as to how the fault complained of slipped past him. As previously stated, a good chairman—generally the chief inspector—of the meeting will always maintain an open mind about the complaint and will not assume carelessness on the part of the inspector until he has heard the latter's explanation. It may be quite a good one, revealing that the method of inspection is faulty rather than its execution.

For example, an inspector of wiring connections, joints, etc., may have been unable to examine certain inaccessible joints by pulling them with pliers and had depended upon a visual inspection of the connections so as not to hold up urgent orders. Failure of some of the joints having brought this to light, the chief inspector would arrange to have these particular joints inspected at some earlier stage along the assembly line.

Another cause for failure of inspected items may be due to ignorance or misunderstanding on the part of the operative. A case in point concerned the breakdown of a small stand-off insulator made to a new design.

A test gear was designed to apply 1,000 v. between the extremities of the insulator, and a girl shown how to place the component on two clips, press a button, and to reject any that caused a red lamp to light up. She was told that the test took 15 seconds. After a short while the assembly line inspectors reported that

some of these insulators were breaking down, and upon investigation it was found that the girl was being paid piece-rates, and was therefore doing the test as quickly as possible, taking only three or four seconds per item. Her explanation was that she thought the time of 15 seconds mentioned to her meant an average worker's time to do the job, but by working fast she thought she was benefiting all concerned by considerably reducing that time.

The cure was to pay her at a flat rate, and to put a delay action on the switch so that it remained closed for 15 seconds.

### Types of Faults

An essential part of the inspection department's routine is to compile statistics giving details of the types of faults for which the instruments or components have been rejected, and giving these figures as a percentage of the work done.

For example, if a certain group of operators inspecting volume controls had 100 pass through their hands they may reject one for rough track, one for bad contact and four because they were broken. These figures not only show the type of faults occurring but also which is the more serious, so that the matter may be taken up with the supplier or maker.

The most serious fault—breakages—may be found to be due to rough handling between departments, and a better way of carrying the components or packing them would overcome the trouble.

In large factories everything of this nature must be reported upon, and copies of the report issued to the other departments.

Chassis which are rejected by the inspectors will either go through the assembly line again, or will be handed over to a separate group of expert fault-finders, depending upon the reason for the rejection of the chassis.

If the inspection had rejected the chassis in the early part of the assembly line it is probable that the chassis will be put back at the beginning of the line to be picked up by the operator responsible for the fault to go over the work again. If, on the other hand, the chassis failed to pass its final test it will be handed to the fault-finders for examination.

## RADIO CLUBS & SOCIETIES

*Club Reports should not exceed 200 words in length and should be received by the First Post on the third Monday in each month for publication in the next issue.*

**YOUTH RADIO CLUB FORMED IN PRESTWICH**  
Organiser: R. Lawton, 10, Dalton Avenue, Thatch Leach Lane, Whitefield, Near Manchester.

AN open meeting of this new club was held at the Heys School, Prestwich, on January 10th, for young people between the ages of 14 and 20 interested in radio. The purpose of this meeting was to find out if a radio club for young people was wanted. The attendance at the meeting, and the many suggestions made during it, proved beyond doubt that a radio club was definitely wanted, and it was decided there and then to appoint the following youth officers to take over various duties in the new club, as follows:

Secretary: Mr. Peter Dean, Prestwich.  
Chairman: Mr. C. J. Holding, Prestwich.  
Technical Adviser: Mr. A. Swire, Sedgley Park.  
Technical Adviser: Mr. G. Keny, Whitefield.  
Morse Instructor: Mr. A. D. Coates, Prestwich.

Mr. R. Lawton, Secretary of the North Manchester Radio and Television Society, and organiser of the club, will remain with the club to give lectures and talks, etc., assist officers, and generally act as instructor.

It was decided at the meeting that all the following subjects be covered by the club: Learn to send and receive Morse code, receiver construction (particularly short-wave), theory, receiver demonstrations. A

### Test Equipment

These men know the whole assembly of the chassis from A to Z, and soon acquire ability to drop on to the cause of any particular fault for which the chassis was rejected. They are supplied with good test equipment, because it is essential that they clear the fault as quickly as possible. Often, they will work with cathode-ray oscillographs if some particular form of distortion is causing trouble. By injecting a pure sine-wave signal from an audio-frequency oscillator into the chassis and examining the wave-form at each stage by means of an oscillograph the part of the circuit where the distortion is produced is soon located.

Some firms employ only a few skilled men to find the faults, and to mark on special labels the reason; for example, "faulty oscillator coil assembly—replace." The chassis is then passed over to cheap labour for the component to be changed, and for the complete chassis to be taken back to the test gear for approval.

Other manufacturers prefer to have repairs carried out by the fault-finders themselves. It just depends upon the output expected from the floor, and how finely costs have been cut.

### Service Liaison

With regard to any faults found during production, it is important that a liaison should exist between the inspection department and the service department. It is possible that a mistake may be made in a batch of chassis which, through some misunderstanding, is allowed to pass through the inspectors and away into the packing department before the fault is found. Perhaps it is a type of fault which gives rise to a whistle on a certain wavelength due to instability, and the inspection had not been instructed to try out the receiver on that particular wavelength. A slight modification such as the alteration in the capacity of the padding condensers, or a different dressing of a part of the wiring may effect a cure, and if the hint is passed on to the service department the information can be incorporated into a notice for distribution to the company's own service engineers, and to their dealers. Thus, directly a fault is met with in the field a remedy may be applied.

receiver is to be installed at the meeting room in order that short-wave listening can be carried out when required.

From now until further notice all details concerning the club can be obtained by calling or writing to Mr. R. Lawton at the address given above. The organisation will work on the lines approved by the Local Youth Movement Advisory Committee, and the exact name of the club will be announced later.

**ASHTON-UNDER-LYNE AND DISTRICT AMATEUR RADIO SOCIETY**

Headquarters: Beaconsfield Club, Stalybridge Road, Ashton-under-Lyne.

Sec.: K. Gooding (G3PM).

Meetings: Wednesdays and Fridays at 7.30 p.m.

TWENTY members attended a special meeting held early in the New Year, when it was unanimously resolved to carry on the society's activities. A new club-room (centrally heated) has been obtained at the Beaconsfield Conservative Club, Stalybridge Road, Ashton-under-Lyne, where both old and new members will be welcomed.

Morse classes are in full swing, and a two-way contact system employing a valve audio-oscillator and headphones is being used. The loud-speaker system installed at the old club-room has been scrapped. The "T. & R. stations" are located at opposite ends of the room, and it is hoped to install another 2-way system very soon. Members are now busy converting the club receiver from A.C. to D.C. working, and this matter of mains is the only snag.

Messrs. W. P. Green and J. Cropper are arranging to continue their series of lectures dealing with the principles and design of super-hets, and round-table discussions are being fixed up.

G3NX, G3OC, 2BBV, and 2FOS called in when, over on leave recently, and letters from members "somewhere out of England," were read at the last meeting.

# Practical Hints

## Experimental Coil Tappings

USUALLY to effect the tapping of a coil, a crocodile clip is used in the appropriate position on the coil windings. I found that every time I removed and

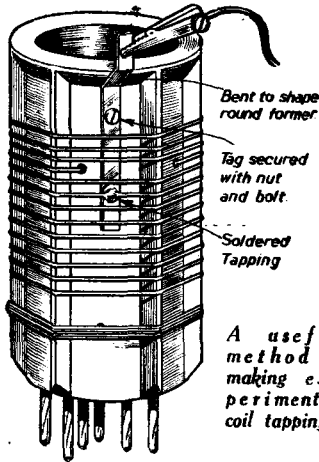

A useful method of making experimental coil tappings.

replaced this clip, the dial readings of the tuning (and sometimes even the reaction) condenser were altered, due either to the position of the clip or the windings, which may have been moved slightly when the clip was replaced. In order to overcome this difficulty, I altered the coil as shown in the accompanying sketch. A piece of thin brass strip is cut to a suitable size and fixed securely to the coil. The clip can then be clipped to the tag without fear of upsetting the capacity of the circuit.—A. D. SMITH (Kirkby-in-Ashfield).

## A Multi-change Circuit

THE following is a novel circuit I rigged up for a young friend, in order to study the effect of various circuit arrangements in a crystal set. It would be equally applicable to the H.F. stage of a receiver. Three coils are used, the two left-hand ones (in the circuit diagram) being on the one former, and the right-hand one separate. The left-hand one is 50 turns, the centre 60 turns, and the right-hand one 150 turns—all on a 2in. former.

Plugs and sockets are used throughout. The following are the circuits which can be "switched" on in a moment or two. Simply plug the first letter into the second.

- 1.—Straight circuit: M—F, O—G, N—M, Q—O, K—N, L—Q.
2. Circuit with condenser in aerial lead: M—K, L—F, N—L, O—G, Q—O.

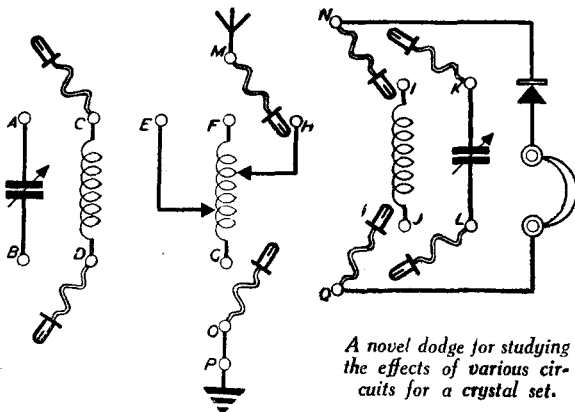

A novel dodge for studying the effects of various circuits for a crystal set.

## THAT DODGE OF YOURS!

Every Reader of "PRACTICAL WIRELESS" who has originated some little dodge which would interest other readers. Why not pass it on to us? We pay £1-10-0 for the best hint submitted, and for every other item published on this page we will pay half-a-guinea. Turn that idea of yours to account by sending it in to us addressed to the Editor, "PRACTICAL WIRELESS," George Newnes, Ltd., Tower House, Southampton Street, Strand, W.C.2. Put your name and address on every item. Please note that every notion sent in must be original. Mark envelopes "Practical Hints." DO NOT enclose Queries with your hints.

## SPECIAL NOTICE

All hints must be accompanied by the coupon cut from page iii of cover.

- 3.—Circuit with crystal tap: M—F, O—G, N—H, Q—O, K—M, J—Q.
- 4.—Auto-coupled circuit: M—E, N—F, O—G, Q—O, K—N, L—Q.
- 5.—Inductively coupled circuit: M—C, O—D, C—A, D—B, N—F, Q—G, K—N, L—Q.
- 6.—Aperiodic: M—C, O—G, N—F, D—O, Q—P, K—N, L—Q.
- 7.—Wavetrap: M—F, O—G, N—M, Q—O, K—N, L—Q, C—A, D—B.
- 8.—Long wave: M—I, O—J, N—M, Q—O, K—N, L—Q.—WM. NIMMONS (Belfast).

## Home-Made Coil Formers

RECENTLY, I desired to wind two coils, but as no tubes were available at the time I utilised some small round cartons

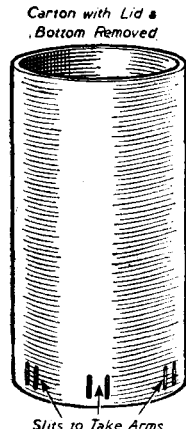

Utilising cardboard cartons for making coil formers.

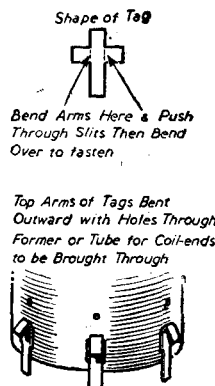

The top or short arms of the tags are then bent outward from the tube, and these are used for anchoring the ends of the windings, a small hole being made in the cardboard beside each tag to enable the wire to be threaded through.—J. McLAUGHLIN (Londonderry).

## A Vice-clamping Hint

IF the kitchen table is used as an occasional work-bench, and you wish to use a small vice, here is an effective method of fixing it to the table.

A piece of wood of suitable width and thickness is cut to a length equal to the width of the table, and clamps having holes bored in them, as shown in the sketch, are held in position one at each end of it by means of wood screws. The vice is then bolted to this piece of wood so that after use the whole thing can be lifted off in one piece and put away till again required for use.

It will be found that as the clamps are screwed to the piece of wood, the relatively large surface of the latter bearing down on the table top, ensures that the vice is held immovably to the table without causing any damage thereto.—JOHN H. MARR (Glasgow, N.).

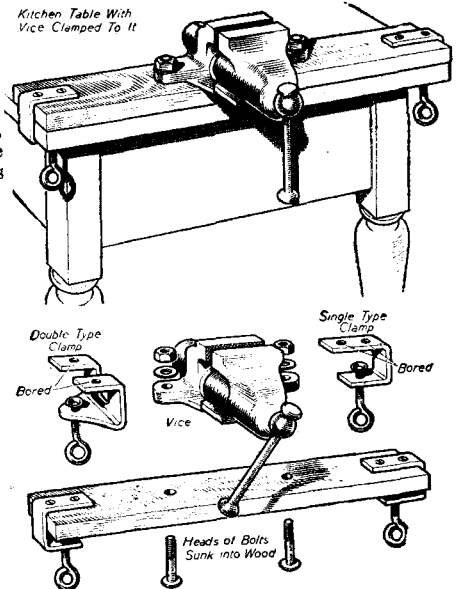

Fitting a vice to a clamping-board for attachment to a kitchen table.

which usually contain pepper, etc.

First, I selected two of the required diameter and thoroughly dried them in the oven, and whilst still hot, a coat of shellac was applied, both inside and out to render them damp-proof. For tags I cut some pieces of light metal, in the shape of a cross, as shown in the sketch. Two "arms" of the cross are bent, and these are pushed through slits cut in the end of the tube, being firmly bent over on the inside to hold them in position.

## THE PRACTICAL WIRELESS ENCYCLOPEDIA

By F. J. Camm

A complete guide, in alphabetical order, to the construction, operation, repair and principles of every type of wireless receiver includes definitions, explanations, formulae and complete instructions on the making and testing of various wireless components.

Illustrations include a complete series of circuits for every type of modern receiver.

392 pages. Over 500 illustrations.

Of all Booksellers, 7/6 net, or by post 8/- from George Newnes, Ltd. (Book Dept.), Tower House, Southampton Street, London, W.C.2.

# A NOVEL AUTOMATIC TUNING UNIT

How an Ordinary Telephone Dial Can be Utilised for the Purpose

**P**USH-BUTTON and other methods of automatic tuning have become very popular of late, and nowadays there are not many receivers on the British market that do not employ one or other of these devices.

The telephone dial lends itself very readily to this type of tuning, both for its simplicity of operation and easy adaptation for remote control. In spite of this, it is not widely used amongst home constructors, owing apparently to their lack of knowledge of the fundamental principles of the circuits involved. This article is intended to fill this gap, and once the elements of the operation of the dial have been assimilated the amateur will be able to adapt the principles explained to his own particular needs.

## The Dial

The dial, and its accompanying mechanism the uni-selector, can be purchased for a few shillings from advertisers in PRACTICAL WIRELESS.

For those who have never handled a telephone dial a brief description is here given. From the front view we see a round dial with ten finger holes in it which are numbered "1" to "0." To dial a number

Fig. 2.—Method of connecting the uni-selector contacts to the band-pass H.F. and detector stage of a receiver, using pre-selector condensers.

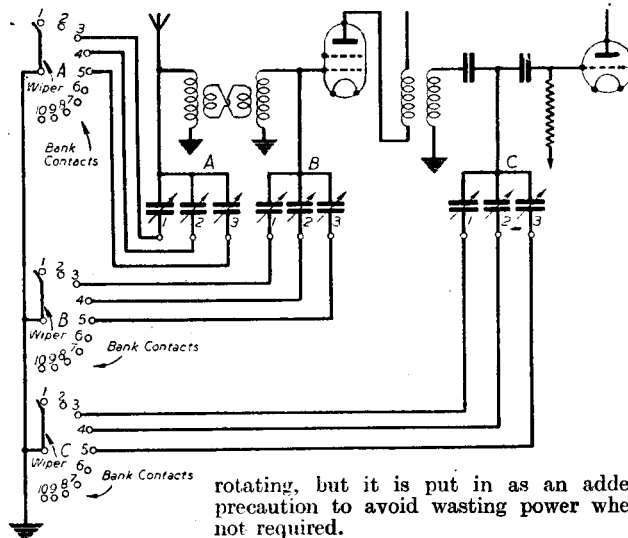

found four banks of twenty-five contacts forming a quadruple arc; in addition there is a homing arc, the purpose of which will be made clear later. Five wipers are mounted on a spindle so that when the latter is turned, the wipers sweep over the arc, the brushes connecting these wipers being brought out to contacts at the top of the uni-selector. An electro-magnet is mounted so that when energised an armature is attracted to the poles, and in doing so a pawl and ratchet arrangement pulls the wipers round to the next contact. There are also a pair of spring contacts fitted so that their contacts are broken

rotating, but it is put in as an added precaution to avoid wasting power when not required.

Fig. 2 shows the method of connecting the uni-selector contacts to a circuit; for the purpose of simplicity, part of a receiver is shown with one band-pass H.F. stage and detector with pre-selector condensers, each set of which is tuned to the required station. This is a very well-known method, so it will not be dealt with in detail here.

It will be observed that the first set of contacts are not used, as these form the normal "home" position of the wipers; nor are the second set used, for it will be seen that as soon as the dial is off-normal the selector will automatically step to this contact. Assuming that 1 is dialled; on rotation of the dial, the off-normal springs are operated and the circuit is completed from one side of the battery, through the electro-magnet, then to the impulse springs, via the off-normal springs, and back to the other side of the battery. When the dial is released it returns to normal, and the impulse springs will open once, then close, thus the armature will restore, and then operate again, and so the wipers will move another step. Finally, when the dial comes to rest, the off-normal springs will open and the armature restores; therefore, we get two impulses when one is dialled, three when two is dialled and so on. Contacts number 2 should therefore be left free.

Let us now assume we require number 3 station. For the reasons explained above it will be clear that this station will have to be connected to contact number 5. The brushes of the wipers should be earthed (omitting, of course, the wiper on the homing arc). Three is now dialled and number 3 pre-selector condensers are connected via the contact bank and the wipers to earth, and so the station number 3 is obtained.

It will be noted that the off-normal springs of the dial consist of two pairs, and as only one pair is required for operating the uni-selector, the other pair can be made to mute the loudspeaker whilst dialling a station. This will prevent the sound of stations that are passed through in the process of dialling being heard. The muting can be done by short-circuiting the loudspeaker direct, or by the employment of a relay.

## Homing

When it is required to restore the uni-selector to its normal position, use is made of the homing arc. Fig. 3 shows the

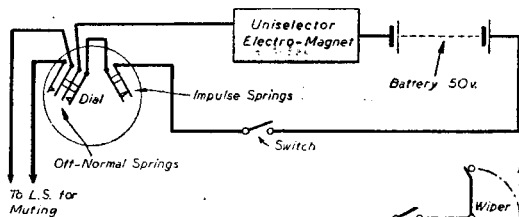
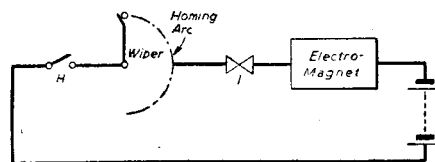

Fig. 1 (Left).—Circuit diagram showing the contact springs, and position of uni-selector unit.

Fig. 3 (Right).—Diagram of connections used when restoring the uni-selector to normal position.



the finger is placed into the hole containing the figure required and the dial is pulled round to the stop, and then released; the dial automatically returns to its original position, and in doing so sends out a number of impulses corresponding to the figure dialled. At the back, two sets of springs are fitted; the pair on the top of the dial are termed the "off-normal" springs; these springs have contacts fitted to them which are closed as soon as the dial is rotated; (i.e., when the dial is off its normal position). On the right of the dial will be found the impulse springs; with these the contacts are normally closed, but when the dial is rotated and then released, they open and close as it returns to its "home" position, the number of makes and breaks depending on the number dialled. The springs can be seen in Fig. 1.

## The Uni-selector

This has the appearance of a complicated piece of mechanism, but actually it is very simple. First there are a number of banks of contacts; in a small uni-selector, such as is suitable for our purpose, there will be

when the armature operates; these springs are called the off-normal or interruptor springs, and they are usually used in conjunction with the homing arc.

The electro-magnet requires about 50 volts to operate.

## Operation

Figs. 1 and 2 show the method of connecting up the circuit so that the operation of the dial will cause the contacts of the uni-selector to be connected up to the desired circuit. The main switch is not absolutely necessary, as no current is drawn except while the wipers are

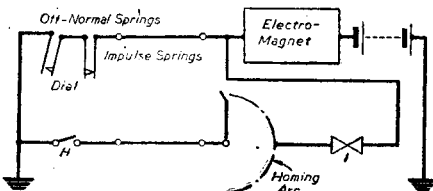

Fig. 4.—Circuit diagram showing how one side of the operating battery and remote dial circuits are earthed.



connections. The battery is taken to one side of the electro-magnet and then to the interruptor (or off-normal) springs on the uni-selector; the other side of the springs are connected to the homing arc; the homing wiper is then taken to the homing press button (H), and so to the other side of battery. When the button "H" is pressed the circuit is made and the armature operates; in doing so the interruptor springs are opened, and so the circuit is broken and the armature restores; with the armature restored the interruptor springs are closed and so the circuit is again made, once more the armature operates, and the interruptor springs open. This series of cycles will continue until the homing wiper comes to the home contact, which should be left free, and rotation therefore ceases. The restoration takes hardly one second.

It should be noted that when a number has been dialled the homing button must be pressed to restore the circuit, before dialling another number.

**Numbering Scheme**

The numbers to be dialled for different stations is largely a matter of personal choice, but here follows a practical scheme

with the reasons for adopting it. Firstly we can have the numbers 1 to 9 thus:

No.	Contact.	No.	Contact.
1.....	3	6.....	8
2.....	4	7.....	9
3.....	5	8.....	10
4.....	6	9.....	11
5.....	7		

We have now nine stations, and to get a tenth we can dial 0 or 10. If 10 is dialled the wipers will move to the 13 contact but a burst of music will be heard on the loudspeaker as soon as the dial comes to rest after dialling 1, and before the dial is rotated for the next figure. If it is desired to avoid this a separate muting button for the loudspeaker could be employed; or a better way would be to use a slow-release relay that is operated by the dial's off-normal springs. The numbering now proceeds 10, 20 and so on to 00. This brings us to the 22nd contact. Now there is 100, 200, 300 left. This brings us to contact 25. We could now use the second contact by dialling 500, which takes the wipers all round the uni-selector, and back to the second contact.

By using the above scheme a maximum

of 24 circuits is obtained. If all these are not required it can be arranged to avoid unwanted bursts of music coming through without having a separate muting circuit. That method is to leave the "0" contact free (i.e., contact 12). The numbering then proceeds 01-02 and so on to 09. The next contact (00) is left free, and then we have 001, 002, etc.

The uni-selector should be mounted in the receiver itself but the dial and homing button could be placed at any distance away. Moreover, wherever there is an extension loudspeaker, a dial could be fitted in conjunction with it—a novel yet simple method of remote control.

Another point worth mentioning is that to avoid a multiplicity of leads, one side of the operating battery could be earthed and the remote dial circuits completed through earth. Fig. 4 shows how this can be done.

The scheme lends itself to infinite variations for remote control work; for instance, lights can be switched on and off by dialling a number, but it must be remembered that the uni-selector contacts are not designed for very heavy currents, and so relays should be employed to avoid trouble from this source.

# Using Obsolescent Coils

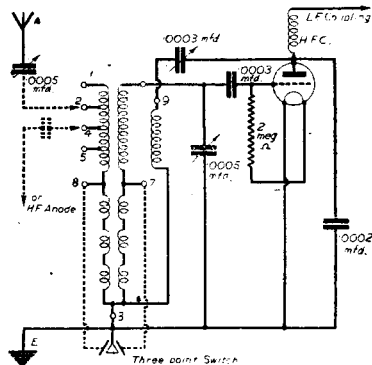

Fig. 1.—For a single tuned circuit receiver, this coil gave very satisfactory selectivity.

**M**OST constructors have spare coils in their den, and now is the time to make use of them in simple and efficient receivers.

It so often happens that a coil which is now termed obsolescent, because it is no longer made or listed by the manufacturers, is quite satisfactory for a "stand-by" receiver or for use in the country where the problem of selectivity is not so acute. Generally speaking, the early types of air-cored coil gave a better input to the detector but suffered from poor selectivity. With the present broadcasting arrangements this fault does not become so serious as in normal times, especially when the coils are used in simple circuits of the det. and L.F. type. Previous articles have given the connection details of certain popular early products, therefore the information given below relates to those not yet covered.

**Colvern Coils**

Type T.D. This particular coil was widely used. It is of the screened air-core type and provided with tapped coupling. A typical circuit arrangement is shown in Fig. 1. It is ideal for a simple det. L.F. receiver or one embodying a stage of H.F. amplification. One outstanding

feature of the T.D., apart from its selectivity and sensitivity, is that it is not so susceptible to medium-wave break-through when the long waves are being received, as some of similar construction.

Now is the Time to Bring Back into Service Those Coils in the Spares-box, and so Reduce Demands on Raw Materials

**Types T.G., S.C. and S.R.**

These are of the larger diameter types, embodying wave-change switch. The S.C. model is suitable for tuned-grid coupling or aerial circuits, but no reaction coil is fitted. It should be noted, however, that a coupling condenser—suitable for the windings—is embodied in the actual construction.

The S.R. has a reaction winding, but no coupling condenser. It is not really designed for use in the aerial circuit, but it can be used in such positions when a high degree of selectivity is not desired. Typical circuits are shown in Fig. 2.

**Types R.M. 1S, 2S and 3S**

These are dual-range aerial with variable

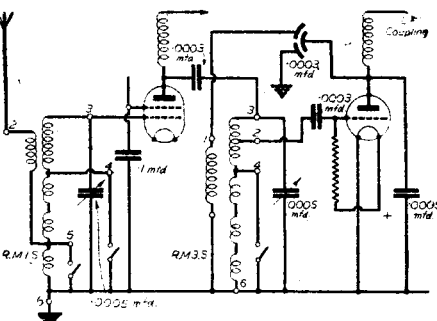

Fig. 3.—An efficient S.G. Three can be built around these types.

coupling and wave-change switch; dual-range aerial with variable coupling, reaction winding and wave-change switch; and dual-range H.F. coil with reaction winding and wave-change switch respectively. The connections are shown in Fig. 3.

As there appears to be quite a number of six-pin coils still in existence, we will conclude the Colvern group with the M.M., series. These were designed to cover 20 to 2,500 metres in four steps, the bands and

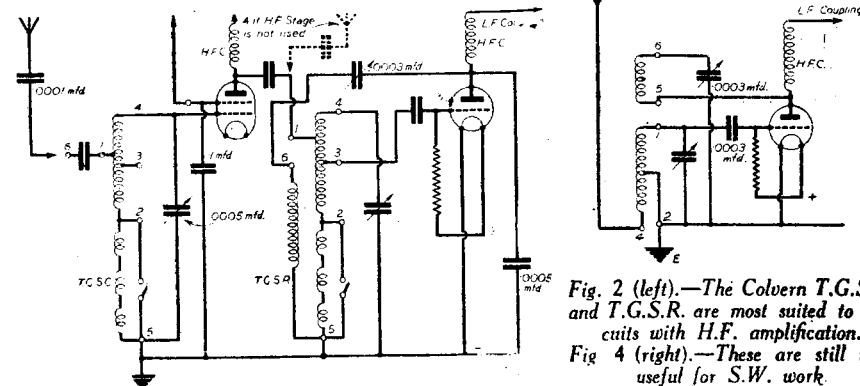

Fig. 2 (left).—The Colvern T.G.S.C. and T.G.S.R. are most suited to circuits with H.F. amplification.

Fig. 4 (right).—These are still very useful for S.W. work.

coil numbers being M.M. 31, 20-45 metres, M.M. 32, 40-85 metres, M.M. 3, 200-600 metres and M.M. 3X, 830-2,500 metres. The connections are shown in Fig. 4.

**Lissen Coils**

Types L.N. 5180 and 5314. These are of the dual-range air-cored pattern, without wave-change switch. L.N. 5180 differs from the 5314 in one respect: it has a variable

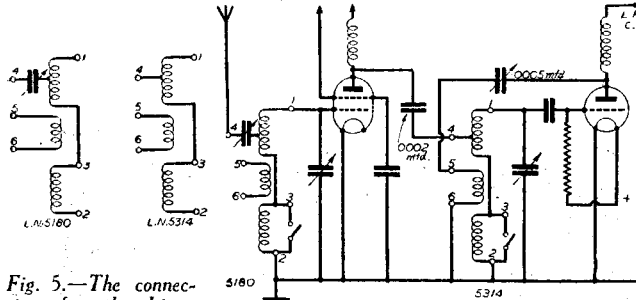

Fig. 5.—The connections for the Lissen coils L.N. 5180 and L.N. 5314. Fig. 6.—A suitable 3-valve circuit for the Lissen coils shown on left.

condenser—.0002 mfd.—built in and arranged to act as an aerial series or coupling condenser, thus allowing more control over the selectivity of the tuned circuit.

The two circuits are shown in Fig. 5. The coils are designed, primarily, for use in receivers without an H.F. stage. However, they can be used in, say, a circuit using one stage of S.G. amplification—provided the coils are placed far enough apart to prevent an interaction between their fields. They are not canned; therefore the above precaution must be taken or adequate screening provided. A suitable tuned-grid circuit is shown in Fig. 6.

They are not really suitable for ganged circuits as the windings are not specially matched, but it is possible to use one coil of each type in a resistance-coupled band-pass arrangement provided that a little care is taken with the lay-out and the selection of the coupling resistance. The maker's suggested circuit is shown in Fig. 7.

The two coils can be identified quite easily. The L.N. 5180 has a moulded top to the coil, through which projects a knurled knob connected to the small variable condenser which is housed inside the coil-former.

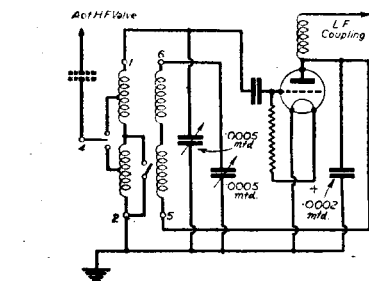

Fig. 10.—The Lissen 5372 used in a simple detector circuit. The aerial tapping points increase selectivity.

**Types L.N. 5320, 5321 and 5372**

Rather more modern types are those mentioned above, which are of the "canned" iron-cored pattern, the 5320 being a general purpose coil without wave-change switch; 5321 an aerial and band-pass coil with switch and 5372 a grid coil also with switch.

Their applications are shown in Fig. 6. The aerial coil L.N. 5321 has its internal

switch so arranged that the aerial is tapped into both medium and long-wave windings, thus giving a good degree of selectivity on both bands. Two of them form an efficient band-pass unit, the coupling being obtained by the special windings provided. The grid coil L.N. 5372 forms an ideal

tuned-grid coupling between a screened-grid H.F. stage and the detector, the switching arrangements being the same as the aerial coil, but the band-pass coupling coil is replaced by a reaction winding.

Another of the older Lissen coils which deserves mention is their L.N. 5386, which is a four range model suitable for aerial or tuned-grid use. The "All-Wave Battery Three"—*Wireless Magazine*, July, 1934—used two of them.

Their windings are designed to allow 12-34 metres, 27-84 metres, 200-555 metres and 900-2,100 metres to be covered with an ordinary .0005 mfd. tuning condenser.

The wave-change switch is built in and the coils are completely "canned," so there is no need to worry about interaction. The connections are given in Fig. 7. When the coil is used as a tuned grid, a small coupling condenser is required, say, .00005 mfd., being quite satisfactory, and when it is used as an aerial coil, it is advisable to include, say, a .0003 mfd. condenser in series with the aerial when short waves are being received. On medium and long waves, the aerial can be taken direct to the coil.

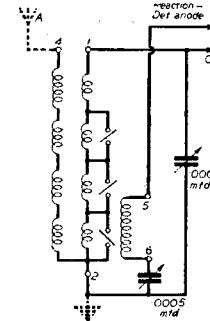

Fig. 11.—The connections of the Lissen Four-range coil are shown here. Some of these are still available.

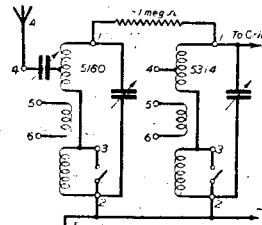

Fig. 7.—A simple but effective way of obtaining a band-pass circuit using Lissen 5180 and 5314 coils.

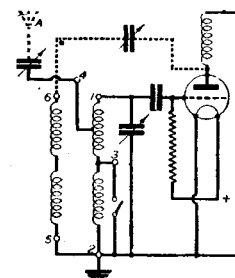

Fig. 8.—More modern type of Lissen coil No. L.N. 5320.

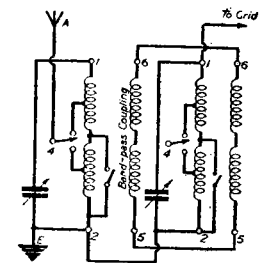

Fig. 9.—An inductive band-pass coupling using Lissen 5321's.

*Prize Problems*

**PROBLEM No. 417**

PERKINS'S receiver was rather old. In fact, it employed an output pentode of the early type fitted with a side terminal for the auxiliary grid. The circuit was 1-v-1 and it obtained its H.F. from an eliminator. The pentode ceased to function, and as Perkins could not obtain another of the same type and fitting, he decided to use a super-power valve he had spare. He was disappointed to find that the receiver lost a good deal of its sensitivity, the reproduction was distorted and weaker and the tone was inclined to be deep. What were the items responsible for the trouble, or, in other words, what had Perkins overlooked when making the change? Three books will be awarded for the first three correct solutions opened. Entries must be addressed to The Editor, PRACTICAL WIRELESS, George Newnes, Ltd., Tower House, Southampton Street, Strand, London, W.C.2. Envelopes must be marked Problem No. 417 in top left-hand corner and must be posted to reach this office not later than the first post on Monday, February 17th, 1941.

**Solution to Problem No. 416**

Yeoman was either ignorant of or overlooked the fact that when condensers of equal value are connected in series, the resultant capacity is only half that of one. When making the modifications, therefore, Yeoman reduced the value of the smoothing condensers, with the result that hum became pronounced. The following three readers successfully solved Problem No. 415, and books have accordingly been forwarded to them: P. L. Orr, Roxburgh, 134, Dorchester Road, Weymouth, Dorset; C. Pierrepont, 13, Chorley New Road, Bolton; John R. Leeming, 122, Nulhall Street, Blackburn, Lancs.

**BOOK RECEIVED**

**THE R.A.F. IN PICTURES.** 5s. net. 97 pages. Fully illustrated. Published by Country Life, Ltd., and obtainable from Country Life, Ltd., Tower House, Southampton Street, Strand, London, W.C.2.

"THE R.A.F. IN PICTURES" (including aircraft of the Fleet Air Arm) has been prepared by Major Oliver Stewart, who is the editor of *Aeronautics*, himself a pilot of great experience, which he has used in preparation of this handsome illustrated volume—a veritable pictorial pageant of our aerial fighting forces. Here you will find illustrations and easily assimilated facts about all our aircraft, and the half-tone plates alone make the book remarkable value for money. As an historical record, it is worth more than twice its price. We recommend every reader (and especially those interested in the R.A.F. Training and Cadet Schools, and aircraft spotters) to purchase a copy. It costs 5s. 6d. by post.

**A.C. TWO-VALVE AMPLIFIER—CORRECTION**

In the specified list of components for the above-mentioned unit, which is fully described in our issue dated February, 1941, an error was made in giving the maker's name of the valveholders. These should have been specified as Celestion Amphenol, and not Amplion Amphenol as published.

# ROUND THE WORLD OF WIRELESS

## Radio in the Desert

ACCORDING to reports, wireless is playing a big part in the Libyan Desert campaign. Every tank has its own set, and small portable sets are carried by infantrymen in the front line. Many armoured vehicles also have wireless sets, and thus, with the heavier sets at divisional and corps headquarters, there is a complete wireless chain linking up the various army units.

## Radio Men from Canada

THE arrival of a number of airmen radio mechanics in this country from Canada recently is a feather in the cap of the Royal Canadian Air Force, and is incidentally a tribute to the usefulness of the Empire Air Training scheme.

The rate of expansion of the R.A.F. frequently gives rise to sudden calls for specialists of one sort or another. When radio mechanics were wanted, Canada was asked to supply them, found them at very short notice, and trained them under the Empire Air Training scheme. This scheme is primarily for the training of air crews, and it is, therefore, all the more satisfactory that it should have yielded this number of men for ground duties.

## Civilian Training in Wireless

FOR some time men trained at certain civilian wireless schools have been accepted for the Royal Air Force as wireless operators.

This scheme is now to be extended. Civil wireless schools administered by the General Post Office and municipal technical colleges are to give courses in wireless to boys who intend to enlist.

Boys so trained will be accepted for the Royal Air Force as wireless operators from the age of 17½, if suitable. In such cases a return of tuition fees can be claimed up to £25.

## Wireless Operator Gets the O.B.E.

MR. G. W. HACKSTON, wireless operator of S.S. *Harby*, has been awarded the O.B.E. in recognition of his devotion to duty when his ship was attacked by an armed raider. He sent out the position of the vessel, and remained at his post in the wireless room throughout the attack, until it was set on fire.

## Alteration in French Station Names

IT is reported from the U.I.R. that as a result of the reorganisation of the French broadcasting system, the names of the stations have been altered. The name of the town will in future be suffixed by "National" instead of "P.T.T." etc., i.e., Lyon-National, Toulouse-National, etc., instead of Lyon P.T.T. and Toulouse-Pyrénées.

## B.I.R.E. Forms New N.W. Section

WORK has commenced with a view to forming a N.W. section of the British Institution of Radio Engineers, according to G. D. Clifford, general secretary of the Institution. A provisional committee has been elected, with A. G. Eggiuton, 83, Washway Road, Sale, Manchester, as chairman, and A. V. Simpson, 10 Pullman Street, Deplish, Rochdale, as honorary local secretary.

Some time in March an inaugural meeting will be called, when, with the exception of the two officials named

the provisional committee will offer themselves for formal re-election by all members residing in the N.W. area.

## B.B.C. Programmes for Northerners

NORTHERNERS exiled in many parts of the world are to be specially catered for by the B.B.C., which will keep them in touch with what is going on in their home towns.

For many months, performances by bands which are household names in the North

## Standard Frequency Station Destroyed

THE National Bureau of Standards in America are using a temporary 1 kW. transmitter, following the destruction by fire of its standard frequency station WWV at Washington last November. The station transmits a frequency of 5,000 kc/s from 10 a.m. to midnight daily, except Sunday. The temporary service is CW, with announcements in morse.

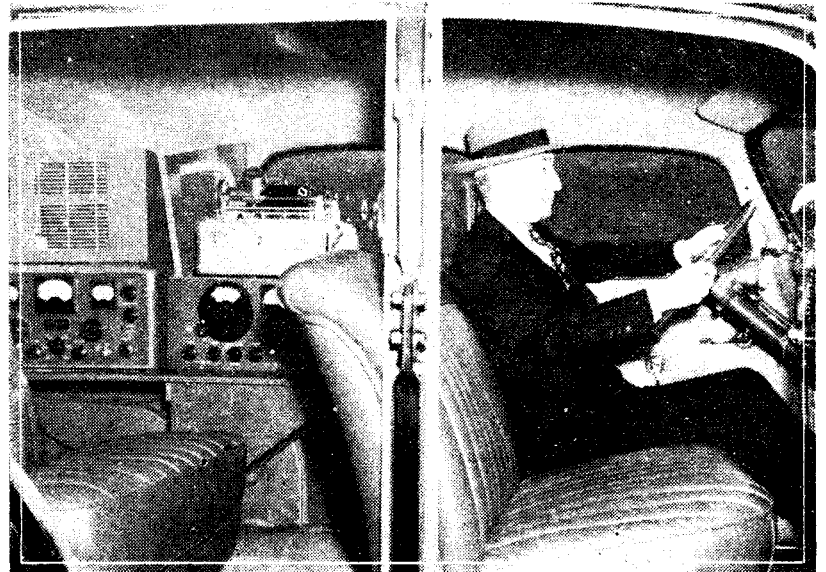

A travelling radio monitoring officer in the U.S.A., with directional apparatus for tracking unlicensed radio transmitting stations.

have been heard in Empire programmes.

The response already received to Northern programmes which have been broadcast to the Empire in recent months shows how much these are appreciated by Northerners exiled in the far corners of the world. One of the most successful broadcasts has been that of D. G. Bridson's play, "Aaron's Field," which has a Northern setting. Among bands which have been heard throughout the Empire are Foden's and Baxendale's. One of the biggest successes has been Victor Smythe's "Works Wonders" programmes. These concerts by munitions workers for munitions workers have been broadcast live at 2.30 a.m. from a number of factories in the North.

## Women Radio Operators Wanted

THE further expansion of the Air Force planned for this year brings the opportunity to thousands of girls of all ages to join the W.A.A.F.

One of the most interesting jobs is radio operator, open to the responsible type of young woman, aged from 18 to 35.

Here are some of the other trades for which recruits are wanted. The age limits are all 18 to 43:

- Morse Slip Readers (Touch typists only);
- Teleprinter Operators;
- Mess and Kitchen Staff;
- Clerks, General Duties;
- Equipment Assistant.

Application should be made to the nearest Area Headquarters of the W.A.A.F.—there is one in London, Bristol, Birmingham, Sheffield, Manchester, Newcastle-on-Tyne, Cardiff, Glasgow, and Belfast.

## American Amateur Radio Committee

WE learn that seven members of the American Radio Relay League have been appointed to the Amateur Radio Committee of the U.S. Defence Communications Board. The committee is to consider all question relating to amateur radio, and its place in the national defence programme.

## Listen-in to Athens

A NEWS bulletin in English is now broadcast every evening from Athens between 8.45 and 9 p.m. (P.S.T.). The broadcast is transmitted on the short-wave band of 30.196 metres.

## Timber for Radio Sets

ACCORDING to a recent announcement by Major A. I. Harris, Timber Controller, limited quantities of timber and plywood are being released for the manufacture of radio cabinets of the cheaper type.

## "Wireless for the Blind" Fund's £10,000

MR. ERNEST BEVIN, who broadcast on Christmas Day for the British "Wireless for the Blind" Fund, has handed over a cheque for the first £10,000 received in response to his appeal. He handed the cheque to the "Unknown Blind Man" who has personally made the annual appeal on two occasions, and had been chosen to receive the money on behalf of the 70,000 sightless people in this country.

MANY designs of portable receivers have emanated from our laboratories in the past: each one was outstanding in its class and represented a distinct and tangible improvement on previous designs. Progress was maintained until the time arrived when we had to restrict our desire to offer our readers a receiver comparable with commercial design and efficiency, because of the constructional and wiring work involved, and the fact that many constructors did not want anything

# F. J. CAMM'S ALL-DRY

## A Compact Self-contained Receiver to Satisfy Readers' Requirements

ations. In keeping with our usual policy of providing designs which are in step with the latest developments, we have produced the All-Dry Superhet Portable, a compact, self-contained, four-valve superhet receiver, comparable in construction and efficiency with commercial products, using the latest 1.4 volt valves and incorporating A.V.C., a high-grade P.M. moving-coil loudspeaker, single-knob tuning, automatic grid-bias and a single dry battery to supply both H.T. and L.T.

of the two-gang condenser. The oscillator grid and anode have their circuits completed through the oscillator coil, Bulgin Type C.72, which is designed for 465 kc/s operation. This particular component calls for special mention, as it simplifies wiring

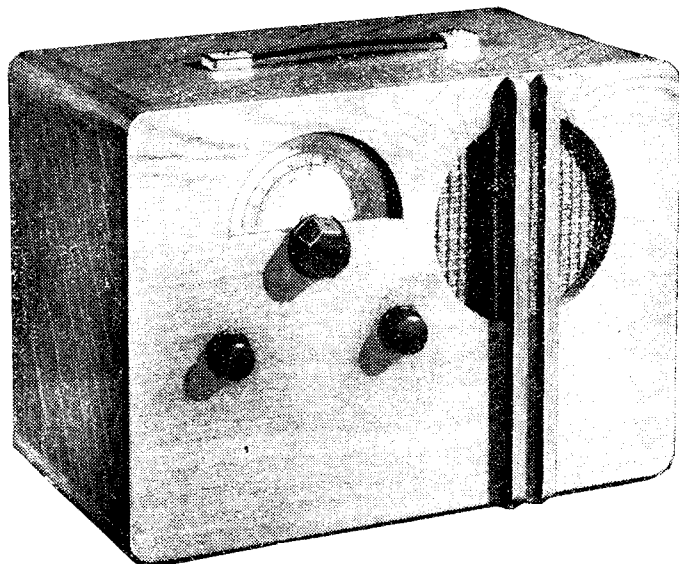

The finished set housed in the well-designed and sturdy cabinet.

too complicated. We appreciated their views, and endeavoured to combine efficiency with simplicity. In this direction, we were helped by the power radiated by the transmitting stations in pre-war days, which was such that it was not really essential to use an elaborate circuit specification to achieve satisfactory results. Conditions now, however, are somewhat different; the modified broadcasting arrangements, the poor reception due to receivers being used underground or in metal A.R. shelters, and the necessity of dispensing with accumulators, have introduced requirements which now outweigh peace-time consider-

ations. In keeping with our usual policy of providing designs which are in step with the latest developments, we have produced the All-Dry Superhet Portable, a compact, self-contained, four-valve superhet receiver, comparable in construction and efficiency with commercial products, using the latest 1.4 volt valves and incorporating A.V.C., a high-grade P.M. moving-coil loudspeaker, single-knob tuning, automatic grid-bias and a single dry battery to supply both H.T. and L.T.

### Theoretical Details

The circuit is shown in Fig. 1. Regular readers will recognise that it is practically identical with the All-Dry 4-Valve Superhet which was first mentioned in our issue for October, 1940. The reason for this is the fact that the circuit has been well tried and not found wanting, and, with the same

valve specification, there are no worthwhile modifications which could be made. In addition to this, constructors who have made the above set can, if they so desire, convert it to the portable model about to be described with the minimum of trouble and outlay. For those who would like a brief description of the circuit, here are the chief details.

The first valve—a Cossor 1A.7.V.G.—is a pentagrid, having variable-mu characteristics, and operates in a perfectly normal frequency-changing stage. The signal grid receives its bias via the frame aerial windings which are tuned by one section

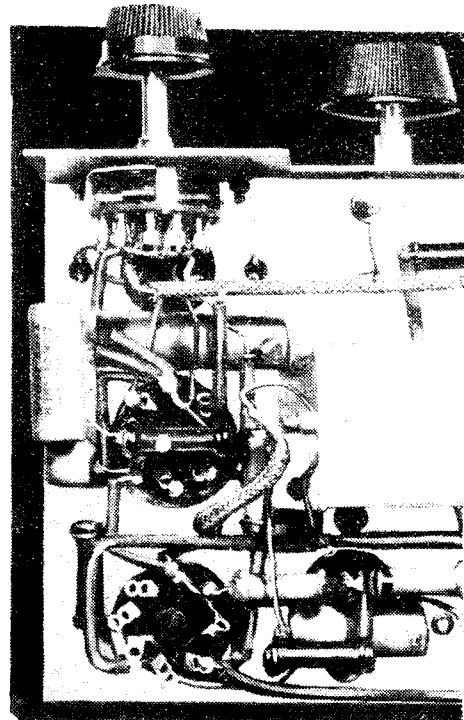

This view will prove helpful when assembling and adjusting the necessary padding condensers are incorporated in its construction.

and adjustment because the necessary padding condensers are incorporated in its construction.

The anode of the pentagrid is connected to one side of the primary of first I.F. transformer, Bulgin Type 73, thus allowing the secondary to pass on the signal to the second valve which is an H.F. variable-mu pentode Cossor 1N.5.G.—operating as a

The compact chassis arrangement will be noted.

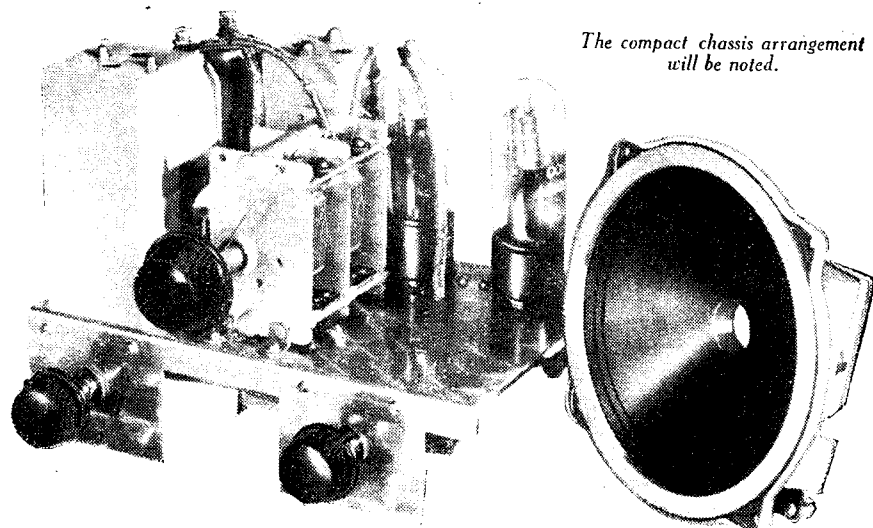

The assembled receiver compared with the 1/2" speaker gives an indication of its compactness.

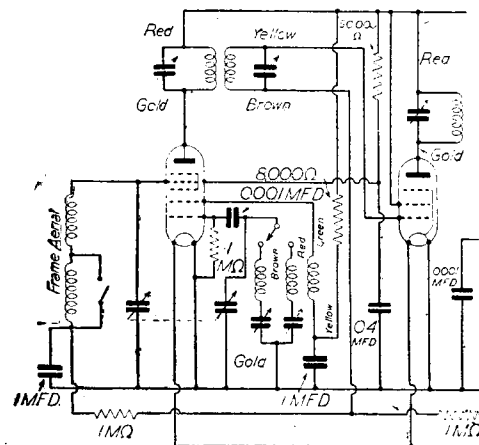

Fig. 1.—The circuit does not include any unnecessary wiring.

# SUPERHET PORTABLE

All-dry Superhet Receiver Specifically Designed to Satisfy Present and Existing Reception Conditions

pure H.F. amplifier under A.V.C. conditions. The third valve is a diode-triode—1.H.5.G.—and serves as a diode detector, source of A.V.C. and as an L.F. amplifier. The particular section of the circuit has been kept as simple as possible, consistent with

the resistance connected between H.T. and L.T. negatives, therefore it is essential to adhere to the value specified.

### Constructional Details

With a set of this type, the constructional work is bound to be slightly more difficult than that required for a less ambitious circuit. It is not possible, when compactness is a consideration, to adopt haphazard methods for the location or wiring of the components, therefore it has to be admitted that the constructor who wishes to build a satisfactory model of this set must be prepared to expend a reasonable amount of skill and patience; otherwise the whole design will be ruined. It will also be noted that soldering is used for all connections, and as many of them involve more than one wire, care must also be taken to see that neat and efficient joints are made. Avoid excessive flux and solder at all costs. See that the iron is clean and kept at the right working temperature, and that the smaller components are not overheated when applying the solder.

All dimensions are given on the plan drawings, and as space is a vital consideration, these must be adhered to when marking off. In the interests of economy, the chassis does not take the usual form. A single piece of 18-gauge aluminium, 7½ in. by 5½ in., is used for the top, half an inch along the front edge being turned down at right-angles, thus leaving an overall dimension of 7½ in. by 5 in. Five small odd pieces of metal are required, two for the front component mounting brackets, which also serve as legs or location pieces; these are 2½ in. by 1 15-16 in. These are

fitted inside the bent-over edge of the chassis, therefore, as they are intended to keep the assembly 2 in. high, allowance must be made for the thickness of the metal. In the above measurements we have allowed 1-16 in., but if metal of a different gauge is used, this must be adjusted accordingly. Two smaller pieces must also be cut to act as anchoring supports for the back of the assembly. They can be ½ in. in width, and of sufficient length to keep the chassis at 2 in. above the wooden shelf fitted inside the cabinet. If ¾ in. is bent over at right-angles at one end of each strip, this will allow them to be bolted to the chassis, whilst the other ends can be screwed to the shelf, once the set is in position.

The fifth piece is required for the fixing of the L.F. transformer, which is located under the chassis. This should be 1½ in. by 1½ in., ¼ in. of which is turned at right-angles to form a base, thus leaving a surface of 1½ in. by ¾ in. for the seating and fixing of the L.F. transformer can. A hole 1 in. in diameter has then to be drilled to allow the connecting wires to be brought through, but this is not drilled dead centre of the brackets' height. It is approximately ¼ in. off centre, i.e., raised that amount off the underside of the chassis, to provide clearance for wiring which passes between screening can and chassis.

It is best to undertake all drilling before fixing any of the brackets or components. When this has been done, the valve holders can be bolted in position, taking care to see that they are placed with the key slot—between contacts number 1 and 8—in the same positions as those indicated on the plan. Failure to observe this small but important point will possibly result in incorrect connections being made to the valve holders. Proceed with as much wiring as possible before bolting on any other parts, but when the time comes to do this, we suggest the following order: I.F. transformer on top of chassis; oscillator coil; wave-change switch and bracket; two-gang condenser; I.F. transformer underneath chassis and then potentiometer and bracket. The above

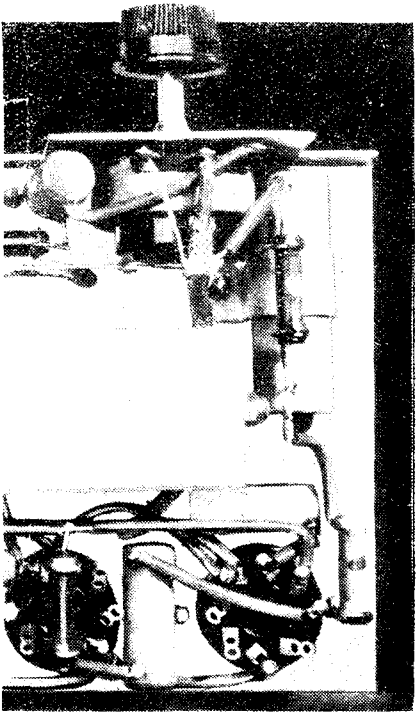

Wiring the components, as it indicates exact location under the chassis.

satisfactory results, to avoid any unnecessary components or complications. The L.F. output is fed to the grid of the output pentode—1.C.5.G.—by means of a resistance-capacity coupling, the strength of the signal reaching this point being controllable by means of the potentiometer in the grid circuit of the previous valve. The pentode secures its grid-bias by virtue of

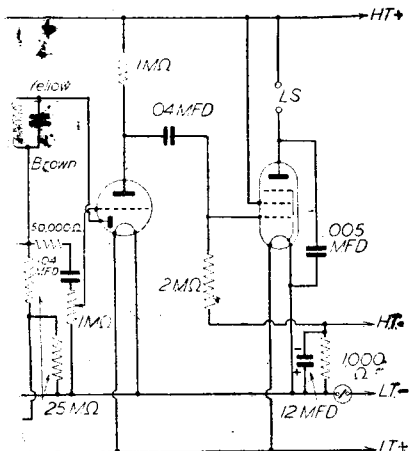

Wiring of components, thus simplifying its construction.

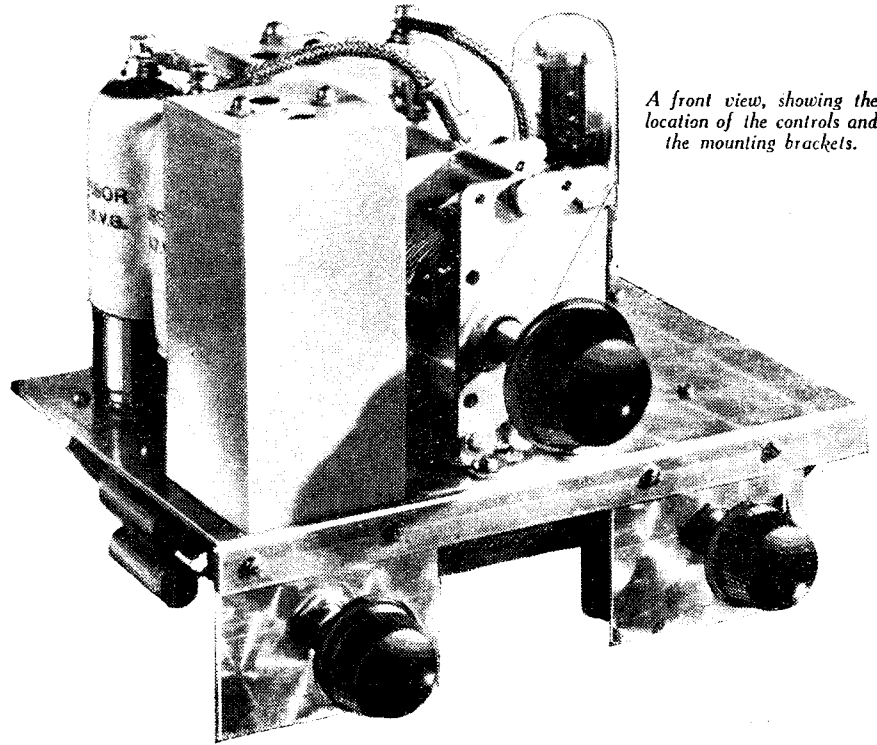

A front view, showing the location of the controls and the mounting brackets.

should be fitted as and when required, as the wiring work can be made easier by the freedom gained by keeping components off the assembly until they are actually required. Special attention is called to the earthing wires, and the use of metallised sleeving. Note, for example, that the frame and moving vanes of the ganged condenser are electrically connected to the chassis by a short length of metallised sleeving. Likewise, a direct connection is made between the L.T. negative side of the filaments and the chassis, whilst all lengths of metallised sleeving are also definitely connected to the common negatives.

A word of warning is here given—keep all resistances and H.T. conductors well clear of metal work, and don't take any risks by skipping the insulating sleeving. Four flexible wires are required for the battery supplies, and these should terminate at the four-pin plug which is used to make contact with the four-point socket fitted to the specified H.T.—L.T. battery.

**Dial**

The specified two-gang variable condenser incorporates a neat slow-motion drive in its spindle which enables the pointer to traverse a 180-degree dial. No dial or escutcheon plate is provided, as it is intended to make use of a simple dial marked off on, and cut out of, stiff Bristol board, an item which each constructor himself could undertake. The advantage of this method, apart from reducing cost, is that the dial can be calibrated according to the stations most in demand. Complete details of the construction and fitting of the dial will be given in our next issue.

**Cabinet and Frame Aerial**

The cabinet illustrated has been especially produced for this receiver by Messrs. Lockwood, and its design, construction and finish make the completed assembly comparable with many commercial receivers. The battery fits into the bottom of the cabinet, whilst the chassis and M.C. speaker are fitted at opposite ends of the front panel, thus securing a very even distribution of weight for carrying purposes. A neat leather handle is fitted to the top of the case, but it is so inconspicuous that it does not detract from the pleasing lines.

The frame aerial is wound on supports which are mounted on the flat, removable

back, and although it has directional properties, they are not sharp enough to prevent the cabinet being placed at the most satisfactory angle for listening. The switching of the two sections of the frame is provided for by one series of contacts on the rotary switch. These connections are not shown in the illustrations in this issue, but they will be clearly indicated in the final article.

For the benefit of those who are able to complete the chassis assembly before our next issue, when all details connected with

the frame aerial, testing and fitting the set into the cabinet will be given, we would mention that a preliminary test could be carried out by substituting a modern type of dual-range coil for the frame. This will not, unless particular attention is paid to the trimming, give maximum results, but it will allow one to discover if all wiring has been carried out in the correct manner. Remember to locate all components and wiring, as indicated on the wiring plan, and see that all connections are sound and electrically perfect.

**Wiring Diagram for F. J. Camm's All-dry Superhet Portable**

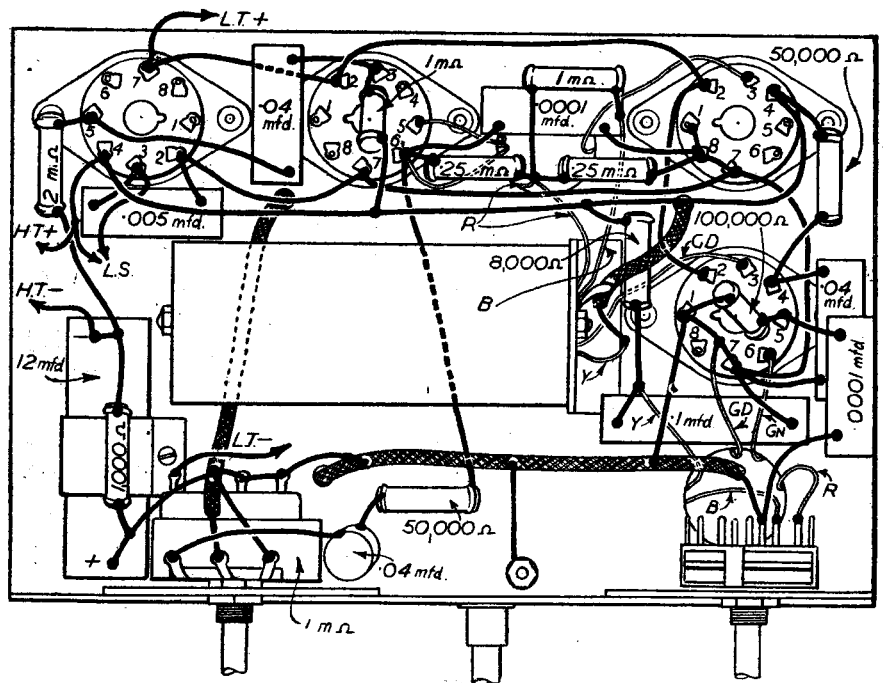
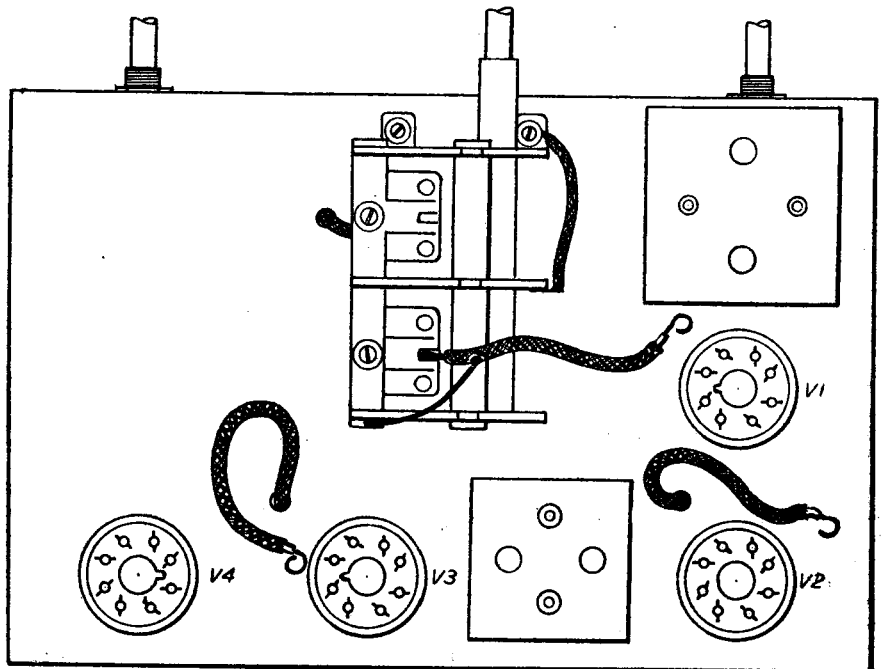

**LIST OF COMPONENTS**

- One Bulgin coil, type 72.
- Two Bulgin I.F. transformers, type 73.
- One 2-gang tuning condenser, J.B., .0005 mfd. Type 4301.
- One wavechange switch, Bulgin type, S.204.
- Four octal valveholders (Celestion-Amphenol).
- Fixed condensers (Dubilier):  
Two .1 mfd., type No. 4603/S; three .04 mfd., type 4601/S; two .0001 mfd. type 4601/S; one .005 mfd., type 4601/S; one 12 mfd., type 3016.
- Cabinet. (Lockwood.)
- Resistances (Erie), 1/2-watt type:  
Two 1 megohm; two 50,000 ohms; one 100,000 ohms; one 8,000 ohms; two .25 megohms; one 2 megohms; one 1,000 ohms; one potentiometer with 3-point switch, one megohm.
- One four-pin plug. Bulgin. P.104.
- Three top cap connectors, Bulgin, type P.96.
- Four Cossor valves, Types 1.A.7.V.G., 1.N.5.V.G., 1.H.5.G., 1.C.5.G.
- One H.T. and L.T. dry battery, type H. 1157 (Exide).
- On: W.B. speaker. Junior.

# Planning Your Receiving Station

Station Efficiency and Smooth Working can be Seriously Impaired by Lack of Consideration for the Layout of the Equipment  
By L. O. SPARKS

**S**TATION planning and efficiency are intimately related; a shack filled with a mass of hook-up and make-shift arrangements is not usually productive of first-class results or a high degree of reliability. Apart from results, the layout of a station is indicative of the mind of the operator, and reveals whether the work is treated in a slipshod manner or carried out with due respect for the apparatus in use, and according to a reasonably methodical system. There are, of course, exceptions; a neat, well-laid-out station owned by an operator who thinks more about appearance than experimenting is of far less use to the amateur movement than one in a less orderly condition, due to the fact that genuine work is being undertaken.

## Space

Space is usually one of the governing factors so far as amount of equipment and its shape and size. Few amateurs are able to ignore it, so one of the first steps in station planning is to prepare a list of the minimum apparatus likely to be required for the particular work the owner has in mind. The accumulation and harbouring of unnecessary gear, the duplication of apparatus and the construction or purchasing of testing equipment which is not likely to frequently be used, are points which must be avoided. Compactness and the use of multi-range and/or application units should form the high lights of the equipment, and before any additional piece of apparatus is added, careful thought should be given to determine if it is going to be really useful and, if so, where can it be located.

Rack construction, to which too little consideration is given by the average amateur, can do a lot towards freeing space, as the ground area occupied is very small, whilst the height of racks and the number of sections they can carry can be adjusted to individual requirements. Although this form of housing equipment is so closely connected with transmitters, there is no reason why it should not be used, with great advantage, in listening station design; in fact, it is the one solution of the space problem for the amateur who has a shack of very limited area. Suitable designs and constructional details have been given in past issues.

## Bench and Operating Table

Wherever possible, a bench—even if of small dimensions—should be provided in addition to the operating table. It is very difficult, and usually most unsatisfactory, to try to make do with a table for both purposes. The bench is essential for all constructional work; it allows all tools and materials to be kept together and provides a satisfactory surface on which all constructional work can be undertaken with the minimum of trouble. The operating or receiving table need not be large; it is not intended to carry all the station equipment, therefore its size can be governed by the receiver in use, plus allowances for, say, a frequency meter, log books and elbow room sufficient for writing purposes. It is a great mistake to place every available piece of apparatus on it, as its sole purpose is to enable the owner to operate his receiver efficiently and make such records as may be necessary.

## The Bench

As normal radio constructional work is not of a heavy nature, it is not necessary to make the bench a massive affair. A small kitchen table is quite satisfactory, but if one has to be constructed, suggestions are given in Fig. 1. The legs need not be stouter than 2in. by 1½in. material. For

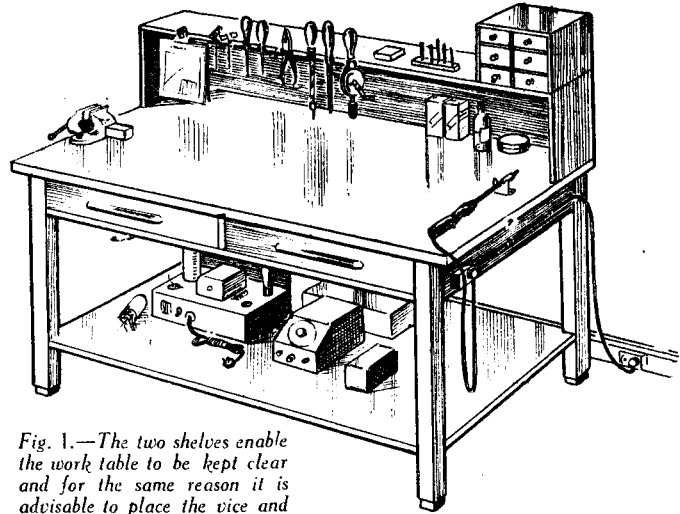

Fig. 1.—The two shelves enable the work table to be kept clear and for the same reason it is advisable to place the vice and soldering iron on opposite sides.

the top, ½in. by 9in. planks are most suitable, as they provide ample rigidity without looking too bulky. Two small drawers will prove useful, and the two shelves shown in Fig. 1 will enable all requisite materials to be stored within reach, whilst the front of the top shelf can carry a neat tool rack. Small parts, such as nuts, bolts, drills and taps, screws, etc., should have their individual boxes, and a piece of metal or other fire-proof material should be fastened to the right-hand side of the top of the bench, to form a base for the soldering-iron holder. The actual size of the bench will depend on available space, but a handy size is 3ft. by 18ins., the height being 3ft.

## Equipment

The complete equipment of no two work benches is the same; much depends on the individual, but there are certain minimum essentials. The following tools are advisable: Square and round taper-nosed pliers; small side or top cutting pliers; screwdrivers—½in. to ½in. (long and short shanks); small and large twist-drill, together with wide range of twist drills; taps and dies (B.A. range); hack-saw and blades; soldering iron; light hammer; files; small vice; steel rule; scriber; snips; square-edge; bradawl and one or two woodworking implements. It is advisable to include a block of hard wood, say, 2 to 3in. thick by 6in. by 6in., on which all drilling should be done, thus protecting the top surface of the bench. A more complete range of tools should be acquired by adding to one's kit as the need arises, and funds permit. Good tools are a valuable asset, therefore, they should only be used for the purpose they are intended, and always looked after with care.

## The Operating Table

Here again, a plain deal table is the best, bearing in mind that it may be necessary to fix to it various fittings, etc., which one would be loath to do to a more valuable piece of furniture. The top can be finished off with fine sandpaper and stained if so desired, but the writer favours covering it with a piece of plain inlaid lino, neatly cut to size and held in position by suitable tacks. No attempt should be made to cover the edges; it is best to stain them. The table top should not be overcrowded;

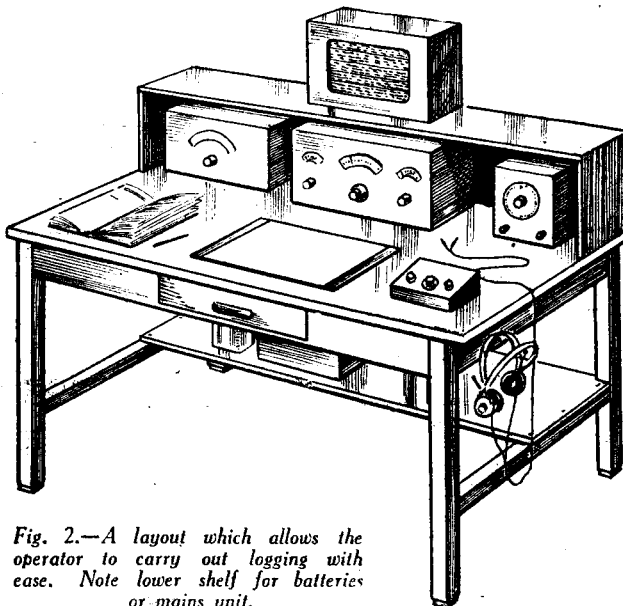
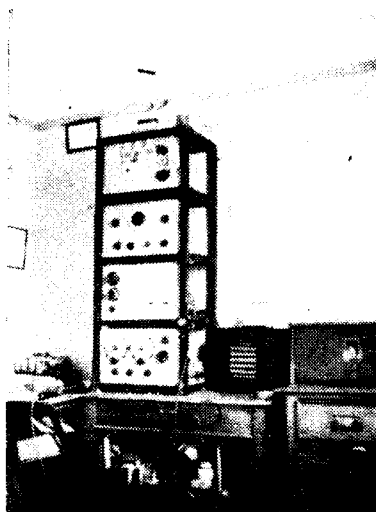

Fig. 2.—A layout which allows the operator to carry out logging with ease. Note lower shelf for batteries or mains unit.

the main receiver, a smaller "stand-by" set, and a reliable frequency meter represent all the apparatus it need carry. These should be so placed that they are easy to reach and operate, and leave sufficient room for note, log, and call-sign books. If the speaker is not "built" in the receiver, it is best to suspend it against the wall over the table or erect a neat shelf, similar to the one suggested for the work-bench, above the sets so that it can be fixed in a position most suitable to the operator. It is not advisable to let it, or anything else, rest on the set cabinet, as the tops of these should be left free for coil changing or rapid tests. Any external switching which might be required is best provided for by making a neat switching or controlling panel which can be fitted to the side or front of the table frame or, better still, mounted in a small case of the sloping type and fixed to the table top. Phones should be hung up out of the way when they are not in use. A brass dresser hook in the side of the table will enable this to be done, and prevent them from being knocked on to the floor.



A neat form of rack construction made and used by one of our readers, Mr. B. C. Tunstall.

**Batteries and Mains Units**

There are several reasons why these items should not be located alongside the sets on the table top, but from the point of view of space alone, it is advisable to make other arrangements for them. The simplest and most efficient storage place can be formed by fixing a shelf under the table. It should be high enough off the floor to allow free movement of the feet of the operator, but not so high that it becomes difficult to get at, or make adjustments to, the batteries, etc. For connecting leads, use slightly heavier flexible wire, especially for L.T. supplies, to prevent any possibility of voltage-drop. If a permanent installation is being erected, and any mains-operated equipment (such as a trickle-charger, eliminator, or receiver), is to be used, it is very advisable to carry out the mains wiring—from wall socket to switch to apparatus—with twin lead-covered wire, the metal covering of which can then be connected to earth for safety. Very neat wiring can be produced by using a little care, a few clips for holding the wire in position, and a little forethought to determine the best way to run the wiring. When mains supplies are used, one cannot be too careful in the way the work is handled, and the selection of the materials used.

# New Varley Products

SINCE we had the opportunity of subjecting one of the first Varley Dry Accumulators to some most intensive and rigorous tests, several new types have now been released. Technically, the Varley Dry Accumulator is similar in basic principles to the standard free-acid type of accumulator, but its construction is such that it contains *no free acid*. This important fact, combined with special features in design and assembly of the elements, allows the cell to maintain constant operation without disintegration under concussion or rough treatment.

ordinary 2-volt cell, such as is used for radio work. Two charging rates are provided, namely,  $\frac{1}{4}$  ampere and  $\frac{1}{2}$  ampere.

**Dry Accumulators**

The model shown on the left of the second illustration is ideal for cycle lamps, which normally use a two-cell dry battery. Its voltage output is 2 volts and its ampere-hour capacity, at the 20-hour rate, is eight, thus providing a most satisfactory period of service on each charge.

The other model is even a more recent

*It will be seen from this illustration that the new Varley home charger is a neat and compact unit.*

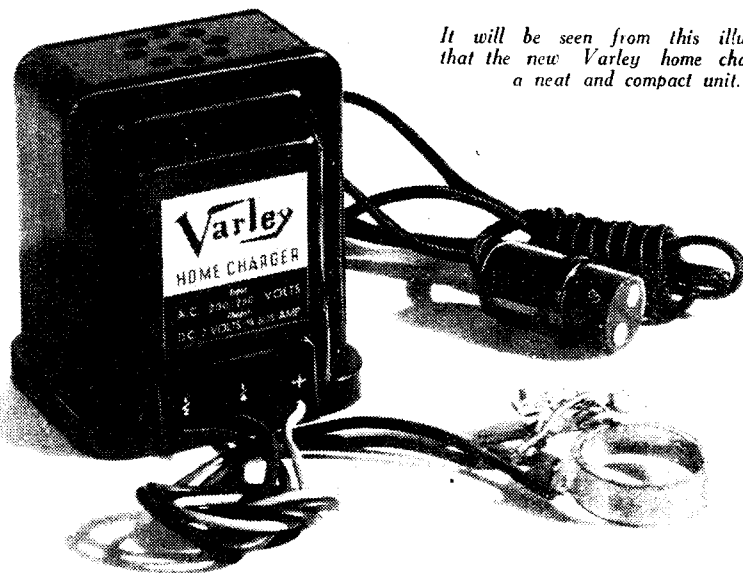

**Home Charger**

The above illustration shows the compact charger which is produced by Varley, to enable the various types of their dry accumulators to be charged at home by those users who have A.C. mains supply in their homes. It is housed in a neat, strong bakelite case, thus rendering it perfectly safe to handle and place in any convenient spot. A generous length of twin-flex, fitted with a standard lamp-adaptor connector, forms part of the assembly and, although the leads for the accumulator are terminated with special connectors for the dry accumulators, the charger is equally suitable for use with an

addition. It is known as the V.P.T.I. and delivers the same voltage as the above, but its capacity, under the same conditions, is 4 1/2 hours. We understand that this particular cell can be supplied in blocks or units to any required voltage. Other models are the "V" type, having a capacity from 10-40 ampere hours; the "T" type from 2 1/2-8 hours; the T.U.B. types, which are ideal for Deaf Aids, from 2 1/2-4 hours; and the PV20, which is invaluable when a continuous power supply for a long period is required.

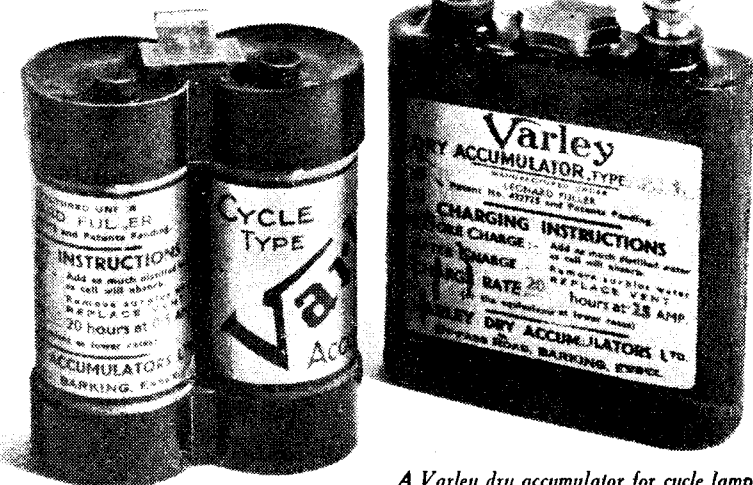

A Varley dry accumulator for cycle lamps, and their model V.P.T.I.





*Comment, Chat and Criticism*

# Outline of Musical History—17

## Music and Inspiration

By our Music Critic, MAURICE REEVE

**E**DISON'S dictum that genius is two per cent. inspiration and ninety-eight per cent. perspiration is as witty as it is true. The inspiration that gives birth to a great work of art, as compared to the months of work that are necessary for its fashioning and completion, would be as a baby is to a mature adult could they be measured side by side. But in art the mere toil expended on a creation counts for nothing; and even the knowledge displayed throughout its composition—something which took years to acquire and cultivate—means very little. Hardly a thank you is handed out to the great masters for having devoted years of their life to gaining and building up an encyclopædic knowledge of their subject, except, of course, where it has led them on to new paths of discovery.

It is the "inspiration" that gave rise to the work; that white-hot impetus which drove him to the task; that "something," the possession of which entitles a man to the appellation of "genius," that counts with posterity. At least that is the common belief.

### Inspired Music

As a matter of fact, a cursory examination is sufficient to prove that much of the so-called "inspired" music (to deal exclusively with that art with which this page preoccupies itself) is of the second class so far as quality and immortality are concerned, and that the greatest masterpieces are those works which their authors wrote "for money," without which they would have starved.

The greatest of all musicians, Beethoven, Bach, Brahms, Wagner, Mozart, etc., were no more and no less than men earning a living. If they didn't compose they had no money on which to subsist; and most of them were good business men—in the case of Wagner, too good for most of the poor unfortunates who had any dealings with him.

The fact that a man earning his living at composing music does so in his own home, and in his own chosen hours, and does not have to catch the 8.15 and be in the office by 9.30, has led to the quite erroneous, though highly romantic, belief that your musician is someone magically propelled through life by some unseen forces, who, at certain given moments of "inspiration," rushes to the piano to work out the masterpiece (a matter of a few hours at most) that he has just conceived; and then, whilst the great work goes down to posterity as the "Moonlight Sonata," or whatever one it may be, with fantastic stories attached to it of incredible adventures with peerlessly beautiful women, the great man subsides again into his celestial diet of nectar and ambrosia until the next flash comes along and the magic process is repeated.

### Beethoven

How far this is from the truth only the great men themselves know fully. Beethoven was a composer who probably had more fixed and rigid hours for work than most others. Most of his finest compositions are nothing but sweat and toil, edifices built up by means of his magnificent

equipment plus, of course, his vast experience of life, and his exhaustless capacity for always having something beautiful to say. Most of the supreme moments in his pages are the logical outcome of the processes that have gone before. In fact, his sketch books prove conclusively that many of his greatest passages are nothing but the result of working out, years later, ideas that he put down in the sketch books when and where they came to him.

Those ideas can, of course, be called the "inspirations" that give rise to the great works of art. But I doubt it, especially in Beethoven's case. And in any case it does not do away with the fact that enormous labour is required, which of itself is the antithesis of inspiration.

### The Added Bar

A perfect illustration of an "inspiration," as apart from something absurd and illogical, is afforded from Beethoven's own pages. Some days after he had sent the manuscript of his tremendous piano sonata Op. 106 to the publisher, he rushed a letter down ordering the publisher to add one bar, containing the two notes A and C sharp played by both hands in unison, in front of the third, slow, movement. Anyone can play the first lines of that wonderful movement both without and then with those two notes, and he will not be slow to hear the magical effect which their addition produces. That is inspiration; and the same applies to your executive artist. We listen to the greatest pianists, violinists, singers, etc., and we say how "inspired" they were, and how they "stirred our emotions." Ask that great person to play, or sing, to you when he hasn't practised for six weeks or a couple of months, and you will be quick to realise the absolute truth of Edison's observation. Every tiny variation of tone colour which, cumulatively, produces your "emotion" and your "inspiration," and which a concert artist must be able to unflinchingly produce every time he steps on to a concert platform, is solely the result of technical preparation, practice, and perfect muscular control. The fact that a musical mind of the finest quality and sensitiveness is behind it all is an elementary fact that hardly needs stating.

### Liszt

The type of composer who writes only when "inspirations" come to him is usually a man who hasn't got to work for his living or, perhaps I should say, one whose compositions haven't got to produce money for his subsistence. Liszt was very much

one of this type. Born of wealthy parents, and making a vast fortune as a concert pianist, he composed largely as a means of self-expression and as a dilettante. The result is seen in pages and pages of very second-class material, though his best work is fine indeed, and some of it amongst the immortals.

Mendelssohn was another. The magic of the "Midsummer Night's Dream" music, and the violin concerto, were seldom repeated, largely, I venture to suggest, because he hadn't "got" to.

Another interesting viewpoint on this subject is obtained if we study the various subjects that are supposed to have "inspired" great music. Firstly, we fail to find any source of visible motive for all the great classics. Only the genius of their composers can account for their existence at all. We listen to the pages of Beethoven's or Brahms's symphonies and quartets, or the great fugues of Bach, and we fail to find any "motive" or "reason" for their existence at all, except the love of writing beautiful music, or the necessity of earning a living! And there is no other reason because it is "absolute" music, music written for itself, and because of itself.

### Programme Music

The other category of music, "programme" music, contains most of the works inspired by a "programme," a story, or an idea; and the work may be anything, from such masterpieces as Mendelssohn's "Midsummer Night's Dream" music, Debussy's "Après Midi d'une Faune" and his other great works, and Ravel's "Bolero," to anything such as patriotic marches, sentimental ballads and bird or animal imitations.

Liszt's "Liebestraume" is typical of the sort of composition that might well have been written "on the spur of the moment," very beautiful, but too bound up in the theme that inspired it and consequently lacking in character.

Religion has inspired some very great music, whereas patriotism, I'm afraid, little or none. The tender passion, also, has not been the motive of much outside of opera and some master song writers like Schubert.

The greatest music is very much like architecture—massive edifices built up of many materials, and to a definite plan or design. Hence its extreme intellectuality, and its sobriquet "highbrow." A thousand pities that such a marvellous sphere of human activity should so frequently be greatly misunderstood.

## A LIBRARY OF STANDARD WORKS

By F. J. GAMM.

PRACTICAL WIRELESS ENCYCLOPEDIA 7/6, by post 8/-.  
EVERYMAN'S WIRELESS BOOK 5/-. by post 5/6.

SIXTY TESTED WIRELESS CIRCUITS 3/6, by post 4/-.  
WIRELESS COILS, CHOKES and TRANSFORMERS and HOW TO MAKE THEM

3/6, by post 4/-.  
PRACTICAL WIRELESS SERVICE MANUAL 6/-. by post 6/6.

WORKSHOP CALCULATIONS, TABLES AND FORMULAE 5/-. by post 5/6.  
PRACTICAL MECHANICS HANDBOOK 8/6, by post 9/-.  
WIRELESS TRANSMISSION FOR AMATEURS 3/6, by post 4/-.  
NEWNES SHORT-WAVE MANUAL 5/-. by post 5/6.  
RADIO ENGINEER'S POCKET BOOK 3/6, by post 3/9.  
THE SUPERHET MANUAL 5/-. by post 5/6.

All obtainable from or through Newsagents or from Geo. Newnes, Ltd., Tower House, Southampton St., Strand, W.C.2.

# Impressions on the Wax

A REVIEW OF THE LATEST GRAMOPHONE RECORDS

## H.M.V., Parlophone, and Columbia

**R**ICHARD TAUBER has chosen Eric Coates' "Sleepy Lagoon" for his latest recording on Parlophone R 020492, whilst on the reverse side he sings "All the Things You Are." He sings both songs in English. A colourful orchestral recording is supplied by the Orchestra Mascotte, who play Johann Strauss' "Tales from the Vienna Woods," coupled with "Ever or Never," on Parlophone P 1794.

Anne Ziegler and Webster Booth, who have sung many duets together on the radio, have recorded a medley of duets on H.M.V. B 9120. The songs they have chosen will be familiar to most readers and include "Until," "Love's Old Sweet Song," "I Hear You Calling Me," "Two Little Words," "Deep In My Heart, Dear," "I'll Walk Beside You," "I Give My Heart," and "I'll See You Again."

Uncle Mac, who is a firm favourite with children in the "Children's Hour" broadcasts, has produced three records under the title of "Uncle Mac's Nursery Rhymes." The records are sold in an attractive folder. The numbers of the records, which can be obtained separately are H.M.V. BD 886-8.

John McCormack, the famous Irish tenor, has made two lovely recordings this month. The songs he has chosen are "See Amid the Winter's Snow" and "All thro' the Night"—H.M.V. DA 1756.

Those two cads, the Western Brothers, give a very amusing rendering of "It Was Bound to Happen in the End" and "You Can't Take the Breed from the British" on Columbia DB 1969, whilst if you like dancing then you cannot do better than dance to "Lincke in the Ballroom" and "Ancliffe in the Ballroom," played by Victor Silvester and his Ballroom Orchestra on Columbia FB 2537. Stringed instruments are heard to advantage in "Autumn Serenade" and "All the Things You Are," played by the Albert Sandler Trio on Columbia DB 1978.

Nelson Eddy, the popular film star, sings in French for his latest recordings. The songs, "Vision Fugitive," from the opera "Hérodiane," and "Chanson du Toreador" (Toreador Song), from "Carmen," suit his baritone voice admirably.

## Dance Music

**C**ARROLL GIBBONS and The Savoy Hotel Orpheans have made two records recently of popular hit tunes. They are "I'll Never Smile Again" and "The Memory of Rose" on Columbia FB 2490, and "Turn Your Money in Your Pocket" and "I'm Stepping Out With a Memory To-night" on Columbia FB 2491. Other dance tunes are supplied by Nat Gonella and his New Georgians with "Plucking on the Golden Harp" and "Hep! Hep! The Jumpin' Jive" on Columbia FB 2492, and "I Haven't Time To Be a Millionaire" and "No, Mama, No," on Columbia FB 2493, whilst Felix Mendelssohn and his Hawaiian Serenaders play "Tiger Rag" and "Good-bye Blues" on Columbia FB 2494. Finally we have Louis Levy and his Orchestra playing a selection of the music from the Metro-Goldwyn-Mayer film, "Gone With the Wind," on both sides of Columbia DX 981.

## Decca, Brunswick and Rex

**A** NEW record by the Boyd Neel String Orchestra is always interesting, and this one particularly so, as it is a recording

of a work that has hitherto been neglected—"The Faramondo Overture" (Handel)—Decca K 947. Frederick Grinke, the leader, is one of the best violinists of the day, and the whole ensemble play perfectly under the baton of Boyd Neel.

If you are in the mood for strings, have you yet heard that amazing child violinist, Ida Haendel? If not, you must hear "Meditation" and "La Ronde de Lutins" on Decca F 7659.

There are two charming records by Edith Howes, soprano—Decca K 948-9—a collection of folk songs which bring to mind visions of village greens and the hamlets of England.

## Rocky Mountain Melodies

**E**LSIE CARLISLE, the popular radio crooner, has made a new recording of "Tiggerty-Boo" and "Shake Down the Stars," on Rex 9847, whilst another well-known radio star—Big Bill Campbell and his Rocky Mountain Rhythm—introduces a medley of Rocky Mountain Melodies on Rex 9851.

Dance music is supplied by a number of popular bands. Billy Cotton heads the list with "Fools Rush In" and "Turn Your Money in Your Pocket," on Rex 9854, and "Sons of the 'Old Contemptibles'" coupled with "Sarah, Sarah," on Rex 9855. Next comes Jay Wilbur and his Band with "I Haven't Time to be a Millionaire" and "Imagination," on Rex 9844, and "Mist on the River" and "Tiny Old Town," on Rex 9845. In strict dance tempo we have Oscar Rabin and his Strict Tempo Dance Band playing "By the Sleepy Lagoon" and "Au Revoir," on Rex 9848.

# THIS YEAR WE CLIMB TO VICTORY

To achieve Victory we must be efficient—to be efficient we must be trained.

You can help your country and yourself at the same time if you do your best, but you are not doing your best if you waste time.

By becoming efficient in your vocation you can give the best service to your country and to yourself. The more you increase your earning power the better it is for the country and for yourself personally.

War or no war, earning power always brings its possessor to the front. It is no use waiting for better times. The ideal opportunity never arrives. We have to make the best of existing conditions. Therefore, delay is useless; it is worse, it is harmful.

If it is your desire to make progress and establish yourself



LET ME BE YOUR FATHER

in a good career, write to us for free particulars on any subject which interests you, or if your career is undecided, write and tell us of your likes and dislikes, and we will give you practical advice as to the possibilities of a vocation and how to succeed in it. You will be under no obligation whatever. It is our pleasure to help. We never take students for courses unless we feel satisfied they are suitable. Do not forget that success is not the prerogative of the brilliant. Our experience of over thirty years proves that the will to succeed achieves more than outstanding brilliancy.

*J. McCormack*

## EARNING POWER IS A SOUND INVESTMENT!

### DO ANY OF THESE SUBJECTS INTEREST YOU?

- |   |  |                                   |
|---|--|-----------------------------------|
| Accountancy Examinations                              | Engineering. All branches, subjects and examinations | Pumps and Pumping Machinery       |
| Advertising and Sales Management                      | General Education                                    | Radio Communications              |
| Agriculture   | S.P.O. Eng. Dept.                                    | Radio Service Engineering         |
| A.M.I. Fire E. Exams.                                 | Heating and Ventilating                              | Road Making and Maintenance       |
| Applied Mechanics                                     | Industrial Chemistry                                 | Salesmanship, I.S.M.A.            |
| Army Certificates                                     | Institute of Housing                                 | Sanitation                        |
| Auctioneers and Estate Agents                         | Insurance  | School Attendance Officer         |
| Aviation Engineering                                  | Journalism   | Secretarial Exams.                |
| Aviation Wireless                                     | Mathematics  | Sheet Metal Work                  |
| Banking   | Matriculation  | Shipbuilding                      |
| Blue Prints   | Metallurgy   | Shorthand (Pitman's)              |
| Boilers   | Mining, all subjects                                 | Short Story Writing               |
| Book-keeping, Accountancy and Modern Business Methods | Mining, Electrical Engineering                       | Speaking in Public                |
| B.Sc. (Eng.).   | Motor Engineering                                    | Structural Engineering            |
| Builders' Quantities                                  | Motor Trade  | Surveying                         |
| Building, Architecture and Clerk                      | Municipal and County Engineers                       | Teachers of Handicrafts           |
| B of Works  | Naval Architecture                                   | Telephony and Telegraphy          |
| Cambridge Senior School Certificate                   | Novel Writing  | Television                        |
| Civil Engineering                                     | Pattern Making                                       | Transport Inst. Exams.            |
| Civil Service   | Play Writing   | Viewers, Gaugers, Inspectors      |
| All Commercial Subjects                               | Police, Special Course                               | Weights and Measures Inspector    |
| Commercial Art  | Preceptors, College of                               | Welding                           |
| Common Prelim. E.J.E.R.                               | Press Tool Work                                      | Wireless Telegraphy and Telephony |
| Concrete and Structural Engineering                   | Production Engineering                               | Works Managers                    |
| Draughtsmanship. All branches                         |  |                                   |

If you do not see your requirements above, write to us on any subject. Full particulars free.

## STUDY AT HOME IN YOUR SPARE TIME

### JOURNALISM

#### Short Story, Novel and Play Writing

There is money and pleasure in Journalism and in Story Writing. No apprenticeship, no pupilage, no examinations, no outfit necessary. Writing for newspapers, novels or pictures, is not a gift; it is a science that can be acquired by diligent application and proper guidance. It is the most fascinating way of making pastime profitable. Trained ability only is required, we do the training by post. Let us tell you about it.

Department of Literature No. 104

IF YOU ATTEND TO THIS NOW IT MAY MAKE A WONDERFUL DIFFERENCE TO YOUR FUTURE

**COUPON—CUT THIS OUT**

TO DEPT. 104, THE BENNETT COLLEGE, LTD., SHEFFIELD.

Please send me (free of charge) Particulars of ..... (Cross out line which Your private advice about) does not apply.)

PLEASE WRITE IN BLOCK LETTERS

Name .....

Address .....



# Open to Discussion

The Editor does not necessarily agree with the opinions expressed by his correspondents. All letters must be accompanied by the name and address of the sender (not necessarily for publication).

## "The Fleet S.W. Two."

SIR,—I feel I must write to you to let you know how pleased I am with results obtained from the "Fleet S.W. Two" receiver, which I have recently constructed.

All my listening has been on loudspeaker, and among the stations I hear at good speaker strength, and quite regularly, are TAP Ankara, WGE0q Schenectady, CS2WA Lisbon and WCBX Wayne, N.J.

I have been very surprised at the results, bearing in mind the fact that only two valves are utilised. In conclusion, I should like to thank you for the help you gave me, while building the set.—R. G. STEPHENS (Taunton).

## Automatic All-clear Detector

SIR,—I read with interest your article entitled, "An Automatic All-Clear Detector," but think that the calculation of the dimensions of the resonator tube is open to slight criticism.

The resonator is of the open-tubed variety and its fundamental response must be such that there are anti-nodes at both free ends whilst there is, of course, a nodal point in the centre. In practice, however, the anti-nodes fall just outside the ends, and a correction must be applied to allow for this. The formula then becomes:

$$L = \frac{1090}{2f} - 2k$$

where  $k = 3$  times the diameter of the open ends. Also, perhaps to split a hair, 1,090ft. per second is a more accurate figure for the speed of sound. The total length of the resonator, including adjustment tube, thus becomes:

$$L = \frac{1090}{2 \times 576} - (.075 + .050) \text{ ft.} \\ = .821 \text{ ft.} \\ = 9.8 \text{ in., approx.}$$

As the two ends of the tube are of different diameters, the expression within the brackets will be understood as each end-correction must be evaluated separately.

It will thus be seen that the main tube is best made about 8in. long plus the 3in. adjustment tube. All this is, of course, based on a frequency of 576 c.p.s., but the siren may or may not be of this pitch. The general principle, however, holds.—ERIC JOHNSON (Highams Park).

## Some Suggestions: Using a S.G. Valve and Detector

SIR,—I have noticed several times in your columns an invitation for readers to write you concerning their requirements, and I would like to mention that, as your theoretical circuits are very interesting they should be printed larger, so that study becomes easier. Also, I think that prices of components should be stated.

The monthly issue has definite advantages over a weekly one; articles can be kept together for reference and theoretical and wiring diagrams could be published in the same issue.

With reference to the article on "Re-

versed Valves," I used a S.G. valve as diode detector and amplifier for a short period in a superhet. The valve worked quite well, but I fancy the high notes were accentuated a trifle. The idea is not original, but I enclose the circuit, which may be of interest to other readers.—G. DAVIES (Cardiff).

## Changes at the B.B.C.

SIR,—May one make a few inquiries concerning the changes which are promised in the B.B.C. with the object, so it is said, to improve national propaganda and bigger and more powerful stations for its transmission; which would be all to the good, no doubt, but where is the cost of all this to come from? Will it be covered by a

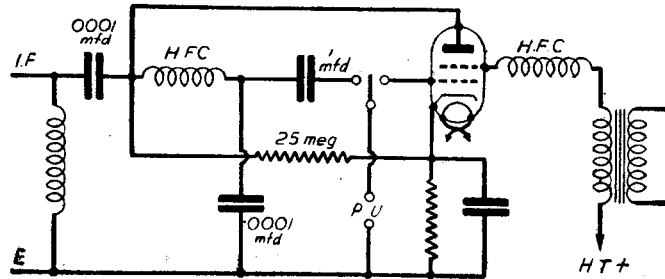

Circuit diagram, showing how Mr. G. Davies used a S.G. valve as a detector.

Government grant, derived from general taxation, or merely pinched from our licence fees? Since such propaganda is in the interests of the whole community, it would be most unfair if the cost of it was inflicted on radio fans alone. Motorists have for long endured this sort of thing in that the money extracted from them in the form of their licence fees, which were originated for road making and upkeep, has been raided to the tune of many millions to pay for, and bolster up, all sorts of objects quite apart from any motoring interest or advantage. We don't want this somewhat dishonest and unconstitutional method introduced in respect of our radio licence fees. The thin edge of this stunt was put into use some time ago, in the form of school broadcasts, which we have to pay for in addition to paying our ordinary Education Rate, and this is one of the causes of our terribly boring programmes, because it sops up B.B.C. revenue which otherwise could be used for the engagement of well-known artists as a change from the old dug-in staff veterans. We should resist the same plan being put into operation a second time for propaganda work in the interests of the community as a whole. In common honesty the right course will be for the Government to make the B.B.C. a special grant for this new departure. The names of certain well-known men have been put forward to take charge of it, all of them of high standing and repute, but with one possible exception, none of them with the least experience of the programmes side of the B.B.C. work, and, if they are given control over both propaganda and programmes, the latter will certainly become even more awful than they already are. Eliminate the schools broadcasts and the never-ending talks, post-scripts, commentaries, etc., and there is

very little else to listen to, and we have the alternatives of listening to all sorts of previously unheard of nonentities giving us their views on everything from Dan to Beersheba, or switching off our sets. It has been said that people get the sort of Governments they deserve, and the same thing would seem to apply to their radio programmes and their cost. From a purely entertainment point of view what we now get might well be considered very costly at 2s. 6d. per annum.—"ANTI-JAWING" (Birkenhead).

## New Voluntary Radio Group

SIR,—I shall be pleased to hear from any owner of a battery-operated receiver, situated in the North Manchester area, who has a little knowledge of radio, and who is not afraid to speak over a microphone.

Volunteers will not be called on to put in a lot of time in the scheme, which will be concerned with the dissemination of news announcements, but they will, if they offer their help, be assisting a service which will be valuable and useful to this country. Any persons with old battery receivers which they may not now want, can also help

if they wish, by giving same to the organisation for use in the scheme. Full details about the scheme will be made public at a later date; little can be done until all volunteers have been consulted.—R. LAWTON (Secretary, North Manchester Radio and Television Society, 10, Dalton Avenue, Thatch Leach Lane, Whitefield, Near Manchester).

## "Making Simple Superhets" = Correction

SIR,—After reading the article on "Making Simple Superhets" (pp. 150-1), I should like to point out that the .001 mfd. condenser, which should be in series with the long-wave winding of the oscillator coil, is shown wrongly connected in the circuit diagram. As shown it would be out of circuit on long-waves and shunting the long-wave winding when switched for medium-waves.

Also, in column 5, 10th line, you have put 200 to 400 degrees instead of metres.—R. V. GOODE (York).

## Correspondents Wanted

S. V. ALLANSON, of "Hawskwick," S. 10, Chapel Street, Calverley, Nr. Leeds, Yorkshire, would like correspondents in any part of England, of about 16 years of age. He is a beginner in radio.

J. Roberts, of 30, Milton Grove, Whalley Range, Manchester, wishes to correspond with any reader interested in television.

J. Gatt, of 12, Arbaur Street, Southport, Lancs, would like to contact anyone living in the Southport district, aged about 18, who is interested in short-wave work.

# NEWS AND NOTES

## New Maximum Prices for Torch Batteries

THE Board of Trade have made an Order replacing the Dry Batteries (Prices) (No. 2) Order, 1940, under which maximum prices were fixed for imported batteries. This is the Dry Batteries (Prices) (No. 4) Order, 1940—Statutory Rules and Orders, 1940, No. 2168; it is obtainable from H.M. Stationery Office, price 1d. Under the new Order new maximum prices are fixed for batteries imported from Hong Kong and the prices for batteries imported from countries other than the United States, Canada and Hong Kong are slightly increased. The prices fixed for imported batteries are as follows:

CLASS A Batteries imported from the United States	CLASS B Batteries imported from Canada	CLASS C Batteries imported from Hong Kong	CLASS D Batteries im- ported from any country other than the United States, Canada or Hong Kong
--	--	---	--

	MAXIMUM SELLING PRICE PER BATTERY.
1. Bijou or No. 216 ..	7d. 5d. 3½d. 4½d.
2. Large Unit Cell Large Mono or No. 2	5d. 4½d. 3½d. 4d.
3. Medium or Baby Small Mono or No. 1 Unicel ..	5d. 4d. 2½d. 3d.
4. Fountain 'Pen' or Penlite Single Cell or No. 9 Unicel..	4d. 3d. — —
5. Fountain Pen or Penlite 2 Cell ..	8d. 6d. —

These prices do not include Purchase Tax; the permissible addition where tax has been paid is ¼d. on a battery costing 2½d.; ½d. on a battery costing 3d. or 3½d.; 1d. on a battery costing 4d. or 4½d.; 1½d. on a battery costing 5d. or 6d.; 1½d. on a battery costing 7d.; and 2d. on a battery costing 8d.

## B.B.C. Takes Over Famous London Theatre

TO provide accommodation for the production of the extensive programmes now being broadcast in the B.B.C.'s North American service, one of London's famous old theaters has been taken over, lock, stock, and barrel. In the star dressing-room—which in the past has been used by such famous artists as Marie Tempest, Lilian Braithwaite, Alice Delysia, James Welch, Cyril Maude and Ernest Thesiger—Mr. Cecil Madden, the B.B.C. producer, is to be found at work on these North American broadcasts.

The boxes and seats are covered with dust sheets and the theatre lights are dimmed. Only the stage, where B.B.C. microphones now stand, is still brightly lit. Gramophone turntables occupy most of the space in the anteroom of the Royal Box, and the Royal Box itself is filled with broadcasting apparatus. Utilitarian office desks have replaced the ornate furniture of the star dressing-room—but the room, with its two large mirrors and elaborate frieze of Hyde Park in the time of Queen Victoria, still retains an atmosphere of past theatrical glories, although a steel helmet can be seen hanging from the old-fashioned gas bracket on the wall.

## All-night Work

THE theatre now never sleeps. Radio programmes go out from it at all hours of the day, under the general production of Cecil Madden, who handles all special events and vaudeville programmes in the B.B.C.'s North American service. Mattresses, sleeping bags, and rugs are provided for the radio stars and B.B.C. staff who,

in brief off-duty periods, snatch sleep in stage boxes, dress circle, stalls and orchestra pit—a sight which would have astonished the theatregoers who, in another war, 25 years ago, thronged into the theatre to see its longest run.

## 21,500 Sets for the Forces

ACCORDING to the latest figures available, the Forces' requirements in radio sets are helping to keep the wheels of the wireless industry going. Judging from the following figures the troops are keen listeners.

Latest order.....10,000 sets.  
Recently bought..... 4,000 sets.  
Previously bought.... 7,500 sets.

The last mentioned were mainly supplied through the Nuffield Trust. The latest 10,000 order was recently announced by Mr. Eden.

## PERSONAL PARAGRAPHS

Alfred Duncan Gay has succeeded to the Presidency of the Radio Society of Great Britain after serving as a Council member since 1930. During this period Mr. Gay has acted as Honorary Treasurer (1937) and as Executive Vice-President (1938-40).

Leading Telegraphist D. S. Thomson, of the Decca Record Co., Ltd., has been awarded the D.S.M. "for determination in a successful attack on an escorted enemy supply ship."

Admiral H. W. Grant, C.B., has been appointed chairman and managing director of the Marconi International Marine Communication Co., Ltd.

M. W. Richardson has been appointed Private Secretary to the Assistant Postmaster-General, in place of Mr. R. E. German, who has been promoted.

# A sound foundation for every valve!

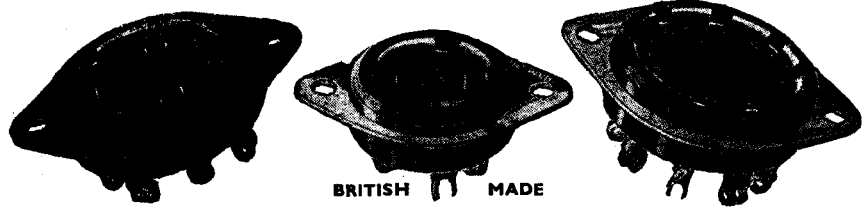

BRITISH MADE



Reg. U.S. Pat. Off.

Specified for the "All-dry Portable" receiver designed by F. J. Gamm (Editor of "Practical Wireless")

### PRICE LIST

#### British Types :

MIP4/E 4-pin ... ..	6d.
MIP5/E 5-pin ... ..	6d.
MIP7L/E 7-pin ... ..	9d.
*MIP8/E 8-pin ... ..	8d.
MIP9L/E 9-pin ... ..	10d.

\*Type specified by the designer of the "All-dry Portable" receiver

### Why Celestion-Amphenol were chosen

#### FOR THEIR STRENGTH AND EFFICIENCY

Exclusive Celestion-Amphenol Moulded-in Plates ensure maximum strength, rigidity and a high degree of efficiency. The sturdy plates keyed into the body cannot rattle loose.

#### FOR THEIR UNIFORM CONTACT & INSULATION

Celestion-Amphenol Contacts pressed from specially treated phosphor bronze are engineered to ensure uniform contact on all prongs. There will be no "fatigue" even after constant use. Exceptional insulation is assured by the special properties of the moulding powder.

All standard British and American Types available.

# CELESTION, LTD.

Engineers

KINGSTON - UPON - THAMES, SURREY

Telephone : KINGston 5656-7-8.

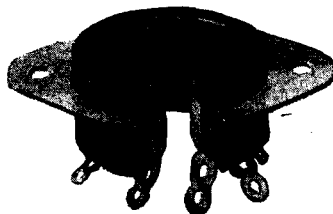

# B.L.D.L.C. The British Long-Distance Listeners' Club

## Experimental Equipment

IN the early days of radio, no two experimenters appeared to have the same idea regarding the layout or design of their equipment. No two shacks presented the same appearance, and one of the big features about visiting trips was the appreciation (or otherwise) of the ideas embodied in the design, construction and layout of the other fellows' gear. There were no set or stereotyped arrangements; each amateur showed a certain amount of originality, and many happy hours used to be passed discussing the pros and cons of the equipment in use and listening to your host expounding his theories on the relative merits of his apparatus compared with your own or that used by the rest of the local circle of amateurs.

It can be imagined that those visits used to prove most interesting, informative, and a most pleasant way of strengthening the bond between fellow experimenters. No alleged social distinctions were allowed to interfere with the round of calls. A great deal of good work could be done now, if only those members living in the same districts would arrange to visit each other in turn, and there is no reason why, at a later date, some form of inter-district visits should not be arranged. A little closer contact and co-operation between all members is all that is necessary. We at this end will do all we can to further the idea, but it must be appreciated that the main work must, of course, be done by those members in the various towns or districts.

We would welcome news, views, and ideas about what apparatus or procedure is used by members for their experimental work. It is possible that some still favour the very flexible "unit" construction. Others may have found out that a particular form of baseboard construction lends itself most readily to the many alterations so often necessitated during tests and experiments. Chassis arrangements are bound to have a certain number of adherents, and although each of the arrangements mentioned can possibly claim some advantages, we feel sure that all members would like to hear about any one particular idea which has been developed—through practical work—to offer the greatest facilities to the keen experimenter. If, therefore, your shack houses something which you have found most useful, and which has a touch of originality, let us have the details to pass on to all members. After all, this page is devoted to the exchange of members' ideas.

## Think It Over

IN a letter we have received from Member 6,583, for which many thanks, he asks a query which we give below for your consideration. No prizes are awarded for the correct solution, but if it happened with your installation, could you explain the reason why?

"I have been experimenting with an 0.v.0 and had some grand fun using it as a converter. I use an A.C. eliminator for H.T. supply, and decided to add some extra smoothing. Joining A.B. to eliminator and C.D. to set, violent hum and beating (motor-boating, we assume) is heard, but on joining C.D. to eliminator

and A.B. to set, the trouble is eliminated. Can you explain this?"

We have replied to the member concerned by post, but for your benefit we are reproducing his sketch on this page.

## Do You Realise?

WHEN we have won this war, and conditions are back to normal, there is going to be a great deal of activity on the 5 metres, 2½ metres and, believe it or not, the 1½ metre bands. Our American friends are already doing some very useful work on these bands, although they are more concerned with the last two than the first, as 56 mcs. transmission and reception seem to have lost their kick, so far as they are concerned. To give you a better idea of this, we would like to quote a few lines from an article in the November issue of *Radio*.

"A few short years ago amateurs who engaged in u.h.f. experimenting will tell you '56 mcs. is duck soup; anything will work on five. But 112 mcs., that is some-

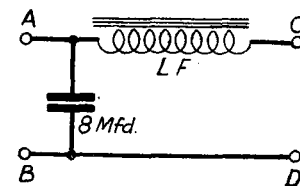
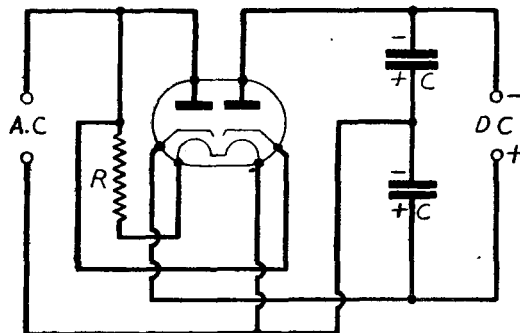

(Left) The voltage-doubling circuit.

(Right) The smoothing circuit used by Member 6,583.

thing else again. You have to use the right oscillator tube and part your hair just right.' Now that 112 mcs. no longer appears to scare anyone, 224 mcs. is looked upon as the band that requires especial care and equipment that is just so."

This extract precedes a description of a super-regenerative 224 mcs. receiver, whilst on the next page the construction of a transmitter to cover the same band is given. This only goes to prove our remarks above, and it is high time that we amateurs started to become more acquainted with the higher frequencies, as it will, without doubt, form an important link in the communication system of the future.

## Voltage-doubling Rectifier

MANY have asked for details of the circuit used in some of the A.C./D.C. type of receivers, of a voltage-doubling rectifier making use of a valve. As we think that the subject might be of general interest, we give on this page the theory of a circuit employing a 25Z6 valve. It will be appreciated, from the name given to the arrangement, that its sole object is to provide an output (D.C.) voltage of approximately twice the input (A.C.) voltage, the current output being that for which the valve is rated. With the type mentioned above, this is in the region of 85 mAs. The arrangement has, perhaps, a greater appeal in America, where the mains supply voltage is around 100 to 125 volts, when it becomes necessary—with

A.C./D.C. sets not using a mains transformer—to raise the rectified or D.C. voltage to values higher than the mains. When a 25Z6 is used on a supply having a voltage higher than that mentioned above, it is essential to include in each anode circuit a resistances of, say, 100 ohms. The output voltage is governed to a great extent by the capacity of the condensers, and we would suggest 6 mfd. as being satisfactory for British supply voltages.

## Morse Transmissions

MAKE a note of the following times and wavelengths if you wish to have some first-class morse practice. GBR, GAY, GIM and GIJ at 00.30 hrs., GBR, GAI2, GIA and GIM at 13.00 hrs. and 17.02 hrs.; GBR, GAY, GIA and GIM at 20.48 hrs. All times being B.S.T. The transmissions consist of British news bulletins from the Post Office stations operating under the calls given above. It should be noted that GIA has a directional aerial on S. America. The wavelengths are: GIA, 15.27 m.; GAI2, 16.03 m.; GIM, 23.13 m.; GAY, 33.67 m.; GIJ, 42.95 m.; and GBR, 18.75 m.

## Contacts

MEMBER 6,868, a newcomer to our ranks, would like to make contact by correspondence with other members in his area or overseas. His address

is 21, Racecourse Avenue, Monkmoor, Shrewsbury, Shropshire.

Member 6,575, of 22, Drummond Drive, Stanmore, Middlesex, would also like to get in touch with other members in his district, to see if some arrangements could be made for a local club or the means of holding frequent meetings for general discussions on S.W. work.

## Calling Leigh, Lancs

MEMBERS in or around Leigh will, we hope, be interested in the following letter we received last month from Member 6,310, of 49, Twist Lane, Leigh, Lancashire. He says: "Re your suggestion about the enjoyment and interest which could be obtained if members could contact each other in surrounding districts, and, say, meet once or twice weekly in a fellow-member's shack. I am almost sure members would take to this suggestion at once, and thus keep the ball rolling until peace and better conditions are with us again. Might I add that I would be only too pleased if any member, or S.W.L.s who could become members, would call at my shack any night of the week to discuss radio matters. I already have one visitor, member No. 6,598, who lives in Leigh, so I hope that many more will come along."

Judging by the photo of his den, for which we thank No. 6,310, he is evidently a keen enthusiast. Therefore, we hope that his letter will induce several members to get together to form a local section.

## PORTABLE RADIO RECEIVERS

The following list covers those sets for which Varley Dry Accumulators are suitable:—

Make of Receiver.	Type No.	Volt- age.	V.D.A. Suitable.	Notes.
Alba	35 30	2 2	T. 2 T. 2	
Beethoven	P. 555	2	T. 2	
	P. 44			
	202			
	107			
B. 43	2	V. 20 or V. 40	Resistance for 2 volt accumula- tor fitted in circuit.	
730	1.5	V. 20 or V. 40		
P. 600 } Major S 9 4	2	V. 20		
Burndept	292	2	T. 2	
	309	2	T. 2	
Burgoyno	Portable S G 4	2	V. 20 V. 20	
Bush	P. B. 70	1.5	V. 20	Resistance fitted in circuit for 2 volt accumu- lator.
Goscor	Portable	2	V. 20	
Defiant } C.W.S. }	P. 500	2	T. 2	
	P. 600	2	V. 20 or V. 40	
Ekco	P. 151	1.5	V. 20	Resistance fitted in circuit for 2 volt accumu- lator.
H.M.V.	1406	2	V. 60	
	1402	2	V. 20	
Invicta	New Junior	2	T. 2	
	Portable			
	650 654			
Kolster Brandes	Portable 156	2	T. 2	
Lotus	S. G. Portable	2	V. 20	
Marconi	895	2	V. 60	
	1402	2	V. 20	
Mc Michael	Suitcase 5	2	V. 20	
Mullard	MBS 7	2	T. 2	
Murphy	B. 81	2	V. 40	
Ormond	Suitcase 5	2	V. 20	
Phillips	Portable	2	V. 60 T. 2 T. 2 V. 20 or V. 40	Resistance and Adaptor sold separately by makers.
	252			
	228 B			
	225 B			
229 B	2			
Portadyne	S.B. 4 B. 4	2 2	T. 2 V. 20 or V. 40	
Powertone	Allsuitcase Models	2	V. 20	
Princess	Portable	2	V. 20	
Pye	Baby Q	2	T. 2	
Rees Waco	Phantom	2	V. 20	
	Baby Gnome	2	V. 60	
Regentone	S. G. Portable	2	T. 2	
Roberts Radio	M 4 D	2	V. 20, V. 40	With 90 volts H.T.
	M 4 Q	2	T. 2	
Rolls Gaydon	Phantom Suitcase	2	V. 20 V. 20	
Spencer Cameo	R. P. 9	2	V. 40	Fitted as Stand- ard.
	A. R. P.	2	V. 40	
Truphonic	Suitcase		V. 20	
Ultra	61	2	T. 2	Resistance fitted as standard for 2 volt accumulator.
	62	2	V. 20 or V. 40	
	63	1.5	V. 20 or V. 40	



# MUSIC

## WHERE YOU WANT IT . . .

This winter has introduced a rapidly increasing number of listeners to a new radio pleasure: "music where they want it"! Free from the restrictions of one-room radio, they are enjoying their favourite programmes in the Shelter, whilst working in the kitchen, or wherever it is convenient to listen; and all by the simple connection of a Stentorian Extension speaker to their existing radio. What's more, these handsome but moderately priced speakers offer an appreciable improvement in reproduction over most built-in speakers. Why not make full use of your radio NOW by installing a Stentorian?

Write for Illustrated literature.

Cabinet Models from 21/6.

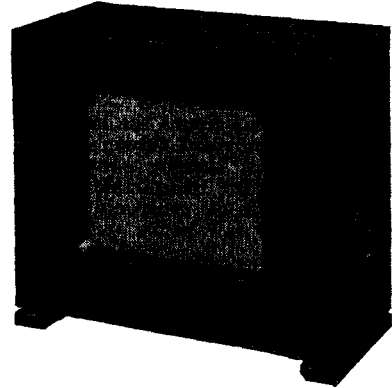

# Stentorian

THE PERFECT EXTRA SPEAKER FOR ANY SET

WHITELEY ELECTRICAL RADIO CO. LTD. - MANSFIELD - NOTTS.

## TAYLOR-METER 32 RANGE UNIVERSAL METER

Sensitivity 1,000 ohms per volt. A.C. and D.C.

The set testing functions of this precision instrument covers all ranges essential for carrying out accurate electrical measurements for Radio and General test work.

Model 90. PRICE  
**£9.9.0**  
(No purchase tax payable)

Complete with leads, test prods and comprehensive book of operating instructions. Delivery at present ex-stock.

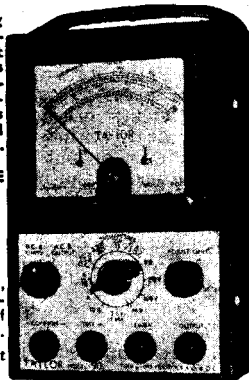

**STUDY THESE FEATURES:**  
**METER.** 4 1/2" square type Taylor moving coil meter. Sensitivity of 900 microamps. **SCALES.** The large dial has 3 clearly marked scales for measurements of Resistance, A.C. and D.C. volts, A.C. volts and amps. **RANGES.** The 32 ranges include:—(7) D.C. Volts 0-0.25 up to 1,000. (6) Output Volts 0-2.5 up to 1,000. (6) A.C. Volts 0-2.5 up to 1,000. (5) D.C. Current 0-1 mA. up to 2.5 amps. (4) Resistance from 1 ohm to 10 megohms. (4) A.C. Current 0-1 mA. up to 2.5 amps. **SOCKETS.** There are 4 on the front panel, "Common," "Test," "1,000V" and "Output." **ACCURACY.** A high degree of accuracy is assured, as every instrument is carefully checked against our standards.

Model 95, 17 Range D.C. Meter ... £7.17.6  
Technical Brochure free on request.

BRITISH MADE. GUARANTEED 6 MONTHS.  
**TAYLOR** Electrical Instruments Ltd.  
419-422, Montrose Avenue,  
SLOUGH, Bucks.  
Telephone: Slough 21381.

## TRAINED MEN URGENTLY NEEDED

NEVER before has there been such an urgent demand for trained radio men. There's a job waiting for you; or you can earn good money in your spare time.

Are you liable for military service? The R.A.F. is appealing for radio men, and many of our students have already been accepted as Radio Mechanics, Operators and Instructors. They like the work and the pay is good.

You can study at home in your spare time and become a qualified Radio Engineer. Even if you know nothing about radio, we can train you.

Hundreds of our students who had no previous knowledge or experience of radio have secured well-paid employment or spare-time work as a result of our training.

Our Home-Study Courses are praised and recommended by leading Radio Authorities. Our fees are reasonable and can be paid by easy monthly instalments.

Wherever you live you can study at home without interfering with your ordinary occupation. Do not delay, but post coupon now for full details of our Courses.

We have moved from London and Ealing;  
our new address is:—

## T. & C. RADIO COLLEGE 29, Market Place, READING.

(post in unsealed envelope, 1d. stamp)

Please send me free details of your Home-Study Radio Courses.

NAME .....

ADDRESS .....

P. 13.

# A "Class B" Degenerative Feed-back Amplifier

## Details of an Interesting Circuit Incorporating a Pentode Driver Stage

IN an effort to obtain as large an undistorted output as possible from a battery-operated receiver, J. M. Riddle, junior, of the Radio Corporation of America, has been experimenting with "Class B" amplifiers employing degenerative feedback and a pentode driver, and has produced the three-stage amplifier shown in the circuit diagram (Fig. 1). In this circuit the inverse feedback loop is provided through the three amplifier stages, thereby correcting distortion and other undesirable frequency characteristics of the pentode driver stage, permitting the full power output there-

from to be made available for driving the "Class B" stage, and permitting a relatively high gain through the amplifier by reason of the high gain of the pentode stage over the reduction in gain introduced by the high degree of inverse feedback.

transformer 30, the secondary 31 of which is connected with the loudspeaker load represented by the speech coil 32. One side of the secondary circuit is earthed to chassis as indicated at 34. The opposite high potential side of the secondary is provided with a terminal connection 35 for an inverse-feedback lead 36 having a series controlling resistor 37 and an output connection to the cathode terminal 38 of the cathode resistor 14 in the first stage, in order to provide inverse feedback to the first audio-frequency stage under control of the resistor 37.

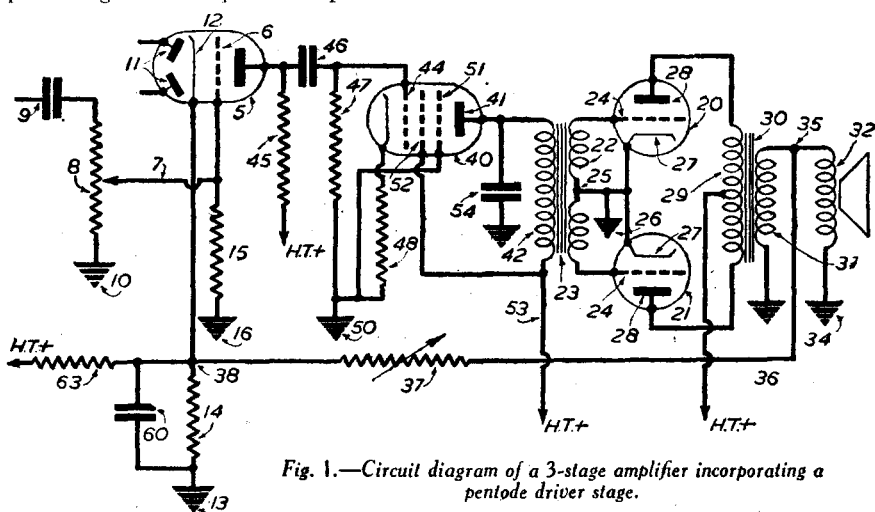

Fig. 1.—Circuit diagram of a 3-stage amplifier incorporating a pentode driver stage.

Referring to Fig. 1, the audio-frequency amplifier includes a high-impedance triode-voltage amplifier provided by a valve 5 as a first stage having a control grid 6 connected to the volume control contact 7 of a volume-control potentiometer 8, to which incoming audio-frequency signals are applied through an input lead 9 and a ground or chassis connection 10.

The high-impedance first-stage amplifier valve is included in the same envelope with diode detector anodes indicated at 11, having a common cathode 12 connected to ground or chassis 13 through a low resistance bias resistor 14. The bias potential from the resistor 14 is applied to the control grid 6 through a grid resistor 15 connected to chassis as indicated at 16.

The high-impedance first-stage amplifier valve is included in the same envelope with diode detector anodes indicated at 11, having a common cathode 12 connected to ground or chassis 13 through a low resistance bias resistor 14. The bias potential from the resistor 14 is applied to the control grid 6 through a grid resistor 15 connected to chassis as indicated at 16.

### Output Stage

The amplifier output stage consists of a pair of "Class B" amplifier triodes 20 and 21 having a balanced input circuit comprising the secondary 22 of a step-down transformer 23 providing a low-resistance input circuit connected at its terminals to the control grids 24 and having a centre tap 25 connected to earth 26, and to the cathodes 27, as indicated, for zero-bias "Class B" operation. The output anodes 28 are connected in balanced relation to the primary 29 of the "Class B" output

### Driver Stage

The amplifier utilises a pentode valve 40 as the second-stage amplifier or driver stage for the output stage. The use of a pentode valve for a driver stage ordinarily results in severe distortion, and an unsatisfactory fidelity characteristic. However, the pentode driver has the advantage that a higher power output is obtainable therefrom because of the better plate efficiency of the valve for a given plate voltage. This provides an adequate power source for driving an output stage of the "Class B" or "Class AB" type and, at the same time, takes less output voltage from the first audio-frequency amplifier stage 5.

The advantage of the high signal gain and power of the pentode is retained by employing a relatively high degree of inverse feedback which is sufficient to correct the high-distortion characteristic of the pentode driver stage, while a portion of the relatively high gain is maintained through the amplifier substantially higher than available with a usual triode driver.

The pentode driver stage is connected between the first-stage valve 5 and the "Class B" stage 20-21 by connecting the output anode 41 of the pentode to a high impedance primary 42 of an interstage coupling transformer 23, and the input or signal grid 44 is coupled to the high impedance output circuit 45 of the first-stage amplifier through the usual capacity coupling means 46, provided with a high resistance grid leak 47.

### Lack of Phase Shift

The pentode is provided with an un-bypassed cathode resistor 48 from which bias for the control grid 44 is derived, and a predetermined degree of degeneration which further aids in preventing distortion. Furthermore, the unbypassed resistor does not introduce any phase shift. The cathode circuit is earthed as indicated at 50. The suppressor grid 51 is connected to earth, and the screen-grid 52 is connected to the positive supply lead indicated at 53, which also supplies the anode 41. The primary 42 is shunted by a condenser 54 which cuts off the amplifier response above the audio-frequency range to prevent oscillation at a high frequency such as 35 kc., where the low leakage reactance tends to resonate.

With an RCA 6Q7 valve for the first-stage amplifier, an RCA 6J7 pentode as the valve 40, and the valves 20 and 21 provided by a single RCA 6N7 "Class B" twin output valve, highly stable amplifier operation has been obtained in a low-power battery amplifier with a resistor of substantially .5 megohms at 45 and 47, a coupling capacitor of .5 mmf. at 46, and a grid leak of one megohm at 15. The self-bias resistor 48 without by-pass is approximately 600 ohms.

The resistor 14 in the cathode circuit of the first-stage amplifier 5 is preferably of a low value, and is of the order of 680 ohms to prevent degeneration in the first stage. For this reason, bleeder current is provided from a suitable source controlled by a series resistor indicated at 63. The by-pass condenser 60 is of a value sufficiently small to prevent introducing any frequency characteristic into the feedback circuit.

It has been found that, with a resistance of 1,500 ohms at 37 a feedback of the order of 32 db is provided, and that the resistance may be increased to 3,200 ohms with a feedback of substantially 36 db with stable operation, for the reason that the pentode driver stage is included in the feedback loop between the amplifier input circuit and the output stage. Previously an inverse feedback of the order of 15 db has been considered normal.

### Characteristic Curves

For a given wattage output, the three-stage amplifier shown has an over-all characteristic as indicated by the curve 65 in Fig. 2, whereas, with an equivalent rating triode driver in place of the pentode 40, the distortion is indicated by the curve 66. The distortion of a standard "Class B" amplifier with triode driver and no feedback is indicated by the curve 67.

It has been found that the undistorted power output of an amplifier, as shown in Fig. 1, may be of the order of 40 per cent. higher than that obtained with a conventional "Class B" feedback amplifier, provided with a triode driver stage, and first-stage amplifier.

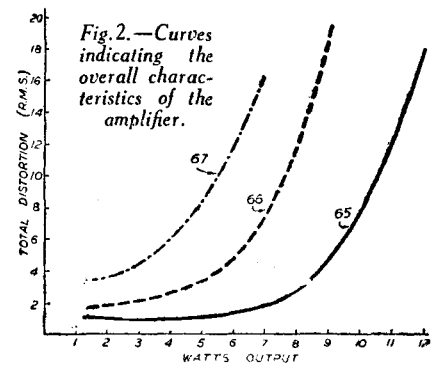

Fig. 2.—Curves indicating the overall characteristics of the amplifier.



# Practical Wireless BLUEPRINT SERVICE

PRACTICAL WIRELESS		No of
Date of Issu		Blueprints
<b>CRYSTAL SETS</b>		
Blueprints, 6d. each.		
1937 Crystal Receiver ..	—	PW71
The "Junior" Crystal Set ..	27.8.38	PW94
<b>STRAIGHT SETS. Battery Operated.</b>		
One-valve : Blueprints, 1s. each.		
All-Wave Unipen (Pentode) ..	—	PW31A
Beginners' One-valver ..	19.2.38	PW85
The "Pyramid" One-valver (HF Pen) ..	27.3.38	PW93
Two-valve : Blueprint, 1s.		
The Signet Two (D & LF) ..	24.9.38	PW76
Three-valve : Blueprints, 1s. each.		
Selectone Battery Three (D, 2 LF (Trans)) ..	—	PW10
Sixty Shilling Three (D, 2 LF (RC & Trans)) ..	—	PW34A
Leader Three (SG, D, Pow) ..	—	PW35
Summit Three (HF Pen, D, Pen) ..	—	PW37
All Pentode Three (HF Pen, D (Pen), Pen) ..	29.5.37	PW39
Hall-Mark Three (SG, D, Pow) ..	—	PW41
Hall-Mark Cadet (D, LF, Pen (RC)) ..	16.3.35	PW48
F. J. Camm's Silver Souvenir (HF Pen, D (Pen), Pen) (All-Wave Three) ..	13.4.35	PW49
Cameo Midget Three (D, 2 LF (Trans)) ..	—	PW51
1938 Sonotone Three-Four (HF Pen, HF Pen, Westector, Pen) ..	—	PW53
Battery All-Wave Three (D, 2 LF (RC)) ..	—	PW55
The Monitor (HF Pen, D, Pen) ..	—	PW61
The Tutor Three (HF Pen, D, Pen) ..	—	PW62
The Centaur Three (SG, D, P) ..	—	PW64
F. J. Camm's Record All-Wave Three (HF Pen, D, Pen) ..	31.10.36	PW69
The "Colt" All-Wave Three (D, 2 LF (RC & Trans)) ..	18.2.39	PW72
The "Bapide" Straight 3 (D, 2 LF (RC & Trans)) ..	4.12.37	PW82
F. J. Camm's Oracle All-Wave Three (HF, Det., Pen) ..	28.8.37	PW78
1938 "Triband" All-Wave Three (HF Pen, D, Pen) ..	22.1.33	PW84
F. J. Camm's "Sprite" Three (HF Pen, D, Tet) ..	26.3.38	PW87
The "Hurricane" All-Wave Three (SG, D (Pen), Pen) ..	30.4.38	PW89
F. J. Camm's "Push-Button" Three (HF Pen, D (Pen), Tet) ..	3.9.38	PW92
Four-valve : Blueprints, 1s. each.		
Sonotone Four (SG, D, LF, P) ..	1.5.37	PW4
Fury Four (2 SG, D, Pen) ..	—	PW11
Beta Universal Four (SG, D, LF, Cl, B) ..	—	PW17
Nucleon Class B Four (SG, D (SG), LF, Cl, B) ..	—	PW34B
Fury Four Super (SG, SG, D, Pen) ..	—	PW34C
Battery Hall-Mark 4 (HF Pen, D, Push-Pull) ..	—	PW43
F. J. Camm's "Limit" All-Wave Four (HF Pen, D, LF, P) ..	26.9.36	PW67
"Acme" All-Wave 4 (HF Pen, D (Pen), LF, Cl, B) ..	12.2.33	PW33
The "Admiral" Four (HF Pen, HF Pen, D, Pen (RC)) ..	3.9.33	PW90
<b>Mains Operated.</b>		
Two-valve : Blueprints, 1s. each.		
A.C. Twin (D (Pen), Pen) ..	—	PW18
A.C.-D.C. Two (SG, Pow) ..	—	PW31
Selectone A.C. Radiogram Two (D, Pow) ..	—	PW19
Three-valve : Blueprints, 1s. each.		
Double-Diode-Triode Three (HF Pen, DDI, Pen) ..	—	PW23
D.C. Ace (SG, D, Pen) ..	—	PW25
A.C. Three (SG, D, Pen) ..	—	PW29
A.C. Leader (HF Pen, D, Pow) ..	7.1.39	PW35C
D.C. Premier (HF Pen, D, Pen) ..	—	PW35B
Ubique (HF Pen, D (Pen), Pen) ..	—	PW36A
Armada Mains Three (HF Pen, D, Pen) ..	—	PW38
F. J. Camm's A.C. All-Wave Silver Souvenir Three (HF Pen, D, Pen) ..	—	PW50
"All-Wave" A.C. Three (D, 2 LF (RC)) ..	—	PW54
A.C. 1938 Sonotone (HF Pen, HF Pen, Westector, Pen) ..	—	PW56
Mains Record All-Wave 3 (HF Pen, D, Pen) ..	—	PW70
Four-valve : Blueprints, 1s. each.		
A.C. Fury Four (SG, SG, D, Pen) ..	—	PW20
A.C. Fury Four Super (SG, SG, D, Pen) ..	—	PW34D
A.C. Hall-Mark (HF Pen, D, Push-Pull) ..	—	PW45
Universal Hall-Mark (HF Pen, D, Push-Pull) ..	—	PW47

SUPERHETS		
Battery Sets : Blueprints, 1s. each.		
£5 Superhet (Three-valve) ..	5.6.37	PW40
F. J. Camm's 2-valve Superhet ..	—	PW52
Mains Sets : Blueprints, 1s. each.		
A.C. £5 Superhet (Three-valve) ..	—	PW43
D.C. £5 Superhet (Three-valve) ..	—	PW42
Universal £5 Superhet (Three-valve) ..	—	PW44
F. J. Camm's A.C. Superhet 4 ..	—	PW53
F. J. Camm's Universal £4 Superhet 4 ..	—	PW60
"Qualitone" Universal Four ..	—	PW73
Four-valve : Double-sided Blueprint, 1s. 6d.		
Push Button 4, Battery Model ..	22.10.38	PW95
Push Button 4, A.C. Mains Model ..	—	—
<b>SHORT-WAVE SETS. Battery Operated.</b>		
One-valve : Blueprint, 1s.		
Simple S.W. One-valver ..	23.12.39	PW88
Two-valve : Blueprints, 1s. each.		
Midget Short-wave Two (D, Pen) ..	—	PW38A
The "Fleet" Short-wave Two (D (HF Pen), Pen) ..	27.8.38	PW91
Three-valve : Blueprints, 1s. each.		
Experimenter's Short-wave Three (SG, D, Pow) ..	—	PW30A
The Prefect 3 (D, 2 LF (RC and Trans)) ..	—	PW63
The Band-Spread S.W. Three (HF Pen, D (Pen), Pen) ..	—	PW68
<b>PORTABLES.</b>		
Three-valve : Blueprints, 1s. each.		
F. J. Camm's ELF Three-valve Portable (HF Pen, D, Pen) ..	—	PW65
Parvo Flyweight Midget Portable (SG, D, Pen) ..	3.6.39	PW77
Four-valve : Blueprint, 1s.		
"Imp" Portable 4 (D, LF, LF (Pen)) ..	—	PW86
<b>MISCELLANEOUS</b>		
Blueprint, 1s.		
S.W. Converter-Adapter (1 valve) ..	—	PW48A
<b>AMATEUR WIRELESS AND WIRELESS MAGAZINE</b>		
<b>CRYSTAL SETS</b>		
Blueprints, 6d. each.		
Four-station Crystal Set ..	23.7.38	AW427
1934 Crystal Set ..	—	AW444
150-mile Crystal Set ..	—	AW450
<b>STRAIGHT SETS. Battery Operated.</b>		
One-valve : Blueprint, 1s.		
B.E.C. Special One-valver ..	—	AW387
Two-valve : Blueprints, 1s. each.		
Melody Ranger Two (D, Trans) ..	—	AW388
Full-volume Two (SG det. Pen) ..	—	AW392
Lucerne Minor (D, Pen) ..	—	AW426
A Modern Two-valver ..	—	WM409
Three-valve : Blueprints, 1s. each.		
£5 5s. S.G. 3 (SG, D, Trans) ..	—	AW412
Lucerne Ranger (SG, D, Trans) ..	—	AW422
£5 5s. Three : De Luxe Version (SG, D, Trans) ..	10.5.34	AW435
Lucerne Straight Three (D, RC, Trans) ..	—	AW437
Transportable Three (SG, D, Pen) ..	—	WM271
Simple-Tune Three (SG, D, Pen) ..	June '33	WM327
Economy-Pentode Three (SG, D, Pen) ..	Oct. '33	WM337
"W.M." 1934 Standard Three (SG, D, Pen) ..	—	WM351
£3 5s. Three (SG, D, Trans) ..	Mar. '34	WM354
1935 £6 6s. Battery Three (SG, D, Pen) ..	—	WM371
PTP Three (Pen, D, Pen) ..	—	WM389
Certainty Three (SG, D, Pen) ..	—	WM393
Minutube Three (SG, D, Trans) ..	Oct. '35	WM396
All-Wave Wining Three (SG, D, Pen) ..	—	WM400

These blueprints are drawn full size. Copies of appropriate issues containing descriptions of these sets can in some cases be supplied at the following prices which are additional to the cost of the Blueprint. A dash before the Blueprint Number indicates that the issue is out of print. Practical Wireless (issues dated prior to June 1st, 1940). 4d. Post Paid (Issues dated June 1st to July 27th, 1940, 5d. Post Paid (Issues dated September, 1940 and after) 7d. Post Paid

Amateur Wireless Wireless Magazine .. 4d. " " The index letters which precede the Blueprint Number indicate the periodical in which the description appears. Thus P.W. refers to PRACTICAL WIRELESS, A.W. to Amateur Wireless, W.M. to Wireless Magazine.

Send (preferably) a postal order to cover the cost of the blueprint, and the issue (stamps over 6d. unacceptable) to PRACTICAL WIRELESS Blueprint Dept., George Newnes, Ltd., Tower House, Southampton Street, Strand, W.C.2.

# BULGIN



## reliable FUSES and HOLDERS NATIONAL EFFORT

IN these times, in many directions, needless to say, we are directing our main efforts and supplies towards the requirements of the Government Services. However, some supplies of components are still available for Radio Servicing, but should delays occur we know our friends will appreciate the difficulties which at present arise from day to day.

We would point out that delays can be minimised and often avoided if alternatives are, wherever possible, specified when ordering.

Prices are being kept as low as possible despite increased costs in every direction. Meanwhile you still have the best and largest range of radio products in the United Kingdom to choose from.

## THANK YOU! A Selection of FUSEHOLDERS

- Baseboard Fuseholder— (Single) List No. F.27 6s.
- Baseboard Fuseholder— (Double) List No. F.26 9d.
- Accumulator or Flex-Wire Fuseholders List No. F.10 1/3
- Baseboard Fuseholder— (Triple) List No. F.50 1/3
- Baseboard Single Fuseholder List No. F.12 1/3
- Panel Mounting Single Fuseholder List No. F.24 2/3
- Baseboard Twin Fuseholder List No. F.11 2/3
- Safety Twin Model with cover List No. F.14 2/6
- Safety Twin Main Fuseholder List No. F.19 3/-

ALL PRICES SUBJECT  
+ 16 2/3% War Increase

## FOR ALL RADIO COMPONENTS

Advert. of A. F. BULGIN & CO., LTD.  
BY-PASS ROAD, BARKING.  
Tele. R1Ppleway 3474 (4 lines).

The "Fluxite Quins" at Work.

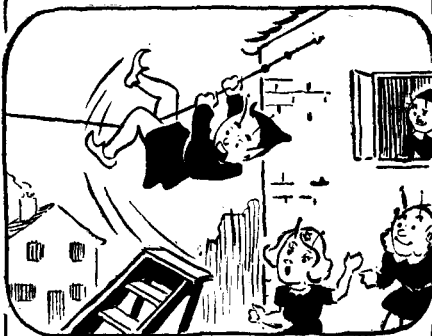

When young Ol' a fault tried to trace  
He found himself hanging in space.

"Thanks to FLUXITE  
This aerial's fixed tight  
And it's that now that's saving my face!"

See that FLUXITE is always by you—in the house—garage—workshop—wherever speedy soldering is needed. Used for 30 years in government works and by leading engineers and manufacturers. Of Ironmongers—in tins, 4d., 8d., 1/4 and 2/8.

Ask to see the FLUXITE SMALL-SPACE SOLDERING SET—compact but substantial—complete with full instructions, 7/6.

TO CYCLISTS! Your wheels will NOT keep round and true, unless the spokes are tied with fine wire at the crossings AND SOLDERED. This makes a much stronger wheel. It's simple—with FLUXITE—but IMPORTANT

The FLUXITE GUN is always ready to put Fluxite on the soldering job instantly. A little pressure places the right quantity on the right spot and one charging lasts for ages. Price 1/6, or filled 2/6.

Write for Free Book on the art of "soft" soldering and ask for leaflet on CASE-HARDENING STEEL, and TEMPERING TOOLS with FLUXITE.

FLUXITE LTD. (Dept. W.P.),  
BERMONDSEY ST., S.E.1.

**FLUXITE**  
SIMPLIFIES ALL SOLDERING

# A Service Engineer's Log

A Further Selection of Notes Which Will be Found of Practical Aid by Both Service Men and Constructor-experimenters

A RECEIVER, that I was called out to see recently, was a high-class superhet with triode-hexode frequency-changer and one stage of pre-F.C. high-frequency amplification. Normally, it had an extremely good range and plenty of output, but a fault had developed suddenly which resulted in an almost complete cessation of signals except from the Home Service; these were so weak as to be barely audible.

Since the set was well screened, I first tried the effect of removing the aerial lead and connecting a length of flex in its place. That was to make sure that there was not a break in the aerial lead close to the aerial terminal. But it did not make any difference, so it was evident that the fault was within the set. When a pick-up was connected, reproduction of records was quite satisfactory, which showed that the fault was prior to the L.F. stages. A rough check was made of the voltages to the preceding valves, which were in order. The next step was to connect the aerial lead, through a small fixed condenser, to the control grid of the first detector; the receiver then behaved well, so it was evident that the fault lay in the H.F. stage.

## Broken Choke Connection

The H.F. valve was temporarily replaced as a check, but that did not make any difference. It was then realised that in making a test of H.T. voltages the meter had been connected to the H.T. side of the H.F. choke in the anode circuit of the first valve, so another test was made by connecting the meter between earth and the anode terminal. Since the meter needle remained at zero it was clear that there was no circuit through the choke. Close inspection of this component revealed a broken connection between one end of the winding and the pigtail; when this was re-made the set operated normally again.

The tests described could, of course, have been made in various other ways, and it might be argued that H.T. current measurements should have been made at the commencement of the tests, but this is always rather difficult since it means breaking the anode circuits.

## Simplified Circuit Testing

Incidentally, it is worthy of mention here that in building a multi-valve receiver of fairly pretentious type—such as a high-class communications receiver—it is an excellent plan to include small jacks in the anode circuit of each valve. The jacks should be of the closed-circuit type, so that their contacts are closed when no plug is inserted; the meter plug opens the contacts and connects the meter between the two terminals of the jack, as shown in Fig. 1. It will be obvious that the jacks should be on the H.T. side of the anode-coupling components, and that the meter should be shunted by a non-inductive fixed condenser of about 1 mfd. capacity.

## Meter Shunts

This arrangement is followed in the case of many commercial-station receivers and

is elaborated slightly, the elaboration consisting of wiring suitable shunt resistors across the various jacks so that a single meter can be used for reading the anode current of each valve and also the total current consumed by the set. Thus, if a 1 mA. meter is used, readings up to 2 mA. can be taken by shunting the jack by a resistor equal in value to the resistance of the meter; 5 mA. can be read by using a shunt resistor equal to one-quarter the resistance of the meter, and so on. It may be helpful to mark the jacks with figures to indicate the "multiplication factor." One slight difficulty which cannot easily be avoided is that the ordi-

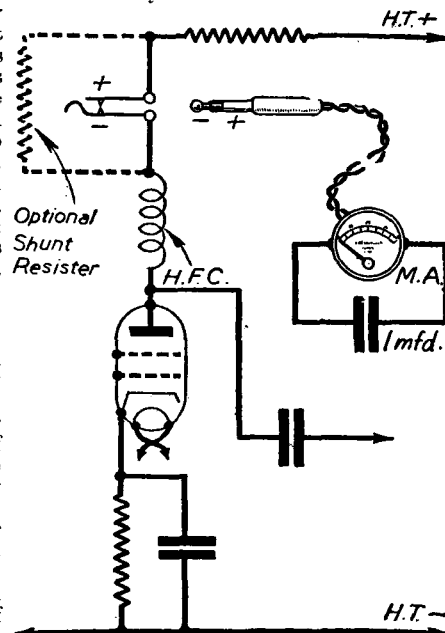

Fig. 1.—Connections to a plug and jack used for quick measurement of anode current. Care should be taken to see that the polarity of the jack and plug is correct for the meter and that the jack is well insulated from the metal panel, if such is used.

nary resistors on the market are not accurate to within about 10 per cent., and therefore, readings are not precise. This is seldom important, since the main requirement is that any change in readings should be easily seen.

Just one point to remember: see that the plugs and jacks are wired correctly in relation to the polarity of the meter and of the jack terminals. This is indicated in Fig. 1.

## A Misleading Fault

What at first appeared to be a very simple matter caused a certain amount of confusion when testing a three-valve "straight" set. The owner complained of crackling noises, and when a meter was included in the anode circuit of the detector the needle flickered. It was fairly obvious that the L.F.-transformer primary winding was at fault, and the decoupling resistance was checked to verify this.

Rather as an afterthought it was decided

to test the transformer and to make sure that the fault was not in the leads from the windings to the terminals. This was done by connecting a milliammeter, series resistor and G.B. battery between the primary terminals. But the test indicated that the transformer was sound. It was then found that the lead from the H.F. choke was attached to the transformer through a "dry" soldered joint, the joint having a resistance in the region of 100 ohms at the time of the test. Consequently, it was necessary only to pull the wire away, clean the wire and the soldering tag and re-solder to stop the cracklings.

**Erratic Working of Amplifier**

A five-watt A.C. amplifier was in for test, the trouble being that it sometimes failed to work at all and sometimes worked normally for a short time and then began to produce all sorts of weird noises. When we first put it on test it refused to function, so we quickly proceeded to make various voltage and current tests with a universal meter. By the time we had measured the rectified output from the H.T. section, however, the amplifier started to work, although there was a certain amount of "clicking" in the speaker. When this happened it was noticed that the rectified H.T. voltage rose suddenly.

That was a fairly clear sign that the valves were not passing their full share of anode current when the "clicking" occurred, and therefore that there was

a particular commercial American-made receiver of very compact type which was frequently giving trouble due to resistors going o/c. There was no circuit diagram available, and it was always difficult to find the resistors associated with the particular circuit which was found to be open. After spending a good deal of time, on two separate occasions, in tracing resistors, we simplified any future work on the set by drawing a rough skeleton circuit including most of the resistors. We then numbered both the circuit and the components R.1, R.2, etc. It is now a very simple matter to trace through the set in case of trouble, although now that we have replaced several of the 1/2-watt resistors by good ones rated at one-watt, it is unlikely that there will be much further trouble in this direction.

The hint may be useful to constructors who build elaborate receivers in a compact form, although in their case resistors with an ample "margin" will generally have been specified.

**Potentiometer Tests and Repairs**

Volume-control potentiometers are apt to be troublesome after they have been in use for some time. The reason is, generally, that the fine wire winding becomes worn through at one point due to constant rubbing of the contact arm. This fault appeared to have arisen in a set which we had on test recently, since output was "jumpy" as the volume-control knob was turned from minimum to maximum;

Fig. 2.—A simple method of testing a volume control potentiometer and (inset) a method of effecting a makeshift repair.

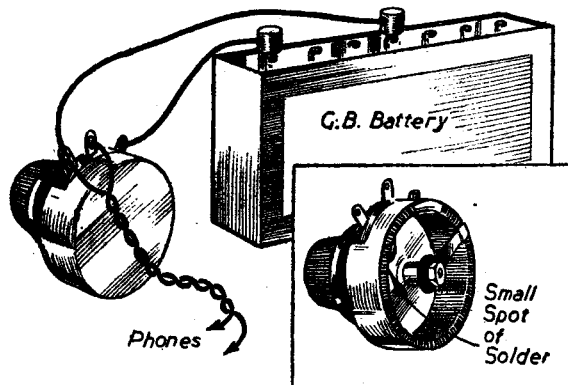

probably a bad connection in the H.T. line. The wiring seemed to be sound enough, and the thermal-delay switch came under suspicion; incidentally, this had, no doubt, been included because a directly-heated rectifier was used in conjunction with two indirectly-heated pentodes in push-pull. As a test of this switch, we wired a Q.M.B. switch in parallel with the input and output H.T. terminals and turned this on after waiting about 30 seconds for the heaters to reach working temperature. With this switch in circuit the amplifier behaved correctly, so there was no doubt that the T.D. switch was defective. Since a new one was not readily available, we made an examination of the old switch and found that the bi-metal arm was strained, so that there was insufficient pressure on the contacts. By carefully bending the arm and cleaning the contacts, the switch was made serviceable again. Before putting it into use, however, a few tests had to be made of the adjusting screw to ensure that the contacts did not close for between 30 and 40 seconds after the mains had been switched on.

**To Simplify Component Tracing**

The following is rather outside the normal scope of these notes, but the hint may be of interest to other service men. We had

there was also a certain amount of "crackling" as the control was operated.

It was first necessary to remove the component from the receiver, and after that a simple test was carried out as shown in Fig. 2. A voltage, from a G.B. battery, was applied between the two outside terminals of the potentiometer, and a pair of phones was connected between one outside terminal and the centre terminal. Pronounced crackling as the knob was turned showed that the element of the wire-wound potentiometer was defective. In this case it was possible to open the case of the potentiometer, so the test was repeated with the wire winding exposed. It was then an easy matter to find where the break occurred. There was only a single break, but this affected the control at various positions of the knob due to slight movement of the whole winding.

As a new control was not on hand, the wire was cleaned round the break, lightly smeared with flux and a small spot of solder dropped on to it. With a small, hot soldering iron the solder was quickly (speed is important) "spread" so that it did not project above the level of the wire. When soldering is impossible it is sometimes possible to wedge a slip of tinfoil between the winding and the case if this is not made of metal.



**FOR THE RADIO SERVICE MAN, DEALER AND OWNER**

The man who enrolls for an I. C. S. Radio Course learns radio thoroughly, completely, practically. When he earns his diploma, he will KNOW radio. We are not content merely to teach the principles of radio, we want to show our students how to apply that training in practical, every-day, radio service work. We train them to be successful!

**INTERNATIONAL CORRESPONDENCE SCHOOLS**

Dept. 94A, International Buildings, Kingsway, London, W.C.2. Please explain fully about your instruction in the subject marked X.

Complete Radio Engineering  
Radio Service Engineers  
Elementary Radio  
Television

If you wish to pass a Radio examination, indicate it below.

Inst. of Wireless Technology  
P.M.G. Certificate for Wireless Operators  
Provisional Certificate in Radio Telegraphy and  
Telegraphy for Aircraft  
City and Guilds Telecommunications

Name.....Age.....

Address .....

(Use penny stamp on unsealed envelope.)

**RECORD BREAKING WITH A TROPHY**

"70 different countries and 1,200 stations on loudspeaker" is one Trophy user's record.

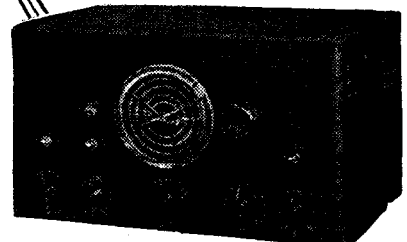

This 8-valve A.C. receiver with all essential tuning refinements for efficient short-wave operation still remains unbeatable in performance and price. Wavelength 7 to 550 metres, continuous bandspread tuning. R.F. on all 5 bands. For use with separate P.M. type speaker. Phone sockets. Accurately aligned and ready for use. Price, £14. 19. 6d. Matched Cabinet Speaker available, 46/3 extra. Terms: £3 down and 44/- monthly.

**TROPHY 6** .. .. . £11. 11. 0.  
Including built-in speaker.

Terms: 45/- down and 34/6 monthly.

SEND FOR FULL LISTS.

**PETO SCOTT CO. LTD., 77 (P) CITY ROAD, LONDON, E.C.**

'Phone Clerkenwell 5911.

This book is meant  
for

**YOU**

## Introducing Radio Receiver Servicing

By E. M. SQUIRE

Only recently published, this book is already being talked of as the best book on receiver servicing. It is handy and concise, and gives readers a sound knowledge of receiver operation and equipment without unnecessary theoretical frills. A downright practical book for practical men like yourself. Get your copy to-day. 6/- net. 6/4 post free. Order from a bookseller or direct from the publishers.

### THE SUPERHETERODYNE RECEIVER

By Alfred T. Witts, A.M.I.E.E. "Gives all the information necessary for a complete understanding of the Superheterodyne Receiver."—*Practical Wireless*. Fourth edition. 4/6 net.

### RADIO UPKEEP AND REPAIRS

By Alfred T. Witts. In its Fourth Edition, which speaks volumes. Recognised as one of the leading introductory books. Well illustrated. 6/- net.

### WIRELESS TELEGRAPHY

Compiled by W. E. Crook, A.M.I.E.E. R.A.F. men in particular are finding this book a god-send. Its soundness and concentration upon practical matters account largely for its undoubted success. Second edition. 7/6 net.

### FIRST COURSE IN WIRELESS

By "Decibel." Explains the fundamental principles of wireless and gives a step by step description of the theory and working of wireless receivers. 5/- net.

PITMAN, Parker St., KINGSWAY, W.C.2

## PUBLIC APPOINTMENTS

### WIRELESS TECHNICAL INSTRUCTORS REQUIRED IN ARMY UNITS

**Emoluments.**—Pay, 8s. 9d. per day (7 days a week). Clothing, rations and accommodation, or if this cannot be provided, allowances at authorised rates. If married and otherwise eligible family allowance payable in respect of wife and children, subject to allotment from pay.

Candidates should preferably be under 35 and over 24 and—

- (a) Hold one of the following qualifications:
- Graduateship of the Institution of Electrical Engineers.
  - Final (Grade III) Certificate of City and Guilds of London Institute Examination in Radio Communication.
  - Higher National Certificate in Electrical Engineering.
  - Certificate of City and Guilds of London Institute in Radio Service Work.

OR

- (b) Be able to pass an examination on the following syllabus:

Simple algebra, including quadratic equations; simple trigonometrical ratios and identities; vectors.

Properties of electrical currents; heating of conductors; magnetic fields; unit of current; Ohm's Law; resistance in series and parallel; potentiometers.

Magnetic effect of current; fields due to parallel wires; field due to a solenoid; electro-magnets. Meters.

Induction; effect of rotating a coil in a magnetic field.

Mutual and self induction and inductance; effect of inductance on growth and delay of current.

Capacity; charging storage and discharge of condensers; through resistance and inductance.

Alternating currents: vector diagrams; effect of resistance variation; effects of L and C in A.C. circuit; phase difference of currents; resonance in a series circuit; parallel circuit of L and C; Q factor.

Elementary knowledge of valves; simple theory of amplifiers; oscillators and detectors; general principles of radio practice.

**Suitable candidates** will be interviewed at local centres, and, if successful, will be enlisted and appointed Acting Sergeant Tradesman. For those who are on the Schedule of Reserved Occupations, special arrangements will be made to enable them to be enlisted. In the event of any applicant found to be reserved under Schedule of Reserved Occupations special application will be made for relaxation of the Schedule. No guarantee can be given that this application will be successful.

**Application Forms**, obtainable by post card from the Under Secretary of State, The War Office (A.G.Gc), "Poles," London, S.W.1, to be lodged by Friday, February 14th, 1941.

# The Bombing of Broadcasting House

IT was recently revealed that Broadcasting House has been twice hit and seriously damaged during air raids. A number of the B.B.C. staff were killed and others wounded, most of the casualties being among members of the monitoring staff. During both raids separate programmes were being simultaneously transmitted to the home country, to Europe, and to the world. On both nights all programmes

went on without a break. Both the Home Service and the Forces programmes have since been regularly maintained. The accompanying illustrations give a good idea of the extent of the damage done during the second raid. We think that great tribute is due to the B.B.C. and its staff for maintaining its service under "front-line" conditions.

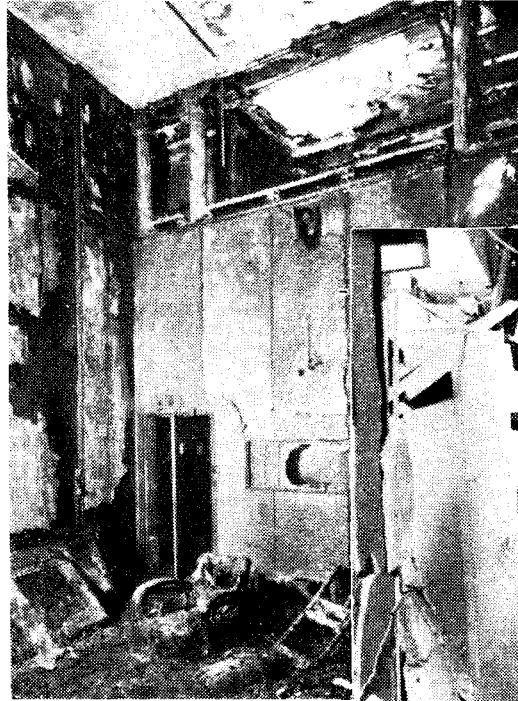

(Left) This illustration gives a good idea of the extent of the damage to one of the studios.

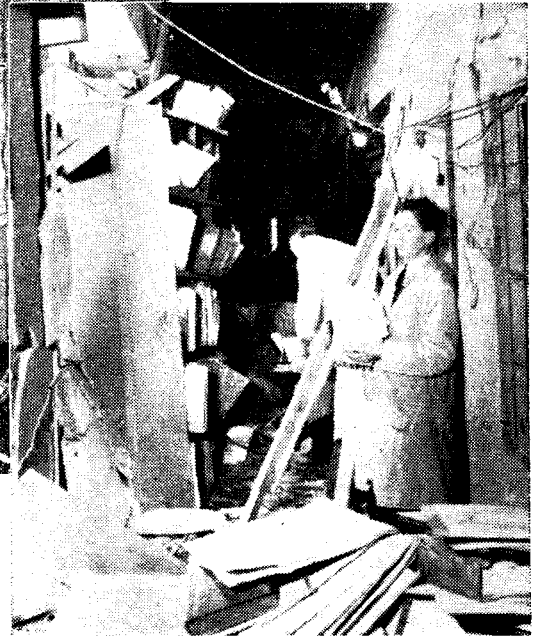

(Right) Salvaging some of the books from one of the bombed offices.

## Wireless Operator Saves a Bomber

THE crew of a heavy bomber must be a carefully-chosen team if the best results are to be obtained and the aircraft brought comfortably back to base. Some of the men may seem to have more spectacular jobs than others. The bombardier times his release to do the utmost damage to the enemy; the pilots take turns at the controls; and the tail gunner in his little glass house keeps a watchful eye open for attacking aircraft.

Perched at his instruments amidships, in the dark interior of the bomber, sits the wireless operator, who would seem to have only routine stuff to do; but sometimes it all depends on him. The other night, our aircraft went out in foul weather to raid important German targets. Many of the bombers ran into icing conditions and fierce storms. Against the enormous odds of this weather one bomber had to abandon the attack on the primary target. The aircraft had iced up, and consequently the engine was not behaving well. The whole flight had been made through stormy weather, visibility amounted to next to

nothing, and the air was heavily charged with electricity. The tail gunner reported sparks all round the tail, and later, when the starboard engine was overheating badly, flames joined the sparks. Then the port engine began to misbehave.

Electrical disturbance was all around, and the wireless operator had to keep his aerial earthed most of the time to avoid the last nuisance of all, a blown-out set. There were only a few lulls in the electric storm, and every minute was precious. An extra hour in the air in those conditions might mean disaster. A minor deviation would take the aircraft beyond its capacity to struggle home. Navigation, without the wireless operator, was a matter of lead reckoning, because there was no visibility.

In a pause, while the storm and disturbance lulled, the wireless operator managed to get into communication with a home station. Catching another lull, the position was checked and rechecked. The entire crew was suffering from the bitter cold, the engine gave every sign of giving out. The wireless operator put up a grand show. Crew and aircraft depended on him. Snatching the odd moments, and never faltering, he sat at his instrument, picking up direction, checking it up, and finally bringing the aircraft home to a safe landing.

# Replies to Queries

## Methods of Detection

"I am building a receiver to give me good-quality reproduction, and I cannot make up my mind whether to use a leaky-grid or an anode-bend detector. I understand that the former method is likely to introduce distortion. Is this so in actual practice; if it is, do you think that the distortion would be noticeable by an average listener? I rather wanted to be able to receive one or two of the more distant stations, if possible."—F. H. (Shrewsbury).

If you wish our answer to be in the practical sense, we would suggest that you use the leaky-grid method, as it is more sensitive and, in a well-designed circuit, the amount of distortion it is likely to introduce would not be apparent to the average listener. Make some provision in the pre-detector circuits, to control the signal strength reaching the grid of the detector, thus eliminating the possibility of the valve being overloaded.

## R.C. versus Transformer

"Having noted that you have been good enough to act as arbitrator on past occasions, when readers have held different views about matters connected with radio, I wonder if you will settle a little debate I have been having with two other constructors. I would mention that we are all readers of PRACTICAL WIRELESS. The point in question is, can an L.F. transformer give as good response, when used as an inter-valve coupling, as the resistance-capacity method?"—T. D. (Eltham).

As you ask a very definite question, we must answer it with a yes or no; therefore, we say Yes. We would, however, like to protect ourselves from R.C. enthusiasts by adding the following. The transformer must be of good design and make. The circuit, valves and operating conditions must conform with the makers' specification, and for preference, its ratio should not be high. R.C. coupling is now widely used because of the high gain obtainable from modern valves, but unless reasonable care is taken with the selection of component values, distortion can be introduced and, what is even more detrimental, if the coupling delivers a signal swing to the next valve sufficient to drive it over its correct operating point, grid-current is likely to be more pronounced—together with its bad effects—than with a good transformer.

## Mains Dropping Resistance

"I have come up against a snag—being a comparative newcomer to radio—when trying to build an A.C./D.C. type of receiver. It is, in connection with the voltage and current ratings of the valves, and the value of the resistance required to reduce the mains voltage. Is the total heater current the same as that required by one valve, i.e., in my case .2 amp., and must all the valves have the same heater current rating?"—P. D. (Chester).

ALL valves must have the same heater current rating, and this also applies to any dial lights which are connected in series with the heaters. If each valve requires, say, .2 amp. for its heater, then that value will represent the total current flowing in the circuit. (It should be remembered that the heaters are wired in series and not parallel as with ordinary A.C. valves.) The total voltage required can be

determined by adding the heater voltage rating of each valve, plus dial lights if they are incorporated. Supposing the total is 80 volts, and the mains supply voltage is 200 volts, then to find the value of the resistance required apply the following. From the mains voltage deduct the value required for the valves, i.e., 200 minus 80, which equals 120 volts. This represents the voltage which has to be dropped across the mains resistance, the value of which can now be found from  $R$  equals  $\frac{E}{I}$  when  $R$  is the resistance,  $E$  the voltage to be dropped and  $I$  the current flowing. Therefore,  $R$  equals  $\frac{120}{0.2}$  which equals 600 ohms.

## L.S. Extension Losses

"I have just finished wiring an additional point for an extension speaker, and I am very dissatisfied with the results. The reproduction seems to be on the weak side, and

### RULES

We wish to draw the reader's attention to the fact that the Queries Service is intended only for the solution of problems or difficulties arising from the construction of receivers described in our pages, from articles appearing in our pages, or on general wireless matters. We regret that we cannot, for obvious reasons—

- (1) Supply circuit diagrams of complete multi-valve receivers.
- (2) Suggest alterations or modifications of receivers described in our contemporaries.
- (3) Suggest alterations or modifications to commercial receivers.
- (4) Answer queries over the telephone.
- (5) Grant interviews to querists.

A stamped, addressed envelope must be enclosed for the reply. All sketches and drawings which are sent to us should bear the name and address of the sender.

Requests for Blueprints must not be enclosed with queries as they are dealt with by a separate department.

Send your queries to the Editor, PRACTICAL WIRELESS, George Newnes, Ltd., Tower House Southampton Street, Strand, London, W.C.2. The Coupon must be enclosed with every query.

the reproduction is not so good as that from the speaker in the set. Owing to the location of the new point, I had to use nearly 20 yards of wire and I am wondering if this, together with the fact that I used thin twin bell-wire, is responsible."—B. H. (Newbury).

YOU do not give us any idea of the impedance of the speaker you are using for the extension, but from the details of your trouble we imagine that it is of the low impedance type, possibly in the region of five to 10 ohms. If this is the case, then the extension leads you are using would be responsible for the trouble, as their resistance, compared with that of the speech-coil of the speaker, would be unsatisfactorily high and would cause an unreasonable percentage of the power to be lost or absorbed in the transmission lines. We would suggest that you try and reduce the length and use larger gauge wire. Twin lighting flex would be better or, if you wish to make a first-class job, the heavier flex, known as "workshop" or power flex, would prove most satisfactory.

## Voltage and Power Amplifiers

"I sometimes see the terms 'voltage amplifier' and 'power amplifier' and, so far, I have not yet been able to find a clear explanation of what they mean. When

diagrams have been given, they appear to me to be fundamentally the same; another thing which has helped to confuse me is the fact that the terms do not, apparently, only apply to L.F. stages. Could you help me to get a better understanding?"—L. K. (Birmingham).

It will help you if you think of an ordinary amplifier circuit as consisting of two parts or sections. The first, which includes the valves preceding the output stage, being solely concerned with amplifying the signal voltage applied to the input. These valves act as voltage amplifiers, i.e., they are not concerned with providing power in its true sense. Their characteristics, if the right valves are selected, enable them to give high amplification (voltage) at comparatively low anode currents. The output valve(s), however, has totally different characteristics. It is able to handle a large voltage input on its grid, with a correspondingly much larger anode current swing, depending on its amplification factor, therefore, it can deliver a large power output and consequently it is rated as a power amplifier. The term holds good for H.F. amplification, as, say, in the case of a transmitter, and for L.F. work involving the normal amplifier circuits. It is possible for a power amplifier stage to be used before the actual output, as, for example, those arrangements where the output valve(s) demands an appreciable power to produce full loading.

## REPLIES IN BRIEF

The following replies to queries are given in abbreviated form either because of non-compliance with our rules, or because the point raised is not of general interest.

**D. L. (Canterbury).** The L.T. section is built-in the H.T. battery, and as it is usual to employ automatic grid-bias, the receivers become in effect a single battery outfit.

**G. B. (Plymouth).** It is no longer possible to get copies of the blueprint in question. The diagrams given in the issue are quite clear and you should be able to wire the circuit from them as there are no complicated switches or components to cause confusion.

**J. L. (Birmingham).** The detector anode by-pass condenser has a capacity too high for the type of circuit you are using. No, we cannot help you with the coils as we are now without any details concerning them.

**K. T. (Newmarket).** The circuit is satisfactory, but we do not like the layout. We would advise the mains transformer being mounted on the side remote from the coils, thus locating it close to the rectifying valve and smoothing gear. Electrolytic condensers should be used.

**J. B. H. (Winchester).** We can only suggest that you get in touch with the makers. A simple scratch-filter for the pick-up can be made by connecting a 25,000 ohm variable resistance in series with a .002 mfd. condenser, across the P.U. leads.

**G. C. P. (Boxhill-on-Sea).** We have not published a design of a one-valve S.W. A.C. operated receiver; therefore, we can only suggest you modify one of the battery designs which have appeared in past issues. A very efficient design is given in our October issue.

**J. K. (Bromley).** The valve base mentioned is evidently of the octal type. Valveholders can be obtained from most of our component advertisers.

## TAX-FREE RADIO GOODS IN STOCK! Supplies Dwindling Fast

New supplies will be 25% higher. Complete Receivers, Loudspeaker Units, AVOMINOR Test Meters, etc., etc.

**ORDER FREE-OF-TAX NOW!**

L.R.S. EASY TERMS ON REQUEST

Send 2½d. stamp for illustrated price lists.

Terms: Cash with order or C.O.D.

**LONDON RADIO SUPPLY CO.**

Established 1925.

All communications to evacuation address—

"Winden," Ardingly Road, Balcombe, Sussex

## Classified Advertisements

### BATTERIES

**RECHARGE** H.T. Batteries, Save Pounds, 2s. Gd. brings special new formula.—62, Hardwicke, Bury St. Edmunds.

### CABINETS

**A CABINET** for every radio purpose. Surplus cabinets (undrilled) from noted makers. We have hundreds in stock (no catalogues). Send measurements of chassis, etc., and say what kind of cabinet required. Stamp for reply. Inspection invited.  
**H. L. SMITH AND CO., LTD.**, 289, Edgware Road, W.2. Tel.: Pad. 5891.

### LOUDSPEAKER REPAIRS

**LOUDSPEAKER** repairs, British, American, any make. 24-hour service, moderate prices.—Sinclair Speakers, Pulteney Terrace, Copenhagen Street, London, N.1.

### MISCELLANEOUS

**DETECTION** Revolutionary theory; circuits; practical experiments. First Edition. World-wide circulation. 2s. Post free.—D'Arcy Ford, Gandy Street, Exeter.

### MORSE EQUIPMENT

**FULL** range of Transmitting Keys, practice sets and other equipment for Morse training.—Webb's Radio, 14, Soho Street, London, W.1. Phone: GERrard 2089.

### MORSE TRAINING

**FREE.** "Book of Facts," tells you all about The Candler System of Code training. Courses for Beginners and Operators.—Write: Candler System Co. (L.O), 121, Kingsway, London, W.C.2.

### NEW LOUDSPEAKERS

**3,000** Speakers, P.M. and energised 4in. to 14in. including several Epoch 18in.—Sinclair Speakers, Pulteney Terrace, Copenhagen Street, London, N.1.

### RADIO CHASSIS

**ARMSTRONG CO.** regret owing to the great difficulty in obtaining materials and skilled labour they have reluctantly been compelled to cancel many orders for various Armstrong chassis. A small number of the latest EXP48 chassis as advertised in the November issue of PRACTICAL WIRELESS are still available. Particulars gladly sent on request.—Armstrong Co., Writers Road, Holloway, London, N.7.

### RADIO MAP AND GLOBE

**WEBB'S** Radio Map of the World enables you to locate any station heard. Size 40" by 30" 2 colour heavy Art Paper, 4/6, post 6d. Limited supply on Linen, 10/6, post 6d. **WEBB'S** Radio Globe—superb 12" full-colour model. Radio prefixes, zones, etc. Heavy oxidised mount. Post Paid, 27/6.—Webb's Radio, 14, Soho Street, London, W.1. Phone: Gerrard 2089.

### READERS' BARGAINS

**A.C. ELIMINATORS**, as new, 20s.; with trickle charger, 30s.; carriage free.—12, Yewcroft Avenue, Newcastle-on-Tyne, 5.

**S.T. 900** specified kit, panel, valves, 2 pair coils, offers. Wanted Milnes H.T. unit, Stentorian Senior.—Bird, 67, High Street, Kempston, Beds.

### RECEIVERS AND COMPONENTS

**GOULPHONE** Radio, Station Road, New Longton, Preston. Prompt personal service. All goods Brand New. Tungram Valves. Guaranteed American valves, 5/9. Octal types, 6/9. Cosmocond Crystal Pickups, 23/6. 10" Rola P.M. speakers, 22/6. 8" Goodmans P.M. speakers, 17/6. Energised 8", 13/6. All with transformers. "Utility" Dryshavers 110/250 v. A.C./D.C., 22/6. Zenith All-Wave Aerials, Doublet, 18/6. Erie and Dubilier 1 watt resistors, 4/3 doz. Centralab volume controls with switch, 3/6. 8+8 mfd. 500 v. electrolytics, 4/3. Stamp for list.

**VAUXHALL.** Rola 8" P.M. speakers, with transformer, 14/9. Electrolytic condensers, 8 mfd., 500v., 2/3; 8+8 mfd. 500v. 3/6. 3-gang bandpass-H.F. iron-cored tuning coils, 19/6.—Vauxhall Utilities, 163A, Strand, London, W.C.2. Postage extra under 3/, 1d. stamp for list.

## AN EXCELLENT OPPORTUNITY!

For Gramophone or Microphone use in the Home, Office or Factory,

This Modern 5-watt, 4-Valve 220-volt A.C. AMPLIFIER CHASSIS is an outstanding bargain.

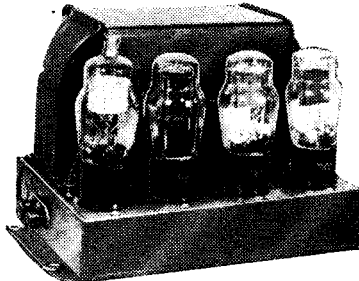

Two Triodes in output stage. HI-GAIN Screened Grid L.F. stage. Designed for energised M.C. Speaker, may be adapted for P.M. Speaker by using field replacement choke. Limited supplies only of this unrepeatable offer. Price, including valves and Output Transformer **£3.5.0** Energised Speaker to suit, 15/-.

**MICROPHONES:** Heavy duty, double button type. Chromium-plated case. Gold-plated electrodes. High output. Good Quality. With mounting clips and springs, **£1.15.0**.

**TRANSFORMERS** for above microphone, 7/6.



**AUDAK PICK-UP HEADS.** High resistance coil, 6/6.

**AUDAK CUTTING HEADS.** (Heavy duty). 3-5 ohm coil. High quality instrument, 17/6. **B.T.H. CAPACITOR GRAMOPHONE MOTORS,** with 12 inch Turntable, 100-250 volts, 33/6; an unusual Bargain!

**SINGLE EARPIECES,** with flexible metal sheathing, chrome plated, 2/6.

**ELECTRO-MAGNETIC COILS,** Resistance 500 ohms, counting from 1 to 12,999, 9/6. Smaller Type, 1 to 9,999, 5/6. Useful for innumerable purposes.

**TELEPHONE HAND SETS.** Second-hand, in good order. Ideal for A.R.P., etc., 6/6. **WESTINGHOUSE RECTIFIERS.** Type H.T.8, slightly used. Guaranteed O.K., 8/6.

**COMPLETE MOTOR-DRIVE TUNING ASSEMBLY.** Including 2-gang .0005 condenser, tuning motor with muting switch and homing commutator and station selector. With 8-button push-button switch, 25/-. Full details supplied.

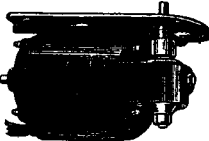

**B.T.H. HEAVY DUTY RECORDING MOTORS.**

79 r.p.m. capacitor type, 220 volts A.C. 50 cycles, baseboard or under-baseboard mounting. Weight 7lbs. Without Turntable, but including Capacitor, **£2.2.0**.

**SMALL REVERSIBLE A.C. MOTORS** (as used for motor tuning). 25-30 volts A.C. Built-in reduction gear spindle. Speed about 60 r.p.m. A first-class job with hundreds of applications, 8/6.

**TAPPED MAINS RESISTANCES** for 2 amp. valves tapped 200, 230-250, 4/-. **SATOR** 5 meg. Volume Control and switch, 1" spindle, 1/9.

**HEAVY TYPE MORSE KEYS,** 6/3 each. **PERMANENT CRYSTAL DETECTORS,** 2/- each.

**DECCA MICROPHONE TRANSFORMERS,** 2/- each.

**CERAMIC TRIMMERS,** 140 x 2 mfd., 8d. each.

**PILOT LAMP RESISTANCES,** 40 ohm, 6d. each.

**T.C.C. TUBULAR CONDENSERS,** 5 mfd., 450 volt working, 9d. each.

**MIXED RESISTANCES,** 1 watt, 1/6 doz.

**LONDON CENTRAL RADIO STORES**  
23, LISLE STREET, LONDON, W.C.2  
Phone: GERrard 2969.

### RECEIVERS AND COMPONENTS

**FRED'S RADIO CABIN**  
75, Newington Butts, S.E.11. Phone: Rodney 2180  
THE SPOT FOR KEEN BARGAINS

**VOLUME CONTROLS.** Previous stocks completely sold out. A new supply now available—rather better quality. We offer these with every confidence: 12 assorted, some with switches various values. Ideal for servicing, etc. Same price as before, although a better line, 3/- per doz.

**BLACK** milled knobs, standard 1" spindle, improves the appearance of your set, 6d. each.

**KNOBS, KNOBS, KNOBS.** Suitable for every purpose. When servicing don't be stumped for a knob. Assorted, standard spindle, 2/6 per doz.

**BULGIN** Bulb-holders. Ex. important manufacturer. Neatly mounted on circular paxolin base, 3d. each.

**MICROPHONE** Buttons. Absolutely first quality; no junk; to clear, 2/6 each.

**MICA** Condensers, small type; assorted; all useful values; ideal for servicemen, 1/6 per dozen.

**CONDENSERS.** Single-pole mounting, 50 mfd., 12 volt working, 1/3 each.

**T.C.C. CONDENSERS.** .25 mfd., 1,000 volt working; .1 mfd., 1,000 volt working. Special low price to clear remaining stocks, 6d. each. State value required.

**TUBULAR** Condensers. Only a few remaining to be cleared. .1 mfd., 350 volt working; first-class condition, 2/6 per doz., or 3d. each.

**RESISTANCES;** wire-end; all values, 12 assorted 1/6. Invaluable for servicemen and experimenters. Only a few to clear.

**RESISTANCES AND CONDENSERS.** Ex. famous maker. Paxolin strip carrying approximately 8 resistances and 4 condensers; all useful values. Cannot repeat. 1/3 complete.

**T.C.C. BLOCK ELECTROLYTIC CONDENSERS.** Salvage stock at real bargain prices. Serve many useful purposes. Assorted, 8+8+2, 24+8+2, 12+8, and many other values. In some cases one section of the block is dead, but these have been cut out. 7/6 doz.

**N.B.** A special low price will be quoted for quantities.

**COIL-FORMERS.** Brand new stock, 4 1/2" by 1 1/4" at 4d. each. Also a line of 1" coil formers in cardboard at 1/6 doz.

**ASSORTED COIL FORMERS.** These are ideal for experimenters wishing to build up their own coils, 2/6 per dozen.

**TRANSFORMERS.** Another useful line for experimenters and handymen. These are burnt out rejects and if stripped provide perfect laminations. 4" by 3 1/2" by 1", 1/6 each.

**L.F. TRANSFORMERS.** All perfect, various makes, Telsen, etc. Take your chance. 9d. each. What a bargain!

**DUAL-RANGE** 6-pin coils in perfect condition, complete with circuit diagram, 1/9 each.

**MAINS CHOKES.** Only a few left to clear, 60 m.a., 350 ohms, at special clear-out price of 2/- each. Also H.F. Filter chokes, twin mains, for smoothing, 1/9 each.

**CRYSTAL** and catswhisker in tin box. Bargain line to clear, 7d. each. Very useful to experimenters. Also Lucerne permanent crystal detectors, 1/6 each.

**EX-ROLA** speaker transformers. For pentode output only. These have sold extremely well and have had many repeat orders. Definitely the last few, 1/9 each.

**TRIMMERS.** Strip of 8 trimmers for push-button circuits, 1/6 each.

**ORMOND,** .0005 mfd. Slow-motion condensers, complete with knob, 2/- each. This is indeed a bargain. Also 10/1 slow-motion gears—a cheap line at 1/3 each. 5-way battery cords—cheap to clear, 4d. each. Rubber grummetts, 9d. doz.

**IMPROVE THE APPEARANCE** of your receiver. Attractive chromium-plated speaker grills in modernistic design. You will like these. Overall size, 7" deep, 3 1/2" wide, 1/6 each. Also chromium bars, 8 1/2" long, 1" wide, 6d. each. And brass bars; many uses; 1 1/2" long, 1" square, 8d. length.

Postage must be included with all orders.

Regret cannot accept C.O.D. orders.

**FRED'S RADIO CABIN FOR BARGAINS,**  
75, Newington Butts, S.E.11. Phone: Rodney 2180.

**SOUTHERN** Radio's Bargains.

**ALL** Guaranteed. Postage Extra.

5/- Parcel of useful Components, comprising Condensers, Resistances, Volume Controls, Wire, Circuits, etc. Value 25/-, 5/- per parcel.

15/- Service Man's Component Kit. Electrolytic Condensers, Volume Controls, Resistances, Tubular, Mica, Paper Condensers, Valve Holders, etc. 120 articles contained in strong carrying case, 9" x 7" x 7", 15/- the Kit.

5/- 100 Wire-end Resistances, assorted capacities, 1/2 and 1 watt, 5/- per 100.

**ORMOND** Loud-speaker Units, 2/6. Crystal Sets, 5/6; Westcoasters Type W2, 2/6; Crystal Detectors, 2/-; Crystals, 6d.; "P.O." Microphones on Stand, for use with any receiver, 5/-; Telsen W340 Iron-core Midget D.R. Coils, 5/6; Morse Tapping Keys, 3/-; Buzzers, 1/6.

2/- Tool or Instrument Carrying cases, ex Government Stock. Wood 9" x 7" x 7", 2/-.

**SOUTHERN** Radio, 46, Lisle Street, London, W.C. Gerrard 6653.

**BANKRUPT** Bargains, GENUINE OFFER. Brand new 1930-40 models, makers' sealed cartons, fully guaranteed, at 25 per cent. to 40 per cent. off present prices; also portable midgets. Send 1 1/4d. stamp lists. Radio Bargains, Dept. P.W., 261-3, Lichfield Road, Aston, Birmingham.

**RECEIVERS AND COMPONENTS**

**GALPINS ELECTRICAL STORES**  
 Owing to War Circumstances this business has now been transferred to Galpins Electrical Stores, 21, Williams St., Slough, Bucks. Terms: Cash with Order  
**PHILLIPS TRANSFORMERS.** 220v. input, output 2,000-0-2,000v. 200m/a. and 2 L.T.s., 50/-, carriage forward.  
**2 K.W. Transformer** cores for rewinding, sound windings, but rating unknown; 20/- each, carriage forward.  
**4 M.F. Block condensers,** 3,000v. working, 20/- each, carriage 1/6 passenger train.  
**D.C. MOTOR BLOWERS,** 2-in. inlet and outlet. Aluminium body, laminated field, ideal for dug-out ventilation. 100 volts, 25/-.  
**CRYPTO SHUNT WOUND DYNAMO,** 12/18 volts, 8/10 amps., 2,200 r.p.m., in new condition, 37/6, carriage forward.  
**HIGH-VOLTAGE TRANSFORMERS,** useful for all test work, or television. Input 200-240 volts, output 5,000 and 7,000 volts, 6/6 each, post 1/-.  
**VOLTAGE CHANGING TRANSFORMERS** (Auto Wound), 100/110 to 200/240 volts or vice versa. Guaranteed 12 months: 500 watts, 32/6; 1,000 watts, 60/-.  
**DYNAMOS,** for charging or lighting, etc., all shunt wound and fully guaranteed. 100 volt 10 amp., 4-pole, 1,500 r.p.m., 90/-; 50/75 volt 15 amp., 1,750 r.p.m., 4-pole, 90/-; 25 volt, 8 amp., 1,750 r.p.m., 2-pole, ball-bearing, 37/6; 50/75 volt 25 amp., 4-pole, 1,500 r.p.m., 110/-.  
**HIGH VOLTAGE CONDENSERS.** Infid. at 4,000 vol. working, 5/6 each, carriage 1/6.  
**REGULATORS, STARTERS, AND LARGE DIMMER RESISTANCES.** Stud switch-arm type. Please state requirements.  
**SWITCHBOARD VOLT AND AMPMETERS MOVING COIL AND MOVING IRON.** All first-class makers. Please state requirements.  
**D.C. ELECTRIC LIGHT CHECK METERS,** 200/250 volts 5 and 10 amps., 4/6 each, post 1/- (in new condition).  
**X-RAY TRANSFORMERS** by Watson & Phillips. Input 200-250 volts, 50 cv., 1 ph., output 40,000 volts 2 kVA., 27/10/-, carriage forward. Another, 70,000 volts 3 kVA. output, 120 volt primary, 212/10/-, carriage forward.  
**A.C. ELECTRIC LIGHT CHECK METERS,** suitable for subletting, workshop, garage or any purpose where a separate check is required, for A.C. mains only, 200/250 volt, 50 cycle, single phase, in good condition and electrically guaranteed; 5 amp. type, 6/-; 10 amp. type, 7/-; carriage 1/- on any size.  
**DUGOUT LAMPS, EX R.A.F.,** as new, solid brass construction; any size bulb can be used; wall type, 3/- each, post 6d. ditto, wing type, 2/6, post 6d.  
**DUGOUT LAMPS EX R.A.F.,** as new, porcelain type; solid brass construction, 6-in. dia., 3 colour glass dome; white, red, or green, complete with bulb. Any size bulb can be used. Price 5/-, post 6d.  
**EX R.A.F. AUTOMATIC CHARGING CUTOUTS AND VOLTAGE REGULATORS,** for 12 to 20 volt up to 20 amp. circuit (new) and complete in metal case, 3/6 each, post 3d.  
**EX R.A.F. GLASS ACCUMULATOR TANKS,** 5 x 5 x 3in., new and unused, 3/6 each, post 1/-.  
**EX R.A.F. SWITCH PANEL,** with case (new), fitted 6 small knife switches, leads, cords and cleats, complete in wood case, 2/6 each, post 6d.  
**1 KW. TRANSFORMER,** 100 volt, 100 cycles input, output 10,000 v., centre tapped, 30/-, carriage forward.

**SHORT-WAVE EQUIPMENT**

**"H.A.C." Short-wave Receivers.**—Famous for over eight years. Improved one-valve model now available. Complete kit of precision components, accessories, full instructions, soldering absolutely unnecessary, only 16s., postage 6d. Immediate despatch. Illustrated catalogue free.—A. L. Bachins, 109, Hartington Road, S.W.S.

**TUITION**

**PRACTICAL** Postal Courses, radio, television, test equipment design, trade-test coaching for R.A.F. posts, I.P.R.E. and I.W.T. exams.; booklet free.—Secretary, I.P.R.E., Bush House, Walton Avenue, Henley-on-Thames.

**YOUNG MEN** wanted to train as Radio Officers in Merchant Navy and R.A.F. Students of both sexes also prepared for appointments in Radio and Television. Boarders accepted. Low fees. College in ideal peaceful surroundings. Prospectus free.—Wireless College, Colwyn Bay.

- T.C.C. 8 mfd. tubulars electrolytics. 150v. 1/6 each.
- B.I. wire-end bias electrolytics. 50 mfd.—12v. 1/6 each.
- B.I. bias condensers. 50 mfd.—50v. 2/11 each.
- TUBULARS wire-end non-inductive paper condensers. All sizes up to 0.01. 5d. each. 1. 7d. each.
- B.I. 4 mfd. tubulars. 1/9 each. B.I. 8 mfd. cartons. 2/11 each.
- HUNTS 8 x 8 mfd. electrolytic condensers. 700v. peak. 5/- each.
- CONDENSERS. 0.0005 twin, 1/3 each. Triple, 1/9 each.
- LISSEN Mica condensers. Our assortment, 2/- dozen.
- WESTON metres. 0-50 m.a. and 0-300 m.a. Moving coil type. 25/- each.

**RADIO CLEARANCE, Ltd.**

**PLESSEY 4 Waveband Coil Units,** with Switching, fully screened Pre H.F. stage. 465 kc oscillator 13 metres, 2,000 metres, 21/- each. I.F. Transformers, 2/6 each extra. Gang Condensers for same, 2/11.  
**2V. OUTPUT PENTODE VALVES,** 5-pin, unboxed, 2/11 each.  
**LISSEN,** 2v. battery pentodes, 4-pin, side terminals. P.T.2.A., 4/11 each.  
**LISSEN** rectifier valve U650, 2/11 each.  
**LOW-LOSS** Ceramic valve holders. Lissen Hi-Q Baseboard and chassis 7-pin, 1/- each.  
**LOW-LOSS** short-wave Condensers, variable. Ceramic insulation, brass vanes. Lissen Hi-Q. Minimum capacity, 5 microlarads. 20 mfd. List 5/6 each. Our price, 2/6 each.  
**ROTARY COIL UNITS,** Lissen Hi-Q. 4-hand from 4.8-91 metres. Can be selected by turn of knob. With circuit. Boxed. List 15/6. Our price, 6/11 each.  
**PUSH-PULL** switch. Lissen 2-point, 4d. each. 3-point, 6d. each.  
**YAXLEY** type switches, 4-pole, 3-way 9d. each.  
**YAXLEY** switches. 4-bank, 2-pole, 4-way, 2/6 each.  
**YAXLEY** switches. 6-bank, 3/- each.  
**YAXLEY** switches. 9-bank, 3/6 each.  
**AMERICAN LINE CORDS,** with fittings, 3/6 each. 3-way American Line Cords, 450 ohms resistance, 3/6 each.  
**ROLA** P.M. speakers. Latest model 7in. cone, with power and pentode transformer. Boxed, 15/- each.  
**MAGNAVOX** 10in. energised speaker. Field resistance, 3,000 ohms, 12/6 each.  
**CLOCK-FACED DIALS,** 5in. x 5in. With printed scale. 4-wave, 2/6 each.  
**STRAIGHT LINE 3 waveband dials,** 1/11 each.  
**MAINS TRANSFORMERS.** G.E.C. American windings. 350-0-350v., 65 m.a., 5v., 2 amps., 6.3v., 3 amps. Suitable for replacements in G.E.C. models, 6/6 each.  
**MAINS TRANSFORMERS. WEARITE** R.C.1. 250-0-250v., 80 m.a., 4v., 2.5 amps., 4v., 4 amps., 9/11 each. R.C.2. 350-0-350v., 120 m.a., 4v., 2.5 amps., 4v., 4 amps., 12/6 each. R.C.3. 350-0-350v., 150 m.a., 4v., 2.5 amps., 4v., 2 amps., 4v., 5 amps., 15/- each. R.C.4. 500-0-500v., 150 m.a., 4v., 2 amps., 4v., 2.5 amps., 4v., 5.6 amps., 21/- each. R.C.5. 100-watt auto-transformers. 100-110v., 200-250v. Reversible, 14/11 each. All above transformers, 200-250v. tapped primaries. R.C.D. drop-through type, capped, 350-350v., 100 m.a., 5v., 2 amp., 6.3v., 5 amps., 10/6 each.  
**CHASSIS** mounting valve holders. American 4-5-6-pin, 4d. each. Octals, 6d. each.  
**CHASSIS** mounting valve holders. British Clix type. 4-5-7-pin, 3d. each. Celestion valve holders. 5- and 7-pin chassis type, 4d. each. Baseboard type, 5-pin, 2d. each.  
**VOLUME CONTROLS.** Cent. 25b. Spindles length 2 1/2in. With switch, 100,000, 250,000, 500,000 and 1 meg., 2/11 each.  
**CENTRALAB VOLUME** controls. Midget type. 2,000, 5,000, 25,000, 50,000, 100,000, 500,000 ohms. Less switch, 2/9 each. 1,000, 25,000. With switch, 3/6 each.  
**SPEAKER TRANSFORMERS,** Pentode output, 3/6 each.  
**PRESS BUTTON UNITS.** Size of unit, 6in. x 6in. x 2in. Complete with press buttons and capacitors, 4/11 each.  
**PLESSEY MOTOR TUNING UNITS.** Including fractional h.p. A.C. motor for 12v. continual running on 24v., intermittent running and 2 gang 50 condenser, 2/6 each.  
**12-WAY PUSH-BUTTON SWITCHES,** 1/6 each. 11-way push-button switches, 1/6 each. 6-way push-button switches, 1/- each. 7-way push-button switches, 1/- each.  
**SPEAKER CABINETS.** Suitable for 8in. speaker, 4/6 each.  
**DROPPING RESISTANCES.** For all purposes. Total resistance 535 ohms, 5 taps in steps of 50 ohms. Standard for Pye, Lissen, Ever Ready, etc., 3/- each.  
**RESISTANCES.** 100 ohms 10 watt. 1/- each.  
**10FT. COILS** connecting wire. Glazed, 4d. each.  
**DUAL CAPACITATORS.** 300 x 600. 4d. each.  
**I.F. TRANSFORMERS.** 465 kc's in 1 1/2in. cans. 2/6 each.  
**COILS KITS** for superhet circuit, including 2-gang straight condensers, aerial coil assembly, oscillator coil assembly and 2.465 kc I.F. Transformers. With circuit diagram. 8/11 each.  
**PILOT LAMPS.** 6.3 0.3 amps. 6d. each.  
**PUSH-ON** pilot lamp-holders, 3d. each.  
**PLESSEY** single-gang 0.0005 variable condensers. 1/6 each.  
**2-GANG .0005 VARIABLE CONDENSERS.** With Vernier control, 1/11 each.  
**PERMABILITY TUNED** press button units, 2/6 each.  
**All orders must include SUFFICIENT POSTAGE TO COVER. Hours of Business: Week-days, 9-4. Saturdays, 9-1 p.m.**  
**PLEASE WRITE YOUR NAME IN BLOCK LETTERS.**  
**We cannot undertake to answer enquiries unless full postage included (2d.).**  
**RADIO CLEARANCE, Ltd., 85, HIGH HOLBORN, LONDON, W.1.**  
 Phone: Holborn 4361.

**RECEIVERS AND COMPONENTS**

**GEE GEE GEE GEE GEE GEE**  
**15, LITTLE NEWPORT STREET, W.C.2.**  
**CELESTION P.M. Speakers.** Absolutely brand new, latest type 6in., at special low price, 12/6 each.  
**A.C. BATTERY CHARGERS.** Made by famous maker. 1 amp. 14/6; 1 amp. 50/-, 2, 6, and 12 volt.  
**MAINS DROPPING RESISTANCES,** 150 ohm flat metal type, most suitable for midget receivers, 1/- each. We carry large stock of mains droppers, 2 amp. and 3 amp. tapped. Tell us your requirements.  
**AMERICAN & B.V.A. valves.** All types in stock, from 4/- each. Send us your list and we will supply.  
**SCREENED SLEEVING.** A good line of circular metal wrapped sleeving. Unrepeatable. 6d. a yard.  
**RESISTORS.** Assorted, 1 watt American Bradley Unit. A good line for servicemen, 1/- doz.  
**EX-G.E.C. Speaker transformers.** Brand new for pentode output only. Not a junk line, but good-quality stuff in first class condition, 2/3 each.  
**SOLDER.** Very best quality resincore solder, 50 per cent tin, 12 gauge, 6d. a length.  
**KLAXON MOTORS.** 250 volt A.C. 1/100 h.p. Continuous 1,375 r.p.m. Reversible, suitable for fans, etc. Can be geared. Brand new, silent running and fitted with snippers, 30/6.  
**TWO-WAY** Mercury switches, 3/11 each.  
**EX-PHILCO** new American battery valves. Types: 1A4E, 1B4E, 1L6 each.  
**VARIABLE CONDENSERS.** 3-gang .0005 mfd. 2 speed. A fine job with die-cast frame and solid aluminium vanes, 2/6 each.  
**We hold large stocks of the above items, and will quote extremely low terms for large quantities. Postage extra.**  
**GEE ELECTRIC, 15, LITTLE NEWPORT ST., W.C.2.**

**WANTED**

**WANTED, Mains Model.** F. J. Camm's 1938 Push Button Four made up, or all specified parts for same. —Box 207, c/o "Practical Wireless."

**P.A. Amplifiers and Speakers** urgently wanted. Good prices paid.—John Bell & Croyden, Wigmore St., London, W.1.

**WANTED,** copies of "Practical Wireless" September, November, December, 1940. Details to Eric Dakin 24, Imperial Road, Wood Green, London, N.22.

**WANTED,** S.G.220 (S.W.), PX230 (S.W.), H1VAC valves, 2v. Pay good price.—H. Bennett, 11, Inver Road, Clapton, London, E.5.

**A.C. ST 900,** wiring chart wanted, 2s. 6d. offered. Please oblige.—Edwards, Solid Lane, Dodinghurst, Brentwood, Essex.

**CABINETS**

FOR THE ALL DRY PORTABLE DESCRIBED IN THIS ISSUE.

OAK - - - - - 23/6  
 MAHOGANY OR WALNUT 25/6

COMPLETE WITH ALL HOLES READY DRILLED.

LOCKWOOD & CO., Phone EYRon 1818.  
 LOWLANDS RD., HARROW.

**FREE ADVICE BUREAU COUPON**

This coupon is available until March 1st, 1941, and must accompany all Queries and Hints. PRACTICAL WIRELESS, March, 1941.

**ROTHERMEL** Crystal microphones. List 22/2-. Our price, 15/- each.  
**ROTHERMEL** Senior Crystal pick-ups, 30/- each.  
**SMALL BROWN KNOBS,** 2d. each.  
 We have in stock a large selection of high voltage paper condensers. All capacities but too numerous to advertise. Advise interested clients to call.  
 Also large selection of high voltage transmitters and chokes.  
**RAYTHEON VALVES, FIRST GRADE.** Largest stockists. All types stocked, including glass series, glass octal series, metal series, bantam series, single-ended metal series and resistance tubes.  
 All at most competitive prices. Send for Valve List

# FREE!



## This IMPORTANT GUIDE to SUCCESSFUL ENGINEERING CAREERS

After months of intensive effort and research to announce that the new edition of "ENGINEERING OPPORTUNITIES," is in the publishers' hands and ready for free distribution. Containing 208 pages of practical guidance, this is, beyond argument, the finest and most complete handbook ever compiled.

## R.A.F. PILOTS OF FLYERS

Special air-crew study courses in the essential branches of Mathematics. For full details of this scheme apply or write

I.E.T. (Dept. M409)  
17 Stratford Place, LONDON, W.1.

WE DEFY "NO"

If you are earning less than £100 a week you cannot afford to miss this "ENGINEERING OPPORTUNITIES"

In your own interests, we advise you to write (or forward the coupon) for your copy of this enlightening guide to well-paid posts - NOW. There is no cost or obligation of any kind.

## BRITISH INSTITUTE OF ENGINEERING TECHNOLOGY

Principal: Professor A. M. Low

409a, SHAKESPEARE HOUSE, 17, 18 & 19, STRATFORD PLACE, LONDON, W.1.

TEAR OFF HERE  
**COUPON**

SHAKESPEARE HOUSE, 17, 18 & 19, STRATFORD PLACE, LONDON, W.1.

Please forward, Free of cost or obligation of any kind, your 208-page Handbook, "ENGINEERING OPPORTUNITIES."

Name .....

Address .....

.....

.....

Published on the 7th of each month by GEORGE NEWNES, LIMITED, Tower House, Southampton Street, Strand, London, W.C.2. and printed in England by THE NEWNES & PEARSON PRINTING CO., LTD., Exmoor Street, London, W.10. Sole Agents for Australia and New Zealand: GORDON & GOTCH, LTD., South Africa: CENTRAL NEWS AGENCY, LTD. Subscription rates including postage: Inland 7s. 6d. per annum, 3s. 9d. for six months; Abroad 7s. per annum, 3s. 6d. for six months. Registered at the General Post Office for the Canadian Magazine Post.  
CONDITIONS OF SALE AND SUPPLY.—This periodical is sold subject to the following conditions, namely: that it shall not, without the written consent of the publishers first given, be lent, resold, hired out or otherwise disposed of by way of Trade except at the full retail price of 6d.; and that it shall not be lent, resold, hired out or otherwise disposed of in a mutilated condition or in any unauthorised cover by way of Trade; or affixed to or as part of any publication or advertising, literary or pictorial matter whatsoever.