

**RADIO**  
FOR THE  
**MILLION**

PRICE

2/6

THE RADIO OWNER'S MAGAZINE

Vol. I., No. 4

September 1927



**AUTUMN  
DOUBLE  
NUMBER**



# MUSITORIUM

*where the Editor makes a brief introduction to this great number and gives helpful direction on the respective merits of the new Mullard P.M. Receivers and new Mullard P.M. Apparatus described in following pages.*

**T**HE long awaited Autumn is here at last. Happily to yesterday belong the terrific roars and crackles which have thundered in upon ears listening intently—but often vainly—for just one word or mark of recognition from a distant transmission.

And now to-morrow . . . the dark evenings—for all to enjoy from Europe, and may be from the great continents across the Atlantic and Pacific, the ever-fascinating wonders of radio which encircle this globe of ours almost every hour of the day and of the night.

Radio knows no boundaries; it radiates to the North and South, to the East and West, showing neither caprice nor prejudice.

The simplest aerial stretched across the low ceiling of the country cottage, and the aerial system of a palace are both impressed by the feeble waves—each similarly affected by the rapid pulsations.

The single valve receiver, costing a mere song, may reach “down under”—three valves easily bring entertainment from Europe and America—while a five or six valve receiver will deliver music at such an immense volume as would fill many a well-known concert-hall.

New devices offer us radio music of a new quality uncannily faithful in its interpretation to the original rendering in some distant broadcast studio. Who would not revel in this universal joy which has advanced almost beyond yesterday's recognition? Who could resist Radio's galvanic pleasure? Not those who seek respite from the day's turmoil in the pleasure of entertainment.

## Build a good set

Modern Valves, improved inter-valve couplings and the manufacture of speakers responsive to an almost infinite variety of tone colours—each separately and in combination—perform their share of supplying the radio owner with broadcast reproduction as near to the real thing as anything so far yet achieved.

Choose your apparatus carefully, realising that the quality of the ultimate reproduced music depends upon the quality and efficiency of the component parts.

Build a good set—do not try to save a shilling or two—for that may deprive you of just that little extra “something” which makes the vital difference between dross and refined gold.

Five new P.M. Receivers are described in this, the first Autumn Double Number of *Radio for the Million* ranging

in character from the Hawkins P.M.—an extremely suitable set for the reception of the local station with a certain alternative programme from either of the Daventry stations—to an ambitious Super Heterodyne Receiver called the Collingwood P.M.

This is a series of sets providing the radio public with tested receivers, constructional details of which are published after many weeks on the test bench, and many days and nights connected to the aerial and earth.

A radio set is not unlike human nature—it is not until one lives with it that its idiosyncrasies come to light. The production of the 1927-1928 series of P.M. Sets has involved many late nights far into the early morning—week after week—and many a whole week-end, twisting dials so that every wayward trick of the receivers would reveal itself. In fact, the editorial sanctum was completely transferred to the test bench, and by thus living with the sets for a few weeks—just as any home constructor might do who builds P.M. Sets—every source of trouble has been removed. It is felt therefore, after this prolonged personal handling of these receivers, that a wonderful treat is in store for every P.M. Set enthusiast who decides to enjoy this winter's radio on a P.M. Set equipped with a P.M. Speaker and P.M. H.T. Supply Unit.

## Aim at quality

Each of the P.M. Sets in this issue has a very definite appeal; there is not a fancy which cannot be satisfied. Choosing the best P.M. Set for a given purpose is nothing if not extremely simple. Run over their performance; if it provides Radio in the form you wish, then allow your choice to have its head. It is not unusual that a set only does what you wish it to do at the expense of a fair margin of safety or at the sacrifice of quality. Aim at quality—radio reproduction which is enriched by a touch of realism, makes radio invaluable to yourself, family and friends.

With a margin of safety, with a little more power in hand, you may smile at “bad nights” which cut down effective radiation. Being able to switch over to some greatly desired programme and put it on the speaker in spite of poor conditions is an advantage which most of us could not refuse.

\* \* \* \*

Now that it is possible to obtain a perfect high tension supply from the mains, to charge one's low tension battery without the fatiguing business of carrying it to a charging station—which, by the way, is never near home—and with the reduction of Mullard P.M. Filament consumption to 0.075, the prospect of owning a large receiver is now brought within reach of the great majority of radio listeners for the first time since broadcasting begun.

**Easy to handle**

It must not be assumed that a large set is difficult to handle because it employs a large number of valves. The true state of affairs is rather to the contrary. Within reasonable limits, say five valves for an ordinary H.F. Set, operation is less difficult than with a three valve set continually being pressed to deliver its utmost volume and being pushed to its utmost range. A group of stations may be tuned-in on such sets as the Raleigh P.M. or on the Collingwood P.M., which by comparison almost place a slightly lower-powered valve receiver into the category of the crystal set.

It is scarcely believable that the simple addition of two or three valves may completely transform a radio receiver so that it will always provide its owner with more programmes than will ever be called upon to deliver their entertainment. Such an overwhelming supply of music from opera to jazz, from musical comedy to the concert-hall, is at the call of any reader who owns either a Raleigh P.M. or a Collingwood P.M.

\* \* \* \*

The Hawkins P.M. has great potentialities in that it offers radio from room to room. It is portable in the real sense of the word, and it is surprisingly efficient when the small size of the self-contained aerial is considered. It is not intended to supply broadcast from more than three stations—the local and the two Daventry Stations. Whether one lives at Penzance or John o'Groats, in the East or in the West, simply pull out one little battery switch and a programme will be available.

\* \* \* \*

**An ideal receiver**

Then we have the Nelson P.M. de Luxe which presents an opportunity to all owners of the Nelson P.M. published in the first issue of *Radio for the Million* to take advantage of a different high-frequency stage at the expenditure of a few shillings. The change-over to the new H.F. arrangement has greatly increased the efficiency of the receiver not so much from the point of view of range and volume, but upon the count of simplicity of operation. Upon the one condition that the published design is strictly followed, particularly where it concerns the layout and the wiring of the H.F. side, the resultant set makes an ideal four-valver. It is practically impossible to design a four valve set with a more satisfactory all-round performance.

Finally, mention must be made of the Blake P.M. which although intended for short wave reception only, may by the use of different coils, serve also for the reception of any British Broadcasting Station, including Hilversum and Radio Paris on the long waves. Strong Continental Stations—as Brussels, Langenberg, Hamburg, Stuttgart, Bremen, Frankfurt, Muenster, Koenigsburg, and many others are known to be—would all “come-over” at great strength after dark. Where funds are limited, no better receiver than this could be chosen. It is indeed as universal as the test report implies, as it functions to an extremely satisfactory degree from 20 to 2,000 metres.

As a probable indication of future popularity, it may be added that of the receivers described in this number, the original set enjoys more covetous glances from the editorial staff than any of the sets published. After all, there is a great fascination in bridging the Atlantic after the local has closed down. It was never an experience five years ago, yet to-day, three valves will give New York strong enough to fill a medium-sized house!

\* \* \* \*

**The wonderful P.M. valve**

No little responsibility for the efficient performance of radio sets lies with the valve. One might go as far as to say that the amazing sensitivity of the valve alone, makes radio possible as we know it to-day. The wonderful P.M. filament blazed the way to better radio; comparative tests to-day, show this world-famous filament to be no less prominent. The

pioneer work continues—increased efficiency with a lower filament consumption. The new 0.075 series requires three charges to the .1 type's four—one L.T. Battery charge in four is thus saved.

\* \* \* \*

Carrying L.T. Batteries to the charging station is now unnecessary. This troublesome journey has now become a necessity of the past—not that we recommend the elimination of the L.T. Battery, for up to the present it is the only satisfactory and reliable method of supplying current to valve filaments. The production of the P.M. L.T. Battery Charger is the great trouble-saver. Connected to your battery once a week for a fifteen-hour steady charge and the L.T. Battery worry has vanished at a stroke.

\* \* \* \*

The P.M. H.T. Supply Unit is another tremendous boon to the radio enthusiast. Completely fool-proof and absolutely silent in operation, one of these units should be installed in every home where the radio set is in daily use. As a matter of considerable interest, mention is made of the fact that all P.M. Sets described in this number have been thoroughly tested on the P.M. H.T. Supply Unit. Experimental as well as final designs have obtained their H.T. current supply exclusively from the mains by means of this unit. It goes without saying, therefore, that the published designs appearing in this issue represent a huge stride in designs for home constructors, in that the numerous troubles for which the old H.T. Battery was responsible, are now relegated to the past.

\* \* \* \*

**A new P.M. Speaker**

The new conception of radio reproduction which the P.M. Speaker introduced at the middle of last season, is now brought within the means of everyone by the production of a new P.M. Speaker costing but £3 5s. od. More than commendation is deserved by the engineers who have succeeded in retaining for it the exclusive musical characteristics of the more expensive model.

Readers will recall the results of the test on this latter model, published in our March issue. Here we must be content with suggesting to the reader that he (or she) again reads those interesting and exhaustive comments which directed a new light upon Speaker reproduction. Judge the performance of a Speaker from the viewpoint of harmonic-response—it is the only way—and you will choose one of the P.M. Models according to the weight of your purse.

\* \* \* \*

P.M. Inter-valve Coupling which became popular with the publication of P.M. Receivers, is now available as a complete Unit. This is a welcome feature and will be greatly appreciated by advocates and admirers of the P.M. Intervale Coupling. It is natural that this Unit is featured prominently in the 1927-1928 series of P.M. Sets. This policy has been adopted since it was felt that readers would prefer the business of set building further simplified. Use of the unit requires only half the number of connections necessary when separate resistances, condensers and leaks are employed. Moreover, a great gain is made when appearance is considered.

In receivers which call for different values of resistance, leaks or coupling condenser then, of course, the Unit is not practicable. Home-constructors who wish to experiment with interchangeable components, are reminded that the Mullard Wire Wound Anodé Resistances, the Mullard Fixed Condensers and the Mullard Grid Leaks are the most efficient components for assembling the R.C.C. system at home.

\* \* \* \*

Lastly, this season also sees the production of a new type of Mullard Grid Leak which marks yet another step in the Mullard policy of giving the public better radio.

# THE NELSON . P.M de LUXE

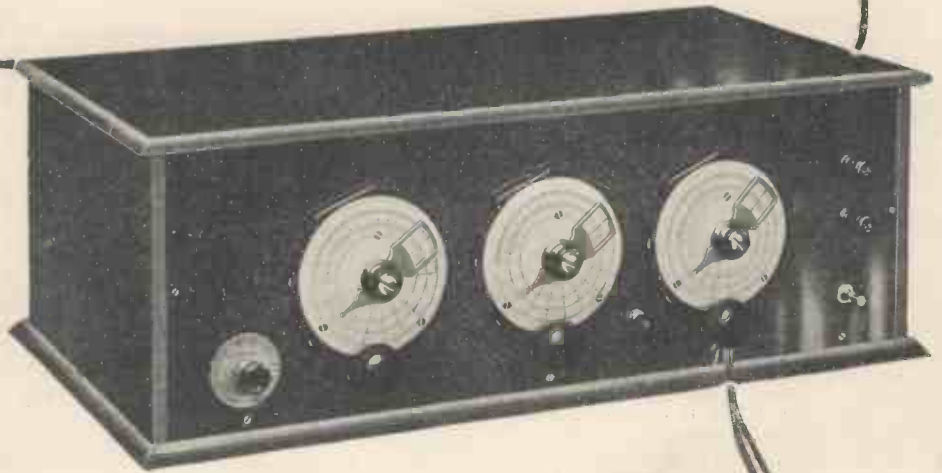

THE original receiver has been tested on various aerials and it was not in the least surprising that its performance was revealed to the greatest advantage when connected to an ordinary aerial, such as might be used by any town householder—20 feet long, 20 feet high and about 10 feet below roof-height, surrounded on three sides by trees and screened on the remaining side by the house.

**N.B.** This receiver employs a system of high frequency coupling which, upon comparative aerial tests, gives a higher standard of performance than any other system.



## About fifty shillings will re-model your Mullard Nelson P.M. for the Winter

**R**ADIO ownership is very similar to motor ownership—the commencement of a new season brings with it the desire for the most recent designs. Just as the motorist sets his heart upon driving a car embodying the new season's improvements, so the radio enthusiast, each Autumn, expects to build a better receiver by the aid of which to enjoy better radio during the Winter.

The design of the Nelson P.M. de Luxe enables owners of the Nelson P.M. to transform their present set into a four-valve combination to which present scientific knowledge awards the blue riband of the air. This new Mullard P.M. design, however, may also be constructed by any person whether or no they have had previous experience in set building.

*This photograph shows some of the improvements which have been effected. For example, a six-pin aerial coil is now included as also are three large by-pass condensers across H.T. Tappings.*

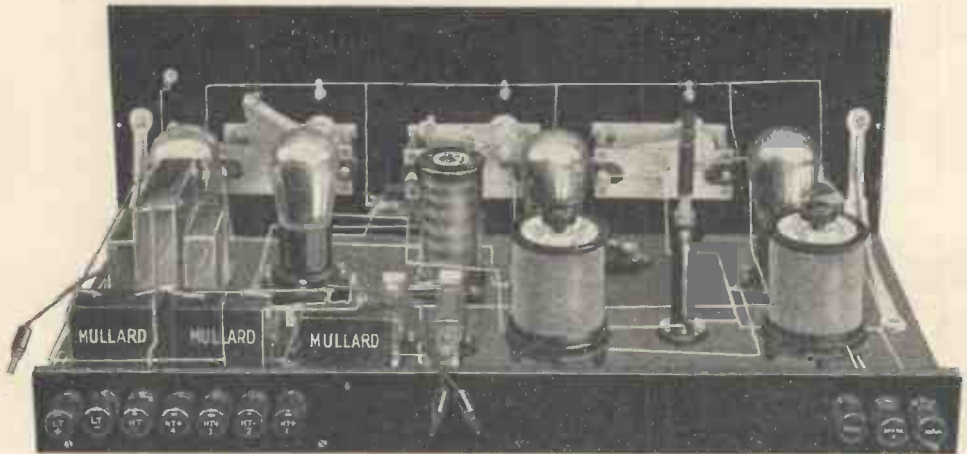

It will not come as a surprise to our readers for them to learn that the Mullard Nelson P.M. Receiver, details of which were published in our first number, was the most popular set during last season.

Readers as individuals, may not have realised that up and down this country, as well as several Continental countries, many, many thousands of fellow radio owners enjoyed broadcast music from a receiver similar in design to their own. There is something very impressive about that fact.

It may seem strange, but nevertheless easily within the bounds of possibility, that upon scores of evenings during the past summer and winter when you have been listening to a Continental station, someone in that actual distant town or city may have been listening to *your* local station on a Mullard Nelson P.M. Receiver.

### A highly successful set

Vast indeed is the number of Nelson P.M. Sets in active and satisfactory use to-day, and it may be that many proud possessors will hesitate before making any improvements to an already highly successful receiver, which in its previously published form would continue to serve them both efficiently and economically.

But as last year's motor would run many more thousands of miles with no less efficiency than it had in the past, there is, for all that, something very satisfactory in being able to say to one's friends—"This year's model containing all the latest improvements!"

We feel very confident that the majority will make the improvements which are suggested, for it will be found that for the small expenditure of about fifty shillings, you will revitalise radio in your home.

Reference to the list of parts shows that the components in your present set may be utilised. As a matter of fact, we have used the same essential apparatus and the set has been designed so that the improved model may make use of the same equipment, even to the panel.

Three Mullard Mansbridge Condensers, one six-pin coil and base, one pair of panel brackets, three slow-motion dials and a new terminal strip alone require to be purchased.

By the inclusion of a six-pin coil in the aerial much greater efficiency has been obtained with the result that the received signals reach the grid of the H.F. Valve with greater strength. Weak signals, which previously were partially absorbed by high-loss coils, are now passed on with no decrease of strength.

### Of interest to all

The information given in this issue is not intended for owners of the Nelson P.M. exclusively. All the constructional details necessary for building the set from entirely new apparatus are published. The Free Blueprint No. 205 and the point-to-point directions render invaluable assistance in wiring and by careful working any errors may be avoided.

Another feature found decidedly attractive during the course of the tests was the ease with which stations came in. Of course, it is important to neutralise correctly. When this has been done the advancing or retarding of the two tuning condensers in step is really the only adjustment to make from Strassburg at 222.2 metres to Munich operating on 535.7. Weak stations, of course, demand a slight increase of reaction, which is applied by rotating the reaction condenser a few degrees to the right.

# Neutralising adjustment holds on both wavebands

Consequently, the Nelson P.M. de Luxe makes an ideal four-valve receiver for all who cannot afford to instal more than this number of valves. Other high-frequency arrangements have been tried to exhaustion, but there is not one system which gives such a wonderful performance on both broadcast wavebands. It is realised that any published design must function equally efficiently on these two wavebands and furthermore, interchangeability must be arranged so that in changing over from one band to the other the neutralising adjustment must hold good in each case. It is not only impracticable to alter this adjustment when changing from high to low or from low to high, but the owner of such a set would thus be deprived of making the fullest use of both wavebands.

## Constant neutralising condenser setting

Neutralising adjustments once made should remain constant as these do in the case of the Nelson P.M. de Luxe. This point, in conjunction with the feature that this P.M. receiver is exceptionally easy to neutralise, must provide readers with a very strong incentive to construct it.

A further point which must not be omitted; it is that the Nelson P.M. de Luxe operates perfectly in conjunction with the P.M. H.T. Supply Unit. The test report which accompanies these introductory remarks was obtained while drawing the H.T. current from this source. Judging by this test report, the use of the P.M. H.T. Supply Unit had an advantageous effect upon the range of the Nelson P.M. de Luxe.

There are very few radio enthusiasts who have not yet tuned in 5 G.B.—the new Daventry Station operating on 491.8 metres. Those readers who have taken advantage of

powerful transmission. On the other hand, residents in the Midlands may probably find that without H.F. there is some difficulty in receiving either of the Daventry Stations without interference from the other.

The H.F. scheme employed in the Nelson P.M. de Luxe is very selective as the test report proves and for this reason it is an admirable receiver where contrast programmes are required. It was revealed during the tests that within a range of 120 miles from 5 G.B., with one stage of H.F., one L.F. valve was sufficient to operate the Speaker at full strength.

Consequently a switch has been incorporated whereby it is possible, when strong transmissions are being received, to switch-off the filament of the first L.F. Valve and to cut-out the preceding intervalve coupling.

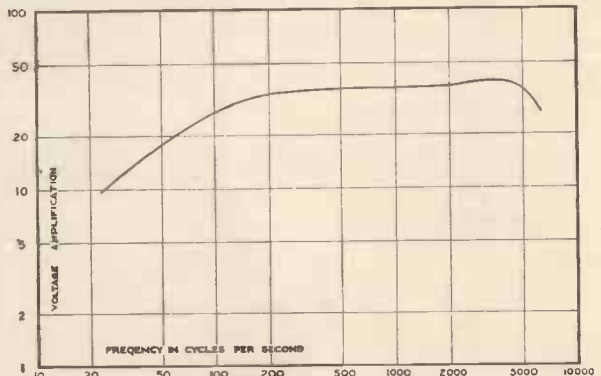

*The placing of the Grid Bias Batteries is shown in this illustration.*

This graph shows the voltage-amplification curve of the R.I.-Varley L.F. Transformer user in the Nelson P.M. de Luxe. It will be noted that the graph is drawn on the log or musical scale. Such a method, of course, being the correct procedure. This point should be borne in mind when comparing this curve with one drawn on equally divided metric paper. Excluding the slight rise and fall at the higher-frequency end, the above curve shows this transformer to be exceptionally good.

A diagram is reproduced reducing the connections to simplicity itself. Needless to say this switch is also extremely serviceable when stations such as Brussels, Langenberg, Muenster, Frankfurt, Nuremburg, Toulouse and Stuttgart are relied upon for regular reception since their transmissions may be normally received with but little reaction and one low-frequency stage.

## Alternative aerial connections

One other little point which will be found useful by those residing within twenty miles of a local station is the third aerial terminal which, as shewn, connects the aerial direct to the anode of the H.F. valve. With the aerial connected in this way, and the H.F. filament turned off by the rheostat, the Nelson P.M. de Luxe may be used as a detector and two low-frequency combination.

It should also be noted by those who are constructing their receiver from new apparatus that it will not be necessary to purchase 2 Mullard 100,000 ohms Wire Wound Resistances. These have been incorporated in the published design for the reason that owners of the Nelson P.M. will have two examples already in their possession. The list of parts calls for one Mullard 200,000 ohm Wire Wound Resistance which should be placed in the position designated for R 3 in the FREE BLUEPRINT and wires numbers 9 and 34 would be connected to either end respectively and wire No. 3 omitted.

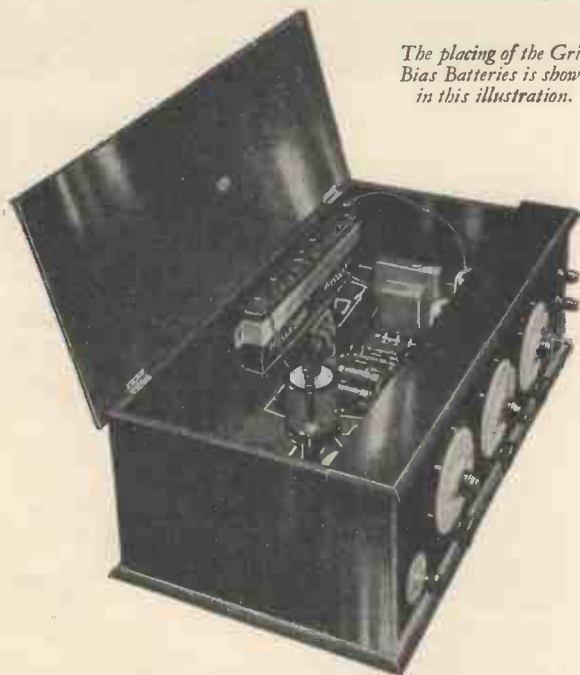

the contrast programme provided by this high-power station will have some idea of the great strength with which this station comes over.

Naturally, any set installed extremely close to a local station without a selective stage of high-frequency amplification will have some difficulty in separating the local from this

**Making the first few steps**

It is assumed that the building of the Nelson P.M. de Luxe will not present any complications which call for a detailed description. The process of drilling the panel and arranging the baseboard components is quite a simple job for anyone who is able to drive home a nail without crushing the top of a finger. Sufficient time to take occasional glances at the reproductions of photographs and the full-size Free Blue print is alone necessary to make a perfect job. Dispose of the components exactly as indicated by the plan view and no wiring difficulties will be encountered at a later hour.

With all the components mounted into position and the terminal strip screwed to the back of the baseboard, wiring may be commenced. The point-to-point system which numbers each wire, gives to every wire definite starting and finishing points. After soldering a wire into position mark it off on the blue-print with a red crayon.

By following this suggestion, the progress you have made on the previous evening is readily indicated without resort to checking. Naturally, when every connection is struck through the wiring will be completed. Then make a thorough check-over and correct mistakes should any be discovered.

**Installing the set**

Connect up your batteries : the L.T.+ terminal on the set to L.T.+ on the L.T. battery ; L.T.- to the L.T.- terminal on the L.T. battery. Red indicates positive and black the negative terminals. High-tension connections should be then completed according to the suggested voltages printed below. If you have up to 120 volts high-tension available you will need two nine-volt grid bias batteries. In the event that you are running a Mullard P.M. H.T. Supply Unit and a P.M. Super-power Valve in the last L.F. Stage (*i.e.*, for V.4) three nine-volt grid bias batteries will be required. Leads to these batteries are arranged as follows :—

- G.B.+ to the positive end of the first G.B. battery (that is to the first socket at the end marked with a +).
- G.B.-1 to either of the next two sockets in the same battery ; that socket which during reception gives the most pleasing quality should be chosen.
- G.B.-2 : When using a P.M.2, P.M.4 or P.M.6 the last socket (marked -) in this same battery will be found to give the best results. With a 100-120 volts and a P.M. Super Valve—P.M.252, P.M.254 or P.M.256, it will be necessary to link up the second grid bias battery to the first by means of a short piece of flex with a black and red wander plug at either end. Connect the batteries so that the negative end (marked -) of the first G.B. battery is connected to the positive end (marked +) of the second. G.B.-2, connected to terminal No. 5 of the L.F. Transformer is taken to the negative end of this second battery. With 120-150 volts or when employing a Mullard P.M. H.T. Supply Unit, a third G.B. battery should be connected in a manner similar to that described above. G.B.-2 in this case is taken to the third or fourth socket in this last battery.

**Recommended H.T. voltages**

H.T.+1 : 75 volts or the second tapping on the Mullard P.M. H.T. Supply Unit.

H.T.+2 : 75 volts or the second tapping on the Mullard P.M. H.T. Supply Unit.

H.T.+3 : 100 volts or the third tapping on the Mullard P.M. H.T. Supply Unit.

H.T.+4 : 150 volts or the fourth tapping on the Mullard P.M. H.T. Supply Unit.

**Note** :—If the P.M.2, P.M. 4 or P.M.6 are employed, H.T.+4 will call for 100-120 volts or the third tapping on the Mullard P.M. H.T. Supply Unit.

**Test Report on Nelson P.M. de Luxe**

Broadcast Wave Stations received on Sunday Evening, August 7th, 1927 ; Long Wave Stations on Monday, August 8th, 1927.

The following list was compiled as stations were tuned-in. Identity was confirmed by the Emerald Wavemeter.

Wave-length.	Frequency.	STATION.	H.F.
222.2	1350	Strasbourg .. .. .	18
241.9	1240	Muenster .. .. .	37
252.1	1190	Relays—Bradford and Bremen .. .. .	45
254.2	1180	Kiel .. .. .	47
260.9	1150	Malmo .. .. .	52
272.7	1100	Sheffield .. .. .	60
275.2	1090	Nottingham .. .. .	62
283	1060	Dortmund .. .. .	67
288.5	1040	Edinburgh .. .. .	70
291.3	1030	Lyons .. .. .	73
294.1	1020	British Relays .. .. .	75
297	1010	San Sebastian (Hanover and Liverpool)..	76
303	990	Nuremberg .. .. .	80
306.1	980	Belfast .. .. .	82.5
312.5	960	Newcastle .. .. .	86
315.8	950	Breslau .. .. .	88
319.1	940	Dublin .. .. .	90
326.1	920	Bournemouth .. .. .	94
329.7	910	Koenigsburg .. .. .	95.5
337	890	Copenhagen .. .. .	100
340.9	880	Paris .. .. .	102
344.8	870	Barcelona .. .. .	105.5
348.9	860	Prague .. .. .	106
353	850	Cardiff .. .. .	108
357.1	840	Graz .. .. .	110
361.4	830	London .. .. .	112
365.8	820	Leipzig .. .. .	113.5
375	800	Madrid (EAJ7) .. .. .	117
379.7	790	Stuttgart .. .. .	119.25
384.6	780	Manchester .. .. .	122
392	765	Toulouse .. .. .	125
393	763	Madrid (EAJ2) .. .. .	125.5
394.7	760	Hamburg .. .. .	126
400	750	Plymouth .. .. .	128
405.4	740	Glasgow .. .. .	130
411	730	Berne .. .. .	132
418	708	Bilbao (EAJ11) .. .. .	134
428.6	700	Frankfurt-on-Main .. .. .	135.25
434.8	690	Bilbao .. .. .	140
441.2	680	Bruenn .. .. .	142
447.8	670	Paris .. .. .	144
450	666	Rome .. .. .	144.5
454.5	660	Stockholm .. .. .	146
461.5	650	Oslo .. .. .	147.5
462	649	Barcelona .. .. .	148
468.8	640	Langenberg .. .. .	151
476.2	630	Lyons .. .. .	152
483.9	620	Berlin .. .. .	154
491	610	Daventry (5GD) .. .. .	155.5
500	600	Aberdeen .. .. .	157.5
508.5	590	Brussels .. .. .	160
517.2	580	Vienna .. .. .	162
535.7	560	Munich .. .. .	165
1070	280	Hilversum .. .. .	57.5
—	—	Unidentified .. .. .	70
1250	240	Berlin .. .. .	97
1604.3	187	Daventry .. .. .	134
1750	170	Radio Paris .. .. .	147

¶ Dial Readings printed in Italics were obtained upon a later occasion since when London was working it was not possible to hear these Stations on the Test Aerial which is, approximately, only 2 miles from the Aerial used by 2 L.O.

¶ Stations printed in black face type are always to be heard in daylight in addition to the Local Station.

¶ Only Dial readings are given for the H.F. Condenser for the reason that this stage remains considerably more constant than that of the Aerial.

With only two dials it is quite a simple matter to bring and to maintain the Aerial Condenser in step.

¶ The above test report was taken with Lewcos Coils in the Receiver.



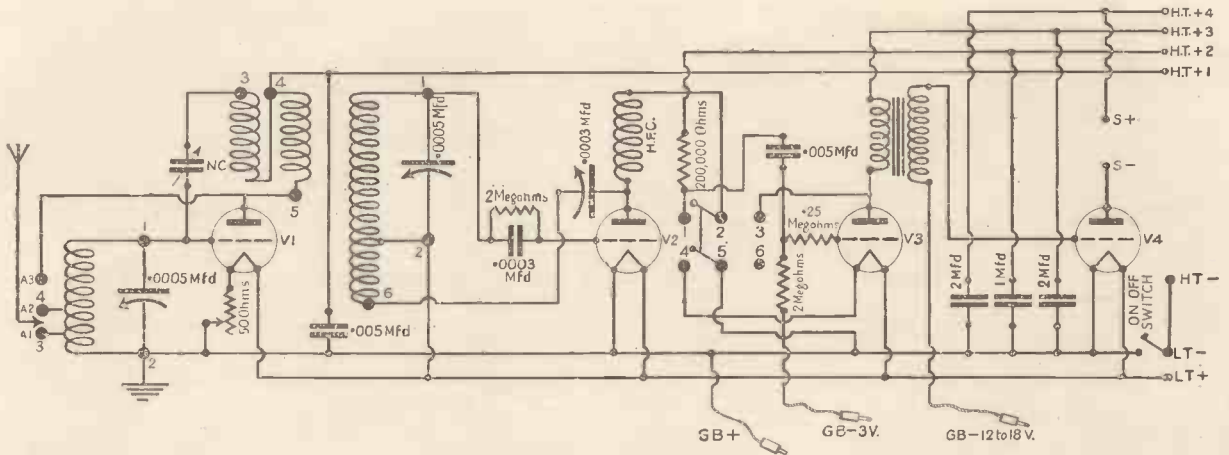

It should be remembered that this diagram shows only one anode resistance to the value of 200,000-ohms. Constructors of the set from a new kit of parts should only purchase one of this value. Full direction on wiring this into circuit is dealt with in the text. Readers changing over from the Nelson P.M. to the Nelson P.M. de Luxe will connect up the two 100,000 ohm resistance in series, as shown by the blueprint.

**The recommended Mullard P.M. Master Valves for use in the Nelson P.M. de Luxe.**

- For 2-volt L.T. Supply:—**
  - V1 1st H.F. Valve: P.M. 1 H.F.
  - V2 Detector Valve: P.M. 1 A.
  - V3 1st L.F. Valve: P.M. 1 L.F.
  - \*V4 2nd L.F. Valve: P.M. 252.
- For 4-volt L.T. Supply:—**
  - V1 1st H.F. Valve: P.M. 3.
  - V2 Detector Valve: P.M. 3A.
  - V3 1st L.F. Valve: P.M. 3.
  - \*V4 2nd L.F. Valve: P.M. 254.
- For 6-volt L.T. Supply:—**
  - V1 1st H.F. Valve: P.M. 5X.
  - V2 Detector Valve: P.M. 5B.
  - V3 1st L.F. Valve: P.M. 5X.
  - \*V4 2nd L.F. Valve: P.M. 256.

\* The foregoing list of recommended P.M. Valves includes a Mullard P.M. Super-power Valve for the Second L.F. valve in each voltage range. Such a valve is definitely advised for the reason that an enormous degree of amplification is obtained from the three previous stages. While the P.M. 2, the P.M. 4 or the P.M. 6 are able to handle moderate volume, those of our readers who are lucky enough to be able to call upon more than 100 volts high-tension supply should invest in the more suitable valve for the output of their receiver.

With less than this value of H.T. one is unfortunately deprived of using the best output valve the British Radio Industry has so far in manufacture. The real remedy lies, of course, in fitting yourself up with a Mullard P.M. H.T. Supply Unit, which delivers 150 volts on the maximum voltage tapping. This value coupled with 20 to 22 volts negative grid bias provides an ideal potential to the P.M. Super-power valve.

If one is really striving for quality, there is but little room for choice, as an evening's experiment on the L.F. side of your set will demonstrate.

Without one of the P.M. Series of R.C.C. Valves for the detector stage a loss of amplification and quality will result. There is no doubt in our minds that this series of P.M. Valves has given to R.C.C. every fraction of the popularity which it enjoys to-day. The old idea that a satisfactory degree of amplification could not be obtained with this L.F. system does not hold true to-day. Experiment with the detector valve in the Nelson P.M. de Luxe will bring about poor results, which only the use of the correct P.M. valve will remedy.

Then there is another point concerning the high-frequency valve, which is no less important if a performance equal to that of the original receiver is desired.

Most valves look alike—a bulb, a cap, four pins and so on; but do not be misled into believing that any old valve will give you distance—because it just won't. Valves may look alike but if you are after a goodly number of stations at respectable volume use the recommended P.M. valve for the job. It is the shortest cut to a satisfactory performance. In the main almost every reader of *Radio for the Million* has already experienced this for himself (or herself).

**Apparatus**

The apparatus required to construct the Nelson P.M. de Luxe is detailed in this list. It will be noted that certain items are additional to the original list of parts specified for the Nelson P.M. in the first issue of *Radio for the Million*. Examination shows these to include Mullard Mansbridge Condensers which are shunted across each H.T. Tapping, and Panel Brackets.

In the Nelson P.M. de Luxe we have used the new R.I.-Varley Straight-Line Power Transformer in place of the R.I. Multi-Ratio, so that readers who are purchasing new components may take advantage of this Company's new product. This same remark also applies to the High-Frequency Choke.

No.	Component.	Maker.	Price.
1	Cabinet (Nelson)	Camco	£ 2 s. d.
1	Baseboard (Nelson)	Camco	2 6
1	Panel (21 in. × 7 in. × 1/4 in.)	Camco	12 3
1	Terminal Strip (20 in. × 2 in. × 1/4 in.)	Camco	3 4
1	Wire Wound Resistance (200,000 ohms), with holder	Mullard	9 6
2	Grid Leaks (2 megohms)	Mullard	5 0
1	Resistance, leak type (.25 megohms)	Mullard	2 6
2	Grid Leak Holders	Mullard	2 6
1	L.F. Transformer	R.I.-Varley	1 5 0
2	Mansbridge Condensers (2 mfd.)	Mullard	10 0
1	Mansbridge Condenser (1 mfd.)	Mullard	4 0
3	Fixed Condensers (two .095 mfd., one .003 mfd.)	Mullard	8 6
3	S.L.F. Variable Condensers (two .0005 mfd., one .00035 mfd.)	J.B.	1 13 6
3	Slow-Motion Dials	Ormond	15 0
2	Six-pin Coil Bases	Colvern	3 0
1	Split Primary Transformer (Broadcast Wave)	Lewcos	10 0
1	Split Primary Transformer (Long Wave)	Lewcos	10 0
1	Tapped Aerial Coil (Broadcast Wave)	Lewcos	6 0
1	Tapped Aerial Coil (Long Wave)	Lewcos	6 0
4	Valve Holders	Lotus	10 0
1	Neutralising Condenser	Gambrell	5 6
1	Panel Mounting Rheostat (50 ohms)	Igranic	2 6
1	Double Pole Double Throw Switch	Lotus	4 0
1	High-frequency Choke	R.I.-Varley	9 6
5	Wanderer Plugs, 2 red, 3 black	Lisenin	10
13	Terminals, A.1, A.2, A.3, E., L.T. +, L.T. -, H.T. -, H.T. +, H.T. + 2, H.T. + 3, H.T. + 4, S+, S-		
1	Pair Panel Brackets	Belling & Lee	6 6
1	L.T. on-off Switch	Camco	2 0
2	Grid Bias Batteries (9 volt)	Igranic	4 9
	Quantity of Self-Soldering Wire	Hellesen	4 0
		Junit	



# Step-by-Step Wiring

**Wire**

- No.**
- 1 Connect together F+ terminals of all four valve holders, and on to terminal L.T.+.
  - 2 Connect right-hand terminal of filament rheostat R.1 to all three dial earthing terminals D.1, D.2 and D.3, and on to F- terminal of valve holder V.4.
  - 3 Connect left-hand terminal of rheostat R.1 to F- terminal of valve holder V.1.
  - 4 Connect wire No. 2 to F- terminal of valve holder V.2.
  - 5 Connect wire No. 2 to tag No. 5 of switch S.1.
  - 6 Connect wire No. 2 to top terminal of switch S.2.
  - 7 Connect tag No. 4 of switch S.1 to F- terminal of valve holder V.3.
  - 8 Connect tag No. 3 of switch S.1 to terminal A of valve holder V.3 and on to terminal No. 3 of transformer T.1.
  - 9 Join terminal nearest panel of resistance R.3 to terminal nearest panel of condenser C.7.
  - 10 Connect wire No. 9 to tag No. 1 of switch S.1.
  - 11 Connect tag No. 2 of switch S.1 to top terminal of H.F. choke.
  - 12 Connect terminal F of variable condenser C.3 to bottom terminal of H.F. choke and on to terminal A of valve holder V.2.
  - 13 Connect terminal S- to terminal A of valve holder V.4.
  - 14 Connect socket No. 4 of coil base H.2 to right-hand tag of condenser C.6 and on to terminal H.T.+1.
  - 15 Connect terminal A.1 to socket No. 3 of coil base H.1.
  - 16 Connect terminal A.2 to socket No. 4 of coil base H.1.
  - 17 Connect terminal A.3 to terminal A of valve holder V.1.
  - 18 Connect wire No. 17 to socket No. 5 of coil base H.2.
  - 19 Connect terminal F of variable condenser C.1 to socket No. 1 of coil base H.1.
  - 20 Connect wire No. 19 to terminal G of valve holder V.1.
  - 21 Connect wire No. 19 to top terminal of neutralising condenser C.5.
  - 22 Connect terminal E to socket No. 2 of coil base H.1 and on to wire No. 2.
  - 23 Connect wire No. 22 to terminal M of variable condenser C.1.
  - 24 Connect bottom terminal of neutralising condenser C.5 to socket No. 3 of coil base H.2.
  - 25 Connect socket No. 2 of coil base H.2 to wire No. 1 and on to terminal M of variable condenser C.2.
  - 26 Connect terminal G of valve holder V.2 to right-hand tag of grid condenser C.4 and grid leak R.2.

**Wire**

- No.**
- 27 Connect terminal F of variable condenser C.2 to socket No. 1 of coil base H.2.
  - 28 Connect wire No. 27 to left-hand tag of condenser C.4 and grid leak R.2.
  - 29 Connect terminal No. 6 of coil base H.2 to terminal M of variable condenser C.3.
  - 30 Connect terminal nearest panel of resistance R.4 to terminal furthest from panel of resistance R.3.
  - 31 Connect terminal G of valve holder V.3 to terminal nearest panel of grid leak R.6.
  - 32 Connect other terminal of grid leak R.6 to terminal nearest panel of grid leak R.5 and on to terminal furthest from panel of condenser C.7.
  - 33 Connect left-hand tag of condenser C.6 to left-hand tag of condenser C.10 and on to left-hand tag of condenser C.8 and right-hand tag of condenser C.9.
  - 34 Connect terminal furthest from panel of resistance R.4 to right-hand tag of condenser C.10 and on to terminal H.T.+2.
  - 35 Connect terminal H.T.+3 to right-hand tag of condenser C.8.
  - 36 Connect wire No. 35 to terminal No. 6 of transformer T.1.
  - 37 Connect terminal H.T.+4 to left-hand tag of condenser C.9 and on to terminal S+.
  - 38 Connect terminal H.T.- to wire No. 33.
  - 39 Connect terminal H.T.- to terminal L.T.- and on to bottom terminal of switch S.2.
  - 40 Connect terminal No. 5 of transformer T.1 to terminal G of valve holder V.4.
  - 41 Connect short-circuiting link between terminals 1 and 2 of transformer T.1.
  - 42 Connect a length of flexible wire 9 ins. long, fitted with a red wander plug (G.B.+ ) to wire No. 33.
  - 43 Connect a length of flexible wire 9 ins. long fitted with a black wander plug (G.B.-1) to the terminal furthest from panel of grid leak R.5.
  - 44 Connect a length of flexible wire 9 ins. long fitted with a black wander plug (G.B.-2) to terminal No. 4 of transformer T.1. A short flexible wire with a wander plug at each end is necessary for connecting the two grid bias batteries in series.

NOTE.—The transformer T.1 mentioned above is the latest type of 'R.I.-Varley Intervalve Transformer. For the benefit of those who desire to use alternative types of transformers we give the following information—  
Some transformers have four terminals marked IP, OP, IS, OS.  
Others have four terminals marked Anode, H.T.+ , Grid Bias, Grid.

The ordinary R.I. multi-ratio has six terminals marked PO, P1, P2, SO, S1, S2. Where we mention terminal No. 3, the equivalents of other types are terminals marked IP, Anode and P2. Where we mention terminal No. 6, the equivalents are terminals marked OP, H.T.+ , and PO. Where we mention terminal No. 4, the equivalents are terminals marked IS, Grid Bias and S2. Where we mention terminal No. 5, the equivalents are terminals marked OS, Grid and SO

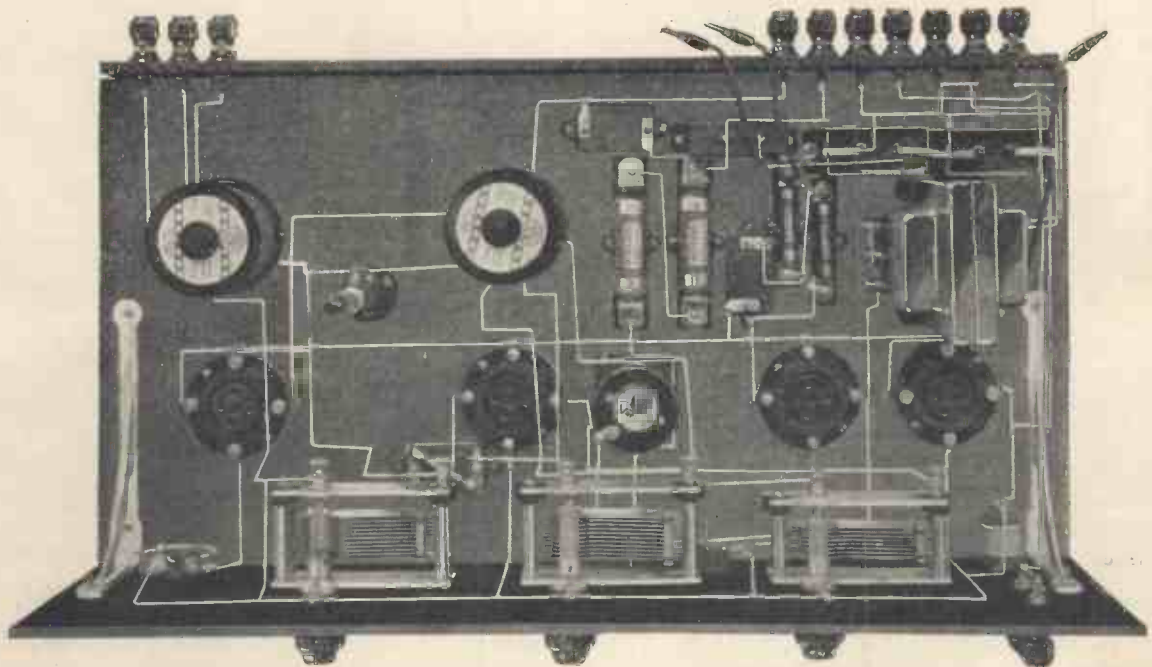

The disposition of the components is made quite clear and easy to follow by this illustration.

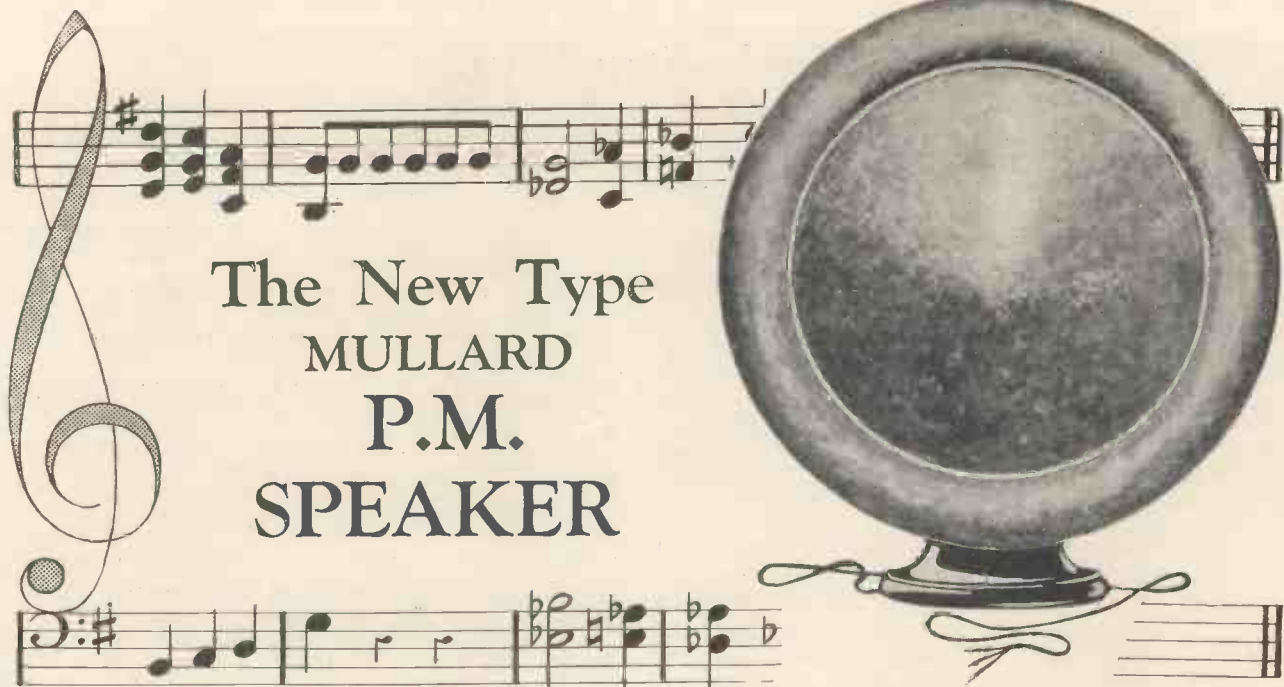

# The New Type MULLARD P.M. SPEAKER

Some few months have elapsed since the publication of the March issue of *Radio for the Million* in which was published the Editor's review of the P.M. Speaker. It must now be told that the impressions of the P.M. Speaker which were recorded in that number were of a spontaneous nature. That particular issue was due for press long before it was possible to have formed any matured ideas of the fundamental qualities which, during the ensuing period, the P.M. Speaker has revealed itself to possess.

A little mental arithmetic will supply the present reader with the total number of hours over a period of six months, during which the P.M. Speaker could reproduce broadcast music, allowing upon an average three hours' reception every night. Approximately, the figure lies very near five hundred and fifty hours, which is about the number that might be considered to equal the normal radio owner's listening time over the summer season.

Not much doubt but that this period would be sufficient to produce very dogmatic opinions upon any question far more intricate and complicated than the intrinsic merits of the P.M. Speaker.

## The one tangible thing

But too great an importance may not be attached to this question of choosing a speaker. After all is said and done, it is the speaker with which one is in closest contact. Radio reception means nothing and is nothing until the received impulses are applied across the terminals of the Speaker.

An entire fortune could be spent upon the erection of an aerial system and upon the purchase of a radio receiver, but it would not count for much if the final translation of electrical impulses into sound was left to a nondescript speaker.

The bearing of the speaker upon radio enjoyment is not to be exaggerated, nor is it in any way whatsoever possible to give too much attention to its choice. The speaker is the

one tangible thing connected with a radio set; damage it, and operation is hampered. One knows it; one is able to hear that it has suffered some damage. This audible sign brings the listener into tangible touch with radio.

The speaker alone makes radio the intricate joy it is to-day if one might put it that way. The musically perfect low-frequency amplifier might as well not exist if its qualities are to be mutilated by the musically imperfect interpretation of the speaker.

Whether high-brow or low-brow, it is the sense of reality for which one aims. Readers of *Radio for the Million*, we are sure, are no longer satisfied with a jumble of sounds which by a superhuman effort of the imagination may be heard as music.

Of course, it is not music at all—nothing like it or approaching it. Make a visit to the Queen's Hall or to the Savoy Hotel and judge for yourself. Mark you, it's not the fault of radio, for you may be assured that the British Broadcasting Corporation transmit radio of an extraordinarily high quality, as every good receiver in conjunction with a P.M. Speaker reveals.

## Add a stage of H.F.

It has been said that some speakers operate from any old set; that is an opinion which is true as far as it goes. Where does poor radio reproduction begin? Not before the rectifying valve! Excessive use of reaction is one great culprit, but this is not without a very effective remedy. One or two H.F. valves will put that matter right just so long as precautions are taken to keep any H.F. out of the L.F. Stages.

The greatest offender is this latter part of the radio set. Honestly—and it's true through every phase of life—one cannot extract more from a radio set than one puts in. Construct a receiver of poor equipment and one will obtain poor results and it may be taken that the nearer the Speaker is

Gosport, Hants.

*I should like to tell you how delighted I am with your P.M. Speaker which I recently purchased. I chose it out of 6 different makes, ranging in price from £5 to £12, I had on trial with my 5-Valve Receiver (the L.F. side of which I have converted to R.C. (from transformer) using your wire-wound resistances); the reproduction is in my opinion wonderful, the undistorted volume, if required, is enough for a large hall, yet the Speaker is very sensitive, making it ideal for distant work.*

E. B. R.



musically perfect the more horrible and frightful will be the resultant medley of sound.

Remember that little point; it is rather important. Musically imperfect speakers are equally bad on good or poor sets—the final reproduction may contain rhythm—not much else.

A musically perfect speaker singles out the imperfect last valve and the imperfect inter-valve coupling apparatus. Of course, it will sound horrible—the more faithful the speaker in its interpretation of the applied signal voltage the greater the horror.

Having taken care to purchase good components for your set, do not make it just like any previous set by connecting up the old speaker—purchase a P.M. and enjoy real radio for the first time in your life.

### The new Mullard Speaker

Visitors to the Radio Exhibition at Olympia will see on show the new P.M. Speaker which is designated as Type E. This model has been produced to enable everyone to enjoy the new conception of radio reproduction which the P.M. Speaker gives.

This new world of radio—for a new world it is—requires no musical knowledge to inspire appreciation. Nor is it necessary to wonder whether or no it is a new world. From the very first moment of switching-on, a new kind of radio music is heard infused with life and character. This reality of musical reproduction is not only a first impression.

In our preliminary remarks we have stated that six months have elapsed since the Mullard P.M. Speaker came into our possession, and although other types of speakers are available, the P.M. Speaker is now always preferred. It may have been assumed by our readers that in our case a high degree of musical quality is the first desirable thing for a radio receiver, in personal use.

### An unqualified choice

Without exception friends who have heard the P.M. Speaker for the first time unhesitatingly exclaim, "The best speaker we have ever heard!" As a further test upon outside opinion, a whole group of Speakers were connected in turn to a receiver, and two friends visiting on that particular evening gave an unqualified choice in favour of the P.M. Confirmation of these tests have been received from every part of the country, and reports show that "to hear a Mullard P.M. Speaker is to own it."

This is the way to purchase a speaker: go to your local dealer and ask for a demonstration of the Mullard P.M. Speaker and whatever the weight of your purse, whether £3 5s. or five guineas heavy, the P.M. Models will come up to the expectations for which this review leads you to hope.

If you are able to persuade your local dealer to allow you to test the instrument at home, so much the better, as you will then be in the happy position of hearing the P.M. Speaker under the varying conditions which obtain during the course of an evening's programme. You will then have the entrancing experience of listening, not to a miscellany of

sounds which have neither character nor tonal quality, but to a clearly defined outline of music which attracts with no less power than any original performance.

You are not asked to analyse the music you hear—with the P.M. Speaker one does this unconsciously, and it is this unconscious analysis that gives to Mullard P.M. radio music the sense of original hearing without which radio is stripped of its entertainment.

### Musically predominant

The Popular Model, listed at £3 5s., possesses the same characteristics as the more expensive model. Viewed from the musical angle there is not a shade of difference between the two models. A very slight advantage on the count of overall performance is held by the five-guinea model; but, after all, this is to be expected from a more expensive instrument.

The fact that both models are highly responsive to harmonics is the reason for their musical predominance. To this sensitivity to harmonics may be attributed the irresistible attraction by which everyone is impressed.

In the past we all have been too prone to accept the next best thing and, for that matter, no less conscientious in acquiring the conviction that reproduction was much better than we knew it really to be. We have been satisfied with mediocre music; lack of tone has been unconsciously supplied by our imagination. Violins have become violins only after our minds have added the characteristic tone of the violin to the sound heard.

### Responsive to harmonics

This example has been the case throughout the full range of musical instruments. To any person who was not familiar with the individual characteristic tonal qualities of orchestral instruments it would be rather illuminating for them afterwards to hear the actual orchestra. Little doubt but that such a person would experience no small surprise after a demonstration of this kind.

The world of difference between the old reproduction with which we have been too long satisfied and the new conception provided by each of the two P.M. Speakers is easily appreciated. Technically, it is the ability to reproduce the infinite variety of harmonics which distinguish instrument from instrument and voice from voice. Non-technically, it is because the P.M. Speaker is responsive to all the delicate

tonal shadings which differ with every musical instrument and with every human voice!

The Mullard P.M. Speaker was designed with that object in view—that the designers have been successful has afforded the world the opportunity to hear and to enjoy music as never before, whether this be from a radio receiver or from the gramophone record.

Cinderford, February 28th, 1927.

Sirs,—I have given your P.M. Speaker an extremely critical test since receiving it, and now I really believe that it is the best so far produced. At any rate, it is the best I have had the good fortune to hear or test. All you claim on your pamphlet is carried out and fully justified on actual test.

On a variety programme, every word, and every consonant in every word, is clearly reproduced, and so the wit and humour were communicated to the listeners quite easily without any strained effort to catch the exact words in order not to miss the point of whatever joke was going. "Hollowness" is entirely absent, and there is no directional "hooter" or megaphone effect.

I cannot find the least fault with the reproduction of music of any kind. The distinctive sound of every instrument appears to be given with all clarity, and the way in which the sound is distributed gives a most pleasingly natural effect.

The volume with which it can deal is astonishing, whilst at the other end of the scale its sensitivity is beyond reproach. Last night, for instance, I received G5KH on 45 metres (120 miles) giving speech and music at low power, at full Speaker strength.

Your P.M. Speaker has now taken the place of my old favourite (which cost £8 10s.) on my private receiver, and my old stager, with which I have so far had no fault whatever to find, and for which I believe I had a real affection, has now gone the way of all things, and has been sold.

A. B. C.

The Editor

# The RALEIGH P.M RECEIVER Five P.M.valves bring in every "Prom"

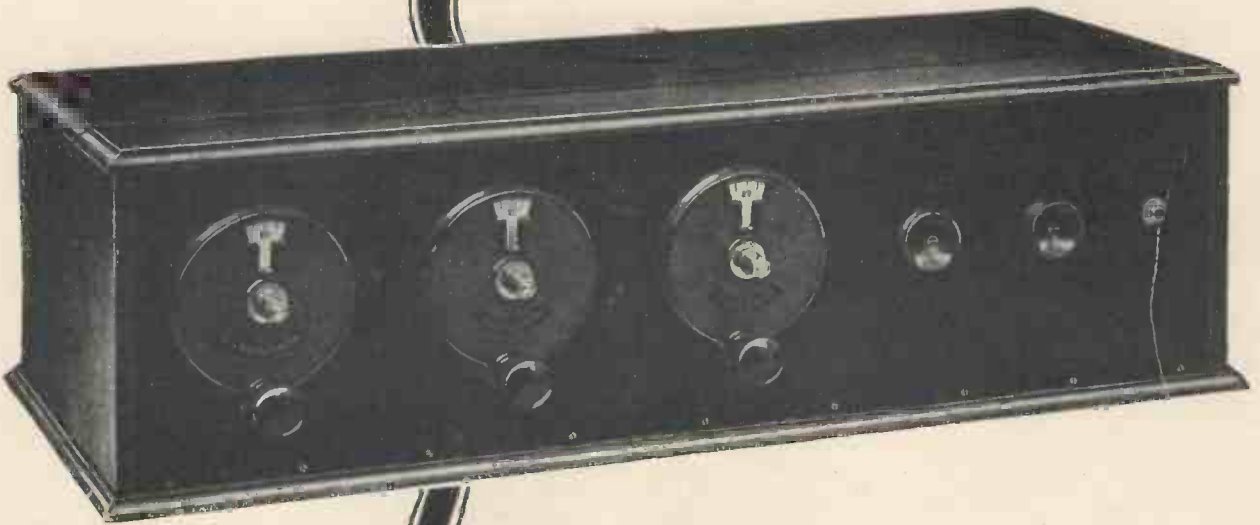

Although this receiver costs to build a few shillings more than you may have allowed for your winter set, do not hesitate at that. From the view point of performance—and, after all, that is what counts—it is easily worth the outlay for two three-valve receivers.

"I must confess that the final test upon this receiver was a revelation in the capabilities of a five-valve receiver. So utterly simple to handle, it was extremely difficult to believe that a small aerial in Hampstead could bring in a matter of forty odd stations without the slightest demand upon tuning skill. It was infinitely easier to bring in those forty or more stations on this receiver than any reader would believe. I cannot recall a set which in any way approached it for volume and absolute ease of control. It is held that four valves constitute the ideal arrangement; but since this test I am convinced that every home constructor, after having had the opportunity to 'run over the dials' of a friend's Raleigh P.M., will find his ideal in this great set . . . ."

—An extract from the EDITOR'S REPORT.



**A great set**

WITH these introductory remarks running through our mind we are trying to visualize at the same time what is your first impression of the Raleigh P.M. If it agrees with the impressions of those who have taken a peep at the set during the various tests, then we shall not be very far wrong in our assumptions on your account.

Truly it is a great set—a gloriously efficient set.

And one is rather compelled to wish that all our readers could be afforded an opportunity of hearing and judging the receiver for themselves.

Although such a suggestion is not practicable under present arrangements, it is felt that good reports of the Raleigh P.M. will soon be passed on from one radio owner

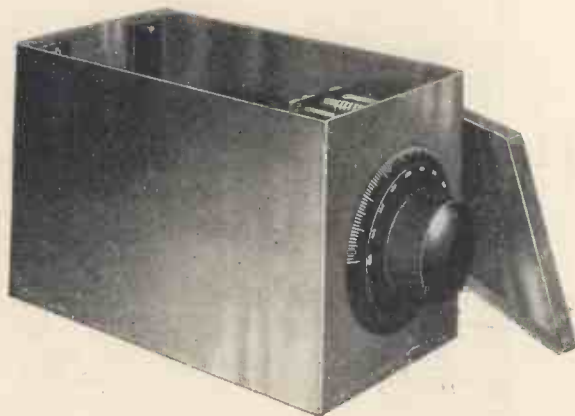

to the next and whatever public demonstrations might be proposed, the experience of other readers will reach you first.

Here in the Raleigh P.M. Receiver the radio owner has every radio wish fulfilled. In the ownership of this set the radio enthusiast has nothing more for which to wish. If, therefore, with every radio desire gratified, your hobby holds out no further charms, do not consider building the Raleigh P.M. Receiver.

Thus are our impressions summed up, in a few words which in themselves are meaningless but to the true radio enthusiasts. Every radio wish fulfilled . . . distance—to the very edge; volume—to fill the house and the one next door; purity—to give radio the breath of life.

That is the Raleigh P.M. Receiver. That describes its performance.

It was nothing if not extremely impressive to be comfortably seated on a chair drawn up to the test bench and with no more mental or physical effort than maintaining three dials in step to produce the test report published in this issue. Few sets, if any, could boast of a performance equal to that!

Has not the vision of such a set filled your mind's eye from time to time? Would not radio be just your greatest joy if you owned a set such as this?

**Two Mullard H.F. Valves**

The great set of your mind's eye is the Raleigh P.M. The Free Blueprint simplifies building to a degree that everyone may duplicate the original set wire for wire without the least difficulty.

With the set in your possession you will be no less amazed than we ourselves at the remarkable power which its five valves have at their command. It is hardly creditable that two high-frequency stages are able to reach out from a comparatively badly screened corner of London to any part of Europe as one feels inclined to direct them.

Yet it is definitely the case, as hearing is believing. On the long waves one journey round the dials brought in eight stations; most other sets satisfy themselves with four. As a matter of interest, previous to testing the Raleigh P.M. Receiver we, ourselves, were satisfied with four. It happens that our standard of performance now calls for a hundred per cent. increased efficiency on the long waves. Haphazard treatment of the long waves deprives the radio owner of stations worth listening to, and it is with no small amount of gratification that we publish the constructional details of the Raleigh P.M. Receiver, since we know as the result of tests that contrary to usual experience its long wave tuning curve is dotted with stations to no less an efficient degree than the broadcast waveband.

**Immense Volume**

Passing to the 200 to 550 metre waveband performance of the Raleigh P.M. it is equally as remarkable. Stations such as Langenberg, Brussels, Frankfurt-on-Main, Nuremberg, 5 G.B., Bruenn, Stuttgart, Toulouse, Munich, Muenster, Berne, Hamburg, Rome and Madrid simply break through like an immense volume from a suddenly-opened swell-box of a great cathedral organ.

This is an experience which occurs over the whole tuning range of the condensers. Mark you, it is not confined to those stations which are known to be working on very high power but is also extended to such transmissions as are not often heard, for reasons of their limited power.

As most of us know, the majority of sets are good for fifteen or so stations at respectable strength. While they will pull in twenty others under favourable conditions, really one's family does not enjoy the ultimate reproduction obtained. And for that matter no radio owner himself is altogether satisfied with such a performance which leaves so much room for improvement. One need not go very far to find a remedy.

**Entertain the family**

If your radio set is to provide your family with a variety of distant programmes at a volume as intensive as the local, it should embody not less than two high-frequency valves. For the satisfaction of mere reaching out, one H.F. stage is ample—but one cannot expect one high-frequency valve to supply programmes from forty to fifty stations at such strength as will entertain one's family.

The illustrations on this page show two views of the screened units used in the Raleigh P.M. Receiver. The arrangement of complete stage screening adds not a little to the amazing performance of this receiver.

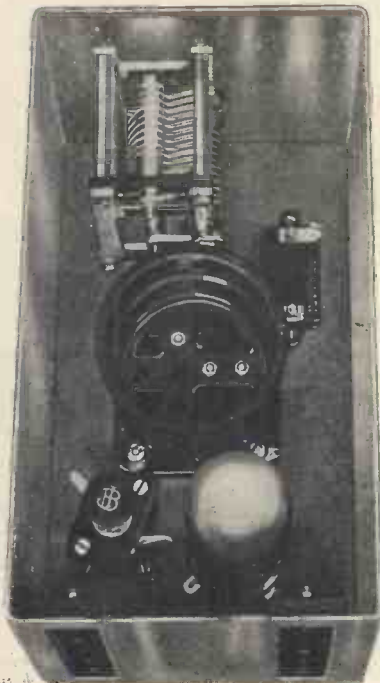

Radio human nature is almost satisfied at having pulled in a distant station—the absence of volume does not take away one scrap of the pride which is justly felt upon these occasions. But everyone must admit that the family do not share the enthusiasm. They are unmoved by our legitimate excitement. "Let's have London" is their only comment, as much as to say "leave the radio alone. For goodness sake sit down and let us have some music." To abbreviate a long story, the trouble with most of us is just simply that we are attempting the impossible in having a solitary H.F. valve.

Imagine how much greater one's radio enjoyment would become if possessed of a set equal to the Raleigh P.M. Once and for all radio from the Continent would find a welcome with all the members of your family. Their prejudice against "foreign stations" which you have almost despaired of ever breaking down, would vanish during your first half-an-hour's test. Think of the untold pleasures to which you will be able to treat them and your friends.

No difficulties should be encountered in laying-out the L.F. side of the Raleigh P.M. which is shown in the above reproduction. The bank of Mullard Mansbridge Condensers plays an important part in the successful performance of the set, as also does the P.M. R.C.C. Unit.

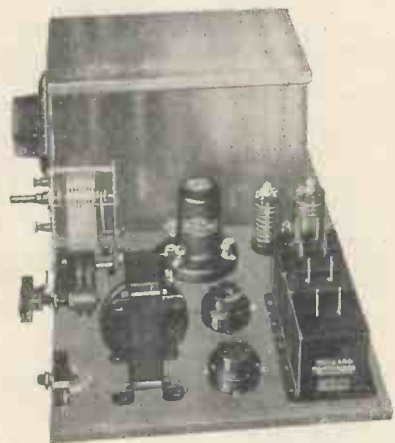

Personal pride

Then lastly—and we hope it is not the most important point of view—there is your own personal satisfaction and pride in the ownership of a great set.

In other walks of life we admire the master craftsman. We dabblers in craftsmanship excuse the mediocrity of our efforts by quarrelling with our tool-kit. It is true the master never finds fault with his workshop equipment—but he knows at least one very important thing. It is that the execution of good work demands the use of good tools in addition to the master touch. The one-string fiddle may be persuaded to produce wonderful music but where is the musician who would prefer such an instrument to the four-stringed violin? What audience would be inspired to a similar degree of enthusiasm about each? Would not they also prefer the more versatile instrument of the two?

Employ a Franklin P.M. or Hawkins P.M. for the reception of local station, either are admirably suited for the purpose. Where a variety of stations are required, where you wish these stations to come over indistinguishable in volume from the local station, use the Raleigh P.M.

You may be certain of one thing, that excluding your fellow enthusiasts who also own a Raleigh P.M. Receiver, your radio set will give a better performance than any receiver in the neighbourhood.

Components

In this list we print the names and makers of the components used in the receiver appearing in the photographs. Deviation from the various makes mentioned may be made, but it is not recommended, since the choice of the apparatus has a considerable bearing not only upon the performance of the set but also upon its construction and operation.

No.	Component.	Maker.	Price.
			£ s. d.
1	Cabinet	W. H. Agar	2 16 0
1	5-ply Baseboard 26 in. x 10 in.	W. H. Agar	2 6
3	5-ply Screen Baseboards	W. H. Agar	1 6
1	Panel (26 in. x 7 in. x 1/8 in.)	Radion	17 6
1	Ebonite Terminal Strip (6 in. x 2 in. x 1/2 in.)		2 0
3	Log-mid Line Variable Condensers (-0005 mfd.)	Cyldon	3 16 6
1	S.L.F. Variable Condenser (-0003 mfd.)	Cyldon	10 6
3	Indigraph Vernier Dials	Igranic	1 2 6
1	L.F. Transformer (4 to 1)	Pye	17 6
3	Six-pin Coil Bases	Lewcos	9 0
3	Metal Screens with Terminal Strips and Terminals	Colvern	2 15 6
1	Set of Raleigh Short Wave Coils	Colvern	1 13 6
1	Set of Raleigh Long Wave Coils	Colvern	1 8 6
2	Neutralising Condensers	J.B.	7 0
1	High-frequency Chokey	Climax	8 6
5	Anti-Vibratory Valve Holders	Pye	11 3
1	Filament Jack	Lotus	2 6
1	Speaker Plug	Lotus	2 0
1	Double Pole, Double Throw Switch	Wilkins and Wright	3 6
1	P.M. R.C.C. Unit	Mullard	17 6
1	Grid Leak (5 megohms)	Mullard	2 6
1	Grid Leak Holder	Mullard	1 3
3	Fixed Condensers (two .005 mfd., one .0003 mfd.)	Mullard	8 0
3	Mansbridge Condensers (2 mfd.)	Mullard	15 0
1	Mansbridge Condenser (4 mfd.)	Mullard	10 0
5	Wander Plugs, 2 red, 3 black	Lisenin	10
2	L.T. Spade Terminals, 1 red, 1 black	Lisenin	8
9	Terminals, A, E, L.T. - , L.T. + , H.T. - , H.T. + 1, H.T. + 2, H.T. + 3, H.T. + 4	Belling & Lee	4 6
24	B.A. Terminals, with Nuts and Washers		
	Quantity of Self-Soldering Wire	Junit	



Before proceeding with the construction of the screened units the components for each should be collected together as shown in the above illustration.



Reaction seldom necessary

Although reaction control has been incorporated in this receiver, it will seldom be found necessary to use it, for the pulling power of the two high-frequency valves is so great as to make the use of reaction unnecessary except on very weak or far-off stations.

Two stages of L.F. amplification are employed and even then, on numerous transmissions the output from the receiver is greater than required. The first stage is resistance-capacity coupled while transformer coupling is used for the second stage. A switch enables either one or two L.F. stages to be used at will. The aerial lead may be taken straight to the detector if it is desired to cut out both stages of H.F. amplification.

Analysis of the following test report on the Raleigh P.M. will show that more than the usual details are given. The dial calibrations of the set were taken on the evening of August 23rd, 1927. Every reading given, with the exception of those printed in Italics (which were added during the following week-end) was obtained by tuning-in the station and its identity checked up against the Emerald Wavemeter. No use of reaction was made during the whole evening. Stations printed in Black face were received with one L.F. Stage in circuit only.

Metres.	Frequen- cy.	STATION.	Aerial.	1st H.F.	2nd H.F.
—	—	Unidentified	76.5	75	76
1750	171	Radio Paris	71	68.5	65.5
1604.3	187	Daventry	64	59	58
1250	240	Berlin	44	44.5	44
—	—	Unidentified	34.5	35	36.5
—	—	Unidentified	31	32	33
—	—	Unidentified	26.5	29	28
1060	283	Hilversum	25	24.75	25
535.6	540	Budapest	94.5	92	93
535.7	560	Munich	88	89	89
517.2	580	Vienna	85	86.25	86
508.5	590	Brussels	83.5	85	85
491	600	Daventry (5GB)	81	82	83
488.8	640	Langenberg	77	78.5	78.5
461.5	650	Oslo	75.5	77	77
450	666	Rome	73.25	75	75
441.2	680	Breslau	71.5	73.5	73.5
428.6	700	Frankfurt-on-Main	69	71.25	71
422	711	Cracow	68	70	70
411	730	Berne	65	68	67.5
405.4	740	Glasgow	63	67.5	67
400	750	Plymouth	62.5	66	66
394.6	758	Hamburg	62	65	65
392	765	Toulouse	60.75	64	64
384.6	780	Manchester	58.5	62.5	62.5
379.7	790	Stuttgart	58	62	62
361.4	830	London	56	59	57
329.7	910	Koenigsburg	45.5	50	50
326.1	920	Bournemouth	44.5	49	49
322.6	930	Paris	44	48	47
319	943	Dublin	43.5	47.5	46.5
315.8	950	Breslau	42	47	45.5
312.5	960	Newcastle	41	45	45
306.1	980	Belfast	38	44	42
303	990	Nuremberg	37	43.5	40.5
297	1010	Liverpool and Hanover	36	41	41
294.1	1020	Innsbruck	34.5	40	39
288.5	1040	Edinburgh	34	37.5	38
272.7	1100	Sheffield and Cassel	31.5	33.5	32
265.5	1130	Lille	28	31	29.5
260	1154	Toulouse	27.5	28.5	27.5
252.1	1190	Bremen	26	27.5	25
250	1200	Gleiwitz	25	26	25
241.9	1240	Muensten	23	23	20
236.2	1270	Orebro	22.5	20.5	19
215.8	1390	Halmstad	10	8	8

First Evening

Collect together the components required to construct the first H.F. unit. Screw the coil-holder, valve-holder and neutralising condenser to the baseboard in the position shown by the Free Blueprint. Mount the variable condenser and terminal strips in the screening case and insert the terminals.

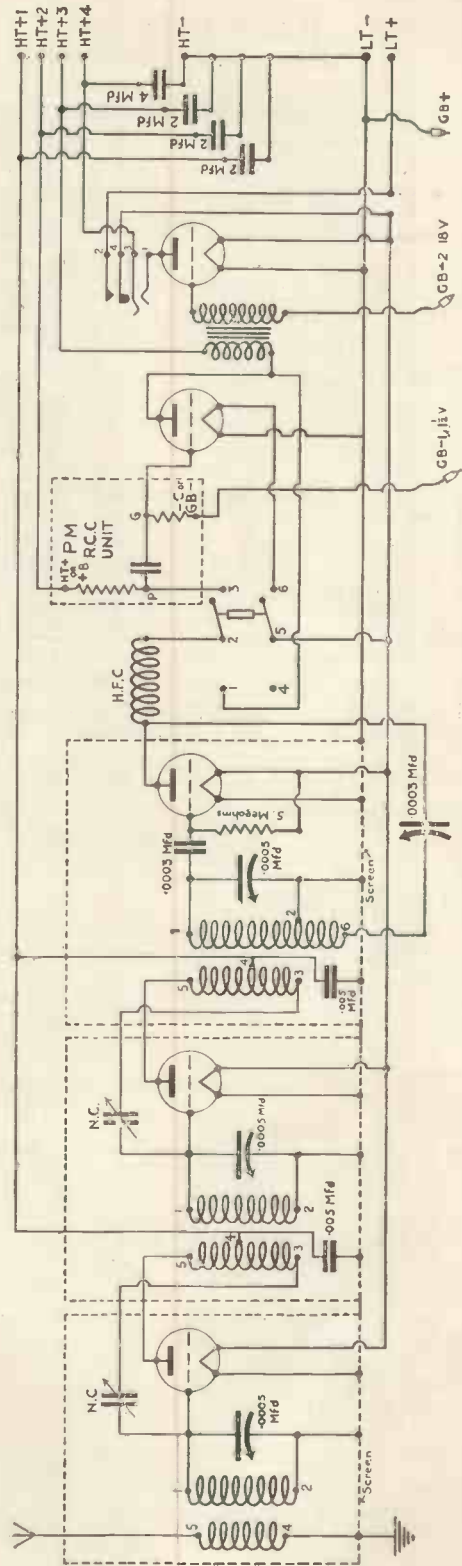

The Circuit diagram for the Raleigh Maillard P.M. Receiver.

**Point-to-Point Wiring**  
**Screen No. 1, 1st H.F. Stage**

- Wire No.
- 1 Connect aerial terminal (terminal strip TS1) to terminal No. 5 of coil holder H1.
  - 2 Connect earth terminal (terminal strip TS1) to F- terminal of valve holder V1.
  - 3 Connect wire No. 2 to nearest point on side of screen No. 1.
  - 4 Connect earth terminal (TS1) to terminal M of TS2.
  - 5 Connect terminal L of TS2 to terminal F+ of valve holder V1.
  - 6 Connect terminal K of TS2 to terminal A of valve holder V1.
  - 7 Connect terminal G of valve holder V1 to terminal F of variable condenser C1.
  - 8 Connect wire No. 7 to terminal No. 1 of coil holder H1.
  - 9 Connect wire No. 7 to bottom terminal of neutralising condenser NC1.
  - 10 Connect together terminals Nos. 2 and 4 of coil holder H1.
  - 11 Connect wire No. 10 to terminal M of variable condenser C1.

**Second Evening**

Collect the components required for the construction of the second H.F. unit and mount the components in their correct positions.

**Screen No. 2, 2nd H.F. Stage**

- Wire No.
- 12 Connect terminal M of TS3 to terminal F- of valve holder V2.
  - 13 Connect wire No. 12 to nearest point on side of screen No. 2.
  - 14 Connect terminal M of TS3 to terminal N of TS4.
  - 15 Connect terminal L of TS3 to terminal M of TS4.
  - 16 Connect wire No. 15 to terminal F+ of valve holder V2.
  - 17 Connect terminal K of TS3 to terminal No. 5 of coil holder H2.
  - 18 Connect terminal L of TS4 to terminal A of valve holder V2.
  - 19 Connect terminal K of TS4 to terminal No. 4 of coil holder H2. and on to nearest terminal of condenser C4.
  - 20 Connect other side of condenser C4 to terminal No. 2 of coil holder H2.
  - 21 Connect wire No. 20 to terminal M of variable condenser C2.
  - 22 Connect terminal F of variable condenser C2 to terminal G of valve holder V2.
  - 23 Connect wire No. 22 to terminal No. 1 of coil holder H2.
  - 24 Connect wire No. 22 to bottom terminal of neutralising condenser NC2.
  - 25 Connect terminal No. 3 of coil holder H2 to top terminal of neutralising condenser NC1 (in screen No. 1). This wire must pass "clear" through the holes in the sides of screen 2 and screen 1, and should preferably be insulated with sleeving.

**Third Evening**

Collect together the components required for the construction of the detector unit as follows:—1 Coil base, 1 Valve-holder, 1 .0003 Grid condenser, 1 5 megohm grid leak and clip, 1 .005 fixed condenser. These components are all mounted on the wooden baseboard which is placed within the screen.

**Screen No. 3, Detector Stage**

- Wire No.
- 26 Connect terminal N of TS5 to terminal O of TS6.
  - 27 Connect terminal O of TS6 to terminal F- of valve holder V3.
  - 28 Connect wire No. 27 to nearest point on side of screen No. 3.
  - 29 Connect terminal M of TS5 to terminal N of TS6.
  - 30 Connect terminal F+ of valve holder V3 to nearest terminal of grid leak R1.
  - 31 Connect wire No. 30 to wire No. 29.
  - 32 Connect terminal A of valve holder V3 to terminal M of TS6.
  - 33 Connect terminal G of valve holder V3 to free terminal of grid leak R1.
  - 34 Connect terminal G of valve holder V3 to nearest terminal of condenser C6.
  - 35 Connect terminal L of TS5 to terminal No. 5 of coil holder H3.
  - 36 Connect terminal K of TS6 to terminal No. 6 of coil holder H3.
  - 37 Connect terminal L of TS6 to terminal K of TS5 and on to nearest terminal of condenser C5.
  - 38 Connect this same terminal of condenser C5 to terminal No. 4 of coil holder H3.
  - 39 Connect free terminal of condenser C5 to terminal No. 2 of coil holder H3.
  - 40 Connect wire No. 39 to terminal M of variable condenser C3.
  - 41 Connect terminal F of variable condenser C3 to free terminal of condenser C6 and on to terminal No. 1 of coil holder H3.
  - 42 Connect terminal No. 3 of coil holder H3 to top terminal of neutralising condenser NC2 (in screen No. 2). This wire must pass "clear" through the holes in the sides of screen 3 and screen 2, and should preferably be insulated with sleeving.

**Fourth Evening**

Drill the panel according to the directions given on the Blueprint. This gives the necessary dimensions for the various holes through which the spindles of the variable condensers pass, and for those also required for mounting the reaction condenser, change-over switch and speaker jack. Fix the panel to the baseboard, place the three copper screens in position and fix them to the baseboard. Mount the three slow-motion dials in position and set them so that when the moving vanes of the variable condensers are fully out, the dials read zero. Mount the remaining components on the panel and on the baseboard.

**L.F. Stages**

- Wire No.
- 43 Connect terminal O of TS6 to terminal HT-.
  - 44 Connect terminal HT- to terminal LT-.
  - 45 Connect terminal LT- to nearest terminals of condensers C10, C9, C8 and C7.
  - 46 Connect terminal F- of valve holder V4 to terminal F- of valve holder V5.
  - 47 Connect wire No. 46 to wire No. 45.
  - 48 Connect terminal G of P.M., R.C.C. Unit to terminal G of valve holder V4.
  - 49 Connect terminal HT+1 to free terminal of condenser C7.
  - 50 Connect wire No. 49 to terminal L of TS6.
  - 51 Connect terminal HT+2 to free terminal of condenser C8.
  - 52 Connect this same terminal of condenser C8 to terminal HT+ (marked +B) of P.M., R.C.C. unit.
  - 53 Connect terminal N of TS6 to tag No. 5 of switch S.
  - 54 Connect wire No. 53 to tag No. 4 of jack J.
  - 55 Connect wire No. 53 to terminal F+ of valve holder V5.
  - 56 Connect tag No. 1 of jack J to terminal A of valve holder V5.
  - 57 Connect terminal G of valve holder V5 to terminal OS of transformer T.
  - 58 Connect terminal A of valve holder V4 to terminal IP of transformer T and on to tag No. 1 of switch S.
  - 59 Connect terminal HT+3 to free terminal of condenser C9 and on to terminal OP of transformer T.
  - 60 Connect terminal HT+4 to free terminal of condenser C10 and on to tag No. 3 of jack J.
  - 61 Connect terminal LT+ to tag No. 2 of jack J.
  - 62 Connect terminal F+ of valve holder V4 to tag No. 6 of switch S.
  - 63 Connect tag No. 2 of switch S to nearest terminal of H.F.C.
  - 64 Connect tag No. 3 of switch S to terminal P of P.M., R.C.C. Unit.
  - 65 Connect terminal M of TS6 to terminal F of variable condenser C11.
  - 66 Connect wire No. 65 to free terminal of H.F.C.
  - 67 Connect terminal K of TS6 to terminal M of variable condenser C11.
  - 68 Connect a piece of flexible wire 9 ins. long to wire No. 44. The free end of this wire should be fitted with a red wander plug marked GB+.
  - 69 Connect a piece of flexible wire 9 ins. long to terminal GB- (marked -C) of P.M., R.C.C. Unit. The free end of this wire should be fitted with a black wander plug marked GB-1.
  - 70 Connect a piece of flexible wire 12 ins. long to terminal IS of transformer T. The free end of this wire should be fitted with a black wander plug marked GB-2.

**External Connections between H.F. and Detector Stages**

- |                                                 |
|-------------------------------------------------|
| Connect terminal K of TS2 to terminal K of TS3. |
| "    "    L    "    TS2    "    L    "    TS3.  |
| "    "    M    "    TS2    "    M    "    TS3.  |
| "    "    K    "    TS4    "    K    "    TS5.  |
| "    "    L    "    TS4    "    L    "    TS5.  |
| "    "    M    "    TS4    "    M    "    TS5.  |
| "    "    N    "    TS4    "    N    "    TS5.  |
- Terminals are placed K, L, M, etc., from top to bottom.

**Fifth Evening**

Complete the wiring of the receiver according to the point-to-point connections. Care should be taken to put them in the correct order.

**Sixth Evening**

The set may now be tested. Connect across from terminal to terminal on the H.F. unit as shown in the photograph taken from the back of the receiver and connect the aerial and earth leads to their respective terminals. Place the valves in their sockets in the set in the order given in the list of valves recommended for use in this receiver. Insert the three short-wave coils, one into each unit. Connect the L.T. negative to the negative terminal, and L.T. positive to the positive terminal of your accumulator. Connect H.T. negative to the H.T. supply by means of a wander plug



inserted in the socket marked H.T. negative. Connect the terminal H.T. + 1 to a tapping on the H.T. supply at about 100 volts. Connect terminal H.T. + 2 to another tapping on the H.T. supply between 60 and 80 volts. The best position for this may be found experimentally. Connect terminal H.T. + 3 to a 120 volt tapping on the H.T. supply and connect terminal H.T. + 4 to the full 150 volt terminal.

Presupposing that a Mullard Super-power Valve is used in the last L.F. stage and with the H.T. voltages recommended above, the grid bias wander plugs should be inserted in the grid bias batteries as follows:—

G.B. positive into the positive end of G.B. battery No. 1.  
G.B. - 1 into the next but one socket of this grid bias battery.

G.B. - 2 into the end socket of the second battery, thus supplying 18 volts negative bias to the last valve.

The negative end of grid bias battery No. 1 must, of course, be connected to the positive end of G.B. battery No. 2, by means of a short length of flex with a wander plug on each end.

Connect the speaker to the plug and insert into the jack. This operation switches the low-tension side of the receiver on and brings the receiver into action. By removing the speaker plug, the set is switched off, thus doing away with the necessity for an additional switch for the low-tension side of the receiver.

**RECOMMENDED P.M. VALVE COMBINATIONS**  
for the Raleigh P.M.

**2 Volt L.T. Supply:—**

- V1 1st H.F. valve: P.M. 1 H.F.
- V2 2nd H.F. valve: P.M. 1 H.F.
- V3 Detector valve: P.M. 1A.
- V4 1st L.F. valve: P.M. 1 L.F.
- V5 2nd L.F. valve: P.M. 252.

**4 Volt L.T. Supply:—**

- V1 1st H.F. valve: P.M. 3.
- V2 2nd H.F. valve: P.M. 3.
- V3 Detector valve: P.M. 3A.
- V4 1st L.F. valve: P.M. 3.
- V5 2nd L.F. valve: P.M. 254.

**6 Volt L.T. Supply:—**

- V1 1st H.F. valve: P.M. 5X.
- V2 2nd H.F. valve: P.M. 5X.
- V3 Detector valve: P.M. 5B.
- V4 1st L.F. valve: P.M. 5X.
- V5 2nd L.F. valve: P.M. 256.

*N.B.—Where not more than 100 volts H.T. supply is available the P.M.2, P.M.4 and P.M.6 should be used in place of the P.M. 252, P.M. 254, and P.M. 256 respectively.*

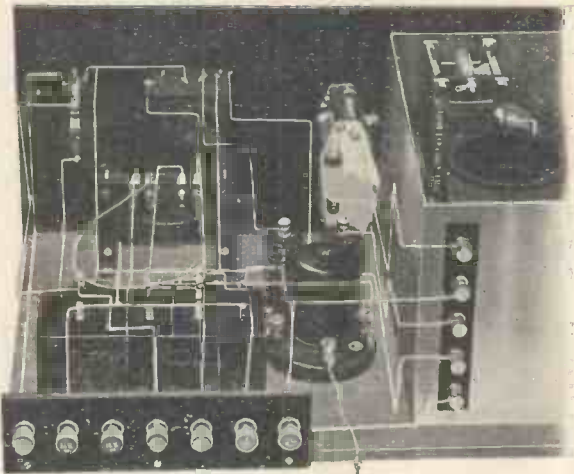

*An illustration showing a view of the low-frequency end of the Raleigh P.M. Receiver, which should prove of considerable assistance during the course of construction.*

**IMPORTANT NOTICE**

**F**OR well-known reasons 2-volt P.M. Valves are the most popular range of valves among radio owners, who, will all be decidedly interested to learn that every P.M. Master Receiver described in this issue was finally approved only after it gave a superlative performance on the 2-volt series of Mullard P.M. Valves.

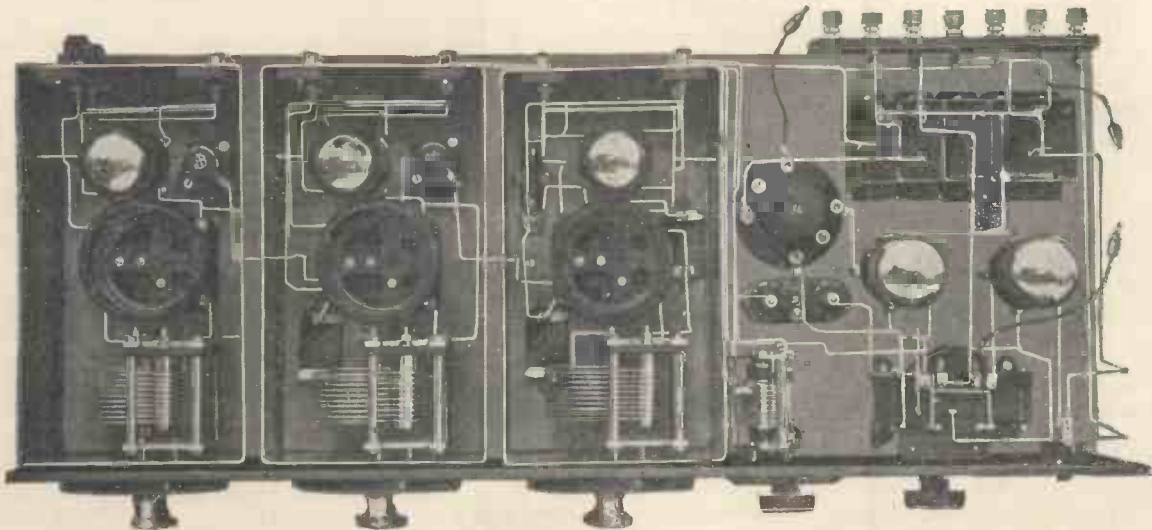

*A complete plan view of the receiver with the lids of the Screens removed. Constant reference to this illustration is advised to avoid any errors in lay-out.*

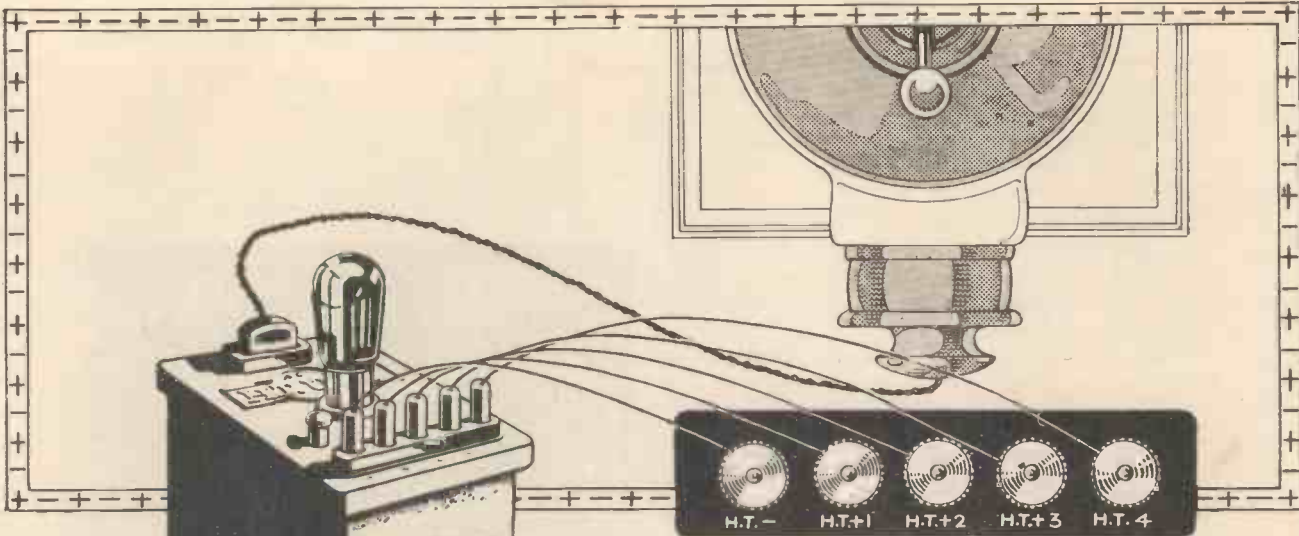

# NOW THE LIGHT SOCKET SUPPLIES THE POWER



The Mullard D.U.2 is the full-wave rectifying valve used in the Mullard P.M. H.T. supply unit.

of a Mullard P.M. H.T. Supply Unit gives its owner.

Nothing is more annoying than to find a frequent renewal of the H.T. Supply imperative to maintain one's receiver in fair running order. In our own experience, the daily drain upon a battery called for a replacement every month; the cost worked out at about six pounds per year for this one item.

## Grossly unfair on the battery

Naturally, the battery was expected to do next to impossible things. For example, to supply current to a nine-valve receiver, the H.T. consumption of which ran very closely to twenty-five milliamps. Obviously, such a treatment was grossly unfair; some other means should have been adopted to provide the high-tension current.

As it was, under those conditions, no alternative was available and the best had to be made of a bad job.

Again, the application of full voltage to any stage of a receiver immediately results, as everyone knows and has most probably observed, in its springing into new life.

"This is great!" one exclaims. Stations which once came over willingly and easily surprisingly resume their former number and strength. Surely it is then that Radio

makes its greatest appeal. Reception from the local station gathers quality and a new timbre which grip the imagination of the most prosaic.

All this jubilation, however, has vanished all too soon. Quality has fallen slowly, with the result that our quickened interest rapidly loses its enthusiasm. The radio set is once more forgotten—one just switches-on—nobody really listens.

One evening, the battery gives up its last ounce of energy and Jack slips up the road for the inevitable replacement.

And so the story goes on—not much different in countless homes where an aerial looks down upon the garden. After all, it is only forgivable where no electric supply is available.

Apart from inability to give its full-rated voltage except for the first few minutes, the dry battery may soon develop a high internal resistance. This is no unusual happening. The breakdown of one cell will be sufficient to increase the internal resistance of a battery to such a degree that any receiver which may be drawing its power from a battery in this state will be hopelessly out of order. Not only will quality have become a mere travesty but volume will also be reduced to almost a whisper. In some cases, sets refuse to function at all under these conditions.

## Neutralise with correct voltages

Furthermore, it would not be incorrect to suggest that many home constructors have given a receiver its maiden trip on a half run down battery, and of course, made the necessary neutralising adjustments upon a virtually low anode voltage to the H.F. and rectifying valves.

There is only one result—the receiver under test performs in a most disappointing manner . . . the last thing about which any one of us might think as being worthy of blame. would be the H.T. battery, hidden away under the table.



Nor does this experience confine itself to that circumstance, for apparent neutralising adjustments on low anode voltages are upset by the application of a higher voltage from a new battery; or, alternatively, the linking up of a new battery delivering something approaching the rated value, sometimes—and we wonder how great this number of times might be—sometimes makes the set refuse to neutralise at all.

All these troubles—not to speak of the constant crackles, annoying sizzles and intermittent bubbling—have been an experience which we are glad remains but a record of our radio history.

The wet or accumulator type of battery, while being a great advance over the dry battery from practically all points of view, brings with it the charging problem—this persistent radio nightmare. It has been our experience to use them, but being made much akin to other human beings, a bank of 100 volts. has lain in a discharged condition for a few days. We confess that the fatigue of carrying them to the charging station was persistently put off until to-morrow—a horrible confession to make. Of course, the cells sulphated and soon we looked upon a ruined battery.

### Choose the mains

One's mother, one's wife—in fact in every home where domestic labour-saving devices have made their appearance—electrically-operated household equipment is preferred. Where is the woman who would not choose the geyser, the gas-cooker, the vacuum cleaner or the electric iron, when once she has enjoyed their usefulness in performing the daily task?

To operate one's radio set from the Mullard P.M. H.T. Supply Unit, inspires an appreciation of a similar kind. It is difficult to realise just how it feels to press down a switch to obtain a goodly supply of H.T. current after having roughed-it with make-shifts and next-best things. It is true the conversion was not altogether an easy one. Someone had whispered of mains hum, of A.C. ripple and other things. Sceptically therefore, this modern improvement was connected up.

Although the unit has supplied much current to operate the whole series of P.M. Sets described in this issue, throughout all the tests, the mains hum, the A.C. ripple and all the other snares have yet to put in an appearance.

It is invariably recommended in *Radio for the Million* that the Speaker should be preceded by one of the Mullard P.M. Super-power Valves. Included in each voltage range—the P.M. 252 in the two-volt class, the P.M. 254 for use with a four-volt accumulator and the P.M. 256 in the six-volt series. The reason is well-known; briefly, it is that greater signal voltage may be applied to the last L.F. valve without distortion. On such receivers as the Nelson P.M. de Luxe, the Raleigh P.M. and the Collingwood P.M. the employment of a P.M. Super-Power Valve is imperative since the H.F. and detector stages are handing-on enormous signal voltage. The Mullard Super-power type of valve is alone capable of handling these signals without distortion. The constant electrical load demanded is best obtained from the mains.

### A constant electrical load

Current drawn from this source is constant in voltage and in amperage. Consequently, a receiver remains up to "concert pitch" once it has been adjusted to give this performance. Tinkering with a set to allow for battery-exhaustion thus becomes another thing of the past.

Finally, installation is simplicity itself, being no more difficult than connecting up an electric iron.

Having selected the position for the H.T. Unit in your home, secure a length of twin flex sufficient to make the connection between the mains plug on the unit and the lamp socket or wall plug at the other end.

The connections from the H.T. Unit to the receiver are completed in the following manner:—

- (1) The projecting screw terminal is connected to earth.

- (2) The plug in socket marked "—" is connected to the H.T. Negative terminal of the receiving set.
- (3) The H.T. positive terminals of the receiving set are connected to the corresponding plugs in sockets marked +1, +2, +3 and +4 of the H.T. Unit.

In the case of receiving sets that have only one positive H.T. terminal, the connections to the H.T. Unit should be made to either of the plugs in sockets marked 3 and 4, it being remembered that the numbers refer to increasing H.T. voltages with respect to the negative socket.

Where the receiving set is provided with more than one H.T. positive terminal, it is recommended that the H.T. supply for the detector valve be taken from either socket 1 or 2, and that for the L.F. and Power valves from either socket 3 or 4.

With the particular Mullard P.M. H.T. Supply Unit suitable for use with your mains, you may be certain of one invaluable fact—that, for you, the H.T. problem is solved once and for all.

As a final word or two it should be remarked that full-wave rectification is employed in the Mullard A.C. P.M. H.T. Supply Unit with the result that as much as a 33½ per cent. increase of current and a marked increase in smoothing efficiency is obtained over half-wave rectification.

At the moment of going to press we are able to announce that the Mullard Engineers are at work upon an H.T. Supply Unit suitable for use with D.C. Mains. Readers who reside in districts served with A.C. are in the position of being able to obtain to-day a Mullard P.M. H.T. Supply Unit from their usual dealer. Those in D.C. districts, however, should make a point of looking for an early advertisement in the press which will give the date of the release of the model suitable for use in conjunction with their mains.

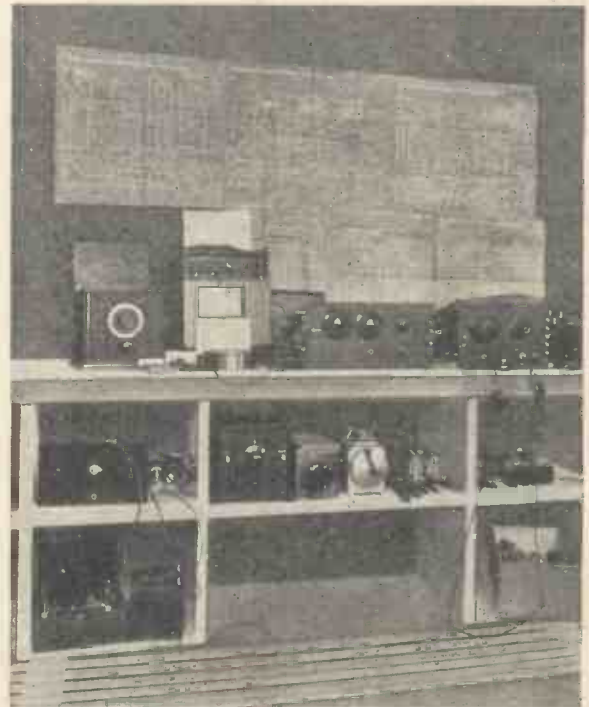

Here we show an illustration which should arouse no small measure of interest to P.M. enthusiasts. It depicts a section of one of the benches upon which the present series of P.M. Sets have been thoroughly tested. It must be admitted that during "working hours" it does not present such a tidy appearance as when the photograph was taken.

# ROOM · TO · ROOM · RADIO



## The HAWKINS P.M. RECEIVER

FEW words, if any, are needed to introduce this receiver. Designed and produced in response to the insistent demands of readers of *Radio for the Million*, the Hawkins P.M. Master Receiver supplies the design for a long awaited simple portable radio receiver. It is a matter of no importance whether put into service in England, Ireland, Scotland or Wales, whether one or a hundred miles from a broadcast station, it will give music to its owner.

THE illustration conveys a good impression of the Hawkins P.M. Receiver. It will be observed that with the exception of the condenser panel which may be covered by the drop-lid, there is little to indicate that the cabinet contains all the components of an efficient radio receiver. Considerable care has been taken in designing the receiver and its cabinet so that every lady of the house is able to include the Hawkins P.M. Receiver in the drawing-room scheme without offending her artistic eye. Interchangeability of the frame aerials has been effected in the manner shown by the reproduction on the right.





WHO has not been often tempted with the type of radio set which was self-contained? Where is the family man whose wife has not complained about the tangled mass of wires hanging from the back of the radio cabinet? What sacrilege to invade the drawing-room fully armed with a receiver and its attendant batteries!

The Hawkins P.M. comes into line with the most capricious wish of the lady of the house, and completely overcomes objections to radio equipment in the drawing-room. After all, why should an unsightly radio set be allowed in the drawing room when such a pleasing self-contained cabinet design as that of the Hawkins P.M. is obtainable?

There is no excuse now for the family man. A few evenings work will be ample time to construct the set from beginning to end. A duplicate of the published cabinet design may be obtained from the manufacturers quoted in the list of parts, together with the baseboard and the interchangeable frame aerials.

### Easily constructed

It was no easy task to adopt a plan of construction devoid of the complications which the average set builder finds difficult to surmount in a set of this type. Little doubt but that the design finally adopted will present none of the usual constructional difficulties. Judging from the comments of radio enthusiasts, who have enjoyed the privilege of an advance view of the receiver, it is a very definite fact that the construction of the Hawkins P.M. will be found just as simple an affair as a receiver of normal design. Nothing is incorporated into the set that may not be purchased in a form ready for immediate mounting into position. This is accepted as an ideal system, and as a matter of fact is an arrangement which is standard throughout the whole series of P.M. Sets.

It will be noticed that dry H.T. batteries are included in the design. The reason for this has been prompted by the realisation that in many outlying parts of the country, electric supply is not yet available. Builders of the Hawkins P.M. who are thus unfortunately placed will naturally follow the published details without any modification.

### H.T. from the mains preferable

Lucky owners of the Mullard P.M. H.T. Supply Unit will, of course, employ the mains in which event the dry H.T. battery is omitted. It is unnecessary to suggest that after having decided where the set will be placed in each room, a plug point should be fitted on the skirting conveniently near such a position. The inclusion in the cabinet of any H.T. supply unit is not recommended.

The foregoing modification to the Hawkins P.M. is to be greatly preferred, and where electric supply is available the receiver should draw its H.T. current from the mains. In this case, a terminal strip carrying the necessary number of terminals should be mounted in an appropriate position on the baseboard, to which should be made normal connections with 17 SWG wire (or Junit) in place of the flex leads used with dry batteries. A multi-lead will connect these terminals to the P.M. H.T. Supply Unit in the usual manner.

A word or two on the question of the results to be expected from the Hawkins P.M. Receiver. In the majority of cases readers have probably had a shot at a self-contained receiver, and encountered disappointment or alternatively constructed a set of normal design with the intention of operating it from a small frame aerial.

By no means is it an exception to the rule that such a scheme is unsuccessful. Operating the usual high-frequency circuits from a frame aerial is invariably attended by instability, particularly upon the long waves, in spite of neutralising devices.

At any rate the normal outside aerial circuits are considerably more selective than the self-contained design requires. Selectivity is already a feature of the Hawkins P.M. by reason of the characteristics of the aerial circuit supplied by the frame aerial.

### More than enough volume

The ideal circuit therefore, would be one in which the H.F. stage is really stable on both wavebands with maximum amplification, selectivity taking care of itself. There is every chance of obtaining stability and amplification since ample selectivity is present whether or no it is required.

Such a scheme is included in the Hawkins P.M. Receiver. It comprises the ideal number of valves—four, and only one stage of high-frequency, which, followed by a rectifying and two L.F. stages was found on test to give more than enough signal strength on the local transmission and the two Daventry stations.

It must be admitted, that although the purpose of the receiver is only to supply broadcast from these three sources, the temptation was far too great not to see what other stations it would pull in.

Surprising though it may appear, Hilversum, Koenigs-wuesterhausen and Radio Paris were heard on the long waves in addition to 5XX, while music from Bournemouth and speech from Brussels was received on the broadcast waveband over and above the transmissions from 2LO and 5GB.

The quality of the reproduction is, of course, quite equal to that which gives signal prominence to any of the P.M. Sets.

Lastly, some readers may wonder why the speaker has not been incorporated in the cabinet. It was felt that to have adopted this idea would have brought about a rather serious limitation to the fullest radio enjoyment in the case of most readers. In the general way, it is not one's good fortune to own more than one speaker.

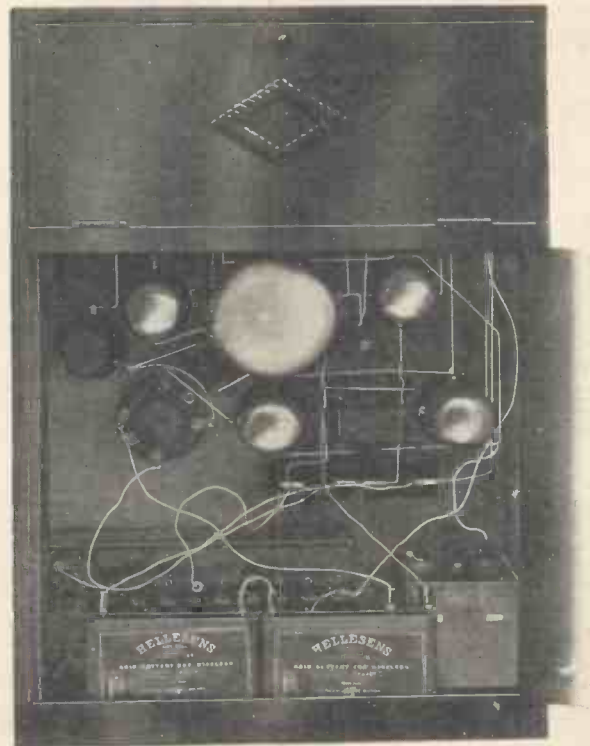

*It will be noted that the batteries are housed in the bottom of the cabinet. Used with batteries as in this illustration, the connections to the speaker are the only external leads.*

All would agree that to screw one's only speaker into a self-contained set is a very unsatisfactory way of doing things, and would certainly not appeal to the man who owns another set of the Columbus P.M., Raleigh P.M., or Blake P.M. type.

**Building**

Detailed constructional hints are scarcely necessary since the various photographs show the design to the fullest advantage. It is advisable to lay-out the components on the base-board and proceed with the wiring as directed by the point-to-point connections. In most cases it will probably be found more convenient to complete as much as possible of the baseboard wiring before mounting the condenser panel. Care should be taken to duplicate wire for wire. Furthermore, in a receiver of this type, more than usual care should be exercised to see that all joints are soldered strongly else a wire or two may come adrift at a rather inappropriate moment.

In fixing the battery leads be certain that you leave them of sufficient length to reach their respective sockets.

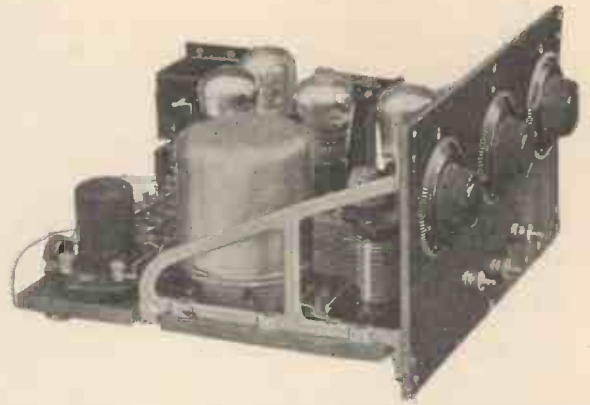

Considerable interest will be centred upon this illustration which depicts the experimental model of the Hawkins P.M. used in the preliminary tests.

## Before tuning-in local station

As the majority of our readers will build the Hawkins P.M. in accordance with the published details, the following dial readings are given so that wherever the set is to be installed the approximate settings may be found for the local station, Daventry or Daventry 5GB. Accuracy of the above readings has been checked against the Emerald Wavemeter.

Wave-length.	Fre-quency.	STATION.	H.F.
1750	170	Radio Paris . . . . .	164
1604.3	187	Daventry . . . . .	146
500	600	Abordeen . . . . .	157.5
491	610	Daventry (5GB) . . . . .	154.5
405.4	740	Glasgow . . . . .	129
384.6	780	Manchester . . . . .	120.5
361.4	830	London . . . . .	117
353	850	Cardiff . . . . .	111.5
326.1	920	Bournemouth . . . . .	92
319.1	940	Dublin . . . . .	88
312.5	960	Newcastle . . . . .	84
306.1	980	Belfast . . . . .	80.5
297	1010	Liverpool . . . . .	74
294.1	1020	Hull, Dundee, Stoke and Swansea . . . . .	72.5
288.5	1040	Edinburgh . . . . .	68.5
277.8	1080	Leeds . . . . .	60.5
275.2	1090	Nottingham . . . . .	58.5
272.7	1100	Sheffield . . . . .	56.5
252.1	1190	Bradford . . . . .	39.5

This list gives the full details of the components incorporated in the original receiver. Builders of this set should not make any attempt to effect radical alterations to any one part unless they have had previous experience that the alternative component has given a satisfactory performance under similar conditions.

No.	Component.	Maker.	Price.
1	Cabinet	W. H. Agar	£ 2 10 0
1	5-ply Baseboard (20 in. × 14 in.)	W. H. Agar	2 0 0
2	Panel Supports (3 3/4 in. × 7 in. × 1/2 in.)	W. H. Agar	6
1	Panel (14 in. × 6 in. × 1/4 in.)		7 0
1	Ebonite Strip (7 1/2 in. × 1 1/2 in. × 1/4 in.)		9
3	Variable Condensers (two .0005 mfd. one .0015 mfd.)	Colvern	3 0 0
1	Neutralising Condenser	McMichael	4 9
1	P.M. R.C.C. Unit	Mullard	17 6
1	High-frequency Choke	Colvern	10 6
1	L.F. Transformer	Pye	17 6
2	Mansbridge Fixed Condensers (2 mfd.)	Mullard	10 0
2	Fixed Condensers (one .0003 mfd., one .001 mfd.)	Mullard	5 0
1	Grid Leak (2 megohms)	Mullard	2 6
1	Grid Leak Holder	Mullard	1 3
1	Resistance, leak type (100,000 ohms)	Mullard	2 6
4	Anti-Vibratory Valve Holders	Lotus	10 0
1	Standard Screen	Colvern	8 6
1	Long Wave Coil	Colvern	9 6
1	Broadcast Wave Coil	Colvern	9 6
1	Long Wave Frame	W. H. Agar	18 6
1	Broadcast Wave Frame	W. H. Agar	18 6
4	Terminals, A., E., S., S +	Belling & Lee	2 0
0	Wander Plugs, 5 red, 4 black	Lisenin	1 2
1	Jack Switch, on-off	Lotus	2 9
2	L.T. Spade Terminals, 1 red, 1 black	Lisenin	8
3	Sockets	Lisenin	1 1 1/2
1	High Tension Battery (99 volts)	Hellesen	1 1 0
1	Low Tension Battery (Non-Spill)	Exide	17 6
2	Grid Bias Batteries (9 volt)	Hellesen	4 0
	Quantity of Self-Soldering Wire	Junit	

Those who are experienced in the reading of circuit diagrams will find all the essential details for building the Hawkins P.M. in this drawing. Although a portable receiver, arrangements are made in the design to use an outside aerial and normal earth connection.

Needless to say, it is very important to turn one side of the receiver towards the station you wish to tune-in so that the frame aerial is directional towards it.

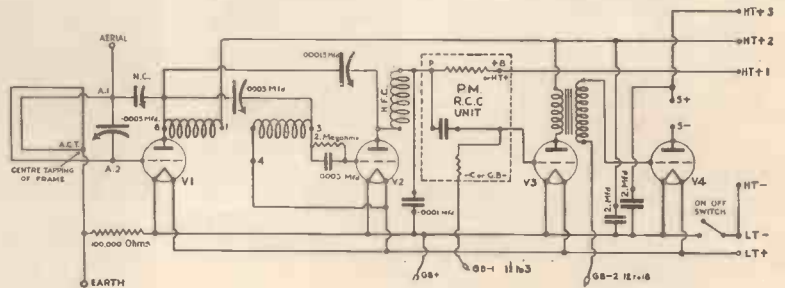



## Point-to-Point Wiring

### Back panel wiring

Wire No.

- 1 Connect together terminals F+ of valve holders V2, V1, V4 and V3.
- 2 Connect wire No. 1 to terminal No. 4 of coil holder H.
- 3 Connect terminal A of valve holder V1 to terminal No. 6 of coil holder H.
- 4 Connect terminal A of valve holder V1 to bottom terminal of neutralising condenser C6.
- 5 Connect terminal F- of valve holder V3 to earth terminal of coil holder H.
- 6 Connect terminal F- of valve holder V4 to terminal F- of valve holder V3 and to nearest terminal of condenser C5.
- 7 Connect terminal F- of valve holder V2 to wire No. 6.
- 8 Connect terminal F- of valve holder V1 to wire No. 6.
- 9 Connect wire No. 6 to left-hand terminal of condenser C8 and on to right-hand terminal of condenser C7.
- 10 Connect terminal A of valve holder V3 to terminal 1P of transformer T.
- 11 Connect left-hand terminal of condenser C7 to terminal OP of transformer T and on to terminal No. 1 of coil holder H.
- 12 Connect terminal G of valve holder V4 to terminal OS of transformer T.
- 13 Connect terminal P of P.M., R.C.C. Unit to terminal marked "long" on HF choke base.
- 14 Connect terminal G of valve holder V3 to terminal G of P.M., R.C.C. Unit.
- 15 Connect free terminal of condenser C5 to terminal marked "long" on HF choke base.
- 16 Connect terminal marked "short" on HF choke base to terminal A of valve holder V2.
- 17 Connect terminal G of valve holder V2 to nearest terminal of condenser C4 and grid leak R2.
- 18 Connect other terminal of condenser C4 and grid leak R2 to terminal 3 of coil holder H.
- 19 Connect terminal G of valve holder V1 to frame aerial socket A2.
- 20 Connect top terminal of neutralising condenser C6 to frame aerial socket A1.
- 21 Connect right-hand terminal of resistance R1 to frame aerial socket ACT.
- 22 Connect a well-insulated piece of flexible wire 9 ins. long to terminal GB- (marked -C) of P.M., R.C.C. Unit. The free end of this flexible wire should be fitted with a black wander plug marked GB-1.
- 23 Connect a well-insulated piece of flexible wire 9 ins. long to terminal HT+ (marked +B) of P.M., R.C.C. Unit. The free end of this flexible wire should be fitted with a red wander plug marked HT+1.
- 24 Connect a well-insulated piece of flexible wire 9 ins. long to left-hand terminal of condenser C7. The free end of this flexible wire should be fitted with a red wander plug marked HT+2.
- 25 Connect a well-insulated piece of flexible wire 9 ins. long to right-hand terminal of condenser C8. The free end of this flexible wire should be fitted with a red wander plug marked HT+3.
- 26 Connect a well-insulated piece of flexible wire 9 ins. long to wire No. 9. The free end of this flexible wire should be fitted with a red wander plug marked GB+.
- 27 Connect a well-insulated piece of flexible wire 9 ins. long to terminal IS of transformer T. The free end of this flexible wire should be fitted with a black wander plug marked GB-2.
- 28 Connect a well-insulated piece of flexible wire 9 ins. long to terminal F+ of valve holder V4. The free end of this flexible wire should be fitted with a red "spade connector" marked LT+.

### Wiring of front panel before mounting in set

- 20 Connect together mounting brackets of variable condensers C2, C3 and C1, and continue this wire to tag No. 1 of switch S.

### Final wiring after assembling front panel into set

- 30 Connect wire No. 29 to left-hand terminal of resistance R1.
- 31 Connect aerial terminal to frame aerial socket A1.
- 32 Connect earth terminal to right-hand terminal of resistance R1.
- 33 Connect terminal F- of valve holder V4 to wire No. 29.
- 34 Connect terminal A of valve holder V4 to terminal S-
- 35 Connect terminal S+ to right-hand terminal of condenser C8.
- 36 Connect terminal M of variable condenser C2 to the terminal of condenser C4 and grid leak R2, to which wire No. 18 is already connected.
- 37 Connect terminal F of variable condenser C2 to terminal No. 6 of coil holder H.
- 38 Connect terminal F of variable condenser C3 to wire No. 37.
- 39 Connect terminal M of variable condenser C3 to terminal A of valve holder V2.
- 40 Connect terminal M of variable condenser C1 to wire No. 19.
- 41 Connect terminal F of variable condenser C1 to wire No. 20.
- 42 Connect a well-insulated piece of flexible wire 2 feet long to tag No. 2 of switch S. The free end of this flexible wire should be fitted with a black spade connector marked LT-.
- 43 Into this same spade connector (LT-) fit another 9 in. length of flexible wire. The free end of this should be fitted with a black wander plug marked HT-.

Recommended Combination of Mullard P.M. MASTER VALVES for the Hawkins P.M. Receiver.

#### 2-volt L.T. Supply:—

- |                              |                                |
|------------------------------|--------------------------------|
| V1 H.F. valve: P.M. 1 H.F.   | V3 1st L.F. valve: P.M. 1 L.F. |
| V2 Detector valve: P.M. 1 A. | V4 2nd L.F. valve: P.M. 2.     |

N.B.—Where the H.T. supply is drawn from the mains through the Mullard P.M. H.T. Supply Unit the second L.F. valve should be the Mullard P.M. 252—the new 2-volt Mullard P.M. Super-power Valve.

#### 4-volt L.T. Supply:—

- |                             |                            |
|-----------------------------|----------------------------|
| V1 H.F. valve: P.M. 3.      | V3 1st L.F. valve: P.M. 3. |
| V2 Detector valve: P.M. 3A. | V4 2nd L.F. valve: P.M. 4. |

N.B.—Where the H.T. supply is drawn from the mains through the Mullard P.M. H.T. Supply Unit the second L.F. valve should be the Mullard P.M. 254—the 4 volt Mullard P.M. Super-power Valve.

#### 6-volt L.T. Supply:—

- |                             |                             |
|-----------------------------|-----------------------------|
| V1 H.F. valve: P.M. 5X.     | V3 1st L.F. valve: P.M. 5X. |
| V2 Detector valve: P.M. 5B. | V4 2nd L.F. valve: P.M. 6.  |

N.B.—Where the H.T. supply is drawn from the mains through the Mullard H.T. Supply Unit the second L.F. valve should be the Mullard P.M. 256—the 6-volt Super-power Valve.

## Frame Aerials

Space does not permit the inclusion of working diagrams for the Frame Aerials. If it is required to assemble these at home it will be seen from the blueprint that attachment is made to the receiver by means of three valve-legs, registering with sockets A.1, A.C.T. and A.2. The number of turns for the short-wave frame is 20, and for the long-wave frame 55.

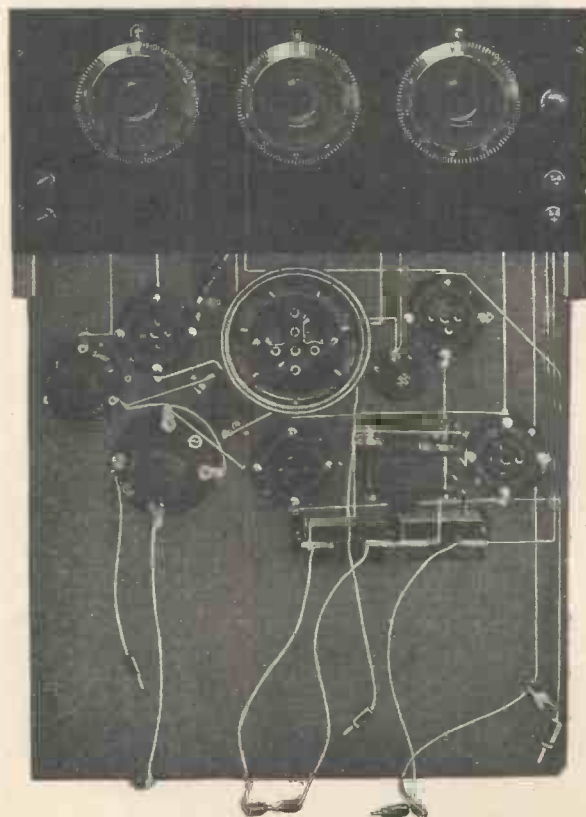

*It is also pointed out that the H.F. Coil is screened to eliminate interaction with the frame aerial situated at the rear of the cabinet. By simply removing the top of the screen, the H.F. coil may be quickly changed when the alternate waveband is desired.*

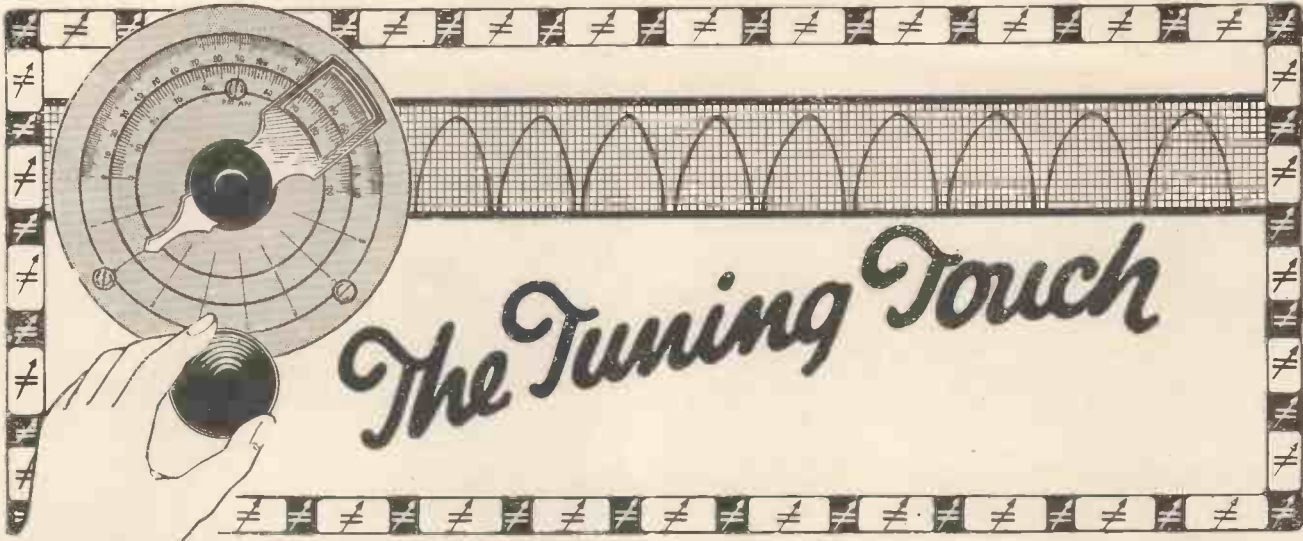

**F**ORTY-THREE Stations on the Speaker last evening"—this is a remark which always inspires the admiration of envious friends.

"Ah," they knowingly nod to each other "that chap owns a great set."

But does the secret lie altogether in the possession of a great set? Has all the story—if any part of the story—been told when it is whispered in an almost disparaging way "that chap owns a great set."

Has it been the joy of any reader to "run the rule" over any of these wonderful receivers? It is thought not.

That fellow's space-spanning receiver is not greatly different from the other ninety and nine. It appears much like others—perhaps not quite so neatly wired, but for all that, it pulls them in, by what might impress the uninitiated as magical charm.

A larger bag of stations at greater volume—what is the secret? Who should know if not that chap with the great set?

### Follow a Method

It must not be gathered however, that tuning is a gift of the gods. Explanation of its peculiarities may involve lengthy description, including a host of "don'ts," but for all that, tuning is so extremely easy, that by following the methods of experts, the results of experts may be obtained.

Nor is a long period of apprenticeship essential; and this is the great fascination of radio. Two or three hours will prove sufficient to understand the individuality of a set (and by the way, each set has its funny little tricks, unsuspected until these do their worst at an inopportune moment) and then Master John at the age of ten may out-do the rest of the family.

Master John always scores—he thinks of but one thing at a time, and concentrates *patiently* upon his pleasure. Patience is the greatest of all qualities. "Genius," it is said, "is an infinite capacity for taking pains."

Operating a radio receiver requires a portion of patience—no larger portion than is necessary to put the receiver on its best behaviour, after which, patience is more than well rewarded.

Let us suppose that you choose to have music from the other end of the dial this evening—the programme, say, at Langenberg appeals to you.

### Keep the batteries up

Now your low tension battery is presumed to be delivering its correct voltage. Should this not be the case, you will find that your receiver may behave in a very strange manner, and that certain adjustments which, previously, you have considered as almost permanent, will require alteration. This remark is particularly applicable to the Collingwood.

As a general rule, thanks to the versatility of the filaments of the Mullard series of valves, there is no loss of overall efficiency, provided your L.T. Battery has not reached the "sinking stage." It is advisable, despite this margin of safety, to keep your L.T. in condition, since the L.F. valves operate best at their rated filament voltage. Quality is only obtainable even from a well-designed low-frequency amplifier under those circumstances.

### H.T. Supply from the Mains

Similar attention should be given to the high-tension supply. Those of our readers who obtain their current from the Mullard P.M. H.T. Supply Unit, have removed the greatest source of trouble in a radio set. Instability in the H.F. stages and low-frequency howl in the L.F. are more often than not due to faulty high-tension supply. Readers should suspect this part of their equipment, when their radio "runs off the rails" sooner than upset various really permanent adjustments, such as the neutralising condenser.

The current supply apparatus properly functioning, the tuning-in of Langenberg is not beyond the skill of any reader—provided, of course, that the receiver will reach out.

Here we must repeat the advice given in the first issue of *Radio for the Million*, which was, that for distance work, a suitable receiver must be employed. The Receiver for this work should employ, at the minimum, one stage of high-frequency amplification—the Nelson P.M. or the Nelson P.M. de Luxe for example. With either of these P.M. Sets, Langenberg is within easy reach in daylight as well as at night.

Having followed faithfully the instructions upon installing the receiver, connecting the aerial and earth, the current supply adjustments, and the copious notes upon neutralising the receiver, and having made any necessary final adjustments to these two latter items upon the transmission from the local station, the two tuning dials, should be turned to Langenberg's approximate dial-reading.

By using standard six-pin coils, no difficulty should be experienced in this. Supposing your set to be the Nelson P.M. de Luxe, one approximate dial setting for this station is to be found in the Test Report.



### The Test Report will help

In the event that you have adhered to the same make of coils and tuning condensers as those used in the original receiver and followed closely the wiring diagrams, the dial reading of the H.F. variable condenser (that is the condenser mounted in the centre of the panel) will almost coincide with the published dial reading.

The reading for the remaining dial is easily found if you have noted the setting for the local station. Again, presupposing that you are using standard six-pin coils, it will usually work out that the correct position of the aerial for any given station will not greatly differ from the published reading for the H.F. condenser. Variation will exist according to the self-capacity of and damping in the aerial system.

As a general rule, the coils match up at one point when, of course, the readings for both dials agree. Above and below this setting the readings may disagree to a varying extent.

### Leave reaction at zero

Note the difference of the dial settings on the local station; very roughly, the same difference (either plus or minus) will exist for other stations. Greater accuracy is possible in calculating the setting for the aerial condenser if it is remembered that the aerial condenser always gains on the H.F. Tuning Condenser. When the aerial setting is slightly lower than that of the H.F., say, on Bradford's Wavelength, they may agree on Bournemouth's reading; but on Daventry's (S.G.B.) calibration, the aerial condenser may then have overtaken the H.F. reading.

During this operation of registering the dials of the two tuning condensers, the reaction condenser should be left at zero. (The reaction condenser is the third condenser mounted to the right of the panel).

Now slowly rotate the reaction condenser to the right, when the receiver will audibly increase in sensitivity as the state of oscillation is more nearly approached. Further slow rotation of the reaction condenser will increase the sensitivity of the receiver, and such increase of reaction should be gradually continued until any further movement threatens to send the set into violent oscillation. With the Standard Split Primary H.F. Transformer the reaction demand will probably not be more than 30 to 50 degrees on the dial.

The process of actually tuning-in the station is now confined to listening for the carrier wave or if the station is modulating, for music or speech.

It may happen that after advancing the reaction condenser to the point where the set is most sensitive, the station cannot be heard. In this event, slowly turn the Aerial Condenser one degree either side of the given setting when the station may come in. Then slowly rotate the H.F. Condenser one or two degrees either side of its setting. By adopting and patiently adhering to this system, the process of tuning-in any station is reduced to simplicity itself and success is assured.

### Advance dials in Step

Searching for distance stations, should always be conducted along these lines until you are able to advance or retard the tuning condensers in step, with the set maintained to a state of sensitiveness by occasional adjustment to the reaction condenser.

The ability to move the tuning condensers, with the set thus adjusted, requires "Radio Sense" which is acquired in much the same manner as continued car-driving develops "Road Sense."

It will be noted that not only is a delicate finger-touch required for the operation of tuning, but a keen sense of hearing in addition, this latter to detect the impending approach of oscillation. In the case of most receivers, with the correct high-tension voltage applied to the anode of the rectifier, there is ample warning given before the receiver actually squeals.

### Employ a geared condenser

In these days of highly selective receivers, it is necessary to employ mechanical means as an aid to accurate tuning. A glance at a wave-length-tabulated list of European Broadcast Stations will show what a difficult task besets the radio enthusiast, and the truth of this observation will be readily and willingly confirmed by the home constructor who endeavours to receive a maximum number of stations during the course of any one evening.

The definite separation of Stations—more especially below 350 metres—is a troublesome affair although slow-motion dials may be utilised. To attempt such a performance with a condenser unaided by one or other form of gearing, invites certain disappointment for the operator and should never be undertaken.

Provide yourself with a satisfactory tuning condenser on this account; it is the first real step towards the tuning touch. Each of the P.M. Receivers described in this issue includes a slow-motion device; it was found essential if the best performance from the receivers was to be obtained.

Receivers described in this issue includes a slow-motion device; it was found essential if the best performance from the receivers was to be obtained.

### Avoid frantic sweeps

When it is found possible to maintain the receiver in a condition of liveliness over the entire tuning range without having to make sudden and unexpected dives to the reaction condenser, then you

have acquired the secret of "the great set" which entitles that bumptious fellow in the train to feel something of a radio expert.

Finally it must be remarked that the rotation of the tuning condensers should always be made very slowly—degree by degree, no faster. Frantic sweeps from one end of the dial to the other will only bring you a nearby local transmission.

The principle is simply this—nothing more difficult or more complicated—first set your tuning dials in step on the local transmission; then slowly rotate them in the same direction, always keeping the set to a sensitive pitch by means of slight adjustments on the reaction condenser. This latter adjustment should be carefully watched all the time the tuning condensers are being slowly rotated in step.

In nearly every case a very slight movement to the reaction condenser will suffice either to keep the receiver up to "concert pitch" or to take it out of oscillation. Remember there is one—and but one only—golden rule. Slowly rotate the tuning dials in step and in the same direction, keeping a sharp ear upon the state of reaction.

And, lastly, let it be known that signals cannot be received while either the H.F. Valve or rectifying valve oscillates; nor are carrier waves to be heard. Operate your set with deliberate care—the greater your care—the greater your bag.



This illustration shows the Emerald Wavemeter, by the aid of which the identity of received stations was confirmed.

# The **COLLINGWOOD** **P.M. RECEIVER**

**TUNING IS SIMPLY  
THE EVEN ROTATION  
OF TWO TUNING DIALS**

**W**HERE it is impracticable to erect an outside aerial, this receiver offers a wide choice of programmes. Operating from a small frame aerial, it is simplicity itself to span Europe from East to West and North to South, with no more skill than is required to maintain the two tuning dials in step. Moreover, the possession of this Mullard Receiver will permit you to triumph over unfavourable conditions and to change "dead spots" into areas easily within the effective radiating range of all the popular broadcast stations.

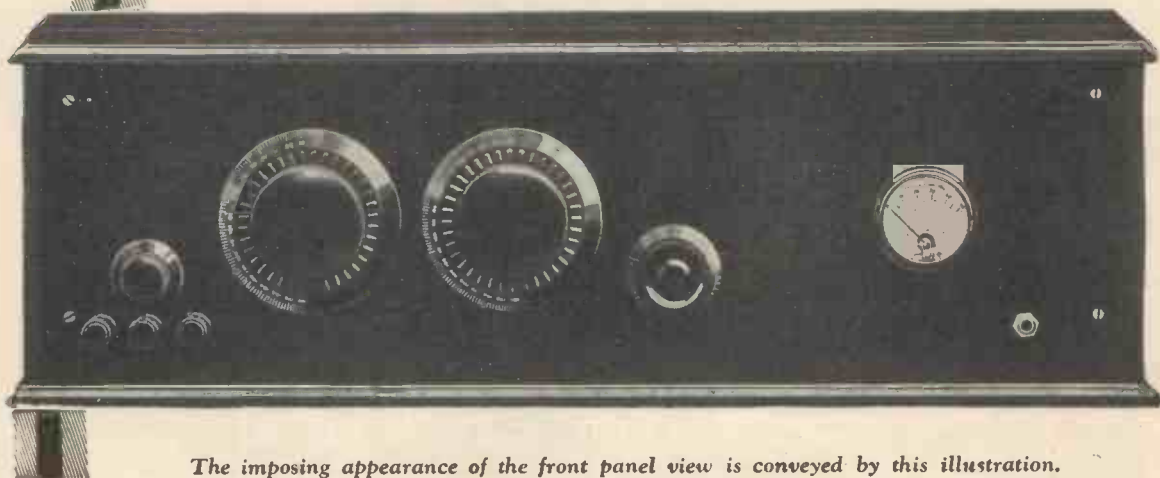

*The imposing appearance of the front panel view is conveyed by this illustration.*



IT is rather interesting to record that these opening remarks are being written while the experimental model of the Collingwood P.M. is receiving music from Prague.

Readers will recall that elsewhere in this publication, reference is made to the fact that Tests on P.M. Sets are conducted only 2 miles from the aerial of 2LO. Therefore, it is scarcely necessary for any emphasis to be laid upon the claim of selectivity. That under these conditions a station operating 12.5 metres below London may be received without any interference from this latter's powerful transmission, is not without distinct merit.

Every super heterodyne receiver will not duplicate this performance. Extreme difficulty is experienced by many, in cutting through 2LO's interference at this short distance. In fact, it is no easy thing six or so miles from 2LO. In the general way, super heterodynes perform exceedingly well in receiving, free of interference, Madrid (EAJ7) on the higher side and Petit Parisien on the lower side of 2LO in N.W. London.

Selectivity may be increased to a point greater than that which characterises the Collingwood P.M. but there is a

### Picks up on a small frame aerial

For such folk, the Collingwood P.M. Receiver operating on a frame aerial gives all the golden opportunities offered by contrast programmes not from two stations but from forty or more, with no less volume than that enjoyed from the local.

Increased satisfaction may be derived from a super heterodyne for the reason that it is alone capable of bringing in stations at will. It is sufficient only to wish for a certain station and providing it is operating, a few seconds need only separate the wish and its satisfaction. No small wonder that this type of radio set is described as the prince of receivers.

It is the favourite long-distance receiver of both American and British enthusiasts. An impression has existed that good super heterodynes only come from across the "herring pond." In this case however, the Collingwood P.M. Receiver is an exception to this generally accepted fact. If performance counts—and it is performance which ultimately decides—then any constructor of the Collingwood P.M. has a receiver of which he has a right to be proud.

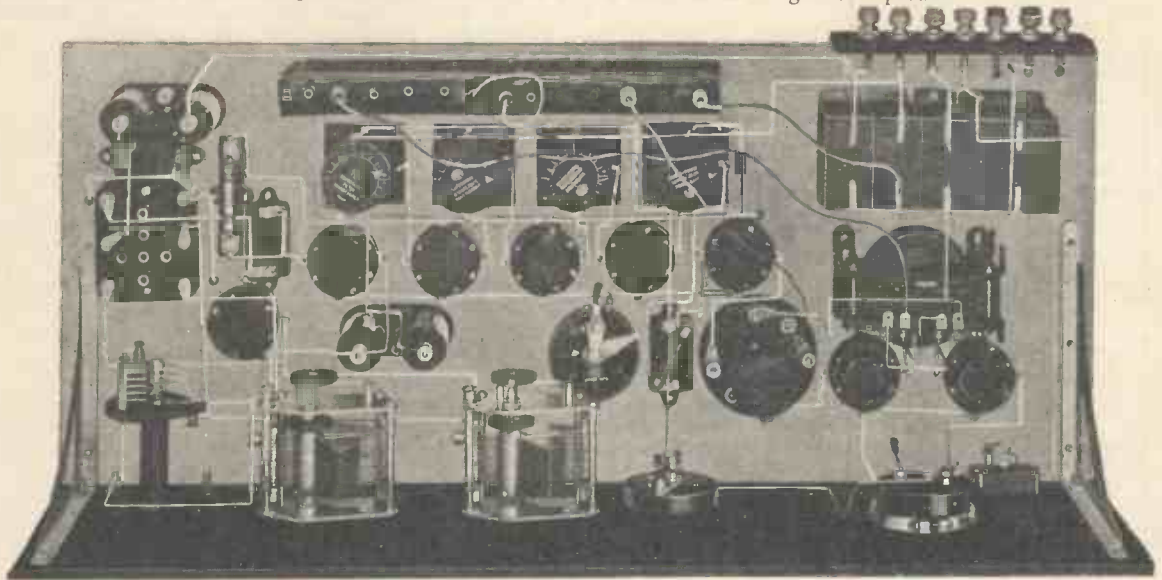

*A plan view of the Mullard Collingwood P.M. Receiver.*

very serious risk of spoiling quality. It is quite possible, however, that after spending a few evenings with it, Cardiff could be tuned-in without great difficulty. With the exception of this station and Leipzig at 365.8, however, all Europe will come over with ease within a mile of a powerful local as 2LO.

### Record selectivity

In the normal way, the super heterodyne receiver invariably scores when selectivity is the prior claim. Without doubt it possesses a higher degree of selectivity than any other type of receiver, and upon this score makes radio for the city dweller, whose aerial is near a strong local station, as great a pleasure as it is for the radio owner resident fifty or so miles away from the nearest broadcast station.

Whether or no a reasonably efficient aerial may be erected is a further and probably serious consideration which has a no less important bearing upon the radio enjoyment of the city dweller. In many instances within our knowledge, the reception of broadcast is confined to the local, because some kind of restriction prevents the use of an outside aerial. Very often it is lack of space and this is particularly the state of affairs in many cities where thousands of families live in service flats.

### Easily operated

He may consider this set to be more selective than any built previously, that its operation is infinitely more simple than any three-valve set irrespective of its circuit arrangement, and that from whatever part of the country the set may be operated, a princely performance will be secured from it.

Although first impressions may convey the idea that a receiver employing eight valves must of necessity be difficult to operate, the truth is much to the contrary. Less operating skill is required to obtain the best from a super heterodyne than is the case with any other multi-valve receiver.

### Ideal tuning

Primarily, there are only two tuning controls—generally accepted as the ideal. Two other adjustments remain; the first, a reaction control which plays no small part in the wonderful performance of the set. It is readily demonstrated, as builders of the Collingwood P.M. will discover for themselves, that just a touch to this adjustment will intensify a signal initially weak and as faint as a whisper, until it becomes an immense and deafening roar,

Such enormous signal strength, of course, is seldom utilised to the last ounce. This reserve of power which is characteristic of the super heterodyne receiver is called into service only when extremely distant stations are being received.

### The potentiometer

The second adjustment other than the midget reaction condenser, is the potentiometer which also acts as a sensitiser.

Its function is to control the bias being applied to the grids of the inter-frequency valves. As the sliding arm of the potentiometer is advanced towards the negative side, the nearer the interfrequency valves approach an oscillating condition. This control remains fairly constant over the whole tuning range of the receiver. It should be set in a position to render the receiver sensitive, further demand for increased power should be made to the midget reaction condenser.

Operation of the Mullard Collingwood P.M. Receiver is extremely simple and having once grasped the function of the potentiometer, success is assured from that moment.

Some idea of its simplicity may be assumed from the foregoing description, but when you find that it is possible to tune-in from thirty to fifty stations in less than an hour without so much as a squeal, then you will be able to realise why the super heterodyne is greatly favoured by the mature radio traveller.

Another striking feature to which reference must be made and one which is confined to the lucky owner of a super heterodyne. Little consequence where the stations are located, and regardless of the power upon which operated, the Collingwood P.M. will receive and amplify all transmissions to an equal degree of volume. Atmospheric conditions alone interfere with its performance.

### Using the "repeat point"

Doubtless for many thousands of our readers, the Collingwood P.M. Receiver will be the first super heterodyne receiver, and it may occur to them that some use should be made of the "repeat point." This one further peculiarity of this type of receiver comes in extremely useful in avoiding interference from unwanted transmissions. It is suggested therefore, that before passing over a station which is apparently being jammed by a spark station that the oscillator condenser (the second tuning condenser) should be rotated to the dial setting where the "repeat point" occurs. In very exceptional cases only, does it happen that improved reception is not obtained.

### Quality is a feature

It has been a general impression since the introduction of the super heterodyne into this country, that under no circumstance was quality to be obtained from this type of receiver. This may or may not have been true seven or eight years ago. At least it may be said that the same defect was applicable to every type of radio set. To-day, however, recognition must be given to the fact that great progress has been made as recently as during the past year. Resistance-capacity coupling and suitable P.M. R.C.C. valves in conjunction with the production of P.M. Super-Power Valves and the P.M. Speaker have each been responsible for this amazing musical progress in the world of radio. These P.M. products have given pure music to the radio owner.

The wonderful strides made in this direction with the assistance of P.M. products have revolutionised radio musical reproduction where it concerns the straight four or five-valve set. To a no less limited degree do Mullard P.M. Pure Music Products revitalise the super heterodyne.

### Super-power valves bring quality

Prior to the manufacture of the P.M. Super-Power Valves, the owner of a super heterodyne was unable to purchase last L.F. stage valves capable of handling the signal voltage which a good set of this type delivers. Consequently, much of the distortion blamed upon the set was really caused by inefficient valves. In these days, however, the situation is quite different—a P.M. Super-Power Valve is included in each of the voltage ranges. Furthermore, the P.M. Series of Master Valves perform an equally vital part in the earlier stages of a super-het.

Coupled with extremely good selectivity, immense volume and great range, the quality that the Collingwood P.M. gives will come as a revelation to the old hand and enjoyment to the newcomer. Really, with the 2-volt range of P.M. valves specified, it would not be possible to ascertain by ear alone that the circuit employed was a super heterodyne.

### Solving the battery problem

It has always been rather a point of interest why the super heterodyne receiver has not enjoyed all the popularity it deserves. Speaking for ourselves, no type of set has occupied more attention. Despite the fact that until the Mullard H.T. Supply Unit came along, the necessary H.T. was perforce drawn from batteries, our enthusiasm for the super heterodyne has never ebbed. For we assume that in the main, it was the battery problem which has robbed the super heterodyne of its place in the sun.

With this great handicap removed, this type of receiver should come into favour, for as in common with all P.M. Sets described in this issue, all tests were conducted with the H.T. current supplied by the Mullard P.M. H.T. Supply Unit.

Then, again, the drain upon one's L.T. battery is lightened by almost 25 per cent. by the new Mullard 4 and 6-volt P.M. 0.075 series-of valves, which, as the recommended list of valves indicates, occupy seven out of the eight valve-holders. This is no small consideration; running costs are therefore, no more than that applicable to a six-valve receiver using the .1 series.

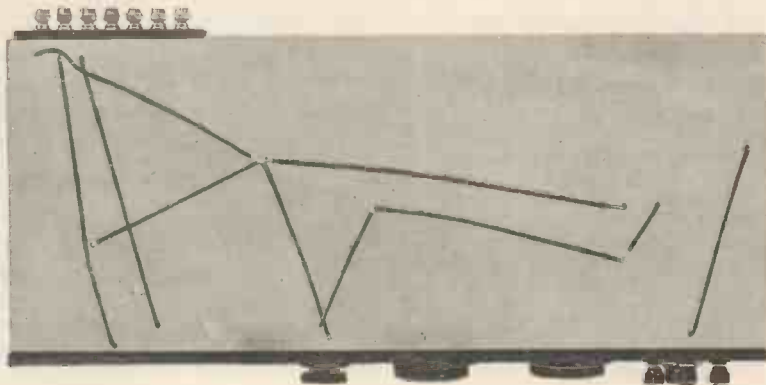

Reference to this illustration should be made during the course of construction. It shows the wiring carried beneath the baseboard. The wires are indicated on the Free Blueprint No. 207 by dotted lines.



**Long-wave performance**

In addition to the foregoing features, reference to the long wave performance of the Collingwood P.M. Receiver must not be overlooked. It may be the impression of some readers that a super heterodyne receiver is not suitable for the reception of Daventry, Radio Paris, Hilversum and other long wave stations. Such may have been the case in the past. But, knowing that to publish a set design without a long wave range would be to deprive owners of the Collingwood P.M. of a number of excellent programmes, arrangements were made so that the oscillator coupler was interchangeable. A six-pin coil was therefore chosen for this component.

The change-over from the short wave range to the long waves requires the removal of the short wave oscillator coil and plugging one suitably wound for the Daventry range into its place. It is also necessary to increase the inductance of the frame aerial, which may be done by either loading-up the short wave frame with a 150 plug-in coil placed in series with the bottom end of the winding or by employing a special long wave frame. Both methods have been tried when it was found that the cost of a special long wave frame was justified by the considerable gain in efficiency. The recommended method is to use suitably wound frames for each waveband.

The Collingwood P.M. Receiver will appeal to every radio enthusiast who is unable to enjoy the advantages which an outside aerial brings. As a matter of fact, one is rather inclined to hold the opinion that this receiver has many distinct advantages over one which makes use of an outside aerial. For example, inefficiency due to a long lead-in and a long earth lead which often cut down the performance of an outside aerial receiver is not present with the frame aerial operated set. Then, should the owner of a set wish to move his radio equipment into a different room, the bother of extending the aerial and earth leads is not encountered with such a set as the Collingwood P.M. since the frame aerial may follow the set into any room. The ideal arrangement, of course, would be to take the family dinner-wagon on permanent loan. The set itself could occupy the upper shelf; the L.T. battery and the P.M. H.T. Supply Unit the lower shelf. The frame aerial would stand beside the receiver.

**A valuable suggestion**

There is a very great temptation to plait the three leads from the frame aerial with the object of maintaining a tidy appearance for the front of the receiver. This is not recommended. Aerial leads bunched together in this manner will result in very poor results. Many an otherwise good super heterodyne has been condemned on that account. To allow the leads to hang loosely is again unsatisfactory since any alteration to their relative positions will affect the dial calibrations of the frame aerial condenser.

The method which presents itself as a reasonable suggestion is one usually adopted by the manufacturers of commercial super heterodynes. It is to attach the three leads to a strap (black upholsterer's webbing serves the purpose admirably) two arranged along the edges with the remaining one in the centre. A distance of not less than one inch should separate each lead.

**Building the Collingwood P.M.**

There is nothing revolutionary in the constructional design of this receiver. It is a straightforward job and certainly considerably easier to construct than many

of the complicated reflex receivers about which we heard so much in the past. It is only necessary to bear in mind when drilling the holes for the panel brackets that an allowance of about half an inch should be made for the raised baseboard. Support at the back is provided by the terminal strip at one end and a small piece of wood at the other.

Cutting out the hole for the Weston Mil-ammeter is best done by means of a series of small holes drilled round the circumference of the aperture required to take the instrument.

**Wiring below and through baseboard**

*The following wires are run below the baseboard and come up to the various terminals through holes drilled in the baseboard. All these wires should be insulated with sleeving.*

Wire No.

- 1 Connect the left-hand terminal of condenser C3 to terminal No. 5 of coil holder H. (This wire should run above baseboard.)
- 2 Connect terminal ACT to wire No. 1.
- 3 Connect terminal No. 5 of coil holder H to terminal F- of valve holder V1.
- 4 Connect terminal F- of valve holder V1 to arm of rheostat R2.
- 5 Connect moving arm of rheostat R2 to tag No. 1 of potentiometer R3.
- 6 Connect terminal F+ of valve holder V6 to terminal F+ of valve holder V1.
- 7 Connect terminal F+ of valve holder V6 to tag No. 3 of potentiometer R3.
- 8 Connect terminal F+ of valve holder V6 to terminal LT+.
- 9 Connect terminal F+ of valve holder V6 to terminal F+ of valve holder V8.
- 10 Connect terminal HT- to - terminal of milliammeter M.
- 11 Connect terminal LT- to tag No. 4 of jack J.

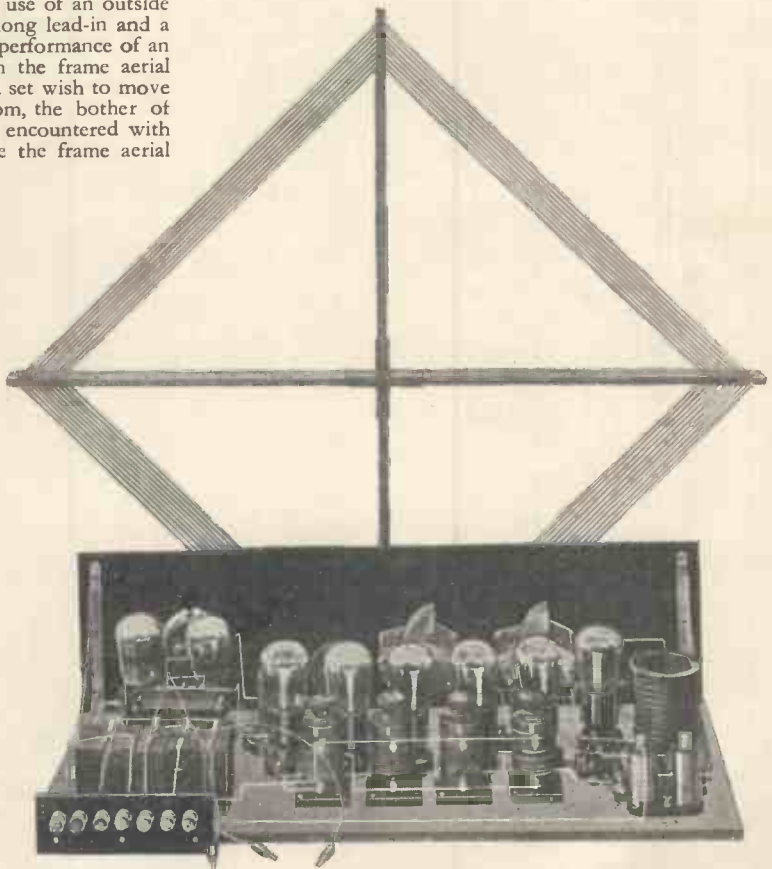

*A view from back-of-panel showing the disposition of the Filter and the three intermediate transformers. It will be seen that the terminal strip supports the baseboard to allow for the under-baseboard wiring. A small piece of wood should be screwed under the baseboard at the opposite end to obviate rocking.*

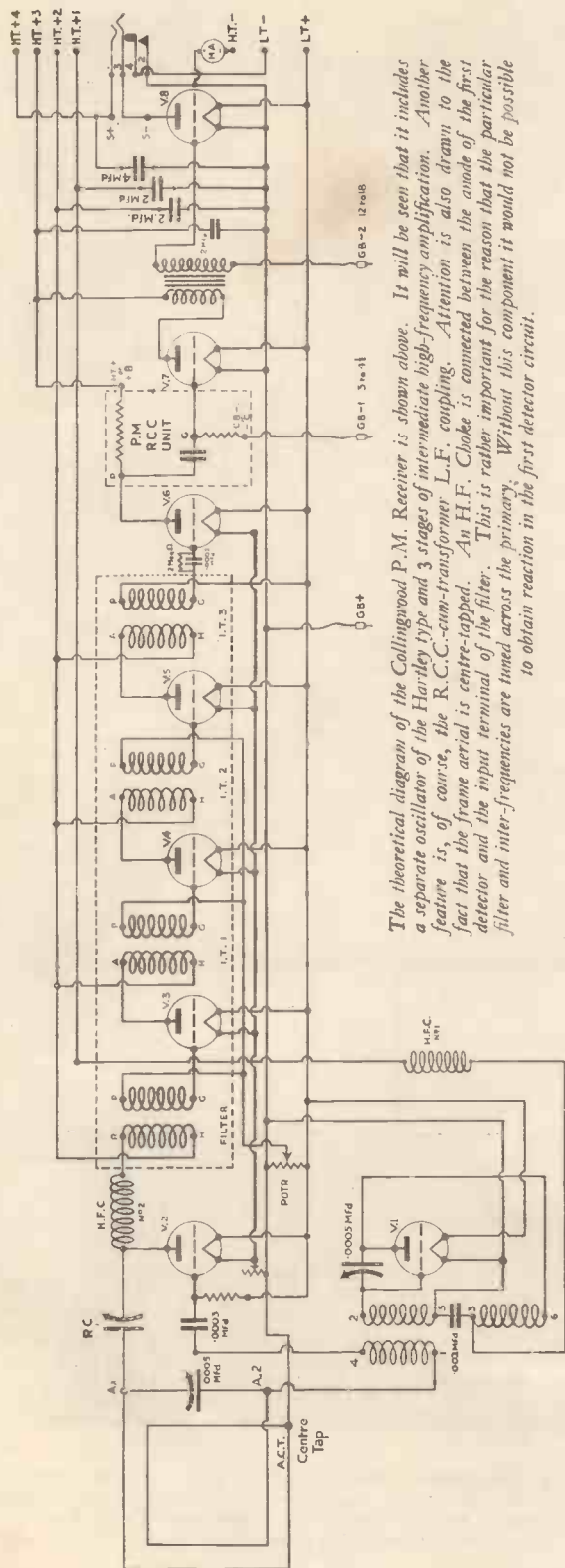

The theoretical diagram of the Collingwood P.M. Receiver is shown above. It will be seen that it includes a separate oscillator of the Hartley type and 3 stages of intermediate high-frequency amplification. Another feature is, of course, the R.C.C.-non-transformer L.F. coupling. Attention is also drawn to the fact that the frame aerial is centre-tapped. An H.F. Choke is connected between the anode of the first detector and the input terminal of the filter. This is rather important for the reason that the particular filter and inter-frequencies are tuned across the primary. Without this component it would not be possible to obtain reaction in the first detector circuit.

Make a point of following the lay-out of the original receiver both as regards the disposition of the components and the style of the wiring. Nothing is more disappointing than a hastily-wired set. Set aside an hour or two longer and endeavour to make a better wiring job than the original set. Keep all wires down near the baseboard—the less wire you see the more you will be satisfied.

To many under-baseboard wiring may appear, at first sight, rather difficult. In practice, however, it will be found to make the remaining above-baseboard wiring much easier although only eleven wires are disposed of in that way. Under-baseboard wires are shown dotted on the Free Blueprint.

- The following wiring is to be carried out above the baseboard.
- 12 Connect together terminal F+ of valve holders V6, V5, V4, V3 and V2, and on to one terminal of grid leak R1.
  - 13 Connect the other terminal of grid leak R1 to terminal G of valve holder V2.
  - 14 Connect one terminal of condenser C4 to wire No. 13.
  - 15 Connect other terminal of condenser C4 to terminal No. 4 of coil holder H.
  - 16 Connect terminal No. 3 of coil holder H to right-hand terminal of condenser C3 and on to right-hand terminal of HF choke No. 1.
  - 17 Connect terminal HT+1 to left-hand terminal of HF choke No. 1.
  - 18 Connect nearest terminal of condenser C6 to wire No. 17.
  - 19 Connect terminal No. 6 of coil holder H to terminal A of valve holder V1 and on to terminal F of variable condenser C2.
  - 20 Connect terminal No. 2 of coil holder H to terminal M of variable condenser C2.
  - 21 Connect terminal G of valve holder V1 to wire No. 20.
  - 22 Connect terminal A1 to terminal M of variable condenser C1.
  - 23 Connect terminal F of reaction condenser C5 to wire No. 22.
  - 24 Connect terminal No. 1 of coil holder H to terminal A2.
  - 25 Connect terminal F of variable condenser C1 to wire No. 24.
  - 26 Connect terminal M of reaction condenser C5 to right-hand terminal of HF choke No. 2 and on to terminal A of valve holder V2.
  - 27 Connect together terminals F- of valve holders V2, V3, V4, V5 and V6.
  - 28 Connect free terminal of rheostat R2 to wire No. 27.
  - 29 Connect terminal G of valve holder V3 to terminal G of "Filter."
  - 30 Connect left-hand terminal of HF choke No. 2 to terminal R of "Filter."
  - 31 Connect terminal A of valve-holder V3 to terminal A of IT1.
  - 32 Connect terminal G of valve holder V4 to terminal G of IT1.
  - 33 Connect terminal A of valve holder V4 to terminal A of IT2.
  - 34 Connect terminal G of valve holder V5 to terminal G of IT2.
  - 35 Connect terminal A of valve holder V5 to terminal A of IT3.
  - 36 Connect terminal G of IT3 to furthest terminal of condenser C10 and grid leak R4.
  - 37 Connect other terminal of condenser C10 and grid leak R4 to terminal G of valve holder V6.
  - 38 Connect terminal A of valve holder V6 to terminal P of P.M., R.C.C. Unit.
  - 39 Connect terminal P of IT3 to terminal F+ of valve holder V6.
  - 40 Connect terminal HT+2 to nearest terminal of condenser C7.
  - 41 Connect wire No. 40 to terminals H of IT3, IT2, IT1, and "Filter."
  - 42 Connect tag No. 2 (moving arm) of potentiometer R3 to terminals P of IT2, IT1, and "Filter."
  - 43 Connect terminal G of P.M., R.C.C. Unit to terminal G of valve holder V7.
  - 44 Connect terminal A of valve holder V7 to terminal OP of transformer T.
  - 45 Connect terminal G of valve holder V8 to terminal OS of transformer T.
  - 46 Connect terminal A of valve holder V8 to tag No. 3 of jack J.
  - 47 Connect together terminals F+ of valve holders V8 and V7.
  - 48 Connect together terminals F- of valve holders V8 and V7 and on to terminal + of milliammeter M.
  - 49 Connect terminal + of milliammeter M to tag No. 2 of jack J.
  - 50 Connect wire No. 48 to tag No. 1 of potentiometer R3.
  - 51 Connect terminal HT+3 to nearest terminal of condenser C8.
  - 52 Connect terminal IP of transformer T to terminal HT+ (marked +B) of P.M., R.C.C. Unit.
  - 53 Connect wire No. 52 to wire No. 51.
  - 54 Connect terminal HT+4 to nearest terminal of condenser C9 and on to tag No. 1 of jack J.
  - 55 Connect together the free terminals of condensers C6, C7, C8 and C9.
  - 56 Connect terminal LT- to wire No. 55.
  - 57 Connect a piece of well-insulated flexible wire 9 ins. long to wire No. 55. The free end of this flexible wire should be fitted with a red wander plug marked GB+.
  - 58 Connect a piece of well-insulated flexible wire 9 ins. long to terminal IS of transformer T. The free end of this flexible wire should be fitted with a black wander plug marked GB-2.
  - 59 Connect a piece of well-insulated flexible wire 12 ins. long to terminal GB- (marked -C) of P.M., R.C.C. Unit. The free end of this flexible wire should be fitted with a black wander plug marked GB-1.



# Test Report Collingwood P.M.

The following table will be found useful as a preliminary guide to the dial settings for the oscillator condenser. It will be noted that calibrations are given for this condenser only; readings for the frame condenser while of use on a particular receiver, will not be found to render much assistance in other circumstances. In practice, it is only necessary to set the oscillator to a specific setting when it is quite a simple matter to bring the frame condenser into step. As it happens, it is far simpler to keep the dials of a super heterodyne into step than is the case with any other receiver. Except where use is made of the "repeat point" the dials advance more or less together over the whole tuning range—the frame condenser gaining upon the oscillator. For the sake of convenience, the appended list is arranged so that all readings were derived from the higher "repeat point." With the particular inter-frequency transformers incorporated into the original receiver, the "repeat points" are separated by 25 to 30 degrees—the precise number depending upon the actual frequency to which the intermediate stages are tuned.

Wavelength Metres.	Frequency.	Station.	Osc.
1750	171	Radio-Paris	99
1604.3	187	Daventry	77
1250	240	Berlin	60
1060	283	Hilversum	37
517.2	580	Vienna	174.5
500	600	Brussels	169
500	600	Aberdeen	164
491	610	5GB	161
468.8	640	Langenberg	147
461.5	650	Oslo	145.5
450	666	Rome	139.5
447.8	670	Paris	138
441.2	680	Bruenn	135.5
434.8	690	Bilbao	132
428.6	700	Frankfurt-on-Main	128
411	730	Berne	119
405.4	740	Glasgow	116
400	750	Plymouth	113.5
394.7	760	Hamburg	111
392	765	Toulouse	109
384.6	780	Manchester	105.5
379.7	790	Stuttgart	102
375	800	Madrid	100
365.8	820	Leipzig	96
361.4	830	London	91
353	850	Cardiff	87
348.9	860	Prague	80
340.9	880	Paris	83
329.7	910	Koenigsberg	77.5
326.1	920	Bournemouth	75
319.1	940	Dublin	72
315.8	950	Breslau	69
312.5	960	Newcastle	68
306.1	980	Belfast	65
303	990	Nuremberg	63.5
297	1010	Liverpool (Hanover)	60.5
294.1	1020	Hull, Dundee, Stoke, Swansea	59
288.5	1040	Edinburgh	56
283	1060	Dortmund	53
277.8	1080	Leeds	50
275.2	1090	Nottingham	49
270	1111	Bordeaux	45
260.9	1150	Malmö	41.5
260	1154	Toulouse	39
254.2	1180	Kiel	38.5
252.1	1190	Bremen (Bradford)	38
243.9	1220	Trondhjem	34
241.9	1240	Muenster	32
230	1304	Juan Les Pins	26
222.2	1350	Strassbourg	19.5
220.6	1360	Karlstad (Sweden)	17
218	1370	Grenoble (Sweden)	15

### RECOMMENDED MULLARD P.M. VALVES.

#### For 2-volt L.T. Supply:—

- V1 Oscillator Valve: P.M.2.
- V2 First Detector Valve: P.M.1 L.F.
- V3 First Intermediate Valve: P.M.1 H.F.
- V4 Second Intermediate Valve: P.M.1 H.F.
- V5 Third Intermediate Valve: P.M.1 H.F.
- V6 Second Detector Valve: P.M.1 A
- \*V7 First L.F. Valve: P.M.1 L.F.
- \*\*V8 Second L.F. Valve: P.M. 252.

#### For 4-volt L.T. Supply:—

- V1 Oscillator Valve: P.M. 4.
- V2 First Detector Valve: P.M.3.
- V3 First Intermediate Valve: P.M.3
- V4 Second Intermediate Valve: P.M.3.
- V5 Third Intermediate Valve: P.M.3.
- V6 Second Detector Valve: P.M.3.A
- \*V7 First L.F. Valve: P.M.3.
- \*\*V8 Second L.F. Valve: P.M. 254.

#### For 6-volt L.T. Supply:—

- V1 Oscillator Valve: P.M.6.
- V2 First Detector Valve: P.M.5X.
- V3 First Intermediate Valve: P.M.5X.
- V4 Second Intermediate Valve: P.M.5X.
- V5 Third Intermediate Valve: P.M.5X.
- V6 Second Detector Valve: P.M.5B.
- \*V7 First L.F. Valve: P.M.5X.
- \*\*V8 Second L.F. Valve: P.M. 256.

\* Where it is found that owing to favourable position all stations come over with enormous strength, a higher degree of quality is obtainable by replacing the above recommended valves with the P.M.2, P.M.4 or P.M.6.

\*\* There is no question but that in a receiver of this type, the use of a super-power valve in the last L.F. stage (i.e. for V8) is almost imperative. Owners of the Collingwood P.M. Receiver will find that with any other type of valve a serious loss of quality will result.

#### H.T. Voltages

- H.T. + 1:—Oscillator Tapping: 40 to 60 volts or the first tapping on the Mullard P.M. H.T. Supply Unit.
- H.T. + 2:—Supplying First Detector and Intermediates: 60 to 80 volts or the second tapping on the Mullard P.M. H.T. Supply Unit.
- H.T. + 3:—Feeding Second Detector and First L.F.: 100 to 120 volts or the third tapping on the Mullard P.M. H.T. Supply Unit.
- H.T. + 4:—Applied to Last Valve: 150 volts or the fourth tapping on the Mullard P.M. H.T. Supply Unit.

#### Grid Bias Adjustment

- G.B. - 1: 3 volts negative on P.M.5X, P.M.3 or P.M.1 L.F.; 6-7½ volts negative on P.M.6, P.M.4 or P.M.2.
- G.B. - 2: 9 volts negative on P.M.6, P.M.4 or P.M.2; 18 volts negative with 120 volts H.T.; 22 volts negative with 150 volts on P.M.256, P.M.254 or P.M.252.

## List of Parts

No.	Component.	Maker.	Price.
			£ s. d.
1	Cabinet, 24 in. x 7 in. x 10 in.	Peto-Scott	2 2 0
1	Baseboard, 24 in. x 10 in.	Peto-Scott	1 6
1	Terminal Strip, 12 in. x 2 in.	Peto-Scott	10 6
1	Panel, 24 in. x 7 in. x ½ in.	Peto-Scott	1 9
1	Pair Panel Brackets	Collett	17 6
1	Filter	McMichael	2 12 6
3	Interfrequency Transformers	McMichael	17 0
2	High-Frequency Chokes	Climax	3 0
1	Six-Pin Base	Lewcos	9 6
1	Oscillator Coupler (Short Wave)	Colvern	9 6
1	Oscillator Coupler (Long Wave)	Colvern	1 17 0
2	Variable Condensers (-0005 Mfd.)	Brandes	6 3
1	Panel Mounting Reaction Condenser	Peto-Scott	2 6
1	Baseboard Semi-Fixed Resistor (6 ohms.)	McMichael	7 6
1	Potentiometer	McMichael	10 0
8	Valve (Anti-Vibrator) Holders	Pye	17 6
1	L.F. Transformer (2.5 to 1)	Pye	17 6
1	Resistance-Capacity Unit	Mullard	5 6
2	Fixed Condensers (one .0003 Mfd., one .002 Mfd.)	Mullard	2 6
1	Grid Leak (2 Megohms)	Mullard	5 0
1	Combined Grid Condenser and Leak	Mullard	1 3
1	Grid Leak Holder	Mullard	5 6
4	Mullard Mansbridge Condensers (three 2 Mfd., one 4 Mfd.)	Mullard	1 5 0
1	Mil-ammeter, 0-50	Weston	1 15 0
1	Short Wave Frame	Climax	
1	Long Wave Frame	Climax	
10	Terminals, A.1, A.2, A.3, L.T. —, L.T. +, H.T. + 1, H.T. + 2, H.T. + 3, H.T. + 4, H.T. —	Belling & Lee	5 9
2	L.T. Spade Terminals, 1 Red, 1 Black	Lisenin	8
1	Filament Jack	Lotus	2 6
5	Wander Plugs, 3 black, 2 red	Lisenin	10
	Quantity of Self-Soldering Wire	Junit	
	Small Quantity Sistofolex		



# A PEEP INTO OUR NOTE-BOOK

## The Test for a Neutralised Set

NO little difficulty is being experienced by some readers in deciding whether or no their receiver is properly neutralised, and the fact that sets are very often compelled to function when not neutralised, probably accounts for much of the oscillation that is to be heard upon occasions.

Tapping the aerial terminal or the grid terminal of the H.F. Valve (or valves) with a moistened finger-tip usually indicates that the H.F. Valve is "up in the air," but this sign does not always appear to give the necessary hint to the operator that further adjustments to the neutralising condenser are called for.

It is equally as important to set the reaction condenser to zero before attempting to neutralise, as it is to neutralise the inter-electrode capacity of the valve over the whole tuning range of the condenser. Sometimes it occurs that the neutralisation obtained on a nearby station located at a dial setting of about 80 degrees may not stabilise the set at its extreme low reading, though more often than not such a setting holds good at the higher readings.

Doubtless many of our readers have taken a number of dial readings after having neutralised on the local station only to find that upon turning their attention to the lower dial settings, the set careers into violent and uncontrollable oscillation.

### Stabilise at low dial setting

Normally, there is always a transmission which may be tuned-in somewhere near the minimum of the condenser and one near maximum capacity. It is advised that after the set has been neutralised on the local transmission, that a station is tuned at the bottom end of the condenser, and the set then properly neutralised. As a general rule, the setting obtained, holds good over the entire tuning range of the condenser. It is advisable at any rate that tests should be made—one, say, in the centre of the dial and another at the top end.

Making these tests presents a problem to many, and it is proposed to describe one method in detail. After placing the reaction to zero, tune-in the local station to maximum

volume. Then set the aerial condenser two degrees *below* its correct setting.

Turning the H.F. Condenser one degree or two either side of its correct reading may cause the set to squeal. The same procedure should be pursued, but with the aerial condenser two degrees *above* the correct setting. Rocking the H.F. Condenser a degree or two either way may result in squeals which respond to the movement being applied to the H.F. Condenser.

The presence of these squeals indicates that the receiver is not yet properly neutralised and further adjustment should be made to the neutralising condenser until these squeals disappear. Equal care should be exercised on a setting near minimum capacity and one at maximum. The production of squeals by displacing the H.F. condenser is a very definite indication that further attention must be given to neutralising.

### Obtaining smooth reaction

Valve receivers employing capacity reaction are often extremely troublesome on account of "floppy" reaction. Where the more usual remedies of varying the H.T. Supply to the detector valve fail, it may be found that a marked improvement is made when the value of the grid leak is increased up to 5 megohms. In some instances this substitution will probably effect a complete cure.

### Motor-biking

It may happen that an intermittent noise results upon connecting up an H.T. Battery Eliminator to a receiver. An examination of the earth system should immediately be made. A good path to earth is very essential when power from the mains is utilised.

### Bias on Super-Power Valves

Those of our readers with a Mullard P.M. H.T. Supply Unit are recommended to supply the anode of the super-power valve from the fourth tapping; this means about 140 volts—150 volts. In this case, better results are obtainable by increasing the grid-bias up to 22 volts in place of the eighteen normally used.



### A remarkable curve

In this page we are reproducing a voltage-amplification curve of a low-frequency combination which consisted of a standard Mullard P.M.5B R.C.C. Valve and a Resistance-Capacity Unit issued by an independent company. Our object in publishing this particular curve is to throw some independent light upon the intrinsic merits of this method of coupling low-frequency valves and to show that in addition to greater sensitivity, increased amplification, and improved quality, the wonderful Mullard P.M. Valves associated with compatible apparatus will give a uniform frequency response.

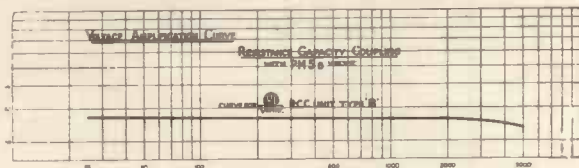

The above graph speaks for itself. It shows a uniform frequency response over an extremely wide frequency range.

To the radio owner this means musical reproduction of a high order. One year ago any curve approaching this uniformity would have attracted no small measure of comment.

This accompanying curve shows that the combination of the Mullard P.M.5B Valve and the particular R.C.C. Unit in question operates to a degree of efficiency nearer the ideal response than the normal musical ear is able to determine. Surely this is an incident in radio practice and a step in the march of radio progress which merits a little space in this publication.

A further point which calls for our comment, occurs to us at the moment of writing. It is that this manufacturer in this instance at any rate, realises the importance of obtaining performance curves with the modern valve. Obviously, this is the correct procedure since any voltage-amplification curve derived in combination with valves other than types in present and popular use, are of little value to the radio owner who wishes to know more about the performance of certain apparatus built into his sets other than merely connecting it into circuit and hoping for the best.



Showing the R.I.-Varley R.C.C. Unit, the L.F. coupling referred to in this page.

### The recommended L.F. coupling

It would appear from every indication that the popular L.F. scheme for the coming season will be R.C.C.-cum-transformer. In point of fact, it is believed that very few receivers will incorporate any different arrangement. Happily, popular favour falls into line with technical recommendations, and in this instance, at any rate, the technical expert and the man in the street find themselves in concord.

When maximum volume is called for, there is, however, very little choice in the detailed arrangement which this scheme should follow.

Primarily, of course, the valve governs the system to a very large extent. In the case of the Nelson P.M. de Luxe, by way of example, so enormous is the volume handed on by the P.M.5B (the rectifying valve) that the L.F. comes mightily near being overloaded. Let it be remarked that it is something more than the usually accepted idea of volume which threatens to overload an amplifier consisting of a Mullard Super Power Valve!

Naturally, under such circumstances it would not be practicable to follow the first L.F. Valve with the R.C. coupling of normal values, using a P.M.5B. Obviously, volume such as one expects from a radio set to-day, would swamp this valve with its comparatively limited grid swing. The substitution of a P.M.5X under such conditions would obviate overloading, but it would be at the sacrifice of overall amplification from the R.C.C. stage.

If it were really necessary to precede an R.C.C. stage with a stage of transformer coupling, it would be essential to reduce the value of the anode resistance, increase the value of the coupling condenser and decrease the resistance of the leak in order to permit the use of a first L.F. valve with a lower impedance. In such a valve, to give sufficient grid swing, a drop of valve impedance is accompanied by a fall in the amplification factor of the valve with the result that on any given receiver, Transformer followed by R.C.C. would give less overall amplification than a set in which the order of things was reversed.

### Maintenance of low notes

Apart from the above consideration favouring the placing of the L.F. Transformer in the second position, it should be remembered that any suppression of the low notes by the transformer is due to insufficient primary inductance.

Were the L.F. Transformer placed first, it would not be possible to employ as the detector a valve of the P.M.5B class, for one reason among others, that the low note cut-off would be greatly increased. A valve of the P.M.5X type would, of course, avoid this result to a degree, but with a consequent loss of volume and an all-round drop in efficiency of the rectifying circuit.

By following the first L.F. R.C.C. Stage by transformer coupling, a straighter voltage amplification curve is obtained than if the positions of these coupling devices were reversed. Of course, this is true under the condition that the first L.F. valve is of the P.M.5X type and that the primary impedance of the L.F. Transformer is suitable for the impedance of this class of valve.

With the amplifier arranged in this way, however, it is quite convenient to employ a power valve of the P.M.6 type as the first L.F. valve. This valve possessing a low impedance is better suited to the impedance of the transformer primary with the effect of lengthening the straight portion of the curve towards the lower frequencies. An even better reproduction of the bass notes is thus obtained.

Where greater volume than usual is available, the inclusion of a power valve (such as the P.M.2, P.M.4 or P.M.6) presents an acceptable method of maintaining distortionless input to the output valve of a low-frequency amplifier.

If maximum efficiency is required from the set, then the Mullard P.M.5B (or P.M.3A or P.M.1A) used in conjunction with the P.M. R.C.C. Unit is recommended. These two items should always be used in combination. Without the sacrifice of amplification and quality, there is no option but to place it immediately after the detector. The P.M.5B (or the equivalent valve in the 4 and 2-volt ranges) performs the function of rectifying while the R.C.C. Stage couples it to the first L.F. Valve. This is a scheme which gives maximum efficiency viewed from all angles. It delivers maximum volume to the second L.F. stage; it supplies undistorted signals.

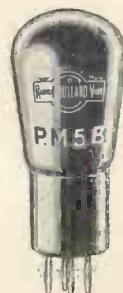

The famous Mullard P.M.5B —one of the P.M. R.C.C. Valves which have carried resistance-capacity coupling to its present height of popularity.

Every care should be exercised in the choice of the L.F. Transformer, although it is disposed in the anode circuit of the first L.F. Valve, which, by the way, should be the P.M.5X (or, if in the 4 or 2-volt range the P.M.3 or P.M.1 L.F. respectively), where it continues to control to as an important a degree as elsewhere, the final musical quality given by the receiver.

The performance of the set is still governed to a great extent by the L.F. Transformer. If the characteristic of this instrument is to cut out the bass and accentuate the higher register, then it stands to reason that whatever its position in the L.F. amplifier it will continue to regulate the frequency response largely in accordance with those characteristics. Whether this influence upon the musical quality of your receiver is good or bad depends almost entirely upon the quality of the transformer.

One musically efficient stage of resistance capacity coupling followed by a poor stage of transformer coupling is most certainly preferable to two poor stages of this latter coupling.

Although there may be little discussion about which does give a straighter voltage-amplification curve of the two couplings, the resultant quality of a R.C.C. followed by transformer amplifier leaves but little to be demanded. Critical as one's musical ear may be, the recommended combination is many lengths ahead of any other arrangement.



*This is the Mullard P.M. R.C.C. Unit which is recommended for inclusion in the first L.F. stage of modern radio receivers.*

**Mullard Super-Power Valves**

Very few radio owners have not made good use of the Mullard P.M. Super-Power Valves. It is very certain that now a 2-volt P.M. Super-Power Valve is available in the P.M.252, much less will be heard of the distortion for which receivers using 2-volt valves were notorious. It is a very definite fact that where a 1 H.F., rectifier and 2 L.F. Set is performing in anything like the way it should, overloading will certainly be present unless a super-power valve occupies the last position.

Prior to the manufacture of the P.M.252, users of 2-volt valves experienced extreme difficulty in obtaining anything approaching pure reproduction. Doubtless, after September 20th—by the way this is the date of the release—those who prefer the 2-volt range of valves, will not hesitate many hours before visiting their local dealer to procure a P.M.252. Mark you, you probably think that just that one valve will not be able to make much difference. But take a chance; one might hazard a guess that once you have heard the world of difference it does make, you will know never to try to obtain pure reproduction without a Mullard Super-Power Valve.

**Mullard P.M. Valves for H.F.**

By some, neutralising is found anything but the simple affair it really is. With either the Nelson P.M. de Luxe or the Raleigh P.M.—which P.M. sets, by the way, incorporate a similar system of neutralised H.F.—the neutralising adjustment is quickly effected and remains constant on both wavebands.

That trouble is encountered with this adjustment is not the fault of the system but rather of other factors. The preferable method of neutralising is to adopt the system already described. This is extremely simple and definitely

stabilises the receiver under working conditions. It is often the case that neutralising adjustments made in any other way do not hold good under operating conditions.

Interaction between stages causes difficulties in neutralising and in some instances, particularly where interaction is excessive, it is not possible to stabilise the receiver at all. The safe way is to screen after the style of the Raleigh P.M. There we have an example of screening which prevents all interaction without causing damping and consequent loss of efficiency.

Under those conditions a neutralising adjustment which holds good over the whole tuning range of both wavebands is not difficult to obtain if care has been taken to separate the grid and the anode, wiring of the H.F. stage. Interaction there will make neutralisation an extremely difficult task.

The coil enters largely into the situation and we are by no means reluctant to inform our readers that in so far as the Nelson P.M. de Luxe and the Raleigh P.M. are concerned, neutralisation is perfect. It is not necessary to switch out the valve to search for the wayward silent point. Simply set the reaction at zero (*i.e.*, moving vanes all out) and cut out the "squeals" by adjusting the neutralising condenser. More than usual trouble has been taken to attain this degree of efficiency. Manufacturers of the Colvern Coils are supplying a complete kit of coils for both receivers, the specification of which is the result of collaboration. Samples have been submitted and personally tested by the Editor on the original receivers. And it should be remarked that in the case of the long waves, these are not to Standard Split Primary Specification.



*Checking up, stage by stage, the amplification of the experimental model of the Raleigh P.M. Receiver.*

The neutralising adjustment for the long waves is not only the same as for the short waves but is easy to find, whether you make initial adjustments on 5XX or your local station.

Under such conditions the neutralising condenser does not complicate the handling of the set by introducing "another knob to turn." It rather permits, on the other hand, the owners of such receivers operating on P.M. Master Valves, (which they know by prolonged personal experience to be the best the world produces), to operate perfect radio receivers and to enjoy perfect radio entertainment without running to the unnecessary expense of special equipment and going to the trouble of building complicated receivers.





# COILS FOR P.M. MASTER SETS

This article gives helpful information on the correct coils for Mullard P.M. Receivers together with diagrams showing how to connect them into circuit.

FROM numerous letters sent to us by readers, we have come to understand that by no means is it an unusual occurrence for home constructors to find themselves trying to operate a receiver with the incorrect six-pin coils plugged into the aerial and H.F. stages. It is not difficult to imagine the dire consequences with which we have become acquainted.

In some cases batches of valves have been rendered filamentless; other reports have recounted the dead shorting of either the low or high tension batteries, while other readers have endured the more exasperating experience of trying to persuade an otherwise perfect set to function, with the grid and filament of the rectifier shorted by the use of an incorrect coil.

The object of these few notes and diagrams is to provide our readers with such information as will obviate disappointment and, may be, save them money for burnt-out valve replacements and new batteries.

## Many different types

In every case, the building instructions call for a specific coil—it may be Split Primary, Split Secondary, Reinartz or Rodney—each of these coils have different pin connections or in other words different windings which invariably require different pin connections. Reference to the diagrams will show the variation which exists in the range of coils for P.M. Receivers.

We have known cases where dealers have been asked for a coil for the Rodney P.M. Receiver and have supplied a Split Primary Transformer—the trader believing that all six-pin coils were alike. This idea of the six-pin coil is erroneous.

To a large degree, however, the responsibility for obtaining the correct coil rests with the home constructor. Firstly, he should make himself acquainted with the type required. In every instance this will be found in the list of components, and in some cases is strongly emphasised in the text. As a general rule, it will be found that two types are called for—an aerial coil and one, or more, high-frequency transformers,

according to the number of H.F. stages employed by the receiver. It should be added that until the type is familiar and definitely known and associated with a particular circuit, no home-constructor should go to his local dealer to purchase this part of the equipment.

The chance that the wrong type will be obtained is very high.

Having assured yourself upon the type of six-pin coil demanded by the circuit, you will then be in the position to go to your usual dealer with your order. Do not say—"six-pin coil." Rather tell your dealer "A split primary transformer with six-pin base."

## Look for the Name

Do not be content with making this definite request, but examine the coil before you leave the shop and satisfy yourself that you read upon it the name of the type for which you have asked.

The Colvern Coils bear the inscription upon a label inside the former; Lewcos Coils carry the name upon the top of the coil as also do the Copex Coils. Where other makes of coils are purchased the same precautions should be taken to see that you have been supplied with the correct type of coil.

Having purchased the coils and plugged them into the receiver, you should obtain satisfactory results

providing, of course, that you have followed carefully the instructions and wiring given for the receiver. Should it happen that no signals are to be heard—and by the way, this again, is not an unusual occurrence—the fault may be due to the fact that one or more of the pins on the coil are not making good contact with their appropriate socket in the six-pin coil base. The coil should be drawn away carefully from its base and each of the six pins carefully opened out with a pen knife or suitable tool. This simple and perhaps obvious operation is sometimes overlooked. Nevertheless, it will often bring a mute set into satisfactory operation.

*As most of our readers know there are many different types of six-pin coils. An impression does exist, however, that so long as the coil has six pins, it is the correct coil. When setting out, therefore, to purchase six-pin coils, first refer to the list of components so that you may become familiar with the particular type required for the circuit you propose to build. Colvern, Lewcos and Copex coils are suitable for P.M. Receivers. In this issue we have stated the actual make of coil used for the purpose of the test report.*

**Mullard Columbus P.M.**

This receiver employs an aerial coil and one high-frequency coil, the former is described as a Tapped Secondary Aperiodic Aerial Coil while the latter is known as the Split Primary Transformer with Interchangeable Primary for the Broadcast waves and Split Primary (Long Wave) Transformer for the Daventry range.

**Mullard Nelson P.M.**

The published design for this set comprised plug-in-coils for the Aerial:—Broadcast Range: 35 or 50 in the first holder and a centre-tapped 60 or 75 for the second coil holder; Daventry Range: 100 in the first coil-holder, 200 centre-tapped in the second holder. The high-frequency stage embodies a Split Primary Transformer for both wavelength ranges.

**Mullard Rodney P.M.**

This set also uses plug-in coils for the Aerial:—Broadcast Range: 35 in the first coil-holder and 60 or 75 centre-tapped in the second holder; Daventry Range: 100 in the first coil-holder and 200 centre-tapped in the second. The Colvern Magnetic Reaction H.F. Transformer is the correct coil for the high-frequency stage.

**Mullard Drake P.M.**

This receiver employs a centre-tapped plug-in coil—50 for the Broadcast Wave, 150 for the Daventry Range.

**Mullard Nelson P.M. de Luxe**

Into the aerial, plug-in a Tapped Aerial Six-pin Coil and into the H.F. Stage a Split Primary Transformer. Where Colvern Coils are preferred care should be taken to obtain for the long waves the Colvern Split Primary H.F. Transformer Type B. The standard transformer is, however, quite satisfactory on the 250-550 range. That the complete set of coils for this receiver should be purchased as a kit is a better suggestion.

**Mullard Hawkins P.M.**

This receiver requires a Colvern Hawkins High-Frequency Transformer for the H.F. Stage. The aerial coil takes the form of a frame aerial.

**Mullard Raleigh P.M.**

The high-frequency stages call for Split Primary H.F. Transformers while the aerial coil demanded for this set is a special coil described as the Raleigh Aerial Coil. The same remarks which are directed to the long wave H.F. Transformer in the case of the Nelson P.M. de Luxe, also apply to this receiver. Be certain to obtain the Colvern Long Wave Split Primary Type B. It is better to purchase a complete kit of coils; then you are certain of possessing the right coils.

**Mullard Collingwood P.M.**

Only one coil is necessary for this receiver, this being the oscillator coil. This is obtainable for both wavebands.

**Mullard Blake P.M.**

It will be noted from the design published in this issue, that Dimic and Unimic Coils are incorporated into this receiver—for the short waves (20 to 70): Short Wave Unimic and Dimic S.W.4; for the Broadcast Range: Unimic No. 50 and Dimic No. 1; Daventry Range calls for a Unimic No. 75 and a Dimic No. 2A.

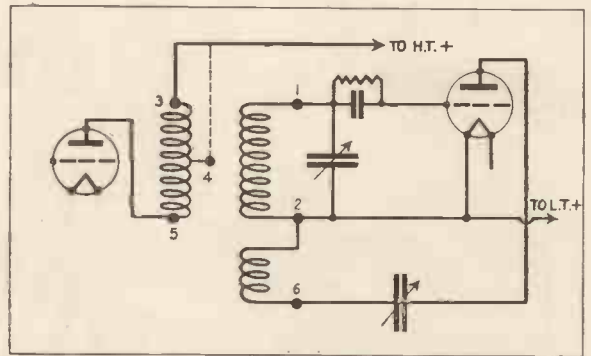

Pin connections for Nelson P.M. Increased selectivity may be obtained from this receiver by connecting H.T.+ to pin No. 4, as shown by the dotted line, in place of pin No. 3.

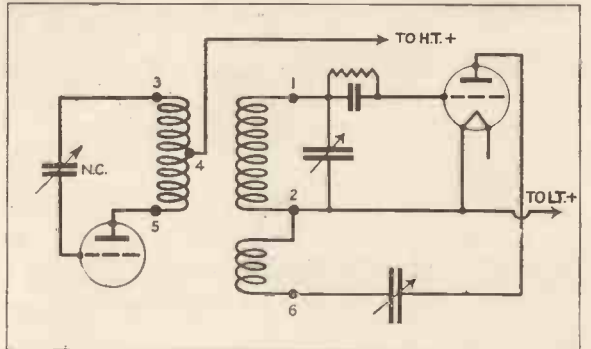

Coil connections for Nelson P.M. de Luxe, Columbus P.M. and Raleigh P.M.

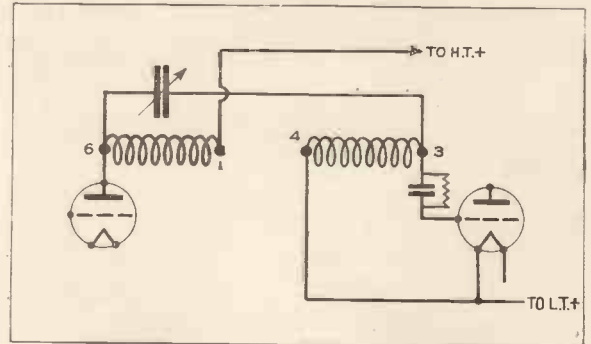

This diagram shows how the pins are utilised in the Hawkins P.M.

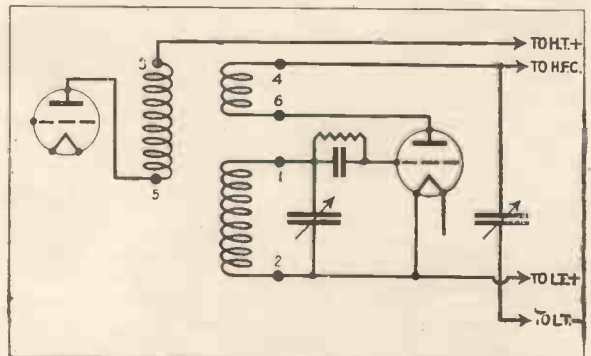

Pin connections for the Rodney P.M.

Continued on page 38.



# After Saturday's Programme

## —charge your L.T. Battery

Very few of our readers have not despaired of solving the L.T. battery charging problem. The following article shows just how simple it is to be relieved of the annoying and troublesome business of carrying the L.T. battery to a charging station ever so often.

One might wonder what is the radio owner's greatest wish in the world. Would it be to hold the record for the greatest number of stations received during an hour? Or, to log one of the many "down under" amateurs? Perhaps to own a set which cast a shadow upon every friend's receiver on the point of realistic quality?

Thousands of us may aspire towards one or may be all of these things. Letters from readers prove that the majority expect range, volume and quality from P.M. Sets. That each of these three are obtained by owners of P.M. Sets is amply confirmed by the long lists sent in of stations received, the glowing reports of pleasing radio music and the insistent demand for further P.M. designs.

### Near the ideal

But this is the romantic side of radio, and like every romance, always tempered by reality. This rude awakening from the pleasant charm of radio is not yet understood. Batteries at best only function for a brief period at maximum efficiency. Unfortunately the romance of radio is dependent upon that efficiency to some degree, small though it is to-day.

But referring once more to this greatest wish in the world. Speaking for ourselves it was to be independent of the charging station. Batteries will not remain charged for an indefinite period, although the P.M. Filament has done more to extend their active life between charge than all other apparatus combined. With Mullard P.M. Valves installed radio comes pleasantly near the ideal and almost brings the greatest wish—but even the new 0.075 series must be supplied with current at the rated pressure.

With care, the L.T. Battery may be charged and recharged for years. It may be expected to have a long and useful life. Serving Mullard P.M. Valves the L.T. Battery may almost be forgotten; we really do forget it until unexpectedly reception slowly decreases in volume and finally the receiver refuses to function at all.

With the purchase of the P.M. L.T. Battery Charger, the radio owner disposes of this dread reality. By simply inserting a plug into a lamp or wall socket and connecting two leads to the terminals of the L.T. Battery, the whole responsibility for charging is shouldered by the Mullard P.M. L.T. Battery Charger. And, by the way, it is no more difficult than we have described. The design of the unit has removed any necessity to understand anything about the technical considerations of battery charging.

Being absolutely automatic in operation, no instruments are required to indicate how the Unit is performing—nor is its owner compelled to know at what rate the L.T. should be charged.

A simple calculation will tell how much current is being taken from the L.T. Battery each week, and it will be found that for most radio owners one charge once a week will be sufficient to put back into the battery the energy taken from it. This suggestion is based upon the assumption that the majority of readers regularly run a four-valve set incorporating four Mullard P.M. Valves.

This once-a-week method of battery charging is to be recommended. A regular charge and discharge greatly increases the output efficiency of the battery, and its useful term of life is considerably lengthened thereby.

All these things are the responsibility of the P.M. L.T. Battery Charger itself. No matter whether your accumulator is 2-volt, 4-volt or 6-volt, the same condition exists, all that it is necessary to do is not one whit more dangerous or difficult than switching on an electric fire.

### Easily arranged

Therefore, it comes rather as an excellent idea to call the P.M. L.T. Battery Charger into use when the receiver is switched off after Saturday evening's performance, leaving the battery on charge until the commencement of Sunday's Broadcast.

Do not be under the impression that any harm arises by leaving the Mullard P.M. L.T. Battery Charger switched on overnight, or while you are out in the car on Sunday. It functions safely whether you are asleep upon the premises or coasting along country roads. The Unit remains perfectly safe under those conditions. When the battery on charge has been gassing for a few hours it may be considered to be fully charged, and once again may be relied upon to serve you satisfactorily for the remainder of the week.

### Cost of running

In the general run of things, however, a charge once a week will prove ample for the great majority. The charging rate of the Mullard P.M. L.T. Battery Charger is 1.3 amps and the cost of running less than the price of the shoe-leather worn out in the journey from home to the charging station and return.

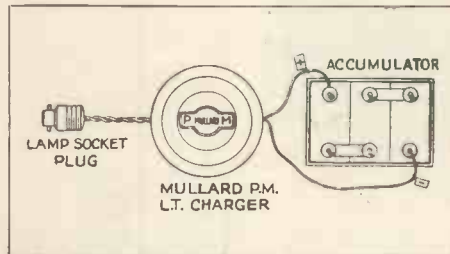

*The simplicity of attachment is revealed by this drawing of the Mullard P.M. L.T. Battery Charger for A.C. mains connected to an L.T. Battery. Plug into a wall or lamp socket, then switch-on—that's all.*

Apart from the labour-saving effected by the possession of a Mullard P.M. Battery Charger it must be remembered that the P.M. Filament functions best at the rated filament voltage, and only in very exceptional cases is it in any way necessary to reduce the filament current.

**Run valves at rated voltage**

In the present series of P.M. Sets, there is only one instance where filament control is at all important, and for that reason a rheostat is placed in the negative lead of the filaments of the interfrequency amplifying valves in the Collingwood P.M. Receiver. Elsewhere the wonderful Mullard P.M. Valve connected directly across the L.T. battery *definitely performs better than any other make or type of valve available to the radio public.*

It should be mentioned that filament temperature controls the electronic emission; but as we have all experienced the immense increase of efficiency which a newly charged battery gives to a radio set, it would be out of place to amplify into technical considerations the great advantages secured by using a fully charged battery.

We feel very sure of our ground in saying that most readers have experienced for themselves this increase of efficiency endowed upon a radio receiver when a newly charged battery is connected to it. It is doubtless sufficient to say that the P.M. Series of valves operate at maximum efficiency when run at their rated filament.



The Mullard P.M. L.T. Battery Charger for A.C. Mains.

Under these conditions the P.M. Valve has been designed to operate, and to render its owner the greatest possible service.

**A Radio axiom**

That this is true, even to the most exacting conditions, is borne out by the Test Report on the Blake P.M. Receiver. It will be observed that 2XAD and 2XAF—two New York short wave stations—were received on three valves at speaker strength without filament control. It is true that the L.T. Battery was delivering its full pressure upon that occasion—but the operation of the receiver was in no way complicated by the introduction of filament control.

That the L.T. Battery should be in tip-top condition and that the wonderful Mullard P.M. Valves should be connected directly across the battery is a radio axiom, and, let it be said, one which, faithfully carried out, brings better radio to the observer.

**IMPORTANT NOTICE**

**I**N view of the reduction of the filament consumption with certain Mullard P.M. Valves, prospective builders of the Drake Mullard P.M. Receiver, as described in the second issue of *Radio for the Million*, will require a special shunt-resistance across the filament of any .075 valve which may be used in place of the .1 series. This special resistance is obtainable from Messrs. Climax Radio Electric, Ltd.

**Coils for Mullard P.M. Sets**

(Continued from page 36)

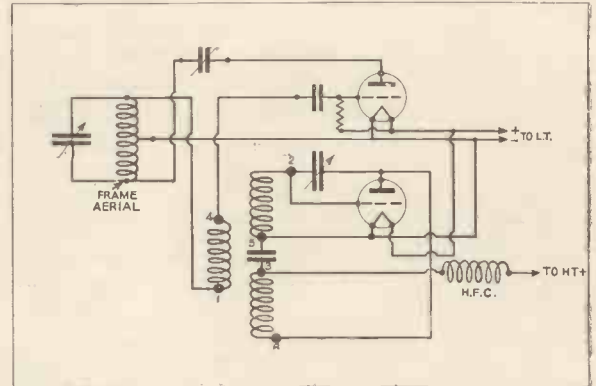

Here we reproduce the aerial arrangement for the Nelson P.M. de Luxe. This coil being of similar appearance to the H.F. Transformer care should be taken not to insert it in the holder of the H.F. Stage. A shorted L.T. Battery will be the consequence.

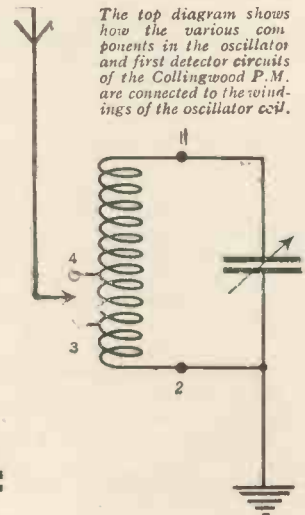
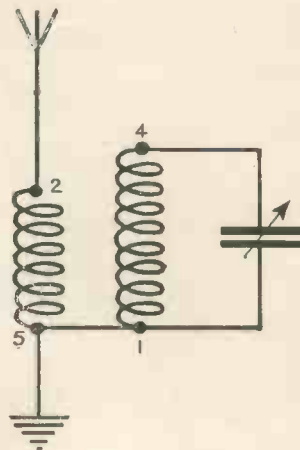

The top diagram shows how the various components in the oscillator and first detector circuits of the Collingwood P.M. are connected to the windings of the oscillator coil.

The first six-pin holder in the Columbus P.M. requires the aerial and earth connected to pins 2 and 5, while the grid is connected to pin No. 4. Pins No. 1 and 5 are joined to L.T.—

The Raleigh P.M. calls for an aerial coil of this design. It will be noted that it conforms to the Split-Primary arrangement except that pins Nos. 3 and 6 are not employed.

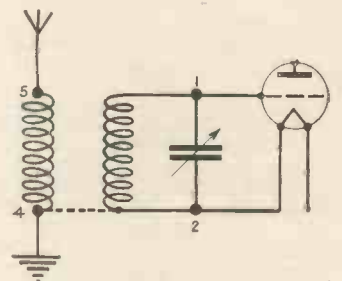



## Bridge the Atlantic with the Mullard Blake P.M. Receiver.

**W**ITH the recent introduction of Empire Broadcast arrangements, this receiver will arouse considerable interest. It is, however, designed in such a manner that where funds are limited it may also be adapted for the 200-550 and 1100-1800 wavebands by the simple expedient of changing over the coils.

**I**T is comparatively easy to smile rather tolerantly at that fellow living at the other end of the street who sits up into the early hours of the morning, working the numerous short-wave telephony stations dotted over the world. To the mind of the ordinary man such overflowing enthusiasm seems hard to explain and difficult to understand.

The short-wave enthusiast comes in for no small share of consolation. Judging by some comments we have heard from time to time, short-wave enthusiasm is considered a kind of modern mania confined to males averaging in age from sixteen to sixty. This conception of the short-wave wizard is held only by those who have not experienced the fascinations of the short-waves.

The reception of stations located across the Atlantic is fascinating: There is more pleasure consequent upon their reception than in tuning-in a host of European Stations.

Music is a universal language. Regardless of its source of origin, whether France, Germany, Holland, Spain or Sweden, infinite pleasure is found in listening to it.

### Hear our own language

Linguists alone are provided with entertainment by the reception of speech from Continental Stations—but stations across the Atlantic broadcast in our own language. Announcers speak in a tongue we understand. Sitting

comfortably at home listening to an American station, is an experience which no Britisher should miss, particularly when such a simple receiver as the Blake P.M. supplies the means.

It is well within the bounds of possibility that what these short-wave fellows—old and young—are doing to-day, will be considered commonplace in a couple of years time, by the average man in the street. Constructional details of the Blake P.M. Receiver are published in the hope that it will popularise this side of radio and will inspire many modern Britishers to "Westward Ho."

### No alteration to aerial or earth

Rather in contradiction to the generally accepted idea about short-wave reception, builders of the Blake P.M. will not encounter any of the difficulties which are normally attributed to the higher frequencies. When testing out the Blake P.M. Receiver, no alterations were made either to the aerial or earth systems. The former remained in the same condition as normally used for ordinary broadcast reception, while the earth as usual consisted of a piece of wire wrapped round a water tap. In point of fact, outside body-capacity effects any American short-wave station, comes over as strong, if not stronger, than many of the popular Continental Stations. The presence of body-capacity effects, however, is only to be overcome entirely by totally enclosing a short-wave receiver in a metal screen. The advantage gained, while being very helpful, does not bring in short-wave stations any the stronger.

It is also interesting to observe that the usual difficulties involved in the definite separation of stations on the broadcast waveband is not present on the extreme high-frequencies. For example, it would be possible to allocate 391 stations with a 10 kilocycle separation between 2XAD and 2XAF. Although tuning is razor sharp, the first attempt to bag either of the above stations will be rewarded with success

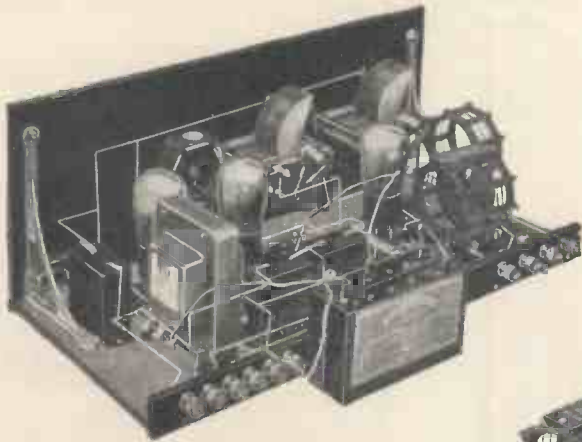

*The general lay-out of the receiver appears in the above reproduction. Attention is drawn to the position of the high-frequency choke which may be recognised as a plug-in-coil. It will also be noted that large by-pass condensers are again featured in this set.*

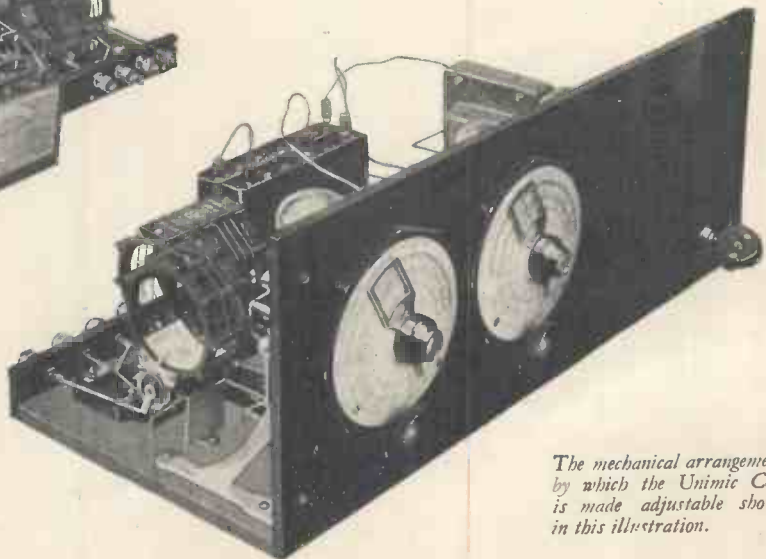

*The mechanical arrangement by which the Unimic Coil is made adjustable shows in this illustration.*

Variable aerial coil

Reference to the illustrations, shows that a Unimic Coil forms part of the aerial coupling and that this coil may be swung either nearer to or away from the grid coil. Short-wave reception demands an adjustable coupling, for it is necessary to maintain the receiver in a sensitive condition. It will be found that when first operating the receiver, the set appears dead over a certain narrow band. This indicates that the aerial has come into tune with the grid coil. Adjustment of the Unimic Coil will bring the set once more into a state of oscillation.

Usually one particular setting of the aerial coil will be found which maintains oscillation over the whole range of the tuning condenser.

In designing the Blake P.M., several considerations have been served. A special make of short-wave coil has been used for the reason that by the purchase of larger sizes it is possible to employ the set for the reception of stations on the broadcast wave—the local, 5GB, Daventry, Langenberg, Brussels and so on. By this arrangement, a limited purse does not prevent full radio enjoyment being attained. The only expense involved over that of an ordinary radio set, is that necessary to obtain extra coils to cover the short waves.

Operates with Mullard P.M. H.T. Unit

Secondly, reception on the higher frequencies was to be achieved while operating the set on a Mullard P.M. H.T. Supply Unit. As a matter of general interest, the P.M. H.T. Supply Unit delivered the H.T. current during the tests which are reported in this issue. Needless to say the set worked perfectly under those conditions.

Thirdly, in accordance with the Pure Music policy, a stage of resistance-capacity coupling follows the detector valve. This is an extremely commendable feature. Reaction with this arrangement, by the way, leaves nothing to be desired.

Short-Wave Test Report

Metres.	Fre-quency.	STATION.	Dial Reading
22-02	13623	2XAD New York .. .. .	85
25-8	11627	Unidentified .. .. .	34.5
32-77	9155	2XAF New York .. .. .	67-9

Monday Evening, August 15th, 1927.

11.19 p.m. Market Report from 2XAD. Heard clearly with scarcely any fading on Speaker.

11.49 p.m. Picked up on Speaker on dial-reading of 34.5, very strong telephony, familiar piece from Musical Comedy—recognised as selection from "Maid of the Mountains," followed by a Song by a Spanish Baritone. After hearing announcement in English that the orchestra would play a Barcarole returned to 2XAD.

12.31 a.m. August 16th, 1927. 2XAD gave News Bulletin and signed off at 12.36 a.m.

Tuesday Evening, August 16th, 1927.

Tuned-in at 11.50 p.m. 2XAF at amazing strength, free of atmospherics and fading—listened to programme for over an hour. News Bulletin at 12.20 a.m.; Talk on fishing followed.

¶ In addition to the above telephony, scores of amateur C.W. Stations were tuned-in on both evenings. These were so numerous that dial readings were not taken.

Note: If the Blake P.M. is constructed solely for the reception of the short waves it is advisable to substitute variable condensers of .00025 mfd. rather than .0005 mfd. The object in illustrating our photographs with this latter value indicates the model for universal application.

Apparatus

In building a receiver for Short Wave reception more than ordinary care must be exercised in the choice of components. Substitution may result in extremely disappointing results. It is recommended therefore, that any modification to the component parts should be made only with great discretion.

No.	Component.	Maker.	Price.
1	Cabinet, 18 in. x 7 in. . . . .	W. H. Agar	£ 2 6 0
1	Baseboard, 18 in. x 8 in. x ½ in. . . . .	W. H. Agar	1 6
1	Terminal Strip, 18 in. x 1½ in. x ¼ in. . . . .		1 0
1	Panel, 18 in. x 7 in. x ¼ in. . . . .	Camco	10 6
1	Pair Panel Brackets . . . . .	Camco	2 0
3	Valve Holders (Anti-Capacity) . . . . .	Bowyer-Lowe	9 0
1	Anode Resistance (100,000 ohms) . . . . .	Mullard	5 0
1	Anode Resistance Holder . . . . .	Mullard	1 6
3	Grid Leaks : 5 Megohms, .25 Meg., 1 Meg. . . . .	Mullard	7 6
3	Grid Leak Holders . . . . .	Mullard	3 9
1	L.F. Transformer . . . . .	R.I. Varley	1 5 0
3	2 Mfd. Mansbridge Condensers . . . . .	Mullard	15 0
3	Fixed Condensers : .0001 Mfd., .0003 Mfd., .005 Mfd. . . . .	Mullard	8 0
1	S.W.3 Dmic and Base . . . . .	McMichael	11 6
1	Short Wave Unimic, with Base . . . . .	McMichael	7 6
2	Variable Condensers (Logarithmic, .0005 Mfd. each) . . . . .	Ormond	1 6 0
2	Slow Motion Dials . . . . .	Ormond	10 0
1	Plug-in Coil, No. 50 . . . . .	Edison Bell	2 6
1	Coil Base . . . . .	Edison Bell	1 0
1	Filament Lighting Jack . . . . .	Lotus	2 6
1	Speaker Plug . . . . .	Lotus	2 0
10	Terminals, A.1, A.2, A.3, E, L.T. +, L.T. -, H.T. -, H.T. + 1, H.T. + 2, H.T. + 3 . . . . .	Belling & Lee	5 0
5	Wander Plugs, 3 black, 2 red . . . . .	Lisenin	10
	Quantity of Self-Soldering Wire . . . . .	Junit	

N.B.—Those of our readers who may wish to make additional use of the Blake P.M. Receiver, will find the following dial calibrations of great use in locating many stations transmitting on the longer waves.

Those stations included in the following list were tuned-in and their identity checked against the Emerald Wavemeter.

Metres.	Fre-quency.	STATION.	Dial Reading
252.1	1190	Bremen . . . . .	6
272.7	1100	Relays—Sheffield . . . . .	31
275.2	1090	Nottingham . . . . .	34
277.8	1080	Leeds. . . . .	36.5
283	1060	Dortmund . . . . .	41.75
287	1045	Lille . . . . .	44.5
288.5	1040	British Relays . . . . .	54.5
303	990	Nuremberg . . . . .	57.5
312.5	960	Newcastle . . . . .	63.5
315.8	950	Breslau . . . . .	65.5
326.1	920	Bournemouth . . . . .	72
348.9	860	Prague . . . . .	84.5
361.4	830	London . . . . .	92.5
405.4	740	Glasgow . . . . .	110
428.6	700	Frankfort . . . . .	119.5
441.2	680	Bruenn . . . . .	124
454.5	660	Stockholm . . . . .	12
461.5	650	Unidentified (probably Oslo) . . . . .	130
468.8	640	Langenberg . . . . .	133.25
483.9	620	Berlin . . . . .	138
491	610	Daventry (5GB) . . . . .	140
500	600	Aberdeen . . . . .	142.25
508.5	590	Brussels . . . . .	145
535.7	560	Munich . . . . .	152
1604.3	187	Daventry . . . . .	75



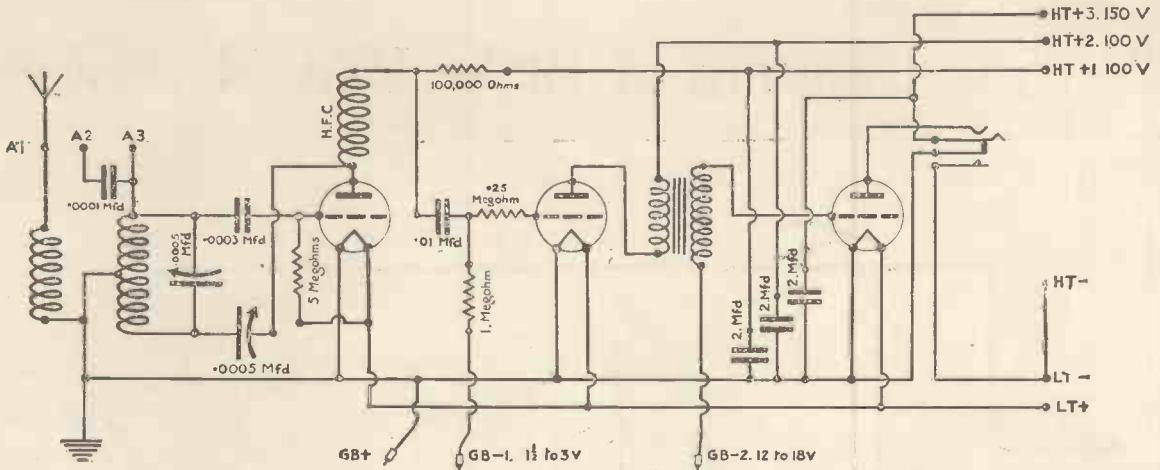

This is the theoretical diagram of the Blake P.M. Those of our readers who are accustomed to the reading of circuit diagrams will find it to contain all the information necessary for the construction of the receiver.

### Point-to-Point Wiring

- |                                                                                                                                                                                                                                                                                                                                                                                                                                                                                                                                                                                                                                                                                                                                                                                                                                                                                                                                                                                                                                                                                                                                                                                                                                                                                                                                                                                                                                                                                                                                                                                                                                                                                                                                                           |                                                                                                                                                                                                                                                                                                                                                                                                                                                                                                                                                                                                                                                                                                                                                                                                                                                                                                                                                                                                                                                                                                                                                                                                                                                                                                                                                                                                                                                                                                                                                                                                                                                                                                                                                           |
|-----------------------------------------------------------------------------------------------------------------------------------------------------------------------------------------------------------------------------------------------------------------------------------------------------------------------------------------------------------------------------------------------------------------------------------------------------------------------------------------------------------------------------------------------------------------------------------------------------------------------------------------------------------------------------------------------------------------------------------------------------------------------------------------------------------------------------------------------------------------------------------------------------------------------------------------------------------------------------------------------------------------------------------------------------------------------------------------------------------------------------------------------------------------------------------------------------------------------------------------------------------------------------------------------------------------------------------------------------------------------------------------------------------------------------------------------------------------------------------------------------------------------------------------------------------------------------------------------------------------------------------------------------------------------------------------------------------------------------------------------------------|-----------------------------------------------------------------------------------------------------------------------------------------------------------------------------------------------------------------------------------------------------------------------------------------------------------------------------------------------------------------------------------------------------------------------------------------------------------------------------------------------------------------------------------------------------------------------------------------------------------------------------------------------------------------------------------------------------------------------------------------------------------------------------------------------------------------------------------------------------------------------------------------------------------------------------------------------------------------------------------------------------------------------------------------------------------------------------------------------------------------------------------------------------------------------------------------------------------------------------------------------------------------------------------------------------------------------------------------------------------------------------------------------------------------------------------------------------------------------------------------------------------------------------------------------------------------------------------------------------------------------------------------------------------------------------------------------------------------------------------------------------------|
| <p>Wire No.</p> <ol style="list-style-type: none"> <li>1 Connect terminal A1 to terminal No. 2 of coil holder H1.</li> <li>2 Connect terminal A2 to nearest terminal of condenser C8.</li> <li>3 Connect terminal A3 to other terminal of condenser C8.</li> <li>4 Connect terminal A3 to terminal No. 1 of coil holder H2 and on to nearest terminal of condenser C7, and on to terminal M of condenser C1.</li> <li>5 Connect earth terminal to terminal No. 3 of coil holder H2 and on to terminal No. 1 of coil holder H1.</li> <li>6 Connect wire No. 5 to terminal No. 2 of coil holder H2 and on to terminals F- of valve holders V1, V2 and V3.</li> <li>7 Connect wire No. 6 to tag No. 4 of jack J.</li> <li>8 Connect terminal No. 4 of coil holder H2 to terminal F of condenser C1.</li> <li>9 Connect wire No. 8 to terminal F of condenser C.</li> <li>10 Connect right-hand end of grid leak R4 to terminal nearest panel of condenser C7 and on to terminal G of valve holder V1.</li> <li>11 Connect terminal F+ of valve holder V1 to left-hand end of grid leak R4 and on to terminals F+ of valve holders V2 and V3.</li> <li>12 Connect terminal A of valve holder V1 to terminal M of condenser C2.</li> <li>13 Connect terminal M of condenser C2 to terminal No. 1 of coil holder H3.</li> <li>14 Connect terminal No. 2 of coil holder H3 to right-hand terminal of condenser C3 and on to nearest terminal of resistance R3.</li> <li>15 Connect right-hand terminal of grid leak R2 to left-hand terminal of condenser C3 and on to right-hand terminal of grid leak R1.</li> <li>16 Connect left-hand terminal of grid leak R2 to terminal G of valve holder V2.</li> <li>17 Connect terminal LT+ to wire No. 11.</li> </ol> | <p>Wire No.</p> <ol style="list-style-type: none"> <li>18 Connect terminal A of valve holder V2 to terminal No. 3 of transformer T.</li> <li>19 Connect together terminals 1 and 2 of transformer T by means of the special link provided.</li> <li>20 Connect terminal A of valve holder V3 to tag No. 1 of jack J.</li> <li>21 Connect terminal G of valve holder V3 to terminal No. 5 of transformer T.</li> <li>22 Connect terminal HT+1 to terminal nearest terminal board of resistance R3.</li> <li>23 Connect wire No. 22 to right-hand terminal of condenser C4.</li> <li>24 Connect left-hand terminal of condenser C4 to right-hand terminal of condenser C5.</li> <li>25 Connect terminal HT+3 to tag No. 3 of jack J.</li> <li>26 Connect wire No. 25 to one side of condenser C6.</li> <li>27 Connect tag No. 2 of jack J to the two fixed terminals of condensers C1 and C2.</li> <li>28 Connect free terminal of condenser C6 to wire No. 27.</li> <li>29 Connect terminal HT- to terminal LT- and on to wire No. 29.</li> <li>30 Connect wire No. 29 to wire No. 24.</li> <li>31 Connect terminal No. 6 of transformer T to left-hand terminal of condenser C5.</li> <li>32 Connect terminal HT+2 to wire No. 31.</li> <li>33 Connect a piece of flexible wire 9 ins. long to wire No. 29 between terminals HT- and LT-. To the free end of this wire attach a red wander plug marked GB+.</li> <li>34 Attach a piece of flexible wire 9 ins. long to the left-hand terminal of grid leak R1, to the free end of this wire fit a black wander plug marked GB-1.</li> <li>35 Connect a piece of flexible wire 9 ins. long to terminal No. 4 of transformer T to the free end of this wire fit a black wander plug marked GB-2.</li> </ol> |
|-----------------------------------------------------------------------------------------------------------------------------------------------------------------------------------------------------------------------------------------------------------------------------------------------------------------------------------------------------------------------------------------------------------------------------------------------------------------------------------------------------------------------------------------------------------------------------------------------------------------------------------------------------------------------------------------------------------------------------------------------------------------------------------------------------------------------------------------------------------------------------------------------------------------------------------------------------------------------------------------------------------------------------------------------------------------------------------------------------------------------------------------------------------------------------------------------------------------------------------------------------------------------------------------------------------------------------------------------------------------------------------------------------------------------------------------------------------------------------------------------------------------------------------------------------------------------------------------------------------------------------------------------------------------------------------------------------------------------------------------------------------|-----------------------------------------------------------------------------------------------------------------------------------------------------------------------------------------------------------------------------------------------------------------------------------------------------------------------------------------------------------------------------------------------------------------------------------------------------------------------------------------------------------------------------------------------------------------------------------------------------------------------------------------------------------------------------------------------------------------------------------------------------------------------------------------------------------------------------------------------------------------------------------------------------------------------------------------------------------------------------------------------------------------------------------------------------------------------------------------------------------------------------------------------------------------------------------------------------------------------------------------------------------------------------------------------------------------------------------------------------------------------------------------------------------------------------------------------------------------------------------------------------------------------------------------------------------------------------------------------------------------------------------------------------------------------------------------------------------------------------------------------------------|

### Short-Wave Time Table

WAVELENGTH.		STATION.	SUNDAY.	MONDAY.	TUESDAY.	WEDNESDAY.	THURSDAY.	FRIDAY.	SATURDAY.
METRES.	FREQUENCY.								
62-	4838	KDKA E. Pittsburg, U.S.A.	— 5 a.m.	11 p.m.- 5 a.m.	11 p.m.- 5 a.m.	11 p.m.- 5 a.m.	11 p.m.- 5 a.m.	11 p.m.- 5 a.m.	11 p.m.- 5 a.m.
52-02	5767	WLW Cincinnati, U.S.A.	9 p.m.- 3 a.m.	9 p.m.- 3 a.m.	9 p.m.- 3 a.m.	9 p.m.- 5:30 a.m.	9 p.m.- 5:30 a.m.	—	11:55 p.m.- 3 a.m.
32-77	9155	2XAF Schenectady, U.S.A.	—	—	11 p.m.- 3 a.m.	—	11 p.m.- 3 a.m.	—	11:45 p.m.- 3 a.m.
30-02	9993	PCJJ Eindhoven Holland	—	—	6 p.m.- 9 p.m.	—	6 p.m.- 9 p.m.	—	Often works during evening
22-02	13,623	2XAD Schenectady, U.S.A.	Midnight- 2 a.m.	11 p.m.- 12:30 a.m.	10 p.m.- 11 p.m.	11 p.m.- 3 a.m.	—	11 p.m.- 3 p.m.	—

Many of our readers will find the above table helpful as it will be seen to provide the times during which some of the short wave stations are operating.

# Wiring Diagram of Blake P.M. Receiver

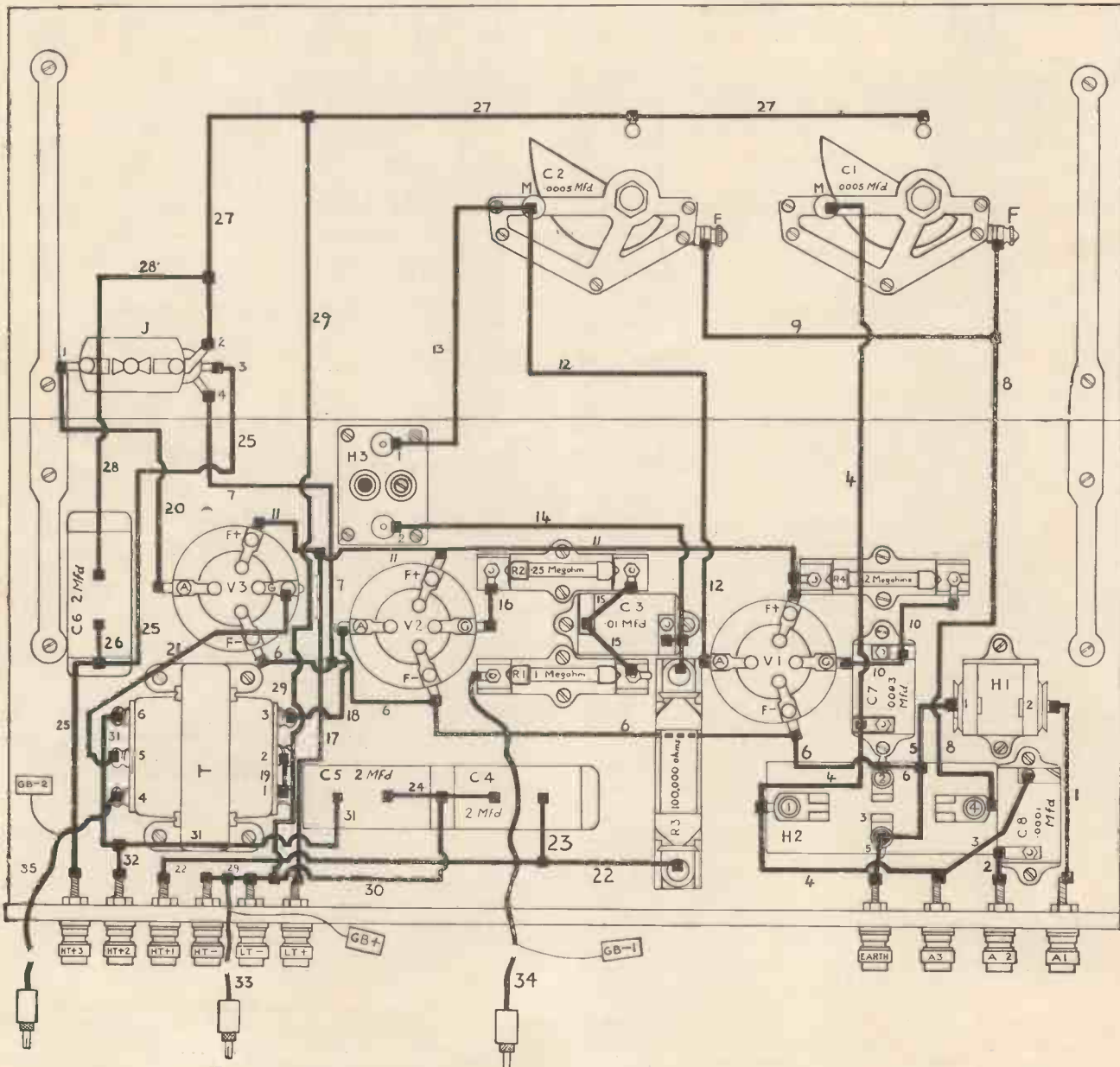

*This receiver, although primarily intended for the more advanced home-constructor, will not be overlooked by the newcomer to radio. If we understand the wishes of the radio public rightly, then we have every reason to believe that the Blake P.M. will be chosen as a Winter set by many of the less experienced, though not less skilful in the art of set building. It was not possible to issue a full-size blueprint. The above wiring diagram is approximately one-third actual size and affords every assistance towards the successful construction of the set.*



# MULLARD P.M. MASTER RADIO

lifts gramophone record reproduction to a high  
standard of musical quality

## P.M. RADIO APPARATUS GIVES BEST MUSICAL PERFORMANCE

**T**HE production of an instrument described as the Gramophone "Pick-up" has aroused great interest among radio enthusiasts who are in the possession of a gramophone. Although the majority of our readers may be quite familiar with this device it is proposed to outline briefly here the function it is intended to perform.

Gramophone "Pick-up" does not convey its application at first hearing, and it is quite reasonable to suggest that many readers will escape understanding its great utility on that account. Briefly, it brings to every radio owner, the advantages of an electrically-reproducing gramophone for a ridiculously low sum of money.

The first commercial example of this type of gramophone is listed at £120 and the quality which characterises the reproduction of this instrument surpasses the wildest dreams of the cabinet gramophone advocate. Attendance at a public demonstration of this particular gramophone was an experience with which we were glad to have been privileged.

### A dual contribution

The system is by no manner of means confined to either the radio enthusiasts or the gramophone advocates. It is essentially an arrangement which brings the radio and the gramophone owner on to common ground where each for the benefit of the other, pools the best that both provide.

Radio supplies the electrical side of the system—amplifying valves, low-frequency coupling apparatus and speakers. From the gramophone industry we obtain the mechanical part of the system—the motor, the turntable, the tone arm and the record. Nor must reference to the new electrical recording be omitted, for as everyone with a gramophone knows, the employment of the microphone in the recording room has revolutionised the musical quality obtainable from the record.

There is little doubt but that electrical recording has paved the way for the gramophone "pick-up" although experiment shows that the old type of record is greatly improved by using this system. In point of fact, the old record is given a new lease of life and it is felt that because of this, apart from any other reason, the gramophone "pick-up" will enjoy great popularity.

The object of utilising the electrical method of reproduction is that a higher standard of musical quality is obtainable than with the normal sound box and self-contained horn. Every owner of a P.M. Set has the best facilities for improving the reproduction of the gramophone record. Should he also possess a P.M. Speaker then no doubt exists but that a great treat is held in store.

But let it be clearly understood that while a high standard of performance is easily secured it is just as simple to meet with disappointment. As in the case of the radio speaker, it is necessary to choose your gramophone "pick-up" at a demonstration. This is a recommendation which it is hoped our readers will adopt.

As the illustration on this page suggests, the ordinary gramophone may be used without any modification other than the removal from the tone arm of the sound box, in place of which is clamped the "pick-up." A portable, table model or a gramophone of cabinet design are equally suitable.

### Suitable with P.M. Sets

The particular make of "pick-up" appearing in our reproduction is that known as the "Phonovox" which is supplied separately or with a suitable volume control. When the "pick-up" is required to be used in conjunction with one of the P.M. sets, a further gadget for plugging into the detector valve socket is also obtainable from the makers of the "Phonovox."



## Adaptable to Mullard P.M. Master Receivers

Owners of P.M. Sets who also possess a gramophone may, by the purchase of such a device as the "Phonovox" with the requisite volume control and plug-in adaptor, or such make of gramophone "pick-up" as after hearing, their taste has indicated, be enabled to utilise their radio receiver for reproducing the music from the gramophone record.

Beyond removing the detector valve and inserting the plug-in adaptor, no alteration to the set is required. Two leads from the "pick-up" are connected in parallel with the volume control, the two leads from which are connected to the plug-in adaptor. Through the low-frequency stages of the radio set, amplification takes place in the usual manner.

### Two special Mullard P.M. Amplifiers

For the benefit of those who wish to build a separate amplifier for the purpose of amplifying the impulses applied by the "pick-up," we are reproducing various diagrams—both theoretical and practical.

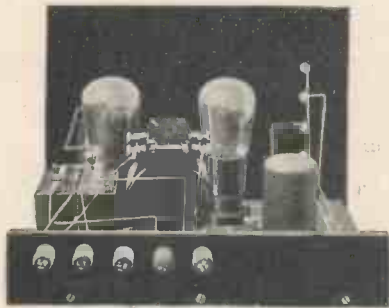

*A view of the P.M. Gramophone "Pick-up" Amplifier "B." The arrangement, as shown by the circuit diagram, may be used either as an amplifier with the "pick-up" or as an amplifier unit for use in conjunction with a single valve receiver.*

*Another view of the same amplifier. Four terminals are seen mounted on the panel, the use of which is fully explained in the text.*

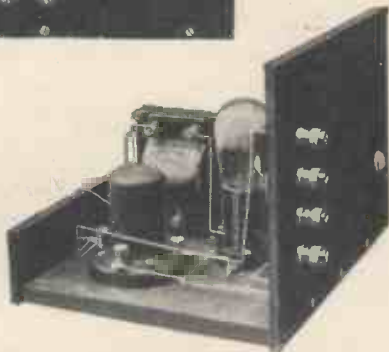

The first arrangement consists of one stage of R.C.C. and one stage of transformer coupling. Reference to these will show that in addition to its function as an amplifier for use in conjunction with the gramophone "pick-up" any owner of a single valve receiver may also use the arrangement to secure speaker reception from his one-valve set.

This amplifier, which is not intended to deliver the necessary volume to fill a dancing hall, will be found admirably suitable for use at home.

The second suggestion gives all the necessary details for the construction of a three-valve amplifier, comprising an input valve and two additional amplifying valves coupled by the R.C.C. System. This latter amplifier will be found extremely suitable when the gramophone is required for private dance parties. Sufficient volume would be delivered by this three-valve combination to entertain a dance party of fifty couples.

It is not possible to emphasise too greatly that in a similar manner to the radio set, the choice of apparatus governs the

performance of your amplifier. Readers of *Radio for the Million* are therefore advised not to make experiments in diverting from the published directions without expert guidance, unless they are qualified by experience to do so.

### Splendid reproduction with Mullard Speaker

Beside obtaining a gain in volume, the idea of the gramophone "pick-up" is to supply an improvement in quality of reproduction. And it is rather important that such apparatus as will give quality reproduction is incorporated into the amplifier.

The Editor wishes to intimate that he has an amplifier in use conforming in design to the one concerning which details are given here, and that the P.M.1A, P.M.1L.F. and P.M.252 are the valves employed.

Doubtless, our readers would appreciate some indication of the results that are to be obtained with such an amplifier in conjunction with P.M. Valves, and the Mullard P.M. Speaker?

After one record had been run through with the normal sound box, the system was changed over to the electrical method: It was immediately apparent that every trace of scratch had become inaudible and that the "megaphone effect," so conspicuous with the ordinary gramophone, had completely disappeared.

While listening to the electrically reproduced gramophone record, one is greatly impressed by the fact that the beauties of recorded music may be enjoyed in a manner hitherto neither possible nor practicable.

If you own a gramophone, adapt it to employ the gramophone "pick-up"; the small expense is well worth while.

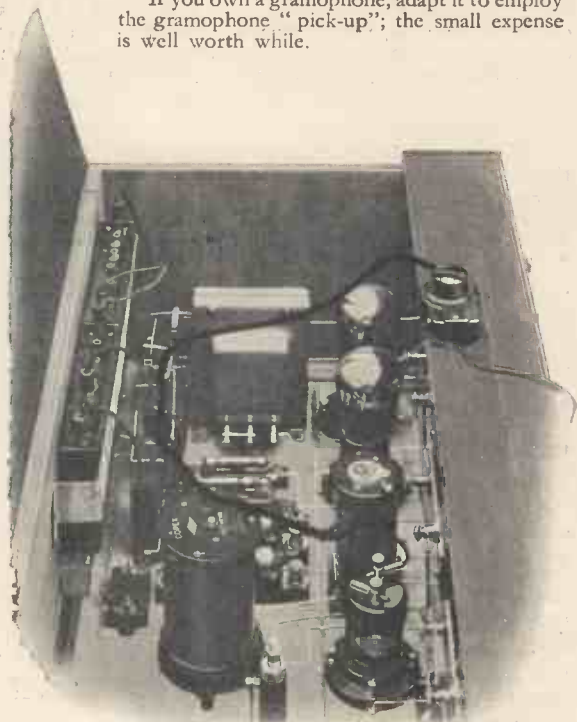

*Here we show the method of inserting the "Phonovox" Adaptor into the detector-valve socket of the Nelson P.M. de Luxe.*



On this page we are reproducing a wiring diagram of the Mullard P. M. Gramophone "Pick-up" Amplifier "B" by the aid of which any reader may construct an extremely useful little unit. As previously mentioned, this particular amplifier serves a double purpose, in that when not required for use in conjunction with a gramophone "pick-up," it may be connected to a single-valve receiver.

**For single valve set :—**  
Connect terminal marked A on the wiring diagram to the telephone terminal of set already connected to H.T. +1 and connect terminal marked B to telephone terminal already connected to the anode of the Detector valve.

**For gramophone amplifier:—**  
Connect terminal marked B to one lead from the "pick-up" (or volume control if this component is included). Connect terminal marked C to the other lead from "pick-up" (or volume control if this component is included). Terminals marked A and D are left free.

Where a volume control is used, the two leads from the "pick-up" are so connected that the former is connected in parallel with the latter. The illustration shows exactly how this is done in practice.

**Note :—**It is important to disconnect the condenser usually shunted across the telephone terminals of a single-valve receiver before linking up the amplifier. One of the Mullard P.M. R.C.C. valves should be used in the valve-holder of the single-valve set.

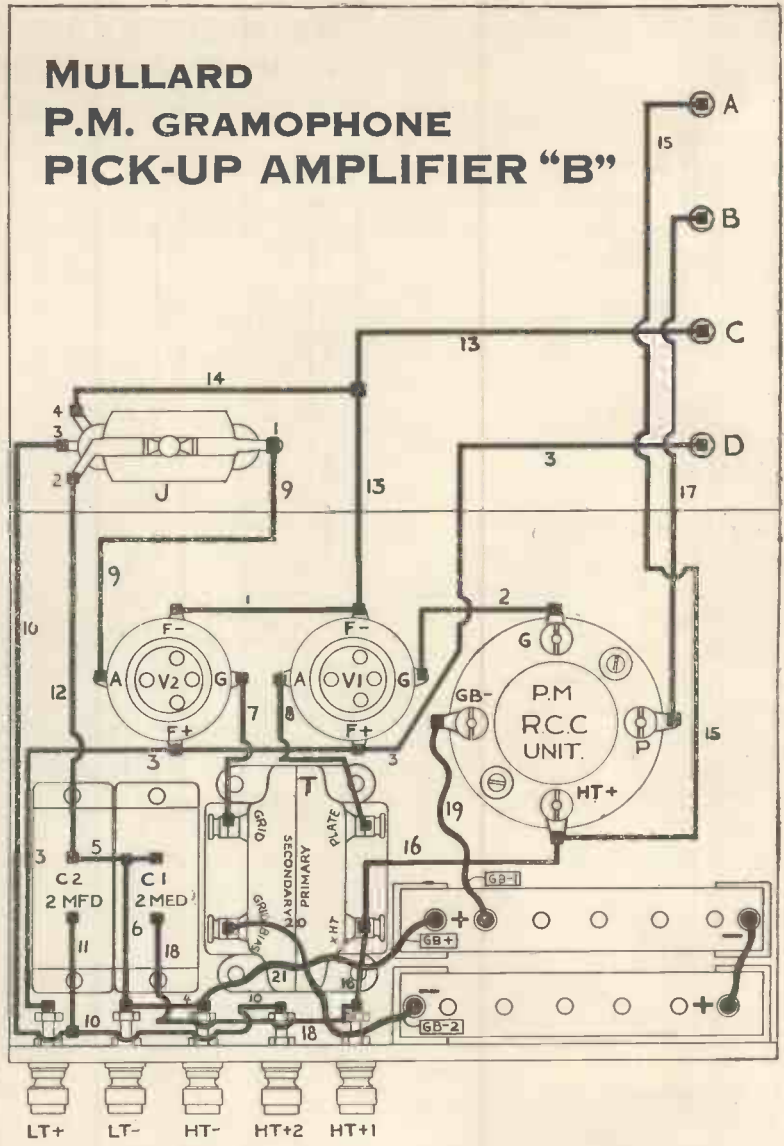

**Point-to-Point Wiring**

- | Wire No.                                                                                | Wire No.                                                                                                                                                                                          |
|-----------------------------------------------------------------------------------------|---------------------------------------------------------------------------------------------------------------------------------------------------------------------------------------------------|
| 1 Connect terminal F- of valve holder V1 to terminal F- of valve holder V2.             | 12 Connect tag No. 2 of jack J to wire No. 5.                                                                                                                                                     |
| 2 Connect terminal G of P.M., R.C.C. Unit to terminal G of valve holder V1.             | 13 Connect terminal C to terminal F- of valve holder V1.                                                                                                                                          |
| 3 Connect terminal LT+ to F+ terminals of valve holders V2 and V1 and on to terminal D. | 14 Connect tag No. 4 of jack J to wire No. 13.                                                                                                                                                    |
| 4 Connect terminal HT- to terminal LT-.                                                 | 15 Connect terminal A to terminal HT+ (marked +B) of P.M., R.C.C. Unit.                                                                                                                           |
| 5 Connect together terminals nearest front panel of condensers C1 and C2.               | 16 Connect terminal HT+ (marked +B) of P.M., R.C.C. Unit to "+HT" terminal of transformer T, and on to terminal HT+1.                                                                             |
| 6 Connect terminal LT- to wire No. 5.                                                   | 17 Connect terminal B to terminal P of P.M., R.C.C. Unit.                                                                                                                                         |
| 7 Connect terminal G of valve holder V2 to "grid" terminal of transformer T.            | 18 Connect free terminal of condenser C1 to terminal HT+1.                                                                                                                                        |
| 8 Connect terminal A of valve holder V1 to "plate" terminal of transformer T.           | 19 Connect a piece of well-insulated flexible wire 6 ins. long to terminal GB- (marked -C) of P.M., R.C.C. Unit. The free end of this wire should be fitted with a black wander plug marked GB-1. |
| 9 Connect terminal A of valve holder V2 to tag No. 1 of jack J.                         | 20 Connect a piece of well-insulated flexible wire 6 ins. long to "GRID BIAS" terminal of transformer T. The free end of this wire should be fitted with a black wander plug marked GB-2.         |
| 10 Connect terminal HT+2 to tag No. 3 of jack J.                                        | 21 Connect a piece of well-insulated flexible wire 9 ins. long to terminal HT-. The free end of this wire should be fitted with a red wander plug marked GB+.                                     |
| 11 Connect free terminal of condenser C2 to wire No. 10.                                |                                                                                                                                                                                                   |

On this page appears the wiring diagram for the Mullard P.M. Gramophone "Pick-up" Amplifier "C" from which, we believe, any interested reader will be able to build a very efficient three-stage R.C.C. Amplifier. It provides all the information contained in the usual blueprint with but the one difference that it is reduced in size. Although not full-size, it will be found to be just as useful and helpful.

Whether you employ your own radio set or prefer to build one of the specially designed Mullard P.M. Amplifiers for your gramophone, you will obtain pleasing reproduction only when you make use of the wonderful P.M. Master Valves and the musically predominant Mullard P.M. Speaker. The adoption of this advice is certain to bring you permanent satisfaction.

### THE MULLARD P.M. GRAMOPHONE "PICK-UP" AMPLIFIER "C"

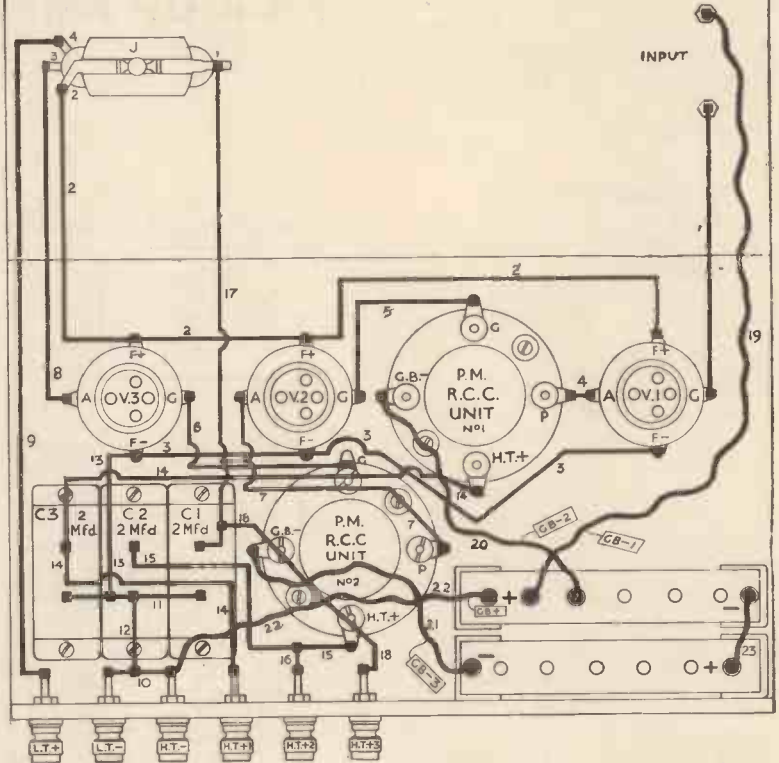

#### Point-to-Point Wiring

Wire No.

- 1 Connect terminal G of valve holder V1 to bottom input terminal.
- 2 Connect together terminals F+ of valve holders V1, V2 and V3, and on to tag No. 2 of jack J.
- 3 Connect together terminals F- of valve holders V1, V2 and V3.
- 4 Connect terminal A of valve holder V1 to terminal P of P.M., R.C.C. Unit No. 1.
- 5 Connect terminal G of P.M., R.C.C. Unit No. 1 to terminal G of valve holder V2.
- 6 Connect terminal G of valve holder V3 to terminal G of P.M., R.C.C. Unit No. 2.
- 7 Connect terminal P of P.M., R.C.C. Unit No. 2 to terminal A of valve holder V2.
- 8 Connect terminal A of valve holder V3 to tag No. 3 of jack J.
- 9 Connect terminal LT+ to tag No. 4 of jack J.
- 10 Connect together terminals LT- and HT-.
- 11 Connect together the three terminals nearest terminal strip of condensers C1, C2 and C3.
- 12 Connect wire No. 10 to wire No. 11.
- 13 Connect wire No. 11 to terminal F- of valve holder V3.
- 14 Connect terminal HT+1 to free terminal of condenser C3 and on to terminal HT+ (marked +B) of P.M., R.C.C. Unit No. 1.

Wire No.

- 15 Connect terminal HT+ of P.M., R.C.C. Unit No. 2 to free terminal of condenser C2.
- 16 Connect terminal HT+2 to wire No. 15.
- 17 Connect free terminal of condenser C1 to tag No. 1 of jack J.
- 18 Connect terminal HT+3 to wire No. 17.
- 19 Connect a piece of well-insulated flexible wire 9 ins. long to the top "input" terminal. The free end of this wire should be fitted with a black wander plug marked GB-1.
- 20 Connect a piece of well-insulated flexible wire 9 ins. long to terminal GB- (marked -C) of P.M., R.C.C. Unit No. 1. The free end of this wire should be fitted with a black wander plug marked GB-2.
- 21 Connect a piece of well-insulated flexible wire 9 ins. long to terminal GB- (marked -C) of P.M., R.C.C. Unit No. 2. The free end of this wire should be fitted with a black wander plug marked GB-3.
- 22 Connect a piece of well-insulated flexible wire 9 ins. long to terminal HT-. The free end of this wire should be fitted with a red wander plug marked GB+.
- 23 A piece of flexible wire 3 ins. long fitted with a red wander plug at one end and a black wander plug at the other end, is used for connecting the two grid bias batteries in series.



AMPLIFIER "B"

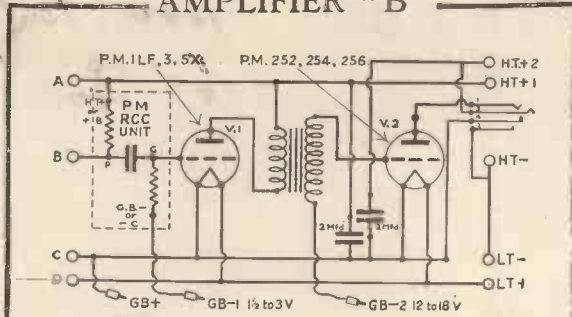

List of Parts

No.	Component.	Maker.	Price.
1	Cabinet, 10 in. x 7 in. x 7 in. ..	W. H. Agar	1 12 0
1	Baseboard, 10 in. x 7 in. x 1/2 in. ..	W. H. Agar	1 6
1	Panel, 10 in. x 7 in. x 1/8 in. ..	Radion	5 9
1	Terminal Strip, 10 in. x 2 in. x 1/2 in. ..		1 8
1	P.M., R.C.C. Unit ..	Mullard	17 6
2	Valve Holders ..	Pye	4 6
2	2 Mfd. Mansbridge Condensers ..	Mullard	10 0
1	Filament Jack ..	Lotus	2 6
1	L.F. Transformer (A.F.3) ..	Ferranti	1 5 0
9	Terminals L.T., L.T.+ , H.T., H.T.+1, H.T.+2, 4 Input Terminals ..	Belling & Lee	4 6
5	Wander Plugs, 2 red, 3 black ..	Lisenin	10
	Quantity Self-Soldering Wire ..	Junit	

RECOMMENDED P.M. VALVES for Gramophone "Pick-up" Amplifiers.

Amplifier "B"

For 2-volt L.T. Supply:—

- V1 1st L.F. valve: P.M. 1 L.F.
- \*V2 2nd L.F. valve: P.M. 252.

For 4-volt L.T. Supply:—

- V1 1st L.F. valve: P.M. 3
- \*V2 2nd L.F. valve: P.M. 254.

For 6-volt L.T. Supply:—

- V1 1st L.F. valve: P.M. 5X.
- \*V2 2nd L.F. valve: P.M. 256.

\* Where not more than 100 volts H.T. supply is available the Mullard P.M.2, P.M.4 and P.M.6 should be used in place of the Mullard super-power valves the P.M. 252, P.M. 254 and P.M. 256 respectively.

NOTE.—When use is made of the Mullard P.M. H.T. supply unit a Mullard super-power valve should invariably be used for the last L.F. valve, in which case 22-volts Grid Bias should be applied.

H.T. VOLTAGE

H.T.+1: 100 volts or 3rd positive tapping on Mullard P.M. H.T. Supply Unit.

H.T.+2: 150 volts or 4th positive tapping on Mullard P.M. H.T. Supply Unit.

GRID BIAS

G.B.—1: 3 volts negative (first or second socket from positive end of first G.B. Battery).

G.B.—2: 6-7 1/2 volts negative with P.M.2, P.M.4, or P.M.6 with 100 volts H.T.; 12 to 18 volts with P.M. 252, P.M. 254 or P.M. 256 with 120 volts H.T. second or last socket at negative end of second G.B. Battery. 18 to 22 volts negative for any of the Mullard Super-power Valves with 150 volts H.T. Last socket of second G.B. Battery or 4th socket in third G.B. Battery.

AMPLIFIER "C"

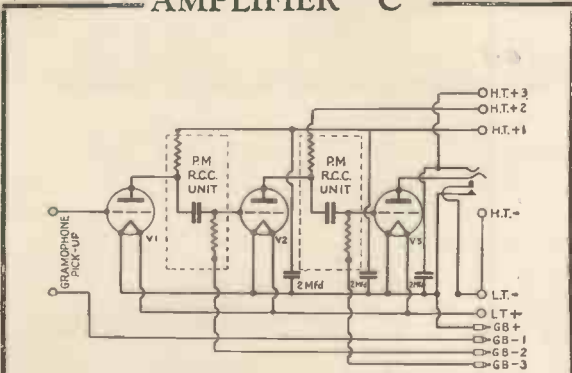

List of Parts

No.	Component.	Maker.	Price.
1	Cabinet 12 in. x 7 in. x 7 in. ..	W. H. Agar	1 14 0
1	Baseboard, 12 in. x 7 in. ..	W. H. Agar	1 6
1	Panel, 12 in. x 7 in. x 1/4 in. ..		7 0
1	Terminal Strip, 12 in. x 2 in. x 1/2 in. ..		2 0
2	R.C.C. Units ..	Mullard	1 15 0
3	Valve Holders ..	Pye	6 9
1	Filament Jack ..	Lotus	2 6
3	Mansbridge Condensers (2 mfd.) ..	Mullard	15 0
8	Terminals, 2 Input, L.T., L.T.+ , H.T., H.T.+1, H.T.+2, H.T.+3 ..	Belling & Lee	4 0
6	Wander Plugs, 2 red, 4 black ..	Lisenin	1 0
	Quantity Self-Soldering Wire ..	Junit	

Amplifier "C"

For 2-volt L.T. Supply:—

- V1 Input valve: P.M. 1A.
- V2 1st L.F. valve: P.M. 1 H.F.
- \*V3 2nd L.F. valve: P.M. 252.

For 4-volt L.T. Supply:—

- V1 Input valve: P.M. 3A.
- V2 1st L.F. valve: P.M. 3.
- \*V3 2nd L.F. valve: P.M. 254.

For 6-volt L.T. Supply:—

- V1 Input valve: P.M. 5B.
- V2 1st L.F. valve: P.M. 5X.
- \*V3 2nd L.F. valve: P.M. 256.

\* Where not more than 100 volts H.T. supply is available the Mullard P.M.2, P.M. 4 and P.M. 6 should be used in place of the Mullard super-power valves P.M. 252, P.M. 254 and P.M. 256 respectively.

NOTE.—When use is made of the Mullard P.M. H.T. supply unit a Mullard super-power valve should invariably be used for the last L.F. valve, in which case 22-volts Grid Bias should be applied.

H.T. VOLTAGE

H.T.+1: 75-100 volts or 2nd positive tapping on Mullard P.M. H.T. Supply Unit.

H.T.+2: 100 volts or 3rd positive tapping on Mullard P.M. H.T. Supply Unit.

H.T.+3: 150 volts or 4th positive tapping on Mullard P.M. H.T. Supply Unit.

GRID BIAS

G.B.—1: 1 1/2 volts negative (first socket from positive end of first G.B. Battery).

G.B.—2: 3 volts negative (second socket from positive end of G.B. Battery).

G.B.—3: 6-7 1/2 volts negative with P.M.2, P.M.4, P.M.6 with 100 volts H.T.; 12 to 18 volts negative with P.M. 252, P.M. 254, P.M. 256 with 120 volts H.T.; 18-22 volts negative for any of the Mullard Super-power Valves with 150 volts H.T.

# RAPID VALVE GUIDE

## The Mullard P.M. Master Valve Chart

Valve.	Impedance in ohms.	Amplification Factor.	FILAMENT		Purpose.	Price.
			Voltage.	Consumption in amps.		
P.M.1A.	72,000	36	2-v.	.1	Detector or 1st L.F. when followed by R.C.C.	£ s. d. 10 6
P.M.1.H.F.	28,000	13.5		.1	H.F. amplifier or detector	10 6
P.M.1.L.F.	18,000	8.9		.1	1st stage L.F. amplifier or detector.	10 6
P.M.2.	7,000	6.25		.15	L.F. Power valve .. ..	12 6
*P.M.252.	3,800	3.8		.3	Super-Power valve for last stage of L.F.	1 0 0
P.M.3A.	63,000	35	4-v.	.075	Detector or 1st L.F. amplifier when followed by R.C.C.	10 6
P.M.3.	16,000	13.5		.075	H.F. amplifier, detector and 1st L.F. amplifier.	10 6
P.M.4.	7,000	7		.1	L.F. Power valve .. ..	12 6
*P.M.254.	3,500	3.15		.25	Super-Power valve for last stage L.F.	1 0 0
P.M.5B.	74,000	37	6-v.	.075	Detector or 1st L.F. when followed by R.C.C.	10 6
P.M.5X.	19,000	17.5		.075	H.F. amplifier, detector and early stages of L.F.	10 6
P.M.6.	5,700	7.1		.1	L.F. Power valve .. ..	12 6
*P.M.256.	3,500	3.15		.25	Super-Power valve for last L.F. stage.	1 0 0
<i>P.M.6D</i>	<i>9,000</i>	<i>18</i>		<i>0.1</i>		

\* These valves are essential for use in last L.F. stage in cases where very powerful signals are to be handled.

### Choose your Mullard P.M. Valves from this Table

Purpose.	Remarks.	2-volt.	4-volt.	6-volt.
<b>H.F. Amplifier</b> .. ..	General .. .. .	P.M.1.H.F. P.M.1A.	P.M.3. P.M.3A.	P.M.5X. P.M.5B.
<b>Detector</b> .. ..	Followed by transformer-coupled L.F. amplifier.	P.M.1.L.F.	P.M.3.	P.M.5X.
	Followed by resistance-coupled L.F. amplifier.	P.M.1A.	P.M.3A.	P.M.5B.
<b>L.F. Amplifier</b> followed by transformer-coupling.	1st stage .. .. .	P.M.1.L.F.	P.M.3.	P.M.5X.
	2nd stage .. .. .	P.M.1.L.F. *P.M.2.	P.M.4.	P.M.6.
<b>L.F. Amplifier</b> followed by resistance-coupling.	1st stage .. .. .	P.M.1A.	P.M.3A.	P.M.5B.
	2nd stage .. .. .	P.M.1.H.F. *P.M.1.L.F.	P.M.3. *P.M.4.	P.M.5X. *P.M.6.
<b>Power Amplifier</b> ..	For last stage of L.F. amplifiers,	P.M.2. *P.M.252.	P.M.4. *P.M.254.	P.M.6. *P.M.256.

\* These valves are most suitable in cases where very powerful signals are to be handled.