



# T. & K. Bulletin

Incorporating

## The Journal of the Inc. Radio Society of Great Britain

(BRITISH EMPIRE RADIO UNION)



Vol. 5. No. 6. December, 1929 (Copyright)

Price 1/6

### CLAUDE LYONS, LTD., LIVERPOOL

cordially thank their numerous R.S.G.B. friends for their generous support in the past, soliciting the favour of their continued enquiries and orders in the future, which shall at all times receive prompt and personal attention.

They take this Seasonable Opportunity to wish every

**“DYED-IN-THE-WOOL” XR “HAM”**

**A**

**Happy Christmas**

and a

**Bright and “Chirpy” New Year**

**AND “MORE POWER TO HIS AERIAL!”**

*Those who desire to retain their XR licences are enjoined not to wander from the “strait and narrow.”! The “GR” type 558-P GPO “approved” wavemeter for 5, 10, 20, 40 and 80 metre wavebands, individually calibrated with a guaranteed maximum inaccuracy of 0.25% will ensure this—and at only £5 (ham price) per complete outfit, cash with order, carriage paid!!*



**Hullo!  
Hullo!! this is Wrrr-ittle**

If you're a real "old stager" in radio you will remember "Wrrr-ittle"—"Two Emma Toc," Capt. P. P. Eckersley's station. How his "Wrrr-ittle" used to thrill us! Those were the days! The B.B.C. first official transmission—via 2LO—was in 1922—"Wrrr-ittle" days were pre-B.B.C. days—days when we knew only "R" valves—long, cumbersome sliding tuners, and hefty .001 variables. In those days transmitting and receiving gear depended largely on T.C.C. Condensers for their efficiency.

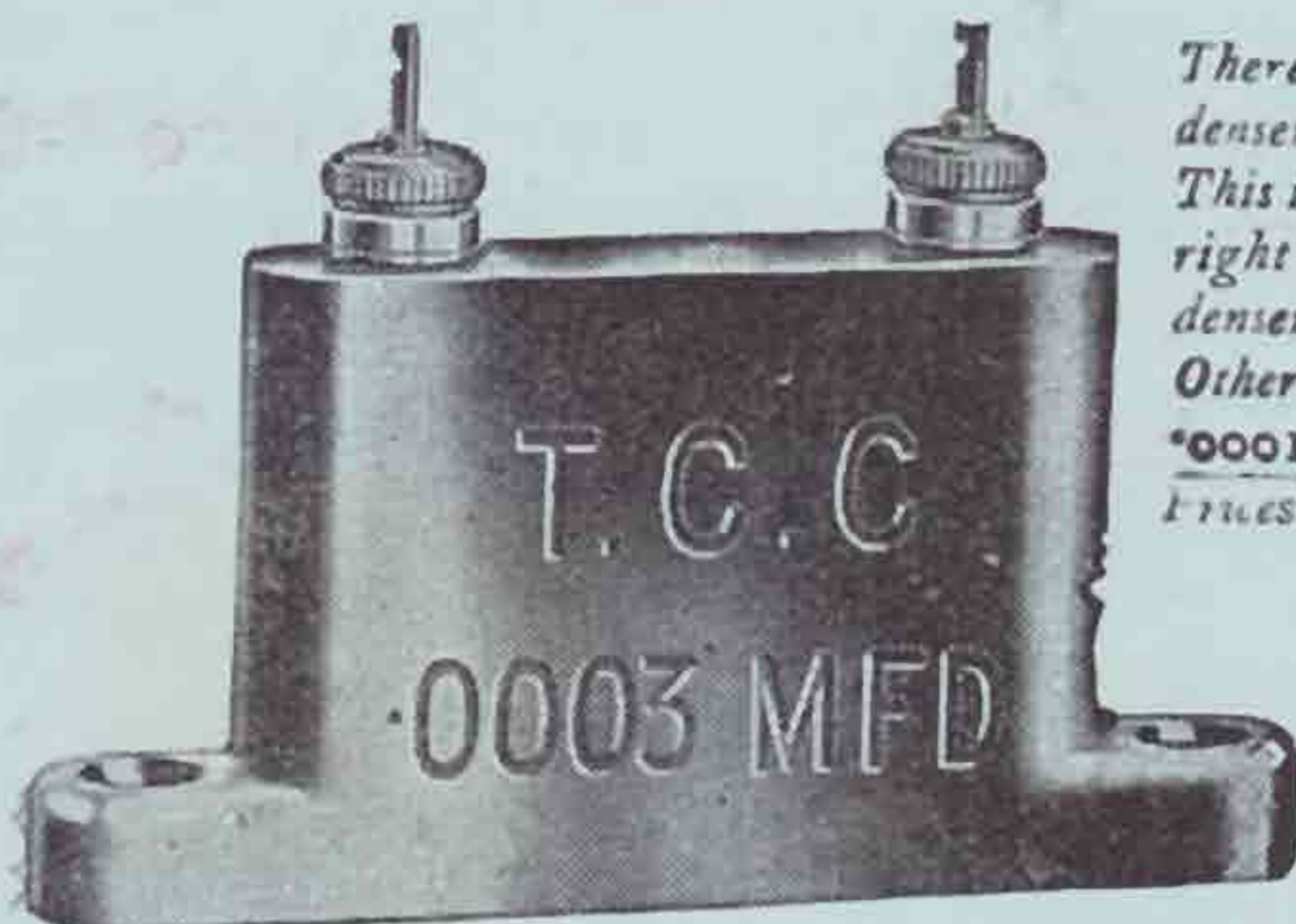
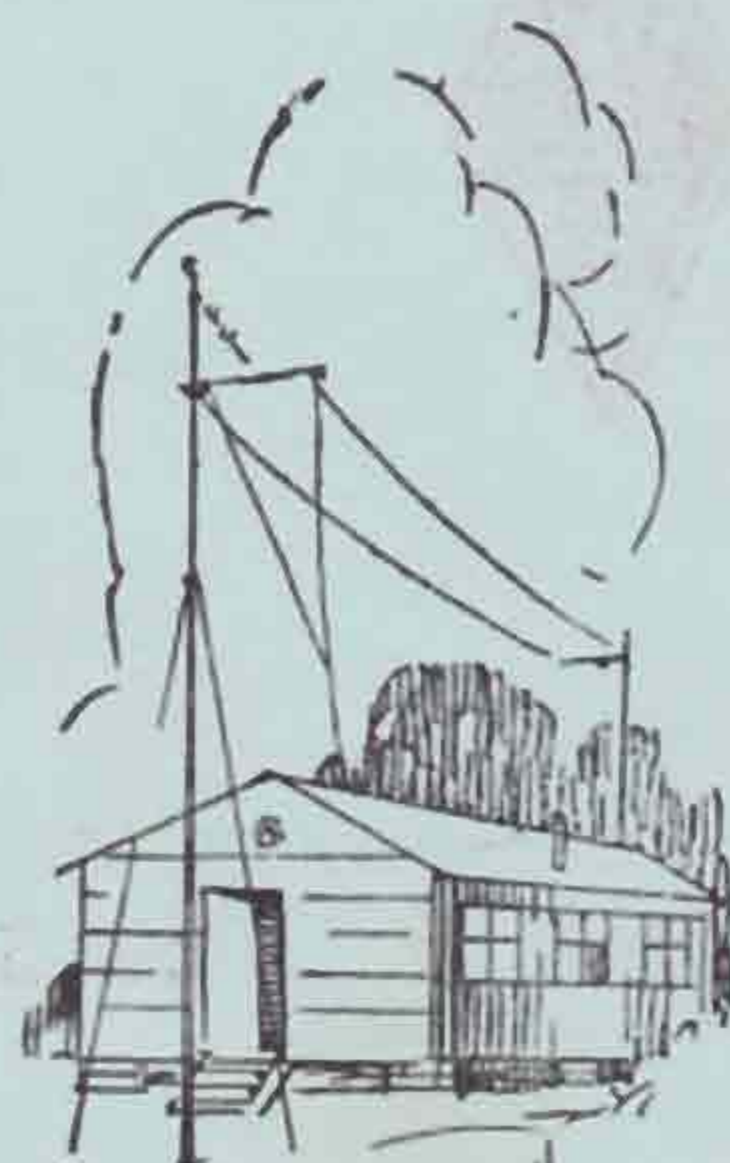

There is a T.C.C. Condenser for every purpose. This is the .0003 mf. Upright Type Mica Condenser, price 1s. 10d. Other capacities from .0001 mf. to .25 mf. Prices 1s. 6d. to 15s. 0d.

It's the same to-day—the choice of the serious experimenter and amateur alike is T.C.C.

# T.C.C. CONDENSERS

Advt. Telegraph Condenser Co., Ltd., Wales Farm Rd., N. Acton, London, W.3.

932

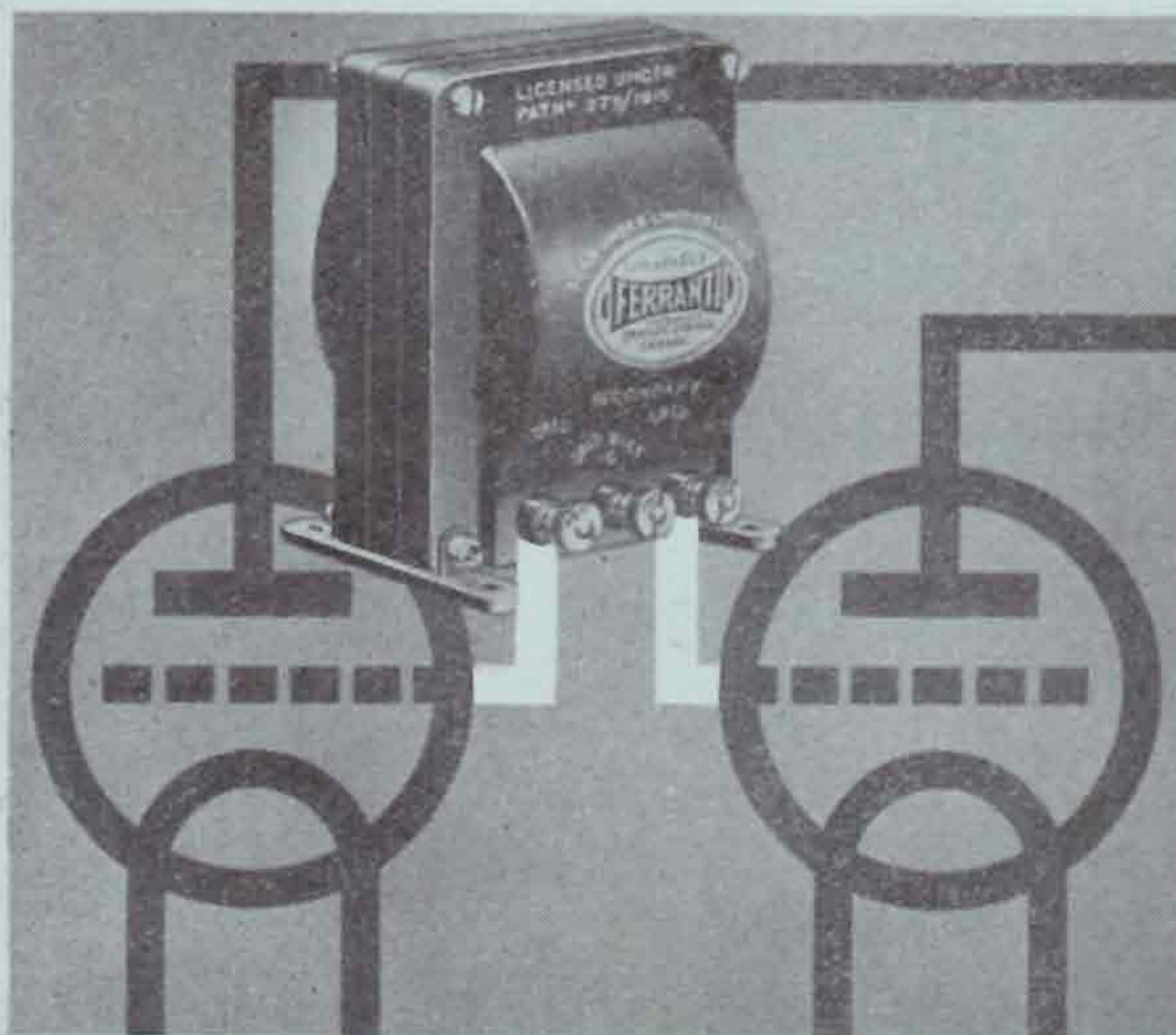

## PUSH - PULL AMPLIFICATION

Push-Pull amplification, with moderate H.T. Voltages, enables you to handle considerable volume in the output stage without distortion.

In this system the output of the receiver is divided between two valves, or a multiple of two. The product is combined by means of a Push-Pull output transformer and fed to the speaker. A greatly enhanced grid swing is thus permissible and a correspondingly louder signal can be handled without the harshness or "chatter" due to overloaded valves.

A descriptive leaflet Wb 412, gives full particulars, Transformer details and circuit. It should be in the hands of everyone interested in the combination of ample volume and quality reproduction. Ask your dealer or write direct.

# FERRANTI

FERRANTI LTD.

HOLLINWOOD

LANCASHIRE

ALWAYS MENTION THE R.S.G.B. WHEN PURCHASING.



# TRAR

# BULLETIN.

*The only British Wireless Journal Published by Amateur Radio Experimenters*

*All correspondence and matter for publication to be addressed to the Hon. Secretary, 53, Victoria St., London, S.W. 1.  
Tel.: Victoria 4412.*

### Officers and Council for year 1929.

*President* : GERALD MARCUSE, Esq. (G2NM).

*Acting Vice-President* : H. BEVAN SWIFT, Esq. (G2TI).

*Honorary Treasurer* : E. DAWSON OSTERMEYER, Esq. (G5AR).

*Honorary Secretary* : G. F. GREGORY, Esq. (G5PZ).

*Honorary Editor* : G. W. THOMAS, Esq. (G5YK).

#### COUNCIL :

K. ALFORD, Esq. (G2DX), D. P. BAKER, Esq.

(2OQ), J. CLARRICOATS, Esq. (G6CL) A. HAMBLING,

Esq. (G2MK), CAPTAIN K. HARTRIDGE (G5CB),

A. HINDERLICH, Esq. (G2QY), E. MEGAW, Esq.

(GI6MU), J. W. MATHEWS, Esq. (G6LL), R. L.

ROYLE, Esq. (G2WJ), A. WATTS, Esq. (G6UN).

DECEMBER, 1929.

Vol. 5. No. 6.

## EDITORIAL.

### The Year's Work.

IT seems fitting at this time of year to review as briefly as possible the progress made during the past twelve months in Amateur Radio. This Society has, we are confident, kept well to the fore in appreciating and handling those problems which beset the amateur experimenter, and we hope the Society has proved its usefulness in this direction and that a continued support will be shown both in this country and throughout the rest of the world during the coming year.

In the transmission fields perhaps the most outstanding results during the earlier months of the year are to be found in the continued successes in the 28,000 K.C. band, both in continuing the work with the U.S.A. and also in communicating with India. It is to be hoped that more countries will soon be conquered now that many other amateurs have joined the ranks of those actively engaged on the experimental work on this frequency. Although the summer months produced no long distance contacts, some of our members spent many hours each week-end keeping watch on an empty band. It is the spirit of this kind that has made Amateur Radio in this country what it is to-day, and we hope those enthusiasts have by now reaped their harvest. The pioneer work on 56,000 K.C., when Mr. Noden's signals were heard by Mr. Somerset, is still fresh in our minds and further comment is unnecessary in this column. We sincerely hope, however, that further successes will be achieved by these pioneers and that we shall soon have fresh results of theirs to chronicle.

Contact Bureau has, during the past twelve months, made great strides. We were all very sorry to lose Mr. Allen as the Honorary Organiser and we very much appreciate the noble way



in which Mr. Powditch is carrying on the splendid work. Contact Bureau is now settling down to its natural level: when started it was something new and many of our members rushed to enrol themselves. By degrees some let themselves slide out; this was inevitable, but it has left the remainder in a very much stronger position. They can assure themselves that they possess a 100 per cent. active membership and are thus in a position to tackle in a better way the many problems to which they devote themselves, not feeling that they are being impeded by a number of hangers-on. Our thanks and good wishes go to Mr. Powditch and his assistants for their very valuable work.

With the close of Summer, the Radio Exhibition and our Convention gave the British amateur a chance of meeting his brother of the air, whom possibly he had not seen since the previous Convention. We were also able to extend a hearty welcome to a number of fellow amateurs from across the seas. Now that the Winter season is with us, a considerable increase in activity is noticed throughout Europe. There are more stations than ever transmitting nowadays, and the congestion on some waves last year is nothing compared with the congestion this winter. This increase in activity is a sure sign that Amateur Radio is still flourishing and drawing more Radio enthusiasts into its fold. We say this with the words of the pessimists still in our ears: words telling of the downfall of Amateur Radio—saying that we should not survive when the 1927 Washington regulations were enforced upon us. That seems a long while back, but we have thrived under the new regulations for a year now, and it cannot be said that Amateur Radio has suffered even a temporary set-back. In point of fact such regulations as were laid down in 1927 have served as an additional impetus for the experimenters of to-day; new difficulties appeared, and, as in former days, have been overcome. This Society follows keenly every phase of amateur activity and an increase in the popularity of Amateur Radio reacts very favourably on the Society. Our strength lies in our numbers, and what is food for one is food for both.

In conclusion we, at Headquarters, would like to wish all members, whether at home or abroad, the Compliments of the Season and may their good work be carried forward into the New Year with increased vigour.

## Joining Tantalum Electrodes.

A. D. GAY (G6NF).

Some difficulty is often experienced in making a permanent joint between tantalum and lead in an electrolytic cell. The proximity of sulphuric acid makes corrosion almost inevitable, unless the joint is made outside the cell. This necessitates the use of long strips of the precious metal.

The writer made up a 200-volt grid-bias rectifier twelve months ago, using a scheme which has proved very satisfactory. A voltage doubling circuit with 12 cells was employed. Very thin strips of tantalum, 4 cm. long, were used.

No. 12 gauge lead fuse wire was used for the other electrode. This wire was cut into lengths long enough to form a positive electrode and join across and dip into the next cell with a piece of tantalum sealed into the end. The only other requirements are some roll or flowers of sulphur and a short length of 4-mm. bore glass tubing. The latter is nicked every centimetre with a triangular file, and with a combined pulling and breaking action broken up into pieces 1 cm. long.

The end of the lead which is to receive the tantalum is cut 5 mm. lengthwise with a knife and the strip placed in the cut, afterwards firmly closing up with pliers. The whole is then supported vertically, tantalum uppermost, with the end of the joint midway in the glass tube. Sulphur is poured in, and when cool the electrode is ready. Sulphur expands on cooling, making the joint very secure.

The sulphur can be melted in a tin lid bent to form a spout, and this part of the process is great

fun. Don't melt sulphur in the kitchen if anyone else is using this room. Sulphur oxidises when burning, forming an invisible choking gas which will not be appreciated.

## Forthcoming Events.

Meetings will take place at the I.E.E. on the following dates during the early part of next year and members are asked to make a note of them. Full details will be announced later.

|             |             |
|-------------|-------------|
| January 24. | February 28 |
| March 28.   | April 25    |
| May 23.     | June 27     |

*(Continued from next page.)*

The mechanical construction of a material picture is absolutely different from seeing a living image. From the point of view of radio research it is a splendid thing to be able to do both, and no doubt the public will like to have a machine drawing pictures for them as well as being able to see by wireless. I hope in the next part of my series to deal with the Baird television system in detail, and that members of the Society will take up this science with the enthusiasm with which they took up wireless years before broadcasting.



# The Science of Television.

By MAURICE GIBSON, F.T.S., M.A.F. de T.

## PART 2.

I wish first of all to give the readers a rough sketch of the television developments in France, Germany, and the U.S.A. This section was unfortunately omitted from the first part, but I think that what is to follow will be more easily understood if I just touch on these facts. In America the chief investigators in television have been: (1) Jenkins, on shadowgraphs, cinema film transmission, and the moving beam device with the glass disc with the edge ground into prisms; (2) Moore, on neon tubes (crater type), and photoelectric cells; (3) Alexanderson (G.E.C.), on photograph transmission and light drum television; (4) Zworkin (Westinghouse), on the cathode ray tube system; (5) Farnworth, on the cathode ray tube system; (6) Ives (Bell system, A.T.T.), on photograph transmission and black and white images; (7) Clarkson, on his vacuum television camera; (8) Nakken, on photo-electric cells. In France the chief investigators have been: (1) Belin and Holweck, on shadowgraphs and photographs, by vibrating mirrors; (2) Fournier and Rignoux, on large selenium cells used with the Korn-Einthoven light valve; (3) Dauvillier, on vibrating mirrors used with a cathode ray tube; (4) Valensi, on the cathode ray tube system. In Germany the chief investigators have been: (1) Karolus (A.E.G.), on cinema films, shadowgraphs and Kerr cells; (2) Nesper (Telefunken), on photographs and shadowgraphs; (3) Dieckmann, who has tried mechanical scanning, oscillating mirrors, and is now trying the cathode ray tube system. He is famous in Germany for his clockwork picture-apparatus. Among other famous television investigators are Von Mihaly, a Hungarian, who uses oscillating mirrors and Fulton, an Austrian who principally works on clockwork picture apparatus.

The Editor has asked me to include a section about wireless picture transmission in my series, and although the methods of stylographic picture transmission are more akin to wireless telephotography than to true television, there is certainly some connection between the two. The transmission of pictures can be carried out not only by the stylographic methods of Fulton and Dieckmann, but also by true television methods as in the transmission of films, slides and shadowgraphs. The latter methods will be considered with true television and the former, clock-work picture-apparatus, will be dealt with now. A brief précis of the invention is necessary to understand exactly what happens. A photographic negative is printed on an emulsion spread over a thin copper plate. During developing, parts of the emulsion disappear as in etching. The copper plate is placed round the cylinder of the sending apparatus. The cylinder revolves slowly and a needle traces over it. At the places where emulsion is left on the plate, the needle does not come into contact with the copper and nothing happens. Where clear copper is left, however, the needle comes into contact with it and an electric circuit is formed. The current flows on to a wireless transmitter and is broadcast. The loud-speaker is removed from a wireless

receiver, and a clockwork Fultograph is put in its place. A piece of paper dipped in a solution which changes colour when an electric current flows through it is wrapped round the cylinder of the Fultograph. Currents corresponding to those from the transmitting set flow between the needle and the cylinder, and the paper is discoloured. When the transmission is finished, the colorations have become an easily distinguishable picture.

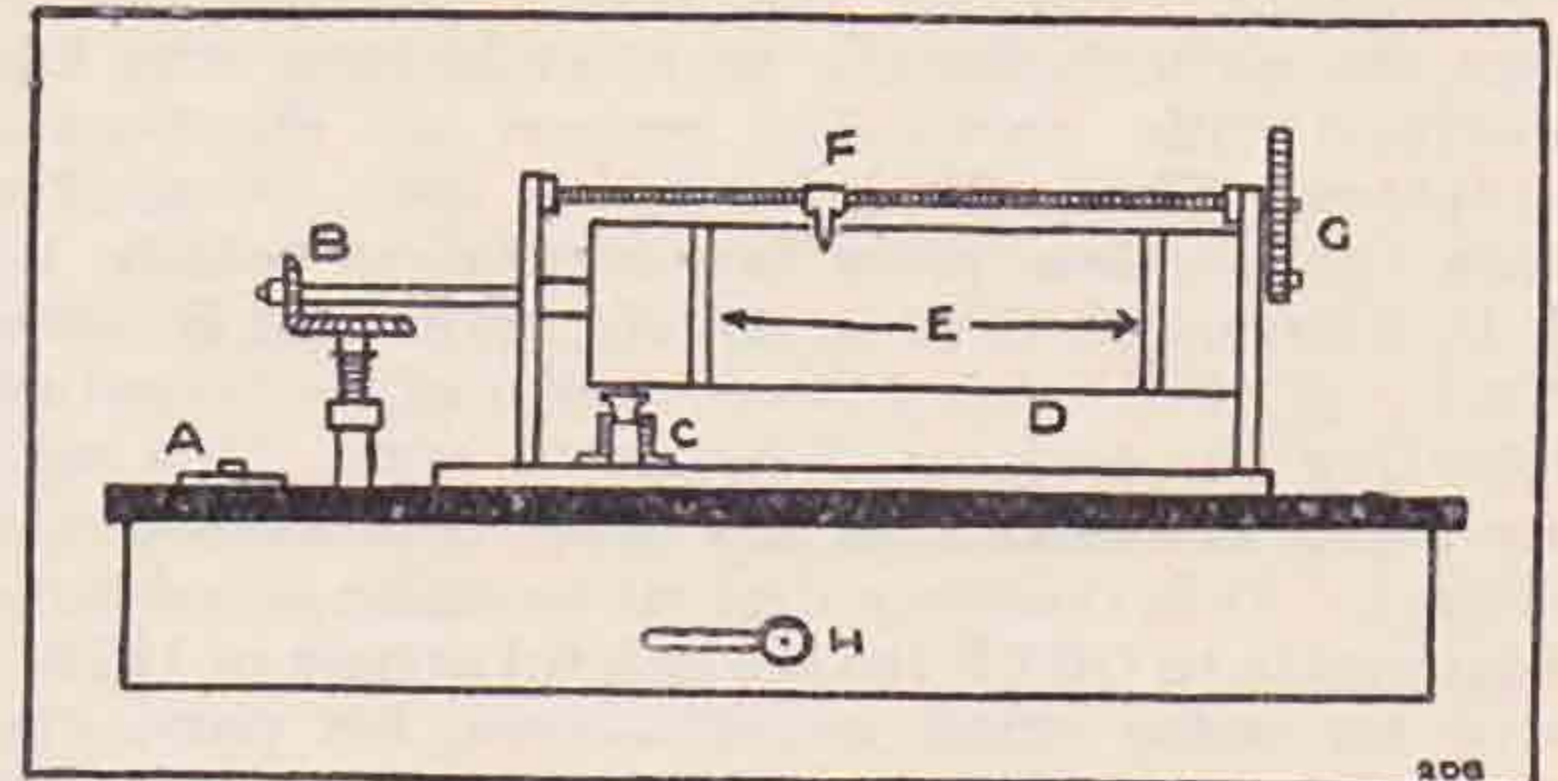

Fig. 4. DIAGRAM OF WIRELESS PICTURE RECORDER.

- |                         |                  |
|-------------------------|------------------|
| A—Speed Regulator       | E—Rubber Bands.  |
| B—Gears to Motor Shaft. | F—Needle Holder. |
| C—Trip Magnet.          | G.—Gears.        |
| D—Drum.                 | H.—Motor Crank.  |

The Fultograph type of picture receiver has become very popular in Germany; there the apparatus in general use was designed by Dieckmann, as already mentioned. One of the most interesting uses to which it is put is to use it to receive weather charts from the meteorological office. In France the Fultograph is also very popular in spite of the many Belin picture transmission systems, and the Daventry picture transmissions are received regularly, and are considered to be one of the clearest in Europe. An interesting device was described recently in *La Television* by which dealers could demonstrate the picture receivers without the necessity of receiving a broadcast transmission of pictures. This consisted of the picture vibrations printed on a gramophone record and taken up from the gramophone by means of a pick-up. The impulses (L.F.) were then amplified and relayed to the picture apparatus in the usual way. In America a good attempt has been made to make it possible for the amateur to construct as much as possible of the Fultograph type of apparatus; even then it is impossible to construct the actual recorder and relays without a well equipped workshop. Greater interest is now, however, being shown in the Jenkins Televisor, as in Germany, where interest in the Telefunken-Karolus televisor is rapidly exceeding that in the Dieckmann picture machine. In France it is easy to understand the enthusiasm that still exists for picture and photograph transmission, as the television experts there have had more success in this line than in any other.

In my opinion, although the apparatus for true television is undoubtedly simpler in construction, it will never take the place of the other, or *vice versa*.

(Continued at foot of previous page.)



# The Construction of a Super-Heterodyne Receiver for the Higher Frequencies.

By G. G. LIVESEY (FO3SRB).

I have been vainly endeavouring for some years past to acquire a few skeleton facts about the actual practical results to be obtained from the supersonic system on short waves, and also some ideas about the oscillating system for frequency changing which would be most suitable. However, it has been singularly impossible to glean any information, even via the BULLETIN—nor has it been the writer's fortune to meet anyone who has practised this particular system of short-wave reception. The only information ever obtainable from the wireless press lay in a good article by C. P. Allinson (G6YF) in the old periodical *Wireless Weekly* of 1926—April 7—with one other exception occurring in *Amateur Wireless* of some time ago, the writer is unaware of any other treatment of the subject. It is therefore desired to make all acknowledgements to G6YF for his helpful article of 1926—save for some small modifications, his particular arrangement was adhered to theoretically, but not as far as components were concerned.

The frequency-changing arrangement for the first detector is quite straightforward; it is emphasised that the radio frequency choke must be of really high efficiency, otherwise there will be difficulty in maintaining oscillation over a wide band of frequencies. The grid leak potentiometer return is useful for this. The "Bulgin" S/W model is excellent, and the writer has been using an "Eddystone" model, made by Stratton & Co., Birmingham. This model is stated to have a range of 10 to 2,000 metres—at all events it has proved highly efficient between 28 M.C. and 7 M.C. on this receiver. At this point it is necessary to plead guilty of lamentable ignorance and laziness, and to throw oneself on the mercy of members. Will some brainy reader come forward and explain exactly what frequency the H.F. choke is supposed to be impeding, in order that this frequency shall be fed back to grid circuit of the autodyne detector?—*i.e.*, is there a feed-back of intermediate radio frequency, input signal frequency from the antenna, or what have you?

The milliammeter is indispensable for indicating when the first detector is oscillating—this is shown by a drop in anode current. The aural test, though possible when the I.F. amplifier is oscillating, is hard to detect, but consists in that, given the rushing sound caused by the I.F. amplifier oscillating, the beginning of oscillation in the autodyne is indicated by a distinct change in character of I.F. oscillation—it sounds fiercer. However, it is inadvisable to work without a milliammeter for this purpose.

For receiving C.W. a separate heterodyne valve, beating with the intermediate frequency, should be used. This is shown in the theoretical diagram. The use of an oscillating I.F. amplifier, controlled by potentiometer, is of course ear-splitting!! In the tropics, at any rate, with this static. The 30-ohm rheostat in series with negative side of potentiometer winding is useful as a vernier control over intermediate-amplifier oscillation. The "Silver-Marshall" make of I.F. transformer are

considered about the highest grade obtainable, and are carefully matched on about 6,000  $\lambda$ . Further, it should be possible to arrange for one of the two (maybe both) I.F. valves to be of the S/G class, provided that a suitable coupling device be arranged; this, it seems, presents a serious problem. Tuned anode seems the only feasible arrangement. (It would be interesting to hear what other members have to say about this.)

On a bad aerial, with no ground connection, the signal strength of all commercials between 15 and 40 metres was terrific—KAZ, for example, on the Pacific coast of America (6th district) paralysing the receiver even on key thumps, with the I.F. stages in a non-oscillating condition. Roughly

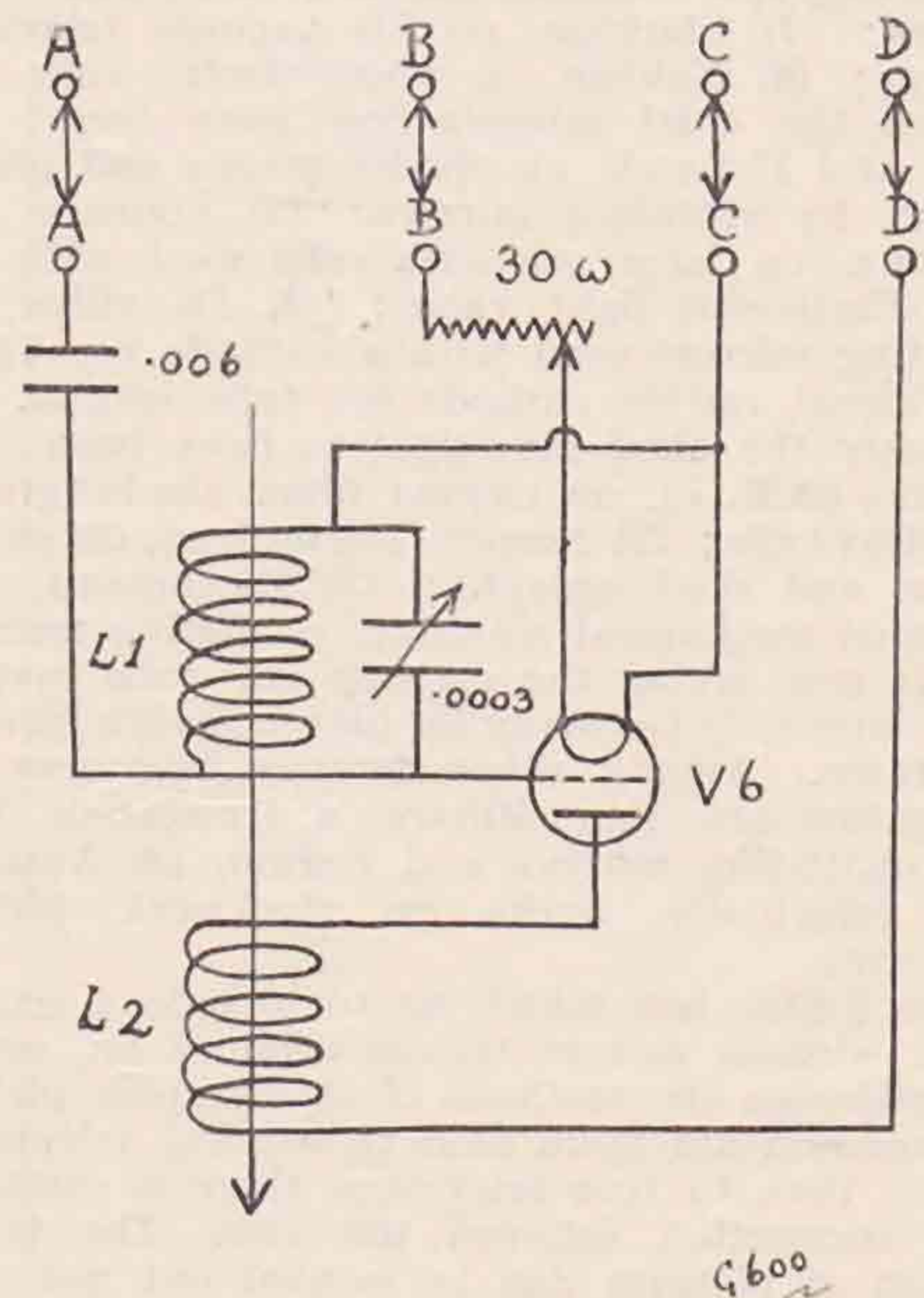

FIG. 1.

CONNECTIONS FOR ATTACHING SEPARATE HETERODYNE VALVE TO BEAT WITH INTER-FREQUENCY FOR C.W.

$L_1$  and  $L_2$  are primary and secondary of a McMichael H.F. No. 4 plug-in barrel transformer. Ordinary long-wave plug-in coil in an adjustable holder would do equally well, provided that inductance values suitable for producing a beat note with the particular frequency of the I.F. amplifier are chosen. It was found that, by inserting a rheostat in the L.T.+ lead of the heterodyne valve and connecting its anode to L.T.+ that oscillation occurred without using a higher H.T. voltage. This scheme can be changed to the usual system if desired. C.W. can be tuned in with the I.F. amplifier oscillating (the long-wave heterodyne valve being switched off). Tune the signal to silent point, withdraw I.F. amplifier from oscillation by potentiometer, switch on heterodyne valve and tune for beat note of desired pitch.

speaking, I should estimate strength to be considerably greater than the four-valve standard S/W receiver I use here, *i.e.*, S/G+det.+two transformers coupled L.F. stages. Quality, however, is not nearly so good, as far as telephony is concerned, and there is always a noisy background.

Stability is rather striking, considering that no



decoupling resistances and by-pass condensers have been used at all. The H.T. supply was accumulators. Decoupling devices are strongly advised, however.

If "Tropaformers" are used, they must be tuned to suit the characteristics of the particular valves in use for the inter-stages. They have a ratio of 2:1. Using PM5X valves in I.F. stages, with 55 volts on anodes, an Osram HL610 as autodyne with +80 on anode, PM5X as second detector with +75, and an Osram DE5, DEL610, or DEP610 with about 120 volts on anode, the H.T. consumption will be found fairly reasonable—probably under 15 milliamps. It was found that the same inter-frequency unit and L.F. stage, with

cut in the copper sheet. The tuning and the reaction condensers are *not* mounted on the metal screen, but behind it on an ebonite strip raised a few inches above the baseboard—this ebonite strip is attached to two wooden uprights secured to the baseboard, thus forming a rigid and well-insulated support. The inductances are "Eddystone" duplex type, mounted on the special raised holder supplied with each set—Messrs. Stratton supply an extra S.W. coil to go down below 15 metres, if this is desired.

It should be mentioned that a *very* loose antenna coupling must be used.

The writer concludes by asking indulgence from the experienced members of the Society, who know the peculiarities of the supersonic system too well.

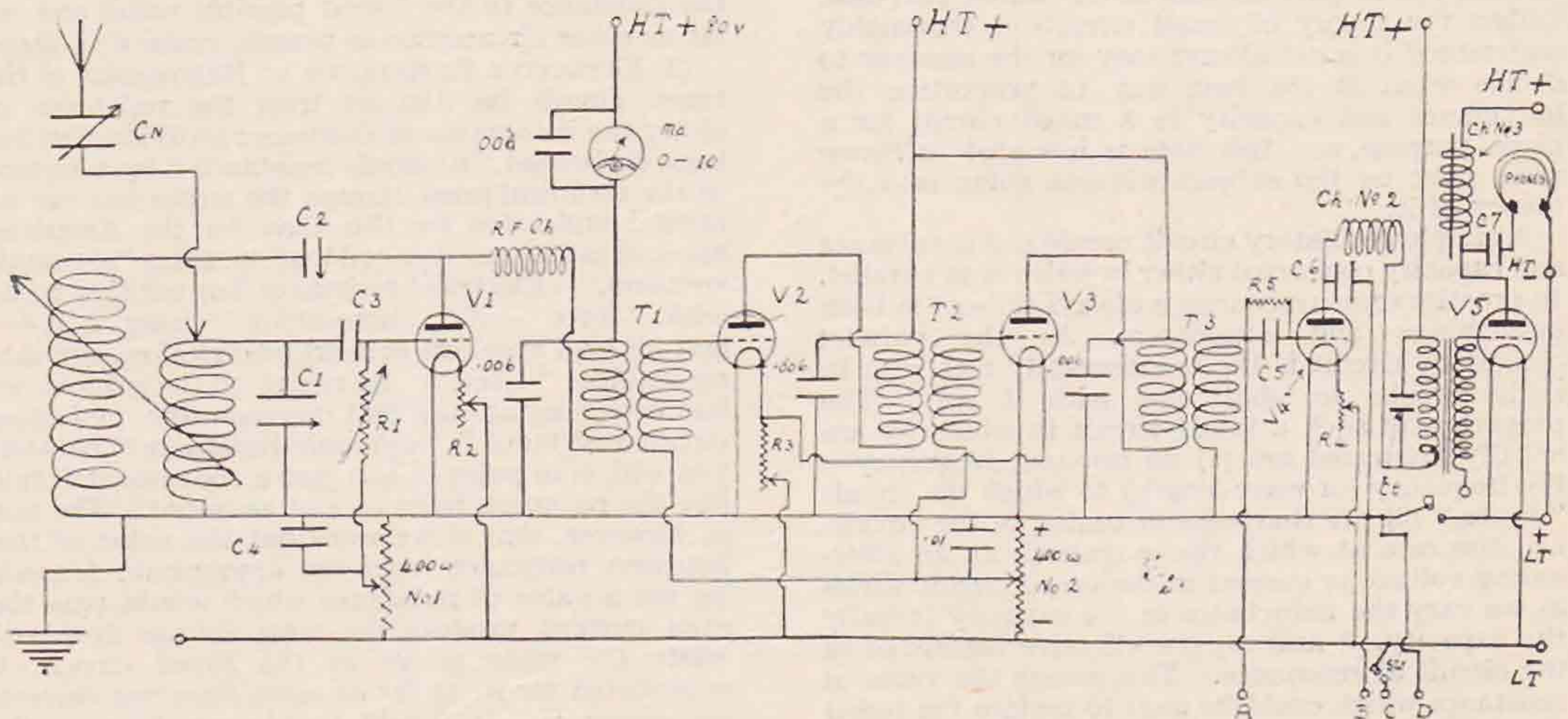

FIG. 2.  
DIAGRAM OF S/W SUPER-HETERODYNE. FIVE VALVES WITH LONG-WAVE OSCILLATOR.  
A 30-ohm rheostat should be connected in series with the negative contact of potentiometer No. 2 and L.T.—bus bar—this gives a good vernier control over I.F. oscillation point.

- |   |  |  |
|---|--|--|
| C <sub>1</sub> . .0001 Ormond, 55:1.                        | R <sub>5</sub> . 2 megohms.                      | V <sub>2</sub> and V <sub>3</sub> . PM5X, HL610 (or DEH610, PM5B). |
| C <sub>2</sub> . .0003 to .0005 (ungeared).                 | K <sub>1</sub> . Variable, .5 to 5 megohms.      | V <sub>4</sub> . PM5X, HL610, PM5D, DEL610.                        |
| C <sub>3</sub> . .0002.                                     | R.F.C. Eddystone, 10 to 2,000 metres model.      | V <sub>5</sub> . PM256, DEP610, or Pentode.                        |
| C <sub>n</sub> . Neutralising type.                         | Ch. No. 2. Dubilier No. 12.                      | V <sub>6</sub> . Any general purpose valve.                        |
| C <sub>4</sub> . .01.                                       | Ch. No. 3. Ferranti B1 L.F. choke.               | T <sub>4</sub> . Ferranti A.F.5.                                   |
| C <sub>5</sub> . .0003.                                     | V <sub>1</sub> . PM5X, HL610, DE5, PM6D, DEL610. | S.W. switch.   |
| C <sub>6</sub> . .001 to .002.                              |  |  |
| C <sub>7</sub> . 4 mfd.                                     |  |  |
| C <sub>t</sub> . .0003.                                     |  |  |
| R <sub>2</sub> , R <sub>3</sub> , R <sub>4</sub> . 30 ohms. |  |  |

the addition of a suitable first detector and separate oscillator valve, the latter passing about 6 milliamps, took in all about 20 milliamps when in suitable condition of adjustment for reception of ordinary broadcast from Johannesburg.

In connection with the arrangement of the inter-frequency amplifier, it would be interesting to learn if any of our members have had interesting experiences with neutralising triodes in these positions, either by capacity methods, or feed-back windings in the transformers.

It is as well to make up the super-heterodyne here designed on a baseboard only, using only a very low panel; in front of the two tuning condensers, as a means of reducing hand-capacity effects, I fixed a small vertical copper sheet, connected to L.T.+. Two short wooden extension rods, say, 5in. long, can be attached to the metal condenser spindles, and can pass through two holes

Nothing new is claimed in this article—nothing revolutionary—nothing marvellous by way of reception, but the experiences are offered in the BULLETIN spirit, to endorse the fact that this system does work fairly well, and to clear away a little of the scepticism which seems to envelop the S.W. supersonic among many amateurs.

The writer, unfortunately, is much limited for time, and apparatus is difficult to obtain here; often it is many weeks before the simplest things can be obtainable at all.

An inquiry has just been made for clean sheet zinc for screening purposes, as an instance; it is unobtainable in Rhodesia. This will show one's difficulties.

There is scope for trying several variations of connections for the grid circuit of second detector.

(Continued at foot of column 2, page 139.)



# Tuned Circuits.

## "High C" or "High L"?

BY MICRON.

In articles describing stable frequency transmitters, attention is often drawn to the possibility of improving the stability of self-controlled (self-excited) transmitters by using a large ratio of capacity to inductance in the tuned circuit. In short-wave receivers the C/L ratio is sometimes high and sometimes low and many modern receivers use a relatively large fixed tuning condenser with a smaller one in parallel with it for tuning purposes. Unless the theory of tuned circuits is thoroughly understood it is not always easy for the amateur to decide what is the best way to proportion the inductance and capacity in a tuned circuit for a given purpose, and this note is intended to throw some light on the subject without going into the theory of it.

A simple oscillatory circuit consists of inductance and capacity connected either in series or in parallel. In practice some resistance is always present in both inductances and condensers. As the parallel oscillatory circuit is the one generally met with in radio circuits we shall deal with it only. The properties of such a tuned circuit in which we are usually interested are (1) its resonant frequency—the frequency (or wave-length) to which the circuit "tunes," (2) the sharpness of tuning of the circuit, *i.e.*, the rate at which the magnitude of an alternating voltage or current in the tuned circuit varies as we vary the inductance or the capacity (usually the capacity), \* and (3) the effective resistance of the circuit at resonance. This means the value of resistance which could be used to replace the tuned circuit *at its resonant frequency* (the resonant frequency of a circuit is the frequency at which it behaves as a pure resistance, the effects of the inductance and capacity balancing each other out). Now these three things, resonant frequency, sharpness of tuning and effective resistance, all depend on the fundamental electrical properties of the circuit, that is the inductance and capacity and the resistance in each. The resistances in the inductance and capacity are relatively small in practical radio circuits and much effort is expended in trying to make them smaller still. The resistance (at radio frequencies) of a good inductance is relatively much higher than that of a good condenser.

(1) RESONANT FREQUENCY can be found approximately by neglecting resistance altogether and applying the appropriate formula for a circuit containing inductance and capacity only (this and other formulæ are quoted below in an appendix which can be conveniently ignored by non-technical readers). If the resistance of the inductance is included the result will be very nearly accurate,

\* This is not an accurate definition. Those who are interested in accurate definitions of "sharpness of tuning" and "selectivity" and of the difference between them will find an interesting note on the subject by F. M. Colebrook in the August issue of *Experimental Wireless*. Those who are not interested will probably continue to use both terms indiscriminately.

while those who like work for its own sake can also allow for the resistance of the condenser. The resonant frequency may, of course, also be found by means of a frequency meter.

(2) SHARPNESS OF TUNING is increased by using large values of capacity and decreased by using large values of inductance or resistance. Thus if we wish a circuit to be sharply tuned we must reduce the resistance to the lowest possible value and, so far as other circumstances permit, make C/L large.

(3) EFFECTIVE RESISTANCE AT RESONANCE of the tuned circuit (as distinct from the resistance of either the inductance or condenser individually) has been christened "dynamic resistance" by a section of the technical press, though the writer can see no more justification for this than for the American habit of calling moving-coil loud speakers "dynamic speakers." Electrical resistance has nothing to do with "force"—its "dimensions" being L.T.<sup>-1</sup>—and all loud speakers convert electrical energy into mechanical "force." To return to the subject, we had better say at once that this quantity, "effective circuit resistance," "dynamic resistance," or what you will, is in point of fact just a convenient fiction like the radiation resistance of an aerial. The fact is, however, that if we work out the value of this fictitious resistance from the appropriate formula we get a value of resistance which would pass the same current, produce the same voltage drop and waste the same power as the tuned circuit, if substituted for it, *so far as radio frequency currents are concerned*. It should be obvious to even the most non-technically minded that the d.c. resistance will always be the same and will simply be the d.c. resistance of the inductance since no direct current can pass through the condenser. Now, as to the actual value of the circuit equivalent resistance a little reflection will show that the higher the value the smaller the current which will flow through the resistance and consequently the smaller power loss. Conversely a low equivalent resistance will mean a large loss. The equivalent resistance at resonance of an ideal tuned circuit (containing no resistance) would be infinite and the power loss zero as no current would flow. In a practical circuit where some resistance is present in the inductance and condenser the equivalent circuit resistance is less than infinity and there will be some power loss. In fact the *higher* the resistance of the *components* of a parallel tuned circuit the *lower* the equivalent resistance of the *circuit* and the greater its losses. Thus we see that low power loss as well as sharp tuning is achieved by keeping the resistance of both inductance and condenser as low as possible. But the resistance of the components is not the only factor in the case and the circuit effective resistance (at resonance) (call this R for short) also depends on the values of inductance and capacity. Large inductance gives a large R and large capacity gives a small R, the component resistances and the frequency of resonance being the same in both cases. Hence *for a low loss circuit the resistance of the components should be small and C/L should be*



*small.* From this one would expect the losses in an ordinary circuit tuned by a variable condenser to be much lower when the condenser is near minimum than when it is near maximum. This is actually the case, but the effect is reduced in practice because the resistance of the coil is higher at the higher frequencies corresponding to the lower settings of the condenser. The resistance of the condenser will vary with the condenser setting in a way which depends on the proportion of the condenser losses between plate resistance loss and loss in the solid dielectric. Plate resistance loss will predominate at the higher capacity settings and dielectric loss at the lower, and in all normal cases the total condenser loss is maximum at minimum setting.

A few examples of tuned circuits will now be mentioned to illustrate the application of these principles. In a self-controlled oscillator for transmission or other purposes the component resistances should be as low as possible for the sake of efficient working. The higher the C/L ratio is the less liable will the oscillator frequency be to variations and the smaller the amplitude of the harmonics generated by the circuit. With a low C/L ratio the circuit losses will be lower, but the oscillator frequency will be less stable and the harmonics will be more pronounced. (Unless excessive grid bias and grid excitation voltage are used the harmonics will not as a rule be troublesome with any normal oscillatory circuit.) A compromise must be effected between these two extremes according to the requirements of the case—good stability or large output or a little of both. With a crystal-driven valve oscillator the case is rather different. Here the frequency is fixed and output and harmonics are the only important considerations. Usually both are wanted (if the final signal is to be produced on some harmonic of the crystal frequency), and everything points to a small C/L ratio for the anode circuit of the crystal oscillator. A plain coil without any tuning condenser is quite satisfactory and it is quite a mistake to use a large tuning capacity. The coil should have a natural frequency (with its self-capacity) just above that of the crystal. If it is desired to select a particular harmonic directly from the crystal oscillator a separate tuned circuit with large C/L (to tune sharply to the frequency of the wanted harmonic) should be coupled fairly tightly to the oscillator anode coil and connected in the grid circuit of the next valve. The anode tuned circuit of a "frequency doubler" or "frequency multiplier" stage should also have a high C/L ratio. The final tuned circuit of any oscillator-amplifier chain should have a low C/L ratio as large output is the main consideration and there is no chance of frequency variations (provided the rest of the chain is properly constructed). In a receiver any tuned circuits associated with radio frequency amplifiers should have low C/L as it is very important to keep the circuit losses low if any R.F. amplification is to be obtained. In a circuit where losses can be made up for by means of reaction a high C/L ratio may be used in the interests of frequency constancy and freedom from body capacity effects, but it should not be too high or the reaction control may become awkward. By using a fixed capacity in parallel with a variable tuning capacity any given frequency range may be covered by suitably proportioning the condensers and the inductance and a narrow fre-

quency band can be spread over the whole condenser scale without using excessively low C/L. The same scheme may be applied to frequency meters and is particularly desirable for valve heterodyne meters except where they are required to produce harmonics very freely, in which case the C/L ratio should not be too large.

APPENDIX.

Useful formulæ for use with tuned circuits:—

The *resonant frequency* of a tuned circuit is given by:—

$$(1) f = \frac{1}{2\pi\sqrt{L.C}} \dots \text{neglecting all resistance.}$$

$$(2) f = \frac{1}{2\pi} \sqrt{\frac{1}{L.C} - \frac{R_L^2}{4L^2}} \dots \text{neglecting condenser resistance.}$$

$$(3) f = \frac{1}{2\pi} \sqrt{\frac{L - R_L^2 \cdot C}{L^2 C - R_L^2 \cdot C \cdot L}} \dots \text{including both condenser and inductance resistances.}$$

(N.B.—The three formulæ above are for a circuit consisting of inductance and capacity in parallel.)

The *selectivity* of any tuned circuit is given by:—

$$(4) \omega r \cdot \sqrt{\frac{1}{Z_r} \cdot \left| \frac{\delta^2 Z}{\delta \omega_r^2} \right|}$$

The *sharpness of tuning* of any tuned circuit is given by:—

$$(5) C_r \sqrt{\frac{1}{Z_r} \cdot \left| \frac{\delta^2 Z}{\delta C_r^2} \right|}$$

(See Colebrook, E.W. & W.E., August, 1929.)

The *effective (shunt) resistance at resonant frequency of a parallel tuned circuit* is given by:—

$$(6) Z_r = \frac{L}{C \cdot R_L} = \frac{\omega_r^2 \cdot L^2}{R_L} = \frac{1}{\omega_r^2 \cdot C^2 \cdot R_L} \dots \text{neglecting condenser resistance.}$$

NOTE.—The suffix "r" denotes the value of the quantity concerned at the frequency of resonance.

**Superheterodyne Receiver**—(Continued from page 137).

- (a) Anode rectification (hardly advisable, because overloading is improbable).
- (b) Circuit returned to moving contact of potentiometer No. 2.
- (c) Circuit returned to either +, or —, L.T. bus bar.
- (d) Grid leak returned to a 400-ohm potentiometer across L.T.

Only three inter-frequency transformers are shown—I have used four, but by connecting, for example, a 4½-volt flashlamp battery in series with moving arm of potentiometer and lead to secondaries of the transformers, it should be easier to obtain absolute stability, and work the two I.F. valves at higher efficiency.

An earth connection, to the grid circuit of the autodyne, is apparently detrimental.



## Station Description No. 2. G6CI.

By B. W. WARREN.

It was a number of years ago, when the majority of amateur experimental work was conducted on 440 metres, that this station began work. During the time that has elapsed between that period and the present, the development of amateur activities has been keenly followed. This station has always taken an active part, and until quite recently the lay-out depicted in the photograph has been in constant use.

It is now felt that, owing to the present-day re-

quirements, the station could be considerably improved. Accordingly, it is being entirely re-designed to conform to the new regime. In the meantime, a description of the station as it was will be given.

At the left is the S.W. receiver. This utilises two valves, as detector and audio stage, arranged in the well-known Schnell circuit. Transformer coupling for the amplifier is employed. Coupling to the antenna is obtained through a six-turn coil, one

end of which goes direct to the negative end of the grid coil, while the other, of course, connects to the antenna. The receiver covers all the amateur bands at present in use with a minimum wave-length of 9 metres. Mounted on the wall immediately above the receiver is the 10-metre transmitter, a full description of which appeared in the "BULL." dated May, 1929. On the shelf to the right may be seen the 20-metre transmitter. This has a UX210 valve

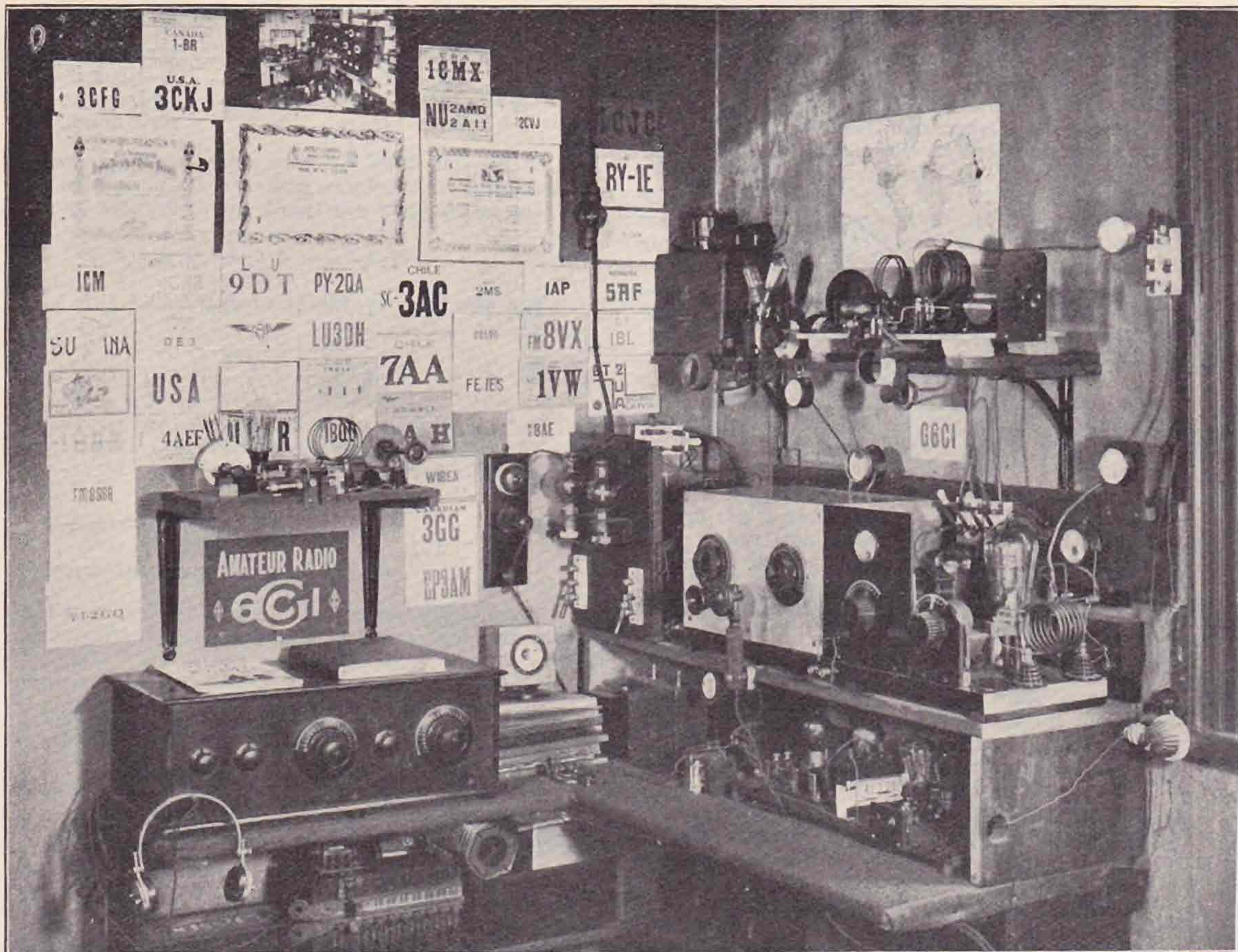

operating in a series-feed T.P.T.G. circuit, the valve being supplied with 500 volts of R.A.C.

Immediately below this can be seen the crystal-controlled 20 and 40-metre transmitter. The crystal oscillator is housed in the shielded cabinet. Here 300 volts are supplied to the DE5B.

Behind the panel adjoining is a 40-metre frequency doubler. Again 300 volts are supplied to its valve, this time an LS5D. Finally, there is the DET1 arranged as a 20-metre frequency doubler,



the output of which is taken direct to the antenna. The full output of the rectifier, namely, 500 volts, is applied to the DET1. To assist frequency doubling and to keep the plate current within reasonable limits, a grid leak of 100,000 ohms is used in this stage. For 40-metre work the antenna is usually coupled to the first doubler, though the DET1 stage can be converted to a 40-metre power amplifier.

At the extreme left of this transmitter is the main power supply. Here the 200-volt 50-cycle A.C. mains are stepped up, rectified by an Osram U8, and passed through the usual "brute force" filter, consisting of 8 microfarads of capacity and a 30 henry choke. Underneath the bench, two U-30 valves supply 300 volts for the crystal oscillator and first doubler.

The breadboard layout to the right of the key is a four-tube speech amplifier.

Outside, a lot of work has been undertaken in the testing of many types of radiating systems. Experiments show that for general non-directional long distance work the antenna length should correspond to half the working wave (in metres), and fed by the well-known two-wire feeder, either in the centre (current), or at either end (voltage).

Best results are obtained when the antenna is suspended at a height equal to the length of same, and in a horizontal plane. Such a system is in use at the moment of writing.

An antenna whose length is equal to the working wave seems to exhibit marked directional properties. To quote one example, South America was one of the continents lying in the direction of the antenna. There a great number of stations have been worked, and audibility reports of R8 and R9 were not infrequent. On the other hand, North American work was very poor indeed. The signal strength from the few stations worked was very low. It is intended shortly to write an article dealing fully with the above subject, so no more need be said now.

A final glance at the photograph reveals the certificates of the R.S.G.B., W.A.C. Club, and A.R.R.L., while surrounding them are a few QSL cards from stations worked.

In conclusion, it is desired to take this opportunity of expressing thanks to the many amateurs in all of the six continents who have contributed in no small measure to the success of this station's experimental work.

## 56 Megacycles.

By E. T. SOMERSET (G2DT).

It will be difficult in what follows to give credit where credit is due, as three of us (W2AIU, G6TW, and the writer, G2DT) have been very busy of late delving into the mysteries of 5 metres, but I wish to acknowledge, with untold thanks, the basic ideas as emanating from W2AIU, who has been engaged in research on this band for the past four years. He says in *Radio Engineering* for June, 1929: "It has always been assumed that a wave is a wave, no matter how it is generated, and if a 5-metre wave is transmitted, this should remain the wave, provided fluctuations of plate and filament power supply are kept at a minimum. We do not care to go exactly contrary to this belief; nevertheless, some recent observations have indicated that maybe our so-called 'skip-distance' is due to nothing more than the 5-metre signal being reflected at, say, 4.8 metres." W2AIU then goes on to say: "Signals were recorded nicely at a distance of two miles. By removing the receiver to the summit of a close-by hill, signals remained on the same tuning point, but with a marked increase in audibility. On going over to the reverse slope and at the base of the hill, signals became inaudible. The receiver, in these cases, had a very low tuning scale and micrometer control. On the observers' side of the hill in question, and at the summit, signals were tuned in on the centre of the scale, but, upon going to a flat part, nine miles away from the transmitter, all the coaxing in the world failed to record impulses, and, as a final resort, the receiver tuning inductances were shortened, thereby decreasing the tuning range scale, and the signals were picked up on an entirely different setting, that is to say, on a lower wave-length and in the neighbourhood of 5.07 to 5.14 metres. The point should not be overlooked that the transmitter remained at a fixed wave-length of 5.17 metres. The foregoing could not have been

observed had the receiver covered a metre tuning scale or even half a metre." In a letter to the writer, this experimenter goes on to say: "I will not attempt transmission to any Hams having receivers running from five to six metres . . . now, if one has a receiver with a seven centimetres scale, one can pick up the signal within 500 miles on a single circuit receiver, detector, and two audio stages, and a transmitter employing a 7 to 10 watt tube will do very nicely with 500 volts on the plate. I have done this repeatedly—transmitter operated by clockwork and starting on the hour for full 24 hours—and was able to record everything on each day for seven days of my test; I, in this case, being just under 500 miles away. I found tuning was *very sharp on a 7 cms. scale*, so what could it be like trying to tune 5 to 6 metres or even less!" It was upon receipt of this letter that G6TW and the writer "sat up and took notice," and set about making the receiver as detailed later, and for which it is hoped the diagrams prepared are self-explanatory.

It will be realised that what is wanted is a very broad tuner, and thus diametrically opposed to BC work, where a very sharp tuner is necessary, so that everybody's music is not heard at once! For the present, we may be allowed our fad in wanting a receiver that will pick up a few fellows transmitting on 5 metres all at once. In fact, we require a receiver that, when, say, three miles from the transmitter, will *not* tune out the signals, but, at a hundred times this distance, *will* tune it out with about half a dozen turns of the micrometer control.

W2AIU goes on to say that sunlight has always played a large part in 5 metre experiments, and that it has been noticed that daylight reception is far more reliable, remaining so until the going down of the sun, whereupon signals fade badly and disappear



when dark. This led him to think that the transmitter was radiating more energy by day than by night, and experiments were duly conducted. A reliable source of plate and filament current was used so that this would be independent from the mains and their subsequent change during these periods. A wavemeter, equipped with flashlight bulb, was placed in inductive relation to the oscillator, and tuned by an extension system until the filament gave forth a glow. This was accomplished during daylight, and, as dusk appeared, the glow left the flashlight bulb filament. A small movement of the wavemeter towards the oscillator caused the bulb to glow afresh, only to disappear when darkness settled. These observations were continued, and rechecked, and indicate that an oscillator at 5 metres does not radiate as much energy during darkness as in bright sunlight. Although the amount of loss is small close to the oscillator, it might be greater at a long distance.

should be fastened a thick threaded washer or threaded bushing, as a screw guide. By inserting a long brass machine screw through the panel and held securely to it by lock-nuts any action of the control knob will move the wedge horizontally between the two capacity plates, A, A. To prevent the wedge from shaking or wobbling, a spring à la "Break-back" mouse variety, clamped to ebonite base B will do, or an upper and lower wooden track-tongue with grooved wedge will suffice. Anything, in fact, that will stop the wedge moving horizontally without binding or vibration, which would change the tuning otherwise than by the natural method intended.

Fig. 2 is an attempt to explain the micrometer rheostat used in regeneration control in conjunction with an ordinary rheostat in series. Procure a wood block and bore a hole about  $\frac{3}{8}$ " diameter for a depth of  $3\frac{1}{2}$ ". On a suitable brass machine screw, affix a control knob and wind the screw thread full of ordinary rheostat wire. Insert the screw, with wire, inside the hole in the block, and fasten securely the projecting leads to washers affixed at each end of the block. Carefully withdraw the screw from the block for the first time by rotating the knob anti-clockwise. The block will now contain a spiral of resistance wire which has the same pitch as the screw used, and the change of resistance is accomplished by rotating the knob one way or the other, progressively open circuiting or short circuiting the wire.

The most sensitive portion of the receiver—which is a joy—appears to be where a faint high-pitched

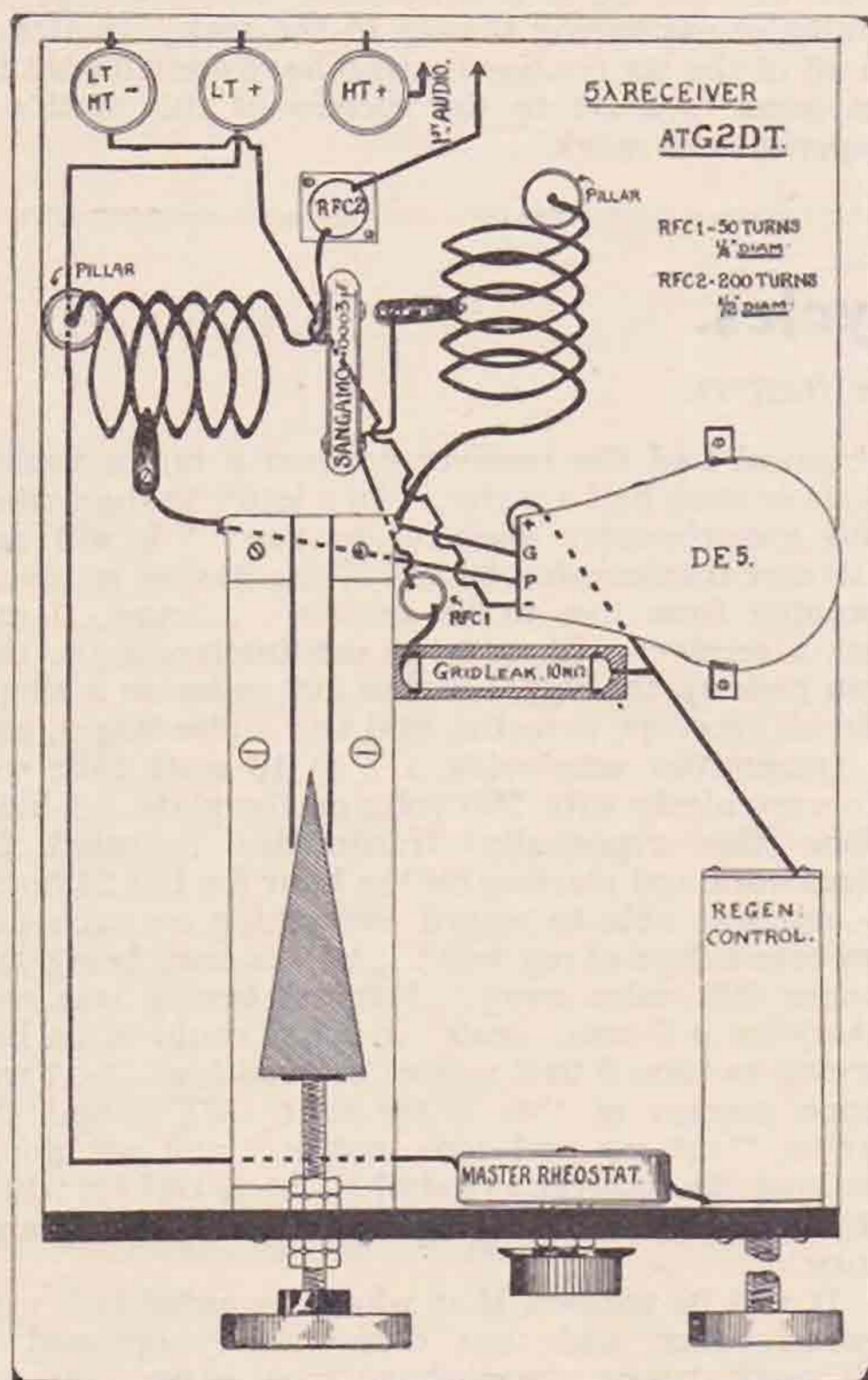

THE RECEIVER.

In the BULLETIN for November appears the circuit diagram, and I now propose to give constructional details of the special variable condenser and regeneration control, together with inductance details. Referring to Fig. 1, A, A are two strips of spring brass about  $2\frac{1}{2}$ " long, and  $\frac{1}{8}$ " wide, and separated about  $\frac{1}{4}$ " from each other. Two ends of these strips are secured to the ebonite strip base B. The wedge is about  $3\frac{1}{2}$ " long, 1" wide, and 1" thick at the base. In the end is bored a hole  $3$ " long and slightly larger than the control screw used; and on this same end

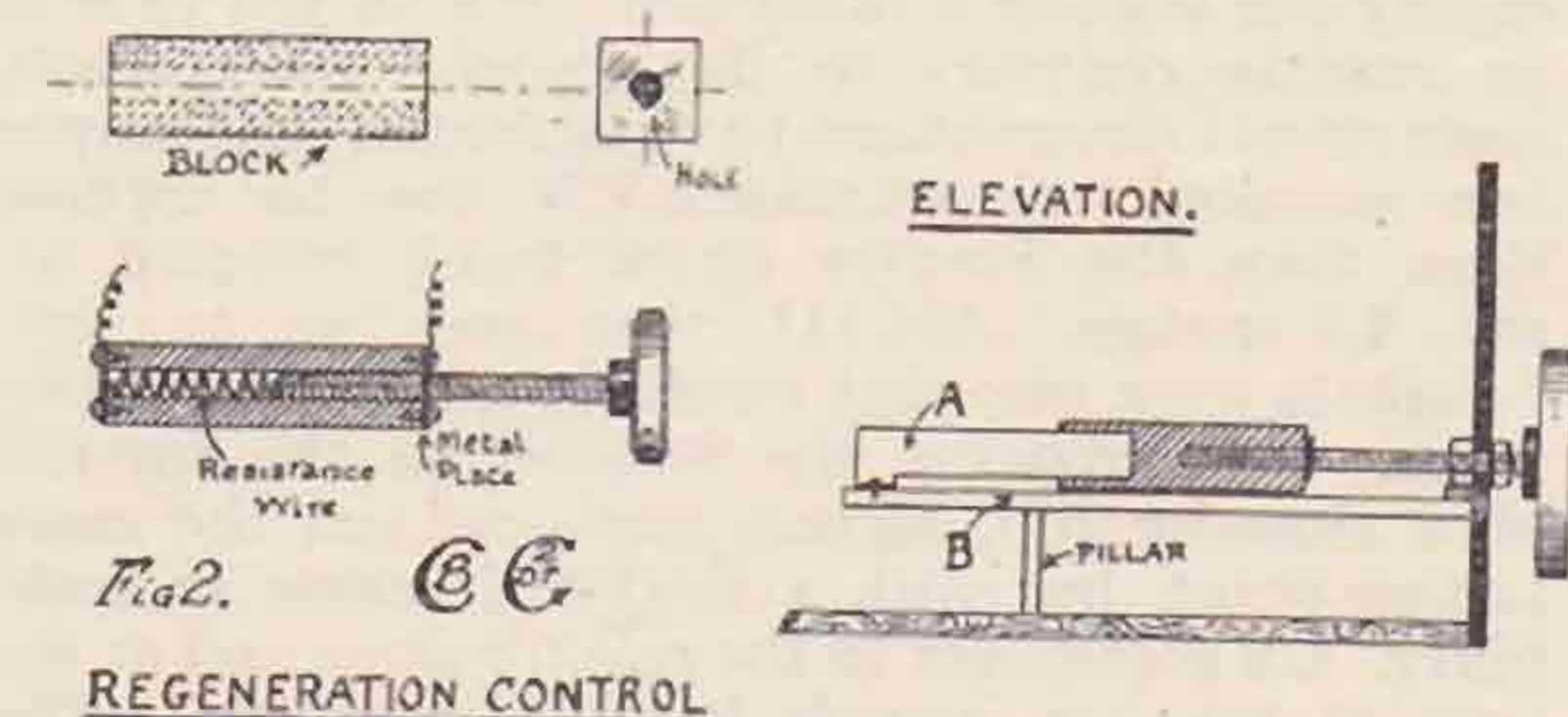
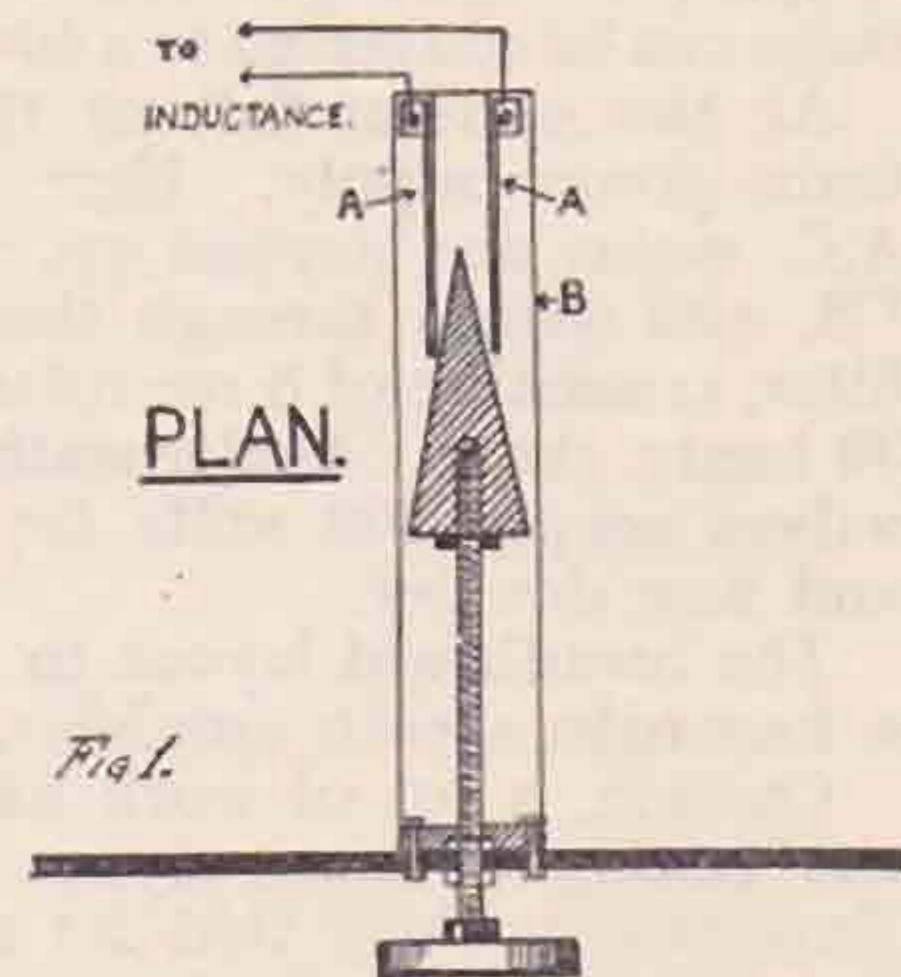

sound is heard in the fones. The inductances are spiral of 1" diameter, and air-spaced  $\frac{1}{4}$ " and made of five turns No. 10 gauge copper wire. It is advisable to use flexible filament leads of something like "Lewcos" loop aerial wire wound into a 1-16" spiral, so as to counteract vibrations reaching the detector valve, which itself might advantageously be cushioned.

When this receiver was first put into commission at G2DT it was found that, upon setting it to, say, 5.3 metres by means of the clips and rotating the

(Continued at foot of next page.)



## An English Amateur visits Denmark.

By C. G. PHILLIPS (G5PJ).

Being one of those fortunate people who enjoy a long vac. in the summer, I decided to take a trip abroad, and having pleasant memories of a previous trip, set off to revisit Copenhagen.

I got down to radio straight away in the shape of a  $\frac{1}{4}$  k.w. spark transmitter on board the ship, and had one or two QSO's on 600 metres. It required some effort to refrain from talking to the coast stations in ham language. What the op. at OXB would have thought of "ge ob es tnx fr call-ur fb T7 sigs. R5 ere" is difficult to imagine. After my own transmitter I found it a little disconcerting to have a  $\frac{1}{4}$  k.w. spark just by my ear!

I had written to the EDR before leaving England, and had been invited to their meeting. I attended this on Thursday evening and met several Danish hams, all of whom spoke English very well. I was deeply interested in a long conversation between OZ7HW and a friend of his, but as it was in flowing Danish I was not much the wiser!

The next day I went out to the aerodrome at Kastrup, and after a little diplomacy succeeded in getting into the radio room, where I was shown round by three very affable ops. There are two sets, one for 900 metre 'phone reception, and one for 1,210 metre telegraph reception. Both operate loud speakers and QRN was bad the day I was there, so things were pretty noisy. I had the pleasure of sending several messages to other European air stations on one of the finest keys I have ever handled, made by the G.N. Telegraph Co. The transmitter is at Lyngby, some ten miles away, and was operated through a key relay, the valve filaments being on all the day.

Through the kindness of OZ2Q, the vice-president of the EDR, who made arrangements for me, I was able to go over the Lyngby station the next day, and was shown round by the engineers, who did everything they could for me, including allowing me to take photos. The main set (OXE), operating on 5,180 metres, is a 6 k.w. valve set supplied from a 6-phase supply. I gazed with awe at the aerial ammeter, registering 38 amps, and thought of my handsome 0.2 at home! There is also a 10 k.w. arc set, but this is seldom used. The aerial inductance is surrounded by an earthed wire cage, to stop mush upsetting the Copenhagen BCL's!

The aerodrome set is about 3 k.w. and operates with a modulated note on 1,210 metres. I had the unique experience of calling the op. at Kastrup on his own transmitter, as there was a key at each end of the relay line. On an outside receiver it must have sounded rather strange to hear OXS saying good afternoon to himself!

There are two short wave sets, OXZ and OXY. OXY is the very latest thing and is a fine piece of work. The circuit is the MOPA, and the input is about 1 k.w. Three separate zepps are used for 19.6, 31 and 49.5 metres, and on 31 the feeder current was 2 amps. the day I was there. All condensers are fitted with glass spindles and the coils are all silver-plated. This was because they were found to get too hot when unplated copper was used. For 19 metres the coils are made from plated strip, about 1 inch broad by  $\frac{1}{4}$  inch thick, made into a helix.

Crystal control is used, and the note is very good, but OXZ which is not CC was giving trouble with a bad note. I was in a position to sympathise on that point!

The next night I had the pleasure of visiting OZ7LO's station, and I must say I thought I had got into another commercial station! His transmitter is a very fine TPTG, operating from a 3-phase generator with an input of 50 watts. Keying is by relay in the H.T. negative. Owing to Danish regulations amateurs must QRT during B.C. hours, so I did not have an opportunity of working the set.

The following evening I visited OZ7IM, who has a 4-watt Hartley and uses silver-plated copper tube supported in glass rails for coils. He asked me to give his 73 to G6WY, G6HP, G6CL and G6WN, but as these gentlemen spend all their lives on 14 M.C., I do not see any prospect of QSO-ing them!

I also inspected OZ2Q's transmitter, but he was not on the air just then, although he hopes to be in a few weeks now.

I returned to the ship after a visit to the Danish Radio Exhibition, which consisted mainly of radio gramophones and speakers. I was struck by the absence of English goods, Lissen and Cossor being about the only firms represented.

The homeward journey was made with the good old  $\frac{1}{4}$  k.w. spark set and 600 metre QSO's.

In conclusion, I should like to express my appreciation of the kindness and readiness to oblige shown by my Danish radio friends.

*(Continued from previous page.)*

knob controlling the variable condenser, it went out of oscillation, and nothing would persuade oscillation to re-appear except by altering the clips again, when it would be on the cards that the wave-length altered to 5.25 metres. This was hopeless, and the cure for this was to open out the spacing of the turns of the two inductances to just over the quarter-inch when everything became normal. The trouble just related was due to capacity between the turns. Incidentally, it is of interest to note that when the cure was effected all traces of body-capacity previously noted as affecting the regeneration control disappeared. Assuming the detector used is a debased DE5 with 60 volts on the plate, and that all leads are kept short; then, with  $3\frac{1}{2}$  turns plate and four turns grid, and with the aerial tapped on to the second turn of the plate coil from the RFC end, the wave-length at which the receiver oscillates will be about 5.25 metres, *i.e.*, the QRH of G6TW's transmissions.

### Stray.

G6TX states that on November 17 he worked HAF9AF at 00.30 and was reported T8 R6. Immediately afterwards CTICP reported him T4 R5. CTICP had also the same tale to tell of quickly altering notes, though the transmitters had not been touched. G6TX would like to have readers' opinions on the cause of these changes.



## The Society Trophies.

Each year at this time, the Council and General Committee have the difficult and onerous duty of awarding the Society's trophies. After due care and thought they have decided to present the coveted Rotab Cup (donated by our President, Mr. Gerald Marcuse) to that indomitable worker, Maurice Pilpel (G6PP). Mr. Pilpel has for many years shown his ideas of Ham spirit to the world by operating a wonderful low power station in a manner which is a credit to the British amateur. His successes have been the more remarkable when one realises the physical difficulties under which he works. His efforts on behalf of the Society need little mention here, but the duties he has performed as Honorary QRA Manager deserve the thanks of not only the members of our

Society but of amateurs throughout the world.

Our other cup, kindly presented to the Society by Dr. Wortley-Talbot, is to be awarded jointly to Mr. J. Noden, G6TW, and Mr. E. T. Somerset, G2DT. Their efforts in connection with all the troubles relating to 56,000 K.C. transmission and reception do not require enlarging on in these columns again. Although no further successes have been achieved on the actual transmission and reception of signals on this frequency, much time has been spent in perfecting the apparatus, as is obvious by a glance at the C.B. notes in any issue.

By the time these notes appear, the trophies will be in the hands of the new holders, and we are sure the best wishes of the Society go with them.

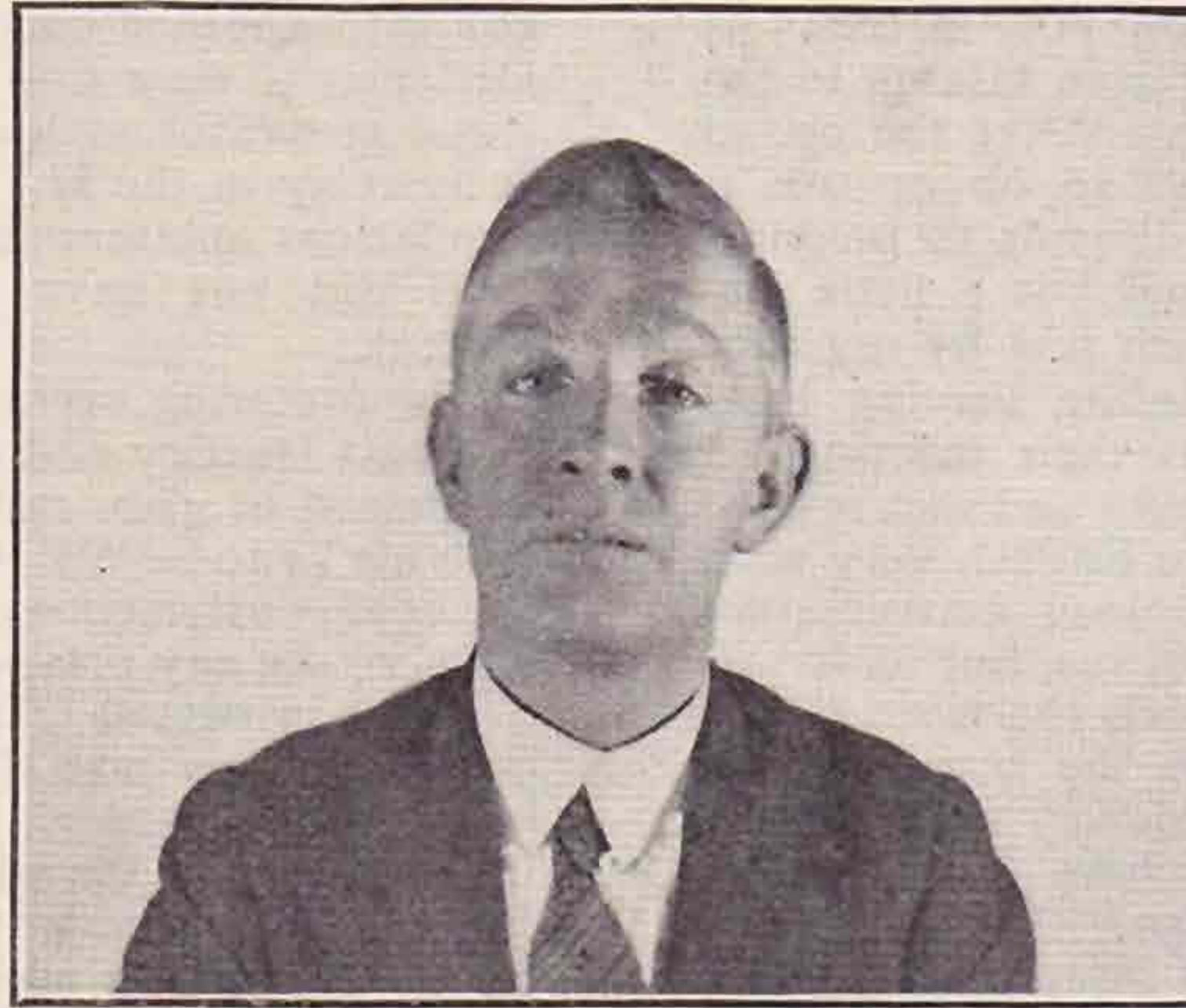

J. NODEN, G6TW.



M. W. PILPEL, G6PP.

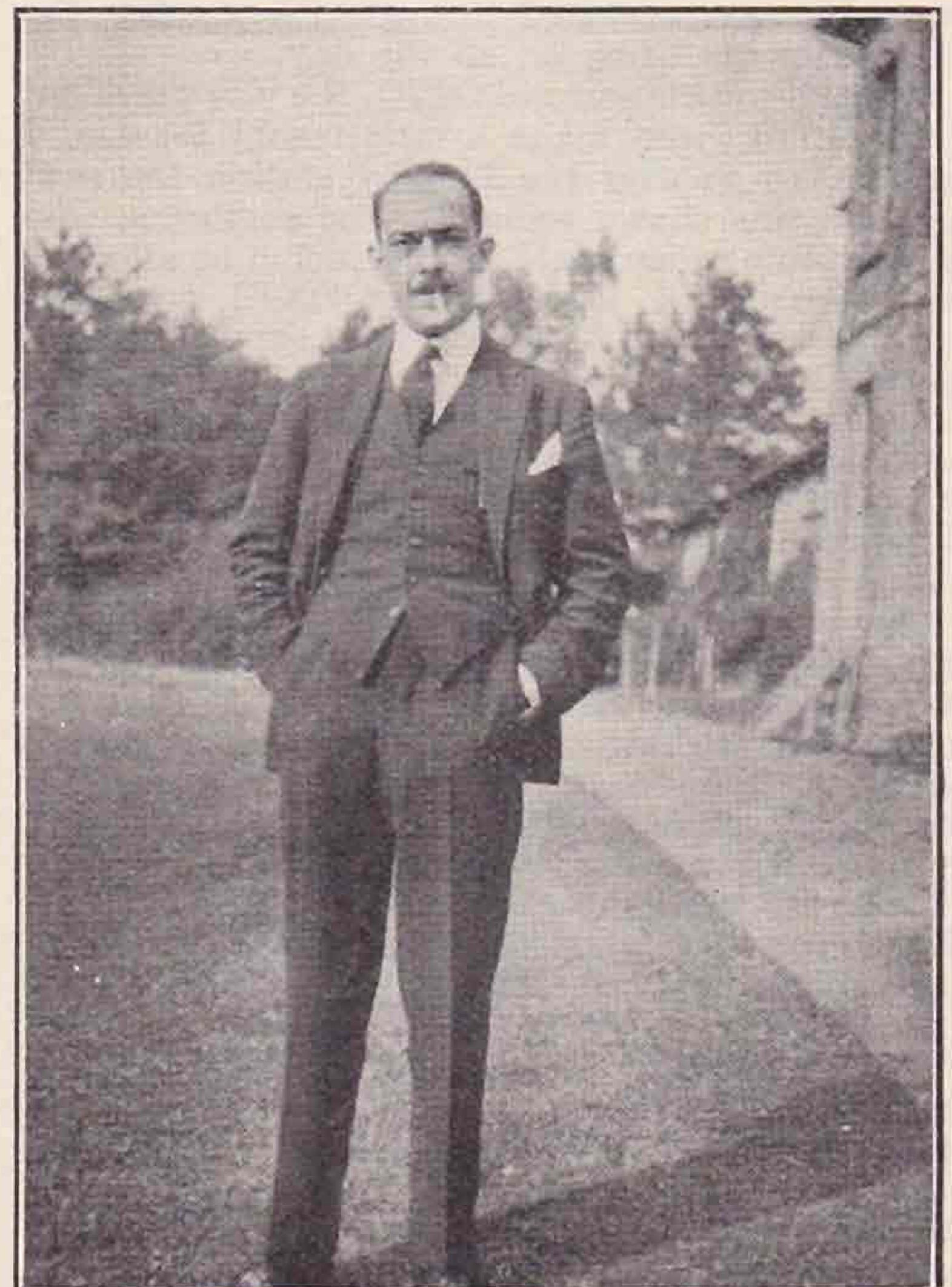

E. T. SOMERSET, G2DT.



## DX Reception on a Portable Receiver.

By H. K. BOURNE (BRS212).

As it was necessary to spend two months of last summer away from home, at Rugby, the writer decided to take a short wave receiver with him to keep in touch with the "ham" world. Accordingly a portable receiver was made up, consisting of detector, followed by an optional transformer coupled L.F. stage. Throttle control reaction was employed.

The valves used were of the 2-volt type, the L.T. being supplied from a  $4\frac{1}{2}$ -volt dry battery, the voltage of the latter being dropped in a rheostat which was cut out as the battery voltage fell. The H.T. supply was from a 60-volt battery of especially small dimensions.

The wavelength range of the receiver was from about 25 to 2,000 metres, thus covering the broadcast bands as well as the 7 M.C. amateur band. Unfortunately, reception could not be obtained on the 14 M.C. band owing to a "dead spot" caused by the H.F. choke. The whole receiver together with batteries, 'phones, and aerial wire, was contained in an attaché case measuring 15in. long by 9in. wide by 4in. deep.

The aerial used was only 15ft. high and 35ft. long, single wire. No earth was used on short waves, but a connection was made to a gas pipe when the receiver was operated on the higher waves. It was found that signals came in so well that it was quite sufficient to use only one valve, and so this was done in order to save the filament battery.

Little listening was done on the broadcast bands, but numerous harmonics of the local station, GBR, on 18,000 metres were heard. Several amateurs were heard on the 1,750 K.C. band, including G6QL, G6RW, G6ZR, G5UG, and one or two others on 'phone.

On the 7 M.C. band many stations were logged. During the period of two months, the following countries were received on the 7 M.C. band: UO, ON, OK, OZ, EAR, F, G, GI, EI, I, D, LA, SM, PA, CT1, CT2, CT3, CV, OH, SP, EU, HAF, W (1, 2, 3, 4, 5, 8, 9), VE, CM, ZL, FR, K, AUI, AU7.

Five continents were logged in spite of the poor aerial and the bad midsummer conditions, and the heavy 7 M.C. QRN.

Some 100 U.S.A. stations were logged; and three ZL stations (ZL3AS, ZL2AB, ZL4AO) were received on several occasions at good strength—R4 on one valve.

It was interesting to compare the strengths of G stations heard in Rugby with their relative strengths at the home QRA at Bristol. Among the loudest G stations audible were G6WT, G6WY, and G6RB. Many of the QRP stations, such as G2ZN, G5RV, G6ZR, G5JF, were also heard at good strength.

### Stray.

Members will be interested to know that the "Discovery" carried short-wave wireless apparatus operating under the call VPHQ. Transmissions take place on 35 metres from 21.00-21.30 G.M.T., and the "Discovery" stands by on 21 metres for calls.

## QUARTZ CRYSTALS

STANDARD . . . £1. 0. 0.

POWER . . . £1. 10. 0.

*Our Power Crystals are guaranteed TESTED with 500 volts H.T.*

CRYSTAL HOLDERS 4. 6.

*Full particulars on request:*

**THE QUARTZ CRYSTAL CO.** (G2NH & 5MA),  
63a, Kingston Road, New Malden, Surrey.

## TRANSFORMERS

We invite your enquiries for all types of Transformers and Chokes. Special heavy duty eliminators supplied to meet any requirements. Transformers for Transmitting.

### CHESTER BROS.,

244, Dalston Lane, London, E.8.



## COILS

**R.S.G.B. 4 & 3 . . 8/6 each.**

„ „ **Bases 1/6** „

**Terminal strip complete and all ebonite parts for the S.G.4. 7/2.**

### LOW LOSS SKELETON FORMERS

*ebonite screws, grooved to your own requirements, 4/6 each.*

*Photo on pages 51 and 53 of the "Bulletin" for September.*

### COILS, SCREENS, RESISTANCES

## B. & J. WIRELESS CO.

ATHELSTANE MEWS, LONDON, N.4



## Contact Bureau Notes.

By H. J. POWDITCH (G5VL).

It seems early yet to say "a Merry Christmas," but by the time this is published the wish will be a seasonable one. So to all the members of C.B. G5VL sends "all the best" of good wishes.

One or two minor matters of internal arrangements for groups. There is a very good custom that all C.B. reports be written on R.S.G.B. paper when possible. This supports the funds and also gives neater letter budgets for post. If possible, I would like groups not already observing the custom to adopt it. Since the start I believe that reports from G.C.'s for these notes have been asked for at varying dates. Please note that now the last date for inclusion is the 12th, and I cannot promise to include anything reaching me after this in the current notes.

On another page of this issue is an article giving full details of the 56 M.C. receiver of G2DT and G6TW, the diagram of this was shown on p. 119 last month, and should be referred to with this article. As this is a full dress effort, the Editor is printing it separately from these notes. I hope that with all the details supplied by Group 7A lately some more may be persuaded to take up 56 M.C. work. As I have already pointed out (till you are probably tired of seeing it), this band offers the greatest field for individual experiment. I inserted two queries in G2DT's notes last month. He replies that QRP tubes are preferable for txmtg, because a large valve will "drift" more and reach beyond the 7 cm. scale of a receiver. In fact, a 75-watt valve will be heard as a loud roar over the whole scale of such a receiver at 20 miles, and at 100 miles will still cover the scale. I think this refers to American valves, and G2DT does not say if the valve is loaded to its full output, probably a point having a considerable bearing on this result. The second query concerned the use of a micrometer rheostat for receiver, and the answer is that W2AIU found that a quarter turn of the screw in a micro-rheostat was sufficient to drop regeneration, although the consequent voltage drop was insufficient to register on a sensitive meter. Thanks, G2DT, for answering my questions.

You will see from G6LL's 28 M.C. notes that this band is waking up at last. Amongst our own members, G5SY, G2OD, G6LL, and probably many others have secured successes. I hear wonderful accounts of the work of BRS190, and hereby extend to him an invitation to join up and tell our 28 M.C. people how he does it. How about it, BRS190?

One or two have written in supporting the idea of a group for A.A. stations. Are there any more desirous of joining this?

2AUH has room for one more in his new QRP group, 8D. Please drop him a card. G2ZC is still getting his group, 2B, together for skip, and G2NH has sent out a circular letter giving details of his proposed crystal work.

The group reports are: 28 M.C.

*Group 1B.*—G.C. G5SY heard ZT6C on November 10, R1 improving to R3. G5LU is still occupied with exams. G6LL is using a T250 as 20/10 F.D.,

driven by a DET1SW. G5ML has had three blank Sundays hearing only commercial harmonics. He is using a full-wave vertical Zepp., and finds signals louder than with  $\frac{1}{2}$  wave. The G.C. wants to get opinions on this aerial question from all with experience, and especially as to the results from vertical aerials with  $\frac{1}{2}$ -wave radiators and both  $\frac{1}{4}$ - and  $\frac{1}{2}$ -wave Zepp. feeders. (I wonder if G5SY intends to keep the radiator at  $\frac{1}{2}$  wave for the latter for current feed.) He also enquires as to the radiation from the two halves of a full-wave straight wire, horizontal or vertical, the latter being the most difficult to arrive at. BRS250 has heard a faint W, believed to be ?ASZ, and local signals from G6VP and G6LL.

*Group 1C.*—Has now G6DH and BRS26 added to its strength. G5YK has doubts as to the efficiency of the S.G. stage and is again rebuilding. He finds background counterbalances other advantages. Has only heard HJO. G6WN ops. were held up for rectifier, but logged the usual G's and WIK, and were heard by BRS72. G6DH heard W2JN on October 27 and WIK and WIY on 28th. He uses a 27-ft. indoor aerial tapped to bottom of reaction coil. Txmns from G6DH on Sundays 11.20, 14.30 and 18.00, and reports are wanted. 2BIV (late BRS26) has a new shielded receiver, and is also busy with A.A. tests on 28 M.C. Please let us have results. G.C. G6VP has the usual list of G. QSO's, and has heard seven different G. stations during the month.

*Group 1E.*—G.C. G2OD has G5PL and G5GU in group. He ran tests with VK3BQ on October 13, but without results. On November 10 he worked W2JN, who reported it as his first DX since March! W2JN was R6/7 and G2OD was "C.C., L.S. all over house." An interesting effect was that at 16.30, just as the sun began to dip, signals both ways dropped to R1/2. This strength persisted during the twilight period, but at 17.15, with darkness, both signals had built up again to R7. G2OD says that this effect has repeatedly been noticed in QSO's with W2JN, but never before has it been so marked. Signals were still at full strength when the contact was broken. W2JN is using a  $\frac{5}{2}$  wave antenna, and finds this far better than a short vertical. G2OD agrees, and adds his opinion that location plays a great part in 28 M.C. success. On the following Sunday, November 17, signals were again R7 at both ends, but faded with darkness, and on this day did not reappear. (G5VL and others repeatedly noted a fade out and return of signals in the early part of this year between 15.00 and 15.30. Will the above-mentioned prove to be a similar fade occurring at a later period and becoming earlier as the season advances?)

*Group 1F* fails to report, although I know they are active. How about this G.C. G2CX?

*Group 1G* has been split up and the members report with other groups.

*Group 1H.*—G.C. G6OO has a blank month to report. His own times are 9.00, 11.45, and 16.45



daily. Reports will be welcomed. Input 4 to 8 watts.

*Group 2B (skip).*—G.C. G2ZC and his merry band will be in the limelight next month.

*Group 3A.*—G.C. G2NH is in the same position as G2ZC, getting going.

*Group 7A (56 M.C.).*—G.C. G2DT hears that HAF3CA is working on the band. G6TW has his new receiver working perfectly. He reports that meters are sluggish, with the coming of cold weather, and rejoices over a valve which has stood up to double load for four months. He adds this as a proof of the efficiency of a properly balanced circuit which is also quite free from body effects. Skeds, as already published, are continued. In view of W2AIU's experience that signals fade out after dark, it is particularly requested that anyone who can will listen for G6TW's 11.00 to 11.30 tests on Sundays. G6DH is keeping up the transmission skeds already published. He is busy with Ultra-audion circuit. G2DT has the receiver described elsewhere and also finds it very good. He awaits brass rings from W2AIU and G6TW in resonance with these transmitters, and then confidently hopes to rope their tests within the 7 cm. tuning band of receiver. G6HX, G6LK, 2AAM and BRS98 have not reported. Are these stations still working?

#### QRP GROUPS.

*Group 8A.*—G.C. G2ZN finds conditions bad for October on all bands. G5RV and himself have been trying High C. circuits for QRP. As usual, the report is steadiness with slight drop of efficiency. In addition, G5RV tried "Litz" for his plate coil. G2ZN remarks on H.F. losses incurred. G5AZ has little time, but got a short QSO without aerial. This station has a report from Rio on a 2.5 watt transmission. G5PJ has had a portable in Lancs. and covered 500 miles on 4 watts. He notes that for daylight work slightly greater power is undoubtedly a benefit, whilst the difference might not be noticeable after dark. BRS245 questions the value of power reductions during a QSO, as the conditions vary so rapidly and changes may be due to outside conditions as often as to power alterations. 2AUT has tried a S.G. stage; unsatisfactory. Also on chemical rectifiers. G5RV has the star for three QSO's covering a total of 5,150 miles. G2ZN with two on 1.3 watts covers 1,500 miles.

*Group 8B.*—G5JF has three L.F. transformers in series as a key filter with .5 mfd. at each end, and hopes to quell BCL QRM. He reports Iraq with 3 watts, and is busy on 100 per cent. mod. fone with QST's amplifier. G6SO has new and improved chemical rectifiers, and finds his V.F. Hertz an improvement. G2OA has changed from Hartley to Ultra-audion, and likes this better. He reports seven European countries, one ship, and also got a fine QSO with W on 5 watts. He recommends a Radion Super Power valve. He has also heard W stations and G's on 28 M.C. (Let's have details, please, to G6LL or G5VL.) G5CM has only limited time. He is using a single feed line to Hertz the feeder tapped in at one-third total length of aerial. Best QSO is with OK on 7 M.C. G2RT is puzzled by the fact that using choke control fone his total feed current to oscillator and modulator drops when a DEL is used as modulator and rises normally when a CT15X is used. Changing to RAC supply and will have to take measures to keep QRP. G2VV has only a ship off Bilbao and an I. QSO to

report. He and other group members notice that nearer countries in Europe (D and ON) can be worked easily on 3 watts, but with 5 watts these countries are not worked or give low QRK, whilst districts further away can (naturally) be worked. To quote: "With 5 watts the signals seem to skip over D and land further away. With 3 watts they seem to land in D and round that way, but do not go much further." F reports rise and fall in accordance with the input, however. G's are variable and subject to local conditions. Any of the other QRP groups agree these notes? G2VV has coils mounted on condensers to shorten leads and finds an improvement. Both he and G2JF are using AOG aerials, 69½ ft. long, but the former has to bend back, inverted L shape, for 30 ft.

*Group 8C.*—G.C. G5PH puts in a first report. They start off in a time of bad conditions, but G6PS has a R7 from EU and G5PH the same from OH, both with about 3 watts input. These two have been investigating fading with darkness. G5PH finds his crystal direct across grid coil takes full control and gets T9, R6/8 reports from EAR, SP, UO and FM. Other stations of this group please let G.C. have your reports this month for a full budget.

*Group 8D* will probably consist of G.C. 2AUT with G6HK, G2SA, 2BHI and G2GA.

*Group 10A.*—(1,770 K.C.).—G.C. G6OT reports a quiet time on this band, although conditions (in defiance of the higher frequencies) have not been bad. G5UM and BRS164 have been carrying out some good work in connection with weather and propagation conditions. BRS164 reports hearing the following G stations: 6PA, 5SN, 6OU, 6FY, 6OT, 2ZN, 5VN, 5UM, 6BX, 2NZ, 5BR and 2AX. He notes that, in Yorkshire, all Southern stations appear about R3, although their inputs are obviously different. G5UM reports that on October 13 conditions were abnormal, and a number of stations usually rather weak came in very well. Some of those heard were (all G's) 5BR, 6QR, 2NZ, 6BX, 2II, 5GY, 2CW, 5SN, 5VN. (I have given these reports in detail, as they are a fine answer to those who say that no one works on 1,770 K.C. these days.) G.C. points out that the last report seems to show that conditions may vary as much as on the higher frequencies. G5RX has visions of crystal-gazing shortly. G6OT has been rebuilding receivers with new H.F. transformers and finds 100 per cent. improvement. "Mush" still worries him badly. He has been carrying on some very interesting experiments in relaying other stations, and G2ZN was very astonished to hear OZ7Y and various beam stations coming through on 160 metres! But the voice of G6OT, following, gave the explanation. Several Continental B.C. stations and W2XAD have also been successfully put out. These experiments are continuing, and G6OT will, no doubt, like reports.

That finishes up the month's group reports. I would like to mention a report from 2AAK on the series tuned receiver described by BRS255 recently. 2AAK finds it very good on 7 M.C., and comments on the total lack of hand capacity, without screening. He can put his hand inside the case or touch E. plates on condenser with little frequency change. C.B. members: BRS261, G5PH, G2AT, G5QA, G6PS, G2AV, XG2ZP, G2VQ, BRS234, BRS272, G2DZ.



## 28 M.C. Notes.

This month has shown considerable improvement in conditions, and quite a lot of activity on the part of British stations.

November 10 was apparently the best Sunday, as far as "DX logged" is concerned, the 17th being about the same. The 4th was apparently "dud," and the 24th only fair.

The laurels this month go again to BRS190, who has logged six different W stations, two South Africans and a Brazilian. Splendid work, OM! BRS25 also has done some good receiving work, as a perusal of the "Calls Heard" column below will show. G2OD worked W2JN on 10th, this being, as far as we know, the first G—W contact since last March.

On the 16th, G2OD worked W2JN on schedule when strengths were again reported R7 each way. The time of contact was 16.00 G.M.T., when the American reported G6LL's signals as having completely faded out. Further interesting points in connection with signal strength between these two stations are to be found in C.B. Notes, and both stations confirm that they can work each other after other stations have faded out.

G6LL has worked W2JN twice, on the 17th and 24th, but not until after 15.30 G.M.T. No DX appears to be audible in his district before about this time, although in South London W stations have been logged before 14.30 G.M.T. Query: Is there really such a lot in "location"?

A large number of London stations are now radiating on 28 M.C., and we look forward to some interesting contacts in the near future, if conditions are good. G2CX logged 15 "local" stations in one afternoon!

Although London seems to be having such a galaxy of DX, the conditions further north do not seem to have improved much, G5YK having heard nothing, and G5ML having heard W2JN on the 24th, and one or two other W stations, but unable to raise any. The number of reports this month is much more promising, and we hope that next month will show still further increase.

G2GM reports hearing W2JN at QSA4 at 15.10 G.M.T. on November 17 and copying him until 16.25 G.M.T. On the 23rd he heard PCR and other harmonics, and W2JN, WIK and WIZ on the 24th.

Calls heard on 28 M.C. (*Local calls are omitted, being considered unnecessary.*)

BRS190.—W2NM, W2JN, W2AOB, W1BJD, W2ACN, W2ALW, ZT6C, ZS4A, PY1IA.

BRS25.—W2NM, W2JN, W2AOB, W2ACN, W1BJD, VE?

2ABK.—W2JN, W2NM, W2AOB.

G6NT.—W1CAA? FVA, WQA.

G5ML.—W2JN and others.

G2OD.—W2JN, W2NM, W1BJD.

G5SY.—ZT6C.

G5VL.—W2JN, W2NM.

G6LL.—W2JN, W2NM.

### Catalogues Received.

From Gambrell Radio, Ltd., details of the Gambrell Novotone for Electrical Reproduction of Gramophone Records.

## Book Reviews.

*Telegraphy and Telephony, Including Wireless.* By E. Mallett, D.Sc. (Eng.), London. 413 ix pages. Published by Chapman & Hall, Ltd. Price 21s. net.

This excellent volume is divided into three sections, and is intended as an introductory textbook on electrical communications.

The reader is assumed to have a good knowledge of elementary electricity and magnetism, and none of the usual introductory chapters on these subjects appear in this book. This is a reasonable attitude, as the reader of such a book as this will have reached a stage in his technical education where he requires a stepping stone from the elementary books to the specialised treatises.

Part I is devoted to telegraph apparatus and systems, short lines, long lines, transients, and high-speed apparatus.

Part II treats line telephony in a comprehensive manner, and the section dealing with wave-forms in speech should appeal strongly to all amateurs whose interests lie largely in the transmission of sound. It is interesting to find that vowels may be divided into two classes, characterised by a single and a double frequency respectively. The "ee" sound in "three" has frequencies of 308 and 3,100, while the "oo" sound in "two" has a frequency of 326. If the frequency of 3,100 were cut off from the sound "ee" the vowel would degenerate to "oo" and the "three" might be heard as "two."

Speech apparatus, line transmission, valve repeaters, and signalling are clearly treated, and the excellent descriptions of common battery and automatic exchanges should be of help to many "light" electrical engineers just now.

Part III deals with wireless. There are, amongst others, excellent sections on wave propagation, valve methods and quartz control, keying and modulation, and reception methods.

An Appendix of tables and formulae is added, and references are given at the end of each chapter.

Though the treatment of the subjects is often mathematical, requiring a knowledge of the Calculus, the amateur without this knowledge will find much of great interest and help in this volume.

T. P. A.

*ABC of Television, or Seeing by Radio.* By R. F. Yates. Published by Chapman & Hall, Ltd., London. 210 pages. Price 10s. 6d.

Though it would seem that the next big step in the science of radio would be in the direction of television, it is remarkable that the average British amateur has so far shown little enthusiasm for this subject. The lack of suitable literature on television may have had its effect, but that deficiency is rapidly being removed, and in this book the amateur will find the subject treated in a practical manner, and an account of the various methods used by different experimenters.

The book is written for the experimenter, but should also prove of interest to those who wish to follow future developments with an intelligent appreciation.

Mathematical treatment is avoided, and the style



is vigorous and "popular"; however, this "popular" style is not, with the exception of the first chapter, carried to an annoying extreme, and should be very acceptable to the average amateur experimenter.

Only one criticism might be raised here, and that is in connection with what should prove the most interesting chapter—photo-electric cells. This chapter appears to have been either written or corrected hurriedly, and deserves revision. Many words are used in an incorrect sense, and the meaning is sometimes obscure.

The author makes the astonishing statement that when an electron collides with a gas molecule and knocks an electron out of it, the two electrons pass on and leave a *neutral* molecule. If the molecule has lost an electron it will have a *positive* charge.

Throughout the book the illustrations and photographs are excellent, and it cannot fail to interest the amateur experimenter.

Various chapters deal with: Television Systems, Telegraphing Pictures, Amplifying Pictures, Photo-electric Cells, The Neon Lamp, Selenium Cells, Scanning, Synchronising, and Television at Home.

T. P. A.

## Correspondence.

### Circuits at Resonance.

To the Editor of T. & R. BULLETIN.

DEAR SIR,—The article on "Curing Interference" in the September "BULL." has raised a theoretical point which I venture to criticise. My views are tentatively put forward and possibly open to correction. If so, I hope that some of our more enlightened members will come forward to adjust my opinion.

Referring to the trap circuit in Fig. 2 of the article in question, G2ZN says: "It is a common fallacy that at resonance the trap offers a high impedance to incoming signals, etc. . ."

If one applies G2ZN's explanation of the trap action to the parallel-tuned circuit of the same figure, its inaccuracy should at once become apparent. In these circumstances, the only impedance offered to the flow of current at the resonant frequency would be the ohmic resistance of the coil. Consequently, the only voltage oscillation that could be applied across the detector grid and filament would be the IR drop across the coil. This effect could be obtained just as well by dispensing with the whole tuning circuit and substituting a straight length of wire whose ohmic resistance would equal that of the grid coil. As everyone knows, this would hardly make an efficient receiver. The above argument would appear to be logical, for the trap and the B/C tuning circuit are essentially identical, inasmuch as each consists of L and C in parallel. Therefore that which applies to the trap at resonant frequency must also hold good for the B/C tuning circuit at its resonant frequency.

Now for the constructive part:—

In the general case an inductance L and a condenser C are connected in parallel, and an oscillating voltage is applied across them. Then, if the voltage is not at the resonant frequency of LC, a current  $I_L$  will pass through the inductance, and another,  $I_C$ , through the condenser. Assuming no ohmic

resistance,  $I_L$  will lag by  $90^\circ$  and  $I_C$  will lead by  $90^\circ$  on the applied EMF.  $I_L$  and  $I_C$  are consequently

$$180^\circ \text{ out of phase. Now: } I_L = \frac{E}{\omega L} \text{ and } I_C = \omega CE.$$

The resultant current  $I_R$  will then be the difference of  $I_L$  and  $I_C$ , i.e.,  $I_R = \left( \frac{E}{\omega L} - \omega CE \right)$

$$\text{or } I_R = E \left( \frac{1}{\omega L} - \omega C \right)$$

#### RESONANT CASE.

Now when the applied voltage is at the resonant frequency of LC,  $\omega C = \frac{1}{\omega L}$

$$\text{so } I_R = E \left( \frac{1}{\omega L} - \omega C \right) \text{ becomes}$$

$$I_R = E \times 0 = 0.$$

In other words, if an oscillating voltage be applied across a circuit comprising an inductance and capacity in parallel, and the circuit is tuned to resonance, NO current is taken from the source.

Thus, in effect, LC offers infinite impedance at its resonant frequency. Although in this ideal case no current is taken from the source on the *initial* application of the EMF, energy is supplied to the circuit. The condenser C is charged and the energy stored in it will be  $\frac{1}{2} CE^2$  Joules (or  $\frac{1}{2} LI^2$  Joules on discharge through L). Assuming no resistance, this would suffice to keep LC in oscillation *ad infinitum*.

Now, in the practical case where a small amount of ohmic resistance is always present, the currents  $I_L$  and  $I_C$  will not be exactly  $180^\circ$  out of phase.  $I_L$  will lag  $\phi_L^\circ$  and  $I_C$  lead  $\phi_C^\circ$  on the applied voltage,  $\phi_L$  and  $\phi_C$  being less than  $90^\circ$  by an amount dependent on the values of resistances  $R_L$  and  $R_C$  in the inductance and condenser branches.

$I_L$  may now be split up into two components, i.e.,  $I_p$  lagging  $90^\circ$  behind, and  $I_{pr}$  in phase with the applied voltage. Similarly  $I_C$  can be split up into  $I_q$  and  $I_{qr}$ , the former leading by  $90^\circ$ . Components  $I_p$  and  $I_q$  will thus be  $180^\circ$  out of phase.

In the case of non-resonance, the supply will now be called upon to make good (a) the difference between the components  $I_p$  and  $I_q$ , and (b) the sum of the currents  $I_{pr}$  and  $I_{qr}$ . In the resonant case, the circuit will draw from the supply only the sum of the small currents  $I_{pr}$  and  $I_{qr}$ , as  $I_p$  will then equal  $I_q$ .

$$I_r = \frac{E}{\omega L} \text{ and } I_q = \omega CE.$$

as  $1/\omega L = \omega C$  at resonant frequency,

$$I_p = \frac{E}{\omega L} \text{ and } I_q = \frac{E}{\omega L} \therefore I_r = I_q.$$

In an efficient circuit the resistance will be small, and so the drain on the supply will also be small. It can be shown that, at resonance,  $I_r$  is equal to

$$\frac{RC}{L} \text{ where } R \text{ is the sum of } R_L \text{ and } R_C, \text{ i.e., the}$$



greater the resistance, the greater the current taken from the source. Most of the supply is therefore rejected and in effect the circuit LC offers a high impedance to the flow of current across it.

In Fig. 2 of the article in question, we have two such circuits in series. Each of these acts as a rejector to its own resonant frequency, and offers but small impedance to the other's resonant frequency owing to the wide difference between them (about 6 or 7 megacycles).

Yours faithfully,

C. D. CONNERTON (YIILM).

Box 117, Baghdad.

October 2, 1929.

## Strays.

### TRANSMISSIONS ON 56 MEGACYCLES.

Tests on the 56 megacycle band are being carried out from G6XN and G5QB as follows, throughout December and January.

On each Sunday (Times G.M.T.), 10.00-10.10, 10.30-10.40, 11.00-11.10, 11.30-11.40, 14.00-14.10, and for 10 minutes past each hour and half hour until 22.40.

Transmissions will take place alternatively from G5QB and G6XN, and will consist of a series of V's, followed by the call-sign, or the word "Test" followed by the call-sign and an announcement of the frequency.

In addition, automatic signals will be sent from G5QB from 21.00-22.00 G.M.T. on each week-day from Monday to Friday inclusive.

Reports should be sent direct to G6XN, 5, Pembroke Mansions, Canfield Gardens, London, N.W.6, or to G5QB, 120, Mill Lane, London, N.W.6.

The German station DOO7 is working every Saturday from 23.00 to 23.30 and Sunday from 02.00 to 02.30 and 04.30 to 05.00 G.M.T., using crystal control on 43.3 metres. He requests reception reports, which will be answered by return. Details of WX are particularly required. The power used is 250 watts, and the QRA: Flugfunkschule, Staaken bei Berlin-Spandau.

### NON-STOP FLIGHT ENGLAND TO SOUTH AFRICA.

The British machine which is attempting to break the present world's record for a non-stop flight will leave England some time about the middle of December. She will carry a short-wave transmitter operating on 8,900 K.C. (33.71 metres). Call sign GEFAA. Transmissions will be made at 08.00, 12.00 hours G.M.T., and every fourth hour during the flight. The machine cannot receive in flight. In the event of a forced descent, distress calls will be made from the ground for the first five minutes of each hour, and a listening watch between 30 and 43 metres for the next 15 minutes.

Any information on the signals from this machine during the flight should be sent to Flight-Lieut. Durrant, Signals, Air Ministry, Kingsway, London. (Telephone: Holborn 3434, Extension 338.)

## FOR A SAFE EXAM-PASS ENROL WITH THE T.I.G.B.

Expressly designed for the benefit of prospective candidates for the leading Professional examinations including—

The Institution of Electrical Engineers  
The Institution of Mechanical Engineers  
The Lond. Univ. B.Sc. (Eng.) Degree.  
The Radio Association, etc.

the T.I.G.B. correspondence courses furnish training of the highest standard; they present the knowledge and experience of a most highly qualified tutorial staff and practically assure a safe exam-pass at the first attempt. *The T.I.G.B. Guarantees Training until Successful.*

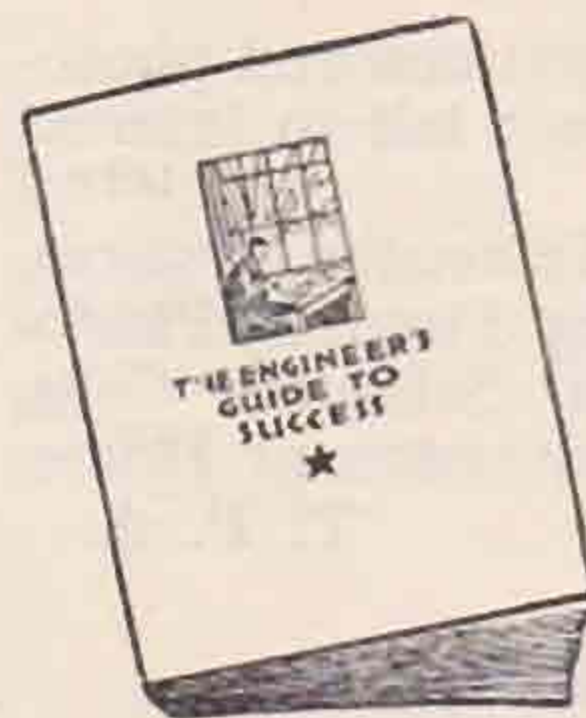

FREE—THIS 124 PAGE GUIDE.

Get "The Engineer's Guide to Success," containing the widest selection of engineering and allied-technical courses in the world (including a specially advanced course "Radio and High Frequency Engineering," p. 55), and investigate the remarkably successful Tuition methods of The T.I.G.B. Write to-day for copy and state your tuition requirements, to

The Technological Institute of Great Britain

(Established 1917).

42, TEMPLE BAR HOUSE, LONDON, E.C.4.

## R.S.G.B. Sales Department

The following can be obtained from Headquarters on application:—

|   |     |
|---|-----|
| A.R.R.L. Handbook, by Handy ...                   | 4/- |
| Citizens' Radio Amateur Call Book                 | 4/6 |
| (4/- to Members)                                  |     |
| Enamelled Coat Badges of Emblem                   | 2/6 |
| Members' Headed Notepaper (per 100 sheets) ... .. | 2/- |
| Enamelled Car Plaques of Emblem                   | 3/6 |
| Call Sign Brooches... ..                          | 2/6 |
| Rubber Stamps of Emblem ...                       | 1/6 |

### "T. & R. Bulletin."

#### ADVERTISEMENT RATES.

|   | Per insertion. | Per insertion.      |        |
|---|----------------|---------------------|--------|
| Full Page ..  | £5 0 0         | Half Page.. £2 10 0 |        |
| Quarter Page  | 1 5 0          | Eighth Page         | 0 12 6 |
| Series Discounts—5% for 6 or 10% for 12 consecutive insertions.   |                |                     |        |
| Advertisements specified for Facing Matter Positions are not subject to series discounts.   |                |                     |        |
| The T. & R. BULLETIN is published on the 14th of each month. Orders, Copy and Blocks should be received by us on the 30th of each month preceding month of issue. |                |                     |        |
| All applications for space or specimen copies should, please, be sent to Advertisement Manager,   |                |                     |        |
| <b>PARRS ADVERTISING, LTD.,</b>   |                |                     |        |
| Craven House, Kingsway, W.C.2.  |                |                     |        |
| Telephone: Holborn 2494.  |                |                     |        |



## Crystal Control at G6PP.

By M. W. PILPEL.

Although the subject of this little article has been thrashed out before, and much ink spilt over it, I think that a few details of my own experiences in the matter may be of use to some of the new hands at the game, who would all have T9 notes if they only knew how easy it is to get one. I might as well say at the start that I do not intend going into mathematics on the subject. That is best left to Messrs. Hinderlich, Dedman and company, who are much more versed in that direction than I am.

When starting up, two years ago, the intricacies of crystal control were, to all intents and purposes, a closed book to me. If the wind blew and my aerial swung, it was a case of either closing down altogether, or putting up with a T7 note. Rather an unsatisfactory state of affairs, but at that time I knew of no simple way to cure it.

One day, however, reading in the "BULL" that G6VJ had obtained good results with a crystal connected across the grid coil of his transmitter, it struck me that here might lie a solution to my difficulties.

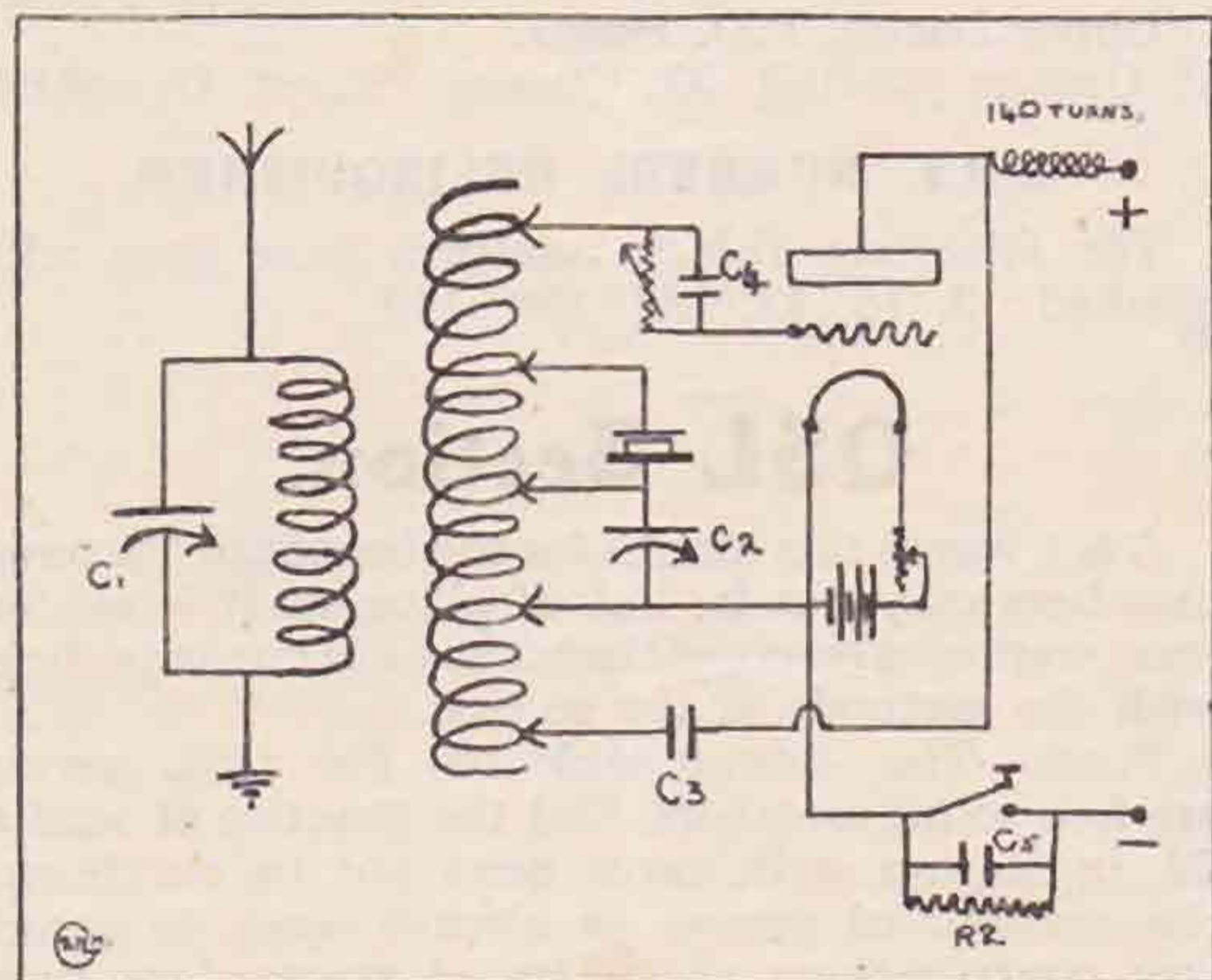

Accordingly, I went round to a local optician and purchased the thinnest piece of quartz he had in stock. On bringing this home the first thing to do was to place it on the grid coil of the receiver and turn the dials. This I did, and got a series of clicks in the neighbourhood of 49 metres. Perhaps I was rather lucky, though, after all, those clicks might have been inside the 45-metre band, as it then was. Anyhow, as they were not, the next thing to do was to get them there. The fact that I got a series of clicks, and not one only, indicated that the surface was not perfectly level, but it was ultimately found that this mattered little.

My method of grinding was to spread some 60-hole emery powder on about a square foot of emery paper and grind with a circular movement, renewing the powder at intervals. The less said about that part of the business the better. Suffice to say that after about four hours of grinding the top-most click of the series was on about 44.5 metres. I say the top-most one because during all my experiments I have found that it is that one which controls best. This may be just a coincidence, but I thought it was best mentioned. It is important that the crystal be frequently tested on

the receiver grid coil between periods of grinding, so as to ensure that too much is not taken off. The crystal in use here at present is unpolished, and works perfectly. Polishing is rather a lengthy process, and I doubt whether any benefit accrues therefrom.

Having got the crystal ready for working on the required wavelength, the next thing to do was to get a holder for it. A simple holder can easily be made by taking two brass discs, about the size of a penny, and mounting one on a square of ebonite to which two terminals have previously been fixed. A short piece of brass rod should be soldered to the centre of the other and a length of thin wire taken from this to one terminal. This is the top plate. The other terminal should be connected to the bottom plate, and a lead from each terminal to the grid coil of the transmitter. This is just about the simplest form of holder it is possible to use, but other types have been described from time to time.

Before going further, it is essential to rid the crystal of any traces of grease which have adhered to it, and for this purpose carbon tetrachloride is excellent. This is retailed under the name of "Mel," or can be purchased under its real name from a chemist. Wipe both sides of the crystal carefully with a piece of linen or silk dipped in it, and do not handle the crystal after that or the washing will be rendered ineffective. The holder also needs cleaning in the same way.

My method of tuning is as follows: With the aerial connected to the receiver, and the transmitter switched off but with the crystal in position, rotate the receiver dials until the click or clicks are heard in the 'phones. They will probably be rather weak, but nevertheless distinct. Leave the receiver tuned to the desired click, switch the transmitter on and connect the aerial to it. Next, rotate the transmitter plate condenser until clicks are again audible in the 'phones, and tune to the one selected. This will be the loudest under these circumstances. Slight adjustment of the aerial tuning condenser may now be necessary. In order to ascertain whether the crystal is controlling, listen to the first harmonic. If the control is not perfect, slight readjustment of the condensers will achieve it. The diagram gives details of the Hartley circuit used here, but similar results can be attained with the T.P.T.G. or any tested circuit.

At first I connected the crystal across the entire grid coil, but found that the energy transference was rather small. After some testing I discovered that the crystal controlled equally well when connected across only half the coil, the half nearest the plate, and the energy transference and consequent efficiency were greater.

It must be emphasised that a crystal improves with use, and although a certain amount of difficulty may be experienced at first, after a week or two it will control quite easily. Loose aerial coupling should be used for a start, three or four inches, or even more; this can be decreased, if necessary, when the crystal has been run-in. A fairly low resistance across the key should also be used at first, say, 15,000 ohms, increasing to 30,000 ohms after about 50 hours of use.

In conclusion, I should like to offer my best thanks to G5MU, who gave me much valuable assistance when first starting up on CC.



# HIC et UBIQUE.

## QRA Section.

A MERRY CHRISTMAS AND A HAPPY AND PROSPEROUS  
NEW YEAR TO ALL.

OK2YD has informed me that my reference to the Czecho-slovakian QSL agency in these notes a month or two ago was incorrect. Our own QSL section can be trusted, however, to forward cards through the proper channel.

### NEW QRA'S.

- G2AT.—J. W. MARLOW, "Nettleton House,"  
Caistor, Lincs. (Until 1.3.1930).  
G5SZ.—J. W. RIDDIOUGH, The Oval, Tranmere  
Park, Guiseley, Yorks.  
G5VB.—A. F. ELTON BOTT, "Francisca," Barlow  
Road, Hampton, Middlesex.  
GI5WD.—W. S. DAVISON, 42, Eglinton Street,  
Portrush, Co. Antrim.  
G5XM.—J. ARMSTRONG, 109, Rupert Street, Bolton,  
Lancs.  
G6AL.—J. P. MORTER, 57, Westow Hill, London,  
S.E.19.  
G6PS.—A. F. M. PARSONS, 358, Beverley Road,  
Hull, Yorks.  
G6QF.—A. M. ROBERTSON, 114, Victoria Road,  
Stretford, Manchester.  
G6SV.—M. SAVAGE, 144, Hoppers Road, London,  
N.21.  
G6TX.—J. FYNN, 24, The Broadway, Woodford  
Green, Essex.

The following are cancelled : GI2IT, 2AWH.

All new QRA'S to G6PP please. QRA : 54,  
Purley Avenue, London, N.W.2. Telephone :  
Hampstead 2590. M. W. P.

### NEW MEMBERS.

- J. PARTINGTON (BRS303), 48, Hamilton Street,  
Ashton-under-Lyne, Lancs.  
C. W. SHILLAM, 36, Bayswater Avenue, Redland,  
Bristol.  
F. DEARDEN, 6, Derbe Road, St. Annes-on-Sea,  
Lancs.  
J. J. CURNOW, 24, Muswell Road, N.10.  
L. K. WINSOR (G2FS), 375, Hessle Road, Hull.  
W. P. SMITH (BRS302), 56, Martin Street, St.  
Pauls, Bristol.  
G. S. HEPTON (BRS301), Jesmond, Northfield,  
Hessle.  
V. LEACH (G2LV), "White House," Hucclecote,  
near Gloucester.  
W. C. G. SLATTER, 65, Kent Road, Swindon, Wilts.  
A. M. TINGLEY, 47, Freeman Street, Wollaston,  
Mass., U.S.A.  
M. J. BEAVIS, 13, Park View Road, Grays, Kent.  
W. LOCKE, Daisy Hill Villas, Newry, Co. Down,  
Ireland.  
T. GREAVES (FO4SRB), Box 646, Salisbury,  
Rhodesia.  
B. MORISON (FO7SRB), Box 34, Salisbury, Rhodesia.  
F. P. MARKS (ZT6M), 146, Donnelly Street, Turffon-  
tein, Johannesburg.

- J. LODGE (BRS299), 1, Meadow Street, Darwen,  
Lancs.  
V. E. COPE (BRS297), 58, Queen Victoria Street,  
E.C.3.  
R. A. DERSLEY (ZT2B), Box 82, East London, Cape  
Province, S. Africa.  
W. DODSWORTH (BRS298), 145, Hyde Park Road,  
Leeds.  
C. H. HILL (ZS4M), Box 93, Bloemfontein, South  
Africa.  
J. WRIGHT (G5VA), 13, New Street, Bail Green,  
Stoke-on-Trent.  
D. A. WEALE (BRS300), 6, Chesilton Road, Fulham,  
S.W.6.  
S. H. WALTERS (ZUID), 37, Church Street, Wor-  
cester, Cape Province, S. Africa.  
W. G. ROSE (G5RJ), 46, Trewince Road, Wimbledon,  
S.W.20.  
C. H. ORR-EWING (BRS296), 22, Coleherne Court,  
London, S.W.5.  
B. McCANN (GI2KN), 104A, Divis Street, Belfast.  
W. H. POWER (W3AZZ), 232, Eagle Road, Merwood,  
Upper Darby, P.O. Penna.  
B. GROOM (G6RG), 33, Channel Street, Galashiels.

### B.R.S. NUMBERS RELINQUISHED.

The following B.R.S. numbers have been relin-  
quished : 3, 15, 43, 133, 138, 149.

## QSL Section.

A few words this month for the benefit of the newer members may not be out of place, as it is evident from enquiries received that many are not acquainted with the methods of the section.

First.—The advantages of the QSL service are free to all members, and the practice of sending 2d. in stamps with cards need not be continued ; the section, of course, is always open to receive any contributions, and gifts of stamps are never refused !

Cards are received from members for distribution to any country in the world, irrespective of the fact that some countries may have no known QSL agency. In return, the section receives for distribution to British amateurs (members and non-members) cards from all the foreign QSL agencies, and from many other sources. These cards are forwarded to the stations concerned in their own envelopes which can be obtained, stamped and addressed, at 2d. each, from the QSL Section. Full particulars in the October BULLETIN. Alternatively, stamped self-addressed envelopes may be sent to the section. If the latter course is preferred, the following rules should be observed :—

(1) The envelopes should be of the regulation size, viz., 6½ in. by 4½ in., or as near to those dimensions as possible.

(2) The call sign should be printed in the top left-hand corner of the envelope, together with instructions as to the number of cards to be posted in each envelope. In the event of no instructions being given, the envelopes will be marked, "Wait for 3," and posted when that number of cards has arrived.



(3) Envelopes should be stamped to the value of 1½d., and the address clearly written.

It will greatly assist sorting processes at H.Q. if members will put their cards into order of countries before despatching, and in cases where the space provided on the QSL card is small or not immediately obvious, it would be helpful if the call sign of the station could be written boldly on the back of the card.

Finally—and I must apologise for mentioning this again, but it seems still to be a matter of doubt to some—the only address to which cards and envelopes may be sent is 53, Victoria Street, S.W.1.

J. D. C.

## Publicity Section.

We are carrying on our work and hope before long to have a representative of the R.S.G.B. and B.E.R.U. in every part of the Empire.

That our brothers overseas realise the possibilities of the B.E.R.U. is shown by the following extracts from letters received recently:—

From South Africa: "I am very much in favour of the idea, which is suggested in your letter, of establishing a chain of members throughout the Empire, and I feel that it is going to have a far-reaching effect in binding us more closely together."

From Canada: "... They are awfully keen to keep in touch with their old home."

From Hungary: "... Kind of you making such efforts to create connections with us."

Do you, our members in Great Britain, realise the vast field that lies before us? If you do you will not fail to bring in at least one new member during this year.

Remember, if you bring in the greatest number of members during the year ending August 31, 1930, you get your next year's subscription paid for you. The four members of the Publicity Section can do and are doing a lot, but 1,500 members can do much more to make the R.S.G.B. better known.

A. E. W.

## THE BRITISH EMPIRE CERTIFICATE.

For some months past it has been in the minds of those responsible for the progress of R.S.G.B. that some recognition should be given to those of its members who have been successful in effecting two-way communications with the distant parts of the globe.

The recent extension of the British Empire Radio Union has provided an excellent opportunity of putting into effect a scheme whereby those persons may claim such recognition.

A specially-designed certificate will be awarded to members of the Society who have established communication with some part of the British Empire situated in each of the five continents of the world.

Members are invited to submit designs and make suggestions for a suitable name describing the certificate, which will undoubtedly be looked upon as the British Blue Riband of the Air.

Final details regarding the qualifications are being worked out, and will be published in an early issue. In the meantime, we recommend that members make every endeavour to obtain documentary

evidence of Empire contacts in order that they may be in a position to apply for early admission into this unique fellowship of British amateurs.

Finally, let our New Year motto be "Make Empire Friendships."

\* \* \*

## BRITISH EMPIRE RECEIVING STATIONS.

In accordance with the recent decision of Council, B.E.R.S. numbers are now being issued to Colonial members of the Society.

At present nearly 200 Colonial amateurs are B.E.R.U. members, many of whom are entitled to receive an identity number which will definitely associate them with the leading British Amateur Radio Society.

Applications for these numbers should be made to the Honorary Secretary, 53, Victoria Street, London, S.W.1.

Members holding these numbers are requested to notify Headquarters immediately they obtain full transmitting powers.

\* \* \*

## MANCHESTER CONVENTIONETTE.

Another informal conventionette took place in Manchester on Saturday, November 23, when G5FC, BRS161, 245, 269, 274 and G6BJ were present. The visit to the studios and control room at 2ZY, which had been arranged, had to be cancelled, so everyone made for a café and helped to keep a rag-chew going for some time. Afterwards a round of all the junk radio shops was made.

## CALLS HEARD.

By G5WQ, on board the s.s. *Ixion* between Yokohama and Vancouver, September 20 and October 3 (14,000 K.C.):—g2ao, g2az, g2nh, g2gf, g5bd, g5ml, g5uq, g5ux, g6ci, g6cl, g6dh, g6mc, g6vp, g6wl, g6wt, g6xg, g6xq, ei8b.

## Calibration Service.

Calibration waves will be sent from G5YK on the second and fourth Sundays of each month as follows:—

10.00 G.M.T. 7,050 K.C. (Nominal)

10.05 G.M.T. 7,250 K.C. (nominal)

The call will be RSGB DE G5YK, followed by a two-minute dash and the frequency used.

## STRAYS.

G5JF welcomes reports on his low power phone on 7,000 K.C. each evening at 2,200 G.M.T., and early Sunday mornings.

Orders for the December issue of the Citizens' Radio Amateur Call Book should be received in this office as soon as possible, otherwise there may be a delay on delivery. Price 4s. 6d. (4s. to members).



# NOTES & NEWS FROM THE BRITISH ISLES.

## DISTRICT No. 1.

Representative: D. J. BEATTIE (G6BJ), 14, Rosehill Mount, Manchester Road, Burnley. (Tel. 3659).

REPORTS this month are few and far between. No doubt you have all read the notes at the head of last month's Notes and News. Having done so, it's up to you to let us know what you are doing. I know the District is alive (*vide* the Manchester Convention), so make No. 1 the star district and keep it there.

It may be of interest to know that there are 88 licensed transmitters in the district and eight BRS stations. Compare this with the number of reports. Now for the reports:—

2AUH, 2AOI, BRS161 and BRS269 are all applying for full tickets. BRS269 and BRS274 say that they get wipe-out from G6BJ at a distance of one mile (Cure? G6BJ.) G2DH has been more or less active. 2AOI, temporarily in Manchester, is testing Canadian receivers. A strange station, signing WAP, and calling M & P, has been heard on 230 metres giving gramophone records—strength R9. Has anyone else heard this? G5JF is building a separate transmitter and receiver for each band, is testing QRP 'phone after 22.00 G.M.T., and would like reports. G5CI, G6CA, G2GA and the rest are all active, but don't say so. G6BJ is practically QRT pending the arrival and construction of a new bench, receiver, control panel, etc. A PX650 valve has been found exceptionally good at G6BJ where the power supply is limited to 220 volts and, in spite of its low impedance and amplification factor, it can be highly recommended. Anode current consumption in a T.P.T.G. circuit is about 8 ma. on no load (on 7 M.C. band), and anything up to 50 ma. on load, while the H.F. output is quite high.

There will be no December meeting owing to other attractions, so all the best of DX for 1930.

## DISTRICT No. 2.

Representative: T. WOODCOCK (G6OO), 8, George Street, Bridlington, Yorks.

G5QY reports his month's work on 7 M.C. band, using QRP and finds series feed to T.P.T.G. circuit superior to parallel. Best QSO was raising OH on 0.7 watts, using 2 v. power valve. Hopes soon to start up on 14 M.C. band, carrying out aerial experiments with Hertz aeriels, and finds Zeppelin best. G6UJ finds conditions poor and 14 M.C. tests raised only few Europeans. 7 M.C. brought medium DX QSO's including Canary Islands, Azores and a QSA5 R9 report from EU, being the best ever from the latter country. On 28 M.C. conditions remain very poor. G6BW has worked most of Europe on 7 M.C. band with 5 to 7 watts input. Fading highly marked on 7 and 14 M.C. this month. ZS4M only station received consistently. A little fone, using grid modulation, has been tried—no reports received so far. G6YL still needs QSO with South America and Antipodes to qualify for her W.A.C. (Hope you manage it by Christmas!) Two pleasant QSO's with SP3YL and SP3KYL on 7 M.C. band (more YL's!) have been accomplished. A QSO with YM4ZO also on 7 M.C., but conditions with quick fading and QSB have been preventing any real DX. Vibro-

plex key purchase has made the station a happier place. G2BIV is busy building TX; built A.C. rectifier and filter 9 watts output; gives T8 when tested on RX with headphones. Grinding quartz; 28 M.C. experiments every Sunday on RX; all this leaves little time for listening to DX at present. BRS290 reports RX conditions on 7 and 14 M.C. bands very poor. U.S.A. being almost conspicuous by its absence, not more than 20 being logged. Busy building 28 M.C. RX and testing new coil system for RX's on various bands. BRS264 finds 7 M.C. best at present and has reported on 50 G stations sigs. 29, of whom acknowledged same. Best G sigs. heard were from G5JO, G6UU, G2GF. Morse is being "brushed up" with high hopes of soon joining the "AA" gang. On 28 M.C. conditions have shown the band to be "dead." G2YU has nothing to report this time owing to extensions on existing "shack" being in progress. G6NG is still finding business QRM fierce and will not be active till Christmas or early in the New Year. G5DR finds conditions poor, with QSC and QSB on 7 and 14 M.C. bands. G6OO on 28 M.C. a complete "blank," and 14 M.C. work produced one QSO with FM, otherwise Europe, on 7 M.C., using QRP is the extent of QSO's this month. Conditions continue very poor on all bands. G6OO wishes to hear from the following active stations in District No. 2: surely there is something to report each month: G2KM, 5JA, 5LT, 5LW, 5CX, 5US, 6BR, 6PY, 6YC, 2DV, 2FS, 6XC, 5DF, 2IJ.

## DISTRICT No. 3.

Representative: JOSEPH NODEN, (G6TW), Coppice Road, Willaston, Nantwich.

Last month I made the remark that, "I hoped for a better show of reports from Cheshire," but I am sorry to say there appears to be very little improvement. Well, it's up to you. The coming season's greetings to all.

G5FC is working on 7 M.C. QSO with FM, and now two Continents and 21 countries, also weekly sked with EAR62 in Mallorca. G5BR has been using 50 watts on 7 M.C. and 10 watts on 1.75 M.C. On the latter, QSO with G2AX, G2BI, G5RX. Now fixing up a DET1 for high power choke control. Station visited by G6CL and G5AR. G2VP erected a new V.F. Zepp. Antenna, and is practically ready for going over to the rectified A.C. G2CG is now going on 14 M.C. with 10 watts, and has worked 19 countries and two continents, also getting D.C. T8 with chemically-rectified mains with A.C. on the filament. 2BHI has done no great DX this month, but heard an OH station on the 1.75 M.C. band and worked with Harmonic C.C. on artificial aerial. G6TW finds his time being very much taken up with 56 M.C., but would like to hear of more listeners down on this wave, or "up on this frequency." There is splendid opportunity on this band for research. Also found time for the usual 7 M.C. and 1.75 M.C. work.

## DISTRICT No. 4.

Representative: A. C. SIMONS (G5BD), Lynwood, Mablethorpe, Lincs.

Reports rather scanty again this month. I expect it is owing to the moderate conditions prevailing on the two main bands. In spite of bad



conditions, Australians and South Africans and a few Far Eastern stations are coming over well in the late afternoon on the 14 M.C. band. Incidentally, I have not yet received a report from 75 per cent. of the District. Let me hear from you, even if it is only a grouse.

G2AT has changed his QRA. Is now in a CB QRP Group. Norway worked with 2 watts, and Russia with 3. Has followed the gang's lead, and put up 21-metre Zepp, and is expecting increased efficiency.

G5CY.—New Zepp 10.5 metres by 48 ft., compares favourably with previous edition (21 metres). As yet, no real DX raised, but reports are better from all Europe. In slight difficulties with SG SW receiver.

G6LI will shortly be active after three years' silence with medium power TPTG, using SW/50 valve and DC/MG on 7 and 14 M.C., and later on 28 M.C., and is hoping to get in touch with his brother FO3SRB.

2BIC busy with BCL receiver. Reports bad conditions and has heard nothing over 2,000 miles on either 7 M.C. or 14 M.C.

G5BD, with new Zepp, dimensions as same above, has at last worked South Africa (ZS2N). Has also worked U.S.A. on 7 M.C. (the first one since the restricted bands).

G6HK reports extraordinary evening conditions to date on 7 M.C. band. Rarely more than one European station heard, and generally none. On two occasions the only stations heard were Ws at QSA. 4—this on 7 M.C. before 23.00.

#### DISTRICT No. 5.

Representative: D. P. BAKER, Crescent House, Newbridge Crescent, Wolverhampton.

##### Staffordshire.

G6UZ has had little time for working, but is still getting good results in the small amount available.

##### Warwickshire.

Representative: G6CC.

G6CI has worked on the 14 M.C. band Brazil, SN1AA, Ascension Islands, Chili, Kenya, British Guiana, U.S.A., New Zealand, Cuba, Egypt, N. Africa, and several Europeans. All these were worked with the new Zepp. Antenna while testing same. He reports that this band has fallen off very much towards the end of the month.

#### DISTRICT No. 6.

Representative: R. C. HORSNELL (2ABK), "Hepani," Guernsey Gardens, Wickford, Essex.

I am glad to report an increase in activity for this district.

I had the pleasure of attending a recent committee meeting at H.Q., and I was really surprised at the bulk of work done by those in office, and ask all to give them their best support. G5RV has been on ultra-QRP, and also on 10 watts. G2SA has done usual 7 and 14 M.C. work. Found his aerial ammeter the cause of chirpy note. G2HJ rebuilding, and has been operating from G5PJ. G5YK also is rebuilding, and doing a little dud listening on 28 M.C. G5YX has had mains altered from 90 to 50 cycles, so T.X. is out of action for a while. G6CR has built a nice C.C. T.X. in cabinet and reports increase in output. BRS191 has entirely rebuilt R.X. and gets beneficial results. BRS233 has a good log on 7 and 14 M.C. 2ABK has been very active on 28 M.C., a full report sent up to these notes, also building an oscillator. G5QV has lost

his 250-watt valve after three years' use, so is inactive for a while. 56MC still keeps 2BVR busy, although he has heard nothing except his own closed circuit oscillator. BRS77 has been on 28 M.C. but only G5YK and local harmonics heard. BRS76 and G6DG are inactive at present.

#### DISTRICT No. 7.

Representative: H. C. PAGE (G6PA), Newgardens Farm, Teynham, Kent.

The total number of reports received this month is only nine. Am I to conclude that there are only nine active stations in the Area? What about the BRS stations? I know there are quite a few of you. I should hate to think that the only reason you take a BRS number is to put it on your cards, but really it looks like it, when none of you take the trouble to let me know what you are doing.

Now for more pleasant news. I have to welcome G2AX to the fold. Also BRS287.

Conditions seem to have been consistently bad. Very little DX has been done.

##### Sussex.

By G5UY.

G2RM is still trying to get out on 7 M.C. His transmitter is working well, but apparently the aerial is not doing its bit.

G2DT is also having aerial trouble, but has managed to get going on 14 M.C. He has got a High-C transmitter working, but finds it will only work with a high impedance valve. He has been getting out quite well on 7 M.C. with a similar transmitter. G5UY has been putting in a good deal of time trying to round up some of the faint hearts in Sussex. G5AQ has finished building his 7 M.C. outfit, and is now testing it. He would welcome reports. He hopes to have a separate transmitter for 14 M.C. before long.

##### Surrey.

By G2VV.

G5CM has been on the sick list, but he has managed to put up an End-on V.F. Hertz aerial. G2DZ is now active on 28 M.C., and has managed to work someone on that band already. He reports conditions as very bad on both the 7 and 14 M.C. bands. G2AX has been doing a fair amount of work on 1.7 M.C. Signals seem to go out well, as he has worked G5BR. He has found 14 M.C. poor. A DET1 is being tried, but so far the LS5 seems definitely superior. G2RT is changing his power from dry batteries to RAC. He hopes to be putting out a good DX note by the time this appears. His input is never more than 5 watts. He is one of the CB low power enthusiasts. G5RS has been carrying out some phone tests, and has been getting very good reports. He reports conditions too bad for DX. G2VV is kept very busy with CB Group 8, and is thinking of having a complete re-build, and hopes to fix up separate transmitters for 7 and 14 M.C. He had a report from BRS212 on his 3.5 M.C. signals, when he was working G6NT on 7 M.C.!

##### Kent.

G6PA has this section to himself as usual. However, he has hopes of a few companions in the near future. He has been very busy building a screen grid receiver. Although conditions have been very bad, it has been possible to hear DX stations any evening on this set. Some of the South African stations have been coming in very well.



**DISTRICT No. 9.**

Representative: G. COURTENAY PRICE (2OP),  
2, St. Annes Villas, Hewlett Road, Cheltenham.

There is nothing of interest to report. The following stations report being active: G2CJ is on 14 M.C.'s and has been running a sked. with SNIAA. G2OP is on 14 M.C., and G5QA, on 14 M.C., has now worked W1-9. G6XB is on 14 M.C. and 28 M.C., but has had no QSO on the latter band at the moment. BRS212 has been hearing harmonics on the 3.5 M.C. band of many countries working on the higher frequencies.

**DISTRICT No. 10.**

Representative: J. CLARRICOATS (G6CL), Ciel,  
6, Hartland Road, London, N.11. (Tel. No.  
Finchley 3512).

G5UM reports that conditions have been only fair on 1.7 M.C. His most interesting QSO was with G2ZN, who was reported R2 QSA3 when he was using .005 watt input (10 volts at 0.5 ma.). A new crystal (171 m.) is in use, as well as the original one which operates on 161.1 m. G6KW reports from Southampton, where he has been stationed for the last three months. He is unavoidably off the air but says that he would miss the Area Notes if they were discontinued. He sends some interesting information regarding "Broadcast on Tap." The Aberdonian is requested to get in touch with Mr. Kirlew, who will put him wise as to the means of obtaining something for nothing. G6CL has little to report except that a new transmitter has been built and is functioning satisfactorily. Copper tape coils have been superseded by Eddystone coils. Conditions on the whole have been poor and a prolonged test has not yet been possible. G6CL was pleased to hear that G2GF also operates his transmitter contrary to generally accepted principles. G6XN thinks that these notes would be more interesting if they were to contain points of outstanding experimental interest. I personally consider that information of this character should appear under Contact Bureau Notes. He wishes me to point out that the "new aerial" referred to last month was "a half-wave single wire fed Hertz." He says this is rather a peculiar type of aerial and would like to know the theoretical principles on which it works. He has spent a little time on 28 M.C. but has had nothing but ground wave reports. Work on 56 M.C. will shortly commence. BRS272 sends a very welcome report in which he mentions that he has carried out a number of tests in order to discover the ideal rectifying valve. His final choice was a V.T. 24. He places the PM 4DX DEH610 and DER as the next best in order. A new aerial has been erected, which has improved results considerably. No further reports were to hand on November 25.

G6PP has little DX to report, but has been heard in W8 and 9 on 14 M.C. He has only once worked U.S.A. on this band, so is anxious to receive details of his reception. He is hoping to have a new aerial up shortly, G6XN having offered his assistance.

**DISTRICT No. 11.**

Representative: L. H. THOMAS (G6QB), "Conway,"  
66, Ingram Road, Thornton Heath, Surrey.

Written reports have been very scarce again this month, but as the L. is in touch with most of the stations in the area, either by radio or in person, he has filled up some of the blank spaces himself. Do not be so slack about sending a

post card in future, though, or he will have to supply you one and all with a penny stamp a few days before the 20th. BRS25 has again been doing most of his listening on 28 M.C., full details of which are to be found under "28 M.C. Activities." BRS190 is still going great guns on 56 M.C., and hears plenty of stations, mostly harmonics of G's on 7 M.C. On 28 M.C. he has heard ZT6C, ZS4A, and PY1AA, in addition to six W's. BRS250 reports lots of DX on 14 M.C., and quite a lot of activity on 28 M.C. One night between 22.30 and 01.15 he logged W6, W7, VE5, and WFA! G2DZ is reporting to the Surrey area of No. 7 District in future. G2NH has not been on much owing to losing a crystal that jumped out of its holder when he switched on! G2CX has a new receiver and his C.C. transmitter is nearly finished and going O.K. G5WK has been rebuilding, and will probably be on 28 M.C. by the time this appears. G6HP has not been on much owing to work, but has worked Brazil on 14 M.C. in the early morning. G6NT sends in a comprehensive report from the middle of July. In September he has been working W at mid-day, and CE and VP5OUX in evenings. During October he worked sundry ZL's and VK's in the mornings, since when he has been on 7 M.C. mostly. He has worked Turkestan, SU8RS, and a ship near Iceland on that frequency. 14 M.C. is still O.K., O.M., why shift? G6WY has worked W7 in the afternoon on 14 M.C., but finding conditions bad, he took a plunge in the other direction, and is on 28 M.C. now and then. G6QB, when he gets some time, hopes to be on 28 M.C., and 56 M.C., but at present when he is on the air he hasn't more than about twenty minutes to spare, and that is no good for either of those frequencies! Let's try and make the January number a record for No. 11 District notes. A little rivalry with North London in this respect wouldn't do either Area any harm. Reports by 20th please.

BRS240 has a new 4-valve receiver, using one stage of S.G., which he finds satisfactory but reports poor conditions.

**DISTRICT No. 12.**

Representative: T. A. ST. JOHNSTON (G6UT), 28,  
Douglas Road, Chingford, E.4. Telephone:  
Chingford 118.

G2ZN reports 7 M.C. poor, owing to fade-out; he has occupied his time on 1.75 M.C., conducting reduction of power tests. G6FY is also using the 1.75 M.C. band; his transmitter uses chemically rectified 500 cycle generator supply; he wants data on transformer iron losses. 2AZR reports reception on all bands poor, except 1.75 M.C., and offers to give reports by request on schedule. G2NU is busy rebuilding for C.C. throughout. G6LL, on 28 M.C., has worked W2JN on two consecutive Sundays. G6UT has received a number of reception reports from Tasmania. The next District "at home" will be held at Chingford on Tuesday, December 17; further meetings will then revert to the fourth Tuesday of each month.

**DISTRICT No. 13.**

Representative: H. V. WILKINS (G6WN), 81,  
Studland Road, W.7.

It has been ascertained that we have 66 stations (including BRS men) in this area, and yet we can only show a total of five reports in the "BULL." Why? I think it is about time some of you woke up and realised that it is *your* missing report that



keeps this Area's notes small. The gathering at my home was attended by nine members, and a pleasant evening was spent. All present are looking forward to another similar gathering.

G5VB (ex BRS72) made his debut on the ether this month. Has been on 7, 14, and 28 M.C., and worked eight countries on 7 M.C., and nine on 14 M.C. On 28 M.C. he has worked four G's. This in his first month! G6CO has only raised locals and Europeans this month. He says the G's are the only ones who know the 1929 Q code. G6WN has been active on low power to his C.C. set all the month on 7, 14, and 28 M.C. Has worked two G stations on 28 M.C., with 1.8 watts input. 2BXM has entered this Area, and is experimenting with rectifiers for both transmitter and receiver. Hopes to get licence soon, and will be on 56 M.C. G2OL has been trying a half-wave 20-meter C.F. Hertz; it works well on 14 M.C., but is no good for 7 M.C. He found conditions on 14 M.C. very variable. Has heard PY at 10.00 G.M.T. G6VP has WAC again on 14 M.C., and had report from WIAZE on his 28 M.C. signals. Station visits: G6WN to G2OL G6VP and G2UN. G6JY, G6CO, G6NK, G2OL, G2BY, and ex EARW to G6WN.

#### DISTRICT No. 14.

Representative: MR. J. WYLLIE (G5YG), 31, Lubnaig Road, Newlands, Glasgow.

A new station, with the call G5DK, has appeared in "A" District. It is owned by Mr. J. S. Dykes, Thorncliff, Skelmorlie, Ayrshire.

In the matter of DX, October-November has been very poor indeed. Conditions generally were bad, with a few short bright spells. The lack of DX has occasioned a good deal of additional experimental work in the Area, which is all to the good.

B. and D. Districts remain dead, and the same can be said of C. District, if one rules out G6KO. Fortunately, a different story is to be told of A. District, where enthusiasm at present runs high.

28 M.C. was hopeless until the first week of November, when things picked up a little. 56 M.C. continues to hold the interest of several, and further, there is a 112 M.C. TX actually "perking" in A. District.

During the period under review I have received several visits from F. Dearlove, the designer of VO8AE and its sub-stations. Mr. Dearlove's portable Colpetts TX, which was used all over Labrador to maintain contact with St. Anthony, is at present at G5YG, where it is occasioning much interest.

I also had visits from GI6WG and D4CL, and with the latter paid a visit to G6WL.

G2WL is now back in Glasgow permanently, and his QRA till the end of December will be as formerly—206, Newland Road, Cathcart.

I am also now able to furnish the QRA of G6RG, which is 157, Wood Street, Galashiels.

#### "A" DISTRICT.

Sub-Representative: MR. DAVID D. MARSHALL (G2MA), 41, Kelvinside Gardens, Glasgow, N.W.

G2MA is at present on the air with a re-designed 10-watt TX, has done a fine month's work on 14 M.C., despite the poor conditions. Uniformly good results have been received from ZL, VU, VS, VO, VE2, and 5 (Yukon), W, SU, CN, and FM. Half and full wave Hertz systems have been tried, but the angle of propagation of the half wave was thought to be too steep. (Largely depends upon

its height above earth OM—G6YG). G5CL is trying various circuits on 7 M.C., and is now prejudiced in favour of a balanced Colpitts, which has yielded remarkable results with a 7-watt input. G5XQ, after a month or more of less abortive efforts to reach out, found a miscalculation in the length of his aerial "feeders." G5YG is in trouble from a "blown" anode feed condenser. Will not get delivery of new one till middle of December. Has experimented with frozen-over glass feeder spacers, and can say with reasonable certainty that ice or snow on the spacers does not appear to affect the feeding of the aerial to any appreciable extent. With thoroughly wet spacers, however, there is a different story to be told. G6MS, working both on 7 and 14 M.C. bands, has at last succeeded in putting a signal out of Europe—AU to be exact. Finds conditions on 14 M.C. very bad. G6NX is experimenting with various types of radiating systems. Also finds things very bad on 14 M.C. G6WL, in conjunction with BRS266, has been spending a lot of time in more or less unknown territory, *i.e.*, 56 to 112 M.C., and has succeeded in getting an Ultraudion TX to work well on 112 M.C. G6KO doing a little 28 M.C. work at the week-ends. Reports conditions better there, and would be glad of any reports of his C.C. emissions on that wave.

#### DISTRICT No. 15.

Representative: H. ANDREWS (G5AS), Wireless Depot, Ystradgynlais, Swansea.

It is very disappointing to think that we have in this Area at least 24 members, including 12 active stations and yet only two reports are to hand. At our last Conventionette we decided that the notes in the BULLETIN were wanted and this is the result. Now for the last time, come on and let's have some news. Send your reports to me direct, or to the Sub-Representative, H. Harding (G2HH). G5PH is very active just now, being G.C. of No. 8C Group of C.B. He is also doing very good low-power tests on 7 and 14 M.C. and is using choke control for fone. G5TJ thinks of nothing but increasing the membership of R.S.G.B., and I am doing my best to keep him supplied with application forms. He is still on the 7 M.C. band and is getting good reports with 9 watts input. G5AS is now on the air again after a long spell of silence; he is using a M.O.P.A. and finds it satisfactory. A visit was paid to Birmingham and a very enjoyable time was spent in the company of G6XJ and G6XQ. G2AV—I have just received information that this station has pushed his sigs. into New Zealand; the power used was 2.5 watts to a D.E.5 valve. Some QRP, OM! (Can we have full details of this contact, please?—Ed.)

#### DISTRICT No. 16.

Representative: C. MORTON, Simla, Glastonbury Avenue, Belfast.

There has been very little activity among the GI's during the past month, although radio conditions appear to have improved steadily. One or two of the active stations have forgotten to send in reports, and I hope they send them along before the 20th of next month. GI2CN is rebuilding the transmitter, but sends no details. GI5HN is active again and reports he was heard in New Zealand on 14,000 K.C. whilst using 8 watts input from a hand gen. GI2KN is a newly licensed station, and I welcome him to the gang and wish him good luck. His QRA is 104 A, Divis Street,



Belfast. At present he is working on 7,000 K.C., and hopes to instal crystal control soon. GI6YW is still busy rebuilding but has managed to do a little 14,000 K.C. work as well. GI5WD spent most of the month getting fixed in his new QRA and has only had a few local contacts.

#### CHANNEL ISLANDS.

Representative: A. M. H. FERGUS, La Cotte, St. Brelades, Jersey (G2ZC).

For the past three months there has been very little to report, as I am now the only active station in the Islands. I have, however, heard from Lieut. D. Grove White, R.N. (G5GW) that he is due home early in December on leave, and I take

the chance of letting his friends know this, as his will not be a silent key.

The most worthy item of note has been the prevailing local skip on 7 M.C. signals during the past two months or so, when stations quite near have been quite inaudible, while those in Poland, Jugoslavia, etc., which one should not hear during the day, have been plainly audible. This condition seems to have covered the south of England, and it is of interest to note that stations in Germany, Southern France, etc., have been heard in Wiltshire and Jersey, while these two districts have been quite inaudible. Certain districts, too, have noticed signals coming in in the form of "wavy" fading, which is quite a new type of phenomena, but stations in C.B. are looking into the matter.

## B.E.R.U. News.

#### IRISH FREE STATE.

Representative: COL. DENNIS (EI2B), Fortgranite, Baltinglass, Co. Wicklow.

Conditions over here still continue to be poor on all bands and, with only occasional exceptions, far worse than at the corresponding period of last year. I think that it would be of interest if reports both to and by D.R.'s were to deal at greater length with conditions experienced during the month so that some estimate could be formed as to how far they are general and how far merely local. Reports have been received through EI7C of nine stations, but with two exceptions they contain nothing of general interest. EI8B and EI7C have both heard W stations on 28 M.C., but no contact has been effected. The transmitters' section of the W.S.I. has arranged an attractive series of lectures for the winter months which should prove of benefit to all concerned by promoting discussion of the many subjects to be dealt with. Stations reporting should note the Editorial remarks under the heading "District Notes and News" in the November BULLETIN, and frame their reports as far as possible in accordance with them in future.

#### SOUTH AFRICA.

By W. HEATHCOTE (ZT6X).

Conditions on the 21 metre band showed a decided improvement during October as far as the American and European amateurs were concerned, but, unfortunately, VS, VU and PK gradually fell off in strength. ZU6N sends me a list of the following G stations he has worked recently, viz.: G6NT, G6LK, G6WT, G6VP, G6NF, and G6DH, and comments on the splendid tone of most of the "G" stations. Unfortunately, quite a number of Continental stations still persist in using unrectified A.C., and judging by the way their notes spread all over the band, QRM must be terrible in Europe. SNIAA (Ascension) has been heard at regular intervals recently.

Mr. E. R. Cook (ex G6UO) is now resident in South Africa, his QRA being 6, Annandale Street, Cape Town. He has just obtained his licence from the Union Government and now transmits under the call sign of ZU1J. I had the pleasure of having a QSO with him as soon as the ink on his licence was dry, and as he is anxious to work "G" stations I shall be pleased if the R.S.G.B. members will give him a call when they hear him.

Division 6 (Transvaal) of the S.A.R.R.L. held a field day on November 1. This was a very successful affair, and quite a lot of useful information was obtained on direction finding on the 40 metre band.

The following members of the S.A.R.R.L. have joined the R.S.G.B. during the past month:—F. P. Marks (ZT6M), 146, Donnelly Street, Turfontein, Johannesburg; R. A. Dersley (ZT2B), Box 82, East London; S. H. Walters (ZUID), 37, Church Street, Worcester, Cape Province.

Many thanks, G2DT, for the interesting "dope" on 28 M.C. receiving condensers. I am sure the amateurs in S.A. interested in 10-metre transmission and reception will appreciate your excellent diagrams, which will appear in the next issue of Q.T.C.

During the past month ZT6T reports the reception of WKU and IRB, working on the 28 M.C. band; he mentions that they were working automatically, but when I state that ZT6T is one of the finest operators in the country, and has been suspected of taking down the Beam station, it was a fairly easy matter for him to read their signals.

ZUID reports conditions on 14 M.C. as being very good during the early part of the month. He was using a Zepp aerial but on changing over to a straight "L" type approximately 90 ft. in length and without a counterpoise, reports that he is getting far better results. Anyhow he will be sending to the A.R.R.L. for his WAC in the near future. ZU6N has qualified for his WAC and ZT6X expects his from America this week.

Whilst on the question of WAC certificates, what about the R.S.G.B. issuing a certificate? (This matter is now well in hand.—Ed.)

VO2NC (Tommy Yule, N'dola, Northern Rhodesia) says that conditions are bad up in his part of the globe after sunset. He reports having worked F8WB a number of times, but mentions that "G" stations were very weak.

My personal experience is that DX on 14 M.C. has fallen off a bit during the past week, the only DX stations coming in at good strength being VS7AP and VU2DR. I worked AC1BD, who reported my sigs. as R 8-9 (my input, by the way, being 20 watts), and although he is using a M.G. with 1,000 volts, his sigs. were hardly R 2. SNIAA (Ford Smith, of Ascension Island) has been heard fairly frequently, his sigs. being about R 3-4. Yanks have fallen off, whereas last month they were very strong. European stations have also got



much weaker, but several F's have been heard, with notes like a buzz saw, and the amount of QRM they must cause the European amateurs must be appalling.

The appointment of Mr. Watts (G6UN) as manager of the Publicity Section is a step in the right direction. Good luck, OM, and may the B.E.R.U. progress during 1930.

Conditions on the 7 M.C. band were very good indeed; this band is being mostly used for inter-communication between local amateurs, but QRM (this being our rainy season) is at times very annoying.

New members of the B.E.R.U. :—

ZU6N.—PRENTISS SELBY, c/o Box 7028, Johannesburg.

ZS6P.—J. H. PIENAAR, 30, Grove Road, Fairwood, Johannesburg.

ZU6X.—J. L. ATKINSON, c/o Box 7131, Johannesburg.

Please note that QSL cards for South African stations can be sent to Q.T.C., Box 7028, Johannesburg.

I wish all members of the R.S.G.B. the compliments of the season, and may the forthcoming year see a wonderful expansion of the Society.

#### CANADA. No. 2 District.

There is really very little to report from this section for the last month. Activity on 14 M.C. has been confined to very few stations, namely VE2BB and VE2CA. Other stations, for some unknown reason, will not sit by the receiver for hours to wait for DX to come in. The 14 M.C. band has been very bad indeed, and DX is only a matter of luck. ZS stations come in from 05.00 to 08.00 G.M.T., and also a few G stations occasionally are heard.

Last year up to this time ZL and VK could be heard with comparative ease, while now nothing comes in after 8 p.m. (E.S.T.).

Friends of VE2BE will be glad to know that he is nominated as Canadian General Manager of the A.R.R.L., and we hope he comes out victorious.

#### NEW ZEALAND.

By J. JOHNSON (ZL2GA).

Conditions during the last two months have been remarkable for some extraordinary changes in the 14 M.C. band, which is now recognised as our main DX band. During September the W stations, which had been coming in very loudly, and in great numbers, gradually weakened off and at the beginning of October only a few could be heard. Taking their place were Europeans and South Americans. Up to October 17 work with

Europe was excellent, but after that date there was a sudden change in conditions again, making communication difficult. South America is still comparatively easy, and nearly all European and South American countries were workable during October.

It is expected that the W stations will now come back in strength and that from now on work with Europe will be more difficult.

On 7 M.C. W is still easy to work and many ZL stations report working Europe several times. Our trouble here with this band is to sort out the European stations from the hordes of W's and K's. Those stations at the bottom of the bands are the easiest to locate. G, F, ON, EAR, seem to be the chief European countries heard or worked.

The 3500 K.C. band is very lively out here as it is the policy of the P. & T. Department to keep all new amateurs to this band until they have proved themselves capable of good work on the higher frequencies. Also it is the highest frequency band on which we are allowed to use telephony. A large number of W stations come in well on this band, but as they are chiefly concerned with traffic locally there are seldom any contacts.

It is suggested that some little space in the T. & R. BULLETIN be devoted to a résumé of conditions on the bands each month and collected from as many continents as possible. Out here it is very interesting to know how crowded the bands are in Europe or in other places.

There is to be a big N.Z.A.R.T. Convention at Auckland at Christmas. There are many rumours around, especially about some ferry-boat which is to be commandeered!!

WFA, the base station of the Byrd Antarctic Expedition, comes in very well, but WFAT, the S.S. *Eleanor Bolling*, now at Dunedin, tells me that sometimes they have difficulty in getting through. WFAT is going South again soon and it is probable that ZL4AO will go as operator again. He has already taken the flag of the N.Z.A.R.T. to the Bay of Whales.

The N.Z.A.R.T. have a chain of receiving stations spread throughout New Zealand collecting data on the characteristics of WFA signals, while the Expedition is in the South. This work is expected to be spread over two years.

So far there are no reports on the RX-TX tests on 14 M.C., organised by G5UQ. In my own case, nothing has been heard, although a watch has been kept. Those of our receiving men to whom, I have spoken report similar conditions. There is only one part of the schedule which may be heard in ZL and I have concentrated on that, but no results as yet. However, keep at it, as conditions are changing here.

## Notes and News from Europe.

#### NORWAY.

By G. H. PETERSEN (LA1D).

During October a considerable increase in activity on the 14 M.C. band is reported, as 7 M.C. is now too QRM-ridden. Among our 14 M.C. we have, in addition to the pioneer, LA1G, LA1W, LA2C, and LA1J. LA1G has set a new personal and national DX record by working WFA, in the Ross Sea, 78 south—nearly our antipodes—and

LA1W worked ZL3CM, his first New Zealander. LA1J in Bergen has made the first W contact from that city.

N.R.R.L. wishes to warn foreign amateurs that the Norwegian calls LA3K and LA3V are unassigned and are being used by unlicensed stations. Cards will not be forwarded *via* N.R.R.L., as their identity is unknown, and, incidentally, we do not want to support unlicensed stations, as any real



and interested amateur can get his licence without too much trouble in our country.

### BELGIUM.

By PAUL DE NECK.  
(President, R.B. ON4UU.)

With the coming of winter, amateur activities are increasing, but as far as DX is concerned, the late summer conditions were very poor on all the bands, except perhaps on 14,000 K.C. The inverse is now taking place, 20 m. band doing nearly nothing in really distance work, only being successful during day-time and for European contacts.

The actual winter conditions are thus exactly the reverse of last year. Nevertheless, some good work has been done by our amateurs; Japan and China were about the best contacts made by:—ON—4FM, 4BZ, 4HP, 4US and 4RS. The Byrd Expedition in the South Seas (WFA) has been worked by 4FP, who made contacts with the six continents in twelve hours, and has worked about 63 countries. Formosa Island was worked by 4CK and Ascension Island by 4JA. Our training sailing ship *L'Avenir*, is now back again in Antwerp, coming from Charleston, S.C., through Scandinavian waters. Some changes have taken place in our officers: 4JX, Mr. Desaegher, has been elected District Manager of our Liege section, and 4GW, Mr. R. Keerse, as D.M. of the Antwerp district, respectively, in place of E. Ziane (4ZZ), and H. W. Dierickx (4EA). We had the pleasure of meeting Mr. K. B. Warner recently. In the Hague, our President, Mr. de Neck, had a very long chat with him, and afterwards, on his way back to U.S.A., he found our Hon. Secretary, Mr. Ulrix, waiting for him in Paris.

\* \* \*

L'Union Radio Club de Liege is making arrangements to welcome, and act as guides to, visitors to the International Exhibition at Liege in 1930. The offer is extended to foreign visitors who are members of their own National Radio Societies.

\* \* \*

Good DX work has been accomplished by French amateurs towards the end of the summer. The Pacific coast stations have been worked regularly and M. Pieton has been heard in Alaska when using only 3 watts. Hawaii and Peru are also included in Western working. Successful communications have also been effected by French station with all parts of the Middle and Far East, including Japan and China. South Africa and Australia has also been worked consistently. The International Radio Exhibition in the autumn, in which the R.E.F. exhibited, attracted a large number of visitors, including many foreigners.

## EXCHANGE & MART.

Rates 1d. per word, minimum 1/6. First line in capitals if desired. 2d. per word where all capitals are required. Minimum 3/-.

**M**CMICHAEL Supersonic Block Unit, Broadcast wavelength, £2 10s.; with four 4-volt valves, £3; also Mullard 0/40 transmitting valve, 20s.—TOMKINS, 238, Drakefell Road, Brockley, S.E.4.

**F**OR SALE, Complete Amateur Transmitting and Receiving Station; three transmitters, two receivers, crystals, heterodyne wave-meters, buzzer wave-meters, crystal resonators, volt meters (high and low), ammeters and milli-ammeters, H.W. ammeters; in fact everything for the amateur. The best and no reasonable offer refused; health only reason for giving up; genuine buyers only need apply; inspection invited.—Apply, G2SO, Macclesfield, Cheshire.

**T**ANTALUM AND LONIUM.—Make your own Battery Chargers for alternating current. Simple, reliable. Lionium Rectifying Electrodes, 2-4 amps., 10s., 5-10 amps., 15s. Also Transformers, Blue Prints, 1s. each, and complete Chargers.—BLACKWELL'S METALLURGICAL WORKS LD., Liverpool.

**P**ATENTS obtained, Trade Marks and Designs registered, British and Foreign.—GEE AND CO., Patent and Trade Mark Agents (H. T. P. GEE, Member R.S.G.B., A.M.I.R.E.), 51-52, Chancery Lane, London, W.C.2. Telephone: Holborn 1525.

**F**OR SALE.— $\frac{1}{4}$  h.-p. Self-starting 200—240-volt 50-cycle A.C. Motor, coupled to Marconi 600-volt 30-milliamp. Generator; fitted with special pulleys for endless belt drive. Whole mounted on bedplate; spares; guaranteed perfect. W.A.C. with this machine, £8.—G6GZ, R. C. NEALE, Farnborough Road, Farnborough, Hants.

**S**ALE.—Evershed Generator, 600 v. 30 m.a., not disposal board, perfect condition, coupled to Crypto  $\frac{1}{4}$  h.p. motor, 240 v. D.C. Both practically new. Bargain, £6.—5TV, 16, Clifden Road, Twickenham.

**600V. HAND GENERATOR** for sale; owner going to Canada; £2 5s.—Apply Box 101, T. & R. BULLETIN, 53, Victoria Street, S.W.1.

**G**2JB closing down temporarily. 250 watt Transmitter complete valves (4), and power supply up to 500 watts; 3 Transformers, 4 heavy duty latest type "S" tube rectifiers; 10 oil Condensers (3,000 volts), meters, etc.; complete £35; much other apparatus; enquiry solicited.—1, Stapleford Road, Wembley.

"DON'T FORGET YOUR LOG PADS—6CC." OBTAINABLE ALSO FROM T. & R. OFFICES.

## 750 WATT "Q.M.B." SWITCH

**LYONS' NEW "B.A.T." (Best-After-Test) QMB Switch** breaks 3 amps. at 250 volts! For H.F., L.F., H.T., L.T. circuits. For A.C. Sets, Mains Units, Gramo-Motors. Also M/C Loud-Speaker Field Switch. These switches may be had, same price, with "OFF" at top—also horizontal faceplates. Send for FREE 4-pp. circular; request at the same time our famous 36-pp. "Clarostat" Book (all about D.C. and A.C. Mains Units, with scale drawings).

Trade enquiries solicited.

**CLAUDE LYONS, LTD.,**  
76, OLDHALL STREET, LIVERPOOL,  
ENGLAND.

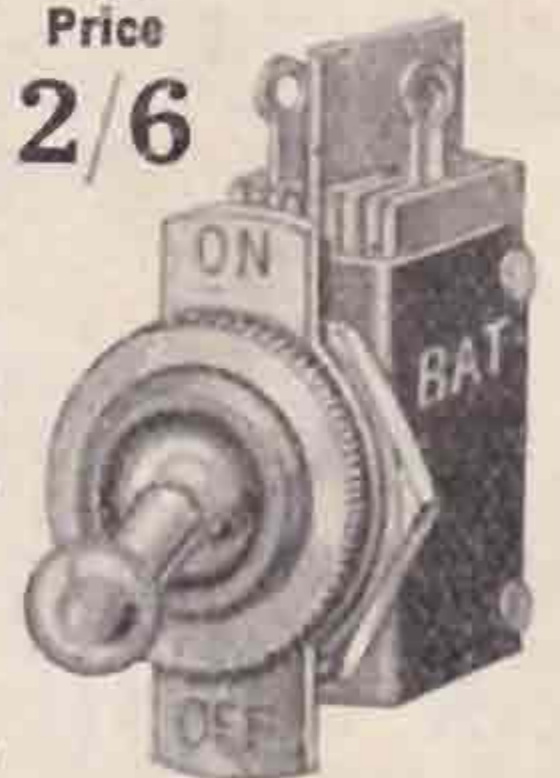

List Price  
**2/6**



# They all place Polar behind their panels

When it is a question of efficiency and economy there are no components more worthy of being placed behind your panel than Polar.

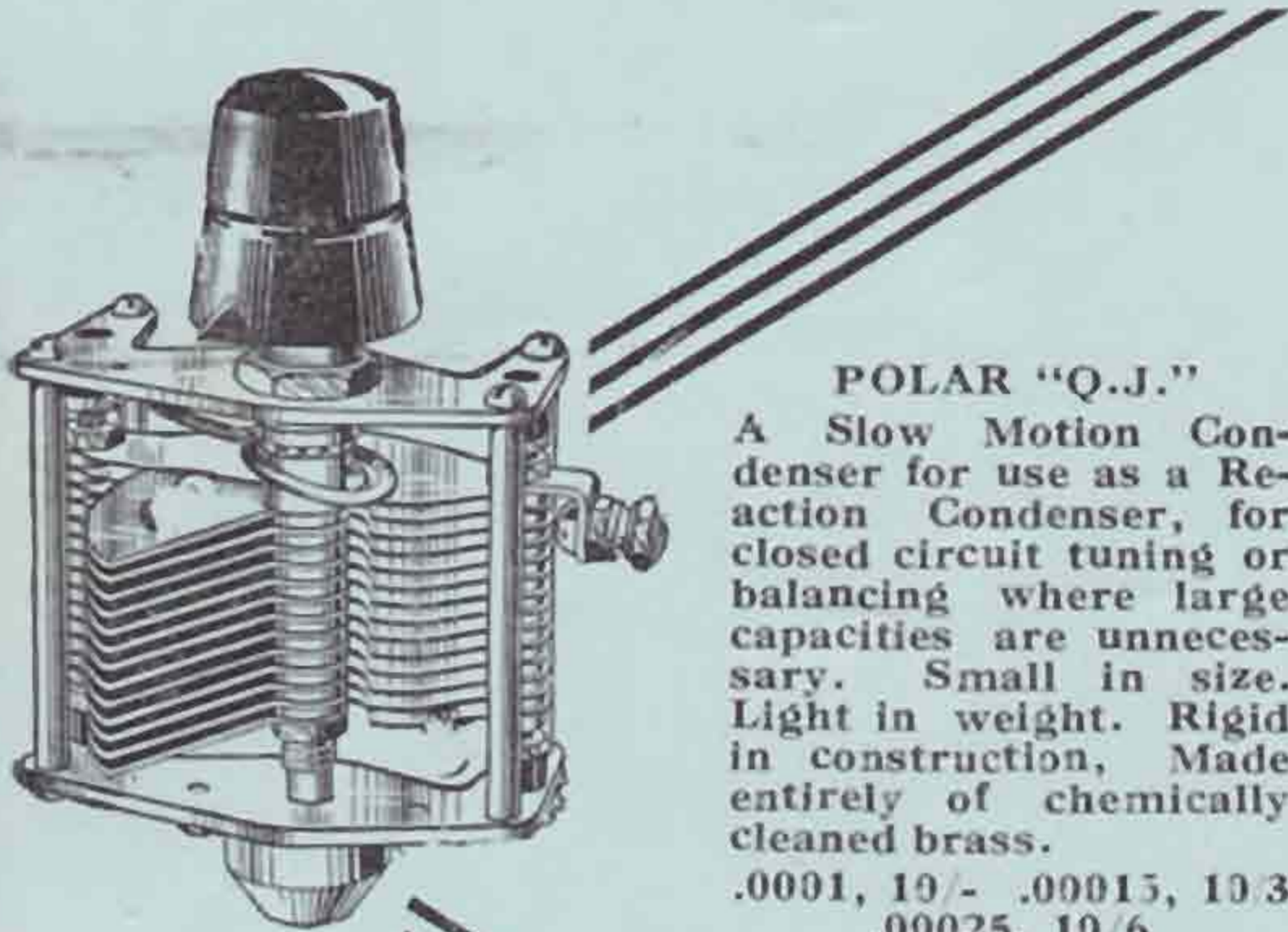

### POLAR "Q.J."

A Slow Motion Condenser for use as a Reaction Condenser, for closed circuit tuning or balancing where large capacities are unnecessary. Small in size. Light in weight. Rigid in construction. Made entirely of chemically cleaned brass.

.0001, 10/- .00015, 10/3  
.00025, 10/6

Knob-pointer as illustrated or with Dial to match the "Ideal."

### POLAR FIXED POTENTIOMETER

This Polar Fixed Potentiometer prevents your receiver breaking into oscillation and greatly assists the control of reaction. Resistance is of 3,000 to 4,000 ohms, thereby making the expenditure of L.T. current negligible.

Price 2/-

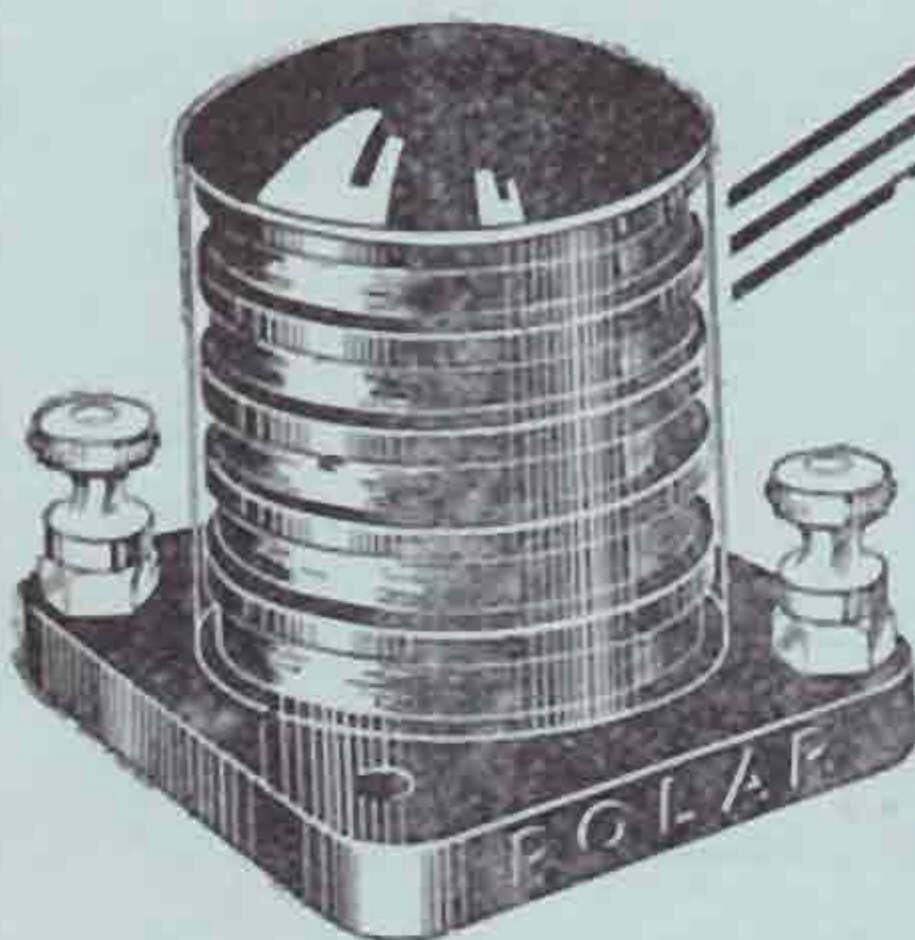

### POLAR H.F. CHOKES

The Standard Polar Choke, (as illustrated,) ensures choking effect being definitely maintained over a range of 20 to 2,000 metres. Price 4/6

### SHORT WAVE CHOKE

This is for Ultra-Short Waves (20 to 100 metres). Inductance 380  $\mu$ h. Compact. Neat. Easily fixed. Price 4/-.

Get a copy of the Polar Catalogue (T).

**WINGROVE & ROGERS, Ltd**  
188/9, STRAND, LONDON, W.C.2  
Mill Polar Works: Lane, Old Swan, Liverpool.

# CLIX

for every form of contact.

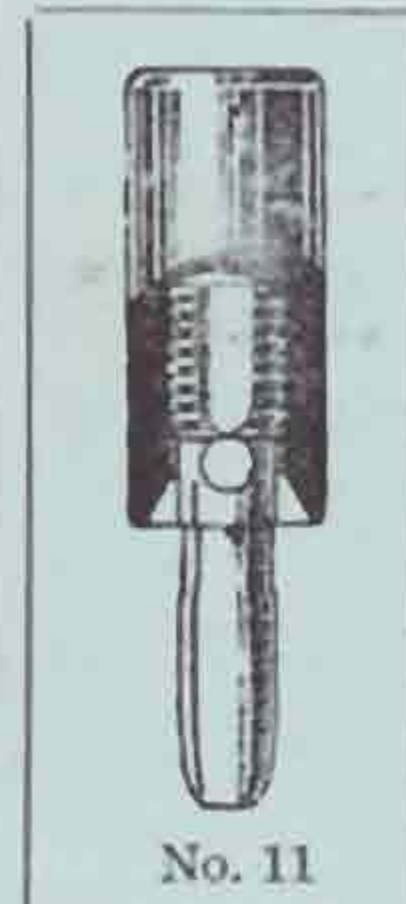

No. 11  
POWER PLUG  
Red and Black 2½d.

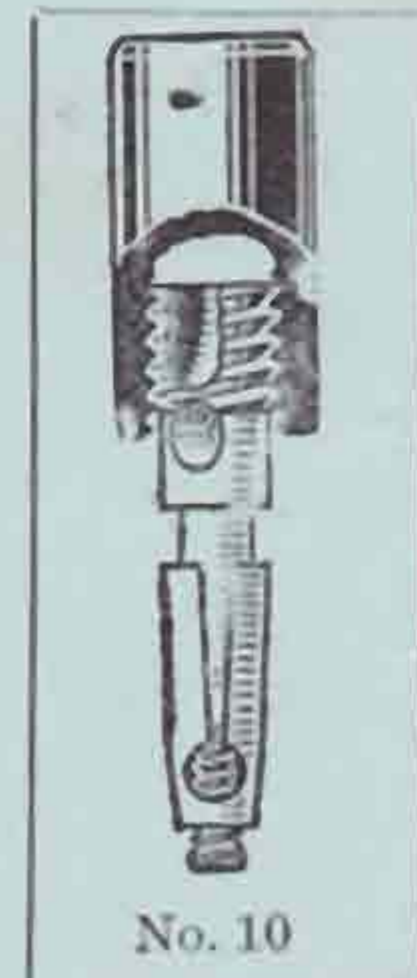

No. 10  
CLIX-LOX WANDER PLUG  
Red, Black and Green. 2½d.



No. 9  
PARALLEL PLUG  
Red and Black 2d.

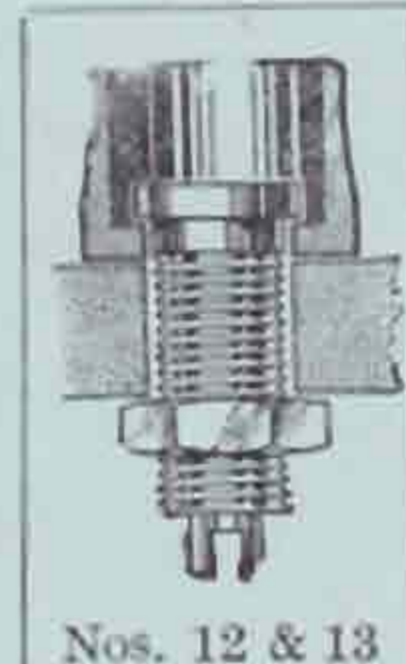

Nos. 12 & 13  
No. 12. POWER SOCKET  
With one locknut 2d.

No. 13. POWER SAFETY BUSH  
Red and Black 1½d.  
Price complete 6d.



No. 15  
CLIX ALL-IN PLUG & SOCKET TERMINAL



No. 19.  
PARALLEL SOCKETS  
With locknut 1d.  
With locknut and Engraved Safety shoulder.  
Red and Black 1½d.

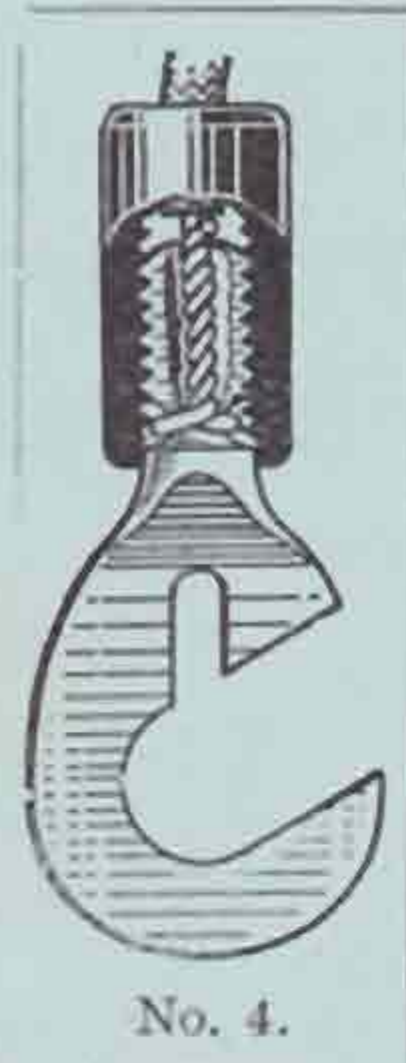

No. 4.  
HOOK TERMINAL 2d.

The only complete panel terminal entirely insulated from the panel as well as when connected or disconnected. With it you will obtain safer, speedier and better contact. Price complete 8d.  
Panel portion 4d.  
Flex portion 4d.  
(Supplies immediately obtainable through all Dealers)



No. 5  
"FIT-ALL" SPADE TERMINAL 2d.

Write for the Clix Folder containing details of the 21 Varieties.

**Lectro Linx, Ltd.,** 254, Vauxhall Bridge Rd., S.W.1.



# LOW TEMPERATURE FILAMENT TRANSMITTING VALVES.

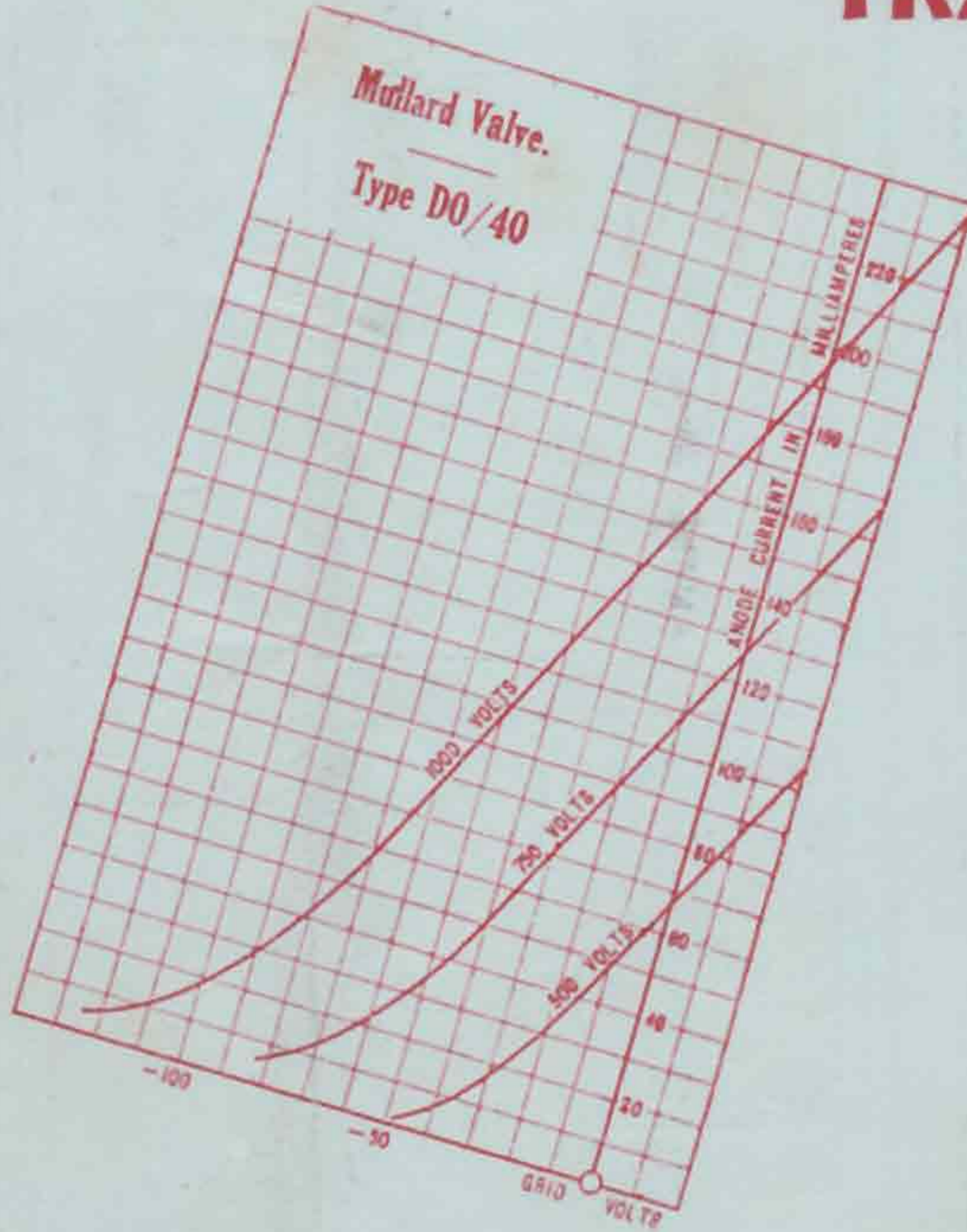

The Mullard D.O/40 is a dull emitter transmitting valve capable of working on anode voltages up to 1,000 volts and tested dissipating 40 watts at the anode.

The D.O/40 has a low impedance, and is suitable for use as a modulator in choke control transmitters. It is also suitable for short wave transmission (down to 40 metres).



|                              |              |
|------------------------------|--------------|
| Max. Filament Voltage ... .. | 6.0 volts.   |
| Filament Amps. ... ..        | 2.0 amps.    |
| Max. Anode Voltage ... ..    | 1,000 volts. |
| Total Emission ... ..        | 300 mA.      |
| Impedance ... ..             | 4,000 ohms.  |
| Mutual Conductance ... ..    | 2 mA/Volt.   |
| Amplification Factor ... ..  | 8            |

**PRICE £5-5-0**

## Mullard

**THE · MASTER · VALVE**

The Mullard Wireless Service Co., Ltd., Mullard House, Charing Cross Road, London, W.C.2.