

the TAPE RECORDER

PRICE 1/6

DECEMBER 1962
Vol. 4 No. 11

INCORPORATING "SOUND AND CINE"



A Merry Christmas to You!

Give him an
E-type if you can

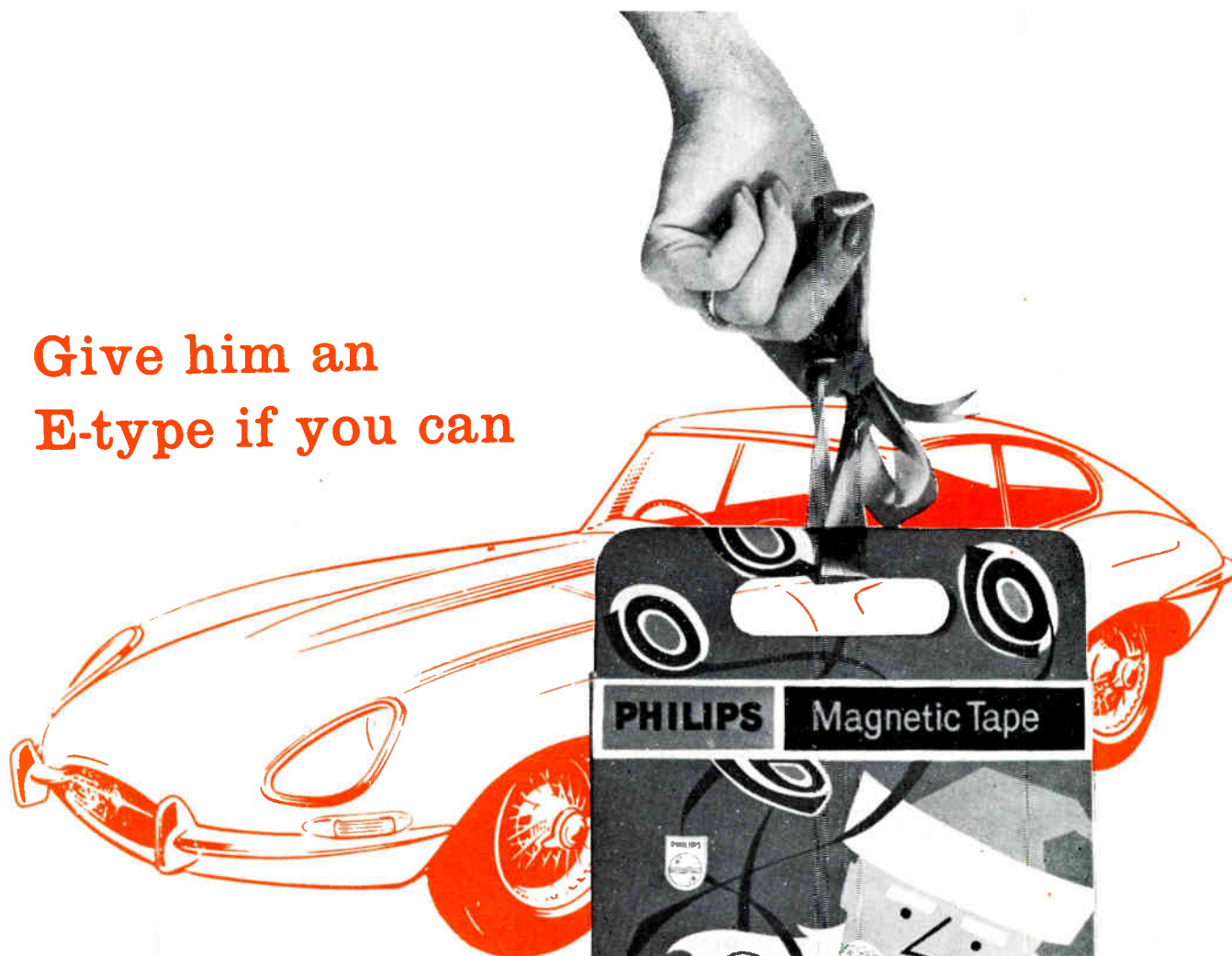

If you can't—
give Philips Tape

Tape recording friends may pine for E-types — but they'd be delighted with a gift of Philips Tape. In the new, colourful Christmas packs, Philips Tape makes the perfect present for anyone who owns a tape recorder. Strong, sensitive, it gives sound that really lives. Show a new shrewdness in gift selection. Buy your friends some Philips Tape today!

Say Happy Christmas to a faraway friend

New Zealand, Australia, Canada, the States, wherever your friends or relatives are, say Happy Christmas to them this year. Philips 3 message tapes are ideal for this purpose. Available in colourful ready-to-send Christmas wrappers, they'll make your message far more personal, far more welcome.

PHILIPS
TAPE

**CHRISTMAS PACKED
FOR HAPPY GIVING**

ANOTHER FINE PRODUCT FROM PHILIPS—THE FRIEND OF THE FAMILY



MADE IN HOLLAND

P1A416X

FABULOUS CHRISTMAS

OFFER!!!

BRAND NEW
BOXED GRUNDIG TK60
STEREO RECORDERS

LIST PRICE **£134** OUR PRICE **89** GNS.



Never before have we been able to make such a fantastic offer!!! These superb GRUNDIG TK60 stereo tape recorders, boxed brand new in sealed cartons are offered at a fraction of their list price, showing a saving of over £40!!! No additional amplifiers, speakers, etc., required as this recorder is a complete stereo system. Superb ultra high fidelity inbuilt 9-WATT STEREO AMPLIFIER driving 2 matched dynamic 10-in. speakers housed in completely detachable acoustically designed enclosures, producing superb stereo or monaural of a quality hitherto undreamed of.

We have a very limited number at this amazing price, so please hurry while stocks last.

Special Offer!! 2 Grundig GCMIII microphones listed 12 Gns. available to purchasers at £10 pair.

SPECIFICATION

Complete stereo record/replay. 9-Watt stereo Hi-Fi amplifier. 2 Superb 10-in. dynamic speakers. 2 Speeds: 3½ and 7½ ins. per sec. Frequency response: 50/16,000 c/s ±3 db. Signal to noise ratio: 45 db. Wow and flutter less than ± 0.2 per cent. Cross talk better than -50 db. Automatic foil tape stops. Independent bass, treble and vol. Superimposition facilities. Mixing facilities. Mic/radio, etc. Provision for remote control, etc. Valves: 2 EF86, 2 ECC81, 1 ECC83, 2 EL84, 2 EL95, 1 EM84, and 4 rectifiers.

SHOWROOMS

Our City showrooms are closed all day Saturday and open Sunday 9.30 a.m.—2.0 p.m., open all day Thursday. Other branches open Monday to Saturday 9.0 a.m.—6.0 p.m., half-day Thursday.

228 BISHOPSGATE, E.C.2
OPPOSITE LIVERPOOL STREET STATION

BIS 2609

2 MARYLAND STATION, STRATFORD, E.15
ADJOINING MARYLAND STATION MAR 5879

205 HIGH ST. NTH., EAST HAM, E.6
OPPOSITE EAST HAM STATION GRA 6543

CITY & ESSEX TAPE RECORDER CENTRES

For highest
quality equipment



at lowest
possible prices

TO ALL MUSIC LOVERS AND HI-FI ENTHUSIASTS

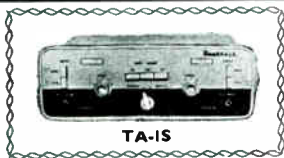

TA-IS

TAPE AMPLIFIER UNITS
Models TA-IM and TA-IS

The monophonic version (TA-IM) can be modified to the stereo version (TA-IS) by modification kit (TA-IC). Special features include the provision of a bias level control; easy-to-read thermometer-type recording level indicators; large printed circuit boards. Both models have identical presentation. TA-IM £19.2.6
TA-IS £24.10.0 TA-IC £6.15.0



TRUVOX D83 AND D84 TAPE DECKS. High quality mono/stereo tape decks. D83, 2-track for highest fidelity. £31.10.0

With TA-IM, £47.2.6
With TA-IS £52.6.0

TRUVOX D84, 4-track, for most economical use of tape (same presentation) £29.8.0
With TA-IM £45.5.0 With TA-IS £50.9.6



COLLARO "STUDIO" TAPE DECK. Operating speeds: 1½ in., 3½ in. and 7½ in. p.s. Wow and flutter not greater than 0.15% at 7½ in. p.s. £17.10.0

With TA-IS £35.14.0 With TA-IM £30.10.0

"MOHICAN" GENERAL COVERAGE RECEIVER Model GC-1U. Fully transistorised. 4 piezo-electric transmitters. To overcome the problems of alignment, etc. the R.F. "front end" is supplied as a pre-assembled and pre-aligned unit. £39.17.6

GOLDRING-LENCO TRANSCRIPTION RECORD PLAYER Model G.L.58. Fitted with the G.60 pick-up arm, it has infinitely variable speed adjustment between 33 and 80 r.p.m. and four fixed speeds. 3½ lb. turntable to reduce rumble, "wow" and "flutter". £19.12.6



AUDIO SIGNAL GENERATOR Model AG-9U. Delivers up to 10 volts pure sine-wave (less than 0.1% distortion, 20 c/s to 20 kc/s). Decade switch-selected frequencies from 10 to 100,000 c/s. Internal 600 Ohm N/I load, or external. £21.9.6

TRANSISTORISED TELEPHONE AMPLIFIER, Model TTA-1. Provides instant group listening and conversation. Freely portable for use with any telephone; hands-free operation; automatic switch; 9v battery operated; compact and elegant cabinet. £7.9.6

SUGDEN MOTOR UNIT "CONNOISSEUR CRAFTSMAN". Heavy duty motor operating at 33½ and 45 r.p.m. Very heavy 12 in. turntable. Virtually no rumble. £18.3.6

No electronic or soldering experience is necessary to build any Heathkit model: our simple, well illustrated manual guides you step by step. A FREE CATALOGUE of the full range, and detailed specifications of any item, will be gladly sent without obligation on your part, on request.

"COTSWOLD" SPEAKER SYSTEM

This is an acoustically designed enclosure 26" x 23" x 14" housing a 12" bass speaker with 2" speech coil, elliptical middle speaker, and a pressure unit to cover the full frequency range of 30-20,000 c/s. Capable of doing justice to the finest programme source. Delivered complete with speakers, cross-over unit, level control, Tygan grille cloth, etc.



"COTSWOLD"

COTSWOLD MFS SPEAKER SYSTEM

A minimum floor space model. Size 36" high x 16½" wide x 14½" deep with performance similar to the standard model. Specially designed for small rooms. Either Model £23.4.0



"THE MALVERN"

HI-FI EQUIPMENT CABINETS

A range of equipment cabinets is now available to meet the differing needs of enthusiasts. All accurately machined for ease of assembly and left "in the white" for finish to personal taste. Designed for the maximum operating convenience or for where room space is an overriding consideration, this range holds at least one model to meet your requirements. Why not send for full details? £11.12.6 to £18.10.0

HI-FI FM TUNER, Model FM-4U

For your convenience, this model is available in two separately sold units: Tuning Unit (FMT-4U—£3.2.0, including P.T.) with 10.7 Mc/s I.F. output, and Amplifier Unit (FMA-4U—£12.6.0). Built-in power supply; 7 valves. Total £15.8.0

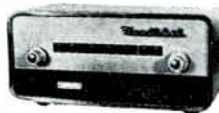

FM-4U

HI-FI AM/FM TUNER, Model AFM-1

Also available in two units as above: Tuning heart (AFM-T1—£5.5.6, incl. P.T.) and I.F. amplifier (AFM-A1—£20.13.0). Printed circuit board; built-in power supply; 8 valves; consecutive FM limiting and ratio detector. Total £25.18.6



S33

HI-FI STEREO 6-WATT AMPLIFIER Model S-33. Attractively styled, completely self-contained. Printed circuit makes it easy to build. Only 0.3% distortion at 2½ W/chal. 20 dB N.F.B.; sensitivity 200 mV. U/L output, ganged controls. £13.7.6

HI-FI STEREO 18 WATT AMPLIFIER Model S-99.

Within its power rating, this is the finest stereo amplifier available, regardless of price. Printed circuit board construction; ganged controls. U/L push-pull output. 0.2% distn. at 9 W/chal. £27.19.6



S-99

TRANSISTOR INTERCOM, Models XI-1U & XIR-1U



REMOTE XIR-1U

Designed for use in the business office or the home, the Master unit (XI-1U) can operate up to five Remote units (XIR-1U) which give instant service without warming-up delay.

"Private" switch. 9 volt battery operated. Supplied with assembled sapele-mahogany cabinets XIR-1U £4.7.6 XI-1U £10.19.6



MASTER XI-1U



USC-1

STEREO CONTROL UNIT
Model USC-1

Push-button selection, accurately matched ganged controls to ±1 dB. Negative feedback rumble and variable low-pass filters. Printed circuit boards. Accepts inputs from most tape heads and any stereo or mono pick-up. £19.10.0

TRANSISTOR PORTABLE RADIO Model UXR-1

Presented in elegant real hide case with gold relief. Can be assembled in 4 to 6 hours. Pre-aligned I.F. transformers, printed circuit and a 7 in. x 4 in. high-flux speaker. £14.3.0



UXR-1

4-wave TRANSISTORISED PORTABLE RADIO Model RSW-1

Using 7 latest type transistors and three diodes this highly sensitive set is specially designed for Short and Medium wavebands (250-500, 90-200, 18-50 and 11-18 m.). In leather case fitted with retractable whip aerial. £22.8.0



RSW-1

HEATHKIT ELECTRONIC WORK SHOP KIT, Model EW-1. This kit will help your boy to understand electronics, by making at least 20 exciting experiments, including Transistor Radios, Intercom Sets, Burglar Alarm, Electric Eye, etc. £7.18.0

POWER AMPLIFIER 12-WATT Model MA-12. Single channel, ideal for stereo conversion. £11.9.6

HI-FI SPEAKER SYSTEM Model SSU-1. This kit is easily assembled. It contains twin speakers and balance control in its ducted port reflex cabinet. It is equally suitable for stereo or mono in average room. (Legs 14/6). Less legs £11.5.0



SSU-1

A WHOLE RANGE OF PACKAGED DEALS (INCLUDING "CONNOISSEUR CRAFTSMAN" TURNTABLE and DECCA ffs PICK-UP) NOW AVAILABLE TO SAVE YOU FURTHER MONEY.

ALL MODELS ARE ALSO AVAILABLE ASSEMBLED. PRICES ON REQUEST.

All prices include free delivery in U.K. Deferred terms available on orders over £10.

JUST POST THIS COUPON FOR FURTHER INFORMATION

Without obligation please send me

★ FREE BRITISH HEATHKIT CATALOGUE . . .

FULL DETAILS OF MODEL(S).....

Kindly write below in BLOCK CAPITALS

NAME.....

ADDRESS.....

TICK HERE

HT12

SOME OTHER HEATHKIT MODELS AVAILABLE

World's largest-selling VALVE VOLTMETER	Model V-7A	£13.18.6
G/P OSCILLOSCOPE (5 in. flat-face screen)	Model O-12U	£38.10.0
AMATEUR TRANSMITTER	Model DX-40U	£33.19.0
VARIABLE FREQUENCY OSCILLATOR	Model VF-1U	£11.17.6
TRANSISTOR RADIO for the youngsters	Model UJR-1	£2.13.6
RESISTANCE/CAPACITANCE BRIDGE	Model C-3U	£9.5.0
AUDIO VALVE MILLIVOLTMETER	Model AV-3U	£14.17.6
AUDIO WATTMETER	Model AW-1U	£15.15.0

DAYSTROM LTD., DEPT. HT.12, GLOUCESTER, ENGLAND

A member of the Daystrom Group, manufacturers of

THE LARGEST-SELLING ELECTRONIC KITS IN THE WORLD

THE SOUND OF **SONY**... A WONDERFUL SOUND



The **SONY** 521 Stereophonic Tape Recorder

Here is brilliant engineering in sound. The Sony 521. Here is perfection in dimensional recording and reproduction. The Sony 521. Here are the many extras usually reserved for professional instruments—built-in amplifiers and speaker units, two and four track play-and-record features and trouble-free synchronous motor drive. The Sony 521. Here are sensitive level meters and split-second stop lever, assuring true fidelity, precise cueing and editing. The Sony 521.

- * $7\frac{1}{2}$ + $3\frac{1}{2}$ tape speeds
- * tape index indicator
- * instant stereo/mono switch
- * tone control
- * automatic cut-off
- * additional line outlet
- * headphone monitor jack
- * professional mixing

124 gns. including 2 dynamic microphones and all accessories

SONY[®]

RESEARCH MAKES THE DIFFERENCE

Detailed specifications on the range of Sony tape recorders are available from the

Sole U.K. Distributors: **TELLUX LIMITED** *A member of the K.G. (Holdings) Group of Companies*
AVENUE WORKS, GALLOW'S CORNER, COLCHESTER ROAD, ROMFORD, ESSEX. Telephone: Ingrebourne 43971

connoisseurs
say

SIMON



... the connoisseur with an eye for a bargain chooses the **SIMON SP5** because no other tape recorder in the price range gives him so much at professional standards!



Unrivalled facilities of the **SIMON SP5** include uni-directional twin track recording, two speeds, 7-inch spools, dual channel mixing, master fader, monitoring through loudspeaker and level setting, controlled echo, track to track recording, controlled bias, recording level meter.



SIMON SP5
Price from 93 gns

"Tape recording in the new age"

* You can buy the **SIMON SP5** as a stereo recorder, or in a monaural version ready wired and fitted for easy conversion to stereo.

... the connoisseur with an ear for performance chooses the **SIMON Cadenza Ribbon Microphone** because he gets studio class results in the middle price range.



The **SIMON Cadenza Ribbon Microphone** is a popular and successful conception of ribbon and magnet arrangement... output is flat to close limits over the very wide range 50-12,000 c.p.s., new shell design eliminates resonant peaks and troughs—especially the "bass hump". Can be used in LZ or HZ condition... though the ribbon area is four times the normal size, dynamic impedance is negligible.



SIMON Cadenza
Ribbon Microphone

Price 10 gns

"Makes a piano sound like a piano"

For full technical details of **SIMON** tape recorders and microphones, consult your dealer. In case of difficulty please write to:

SIMON EQUIPMENT LIMITED
48 GEORGE STREET LONDON W.1

U.S.A.'s 3rd LARGEST SELLER NOW ARRIVES IN BRITAIN!

AKAI *Terecorders*

for those who expect the earth in a world of sound



MODEL 69 'DE-LUXE'

Wide Frequency Range: Equipped with a record/play head which consists of specially treated core-materials being imported from West Germany.
Output Power: 6 watt, can drive larger size extension speaker up to 12 in. Self contained speaker is 6 1/2 in. in diameter.

7 in. Reel Capacity: Accepts 3 in. and 5 in. reels as well.
Level meter: with pilot lamp for easier determination of correct volume control setting when recording.
Index (Revolution) Counter.
Instant Stop Control: Spot editing and momentary stops are easily accomplished by use of the instant Stop Lever.

Monitoring and better reproduction: Monitoring of your recording may be accomplished by plugging a crystal earphone into the recorder's Output Jack. Superb reproduction can be obtained by operating a large Hi-Fi speaker direct from the Output Jack. Also your existing power-amplifier that does not have a pre-amplifier of its own may be driven from the same Jack.

Head Output and three position Power Switch: If desired, the tape transport mechanism (tape deck) of the recorder can be operated independently of the built-in amplifier and speaker. The Head Output Jack and the three-position Power Switch are provided to make this special function possible.

Retails at 79 GNS.

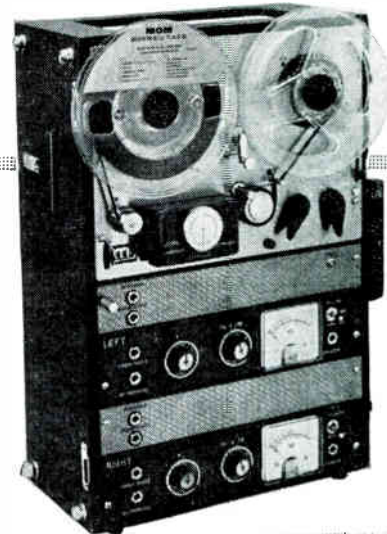

MODEL M6

Records and plays back either 4-track stereophonically or 4-track monophonically and also plays back 2-track prerecorded stereo tapes. Hysteresis Synchronous Motor always ensures constant tape speed. Designed for vertical or horizontal operation. Two inline and accurate VU-Meters reads recording and playback levels.

A precision index Counter. Recording/play head consists of specially treated core-materials which are being imported from West Germany. Maximum output power of the built-in amplifier is 6 watt on each channel (total 12 watt) which can drive up to 12 in. extension speaker system. Dual Head and Preamp Outlets are provided for connection direct to any other pre-amplifiers or stereophonic amplifier.

Instant Stop Lever. All operating controls are Interlocked. Automatic stop device.

The pinch wheel is always automatically released from capstan which protects it against a "spot" on the soft rubber surface causing uneven running.

Retails at 130 GNS.

HI-FI WIDE RANGE STEREO SPEAKER SYSTEM MODEL SS-50

Matched with the Model M-6 in styling and size, complete with connecting cables.

Speakers: Two 8-inch mechanical 2-way (with built-in coaxial tweeter) speakers in a dividable carrying case.

Retails at 30 GNS.



Akai's new modern factory in Japan where the finest equipment is produced under the most up-to-date conditions.

Akai* is the most important contribution that has been made to first-class tape recording equipment for years. In a comparatively short time, they have established themselves in a leading position in the American Tape Recording Field.

Now they have come to Britain and one has only to examine them to see why they are going to prove serious competition to those European manufacturers, who have led the field for so long. You find this hard to believe? Then see the Akai Terecorders for yourself, contact your usual dealer or the sole importers.

*Due to trade agreements Akai are sold under the name of Roberts in the U.S.A.

For descriptive literature and full information of the Akai Terecorders contact your usual dealer or **NORTHGATE (CAMERAS) LIMITED, 119/125 Wardour Street, London, W.1** Tel.: GERrard 7030, 7038, 7039.



ZONATAPE LEADS THE WAY WITH

COLOURED SPOOLS



Zonatape embodies all the professional know-how of great sound-film recordings such as *Ben Hur*, *Guns of Navarone*, *West Side Story* and *South Pacific*. It is this professional difference you will immediately recognise in your first recording on Zonatape. The various Zonatape grades are further distinguished by coloured spools: CLEAR for Diacetate, RED for PVC and GREEN for Polyester. Ask your dealer about this very different tape and send for Zonatape booklet—"The Basis of Every Good Magnetic Recording".

ZONAL FILM(MAGNETIC COATINGS)LTD, ZONAL HOUSE, WESTFIELDS ROAD, W.3 ACORN 6841

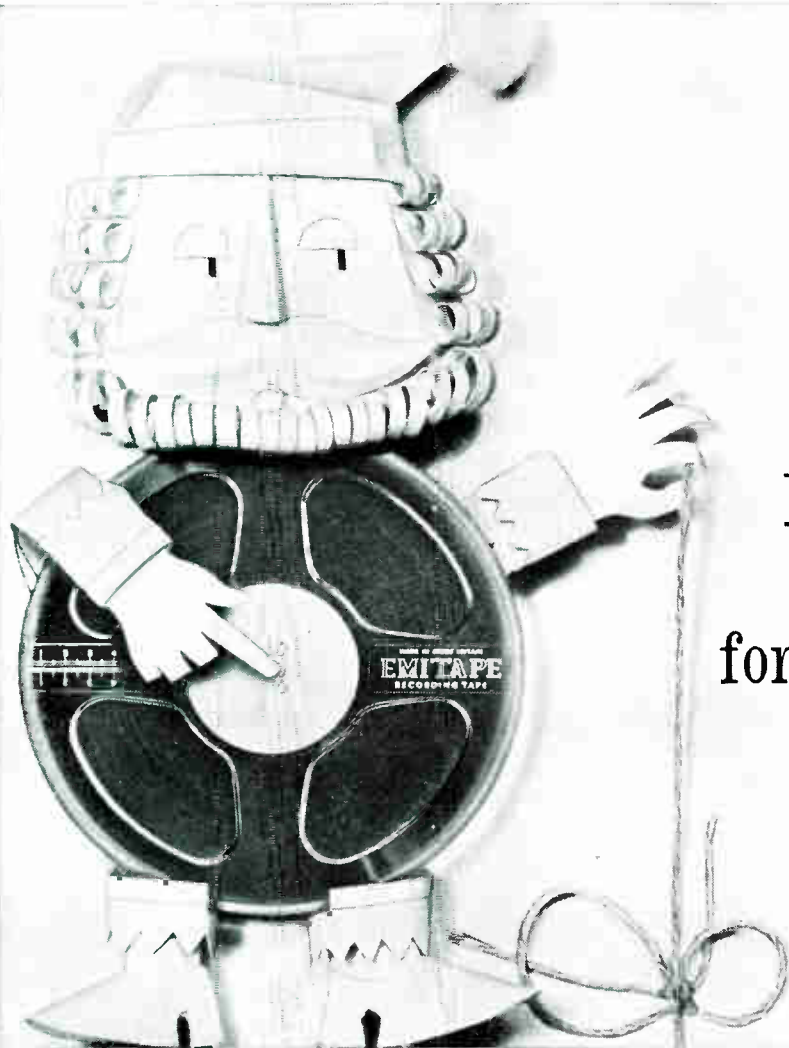

Emitape reels off bright ideas for merry Christmas!

Something for everyone—
or everything for someone!

You can *give* Emi-presents for Christmas. You can *keep* Emi-presents for yourself. Or you can do both (the more the merrier). Anyway, there are stacks of things to choose from. Here are four suggestions:

EMITAPE—FOR FUN AND GAMES!

With every pack of Emitape you buy this Christmas, you get instructions for eight hilarious party games (to be played with tape and recorder). Devised by John Borwick, specially for Emitape, they're printed on the inside of every Christmas wrapper.



EMITAPE PARTY TAPE

Here's something new and exciting! Forty minutes of ideas and examples to get your party swinging—games, quizzes and sound effects—introduced by Dick Emery. And a section by John Borwick on 'How to get the most from your tape recorder at party time'. On a 5½" reel. 37/6.

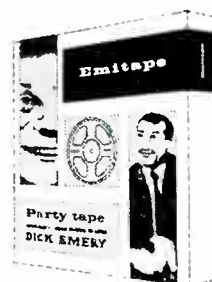

EMITAPE ACCESSORIES ARE NECESSARIES!

The Emitape Accessory Kit's got everything. Three reels of leader tape. One reel of metallic stop foil. One reel of jointing tape. Jointing block. Two tape cutters. And a special Emitray container. The complete box of tricks costs 37/6. But get them separately if you like.

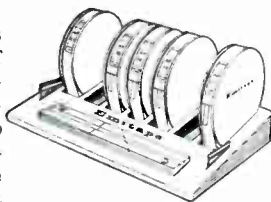

AN EXPERTISE OF EMIGUIDES

The most exciting way to learn about sound is through sound—through Emiguide. Getting the quality right. Microphone technique. Tape editing. Outdoor recording. Trick recording and sound effects. Producing feature tapes... They're a gift! 8/6 each or 51/- the set.

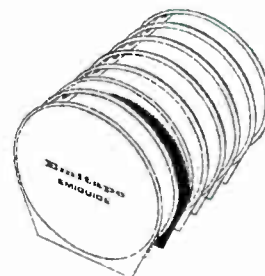

ET66

Emitape

E.M.I. TAPE LIMITED · HAYES · MIDDLESEX

the TAPE RECORDER

Editor - - - - - MILES HENSLOW
 News Editor - - - - - Alan Lovell
 Advertisement Editor - - - - - Julian Berrisford
 Editorial Offices - - - 99 Mortimer Street, London, W.1
 Telephone - - - - - MUSEum 3967 to 3969



MEMBER OF THE
 AUDIT BUREAU
 OF CIRCULATIONS

★
EDITORIAL

IN this age of domestic machinery and domestic electronics, people expect to be able to buy, to plug in, and to use. And they are quite right to think that way. One of the most annoying of all everyday experiences is to buy something and to find that it does not work properly: even more annoying is the experience of waiting for the return of the faulty article, and the discovery that it is not properly in order when it is returned—or, more commonly, collected. This is what hit the popularity of the tape recorder. Too many models were rushed out far too quickly, and far too few people knew how to repair them: and, to make matters worse, many of the manufacturers did not bother to produce satisfactory manuals with details of repair and maintenance. All this may sound very like the replay of an old gramophone record, because we have said more or less the same things several times before in this column. After two or three years of frustration and disappointment the position has now very largely resolved itself. Most of the rubbish has disappeared from the market, more and more dealers are able to offer after-sales service, better basic components have resulted in better recorders being made. In fact, today, the would-be purchaser of a tape recorder has a bigger choice than ever before, and as good a chance of getting something really worthwhile for his money as he has when buying any other domestic object of the electric or mechanical type. Why then must we go through all this again?

Recently, a new type of invasion has taken place. Readers began to write to us, telling us about *new* tape recorders being offered for sale at less than five pounds—complete with microphone, batteries and tape. Some asked whether we knew anything about these instruments. Most writers merely wanted to let us know about them. A few said that they were thinking of giving them as Christmas presents,

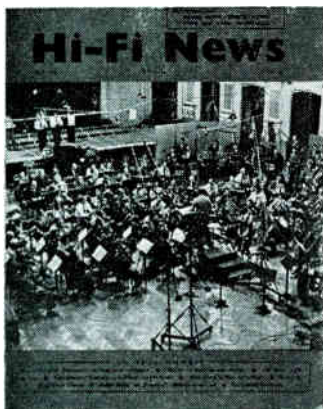

**DECEMBER
 NUMBER**

★
 Contents include:
 A Pre-amplifier for the
 MA. 15
 The Long Road to Hi-Fi
 Pickup Problems

★
NOW ON SALE

DECEMBER - - - - - 1962
VOL. 4 - - - - - No. 11

CONTENTS

	Page
News from the World of Tape	477
News and Pictures from the Clubs	478
A Tape Tour of Paris	481
Tape Recorder Service	
No. 12 Brenell Recorders	
By H. W. Hellyer	483
Tape Recorder Workbench	
No. 41 The Mullard Type C Amplifier	
By A. Bartlett Still	487
Nineteenth Century Nightmare	
By Graham Balmain	490
Sound and Cine	
By Richard Golding	493
Our Readers Write	497
Details of New Products	499
Equipment Reviewed	501
Readers' Problems	511
Classified Advertisements	512
Advertisers' Index	514

and asked our advice. So far we have not examined any of these machines, and we are therefore obviously unable to pass any opinion. They may work quite well—for what they are and for what they cost. If they are bought as novelties, or presents for children, then there is nothing more to be said, except that the purchaser should be well satisfied that the actual object to be bought should be seen and heard working. But if they are to be considered for any other purpose, then a lot more thought should be spent on them before the actual money is paid.

So let us go back to the opening remarks. The reason why some tape recorders caused such disappointment to their owners in the "bad-old-days" is because recorders are not the very simple things that they sometimes appear to be. They are a combination of mechanics and electronics. Their complaints, when they went "off-colour" were beyond the ability of many, otherwise skilled service people to diagnose and cure. Remembering all this, is it wise to buy any recorder today that does not come from a known maker? Is it wise to buy any mechanical or electronic instrument without the assurance that its purchase is backed by some form of service after sales? For our part, we look forward to seeing and examining one of these machines; for, all other thoughts aside, we are amazed to know that any tape recorder can be made (and possibly imported, with the attendant costs of freight, packing, insurance and duty) for a figure which must be somewhere around two pounds! If they are good value for their money, then the children who get them are in for some very good fun! How times have changed. A clockwork engine was once considered a fantastic luxury in some homes, for a few shillings!

To end on another note, we have decided to postpone the inclusion of our Questionnaire until after the Christmas holidays. It was pointed out to us that we could choose a better time for imposing such a task on our readers—and the Postmen will probably appreciate it, too. So, a Happy Christmas to all readers from all at 99 Mortimer Street.

SUBSCRIPTION RATES

The subscription rate to *The Tape Recorder* is 21/- per annum (U.S.A. \$3.00) from The Tape Recorder, 99 Mortimer Street, London, W.1. Subscription + Index, 24/- (U.S.A. \$3.25).

The subscription rate to *Hi-Fi News* is 27/6 per annum (U.S.A. \$4.00) from Hi-Fi News, 99 Mortimer Street, London, W.1. Subscription + Index, 30/- (U.S.A. \$4.25).

* NOW - A CHOICE OF SEVEN GREAT MODELS!



AND THIS!

—the first automatic tape recorder in the world—
MAGNETOPHON 'AUTOMATIC'
 Fun to work—and to play! Simply switch on and push the recording button for correctly modulated recordings. Press the playback button and play back it does! Plays 3 hours with 5½" DP tape **50 GNS**

THERE'S THIS!

—for the exacting amateur who likes to experiment—
MAGNETOPHON 75-15
 Famous multi-purpose model for general recording or for the exacting amateur who likes to experiment. With its wide range of accessories it can be used for adding sound to cine films and slides. Plays 6 hours with 5½" DP tape **50 GNS**



AND ALL THESE!



MAGNETOPHON 95
 —simply operated and fun to use. **59 GNS**



MAGNETOPHON 96
 —for the man who wants four tracks and extra tricks! **69 GNS**



MAGNETOPHON 85 DE LUXE
 —for the music lover, the man with extra sensitive hearing. **83 GNS**



MAGNETOPHON 97
 —for the stereo enthusiast who wants everything. **95 GNS**

* All prices exclusive of microphone

AND The latest in the range. **MAGNETOPHON 98 STEREO.**
 For the enthusiast who wants half track quality with the full facilities normally associated with four-track recording. **95 GNS**

CHOSEN BY EUROPE'S MAJOR RADIO STATIONS

TELEFUNKEN

The originators of Tape Recording

SEND NOW for FREE brochure to:—Dept. TR2

WELMEC CORPORATION LTD 147/8 STRAND LONDON WC2



NEWS FROM THE WORLD OF TAPE

New Technique Gives Low Cost Multi-channel Recorder

NEW tape recording technique is employed in a mobile acoustics laboratory used for measuring noise levels by the Building Research Station of the Department of Scientific and Industrial Research. The laboratory is equipped with an ingenious arrangement of professional tape recorders for simultaneously recording several items of information without the expense of purchasing a multi-channel recorder.

By linking three TR.52 twin-channel machines and a TR.90 it has been possible to obtain multi-channel facilities inexpensively and with greater flexibility. Any number of channels up to eight can be used at a time. The recorders can also be uncoupled and used as individual units whenever required. Use of the mobile laboratory means that noise measurements can be made on site. This is more economical and efficient than carrying out experimental work in the Building Research Station's own grounds.

This laboratory is used for making noise measurements of various kinds and for testing the sound insulation of the structure of different types of buildings in all parts of the United Kingdom. Work is also carried out on the propagation of sound through the air over distances up to a mile or more—and the results are used, for example, to determine the level of aircraft noise in urban districts.

New Look for Grundig TK.40 Tape Recorder

The Grundig TK.40 four-track tape recorder has been given a complete new look. Breaking away from the familiar two-tone grey, the TK.40 is now styled in a cream and charcoal case. The price of this instrument remains the same—£78 15s. including microphone.

Demonstration Held in Newcastle

RECENTLY a Tape Recorder and Hi-Fi Exhibition was held in the showrooms of Fenham Radio, at 158 New Bridge Street, Newcastle. This exhibition, the third that Fenham Radio have arranged in their new premises was by far the most ambitious so far, and the most successful. Mrs. Rosen, a director of the firm, stated that the number of people attending the exhibition almost doubled last year's total. There were stands and demonstrations by all the leading makers with technical representatives on hand to deal with the numerous enquiries.

Some of the equipment had never before been seen in the north-east and the demonstrations in the Hi-Fi department were enthusiastically received. It had been decided that the exhibition should remain open until 8 p.m. on Thursday and Friday, and



Prisoners at Muidstone Gaol recently staged a week's Exhibition with the theme "History of Work", to which the public were admitted. A panel carried photographs of well-known personalities whose comments were heard on a Philips EL 3541 tape recorder using a continuous tape cassette.

this proved to be a sound move. Many enthusiasts who would otherwise have been unable to attend welcomed the opportunity to go to the exhibition after working hours. Both British and Continental tape recorders and radios were on show and the tiny transistor tape recorders drew quite a deal of attention.

"This exhibition has become an annual event now," said Mrs. Rosen, "and is growing in popularity each year. Although we have the largest electrical store in the north, we may have difficulty in accommodating all the exhibitors who wish to show again next year. Two-thirds of the space for next year's exhibition has already been booked."

There is no doubt that interest in Hi-Fi and tape recording is growing in the north-east, and exhibitions like these enable the enthusiast to see all of the latest equipment earlier than would otherwise be possible.

Magnetic Tape

NORMAL magnetic tapes have very low conductivity and are prone to static charging which can be disturbing both during manufacture and use. Various anti-static coating agents have been proposed but are not entirely satisfactory for one reason or another.

Patent No. 907,637 discloses the discovery that if the tape is given a very thin, that is, not more than 0.1μ , metal coating either on the back of the tape or underneath the layer of magnetic medium then static troubles are avoided.

The metal layer may be of aluminium, copper, silver, chromium, iron, cobalt or nickel and can be applied by vacuum vaporisation or by electrolytic coating. Such a thin coating does not interfere with the flexibility of the tape and has no effect on the magnetic characteristics. When the coating is on the back of the tape it can be covered by a protective lacquer without losing its anti-static properties. (Agfa Akt. Ges. Germany.)

TA/PA4 Recording Amplifier and Pre-amplifier

MANY readers have constructed the TWA 1515D stereophonic record and playback amplifier described in *Hi-Fi News* during 1960. Due to the number of letters we have received from readers we have commissioned A. W. Wayne to construct the TA/PA4, a recording amplifier and pre-amplifier. This will shortly be published in *The Tape Recorder*.

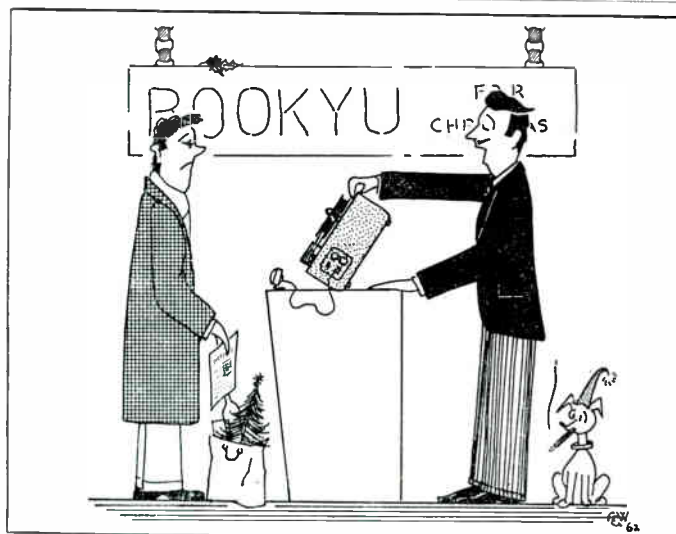

"Special Christmas line sir, works at any angle, with a remote control for under the table . . ."

NEWS AND PICTURES FROM



Some of the equipment owned by members of the Middleton Tape Recording Club seen on show at a recent meeting.

MEMBERS of the Walsall Tape Recording Club are wondering if their next night out with the portables will prove as dangerous and as amusing as their first.

As an entirely new venture, each member was required to obtain an initiative-test interview, and for his task Paddy Finnegan was required to obtain from a coloured immigrant his views on Britain's police. All went well in stopping a Jamaican pedestrian, giving preliminary explanations, and asking for his name and address and other initial information. The trouble, which caused all the laughter on playback, was after the relevant question had been posed. At the word "police" the subject and three companions became highly alarmed, and there was almost an ugly incident in which the interviewer expected to be assaulted at any moment as voices and tempers rose. Playback at club headquarters later the same night, provided members with their biggest laugh of the season as they heard Paddy try to extricate himself from an awkward situation.

Elsewhere outdoors, other members had been able to interview without incident several members of the public, including a desk sergeant on duty, bus crews and a member of the travelling public. Despite his experience, Paddy was foremost in declaring it a first-class night out which should be repeated soon. Meanwhile, members are still wondering what views the Jamaican has of the police—and of club members too.

Further details are available from *N. R. Thompson*, 123 Darlaston Road, Walsall, Staffs.

THE October 22nd meeting of the Whitstable and District Tape Recording Club was given over entirely to the B.A.S.F. film show and lecture. In addition to "The Magic Tape", there was presented a recent B.A.S.F. colour film entitled "Rainbow Makers", which dealt with other products of the B.A.S.F. organisation, paints and dyes, in a truly spectacular fashion. Mr. Parrington followed this with a talk on the history and developments of magnetic recording tape, and demonstrated different types of tapes and recordings on his Telefunken M24 recorder. In keeping with the generous tradition of B.A.S.F. towards the amateur recordist, tape mailing boxes, index booklets and tape calculators, etc., were distributed amongst those present. Incidentally there was a very good attendance of 36, and included members from Sheerness and Medway clubs. There were also a few more local recordists who had not previously visited the club. After the usual questions and answers session, the meeting ended with a hearty vote of thanks to B.A.S.F. and

to Mr. Parrington. Thanks were also expressed to Mr. Martin, proprietor of The Record Centre, in whose delightful record lounge the meeting had been held.

Arrangements for the proposed Talent-on-Tape contest are well in hand, and after some publicity in the local Press, entries are already coming in. There are six separate categories. Further details can be obtained from *T. Robinson*, 17a St. Anne's Road, Whitstable, Kent.

A new venture by the Walthamstow and District Tape Recording Society is an Overseas Circle. Membership is gained by introducing an overseas tape recording enthusiast willing to exchange tapes with the club. This idea was suggested by the founder of the Walthamstow Society, Mr. W. J. Tomlinson. Overseas contacts wishing to take part should tape or write direct to W. J. Tomlinson, 62 Beacontree Avenue, Walthamstow, London, E.17.

The second Christmas party to be run by the Walthamstow Society will be on December 21st at the "Lord Brooke" in Shernhall Street. Invitations to the Mayor and Mayoress, the local Press and businessmen have been accepted.

Secretary Ken Perks said, "We want to say thank you to so many people for all the co-operation we have had during the year, that we decided that the most practical way of doing so would be to ask them to our party. The big push in the Society's affairs during 1962 would hardly have been possible had the Town Hall and the local newspapers not given us the aid we have had". A really bright evening is planned on informal lines with many surprise items.

Further details are available from *K. Perks*, 9 Third Avenue, Walthamstow, London, E.17.

THE South Birmingham Tape Club entertained members of the Birmingham Tape Recording and Audio Club (B.T.R.A.C.) recently to a "Question Night". A panel consisting of two members from each club endeavoured to answer the questions put by the rest of the members. Discussions followed ranging from four-track recording, to impedances, but whether any members were really enlightened on the latter subject hardly mattered. It was agreed to have been a most enjoyable and interesting evening.

Earlier in the month, members of South Birmingham, Kidderminster and Cotswold clubs, held a special meeting at the Lenchford Hotel, near Stourport. Problems on the use of portable recorders, copyright, etc., were discussed and a demonstration was given on a new transistor recorder. During a most excellent tea, members of the clubs were able to discuss their individual problems. The meeting proved an opportunity of extending individual club activities into a wider field and it was hoped that another similar meeting be held later in the year.

Details can be obtained from *J. T. Gilbert*, "Woodside", Box Trees Road, Dorridge, Solihull, Warwickshire.

ON September 26th members of the South Devon Tape Recording Club took part in a "Sound Hunt" organised by the treasurer Jeff Brooke-Stewart. Four teams were formed with one battery portable, one car and one sealed envelope each. The sealed envelopes containing details of sounds and interviews to be collected within an hour. Later in the evening the tapes were played back along with accounts of some of the things that happened to members whilst obtaining them. These included a description of the club chairman chasing an unwinding reel of tape across a railway platform.

On October 10th at the Y.M.C.A., Castle Circus, Torquay, committee member David Pletts gave a talk entitled "How

THE CLUBS

recording began and how it has developed." Many recorded examples were played ranging from a recording made on a wax cylinder to a modern tape record. The occasion was also the club's second birthday meeting and during the interval, members made short work of a cake decorated in the form of a tape recorder by Shirley Furneaux.

The following evening, members joined forces with the Torbay Gramophone Society when club president Donald Aldous gave a talk entitled "Tape Recorders To-day" including many of the latest releases, mono and stereo. The advantages and disadvantages of tape over disc were discussed.

The former honorary secretary of the club Jean Pletts has unfortunately had to resign her position. The new secretary is Lyn Wright, 12 Sherwell Hill, Chelston, Torquay.

* * *

TO be a tape recorder owner you have to be either a millionaire or a young Edison. This was the view of a member of Enfield Recorded Music Society in a debate with North London Tape and Hi-Fi Club. Subject: "Disc or Tape?"

Other objections to tape were: it is complicated (too many tracks, speeds, different-sized reels and tape thicknesses); rev. counter "rather vague"; awkward to handle; breaks easily; expensive. But members of the tape club retaliated vigorously—and not one point raised by the "opposition" was unanswered. A show of hands acclaimed the winner as Tape. Both clubs enjoyed the debate immensely and everyone learned something they did not previously know.

A film show proved the feature of a visit by BASF representative, Mr. Parrington, who listed many uses of tape.

The only serious tape in the club's 11th competition—a crime story—took the prize, which has previously gone to a comedy entry. The winner—Derek Moor—produced a completely unscripted six-minute documentary of the war-time destruction by the Germans of the Czechoslovakian village Lidice. This is the first time that Derek had ever entered any tape competition. Sound effects, including a creaking gate and a car moving off, have been recorded by members and played back at performances of an Enfield amateur dramatic society.

Further details are available from R. Collinson, 30 Ridler Road, Forty Hill, Enfield, Middlesex.

* * *

THE Middleton Tape Recording Club has moved into new premises, and one of its first tasks in the new room was to elect a new honorary secretary in place of Mr. G. E. West who has had to resign from the post he so energetically and efficiently held. The new honorary secretary is J. R. Wits, 119 Heywood Old Road, Rhodes, Middleton, near Manchester.

* * *

ON October 7th, the Boston Soundhunters had their first "Sound Hunt" when they spent a sunny Sunday afternoon recording Mr. Herbert Epton's fairground organ at New Bolingbroke. Monaural and stereophonic tapes were made. Many passers-by joined the visitors to listen to the music and photograph the 1912 organ which Mr. Epton has renovated. It had stood unused for twenty years, and the rats had ruined much of the instrument when he salvaged it.

After two intensive sessions on tape editing, during which a mock interview with Sir Adrian Boult was produced by the club's leader, Philip Towell, a competition was judged on October 23rd. Each entrant had received a four-minute tape of a talk by Mr. Roy Sykes about the St. Nicholas Youth Club in the town. It had to be reduced to a maximum of 2½ minutes, and the winner was Tony Jewers, of Elmwood Avenue, who received the Emiguide on Editing. Members then heard Bromley Tape Club's entertaining "Quest for Glink", in which each of their members had contributed a short section serially in story

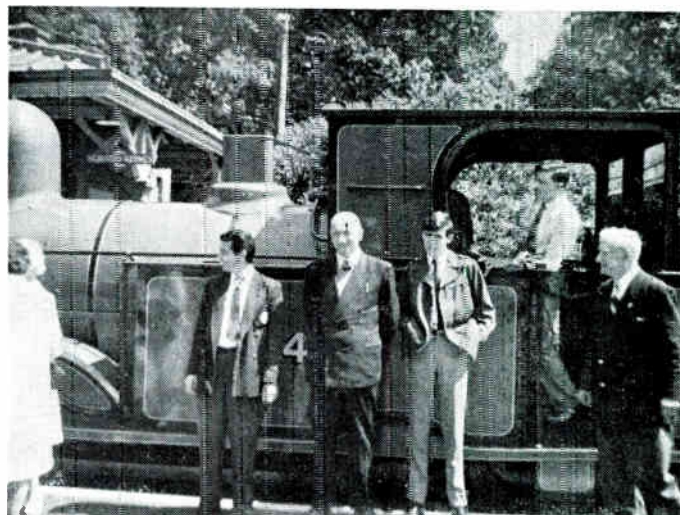

Members of the Dartford and District Tape Recording Club photographed during their visit to the Bluebell Railway.

form (complete in some enterprising cases with sound effects and incidental music).

At this meeting four members of the Skegness Amateur Tape Recording Society paid a return visit. Apparently all their members are under 25 years old—quite the opposite of the Boston group. There are still some vacancies before the membership list is closed. Details available (including programme until May 1963) from: P. Towell, 107 Spilsby Road, Boston, Lincolnshire.

* * *

ON November 1st the Cotswold Tape Recording Society (Cheltenham) welcomed Mr. K. F. Russell, Technical Director of Wharfedale Wireless, who brought with him a comprehensive selection of Wharfedale loudspeaker systems.

He began his lecture by demonstrating a horn-loaded dynamic speaker by BTH, dating from the 1920's. This nostalgic piece of equipment brought back happy memories for those members lucky enough to be old enough to recall those early days of "wireless"; and at least one of these wondered if the increased fidelity of today really compensates for the thrill of those early, scratchy, sounds-through-the-air.

Tearing himself with obvious reluctance from those pioneer days, Mr. Russell gave an account of the problems of loudspeaker construction, stressing the improvements made possible by better magnetic metals and cone-suspension materials. His talk was illustrated throughout by music provided by a Tandberg recorder, playing through Quad amplifiers.

After the intermission, many questions, theoretical and practical, poured in; and the meeting ended with a stereo tape which had been recorded in Cheltenham Town Hall by Peter Duddridge. Norman Tustain also brought along some choral and orchestral recordings made on his TK20, using the Simon Cadenza microphone. Further details can be obtained from P. D. Turner, Pike Cottage, Frampton Mansell, Stroud, Glos.

* * *

THE Annual General Meeting of the Ipswich Tape Recording Club was held recently, when the chairman, Mr. B. Osborne, reported on the events of the past year and recalled the club's outside activities which included visits to Anglia Television's studios at Norwich, I.T.A. transmitter at Mendlesham, Ipswich Co-operative Society's dairy, Ipswich telephone exchange and Tollemache-Cobbold breweries. The outstanding demonstrations of the year were by B.A.S.F. Limited and Grundig (G.B.) Ltd.

Further details can be obtained from the club's Public Relations Officer, K. E. Lingley, 49 Tranmere Grove, Ipswich, Suffolk.

* * *

A New Club

MR. K. CUBLEY, 25 Warrington Road, Hanley, Stoke-on-Trent, Staffs., is interested in starting a tape club in the Stoke-on-Trent area. Any interested readers should contact Mr. Cubley at the address given above.

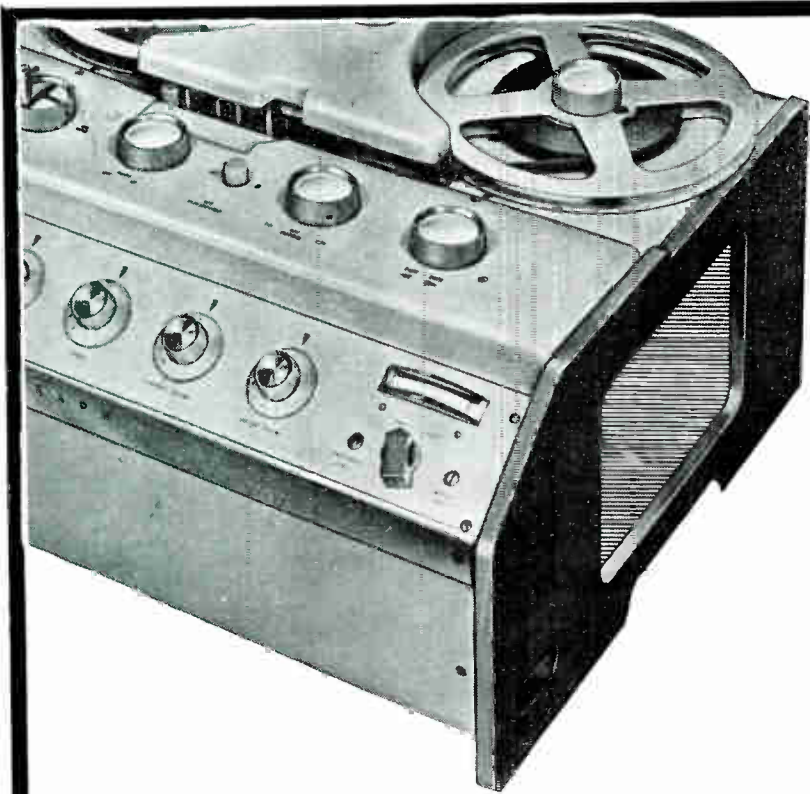

*A dream that
comes true . . .*

This is the *quality* tape recorder. Elegant in design and performance—the **REFLECTOGRAPH** is built, all through, to professional standards—yet is especially suitable for use in the home.

If you have a critical ear for music and sound generally—then undoubtedly the **REFLECTOGRAPH** is the tape recorder for you.

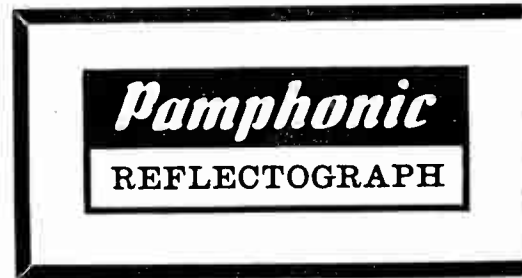

THE TAPE RECORDER THAT YOU HAVE DREAMED OF

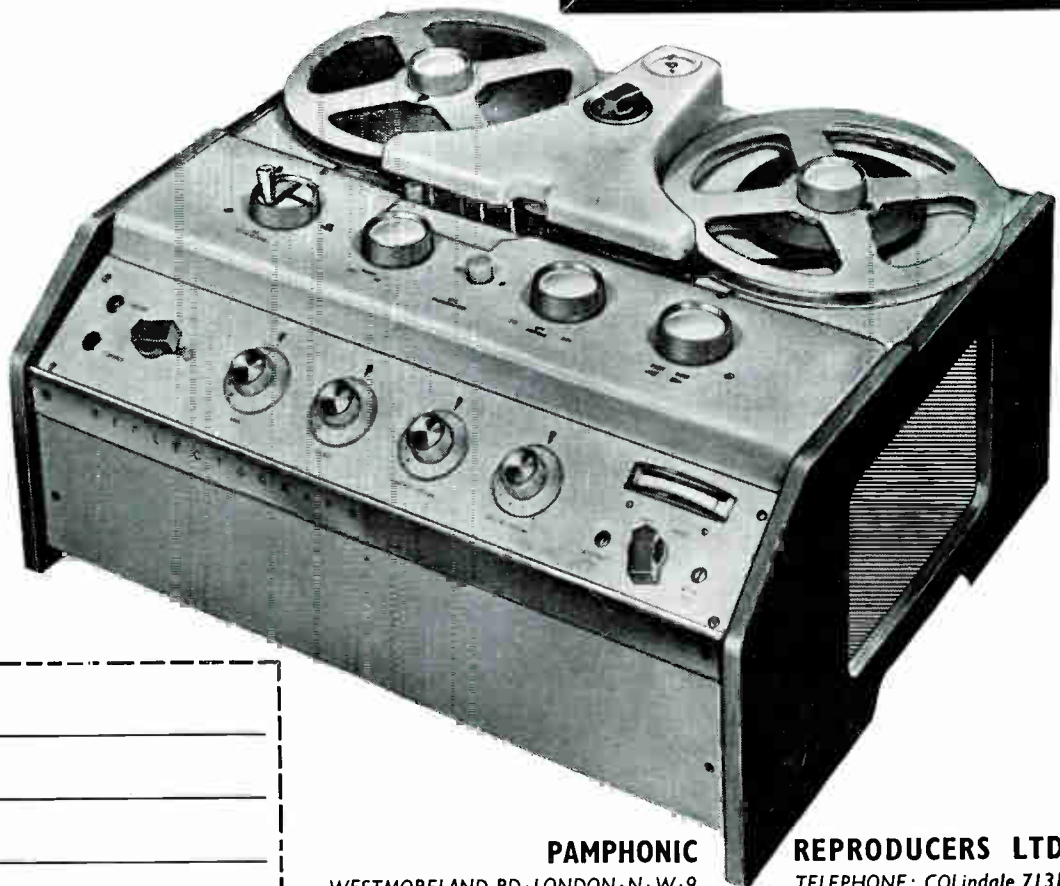

*For full details of
this exciting range
of tape recorders send
completed coupon for
coloured brochure*

name _____

address _____

DaP1262TR

PAMPHONIC
WESTMORELAND RD · LONDON · N · W · 9

REPRODUCERS LTD
TELEPHONE: COLindale 7131

A TAPE TOUR OF PARIS

WHEN M. Jean-Pierre Dubreuil invited us to his sight-seeing agency, we did not know he intended to take us on a trip in one of his double-decker coaches, now familiar to Parisians.

Sitting among the foreign tourists, we pondered uneasily on the multilingual commentary which we were going to have to suffer from some polyglot guide. What awaited us was entirely different, and to give you an idea, we have borrowed the following passage from an account by Pierre Daninois, full of life as usual, which recently appeared in *le Figaro*.

"Earphones in place, I listen to the 'Voix d'Or des Circuits du Trésor' describing Paris in five languages simultaneously, and

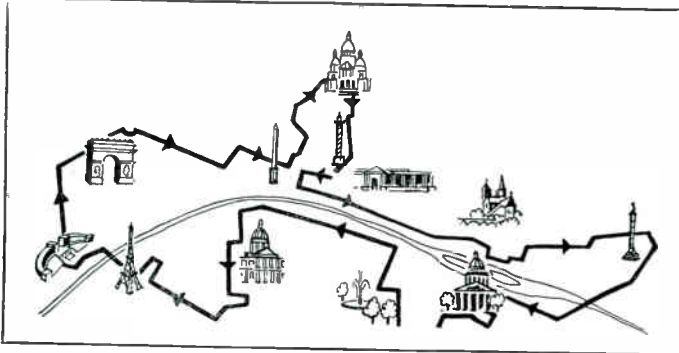

to complete the miracle, at the touch of a finger on the automatic selector, I have the Obelisk in Swedish and the Eiffel Tower in English". In fact, there are eight keys set in the arm of each seat, giving a choice of eight languages. German, English, Spanish, French, Dutch, Italian, Swedish and Russian. The back of each seat is equipped with two low-powered speakers having flexible leads.

The equipment was constructed from materials supplied by Précision Cinématographique and is entirely transistorised. The eight-track "Tape-lecturer" uses 25 mm tape. Each magnetic head is connected to one of eight amplifiers (partly visible at the bottom of the photograph) and eight screened leads are connected to the selector keyboard at each seat (see photograph, showing the keyboard, in the lower right-hand corner). At the side of the

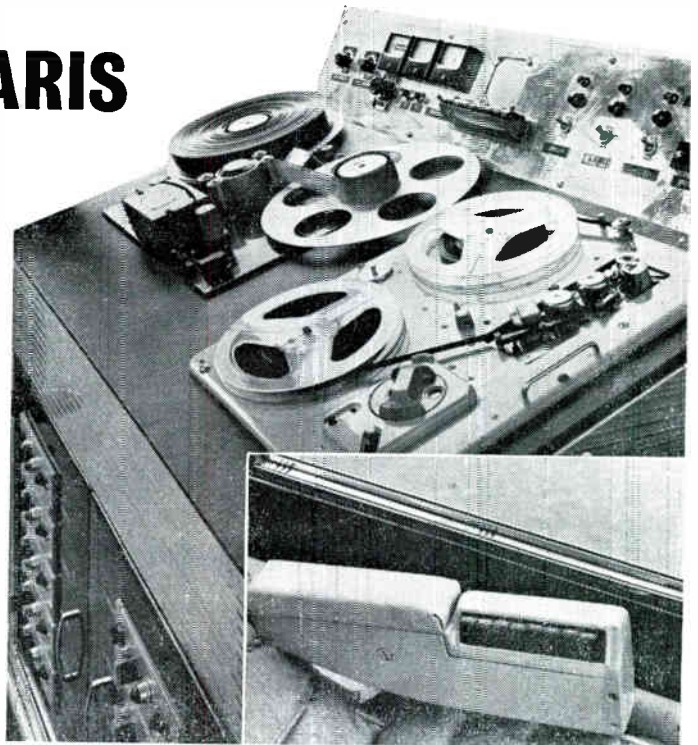

"Tape-lecturer" is a Ferroglyph deck which plays background "atmosphere" music.

The tour of Paris is divided into 70 sequences of different lengths but none exceeding a few minutes. The coach driver follows a pre-determined itinerary and starts the apparatus at each desired point during the tour. Starting the eight-track commentary automatically fades down the background music. When the commentary ends, it is automatically switched off by a stop-foil on the tape and the music fades up again to normal volume.

Five Cityrama coaches were already fitted out and a sixth has since come into operation. The first coach has been working without a breakdown for over three years.

Readers visiting Paris during 1963 would be well advised to keep a keen eye open for these coaches. The equipment is situated at the rear of the coach, and even if a tour cannot be arranged, a look through the rear windows would be very rewarding. (Reprinted by kind permission of *le Magnéphone*.)

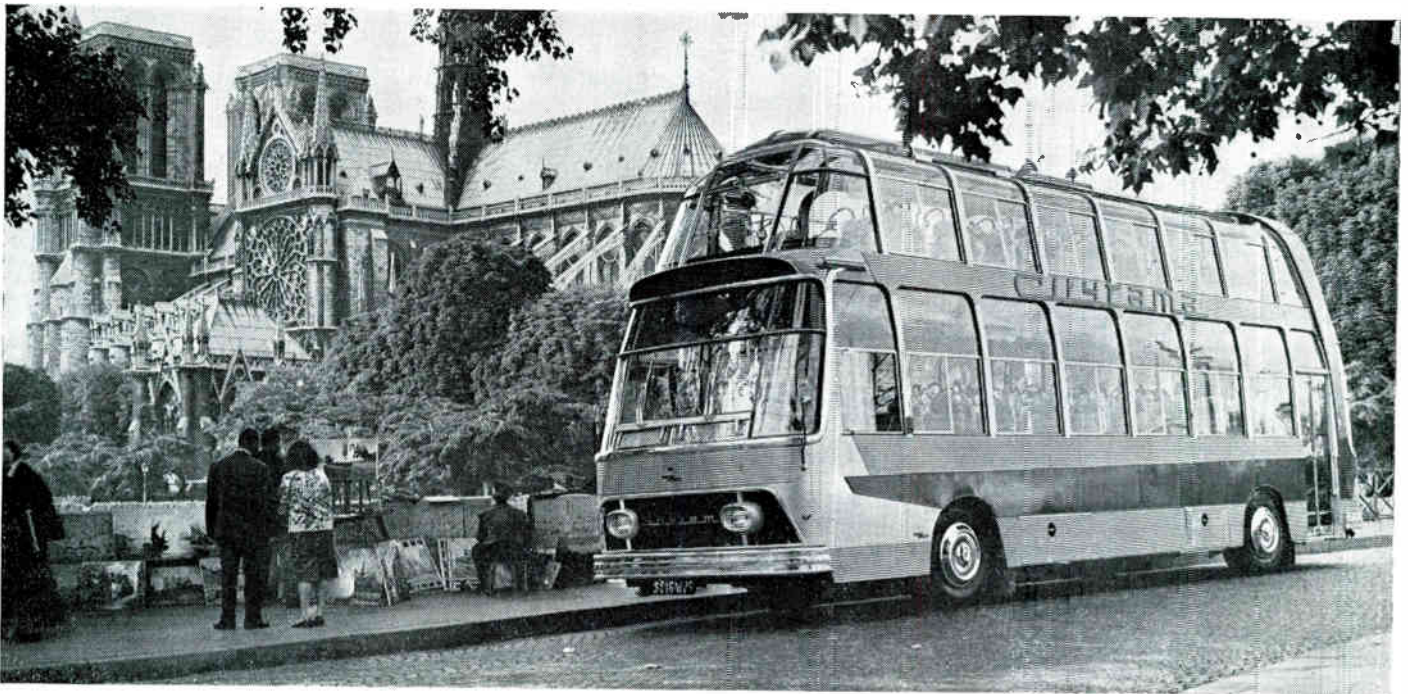

Taped sound breaks through the price barrier

NEW FERGUSON 4-TRACK RECORDER GIVES YOU MORE FEATURES FOR LESS MONEY

How is it possible for the price? The answer lies in the years of designing and engineering effort that Ferguson have spent in producing a tape deck of their own. This recorder is *all* Ferguson. That's why it cost less to build. The cost saving has been passed on to you first by lowering the price, and then by cramming it with all those features you never dared hope to afford. Sceptical? There's only one cure for your scepticism. See the new Ferguson recorder at your dealer's. Trust to the evidence of your own eyes—and ears. Trust to the reputation of Ferguson. And finally, trust to your own instinct for value.

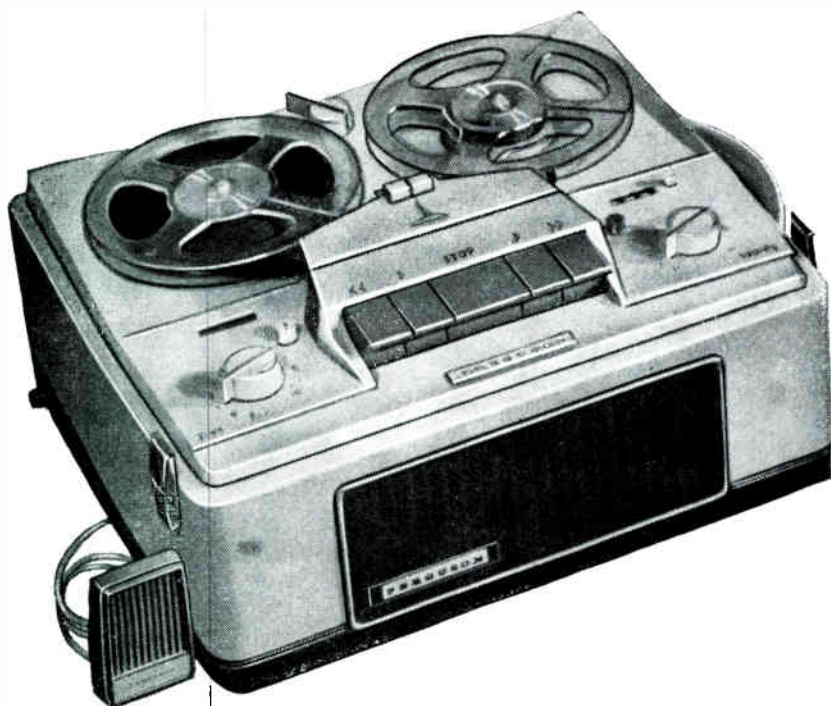

- Piano Key controls
- Tape "inching" facility
- Four-track, two speeds:
3 $\frac{3}{4}$ " per sec., 1 $\frac{7}{8}$ " per sec.
- Reel diameter: 5 $\frac{3}{4}$ "
- Fast spooling in both directions
- Pause control
- 'Play-through'/Superimpose Button
- Press-button reset for tape position indicator
- Automatic stop operates at both ends of tape
- Electron beam recording level indicator
- Weight 19 lbs.

Complete with microphone (incorporating remote control switch), 850' long play tape, take up spool, connecting leads. Powered accessories socket, using suitable attachments, enhances scope of recorder with playback of stereo tapes, track to track recording synchronization, automatic stop/start by voice or signal, synchronized slide projector/recorded commentary operation, etc. etc.

33 MODEL 3202
GNS

A new twin-track single-speed Ferguson, too! Incorporates almost all the features of the four-track model, yet the Ferguson 3200 costs only **26 GNS**

FERGUSON



THORN ELECTRICAL INDUSTRIES LTD., THORN HOUSE, UPPER SAINT MARTIN'S LANE, LONDON, W.C.2

482

TAPE RECORDER SERVICE

No. 12 BRENELL RECORDERS

By H. W. HELLYER

PREVIOUS articles in this series have dealt with those tape recorders that have reached the widest market. The reason is obvious: these are the machines that have occasioned the most correspondence. But an increasing number of readers request information about decks and circuits, and they ask, "When are you going to deal with the so-and-so?"

These queries are answered individually—even those, which do not bring with them a stamped addressed envelope. Where a question and its answer may be of wider interest, space is sometimes found for its publication, as on page 341, September 1962 issue of the *Tape Recorder*. A more detailed discussion of certain decks, with diagrams of parts of the mechanism most likely to need attention, or of special interest because of their individual design, becomes necessary when several readers pose similar problems. It is hoped that the following notes on the *Brenell* range of tape recorders will be of interest not only to those fortunate enough to own one of these excellent machines, but also to the reader who likes to know what goes on "inside the box", even though he would never dream of taking up screwdriver and soldering iron himself.

Brenell Three Star

This is a three-speed ($7\frac{1}{2}$, $3\frac{3}{4}$, $1\frac{1}{4}$ i/s), single-motor machine, recording half-track to international standards, with spools up to 7 inch diameter. The rewind time for a 1,200 ft spool is approximately 55 seconds, and there are several special features, including a visual indicator for record, playback and amplifier (or neutral) function, which consists of a coloured slide, red, green and white, respectively, with a pilot lamp behind the "window". There is provision on the head mounting plate for the fitting of additional heads.

The mechanism of the *Three Star* may at first sight seem a little complicated. An attempt to reduce it to essentials has been made (see fig. 1). In this drawing, the motor pulley *A* and the flywheel *F*

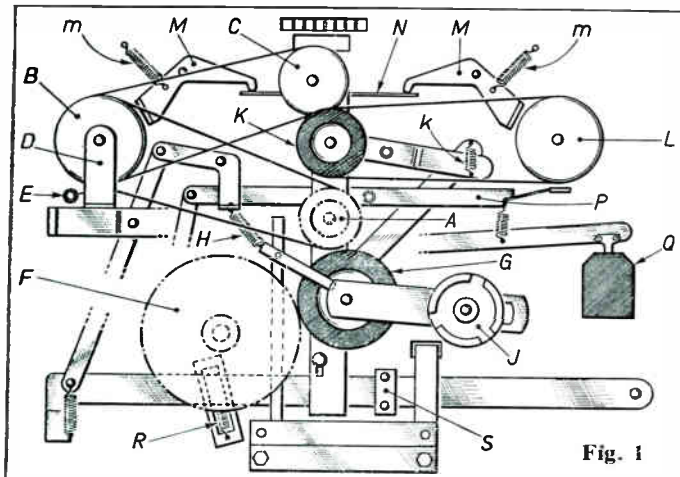

are shown dotted, to indicate that they are mounted on a separate sub-plate. This palette-shaped fitting has been omitted, for ease of explanation. Pulley *A* is stepped, and the intermediate wheel *G* engages the appropriate step when raised or lowered by the action of the cam *J*. Beneath this cam and lever—that is, nearer the deck-plate—is a set of cogged drive levers. Note that the pull on the bearing bracket for the intermediate wheel is regulated by a spring, *H*, which should be checked first when there is a suspicion of erratic capstan speed.

On this machine—as on any other that employs the intermediate wheel type of drive, or speed change—it is important that controls be mechanically returned to neutral before the tape recorder is switched off. Despite recent improvements in materials, rubber tyres of idler

and intermediate drive wheels do not take kindly to being left in engagement and, consequently, under pressure at one spot on their circumference. A very slight flattening of an intermediate wheel can lead to quite serious tape speed variation. In the early stages this may show up as a kind of mild flutter, and it can be difficult to trace. The clue is always the frequency of the irregularity and the proportionate change in flutter rate when the different tape speeds are selected. A logical approach to the problem will sometimes indicate this fault, where actual measurements are difficult to make, and where the naked eye is useless for spotting irregularity.

Drive to the take-up spool is via a plastic belt to the clutch drum *B*. (Direction of tape travel is left to right, *B* is the right-hand spool drum, fig. 1 is a view of the underside of the deck.) A special feature of this

Fig. 2.

Wiring diagram of the motor system used in the Brenell Mark V.

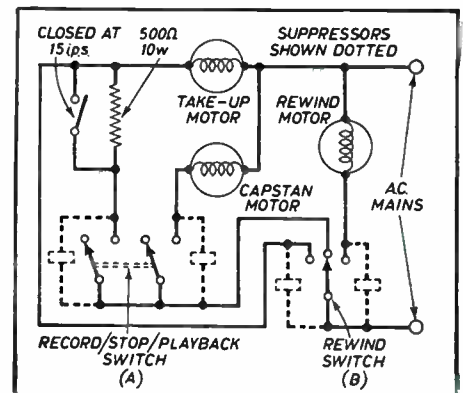

machine is the clutch bracket *D*, which has a grease-filled bearing cap and a tension spring, shown in end view at *E*. This clutch bracket is pivoted near its base, to provide full torque to the spool carrier for fast forward winding. It is most important that the tension of this spring *E* is correctly adjusted so that clutch slip on take-up during record and playback is sufficient at the start of spooling. The end of the spring nearer the base of the bracket (toward the deck-plate), is attached to a tag, held by a screw. The angle of the tag affords adjustment.

A section of this clutch assembly carries the thin rubber belt for position indicator drive *C* and the brake drum is between these two belts. Note that the fixing of the drum section to the spindle is by grub screw. If this should work loose, erratic take-up may be experienced, and it should be first observed that the revolution counter is working correctly, indicating that the lower drum has loosened, whilst the prime drive is in order. But if the rev. counter is also erratic, the culprit may be the clutch bearing bracket itself. Check that the cup is adequately greased but beware an excess of grease at this point, so near the moving belts. A further clue to trouble at this stage of fault-finding is stiff clutch action on the take-up side when the pause control is operated—in other words, when the clutch is slipping only against the reverse tension of the pull of the tape. This should lead one to check spring *E*, which may be found to be too tight.

Braking

The other spool carrier, whose drum *L* is driven by a belt from the idler pulley *K*, is lightly braked by the operation of the pause control, via the action of lever *P*. This reservoir spool carrier is directly clutched; engagement of the idler with the motor pulley is aided by the spring *k* when *Fast Rewind* is selected. A slowing down of fast rewind when a full spool is loaded may well indicate this spring has relaxed.

Braking is direct, with felt-lined pads on swivel arms *M* actuated by the withdrawal of the brake lever arm *N*. There should be a 1/32 inch clearance between this arm and the brake levers when the controls

The truth, the whole truth, and nothing but the truth

Here, surely, is the very essence of the art of Tape Recording and, indeed, the objective of every serious enthusiast, namely to record the truth, the whole truth, and nothing but the truth. It is also *our* objective, and we of the Ferrograph organisation are proud of the fact that during the 14 years of our existence we have been able to make some contribution to the art. It has never been our practice to make extravagant claims in respect of the Ferrograph; we prefer to state the simple facts, and to let the instrument speak for itself.

From the very beginning (when the Ferrograph was the only Tape Recorder designed and commercially manufactured in Britain) we have concentrated all our energies to one end—the attainment of the highest possible standards of fidelity in Tape Recording. How far we have succeeded in attaining those standards we leave

to others to judge. Nevertheless, we have grounds for believing we have come within striking distance of our objective, how otherwise can the following facts be explained? First, a large number of discerning enthusiasts in all parts of the world are owners of the Ferrograph, an instrument for which they willingly paid a price substantially higher than that of the average tape recorder. Second, Broadcasting and Television organisations, to whom the maximum standards of performance are essential, regularly use the Ferrograph. Finally, demand for the Ferrograph is always ahead of supply.

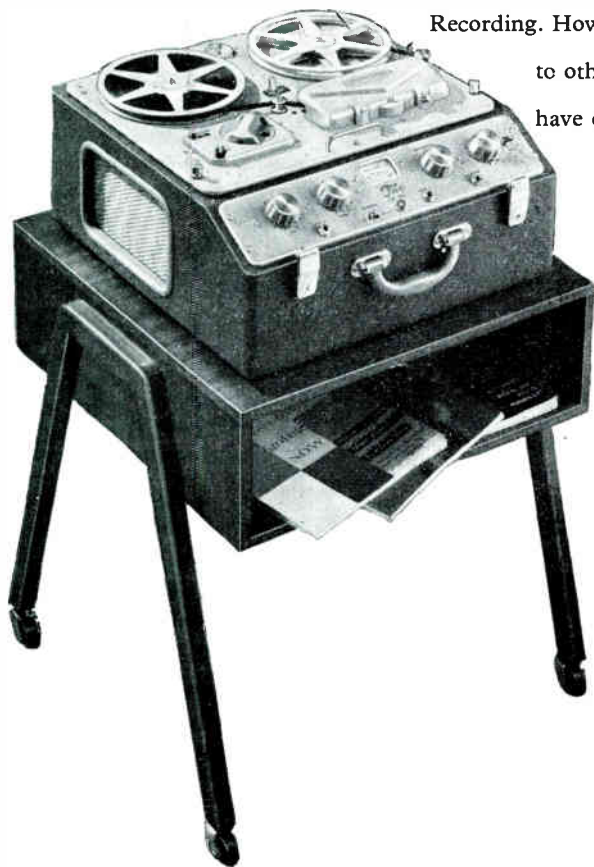

Series 5

Monophonic recording and reproduction.
Model 5A/N (3 $\frac{3}{4}$ /7 $\frac{1}{2}$ i.p.s.)
85 GNS

Series 420

For Monophonic and Stereo recording and playback, with monitoring, re-recording from one track to the other, introduction of echo effects and many other advanced features. Requires power amplifiers and external loudspeakers.

110 GNS

Three Independent Motors · Recording Level Meter · Brief Stop · Switched Speed Change with Compensated Correction Network · Separate Tone Controls · Uses 8 $\frac{1}{2}$ " Tape Spools · Gear Driven Turns Counter · Automatic Switch cuts Motors at end of Spool · Endless Loop Cassette (Optional Extra)

The Incomparable **Ferrograph**

THE FERROGRAPH COMPANY LTD.

84, BLACKFRIARS ROAD, LONDON, S.E.1

Telephone: WATERloo 1981

TAPE RECORDER SERVICE—(continued)

are switched to "Off". The two springs *m* are used to assist engagement, and their tension should be checked if braking is sluggish. A small, auxiliary brake retards the reservoir spool during "Pause" action. This is mounted on the end of lever *P*, with a small, hold-off spring attached to the arm that operates the main on-off switch *Q*.

Note that lever *P* is pivoted just to the right of centre and attached at its left-hand end (in fig. 1) to another lever, whose full length is not shown in the diagram. The lower end of this latter part bears an angle-piece which is used to withdraw the pinch-wheel assembly from the capstan. The spring *R* provides the inward pressure for the pinch-wheel assembly, and sluggish return after operation of the "Pause" control should lead to investigation at this point.

The actual pressure of the pinch wheel to capstan can be regulated by the lower of the two screws in the bracket *S*, which forms a bridge across the main operating bar, shown transversely across the bottom of the diagram. The setting of the complete pressure-pad assembly is regulated by a crescent lever and stop on the top of the deck, as shown in fig. 3. This is a diagram of the *Mark V*, but, apart from the tensioning arm *D*, the *Three Star* is similar, and reference should be made to the adjustment details given below.

Amplifier

Electronically, the *Three Star* is a pleasure to service. The amplifier is simply removed, the power unit is separate, and an octal plug and socket connects the main assemblies. There is one point that needs attention: when the deck is dismantled from the tape recorder, care should be taken not to damage the lever that is used to link the function switch.

Frequency correction during "Record" is selected by the operator, by a switch at the lower right-hand side of the deck, giving peaks at 14, 8 and 4.5 Kc/s for the three speeds $7\frac{1}{2}$, $3\frac{3}{4}$ and $1\frac{7}{8}$ i/s. The switch selects appropriate components in a T-network between the EF86 1st amplifier and the input of the second triode of the ECC83. In this way, a feedback loop over the first triode of the ECC83 is obtained. This is only during "Record". For "Playback", the correction is to CCIR standards, giving a response of 60–10,000 c/s \pm 3 dB at $7\frac{1}{2}$ i/s. Separate treble and bass tone controls allow the operator scope for personal adjustment. The output valve is an EL84 (used as oscillator during "Record"), delivering 4 watts from the 7×5 in. loudspeaker. When servicing, note that the screening can around this valve is at heater potential, not chassis. Care must be taken not to short circuit the heater line.

On the subject of the heaters—hum elimination is aided by a pair of 100 ohm resistors from the heater line to chassis, providing a potential centre-tap. These are fitted on the printed circuit panel side of the connecting plug, and are chosen for minimum hum. A further improvement may be effected by the insertion of a 200 ohm wire-wound variable component in place of these two resistors, with the slider connected to chassis.

The Mark V

This is a more comprehensive model which uses three motors (earlier models had BTH shaded-pole motors, later models had a *Papst* motor for flywheel drive). A sleeve is provided for doubling of the basic speed, allowing the machine to be used on the "quality" speed of 15 i/s. Again, speed selection is by idler pulley which slides along a stepped bracket, its lever attached to the speed selector switch by a bush and two screws. Visual indication of function is similar to the *Three Star*, but the indicator is mounted on the main deck, as is the function switch.

There are several special features, including the stabiliser brake acting on the spindle of the feed spool drum, holding off action of tape from heads during rewind (by pin *A*, in fig. 3), tape tensioner (*D* in same diagram), short-circuiting of the erase head on "Stop" and "Playback": and, as in the *Three Star*, selection of frequency correction during "Record".

Checking the Stabiliser Brake

Checking the action of the stabiliser brake is best done by making a loop of tape between the feed spool and the left-hand guide and allowing the machine to run on "Playback", noting the amount of

wow. Over-tensioning of the stabiliser can accentuate wow, under-tension will lead to a tendency to spillage when "Pause" is operated.

A further cause of wow could be looseness of the capstan sleeve, which is retained by a grub screw near the base. The makers advise that there should be about an eighth of an inch clearance below the sleeve. They also recommend that the larger sleeve be used for smoother drive, only utilising the smaller for $1\frac{7}{8}$ i/s. However, there are other factors affecting this decision. On 15 i/s, full mains power is applied to the take-up motor, and overheating may be experienced. If the 15 i/s speed is not intended to be used, but $1\frac{7}{8}$ i/s is occasionally required, the smaller sleeve can be left in place and the connection between the 15 i/s switch and the 500 ohm, 10-watt resistor removed.

This resistor is a prime culprit when take-up is faulty—and this remark also applies to other machines. Always replace with a good quality, high-wattage component and mount it spaced away from tag strips and other components to allow maximum cooling; this component dissipates a good deal of heat. Fig. 2 shows its position in

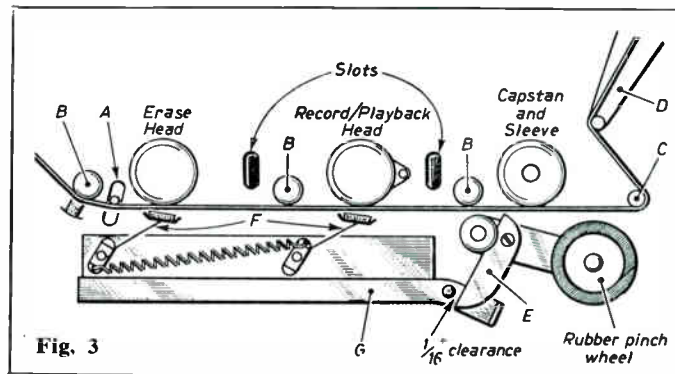

Fig. 3

circuit, and the principal switching of the motor system. Note the provision of suppressors, shown dotted. When dismantling, take care not to damage the fine wires connecting these suppressors.

Brakes on the *Mark V* are of the drum-bearing type, cork-lined, and adjustable by two 4 B.A. screws in the actuating bar. The gap between the brake levers and the screws should be $1/32$ in. with the machine switched to "Stop". Remember to tighten the locknuts afterwards.

Adjusting the Pinch Wheel

Adjustment of pinch pressure (for both these models) is first as set out previously, by a setting of the prime lever from beneath. The pressure-pad assembly, however, requires a separate adjustment. In fig. 3 the main parts on the head assembly plate are shown. This plate is easily removed for service, being retained by six screws. Note the provision of mounting space for additional heads. Tape guides are shown at *B*, the hold-off pin previously mentioned is *A*, and a guide pin mounted on the pinch-wheel bracket is *C*.

On the inner side of the pinch-wheel is a crescent lever *E*, which should be adjusted for $1/16$ th inch clearance from the stop-pin when the larger sleeve is in use on the capstan spindle. This regulates the travel of the mounting bracket *G*, on which the pressure pads *F* are fixed. A wide range of adjustment is possible.

The spool height is also adjustable within small limits, by grub-screw fixing of the spool-holders to the motor spindles. When adjusting these 4 B.A. screws, take care not to damage the brake drums or revolution counter drive (an insulated insert and pulley). There are 2 B.A. screws in the top of the spool-holders for final adjustment of level.

These adjustments should not be touched unless a fault is diagnosed which affects their positioning. But a deck of this description does allow a very close tolerance in working conditions, and the minor points can be checked. A further small alteration, which can affect the running and perhaps cause wow, is the height of the idler which engages the motor pulley. There is a bush on the end of the link of the support lever, with grub-screw fixing. Remember to allow for the inevitable end-play.

As a final point, if this deck is used with separate amplifiers, etc., note that the screening of the head leads is not earthed at the deck end. Inadvertent short-circuiting, especially of the erase head, can be simply overlooked. And the physical mounting should incorporate rubber grommets, leaving at least $\frac{1}{4}$ in. clearance for ventilation.

MALLORY

the greatest dry battery development for more than 80 years

Mallory batteries are built differently—*outside* for complete protection against corrosion and leakage—*inside* for longer life and more energy output.

A Mallory battery holds its power—does not fade either in use or when standing idle. It gives more hours of service than other types *without* the need for rest periods. And its steady discharge characteristic ensures better results throughout the extended life... eliminates those troubles that occur when normal batteries get tired.



for all battery powered portable recorders —

specify

MALLORY

batteries for staying power

MALLORY BATTERIES LTD

Crawley Sussex Crawley 26041

... tape recorder workbench

No. 41. THE MULLARD TYPE "C" AMPLIFIER

by A. Bartlett Still

ONE of my readers from Herne Bay, in Kent, has taken up my recent invitation to pass on any problems of a practical nature, particularly if they were suitable for discussion in this column. Here are a few sentences from his letter: "The machine features a *Collaro Mk. IV "Transcriptor"* deck and a *Mullard type C* amplifier (home built) feeding a *Verdik* 10 watt main amplifier. The fault is that the overall frequency response of the recorder has a peak of about 20 dB at 5,000 c/s at $3\frac{1}{2}$ i/s (the only speed I have seriously tested; other speeds show similar boosts in the treble response)". He then goes on to describe some tests that he has made, and the equipment he used.

The sum total of the information, in respect of the amount of treble boost applied during the recording process, is an indication that the amplifier is performing correctly, according to the *Mullard* publication describing the type C. He also states that the tape deck and amplifier replay perfectly, (presumably using a tape record or some similar acceptable standard, though this is not stated).

Various Types of Heads

This is, of course, where I start treading on rather thin ice. It is one thing to give some thought to a problem such as this and arrive at what would seem to be a reasonable conclusion; but it is quite another thing to question, or appear to question, a *Mullard* publication, particularly when the figures it gives were obtained when using *Collaro* record/playback heads. However, there have been various types of head fitted to the *Collaro* decks and it may well be that the head on the machine we are now considering is of a later type.

What difference is this likely to make? In order to explain this as simply as possible I have prepared some fictitious response curves. They are fictitious in that I would not be prepared to refer to any particular make or type of heads, but they may be taken as sufficiently accurate for use as examples. In fig. 1 is a representation of the unequalised tape response from each of two tape heads. Let us assume that the one marked *A* has an

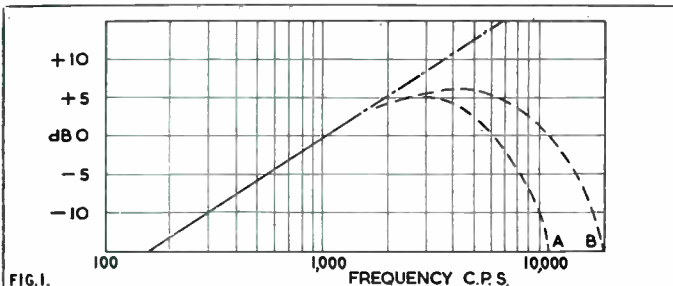

Fig. 1. Assumed tape response for heads "A" and "B".

effective gap width of $\frac{1}{2}$ thou; while that marked *B* has the more modern gap width of $\frac{1}{4}$ thou. Both these curves are derived initially from the basic tape response, being a straight line rising at the rate of 6 dB per octave with increasing frequency. Once a certain frequency has been reached, however, other factors have to be considered, all of which cause a falling off in the output. One of these is known as "tape thickness loss" which quite simply means that high frequencies, because of their shorter wave length, will not penetrate and magnetise the oxide to its full depth, resulting in a weaker signal. (This, incidentally, explains why long- or double-play tape appears to have a better high frequency performance.) The high frequency output is the same but the low frequency output is less because of the reduced oxide thickness.

We also have losses due to the self erasing effect of the shorter magnets produced by the higher frequency signals, and due to the fact that higher frequencies are more readily erased to some

extent, as they are recorded, by the recording bias. The main effect to be considered at the present time, however, is the "gap effect". When the effective gap width of the head exactly equals the wave length on the tape of the signal frequency complete cancellation occurs and no signal can be replayed. For this reason both curves *A* and *B* take a nose-dive down to a theoretical zero output. The frequency at which this occurs will depend first on the gap width and second on the tape speed. While it must be admitted that I have been asked to consider an example primarily concerned with $3\frac{1}{2}$ i/s, the curves I have shown are based on a tape speed of $7\frac{1}{2}$ i/s. This will not, I hope, confuse the issue; the only curves I have available from past measurement were taken at the higher speed. You can rest assured that the principles remain substantially the same within a wide range of tape speeds.

Record and Replay Amplifier Characteristics

In my fig. 2, I reproduce record and replay amplifier characteristics typical of an amplifier such as the *type C*. Now the overall record/replay characteristic will always be the net result of these three curves, the unequalised tape response, the record equalisation and the replay equalisation. By summing these

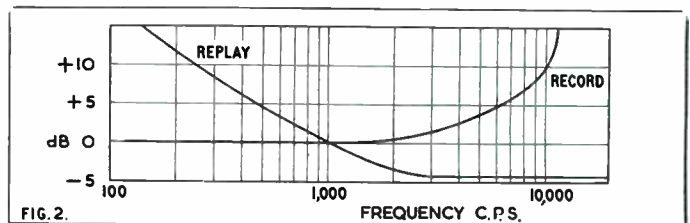

Fig. 2. Approximate record and replay characteristics, Mullard type "C" amplifier.

three curves—i.e. by taking sum and difference figures about the zero dB line one can produce the theoretical overall response curves shown in figs. 3 and 4. Neither of these, admittedly, shows a peak of 20 dB. But the curve for head *B* shows the greatest output at a frequency of just over 10 Kc/s with a peak of about 7 dB. If we remember that this is taken at a higher tape speed and refer to the *Mullard* record response curves a similar peak would occur, at $3\frac{1}{2}$ i/s, at a frequency of just over 5 Kc/s. The magnitude of this peak would be dependent upon a number of factors. On the one hand component tolerances in the amplifier can vary the amount of record treble emphasis at any frequency while on the other the make of tape, head characteristics and bias level can all affect the exact shape of the curve of fig. 1.

Treble Emphasis

The curve of fig. 4, then, would seem to indicate that at the frequencies between 2 Kc/s and 10 Kc/s too much treble emphasis is being applied, for this particular head. It would also seem reasonable that if the record emphasis could be taken to a higher frequency, the overall response could be extended upwards. If we look at the curve in fig. 3 we find the opposite from about 6 Kc/s upwards. Between here and 10 Kc/s we do not want less emphasis; we require a little more.

Let us now consider what adjustments can reasonably be made, and what their effect would be on the complete record/replay performance. In my fig. 5 I have drawn out a small part of the *Mullard* circuit—that section which gives us the record pre-emphasis at the various tape speeds. This is in two sections. The series resistor R30 when shunted at the lower tape speeds by C23 or C24 will provide a general treble lift starting, in the case of the $7\frac{1}{2}$ i/s speed at about 2 Kc/s, lower for the $3\frac{1}{2}$ i/s setting. The shunt part of the circuit consisting of the inductance

BIG
TAPE-RECORDER HIT
FROM HITACHI

SMALLEST PORTABLE

GIVES BIG-MODEL PERFORMANCE!



TRQ-370

Most compact *portable* all-transistor battery-operated model on the market — with table-unit performance.

Note these features — remarkable for a portable:

- * 7 Transistors — 500 mW output.
- * Undistorted reproduction.
- * Two recording speeds — $3\frac{3}{4}$ " /sec. $1\frac{7}{8}$ " /sec.
- * Accurate recording meter — also indicates battery level.

- * Built-in remote control switch in microphone.
- * Single control knob for record, play-back, erase and rewind.
- * monitoring earphone.

Retail price **52 gns.** Includes heavy hide carrying case with strap, also separate leather case for microphone and accessories.

ORDERS AND ENQUIRIES TO: **LEE PRODUCTS (G.B.) LTD.,**
10/18 CLIFTON STREET, E.C.2. TEL: BIS 6711. (Distributors for U.K.)

 **Hitachi, Ltd.**
Tokyo Japan

NINETEENTH CENTURY NIGHTMARE

THE essential simplicity of mechanical devices has always appealed to me, perhaps because (being fairly simple-minded) I cannot understand either the beauty or the operation of complicated ones. Feeling that there must by the law of averages be some more like me somewhere, even among the limited following for tape recording, I recently asked my cartoonist colleague Richard Noble to design a deck whose works could be understood by anyone as an illustration for an article. "No electricity", I said, "You can't see how it works. Use waterwheels or falling weights or mice, if you like, but keep it simple".

"Mice!" he replied, very pained. "Get with it, man!—haven't you heard of steam?" (He's a doctor of something or other, and well up in these things.) A few days later he gave me the brilliant and original design reproduced here. Unfortunately the need for it passed shortly afterwards, so we were left with a magnificent white elephant but no means of recompensing its creator for his trouble. "I wonder if it would work", murmured Richard wistfully. "Let's send it to the machine shop and see what comes back".

Cutting a long story short, we decided to spare our employer the embarrassment and confusion which would undoubtedly follow such a course of action and to try instead persuading our editor to take an interest in it, accompanied by some suitably padded prose. Something like this, perhaps:

"A new recording engine from James Watt (Mechanical Sound Recording Devices Ltd.).

"The House of James Watt proudly presents an entirely fresh conception in the popular new pastime of capturing familiar and unfamiliar sounds for their future magical reproduction, to the enjoyment of self, family and friends. For only the modest cost of our revolutionary engine (price and genuine photograph by return of post on request) and a year's supply of firewood, we guarantee a whole hour of the most unusual entertainment you have ever experienced. And, should you tire of the stark realism of its truly life-like reproduction for a while, you need only withdraw the ultra-modern sound-strengthening devices from their sockets and listen to our invention giving its celebrated impression of Mr. George Stephenson's new steam locomotive 'Rocket' thundering across your drawing-room! We promise that after this experience you will return with renewed appreciation to the engine's superb recreation of more homely sounds.

Technical Description

"For those with scientific knowledge and others with enquiring or sceptical natures, we append a brief technical description of our device: The artist's impression will help you to grasp the subtle simplicity of our designer's conception. We have a motor,

whose speed depends only on the frequency of the power supply, driving a heavy flywheel via an idler pulley. The flywheel is coupled by precision gearing to the capstan, which draws the special recording band at a more or less constant speed past the heads and on to the take-up spool, the latter being driven lightly by the motor to take up any slack in the tape and to store its precious impressions safely. Some back-tension is applied by a simple brake to keep the tape on the supply side of the capstan tightly against the heads—a pressing need, as experience has shown. (The back-tension on later models will be achieved by much the same arrangement as is now used for take-up, but driven in reverse, a spool having been found more convenient than a bin in domestic surroundings).

"The actual means of sound transmission have been specially developed for us by Mr. Faraday and Mr. Lee de Forrest, and their subtlety defies explanation. You will doubtless find the

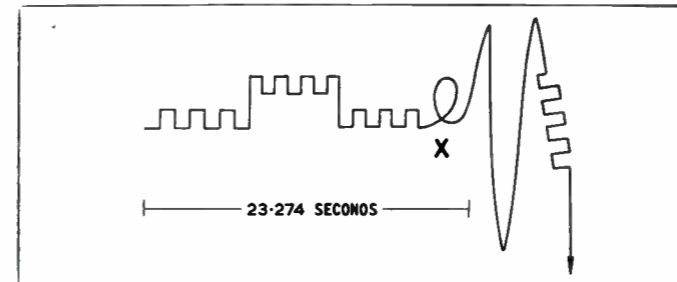

Graphical representation of the remarkable Watt tape engine showing tape-speed (pause control operated at X).

operation of the other elegant refinements shown to be obvious; in particular note the simple, positive action of the pause control. Finally, you will be as surprised and gratified as we were to hear that H.R.H. Prince Albert has been graciously pleased to confirm a Crystal Palace Exhibition Design Award (1st Class) to this company for the 'novelty, excellence and unusual engineering design exemplified in the invention'. This will surely prove, if proof is still needed, that you cannot afford to be without this new manifestation of progress and prestige."

Ideal for Christmas

Just the thing, obviously, to hang one's mattress cover up for on Christmas Eve in the latter half of the last century. I wonder if they ever produced it in kit form?

As soon as something like this appears, someone starts a magazine to explain it all to the new enthusiasts, of course. The first issue contains a brief summary of Mr. Watt's blurb (he probably wrote it himself, advertising agents not having yet become respectable), and the engine is then removed from the publisher's back yard and sent by express train to an independent engineer. His review appears in the second issue:

"It is difficult to pass objective judgment on a completely new device such as this. Indeed, doing so lays great responsibility on my shoulders, for the pattern of future such assessments may well be moulded by this precedent. Nevertheless, I have presumed, after very careful examination of the engine and of the scientific and engineering principles involved, to suggest criteria which appear to bear some relation to the subjective performance of the device and tests which could be said to measure these subjective effects in objective terms."

Here follows a long passage describing the tests, which is omitted since it was undoubtedly unintelligible to everyone except

the reviewer and the designer. Happily, this provided an opportunity for several impoverished young engineers to earn some money by filling the next two years' issues with articles explaining all the technical and practical aspects of the new technique several times over.

The review ends: "To sum up, it is evident from the results above that the engine does all that is claimed for it, and this is confirmed by auditory tests. Reproduction is indeed most life-like, being similar to that obtainable over the telephone instrument and quite distinguishable amongst a trifling amount of background noise to which only a pedant would object. I can only praise the strength and solidity of the mechanism, although I have some doubt about the pause control even though the flywheel appears to function satisfactorily with only one spoke. One point not mentioned in the manufacturer's instructions is that the erase head must be lifted away from the tape during reproduction, otherwise one's valuable recordings are wiped off before they can be heard."

Gas-fired Boiler Available

Manufacturer's comment: "We have now fitted a spring to the pause control anchorage which will eliminate the flywheel spoke trouble noted by the reviewer. The erase head has also been fitted with a spring which holds it away from the tape until it is definitely required to wipe a tape clean. Readers will also be interested to know that a gas-fired boiler has now been designed which will be incorporated in all new engines. The items 'small boy (stoker)', 'Saw, hand' and 'chopper, wood' may, therefore, now be deleted from the list of recommended accessories. This modification greatly improves stability of tape speed."

Two months later: "To the Editor.—Dear Sir, I am having trouble with the gas supply to my Watt tape engine. The boiler keeps bursting and I am spending a small fortune on pot menders. My friend says it is because the gas supply is direct and not alternating. Please advise and oblige, etc."

Two years later: "Dear Sir, I am trying to record from my crystal set by putting my Bell high-quality carbon microphone against the earphone, but all I get is the sound of escaping steam. Can you suggest a suitable suppressor? (I understand from Mr. Watt that a steam condenser would do the trick, but

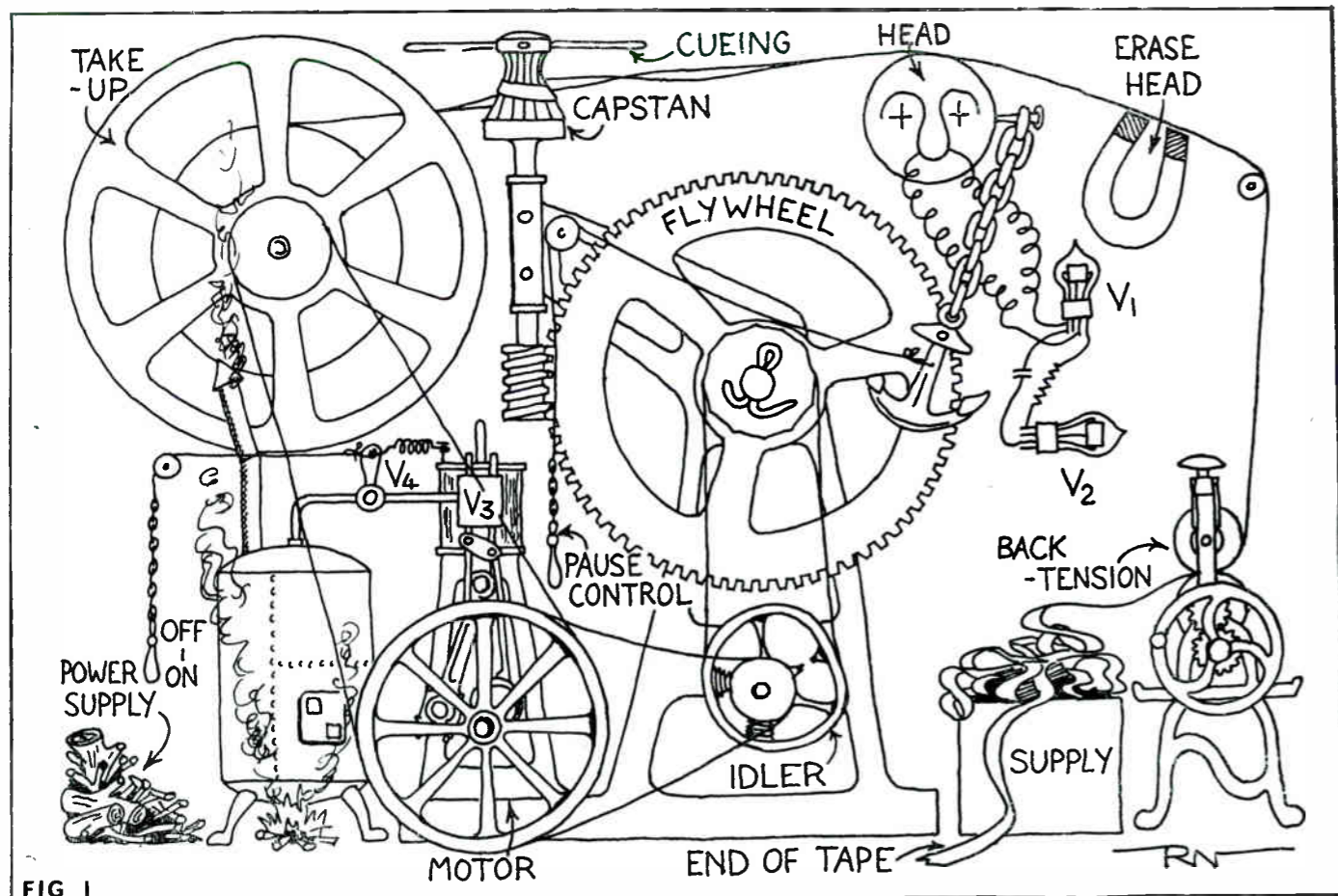
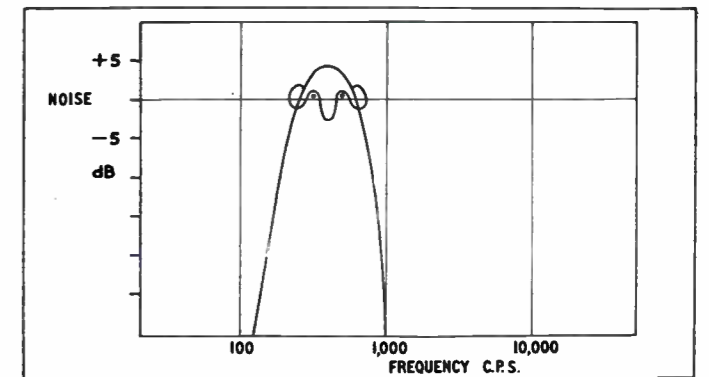

FIG 1



Tonal response of the Watt tape engine.

this is too expensive at the moment.) Mr. Bell says the microphone is probably not matched to the earphone. What does this mean? Yours, etc."

Six months later, in the classified ads.: "Great opportunity. Watt tape engine, excellent running order. Last seen heading north-east across Norfolk emitting sounds like a steam locomotive. Finders keepers!"

A week later, from the Copenhagen Times: "Our eminent scientist Valdemar Poulsen today revealed the discovery of a novel means of storing and reproducing sound. It is reported that the idea came upon him suddenly while he was bathing in the sea off the west coast of Denmark. Mr. Poulsen prophesies a great future for the technique."

Note to Audio Widows: If you want a quick divorce, buy your husband one of these for Christmas.



ONLY A PILLAR-BOX AWAY!

Wherever you live, you are only a 3d. stamp away from HOWARD TAPE RECORDERS, the Biggest Specialists in the British Isles!

Thinking of buying a Tape Recorder? Interested in saving money? We guarantee you that our selection and our terms—which include NO INTEREST CHARGES—cannot be beaten. Write or phone us today for free brochures on all the best makes and full details of our terms, and we will prove it:

HOWARD TAPE RECORDERS

218 HIGH STREET,
BROMLEY, KENT
RAVensbourne 4000 & 4477

TAPE RECORDER WORKBENCH — cont.

L3 and its associated components is designed to tune relatively sharply and in consequence produce a treble lift that starts at a higher frequency, and rises more sharply to a peak determined by the resonant frequency. Additional to these two factors, one must always remember is the effect on the treble frequencies of bias level.

Bias Level

Ideally, the bias level should have been set to the condition known as "optimum bias", that which gives the most effective compromise between tape output, distortion level at a given output, and tape sensitivity. Nevertheless it would, I believe, always be justifiable to modify the bias setting slightly with a view to assisting in frequency correction, particularly as the effect of a changing bias is so much more noticeable at the high frequencies by comparison with the middle and lower range.

Turning back to fig. 3, and remembering that this is all largely a question of surmise, I would suggest that the first experiment one might make would be the increase in value, or complete

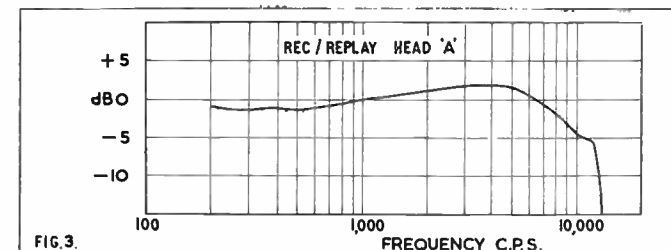

Fig. 3. Derived response head "A".

removal, of R35. This will remove the damping on the tuned circuit and increase the height of the treble lift peak. Should it be more than sufficient the problem is solved. Should it be insufficient one might try a slight decrease in bias level, effecting the increase in 10 Kc/s output in this way. This, however, would probably increase the output around 5 Kc/s also, where it is already on the high side. This might be compensated by a slight reduction in the value of C24 which is providing lift around this part of the curve.

Increase the Resonant Frequency

In the case of fig. 4 it would seem reasonable to try to increase the resonant frequency of the lift circuit by decreasing the value of C25. We would also probably find that C24 could be reduced and I would expect, in the example I have taken, to be able to obtain a reasonably flat response (± 3 dB) to about 18 Kc/s.

I think it will be readily seen that, before attempting to modify the component values in an amplifier circuit in a manner similar

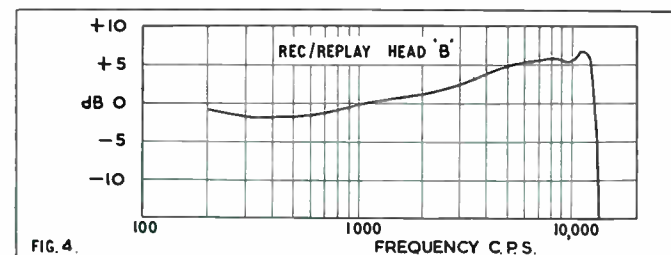

Fig. 4. Derived response head "B".

to that outlined above, it is most desirable to take such steps as are necessary to ensure that the bias level is correct. In view of the importance of correct biasing from the distortion and signal level aspect this should be set without any reference to frequency response, for the heads and tape to be used. Then can the frequency response be checked, adjusted in the amplifier if possible, with minor variations of the bias setting, if required,

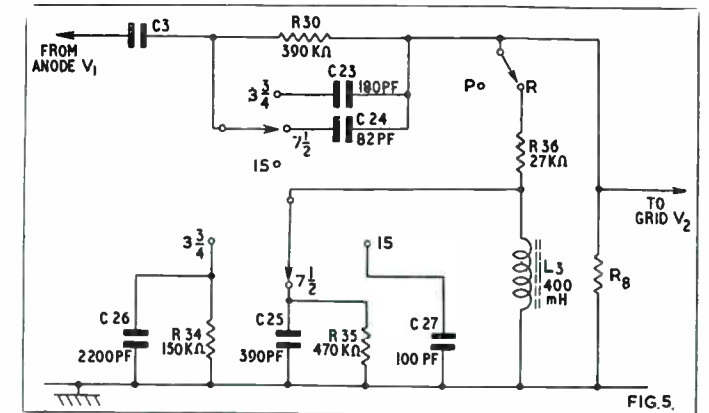

Fig. 5. A section of the Mullard circuit.

as the final step towards satisfactory frequency performance.

I hope the foregoing will be of interest to those readers who build their own machines, and that it will give an idea of one way to get the best performance and some indication of the purpose of the various components in an equalising network. In case some readers may consider it a little unwise to suggest modification to a Mullard design, let me say that their results are stated to be as measured with a particular type of head and make of tape, the suggestion is made that individual adjustment of component values may be necessary to suit the head and tape being used. The information that I have given in respect of component values etc. for the type C amplifier has been taken from the Mullard publication "Supplement to Circuits for Tape Recorders" August 1957, TP322.

Book Review

Radio and Television Test Instruments, by Gordon J. King, Assoc. Brit. I.R.E., M.I.P.R.E., M.T.S. Published by Odhams Press Ltd. 176 pages, 100 illustrations. Price 25s.

SOONER or later, the tape recorder owner who wants to progress from storing Auntie Mabel and the budgie for posterity to serious audio art will be faced with the need of instruments.

Test, not musical. Voltmeters, ohm-meters, signal generators, even, if ambitious, an oscilloscope. The true hi-fi enthusiast could hardly be without some means of believing his ears, and even the man who thinks a wobulator some form of fairground contraption would admit that the possession and use of measuring gear is highly desirable. But what to buy, and how to use it, there's the rub. Advertisements, in their beguiling way, would lead us to fill the shelves of our den and empty the savings account. And then the rows of gleaming dials and knobs would be useless without some expert guidance. All very well to read the instructions at the head of this column, but quite another thing to apply them.

These thoughts were brought home to me forcibly when I saw the latest of a series of books that Gordon J. King has written for the radio engineer and student. Published by Odhams at 25s. and entitled "Radio and Television Test Instruments", this volume contains quite the most comprehensive survey of the wide range of test gear at present available that it has been my pleasure to read.

The work is not merely a survey. Mr. King presents the purpose of each piece of equipment and discusses various applications in a manner that is lucid and instructive. Choice of instruments, construction of basic test equipment, care and maintenance, and, above all, methods of making tests under various conditions are all adequately dealt with. Although the title of this book does not specifically state "Audio", the contents are as useful to the tape recorder enthusiast as to electronic engineers and technicians. As well as the basic instruments, he has described and discussed Audio Oscillators, Output Meters, Test Bridges, Valve-Voltmeters, and Transistor Testers, and devotes two long chapters to the design and applications of the oscilloscope.

The book is beautifully produced, useful both as a work of reference and a guide to test procedures.

H.W.H.

By Richard Golding

SOUND and CINE

THE breakdown on the thirty-one award winners in the recent London Amateur Film Festival reveals the following pattern in sound systems used: 6 were 16 mm optical sound-on-film; 10 were 16 mm magnetic stripe; 2 were 8 mm magnetic stripe; 4 were 16 mm with separate-tape accompaniment; 6 were 8 mm with separate-tape accompaniment; 3 were completely silent. The low number of 8 mm striped films among the awards is surprising for I had expected, this year at least, with its high sales of this type of projector, a great leap forward for this system.

The other surprise—four awards for 16 mm separate-tape—explains itself on closer examination of the prize lists for it appears that three of the films were made by the same producer, J. Eric Hall of Shipley. Mr. Hall seems to specialise in travel and documentary and his system of synchronisation proves quite acceptable. His yearly output is enormous and the translation to magnetic stripe or optical would warrant a great deal of expense. It is to be hoped, however, that one day he will transfer the soundtrack of one of his best films to a more usual medium for wider presentation so that larger audiences may appreciate his work. The silent films were all in the commended class and may have done much better with tracks. In any case they were attempts to do something worth while and may encourage their producers to higher things next time.

“Medina”

The “Amateur Film of the Year”, “Medina” by Laurie Hickman of Brighton, was a most competently-made travel film about the market in Marrakesh, Morocco. The magnetic stripe track was excellently composed with a carefully balanced mixture of commentary, music and background sound. The visuals were delightful and showed much care in selection and composition.

For me, however, the film of the Festival was “Liquid Jazz” by Joseph Kramer of Pennsylvania, U.S.A. This was a six-minute optical sound-on-film animated McClaren-like cartoon. The discs used on the track were of good quality reproduction and the various pieces of music were mixed smoothly into each other, all being fast and non-vocal. The visuals fitted the music perfectly and consisted, in the first half of the film, of jets of coloured liquid propelled into some sort of a tank of coloured liquid. All sorts of filtered effects were used and, at times, the impression was that a washing machine was being used as the tank. The second half of the film was composed of fast studies of paint building up and breaking down into the most intricate and colourful patterns, sometimes twisting violently as the plate-glass background was suddenly whirled on a turntable; giving reference to the washing machine effect of the first half.

“Lyrol”

Another film that had impact was also animated, in so far that still pictures were used in profusion in the “Lyrol” technique to give a terrific feeling of movement. This was “Krushchev” by another American, Robert LeBar of New York, and was also 16 mm optical; but this time in black and white. The film was a satirical and sometimes unkind record of Mr. K’s visit to the U.S. The soundtrack was composed mostly of vocals which were used to counterpoint some antic of the Russian leader. Both films of course, were extensions of the “disque filmé” technique so popular with Europeans over the years, but which has never really caught on over here.

For years now, in competitions all over Europe, I have seen some short abstract film timed to fit a disc, and I have always felt that we were missing some most pleasant filming experiences ourselves by not developing this technique in Great Britain to any extent.

The indifference to this technique seems to be shared by the public with regard to the latest Juke Box development. A friend, just returned from the South of France, tells of going into a café and being confronted by what he took to be coloured television. It was, in fact, a Juke Box, and selection of the required disc brought a short film of the



K. Ouyver (centre) and K. Pettit running “Sound and Vision” at one of the Reading Cine and Tape Recording Society’s practical sessions.

live performance of the singer or orchestra on to the small screen. Moreover, next door, in the adjoining café, there was another similar machine doing exactly the same thing.

There are one or two Juke Boxes of this type to be seen in London but they do not appear to have created any demand for the wholesale installation of the “visual Juke Box”. In certain country districts, however, the demand is a little higher but even there it is felt that the high cost in, first, the mechanics involved—i.e. precision selection machinery and reproduction agent and, second, film production even on a short budget, does not justify extensive experimentation.

Magnetic Striped Film

What experience has been gained in the various interested quarters, however, will not be completely lost to film as a whole; for sometimes experiments which do not come off in one direction do point the way to success in others. One trend has been to experiment with magnetic stripe, transferring the discs to film rather than having a separate synchronised silent film projection together with the normal E.P. selection and reproducing equipment. The magnetic striped film is contained in endless-loop self-threading cassettes. On selection of the desired recording an arm places the required cassette on the projector and a system of mirrors throws the film image on to the daylight screen in front of the Juke Box. As a force in selling alone this development could have tremendous effect on advertising and, for the Juke Box trade, even if only a few machines were needed these could probably be produced economically if it were not for the fact that low cost film production needs enormous outlets.

Under existing conditions, a live-production film of the orchestra or vocalist, even for a three-minute recording, can be very expensive indeed as outside production film units have to be employed by the recording companies. The actual live performance of the artist is, of course, not strictly necessary. Any film which can add to the mood

(continued on page 495)

Stereo hi-fi is cheaper than you think ●

a postcard will bring you IDEAS IN HIGH FIDELITY

LISTEN — LOOK — COMPARE — good sound and good looks — NEW SCANDINAVIAN LINE FURNITURE
10 a.m. to 10 p.m. daily (Sundays from 6 p.m.) Closed Thursdays. MA1 8SS

STUDIO 99 57, FAIRFAX ROAD, SWISS COTTAGE
HAMPSTEAD · N.W.6 **LONDON**

PROFESSIONAL TAPES

by



DIVISION OF

COLUMBIA BROADCASTING SYSTEM

*for
all
who want
better
recordings*

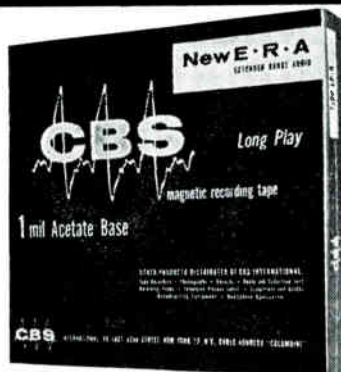

Specially prepared fine magnetic iron oxide dispersion; precision and uniformity in processing with quality control at all stages—these are some of the features that result in C.B.S. Tapes giving you extended frequency range, better wearing; better transients and the chance to make magnificent recordings from all sources even on quarter track machines at $3\frac{3}{4}$ i.p.s. In all sizes—standard, long play and double play. Particularly recommended for $\frac{1}{4}$ track and stereophonic uses.

See report, *The Tape Recorder* September issue, page 359.

BETTER QUALITY FOR LESS COST

		5"	5 $\frac{3}{4}$ "	7"
Standard	1 $\frac{1}{2}$ Mil	600' 17/6	900' 23/-	1,200' 27/6
Long Play	1 Mil	900' 21/-	1,200' 25/-	1,800' 35/-
Double Play	$\frac{1}{2}$ Mil	1,200' 34/-	1,800' 45/-	2,400' 56/-
Standard Mylar		600' 21/-	900' 28/-	1,200' 35/-
Long Play		900' 25/-	1,200' 32/-	1,800' 47/-
Double Play 10 (Tensilised)		1,200' 42/-	1,800' 55/-	2,400' 68/-

- ★ With leaders and stop foils
- ★ Superb quality at $3\frac{3}{4}$ i.p.s.
- ★ Long wearing
- ★ Recommended specially for four track instruments
- ★ Consistently high quality in all grades

CBS TAPES 12-16 WATLING ST., LONDON, E.C.4
CITY 2238

This is the LUSTRAPHONE 'Micridyne'

MICRO-MINIATURE RIBBON MICROPHONE

*Another
outstanding
contribution
to microphone
progress*



Of the many advancements in microphone design made by LUSTRAPHONE the VR/70 "Micridyne" micro-miniature ribbon must be one of the most outstanding yet. This amazingly small instrument incorporates a completely new conception of magnetic design to enable the smallest-ever ribbon microphone to be produced. Improvements of many kinds are incorporated. The head, which has a volume of less than 1 cu. in., permits unobstructed air flow all round, thereby achieving extended frequency response. Substantial blast screening and entirely new anti-vibration mounting technique are used. 3-pin plug and socket connections permit the microphone to be used on its own base, held in the hand or mounted on a stand. The microphone is complete with stand and appropriate cable in high, line or low impedances.

● BRIEF TECHNICAL DETAILS

- Sensitivity—
Low Imp. 90 dB below
1V/dyne/cm.
High Imp. 56 dB below
1V/dyne/cm.
- Response—
Substantially flat from 50-
14,000 c/s.
- Pattern—
Figure of 8.
- Head Dimensions 2 $\frac{1}{8}$ in. x
 $\frac{1}{8}$ in. wide X $\frac{1}{2}$ in. (Height
of microphone unit to plug,
6 in.)
- Overall Height on base, 7 $\frac{1}{2}$ in.
- Base diameter, 5 $\frac{1}{2}$ in.
- Finish. Satin chrome and black
with rubber cushioned legs.
- Weight (complete), 6 $\frac{1}{2}$ ozs.

Price: Low impedance **10 gns.**

KEEPS FAITH WITH SOUND

Descriptive literature on application.

LUSTRAPHONE LTD.

ST. GEORGE'S WORKS,
REGENTS PARK ROAD, LONDON, N.W.1
Phone: PR1Imrose 8844.



SOUND AND CINE — continued

can be used, provided that the visual content of the film is in character with the recording, and the animated cartoon is in special favour in this respect.

The professional film cartoon production company, however, with its high overheads, cannot usually turn out full animation for less than 10s. per frame. At sound speed this represents a minimum cost of £2,000 for a three-minute colour film. Successful experiments have, nevertheless, been made by "fringe" cartoon groups in instant cartoon making in an endeavour to lower the cost. The instant cartoon technique consists of setting up a camera over a wafer-thin topped table. The action, thereafter, involves controlling the artwork by means of magnets under the table top. The artwork, which can be a cut-out photograph of the artist, has movable joints and the variety of action is only limited by the imagination and dexterity of the person controlling the magnets under the table.

The cut-out technique is, of course, one of the older methods of making animated films, and is one that has been exploited successfully through the years by Lottie Rheiniger; first, in her fairy-tale silhouette shorts; and, later, in her full colour treatment of 35 mm cinema commercials. Her technique consists in joining all the movable parts with very thin, soft, wire paper-clips; and in concealing these joints under an appropriate part so that no wire-end is ever seen by the camera. Lottie Rheiniger employs the single-frame method of animation, that is to say, the artwork is moved manually a fraction of an inch between each single camera shot.

I suggest that the two techniques could be married quite successfully to produce an instant "disque filmé" of your own, by using the paper-clip method of joining with the magnetic method of controlling the cut-out character under the table. You have only to watch some children playing table-top football to appreciate the potential that exists in this last method.

Live Action "Disque Filmé"

There is no reason why the abstract film, made to the rhythms of an existing record, should not be successful if made entirely from live action sequences. On browsing through the latest Conroy recorded music catalogue (Berry Music Ltd., 10 Denmark Street, London, W.C.2.), the title—"Spine Chillers" arrests immediate attention. This short disc is described as: "Dramatic, Mysterious, Space", and is made up as follows, totalling 145 seconds.

Dramatic	Foreboding	12 secs	Foreboding	14 secs
Suspended	Horror	... 23 secs	Travel to Weirdness...	19 secs
Suspense	20 secs	Agitato into Unknown	14 secs
Shock, Chord and				
Mysterious		9 secs	Suspense	10 secs
Weird and Mysterious		9 secs	Mysterious	15 secs

A breakdown such as this suggests all sorts of short fascinating themes that could be filmed in a variety of treatments, using basic



"... It looks to me as though your brakes are not working properly!"

film techniques such as the placing of different coloured filters over the camera lens for each sequence to the use of the various filming speeds from 8 frames per second through to slow motion. I would add, however, that if a disc such as this were to be decided upon, the usual copyright restrictions must be observed if the film is ever to have a public presentation.

Copyright and the Amateur

The amateur should be conversant with certain copyright formalities if he is going to re-record commercial pressings, or if he is going to play these pressings to any audience but his own family in his home. Contrary to beliefs of many, however, clearance is easy to obtain and, once given, will cause no additional worry to the amateur who seeks it for all his "lawful occasions". The copyrights held in any record sold by a manufacturer are distributed as under:

First, there is the mechanical copyright which is tenable by the actual makers of the pressing by virtue of the work carried out by them. Coupled to this there is the "dubbing" copyright which reserves the right of copying this record by any means.

Then there is the copyright invested by the composer and/or orchestra with regard to the composition or rendering of the piece, whether music, speech or effects.

The whole is linked under terms of the *Copyright Act*. Under these terms the composer owns the copyright of anything he composes as soon as he writes it, and the copyright exists for fifty years after his death. The means of obtaining permission to use this copyright work in any way, and the fees payable by commercial film makers, need not really concern the normal amateur if he cares to take advantage of the I.A.C. copyright agreement scheme. Under this scheme the agreed figures for dubbing rates are as follows: Per title on a 10 in. record side, 7s. 6d.; on a 12 in. side, 10s. 6d.; on a 10 in. side, 12s. 6d.; on a 12 in. side, 17s. 6d., restricted to private use and club showings not open to public. For all restricted uses and, in addition, for club and national competition shows open to public, and other amateur-convened shows. The retail price of the disc is extra and above to these rates. Further details of this scheme are available from the Hon. Secretary, Institute of Amateur Cinematographers, 8 West Street, Epsom, Surrey.

1963 PROGRAMME

We are pleased to announce that for 1963 the production of the U1 tape deck will continue unchanged. In addition we are introducing the U1/15, this is identical to the U1 but operates at 3½, 7½ and 15 i.p.s. Due to improved production facilities at our new factory the delivery position is rapidly being improved to reasonable proportions and we invite your order for early delivery.

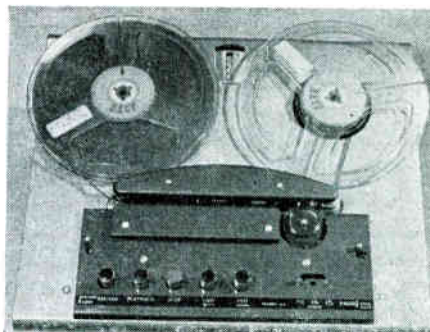

The Planet U1 deck is regarded by most of this country's leading experts as Britain's finest tape deck and it is now being used by many professional studios. This is the ideal deck for the serious amateur who wants the best results at a realistic cost.

Write now for illustrated brochure and independent test reports to:

PLANET PROJECTS LTD.

GOODMAN WORKS, BELVUE ROAD, NORTHOLT, MIDDX.

Give hi-fi books for Christmas

HI-FI YEAR BOOK . . .

The 7th edition of this world renowned annual publication has been enlarged and now contains 272 pages and includes articles by leading authorities. The disc Stereo Picture and Microphones by Stanley Kelly; New developments in Transistor Amplifiers by George Tillett; Radio Tuners by Arthur Wayne; The Dynamic Decibel and Time on Tape by Graham Balmain. Loudspeakers for 1962-3 by Ralph West. Technical specifications are given of over 1000 items of Hi-Fi and Tape Equipment, and over 500 of these are photographically illustrated. **Price 11s 6d post paid.**

CINE YEAR BOOK . . .

For the first time ever, a comprehensive survey in one complete volume of the cine market for the cine user. The new reference book for the professional, the enthusiast, and the photo dealer. This valuable book follows the unique pattern set and maintained by the "Hi-Fi Year Book"—separate and detailed directories for every product group—Cameras, Lenses, Exposure Meters, Lighting, Film Stock, Screens, Projectors, etc. Some 200 photographic illustrations, Suppliers' addresses, product specifications, Library lists, Cine services are all included in this hard bound book. **Price 11s 6d post paid.**

HI-FI FOR BEGINNERS . . .

This work is thoroughly recommended to every enthusiast; it has been acclaimed from all sides as being the ideal book for everyone who has just started or is about to start their hobby. Those whose particular interest lies in tape will find that Chapter 7 alone will make this book worthwhile. **Price 8s 3d post paid.**

EXPERIMENTAL RECORDING . . .

This book presents in convenient form the series of articles by A. Tutchings on "Twenty Practical Experiments in Magnetic Recording" and full introductions for "Building a Fully Portable Recorder", using a clockwork motor and transistor amplifier. **Price 5s 9d post paid.**

HOW TO SPLICE TAPE . . .

If you use tape, sooner or later you will need to know how to splice tape, how to repair simple or complicated breaks, how to edit material, how to cut out words or syllables, etc. All this is described in this well-illustrated booklet. **Price 2s 6d post paid.**

BOUND VOLUMES . . .

We have available copies of Tape Recorder Volumes 2 and 3. These are covered in black buckram, and hand stitched and gold blocked in spine. Special presentation volumes bound in real leather are also available, details on request. **Price (each volume) 52s 6d post paid.**

In preparation . . .

Stereo for Beginners by B. J. Webb

MILES HENSLow PUBLICATIONS LTD.
99 MORTIMER ST., LONDON, W.1

WHARFEDALE SUPER 8/RS/DD

*"Strikes the
right note"*

SAYS DONALD ALDOUS

In a recent review of the Wharfedale Super 8/RS/DD in "Audio & Record Review", Donald Aldous reported as follows:—



The latest Wharfedale Super 8/RS/DD speaker strikes the right note the moment it is removed from its box. It is beautifully made and finished and looks right.

The unit was tested in a corner enclosure of approximately 1½ cu. ft. with the interior heavily lined with carpet felt and a vent of 1½ in. wide across the front at the bottom. The bass radiated with this enclosure was smooth and at an ideal level to give balance with the extended top response.

The music signals and tone bursts confirmed that the speaker is free from any obvious discoloration.

Summary.—We agree entirely with the view of Gilbert Briggs expressed to us as "his humble opinion", that the Super 8/RS/DD unit is easily the best 8 in. model Wharfedale has ever produced. A stereo pair in small enclosures gives sound quality that will come as a revelation to any listeners wedded to massive enclosures, this can easily be matched to 2-5 ohms with the W.M.T1.

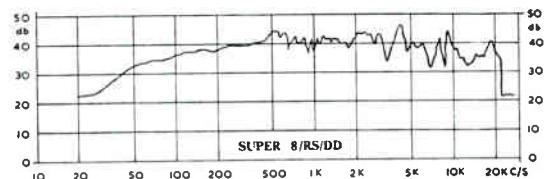

Impedance 10/15 ohms.

CERAMIC MAGNET. Flux density 14,500 Oersteds.

Total flux: 60,000 maxwells.

PRICE 149/5 incl. P.T.



**IDLE
BRADFORD
YORKSHIRE**

Telephone : Idle 1235/6

Telegrams : "Wharfde!" Idle Bradford

our readers write

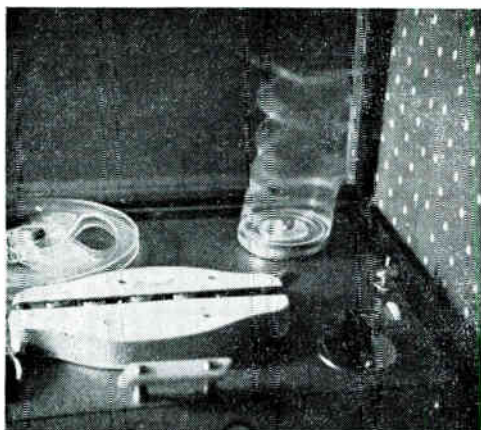

. . . about gravitational pull

From: L. J. Timms, 57 Grange Crescent, St. Michaels, Tenterden, Kent.

Dear Sir:—I recently received a message tape from my relations in Australia. When the tape had run through on playback, instead of flapping around wildly, as is usual, if I am unable to reach the switch in time, it “fell” off the reel in this unusual manner. It repeated its performance for the benefit of the camera enabling me to capture this shot.

Perhaps this illustrates the Aussies’ theory that it is we who are upside down.

Yours faithfully,

* * *

. . . about a linolium Tricolumn

From: M. E. Taggart, 43 Rosebrook Avenue, Sunnylands, Carrickfergus, N. Ireland.

Dear Sir:—Thank you for the reprint describing the “Tricolumn” loudspeaker enclosure which I obtained from you several weeks ago.

Your readers may be interested to know that I constructed a three foot model using rolls of linoleum for material, along with a reasonably good quality radio speaker. The linoleum was rolled upon itself to about three of four thicknesses. Results were surprisingly good, with very little resonance, and I have obtained an excellent speaker enclosure for an outlay of about ten shillings.

Yours faithfully,

* * *

. . . about good value for money

From: G. F. P. Childs, 25 Brattleby Crescent, Ermine Estate, Lincoln.

Dear Sir:—With reference to the letter from Mr. D. Herkes, published in your October edition, I feel that I must crave a little space in your helpful and entertaining magazine to corroborate his statements. Whilst it may be invidious to select one manufacturer for attention, I feel that you and I have one thing in common; to select and recommend worthwhile items, although I function in a smaller sphere.

As Visual Aids Technical Officer to a local authority, I have appraised every make of tape recorder which is available and, whilst most machines have their good points, I decided that the Reps R.10 represented good value for money. Accordingly, I pinned my faith on this machine and over a hundred have been installed in schools in this area. Over a period of two years, apart from regular head cleaning and de-gaussing, operational faults have boiled down to valve replacement (not really the recorder manufacturer’s baby), and one “lulu” . . . a “tracking” valve holder, resulting in an intermittent high resistance H.T. leak to chassis. Mother warned me that there would be days like that! Service from the firm has been courteous, swift and very much to the point, almost embarrassingly so. As Mr. Herkes so rightly states, it is important to find a British firm so vitally

interested in the performance of their product in the user’s hands . . . not, I hasten to add, that it is my intention to infer that no other firm gives a comparable service.

I find that frequency sweep test tapes can be misleading, one which was recently sent to me indicated that response below 100 c/s was markedly deficient. In fact, bass response from the Reps R.10 on a three-speaker assembly, which will comfortably handle the ten watts audio available from this recorder, is outstanding and I am very difficult to please in the matter of quality reproduction. This would tend to confirm an opinion which has been hardening in my mind for some time, namely, that the true test of high-quality reproduction exists in the ear of the individual listener.

Yours faithfully,

* * *

. . . about good service

From: G. A. C. Keenan, 55 Newhall Road, Swadlincote, Burton-on-Trent.

Dear Sir:—I would like to bring to your notice a very fine example of after-sales service, worthy indeed of the fine reputation of Ferrograph.

The capstan motor seized up some weeks ago and it was found that one of the windings had gone. The motor was returned to Ferrograph who sent a new motor, free of charge. The recorder, I should mention, was purchased in September 1956.

There are still a few honourable firms left.

Yours faithfully,

* * *

. . . about ditto

From: J. Bennett, 3 Crokeswood Walk, Lawrence Weston, Bristol.

Dear Sir:—My 13-month-old 4A/N tape deck suddenly developed several serious faults, i.e. capstan motor went wrong, and paint started flaking. I corresponded with the company, and a special case was sent to me from South Shields. Three weeks later the deck was returned to me in new condition, and the performance was better than when new. Although the guarantee had expired, no charge at all was made. Such action as this can only bring credit to the Ferrograph Co., and I for one am prepared and willing to give them my earnest recommendation. Perhaps other manufacturers could take a few timely hints from them.

Yours faithfully,

* * *

. . . about overloading

From: C. Braddock, The Tape Recorder Centre (Blackpool), 266 Waterloo Road, Blackpool, Lancs.

Dear Sir:—Regarding my letter in the November issue of *The Tape Recorder*, “Entering the Common Market”. Could you please advise your readers in the next edition that I am unable to answer any further queries regarding the type of machine in question. I have been inundated with requests since the letter appeared.

Yours faithfully,

* * *

. . . about a Ceylon tape club

From: R. C. Sembacuttiaratchy, 25 Malwatta Avenue, Nugegoda, Ceylon.

Dear Sir:—We take pleasure in announcing the inauguration of a new club in Ceylon for tape recorder enthusiasts, to be called Tapelawka-International.

We aim to bring about closer contacts with friends abroad through the medium of tape exchange. In particular, we seek to exchange as many recordings as possible of popular music, jazz, dance music and other instrumentals, taped live at club gatherings, etc. Needless to add, we also welcome just friendly chatter and news from anyone. (This tape club has been formed within the framework of “Ceylon Youth, Students and Pen-pals” —which is an affiliate of the National Youth Council of Ceylon.)

At present we can tackle only at 3½ i/s and two tracks.

Yours faithfully,



NEW FI-CORD 202

**PORTABLE
BATTERY/MAINS
RECORDER**

so much in so little space

The FI-CORD 202 offers all these features:
 2 speeds— $7\frac{1}{2}$ and $3\frac{3}{4}$ • Standard 4" spools •
 Vu-meter • Fast forward wind • Fast rewind •
 Resettable counter • Manual and automatic
 volume control • Built-in loudspeaker • Ex-
 tension speaker socket • Low and medium
 input sockets • Socket for remote control •
 Safety record switch • Easy-load battery cas-
 cettes • Battery warning lamp • Mains input.

FI-CORD 202 the new portable battery/mains high fidelity tape recorder, has been developed after years of exacting tests in the Fi-Cord laboratories. It is a worthy successor to the famed FI-CORD 1A, used internationally by broadcasting companies during recent years.

FI-CORD 202 is for the most exacting professional and equally for the enthusiastic amateur demanding the highest professional standards. It incorporates all the practical advantages of a full-size recorder in a small, light-weight machine.

FI-CORD 202 gives you high fidelity recording at your fingertips—whenever you wish, wherever you go.

AND the FI-CORD 202 weighs only $6\frac{1}{2}$ lb., measures $9" \times 6\frac{1}{2}" \times 4\frac{1}{2}"$.



Price: 66 guineas, including long life mercury batteries and tape.

ACCESSORIES INCLUDE:
 Carrying case, choice of microphones, power packs for mains and car.

Write for fully illustrated brochure and address of nearest stockist to:

FI-CORD INTERNATIONAL
 40a Dover Street, London W1. HYDe Park 3448

TAPE, RECORDERS & ACCESSORIES

FIRST DETAILS OF NEW PRODUCTS

● We remind our readers that notices of equipment listed and illustrated in this monthly feature are in no sense reviews. When figures, specifications and diagrams are published, these data are extractions from manufacturers' lists. When samples of this equipment are submitted for test, they are passed to our technical contributors, whose reports are published in a separate section.

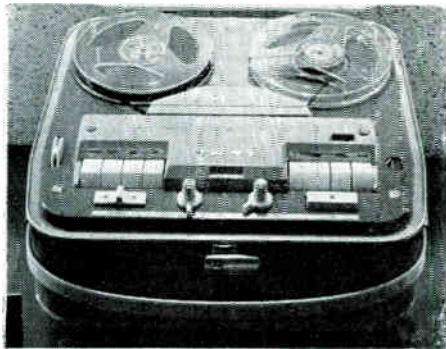

★
**GRUNDIG
 TK41
 TWO-TRACK
 RECORDER**

THE TK41, introduced by Grundig (Great Britain) Limited, is basically the twin-track version of the TK40, but it is equipped in addition with a 7 watt push/pull output stage and separate bass and treble controls. The 6½ in. x 4½ in. elliptical loudspeaker is fed with a reduced output power to prevent damage to the loudspeaker when the volume control is at maximum, the full output power being available from the extension loudspeaker sockets of the machine. The frequency response extends to 18,000 c/s ±3 dB at a tape speed of 7½ i/s; the wow and flutter figure is less than .1 per cent. at 7½ i/s, and the signal to noise ratio is better than 50 dB. Inputs are provided for microphone, telephone adaptor, radio extension, loudspeaker/gramophone pickup and radio diode and there are facilities for the connection of a remote control which can be fitted as an additional accessory. High and low impedance output sockets are also fitted. The machine is automatically switched off when the end of the tape is reached and a press button operated digital indicator and tape cleaner are incorporated.

In appearance the TK41 closely resembles the TK40. Following the Grundig line it is finished in two-tone grey. The price is £78 15s., including microphone.

Another newcomer to the Grundig range of tape recorders is the TK46. Mechanically identical to the TK41, the TK46 is a fully stereophonic four-track recorder and reproducer. A second recording can be made in synchronisation with an earlier recording—whilst listening to the playback from one track a second

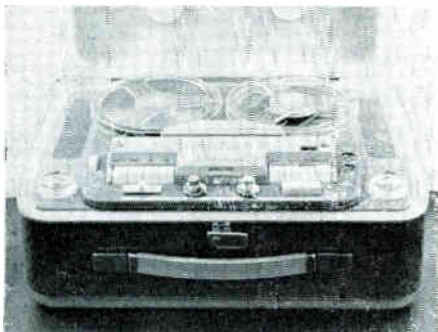

★
**GRUNDIG
 TK46
 FOUR-TRACK
 STEREO
 RECORDER**

recording can be made on the next. Both can be played back together or the operation repeated, thus adding more and more "instruments" to the original recording. Echoes can be introduced, the delay being governed by the speed selected which corresponds to 210, 420, 840 milliseconds. The intensity of the echo is controlled by an internal feed-back control. Monitoring can be done either at the time of recording or with a time delay equivalent to the figures quoted above by the separate playback

amplifier and playback head "via tape". Superimposition is possible without erasing the earlier recording and the output level from both channels can be controlled independently or, after correct balance has been obtained, together by one control.

The TK46 has a press button operated position indicator, tape cleaner, recording input selector, temporary stop button, facilities for remote control and separate treble and bass controls. The output power is 3 watts from each channel, otherwise the electrical performance is similar to that of the TK41. The price of the TK46 is £103 19s., excluding microphone. Microphones available for use with this machine are the GDM 18 at £7 7s. and a special stereo-microphone, the GDSM 202 at £14 14s.

Further details on both of the machines can be obtained from the manufacturers: Grundig (Great Britain) Ltd., 40 Newlands Park, Sydenham, London, S.E.26.



★
**SYMPHONY
 PRE-SLEEP
 LEARNING
 RECORDER**

THIS tape recorder has all the normal facilities for the recording and playback of speech and music tapes. Two tape speeds are provided 3½ and 1½ i/s. The former being the most suitable for music and the 1½ i/s speed is adequate for speech. This is the speed normally used on its special facilities as a Learning Machine.

The recorder incorporates a 24-hour time switch which provides up to three "on" and three "off" times at one pre-setting. That is, the machine can be pre-set to switch on to three sessions of playback. This fulfils the most exacting requirements of sleep-learning researchers who want to use all three "sensitive" periods: i.e. the pre-sleep hour, the hour before waking and the period beginning 3 hours 40 minutes before waking. It can, of course, just as readily be set for only one "on" and one "off" cycle. The setting is effected most simply by sticking pins into holes in the clock dial. It does not, therefore, depend on careful or accurate setting.

The machine stops automatically at the end of a tape fitted with stop foil, independently of timing device. The internal speaker is a high flux 10 x 6 in. elliptical and there is a switch to silence this when the external speaker socket is in use. The external speaker socket can be used for any loudspeaker of 3-15 ohms impedance or for a pillow speaker or headphones.

The machine measures 17½ x 13½ x 10 in. and weight is about 20 lb. The case, which is covered in durable rexine, is fitted with a removable lid. The price is £72 9s. A pillow speaker is available at £3 3s. Manufacturers: Northern Radio Services Ltd., 16 King's College Road, London, N.W.3.



LOEWE OPTA

Hi-Fi Tape Recorders

FOR PERFECTION IN SOUND

OPTACORD 403

- Twin Track 2 Speed 3 $\frac{3}{4}$ " and 1 $\frac{1}{2}$ ". ● 6" reels giving up to 6 hours playing time ● Flat response 40 to 16,000 CP/S
- Push Button selection for Recording, Gram, Radio and Superimposing ● Rev. Counter, Magic Eye, Tone Control and Volume Control ● Extension Leads, 5 watt Output stage ● P.m. Dynamic Speaker ● A.C. Mains 110V to 240V Selector.

43 Gns. ▶

OPTACORD 404

As above but with 53 Gns. 4 Track Deck.

OPTACORD 412

TRANSISTOR BATTERY/ 45 Gns. CAR BATTERY/MAINS RECORDER:

- Twin Track Single 3 $\frac{3}{4}$ " Speed taking 4 $\frac{1}{2}$ " Reels ● Wide Band Speaker, Push Button Control, V/Control ● Magic Eye, Tone Control, Fast Rewind, Radio & Mic. ● Input Socket, W/ext. lead ● Operating off A/C Mains/batteries or car batteries.

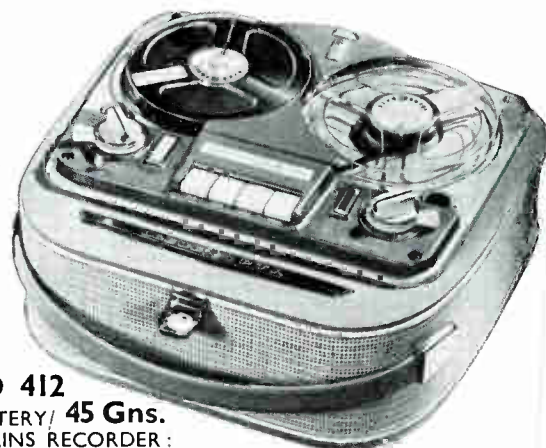
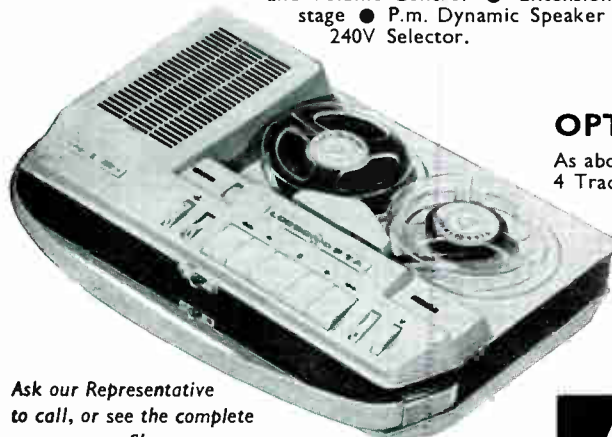

Ask our Representative to call, or see the complete range at our Showrooms.

HIGHGATE ACOUSTICS

71/73, GT. PORTLAND STREET, LONDON, W.1

Telephone: MUSEum 2901/6

FRANCIS OF STREATHAM

RECORDERS

Akai M6 $\frac{1}{2}$ & $\frac{1}{2}$ Tr. St. ...	130 gns.
Akai de luxe 69 ...	79 gns.
Brenell Mk. V Model M ...	88 gns.
*Brenell Mk. V ...	64 gns.
Brnell 3 star ...	58 gns.
Coscor 4 Tr. 1602 ...	38 gns.
Coscor 4 Tr. 1601 ...	59 gns.
Coscor 1603 4 Tr. ...	28 gns.
Elizabethan 200 ...	22 gns.
Elizabethan 2230 ...	32 gns.
*Ferrograph 5AN ...	85 gns.
*Ferrograph 422 or 424 ...	110 gns.
*Ferrograph 4A N ...	81 gns.
*Ferrograph 4AN/S ...	88 gns.
Fidelity Minor ...	22 gns.
Grundig TK14 ...	35 gns.
Grundig TK 23 4 Tr. ...	45 gns.
Grundig TK40 4 Tr. ...	75 gns.
*Grundig TK60 Stereo ...	128 gns.
Loewe Opta 404 2 sp. 4 Tr. ...	53 gns.
Loewe Opta 403 ...	45 gns.
Philips 4 Tr. 3541 ...	36 gns.
Philips 4 Tr. 3542 ...	59 gns.
Philips 3514 4 Tr. ...	27 gns.
*Reflectograph 'A' $\frac{1}{2}$ Tr. ...	105 gns.
*Reflectograph 'B' $\frac{1}{2}$ Tr. ...	115 gns.
Robuk ...	36 gns.
*Simon SP5 ...	93 gns.
Sony Stereo 462 4 Tr. ...	75 gns.
Sony 521 Stereo ...	124 gns.
Stellaphon 4 Tr. 454 ...	39 gns.
Stellaphon 4 Tr. 455 ...	59 gns.
Stellaphon 456 ...	28 gns.
Stuzzi 4 Tr. Junior ...	26 gns.
*Tandberg Series VI Stereo $\frac{1}{2}$ or $\frac{1}{2}$ Track ...	110 gns.
*Tandberg Mono. 3B ...	76 gns.
*Telefunken 85 De Luxe ...	83 gns.

*Telefunken 95 ...	59 gns.
*Telefunken 96 4 Tr. ...	69 gns.
*Telefunken 97 Stereo ...	95 gns.
Truvox 60 2 or 4 Tr. ...	39 gns.
Truvox Series 80/2 Tr. ...	55 gns.
Truvox Series 80/4 Tr. ...	59 gns.
Truvox R7 ...	82 gns.
Uher Universal ...	83 gns.
*Vortexion WVA ...	£93.13.0
*Vortexion WVB ...	£110.3.0
*Vortexion C Stereo ...	£148.10.0
*Vortexion CBL Stereo ...	£160
Wyndor International ...	69 gns.

BATTERY PORTABLES

Coscor 1620 ...	25 gns.
Grundig Memorette ...	55 gns.
Philips Portable ...	24 gns.
Loewe Opta 412 ...	47 gns.
(Mains/Battery/Car)	
Butoba ...	66 gns.
Grundig TKI ...	29 gns.
Claron Phonotrix ...	39 gns.
Fi-Cord 202 ...	66 gns.
Stella ...	25 gns.
Stuzzi Memo-Cord ...	25 gns.

*Microphone extra

Mains Power Pack for Philips or Stella ...	£5.0.0
Grundig Mains Power Pack ...	8 gns.
Truvox Decks with Pre-Amps ...	£42.0.0
PD 82—Standard Twin Tr. ...	£52.10.0
PD 85—Professional 4 Tr. Stereo ...	£63.0.0
PD 86—Professional 4 Tr. Stereo ...	£63.0.0

Tape Decks by Brenell, Wright & Weaire.
Tape to disc and copy service

LEADING STOCKISTS OF EQUIPMENT FOR TAPE and HI-FI

... and NO EXTRA FOR CREDIT TERMS

- ★ Minimum Deposit
- ★ No Interest or Service Charges on H.P. up to 18 months
- ★ Free Service during Guarantee Period

Prices subject to alteration as announced by manufacturers.

Grampian Reflector ... £5.15.0

MICROPHONES AND MIXERS

Grampian GR/2 as advertised	
Grampian DP/4 Dynamic	£8. 0.0
Lustraphone VR/70	£10-10-0
Lustraphone VR/64	
Ribbon	£7.17.6
Lustraphone LRV/59	
Dynamic	£8.18.6
Simon 'Cadenza' Ribbon	£10.10.0
Resio Ribbon or Dynamic	£9.12.6
Resio Cardioid	£9.12.6
AKG Stereo D.88	£19.19.0
TSL 3 Channel Mixer	£2. 7.6
Grundig Mixer	£16.16.0
AKG K 50 Headphones	£7.10.0

Also in stock microphones by ACOS, FILM INDUSTRIES, TELEFUNKEN, A.K.G.

ALL WALGAIN PRODUCTS

- Stands of all types and accessories
- TAPES by all leading makers in all grades and sizes as advertised.
- Pre-recorded by Columbia, H.M.V., Saga, Music-on-Tape.

HI-FI

STEREO AND MONO AMPLIFIERS

Quad	Chapman Rogers
Leak	Dulci
Tripletone	Armstrong

TUNERS

Quad	Rogers	Pye
Leak	Dulci	Armstrong
Chapman		

LOUDSPEAKERS by

Quad	Kelly
W.B.	Wharfedale
Goodmans	Tannoy
Mordaunt	Leak

MOTORS, PICKUPS

Garrard	Tannoy	EMI
Goldring	Lenco	Shure
Connoisseur	Decca Stereo	
Decca Deram	Mk. II	

Philips Ronette

All-Balance. B & O

Ortofon SME Mk. II

Acos

All types of Diamond and Sapphire styli, stereo and mono. Microlifts, Garrard SPG3, Acos Dust Bug.

CABINETS

Record Housing

Leak 'Southdown'

169-173 STREATHAM HIGH ROAD, LONDON, S.W.16

Between St. Leonard's Church and Streatham Station

STReatham 0466/0192

PLEASE NOTE THIS IS OUR ONLY ADDRESS

EQUIPMENT REVIEWED



★
**FERGUSON
 MODEL 3202
 FOUR-TRACK
 RECORDER**

Manufacturer's Specification. Tracks: Four. Speeds: $3\frac{3}{4}$ and $1\frac{7}{8}$ i/s. Frequency Response: 60-10,000 c/s ($3\frac{3}{4}$ i/s) 60-7,000 c/s ($1\frac{7}{8}$ i/s). Signal to Noise ratio: better than -40 dB. Spool Size: up to $5\frac{1}{2}$ in. Output: 3 watts. Automatic stop foils. Speaker: $7 \times 3\frac{1}{2}$ in. Size: $14\frac{1}{2} \times 12\frac{1}{2} \times 6\frac{1}{2}$ in. Weight: 19 lb. Price: £34 13s. Manufacturers: Ferguson Radio Corporation Ltd., Thorn House, Upper St. Martins Lane, London, W.C.2.

THIS review will be different from some of my earlier efforts. I mention this because I experienced a series of minor trials and tribulations which upset the smooth testing of this recorder. I thought these might be of interest to some readers to show some of the pitfalls which beset the path of a reviewer in presenting a fair picture of the capabilities—and faults—of a typical medium-priced tape recorder.

My first test, as always, was to play a pre-recorded tape of known quality and content to judge subjectively the overall playback performance of the machine. Excellent! Volume control a little less than half on for comfortable listening level, and the tone control about half way round for best tonal balance . . . plenty of volume and top response in hand for a badly recorded tape and reasonably low mains hum and motor noise (it is sometimes difficult to separate one from the other on a simple listening test).

Next I loaded the recorder with a pure tone test tape to measure the playback frequency response, connecting a valve

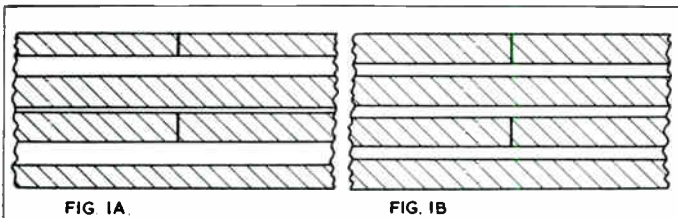

voltmeter to the line output of the recorder to plot the actual level readings. Alas, the meter reading was so unsteady at the higher frequencies that it was impossible to plot a reasonable response. I immediately suspected a faulty or damaged test tape, as the earlier music tape had sounded O.K., and unpacked a brand new test tape—but the readings were equally unsteady. Switching to track 3 partly solved the problem; here the readings were quite steady, and about 3 dB higher than on the upper track. Diagnosis: head set too high so that the top poles overlaid the edge of the tape thus only partly scanning the recorded signal and exaggerating edge effects where the tape is most vulnerable to "drop outs", signal fluctuations and tape wander. I should perhaps explain that I was using a full track test tape so that vertical displacement of the head did not drop the level on track 3.

Before attempting to reset the head I recorded all four tracks on the machine and made them visible by the application of colloidal magnetite (Indicord). The result is shown in fig. 1a and confirmed that the head was indeed too high by about 10 thou'.

The full track test tape was next played on a long wavelength tone (500 c/s) and the head adjusted for roughly equal outputs on tracks 1 and 3 by moving the head downwards until the top track output *just* stopped rising and presumably was completely covered by the tape.

A further Indicord test, fig. 1b, showed that the track placement was now more nearly correct and so the head was rocked for maximum output on a high frequency test recording for correct azimuth setting and the adjusting screws resealed.

Play Only Responses

The playback frequency responses of the top and bottom tracks were now plotted and are shown in fig. 2. The high

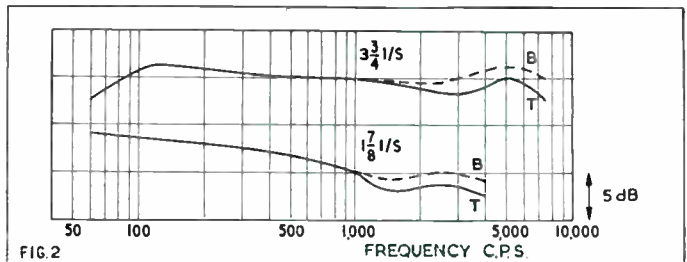

note response was slightly better on the bottom track, but the output from the top track was now quite steady. The azimuth setting was identical for the two tracks.

Record Play Responses

Oscillator tones were next fed to the Phono input and the playback output measured at the Radio socket, fig. 3. The tone control does not affect this output, but the radio or amplifier tone controls can be used to soften the surplus high note response if required.

Acoustic Responses

One third octave bands of filtered white noise were recorded on the machine and the sound level measured on the axis of the internal speaker at three settings of the tone control. Fig. 4 shows the acoustic response and range of control available. The response can be made remarkably smooth over the range 200 to 7,000 c/s and this confirms the middle setting of the tone control for normal tapes. The crystal microphone response is shown in fig. 5.

Signal Noise Ratio

Mains hum was only 25 dB below test tape level on line output which makes the total dynamic range to normal *tape* overload (plus 12 dB) 37 dB—but—and here we come to our second testing problem—maximum recording level as indicated by the magic eye, and corroborated by waveform distortion on playback, was only 6 dB above test tape level! Low bias? Record amplifier overload? Record level indicator wrongly set?

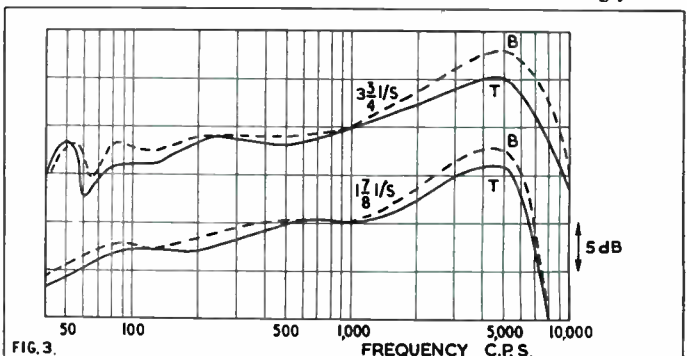

18 Months to Pay

	Deposit	18 Monthly Payments	Cash
	£ s. d.	£ s. d.	Gns.
MAINS 2-TRACK			
Truvox R82 ...	5 15 6	2 17 9	55
Brenell 3 Star ...	6 2 0	3 0 11	58
Reps. R.10 ...	6 4 0	3 2 0	59
Brenell Mk. 5 ...	7 2 0	3 6 10	64
Grundig TK41 ...	8 0 0	3 18 8	75
Telefunken 85 de			
Luxe	8 15 0	4 7 2	83
Brenell 5 Type "M" ...	9 5 0	4 12 5	88
Veritone 16 ...	9 13 0	4 15 6	91
Simon SP/5 ...	9 16 0	4 17 8	93
Reflectograph "A" ...	11 5 0	5 10 0	105
4-TRACK MONAURAL			
Grundig TK23 ...	4 15 0	2 7 3	45
Brenell 3 Star ...	6 2 0	3 0 11	58
Truvox R.84 ...	6 4 0	3 2 0	59
Philips EL3549 ...	6 12 0	3 5 0	62
Reps. R.10 ...	7 5 0	3 12 6	69
Grundig TK40 ...	8 0 0	3 18 8	75
4-TRACK STEREO/MONAURAL			
Philips EL3534 ...	9 16 0	4 16 6	92
Telefunken 97 ...	10 0 0	4 19 9	95
Grundig TK46 ...	10 12 0	5 3 9	99
Akai M.6 ...	13 13 0	6 16 6	130

THE RECORDER CO. features the Superb AKAI M.6 Terecorder

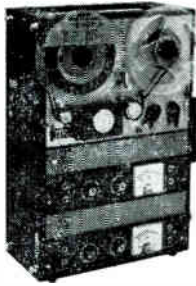

PRICE
130
GNS

Hi-Fidelity 2- or 4-track Stereo/Monaural, Two VU meters, Three speeds — 3 $\frac{3}{4}$, 7 $\frac{1}{2}$ and 15 i.p.s. Automatic Tape Stop. Signal to noise ratio better than 50db.

We will be pleased to demonstrate this remarkable model, send for full details.

- ★ INTEREST FREE terms
- ★ FREE INSURANCE COVERING YOUR PAYMENTS IN THE EVENT OF SICKNESS OR UNEMPLOYMENT
- ★ FREE DELIVERY ★ PART EXCHANGES

12 Months to Pay

	Deposit	12 Monthly Payments	Cash
	£ s. d.	£ s. d.	Gns.
MAINS TWIN-TRACK			
Elizabethan LZ30 ...	3 7 3	2 10 5	32
Grundig TK14 ...	3 13 6	2 15 2	35
Reps. R.10 ...	6 3 11	4 13 0	59
Telefunken 95 ...	6 3 11	4 13 0	59
Ferrogaph 5A/N ...	8 19 0	6 13 0	85
4-TRACK			
Philips "Star Maker" ...	2 16 9	2 2 7	27
Philips EL3541 ...	3 15 8	2 16 9	36
Elizabethan LZ29 ...	3 15 8	2 16 9	36
Truvox R64... ..	4 2 0	3 15 0	39
Grundig TK23 ...	4 15 0	3 10 10	45
BATTERY			
Grundig TK1 ...	2 13 0	1 15 0	23
Philips EL3585 ...	2 10 5	1 17 10	24
Stella 5T470 ...	2 15 0	1 19 2	25
Optacord 412			
Battery/Mains	4 15 0	3 10 10	45
Stuzzi Magnette ...	6 4 0	4 12 11	59
Butoba MTS ...	7 0 0	5 3 10	66
Ficord 202 ...	7 0 0	5 3 10	66
TRUVOX HI-FI TAPE UNITS			
Twin-Track			
PD.82 Standard	4 4 0	3 3 0	42
PD.87 Stereo	6 6 0	4 14 6	63
4-Track			
PD 84 Standard	4 12 0	3 9 0	46
PD.86 Stereo	6 6 0	4 14 6	63

Open all day Saturday—
Friday 6.30 p.m.

THE RECORDER CO.

If unable to call, write for free brochure or send deposit now for quick delivery.

(Dept. R) 188, WEST END LANE, WEST HAMPSTEAD, LONDON, N.W.6.

Telephone: SW1 4977

For Radio .. For Records .. For Tape .. an Armstrong Chassis

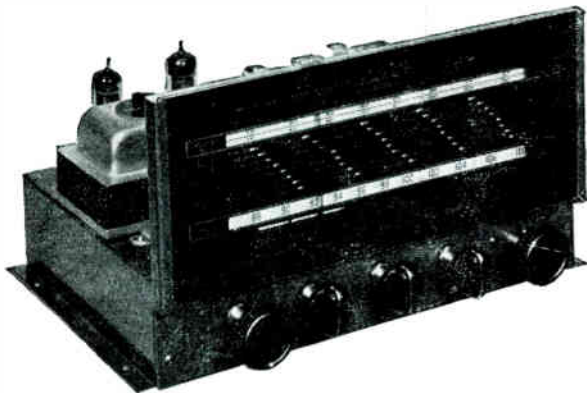

Two complete AM/FM Stereo chassis are also available.

STEREO 12 MK.2 £43.10.0
STEREO 55 £32.15.0

Post this coupon for leaflets or call at your high fidelity or tape recorder dealer or at our showrooms for demonstration. Open 9—5 including Sats.

NAME TCD
ADDRESS

An Armstrong chassis is more than just a radiogram chassis. It is a carefully designed combination of tuner, control unit and amplifier in one compact and convenient unit which can be used as the basis of a complete reproducing system. A system which can include tape recording and playback as well as AM and FM radio and record reproduction. All Armstrong chassis are suitable for use with a complete tape recorder or with a tape deck and its associated tape pre-amplifier.

AF208 CHASSIS (illustrated) £22.18.0

5 watts output with 20db negative feedback ● Full VHF band (87-108m/cs) and medium waveband ● Two inputs for pick-ups ● Tape recording output and playback input ● Separate bass and treble tone controls ● Dimensions: (as for Jubilee Mk 2) 12in. x 8in. x 7in. high.

JUBILEE MK. 2 CHASSIS £30.12.0

8 watts push-pull output ● Full VHF band, medium and long wavebands ● Inputs for all pick-ups and tape playback ● Tape recording output ● Separate bass and treble tone controls ● Automatic frequency control on VHF ● Ferrite rod aerial and magic eye tuning.

ARMSTRONG WALTERS ROAD, HOLLOWAY, LONDON, N.7

NORTH 3213.

EQUIPMENT REVIEWED—continued

No! I worked my way steadily through all these possibilities and eventually, in desperation, tried a new reel of tape (the one in fact used for the other review in this issue which I knew

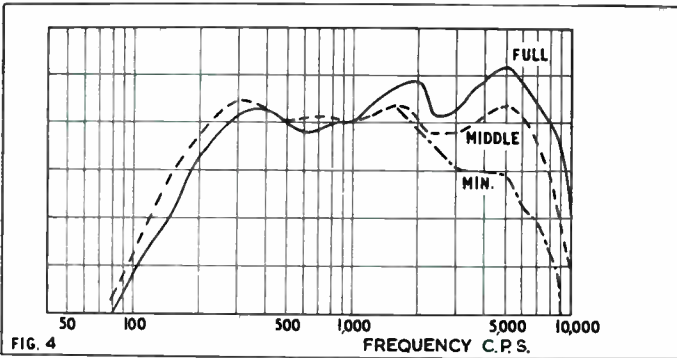

would accept the proper peak recording level). This proved to be the answer. Clashing the magic eye beams recorded a level exactly 12 dB above test tape level and waveform distortion commenced at about 14 dB above test tape level. Thus the culprit was the tape supplied with the machine by the manufacturer. It is 6 dB less sensitive than normal tapes and overloads more easily than the average tape. This is really "spoiling the ship for a ha'porth of tar", and I would advise the recorder manufacturers to check future batches of tape very carefully before issue.

Thus signal noise ratio is 37 dB for the good tape and 31 dB for the poor tape. The former is just tolerable due to the low note (hum) cut off in the internal speaker, but the latter is beginning to show up hum and noise rather badly.

Wow and Flutter

Playing the aforementioned pre-recorded music tape had given no impression of speed unsteadiness, but recordings made and played on this machine sounded slightly off pitch occasionally indicating a certain amount of fairly low frequency wow. Integrated wow and flutter readings seldom exceeded 0.2 r.m.s., which by all normal standards is considered fairly good for a machine in the middle price range. This shows once again that a single flutter bridge reading does not really give much information. Even the separate wow and flutter readings given by the standard

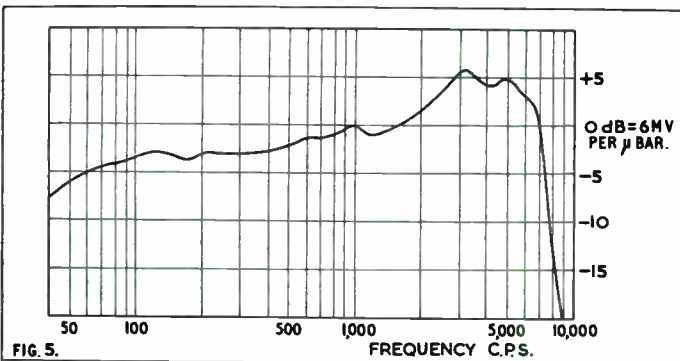

G.B. Kalee wow and flutter bridge lack the necessary information about the frequency and waveform of the cyclical speed variations. For this reason I am showing both "Fluttergrams" and "Wowgrams" for this particular machine. The one second fluttergram is too short to show up speed changes below two or three per second, but is normally required for analysis of flutter content in recorded tapes due to high speed rotating parts in the tape transport mechanism. Fig 6a and b show that tape flutter is quite low but that there is a low frequency speed change which is shown in greater detail in the lower speed pen recordings of fig. 6c and d.

The main offender here appears to be the pressure roller which holds the tape against the capstan: on my review machine it is

visibly out of true, giving two wobbles per revolution. Due to adding and cancelling effects during recording and reproduction the resultant speed changes can vary from 3 c/s to 1 c/s which is the one which gives the impression of a definite change of pitch, but it is extremely difficult to pin down, as a second or two later we may get short section of fig. 6a, where the speed is perfectly steady due to exact cancellation, or the record play phasing may be such as to give a higher frequency wobble in pitch as in fig. 6d.

Comment

It is another problem for a reviewer to decide whether a given fault is "built in" to a machine, i.e. a design fault, or whether it is a production fault in his particular sample. I would guess that these are production faults which could be eliminated by more rigorous inspection and testing of the finished product.

I like the styling and design very much indeed. The control keys are light to the touch and tape handling is very gentle. I like the push button counter reset and the tape foil auto stop also the microphone stop-start switch. Quality is forward and well balanced and mechanical noise is low.

Bad tape, head alignment and pressure roller wobble are

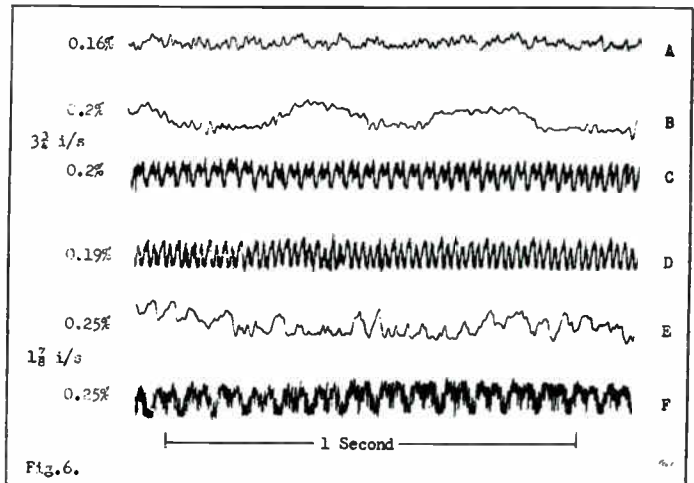

teething troubles which can, and I am sure will, be eliminated as full production gets under way. All I can do is report as I find, and suggest that you use this review as a guide to possible snags which you—or your dealer—must check carefully before you buy.

★ FERROGRAPH SERIES 5A TWO-TRACK RECORDER ★

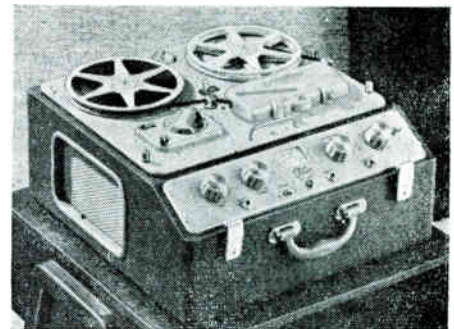

Manufacturer's Specification. Recording medium: Standard or Extra Play $\frac{1}{4}$ in. Plastic coated tape. Reels: up to maximum of 8 $\frac{1}{2}$ in. dia. coating inside. Track width: 0.1 in. displaced to one edge. Number of tracks: 2. Operating tape speeds: $7\frac{1}{2}$ and $3\frac{3}{4}$ is $\pm 2\%$. Playing time per track: Large reel, 45 mins. at $7\frac{1}{2}$ i/s. 90 mins. at $3\frac{3}{4}$ i/s. 1,750 ft. standard tape. Playing time per reel: $1\frac{1}{2}$ hrs. and 3 hrs. respectively. Note: The above playing times will be increased when "extra play" tape is used. Rewind time (and wind on): Less than 1 min. for 1,750 ft. reel standard tape. Frequency response: $3\frac{3}{4}$ i/s. 40-10,000 c/s - 3 dB. $7\frac{1}{2}$ i/s. 40-15,000 c/s - 3 dB. Wow and flutter: Less than 0.16% at $7\frac{1}{2}$ i/s. Long term

TAPE RECORDER COVERS



Smart waterproof cover to give complete protection to your tape recorder. Made from rubberised canvas in navy, wine, tan, grey and bottle green with white contrasting pipings, reinforced base, handy zip microphone pocket and name panel.

Grundig	TK.1	...	49/6	Philips	EL3536	...	70/-
"	TK.5	...	55/-	"	EL3515	...	57/6
"	TK.8	...	63/-	"	FL3541/1S	...	57/6
"	TK.14 & 23	...	59/6	"	Starmaker	...	66/-
"	TK.20	...	52/6	Cossor	1602	...	57/6
"	TK.24	...	55/-	"	1601	...	63/-
"	TK.25	...	55/-	Stella	ST455	...	63/-
"	TK.30	...	60/-	"	ST454	...	57/6
"	TK.35	...	63/-	Saja	Mk.5	...	57/6
"	TK.40	...	60/-	Stuzzi	Tricorder	...	58/-
"	TK.50	...	60/- †	Saba	63/-
"	TK.55	...	63/-	Wyndor	Viscount	...	55/-*
"	TK.60	...	75/-*	"	Victor	...	60/-*
"	TK.830/3D	...	63/-	Elizabethan	Princess	...	60/-
"	Cub	...	35/-*	"	Avon	...	60/-
Telefunken	85	...	60/-	"	Escort	...	57/6*
"	85	...	65/-	"	Major	...	63/-
"	75/1S	...	55/-	"	FT.1	...	66/-
"	76K	...	55/-	"	FT.3	...	75/-
"	95	...	69/6	Fi-Cord	52/6
Philips	8108	...	57/6	Korting	(4 track stereo)	...	63/-
"	8109	...	63/-	Harcing	Stereo	...	66/-
"	FL3538	...	63/-	Fidelity	Argyle	...	55/-*
"	EL3542	...	63/-	Simon	SP4	...	63/-*
				Clarion	(with strap)	...	52/6
				Brenell	Mk.5	...	77/-
				"	3 star	...	69/-
				Minivox	C...	...	61/-
				Robuk	RK.3	...	67/6
				Ferroglyph	80/-
				Sony	S21	...	90/-

*Without pocket. †Price to be announced.

A. BROWN & SONS LTD.
24-28, GEORGE STREET, HULL Tel: 25413, 25412

tape accessories

IN A PRESENTATION GIFT SET

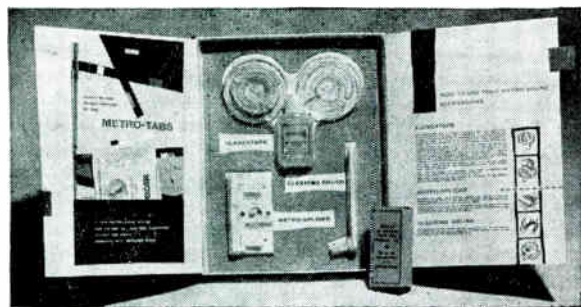

- KLENZATAPE** The approved method for cleaning playing and erase heads. KLENZATAPE KIT 12/6 FLUID REFILLS 3/11 TAPE REFILLS 5/-.
- METRO-SPLICER** For both recording tape and 8 mm. cine film. SPLICING KIT 15/- SPARE CUTTING UNITS 2/6 SPARE FILM EMULSION SCRAPER 1/-.
- METRO-TABS** For QUICK, POSITIVE identification of recorded passages. PRICE PER SET 3/11 INCLUDING INDEX.
- METRO-BRUSH** For cleaning tape decks and cine equipment. PRICE 2/6.

★ **ALL THE ABOVE, PLUS MANY SPARES, CAN NOW BE OBTAINED IN THE METRO-SOUND TAPE ACCESSORIES GIFT SET (AS ILLUSTRATED) PRICE £2.2.0. COMPLETE.**

NEW! METRO-STOP For use with Auto-Stop. Easy to apply and remove. PRICE 17/6.

Available all leading dealers, if any difficulty write to:



METRO-SOUND MFG. CO. LTD.
19A Buckingham Road, London, N.I.
Tel: CLIssold 8506/7



Alive to every sound

Like the ears of a wary fox, the Gramplan DP4 microphone is sensitive to an extremely wide range of sounds. With its uniform frequency response from 50 to 15,000 c/s, the reliable, medium-priced DP4 will greatly improve the standard of your recordings.



Gramplan DP4

— also for broadcasting, public address and call systems

Low Impedance microphone complete with connector and 18 ft. screened lead **£8.0.0**
Medium and high impedance models **£9.0.0**

A complete range of stands, swivel holders and other accessories is available.

GRAMPIAN—sounds like the real thing!

Write or phone for Illustrated leaflet.

GRAMPIAN REPRODUCERS LTD
Hanworth Trading Estate, Feltham, Middlesex. Feltham 2657

NUSOUND RECORDING Co.

35 CRAVEN STREET, W.C.2.

TELEPHONE TRA 2080

Ferroglyph
(Appointed Dealer)

The new SERIES 5 Tape Recorder is on permanent demonstration, in addition to the 420 STEREO SERIES. Hear these recorders linked with QUAD Amplifiers and TANNOY Speakers.

See the range of accessories we carry:

Mixers — Tapes — Microphones — Stands — Tuners, etc.

OUR TECHNICAL AND PRACTICAL EXPERIENCE IS AT YOUR DISPOSAL

IT PAYS TO DEAL WITH A SPECIALIST

The 'NUMIX 2' is a two-channel unit (Mic. and other source) low- or high-impedance feeds. The 'NUMIX 2' can be used with ANY TAPE RECORDER WHICH WILL ACCEPT A HIGH-Z MICROPHONE. Near professional results are guaranteed.



Price: £6.10.0. complete.

Write for leaflet on 'NUMIX 1', 'NUMIX 2' and 'MONITOR' UNITS.

The 'NUMIX Mk. 3' (fully transistorised) 2-channel Microphone Mixer is now available, price: £8-19-6

NUSOUND RECORDING COMPANY

EQUIPMENT REVIEWED — continued

speed stability: Better than 0.5%. **Erase and bias frequency:** 68 Kc/s approx. **Input levels (for full depth recording):** Input 1, min. signal 0.003 V R.M.S. Input 2, min. signal 0.15 V R.M.S. **Impedances:** 1 megohm and 80 K ohms respectively. **Output arrangements:** 15 ohms 10 in. by 6 in. internal elliptical speaker. Socket on front panel for external speakers. **Output power:** 2½ watts into 15 ohms. **Signal noise ratio:** In range 200 c/s to 15 Kc/s, better than 50 dB. Unweighted including hum, 45 dB. **Working voltage:** 200-250 V. A.C. **Power consumption:** 110 watts. **Overall dimensions:** 18½ × 17½ × 9¾ in. high, with lid. **Weight:** 49½ lbs. **Price:** £89 5s. **Manufactured by:** The Ferrograph Co., Ltd., 84 Blackfriars Road, London, S.E.1.

WHEN I reviewed the Ferrograph Series 422 Stereo recorder in the October issue of this magazine, I commented that "the wow and flutter performance (at 3¾ i/s) was not up to the highest modern standards" and that "the basic design had not been changed in nearly 10 years of production". This produced a quick 'phone call from Mr. Merrick of Ferrograph agreeing with my criticism, but pointing out that there was now a

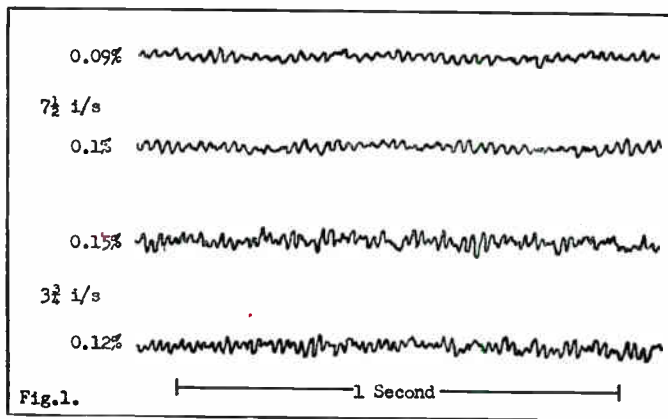

major modification to the flywheel and capstan assembly of the new Series 5 Ferrograph recorders, aimed at improving the wow and flutter performance at the lower speed, and offering to send me one of the new models for further tests.

The new machine has a heavier, deeper, flywheel running at twice the speed of the old one, with a capstan diameter half that of the earlier model. I must admit that I had some misgivings about the smaller diameter rubber covered capstan, which must run true to at least twice the accuracy of the larger one to show any appreciable improvement, but let me say straight away that I need not have worried; wow is now completely negligible even on a sustained pure tone under the most critical listening conditions. The slight 50 cycle flutter shown on my fluttergrams is beyond the range at which the ear can distinguish any change of pitch, and the effect is similar to a very low level mains hum which follows the amplitude of the signal and is therefore completely masked by normal programme recording.

The bias, pre and post emphasis equalisation circuits, etc., have been carefully chosen to give the widest frequency response at the lower speed with no risk of harmonic distortion or noise due to under biasing or overcorrection. The response may not

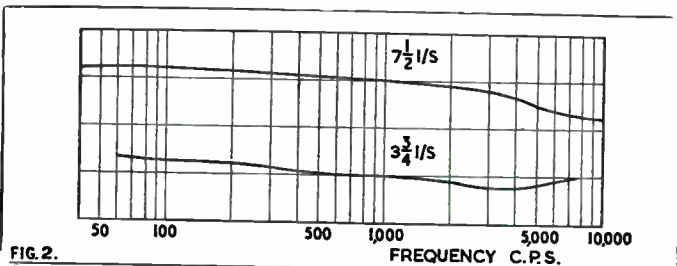

RAPID RECORDING SERVICE

78s and L.P.s. from your own tapes. (48 hour service).
Master Discs and pressings.

Recording Studio.

Mobile Recording Van.

Associated Company:

EDUCATIONAL RECORDINGS LTD.

Specialists in Sleep-learning and Audio-learning. Tapes on Mind Management; Positive Personality; Memory Training; How to Pass Examinations.

Manufacturers of the "Sleep-o-matic Unit" to be used with our Sleep-learning tape.

Foreign language courses available for Sleep-learning.

Brochures on request from:

RAPID RECORDING SERVICE, Dept. TR,
21 Bishop's Close, Walthamstow, E.17. COP 3889

NUSOUND RECORDING CO.

Ferrograph

(Appointed Dealer)

Tape Recorder & Hi-Fi Specialists

Showrooms: First Floor
3-8 BRIGSTOCK PARADE,
LONDON ROAD,
THORNTON HEATH,
SURREY,
(Opposite Thornton Heath LT Bus Depot)
TELEPHONE: THO 7609

London Showroom
35 CRAVEN STREET,
TRAFALGAR SQUARE,
LONDON,
W.C.2
TELEPHONE: TRA 2080

This is a  tape record

and, to be exact, it is our "MESSIAH" High-lights — STE 3034, available in stereo only. (The complete "MESSIAH" is available in mono only. STG 8051-3).
For those discriminating music-lovers who seek and value the *original* sound — Saga tape records are the answer. More permanently recorded, more precisely recorded, Saga tape recordings are the hi-fi devotee's *only* satisfactory answer. Saga tape records, both mono and stereo, 3¾ i.p.s. (32/6) and 7½ i.p.s. (63/-), are the Commonwealth's most accepted tape records.



Ask for  by name

SAGA RECORDS LTD., 127 KENSAL ROAD, W.10

FOR BEST RESULTS USE

ferrania

MAGNETIC RECORDING TAPE

Two Years Guarantee

NOT MASS PRODUCED BUT VIRTUALLY HAND-MADE FOR RELIABILITY AND CONSISTENTLY HIGH STANDARD OF PERFORMANCE

R10 SPECIFICATION: 2 or 4 track version. 10 watts push/pull output.

Record Replay Responses—

7½ ips. 40-16,000 C.P.S. } ± 3 dBs.
 3½ ips. 40-10,000 C.P.S. } At optimum
 1½ ips. 50- 6,000 C.P.S. } bias setting.

Signal/Noise ratio—

half track 50 dBs at 3½ ips.
 quarter track 45 dBs at 3½ ips.

Modified Collaro Studio Deck. Microphone and Radio/Gram inputs each with separate gain controls for mixing. Separate bass and treble controls. ± 12 dBs at 50 cycles and 12 k/c.s. Adjustable monitor volume control independent of record level. Peak signal lever meter 2½ in. square. Bogen heads. Record safety device. 600 ohms Cathode follower output. Two per cent total harmonic distortion on peaks. 200/250 volts 50 cycles or 100/120 volts 60 cycles. Valve line up: 3 EF86, 2 ECC83, 1 ECC82, 2 ECL86. Metal rectifier, contact cooled.

Prices: 2 Track 7" spools 59 gns.
 4 Track 7" spools 69 gns.



Fully illustrated literature available on request to—

REPS (TAPE RECORDERS) LTD.

118 Park Road North, South Acton,
 London, W.3 Phone: Acorn 4141

BRITAIN'S LARGEST TAPE RECORDER AND HI-FI PART EXCHANGE SPECIALISTS

If you have outgrown your present tape recorder or hi-fi equipment and would like to own a more advanced machine, as used by professional and serious tape recorder enthusiasts. Contact us today !!!

MAIL ORDER EXPERTS

AND APPOINTED AGENTS FOR

- Ferrograph 5AN ... 85 gns.
- Wyndor International 75 gns.
- Ferrograph 422/4 ... 110 gns.
- Reflectograph 'A' ... 105 gns.
- Tandberg 6 Stereo ... 110 gns.
- Vortexion WVA ... £93.13.0
- Brenell Mk. 5 'M' ... 88 gns.
- Simon SP.5 ... 93 gns.
- Brenell Mk. 5 ... 64 gns.
- Akai M6 Stereo ... 130 gns.
- Philips Stereo ... 92 gns.
- Sony 521 Stereo ... 124 gns.
- Reps R10 ... 59 gns.
- Ampex Stereo 971 ... 225 gns.
- Revox Stereo ... 110 gns.

ALL ABOVE RECORDERS AVAILABLE FROM STOCK

WE HAVE THOUSANDS OF SATISFIED CUSTOMERS THROUGHOUT THE BRITISH ISLES

TRANSISTOR-BATTERY

- Grundig TK1 ... 29 gns.
- Optacord 412 ... 45 gns.
- Butoba MT5 ... 69 gns.
- Fi-Cord 202 ... 69 gns.
- Philips EL3585 ... 24 gns.
- Stuzzi Magnette ... 59 gns.
- Uher 4000 ... 93 gns.

Complete High-Fidelity systems supplied in parts or built to customers' requirements. The latest equipment and cabinets in stock. Agents for all leading makes.



Ferrograph 4AN

ALL GOODS AVAILABLE ON OUR FAMOUS **NO INTEREST TERMS**

10% deposit, balance 12 months. 18 to 24 months terms available

FREE SERVICING—FREE DELIVERY—300 MACHINES ON DISPLAY—OUR MAIL ORDER DEPARTMENT WILL DEAL WITH YOUR ENQUIRY BY RETURN. WRITE—PHONE—CALL FOR A QUOTATION ON YOUR MACHINE. A LARGE SELECTION OF USED TAPE RECORDERS. HOME DEMONSTRATIONS IN THE LONDON AREA.

REW

EARLSFIELD LTD., 266 UPPER TOOTING ROAD, LONDON, S.W.17
 Telephone: BALHAM 7710

100 yards from Tooting Broadway underground station: opposite Tooting Market



Tape recorders

EQUIPMENT REVIEWED — continued

look so impressive as that of some of the cheaper machines which promise a response to 15 or 20 Kc/s at $3\frac{1}{2}$ i/s, but, like many other high priced semi-professional recorders, the response is silky soft and completely clean.

Speed Wow and Flutter

The tape speed was checked on a standard tape against a stable oscillator and found to be $1\frac{1}{2}\%$ fast, which is within the specification limits of $\pm 2\%$. As mentioned above, wow was very low and could neither be heard nor seen on the fluttergrams or pen recordings.

A slight 50 cycle flutter was evident at both speeds, and this can only be due to the pulsating torque from the drive motor. There is a remarkable lack of any cyclical wow from any rotating part: 25 c/s motor shaft; 10 c/s idler wheel; 6 c/s capstan; 2 c/s pressure roller (all at $7\frac{1}{2}$ i/s). So it can be said that the modifications are quite successful in eliminating the last vestige of audible speed change from the tape transport of this recorder.

Play Only Responses

100 and 200 microsecond test tapes were played at $7\frac{1}{2}$ i/s and $3\frac{1}{2}$ i/s respectively and the responses are shown in fig. 2 with both tone controls at 10. Turning the bass and treble controls to zero introduces a 15 dB cut at 100 c/s and 10 Kc/s.

The $7\frac{1}{2}$ i/s response shows a tendency towards the N.A.R.T.B. playback characteristic with a slight fall at the higher frequencies. The $3\frac{1}{2}$ i/s playback response is very close to the C.C.I.R. recommendation for this speed. Hum and system noise, with no tape running, is 42 dB below test tape level.

Record Replay Responses

The machine was loaded with Scotch Brand 150 Extra Play tape and oscillator tones were fed to Input 2 and the outputs on replay measured across a 15 ohm load plugged into the L.S. output jack. It was found that test tape level was recorded at

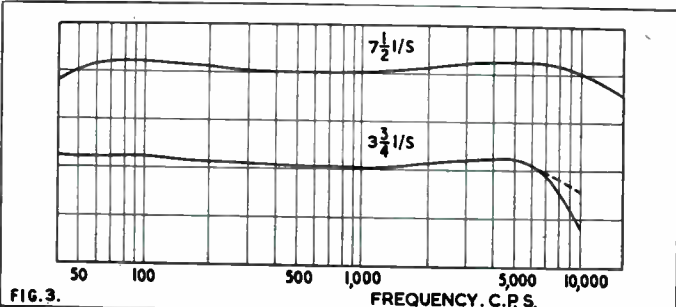

a meter reading of 2, and that 8 on the meter recorded a level 12 dB above test tape level. Waveform distortion was completely absent at this level and only just visible on the C.R.O. at full meter scale, corresponding to a level 16 dB above test tape level. This very gentle overload characteristic shows that the bias is optimum, or even slightly above optimum, for minimum distortion, and that the record circuits give a pure waveform at high output levels so that the tape itself is the first and only non-linear element in the recording chain.

Fig. 3 shows the frequency responses at test tape level at the two speeds. The dotted response at the lower speed is obtained by dropping the recording level 6 dB below test tape level, and this is the response which will be obtained in practice due to the spectral energy distribution in normal speech or music where the high frequency power is much less than at lower frequencies.

The extreme low frequency responses, at both speeds, are particularly smooth and free of head contour effects, and the extra octave below 80 c/s gives a "solid" feel to the reproduction which is markedly lacking in many cheaper machines.

The overall response from tape to air was measured by using a White Noise test tape containing 25 one third octave bands of filtered white noise and measuring the sound output on the axis (continued on page 509)

AMPEX

500 SERIES TAPE

	Standard Play Tape	Long Play Tape	Standard Play Mylar	Long Play Mylar	Double Play Mylar
5"	15s.6d.	£1. 2s.6d.	£1. 1s.0d.	£1. 6s.6d.	£2. 2s.0d.
5 $\frac{1}{2}$ "	£1. 2s.6d.	£1.10s.0d.	Not available	£1.13s.6d.	£2.16s.0d.
7"	£1. 6s.6d.	£1.19s.6d.	£1.12s.6d.	£2. 5s.0d.	£3.12s.6d.

Cash with order for immediate goods by return, post free

NUSOUND RECORDING COMPANY
35 CRAVEN STREET, W.C.2. TELEPHONE TRA 2080

BRAND NEW FAULT FREE 100% TESTED TOP QUALITY RECORDING TAPE

(As supplied to the Far East Broadcasting Corp.)

WHY PAY MORE?

Polyester Long Play. Super Quality			P.V.C. Standard		
Size	Length	Price	Size	Length	Price
3"	220'	3s. 0d.	3"	160'	2s. 3d.
5"	900'	11s. 6d.	5"	600'	8s. 6d.
5 $\frac{1}{2}$ "	1200'	16s. 0d.	5 $\frac{1}{2}$ "	900'	10s. 9d.
7"	1800'	23s. 0d.	7"	1200'	15s. 3d.

REFUND GUARANTEE (Never requested)

N. WALKER, 28 Linkcroft Avenue, Ashford, Middlesex

AUTOMATED SLEEP-SUGGESTION

- WHAT IS SLEEP-SUGGESTION?
- HOW DOES IT WORK?
- HOW CAN IT BENEFIT YOU?

SEND NOW for FREE BROCHURE for up-to-the-minute information on this vital subject.

EDUCATIONAL RECORDINGS LTD.
Dept. 13, 21 Bishops Close, Church Lane, London E.17

you'll be glad
you recorded it on
gevasonor
magnetic tape

GEVAERT

Ask your dealer
for free descriptive leaflet

GEVAERT LIMITED · BRENTFORD · MIDD.X.

Lee Electronics

TAPE RECORDER ■ HI-FI AUDIO SPECIALISTS

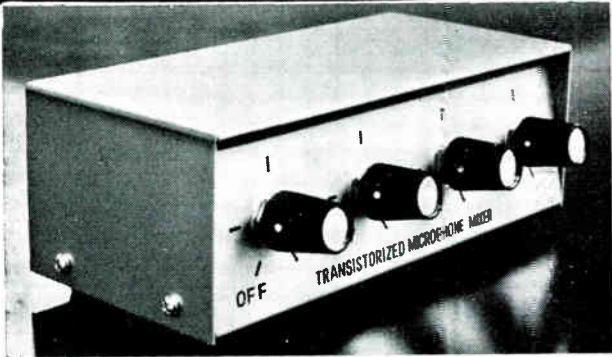

AT LAST A 4-CHANNEL TRANSISTORISED MICROPHONE MIXER AT A REASONABLE PRICE

Four high impedance inputs, e.g. four mics or two mics, one gram and one radio. Output gain approximately 6dB. Inputs, standard jack sockets. Battery PP3.

Price complete with PP3 circuit diagram, instructions etc

£3 - 19 - 6

TRADE SUPPLIED

Details of this, and other offers, available on request.

400 Edgware Road, Paddington

PAD 5521

CRAIGHALL RECORDING STUDIOS

(Geo. Jeffrey Ltd., Edinburgh)

These modern and fully equipped studios offer the following services:

Commercial and Private Recording Sessions.

Hire of Studio for Practice and Rehearsal Work.

Tape to Disc Transfer Service.

Mobile Recording Unit also available.

TAPE TO DISC PRICE LIST

7" Std.	45 r.p.m.	9/6d.	per side
7" EP	45 r.p.m.	11/6d.	" "
7" LP	33 r.p.m.	13/-	" "
10" LP	33 r.p.m.	17/6d.	" "
12" LP	33 r.p.m.	19/6d.	" "

If tapes require editing, a charge of 5/- is added.

Send for our Fully Detailed Price List.

GEORGE JEFFREY LTD.

23 Earl Grey Street, Edinburgh 3. Tel.: FOU 8389.
(Studios: 68 Craighall Road, Edinburgh 6. Tel.: GRA 3685)

THE ANSWER TO YOUR CHRISTMAS PRESENT PROBLEM

two new hi-fi books

SOUND & CINE FOR BEGINNERS

An up-to-date guide for the beginner by Richard Golding with an introduction to some advanced methods including the latest means of producing experimental soundtracks. Contents include making up separate tape tracks; sound stripe; optical sound-on-film; special recording apparatus; recording sessions; how to write commentaries etc; with photographs and line illustrations. "The most comprehensive small book ever to be written on the subject of adding sound to film."

Price 8s. 3d. post paid



CABINETS FOR BEGINNERS

This book gives you all the necessary information for building your own Hi-Fi cabinet. Subjects covered include designing, timber, marking out, tools, materials, joints and finishes. The many photographs and diagrams help to make this book indispensable not only for Hi-Fi applications but also for general cabinet work encountered in the home. This is all new material written by the well-known expert Wheater Smith none of which has previously been published.

Price 8s. 3d. post paid

MILES HENSLOW PUBLICATIONS LTD. 99 MORTIMER STREET, LONDON, W.1

EQUIPMENT REVIEWED — continued

of the internal speaker at a distance of 1 ft. Fig. 4 shows a well balanced response with a useful range from 80 c/s to 8 Kc/s. Due to the rather large speaker cone, high frequency focusing effects are evident, and one feels the need to turn the cabinet round and stoop down to listen on the speaker axis for really critical listening or monitoring of a recording. The addition of a small "tweeter" speaker with a broader polar response would help matters here.

Signal Noise Ratio

A peak level recording, at 8 on the recording level meter, was erased on the machine and the residual signal, tape noise, hum, and system noise was measured at 52 dB, which is considerably better than the specification figure of 45 dB. Erase and bias noise was within 1 dB of bulk erased noise when weighted to reduce hum and low frequency response and so show up the small change in hiss level. The extremely good low frequency

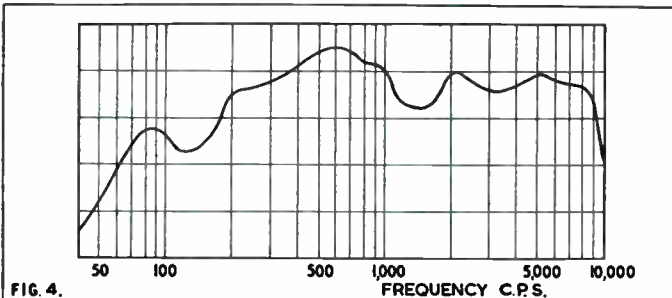

FIG. 4.

response mentioned earlier showed how difficult it is to bulk erase a reel of tape without leaving very low frequency signals on the tape due to the radial erasing field. The reel has to be turned and moved away from the eraser very slowly to avoid this effect. In practice it was most difficult to bulk erase a tape as efficiently as the machine's own erasing system.

Comment

This time we have a modified tape transport system, which certainly pays off in reduction of audible wow and flutter at the lower speed, combined with an amplifier circuit which has been basically unchanged for several years. But this time I have no complaints, the electronics have steadily improved over the years by detail changes such as the substitution of a push pull oscillator circuit for the original single ended oscillator, and small changes in equalisation, etc. The final result is a product which is reliable to the Nth degree because all production "bugs" have long ago been ironed out or bypassed.

This recorder has a soft clean quality which is the result of very low distortion in the recording process combined with exact equalisation and low distortion hum and noise in the playback mode. The output stage in particular deserves special mention. Although only single ended, it is fitted with a large and adequate output transformer, with plenty of negative feedback around the whole amplifier, so that the highest quality external speakers may be fed directly from this machine for ordinary domestic listening with the assurance that a separate power amplifier will only be required if more power is needed; there will be no improvement in quality. The Ferrograph Model 5A now heads my own private popularity poll.

A. Tutchings

THE WAL D-MAG, head demagnetiser, long nylon covered probes. £2.10.0

WAL GAIN transistorised pre-amplifiers, Mono £5.10.0, Stereo £7.10.0 and Hi-Gain (latter CCIR equalised). £7.16.0

THE WAL BULK ERASER. £7.18.6

Available from all leading dealers. (Wholesalers include A. C. Farnell Ltd., Leeds).



WELLINGTON ACOUSTIC LABORATORIES LTD.
Farnham, Surrey (6461)

— YOUR TAPE DEALER —

Specialists in Hi-Fi Equipment and Tape Recorders

CHELSEA RECORD CENTRE

203 KINGS ROAD, S.W.3 FLA 2596

Open till 8 p.m. (except Thursdays)

Disc and Tape Reproducing Equipment and Tape Recorders
by Leading Manufacturers

CUSTOM BUILT INSTALLATIONS

All High Fidelity Requirements and Services Available

Estimates Free

Personal Service

Custom High Fidelity

371 Green Lanes, Palmers Green, London, N.13

Tel. PALmers Green 5228

hifi

FOR ALL LEADING
AUDIO EQUIPMENT

call, write, or telephone

hampstead HIGH-FIDELITY

91a Heath Street, Hampstead, London N.W.3 Telephone HAMPstead 6377

ENGLAND'S BIGGEST SPECIALISTS:

HOWARD

218 HIGH STREET, BROMLEY RAV 4000

LASKY'S RADIO

ALL LEADING MAKES IN STOCK

Cash or Easy Terms

LONDON'S FINEST SERVICE

207 EDGWARE ROAD, W.2

PAD 3271/2

33 TOTTENHAM COURT ROAD, W.1 MUS 2605

SHEEN TAPE RECORDER CENTRE

SPECIALISTS IN TAPE RECORDERS, ACCESSORIES, HI-FI EQUIPMENT
YOUR CENTRE FOR FRIENDLY HELP—SALES AND SERVICE

8 STATION PARADE
SHEEN LANE, SHEEN
LONDON, S.W.14

Showrooms Open until 7 p.m.

PROSPECT 0985

(Opposite Martlake Station S.R.)

— Country and Provincial —

BOURNEMOUTH

NATIONAL RADIO SUPPLIES

66 Holdenhurst Road,

Bournemouth

Tape, Hi-Fi & components

Tel. 25232

ELECTRONIC WORLD

is by far the cheapest
HIGH QUALITY TAPE
 on the market

- * **Acclaimed by experts**
 Reprints of reviews available
- * **Backed by our Guarantee**
 If you are not completely satisfied with any purchase, we undertake to refund the full price plus your return postage

POST COUPON NOW!

DE VILLIERS (Electronic World) LTD.

16d Strutton Ground, London, S.W.1

STANDARD PLAY (Acetate base)

3 in. spool 175 ft. 4 spools for 18/-
 or 48/- dozen

4 in. spool 300 ft. 4 spools for 26/-

5 in. spool 600 ft. 2 spools for 26/-

5½ in. spool 850 ft. 16/- per spool

7 in. spool 1,200 ft. 19/- per spool

ARCHIVE GRADE (S.P. Polyester)

7 in. spool 1,200 ft. 22/6 per spool

LONG PLAY (Acetate Base)

7 in. spool 1,800 ft. 28/-

LONG PLAY (Polyester Base)

3 in. spool 225 ft. 4 spools for 22/-
 or 60/- dozen

4 in. spool 450 ft. 2 spools for 21/-

5 in. spool 900 ft. 2 spools for 35/-

5½ in. spool 1,200 ft. 24/- per spool

7 in. spool 1,800 ft. 31/- per spool

DOUBLE PLAY (Special Polyester base)

3 in. spool 375 ft. 4 for 40/-
 or 108/- per dozen

4 in. spool 600 ft. 2 for 30/-

5 in. spool 1,150 ft. 27/- per spool

5½ in. spool 1,750 ft. 35/- per spool

7 in. spool 2,400 ft. 45/- per spool

I enclose remittance for £ s. d. Post Free

Name

Address

BLOCK LETTERS PLEASE Cash with order

FAULTY RECORDING
 INCOMPLETE ERASURE
 DIRT
 NOISY PLAYBACK
 DISTORTION
 DEPOSITS
 DIRT

THE ONLY REALLY SAFE SCIENTIFIC CLEANING METHOD!

Recommended by leading manufacturers

Many tape recording faults are due to oxide deposits from the tape on the record and erase heads.

You can overcome these by using ...

KLENZATAPE

A completely safe cleaning method developed by sound engineers, to clean delicate and inaccessible surfaces. You merely play through the KLENZATAPE (supplied on two spools) using the special KLENZATAPE cleaning fluid.

IT'S QUICK—IT'S EASY—IT'S KLENZATAPE!

Available at leading dealers. If you have any difficulty, write to...



METRO-SOUND MFG. CO. LTD.
 19a BUCKINGHAM ROAD,
 LONDON, N.1.
 Telephone: CLInfold 8504/7

Look for the bright red pack with the polythene storage wallet. Price 12/6d

USE YOUR TAPE RECORDER FROM ANY D.C. SUPPLY

You can operate your recorder from a car, caravan or boat battery, or from any D.C. mains supply with a VALRADIO D.C. CONVERTER. These D.C. converters enable you to operate T/RECORDERS, etc., for play-back music, telephone conversations and reports whilst on long journeys, in addition to making outside recordings.

Electronic types of converters are also available for 200/250 D.C. with outputs up to 200 watts 50 c/s. from ships' supply or D.C. mains.

Available for practically all makes of recorders, record players, radiograms, amplifiers, etc., with prices ranging from £7.3.0., VALRADIO D.C. CONVERTERS add versatility to your equipment.

For further details just post coupon below to:



LIMITED,
 Browells Lane,
 Feltham, Middlesex.
 Tel. Feltham 4242 & 4837



Valradio and Stereosonoscope are the registered trade marks of Valradio Ltd.

Please send me fully descriptive leaflet, ref: TR on D.C. CONVERTERS for tape recorders and other equipment.

NAME

ADDRESS

Make and type of equipment:.....

D.C. volts in:..... A.C. watts out:.....

READERS' PROBLEMS

★ Readers who encounter snags, or who run into trouble with their tape recording equipment, are invited to write to this editorial office for advice, marking the envelopes "Readers' Problems—Tape". Replies will either be sent direct by post, or published in this column if the subject is of general interest. However, we must emphasise that this advisory service cannot include requests for information about manufacturers' products when such information is obviously obtainable from the makers themselves. It is also essential to keep the queries reasonably short and to the point, and to limit them to one specific subject if at all possible. And, please, in no circumstances confuse such letters with references to other matters which may have to be dealt with by other departments in our office.

Crystal Pickup Load Impedance

Dear Sir:—I have a Countess tape recorder which gives good bass, middle, treble balance when playing pre-recorded tapes or playing back recordings from radio.

However, when playing back recordings from records, using an inexpensive crystal pickup, bass is almost non-existent.

Can this be easily remedied or would a more expensive pickup of a different type have to be used?—*Yours faithfully, D.S.M., Swindon.*

In order that a crystal pickup should reproduce correctly over an appropriate frequency range it is normally necessary that it should feed into a suitable load impedance. This impedance may, on occasion, be that presented by a small network of resistors and capacitors, appropriate to the particular pickup cartridge.

These details can best be supplied by the pickup manufacturer and we therefore feel that it would be best if you were to place your problem before them.

Converting From D. C. Erase

Dear Sir:—I purchased a second-hand "Clarion" some months back for the purpose of recording Fair Ground Organs, and have since rebuilt the mechanical parts including grinding true of all tape transport components, and converting to $7\frac{1}{2}$ i/s.

My troubles now add up to higher background noise than I care for, which is accentuated when played back on my mains operated machine, and lack of good modulation depth without distortion.

Am I correct in my deduction from the "Clarion" circuit diagram that DC bias is the cause of my trouble and do you consider it possible to change to HF bias using Mr. Tutchings' Oscillator with my existing head, and using the space available on the speaker panel?—*Yours faithfully, W. H. W., Ockbrook.*

I feel that you are being rather ambitious with regard to your modifications on your portable tape recorder but I wish you all success. I must confess that I am not completely sure about the "Clarion", but I suspect that, like most portables, it uses HF bias but DC erase. If this is the case, or if you were to modify to introduce HF bias, you would still find quite a degree of tape hiss due to the DC erasure. The reason for DC erasure, incidentally, is to avoid the rather severe battery drain that would otherwise be entailed.

I have had a similar problem with my portable, and have improved things considerably by, in fact, removing the erasing magnets entirely. I now erase all the tape on my mains machine, resulting in comparatively "clean" recordings.



VENNER
14 DAY
CLOCKWORK
TIME SWITCHES
Ideal for Tape Recorders
29/6 P & P
3/-

KINGSWOOD SUPPLIES (T.R.2), 4 Sale Place, London, W.2. PAD 8189

AUTOMATIC CONTROL over radio and/or tape recorder. Will switch ON/OFF or OFF/ON once every 24 hours at any manually pre-set time. Minimum time lapse 30 minutes. It has a current rating of 1 amp sufficient to carry radio and/or tape recorder. Complete with key and mounting bracket. Used but in perfect condition. Fully guaranteed.

YOUR TAPE DEALER

H. D. KIRK
Stereolectrics
LIMITED
Specialists in High Fidelity
150 HIGHER BRIDGE STREET
Phone: 23093
BOLTON

R.E.S. (COVENTRY) LTD.
SPECIALISTS IN HIGH FIDELITY
and all makes of Tape Recorders
All leading makes of High Fidelity Equipment stocked and demonstrated under ideal conditions. ★ *The Best Selection—Terms and After Sales Service in the MIDLANDS.*
R.E.S. (Coventry) Ltd. 128 Far Gosford St. Coventry 28781/2

FARNHAM, SURREY
★ Stockists of all the leading makes of High-Fidelity Equipment
★ Comparative Demonstrations
★ Cabinet Manufacturers and Designers
★ Personal service and satisfaction guaranteed
★ Specialists in custom-built Hi-Fi Equipment
LLOYD & KEYWORTH LTD, The Record Shop
26/7 Downing Street, Farnham, Surrey. Telephone: Farnham 5534
SURREY AND HAMPSHIRE'S HI-FI DEALERS

TAPE RECORDER CENTRE (HALIFAX)
Stock all the best Tape Recorders; Hi-Fi Equipment; Tape; L-P Records, etc.
DEMONSTRATIONS DAILY BY EXPERT STAFF
2 years FREE SERVICE ON NEW RECORDERS over £35
30 King Cross Street, Halifax. 'phone 66832

MANCHESTER
LANCASHIRE HI-FI Limited
and now incorporating
The Tape Recorder Specialists
DIXONS ELECTRONIC (Sales and Service)
8 DEANSGATE - - - next to Grosvenor Hotel

LEICESTER
ALL YOUR HI FI REQUIREMENTS

Speakers by:	H.M.V. QUAD LEAK ROGERS	
	TANNOY MORDAUNT LOWTHER	W.B.
Tape:	WHARFDALE GOODMANS.	
	FERROGRAPH REFLECTOGRAPH	GRUNDIG
	SIMON BRENNEL	
Record Department:	ALL LABELS-PARASTAT SERVICE.	

LEICESTER CO-OPERATIVE SOCIETY LIMITED, High Street, Leicester. Tel: 20431

TAPE RECORDERS and HI-FI

The Largest Electrical store in the North



Fenham Radio
158, NEW BRIDGE STREET,
NEWCASTLE UPON TYNE 1
Telephone: 29866

WESTWOOD'S of **OXFORD**
46 GEORGE STREET
PHONE: 47783

— YOUR TAPE DEALER —

PETERBOROUGH, NORTHANTS

Tel: 5545

CAMPKINS RECORD SHOP

RECORD TAPE AND HI-FI EQUIPMENT SPECIALISTS

NEW ADDRESS

15 LONG CAUSEWAY
(IN CITY CENTRE)

LARGE STOCKS

HAMILTON ELECTRONICS

HIGH FIDELITY TAPE RECORDERS 35 LONDON ROAD

TEL. 28622

SOUTHAMPTON

SOUTHAMPTON—SALISBURY

- ★ All the best makes of Tape Recorders
- ★ Hi-Fi Systems and Records
- ★ Expert knowledge and advice

The West of England High Fidelity Specialists

J. F. SUTTON 421 SHIRLEY ROAD, SOUTHAMPTON
15-18 QUEEN STREET, SALISBURY

Audio Electronics (Midlands) Ltd.

Specialists in Dictation Mcs., Tape Recorders, Inter-Com., Tapes and Accessories

Full After Sales Service on all Equipment
PHILIPS, GRUNDIG, TRUVOX, UHER, ETC

203 STAFFORD STREET WALSALL

Tel.: 21086

WORTHING, SUSSEX

We stock Hi-Fi Equipment by Leak, Quad, Goodsell, RCA, Acos, Garrard, Collaro, Tannoy, Wharfedale and Goodman and give fully comparative Demonstrations

BOWER & WILKINS LTD.

1 Becket Bldgs., Littlehampton Road Worthington 5142

— TAPE TO DISC SERVICES —

The following are members of the Association of Professional Recording Studios who can be relied on to give satisfaction

MJB RECORDING & TRANSCRIPTION SERVICE

specialise in the production of microgroove records from Professional and Amateur recordings (Acetate copies; Processing Masters and Pressings at 16 $\frac{2}{3}$; 33 $\frac{1}{3}$ & 45 r.p.m.) Extended playing times achieved by controlled cutting. Editing, Label printing, Mobile and "Off the Air" Services.

7 HIGH STREET, MAIDENHEAD (Tel: 230)

TAPE RECORDERS · AUDIO EQUIPMENT · DISC CUTTING STD & LP FROM TAPE · STUDIO FACILITIES · HIRE SERVICE · SALES · EXCHANGES

MAGNEGRAPH

1 Hanway Place, London, W.1

Tel: LAN 2156

CLASSIFIED ADVERTISEMENTS

Advertisements for this section must be pre-paid and accompanied by a postal order, money order, or cheque. The rate is 6d. per word with a minimum charge of 7/6d. Box numbers may be used for an extra charge of 1/6d. The trade rate is 9d. per word, plus 2s. for a box number, conditions on application. Send replies to box numbers, c/o "The Tape Recorder", 99 Mortimer Street, London, W.1.

No responsibility will be accepted by the editor, the publishers, or the printers of The Tape Recorder for the quality of any goods offered, bought, or exchanged through the medium of these columns, or for any failure in payment, etc., though the greatest care will be taken to ensure that only bona fide advertisements are accepted.

All advertisements for the January issue must arrive not later than December 7th.

Situations Vacant

Tape Representative Required by World famous tape manufacturer. substantial salary and car provided. Send full details to Box No. 301.

BBC tv

requires TRAINEE ASSISTANT FILM RECORDISTS in London. Applicants, with at least G.C.E. standard of education, should be able to show that they have taken a positive interest both in the film medium and in modern recording techniques. Normal age limit 25. When qualified as Assistants, Recordists must be prepared to travel at short notice. They must also be able to drive a car. Tuition can be arranged for non-drivers. Shift work. Initial appointment at £760. Promotion to £905 rising by five annual increments to £1,155 when fully qualified as Assistant. Requests for application forms (enclosing addressed envelope and quoting reference 62.G.447T.R.) should reach Appointments Officer, Broadcasting House, London W.1., within five days.

For Sale

Pre-recorded tapes. Unique complete catalogue listing all makes, mono, stereo. 7 $\frac{1}{2}$ and 3 $\frac{1}{2}$ i/s including World Record Club tapes. Call for free copy or send 1s. mailing fee. Dept. T.R.3 Teletape Ltd., 33 Edgware Road, W.2 PAD 1942.

Ask your dealer for Americau Ferrodynamics "Brand Five" recording tapes. The 'best tape value!

Find that review you want—get a copy of the index for "Tape Recorder", volumes 1, 2 and 3. Price 2s. each volume, post free.

Use up those odd lengths of tape, splice them together professionally after reading "How to Splice Tape", price 2s. 6d. posted, from The Tape Recorder, 99 Mortimer Street, London, W.1.

All makes of tape recorders repaired or modified. Miniflux heads supplied. "Audiomaster" equipment serviced. Audio installations built to your specification by John C. Latham, Deimos Ltd., 8 Corwell Lane, Hillingdon, Middx.

Lee Electronics offer famous manufacturer's zipped waterproof canvas Tape Recorder Covers, complete with microphone compartment at half retail prices. Send for comprehensive lists: 400 Edgware Road. Tel.: PADDington 5521.

Tape Recorders. Save from 30 per cent. to 60 per cent. on the original price. Large stock of secondhand, new, shop soiled machines. All guaranteed. Obtainable on our No Interest Terms. Best part exchange allowances on your existing equipment. Call, write, 'phone today for free list. Quotation and details. Our mail order covers the whole country. R. E. W. Earlsfield Ltd., 266 Upper Tooting Road, London, S.W.17. Balham 7710.

Ferrograph 422/424 and the latest 5A/N always in stock ready for immediate delivery and demonstration. City & Essex Tape Recorder Centres. See page 467.

Full building instructions for the remarkable "Tricolumn" loud-speaker are available in reprint form from Hi-Fi News, 99 Mortimer Street, London, W.1. Price 2s. 6d. post free.

Tape Bargains in all sizes. Example: Top Brand 5 $\frac{1}{2}$ in. 1,200 ft. 19s. 6d., P. & P. 1s. 3d. S.A.E. for list. Large choice of new and used recorders.—E. C. Kingsley & Co., 132 Tottenham Court Road, London, W.1. EUS 6500.

FANTASTIC XMAS OFFER

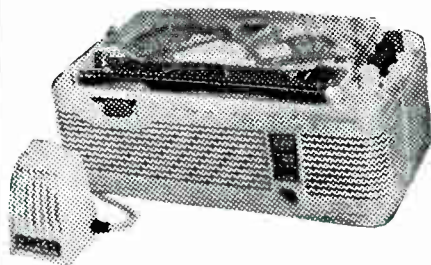

GELOSO TAPE RECORDER G256

USUAL PRICE

26¹/₂
GNS

OUR PRICE

19
GNS

SAVE
£7-17-6

★ INCLUDING CRYSTAL MICROPHONE, 430ft. TAPE SPOOL AND SPARE REEL
SELFROUND SCOOP BRAND NEW IN MANUFACTURERS SEALED CARTONS — FULLY
GUARANTEED 12 MONTHS — ONLY FROM SELFROUND

Accessories:—

Specially designed carrying case.

USUAL PRICE, 25/-. OUR PRICE, 19/6.

Remote control stop (forward and backward
spacer). USUAL PRICE 73/6.

OUR PRICE, 19/6.

Crystal Earpiece. USUAL PRICE 42/-.

OUR PRICE, 19/6.

TECHNICAL SPECIFICATION

Power Supply.

110-250 v., 50 c/s, at 30 va in operation and 7 va on stand by easily
accessible voltage selection panel.

Power Output.

2 watts approximately.

Deck Mechanism.

Push Button Controls. Twin track operation, change over by spool
reversal. Recording sense to B.S.S. Drop in Tape loading. Tape
speed 1½ in. per sec.

Playing Times.

Standard Tape, 1 hour using both tracks. Long playing Tape, 1 hour
25 minutes using both tracks.

Dimensions.

10 in. by 5½ in. by 4 inch.

Weight.

6½ lbs.

STOCKS LIMITED!

FIRST COME FIRST SERVED — TERMS AVAILABLE OR SEND £19 19 0 — TO-DAY!

★ **SATISFACTION GUARANTEED OR MONEY REFUNDED** ★

GET ALL YOUR XMAS PARTY ON TAPE THIS YEAR

No need to stint yourself on your Xmas or any other
recordings when you use SELFROUND 'PLAINBOX'
TAPE, either MYLAR or ACETATE base.

We guarantee unconditionally:

- All Tapes splice free
- Distortion-free
- Maximum strength
- Complete satisfaction or price refunded without question

*Ideal for gifts too—we will dispatch with Greeting Card
if you wish. Send names and addresses with your order.*

SELFROUND LTD.

(B623) 5 NEW BRIDGE STREET,
LONDON, E.C.4.

'PLAINBOX' Tapes are the product of an
internationally known American manufacturer,
and are of the same high quality as used by
Broadcasting Studios all over the world.

By cutting out frills—eliminating wholesale and retail
profits, by selling direct we can offer Hi-Fidelity
Tape at prices which are equivalent to giving
you almost half your Tape FREE. 'PLAINBOX' Tape
is not a tape specially made to sell cheaply,
it is made to the same exacting standards as tapes
sold at normal prices.

1200ft. 5¼in. REEL

MYLAR 22/6 each : 130/- SIX REELS.

ACETATE 18/6 each : 106/- SIX REELS.

1800ft. 7in. REEL

MYLAR 32/6 each : 190/- SIX REELS.

ACETATE 27/6 each : 160/- SIX REELS.

All prices post paid.

CLASSIFIED ADVERTISEMENTS

For Sale (continued)

Tape and gram equipment repairs/mods.—Harding Electronics, 120A Mora Road, Cricklewood, N.W.2.

“Brand Five” American Tape, long play 5 in. (900 ft.) 18s. 6d.; 5½ in. (1,200 ft.) 23s. 6d.; 7 in. (1,800) 35s. sent by return. Post free Watts Radio, 54 Church Street, Weybridge, Surrey.

L. Bishop Ltd., Tape Recorder Services, 1708 Bristol Road South, Rednal, Birmingham. Tel.: Rubery 2709. Grundig Specialists.

Easysplice Tape Splicer makes accurate splicing easy, guaranteed, 5s. 6d.—Easysplice, 30 Lawrence Road, Ealing.

1,800 ft. Branded Tapes, 30s. each. Sound News, 10 Clifford Street, London, W.1.

Manchester and N.W. Eroica for Sound Recording and for the better class tape recorders for the Home, for Industry, Education and professional use. All Ferrograph Models used and supplied here since 1951. Recorders, Mains operated, battery/mains and battery to suit all purposes. Amplifiers (especially the amazing Armstrong), Tuners, Mics, Mixers, Speakers, Defluxers, Tape, etc. All models first fully tried out in the work of this studio. Tape/disc Service Mobile Recording, Studio (Steinway Piano and Electric Organ), Music Editing, Recording for Broadcasting, Audition, etc. Consult experienced recordists for sound advice and practical demonstration. Eroica Recording Studios (Est. 1949) Peel Street, Eccles, Manchester. ECCLES 1624 (STD Code 061) on A.57 5 min. from M.62. Open all day Saturday, easy parking. Director Thurlow Smith, A.R.M.C.M.

Uher Report 4000 with accumulator, charger and leather case; 4 months old; perfect; list £124, now £85. Also National tape recorder, weight 4 lb. (best Japanese portable) £18.—Collard, 113 High Street, Rayleigh, Essex. Tel.: Rayleigh 795.

Cabot Four Channel Passive Mixer two microphone and two high level inputs. Can be used free standing or cabinet mounted. Suit any make of tape recorder. £4 4s. (Post and Pack 2s.) C.W.O.—Cabot Productions Limited, 109 Westbury Lane, Sea Mills, Bristol.

Reflectograph £110 Tape Recorders, new demonstration models, £30 off, full guarantee, special offer, £80.—Wessex Sound Recordings, 12 Maud Road, Dorchester.

Reflectograph Model A. Converted to 15 and 7½ i/s will revert to 3½, 7½ if required. Excellent condition, used by professional studio. Wooden carrying case, £80.—Hunter, 63 Aintree Crescent, Barkingside, Ilford, Essex.

Ferrograph 88 Console Model stereo recorder, £50. E.M.I. 3034 Stereo replay tape deck with built-in mono recorder. Professional specification. Offers?—58 Sharp's Lane, Ruislip. Tel.: Ruislip 9827.

Languages by Tape Recorder. Individual, postal tuition. No tapes to buy. Details.—Linguatape, Cheriton Fitzpaine, Crediton, Devon.

Tape Exchanges

Season's Greetings to all our Members from Britain's biggest, friendliest Tape Exchange.—Worldwide Tapetalk, 35 The Gardens, Harrow.

Tape to Disc

Tape to Disc Recordings. Finest professional quality, 10 in. L.P. 35s. (32 mins.); 12 in. L.P. 40s. (45 mins.); 7 in. E.P., 17s, 6d, 48-hour Postal Service. S.a.e. for leaflet to: Deroy Sound Service, 52 Hest Bank Lane, Hest Bank, Lancaster.

Tape to Disc service, editing, and dubbing, all speeds. Studio available for musical groups. Outside recordings our speciality. Ilford Sound Recording Service, 63, Aintree Crescent, Barkingside, Ilford, Essex. Telephone: CRE 8947 and GRA 5107.

Wanted

Copy of Vol. 1, January 1960 Tape Recorder required. Good price paid for clean copy.—Tape Recorder, 99 Mortimer Street, London, W.1.

Soundbox wanted for Edison Phonograph. Good price paid for correct type, send details to Box No. 302.

ILFORD SOUND RECORDING SERVICE
445 HIGH ST. NORTH, MANOR PARK, LONDON, E.12
WEDDINGS RECORDED
TAPE TO DISC • TAPE TO TAPE
STUDIO:—GRA 5107 OFFICE:—CRE 8947



Approved by the manufacturers of the incomparable Ferrograph Recorders whose decks are drilled and fitted to accept the incomparable Bib Splicer.

RECORDING TAPE SPLICER

18'6

Gives you a professional touch! This handy precision tool lets you edit tapes quickly and accurately—with no tape wastage and no post-editing clicks. The Bib Tape Splicer can be mounted directly on the tape deck. It uses all your odd lengths of tape, and pays for itself in tape saving over and over again. Bib value at 18/6!



TAPE REEL LABELS

For identifying recorded tapes. Self adhesive—for typing or writing. Space provided for title, composer, date, speed and type of tape. 24 in a packet for 2/6d.



AT YOUR DEALER'S NOW!

In case of difficulty, send remittance to: **MULTICORE SOLDERS LTD.** MULTICORE WORKS, HEMEL HEMPSTEAD, HERTFORDSHIRE M11

ADVERTISERS' INDEX

Armstrong Wireless & T.V. Co. Ltd. ...	Page 502
B.A.S.F. Chemicals Ltd. ...	516
A. Brown & Sons, Ltd. ...	504
C.B.S. Tapes ...	494
City & Essex Tape Recorder Centres ...	467
Educational Recordings Ltd. ...	507
Elstone Electronics Ltd. ...	515
E.M.I. Tape Ltd. ...	474
Ferrania Magnetic Recording Tape ...	505
Fi-Cord International ...	498
Francis of Streatham ...	500
Gevaert Ltd. ...	507
Gramspan Reproducers Ltd. ...	504
Heathkit ...	468
Hightate Acoustics ...	500
Hitachi Ltd. ...	488
Howard Tape Recorders ...	492
Geo. Jeffrey Ltd. ...	508
Kingswood Supplies ...	511
Lee Electronics ...	508
Lustraphone Ltd. ...	494
Mallory Batteries Ltd. ...	486
Meero-Sound Mfg. Co. Ltd. ...	504-510
Multicore Solders Ltd. ...	514
Northgate (Cameras) Ltd. ...	472
Nusound Recording Co. ...	504-5-7
Pamphonic Reproducers Ltd. ...	480
Philips Electrical Ltd. ...	466
Plant Projects Ltd. ...	495
Rapid Recording Service ...	505
R. E. W. Earlsfield Ltd. ...	506
Reps Tape Recorders Ltd. ...	506
Saga Records Ltd. ...	505
Selfround Ltd. ...	513
Simon Equipment Ltd. ...	471
Studio 99 ...	493
Tape Recorder Centre ...	470
The Ferrograph Company Ltd. ...	484
The Recorder Co. ...	502
Telesonic Ltd. ...	515
Tellux Ltd. ...	469
Thorn Electrical Industries Ltd. ...	482
Valradio Ltd. ...	510
D. Villiers ...	510
N. Walker ...	507
Wellington Acoustic Laboratories ...	509
Welmeac Corporation Ltd. ...	476
Wharfedale Wireless Works Ltd. ...	496
Zonal Film (Magnetic Coatings) Ltd. ...	473

**BUILD-IT-IN OR
CARRY-IT-AROUND!**



**Tandberg
SERIES 7**

4track model 74 **93 gns.**
(available October 1st)
2track model 72 **93 gns.**
(available December 1st)

(Luggage type carrying case £7.1.8. extra).

**new
Tandberg**

**SERIES 7
STEREO TAPE RECORDER
VERSATILE - COMPACT - COMPLETE**

In teak case 15 $\frac{3}{8}$ " x 11 $\frac{1}{8}$ " x 6" Weight 27 $\frac{1}{2}$ lbs.
Records and Plays Mono or Stereo

- 3 speeds 7 $\frac{1}{2}$ - 3 $\frac{3}{4}$ - 1 $\frac{7}{8}$
- 2 Indicators
- 2 Record, 2 Playback and 2 Power amplifiers (3 watts per channel)
- 2 Monitor Speakers
- 2 outputs for additional speakers or Hi-Fi

A WORTHY COMPANION TO TANDBERG SERIES 6
THE DOMESTIC DECK WITH PROFESSIONAL PERFORMANCE

Tandberg GB ELSTONE ELECTRONICS LTD., EDWARD ST., TEMPLAR ST., LEEDS 2. Tel: 3-5111



30/- weekly
for 50 weeks and Deposit £18.13.0 will bring you the

VORTEXION VVA TAPE RECORDER Cash £93.13.0



25/- weekly
for 50 weeks and Deposit £9.19.0 will bring you the

TELEFUNKEN MAGNETOPHON 96 TAPE RECORDER Cash £72.9.0



40/- weekly
for 52 weeks and Deposit £26.4.0 will bring you the

SONY 521 STEREO TAPE RECORDER Cash £130.4.0

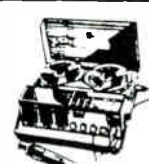

30 - weekly
for 50 weeks and Deposit £22.13.0 will bring you the

UHER 4000 REPORT TAPE RECORDER Cash £97.13.0

telesonic Ltd. SPECIALISTS IN HI-FI.



20/- weekly
for 40 weeks and Deposit £6.0.0 will bring you the

TRUVOX PD. 84 HI-FI TAPE UNIT Cash £46.0.0

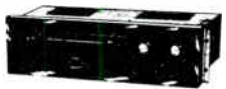

10/- weekly
for 40 weeks and Deposit £4.1.4 will bring you the

DULCI FMT 5 FM VHF TUNER Cash £24.1.4

SPECIAL TAPE OFFERS!
1,800 ft. L.P. Brand New. 27 6
1,200 ft. Std. Brand New. 17 6
P. & P. 1/- per spool
Many other types—list available.

All makes of Tape Recorders and Hi Fi equipment on similar terms.
Complete outfits can be supplied to your own specification. Let us quote you!

OUR FAMOUS INTEREST FREE TERMS!



30 - weekly
for 40 weeks and Deposit £7.4.0 will bring you the

BRENELL MARK 5 TAPE RECORDER Cash £67.4.0



40/- weekly
for 50 weeks and Deposit £15.10.0 will bring you the

REVOX E36 STEREO RECORDER Cash £115.10.0

Buy your Hi-Fi and Tape equipment the "Telesonic way"!!

FREE Packing, Carriage, Insurance anywhere in the U.K. plus the advantage of our famous **INTEREST FREE H.P. TERMS**—you pay no extra for extended credit.

MAIL ORDER DEPT. 92 Tottenham Court Road, London, W.1

Open weekdays 9—6; Thursday 9—7; Saturday 9—1.
Between Warren Street and Goodge Street Tube Stations.

Tel: Museum 8177
Langham 1381

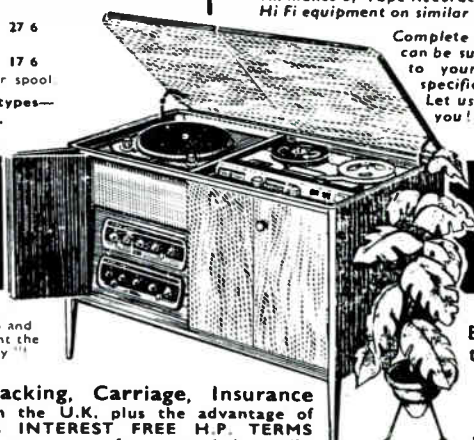

Export to any part of the world

Box 47

BASF tape library boxes in smaller sizes



These exciting swivel-open storage boxes, now available for the smaller spools, are supplied complete with three BASF Double Play Tapes—for the price of the tapes only!

Made in tough rigid plastic, they provide the perfect quick reference library and protect your tapes from dust and damage. In three sizes, pre-packed with
Three 3" BASF Double Play Tapes for 42/-
Three 4" BASF Double Play Tapes for 75/-
Three 4½" BASF Double Play Tapes for 90/-

NEW

for portable users!



BASF triple play tape

Yes, *triple play*—an hour and a half of recording time on a 3" spool to give your twin-track portable a big-machine capacity. BASF Triple Play Tape has treble the playing time of Standard Tape, yet retains all the outstanding BASF qualities—

full frequency response, negligible print-through, dimensional and magnetic stability. Available from your dealer on 3", 4" and 4½" spools, holding 450, 900 and 1200 feet of tape respectively.

with **BASF** you get more for your money



BASF CHEMICALS LIMITED SA GILLESPIE ROAD LONDON N5