

# Electronic Engineering

INCORPORATING ELECTRONICS, TELEVISION AND SHORT WAVE WORLD

## PRINCIPAL CONTENTS

Plastics in the Radio Industry. Part I  
Frequency Modulation. Part I  
Rhodium Contacts  
A Photo Cell Controlled Lift  
Electronic Aids to Industry. Part III (Measurement)  
Review of Progress in Electronics. Part VIII

1/6<sup>D</sup> NOV., 1941

# HIGH SIGNAL-BACKGROUND RATIO

The Eddystone "358" Communication Receiver is a triumph of British radio engineering skill and research. It sets new high standards of signal to noise ratio, and provides unusual sensitivity and selectivity. Its advanced design ensures a performance equal to the exacting requirements of present day working, and its robust construction ensures reliability under the most difficult conditions. Both the Eddystone "358" and the medium frequency Model 400 are available on priority order only.



## EDDYSTONE '358'

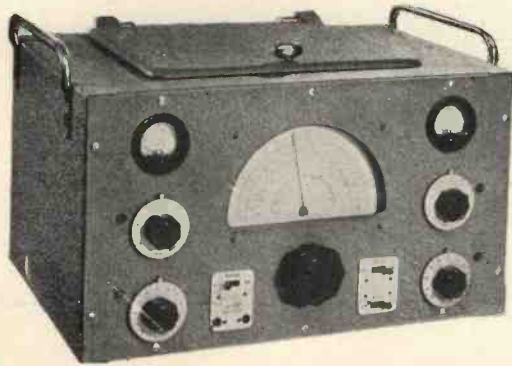

### Communication Receiver

**SPECIFICATION.** The receiver employs one stage of R.F. amplification, frequency changer, two I.F. amplifiers, a separate beat frequency oscillator, octal base Mullard or Osram 6.3 volt valves. Frequency range is continuous from 22m/cs to 1.25 m/cs using four fully screened interchangeable coil units. Five additional coil units extend the range to 31m/cs. and 90k/cs. Illuminated dial is accurately calibrated with four standard coils. Additional coils supplied with separate graph. TO SIMPLIFY MAINTENANCE a metre and test switch is fitted. Main tuning control incorporates fly wheel drive and spring loaded Tufnol gearing (ratio 70-1.) Logging scale supersedes the old type band spread control. SEPARATE POWER UNIT assures freedom from drift and overheating of the R.F. and I.F. stages

**ENERGETIC PRODUCTION** has now made available a range of Eddystone components that meets most requirements. Additions to the range will rapidly be forthcoming.

**MEDIUM FREQUENCY MODEL '400':** A highly sensitive receiver covering medium frequencies only. Similar to the "358" but is provided with four coils only covering frequency range from 130 k/cs. to 2,200 k/cs. Optimum gain is secured with very high signal to noise ratio.

EDDYSTONE '358' & '400' MODELS NOW AVAILABLE WITH BANDPASS CRYSTAL FILTERS



# WEBB'S RADIO

14 SOHO STREET . OXFORD STREET . LONDON, W.1

Telephone: GERrard 2089. Open 9 a.m. to 5 p.m. Sats. 12 noon

Monthly (published last day of preceding month) 1/6 net. Subscription Rates: Post Paid to any part of the World—3 months, 5/-; 6 months, 10/-; 12 months, 20/-. Registered for Transmission by Canadian Magazine Post.

# Electronic Engineering

PROPRIETORS :

HULTON PRESS LTD.,

Editor: G. PARR.

TELEPHONE :  
CENTRAL 7400

TELEGRAMS :  
HULTONPRES LUD  
LONDON.

No. 165 Vol. XIV

NOVEMBER - - - 1941

EDITORIAL, ADVERTISING AND PUBLISHING OFFICES, 43-44, SHOE LANE, LONDON, E.C.4

## CONTENTS

	PAGE		PAGE
Editorial...	481	Stability of Secondary Emission Tubes ...	502
Plastics in the Radio Industry, Part I ...	482	An Inexpensive Sensitive Relay ...	504
Frequency Modulation, Part I ...	485	Book Reviews ...	506
Review of Progress In Electronics, Part VIII ...	487	Impedance in Concentric Lines ...	508
Rhodium Contacts ...	490	Notes from the Industry ...	510
Application of Electronics to Industry, Part III ...	492	Patents Record ...	513
Lift Control by Photocells ...	500	Abstracts of Electronic Literature ...	514

## Salvage

THE recent appeal for salvage of waste paper brings up again the question of what to do with the amount of technical literature which the average engineer accumulates during the course of years to form his own personal reference library.

Some are fortunate in having a works library which they can use as their own, and keep a minimum of private data, but the majority have a collection started in student days and gradually increased until it fills several shelves, not to mention the periodicals and manufacturers' catalogues which are allowed to pile up in cupboards.

A careful owner will usually bind periodicals to which regular reference is made, but the bulk is allowed to accumulate dust waiting for a turnout that seldom comes.

How much of this data is worth retaining? It is unfortunate, but inevitable that in the usual technical publication each ounce of meat in the shape of articles of direct interest to the reader is accompanied by several ounces of bone in the form of general interest. An analysis made by DR. HOLMSTROM of yearly articles on a specific subject (not electronic) showed that a hundred were found in some twenty specialised journals, a further hundred distributed among 120 journals dealing with related subjects, and a third hundred

scattered among no less than 720 journals which only occasionally dealt with the subject in question.

The useful matter in this case averages about 1 in 3. While few engineers subscribe to more than three or four technical publications, the proportion in any specific journal will probably be the same.

### Proc. I.R.E. Abstract.

In the March, 1941, issue of *Electronics and Television*, as this journal was formerly called, an abstract appeared under the heading "Valves for Extremely High Frequencies" which was taken from the paper by B. J. Thompson and G. M. Rose (R.C.A. Mfg. Co) of the same title.

The Secretary of the Institute of Radio Engineers, in whose proceedings the article first appeared, has pointed out that the omission of the date (1933) in the abstract gives the erroneous impression that the work described is of recent years.

We regret the annoyance caused to the authors by the incomplete reference and have pleasure in printing this correction in view of the rapid developments which have taken place in valves for U.H.F. work, for which the staff of the R.C.A. laboratories are largely responsible.

In catalogues and technical booklets the waste material must be even higher, since they tend to "date" more than textbooks or periodicals. It is interesting to look through a catalogue of 1930 and note that power valves were slightly higher in price than they are now, but the reader might query whether the description of the valves is not given in a textbook on the shelves.

The demand for paper scrap is an excellent reason for a wholesale sorting out of literature and an inquiry into how much dead wood is being carried in duplicate information stored away in files. This note is not to advocate a wholesale scrapping of years of accumulated notes, but rather to suggest an opportune compressing and sorting of useful data—a task which will profitably employ the black-out hours and benefit the community at the same time.

The question of how to classify personal data is one which can be left to a later time. Apart from the standard methods of reference which are found in libraries and filing systems, which are generally more suited to a wide range of subjects, many engineers have their own ideas on the most useful way to file and cross-reference data on their own particular work, and we would be pleased to hear of any methods which experience has shown to be useful.



# Plastics in the Radio Industry

## I. Nature and Types of Plastics

by

E. G. COUZENS, A.R.C.S., B.Sc., and W. G. WEARMOUTH, Ph.D.  
(Messrs. B. X. Plastics Ltd.) (Messrs. Halex Ltd.)

“PLASTICS have come to stay” is a statement which is peculiarly applicable to the Radio, Telecommunication and Electrical Engineering industries. This happy state of affairs is partly due to the extremely valuable co-operation shown by these branches of engineering even during those difficult stages of the early development of plastics. Indeed, some of the radio firms studied these problems with such industry that they now own their own factories in which they manufacture from plastics radio components of all kinds. The great usefulness of plastics to the radio world is also partly due to the fact that a large percentage of the better-known plastics have good insulation properties, while at the same time the materials are available in a wide variety of forms, extending from lacquers on the one hand through rubber-like materials to the hard and rigid bakelite type resins on the other.

All the materials discussed contain carbon which has the useful property of being able to link up chemically with other elements such as hydrogen, and the so-called hydroxyl group, denoted by (OH). It can also line up with other carbon atoms.

Carbon is often denoted by  $\text{—C—}$ , the four strokes denoting four combining bonds, and hydrogen by H—, the single stroke representing one combining bond. It is seen that four hydrogen atoms are therefore required to satisfy completely the combining capacity of one carbon atom. The resulting molecule is written

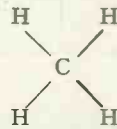

which is the symbol for methane. Simi-

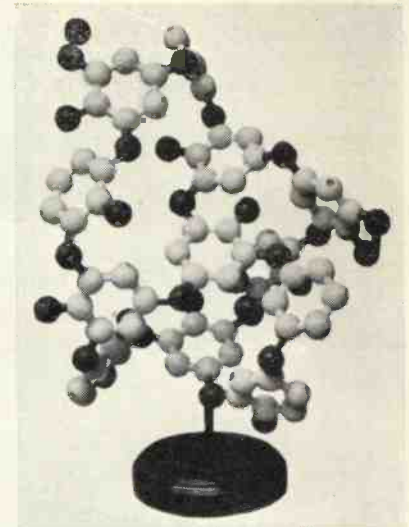
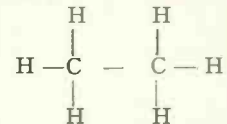
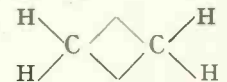

Fig. 1. Phenol Formaldehyde. Model illustrating the cross linked structure of the P.F. resin molecule. The chain to the left is seen to be cross linked at each end with the central chain which is itself linked to a complex on the right. The original phenol unit in the form of a hexagon is linked in each case to its neighbour by a (dark) carbon atom derived from formaldehyde. (By courtesy of Dr. N. A. de Bruyne.)

larly two carbon atoms require six hydrogens for complete saturation, and the resulting product is ethane, written



It is possible to get two carbons linking up with only four hydrogens to give ethylene, written



and one bond on each of the carbons is left unsatisfied. It is more usually written

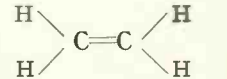

and the double bond, i.e., free or unsatisfied combining bonds with carbon represents a weakness. It is not surprising, therefore, that such a material shows a readiness to link up with other materials which can satisfy the unsatisfied bonds on the carbon atoms. Ethylene is, therefore, a very reactive compound, and it actually forms the starting material for certain synthetic resins, in particular “Alkathene” which consists of many ethylene molecules linked up with one another.

This process of linking is called polymerisation and many carbon compounds having this double bond in their structure can be made to polymerise forming resinous materials.

Thus, the molecules of styrene  $\text{C}_6\text{H}_5\text{—CH=CH}_2$  (note the double bond) will link up with each other to produce polystyrene—a word which means literally “many styrenes.” This building up proceeds through many stages and by suit-



Fig. 2. The Cellulose Chain (left). A model showing composite carbon and oxygen hexagonal rings joined together by oxygens. Certain hexagonal atoms attached to the carbon atoms have been left out for simplicity. (By courtesy of Dr. N. A. de Bruyne.) Right: “The Acetylene Tree.”

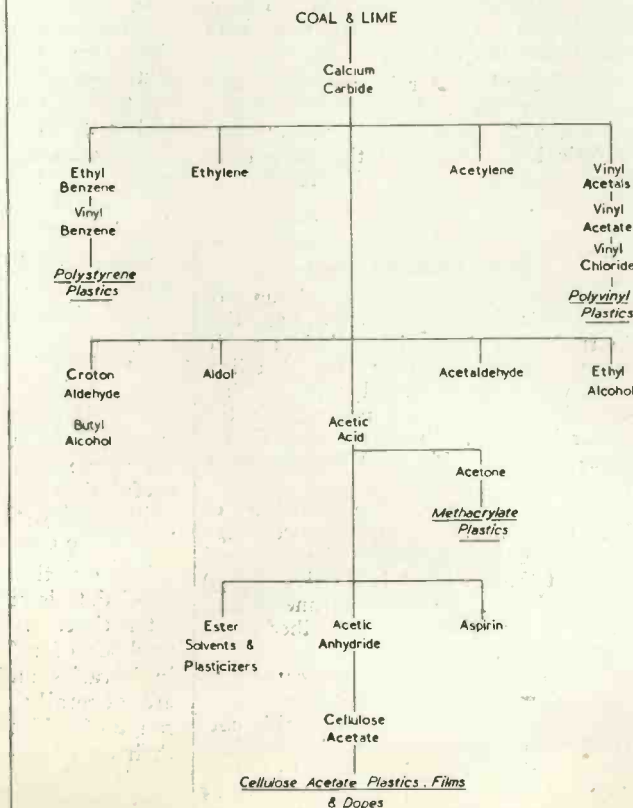

able control of the polymerising conditions polystyrene can be produced with a wide range of molecular sizes.

The outstanding characteristic of all these materials is the existence of very long chains formed by joining the simple units or monomers end to end. The illustration (Fig. 3) shows a model of a short section of such a polystyrene chain the full length of which may consist of 800 to 1,200 units and may be as much as five or six thousand. Well known materials which link up in the same way are vinyl chloride  $CH_2 = CHCl$  (again note the double bond) giving polyvinyl chloride and methyl methacrylate from which Perspex\* and Diakon\* are made.

The physical property of thermo-plasticity which is the outcome of long chain structure is characteristic of all these materials and by permitting plastic flow gives to these synthetic resins their special manipulative value.

The cellulose derivatives are produced in a slightly different manner. The previously mentioned materials can all be formed from chemicals produced synthetically. The cellulose compounds, as their names imply, are produced from cellulose. This is a natural product, although sufficient is known of its chemical structure to say that it is a polymerisation product—the polymerisation being carried out during the growth of the plant from which the cellulose is derived. The illustration (Fig. 2) shows a simplified model of a portion of a cellulose chain in which the resemblance to the resin structure can be traced though the linkage of unit to unit is through the agency of oxygen atoms. By chemical treatment of the cellulose, compounds such as cellulose nitrate, cellulose acetate and ethyl cellulose can be produced which when suitably processed are very tough, flexible and strong.

Cellulose nitrate plastic known as celluloid or Xylonite was originated by Parkes, by plasticising nitro-cellulose and camphor, in the middle of the 19th century and was the forerunner of the plastic industry as we know it to-day and though it is not so useful to the radio engineer as many other plastics, its study and manufacture laid the foundation of the plastic industry. Cellulose acetate suitably plasticised with high boiling point solvents produces the familiar "non-flam" celluloid of which Bexoid and Celastoid are examples and which with celluloid, also a long chain compound, shows characteristic thermoplasticity particularly utilised in the case of cellulose acetate for injection moulding.

A different type of resin of the utmost importance to the electrical industry is the compound of phenol and formaldehyde discovered by Baekeland and known as Bakelite. If two of the hydrogens in methane  $CH_4$  are replaced by oxygen we get formaldehyde  $HCHO$

Fig. 3.  
Polystyrene.  
Model showing arrangement of the carbon atoms in a short section of the polystyrene chain. Note the hexagonal benzene rings attached to the (dark) main carbon chain.  
(By courtesy of Dr. N. A. de Bruyne)

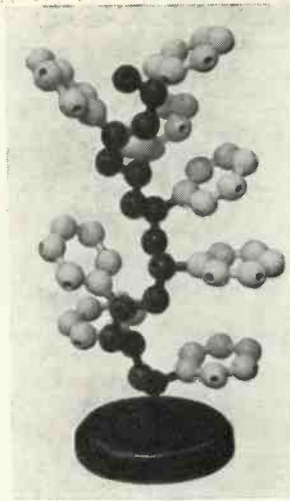

and this material reacts with phenol, written  $C_6H_5OH$ , to give resinous compounds—which are at first soluble and fusible, but which on heating become insoluble and infusible and are not thermo-plastic but thermo-setting. Fig. 1 shows a model illustrating the complicated structure of phenol formaldehyde in the final stage, where what is known as "cross-linking" with primary bonds produces the characteristic hardness and infusibility of Bakelite.

As will be seen from the attached list of plastics some of these Bakelite type resins which include compounds of cresol as well as phenol are available as coating solutions, others as powders for moulding. There are also laminated sheets and tubes which are prepared by coating sheets of paper or fabric with the resin and then pressing the treated sheets together between heated steel

plates. The sheets made up from a paper base are more useful to the radio engineer because of their better insulating properties. These laminated materials can also be prepared with remarkable mechanical strength.

Urea also gives resins by combination with formaldehyde—known commercially as the "Beetle" type resins. These resins are also available as lacquers, moulding powders, laminated sheets and tubes and are thermo-setting.

As already indicated celluloid was first manufactured in the middle of the 19th century and was in fact the earliest plastic. The next great landmark was the invention of Bakelite about 1910—since then intensive research has been proceeding particularly in the direction of the production of completely synthetic materials derived from the simplest and commonest substances, as will be seen from the diagram (Fig. 2) known as the "acetylene tree."

It is during the past decade that such vitally important materials as polystyrene, polyvinyl chloride and methyl methacrylate have been commercially developed, the first two to the great advantage of the radio and electrical engineer. Since it is becoming increasingly possible to predict with certainty what type of resins will be produced in any given chemical reaction the plastics chemist is thus in the position of being able to produce resins to suit particular requirements and the active co-operation which has been so noticeable between the radio and plastics industries in the past should operate with increasing advantage to both parties in the future, as new resins with still more accurately controlled physical properties are produced.

Material.	Form.	Trade Name.	How Manipulated.	Strength.	
Phenol Formaldehyde Resins.	1. Lacquers.	Bakelite. Mouldrite. Nestorite. Rockite. Elo. Epok.	1. Used as Lacquers and Insulating varnish.	1. Coating is stable.	
	2. Powders.		2. Powders are moulded under heat and pressure in steel dies.	2. Very rigid and quite strong.	
Phenol Formaldehyde Resin coated sheets.	Laminated sheet and tube.	Tufnol. Delaron. Paxolin.	Machined. Drilled. Turned.	Very strong.	
Urea Formaldehyde Resins.	1. Lacquers.	Beetle. Mouldrite. Rockite.	1. Used for coatings.	1. Coating is stable	
	2. Powders.		2. Powders moulded in steel dies.	2. Very rigid and strong.	
Urea Formaldehyde Impregnated Sheets.		As Phenol For	maldehyde Sheets.		
Polystyrene.	1. Powders.	Distrene	1. Moulded.	Quite strong in thick sections	
	2. Sheet, Rod and Tube.				2. Machined, turned, can be shaped.
Cellulose Acetate.	1. Powder.	Bexoid. Celastoid.	1. Moulded.	Quite tough, and can be obtained in pliable form.	
	2. Sheet, Rod and Tube.	Rhodoid.			2. Machined, turned and shaped.
	3. Thin film.				
Cellulose Nitrate.	1. Sheet, Rod and Tube.	Xylonite. Celluloid (American).	Machined and turned or moulded.	Very tough.	
Methyl Methacrylate Resin.	1. Powder.	Diakon. Perspex.	Moulded in dies. Machined and turned.	Quite strong.	
	2. Sheet, Rod and Tube.				
Polyvinyl Chloride.	1. Powder.	Welvic B.X. Plastics "P.V.C." Chlorovene.	Machined and turned.	Very tough. Can be made in a flexible grade.	
	2. Sheet, Rod and Tube.				

\*These are registered trade names.



# TABLE OF BRITISH PLASTICS

PHENOL FORMALDEHYDE				TRADE NAME	LACQUERS												
PHENOL FORMALDEHYDE SHEETS					COMPRESSION MOULDING POWDERS												
UREA FORMALDEHYDE					INJECTION MOULDING POWDERS												
UREA FORMALDEHYDE SHEETS					ROD & TUBE												
ANILINE FORMALDEHYDE					LAMINATED SHEETS												
CELLULOSE ACETATE					SOLID SHEETS												
CELLULOSE NITRATE					FILM												
METHYL METHACRYLATE					MOULDING												
POLYSTYRENE					MACHINING												
POLY ISOBUTYLENE					COATING												
POLYETHYLENE					MAKER												
POLYVINYL CHLORIDE																	
ETHYL CELLULOSE																	
COPOLYMERS																	
COLOUR																	
Light Brown	O.		•	Bakelite	•	•											Bakelite Ltd.
White	Tl.		•	Beetle	•	•											British Indstl. Plas.
Off White	Tp.		•	Bexoid		•	•	•		•	•	•	•				B. X. Plastics
White	Tl.		•	Catalin						•							Catalin Ltd.
Off White	Tp.		•	Celastoid						•	•	•	•	•			Brit. Celanese
Off White	Tp.		•	Celluloid	•					•	•	•	•	•	•		Celluloid Corpn.
Yellowish	O.	•		Chlorovene						•	•	•	•	•			F. A. Hughes & Co.
Brownish	O.		•	Delaron						•	•						De la Rue
White	Tl.		•	Diakon						•	•	•	•	•			I. C. I. Plastics
White	Tp.		•	Distrene						•	•	•	•	•			Brit. Resin Prodcnts
Yellowish	O.		•	Elo	•	•											Birkby's Ltd.
Yellowish	O.		•	Epok	•	•											Brit Resin Prodcnts
Yellowish	O.		•	Mouldrite	•	•											I. C. I. Plastics
White	Tl.		•	Nestorite	•	•											J. Ferguson
Yellowish	O.		•	Paxolin													Micanite & Inslatrs.
Dark Brown	O.		•	Panilax						•	•	•	•				Micanite & Inslatrs.
White	Tp.		•	Perspex						•		•	•				I. C. I. Plastics
White	Tl.		•	Rockite	•	•											F. A. Hughes & Co.
Pale Yellow	O.		•	Tutnol						•	•						Ellison Insulators.
Yellowish	O.		•	Welvyc						•	•	•	•	•			I. C. I. Plastics
White	Tl.	•		Xylonite	•					•	•	•	•	•			B. X. Plastics
White	O.		•	Alkathene						•	•	•	•	•			I. C. I. Plastics
Wax White	O.		•	Ethyl Cellulose						•	•	•	•	•			B. X. Plastics
Wax White	Tl.	•		P.V.C.	•	•	•	•		•	•	•	•	•			B. X. Plastics
Off White	Tl.	•		Polybutene						•			•	•			I. C. I. Plastics

**NOTES ON THE TABLE.**

To find the basic composition of any proprietary plastic material, refer to the left-hand columns and read the title at the head of the column marked with the black dot. The forms in which the material is available are given in the right-hand columns, the last three on this side indicating the methods of manipulation. Colour. The colours shown on the left are a guide to the basic colours of the material and must not be interpreted too closely. "White" means water-white; O, opaque; Tl., translucent and Tp., transparent.

Celluloid, although an American proprietary name, has been included in this table for completeness.

**ADDENDA.**

**MYCALEX.** This material, manufactured by the Mycalex Parent Corporation, has a foundation of bonded mica and can be moulded but not machined. It is also available for moulded components. Basic colour: yellowish-brown.

**MICANITE.** A similar material to Mycalex, manufactured by the Micanite and Insulator Co., Ltd.

**ERRATA.**

For "Welvyc" in the above table, read: "Welvic." In the case of Diakon and Catalin read Tp. for Tl. under "Colour." While every care has been taken in the preparation of the above table no responsibility can be taken for the accuracy of the statements therein.

# Frequency Modulation

## Part I. — General Nature of the System

By K. R. Sturley, Ph.D., A.M.I.E.E.

THE direct transmission and reception of speech or music over long distances, though not impossible, is impracticable and propagation of audio frequencies is usually accomplished by using them to modulate an R.F. wave acting as a carrier, *i.e.*, the audio frequencies are used to control one of the three characteristics, amplitude, frequency or phase, of the carrier. The most common method is by modulation of the carrier amplitude, the rate at which the amplitude is changed being directly proportional to the frequency of the original sound and the magnitude of the amplitude change being directly proportional to the intensity (a low intensity producing a small change of amplitude). This is illustrated in Figs. 1a and b, the unmodulated carrier amplitude in each case is constant at 1 volt. Fig. 1a corresponds to a low intensity sound, the carrier amplitude varying between 0.9 and 1.1 volts, whilst Fig. 1b

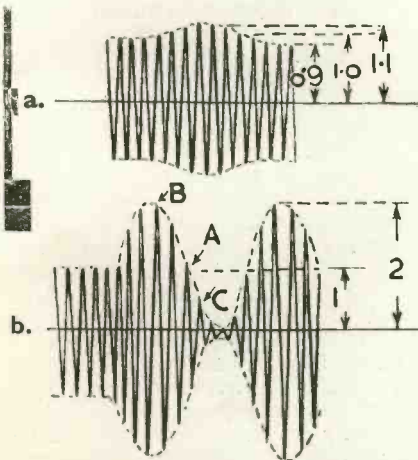

Fig. 1. Amplitude modulated wave.

ponds to a high intensity sound, the carrier being 100 per cent. modulated, its amplitude varying from 0 to 2 volts. In frequency modulation, the carrier amplitude remains constant and its frequency is varied at a rate corresponding to the modulation frequency (1,000 times per second if  $f_{mod} = 1,000$  c.p.s.) and the frequency deviation (rise and fall from the central unmodulated carrier frequency) is controlled by the intensity of the audio frequency. For example, suppose a 1,000 c.p.s. note is being transmitted on a carrier frequency of unmodulated value, 1,000 kc/s, the variation of the carrier frequency takes place at the rate of 1,000 changes per second and the frequency limits may be

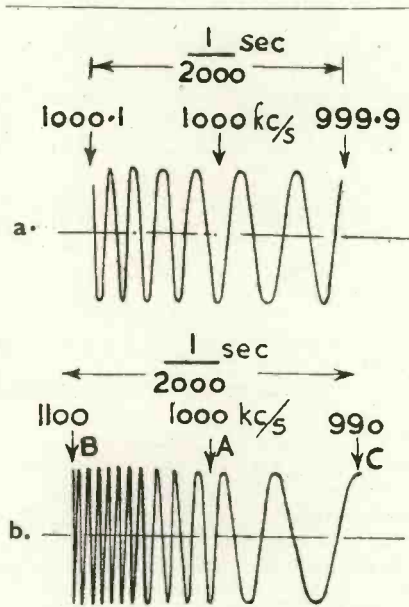

Fig. 2. A half modulation cycle of a frequency modulated wave.

$\pm 100$  c.p.s. (the carrier frequency changes between 1,000.1 and 999.9 kc/s) for a low intensity to  $\pm 100,000$  c.p.s. for a high intensity note. These two conditions are illustrated in Figs. 2a and b for a half cycle of the modulation frequency. With phase modulation the amplitude of the carrier remains constant and its phase angle with respect to its unmodulated condition is advanced and retarded at the frequency of the audio signal. The magnitude of the phase change is determined by the intensity of the audio frequency. Phase modulation has an effect on the carrier akin to frequency modulation, and whilst the phase of the carrier is varying its frequency is also varying. There is a difference between the two, but this is discussed later.

Until recently neither frequency nor phase modulation has been used to any great extent, largely because more complicated apparatus is required for reception and transmission than for amplitude modulation and they appeared to offer few advantages. Armstrong<sup>5\*</sup> has, however, demonstrated that frequency modulation can, under certain conditions, give better fidelity, greatly improved signal-to-noise ratio† and larger broadcast service area than

\* Numbers in text refer to Bibliography, p. 489.  
 † Credit must be given to H. J. Round, who first envisaged the possibilities of an improved signal-to-noise ratio from a frequency modulated system in a letter to the "Radio Review" (Volume 2, p. 220) in 1921.

amplitude modulation and it seems probable that frequency modulation may be considerably developed in the future.

*The Principles Involved in Frequency and Phase Modulated Transmission.*<sup>3, 7</sup>

For understanding the operation of any type of modulation a vector diagram is most useful, and amplitude modulation is quite simply illustrated if the modulation envelope is sinusoidal. The amplitude modulated signal is represented mathematically by

$$\hat{E} \sin 2\pi f_c t [1 + M \sin (2\pi f_m t)] \quad (1)$$

where  $\hat{E}$  is the unmodulated carrier peak value.

$f_c$  = carrier frequency.

$f_m$  = modulating frequency.

$M$  = the modulation ratio, the maximum value of which is 1. The vector (expression 1) rotates at a speed of  $f_c$  c.p.s. and varies in amplitude  $f_m$  times per second. An observer rotating with the carrier vector would see it as stationary with amplitude varying between the limits  $\hat{E}(1 + M)$  and  $\hat{E}(1 - M)$  as shown in Fig. 3a. Expression (1) can be expanded to

$$\hat{E} M \sin 2\pi f_c t + \frac{\hat{E} M}{2} \cos 2\pi (f_c - f_m) t - \frac{\hat{E} M}{2} \cos 2\pi (f_c + f_m) t \quad \dots (2)$$

which consists of a carrier vector  $\hat{E}$  rotating at  $f_c$  c.p.s. and two equal sideband vectors  $\frac{\hat{E} M}{2}$  rotating at  $(f_c + f_m)$

and  $(f_c - f_m)$  c.p.s. about the same point as the carrier vector. Since these two sideband vectors only influence the carrier amplitude it is clear that their resultant must always be in line with the carrier and this is shown in Fig. 3b for successive instants of time corresponding to points A, B and C on Fig. 1b. The upper frequency sideband vector  $S_u$  is rotating round the carrier vector in an anti-clockwise direction (the accepted positive direction of frequency) at  $f_m$  c.p.s., whilst the lower frequency sideband vector  $S_L$  rotates in a clockwise direction round the carrier

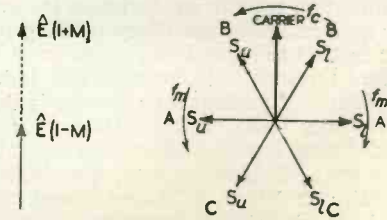

Fig. 3. Vector diagram for amplitude modulated wave.



vector at the same frequency. The carrier vector in Fig. 3b is, for convenience, shown as stationary though actually it moves round in an anti-clockwise direction at  $f_c$  c.p.s.

The problem of representing frequency modulation by a single vector is complicated by the fact that the frequency of the carrier is varying in accordance with the amplitude of the modulating frequency and this means that the carrier vector rotates at varying speeds. Taking the example given above, for a frequency deviation of  $\pm 100,000$  c.p.s. the carrier varies from 1,100 kc. to 900 kc., and if we, acting as observers of the carrier vector, were to rotate at a frequency  $f_c$  c.p.s. (the car-

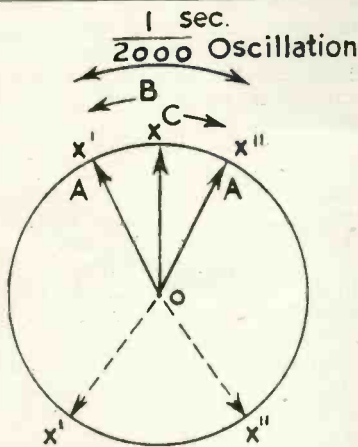

Fig. 4a. Vector diagram for frequency modulated wave.

rier unmodulated value) in the same direction as the carrier vector, the latter would appear to oscillate backwards and forwards like a metronome, at the frequency of the modulating wave, *i.e.*, 1,000 times per second. This condition is illustrated in Fig. 4a; again, like the metronome, the vector is stationary at the extremes, positions  $X'$  and  $X''$ , of its stroke so that the carrier frequency is instantaneously at its unmodulated value  $f_c$  (this is point A in Fig. 2b), whilst it is moving at its fastest, backwards or forwards at the centre  $X$  of its swing. Movement of the vector in an anti-clockwise direction means that the frequency is greater than  $f_c$  and in a clockwise direction the reverse. Hence point  $X$  when the vector moves anti-clockwise corresponds to B in Fig. 2b, but when the vector is travelling clockwise  $X$  corresponds to C. In frequency modulation the carrier deviation is fixed for a given amplitude of modulating input so that the speed of the vector as it passes through  $X$  is constant and independent of the frequency of oscillation backwards and forwards (that of the modulating input). Treating the problem as a mechanical one, the initial velocity at  $X'$  or  $X''$  is zero, and the final velocity  $v$  at  $X$  is constant so that the distance travelled from  $X'$  to  $X$  or  $X''$  is proportional to  $vx t$ , but time  $t$  is

proportional inversely to the modulating frequency so that

$$X'X = X''X = Kvt = K_1t = \frac{K_2}{f_m} \propto \frac{1}{f_m}$$

Hence the angle swept out by the carrier vector is large for low modulating frequencies and small for high modulating frequencies; dotted positions  $X'$  and  $X''$  correspond to a lower modulating frequency than the full line positions. This again is analogous to the metronome which increases its angle of sweep as the frequency decreases. The mathematical expression for a frequency modulated wave is

$$E \sin \left[ 2\pi f_c t - \frac{Mf_c}{f_m} \cos 2\pi f_m t \right] \dots \quad (3)$$

where  $M = \frac{f_c}{f_m}$

and the angle swept out by the vector is  $\frac{Mf_c}{f_m}$  radians or  $57.3 Mf_c/f_m$  degrees,

which is seen to be inversely proportional to  $f_m$ . In the same way that expression 1 for amplitude modulation can be turned into a carrier and sidebands so can expression 3 be treated, but instead of only two sidebands per fundamental modulating frequency it is found that there are a large number<sup>1, 2</sup> spaced from the carrier by frequencies of  $\pm f_m, \pm 2 f_m, \pm 3 f_m$ , etc.

The theoretically infinite number of sidebands is for all practical purposes fortunately limited as the amplitudes of the sidebands more distant from the carrier normally decrease very rapidly. It is not only in the number of sidebands that frequency modulation differs from amplitude, but also in their position with respect to the carrier. All odd numbered sideband vectors  $\pm f_m, \pm 3 f_m$ , etc., from the carrier are so placed that their resultant falls on a line at right angles to the carrier<sup>3, 4</sup> vector, and all even numbered sidebands have a resultant in line with the carrier vector. The addition of a carrier and two sideband vectors (spaced  $\pm f_m$  from the carrier) having a resultant  $90^\circ$  displaced from the carrier vector is shown in Fig. 4b. These two sideband vectors rotate round the carrier vector point O at  $f_m$  c.p.s. and their resultant adds to the carrier to cause the latter to oscillate backwards and forwards along the line AB. In fact it is the same as Fig. 4a apart from the amplitude variation of the vector, and by adding suitable amplitudes of wider spaced sidebands we can neutralise the amplitude variation causing the point of the vector to describe an arc  $X'X''$  giving only frequency modulation. Another important point to note with regard to frequency modulation sidebands is that the individual amplitudes are not directly proportional to the amplitude of the original modulating frequency as in amplitude modulation, but actually vary widely (sometimes becoming zero)

as the angle swept out by the carrier vector changes. When this angle is small ( $f_m$  high) all sidebands except those nearest to the carrier are so small in amplitude that they can be neglected, but for a large angle of oscillation ( $f_m$  low) there are many sidebands of appreciable amplitude. For example, if  $f_m = 50$  c.p.s. and its amplitude such as to give a frequency change of carrier of  $\pm 1,000$  c.p.s., the angle swept out by the vector moving from  $X'$  to  $X$  is

$$\frac{1,000}{50} = 20 \text{ radians or } 1,146^\circ, \text{ whereas for } f_m = 5,000 \text{ c.p.s. and the same frequency change the angle swept out by the vector is } \frac{1,000}{5,000} = 0.2 \text{ radians or } 11.46^\circ.$$

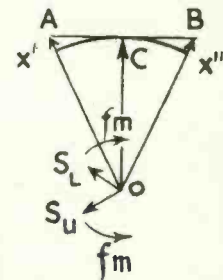

Fig. 4b. Frequency modulation due to 900 kc/sec. shift in sideband vector resultant with respect to the carrier.

11.46°. It should be noted that the carrier vector may make a number of revolutions for low modulating frequencies.

The vector representation of phase modulation is similar to that of frequency modulation with one important difference; the angle swept out by the vector is constant for a given amplitude of all modulating frequencies and is dependent only on the amplitude of the latter. This essentially means that the velocity of the vector at the centre  $X$  (Fig. 4a) increases as the speed of oscillation increases, *i.e.*, the rise and fall in carrier frequency (frequency deviation) is directly proportional to the modulating frequency. It is possible to turn phase into frequency modulation by inserting in the modulation frequency amplifier a network having an amplification characteristic inversely proportional to frequency, giving a low frequency a large amplitude and a high frequency a small amplitude, *i.e.*, the phase angle is no longer constant, but increases as the modulation frequency falls. The mathematical expression for phase modulation is

$$E \sin [2\pi f_c t + \phi M \sin 2\pi f_m t] \dots \quad (4)$$

and the phase angle swept out is equal to  $\phi M$  where  $\phi$  is a constant and  $M$  is proportional to the amplitude of  $f_m$ , but independent of its frequency. Phase modulation has an infinite number of sidebands spaced  $\pm f_m \pm 2 f_m$ , etc., from the carrier, but since the phase angle change is constant (unlike phase

(Concluded on page 489)



# Review of Progress in Electronics

## VIII.—Grid Control of Gaseous Conduction

By G. WINDRED, A.M.I.E.E.

“The development of grid controlled rectifiers for heavy current purposes has been related to the vacuum tube of light duty practice. With the grid-controlled tubes it is possible to solve a large number of problems coming within the sphere of low current engineering and extending also into heavy current practice.”—Dr. M. Schenkel, in a lecture on the Principles and Applications of Grid Controlled Rectifiers and Converters, E.T.Z., August 11, 1932.

FOLLOWING the purely theoretical researches on gaseous conduction to which reference was made in the last article of this series, attention was directed to the subject by investigators interested in the possibilities of commercial development. As a result of this work there appeared firstly the mercury vapour rectifier, followed by the gasfilled triode or thyatron, and its larger prototype the grid controlled mercury arc rectifier. These were developments of major importance in the progress of electrical engineering practice, and occupied a period of more than twenty years.

The true sequence of discovery, representing the contributions of individual workers, is difficult to trace owing to the obscuring factor of commercial secrecy, and it is necessary to rely somewhat upon the unsatisfactory evidence provided by patent specifications.

### The Course of Development

In 1903, P. H. Thomas<sup>1</sup> patented a means of suppressing or releasing the anode to cathode discharge in a rectifier by means of an auxiliary electrode; the arrangement being strikingly similar to the modern one. The electrode could either be internal, in accordance with modern practice, or in the form of a metal band outside the glass bulb of the discharge apparatus and adjacent to the cathode. Thomas also described a means of obtaining phase displacement with the object of allowing the discharge to pass at definite points of the anode voltage cycle.

A similar electrode arrangement, intended for the suppression of backfiring in mercury arc rectifiers, was described in 1906 in a patent by P. Cooper Hewitt.<sup>2</sup> In this case the auxiliary electrode took the form of a cup or shroud surrounding the anode of the rectifier. The anode could be prevented from acting as a cathode by connecting this auxiliary electrode to a suitable source of potential.

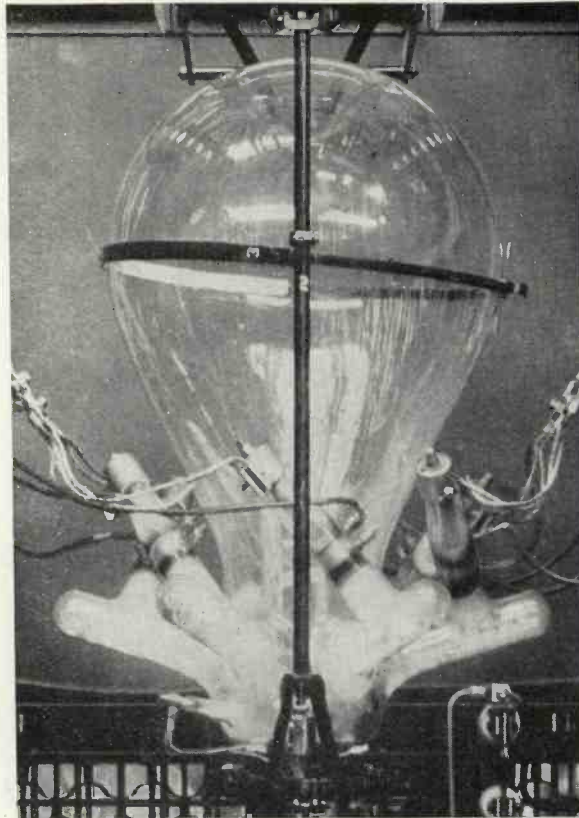
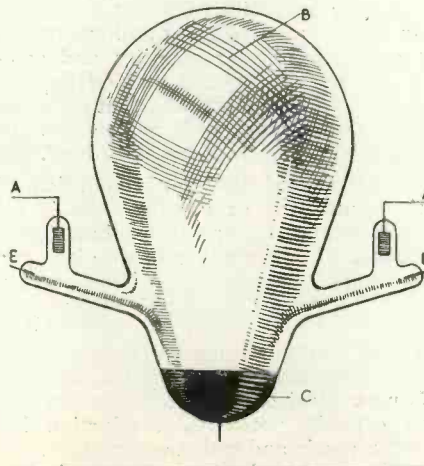

Fig. 2. Glass-bulb mercury arc rectifier with grid control.

Fig 1 (below). Typical arrangement of glass bulb mercury arc rectifier.



In March 1914, G. W. Pierce<sup>3</sup> applied for a patent covering the applications of a grid-controlled gas discharge device. In this patent there are 26 claims, referring mainly to the detection and amplification of signals in radio work. There is little doubt that Pierce was a pioneer in this particular sphere of development, but his work has been overshadowed to some extent by later developments.

It was shown by I. Langmuir<sup>4</sup> in 1914 that control of a discharge could be obtained by means of a suitably disposed grid in a gasfilled enclosure containing a hot cathode and an anode on the same general lines as an ordinary three-electrode thermionic valve. The gas filling was provided by the inclusion in the evacuated bulb of a small amount of mercury, the vapour of which imparted to the arrangement certain characteristics differing entirely from those of the ordinary valve. The device was called a Thyatron, from the Greek word *thyra* meaning a door, owing to the observed property that when the flow of anode current had been initiated by suitable adjustment of the grid potential, no subsequent

variation of this potential had any effect on the current flow as long as anode voltage was maintained.

Considerable attention was directed to Langmuir's thyatron, and numerous uses were found for it. F. W. Meyer,<sup>5</sup> for example, applied the principle to high-tension direct current transmission, frequency changing, rectification and amplification of signal currents and conversion from direct to alternating current.

A study of the thyatron was commenced in 1922 by P. Toulon,<sup>6</sup> who improved upon Langmuir's method of control by varying the phase of the grid voltage with respect to that of the anode voltage so as to vary the duration of the conduction period in each positive half-cycle of anode voltage when the device is used as a rectifier. In this way the average value of the anode current could be controlled smoothly between a maximum, with the grid and anode



voltages in phase, and zero with these voltages 180 degrees apart. This form of control is now widely used in practice, and the large number of ways in which phase displacement of the respective voltages may be obtained has imparted to the arrangements a correspondingly large sphere of application.

With regard to the study of gaseous conduction generally, a great deal of work was carried out by Langmuir in a series of researches published in 1923 and 1924. These researches added greatly to knowledge of the exact processes occurring in gaseous conduction, and led to a better understanding of the principles and possibilities of the thyatron.

### The Mercury Pool Cathode

The extension of the grid control principle to conventional mercury arc rectifiers, both glass-bulb and ironclad type, having a mercury pool cathode represented a great advance, as it extended to the limits of rectifier capacity the advantages of this form of control.

In the conventional glass bulb rectifier shown schematically in Fig. 1 the cathode C takes the form of a pool of mercury at the bottom of the bulb. The anodes A are of a material such as graphite which is strongly resistant to vapourisation, and are located in tubular extensions to the bulb. Sometimes the anodes are located in the ends of the extensions as at E, in which case the arc drop on load is somewhat less than with the arrangement shown. The number of anodes naturally depends upon the number of phases and the circuit arrangements. The upper part of the bulb takes the form of a large dome, the function of which is to provide cooling surface for condensing the vaporised mercury coming from the cathode under load conditions.

In this type of rectifier the grid may be introduced in a variety of ways. It may be placed so as to cover the internal cross section of the anode extensions or may be arranged in the form of a shroud enclosing the anodes. By using higher grid voltages it is possible to obtain control with an electrode in the form of a metal strip wrapped round the outside of the extension arms. Such an arrangement is clearly seen in Fig. 2, which shows a modern grid-controlled glass bulb rectifier.

An alternative form of rectifier having an ironclad construction is shown in Fig. 3. The ironclad type of rectifier forms an interesting contrast to the glass bulb type, from which it differs in practically every feature except the basic principles of operation. The external water-cooling jacket contains a

vacuum chamber in which the main and excitation anodes, control grids and mercury pool cathode are located. The somewhat elaborate auxiliary apparatus required for maintaining the vacuum of the inner container, as well as for vacuum measurement and temperature control, are mounted on the outer steel casing.

There has been some controversy concerning the relative advantages of the alternative types, but the chief point of comparison is that the intensive form of cooling in the ironclad type results

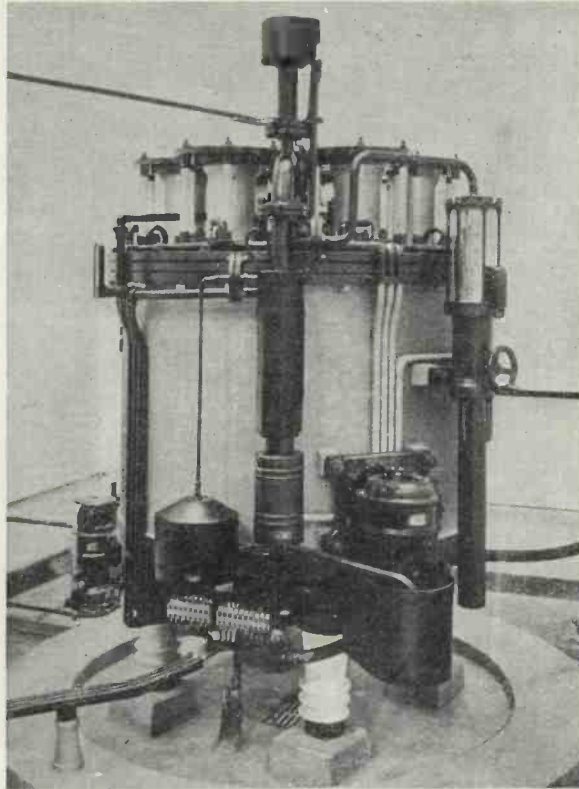

Fig. 3. Iron clad mercury arc rectifier, with auxiliaries mounted on outer casing.

in the possibility of dealing with large amounts of power in a small space. In favour of the glass bulb rectifier can be stated that there is a permanent vacuum, maintained without the use of auxiliary pumping plant and apparatus, that cooling water supplies and associated circulating and cooling apparatus are not necessary, and that no losses due to vacuum and cooling pumps occur when the rectifier is off load.

The general theory of operation of the controlling grid is the same in all the types of apparatus we have mentioned. The anode to cathode discharge can pass in normal circumstances only when the anode is positive with respect to the cathode, so that if an alternating anode voltage is used a rectified current flows in the load circuit. If there is no control grid, or if it is connected to cathode potential, conduction between anode and cathode occurs as soon as the anode voltage reaches the break-

down value at the beginning of each positive half-cycle, and continues till the end of the half-cycle. In rectifiers of the thyatron type, containing only one anode, there is half-wave rectification, but by employing two, three or six anodes it is possible to arrange for full-wave, three phase and hexaphase working. The latter is usually employed for industrial power purposes.

The presence of a sufficiently high negative potential on the grid provides an electrostatic barrier to electrons moving from the cathode region under the accelerating influence of the electric field from the anode. For a given instantaneous value of anode voltage a definite negative grid potential, proportional to the anode voltage, suffices to prevent conduction resulting from the access of electrons to the anode region, but if the negative grid potential is reduced, or the positive anode potential increased, the cathode electrons are able to pass through the grid region. In their highly accelerated movement towards the anode they cause ionisation by collision with the gas molecules (either mercury vapour or other gas, according to the type of tube) and cause the immediate establishment of a discharge between anode and cathode. This discharge persists, and results in current flow in the load circuit, until the anode voltage falls to the extinction value, which is at the end of each positive half-cycle when alternating anode voltage is used. By applying the phase-shift method of control and alternating voltage of the same frequency on anode and grid it is possible to

vary the striking point and thus also the average rectified current in the load circuit. When anode current flows, the grid is rendered completely ineffective owing to the formation of a sheath of positive ions over its surface, but after the zero current stage the recombination of ions and electrons in the arc space is so rapid that at all normal frequencies this space is completely deionised during the negative half-cycles of anode voltage. It is consequently possible to obtain smooth and instantaneous control of load current by the phase-shift method.

These are the fundamentals of grid control as applied to gaseous conduction, but, of course, there are many other considerations, as well as a wide variety of circuit arrangements developed for special purposes. More detailed considerations are contained in a recent series of articles by the author.<sup>8</sup> Some of the American textbooks on electronics contain detailed information concerning thyratons, notably the recent book by H. J. Reich.

A notable development is repre-



sented by the use of rotary distributors for impressing momentary potentials in a definite sequence on the control grids of groups of gasfilled triodes (thyratrons) or individual multiple-anode rectifiers of the larger type so as to obtain a cyclic sequence of conduction in the respective anode circuits. The resulting pulses of anode current are supplied to the primary windings of a transformer, whose secondary accordingly produces alternating voltages. In this way the problem of inversion is solved in a manner which has very considerably increased the usefulness of grid controlled rectifier in electrical engineering practice.

### Principal Spheres of Application

Outstanding practical applications include the following:

1. Rectification, with gradual control of output d.c. voltage between zero and maximum when desired.
2. Inversion from d.c. to a.c. by means of rotary distributors. This feature is of great value as a means of utilising the advantages of high-voltage direct current transmission, since it allows of inversion at the receiving end for the supply of existing a.c. apparatus.
3. Transformation of d.c. voltages. This can, for example, be achieved by combination of the inversion and rectification properties mentioned under 1 and 2 above, through the medium of suitable transformers, according to the degree of transformation.
4. Frequency conversion, utilising the properties of the distributor, and permitting the supply of low frequency networks, e.g., for traction purposes, from an ordinary 50-cycle supply.
5. Long-distance high-voltage d.c. transmission as mentioned under 2 above, representing a proposition of the greatest importance in the electrical transmission of power in view of the attendant advantages over a.c. transmission, as follows:—

- (a) With a given line, maximum permissible voltage for d.c. is 1.4 times that for a.c.
- (b) The d.c. system usually requires fewer conductors than the a.c.
- (c) The d.c. system is not subject to losses due to eddy currents or dielectric hysteresis as in a.c. systems.

There has been considerable discussion among electrical engineers, notably on the Continent, concerning the future possibilities of high-tension and extra high tension d.c. transmission over long distances.

6. Operation of commutatorless motors, a most important development from the traction view-point, opening up a wide sphere of use for the grid-controlled mercury-arc rectifier in this field. The commutatorless motor has only two collector rings, the torque being obtained by periodic excitation of

the field coils in time and space phase, approximating to a translatory field in the airgap. This feature is obtained by distributor control of the anode current.

7. Infinitely gradual control of the speed and torque of ordinary d.c. motors between zero and maximum, utilising the variable-voltage property of the rectifier, without the necessity for contactor control gear and bulky starting and regulating resistors. This also is a development of considerable interest to traction engineers.

8. Elastic coupling of a.c. networks, in which a rectifier is fed from Net. I with or without a transformer, the output d.c. being applied to an inverter as mentioned in 2 above, whose output a.c. feeds Net. II either directly or through a transformer, according to the respective network voltages. The grid-control feature allows of regulation of the amount of power transferred from one network to the other.

The foregoing are merely outstanding applications, and by no means exhaust the sphere of usefulness of the grid-control system, which also has important applications to such widely differing spheres of use as the supply of variable d.c. for electrolytic purposes, for which rectifier units with grid control are at present available up to some 5,000 amperes capacity; control of the current and timing in electric welding, in which the rapidity of grid control renders possible very high speed operation; reverse-energy absorption in regenerative systems; and the supply of high-voltage d.c. for radio transmitting stations requiring anode voltages up to 20 or 30 kV, in which control grids provide efficient and rapid means for the extinction of backfiring.

### BIBLIOGRAPHY.

1. P. H. Thomas, U.S. Patent 783,482 of Feb. 28, 1905; Application filed Feb. 7, 1903.
2. P. Cooper Hewitt, British Patent 706106.
3. G. W. Pierce, U.S. Patent 1,450,749 of April 3, 1923; Application filed Mar. 11, 1914.
4. I. Langmuir, U.S. Patent 1,289,823.
5. F. W. Meyer:
 

U.S. Patents.	British Equivalent.	Subject.
1,364,129	162,961	H.T. Transmission (D.C.).
1,369,457	164,924	Control of elec. machines.
1,408,118	165,986	Frequency changing.
1,649,036	168,107	Rectification and Amplification.
1,669,527	165,985	D.C. to A.C. Conversion.
6. P. Toulon, U.S. Patent 1,654,949; also papers written in collaboration with L. Dunoyer in Comptes Rendus, 1924, p. 179; Journ de Phys., 5, 1924, pp. 257, 289.
7. G.E. Review, 26, 1923, p. 731; 27, 1924, pp. 449, 538, 616, 762, 810; see also Science, 58, 1923, p. 290; Phys. Rev., 22, 1923, p. 148.
8. Electronics and Television, Sept., 1940, to March, 1941, inclusive.

### Frequency Modulation

(Continued from page 486)

frequency modulation) the wider spaced sidebands for low as well as high modulating frequencies can usually be neglected. The resultants of all odd numbered sidebands are 90° out of line with the carrier and those of the even

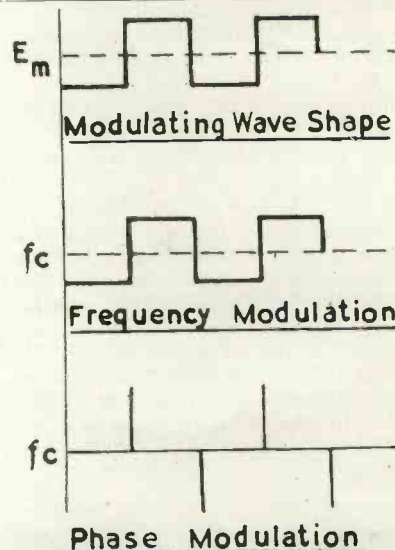

Fig. 5. Illustration of the essential difference between frequency and phase modulation.

numbered ones are in line with the carrier vector. The amplitude of each sideband vector is dependent only on the amplitude of the modulating frequency.

The clearest distinction between frequency and phase modulation has been indicated by Professor Howe.<sup>6</sup> He considers a square-shaped modulating wave as in Fig. 5 so that for frequency modulation the carrier frequency varies above and below its unmodulated value in accordance with the amplitude of the modulation. Phase modulation, however, shows that apart from the sudden instantaneous changes of phase when the carrier frequency becomes +∞ or -∞ the latter is constant at its unmodulated value.

### BIBLIOGRAPHY.

- (1) "Notes on the Theory of Modulation." J. R. Carson, *Proc. I.R.E.*, February, 1922, p. 57.
- (2) "Frequency Modulation." B. Van der Pol, *Proc. I.R.E.*, July, 1930, p. 1194.
- (3) "Amplitude, Phase and Frequency Modulation." H. Roder, *Proc. I.R.E.*, December, 1931, p. 2145.
- (4) "Note on the Relationships existing between Radio Waves Modulated in Frequency and Amplitude." C. H. Smith, *Wireless Engineer*, November, 1930, p. 609.
- (5) "A Method of Reducing Disturbances in Radio Signalling by a System of Frequency Modulation." E. H. Armstrong, *Proc. I.R.E.*, May, 1936, p. 689.
- (6) "Frequency or Phase Modulation." Editorial note. *Wireless Engineer*, November, 1939, p. 547.
- (7) "Amplitude, Frequency and Phase Angle Modulation." Editorial. *Wireless Engineer*, August, 1940, p. 339.

# Rhodium Contacts

## A New Metal for Use in Radio Apparatus

By E. H. LAISTER

**T**HE use of precious metals in electrical apparatus has long been familiar, particularly for contacts of various kinds, and is very largely due to their outstanding property of stability or permanence. Precious metals are comparatively inert chemically, and are accordingly resistant to deterioration as a result of oxidation, tarnish and corrosion.

The advent of radio-communication has largely extended the applications of these metals, and the rapid advances which have been made during the last 25 years have raised many new problems, a few of which are peculiar to this branch of electrical science. Among these are certain contact difficulties in the solution of which substantial advances have recently been made.

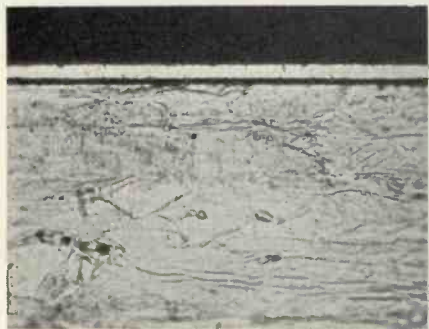

Fig. 1. Photomicrograph of section of rhodium plated contact showing the uniformity of layer. The extreme hardness of the film is indicated by the black "gutter" underneath due to the polishing away of the softer nickel silver.

The design of flexible and easily handled equipment usually involves a very considerable amount of switching, and the currents to be handled are for the most part extremely small.

Many of the switch contacts carry only Radio-frequency or speech-frequency currents of minute proportions with no D.C. potential difference across them to assist in breaking down any oxide or tarnish film that may form during idle periods. Since any changes in the current passing through the closed contacts are more often than not magnified many thousands of times by the following amplifiers, any unstable contact will result in the output being unreliable, possibly marred by crackles and other distressing noises if not failing altogether.

The proneness of many receivers to this type of defect owing to wave-change switch troubles will be as

familiar as it is exasperating. Nickel-silver contacts are particularly bad offenders in this respect in the absence of a very strong wiping action, owing to the high resistance of nickel oxide. It may be as well to offer a reminder that many metals which remain comparatively bright in appearance owe this property to the protective effect of a film of oxide, which is generally an excellent insulator. They would, therefore, be quite unsuitable for the contact faces of such a switch.

Various methods have been adopted for dealing with this problem in ordinary switches, and usually the strong wiping action introduced, together with the breaking down effect of the potential difference across the contacts, is sufficient to ensure satisfactory action. Where R.F. currents only are to be carried these conditions do not obtain, especially as capacities must always be kept to a minimum. It is, therefore, standard practice to employ some contact material which is stable in itself, and some form of precious metal is commonly used. Cost plays an important part, and special alloys such as gold-silver and gold-silver-platinum, which are reasonably cheap and efficient, are made for this purpose in large quantities. They are usually fitted in the form of tiny rivets mounted in the contact blades.

Where absolute reliability under adverse conditions is required, however, a comparative newcomer to the family of contact materials is now available, which is finding wide and successful application. This is rhodium, one of the platinum group metals, comparatively unfamiliar until recently, although discovered nearly 140 years ago.

### PHYSICAL PROPERTIES OF RHODIUM

Atomic Weight	102.91
Specific Gravity	12.44
Specific Resistance	$4.90 \times 10^{-6}$ ohms per cm. cube
Melting Point	1907°C
Coefficient of Linear expansion	$8.5 \times 10^{-6}$
Colour	.... Silvery-white

From the above table it will be seen that rhodium closely resembles platinum in many physical attributes.

It is, however, much rarer, and electro-deposited rhodium costs at the present time about forty-five pounds per ounce troy. Unlike platinum it is very

hard—actually file-resistant—and has remarkable wearing properties.

Chemically it is more inert than platinum, being completely unattacked at ordinary temperatures even by boiling Aqua Regia, whilst oxidation in air does not take place below 600°-800° C. The name rhodium is derived from the fact that most of its salts are of a red colour. (Gr. Rhodos = Red.)

Although a difficult metal to work, rhodium can be deposited electrolytically with comparative ease, and extended tests which have been carried out on polished rhodium surfaces have shown that even with heavy pressure and strong wiping action very little wear is produced in the rhodium, although a soft metal underneath may show some depression if the contact face is narrow and pressure great. At



Fig. 2. Photomicrograph of semi-cylindrical contact showing the effect of flawed base metal.

the same time contact is satisfactory at extremely light pressures.

Since rhodium is so expensive it is necessary to decide with some care the minimum thickness which can be employed for any given purpose, and while, as with most things, experience is the safest guide, some description of practical deposits and their applications should prove useful.

The maximum thickness at present available commercially is .001 in., and although this is not great, judged by ordinary standards, it is amply sufficient for R.F. contact purposes even under the most drastic conditions. It may be remarked that .001 in. of electrodeposited rhodium costs in the region of 10s. per sq. in., so that greater thicknesses would tend to become unnecessarily expensive, even if they were practicable.

It is possible, however, to limit the deposit to quite small areas, and for anything over about .0001 in., this is



usually done. In fact it is quite common practice to plate an area of less than  $1/16$ th sq. in., so that this very expensive metal only appears where it is actually needed.

An electrodeposit of 0.001 in. is therefore specified where conditions are adverse and heavy pressures and much wear are encountered.

0.00025 in. is a good average to employ for less drastic requirements, and is, of course, correspondingly less expensive.

0.0001 in. is sufficient when wear is not great, and is largely used not only for R.F. contacts but for various types of low current relay circuits which may only operate on extremely light pressures, and after long idle periods. Some kinds of automatic alarm and safety devices are good examples.

0.000015 in. is about the thinnest deposit which is used for contact purposes, and is entirely satisfactory for conditions somewhat less exacting from the point of view of reliability over long periods.

Any of these deposits is sufficient to prevent completely the deterioration

account of cost, it is also necessary to give some attention to the metal on which it is to be applied. The best and closest grained deposits of rhodium are obtained on silver which should therefore be used, either as a basis metal, or as a preliminary electrodeposit if the rhodium is to be thin. This is not so important for thicknesses exceeding about 0.0002 in., when there is sufficient "body" in the rhodium to provide full protection of the base, as well as good wearing and contact properties.

Where any electro-deposit is used as an undercoat, a basic material should be chosen which is not likely to suffer from pin-holes and other defects. These will not be covered over and may result in failures at a future date, when they make their presence felt owing to physical or chemical changes taking place just below the surface. Plating solutions, particularly cyanides, are absorbed by any porous metal and tend to set up corrosion there. This state of affairs is obviously undesirable at such a point as the working part of a switch, especially as the latter may be at the

highest efficiency, it is common practice to silver plate the various parts so that the low resistance silver may carry the current with minimum losses. This is quite satisfactory as long as the silver is untarnished, but some deterioration takes place as the tarnish film grows. This is not, however, so great as to reduce the efficiency seriously. What is more serious is the fact that movable "taps," or contacts on the inductances, must be provided, and, when moved, must make instant contact of the lowest possible resistance. The final application of 0.000015 in. of rhodium over 0.001 in.—0.005 in. of silver will produce a durable and reasonably economical finish which will fulfil the foregoing conditions and will protect the whole apparatus from corrosion and consequent deterioration. Where unusually exacting conditions such as sea air or spray or tropical heat and moisture are to be encountered the thickness of the rhodium may well be increased somewhat and the higher figure for the silver should also be used.

The use of the protective powers of the rhodium is, of course, extended to all

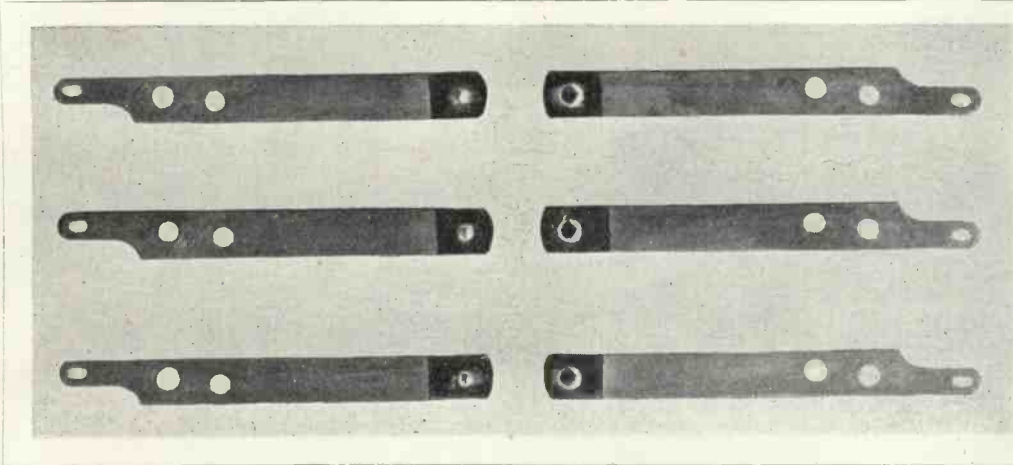

Fig. 3. Contact springs plated with rhodium, showing the restriction of the deposit to the contact area (shown dark in the photograph).

which takes place so readily in many contact materials in the presence of vulcanised rubber.

It should be made clear that, with the exception of special applications, such as the relays already mentioned, these remarks refer to radio-frequency, speech-frequency and minute currents generally. These thin rhodium deposits are not suitable for contacts at which arcing or sparking are likely to take place frequently, as is the case where comparatively large direct or alternating currents are being broken, particularly in inductive circuits. Perforation is likely to take place quite soon under these circumstances, although large R.F. currents may safely be carried.

Much experimental work has been carried out to discover the treatment most suitable for various conditions, and, while thicknesses of rhodium deposits must have first consideration on

other end of the world before trouble develops. It is particularly necessary to beware of some of the poorer types of brass, which have been known to produce most disconcerting results under these conditions. (Fig. 2). Nickel-silver and phosphor-bronze are usually fairly satisfactory in this respect.

A further field where rhodium has proved of great value, while not strictly a contact problem, is closely allied to it. This is the case of ultra-high frequency apparatus, where the need for low losses and short leads has resulted in the parts being built on to one another, so to speak, connecting wiring being practically or entirely eliminated so far as R.F. circuits are concerned. "Skin-effect" at high frequencies becomes very noticeable, and it is undesirable that the bulk of the current should be carried by a high-resistance oxide film on the surface. On account of this effect and in order to obtain the

kinds of radio apparatus where an attractive and lasting finish is needed, while its fine white colour and high reflectivity—approaching 80 per cent. total reflexion—may be utilised in making parallax and other mirrors.

Thanks are due to Messrs. Johnson, Matthey & Co., Ltd., for permission to publish this information and the photographs illustrating it.

The fact that goods made of raw materials in short supply owing to war conditions are advertised in this magazine should not be taken as an indication that they are necessarily available for export.

# The Application of Electronics to Industry

## III. Measurement

by John H. Jupe

**T**HE world of physics and chemistry has been revolutionised during recent years by the introduction and development of electronic devices as measuring instruments. Some were not thought possible ten years ago and yet to-day the cost of the necessary apparatus is comparable with that of older measuring equipment.

Such electronic instruments may conveniently be considered in two groups:

1. Direct reading or separately calibrated scale instruments. (Fig. 1).
2. Comparison or "sample versus standard" instruments. The cost of using instruments in each section, together with considerations of sensitivity and overall accuracy must be dealt with in individual cases and it does not necessarily follow that quantitative measurements require more expensive apparatus than qualitative ones. This is perhaps more true in the electronic field than any other.

In the space available it is only possible to mention a few of the many examples, but they at least give some indication of the scope of the electron as an industrial and laboratory measuring tool.



Fig. 1. Typical electronic precision measuring instruments—valve voltmeters by the Salford Electrical Co.

Temperature measurement by this method is an easy province for the photocell and it has the great advantage of not requiring contact with the hot body as temperature is actually measured in terms of colour. The scope of such apparatus is given in the table on the next page. Fig. 2 shows a typical circuit arrangement.

High accuracy is becoming increasingly important in steel manufacture where customers' requirements call for special grain size and tensile strength, particularly when the open hearth process is used.

By extending the measurement of temperature from the products to the furnaces themselves considerable sav-

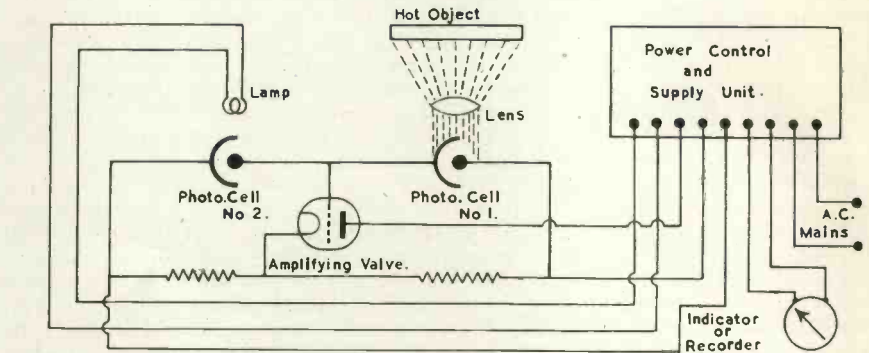

Fig. 2. Photocell Temperature Measuring System. The lamp current also passes through the indicator and varies with the anode current. The resulting light change re-balances what is essentially a "Wheatstone Bridge." This arrangement avoids errors due to cell drift and supply variations.

(Honeywell Brown Ltd.)

ing may be made in refractory brick linings. For example, in a case of non-regulated furnaces, repairs to the linings were necessary after 300 batches of steel had been made, but with electronic temperature control this was increased to 450-500.

For mechanical measurements the electron tube has been adapted with complete success in the motor car industry and self-contained units are available for measuring, sorting, and grading parts such as roller bearings, the caliper being done to an accuracy of 0.0001 in. (Figs. 3 and 4). The actual electronic methods are either to use the interruption of a light beam by gauge arms or to measure the variation in an oscillating valve circuit. In the latter method the grid circuit condenser is built in such a manner that one of the plates is displaced by the material under measurement, causing a frequency change. Such a method enables deflections of 0.000001 in. to be noted and in a particular commercial thickness gauge of this type 0.125 in. plus 0.0000005 causes sufficient change to cause full scale deflection of an ordinary indicating instrument.

Mechanical forces can be measured by piezo-electric or capacitance oscillograph methods, the latter being perhaps the better known of the two in its application to the problems connected with the internal combustion engine, where various pressures and movements and their relationships may be observed on cathode-ray tube screens. The piezo-electric method has been developed to a large extent in Germany and has been applied to gun pressures, and motor vibrations as well as small displacements. It is applicable to forces as low as 0.02 of a pound and to displacements down to 0.0003 in.

Of particular interest to the electrical

engineer is the stroboscopic method of testing integrating meters. Here, light from an incandescent lamp is broken into pulsations by means of meter element with a notched disk. These light pulsations are picked up by a photocell and after amplification, are passed on to a neon tube used to illuminate the meter under test. Thus, to calibrate this meter it is only necessary to adjust its speed until the disk appears to stand still.

Another very large field of electronic measurement is that of colour by means of photocells, and in most cases the accuracy is higher than that obtainable with the human eye. For instance, in chemical analyses use is often made of methyl orange as an indicator of the end-point of reactions and here it is generally possible to obtain 10 times the usual degree of visual precision by substituting for the eye of the chemist, a photocell, a single stage of amplification and a milliammeter. This is due to the fact that the human eye is more sensitive to changes of quality than quantity of light, whereas with cells rather the reverse is the case. So, in the example (methyl orange) the eye seeks for a change in hue to detect the end-point and is not very efficient. A filter, however, chosen to transmit a narrow band of the spectrum in the region of interest will produce a rapid change in the quantity of light passed and this is a change to which photocells can be made very sensitive, with the result that the overall accuracy is increased.

Lastly, attention should be drawn to the photocell as a counting device for very high speed work. Its general use in this respect is well known, but it is not so well known that an interrupted light beam can count faster than any mechanical device. Furthermore, by using another electron tube, the thyr-



tron, in conjunction with an amplifier, it is possible to count in excess of 1,200 units per second.\*

A table of electronic measuring devices not included in the above is given in the adjacent column.

**BIBLIOGRAPHY OF ELECTRONICS AS AN AID TO MEASUREMENT.**

Muller and Partridge, "Chemical Titration," *Ind. and Eng. Chem.*, Vol. 20, p. 423, 1928.

Kluge and Linckh, "Piezo-electric methods of measuring mechanical forces," *Zeitschrift für Forschung auf dem Gebiete des Ingenieurwesens*, 11, Vol. 5, pp. 153-164, 1931.

Kluge and Linckh, "Piezo-electric methods of measuring mechanical forces," *Zeitschr der Ver. Deutscher Ingenieure*, Bd. 74, p. 887, 1930.

Wordley, "Some Experiments on the Measurement of Smoke Under Industrial Conditions," *Fuel Economy Review*, 1931.

Hill, "Photoelectric Relay for Galvanometer Measurements," *Journal of Scientific Instruments*, Vol. 8, p. 262, 1931.

Wynn Williams, "High Speed Automatic Counting," *Proc. Royal Soc.*, London, May, 1932.

Edgerton and Germeshausen, "Stroboscopic Photography," *Electronics*, p. 220, July, 1932.

Partridge, "Electronic Speed and Acceleration Recorder," *Electronics*, p. 262, August, 1932.

Scheibe and Adelsberger, "Quartz Rod Electronic Clock," *Zeitschrift tech. Phys.*, 13, pp. 591-593, 1932.

Neustadt, "Photoelectric Colour Measuring Instruments," *Electronics*, p. 128, May, 1933.

Mallock, "Vacuum Tubes and Calculating Machines," *Proc. Royal Soc.*, Vol. 140, pp. 457-484, 1933.

Goodwin, "The Photronic Photographic Exposure Meter," *Jour. Soc. Motn. Pict. Eng.*, Vol. 20, pp. 95-118, 1933.

Lange, "Applications of Rectifier Photoelectric Cells in Photometry," *Zeit. fur Instr.*, Vol. 53, pp. 344-379, 1933.

Poole and Atkins, "Photoelectric Cells for Daylight Measurements," *Proc. Royal Soc.*, Dublin, Vol. 20, p. 537, 1933.

Barnes and Matossi, "Measurements with Photoelectric Relays," *Zeit. für Physik*, Vol. 76, p. 24, 1933.

"Colour Analyser Plots Own Curve," *Electronics*, p. 17, March, 1936.

Jupe, "Cathode-Ray Photography," *Wireless World*, p. 233, Sept. 7th, 1939.

Nunan, "The Nunan Yarn Tester," *Electronics*, p. 12, Feb., 1939.

\*"Electronic Counting Circuits," *Electronics and Television and Short Wave World*, June, 1940.

Quantity Measured.	Name of Device.	Electronic Principle.
Sound.	Sound level meter. Sound analyser.	Microphone and amplifier.
Humidity.	Humidimeter.	Humidified articles cause capacitative change in resonant circuit.
pH Concentration (hydrogen ions).	pH Meter.	Measurement of high resistance between electrodes, using thermionic valves.
Time.	Electronic clock. Electric timer.	Piezo-electric oscillator. Measurement of charge on condenser.
Light Intensity.	"Lightometer."	Gas discharge tube with condenser and resistance.
Velocity.	Speed indicator.	Photocell and meter. Electric timer operated at intervals (by photocells).
Waveform.	Oscilloscope.	Cathode-ray tube.
Voltage.	Valve voltmeter.	Valve with moving coil indicating instrument.
Resistance (electric).	Wheatstone Bridge (electronic).	Thermionic valve in one or two arms of the bridge for very high resistance measurements.
Depth of ocean.	Echo sounder.	Magnetostriction oscillator.
Earth's Magnetic Field.	Electron compass.	Development of cathode-ray tube.
Solutions of mathematical equations.	Electronic calculator.	Special transformers and thermionic amplifiers.

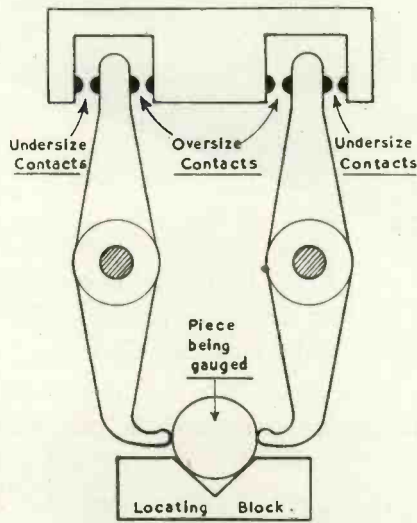

Fig. 3. Self Centring Gauge fitted with contacts. Usually made up as multiple units connected to "Thyratron" grid circuits for gauging to accuracy of 0.0001 inch. Contacts only carry a few microamperes grid current and there is no wear due to sparking.  
(Electronic Control Corp.)

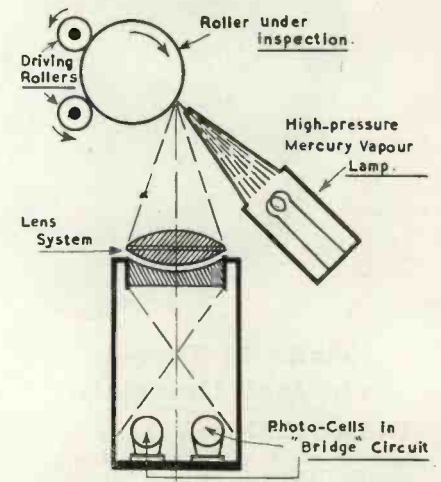

Fig. 4. Apparatus for Automatic Inspection of Bearing Rollers. The equipment, in its full form, contains 57 photocells and the rollers are slowly rotated whilst their surfaces are being scanned. Large optical magnification is used and the slightest crack causes a shadow to be cast on one row of cells. Solenoid operated triggers remove the defective rollers.  
(Electronic Control Corp.)

*Photocell Pyrometers.*

Range.	Valve Amplification.	Voltage Regulation.	Special Optical System and Light Filter.	Accuracy.
980° F. to 3,300° F.	Yes. Multi-stage.	Yes. Full.	Yes.	± 5° F.
1,100° F. to 2,000° F.	Yes. Two stages sufficient.	Yes. Partial.	Yes.	± 10° F.
1,300° F. to 2,000° F.	Yes. Single stage only required.	None required.	None required.	Very low but suitable for some purposes.



**"Everything  
O.K. Sir !"**

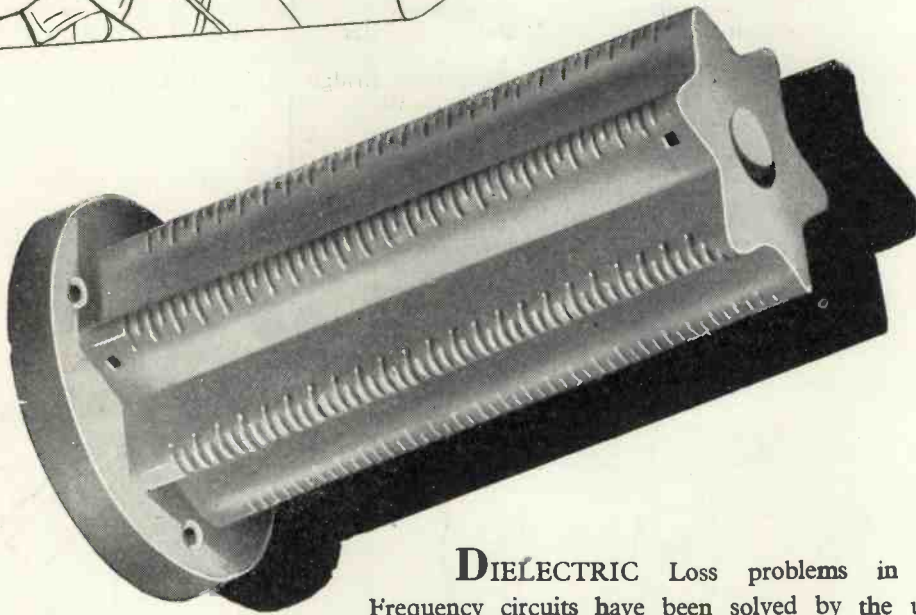

**Made in Three  
Principal Materials**

**FREQUELEX**—An Insulating material of Low Dielectric Loss. For Coil formers, Aerial Insulators, Valve Holders, etc.

**PERMALEX**—A High Permittivity Material. For the construction of Condensers of the smallest possible dimensions.

**TEMPALEX**—A Condenser material of medium permittivity. For the construction of Condensers having a constant capacity at all temperatures.

**DIELECTRIC** Loss problems in High Frequency circuits have been solved by the use of Bullers Radio-Frequency Ceramics.

Many years of research and development in our Laboratories have brought these materials to a high degree of efficiency.

They are in constant use for transmission and reception and play an important part in maintaining communication under all conditions.

# Bullers

## LOW LOSS CERAMICS

BULLERS, LTD. THE HALL, OATLANDS DRIVE, WEYBRIDGE, SURREY  
Telephone : Walton-on-Thames 2451, Manchester Office : 196 Deansgate, Manchester

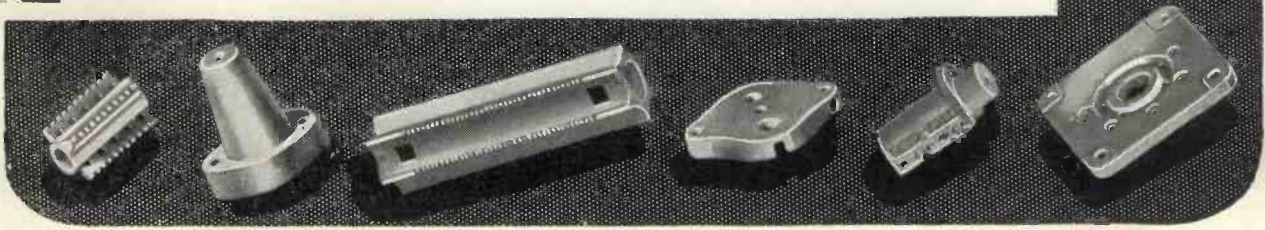



# DATA SHEETS XV, XVI & XVII

## The Inductance of Single Layer Solenoids—(Contd.)

# Electronic Engineering

In last month's Data Sheets Nagaoka's Formula for the calculation of multiturn single layer coils was discussed, this formula is, however, inapplicable to single turn coils.

### Inductance of Single Turn Coil at H.F.

At high frequencies the current flows only in a thin skin near the surface of the wire and we can thus apply the low frequency formula of a coil made of very thin tubing to the case of a solid wire at H.F.

Formulae for single turn inductances of thin tubing have been derived by both Maxwell and Grover; the one given below is due to Grover.

$$L_0 = 0.006283D \left[ \left( 1 + \frac{d^2}{4D^2} \right) \log_e \frac{8D}{d} - 2 \right] \mu\text{H} \quad (8)$$

and as in the majority of cases  $d/D$  is very small the approximation:

$$L_0 \approx 0.00628 \cdot D \left[ \log_e \frac{8D}{d} - 2 \right] \mu\text{H} \quad (9)$$

will be sufficiently accurate. Equation (9) has been plotted on Data Sheet No. 17 for a range of "D" (coil diameter between wire centres) from 2.5 cms. to 30 cms. and "d" from 0.01 cm. to 1.0 cm. A S.W.G. wire scale has been provided in addition.

Formula (9) and Data Sheet No. 17 may also be used for the case of a single turn coil wound with a thin tape, with the tape lying parallel to the axis of the coil. To make the calculation we replace "d" in (9) by  $0.223w$ , where "w" is the width of the tape in cms.

### Inductance of thin Coil $D \gg L$ .

Raleigh and Niven have given the following formula for the inductance of a single layer coil when the length of the coil is much smaller than its radius, i.e.  $l \ll D$ .

$$L_0 = 0.006283 DN^2 \left[ \log_e \frac{4D}{l} - \frac{1}{2} + \frac{l^2}{8D^2} \left( \log_e \frac{4D}{l} + \frac{1}{4} \right) \right] \mu\text{H} \quad (10)$$

When  $L < \frac{1}{2}D$ :

$$L_0 = 0.00628 DN^2 \left[ \log_e \frac{4D}{l} - \frac{1}{2} \right] \mu\text{H} \quad (11)$$

to the order of 1 per cent. accuracy. In (10) and (11), however, "l" is the length of the coil from the outside of the first turn to the outside of the last turn.

### Approximations.

The majority of inductance coils used in radio receivers have their inductances finally adjusted at R.F. against a standard coil by physically displacing one or more turns by a small amount. The inductance of the standard itself is also adjusted experimentally to provide the required performance (for reasons see first paragraph of last month's Data Sheet). Under these conditions it is a waste of labour to calculate inductances to too high a degree of accuracy or use complicated formulae which only provide a very high degree of accuracy at low frequencies. Once the principle of limited accuracy is accepted it is possible to produce charts or derive empirical formulae which will greatly reduce the labour of calculation.

Data Sheet No. 16 is an example of the method of reducing the labour required by solving Nagaoka's Formula (equation (1)) in the form of a series of curves. As one inch equals 2.54 cms. the half centimetre steps are approximately equal to 0.2 inches. For any other number of "turns per cm." the inductance read off the Data Sheet

is multiplied by the factor  $P = \left( \frac{N_1}{10} \right)^2$

where  $N_1$  is the number of turns per cm. actually used. The value of the factor P for a range of  $N_1/10$  from 0.26 to 6.3 is given by the straight line on the Data Sheet 16.

### Example 1.

To calculate the inductance of a coil with a diameter of 6 cms. wound with 45 turns of No. 24 S.W.G. wire in a length of 3 cms. From Data Sheet No. 16 we find that the inductance with 10 turns per cm. is  $L_s = 56 \mu\text{H}$ . Now  $P = 15^2/10^2 = 2.25$  so that  $L_s = 126 \mu\text{H}$ .

Checking the order of  $\frac{\Delta L}{L_s}$  from Data

Sheet No. 14 we have  $D/l = 2$ ,  $p = 1/15$  cms.  $d = 0.0457$  cm. and  $S = 0.685$  which gives  $x < 1$ . The low frequency inductance  $L_0$  would (apart from reading accuracy) therefore be well within 1 per cent. of the calculated current sheet inductance ( $L_s$ ).

H. A. Wheeler (*Proc. I.R.E.*, October, 1928, March, 1929) has given a simple empirical formula for the calculation of the current sheet inductance  $L_s$ . Using inch units for D and l he gives

$$L_s = \frac{DN^2}{18 + 40l/D} \mu\text{H} \quad (12)$$

accurate to 1 per cent. for  $D/l < 2.5$ .

Using centimetre units,

$$L_s \approx \frac{DN^2}{46 + 102l/D} \mu\text{H} \quad (13)$$

For very short coils the above expressions are not accurate and the following may be employed:

With inch units

$$L_s = \frac{DN^2}{18 - D/5l + 40l/D} \mu\text{H} \quad (14)$$

accurate to 2% for  $D/l$  from 0 to 20.

Using centimetre units.

$$L_s \approx \frac{DN^2}{46 - D/2l + 102l/D} \mu\text{H} \quad (15)$$

### Design of S.W. Inductances.

D. Pollack (*R.C.A. Review*, October, 1937) uses equation (14) with the 46 in the denominator replaced by 45 to calculate inductance and states that it provides results within 2% of those given by equation (10) for  $D/l$  values between 1 and 4. Equation (10) is stated to give results within better than 3% of their true values.

Pollack's work on coil losses between 4 and 25 Mc/s shows that the optimum value of  $S = d/p = dN/l \approx 0.7$ . Also, the maximum possible coil diameter and length should be employed. However, if a coil shield is used, the coil diameter should be made half the shield diameter and the ends of the coil should not come within one diameter of the ends of the shield. Data Sheet No. 15 has been prepared for the case of  $S = 0.7$  and  $D/l = 2$ , and Pollack's equation then becomes.

$$L_s = \frac{DN^2}{96} \mu\text{H} \quad (16)$$

It is interesting to note that if we put  $D/l = 2$  in Nagaoka's formula (2) we obtain  $L_s = DN^2/96.5 \mu\text{H}$ .

The straight lines on Data Sheet 15 are a plot of (16), while the curved ones are the locus lines of the different wire gauge numbers which satisfy the relation  $S = 0.7$ .

### Example 2.

To design a short wave coil of  $6\frac{1}{2} \mu\text{H}$  inductance to be wound on a two inch diameter former. With 2 in. = 5.08 cm. we find that 11 turns of No. 16 wire will give the right order of inductance. The actual diameter of the coil then becomes  $5.08 + 0.16 = 5.24$  cm. The inductance of the coil would have to be finally adjusted to the required value by moving the last turn.

# Electronic Engineering

DATA SHEET  
No. 15

DESIGN CHART FOR  
SHORT WAVE COILS  
FOR 4 - 25 Mc./sec.  
FOR WHICH  $s = 0.7$   
&  $D/l = 2$  THROUGHOUT

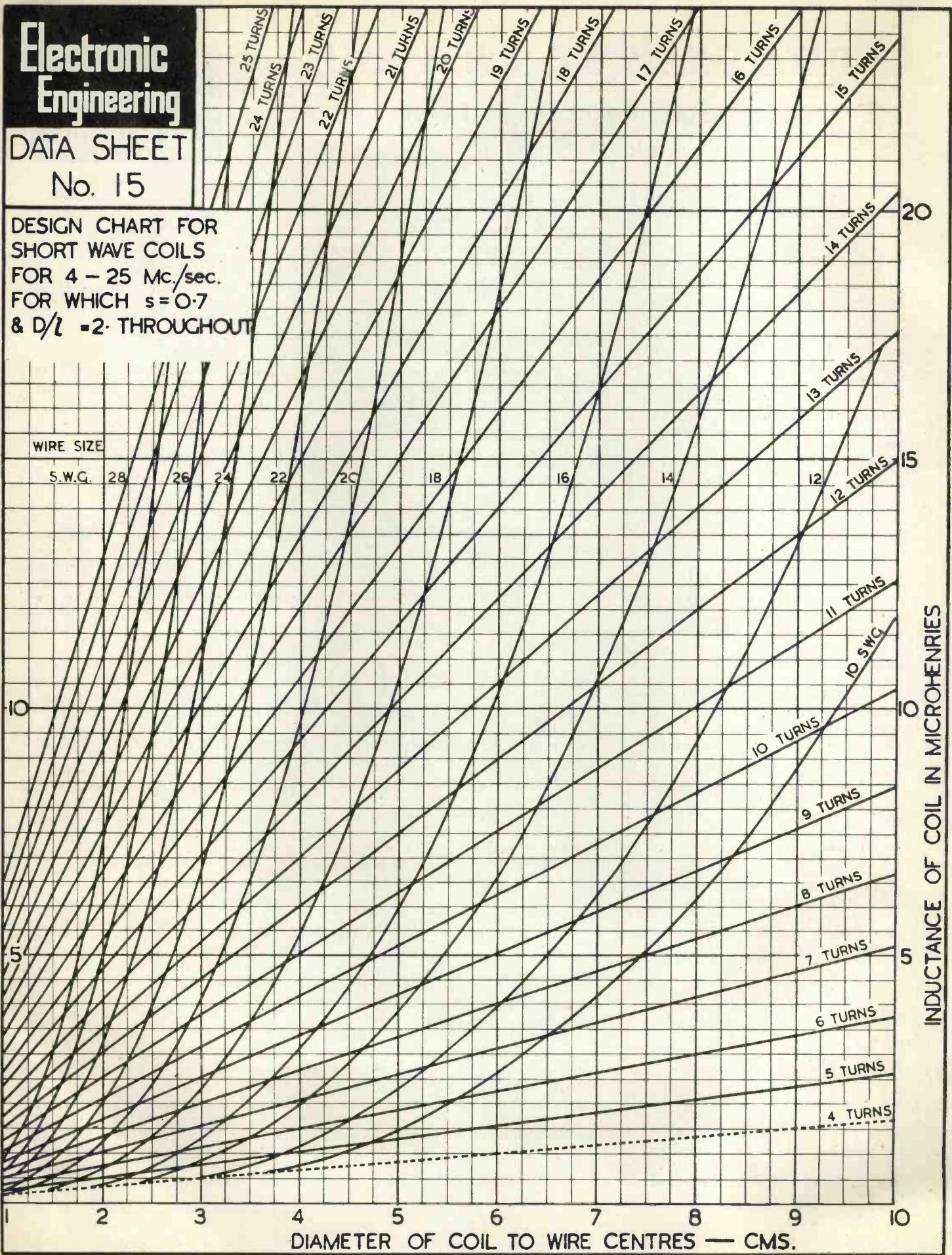

WIRE SIZE

S.W.G. 28 26 24 22 20 18 16 14 12

5

10

5

10

15

20

DIAMETER OF COIL TO WIRE CENTRES — CMS.

INDUCTANCE OF COIL IN MICROHENRIES

25 TURNS

24 TURNS

23 TURNS

22 TURNS

21 TURNS

20 TURNS

19 TURNS

18 TURNS

17 TURNS

16 TURNS

15 TURNS

14 TURNS

13 TURNS

12 TURNS

11 TURNS

10 SWG

10 TURNS

9 TURNS

8 TURNS

7 TURNS

6 TURNS

5 TURNS

4 TURNS



# Electronic Engineering

## DATA SHEET No. 16.

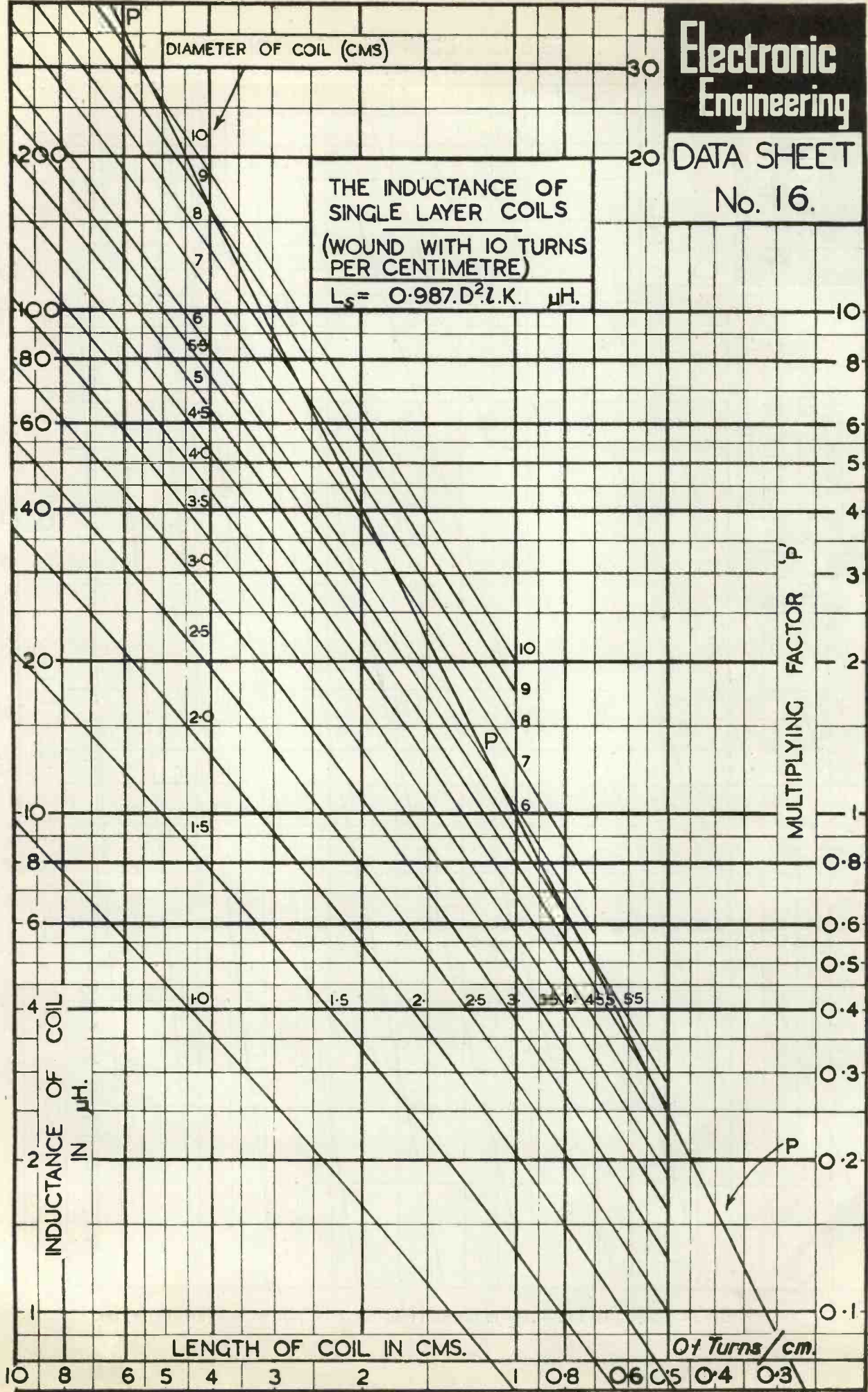

# Electronic Engineering

DATA SHEET  
No 17

THE INDUCTANCE OF  
A SINGLE TURN AT  
HIGH FREQUENCY  
 $L = 0.00628 D \cdot \log \left[ \frac{8D}{d} \right] - 2$

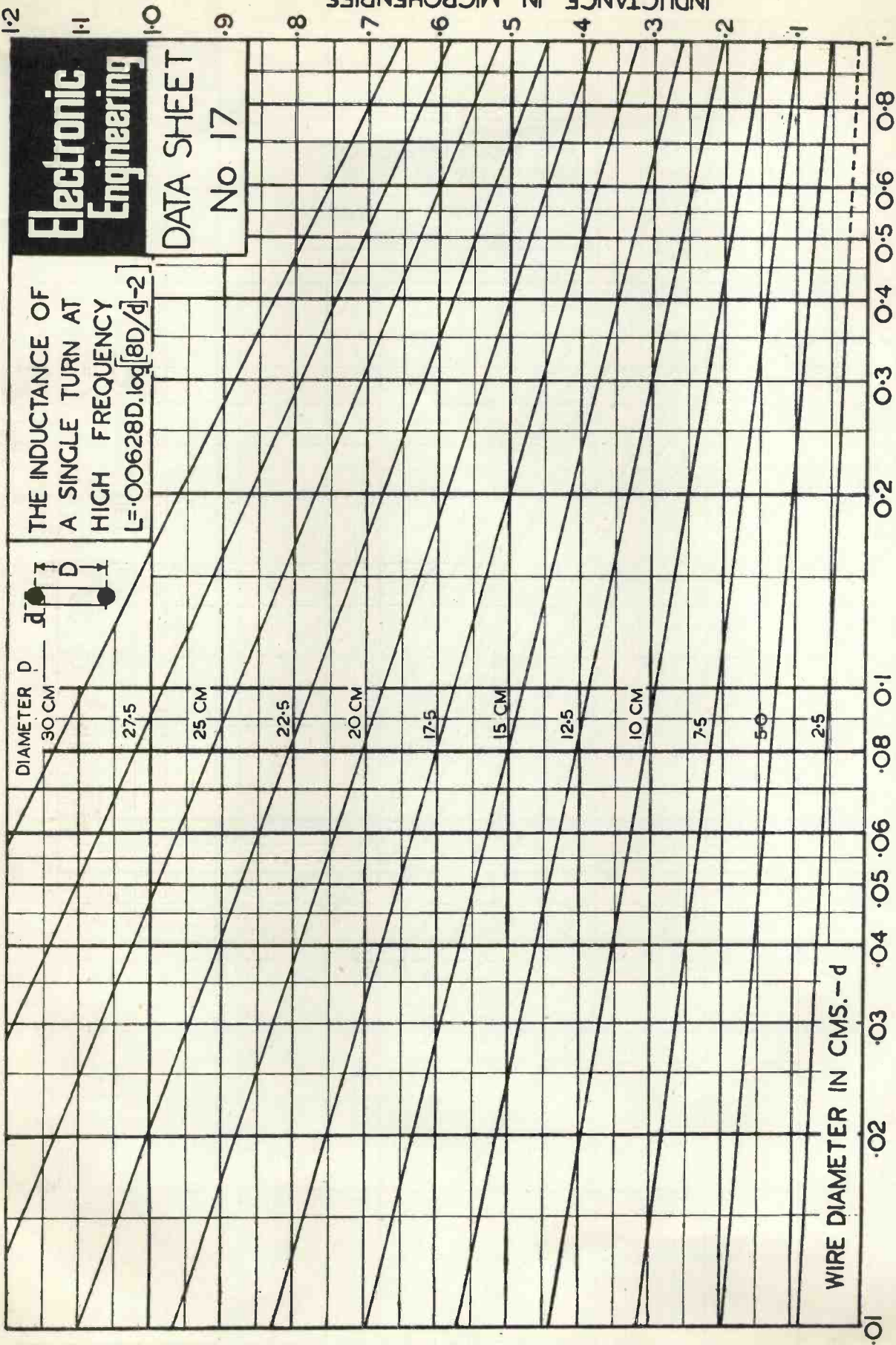
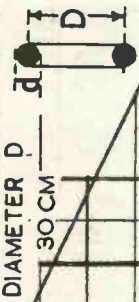

WIRE DIAMETER IN CMS. - d

S.W.G. No.

Correction :—In Data Sheet 14 the value of X should read  $0.0157 \times K (D/l)$  to conform with the text.





MULLARD MEASURING APPARATUS

# CATHODE RAY OSCILLOGRAPH

## TYPE G.M. 3156

This instrument is the first Cathode Ray Oscillograph to be designed to meet the particular needs of the mechanical engineer, especially in the field of vibration measurement. For such work an Oscillograph must be able to deal with frequencies far lower than those encountered in the radio and light electrical fields, and 50 cycles/second is a comparatively high frequency. Furthermore, the amplitude of the vibrations is generally quite small and considerable amplification is required.

The G.M. 3156 Oscillograph contains an amplifier with a voltage amplification of 10,000 which is maintained over a frequency range of 0.1 cycles/sec. to 10,000 cycles/sec. This means that the engineer can examine vibrations caused by engines "ticking-over" at 6 r.p.m. The time base can be varied from one sweep in four seconds up to 2,000 sweeps/sec., and may be synchronised from a contact breaker on the main engine shaft or from the output from the vertical amplifier.

Another feature which will appeal especially to the engineer is the mechanical design of this Oscillograph. The layout of the components and the wiring is particularly "clean" and accessible, and the whole instrument is exceptionally robust. It is completely unaffected by vibration and can be taken right up to the job.

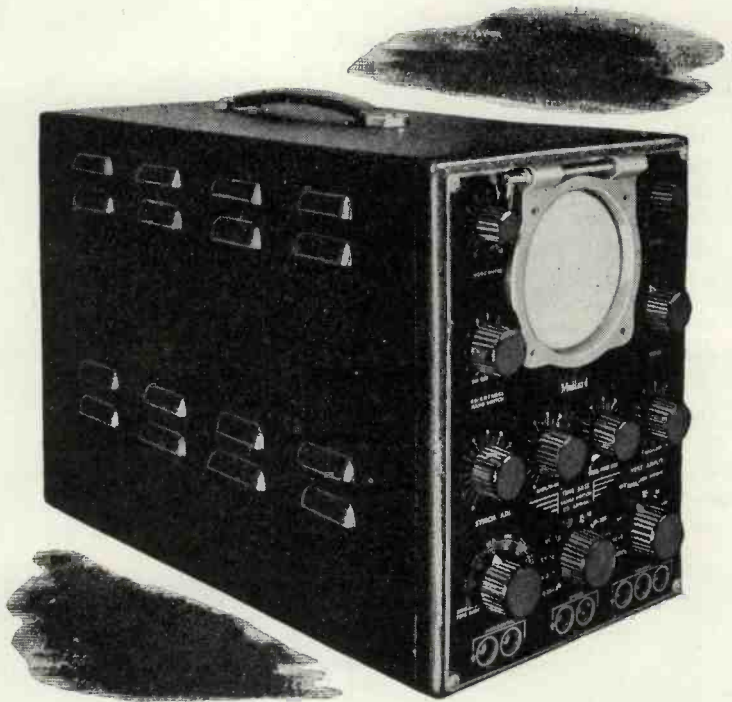

Previous commitments have delayed the release of the instrument for general sale, but it is hoped to release a few this month, and by the New Year a steady flow should be available to meet the demands of industry. In the meantime, a postcard to the address below will bring you a leaflet giving full technical details of the instrument.

THE MULLARD WIRELESS SERVICE COMPANY LIMITED

MEASURING APPARATUS SECTION

CENTURY HOUSE, SHAFTESBURY AVENUE, LONDON, W.C.2

## Lift Control by Photocells

THE photographs show an interesting application of photocell control to the operation of a passenger lift, fitted by Messrs. A. & P. Steven, of Glasgow. Two lifts in a common well are fitted with this photocell control which considerably simplifies the working and does not require any skill on the part of the operator.

A general view of the installation is shown in the lower illustration which has been taken looking down on the top of the car. On the car is mounted a pair of light cells in screened covers, a light source and amplifier box, which includes relays to work the main contactors of the lift motor.

Mounted down the side of the lift shaft are two sets of screening vanes, one for the "up" travel and one for the down. As seen from the detailed photograph on the right, these are so positioned that they intercept the light ray from the lamp to the photocell unit. The length of each vane is that of the distance between each floor, a gap occurring at a position corresponding to the position of the lamp when the lift is stationary at the floor level.

When the lift is travelling in either direction one of the vanes is interposed between the lamp and the corresponding photocell. The other cell receives light during the movement of the lift, and in the stationary position both are illuminated.

The action is as follows :—

In operating the lift the passenger moves the car switch to either the up or down position and holds in on until the lift passes the floor immediately above or below that at

which it is desired to stop. The car switch is then released, but the cell which is illuminated at the time takes over the control through its relay and prevents the main contactor opening.

The motor is, however, slowed down preparatory to stopping at the next floor.

On arriving at the floor level, the gap between the vanes allows light to fall on the other photocell which was previously obscured. The relay connected to this cell then trips the main running contactor and switches off the lift motor.

In re-starting the lift the manual control again takes charge until released, when the same cycle of operation is repeated.

One of the great advantages of the installation is that no special skill is required to bring the lift to rest exactly at floor level. The light-operated control levels the lift to approximately  $\frac{1}{8}$ " of the floor level each time and this control is entirely independent of the operator. Further, there is no need for the installation of special switches in the motor room or well to cause the lift to slow down. The usual limit safety switches are, of course, provided in the event of over-running. It is possible that these might be photocell operated if desired.

The equipment has also been fitted to ten lifts in London wharves, the installation being carried out by Messrs. Steven in collaboration with the Radiovisor Parent Co., Ltd., London, N.W. 1, and we are indebted to these firms for the photographs and particulars given.

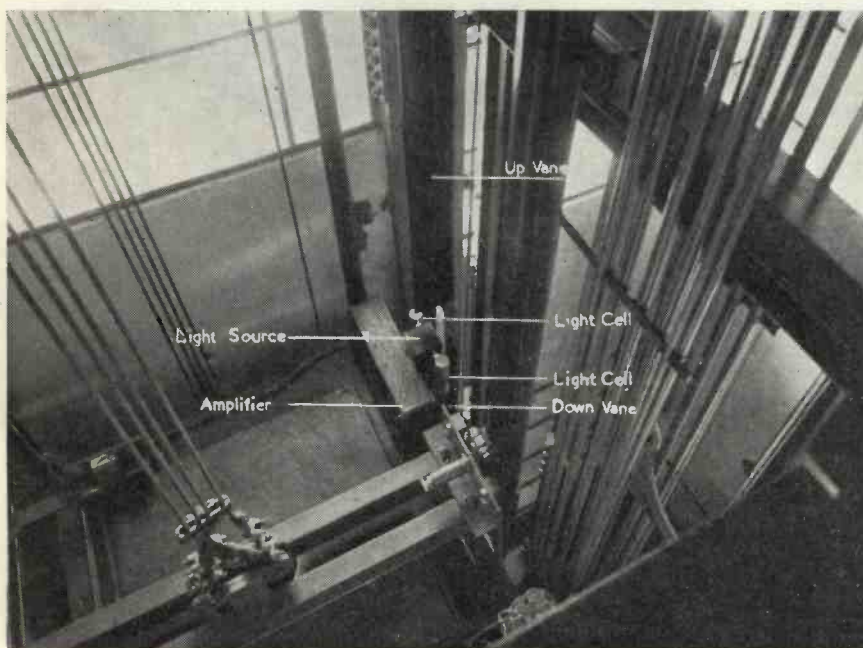
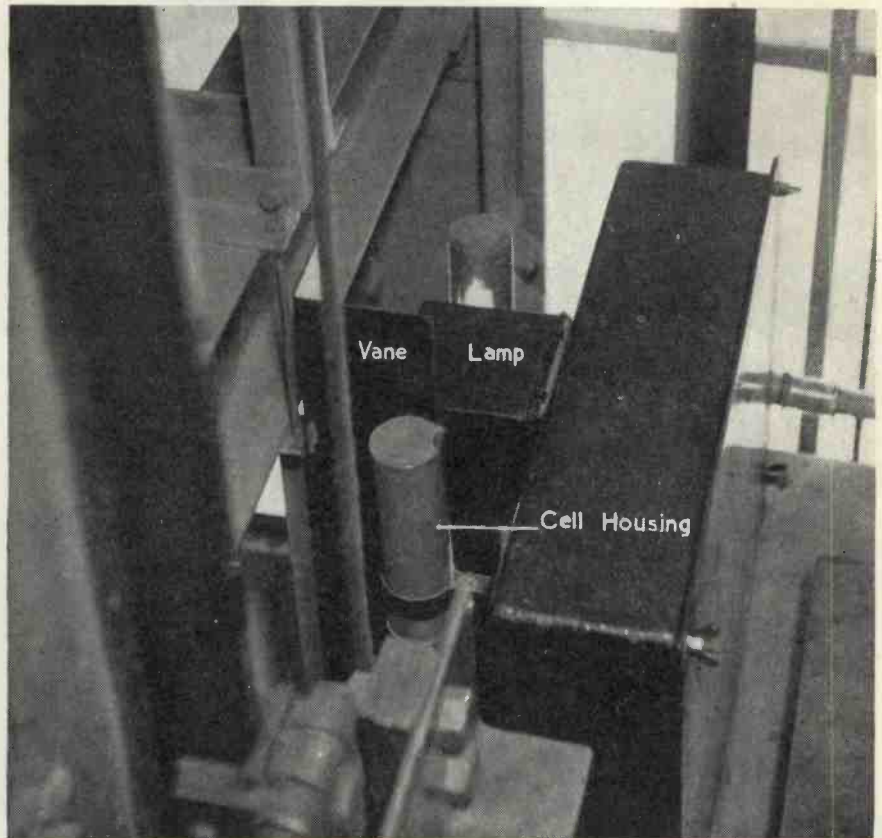





# **TOUGH!**

**Twisted and bent till the metal itself showed signs of giving, but the 'EASY-FLO' joints remained intact.**

In all branches of electrical engineering there is to be found a constantly increasing demand for materials able to withstand higher speeds, greater strains and stresses, and more severe corrosive conditions.

Thus, during the past few years, increasing use has been made of the desirable properties of the precious metals and their alloys.

Silver brazing alloys are but one example, others being :—

**Rhodium plating.**—Widely employed as a hard, corrosion resistant finish, both for contacts and other parts of electrical equipment. Details are given in publication No. 239.

**Silver Fuse Wires.**—Resist corrosive attack and enjoy complete freedom from oxidation. Can be relied upon to maintain their fusing point at the specified amperage.

**Precious Metal Contacts.**—The contact alloys produced by Johnson Matthey and their associate company, Mallory Metallurgical Products, together offer a choice of materials for every type of contact requirement.

**Low melting point silver solders.**—For safe soldering with corrosion resistant material of armature end windings, etc.

*Details of Easy-Flo and other silver brazing alloys are contained in booklets 96, 98 and 99, copies of which will be sent free on request.*

*For informative literature about any of the above products or processes write to —*

**JOHNSON, MATTHEY & CO., LIMITED**  
**HEAD OFFICE AND REFINERIES**  
**73/83 HATTON GARDEN, LONDON, E.C.1**

# A Note on the Stability of Electron Multipliers

by F. J. G. van den Bosch, D.Sc., I.E.M.  
(Messrs. Vacuum Science Products)

At the Annual General Meeting of the Television Society, held on October 4th, at the I.E.E., Dr. van den Bosch read a paper on "Recent Developments in Electron Multipliers, with special reference to the Augetron." The paper in full is being published shortly in a special number of the Society's Journal, and the following extract is reproduced by arrangement. Readers wishing to obtain copies of the full paper should apply to the Editor of the Journal, Mr. W. G. Mitchell, "Lynton," Newbury, Berks.

WHEN examining the properties of any particular electron tube, it is, of course, necessary that the stability of the tube should be sufficient to permit a repetition of results, but a clear distinction should be made between three different kinds of varying results. Any phenomena of instability observed may be due either to unsatisfactory testing equipment or method of testing, or, secondly, through some fault in the assembly of processing of the tube, or finally to some fundamental instability of the electric effects upon which the entire functioning of the tube is dependent.

In order to study secondary emission problems the simplest case is probably that of the photo-electric multiplier in which all the surfaces are of similar chemical composition, and where there is little likelihood of poisoning effects. It will then be found that with moderate illumination (and hence a conservative value of maximum current handled) the characteristics of the multiplier will be exceptionally stable. It is reasonable to assume that under such circumstances any instability observed must be due to some subsidiary poisoning effects complicating the main issue. Actually, the stability attained in a photo-multiplier is very remarkable since in the case of a six-stage multiplier, where the overall gain is the sixth power of the individual average stage gain, a 10 per cent. change in secondary emission ratio would produce nearly a twofold change, and a 10 per cent. change occurring in overall multiplication, which incidentally is easily detectable as a serious instability, only needs about 1.6 per cent. change in average.

Instability is far more likely to be encountered in electron-multipliers where the primary cathode consists of a thermionic cathode, as is the case in the thermionic multiplier. It is unusual in radio valve work to demand very great stability, since in the normal circuits employed a considerable variation in stage gain of a valve amplifier can be tolerated before its effects are detectable by ear. Variations of the order of 5 or

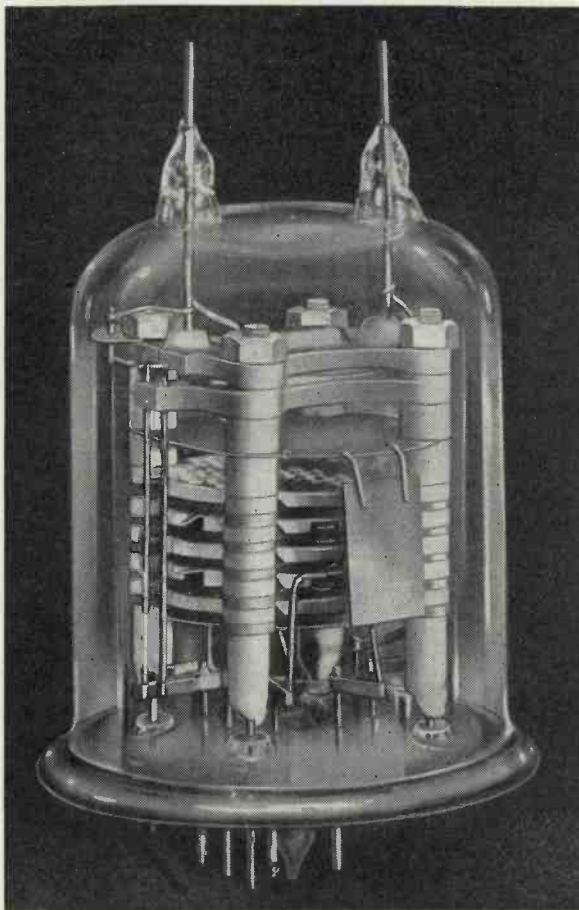

The new "Augetron" electron multiplier. A photo-electric type is also available.

even 10 per cent. drift in anode current are not a serious drawback, but in the case of the multiplier with its high slope and high sensitivity the optimum working point on the grid characteristic is of major importance. What we have in mind here is the variation in contact potential caused during running as a result of slow evaporation of metallic barium from the thermionic cathode and its subsequent deposition upon the wires of the nearby grid. A change of as much as 1 volt is possible as a result of this effect and since the optimum working grid potential is critical to within  $1/10$  of a volt it is obvious that trouble might be anticipated here. However, we have so far not had any difficulty in this direction, as the design of both cathode and grid has been directed to minimise this inconvenience. It is one advantage that

the Augetron has over other types of secondary emission tubes so far developed in that its "gun" design has been particularly directed to overcome the inherent disadvantage of using ordinary thermionic cathodes.

It is difficult to say what other changes in conditions at the "gun" assembly end can cause variations at the output end as regards multiplication and mutual conductance. It should be very difficult for small variations in the total emission of a thermionic cathode to have any influence upon these factors, since provided the thermionic cathode is reasonably efficient, its limitation will be completely caused by space charge, and hardly at all by temperature. A more probable cause of trouble is the evolution of gas, mainly oxygen, from the thermionic cathode or from metal parts. A small liberation of gas is likely to have disastrous effects upon the sensitised secondary emitter surfaces. The gas will be ionised and the positive ions will bombard the thermionic cathode resulting in cathode deterioration and subsequent further gas evolution. When the gas pressure is extremely small it usually ionises between the secondary cathodes and generally starts between the last secondary cathode and the collector. Their bombardment will obviously result in serious damage to the sensitised layer. These small gas evolutions sometimes disappear, being "cleaned-up" by the cesium of secondary cathodes acting as a getter; this will be, of course, at the expense of the sensitivity of the secondary emitter. It is probable that there is always a slow evolution of gas from any oxide cathode, and from this point of view, especially in secondary emission tubes, it is advisable to keep the area of the cathode and the emitting surface down to a minimum in order to avoid this as much as possible. Another effect to be considered is the gradual damage to the first secondary emitter by the slow evaporation of barium metal from the thermionic cathode on to this emitter. This effect is the main reason why secondary emission valves may be unreliable during life and why in some con-

(Continued on page 517)





## *In Town to-night*

... a million people listen in, to Symphony Concert and Music Hall, to the Epilogue and the Children's Hour, to "some of the interesting personalities who are in town to-night". Delicate instruments, fine components make all that possible; make possible Radio itself, that has brought so much happiness to so many and yet remains something of a mystery. To those concerned, Dubilier is a name in which they place the fullest confidence.

**DUBILIER**  
CONDENSER CO. (1925) LTD.



# An Inexpensive Sensitive Relay

By J. S. Worthington

**T**HIS relay was originally evolved for use in remote-control apparatus for the radio control of models, chiefly aircraft and boats. Its light weight and compactness make it ideal for such uses, and its extreme sensitivity enables the auxiliary apparatus to be kept to a minimum.

The contacts can easily be adjusted to close on .5mA. or less, the best setting being that which caused the contacts to close when the current rose to .5mA. and to open again when it dropped below .3mA. At this setting a power of 100 milliwatts is required to operate it.

When driving the relay through a rectifier by an audio signal, as from a receiver, it should be shunted by a condenser of .1  $\mu$ F or more, as the armature is so light and sensitive that it endeavours to respond to the audio frequency and speech can in fact be read from it. With a capacity shunt the action becomes clean and rapid and code signals up to 70 w.p.m. have been recorded without difficulty.

The unit, complete with aluminium cover and terminal panel, measures 2 in. by 1.2 in. by 1.4 in. high overall and weighs only 3½ oz. By omitting the mounting base and taking the connexions directly to the coil and the contacts the weight can be reduced to 2 oz. and the size to 1½ in. by 9 in. by 1 in. high without in any way impairing its efficiency.

The movement consists of a light balanced armature suspended inside the energizing coils. The relay is polarized, both ends of the armature being in strong magnetic fields, as shown in Fig. 1. This design permits very sensitive action, and the fact that the armature is balanced avoids the use of return springs.

The construction is made clear by the drawings of Fig. 2, but several points require a little explanation. The pole pieces are made from 1-32 in. soft iron sheet shaped as shown in Fig. 3. The flanges which are pressed against the poles of the magnet should make good contact and are held in place by the piece of Perspex which is bent to an angle section and forms the supporting shelf for the contact screws. The Perspex may be bent easily if it is immersed in boiling water for a few minutes until it softens. This shelf is held tightly in place by a 9-B.A. brass bolt which passes through it and screws into a tapped hole in a wedge-shaped piece of the same material which is jammed between the converging legs of the magnet as shown in Fig. 4. This makes a very rigid assembly. The two coils (taken from headphones) are clamped in place by the extended pole pieces, at

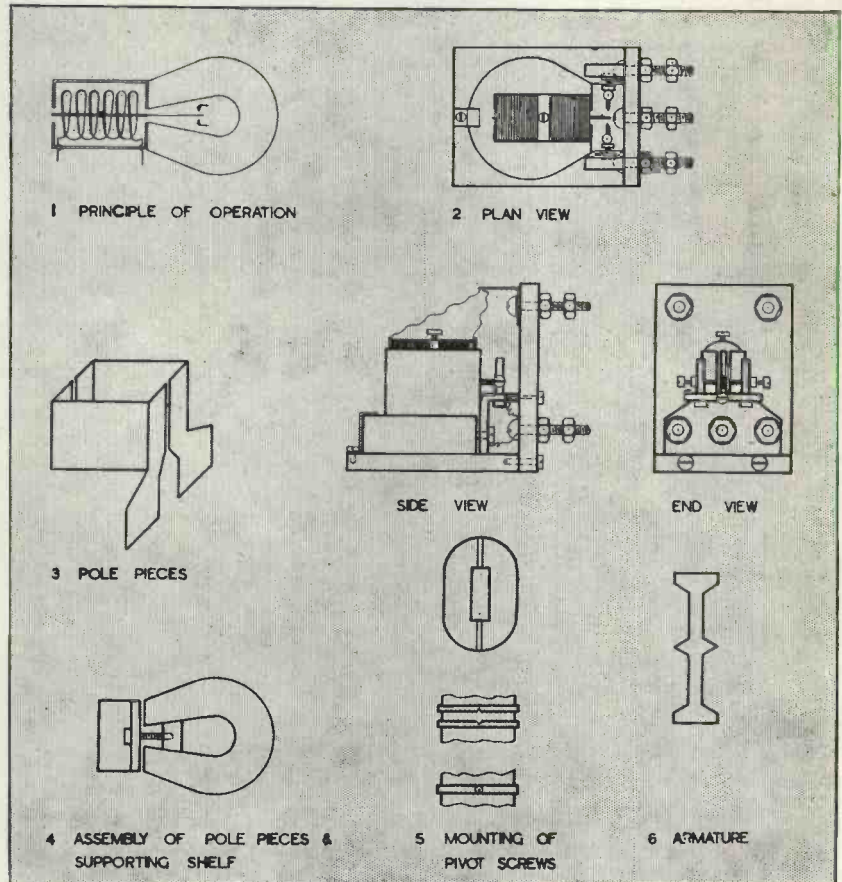

the ends of which opposite magnetic poles appear by induction. The coil bobbins can be removed from their original cores quite easily and must be arranged so that the direction of their windings is continuous. Before finally assembling the coils V-shaped notches should be filed on the cheeks which will be in the middle of the completed assembly. The coils should then be clamped in a vice with the two notches in alignment and a 9-B.A. tap run through between them. Care is necessary to avoid damaging the windings, as the cheeks are fairly thin, but it is not a difficult operation when care is used (see Fig. 5). 9-B.A. brass bolts with the tips countersunk form the supports for the armature which is mounted inside the coils. The armature itself is made from 1-32-in. soft iron sheet, and is shaped as shown in Fig. 6. The cut-away shape of it is to keep it as light as possible to reduce the power required to move it to a minimum. The ends of it should project from the coils just sufficiently to be in the fields of the pole-pieces. To the end nearest the shelf is soldered a light piece of brass carrying the moving contact. In the relay shown, a contact is carried on one side only, the other side merely

bearing on a back-stop, but there is no reason why contacts should not be fitted on both sides if a change-over action is desired. It is important that the armature should not extend beyond the magnetic field and that all bolts, etc., which do not form part of the magnetic circuit should be of non-magnetic material, e.g., brass. The fixed contact screw and back-stop are 9-B.A. brass bolts with lock nuts, mounted in brass pillars made from ¼-in. brass wire, which are in turn mounted on the "shelf." The assembly so far described forms a complete relay, connexion to the moving contact being made via the bottom pivot of the armature. It is realized that this is not a desirable practice as a rule, but the damping introduced by any pigtail connexions destroyed to some extent the sensitivity of the action, and in view of the fact that only small currents at low pressures are normally controlled this method was adopted and so far in practice no trouble has been encountered.

To facilitate handling the relay a base of Perspex was fitted, together with a terminal panel carrying both primary and secondary circuit connexions. A thin aluminium cover completes the construction.





**Check the Vital Spots**  
 Constant improvement\* keeps Eimac 450T consistently better

Straight, solid, tungsten-bar plate lead...all round corners...no feather edges eliminates possibility of corona. This is an important factor in UHF.

Patented spring-tension filament assembly maintains constant tension on filament...no sagging or warpage...no distortion or short circuits.

Sparkling clear glass bulb gives maximum beam radiation. Eimac's exclusive patented pumping technique eliminates gas, thus assuring long life.

\*Note the clean-cut appearance of the new Eimac 450T tube...see the streamlined cap over the plate and the bulky single tungsten-bar plate lead. Notice the new shape of the bulb near plate terminal. These and other improvements have increased its already superior performance capabilities.

## EIMAC 450T sets the pace in modern radio

The adoption of Eimac 450T's for use in aircraft ground stations marked the beginning of a long series of sensational successes for these radically designed but soundly conceived vacuum tubes. Today they occupy the key sockets of many of the most important radio transmitters in the world. In fact many of these transmitters are built specifically around the unusual capabilities\* of the Eimac 450T. Contained in this fact is proof that Eimac 450T tubes are setting the pace in modern radio. Further proof is to be found in that Eimac tubes are the most copied tubes on the market today... their once radical shape is now almost a standard, although their performance has yet to be exactly duplicated. These obvious

truths should mean much to you in the selection of vacuum tubes for your application. Get in touch with the nearest Eimac representative\* for complete information about the Eimac 450T... or any of twenty odd tube types available.

You'll get greater economy in first cost and in operation from these, the only tubes unconditionally guaranteed against premature failures caused by gas released internally.

Follow the leaders to

**Eimac**  
**TUBES**

EITEL-McCULLOUGH, INC. · SAN BRUNO, CALIFORNIA

Agentes Exportadores: Fraser & Co., Ltd., 301 Clay Street, San Francisco, California, E. U. A.

# BOOK REVIEWS

## Plastics in Industry

"Plastes" 234 pp. 32 plates. Chapman and Hall, 12s. 6d. net.

The pseudonym "Plastes" conceals the identity of two (or possibly more) engineers who are obviously thoroughly familiar with the plastics industry and enjoy writing about it.

Commencing with the usual description of the different types of plastic materials, which, however, is very full and accompanied by tables of their properties, the book proceeds to deal with the technique of moulding and fabrication and then to the applications of plastics to the various industries—chemical, electrical, aircraft, motors and to domestic uses in building and furniture manufacture.

The information contained in the chapter on electrical engineering applications is particularly useful as it embodies data which could only be obtained by reference to numerous special articles which have appeared at intervals in the electrical press.

A plate which is of particular interest to radio engineers is that on page 228 which shows the development of the moulded radio cabinet in the designs made by Messrs. E. K. Cole. An interesting comment on the suitability of colours for radio cabinets is made on some coloured radio sets which were produced in 1938. "Some of these were moulded in stone-coloured urea material which unfortunately gave the cabinet a heavy and massive appearance intensified by the tall shape. One had the impression that the cabinets were carved out of solid marble and that if placed on a bookcase would crush it with their weight."

The book is written in a very readable style and can be recommended to engineers for its general interest apart from the valuable data which it con-

tains. The half-tone plates are excellently reproduced and could only have been improved by rendering in colour.

## Dictionary of Radio and Television Terms

R. Stranger, 252 pp. with line drawings in text. Geo. Newnes, Ltd., 6s.

This book is particularly opportune in view of the number of recruits to the radio branch of the Services, and should enable them to understand many obscure references in technical literature.

Although its title mentions only radio and television, the book actually covers a wider field including physics and chemistry where their terms have a direct bearing on the subject.

It also includes brief biographies of eminent men in physics and radio engineering and useful tables at the back on radio symbols mathematical constants and sun-spot numbers.

Mr. Stranger writes in an easy colloquial style, which makes the definitions easier to read than those in the average dictionary which are rendered from standard definitions or in the wording of patent specifications. This colloquial style, however, at times leads to ambiguity, as for example, in the definition of "Cell. Photo-Electric": "A glass bulb carrying two electrodes which varies the current flowing through it. . . ." Again: "There are two kinds of photo-electric cells—one with a vacuum bulb and the other gas-filled."

In the next edition, which no doubt will be speedily called for, Mr. Stranger might do more justice to the Iconoscope than to dismiss it in two lines and might include Dr. Zworykin's name among the distinguished physicists, but these are minor points in a book intended for the British market.

## Electric Discharge Lamps

Francis and Jenkins. Published by the General Electric Co., Ltd.

The scope of this book is perhaps best indicated by a brief survey of five parts into which it is divided.

Part I, as its title "General" suggests, is devoted to a broad discussion on the production of light, followed by the historical development of discharges, the mechanism of the discharge, the radiation spectrum, and sections on fluorescence and practical discharge lamps.

Part II is entitled "Osira High Pressure Mercury Vapour Discharge Lamps." After a short general description this part develops into an exhaustive treatise on the various types of Osira H.P.M.V. lamps now available, and takes one through the many stages of development and design.

In view of the comparatively recent development of Osram fluorescent tubes and of their evergrowing popularity for lighting industrial and commercial establishments, Part V will probably be the most widely studied chapter of the book. Since the introduction of the Osram tube nearly eighteen months ago, much has been written and said about this descendant of the H.P.M.V. lamp. There is also much of interest to engineers that has not previously been published.

Though necessarily of a highly technical nature, the authors have succeeded in presenting their subject in a very readable and lucid form and it is made still more interesting by the judicious but liberal use of diagrams, illustrations and data tables.

To the professional lighting engineer, this book should be of great value; and it is of particular interest to electronic engineers studying gas discharge phenomena.



## BRITISH MADE PHOTO CELLS

Barrier layer photo voltaic cells suitable for all types of light measurement—photometers, exposure meters, comparators, colour matchers, reflection, refraction, and density measurement, light switches, counters, and burglar alarms.

Special cells with very low capacity for sound film work, film gramophones and other acoustic purposes, also push-pull cells.

SPECIAL CELLS MADE TO ORDER.



Some standard sizes of photo elements.      Characteristics and prices on application.

## ELECTRO PHYSICAL LABORATORIES

(RENNY & WENDER) LTD.  
50, BRAMPTON GROVE, LONDON, N.W.4. Hendon 2103



# DAGENITE & PERTRIX

*—the dependable*

## BATTERIES

FOR RADIO, CARS,  
MOTOR CYCLES, COMMERCIAL VEHICLES, ETC.

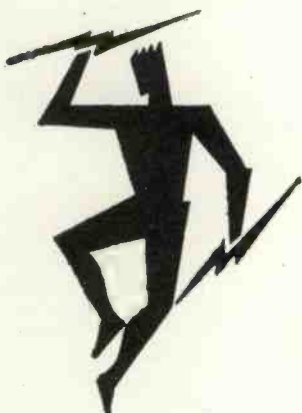

# DAGENITE

are used for London's Buses, Rolls-Royce and Bentley Cars, Britain's Lifeboats and Aircraft.

# PERTRIX

are supplied to His Majesty's Government and, like Dagenite, are used in every other connection where the utmost dependability is essential. You, too, should use Dagenite or Pertrix in your car or radio.

OBTAINABLE FROM HOLSUN SERVICE STATIONS  
AND USUAL DEALERS

*Sales Concessionaires :*

## HOLSUN BATTERIES LIMITED

137 Victoria Street, London, S.W.1

D4b/41

# YOUR

*most urgent need—  
supplied with speed*

## INSTRUMENT MAKING.

### TRANSFORMERS,

CHOKES, AND COILS OF ALL  
KINDS. LIGHT ELECTRO-  
MECHANICAL ASSEMBLIES, etc.  
manufactured to customers'  
requirements :: :: :: ::

## JOYCE ENGINEERING LTD.

The Quadrant, Hendon, N.W. 4  
Hendon 7438

CONTRACTORS to H.M. GOVERNMENT, POST OFFICE, etc.  
A.I.D. ESTABLISHMENT



## Spare-Time Training by Post in all Electrical Subjects

The International Correspondence Schools, largest and most successful institution of its kind in the world, offers thoroughly sound Courses of instruction to cover the following subjects —

- |                         |                                   |
|-------------------------|-----------------------------------|
| Complete Electrical     | Electric Illumination and Heating |
| Electrical Designing    | Hydro-Electric                    |
| Electric Lighting       | Oil-Power Electric                |
| Electric Power          | Power-House Attendants            |
| Electric Traction       | Steam Electric                    |
| Electrical Transmission | Telegraph Engineering             |
| and Distribution        | Telephone Engineering             |

Also the following Examinations —

- Associate Membership, I.E.E.
- City and Guilds Elec. Eng. Practice, Elec. Installation and Telecommunications
- P.M.G. Certificate for Wireless Operators
- Provisional Certificate in Radio Telephony and Telegraphy

WRITE FOR OUR SPECIAL FREE BOOKLET

(Use this Coupon. Penny stamp on unsealed envelope)

## INTERNATIONAL CORRESPONDENCE SCHOOLS LIMITED

Dept. 68, International Buildings, Kingsway, London, W.C.2.  
Please send your Booklet "Electrical Engineering" (72 pages).

I am especially interested in .....

Name..... Age.....

Address .....



# Impedance-matching in Concentric Lines

THE R.C.A. Laboratories have recently suggested methods for matching concentric transmission lines whose surge impedances bear to one another certain ratios, which include ratios which are the squares of the natural numbers. These methods use matching sections that employ only concentric lines, and have the interesting feature that the matching is obtained without the use of standing waves. The general principles underlying these methods are illustrated in the figures shown.

Fig. 1 illustrates a method of transforming from a single transmission line A of impedance  $2Z$  to a pair of like transmission lines of impedance  $Z$ , but working in balanced relationship. The line A is arranged to project to the extent of a quarter wavelength into the enclosed space S and the outer conductor of the line A is connected to the inner conductor of one of the balanced lines, while the inner conductor is connected to the inner conductor of the other of the balanced lines. As the line A projects a quarter wavelength into the space S, this space presents an infinite impedance to the line and all the current flowing in it must necessarily flow in the balanced conductors. Since the balanced lines are effectively connected in series across the line A, their surge impedances must necessarily be each equal to half that of the line. Fig. 2 shows a very slight modification of the device of Fig. 1, the balanced lines

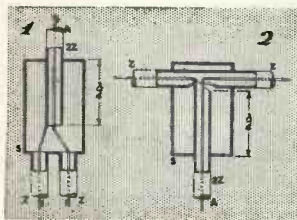

forming with the line A, a mechanical T-structure.

Fig. 3 shows a development of the device of Fig. 1 so as to obtain an impedance transformation in the ratio 4:1. Here the balanced lines are joined together with a half wavelength difference in length, their junction point being connected to the line B, which is of such impedance as to match the pair of balanced lines. This matching involves that the impedance of B should be half that of each of the lines. Thus, the impedance transformation in the ratio 4:1 is achieved.

The device of Fig. 4 may be described as a modification of that of Fig. 3 to give an impedance ratio between lines A and B of unity, the two lines differing only in their physical dimensions. The balanced lines are connected to the line B in the same manner as before, but their inner conductors are connected,

one to the inner conductor and one to the outer conductor of A in the somewhat different manner shown. If the current  $2i$  flowing in at the conductor B is considered, this current splits into two currents  $i$ , each flowing in the balanced lines. With the longer of the balanced lines the current flowing on the inner conductor becomes a current  $i$  flowing in the outer conductor of A, while the current flowing in the outer conductor becomes a current  $i$  flowing on the inner conductor of A. Further equal currents  $i$  are contributed by the shorter of the balanced lines and currents of magnitude  $2i$  are thereby set up in the inner and outer conductors of A.

Fig. 5 shows a device for achieving a 4:1 impedance ratio between lines of differing physical dimensions. Line B is branched into a pair of lines, the outer conductor of one of which becomes the inner conductor of line A.

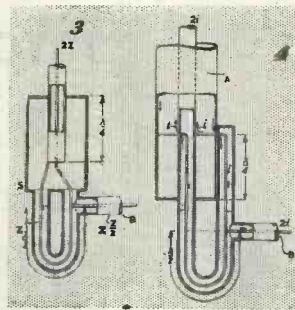

The other of the branch lines projects into the space between the conductors of line A to the extent of a quarter wavelength and its inner conductor is connected to the outer conductor of A; its outer conductor is connected to the inner conductor of the first branch line. A current  $2i$  flowing in at B divides equally into currents  $i$  flowing in the two branch lines; the current flowing in the outer conductor of the first branch line becomes the current on the inner conductor of the line A; the current on the inner conductor of the other branch line becomes the current in the outer conductor of the line A. The connexion between the outer and inner conductors of the branch lines can be achieved without setting up reflections, since at the connexion point the sum of the two travelling-wave currents incident upon this point is zero. It will thus be seen that the current  $2i$  flowing in B becomes a current  $i$  in the line A. At the same time the voltage between the conductors of A is twice that of the voltage between the conductors of B in view of the connecting together of inner and outer conductors. The impedance transformation is thus in the ratio 4:1.

The method of connecting inner and outer conductors of branch lines to give a voltage transformation can be extended to give greater transformation

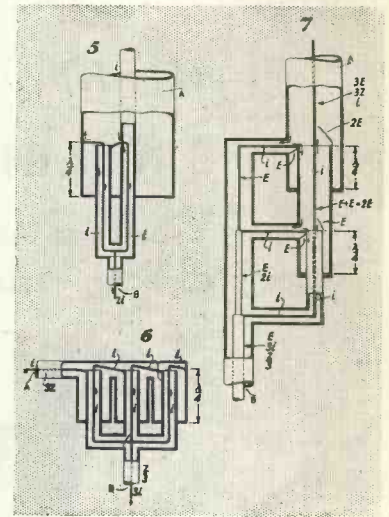

ratios, and the method is applied in Fig. 6 to obtain a transformation ratio 9:1. This demands that the conductor B should be divided into three branch lines. A current  $3i$  flowing in B at a certain voltage thus becomes a current  $i$  flowing out at A at three times the voltage.

Another method for giving an impedance transformation in the ratio 9:1 is shown in Fig. 7. The line B carrying a current  $3i$  is branched at a first branching point so that a current  $i$  travels down a first branching line and a current  $2i$  travels down the continuation of B. This continuation is then branched again so that a further current  $i$  travels down a second branching line, and the remaining current, also of magnitude  $i$  travels down the further continuation of B which may be regarded as a third branching line. The branching lines are then joined together in the fashion shown in the figure, so that first and second branching lines meet in a first junction point, the paths between first branch point and first junction point being equal, while the second and third branching lines meet in a second junction point, the paths between second branching point and second junction point also being equal. The inner conductor of the first branching line becomes the inner conductor of the line A and supplies the current  $i$  in the inner conductor of the line A. The outer conductor of the third branching line is connected to the outer conductor of the line A and supplies the current  $i$  flowing in the outer conductor of A. At the first junction point, since the paths between branch and junction points are of equal length, the current in the outer conductor of the first branching line transforms into the current of the inner conductor of the second branch line. As with the device of Fig. 6, method can be extended by increasing the number of branching points to any desired number.





*The First* COSSOR Cathode Ray Tube was made in 1902. Since these pioneer days, continuous research by Cossor physicists on Tubes both for television and as indicating devices in Scientific Instruments, has brought many notable contributions to the field of electronics, the Double Beam Tube being an outstanding example. Around the perfected Cathode Ray Tube and other electronic devices made by the Company, the well-known range of Cossor Instruments was created. A new technique has thereby been applied to problems involving electrical and mechanical effects.

Cossor Instruments are now firmly established as indispensable in modern laboratory investigation, industrial research, production test work and technical training; in these and other applications they play an important role in the National War Effort.

# A. C. COSSOR LTD.

(INSTRUMENT DEPT.)

COSSOR HOUSE, Highbury Grove, London, N.5

G.A. 4122

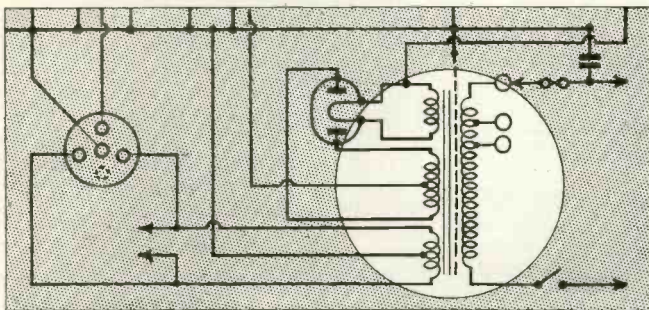

## EMPHASIS ON QUALITY

When stress is laid in any specification on the quality of the mains transformers to be used, the name Gardner springs automatically to the mind for it is, as it has ever been, the criterion in the world of transformers. So when next you need to use Small Power Transformers up to 4 kva. do please have a word with us—we sincerely believe you will find it well worth while.



GARDNER'S RADIO LIMITED  
Somerford • Christchurch • Hants



## The 65-watt 'PENCIL' BIT SOLON

MADE FOR  
USUAL  
STANDARD  
VOLTAGES

One of the range of Industrial type SOLONS. Conforms to Home Office requirements. Pressure tested 600 volts to earth for 1 minute.

**NOTE.**—Production of the popular 'Handyman' 65-watt SOLON has been discontinued.



Other models are available.  
Write for leaflets

W. T. HENLEY'S TELEGRAPH WORKS CO., LIMITED  
Engineering Sales Department, Milton Court,  
Westcott, Dorking, Surrey.

## NOTES FROM THE INDUSTRY

### Radio Component Manufacturers' Federation

At the luncheon of the R.C.M.F. on October 22, Mr. R. A. Watson Watt, C.B., F.R.S., the guest of honour, made one of his characteristically witty speeches. Dealing with post-war problems of radio, he suggested that even people who think that music is primarily based on the saxophone should be entitled to a 15 kc./s band width.

He would like to see our high-brow programmes kept as low as possible—even underground—in the interests of quality, and he visualised a national line distribution network for Regional programmes.

Other remarks which evoked laughter from the large audience were: "It wasn't for nothing that a Scotsman invented the Ionosphere—or rather it *was* for nothing," and "The measure of a healthy industry is the extent to which it has widened its specifications and narrowed its tolerances."

The chairman was Sir Percy Greenaway, Bart., a former Lord Mayor of London.

### Bogus "Royal Radio Institution"

At Salford on September 24, R. W. N. Spencer, who described himself as Secretary and Proprietor of the Royal Institution of Radio Engineers was sentenced to twelve months' imprisonment for false pretences.

In passing sentence the Stipendiary said that he had no hesitation in describing the "Royal Radio Institution" as a ramp. It was alleged that Spencer had purchased the concern from a man named Gorman, who had originated the business because he could see that there was money in it.

There were no examinations and no application for membership had ever been refused. A 17-year-old typist acted as "registrar."

A large share of the credit for exposing this ramp must be given to the British Institution of Radio Engineers, which is a perfectly *bona-fide* organisation which has recently amalgamated with the Institute of Wireless Technology.

The president of the Brit. I.R.E. is Sir Arrol Moir, and the Secretary, Mr. G. D. Clifford informs us that they have never been remotely connected with the bogus concern referred to above. The registered address of the Brit. I.R.E. is Duke Street House, W.1.

### New Adhesive for Bakelite

Messrs. Aero Research, Ltd., of Hinxton Road, Duxford, have sent particulars of their newly-developed adhesive "Ardux," which is capable of welding Bakelite mouldings and laminated sheet material with a strength greater than that of the original substance.

Two varieties are available: I for close-fitting joints and II where gap

joints are required. It is not necessary to roughen the surface of the material and the surfaces to be joined are clamped together under uniform pressure and baked in an oven at 160° C. to set the jointing material. Flat sheets can be jointed by clamping them on a flat steam-heated table.

Further particulars can be obtained from Dr. N. A. de Bruyne at the address above.

### Non-interfering Vibrators

One of the chief sources of radiated interference from vibrators at low frequencies is the rising and collapsing field on the battery leads which carry a pulse of several amperes at each vibrator contact operation. This current variation acting against the inevitable fraction-of-an-ohm resistance of the battery and leads can produce a field of several millivolts per metre.

In the new vibrator packs designed by Masteradio, Limited, for use with communication receivers the form of filtering is one which the vibrator derives each pulse of current from a large capacity fed from the battery through a balanced filter system. This ensures the battery leads carry D.C. only and moreover, since the quantity contained in the condenser is limited a certain amount of rounding-off occurs in the vibrator transformer primary current waveform. Other arrangements are available in which adjustment can be made to completely cancel out a known amount of ripple, in, say, a subsidiary supply to a microphone or valve filament.

A further modification of the waveform of the vibrator transformer current is obtainable by matching the time constant of a combination of condensers and resistances connected across the contacts of the vibrator, so that the time constant bears a relation to the time interval during which the contacts are moving within sparking distance. This has enabled a considerable reduction to be made in the R.F. contained in the waveform, apart from the amount inherent in the square waveform. By attention to the transition of the contacts over this critical period of their cycle, it is possible to increase the current rating without danger of sparking, or overheating, up to the normal rating of the contacts as for D.C.

The details of these points have been covered in Patent Applications Nos. 3970/41 and 3971/41.

The Vibratorpacks are supplied as a self contained unit, in a cadmium plated steel case provided with terminals for input and output, measure 8 $\frac{3}{4}$  in. by 4 $\frac{1}{4}$  in. by 5 $\frac{3}{4}$  in. high, weighing 8 $\frac{1}{2}$  lb. approx., and are built for use under tropical conditions.

For special requirements units can be designed to operate from up to 40 volts and give outputs of up to 60 watts.

### Anti-Vibration Mountings

The difficulties in protecting high gain amplifiers from microphony due to floor vibrations are well known and have given rise to some Heath Robinson designs in rubber suspensions and spring mountings. The anti-vibration rubber mountings designed by Metalastik, Ltd., of Leicester, will be of particular interest to engineers who have amplifier installations in the neighbourhood of vibrating machinery. The photograph shows two types of mounting, one a rubber-metal

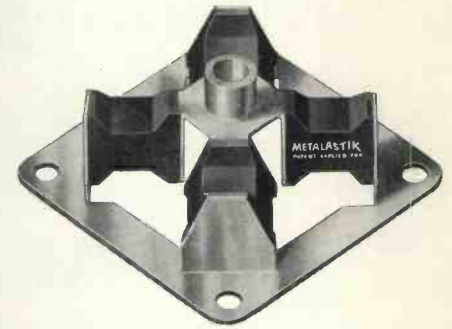

cross for holding instruments and the other a rubber rod with metal inserts which should be very suitable for chassis suspension.

One of the objections to rubber metal mountings of the conventional type is the tendency of the rubber to part company with the metal, but the special process used in the preparation of Metalastik mountings produces a metal-to-rubber "weld" which is proof against the severest torsional and shear stresses. In the ordinary tensile test the rubber still adheres to the metal after the breaking stress has been applied.

The end pieces for chassis mounting shown in the photograph below are supplied in five sizes from  $\frac{3}{8}$  in. dia. to  $\frac{1}{2}$  in. dia., the smallest having an overall length of  $\frac{3}{16}$  in. excluding threads.



The "Cross type" instrument mountings on which the chassis shown in the photograph is suspended, are a new development. They represent a great improvement on former types, having a greater load carrying capacity obtained by an increase in the inner bonding surface, and permitting absolute control of the movements in various directions. Dimensioned drawings can be obtained from the manufacturers at Evington Valley Road, Leicester.



**Fire Extinguishing Powder**

It is not often appreciated that there is a real fire risk in the processing of inflammable alloys such as magnesium, particularly when they give rise to fine filings and powder. While it is not possible to ignite these alloys in bulk, special fire precautions have to be taken in the treatment of swarf and grinding dust from machines.

Messrs. National Fire Protection Co., of Richmond, Surrey, have produced a fire-extinguishing powder which is particularly suitable for use with inflammable metals, not forgetting incendiary bombs. The "D.X." Powder is claimed to extinguish all fires in incendiary metals in their early stages. On application it melts into a viscous liquid which coats the unburnt metal and excludes oxygen. On cooling it again solidifies and enables the unburnt metal to be recovered for scrap.

If ignited by excessive heat from molten metal it burns with a light easily extinguishable flame. A very important feature of the powder is that it is non-abrasive and can therefore be liberally applied to machines without risk of damaging bearings, etc.

D.X. Powder (Pat. No. 518,717) is supplied in 56 lb. drums and should be kept by the machine ready for shovelling on to the fire. It is, of course, only one of the many fire-extinguishing products supplied by this firm, and manufacturers should apply for a series of instructive booklets on industrial and A.R.P. fire protection.

**Beryllium Copper**

THE unique properties offered by beryllium-copper have been familiar to designers for a number of years. The combination in this alloy of exceptionally high tensile and fatigue strengths, high hardness, electrical conductivity and resistance to wear and corrosion have established its great usefulness where such properties are demanded for heavy duty springs, current carrying parts of electrical equipment, instrument diaphragms and a variety of other components of precision equipment.

It is now announced by Mallory Metallurgical Products, Limited (an associate company of Johnson, Matthey & Co., Limited), of 78 Hatton Garden, London, E.C.1, that they are manufacturing an improved ternary alloy of this type, developed from the original beryllium-copper by the addition of a small percentage of cobalt, this resulting in improved and more uniform physical properties. This alloy, known as Mallory 73 Beryllium-Copper, is available as strip, wire and tube in the soft state for forming into springs, switch blades, contact clips, diaphragms, bellows and similar parts. After forming, a short precipitation hardening process develops maximum physical properties—a tensile strength up to 85 tons per square inch, a proportional limit of 50 tons per square inch and a hardness of 360 to 400 Brinell.

**Leland Instruments**

IN a full-page advertisement in our contemporary *The Wireless Engineer*, Messrs. Leland Instruments have published a letter to them from the Clough-Brengle Co., which reads as follows:—

"Gentlemen:

This will acknowledge your several communications relative to some unfounded doubt that we were appointing other distribution in the British Isles in competition to your interests. Let this letter assure yourselves or any authorised witness of it that your company continues as the sole authorised distributor of our products in the British Isles and that any representations to the contrary are unauthorised by this company.

As you must be aware, there has at no time been filed with you any communication signed by this company nor any officer thereof or any person or corporation having power of attorney for this company or its officers discontinuing or threatening to discontinue the trade relationship which has been existing for some time past. Further, there is no action contemplated by this company or its officers which would be prejudicial to the existing relationship."

(Signed) Kendall Clough, President.

This notification will remove any doubts which radio engineers may have had regarding the continuance of the service which Leland Instruments are giving in American equipment.

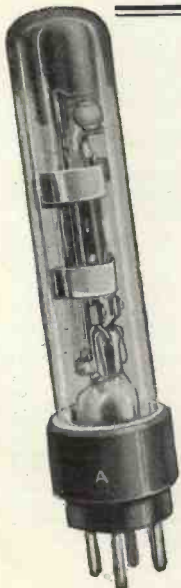

THE vacuum switch shown in the illustration is mounted on a standard 4-pin valve base.

It is a light and convenient relay to handle up to 5 amps A.C. or D.C.

Its principal features are:

- LONG LIFE
- TOTALLY ENCLOSED CONSTRUCTION
- A.C. or D.C. OPERATION
- NON-INDUCTIVE CONTROL CIRCUIT
- ADJUSTABLE TIME DELAY UP TO 15 SECONDS
- WEIGHS ONLY 2 OUNCES

Write for Leaflet No. 101-2A  
For larger relays see leaflet No. 101-2



HOT WIRE

**VACUUM SWITCH**

SUNVIC CONTROLS LTD., 1, KINGSWAY, W.C.2  
Temple Bar 8202

**CONSTANT VOLTAGE**

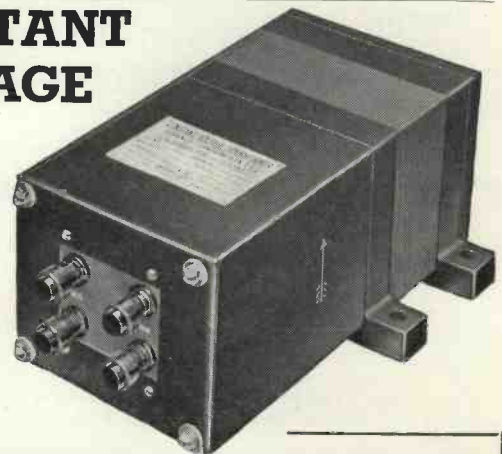

A NEW **ADVANCE** IN TRANSFORMER DESIGN

Line voltage variations of **± 15%** reduced to **± 1%**

Stabilize your Electrical Instruments by using an "ADVANCE" Constant Voltage Transformer

**TYPICAL SPECIFICATION:**

Input Voltage:	.. .. .	190-260 v. 50 c.
Output Voltage:	.. .. .	230 v. ± 1%.
Max. load:	.. .. .	150 watts.
	Input power factor over	90%.

Write for details.

Price on application.

**ADVANCE COMPONENTS LTD.,**

Back Rd., Shernhall St., Walthamstow, London, E 17

Telephone: Larkwood 4366-7

THE DIAGRAMS IN THIS JOURNAL ARE LETTERED WITH

“UNO”

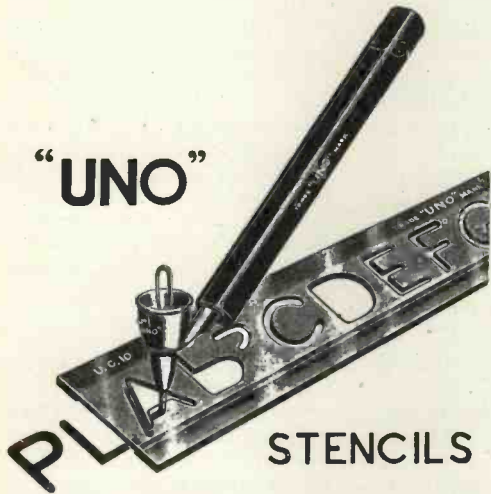

STENCILS

FOR LEGIBILITY & NEATNESS

A. WEST & PARTNERS, LTD.

36, Broadway,  
WESTMINSTER

FOR THE

3<sup>RD</sup>

TIME WITHIN 9 MONTHS  
IT HAS BECOME NECESSARY  
TO REPRINT—

**The Amateur Radio Handbook**

The demand for this standard text book continues unabated. If by any chance your pal's pal has not yet obtained his copy, see that he gets one to-day. Obviously your pal has his copy but just in case he has lent it to his A.C.W.I remind him that this will be the last reprint. We know you have a copy—or have you?

★ The price remains unaltered in spite of very considerable increases in production costs.

Britain's Best Radio Book, 320 pages: 25 Sections, 300 Illustrations:

PRICE  
3/6

(Post free 4/-)

When writing you are invited to apply for a copy of the current issue of "The T. & R. Bulletin," price 1/-, and details of membership.

To The Secretary-Editor,  
Radio Society of Great Britain, 16, Ashridge Gardens, London, N.13.

Dear Sir,—Please send me :—

..... Copy(ies) of "The Amateur Radio Handbook"

..... Copy(ies) of "The T. & R. Bulletin"

Details of Membership.

I enclose remittance for.....

NAME .....

ADDRESS .....

Please write in BLOCK letters.

1041

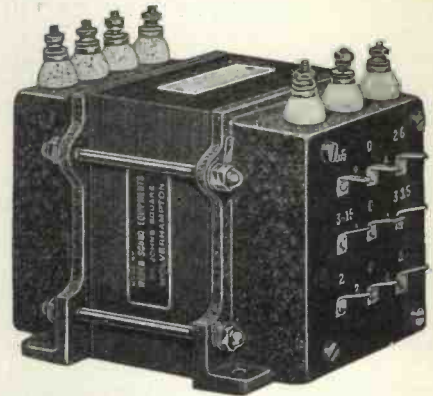

**Put Safety first**—Wherever conditions demand unusual reliability, play safe!—fit Woden Transformers. Special impregnating and dehydrating processes combined with high grade materials and workmanship ensure dependability. Stripped, fully shrouded or special types made to your specification

**WODEN**

FOR ALL TYPES OF

**TRANSFORMERS**

WODEN TRANSFORMER CO. Thornley Street,  
Wolverhampton - - - Tel. Wolverhampton 228 29

Makers of Transformers, Power Packs and special Receiving and Transmitting apparatus

**THE "FLUXITE QUINS" AT WORK**

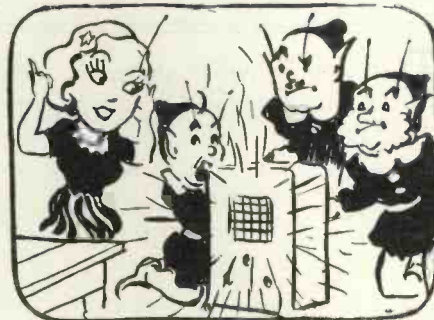

"Thenightingales sound sweet to-night,"  
Cooed OO with unbounded delight!  
Said the lads with deep growls,  
"We hear nothing but 'owls,  
Be a good girl and fetch the FLUXITE"

See that FLUXITE is always by you—in the house—garage—workshop—wherever speedy soldering is needed. Used for 30 years in government works and by leading engineers and manufacturers. Of Ironmongers—in tins, 4d., 8d., 1/4 and 2/8. Ask to see the FLUXITE SMALL-SPACE SOLDERING SET—compact but substantial—complete with full instructions, 7/6. Write for Free Book on the art of "soft" soldering and ask for Leaflet on CASE-HARDENING STEEL and TEMPERING TOOLS with FLUXITE.

To CYCLISTS! Your wheels will NOT keep round and true unless the spokes are tied with fine wire at the crossings and SOLDERED. This makes a much stronger wheel. It's simple—with FLUXITE—but IMPORTANT.

THE FLUXITE GUN puts FLUXITE where you want it by a simple pressure. Price 1/6, or filled 2/6.

FLUXITE LTD. (DEPT. T.V.),  
BERMONDSEY ST., S.E.1.

**ALL MECHANICS WILL HAVE**

**FLUXITE**

**IT SIMPLIFIES ALL SOLDERING**



# PATENTS RECORD

The information and illustrations on this page are given with the permission of the Controller of H.M. Stationery Office. Complete copies of the Specifications can be obtained from the Patent Office, 25, Southampton Buildings, London, W.C.2, price 1s. each.

## TELEVISION

### Periodic Wave Generator

Current rises through the winding 10 and the internal resistance of the tube 11. This current rise produces a change of voltage across the tube 11 and the resultant drop in its anode potential is applied by way of the impedances 17 and 18 to the control grid of the tube 16. The tube 16 is thus cut off during this portion of the cycle of operation, which corresponds to the trace period of the generated periodic current wave through the inductance element 10.

After a certain period, the rate of rise of current through the winding 10 begins to decrease, due to anode saturation of the tube 11 or to curvature of its mutual-conductance characteristic, so that anode potential of tube 11, applied to the control grid of tube 16, increases positively. The latter tube begins to pass current, and the resultant drop in its anode potential is applied by way of condenser 20 and resistor 21 to the control grid of tube 11, serving still further to reduce the rate of rise of the current through this tube and actually to initiate a reduction of the current. Since this action is highly regenerative, the anode current of the tube 11 is rapidly reduced to a low value. The period of this rapid drop in anode current of the tube 11 through the inductance element 10 corresponds to the retrace period of the generated current wave. The grid of the tube 11 remains negative, maintaining the conductivity of this tube at a low value, only during the short retrace period after which the grid returns to its normal bias as determined by battery 12<sup>1</sup> so that the current again begins to rise through the inductance element 10 and tube 11 and the cycle begins anew.

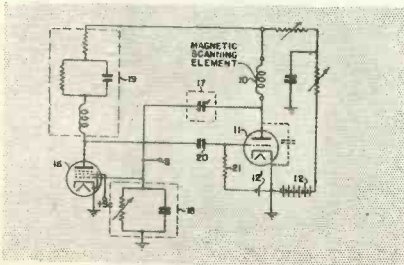

—Haseltine Corporation (Assignees of J. C. Wilson). Patent No. 538,064.

### Reception

An aerial system which substantially eliminates all of the vertically polarised wave components of a received and transmitted wave.

—Standard Telephones and Cables, Ltd. (Assignees of A. Alford). Patent No. 538,036.

## RADIO AND COMMUNICATIONS

### Diversity Reception

To provide means for automatically switching a receiver from an aerial in which the signal strength has fallen to a predetermined minimum to a second aerial receiving the same signal, but in which the signal can be of greater amplitude. An embodiment includes an arrangement responsive to the a.v.c. voltage for actuating either a mechanical relay or a pair of thermionic relays of different characteristics in a form of inverter circuit at the same location or at a different location for switching the receiver from one aerial to another.

—Marconi's Wireless Telegraph Co., Ltd. (Assignees of H. O. Peterson). Patent No. 537,937.

### Transmission

A carrier wave communication system provided with means for maintaining the communication currents at or below a specified transmission level. A sending device is provided at one end for sending signalling currents at a definite level above that of the transmission currents, and a receiving device is provided at the other end responding to signalling currents, but not to communication currents.

—Standard Telephones and Cables, Ltd., and B. B. Jacobsen. Patent No. 537,966.

### Improvements in Micro-wave Devices

A micro-wave device including a component for carrying high frequency oscillating current and a reflector associated with it spaced at such a distance, that the normal variation in frequency modulation or accompanying amplitude modulation, will not include the resonant frequency of the circuit corresponding to the reflected energy. The whole arrangement is such that the currents induced shall not pass through a critical phase change.

—Marconi's Wireless Telegraph Co., Ltd. (Assignees of R. A. Braden). Patent No. 538,040.

### Thermal Converter Arrangement

A thermal converter arrangement for producing a d.c. voltage proportional to the product of two current inputs, comprising a set of thermocouples in bridge arrangement, a pair of input circuits conductively connected to the thermocouples and conjugate to each other, and a d.c. output circuit connected to them at points conjugate to the connexions of the inputs.

—Weston Electric Instrument Corporation. Patent No. 537,938.

# PITMAN

## CATHODE RAY OSCILLOGRAPHS

J. H. Reyner, B.Sc. (Hons.) A.C.G.I., D.I.C.,  
A.M.I.E.E., M. Inst. R.E.

An easily assimilable guide to the practical application of Cathode Ray Tubes to numerous purposes including the examination of oscillations or wave-forms. Has been given the highest recommendations both for students or teachers. 8s. 6d. net.

---

## SHORT WAVE RADIO

By the same author. A companion volume to Modern Radio Communication, this book deals with the developments and progress in the field of short wave radio telegraphy, giving comprehensive data and practical methods of application. Has been quoted as being "one of the finest short wave treatises available." 10s. 6d. net.

---

## EXPERIMENTAL RADIO ENGINEERING

E. T. A. Rapson, assisted by E. G. Akermann. Eminently suitable as a textbook for a three or four years course in radio engineering at a technical college. Contains a number of experiments and methods of measurement, the majority of which may be carried out with standard laboratory equipment. 8s. 6d. net.

39 PARKER ST., KINGSWAY, W.C.2

# BOOKS

# TRIX

## QUALITY SOUND EQUIPMENT

Designed and built for reliability and high quality sound amplification

- ★ Let us send you full details
- Amplifiers 4-400 Watts
- Horns
- Microphones
- Loudspeakers



Equipment available for priority work, factories, etc.

**The TRIX Electrical Co., Ltd.**  
65 BOLSOVER STREET, LONDON, W.1  
Phone: EUSton 5471/2 Grams: Trixradio, Wesdo, London



# RELIABILITY

"Man's best friend" gets full points for this:

Reliable too are the high degree controls produced by Reliance craftsmanship, fulfilling every requirement imposed by the fighting services.

Our experience relating to variable resistances, is always at your service.

# RELIANCE

Manufacturing Co. (Southwark) Ltd.  
Sutherland Rd., Higham Hill,  
WALTHAMSTOW, - E.17

Telephone : : LARKSWOOD 3245

# AUGETRON ELECTRON MULTIPLIERS



Vacuum  
Science Products Ltd.,  
BOSCH ELECTRONICS  
St. George's Wks., Merton Rd.,  
Norwood Junction, S.E.27.

'Phone: Addiscombe 4529.

# ABSTRACTS OF ELECTRONIC LITERATURE

## Circuits

### A Valve Current Integrator (G. J. Perlow)

In experiments in nuclear physics, the useful data are the numbers of disintegrations observed for a given number of particles striking a target. If the primary particles are charged, it is convenient to have a current integrator which will stop the counting after a given charge has been collected at the target.

In the apparatus described, the target current charges a condenser to a voltage sufficient to trip a trigger circuit which in turn operates an ordinary relay to discharge the condenser. A stepping relay is also employed. In the type used pulses through a coil cause a contact armature to advance succes-

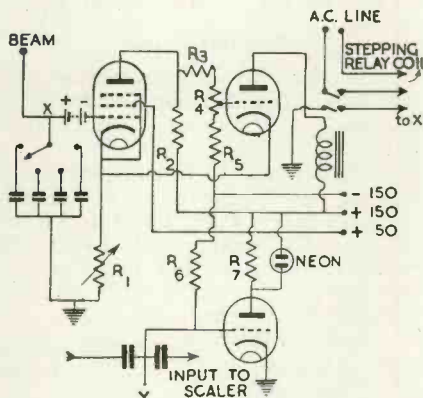

sively over contacts arranged in a circle.

#### Component Values.

- R1 200 ohms. R4 20,000 ohms. pot.
- R2 0.1 meg. R5 0.5 meg.
- R3 0.5 meg. R6 & R7 1 meg. relay res.—2,500 ohms.

Valves: 6J7G and 6F8G.

The beam coming from the left is collected on any one of four condensers of different sizes and raises the grid potential of the pentode. The 45 volt bias battery insures that this valve is initially non-conducting. When the grid-cathode difference of potential reaches a point shortly above cut-off, the grid of the triode to the right, directly coupled and normally conducting, starts dropping rapidly, which decreases the current through the common cathode resistor R1 and diminishes the pentode bias further. The process is cumulative and very rapid. The result is that the triode is very nearly cut-off and the relay in its anode circuit is de-energised, thereby closing two pairs of contacts. One pair energises a stepping relay, moving its armature one step. The other pair shorts the charging condenser at the point X and drops the pentode grid voltage.

This is sufficient to restore the circuit to its initial state and the triode relay re-energises, permitting the stepping relay to recover and the beam to be collected again. When the stepping relay has made the proper number of steps, as determined by the switching system to its right, half of the armature shorts the beam at X, while the other half, by earthing Y, by-passes to earth the signals being counted. At the same time the grid of the lower triode is brought to the potential of its cathode and the neon lamp in its anode circuit turns on, indicating the end of the counting period. The circuit is re-set by keying the stepping relay once. This is best done by keying the pentode anode to ground.

—Rev. Sci. Inst., Vol. 12, No. 8, August, 1941, page 412.

### Half-cycle Electronic Switch (E. Moen)

The first valve of the circuit, a 6C5, is a repeater-amplifier which may be a single valve oscillator. The amplified waves then enter a 6H6 "clipper" valve, in which positive crests enter one channel and negative crests the other channel. A battery and by-pass condenser are inserted to bias grids of the following 6C5's to or beyond cut-off until the appropriate voltage from each wave-crest is delivered by the 6H6. Then during the half-cycle in which the grid of one of the last two 6C5's is made sufficiently positive for the tube to be conducting, any signal voltage injected at A or B will be superimposed upon the input voltage.

The final resultant voltage can then be scanned on a cathode-ray tube if the scanning wave is made linear and synchronised with the original input.

—Electronics, Vol. 14, No. 8, August, 1941, page 54.

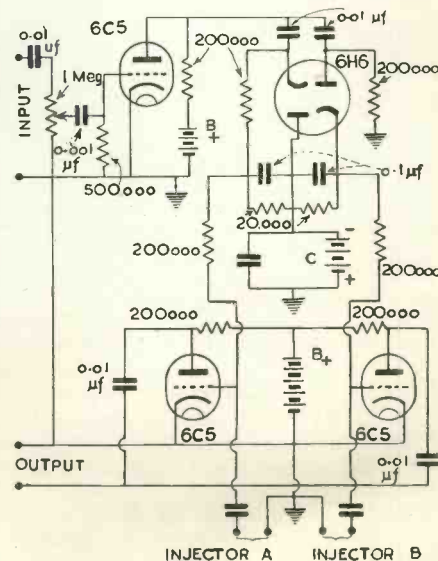



**ABSTRACTS** (contd.)**Industry****Mains Voltage Stabilisers**  
(Denco)

The author gives brief details of suggestions which have appeared in various foreign technical journals regarding electricity at stabilised mains voltage. In one form of stabiliser a mains voltage change of 5 per cent. is claimed to cause an output voltage change of 0.05 per cent. with a maximum operating time of 0.2 seconds and negligible harmonic distortion.

—*Electrician*, August 22, 1941, page 106.\*

**Metal Coating of Plastics**

It is claimed that in the process of coating plastics with zinc, aluminium, copper, or tin, the metal particles join with the synthetic resin particles, and therefore strengthen the surface of the moulded article. The process can also be applied to cast resin and to laminated and cellulose products. Results are given of tests carried out to compare the electro-magnetic screening properties of the metal film with tinfoil of the same dimensions.

—*Br. Plastics and M.P.*, September 1941, page 106.\*

**G.E.C. Heavy Alloy**

(Price, Williams and Garrard)

In this article, the authors describe the preparation properties and industrial uses of an alloy which is stated to be fifty per cent. heavier than lead and to have the tensile strength of a good quality steel. It consists essentially of tungsten, and is made by a powder metallurgical process. Its high density makes it suitable for screening purposes, such as for radium containers, while its good resistance to arcing makes it suitable material for circuit breaker contacts.

—*G.E.C. Journal*, August, 1941, page 223.\*

**Theory****Frequency Response of Parallel Resonant Circuit**

(M. B. Reed)

This paper gives in a readily usable form the results of a complete mathematical study of the current versus frequency response of the wave trap.

—*Electronics*, Vol. 14, No. 8, August, 1941, page 43.

**Some Analyses of Wave Shape used in Harmonic Processes**

(F. R. Stansel)

Analyses by Fourier's series have been made of waves consisting of sinusoidal, rectangular and trapezoidal pulses and also waves of the type found in multi-vibrator circuits. The method of increasing harmonic content by modulating a wave with a submultiple is treated mathematically.

—*Bell System Tech. Jour.*, Vol. 20, No. 3, July, 1941, page 331.

\*Supplied by the courtesy of Metropolitan-Vickers Elec. Co., Ltd., Trafford Park, Manchester.

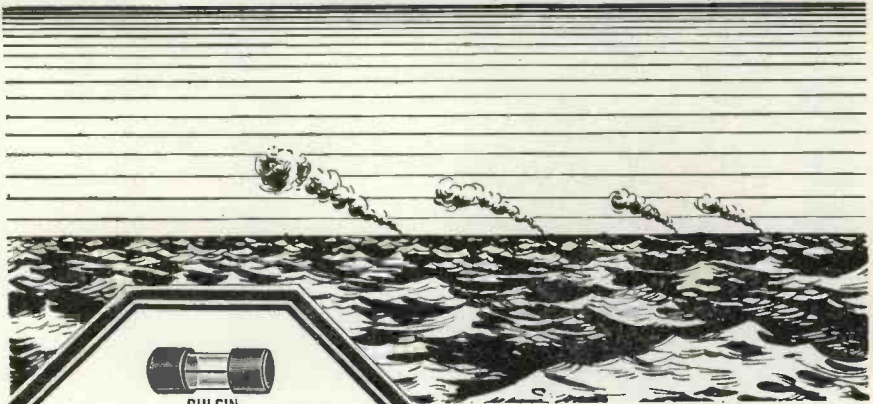
**COMMUNICATIONS DEPEND....****ON SMALL PARTS....**

In countless instances quite intricate pieces of apparatus are wholly dependent on the proved reputation and reliability of their component parts.

All products from the House of Bulgin are pre-eminent for superior design and workmanship, and every article bearing our Trade Mark has to pass exacting and exhausting tests during the course of its production.

We ask the kind indulgence of the public on delivery until peaceful conditions return.

*The Choice of Critics*

**BULGIN FOR FUSES**

The finest Radio and small Electrical Glass-enclosed Fuses in the world. The comprehensive range, from 60 MA. to 25 A., covers every requirement. Accurate and uniform in characteristics and made to British Standard Specification No. 646, R.M.A.—, and R.C.M.F.—Specification. Absolutely fireproof and safe, sure in action upon 50-75% overload.

**ALWAYS DEPEND ON****BULGIN**

REGISTERED • TRADE • MARK

**A. F. BULGIN & CO. LTD., BY-PASS RD., BARKING, ESSEX**

Tel. Rippleway 3474 (4 lines)



# YOUR AD ?

**NO** . . but you may not  
be so lucky **NEXT TIME**

Every day brings its problems—not least of which is the dreadful possibility of FIRE, to engulf your premises, your factory, your stores, destroying goodwill, wiping out profits.

Such a set-back is not easily remedied to-day, with the prevailing acute shortage of plant, premises and personnel. Do not risk the hazard—take precautions now . . . make sure there will not be a NEXT TIME. Enlist the aid of our FIRE PREVENTION SPECIALISTS trained over many years, familiar with every angle of the problem. They can survey, diagnose and prescribe and guarantee you an immunity which will cover you in every way, bearing in mind your particular situation.

This professional advice will cost you nothing, will place you under no obligation whatever.

**MAKE A NOTE TO CALL IN THE NATIONAL FIRE PROTECTION CO., LTD. TO-DAY !**



**THE NATIONAL FIRE PROTECTION CO., LTD.**  
PETERSHAM ROAD, RICHMOND, SURREY  
Telephone RICHMOND 2342-3-4 and 0406

# ROLA

## TRANSFORMER LAMINATIONS

EIGHT STANDARD SIZES  
CORE WIDTHS  $\frac{1}{8}$ " to  $1\frac{1}{2}$ " (E's and I's)  
AVAILABLE FROM STOCK

A Comprehensive Bulletin together with details of Associated Covers and Clamps with design data will be sent to manufacturers on request.

---

**BRITISH ROLA LIMITED**  
MINERVA ROAD, PARK ROYAL, N.W.10 3  
WILLESDEN 4322

## THE TELEVISION SOCIETY

(FOUNDED 1927)

President : SIR AMBROSE FLEMING,  
M.A., D.Sc., F.R.S.

The war may have temporarily checked the development of television in this country, but the interest of hundreds of amateurs has not waned. If you are one of those who wish to keep in touch with television developments and meet fellow enthusiasts, the *Television Society* offers you every facility.

Write for particulars of membership to the Hon. General Sec. :  
**Mr. J. J. DENTON, 17 Anerley Station Rd., London, S.E.20**



## A New Portable Wavemeter

H. Tinsley & Co's. Model 4825

**T**HIS instrument was developed to meet the demand for a portable wavemeter which would have a high degree of sensitivity and discrimination, for frequencies ranging from 160 megacycles to 260 megacycles.

Its advantage over the absorption type wavemeters, generally in use for the same frequency band as portable instruments, is greatly superior sensitivity and greater accuracy. The instrument was developed by Pye, Limited, Radio Works, Cambridge, and H. Tinsley & Company, Limited, London, S.E.25, which latter are taking up quantity production.

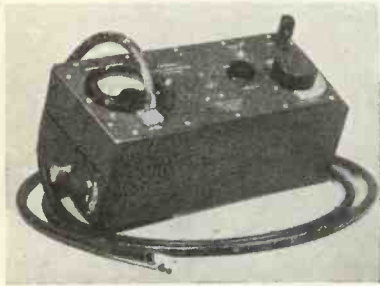

### Specification

*Frequency range on single continuously variable dial:*

160 to 220 Mc./sec. or, alternatively, 210 to 260 Mc./sec. (the instrument can cover either one or the other frequency range, but not both).

### Performance.

A voltage of 3mV. at the end of the artificial line attached to the wavemeter will produce a deflection of not less than 20 per cent. full scale on the indicating instrument (that is, 20 per cent. full scale for resonance). Selectivity is such that  $\frac{1}{2}$  Mc./sec. can be discriminated. Accuracy is of the order of  $\frac{1}{4}$  per cent.

### Supply:

Either a 6 volt battery or 230 volt, 50 cycle mains, according to whether vibrator unit or mains eliminator unit is supplied. (The wavemeter can, of course, be supplied with both units, in which case one of them is supplied as a separate item).

Overall dimensions: 12 in. by 5 $\frac{1}{2}$  in. by 5 $\frac{1}{2}$  in. Weight: Approximately 12 lb.

The instrument is supplied in a teak case which contains a compartment for the calibrated artificial line, which plugs into the wavemeter and serves as aerial.

The price or any further particulars can be obtained on application to H. Tinsley & Co., Ltd., Werndee Hall, S.E.25.

## The Stability of Electron Multipliers (Contd.)

structions of single stage secondary emitters the secondary emitter is sometimes shielded, where the thermionic cathode employed is of normal dimensions rated to give an electron current of 10 or more milliamperes. In the case of the Augetron multi-stage electron-multiplier, however, the initial current is less than 10 microamperes and hence with a small thermionic cathode the amount of barium to settle is small. This in any event has to pass through the opening of the accelerator plate, which has been reduced to a minimum, so that this and only the first secondary emitter will be affected by this phenomena. If, however, such poisoning actually took place this would result in a gradual decrease in the secondary emission ratio of the first secondary emitter and would not affect the remaining secondary emitters a definite advantage of the multi-stage secondary emission tubes. We have not so far observed this phenomena in Augetron tubes during life tests.

Apparent instability may be caused by unsuitable test equipment. Voltage supply should be perfectly stable so as not to affect voltage distribution resulting in variations in secondary emission. When testing an Augetron with thermionic cathode for pure static tests care should be taken to protect the multiplier against self-oscillation by shunting both grid and cathode with a condenser of .001 mfd. In doing so, using as short leads as possible, it should be remembered that the Augetron is a high-gain and very sensitive tube, and therefore oscillates very easily.

When instability is observed it is as well to run the tube in darkness and observe for either a gaseous glow, which has been mentioned already, or for fluorescent effects. These fluorescent effects may be caused by the building up of electric charges upon insulators in the vicinity of the electron stream, which may result in some irregularity of behaviour. The actual nature of the charges on insulators is very complex and the actual potential at any point will depend on the instantaneous value of secondary emission of that portion of the surface. It is possible for an insulator to attain by virtue of secondary emission a positive potential, and these potentials are obviously irregular and subject to very sudden changes. In the Augetron steps to obviate this possibility have been taken with success.

When examining secondary emission tubes for instability it will be found that there is in most cases a minimum condition for which the tube will remain stable, and it must be these conditions which will lead to the cause of the instability. In the case of the Augetron all possible constructional or processing causes for instability having been obviated it will be generally in the circuit arrangement or the apparatus in which the Augetron is used which will cause instability.



## TRANSFORMATION

... a word that has many meanings.

We use it in connexion with transforming one kind of energy to another as for example a high tension Transformer for stepping up the pressure to 50kV. or a heavy current instrument delivering thousands of amperes at a few volts.

Perhaps the form of energy requires to be changed, e.g. 3-phase to single-phase or 2-phase or A.C. to D.C. or vice versa.

If you have a problem involving energy transformation, we are at your service. All sizes from 10 VA. to 25 kVA. power or audio frequencies.

W. ANDREW & COMPANY LTD

**BRYCE**

**BOREHAM WOOD**

HERTS.  
TELEPHONE • ELSTREE 1875

# PREMIER RADIO

PLEASE NOTE—ALL S.W. KITS ARE NOW SUBJECT TO PURCHASE TAX. THIS IS INCLUDED IN THE PRICE.

## PREMIER SMOOTHING CHOKES

Type	Current	Henrys	Res	Prices
C 40/500	40 MA	20-34 H	500 ohms	6/-
C 60/180	60 MA	8 H	180 ohms	6/-
C 60/400	60 MA	25-34 H	400 ohms	8/8
C 60/500	60 MA	18-30 H	500 ohms	8/8
C 100/400	100 MA	20-34 H	400 ohms	10/8
C 150/185	150 MA	20-34 H	185 ohms	15/4
C 200/145	200 MA	20-34 H	145 ohms	18/-
C 250/120	250 MA	25 H	120 ohms	20/-

## PICK-UPS

Premier Pick-Up Heads (Will fit any tone-arm) ... 8/9  
 Pick-up complete with arm and Volume Control ... 17/6

## ANOTHER SPECIAL OFFER.

Rothermel Brush Piezo Crystal Pick-ups.  
 De Luxe Pick-up Head ... 34/9  
 (Will fit any tone-arm)

## PREMIER 1941 HIGH FIDELITY AMPLIFIERS

Each Amplifier is individually tested with specially matched valves, circuits and Instructions. Completely Wired and Tested.

4-watt A.C. Amplifier	£3 11 6
8-10-watt A.C./D.C.	£7 9 0
15-watt A.C.	£9 8 0

Black Crackle Steel Cabinet 17/6 extra.

## MAINS TRANSFORMERS

Wire-ends. All L.T. Windings

Centre-Tapped	
SP. 250	250-0-250 v. 60 m.a. 4 v. 1-2 a, 4 v. 2-3 a., 4 v. 2-3 a. ... 13/4
SP. 300	300-0-300 v. 60 m.a., 4 v. 2-3 a, 4 v. 2-3 a., 4 v. 2-3 a. ... 13/4
SP. 301	300-300 v. 150 m.a. 4 v. 2-3 a., 4 v. 2-3 a., 4 v. 1 a, 4 v. 1 a ... 17/4
SP. 350A	350-350 v. 100 m.a. 5 v. 2a (not C.T.), 6.3 v. 2-3 a. ... 16/-
SP. 350B	350-350 v. 100 m.a. 4 v. 2-3 a., 4 v. 2-3 a., 4 v. 2-3 a. ... 16/-
SP. 351	350-350 v. 150 m.a. 4 v. 1-2 a., 4 v. 2-3 a., 4 v. 3-4 a. ... 17/4
SP. 351A	350-350-150 m.a. 4 v 3 a, 4 v. 2-3 a., 4 v. 1 a., 4 v. 1 a. ... 22/-
SP. 352	350-350 v. 150 m.a. 5 v. 2 a., 6.3 v. 2 a., 6.3 v. 2 a. ... 18/-
SP. 806	315-0-315 60 m.a. 5 v. 2 a. and 6.3 v. 3 a. C.T. ... 8/6
SP. 911	Input 110 and 220 v., output 350-0-350 80 m.a. 5 v. 2 a., 6.3 v. 3 a. ... 9/11

Auto Transformers. Step up or down. 100-125 v. to 200, 230 or 250 v. A.C., 60 watts, 11/4; 125 watts 15/-; 250 watts, 22/-.

L.T. Transformers, all C.T.  
 4 v. 2-3 a. ... 11/4  
 6.3 v. 2-3 a. ... 11/4  
 6.3 v. 6 a. ... 15/4

Premier Battery Eliminators PP 150, 150 v. 30 m.a. output, variable tapping 36/6  
 Ditto, with 2 v. 1/2 a. Charger ... 46/6  
 Push-Pull Driver Transformers, ... 6/6  
 Class B Driver 1 1/2 Ratio ... 6/6  
 Universal Output Transformers. 11 Ratios Single or Push-Pull ... 6/6

## MATCHMAKER UNIVERSAL OUTPUT TRANSFORMERS

Will match any output valves to any speaker Impedance.  
 11 ratios from 13 : 1 to 80 : 1, 5-7 watts, 16/10.  
 10-15 watts, 21/10. 20-30 watts, 36/10.  
 Paxolin Valve Holders, chassis mounting, 4 or 5 pin, 4d. each. 7 pin, 4d. each.

## PREMIER MICROPHONES

Transverse Current Mike. High grade large output unit. Response 45-7,500 cycles. Low hiss level, 23/-.

## "LEARNING MORSE"

Premier Morse Practice Key on Bakelite Base and Brass Movement	3/3
General Purpose Morse Key	5/9
Bakelite Buzzers	2/6
3 Henry Chokes	7/6
Complete Oscillator as described in above W.W. publication mounted on Steel Chassis, complete with Valve Brown's Headphones 4,000 ohms.	27/6 17/6 pr.

## NEW PREMIER S.W. A.C. RECEIVER

In response to many requests we have now produced an A.C. version of the popular Premier Short Wave SG3 Kit. Circuit: Pentode H.F. Stage, Pentode Detector, Pentode and F.W. Rectifier, 200-250 v. A.C. Operation. Built-in Power Pack. Hum-free operation. For use with Phones or P.M. Speaker.

Complete Kit of Parts with drilled chassis, all components. Plug-in Coils covering 13-170 metres, 4 valves and full instructions £6-14-6

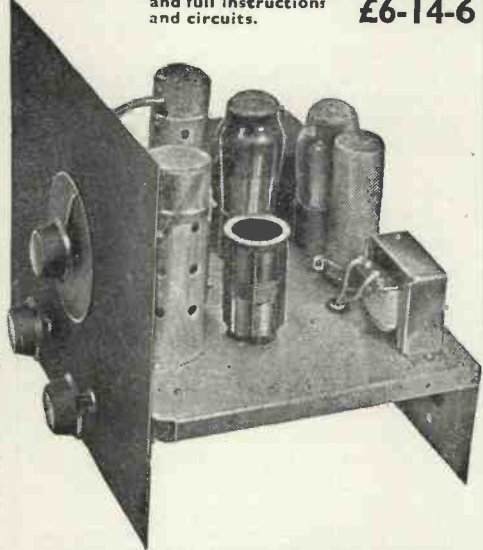

Battery Version also available Kit £4 15 4  
 Extra Coils 9-15, 200-2000m. also available

★ "The Wireless World" said they were "very much impressed" ★  
 See full Test Report pp. 492-3 December issue  
 Send for full details

## PREMIER BATTERY CHARGERS for A.C. MAINS

Westinghouse Rectification complete and ready for use

To Charge: 6 volts at 1 amp. 26/-  
 12 volts at 1 amp. 28/- 6 volts at 2 amps. 43/6

## MOVING COIL SPEAKERS

All complete with transformer. Goodmans  
 6 1/2 in., 16/6; 10 in. P.M.s. 23/6; 8 in. P.M.s. 20/-

## ENERGISED MODELS

Plessey 8 in., 175 ohm field, 7/6  
 Plessey 8 in., 2,000 ohm field, 15/-  
 Prices of all goods are subject to variation without notice

## DE LUXE S.W. KITS

(Battery Models)

Complete Kit, including all Valves, coils, wiring diagrams and lucid Instructions for building and working. Each Kit supplied with a steel Chassis, Panel and plug-in coils to tune from 13 to 170 metres.  
 1-V. S.W. Receiver or Adaptor Kit ... 24/6  
 1-V. S.W. Superhet Converter Kit ... 28/-  
 2-V. S.W. Receiver Kit ... 35/6

## PREMIER DIALS (2-Speed)

3-Band	7/6
4-Band	9/-
Telsen Disc Drives	1/6
Utility Micro Dials Direct and 100-1	6/6

## SHORT-WAVE CONDENSERS

Trolitul insulation. Certified superior to ceramic. All-brass construction. Easily ganged  
 15 m.mfd. ... 2/4 100 m.mfd. ... 3/-  
 25 m.mfd. ... 2/6 160 m.mfd. ... 3/7  
 40 m.mfd. ... 2/6 250 m.mfd. ... 4/-  
 Neut. Cond. 1.5 m.mfd. to 20 m.mfd. ... 4/-

## SHORT-WAVE GEAR

Short-Wave Coils, 6-pin types, to fit 7-pin holder Type 2, also to fit Eddystone coil holder Type 3, 13-26, 22-47, 41-94, 78-170 metres. 2/- each, with circuit.  
 Bakelite Dielectric Variable Condensers, .0005 mf. Suitable Tuning or Reaction, 1/9 each. 0001 and 00075 6d. each.  
 Short-Wave H.F. Chokes. 10-100 m., 10 1/2 d. each. High grade Pie-Wound U.S.A. type, 5-200 m., 2/- each.

Liseen Dual Range Screened Coils. Medium and Long Waves, 3/6 each.

## PREMIER REPLACEMENT VALVES

4 volt A.C. 5-pin Types, A.C./H.L., A.C./L. A.C./S.G. All 5/6 each.

Flexible Couplers: 1/2-in. bore. 11d. each.  
 Valve Screens for International and U.S.A. types, 1/2 each.

Jacks. Single or Closed Circuit. 1/9.  
 Plugs to suit 1/9.

Electric Soldering Irons, 200-250 volts, 5/10. Super Model 11/9.

Potentiometers, all resistances, 3/6 each; with switch, 4/6.

Beehive Stand-offs, 2 1/2 in., 7d. 3 1/2 in., 1/6 each.

Mains Noise Suppressors, comprising double wound Cond. and Conds., 6/6 each.

Tubular Cond. 350 v. working .01 and .1 mfd., each ... 1/-  
 .02, .002, .004, .0002, .005, .001, .0005, .0003 mfd., each ... 9d.

Small 0005 2-gang, with trimmers, 3/6 each.

Ditto 3-gang, fully screened, with trimmers, 5/- each.

Utility 3-gang fully screened, 0005, with trimmers, 4/6 each.

2,000 25-watt Res., with 5 Tapping Clips 1/6 each.

ELECTROLYTIC CONDENSERS.  
 Cardboard cases. 25 mfd. 25 volt, and 50 mfd., 12 volt ... 1/6

15 mfd. 100 volts, 1/3; 8 mfd. 125 volt tub, 1/6.  
 50 mfd., 50 volt. ... 2/6

Small Can Type, 16 and 24 Mfd. 525 v. can neg. 7/6  
 8 Mfd. Wet, 440 v. ... 2/-  
 4 Mfd. Wet, 320 v. ... 1/6

## Microphone Transformers. Suitable for all mikes.

Tapped primaries, A, 20 and 40 : 1; B, 30 and 60 : 1; C, 50 and 100 : 1. 6/6 each.

ALL ENQUIRIES MUST BE ACCOMPANIED BY 2d. STAMP.

All orders under 5/- 6d. post extra.

# PREMIER RADIO CO.

ALL POST ORDERS to: JUBILEE WORKS, 167, LOWER CLAPTON ROAD, LONDON, E.5 (Amherst 4723).

CALLERS to: Jubilee Works, or 169, Fleet Street, E.C.4 (Central 2833), or 50, High Street, Clapham, S.W.4 (Macaulay 2381).





# RELAYS

For A.C. and D.C.



2V.A. coil consumption, from 2-600 volts, tested to 2000 volts. Time lag relays, High Sensitive Relays, Synchronous Process Timers, and complete Control Plants.

Ask for leaflet SPN/EO,

# LONDEX

LTD.

Electrical Remote Control Engineers & Manufacturers  
Anerley Works, 207 Anerley Rd., London, S.E.23  
Phone: Sydenham 6258/9

# TELEVISION:

Concise Postal Course of Instruction for Radio Engineers

Apply—

**BRITISH RADIO  
ENGINEERING COLLEGE**

179, CLAPHAM ROAD, LONDON, S.W. 9

(Do not delay. Be conversant with subject now and prepared for business after the War.)

## INDEX TO ADVERTISERS

A.C.S. Radio	520
Advance Components, Ltd.	511
All-Power Transformers, Ltd.	520
Automatic Coil Winder and Electrical Equipment Co., Ltd.	479
Belling & Lee, Ltd.	476
British Institute of Eng. Technology	Cover iii
British Radio Engineering College	Cover iii
British Rola, Ltd.	516
Bryce, W. Andrew, & Co., Ltd.	517
Bulgin, A. F., & Co., Ltd.	515
Bullers, Ltd.	494
Clarkes (Redditch), Ltd.	519
Cossor	509
Dubilier Condenser Co. (1925), Ltd.	503
Edison Swan Electric Co., Ltd.	480
Electro Physical Laboratories	506
Evans, Arthur, & Co., Ltd.	461
Fluxite, Ltd.	512
Foyles, Ltd.	Cover iii
Frazar & Co., Ltd.	505
Galpins	519
Gardner's Radio, Ltd.	509
General Electric Co., Ltd.	474
Henley's, W. T., Telegraph Works Co., Ltd.	509
Holsun Batteries, Ltd.	507
International Correspondence Schools, Ltd.	507
Johnson, Matthew & Co., Ltd.	501
Joyce Engineering, Ltd.	507
Leslie Dixon Co.	Cover iii
Lewis, H. K., & Co., Ltd.	520
Lackwood & Co.	Cover iii
Londex, Ltd.	Cover iii
Muirhead & Co., Ltd.	473
Mullard Wireless Service Co., Ltd.	499
Mycalex, Ltd.	479
National Fire Protection Co., Ltd.	516
Partridge, N.	520
Pitman's	513
Premier Radio Co.	518
Radio Society of Great Britain	512
Reliance Manufacturing Co. (Southwark), Ltd.	514
Sale, Tilney & Co., Ltd.	519
Savage, W. Bryon, Ltd.	Cover iii
Sinclair Speakers	Cover iii
Steatite & Porcelain Products, Ltd.	477
Sunvic Controls, Ltd.	511
Technological Institute of Great Britain	519
Television Society, The	516
Trix Electrical Co., Ltd.	513
Tucker Eyelet Co., Ltd.	476
United Insulator Co., Ltd.	475
Universal Electrical Co.	519
Vacuum Science Products, Ltd.	514
Varley	Cover iii
Vortexion, Ltd.	478
Webb's Radio	Cover ii, iv
West, A., & Partners, Ltd.	512
Westinghouse Brake and Signal Co., Ltd.	478
Wilcox, Edward, & Co., Ltd.	520
Woden Transformer Co.	512

# "LESDIX" EMERGENCY LIGHTING

Emergency Electric Lighting for Shelters, Headquarters, homes and factories.

Have your own Petrol-Electric Lighting and Charging Plant.

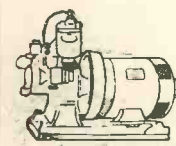

500-watt, single cyl. 2-stroke, water-cooled, self-oiling Pelapone engine mag. Ign. coupled to 50/70 volts, 10 amps., shunt dynamo, 1,000 r.p.m. Fuel and Water Tanks. These are £45 sets ready for immediate delivery at half price.

Stamped envelope for all replies, please.

PLEASE NOTE NEW ADDRESS

## LESLIE DIXON & CO.

19, BROUGHTON STREET, LONDON, S.W.8

Our new offices adjoin our works at Battersea, 19, Broughton Street, Queenstown Road, S.W.8. No. 137 bus or 81 tram. Rly. Sta., Queen's Road, Battersea, from Waterloo. Telephone: Macaulay 2159

# Varley

Quality Components

- I.F. TRANSFORMERS
- WIRE WOUND RESISTANCES
- L.F. CHOKES & TRANSFORMERS
- MAINS TRANSFORMERS
- DELAY SWITCHES

Varley (Prop. Oliver Pell Control Ltd.)  
Cambridge Row Woolwich, S.E.18

## SCIENTIFIC INSTRUMENT CASES

Made in WOOD or METAL and in any quantity to order. Precision work guaranteed.

ALSO

Radio Cabinets—Metal Racks & Panels  
Please send full details or drawings with your enquiry. For Metal work state Government Contract No.

LOCKWOOD & CO.  
LOWLANDS RD., HARROW, MDDX.

Phone: BYRON 3704.

## TRANSFORMERS

to customers' specifications or in accordance with standard list.



W. BRYAN SAVAGE LTD.

Westmoreland Road, London, N.W.9. Colindale 7131

# LOUDSPEAKER & TRANSFORMER SERVICE

(BRITISH AND AMERICAN)

TRANSFORMERS DESIGNED AND REPAIRED.

NEW SPEAKERS 5" to 18" P.M. and MAINS ENERGISED.

SPEAKERS OF ALL KINDS FROM 10/6.

# SINCLAIR SPEAKERS

12, PEMBROKE ST., COPENHAGEN ST., LONDON, N.1. TER 4355

# "AFTER THE WAR" TELEVISION

With the coming of Peace, and backed by the Technical advances that have resulted from the war years, TELEVISION will again spring to life and offer opportunities, as never before, to the trained man.

Now is the time to prepare for this new "market." Our Home-study "Television" Course is comprehensive, up-to-date and suitable both for the amateur and experienced Radio Engineer.

We definitely guarantee

"SATISFACTION—OR REFUND OF FEE"

You are advised to send for details of this special Television Course immediately to investigate its possibilities. Details will also be sent of A.M.I.E.E. and A.M.Brit.I.R.E. Examinations and other courses in all branches of Wireless Engineering. Our literature is quite free.

BRITISH INSTITUTE OF ENGINEERING TECHNOLOGY

Principal: Prof. A. M. Low.

337, Shakespeare House, 17/19, Stratford Place, London, W.1.



**T**HE CONFLICT that darkens five continents has today temporarily eclipsed the unhindered experiment and activity of the radio amateur. We at Webb's always identified ourselves with 'ham' radio, and our premises had become a focal point for technically minded enthusiasts. We are still carrying on, and though we cannot give you the full measure of our peace-time service, we are trying to maintain communications, and hoping through our announcements and personal contacts to bring to your notice all the latest available items and developments in the short-wave world. We look forward to the day when we can again encourage your activities and supply you with receivers and components that, having been created and improved by the exacting necessities of war, will open new horizons of research and achievement to our many fellow enthusiasts.

The receivers illustrated here are two notable developments in the famous Hallicrafter range. Needless to say, they can be supplied to priority order only, but they give an indication of the major trends in design, and the type of equipment that is forthcoming. Full details and prices will be sent to any interested enquirer.

#### **HALLICRAFTER MODEL SX 28 NEW 1941 SUPER SKYRIDER :**

A communication receiver that sets new standards in performance. Frequency range covers 540 Kc to 43 Mc in six bands. The valve arrangement is:

6SK7 RF Amplifiers, 6SA7 Mixer, 6SA7 H. F. Oscillator, 6L7 1st IF Amplifier-noise limiter, 6SK7 2nd IF Amplifier, 6B8 2nd Detector and meter, 6B8 AVC Amplifier, 6SK7 Noise Amplifier, 6H6 Noise Rectifier, 6J5 B.F.O., 6SC7 1st Audio Amplifier, 6V6GT Push-Pull Output Amplifier, 5Z3 Rectifier, 15 valves in all.

Features include:—2 R.F. Stages, 6 step wide range variable selectivity, Band pass audio filter, Wide angle "S" meter, Improved signal to image and noise ratio, 80/40/20/10 meter amateur bands calibrated, Temperature compensated high frequency Oscillator, Input 110v to 250v A.C. only. Dimensions: 9½" high × 20½" wide × 14½" deep. Prices on application.



#### **HALLICRAFTER MODEL S. 29 SKY TRAVELLER :**

A truly portable communication type receiver covering from 542 kc. to 30.5 Mc. in 4 bands. Operates from its own self-contained batteries or from 240 volt AC or DC mains. The Valve Line-up is:

IT4 R.F. I.R.5 Mixer, IP5-GT I.F. Amplifiers, IH5-GT 2nd Det., A.V.C., 1st Audio, 3Q5-GT Output Amplifier, IG4-GT Beat Oscillator, IG4-GT Noise Limiter and 25Z5G Rectifier (9 valves in all). Electrical band-spread. Battery life prolonged through a self-contained charging unit. Self-contained collapsible antenna which can be extended to nearly 3 feet. An R.F. stage used on all bands. This Portable Universal Receiver provides truly remarkable reception throughout its tuning range (553 to 9.85 metres). Dimensions: 7" high × 8½" wide × 13½" deep. Weight including all batteries, 18 lbs. Price on application.



**MODEL S.X. 28.**

**N.B. These Instruments are not available from English stock and can only be supplied against Priority Orders.**

**WEBB'S RADIO, 14 SOHO ST., LONDON, W.1.**

Telephone : GERrard 2089 Open 9 a.m.—5 p.m. Sats. 12 noon.