

*Kelly*

# Electronic Engineering

Incorporating ... ELECTRONICS, TELEVISION & SHORT WAVE WORLD

VOL 20 No. 240

FEBRUARY 1948

PRICE 2/-

**10 to 310  
MCS**

The "ADVANCE" Signal Generator embodies many novel constructional features. It is compact in size, light in weight, and can be operated either from A.C. Power Supply or low-voltage high-frequency supplies.

A Colpitts Oscillatory circuit is employed, which may be plate modulated by a 1,000-cycle sine wave oscillator, or grid modulated by a 50/50 square wave. Both types of modulation are internal, and selected by a switch. The oscillator section is triple shielded and external stray magnetic and electrostatic fields are negligible. Six coils are used to cover the range, and they are mounted in a coil turret of special design. The output from the R.F. oscillator is fed to an inductive slide wire, where it is monitored by an EA50 diode. The slide wire feeds a 75-ohm 5-step decade attenuator of new design. The output voltage is taken from the end of a 75-ohm matched transmission line.

Instrument totally enclosed in a grey enamelled steel case with detachable hinged lid for use during transport.

Price £80

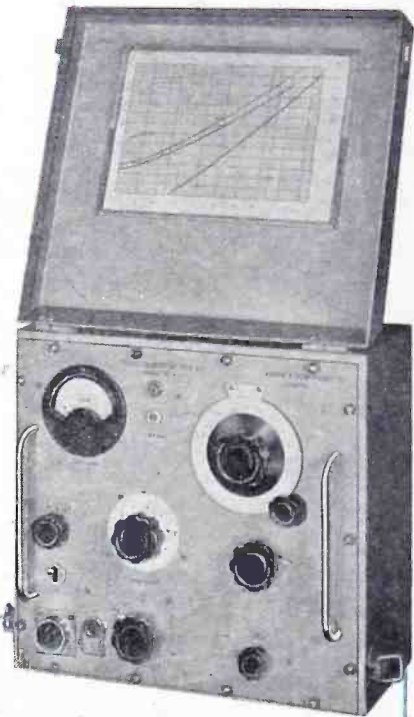

WRITE FOR DESCRIPTIVE LEAFLET.

**Advance**  
*Signal*  
**GENERATOR**

TYPE  
**D1**

ADVANCE COMPONENTS LTD., BACK RD., SHERNHALL ST.,  
WALTHAMSTOW, LONDON, E.17. Phone: Larkwood 4366-7-8

- Light Weight ... 36 lbs.
- Negligible Stray Field.
- Frequency Calibration ... 1%
- Modulation 30% sine wave 1,000~ and pulsed 50/50 square wave at 1,000~
- Max. Attenuation error at 300 Mc/s. ± 2db
- Precision Slow-motion Dial.
- Wide Range ... 10-310 Mc/s.
- Compact ... 12½" × 13½" × 7½"
- Dual-Power Supply { 200-250 v., 40-100~  
80 v., 40-2,000~



call up  
the little  
horses . . .

SO WATT. It was James Watt, y'know, who dragged horses into this business of measuring power. In a kind but firm way he persuaded a large shire horse to raise a weight of 550 pounds to a height of one foot in one second. After some discussion the horse and Watt agreed to call this One Unit of horsepower though some claim that the horse wasn't trying. Many years later we entered the racket and before long had a whole team of tiny horses working in various small tools with quite astonishing efficiency.

Watt's old horse would have felt pretty sick if he'd been asked to revolve at 2,500 revs. per min. Desoutter-trained horses are doing it all the time. And never get the staggers.

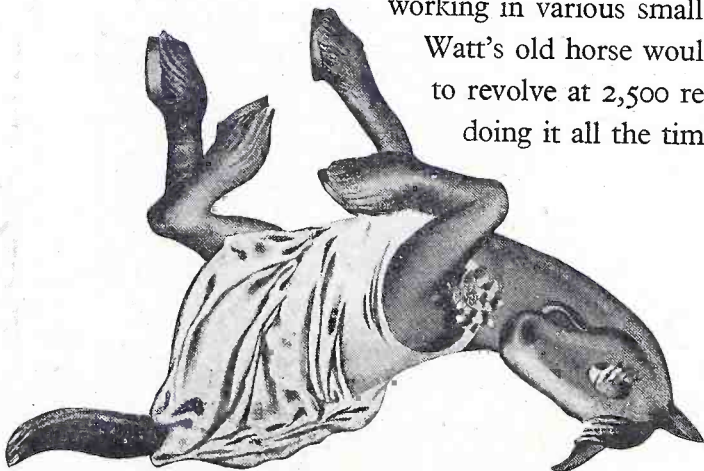

**DESOUTTER**

*Specialists in Lightweight, Pneumatic and  
Electric Portable Tools.*

## CLASSIFIED ANNOUNCEMENTS

The charge for these advertisements is twelve words or less 5/- and 4d. for every additional word. Box number 2/- extra, except in the case of advertisements in "Situations Wanted" when it is added free of charge. A remittance must accompany the advertisement. Replies to box numbers should be addressed to: Morgan Bros. (Publishers) Ltd., 28, Essex Street, Strand, London, W.C.2 and marked "Electronic Engineering." Advertisements must be received before the 10th of the month for insertion in the following issue.

### OFFICIAL APPOINTMENTS

Vacancies advertised are restricted to persons or employees excepted from the provisions of the Control of Management Order, 1947.

#### CITY OF WAKEFIELD EDUCATION COMMITTEE.

##### WAKEFIELD TECHNICAL COLLEGE.

Principal: G. N. BLAIR, M.C., B.Com., A.C.I.S., F.I.I.A.

**INSTRUMENT MECHANIC** is required for the Department of Technology and Science.

Applications are invited from men who have served an apprenticeship as an instrument mechanic and who have had subsequent experience in that capacity.

**SENIOR LABORATORY STEWARD** is required for the Department of Technology and Science. Duties will be primarily concerned with the Physics, Chemistry, Mechanics and Electrical Laboratories.

Applications are invited from men who have served an apprenticeship, preferably in some branch of engineering. Previous experience as a laboratory steward, though not essential, is desirable. Experience of keeping or of simple maintenance work would be an advantage.

Salaries, £300 per annum, rising by three annual increments of £15 and one of £5 to £350 per annum. Further information regarding nature of work, hours of duty, superannuation, holidays, etc., may be obtained from the undersigned on receipt of a stamped, addressed envelope. Applications should be returned within 15 days of the issue of this advertisement.

C. L. BERRY,  
Director of Education.

Education Office,  
King Street, Wakefield.

**C.** invites applications to fill a vacancy in the Research Department of the Engineering Division. The work involves theoretical and practical investigations on aerials, transmitters, and systems of modulation. Practical experience of such work is desirable, but not essential. Applicants must possess recognised scientific qualifications, including a knowledge of the theory of wave propagation, and an aptitude for original investigation. The salary is on a grade rising in annual increments of £25 to a maximum of £580 per annum; good promotion prospects. The successful candidate will be based at Oxford, but will later be transferred to a permanent base near London. Applicants stating age, qualifications and experience should reach the Engineering Establishment Officer, Broadcasting House, London, W.1, within 14 days of the appearance of this advertisement.

**C.** invites applications for the post of Engineer in the Audio Frequency Section of the Research Department, based in London. Candidates must possess a University degree, or equivalent qualifications, in Physics or Electrical Engineering, and must have taken Telecommunication as part of their training. Knowledge of electrical measurements, measuring instruments and experience in microphone and loudspeaker technique is essential. The work includes research into microphones and loudspeakers and carries out other aspects of audio frequency research and development. Preference will be given to a candidate with the ability to guide development work in the Drawing Office and Workshops. Musical ability is an advantage. The salary is on a grade rising in annual increments of £40 to a maximum of £890 per annum. Applications, stating age, qualifications and experience, should reach the Engineering Establishment Officer, Broadcasting House, London, W.1, within 14 days of the appearance of this advertisement.

**C.** invites applications for two posts of Engineer in the Field Strength Section of the Research Department based at Oxford. Candidates should possess a University degree, or a recognised diploma, and should have taken Telecommunication as part of their training. They must be capable of conscientiously carrying out instruments involving radio frequency measurements in any part of the British Isles and should have an interest in field strength measurement work and allied problems of propagation applicable to broadcasting. Experience of transmitter and aerial work and the use of receiving equipment is desirable. The successful candidates will be based at Oxford in the first instance, but will be required to spend a large proportion of their time away from base, and at a later date the base will be transferred to the London area. The salary is on a grade rising by annual increments of £30 to a maximum of £680 per annum. Applications, stating age,

qualifications and experience, should reach the Engineering Establishment Officer, Broadcasting House, London, W.1, within 14 days of the appearance of this advertisement.

**B.B.C.** invites applications for a number of posts for Senior and Junior Engineers in the Designs Department in London. Applicants should have a University degree in Engineering or an equivalent qualification, preferably in communication subjects. The work of the Department covers design of testing equipment and transmission equipment for music and for 405-line television, the design of transmission apparatus for teleprinter and telephone carrier transmission, and for the various systems of disc and magnetic recording and reproducing equipments used in broadcasting. Specialist knowledge and experience in design work in any of the above is essential in the higher grades and will be an advantage in all cases. Starting salaries dependent on qualifications and experience; appointments will be in grades ranging from £580 per annum maximum for junior designers, to £995 per annum maximum for senior designers. Applications, stating age, qualifications and experience, should reach the Engineering Establishment Officer, Broadcasting House, London, W.1, within 14 days of the appearance of this advertisement.

### SITUATIONS VACANT

**FERRANTI LIMITED** require for Vacuum Physics Laboratory Physicists or Engineers, graduates or with equivalent qualifications, preferably with experience of electronic vacuum work or U.H.F. valves. Application forms from Personnel Manager, Ferranti Limited, Ferry Road Edinburgh, 5.

**RESEARCH AND DEVELOPMENT** Assistants of H.N.C. or Intermediate standard for high vacuum equipment developments, covering electronic, instrument, physical and light mechanical engineering work. Progressive superannuated posts with opportunities for continued study. Salary commensurate with age, experience and qualifications. Apply with full details to W. Edwards & Co., (London) Ltd., Kangley Bridge Road, Lower Sydenham, London, S.E.26.

**THE RADIOCHEMICAL CENTRE.** Applications are invited for the following appointments:—

- A Physicist or Physical Chemist having experience of high vacuum work and laboratory methods of gas manipulation, to design and operate plant for the production of radioactive gases; experience of radon work would be an advantage.
- A Physicist with previous experience of measurement of ionising radiations, to supervise standardisation of radioactive substances.

Applicants should be men of good professional standing, who are capable of developing the work on their own initiative and collaborating with other institutions. They will be required to pass a medical examination, and should be between the ages of 25 and 45. Good salaries will be offered to those having the required experience and qualifications, and a superannuation scheme is in force. Successful candidates will be appointed to the staff of Thorium Ltd. (Managing Agents to the Minister of Supply), to whom applications should be sent at The Radiochemical Centre, White Lion Road, Amersham, Buckinghamshire.

**FEMALE LABORATORY ASSISTANT** required by a light engineering firm in the East London area for new section of component division. Some knowledge of Physics, Electrical Engineering or Statistics required. State experience, age and salary to Box 188, E.E.

**YOUNG ENGINEER** required as representative of leading electronic instrument manufacturers, London area. C. & G. Grade III or equivalent Service qualifications. State age, experience and salary required. Box 186, E.E.

**SERVICE ENGINEERS** and Assistants for Ship-borne centimetric radar equipment required. Applicants should be prepared to live in a port, and travel as work requires. Preference will be given ex-Naval men. Box PP.1912, W. H. Smith & Son, Ltd., Manchester, 3.

**LEADING COMPANY** requires junior development engineer (inter-B.Sc. standard), preferably with experience in radar or communications work. Commencing salary between £350 and £400 (according to experience), with excellent prospects for advancement. Box 187, E.E.

**ELECTRONIC DEVELOPMENT ENGINEER** required. A good general knowledge and experience of valve circuit design is essential, together with practical ability. Particular experience in the design of measuring equipment including field strength and noise measurement is an advantage. Engineer is required to take charge of development section. Write fully, stating age, experience and qualifications, and salary required, etc. Erskine Laboratories, Ltd., Scalby, Scarborough, Yorks.

**PUBLICITY DEPARTMENT** of large electrical engineering firm requires assistant to take charge of publication of sales promotion literature. Work comprises sub-editing of material and direction of presentation and printing. Essential qualifications: Good education and personality, B.Sc. (Electrical Engineering), age 27 to 45; leadership and administrative ability; originality and good artistic appreciation; knowledge of type and of reproduction processes; previous experience of similar duties. Write, giving full particulars of experience and state salary required, to Box N.5378, A. K. Advtg., 212a, Shaftesbury Avenue, W.C.2.

**SENIOR AND JUNIOR DRAUGHTSMEN:** A large reputable engineering company in the East London area has a number of interesting situations in their research and development departments. The appointments concerned are in connection with:—

1. Test gear design,
2. Electronics,
3. Light electrical mechanical engineering,
4. Special design work for H.M. Government,
5. Fractional H.P. motors.

Applicants, in the first instance, should state age, experience, the kind of work for which they have preference and the salary that they require. Box 189, E.E.

**TECHNICAL ASSISTANT** wanted for technical control of all processes in experimental valve manufacture. Experience in this type of work essential. Some knowledge of high vacuum technique and glass-working practice desirable. West London area. Applications, including academic qualifications, age, experience and salary required, should be addressed to Box 190, E.E.

**REQUIRED FOR RADIO FACTORY** in South Wales, near Aberdare, experienced Radio and Television Design Engineer. Write, stating age, qualifications, experience and salary required, to Box R.F.E., Smith's Library, Aberdare.

**GLASS BLOWER** required for vacuum research laboratories, experienced in bench and lathe work. Staff appointment for competent man; permanency; salary, including cost-of-living allowance, up to £500 per annum. Apply Personnel Manager, Ferranti Limited, Ferry Road, Edinburgh, 5.

**REQUIRED FOR RADIO FACTORY** in South Wales, near Aberdare, small parts mechanical designer, preferably experienced in radio and television production. Write, stating age, qualifications, experience and salary required, to Box R.F.E., Smith's Library, Aberdare.

**E.M.I. ENGINEERING DEVELOPMENT LTD.,** have vacancies in their designs drawing office for the following:—

- (a) Senior Electro-mechanical Designer-Draughtsmen.
- (b) Senior Mechanical Designer-Draughtsmen.
- (c) Senior Electrical Designer-Draughtsmen.

The above are required on electronic, telecommunication, and electro-mechanical engineering. Only first-class designer draughtsmen need apply. Vacancies offer excellent prospects on high-class work of paramount national importance. Apply, stating age, fullest details of experience, together with salary required, to Personnel Department, E.M.I., Ltd., Blyth Road, Hayes, Middlesex.

**ASSISTANT ENGINEER** required for our laboratory engaged on the design of radio broadcast receivers. Applicant must have held similar position for three or more years. Write, in first instance, stating full particulars and salary required, to the Personnel Manager, McMichael Radio Limited, Wexham Road, Slough, Bucks.

## INDEX TO ADVERTISERS

SEE PAGE 24

## CLASSIFIED ANNOUNCEMENTS (Cont'd.)

**SCIENTIFIC GLASSBLOWER** required for industrial laboratory engaged in development of wide range of electronic products, cathode-ray tubes, photo-cells, etc. Experience of bench and lathe work essential; knowledge of hard- and soft-glass working, glass-to-metal sealing techniques desirable. Reply, giving age, experience and wages required, to Cathodeon Limited, Church Street, Cambridge.

**DEVELOPMENT ENGINEER** for responsible position in works laboratory. Experienced in audio and radio frequency electronic apparatus, oscillators, bridges, etc. Knowledge of telephone circuit characteristics, filter design and mechanical design is desirable. Must be thorough, reliable and capable of taking charge of staff. Write, giving full details of training, experience and salary required, to Muirhead & Co., Ltd., Elmers End, Beckenham, Kent.

**BELING & LEE LIMITED** have vacancy for Assistant in their research department. Applicant must be under 25 years of age and possess School Certificate or equivalent educational qualifications and must be studying a recognised radio course. Salary according to age and qualifications. Applications by letter only, giving full details and salary required, to 540, Cambridge Arterial Road, Enfield, Middlesex.

**MICROWAVE ENGINEER** required to take charge of department engaged on important practical development work. Suitable applicants must have first-class technical qualifications and previous experience of this work. State full details of experience to Box 197, E.E.

**RADAR TECHNICIAN**, familiar with details of development and testing of airborne radar equipment, especially H2S Mk. II D and H2S Mk. III. Write or cable the address below for further information, giving age, experience, etc. North West Industries Limited, Edmonton, Alberta, Canada.

**E.M.I. ENGINEERING DEVELOPMENT LTD.**, Hayes, Middlesex; have a number of vacancies for intermediate and senior engineers between the ages of 25 and 35, for the development and design for production of communication receivers and transmitters. It is essential that applicants should have qualifications of degree standard, and have had practical experience in the development field; for the senior posts, at least five years actual design experience is required. The inclusive starting salary of these posts is from £400 to £700 according to age and experience, with further possible additions for exceptional qualification in design experience. In addition, there are vacancies in the junior and intermediate grades (£325 to £500 with degree qualification) for work on wave-guide transmission and components, development of domestic receiver components, car radio receivers and other electronic developments, both of the circuit and of the vacuum physics classes. Write, giving full details of qualifications and experience, to Personnel Department, R/S, E.M.I. Ltd., Blyth Road, Hayes, Middx.

**SENIOR ENGINEER** to take charge laboratory developments. Commercial radio and television receivers, London. Apply giving full experience and age. Box No. 774, New Era Advertising Service Ltd., Ludgate House, 107 Fleet Street, London, E.C.4.

**WANTED—YOUNG ELECTRICAL ENGINEER** with good qualifications and experience to take charge of new industrial induction heating plant in Midlands. Salary £500—£750 p.a. according to ability. Apply in writing—Director of Research, G.K.N., Research Laboratories, Manor Works, Ettingshall, Wolverhampton.

## SITUATIONS WANTED

**DEVELOPMENT ENGINEER** seeks progressive position. Several years' experience. Salary, £500-£550. Box 193, E.E.

**BRADFORD TECHNICAL COLLEGE**, electrical diploma graduate, 26, alien, desires position to use academic knowledge and inventive ability. Would consider experimental work and technical translation from and into German. Box 196, E.E.

**PHYSICAL CHEMIST**, specialised development of dielectrics and radio components, high academic qualifications, publications, seeks responsible technical/administrative post. Box 192, E.E.

**YOUNG MAN** (single) requires electronic research laboratory position. Electrical H.N.C., O.N.C., Radio O.N.C., 4 years' experience, practical and creative ability. Box 199, E.E.

**TECHNICAL EXECUTIVE**, fully experienced in electronics and communications, design and production, University degrees, requires part time or full time consulting work. Would consider staff position. Box 200, E.E.

**ELECTRO-ACOUSTIC ENGINEER**, with varied experience in motion picture sound recording, radio broadcasting and Services radar, seeks executive and/or technical position in electronics industry. Recently recording supervisor with news reel company. Highest references; Dip. Eng. (U.S.A.); married, but free to travel; salary expected £1,000 per year, but might consider less as opportunity to demonstrate ability. Box 198, E.E.

## EDUCATIONAL

**SPEECH DISABILITY:** Mr. H. V. Hemery consults at Wigmore Hall Studios, Wigmore Street, W.1.

**COMPLETE CORRESPONDENCE COURSE** covering Amateur and C. and G.I. Examinations, consisting of 12 lessons. Send for particulars. Everyman's Correspondence College, 72, St. Stephen's House, Westminster, S.W.1.

**A.M.I.E.E., City and Guilds**, etc., on "NO PASS—NO FEE" terms. Over 95 per cent. successes. For full details of modern courses in all branches of Electrical Technology send for our 112-page handbook—FREE and post free. B.I.E.T. (Dept. 337B), 17, Stratford Place, London, W.1.

## FOR SALE

**IN STOCK.** Rectifiers, Accumulator Chargers, Rotary Converters, P.A. Amplifiers, Mikes, Mains Transformers, Speakers of most types, Test Meters, etc. Special Transformers quoted for.—University Radio, Ltd., 22, Lisle Street, London, W.C.2. GER. 4447.

**2" THERMOCOUPLE MOVING COIL MILLIAMMETERS.** 0-350 m/a. New ex-Gov. A bargain at 5/6 each. £3 per dozen, post free. S. McMillan, 5 Oakfield Road, Bristol, 8.

**0-100 MICRO-AMP.** moving coil meters, by reputable manufacturer. Surplus stock, cheap to clear. Box 162, E.E.

**ONE HIGH FREQUENCY VALVE GENERATOR**, Philips type F.12/1, capable of inducing 5 KW. energy into work coil. Unit in new condition, and perfect operating order. Equipped with high-grade measuring instruments for indicating: filament volts, anode current, grid current and H.F. current. Also electronic timing device. A spare oscillation valve—Mullard type TX10-4000 (silica envelope) is clipped into the cabinet; also two spare RG3-1250 mercury vapour rectifying valves. Overall dimensions 4 ft. 3 in. by 3 ft. 6 in. by 5 ft. 9 in. An ideal plant unit for many phases of clean and directed process heating by the eddy current method. For educational institutions, such would prove a really satisfactory means of demonstrating the numerous applications of high frequency heating. Price £1,000. Apply to Box 191, E.E.

**SWITCHES.** Approximately 50 type D224A Muirhead 4-pole 24-way, 30s. each. 12 Macclesfield Street, Shaftesbury Avenue, W.1 (Ger.: 3057).

**POWER UNITS** featuring small size 6 in. by 5 in. captive head terminals, plug type mains connector, on/off switch and indicator lamp and 6.3 volt 5 amp. Two types 250 volts 80 mA hum level 0.25 per cent., price £4; 350 volts 100 mA, price £4 10s. James S. Kendall, Assoc. Brit. I.R.E., A.M.I.R.E., 133, Osmaston Road, Birmingham, 17.

## WANTED

**COPIES OF "ELECTRONIC ENGINEERING"** for January, February, March, September, and November, 1947. 1s. 2d. given for each complete copy. Please send to Circulation Department, "Electronic Engineering," 28, Essex Street, London, W.C.2.

**AUDIO FREQUENCY LABORATORY** wishes to purchase the following equipment of reputable manufacturers (Marconi, Muirhead, Salford, Dawe, etc.): Distortion factor meter, wave analyser, microvolter, A.F. attenuator, sensitive valve voltmeter, impedance bridge, 5-watt audio oscillator, noise meter, oscilloscope. Write to Box S19/3, Harwood Press (Advertising) Ltd., 47, West Street, Harrow, Middlesex.

## SERVICE

**LOUDSPEAKERS**—We carry on. Sinclair Speakers, 12, Pembroke Street, N.1.

**LOUDSPEAKER** repairs, British, American, any make, moderate prices.—Sinclair Speakers, 12, Pembroke Street, N.1.

**FACTORY HAS TECHNICAL** Staff and capacity available for manufacturing scientific or other articles in glass. Box 163, E.E.

**FACILITIES AVAILABLE** for radio assembly work on amplifiers, radar and small radio chassis. Prompt deliveries, first-class work. Write R. T. M. C. Ltd., 141, Little Ealing Lane, W.5 (Ealing 6962).

**COMPREHENSIVE INFORMATION SERVICE** available to firms requiring bibliographies, abstracts, technical translations, etc. Supervised by scientist with extensive industrial and Government experience. Box 194, E.E.

## MISCELLANEOUS

**WE WILL BUY** at your price used radios, amplifiers, converters, test meters, motors, pick-ups, speakers, etc., radio and electrical accessories. Write, phone or call, University Radio Ltd., 22, Lisle Street, London, W.C.2. GER. 4447.

**PHOTOGRAPHY BY BEHR** will show your product at its best. Ask for illustrated list. 44, Temple Fortune Lane, London, N.W.11. SPEdwell 4298.

**WEBB'S** Radio Map of the World enables you to locate any station heard. Size 40 in. by 30 in. 2-colour heavy Art Paper, 4/6, post 6d. Limited supply on Linen, 10/6, post 6d.—Webb's Radio, 14, Soho Street, London, W.1. 'Phone GERrard 2089.

**MORSE** Practice Equipment for Class-room or Individual Tuition. Keys Audio Oscillators for both battery or main operation. Webb's Radio, 14, Soho Street, London, W.1. 'Phone: GERrard 2089.

**S.H.E.F.I. MOVING COIL PICK-UP** is now available for both home trade and export. It combines for the first time high fidelity with high output voltage, enabling it directly to replace normal moving iron pick-ups without any extra amplification. It has an exceptionally clean response with no undesirable resonances, thereby reducing needle scratch. Retail price including transformer 40/- plus 8/11 purchase tax. Wholesale and retail enquiries invited. Illustration sent on request. Brooks and Bohm Ltd., 90, Victoria Street, S.W.1.

**CHESTERFIELD** (one of the most prosperous Derbyshire towns). Shop to let on lease in finest position in busiest ready-money street—Burlington Street. Please write Owners, City and Town Buildings, Regina House, 1, Queen Street, Cheapside, London, E.C.4.

## WE OFFER

A large range of used and new Test Equipment, Converters, Recorders, Amplifiers, Motors, Transformers, etc.

All guaranteed and at very attractive prices.

Try us first and buy more gear for less money.

**UNIVERSITY RADIO LTD.**  
22 LISLE STREET, LONDON, W.C.2.

Tel.: GER 8582

## HIGH FIDELITY

We welcome all enthusiasts to our new premises. We carry stocks of Partridge and Varley Transformers and Chokes, matched output valves, matched resistors, high quality loudspeakers, P.U.s., gramophone motors, baffles, Bass Reflex cabinets, and all components for High Fidelity Receivers and Amplifiers. Complete equipments are also available. Our price list is available and we will be glad to send you a copy on receipt of your address and 2½d. stamp.

**ROGERS DEVELOPMENTS CO.**  
12, MACCLESFIELD STREET,  
SHAFESBURY AVENUE, W.1

Telephone—Gerrard 3057

# WHERE HIGH PRECISION CALLS FOR

# QUICK PRODUCTION

*Bullers possess the men and the means  
to tackle the most exacting job*



**Made in Three  
Principal Materials**

**FREQUELEX**

An insulating material of Low Dielectric Loss, for Coil Formers, Aerial Insulators, Valve Holders, etc.

**PERMALEX**

A High Permittivity Material. For the construction of Condensers of the smallest possible dimensions.

**TEMPLEX**

A Condenser material of medium permittivity. For the construction of Condensers having a constant capacity at all temperatures.



## BULLERS LOW LOSS CERAMICS

BULLERS LTD., 6, LAURENCE POUNTNEY HILL, LONDON, E.C.4

Telephone: Mansion House 9971 (3 lines)    Telegrams: "Bullers, Cannon, London"

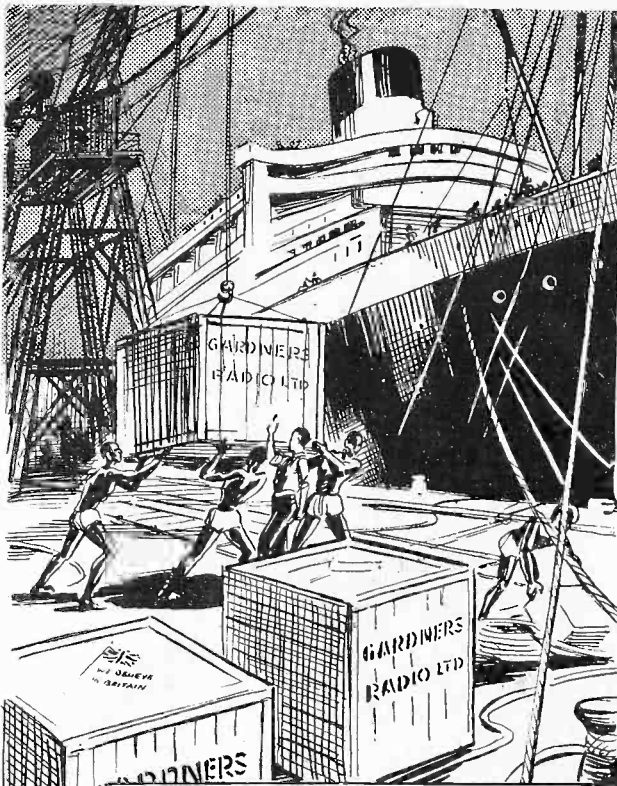

## IN THE TROPICS

Back they go! Back to the tropics. Back to the grim testing grounds of 1942-45.—Remember—the arduous conditions of the Burma campaign? But happily—very very happily—with a difference—contributing to the export drive, instead of war.

These "Sommerford" Transformers and Chokes, being shipped to the tropics, are absolutely as standard, the robust construction and technical superiority being ideal for withstanding the hazards of steaming humidity.

You may select exactly the same from the "Sommerford" range.

It is no accident that "Sommerford" Transformers are constantly used by the National Research Establishments, together with Industrial and University Laboratories.

Distributing Agents:—

INDIA: J. V. Mehta & Co., Opera House, Tram Terminus, BOMBAY, 4.

BURMA: E. Ruttons (Burma) Ltd., 77 Phayre Street, RANGOON.

MALAYA: Swee Electro Radio Service Co. Ltd., 5 & 7 Bukit Bintang Road, KUALA LUMPUR.



# GARDNERS "SOMMERFORD" TRANSFORMERS

WORLD-FAMOUS FOR DEPENDABILITY

GARDNERS RADIO LTD., Somerford, Christchurch, Hants.

**FOR RADIO • INDUSTRY • LABORATORY**

# Advice on Current problems



The engineers of the British Electric Resistance Co. Ltd. are ready to assist in all problems connected with current control.

Twenty years experience in the construction of resistances which satisfy the most rigorous tests of performance is at your service.



THE BRITISH ELECTRIC RESISTANCE CO. LTD.  
Queensway, Ponders End, Middlesex  
Telephone: Howard 1492.      Telegrams: Vitrohm, Enfield.

BR2052-BQI

## CONSISTENTLY *Accurate*



A new Series 65, with 6½" scale length is now available in Moving Coil, Rectifier, Thermo-couple, Moving Iron and single element Dynamometer Types. The well known Series 35 with 3½" scale length can now be supplied in the Moving Iron Type for AC/DC circuits.

Modern engineering practice demands switchpanels of distinction; rectangular switchpanels need rectangular instruments—specify Pullin.

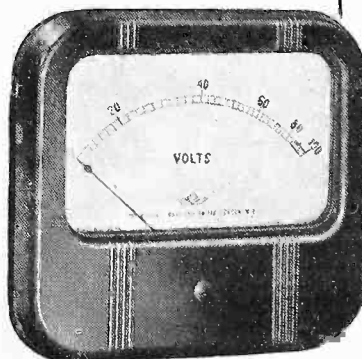

**PULLIN**  
Rectangular  
**SWITCHBOARD  
INSTRUMENTS**  
3½" & 6½" scales  
FLUSH MOUNTING

We can give early deliveries—  
write for details

MEASURING INSTRUMENTS (PULLIN) LTD  
Dept. E. Electric Works, Winchester Street, Acton, W.3. Acorn 4651/4.

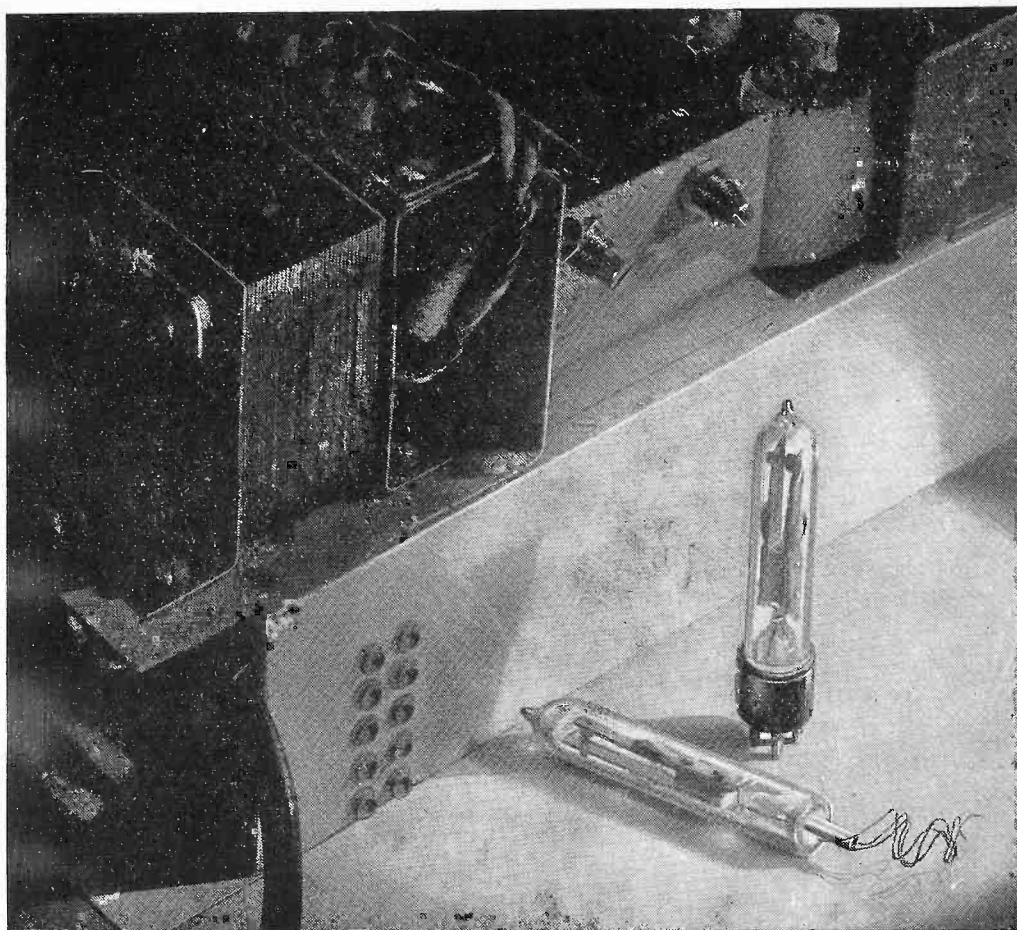
**SUNVIC**

## MINIATURE TIME-DELAY SWITCHES

Reliable, compact, bimetal switches, glass-sealed and evacuated, to operate after a time-delay (such as may be needed to allow valve-filaments to heat-up). The switch operates on 6.3 volts and switches in a maximum of 1 amp. at up to 380 volts AC or 600 volts DC. Time-delay 25 to 100 seconds. Available unmounted (Type 2TQV) or with English miniature 4-pin base (Type 2TQVM). For full specification please write for Publication TV10/16. Other time-delay switches, Publication MS10/16.

## SUNVIC CONTROLS LTD.

10 ESSEX STREET, STRAND, LONDON, W.C.2.

TAS/SC 192



Announcing ... SIX ENTIRELY NEW

# ELECTRONIC INSTRUMENTS

by CINEMA-TELEVISION LIMITED

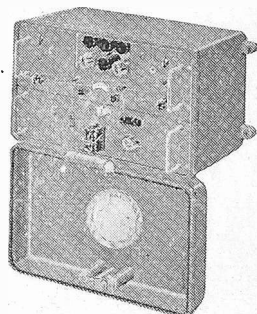

## INDUSTRIAL ELECTRONIC METAL DETECTOR

An automatic inspection equipment for the detection of ferrous and non-ferrous metal particles of all kinds in non-metallic substances such as foodstuffs, plastics, textiles, tobacco, timber, pharmaceutical products, etc.

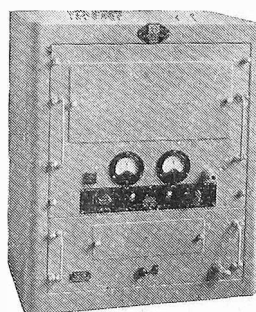

## STANDARD ELECTRONIC COUNTER

A high speed electronic counter of particular appeal to the industrialist. Facilities are provided for batching, selective counting etc., the maximum counting-speed for the equipment being 30,000 per minute.

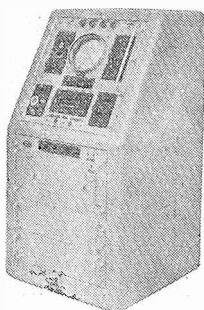

## UNIVERSAL OSCILLOSCOPE

A unique instrument meeting fully the requirements of the serious users of oscilloscopes for laboratory and industrial purposes, arranged to permit readily the assembly of suitable units to fulfil every application. Complete range of units is available, e.g. stabilised time base, A.C. and D.C. amplifiers, 5 beam switch unit etc.

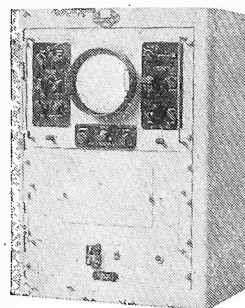

## LABORATORY OSCILLOSCOPE

A high grade 6" screen oscilloscope expressly designed for laboratory use, incorporating hard valve linear time base, 3 megacycle "Y" amplifier and 1 megacycle "X" amplifier. Cupboard and trolley are available if required.

## DEMONSTRATION OSCILLOSCOPE FOR LECTURE PURPOSES

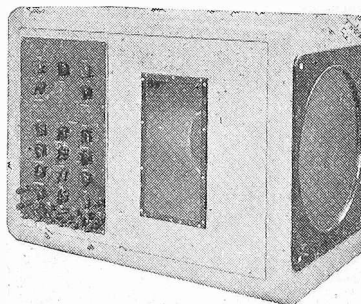

Demonstrator and student alike will acclaim the features of this equipment — 15" tube with glare removing filter, 2 beam switch for simultaneous delineation of two recurrent wave forms, or their "addition" to produce a single resultant trace. Provision is made for setting up from rear of instrument

## PROCESS TIMER

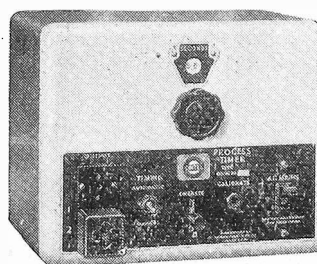

A compact instrument, from the "CINTEL" range, providing simple and accurate electrical control for scientific and industrial processes of every kind. The timing range extends from 0.25 to 90 seconds.



**CINEMA-TELEVISION LTD.,**

INCORPORATING BAIRD TELEVISION LIMITED  
WORSLEY BRIDGE RD., LONDON, S.E.26

Telephone: HITHer Green 4600

Suppliers to ADMIRALTY, MINISTRY OF AIRCRAFT PRODUCTION, MINISTRY OF SUPPLY,  
ARMAMENT RESEARCH, etc. Manufacturers of Scientific Instruments and Photo-electric cells.



# MAZDA

## HIGH VOLTAGE RECTIFIER

### 19.H.1

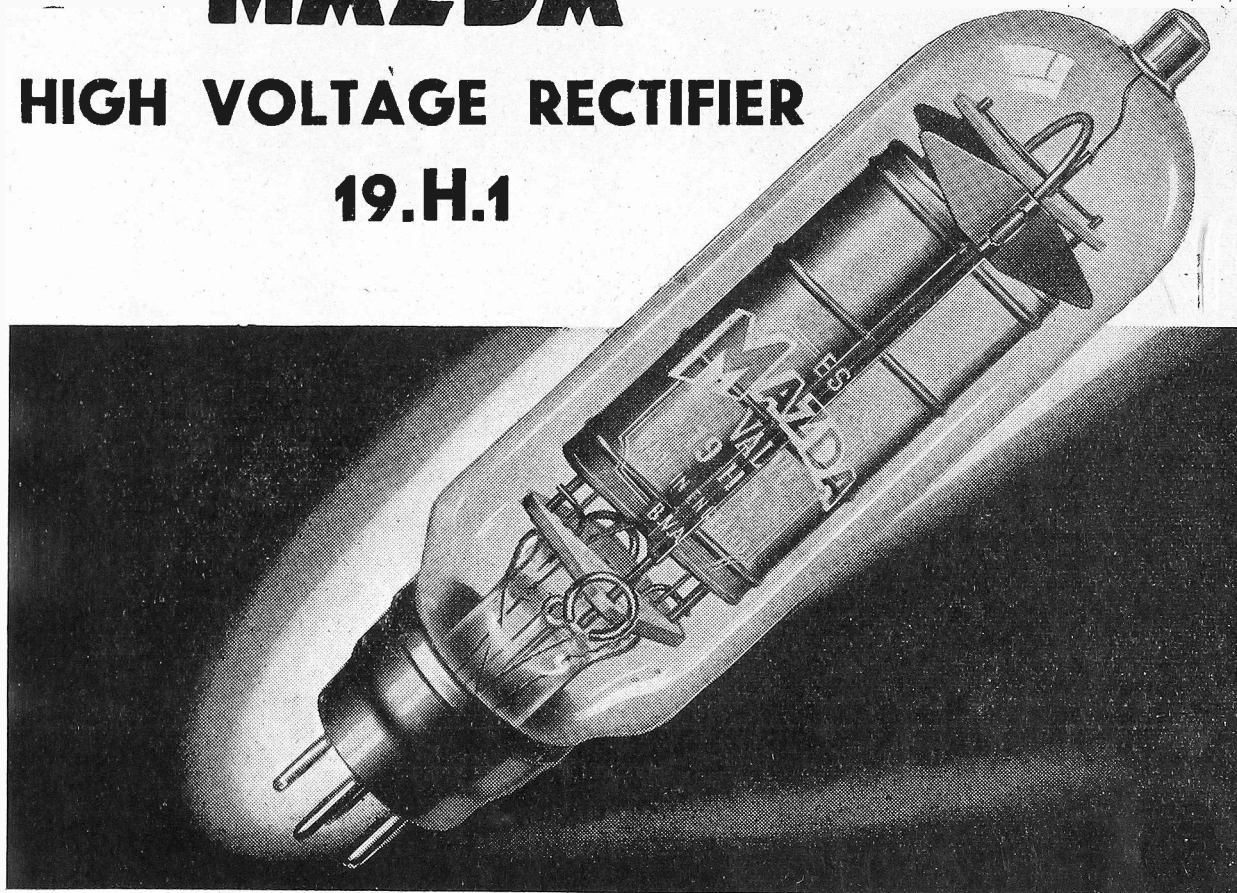

*This High Vacuum Half Wave Rectifier is now available for use in Industrial or Amateur Electronic Equipment. Its main characteristics are :*

FILAMENT VOLTAGE	4.0 v.
FILAMENT CURRENT	* 2.0 A.
MAX. PEAK INVERSE VOLTAGE (Working)	15 KV
MAX. PEAK INVERSE VOLTAGE (No Load)	† 17.5 KV
MAX. PEAK ANODE CURRENT	600 mA
MAX. MEAN ANODE CURRENT	75 mA
MAX. VALUE OF RESERVOIR CONDENSER	1.0 $\mu$ F
MIN. SURGE LIMITING RESISTOR	2,500 ohms.
MAX. OVER-ALL LENGTH	210 mm.
MAX. DIAMETER	51 mm.

LIST PRICE

**£1.2.6**

\* The filament must be switched on for 10 seconds before the anode voltage is applied.

† This rating is absolute and must not be exceeded in service.

**THE EDISON SWAN ELECTRIC COMPANY LIMITED**

RADIO DIVISION

**155 CHARING CROSS ROAD, LONDON, W.C.2**

**PUT IT ON  
OUR PLATE!**

At British N.S.F. switches are lived morning, noon and night. The result is that your switch problems are likely to come easy to us. We are also able, when standard types would not be suitable, to place unique resources at your disposal for special needs.

But whether standard or special, all OAK switches embody the OAK equalised pressure, double-contact clip and the OAK floating rotor. These features maintain a mechanical and electrical efficiency that gives long life and trouble-free operation.

Other N.S.F. Products include Paper Capacitors, Silvered Mica Capacitors, Wire Wound Resistors, and Potentiometers.



**OAK**

**WITH THE EXCLUSIVE DOUBLE  
CONTACT & FLOATING ROTOR  
SWITCHES**

**BRITISH N.S.F. CO. LTD.** Head Office & Export Sales: **KEIGHLEY, YORKSHIRE**

London Office: 9 Stratford Place, W.1. Telephone: MAYfair 4234

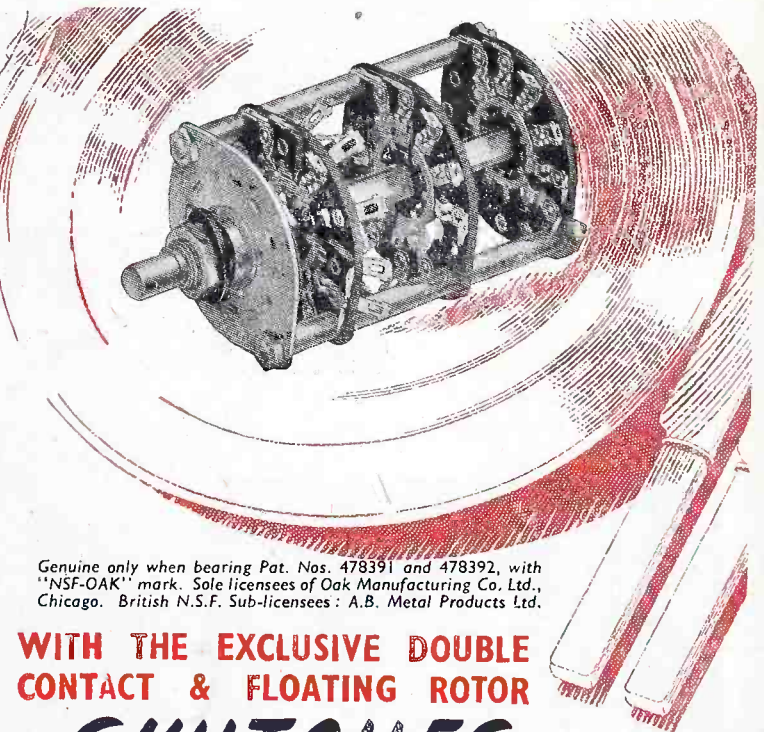

Genuine only when bearing Pat. Nos. 478391 and 478392, with "NSF-OAK" mark. Sole licensees of Oak Manufacturing Co. Ltd., Chicago. British N.S.F. Sub-licensees: A.B. Metal Products Ltd.



*Hermetically Sealed*

## TRANSFORMERS

W.A.B. Hermetically Sealed Transformers were developed during the war to meet the requirements of the Services for a unit which would operate continuously under conditions of high relative humidity and high ambient temperature.

A patented method of internal construction ensures that the weight of the Transformer is taken directly on the fixing bushes and not on the case, thus preventing a risk of damage to the sealing of the case when the unit is subjected to mechanical shock.

All Transformers in this range are so constructed that they can be used for either chassis or baseboard mounting.

**W. ANDREW BRYCE & CO. LTD.**  
SHENLEY ROAD, BOREHAM WOOD, HERTS

Telephone: ELStree 1870, 1875 and 1117

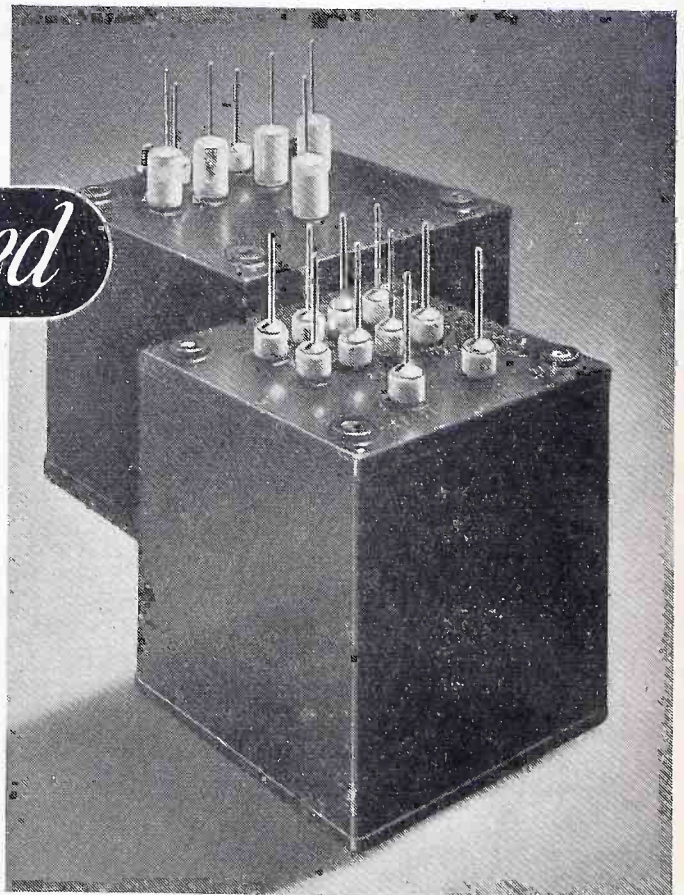

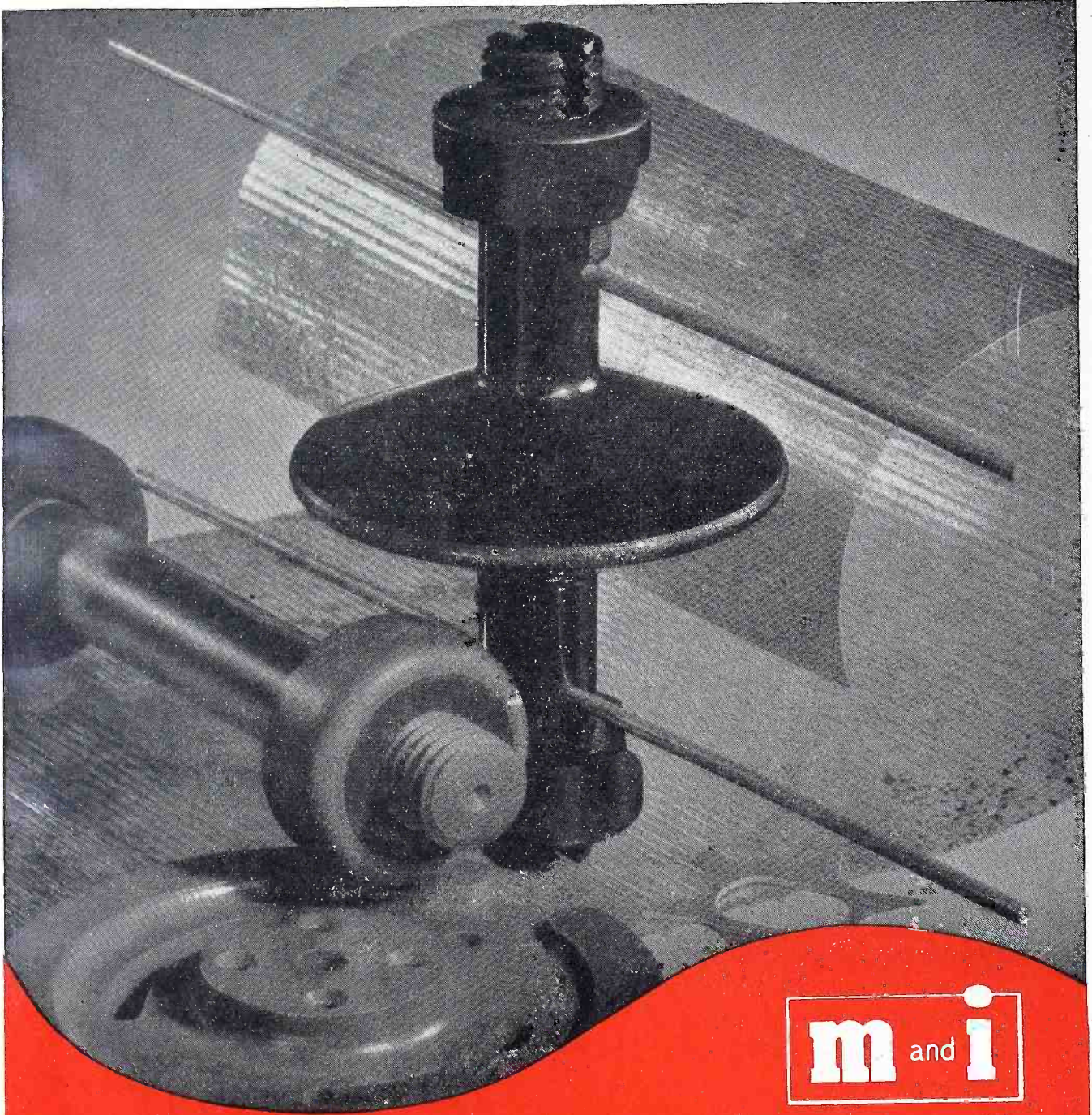

## **THE MICANITE & INSULATORS CO. LTD.**

**Empire Works, Blackhorse Lane, Walthamstow, London, E.17**

*Manufacturers of MICANITE (Built-up Mica Insulation). Fabricated and Processed MICA. PAXOLIN Laminated Materials. EMPIRE Varnished Insulating Cloths and Tapes. HIGH VOLTAGE BUSHINGS and TERMINALS. Distributors of Micoflex-Duratube sleeveings.*

# COSSOR

## Announce

THE NEW MODEL  
**1035**  
DOUBLE BEAM  
OSCILLOGRAPH

The Model 1035 is a general purpose Oscillograph, consisting of a Double Beam Tube Unit, Time Base, Y Deflection Amplifiers and internal Power Supplies. The two traces are presented over the full area of a flat screen tube of 90 mm. internal diameter and operating at 2 kv. Signals are normally fed via the Amplifiers, with provision for input voltage calibration. The Time Base is designed for repetitive, triggered, or single stroke operation, and time measurement is provided by a directly calibrated Shift Control.

### MODEL 1049

#### Industrial Oscillograph

is designed specifically for industrial use where the main interest is in the observation and measurement of low frequency phenomena. Its presentation is generally similar to that of Model 1035 illustrated and a comprehensive specification includes 4 kv tube operation for transient recording.

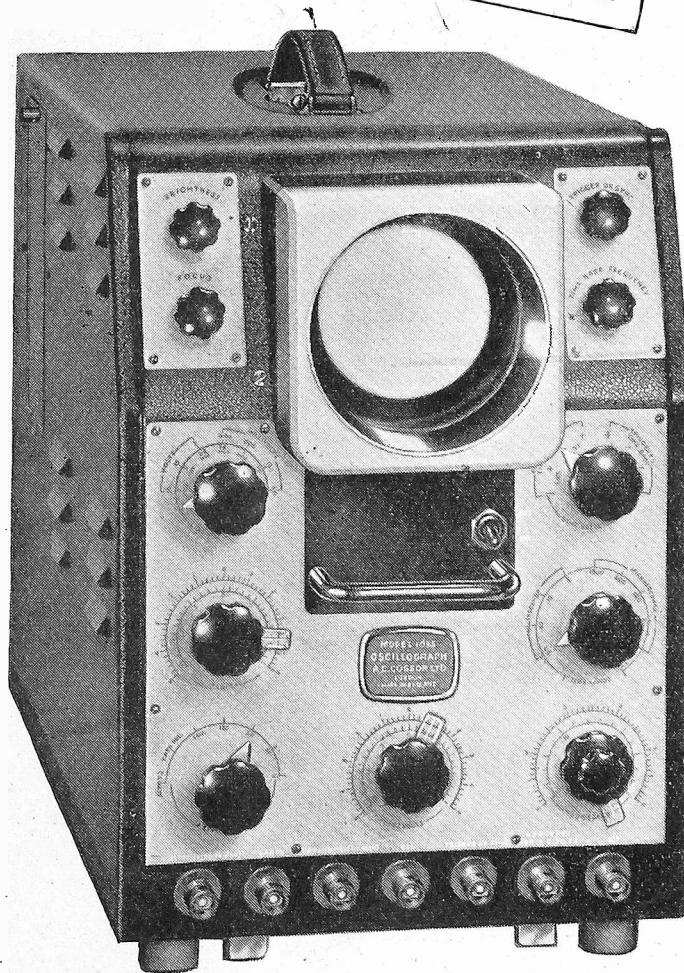

For photographic recording, both models have provision for the attachment of a Camera, Model 1428, which may be operated either manually or by motor drive.

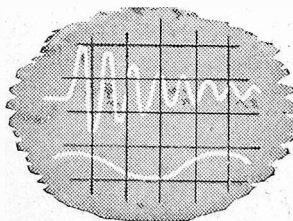

Further details on application to:—

**A. C. COSSOR LTD., INSTRUMENT DEPT., HIGHBURY, LONDON, N.5**

You  
get  
years of  
faultless  
service  
from . . .

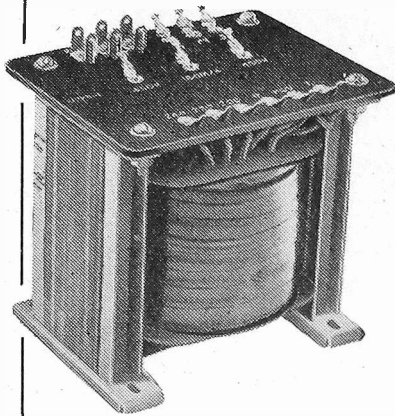

because they are :-

- INDIVIDUALLY DESIGNED
- RIGOROUSLY TESTED
- MECHANICALLY SOUND
- ELECTRICALLY PERFECT

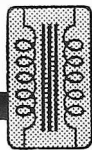

**"PURPOSE-BUILT"**  
**Savage**  
**TRANSFORMERS LTD.**

51, NORTHGATE STREET, DEVIZES. Phone 536

# 4,120v 8mA.

## in a half-wave circuit from a single unit

Cat. No. 16HT258  
Max. open circuit input volts 3,805.  
Output in half-wave circuit 4,120 volts.  
Max. mean output current 8 mA.  
Condenser 0.20 mFd.  
Length  $13\frac{1}{8}$  ins. Diameter  $\frac{7}{8}$  ins.  
Weight 3.8 ozs.

The range of 16HT rectifiers has been developed for E.H.T. supply to television equipment, H.T. supply to small electronic devices, cable testing and condenser testing. Full details are given in Rectifier Data Sheet No. 42, a copy of which may be obtained from Dept. E.E.

Type 16 HT.

**WESTINGHOUSE**  
**WESTALITE**  
**RECTIFIERS**

Westinghouse Brake & Signal Co., Ltd.  
82 York Way, King's Cross, London, N.1.

## TELE - RADIO (1943) LTD.

We can supply a small quantity of communication receivers ex-stock. These receivers have all been checked and re-aligned by us, and carry our usual guarantee.

**HAMMARLUND SUPER PRO**  
540 Kc/s.-20 Mc/s. Complete with power pack and loud-speakers. Five switched wavebands ... each **£65**

**NATIONAL HIGH-FREQUENCY RECEIVER, 300 Kc/s.-16 Mc/s.** In five switched wavebands. Less loud-speaker. ... each **£50**

**NATIONAL NC-100 RECEIVER.** 540 Kc/s.-30 Mc/s. In five switched wavebands ... each **£45**

**HALLICRAFTER HIGH-FREQUENCY RECEIVER S27.** 28 Mc/s. - 144 Mc/s. Less loud-speaker ... each **£65**

**HALLICRAFTER SX12.** 550 Kc/s.-38 Mc/s., with crystal gate, magic eye, A.C. operated ... each **£55**

**ECHOPHONE A.C./D.C.** 110 volts. Three wavebands with band spread. 560 Kc/s.-30 Mc/s. BFO noise limiter, etc. ... each **£25**

**NATIONAL HRO RECEIVER,** with four coils (H.F.) ... each **£65**

PHONE: PADDINGTON 6116 and 5606.

**177, EDGWARE ROAD, PADDINGTON, W.2.**

*They used a NEW*

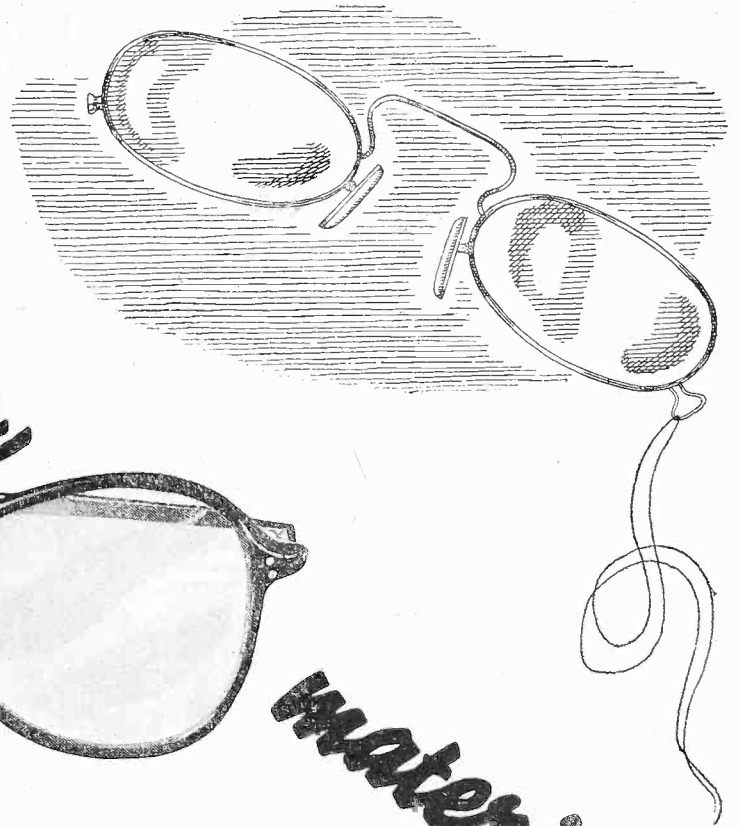

*material...*

*... and made the comfortable and elegant modern spectacles.*

Similarly, engineers are using TUFNOL, a comparatively new material, with advantage to improve their products and plant. In practically every industry TUFNOL has proved to be the solution to tricky problems — as improved gear wheels, textile

bobbins, aircraft pulleys, chemical trays and electrical insulators to name only a few of the thousands of different uses. Can TUFNOL improve your products or plant? Write for fuller details or ask for one of our technical staff to call on you.

- TUFNOL . . a comparatively new material. Made in the forms of sheets, tubes, rods, bars, angles and channels.
- For quantity production, some components can be moulded to shape during manufacture.
- Light in weight, strong, electrical insulator, resists corrosion, unaffected by water, oil or petrol. Does not warp. Is not attacked by rodents or termites.
- Can be machined easily and accurately.

**TUFNOL**  
*The Engineer's  
Material*

# Electronic Engineering

EDITORIAL, ADVERTISING AND PUBLISHING OFFICES, 28, ESSEX STREET, STRAND, W.C.2.

TELEPHONE: CENTRAL 6565 (10 LINES)

MANAGING EDITOR: G. PARR, M.I.E.E.

TELEGRAMS: LECTRONING, ESTRAND, LONDON

Monthly (published last Friday of preceding month) 2/- net. Subscription Rate: Post Paid 12 months 26/-.

Vol. 20. No. 240

## CONTENTS

February, 1948

Magnetic Amplifiers ... .. 38	Multi-Lingual Interpreting Systems (abstracted) 60
By S. E. Tweedy, B.Sc.	By C. A. Tuthill
High Vacuum Pumps—Part 2 ... .. 44	Commercial Disk Recording (Summary) 61
By R. Neumann, Dipl. Ing., A.M.I.Mech. E.	
The Synchrony—Refinements and Extensions 49	Correspondence ... .. 62
By D. G. Tucker, Ph.D., A.M.I.E.E. and J. Garlick, B.Sc.	Notes from the Industry ... .. 64
The Cathode-Follower—Part 2 ... .. 55	February Meetings ... .. 65
By E. Parker, M.A. (Oxon). A.M.I.E.E.	Book Reviews ... .. 66
Developments in C.R. Tube Recording ... .. 58	Abstracts of Electronic Literature ... .. 68
The New Television Camera ... .. 59	

## Innovations

IT is just over twenty years since the Bel and its sub-multiple, the decibel, were legalised by the Washington Telecommunications Conference as units of gain or loss in transmission lines and the amplifiers associated with them. It is significant to recall that the unit was formerly known as the Transmission Unit (T.U.) and that it was primarily used for comparing power losses in lines of constant impedance.

Since that time the use of the decibel has become firmly established, but its original significance is neglected and it is more common to use it to express voltage amplification under wide (and often unspecified) conditions of load. The subject was discussed in this Journal in 1941\*, when correspondents agreed that the use of a power comparison unit for voltage gain was unsatisfactory, but the solution put forward did not meet with general approval.

Since 1927 amplifiers have been used for a much wider variety of purposes than could have been foreseen by the delegates to the Conference. Electronic amplifiers for photo-cells, cathode-ray tubes, and biological work are examples of some in which the power output or load impedance is of less importance than the overall voltage gain without distortion. In such cases it is

usual to quote a gain of so many thousand, but this does not specify the performance clearly.

In this issue\*\* Dr. Grey Walter proposes a fresh unit for voltage gain—the pV—on analogous lines to the pH unit. This may or may not find favour, but its propounding raises a query which is: Are suggested innovations of this type given the consideration they deserve?

As an example, in 1942, B. C. Fleming - Williams† suggested a scheme for classifying the frequency bands in order to avoid such terms as "ultra-high-frequency" and "super-frequency" which were creeping into the literature. His proposal, on face value, seemed practicable and useful, but beyond a description in the technical press no further notice seems to have been taken of it.

### A Modern Home-built Televisor

A second edition of the "ELECTRONIC ENGINEERING" booklet on the construction of a high-quality television receiver is now in press and will be ready shortly.

Readers who have already placed orders will have them dispatched as soon as copies are to hand.

Orders for copies should be addressed to the Circulation Dept., 28 Essex St., Strand, W.C.2, and be accompanied by a P.O. for 2s. 8d. to include postage.

The British Standards Institution reflects the views of the engineering industry on a variety of subjects, including new terms and definitions, but, as it is careful to point out, it does not formulate new terms unless asked to do so.

The whole field of electrical engineering and electronic engineering in particular, has grown since the days of the original committee which decided the units and definitions, and it might well be that a reconsideration of some of them is due. Some have never found favour and have fallen into disuse, and some, like the decibel, have taken on interpretations which are different from those originally intended. Recently a new range of definitions has been discussed for wave-guide technique and it may be that new units will be required to express measurements in this field.

In any case, a suggestion for improving the technical terms of the radio or electrical profession should be given more than passing consideration, and should not be allowed to remain on the file as an item in the correspondence column.

\* The Decibel: Does it need Clarification? W. Bacon, ELECTRONIC ENGINEERING Vol. 14, No. 162 p. 356 1941.

\*\* p. 62.

† *ibid.* Vol. 15 No. 175 p. 148.

# Magnetic

By S. E. TWEEDY, B.Sc.\*

## Summary

In the first part of this article some basic circuit arrangements known as "transducers" (saturable twin-core reactors) are analysed, their properties described, and the design of such devices controlling a load is considered, in so far as it is applicable to magnetic amplifiers having high amplifications, discusses the properties of such magnetic amplifiers in various circuit connections, and considers their advantages, construction and uses, finally describing in greater detail a specific application.



External view of Magnetic Amplifier

**A**LTHOUGH Magnetic Amplifiers are to-day considered by many people as relatively new devices, they have actually been known in principle for at least 30 years. During the greater part of that time, however, little progress was made in their development. The primary reason for this was that in the initial stages they were rather inefficient, and developments in other fields of electrical engineering which could be applied to the improvement of magnetic amplifiers had not then taken place. As a consequence, they were largely shelved, except for saturable reactors used as variable A.C. impedances, e.g., for stage lighting control.

Subsequent developments in other fields produced high-permeability magnetic alloys and dry-type rectifiers — materials that could be applied with very great advantage to magnetic amplifier technique. However, by this time thermionic amplifiers had raced ahead and the possibility of reviving an older but shelved technique was for some time not considered. It was in Sweden and Germany that these developments of ancillary materials were first coupled with magnetic amplifiers to give the latter a new impetus, which resulted in their displacing electronic amplifiers in an increasing number of applications in the German war machine, where

they were used quite extensively in gun-fire control, in stabilisers, in automatic pilots and in regulating systems.

### The D.C. Current Transformer

In order to understand the method of operation of magnetic amplifiers, it is convenient first to consider a D.C. current transformer developed by W. Krämer in 1936 for that purpose of measuring very large D.C. busbar currents.<sup>1</sup> Two cores of magnetic material linked the busbar so that the current caused them to be magnetically saturated. Two identical windings having a considerable number of

turns were wound, one on each core, the two windings being connected in series in such a way that when the current was such as to assist the M.M.F. of the busbar current in one core, it opposed that M.M.F. in the other core. These cores were built of material such that the permeability was very high and nearly constant up to saturation, at which point further increases in M.M.F. produced only very small increases in magnetic flux. The two windings in series were excited by an A.C. voltage, and the A.C. current drawn by them was rectified and metered. This arrangement is shown in Fig. 1.

For the purpose of analysing this circuit, it will be assumed that the A.C. windings have negligible resistance and that the flux ampere-turn characteristic of the cores follows the idealised "curve" shown at ABOCD in Fig. 2. It is also assumed that the arrangement has a negligible reaction on the busbar current, which is clearly permissible since this current will have a very great back-up capacity, i.e., comes from a nearly infinite reservoir.

Supposing first that no current flows in the busbar, the A.C. circuit reduces to the simple case of two inductances in series. Each core will carry an equal pulsating flux, the magnitude and wave shape of the flux being dependent on the

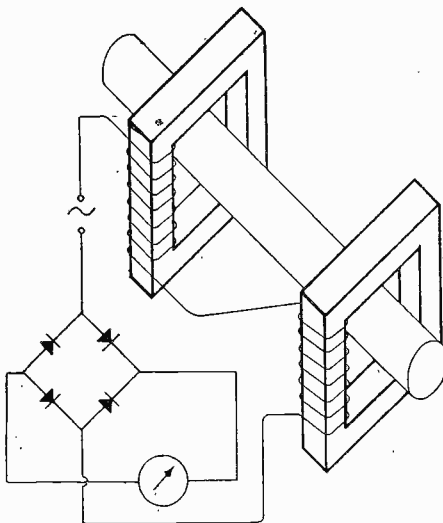

Fig. 1. A D.C. current transformer

\* Electro Methods, Ltd.



# Amplifiers

## Part I

he applied A.C. voltage. If the voltage is not so large as to demand flux of amplitude exceeding the saturation value, each unit will have an infinite inductance (since the permeability has been assumed infinite) and no A.C. current will be drawn. After saturation is achieved, further increase in A.C. voltage will result in a very steep rise in current (infinite in the ideal case under consideration).

Now consider the  $E-I$  characteristic for the A.C. circuit when a constant busbar current is flowing. As convention, let us say that when the alternating current exerts a positive M.M.F. in one core, it also exerts a positive M.M.F. in the other. Consequently the busbar current exerts a positive M.M.F. in one core and a negative M.M.F. in the other, due to the sense in which the A.C. windings are wound on the two cores. Having established this convention, we may now say that the algebraic sum of the fluxes in each core must be such as to give the flux pulsation demanded by the applied A.C. voltage.

Reverting to Fig. 2, let us suppose that the busbar current exerts an M.M.F. equal to OE ampere-turns in one core and OF in the other (OF = -OE). At the instant when the alternating current  $I_{ac}$  passes through zero, one core will be working at G and will carry positive saturation flux OC, while the other will work at H and will carry negative saturation flux OB. The total flux linking the A.C. circuit is therefore the algebraic sum of OC and OB, which is zero. Suppose that the flux linkage at this instant is rising.

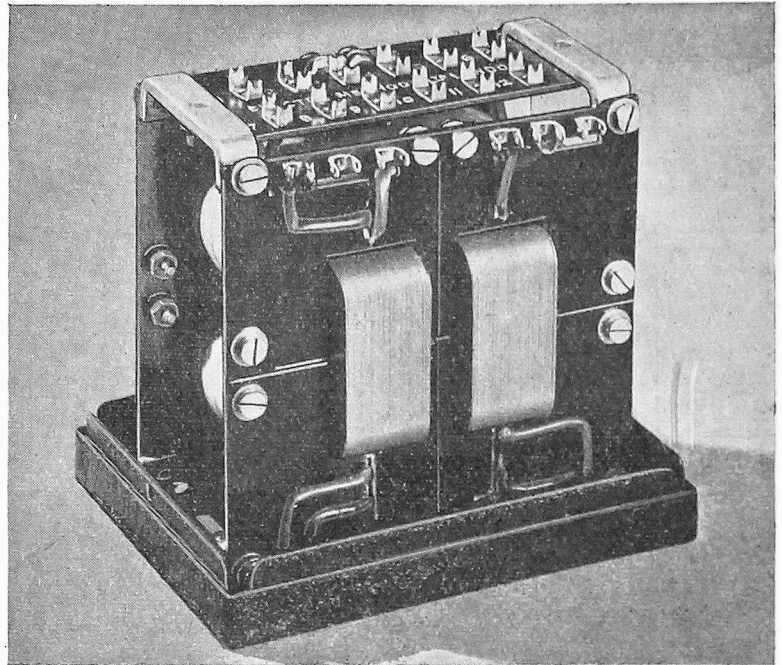

Magnetic Amplifier with cover removed

The working points G and H will therefore move to the right under the influence of the alternating current, to such positions that the sum of the fluxes is at all instants the required amount. Inspection of the diagram (Fig. 2) shows that to cause any change in the sum of the fluxes, the working point H must be on the line BC. Wherever along this line the working point is, i.e., whatever the shape of the flux wave, it is clear that at all times the alternating current is such

as to produce ampere-turns of value FO.

During the other half of the alternating current cycle, the working point D moves to positions along the line CB and the alternating current is such as to produce ampere-turns of value EO. The resulting alternating current is therefore a rectangular wave of amplitude such that its ampere-turns are equal to the ampere-turns produced by the busbar current, independently of the value of the A.C. voltage. The

Fig. 2 (left). Ideal magnetization characteristic

Fig. 3 (right). Flux oscillograms

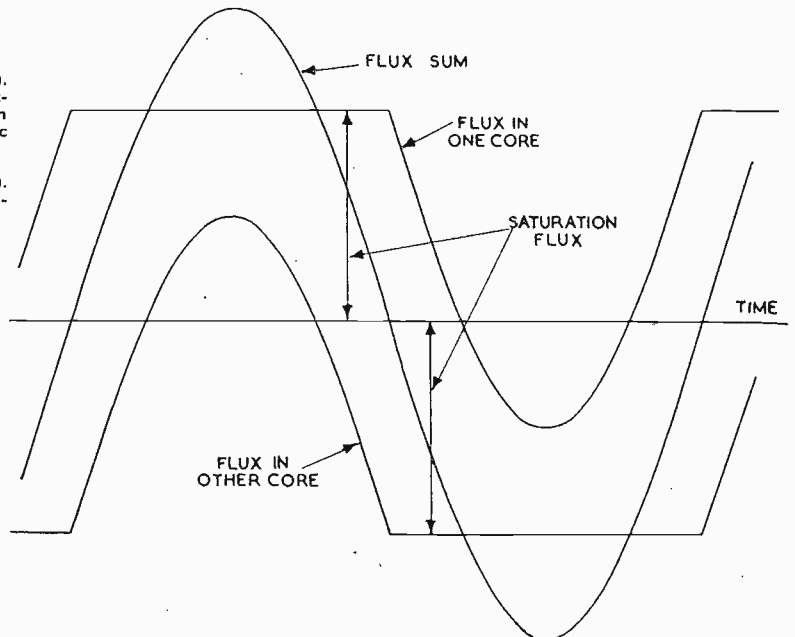
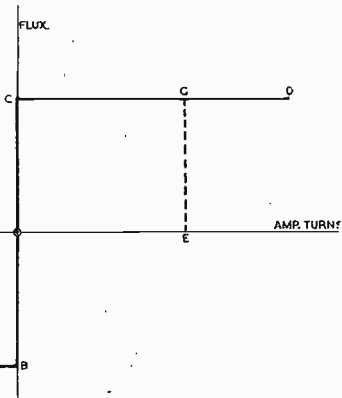

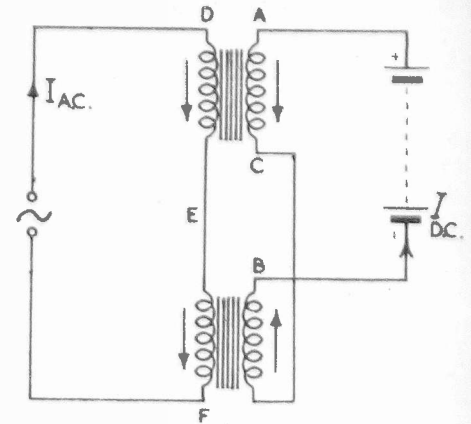
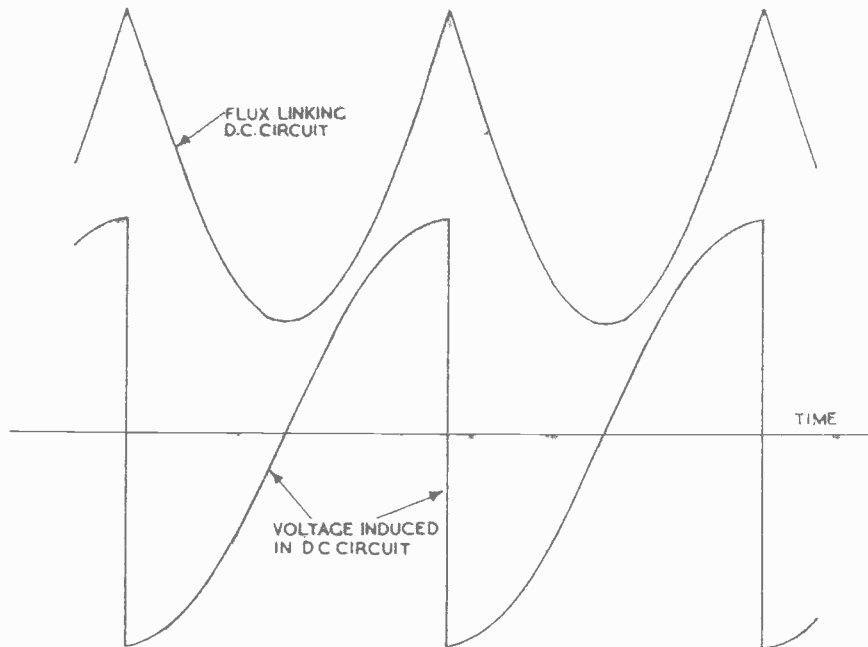

Fig. 4 (left). Reaction on D.C. circuit

Fig 5 (above). Series Transductor with D.C. short-circuited

shape of the flux waves in the two cores for a sinusoidal A.C. voltage is shown in Fig. 3, together with their sum. Saturation voltage is that at which the flux pulsates from full negative to full positive saturation in each core. It can be seen from Fig. 3 that the sum of the fluxes is then of amplitude equal to twice the saturation flux, and hence the saturation voltage has the same value as that when no busbar current flows.

The meter current is the rectangular current with every other half-wave reversed, *i.e.*, it is a smooth D.C. current directly proportional to the busbar current and independent of the A.C. voltage. It is worthy of note that any irregularities in the busbar current will be faithfully mirrored in the meter current, since the relation that the ampere-turns produced by the busbar current equals the ampere-turns produced by the alternating current holds at every instant.

Before leaving this circuit, it is of interest to note the flux linkage with the circuit carrying the D.C., *i.e.*, in this instance the busbar. Due to the counter connexion, it is necessary to take the algebraic difference of the fluxes in each core. For a sinusoidal alternating voltage, the resultant flux is shown in Fig. 4, in which is also plotted an oscillogram of the alternating voltage induced by this flux. This is seen to be of double the frequency of the applied voltage to the A.C.

circuit. The existence of this voltage illustrates the necessity of postulating that no reaction of the A.C. circuit on the D.C. current occurs, before the analysis of the circuit can be undertaken. We shall now consider the reverse case where complete reaction is possible.

#### The D.C.-A.C. Converter

The circuit now under discussion is illustrated in Fig. 5. The busbar has been replaced by two identical windings, one on each core, supplied with D.C. from a battery and counter-connected with respect to the A.C. windings. It is now assumed that the battery constitutes a short-circuit to A.C. and consequently the A.C. voltage across AB is zero.

If the D.C. current is zero (the battery being replaced temporarily by a short-circuit), the E-I characteristics will evidently be as for the previous case (Fig. 1), since no voltage appears across AB due to the counter-connexion.

Replacing the battery, and therefore permitting the passage of a direct current  $I_{DC}$ , will now result in a different analysis from the previous, since that analysis results in an alternating voltage across AB. Since there is no A.C. voltage across these points, it follows that the voltage AC equals the voltage BC. Transferring to the alternating current side, and remembering the counter-connexion, it follows that the voltage DE

is equal to the voltage EF. These conditions are true at every instant. It follows that the voltage across both DE and EF is equal at every instant to half the applied A.C. voltage. For a sinusoidal voltage, there exist then in the two cores two sinusoidal fluxes which are equal as regards their alternating component and can only differ as regards their D.C. component. Considerations of symmetry show that these fluxes must be equally disposed about the line of zero flux, and two such waves are plotted in Fig. 6 to the left of the assumed magnetisation curve.

From the curve may be projected the total ampere-turns required in the upper core (curve A) and in the lower core (curve B). The convention has here been taken that positive flux results from currents going downwards in the windings in Fig. 5. It can be seen from that figure that curve A is produced by the A.C. and D.C. currents acting in unison, while curve B is produced by the A.C. current opposed by the D.C. current. It follows that the A.C. current is given by half the algebraic sum of curves A and B, while the D.C. current is given by half the algebraic difference. Curves A and B, and the A.C. and D.C. currents (or, more strictly, ampere-turns) are plotted as separate oscillograms in Fig. 7. It will be seen that over the period when curve A exhibits a peak, curve B is of very small amplitude, being the ampere-

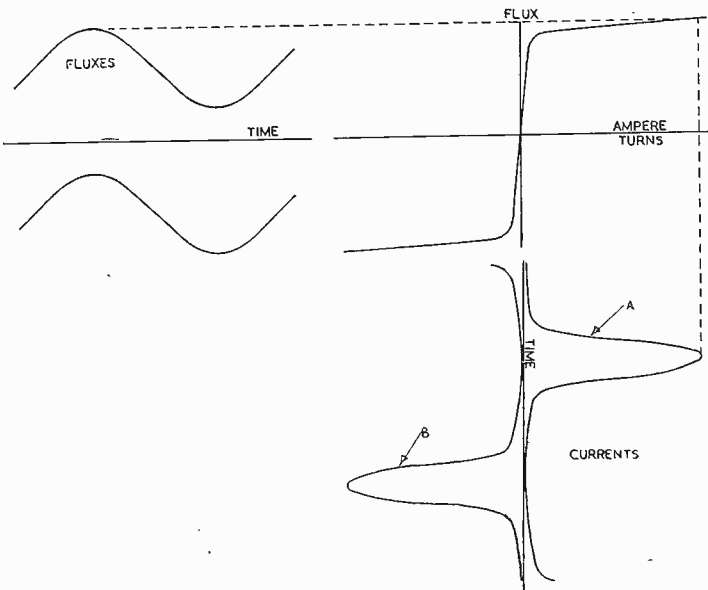
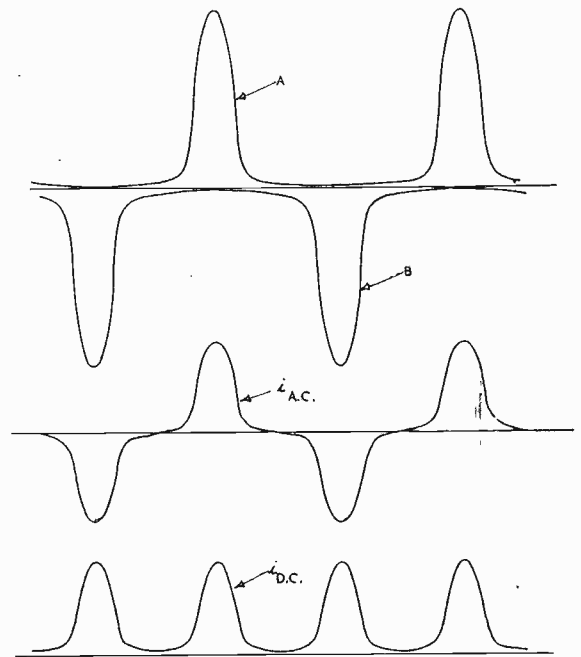

Fig. 6 (above). Flux ampere-turn relationships

Fig. 7 (right). Current oscillograms



turns required when the flux is below saturation value. It follows that the peaks in the A.C. and D.C. currents are very nearly equal, differing only by virtue of the magnetising current. Since the average values are largely determined by these peaks, the relation still holds that the A.C. current drawn is of such a value that its average ampere-turns are very nearly equal to the average D.C. ampere-turns, *i.e.*, the arrangement still acts as a D.C. current transformer, although in this case the relation applies to average values only and not to instantaneous values.

It will be observed that the D.C. current contains an alternating component whose fundamental frequency is double the frequency of the A.C. voltage supply. The reading of a meter in the D.C. circuit will be, of course, the average value of this D.C. current wave. It should be noted that the starting point of the analysis was not this D.C. current, but the D.C. component of the alternating fluxes, from which the A.C. and D.C. currents can be derived. This D.C. flux component, which we will call the "flux shift," is not, oddly enough, dependent only on the D.C. current, as careful consideration of the diagrams (Figs. 6 and 7) will show. In fact, it is much less than the D.C. flux set up by the D.C. currents in the absence of A.C. for a magnetisation characteristic of the assumed shape and complete analysis shows that the

flux shift is dependent almost entirely on the A.C. voltage and is only affected slightly by the D.C. current. This result is also true for the average flux in the first arrangement discussed, as consideration of Fig. 3 will show, and is of importance in considering the time characteristics of these devices.

**F. The Parallel Transductor**

Devices of this type have been named "transductors" in the Scandinavian countries,<sup>2</sup> and following this terminology, the first arrangement (Fig. 1) is known as a "series transductor, D.C. smoothed," while the second (Fig. 5) is a "series transductor, D.C. short-circuited." One further type should be mentioned, *viz.*, the "parallel transductor" in which the A.C. windings are arranged in parallel instead of in series (the D.C. windings must always be in series since otherwise they would constitute a short-circuit to the A.C.).

The analysis of this circuit is similar so that for the series transductor, D.C. short-circuited and will not be described in detail. In this case, the even harmonic currents circulate in the two separate A.C. windings and not more than a fraction will appear in the D.C. circuit. The total A.C. current is double that of the series transductors; this, however, is not in itself advantageous, since the A.C. saturation voltage is halved, due to the parallel con-

nexion. In this case, too, the flux shift is largely independent of the D.C. current.

**Core Material**

So far, no word has been said about the magnetic material constituting the cores. In order to obtain full realisation of the unique properties described, a core material is required which has a very high permeability up to saturation, from which point onwards further increase in flux should require as large an M.M.F. as possible. For these purposes, mu-metal is commonly employed and some typical characteristics of a series transductor, D.C. short circuited, using this material are plotted in Fig. 8. From this graph the action of the device as a D.C./A.C. current transformer may clearly be seen, the A.C. current being dependent almost entirely on the D.C. current, and only slightly on the A.C. voltage.

It must not be thought, however, that transductor cores are confined to mu-metal and similar materials. In fact, mu-metal has two disadvantages, *viz.*, its cost and its low saturation density. This means that it is a good material to choose for low power units, and for units for precision work when due advantage is taken of its properties. For units designed to handle large amounts of power, mu-metal is almost invariably too expensive to be considered, while the use of more conventional materials having a

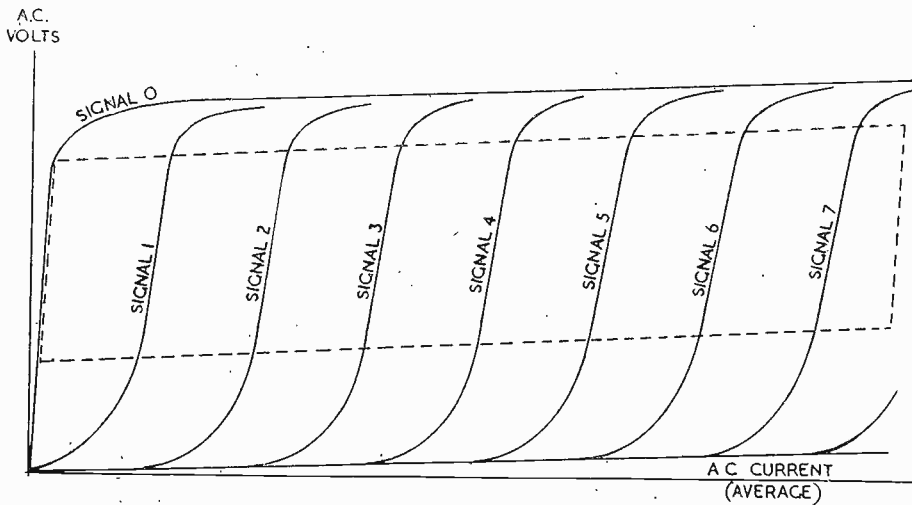

Fig. 8. Typical Transductor characteristics

considerably higher saturation flux density results in a rather smaller unit for the same  $VA$ . In this case, the characteristics are poorer, and the A.C. voltage has a far greater effect on the A.C. current for a given D.C. current than in the case of mu-metal.

#### Design of Transducers

If a transducer is connected in series with a load, it will already exhibit amplifying properties, it being possible to control the power dissipation in the load by means of fractions of that power supplied to the D.C. windings. Before considering magnetic amplifiers proper, which will be dealt with in a later article, it is of interest therefore to consider the design of transducers controlling a series load and the effect of the various factors.

At first sight, it may seem that the transducer functions as a current amplifier, and that the best results are obtained by making the D.C. windings of a large number of turns, while the A.C. windings are only a few turns. In this way, due to the principle of ampere-turn equality, the A.C. current will be many times the controlling D.C. current. That this effect does not constitute a true amplification is readily apparent when one considers that, were the A.C. turns to be doubled, the current would be halved, but the maximum A.C. voltage would be doubled, and therefore the same useful power would be obtained. It follows that amplification must be considered in terms of power.

Since mu-metal is used for the

magnetic amplifiers, forming the subject of the later article, we shall only consider transducers making use of this material. As has been seen, transducers of this type have the advantage that over a wide range of alternating voltage, the current remains practically constant. We shall therefore confine our attention to the range of usefulness of the transducer in which this property is utilised. The design is described in some detail since much of it is immediately applicable to magnetic amplifiers proper, as will be seen in the second article.

A given design problem for a transducer usually implies a knowledge of the value and range of the input signal, the nature and impedance of the load and the range of output power to be controlled. In some cases, only the output data is known and the problem is to achieve this output with a minimum input power. The purpose of the design is to determine the core size, the relative amount of space occupied by the D.C. and A.C. windings, and the wire gauge and number of turns of each.

The design is based on the characteristics of a typical transducer, which have been experimentally determined as, for instance, in Fig. 8. These characteristics will refer to a given core size, and to a given supply frequency. They should preferably be taken for a unit in which the A.C. and D.C. windings occupy an equal space, but, if not, the values may be corrected as explained later. To render these characteristics general as regards the core size, they should

be re-plotted in terms of A.C. volts per turn against A.C. ampere-turns, with D.C. ampere-turns as parameter.

It will be seen in Fig. 8 that the area in which the lines of constant average D.C. are straight and nearly vertical is the parallelogram shown dotted, and to fully preserve the properties of the transducer, its working point should always be within this region.

When there is no D.C. excitation, the impedance of the transducer is a maximum and practically all the supply volts are across it. Since the supply voltage is preferably as high as possible, the original working point of the transducer should therefore be the top left-hand corner of the parallelogram, *i.e.*, point A of Fig. 9. When D.C. flows, the A.C. current rises and consequently the voltage across the load rises, causing the volts across the amplifier to drop. The working point A therefore moves to the right and downwards. At maximum signal, if full use is to be made of the transducer, the working point should have moved completely across the parallelogram to some point such as B. The best position for this point has therefore to be chosen according to the conditions of the problem.

If the load is resistive, then the voltage across the amplifier is given by the equation:

$$V_A^2 = V_s^2 - V_L^2 = V_s^2 - I_A^2 R_L^2 \quad \dots (1)$$

where  $V_s$  = supply voltage

$V_A$  = amplifier voltage

$V_L$  = load voltage

$I_A$  = amplifier current =  
load current

$R_L$  = load resistance

the voltages and currents being R.M.S. values. (Although in the preceding analyses of transducer circuits the relations have been deduced in terms of average values, R.M.S. values are here used since problems of power are involved. This should not be overlooked when the characteristics are used).

At the point B, therefore, the amplifier voltage  $V_A = T \times OB'$  where  $T$  is the number of turns of A.C. winding, while the current is given by  $BB' \div T$ . The supply voltage is  $T \times OA'$ . Putting these values in Equation (1), we have:

$$T^2 (OB')^2 = T^2 (OA')^2 - \frac{(BB')^2 R_L^2}{T^2}$$

Hence  $\frac{R_L}{T^2} = \frac{\sqrt{(OA')^2 - (OB')^2}}{BB'}$  ..... (2)



Magnetic Photometer

It will be seen, therefore, that a particular working point corresponds to a load expressed in terms of ohms per turns squared, i.e., if the A.C. turns are increased in a certain ratio, the load must be increased by the square of that ratio to obtain the same working point. Let us now consider the maximum power that can be developed in a series load, for the given transductor type (i.e., given core size). The voltage across the load at point B is given by  $T\sqrt{(OA')^2 - (OB')^2}$ , while the current in the load is  $\frac{BB'}{T}$ . The power is therefore

$BB'\sqrt{(OA')^2 - (OB')^2}$ . This is clearly a maximum when B is on the lower edge of the parallelogram and as far to the right as possible. This is not completely true since OB' finally becomes equal to OA' and the load power becomes zero, but before this occurs considerations of maximum thermal rating usually set a limit. In fact, this condition positions the right-hand edge CD of the parallelogram and consequently maximum power output occurs when the working point B is at the point C, and the transductor is then worked at its full thermal rating.

Let us now consider the amplification obtained by working at the point B. The power output has been shown to be  $BB'\sqrt{(OA')^2 - (OB')^2}$ . The A.C. ampere-turns are here BB' and consequently the D.C. ampere-turns required are also BB' or of the same order. For a given winding space, the power required to produce a certain number of ampere-turns can be shown to be proportional to the square of the ampere-turns, irrespective of the size of wire used. (The assumption is made that the winding space factor does not depend on the wire size). We

may therefore write D.C. power input =  $C(BB')^2$  where C is a constant that will be known for the transductor experimentally investigated. We may therefore put:

Power amplification  
= Power output ÷ Power input  
=  $\frac{\sqrt{(OA')^2 - (OB')^2}}{C.BB'}$  ..... (3)

Comparison with Equation (2) shows that the power amplification is directly proportional to the load resistance expressed as ohms per turns squared, and it follows that the amplification increases as the point B moves to the left.

It is of interest to note that for any load the product of the power amplification and the maximum power obtainable in that load is  $\frac{(OA')^2 - (OB')^2}{C}$  and is consequently

almost constant, independent of the value of the load.

The proportioning of the winding space has, however, so far been assumed to be equal between the A.C. and the D.C. windings. Due to the ampere-turn equality, this means that the same power will be dissipated in each, and therefore equality is necessary if we work at point C and obtain maximum power output. If, however, to obtain greater amplification, we work at B, then the transductor will be thermally under-rated. To remedy

this advantageously, the A.C. winding may be made smaller and the D.C. winding larger. Suppose that the A.C. winding is decreased to a fraction *k* of its original volume. Assuming that the L.M.T. remains constant, the power dissipation to produce the same ampere-turns may be shown to rise in the ratio 1/*k*. The D.C. winding may now occupy a space equal to (2-*k*) times the original space and its power dissipation will fall in the ratio (2-*k*). Accordingly, *k* may be calculated to give the same total power dissipation as before. For example, when working at C, the total power dissipation is proportional to  $2(B'C)^2$ . If B is now such that  $BB' = 0.5B'C$ , then the new power dissipation is proportional to

$\frac{(0.5B'C)^2}{k} + \frac{(0.5B'C)^2}{2-k}$

Equating this to  $2(B'C)^2$ , we find *k* = 0.14 and (2-*k*) = 1.86.

The A.C. winding may therefore theoretically be reduced to 0.14 of its original size and the resultant gain in amplification would be 1.86. In actual fact, since the improvement in amplification is not tremendous, the A.C. winding should be made somewhat larger in order to avoid hot-spots in the windings.

The steps in the design procedure are therefore firstly to select the position of the point B to give the desired maximum power output, secondly to proportion the windings so that they are correctly rated thermally, and then to calculate the degree of amplification obtained. The position of the point B gives the load in ohms per turns squared, which combined with the actual ohmic value of the load gives the A.C. turns required. This gives the supply voltage from the point A' of Fig. 9 (supply volts = turns × OA'). The gauge of wire for the A.C. windings is now determined since the volume and number of turns are known, while finally the wire gauge of the D.C. windings is chosen to give a winding resistance suitable to the conditions of the input circuit.

Characteristics for similar transductors of different core sizes are readily deduced by application of normal transformer theory, and design procedure may be simplified by plotting for each core size a curve of maximum power output against power amplification, as described above.

(To be continued)

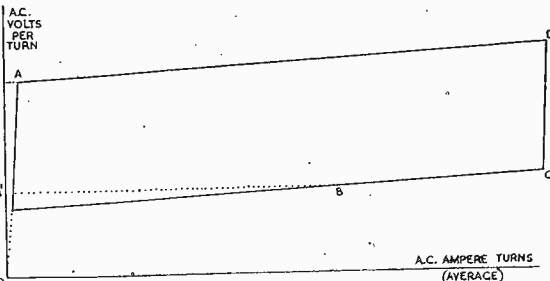

Fig. 9. General Transductor diagram

# High Vacuum Pumps

## Their History and Development

By R. NEUMANN, Dipl. Ing., A.M.I.Mech.E.

Part 2 — Modern Developments

THE development of the electric motor favoured the replacement of reciprocating by rotary machinery. Thus higher running speeds and higher volumetric speeds were obtained with smaller space required. In present-day laboratories and industrial plant the different types of rotary oil pumps are now nearly exclusively used as far as backing pumps are concerned, unless the high volumetric capacity of the whole plant warrants the installation of a large piston-type air pump with, say, 0.1-0.5 mm. Hg low pressure. What is now frequently called Gaede's rotary oil or box pump of 1905 was primarily designed to work as a backing pump for his rotary mercury pump.<sup>48</sup>

At about the same time a similar pump was developed by Siemens-Schuckert, consisting of a fore-pump and high vacuum pump in cascade, allowing an ultimate pressure of  $1.5 \times 10^{-3}$  mm. Hg<sup>49</sup> to be obtained.

The principle of the box pump is shown in Fig. 10. A cylindrical drum rotates eccentrically in the casing. Two sliding blades kept apart by springs are movable in a slit of the drum and divide the crescent-shaped space formed by the drum and the casing in two or three parts, according to the position of the drum. By the rotation of the drum the space connected to the recipient increases and that connected to atmosphere decreases and thus the air is sucked from the recipient and passed out.

It is a rather old principle and Gaede himself states that it was invented by an "English prince." In fact, the prototype was shown by Andrade<sup>50</sup> to be due to Prince Rupert whose "water bolt" was published in 1724 by Leupold. But still older descriptions of the principle may be found. P. Gaspar Schott tells in his "*Mechanica Hydraulico Pneumatica*" (1657) that Pater Urbanus showed him in the Monastery of St. John and Paul in Rome a similar pump which he calls "*Hydracontisterium novum*"

(Table XII) and still earlier Ramelli describes and illustrates in "*Le diverse et artificiose Machine*," Paris, 1588, a similar box pump with four blades for pumping water.

The first to use the principle for pumping, or being driven by, gases or vapours appears to be J. F. Beale.<sup>51</sup> In his rotary exhaustor "two or more sliding pistons are attached to the axle which are furnished with cylindrical pins that project and fit into cylindrical holes in guide blocks which work in

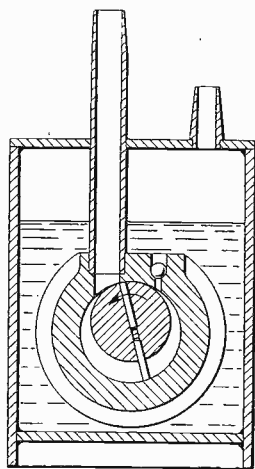

Fig. 10. Box pump

annular recesses in the cylinder covers."<sup>52</sup> The box pump is therefore frequently called the Beale pump.

Numerous modifications of the design have been proposed.<sup>53</sup> In Ramelli's pump the blades were pressed against the cylinder walls by gravity or centrifugal force. The use of springs for effecting this pressure was disclosed by Coméré in a French Patent of 1868.<sup>54</sup>

In order to make the box pump suitable for high vacuum work Fleuss's method of reducing the dead space by oil filling was applied. In Siemens-Schuckert's design the whole pump is immersed in an oil-filled casing. A check valve between cylinder and outlet prevents the air from returning to the cylinder as it is covered by oil. But when

the pump is not working oil may leak through the check valve back to the vessels to be evacuated. Besides, the pump must run idly for some time before starting actual pumping in order to remove the air absorbed in the oil contained in the outlet vessel. In Gaede's design the first drawback is overcome either by providing oil only for lubricating the shaft by oil rings and making the check valve vacuum-tight or by providing two oil friction pumps which, although the pump operates under oil, cease to function when the pump is at rest. The second drawback is overcome by avoiding a special oil-filled outlet vessel and attaining the vacuum-tightness by precisely grinding in the rotary parts of the pump.<sup>55</sup>

A very accurate finish of the working parts is of utmost importance for obtaining the highest possible vacuum. The choice of suitable materials ensures smooth working and long life. The stator is made of harder material than the blades, so that the wear occurs at the latter. This wear is reduced to a very small amount by the oil film on the inner surface of the stator.

This kind of box pump is now most widely used either alone or as backing pump for diffusion pumps. Examples are the "Spedivac" pump of W. Edwards & Co., the "Metrovac" rotary pump of Metropolitan-Vickers, the "Geryk" rotary pump of Pulsometer Eng. Co. in England, the Eisler pump and the "Duo Seal" pump of the Welch Scientific Co. in U.S.A. The principle of design is the same for the different products but they have all their special features.

Lowest pressures ( $10^{-5}$  mm. Hg) are obtained by using two stages in series while higher displacements are obtained by parallel working of the units.

Specially selected iron alloys of suitable hardness, free from porosity and resistant to corrosion, are used in the "Spedivac" design for the main pump castings to make them

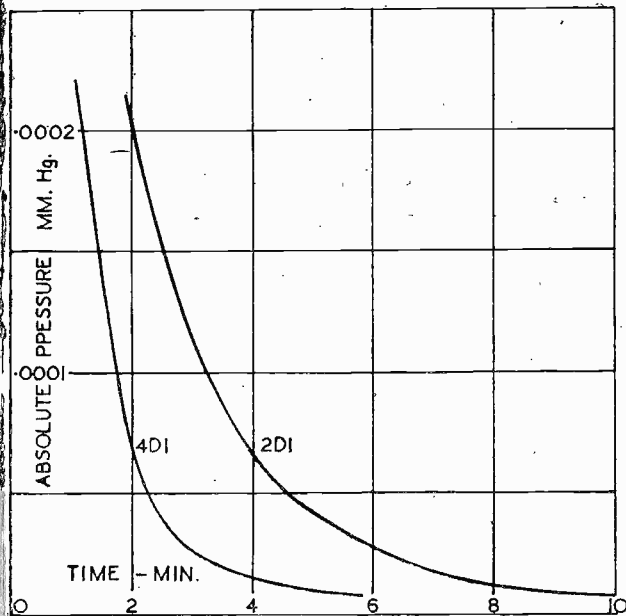

Fig. 11 (above). Curves of exhausting speed of box pumps (Pulsometer Co.)

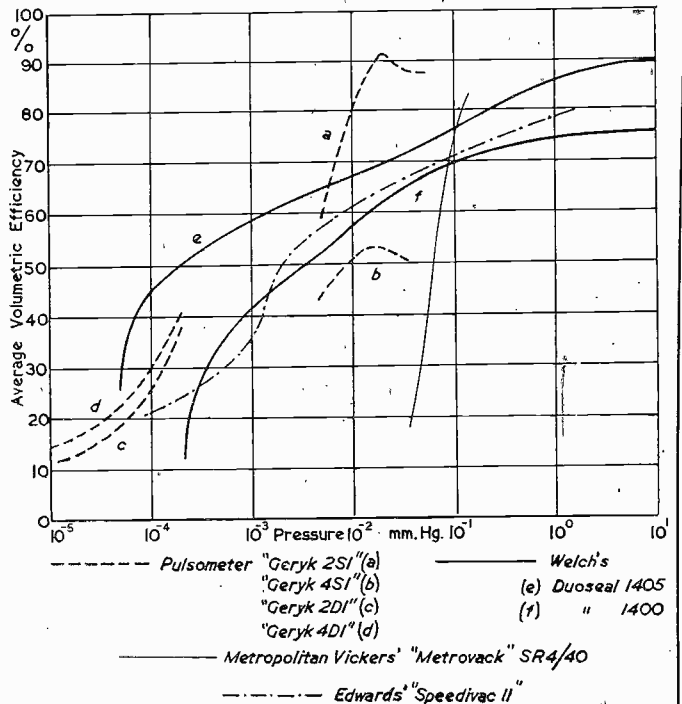

Fig. 12 (right). Volumetric efficiency of box pumps

suitable for applications where acids and similar vapours must be pumped. In the two-stage pumps the oil is freed from gas when passing from the main tank. Other features of the "Spedivac" pump are a long-life rotary seal, requiring no adjustment or packing, and a special spray arrester used where large volumes have to be pumped. The outlet valve is usually of the ball type, but in some of the recent designs a stainless steel plate is used for the valve where quiet running is of special importance. The whole stator and rotor assembly is mounted in an outer tank and submerged in oil.

A special feature of the rotary Geryk pumps is the mounting of the driving pulley on a trunnion bearing so that the belt pull is taken up by the front cover of the tank. This ensures that there is no distorting force acting on the rotor unit. The smaller type pumps are fitted with ball valves on the outlet side, while on larger types a steel flap valve protected by a guard is used. The larger pumps are fitted with a water jacket for cooling. Fig. 11 shows efficiency curves of Duplex pumps, giving the time required for evacuating a volume of  $3\frac{1}{2}$  litres with pumps of 2.4 and 4.8 cu. ft./min. displacements respectively down to an ultimate pressure of  $10^{-5}$  mm. Hg.

The Metrovac rotary pumps are either single-stage or two-stage pumps, the latter type being directly coupled to a motor, driving the rotors by a helical gear arranged between the two stages inside the common casing.

The Eisler pumps are single-, double- or triple-stage pumps. The two-stage compound pump is fitted with a one-piece housing for easing reassembly after cleaning and repairing.

In the Welch pumps a cylindrical seal is machined into the stator with the same radius as the rotor, located between the inlet and the outlet of the pump. The clearance of this seal is  $1/10,000$  in. and in the so-called Duo-Seal type (J. Dubrovin, U.S. Pat. 2337849) the seal is provided with a by-pass which is intended to carry off the last increment of gas which may escape the exhaust port.

In Fig. 12 a set of curves shows the volumetric efficiencies of some of the pumps described. The volumetric efficiency may be defined as the ratio of the time required by an ideal pump for attaining a certain pressure to the time required by the actual pump for attaining the same pressure. The conditions of the ideal pump may be obtained from Fig. 6 and those of actual pumps from curves given in makers' catalogues. But no exact conclusions

can be drawn from comparing the trend and location of the different curves of Fig. 12 as the conditions under which the pressure time curves were determined and the types of gauges used by the different manufacturers have certainly not been the same. The curves published for the Duo-Seal pump were, for instance, obtained with a tube 40 cm. long and 7 mm. diameter connecting the pump with the recipient. Such tubing has a very marked influence on the speed of exhaustion, especially at very low pressures as may be realised from the following examples:

The speed of a pump having a speed of 0.15 litres/sec. at  $10^{-3}$  mm. Hg was reduced to 0.08 litres/sec. with a tube of 1 m. length and 10 mm. diameter, and to 0.007 litres/sec. with a tube of 1 m. length and 5 mm. diameter; if a cold trap was used the speed was raised from 15 litres/min. to 45 litres/min. at  $10^{-3}$  mm. Hg pressure. On the other hand, the size of the recipient and its ratio to the active volume of the pump has no influence on the volumetric efficiency. Very likely the relatively low volumetric efficiency shown for the Geryk pump 451 is due to a bottle-neck somewhere in the system during the tests. Performance curves of a pump are of value only if all conditions under which they were taken are known and

the data adequately checked.

Another type of box pump has found wide application, especially in U.S.A. It is the so-called Cenco pump manufactured by the Central Scientific Company of Chicago and sold in this country by W. Edwards & Co. The principle of design is shown in Fig. 13. The eccentric rotor moves around a shaft concentric with the stator and a single vane arranged in the stator between inlet and outlet moves under the action of the rotor counteracted by a spring, working on an angular lever. The principle of the pump is old, as is shown by the British Patent 1279/1868 of J. Cooke. To-day the pump is built in five types, of which the smallest ("Pressovac"), mainly for schools and industrial laboratories, is used as a vacuum and pressure single-stage pump. The double-stage "Hyvac" pump contains two rotary units, working in series on a common shaft. Of similar design is the "Megavac" which has a larger displacement. The "Hypervac Type 20" has as its roughing stage a reciprocating pump actuated by the reciprocating vane of the final stage and the "Hypervac Type 100" consists of a complete Hyvac unit used as roughing pump and another rotary eccentric type pump serving as finishing stage, both pumps being arranged in a common housing. All the pumping units are immersed in an outer metal case filled with an oil of very low vapour pressure. An internal oil trap collects any oil which tends to rise when the pump is left under vacuum.

The relative merits of the two types of box pumps, the rotary vane type and the eccentric rotor type, were recently discussed by R. Witty.<sup>56</sup>

High capacity vacuum pumps producing comparatively lower vacua as required in processing like drying, evaporation, impregnating or the like fall—generally speaking—outside the scope of this article. But mention must be made of the Kinney pump<sup>57</sup> which, apart from these uses, is quite extensively used also for lamp and radio valve manufacture, electric discharge lamps and the like, and for backing diffusion pumps. While the Kinney pump and the Stokes pump, based on the same principle, were originally manufactured in U.S.A., the Kinney pump is now made in this country by the General Engineering Co. (Radcliffe) Ltd. Its

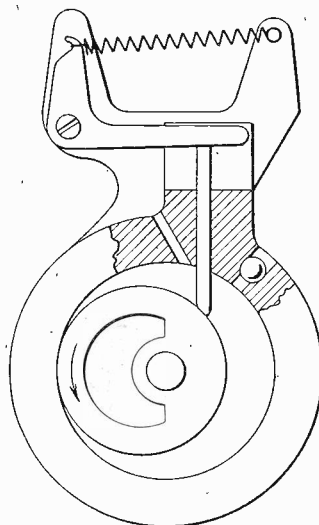

Fig. 13. Cenco pump

mechanism consists of a shaft carrying two eccentric cams set 180° apart. Pistons mounted on these cams have a hollow arm moving freely in a slide pin. The pistons act as rotary plungers moving tangentially to the inside of the cylinder and forcing the air or gas ahead of them through the discharge valve and nozzle to the atmosphere by way of a separator tank. Behind the piston a vacuum is created and the gas is admitted through intake ports in the hollow slide portion of the piston. With a recent compounded design vacua up to  $5 \times 10^{-4}$  measured by an ionisation gauge have been obtained. The displacement of two sizes of these compound pumps is 475 and 1,300 l/min. respectively, while the displacement of the older design in eight different sizes ranges from 350 to nearly 20,000 l/min. achieving a vacuum of about  $5 \times 10^{-3}$  or better.

If any of the pumps described is used for exhausting vapours under reduced pressure or a mixture of gas and vapour must be sucked from a container as in chemical processing, vacuum distillation, drying, impregnating work or the like, condensation of the vapour and contamination of the pumping fluid may lead to considerable trouble. For avoiding this it was proposed by Gaede (Brit. Pat. 475840) to admit a certain amount of air at atmospheric pressure to the pump chamber. This amount is then compressed and expelled from the pump together with the vapour or mixture

and condensation is effectively prevented. The principle is applicable not only to box pumps and the like, but also to molecular and diffusion pumps. Box pumps incorporating the principles are extensively used, especially in Germany, under the name of "gas ballast pumps" (Leybold).

The theory of the gas ballast pump, its mode of operation and a calculation of the necessary gas ballast for sucking off vapours or a gas-vapour mixture are given in a recent posthumous paper of Gaede.<sup>57a</sup>

For the sake of completeness mention should be made of the fact that for backing pumps also the aerodynamic principle is used to some extent, especially in laboratories, in the form of water jet pumps made of glass or metal. But they have a rather small suction speed and a large consumption of water and the attainable final pressure is about 10 mm. Hg. Of greater importance is the vapour jet principle used in combination with diffusion pumps which will be dealt with later.

#### Molecular Pumps

Before dealing with diffusion pumps another type of fine-vacuum pumps should be discussed, the so-called molecular pump which is still used to some extent, although it has now in the main been superseded by the diffusion pump. In fact, the expression molecular pump is used occasionally in a wider sense, comprising both Gaede's molecular pump and his diffusion pump. Their principle is based on the theoretical work of Knudsen on the behaviour of gases at very low pressures at which the mean free path of the molecules is of the same order of magnitude as, or larger than, the dimensions of the apparatus used. Knudsen's experiments on the molecular flow and the inner friction of gases<sup>58</sup> had shown that the molecules are diffusely scattered if they impinge on to the wall of the vessel or tube at very low pressures. That and why this is only valid for very low pressures was shown by Gaede<sup>59</sup> who explains the phenomena at higher pressures with a gas film formed on the walls of the vessel. The very large influence of gaseous friction on the suction speed of mercury air pumps led Gaede to the idea that possibly the obnoxious friction effect experienced with narrow tubing might be turned to good account by using it for produc-



ing the sucking action. Thus he designed his molecular pump<sup>60</sup>, the principle of which is shown in Fig. 14 and the most characteristic feature of which is that, contrary to previous types of pumps, there is no separating wall between fine pressure and backing pressure. One of the walls of the vessel is made movable so that the molecules repelled by it receive a directional

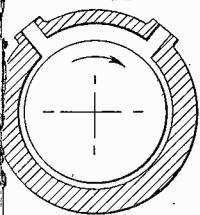

Fig. 14. Principle of molecular pump

impulse. If the drum would move with a speed, exceeding that of the maximum speed of the molecules, no molecule could return in a direction opposite to the movement of the drum and an absolute vacuum could be attained. Gaede could show that the centrifugal effect due to the radial component of the speed is not relevant. But a "kinetic heat effect" could be proved to exist.

**Gaede Pump**

In Gaede's actual design (Fig. 15) the rotating drum has a number of circumferential grooves side by side into which project tongues connected with the stator. The pressure opening of one groove is connected to the exhaust opening of the adjacent groove so that the grooves are connected in series. The pump has a final vacuum of about  $10^{-7}$  mm. Hg and its suction speed is about 10 times larger than that of the rotary mercury pump. The exhaust effect is largest if the mean free path of the molecules is of the same order as the dimensions of the grooves. At  $10^{-7}$  mm. Hg the exhaust effect becomes zero. A great advantage of the pump is its ability to suck off vapours, e.g., water vapour, from the system so that special vapour traps are not required, but, on the other hand, hydrogen cannot be properly pumped away.

The pump maintains the vacuum only while it is running as there is no separating wall between fine- and fore-vacuum. If it is to be stopped and the vacuum preserved some form of tap or trap must be inserted and such devices always introduce vapours. Besides, it requires exceedingly accurate workmanship and skilled attention and is therefore expensive in first cost and operation.

**Holweck's Pump**

An improvement of Gaede's molecular pump was proposed by Holweck<sup>61</sup> and used first at the Curie Laboratories at Paris. It consisted of a smooth light cylinder 6 in. diam.,  $8\frac{3}{4}$  in. long, rotating on ball bearings inside and very close to a heavy casting upon the inside of which 5-7 right and left handed spiral grooves of diminishing rectangular cross section are cut. The grooves unite at the centre and are connected to the exhaust nozzle. The ends of the grooves are connected by a bore inside the casing with each other and with the nozzle leading to the backing pump. The speed of rotation is 4,500 r.p.m. obtained by an induction motor, the rotor of which is mounted on the end of the shaft and enclosed in an air-tight casing, passing the air-gap between stator and rotor. The clearance between the rotating cylinder and the casing is 0.03 mm., the back pressure 15 mm Hg. Sucking speed up to 4.5 litre/sec. were obtained at a pressure of about  $0.75 \times 10^{-3}$  mm. Hg.

The suppression of the projecting tongues used by Gaede permit a smaller clearance and this and the large section of the spiral paths make the output much greater than that of the previous design, but the very small clearance is rather a weak point and it has been reported<sup>62</sup> that during prolonged runs serious breakdowns occurred, owing to the overheating of the rotor.

By replacing the rotating drum by a disk as proposed by Siegbahn<sup>63</sup> a safer design is obtained as thermal expansion does not interfere with a small clearance. The design is therefore still in quite extensive use, especially in Sweden. While with

Gaede's original pumps a suction speed of 1.4 litre/sec. was obtained at  $10^{-3}$  mm. Hg the speeds obtainable with Siegbahn's design were 3-5 litre/sec. with the old model, having a disk of 220 mm. diameter, 12-14 litre/sec. with a 275 mm. disk and 73 litre/sec. with a 540 mm. disk. The limiting pressure is  $6 \times 10^{-7}$  mm. Hg, the limit being set by the use of Apiezon grease for the gaskets. The back pressure is normally 0.05 mm. Hg, but the pump can work against a pressure of several mm. The large capacity pump has three spiral grooves, working in parallel arranged in the casing (Fig. 16(a)).

**Siegbahn Pump**

In the latest design described by Siegbahn the flat disk is replaced by one having flanges on both sides and the spiral grooves are replaced by circular grooves, working in series. The latter are more easily machined, but experience must show whether the clearance of 0.1 mm. between the flanges of rotor and stator is sufficient for avoiding troubles from thermal expansion. The 300 mm. disk runs with 8,800 r.p.m. and a suction speed of 42 litre/sec. is obtained at  $4 \times 10^{-3}$   $10^{-4}$  mm. Hg. The ultimate pressure is  $2 \times 10^{-6}$  mm. Hg at a back pressure of  $10^{-2}$  mm. Hg. But the pump starts working already at more than 1 mm. Hg.

The advantages claimed for this type of molecular pump in comparison with the diffusion pump are the following:

(1) Shorter starting time. This is of special importance, e.g., for its use in connection with the electron microscope. No lock devices are necessary for replacing objects and

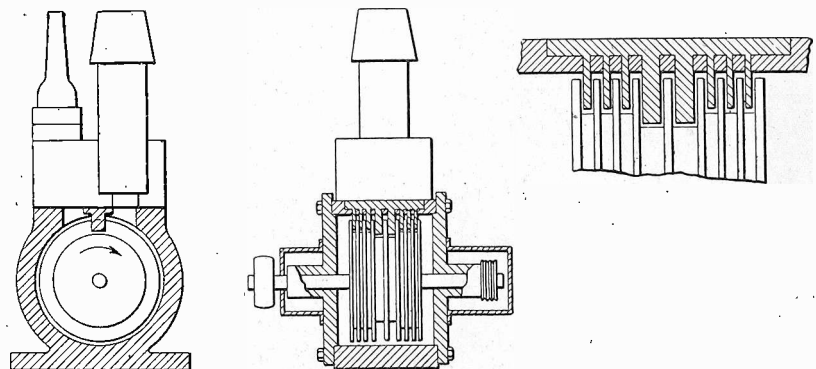

Fig. 15. Gaede's molecular pump

plates as, after a fresh object has been introduced, it takes only 90 sec. to attain the necessary vacuum.

(2) All kinds of gases and vapours may be pumped without the use of cold traps or oil baffles. This property of the molecular pump makes it specially suitable for exhausting X-ray tubes where the use of oil diffusion pumps may lead to trouble as residual oil vapour is decomposed apparently by bombardment. Carbon is deposited on the anode and the cathode filament is attacked by oxygen. Long connecting tubes and baffles proved ineffective and only the use of a liquid air trap usually not required with oil diffusion pumps overcame the trouble, while CO<sub>2</sub> ice and methyl alcohol traps proved less efficient.<sup>64</sup>

(3) Heavy gases are pumped faster than light ones, while diffusion pumps work in the opposite way. This property is valuable if the pump is used for evacuating a cyclotron where deuterium, helium or hydrogen are pumped and the air leaking in is quicker removed and with less loss of the precious light gas.

Measurements of the performance of these pumps were made by Eklund<sup>65</sup> who specially studied the dependence of the fine pressure on the backing pressure and of the suction speed on the number of revolutions.

A modern design of the Holweck pump is being manufactured by Trüb, Täubner & Co., Zurich. The drawbacks mentioned above are overcome by the more robust design of the rotor made of steel and running at 3,000 r.p.m. and also by a reduction of the number of grooves. Suction speeds up to 18 litres/sec. at 10<sup>-3</sup> mm. Hg. are obtained. A section of this pump is shown in Fig. 16(b).

(To be continued)

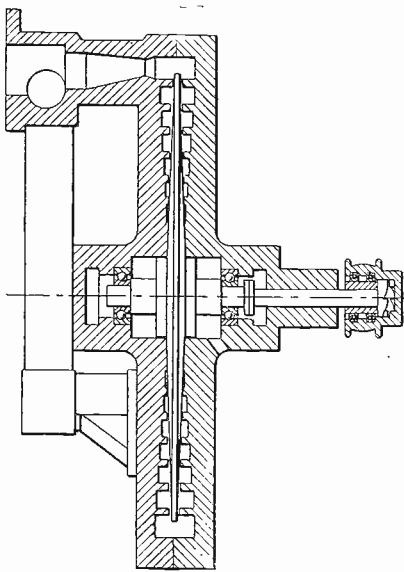

Fig. 16. (a) Siegbahn's molecular pump

#### References

- <sup>48</sup> Meyer, *Verh. Dtsch. Phys. Ges.* 10, 753, 1908.
- <sup>49</sup> Fischer, *Ber. Dtsch. Phys. Ges.* 3, 383, 1905.
- <sup>50</sup> Andrade, *Jour. Sci. Inst.* 5, 78, 1928.
- <sup>51</sup> Brit. Pat. 6777/1835; 8564/1840.
- <sup>52</sup> Clegg, *Practical Treatise on the Manufacture and Distribution of Coal Gas*, London, 1859, p. 190.
- <sup>53</sup> Reulaux, *Theoretische Kinematik*, 1875, p. 359 et seq., Table V. v. Ihering, *Die Gebläse*, 1913, p. 346 et seq.
- <sup>54</sup> French Patent 82345, 1868.
- <sup>55</sup> See Ref. 19, p. 421.
- <sup>56</sup> R. Witty, *Jour. Sci. Inst.* 22, 201, 1945.
- <sup>57</sup> U.S.A. Pat. 1623315 of 1927.
- <sup>57a</sup> Gaede, *Z. Naturforsch.* 2a, 233, 1947.
- <sup>58</sup> Knudsen, *Ann. d. Phys.* 28, 75, 1909.
- <sup>59</sup> Gaede, *Ann. d. Phys.* 41, 289, 1913.
- <sup>60</sup> Gaede, *Ann. d. Phys.* 41, 337, 1913.
- <sup>61</sup> Holweck, *Comptes Rend.* 177, 43, 1923; Elwell, *Jour. I.E.E.* 65, 784, 1927.
- <sup>62</sup> Discussion to Burch and Sykes' paper, *Jour. I.E.E.* 77, 130, 1935.
- <sup>63</sup> v. Friesen, *Rev. Sci. Inst.* II, 362, 1940; Siegbahn, *Ark. Mat. Astr. Fys.* 30, B. No. 2, 1944.
- <sup>64</sup> Bearden, *Rev. Sci. Inst.* 6, 276, 1935.
- <sup>65</sup> Eklund, *Ark. Mat. Astr. Fys.* 27 A. No. 21, 1941 and 29 A. No. 4, 1943.

## Noiseless Sound Recording Equipment

DESIGNED by A. A. Waters and developed by United Motion Pictures, Ltd., 24 Denmark Street, London, W.C.2, the "Water-lite" equipment provides for direct high quality sound recording on either 16 mm. or 35 mm. film.

It consists of a combined two-channel mixer, four stage amplifier and noise reduction amplifier, with dialogue equaliser and test signal generator included, the sound camera and the generator. These are assembled in three self-contained units which, with the accumulators are easily transportable. All components are tropicalised.

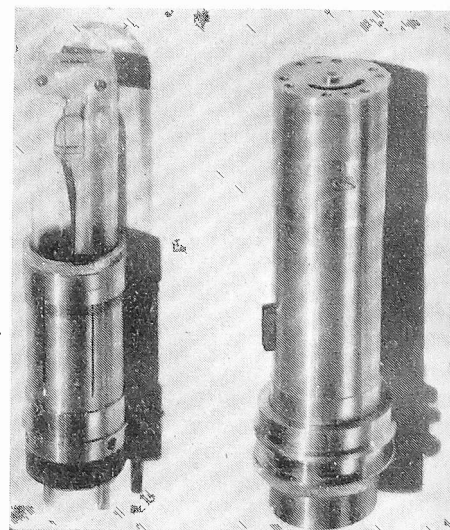

Photograph of Glow-tube and assembly

The optical unit, a special feature of the equipment, consists essentially of a glow-tube and a f2 focusing lens having a focal distance of only .004 in. This is responsible for the very narrow track (.001 in. or even as low as a .0005 in.) which is obtainable. A frequency response of 50-6,000 c/s. is claimed on 16 mm. film running at 24 frames per second; on 16 frames per second the response is only reduced to 50-5,000 c/s.

The two models, 35 mm. and 16 mm., apart from the amplifier, are not interchangeable. Only the 35 mm. equipment is available in this country, the 16 mm. model being available for export only. Recordings on 16 mm. film, however, can be arranged through United Motion Pictures, Ltd.

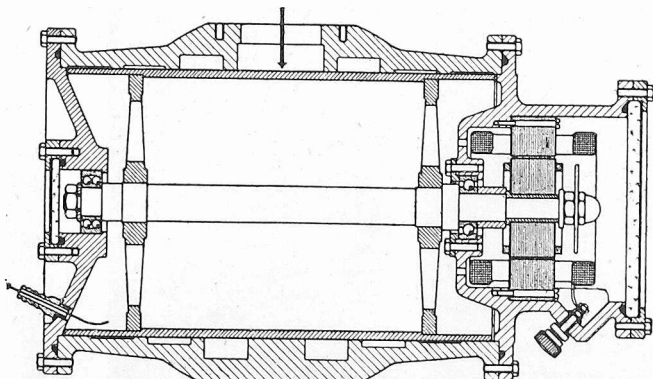

Fig 16 (b) Trüb, Täubner & Co's Holweck pump

# The Synchrodyne : Refinements and Extensions

By D. G. TUCKER, Ph.D.\* and J. GARLICK, B.Sc.\*

## I. Control of the Phase Angle between the Output and Injected Signal of the Synchronised Oscillator †

IT has been shown in a previous article (August, 1947) on the Synchrodyne that the output of the required signal from the demodulator is proportional to the cosine of the phase angle between the local oscillator output and the carrier of the signal fed to the demodulator. This phase angle,  $\theta$ , is given, approximately, for the simple synchronised oscillator by:

$$\sin \theta = \frac{f_o - f_s}{f_o - f_{s1}} \dots \dots \dots (1)$$

where  $f_o$ ,  $f_s$  and  $f_{s1}$  refer to the oscillator natural frequency (in the absence of the injected signal), the synchronising frequency, and the pull-out frequency respectively. Changes in the oscillator natural frequency, due to warming-up, power supply variations, etc., thus produce changes in the level of the received signal, and over a long period may even cause the oscillator to lose synchronism with the injected signal, necessitating slight retuning. Although these effects are not likely to be very troublesome in practice, a means of reducing the variation in  $\theta$ , so avoiding the need for retuning during warming-up, for instance, would be a useful addition.

Since the condition for pull-out from synchronism is, generally,  $\theta = \pm \pi/2$ , a means of reducing the variation of  $\theta$  with change of natural frequency will cause a corresponding increase in the locking range,  $\frac{f_{s1} - f_o}{f_o}$ , for a given level of locking signal.

If the degree of phase control, (i.e., of the angle  $\theta$ ), is large, the synchronising signal to the oscillator can be substantially reduced in level, without loss of synchronism, so that interfering signals in the output of the synchronised oscillator, which are dependent on the level of the injected signals, can be made as small as desired. This result of the separate control of  $\theta$ , although only a useful addition for medium-wave listening, may well become necessary for reception on some wave-bands. In

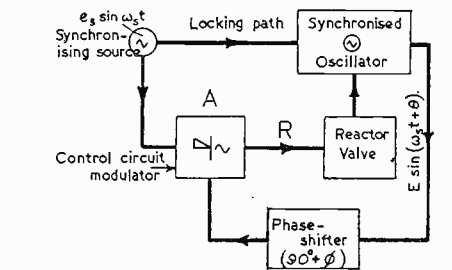

Fig. 1. Schematic diagram of circuit for controlling phase angle of a synchronised oscillator

fact, at short-wave frequencies, the number of stations within a given fractional range of the required station is so much larger than in the medium-wave band, that it is likely that the local oscillator would give interference from, or even become synchronised to, a strong unwanted station, if an injected signal of the usual level of about 30-100 mV were employed.

By using the proposed circuit to increase the frequency range over which the local oscillator will remain synchronised, the need for such a high level of injected signal is obviated, and the associated difficulties avoided. The effect of the phase control circuit on the frequency range over which the oscillator will pull into synchronism can be made only slight, so that it will still be possible to synchronise to a carrier within a small range of a more powerful signal.

The principle of the method for reducing variations in  $\theta$  is to control the local oscillator natural frequency (variations of which are responsible for changes in  $\theta$ ) by a reactance valve fed with a D.C. signal which is dependent on the final phase angle,  $\theta$ , of the synchronised oscillator. The reactance valve (1) is of the type, commonly used in F-M transmission, in which the output impedance is made largely reactive, and dependent on the instantaneous grid voltage applied to the valve. The D.C. signal to the reactance valve is obtained, as the schematic diagram in Fig. 1 shows,

by modulating together the synchronising signal, and the output of the synchronised oscillator, the latter being shifted in phase by about  $90^\circ$ , say  $(90^\circ + \phi)$ ,  $\phi$  being the error (which can be positive or negative) of the phase-shifter.

If we denote the synchronising signal by  $e_s \sin \omega_s t$ , and the oscillator output by  $E \sin (\omega_s t + \theta)$ , then the signals fed to the modulator, A, will be proportional to  $e_s \sin \omega_s t$  and  $E \sin (\omega_s t + \theta + \pi/2 + \phi)$  i.e., to  $e_s \sin \omega_s t$  and  $E \cos (\omega_s t + \theta + \phi)$ . The main sum and difference products from the modulator will therefore be proportional to  $\sin (2\omega_s t + \theta + \phi)$  and  $\sin (\theta + \phi)$ . The former is a high frequency which can easily be filtered out from the wanted D.C. component of  $\sin (\theta + \phi)$ . By making the error,  $\phi$ , of the phase-shifter small, a D.C. voltage can be obtained proportional to  $\sin \theta$ . This is fed to the reactor valve in the correct sense, so that the natural frequency of the oscillator is brought closer to the synchronised frequency, thus reducing the magnitude of  $\theta$ .

Now it is useful to be able to determine the reduction in  $\theta$  which will be obtained for a given level of locking signal due to the connexion of the phase control circuit. Let the D.C. control voltage fed to the reactor valve at R be  $M \sin \theta$ ; let the sensitivity of the oscillator frequency to the reactor valve grid voltage be  $F$  where

$$F = \frac{\Delta f_o}{f_o \Delta v_r}$$

where  $\Delta v_r$  is a change in D.C. voltage at R. If, when  $\theta$  is zero, a small D.C. voltage  $d$  is injected at R, the oscillator natural frequency will change by  $Fd$ , producing, with the phase control circuit disconnected, an output phase angle  $\theta$  given from (1) above by:

$$\sin \theta = \frac{Fd}{1 - \frac{f_{s1}}{f_o}} \dots \dots \dots (2)$$

When the phase control circuit is connected, with the voltage  $d$  still applied, there will be a new phase angle  $\theta_c$ , say, and the total D.C.

\* Post Office Research Station.

† By J. Garlick.

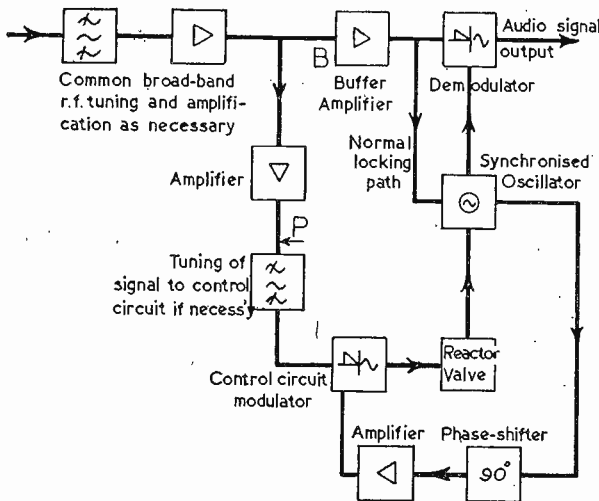

Fig. 2. Application of phase-controlled synchronised oscillator to Synchrodyne receiver

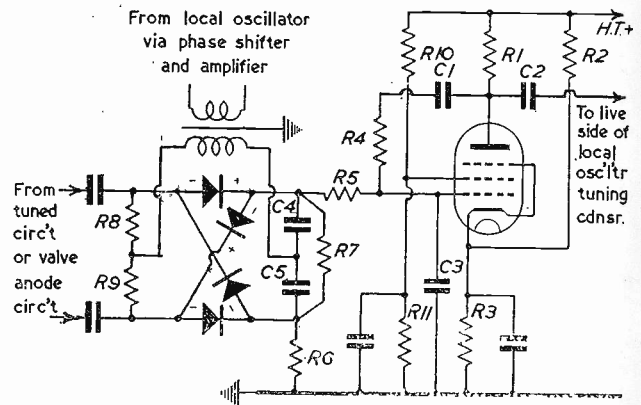

Fig. 3. Diagram of control circuit modulator and reactor valve

Values:  $R_1, R_{11}$ : 10K;  $R_2$ : 40K;  $R_3$ : 470Ω;  $R_4$ : 4K;  $R_5, R_6$ : 100K;  $R_7$ : 2K;  $R_8, R_9$ : 1K;  $R_{10}$ : 5K.  $C_1, C_2$ : 0.1;  $C_3$ : 100pF.;  $C_4, C_5$ : 1μF. Valves: SP.41 Rectifiers: Silicon.

applied to the reactance valve at  $R$  is:

$(d - M \sin \theta_c)$  ..... (3)  
Corresponding to Equation (2) we have therefore:

$$\sin \theta_c = \frac{Fd - M \sin \theta_c}{1 - \frac{f_{s1}}{f_0}}$$

that is:

$$\sin \theta_c = \frac{Fd}{1 - \frac{f_{s1}}{f_0} + FM}$$
 ..... (4)

Dividing Equation (2) by Equation (4) gives:

$$\frac{\sin \theta}{\sin \theta_c} = 1 + \frac{FM}{1 - \frac{f_{s1}}{f_0}}$$
 ..... (5)

Equation (5) expresses the extent to which variations in the phase angle of the synchronised oscillator, due to drifting of its natural frequency, are reduced by the application of the control circuit. Reasonable values are:

$F = 0.02$ , i.e., 2% per volt

$M = 1$ , i.e., a maximum output from control modulator of 1 volt

$\frac{f_{s1}}{f_0} = 0.999$ , i.e., a synchronising range of 0.2 per cent.

so that Equation (5) gives an improvement in phase angle, and therefore also the increase in the range over which the oscillator remains synchronised for a given locking signal, of about 20 times. This can be utilised partly as a safeguard against the local oscillator coming out of synchronism, and partly as a means of permitting the desirable reduction in level of injected synchronising signal.

The output of the synchronised

oscillator,  $E \sin (\omega_s t + \theta)$  which is fed to the modulator,  $A$ , will be subject to stray phase-shifts in addition to the necessary  $90^\circ$  shown in Fig. 1. These can be regarded as contributing to  $\phi$ , the assumed error in the phase-shifter. The effect of such an error is to cause the oscillator phase angle to be controlled to a value other than zero. This will, in general, be serious only if the phase should depart greatly from zero, when there will be a loss in signal level, and the synchronising range will become asymmetrical. The fundamental phase requirement of the circuit is that the phase angle between the two signals fed to the control circuit modulator differs by  $90^\circ$  from the angle between the voltage injected into the synchronised oscillator and the output from it.

The application of the phase control circuit to a synchrodyne receiver is shown in Fig. 2. The incoming signal, in addition to being injected into the local oscillator and fed to the demodulator, is amplified, and tuned if necessary, before being applied to the control circuit modulator, where it is modulated with the output from the local oscillator, which has been synchronised in the normal manner. It is important that the signal path,  $P$ , to the control circuit modulator should not contain any of the output of the local oscillator, and the buffer stage,  $B$ , is therefore desirable, although not always necessary to prevent any much signal coming back through the locking path or demodulator.

The control modulator can most conveniently be of the "ring" type

using crystal rectifiers, as described in a previous article on the synchrodyne (August, 1947). Fig. 3 shows a circuit diagram of this modulator, and the associated reactor valve circuit which has been found suitable for operation at medium-wave-band frequencies. The D.C. output from the modulator is developed across  $R_7$ , and taken via  $R_5$  to the control grid of the reactor valve. The phase-shifting network between anode and grid, necessary as part of the reactance valve circuit is provided by  $R_4$  and  $C_3$ ; the reactive output impedance is connected across the local oscillator tuned circuit via  $C_2$ . The purpose of  $R_2$  is to stabilise the slope of the valve against changes in H.T. voltage.

The design of the remainder of the circuit is based on the normal principles of the synchrodyne phase requirements set out above. Using circuits based on Figs. 2 and 3, and operating at 1 Mc/s., an increase in the synchronising range to 10 Kc/s., representing an improvement of about 15 times, was obtained due to the connexion of the phase-control circuit. This is more than adequate to cater for frequency drift during "warming-up," etc., and would permit a reduction in the level of the synchronising signal injected into the oscillator.

No practical work has been done on the phase control circuit for short-wave frequencies. However, the increasing advantages of the phase control circuit for short-wave synchrodyne reception may well justify an investigation of the problems involved.

## 2. The Reception of Weak Stations Adjacent to Strong, with Overlapping Sidebands†

One of the most frequent questions asked about the Synchronodyne at Radiolympia 1947 was concerned with its performance on weak signals adjacent to strong ones. In the broadcast band, for instance, it is possible to require to receive a weak station whose carrier is separated by only 9 Kc/s. from that of a strong one. In the simple Synchronodyne, this can be done by adding a tuned circuit or filter in the synchronising path, as indicated in the first article (March, 1947); this may be as sharp as desired without causing any distortion to the audio output signal. But since the upper sideband of one station overlaps the lower sideband of the other it is not possible to avoid some interference due to this sideband splash, and if the difference in level of the incoming signals is large, this interference may be intolerable.

It was commonly assumed by inquirers that it is fundamentally impossible to separate overlapping sidebands like this. However, this is not true. At least one method of doing it has been described before,<sup>2</sup> and it will now be shown how the synchronodyne circuit can be used to give perfect reception of a weak station, say, 9 Kc/s. away from a stronger one, even with both carriers modulated by audio-frequencies up to 15 Kc/s.—i.e., not only with overlapping sidebands, but also with the sideband of one station overlapping the carrier of the other. It is only fair to say that the system to be described has not been tested out by the author, who does not plan to develop it at present, but there appears to be no serious difficulty in its use.

It is necessary first to appreciate that the Synchronodyne can be used as a rejector as well as an acceptor. This can be quickly seen mathematically, from the equations of Section 2 of the second article (August, 1947). The output of the demodulator was shown to be the modulation (audio) frequency with an amplitude proportional to  $\cos \theta$ , where  $\theta$  is the phase angle between the incoming carrier and the local oscillation, both referred to the appropriate terminals of the demodulator circuit. Thus normally  $\theta$  is made zero, to obtain the maximum output of the wanted signal. But if  $\theta$  is made  $90^\circ$ , then  $\cos \theta = 0$  and no output of the audio-frequency

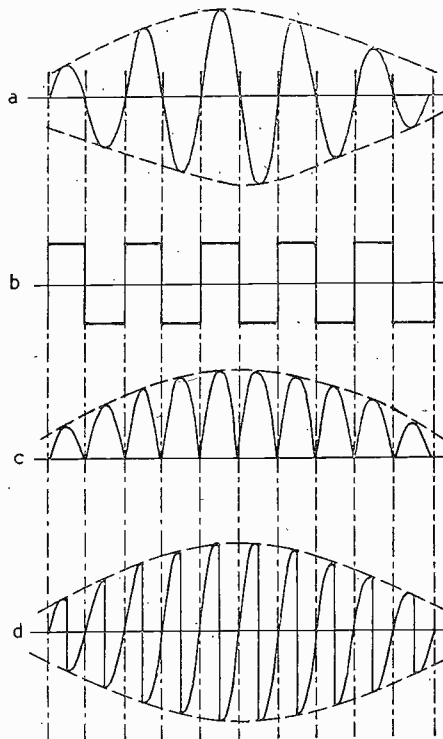

Fig. 4. The operation of the Synchronodyne as an acceptor and rejector

is obtained. This suggests the first stage of our new receiver, which is a Synchronodyne circuit with the local oscillator tuned to the unwanted station and with a  $90^\circ$  phase shifter in the local oscillator output.

The effect of the  $90^\circ$  phase-shift in changing from acceptance to rejection can be very easily seen graphically from Fig. 4. Here, at (a), a portion of the incoming A.M. wave is shown. If the local oscillator is synchronised to this wave, and the phase angle  $\theta$  at the demodulator is zero, then for the ring-type demodulator, in which the local oscillation causes a reversal of polarity every half-cycle, the operation of the demodulator is as shown in curve (b). On applying this operation to curve (a), we obtain the wave of curve (c), which is equivalent to a full-wave rectification of curve (a), and which evidently contains (after smoothing) a D.C. component and a modulation-frequency component in the normal manner. This is the normal synchronodyne condition. But if the local oscillation (curve (b)) is shifted in phase by  $90^\circ$ , then we obtain, on applying the

reversing operation to the input wave (a), an output wave as shown in curve (d). This wave obviously contains neither D.C. nor modulation-frequency components, but consists entirely of envelope-modulated waves of harmonics of the carrier frequency. If these are filtered out, evidently we have left no trace of the signal originally at the frequency of the local oscillator.

The mechanism of rejection of the unwanted station is now clear. At the output of the demodulator, the wanted station, assumed 9 Kc/s. from the unwanted one, appears on a carrier frequency equal to the difference in frequency between its original carrier and the local oscillator, i.e., on a 9 Kc/s. carrier. If the modulation frequency response of the transmitter extends to 15 Kc/s., then it is evident that in the lower sideband of the 9 Kc/s. carrier, the frequency-spectrum of components due to modulation frequencies between 9 and 15 Kc/s. is "doubled-back" and overlaps that of frequencies between 3 and 9 Kc/s. This causes confusion, and it is necessary to use a high-pass filter to eliminate at least the frequency range 0 - 6 Kc/s.\* We then have left a 9 Kc/s. carrier with a lower sideband corresponding to modulation frequencies from 0.3 Kc/s. with a complete upper sideband.

The scheme so far can be followed from the block schematic of Fig. 5, where after R.F. amplification as necessary at A, the incoming signals are applied to demodulator B, fed via  $90^\circ$  phase-shifter D from the oscillator C synchronised to the unwanted carrier. The output from the demodulator is fed through the low-pass filter E, which may have a cut-off anywhere around, say, 50 Kc/s., and which often need not be fitted at all, since the amplifier F, which amplifies the range 6-24 Kc/s. as much as is required, can often be arranged to have a high loss to high frequencies. The output of F is used to synchronise the oscillator J to 9 Kc/s. in the normal synchronodyne manner, and also feeds the second demodulator H via the high-pass filter G, which has a cut-off nominally at 6 Kc/s., but a gradual cut-off between 6 and 9 Kc/s. is

\* It would be better, of course, to eliminate the whole lower sideband by a high-pass filter cutting-off sharply between 8.97 and 9.00 kc/s.—then no phasing difficulties would arise. Unfortunately, it is hardly practicable to make such a filter.

acceptable. The phase-shifter K in the oscillator feed to the demodulator is likely to be necessary to correct for the phase-shift of filter G at 9 Kc/s., but no doubt it can often be omitted. The local frequency from K and the signal carrier after G should be of the same phase, since this stage is an acceptor synchronodyne. The output low-pass filter L is unlikely to be needed. Now at this point the output consists of the modulation frequency of the wanted station, covering the frequency band 0-15 Kc/s., with no interference from the unwanted station. The amplitude-frequency response of this band, however, has a 6 db. drop from around 3 Kc/s. upwards, owing to the fact that in this range, only one sideband contributes to the output. Thus, ideally, an equaliser M should be provided to correct this, but in practice its absence is unlikely to be noticeable in terms of programme equality.

We now see that, on paper, the problem of receiving a 15 Kc/s. audio-band from a weak station separated by only 9 Kc/s. from a

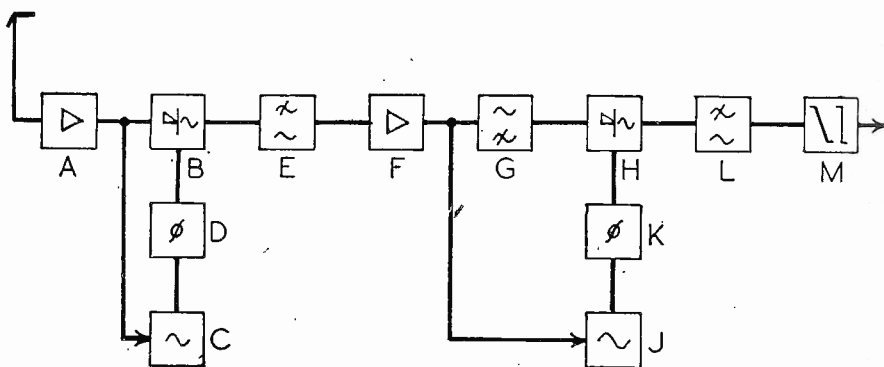

Fig. 5. Schematic of double Synchronodyne receiver to receive a weak signal overlapping a strong one. (See also next page)

strong one has been completely solved. In practice, the limitations will be:

(a) How accurately can the phase angle at the first demodulator be maintained at  $90^\circ$ ? By permitting continuous manual adjustment or by using the phase control circuit described by J. Garlick (above) it should be possible to maintain the angle correct to  $\pm 1^\circ$  for quite long periods. This means that the suppression of the unwanted station

will be at least  $\sin 1^\circ$ , i.e., 0.0175, i.e., 35 db. Allowing for the fact that all of the residual output lying between 0 and 6 Kc/s. is practically eliminated by the high-pass filter G, it will be seen that it should be quite possible to reduce interference to an inaudible level.

(b) How pure an A.M. signal is the broadcast? If there is any F.M. component, this will not be suppressed by the rejector synchronodyne stage.

### 3. Other Methods of Using the Synchronodyne in Radio Reception

#### 3.1 Short Wave Receivers

In the short-wave region, the relative spacing of channels is very much less than for medium waves. Thus difficulty might be experienced in using the simple Synchronodyne for short-wave work, owing to the synchronising range being perhaps as large as the channel spacing, when it would not be possible to discriminate against adjacent signals of equal strength. Two ways of using the Synchronodyne for this wave-range which are likely to be perfectly satisfactory are:

(a) The use of the phase-control circuit described in Section 1, above. In this case the voltage of the injected synchronising signal can be very much smaller than in the simple scheme, so that the discrimination against unwanted signals will be very much higher (see Fig. 5 of the August, 1947, article). Moreover, although the oscillator and control circuit can easily be arranged to lock only to the signal intended by making the pull-in range fairly small, it is possible to make the oscillator remain correctly synchronised over a range of drift of natural frequency very much larger than the channel spacing;

i.e., the pull-out range can be many times greater than the pull-in range.

(b) The use of a preliminary frequency changer, so that the Synchronodyne operates as an i.f. stage at, say, 1 Mc/s. or 500 Kc/s. The full advantages of the Synchronodyne are retained by this process provided the first frequency-changer is linear in the way required by the demodulator. If the Synchronodyne is tunable, a "band-spread" effect is obtainable.

#### 3.2 I.C.W. Receivers

The Synchronodyne can be used for I.C.W. reception by one of two processes:

(a) The use of a Synchronodyne designed as for other purposes, but with the addition of a modulating stage in the r.f. path where the incoming signal can be modulated with a 1,000 c/s. tone (say). Thus, during the time the signal is transmitted, the local oscillator synchronises to it, and a 1,000 c/s. tone is obtained in the output on account of the added local modulation. During the time the signal is interrupted, the oscillator runs free, but no output signal is obtained.

The time required for the oscillator to re-synchronise on each occasion is infinitesimal compared with the duration of the interruptions.

(b) The use of the Synchronodyne receiver in its normal condition except that the synchronising path is disconnected, and the oscillator allowed to run free at about 1,000 c/s. from the signal frequency. Like this, it is not, of course, used as a Synchronodyne receiver at all. If the C.W. is of very high frequency, it may be quite impossible to maintain the local oscillator anywhere near 1,000 c/s. from the signal frequency; in this case a special circuit<sup>(3)</sup> can be used to maintain the correct frequency difference.

#### 3.3 Single-span Receivers

To avoid the necessity for changing coil-ranges in changing from long to medium waves, the single-span system was suggested some years ago.<sup>(4)</sup> The principle was to use a preliminary frequency change upwards, to a fixed i.f. of, say, 1.6 Mc/s., by means of a local oscillator variable between, say, 1.8 and 3 Mc/s. Thus, all the stations between 200 Kc/s. and 1.4 Mc/s. can be tuned

in without a change of range. The objection to the scheme was that the amount of selectivity obtainable at 1.6 Mc/s. was insufficient for most purposes. Now, if a Synchronodyne is used as the 1.6 Mc/s. I.F. stage, adequate selectivity is readily obtainable, and the single-span receiver can be a success.\*

#### 4. Improvements in Details

##### 4.1 Suppression of the Tuning Whistle

The whistle obtained on tuning-in to a signal before the oscillator becomes synchronised is considered by many to be objectionable. There are several ways of avoiding it.

The method used on the Synchronodyne receiver demonstrated at Radiolympia is as follows. In the audio path is connected a rectifier network, as shown in Fig. 6, which normally has a negative bias applied so as to produce a large attenuation in the audio circuit. When the local oscillator is correctly synchronised, and not until then, there is a D.C. component in the demodulator output. This is used to overcome the bias in the network, and thus remove the attenuation. The effect is obviously to suppress (very largely) the tuning whistle, since the circuit is only "unblocked" after synchronism is obtained. The amount of the suppression depends on the type of rectifiers used. Since the signal level into the demodulator must not be large (in order to avoid non-linearity and consequent interference between signals), it is not generally practicable to obtain a D.C. voltage greater than about 0.1 or 0.2 volt. Thus, the bias on the rectifier network is limited to a value of about 0.1 volt. The amount of whistle-suppression obtained is obviously the amount of attenuation that is produced by a 0.1 volt bias relative to that at zero bias. With most types of rectifier this is not large, but with the germanium crystal rectifiers used in the demonstration receiver, a suppression of about 30 db. is obtained.

Another way of avoiding the whistle is a mechanical one. The tuning knob can be arranged so that normally it is held clamped by a spring-operated friction plate, and can be turned only on pulling-out or pushing-in the knob. This longitudinal movement actuates a switch contact on the condenser

\* This suggestion was made by an anonymous visitor at Radiolympia.

shaft which disconnects the audio output of the receiver. The tuning is performed with the aid of a tuning indicator, and only when correctly adjusted is the knob released to restore the audio circuit. Other variants of this scheme are easily devised.

##### 4.2 To make the oscillator frequency independent of the synchronising control potentiometer

In the simple circuits previously published the synchronising signal is taken direct from the R.F. signal path and injected into the oscillator grid circuit via a potentiometer. Normally this would be preset, but in any case, as it is varied, so the resistance in series with the grid circuit varies, and causes a change in the oscillator frequency. This can be irritating in the setting-up process, and can be eliminated by interposing a cathode-follower in the grid circuit, so that the resistance added to the grid circuit is low and constant, independent of the potentiometer setting. The arrangement is shown in Fig. 6, this refinement, too, being included in the "Senior" model. An alternative method is to use a constant resistance attenuator instead of a potentiometer.

##### 4.3 Automatic Gain Control

A.G.C. is rather a difficult problem in the Synchronodyne, owing to the need for good linearity in the R.F. circuit. Most gain control circuits, such as variable- $\mu$  valves, involve considerable non-linearity, and are unsatisfactory in the Synchronodyne.

One possibility is to reverse the application of the rectifier attenuator in the audio path, described in Section 4.1 for tuning-whistle suppression. If increasing D.C. from the demodulator increases the attenuation, then A.G.C. is obtained, in a forward-acting manner, if the circuit is suitably adjusted. Another possibility is to use a thermistor in the R.F. path.

##### Acknowledgements

In presenting the ideas and suggestions in this article, the authors feel bound to acknowledge the large extent to which their work on the subject has been aided and stimulated by discussion with many colleagues at Dollis Hill, who also assisted in dealing with the continuous stream of pertinent and persistent questions from visitors to the Synchronodyne exhibit at Radiolympia. The visitors themselves have, of course, indicated the directions in which further ideas were required.

##### References

- 1 K. R. Sturley, "Frequency Modulation," Electronic Engineering Monograph, 1942 (see Chap. III).
- 2 L. Gabrilovitch, British Patent Spec. No. 504,455.
- 3 F. J. D. Taylor and D. G. Tucker, British Patent Pending, Provisional Appn. No. 30981/46.
- 4 W. T. Cocking, *Wireless World*, 34, 1934, p. 196.

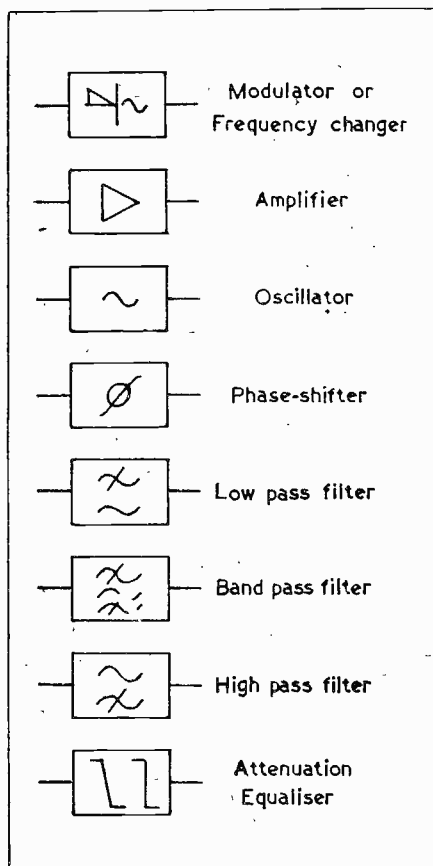

Symbols used in the schematic diagrams. Although most of the symbols used in the Synchronodyne diagrams are B.S.I. standard, they may be unfamiliar to readers who are not used to telecommunication engineering conventions. A list of the commonly used schematic symbols is given above. See B.S.I. 530-1937

##### Triode-hexode Oscillator Modified Coil

In the "junior" model of the Synchronodyne, using a triode-hexode oscillator, it has been found possible to improve the results by the use of greater amplitude of oscillation. To obtain this, the oscillator coil can be rewound with solid wire to the following specification:

- Primary:** 17 turns per slot of 38 g. enamelled copper. Total turns 68. Inductance 160  $\mu$ H
- Secondary:** (Tuned Winding) 17 turns per slot of 27 g. enamelled copper. Total turns 68. Inductance 160  $\mu$ H. Q = 70.

The use of solid wire gives a lower value of Q, and damping across the winding is therefore unnecessary.

For sketch of winding arrangement, see p. 367 of the November issue.

# The Synchrodyne

## Values of Components

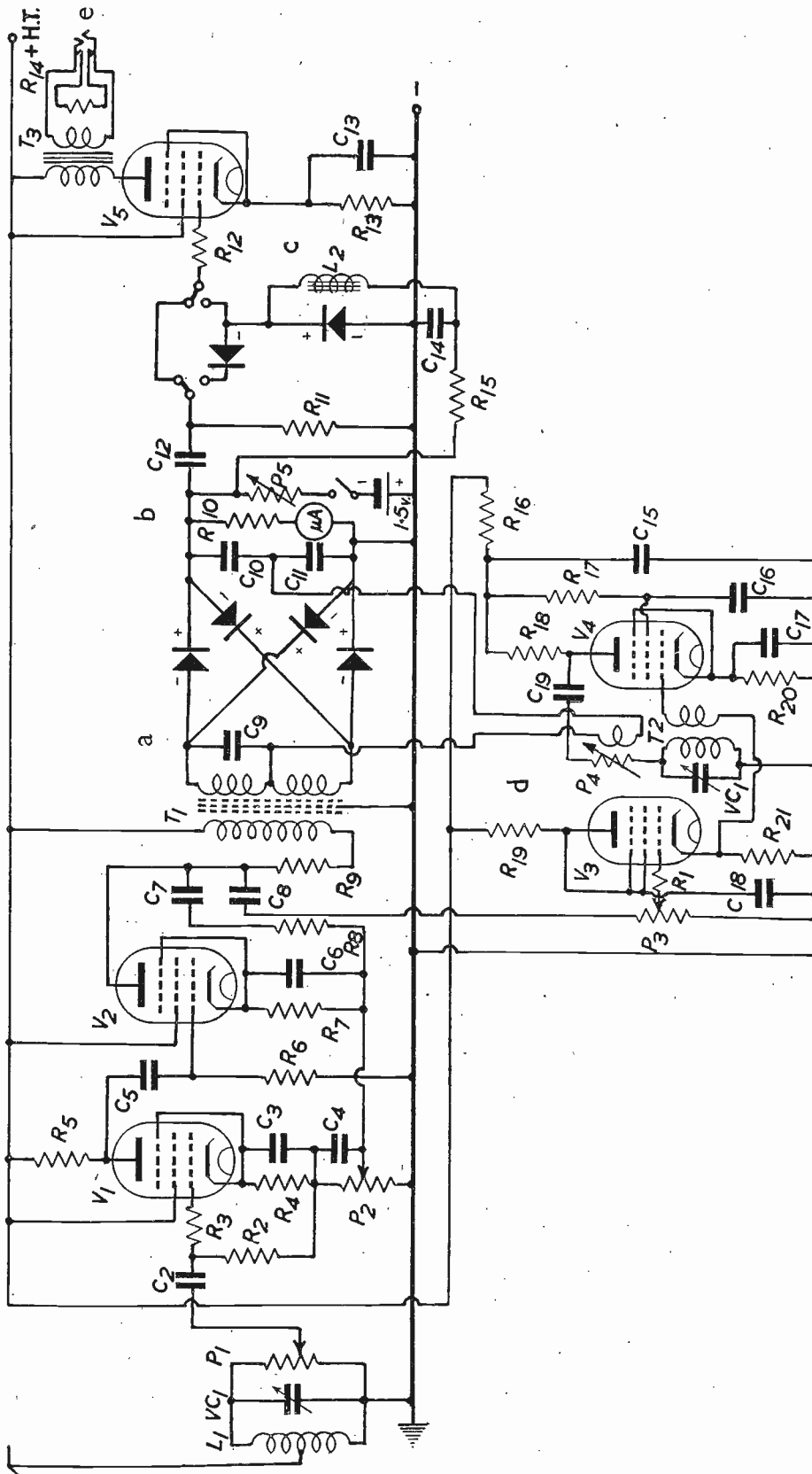

Fig. 6. Circuit diagram of "Senior" model

Resistor Values		Capacitor Values	
No.	Value	No.	Value
R		VCI	500+500 pF, ganged
1	100 Ω	C2	0.01 μF
2	100 K Ω	3	0.01 μF
3	82 Ω	4	0.01 μF
4	150 Ω	5	100 pF
5	10K Ω	6	0.01 μF
6	100 K Ω	7	100 pF
7	150 Ω	8	100 pF
8	22 K Ω	9	300 pF
9	4.7 K Ω	10	0.01 μF
10	3 K Ω	11	0.01 μF
11	4.7 K Ω	12	1 μF
12	100 K Ω	13	50 μF
13	150 Ω	14	0.05 μF
14	1 K Ω	15	0.1 μF
15	4.7 K Ω	16	0.01 μF
16	4.7 K Ω	17	0.01 μF
17	22 K Ω	18	0.1 μF
18	10 K Ω	19	0.01 μF
19	4.7 K Ω		
20	390 Ω		
21	200 Ω		

Potentiometers		Chokes and Transformers	
No.	Value		
PI	20 K Ω	L1	Input Coil
2	500 Ω	L2	L.F. Choke
3	50 K Ω	T1	Mod. Transformer
4	250 K Ω	T2	Osc. Transformer
5	50 K Ω	T3	Output Transformer (about 4:1 turns ratio)

**Valves:** SP.41.  
**Rectifiers:** Germanium.

### Notes on letters in diagram.

- (a) The value of C9 should be adjusted if possible to give the minimum leakage of the oscillator output back into the R.F. amplifier.
- (b) This meter serves as a tuning indicator, and to check the operation of the network C.
- (c) Tuning-whistle suppressing network. The choke L2 should have upwards of 100 henrys inductance and will probably need a magnetic screen to avoid 50 c/s pick-up.
- (d) Cathode-follower in synchronising path to make oscillator frequency independent of setting of P3.
- (e) Output to earphones—or to power stage for loudspeaker direct from anode.



# The Cathode-Follower

By E. PARKER, M.A. (Oxon) A.M.I.E.E.

Part 2. Linear Theory (Continued)

## 6. The Grid Current Points

### 6.1. Introduction

SECTIONS 3 and 4 of Part 1 showed how cathode-follower current and voltage characteristics could be drawn for any valve with any cathode load and any H.T. voltage provided only the parameters  $\mu$  and  $g_m$  of the valve were known, but the theory did not give the range of input voltages for which the characteristics were valid. In other words, the position of the characteristics was defined but not their extent. This will be considered in the present section and in particular the maximum input voltage that can be applied to a cathode-follower without driving it into grid current will be found graphically. The points on the current and voltage characteristics at which grid current begins to flow will be called the "Grid Current Points" and the simplifying assumption will be made initially that it is exactly at  $V_g = 0$  that grid current starts.

### 6.2 The Grid Current Point on the Voltage Characteristic

Fig. 10 shows a single characteristic drawn on a larger scale than those of Fig. 7. The line AP.PK is the (idealised) characteristic. It cuts the horizontal (i.e., input voltage) axis at  $-V_{ht}/\mu$  (by paragraph 4.2). Its slope is positive but less than unity (by paragraph 4.3). Let the line OK, whose equation is

$$V_i = V_o$$

be drawn. Its slope is exactly unity, i.e., greater than the slope of the characteristic, and so it intersects the latter at some point K as shown. Let P be any point on the characteristic between A and K. In the figure it is shown between P<sub>0</sub> and K, but the argument holds equally for P between A and P<sub>0</sub> provided the various voltages are given their proper signs. Let the ordinate through P be PN and let PN cut OK in Q. Then the voltage NQ is clearly equal to the voltage ON. But ON is that input voltage which gives the output voltage NP (since P is a point on the characteristic). Hence NQ, also, is

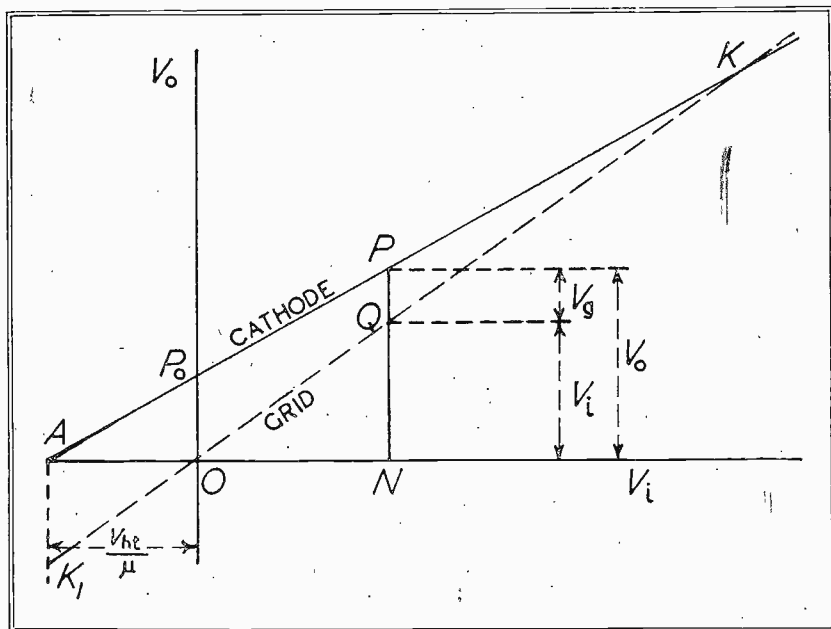

Fig. 10. Voltage graph showing relative grid and cathode potentials

the input voltage which gives the output voltage NP, i.e., the voltages  $V_i$  and  $V_o$  can be marked on Fig. 10 as shown and compared more readily than when they were simply X and Y co-ordinates of a graph, as in Fig. 7. It follows, incidentally, that PQ in Fig. 10 is the grid voltage  $V_g$ .

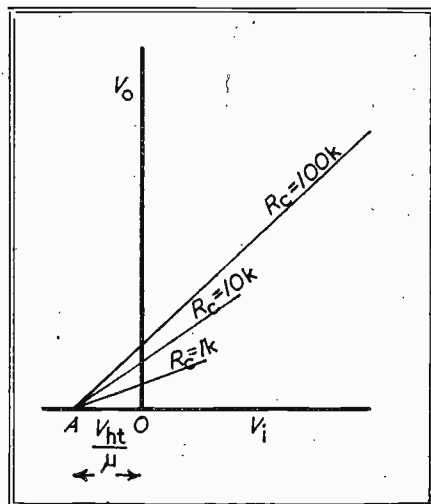

Fig. 7. Cathode-follower voltage characteristics for various values of  $R_c$

(from Part 1, p. 15)

As the ordinate PQN moves across the graph from left to right, the relationship between the input and output voltages undergoes the following changes. When the point P is at A, the valve is just cut off and  $V_o$  vanishes, the value of  $V_i$  then being  $AK_1 = OA = -V_{ht}/\mu$ . As  $V_i$  increases from this negative value to zero (P moving from A to P<sub>0</sub>),  $V_o$  increases from zero to the value OP<sub>0</sub>, and as  $V_i$  becomes positive (P moving from P<sub>0</sub> to K),  $V_o$  increases further, remaining always greater than  $V_i$  until the point K is reached. At K, if the fundamental equations held good, the grid voltage PQ would become positive. But at (or near) the point of zero grid voltage, grid current begins to flow, the original equations break down, and the characteristics are no longer linear. In terms of waveform reproduction, distortion begins at this point. If it is assumed that grid current begins to flow at exactly  $V_g = 0$  then clearly the Grid Current Point on the voltage characteristic is precisely its intersection K with the line  $V_i = V_o$ .

Thus both the upper and lower limits of distortionless working on the (idealised) characteristic are

now known, since the lower limit is, of course, the cut-off point A.

6.3 The Grid Current Boundary Line on the Voltage Graph

It follows at once that OK is the locus of the Grid Current Point as  $R_c$  varies, since whatever the value of  $R_c$ , the Grid Current Point on the corresponding voltage characteristic is the point at which the latter cuts the line OK. In other words, OK is the "Grid Current Boundary Line" on the voltage graph. Above and to the left of it the characteristics are linear. Below and to the right of it is the region of grid current.

A result of Section 4 may be combined with this result to define even more precisely the region of distortionless working on the voltage graph. For it was shown in paragraphs 4.2 and 4.3.1 that the voltage characteristics all lay below a line passing through  $-V_{ht}/\mu$  on the horizontal axis and having a slope  $\mu/(\mu + 1)$ . Hence the linear parts of the characteristics all lie in the wedge-shaped area of Fig. 11 bounded by a dotted line AK, the broken line OK, and the horizontal axis.

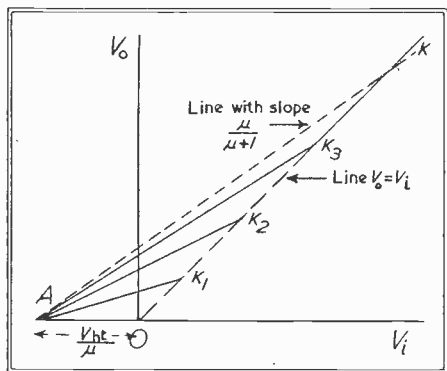

Fig. 11. Voltage characteristics for various values of  $R_c$  showing grid current points all lying on line  $V_0 V_1$

6.4. It is easily seen that if grid current begins to flow at  $V_g = -\frac{1}{2}$ , say, instead of at  $V_g = 0$ , then the line  $V_0 = V_1 + \frac{1}{2}$ , and not the line OK, will be the Grid Current Boundary Line.

6.5 The Grid Current Point on the Current Characteristic

The above paragraph 6.3 reveals immediately one disadvantage of the voltage characteristics, viz., that they are compressed into a small area of the graph, and, for large values of  $R_c$  especially, lie very close together. The current characteristics on the other hand (see Fig. 6) extend more evenly over the

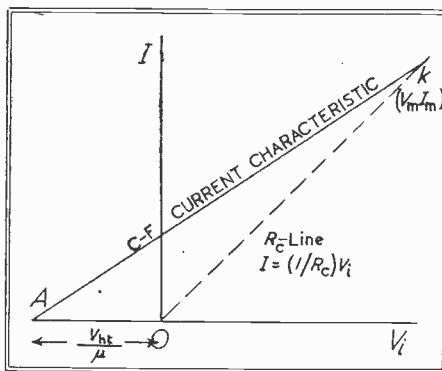

Fig. 12. A current characteristic for a given value of  $R_c$  with the corresponding  $R_c$  line

whole graph and are generally of greater practical use. It is therefore important to adapt the construction of para. 6.2 so that it can be used on the current characteristics graph. This is done by drawing on the latter the line  $I = (1/R_c)V_1$ . This line (Ok in Fig. 12) is the counterpart of the line OK on the voltage graph of Fig. 11, since the current characteristic for a given  $R_c$  is simply the corresponding voltage characteristic with its ordinates changed to  $1/R_c$  of their original value. Hence, the intersection of this line with the corresponding current characteristic marks the point on the latter at which the grid voltage becomes equal to zero. And this (with the same assumption as was made in para. 6.2) is therefore the Grid Current Point on the current characteristic.

6.6 The "Rc-line"

Since the construction line depends, in the case of the current characteristic, on the value of  $R_c$ , it will be called the "Rc-line." There is not, as there was in the case of the voltage characteristics, a single construction line OK through the origin, determining the Grid Current Points on all the characteristics at once. A new Rc-line has to be drawn for each value of cathode resistance. A current characteristic and its associated Rc-line are shown in Fig. 12. The slope of the Rc-line is, of course, equal to  $1/R_c$ .

6.7. If grid current begins to flow at  $V_g = -\frac{1}{2}$ , say, instead of at  $V_g = 0$ , it will be seen that the construction line for the Grid Current Point is the line  $I = (1/R_c)(V_1 + \frac{1}{2})$  parallel to OK but displaced to the left of it by half a volt.

7. Maximum Input and Outputs

7.1. Introduction

The last section showed how the Grid Current Points could be determined graphically on voltage or current characteristics that were given. The present section will show how their co-ordinates can be found without the aid of the characteristics, provided the "Ra" of the valve is known. The simplifying assumption that grid current starts precisely at  $V_g = 0$  will be made throughout. The extension of the results to cover the general case presents no difficulty.

7.2 The Co-ordinates of the Grid Current Points

Consider the current and voltage characteristics corresponding to a given  $V_{ht}$  and given  $R_c$ . Let the  $V_1$  co-ordinate of the Grid Current Points be  $V_m$  (it is, of course, the same on both the current and voltage graphs). Then, since the output voltage is equal at the Grid Current Point to the input voltage (by the assumption of the previous paragraph), the  $V_0$  co-ordinate (on the voltage graph) is also  $V_m$ , i.e.,  $(V_m, V_m)$  is the Grid Current Point on the voltage characteristic. These co-ordinates can therefore be substituted for  $V_1, V_0$  in Equation (4.1), giving

$$V_m = \frac{R_c}{R_m + \frac{\mu + 1}{\mu} R_c} (V_m + V_{ht}/\mu)$$

Solving this equation for  $V_m$  and substituting  $R_a$  for  $\mu R_m$  leads immediately to the result:

$$V_m = \frac{R_c}{R_a + R_c} V_{ht} \dots \dots \dots (7.1)$$

If the  $I$  co-ordinate of the Grid Current Point on the current graph is  $I_m$ , then clearly  $I_m = V_m/R_c$  and so by Equation (7.1),

$$I_m = \frac{V_{ht}}{R_a + R_c} \dots \dots \dots (7.2)$$

These are the required formulae for the co-ordinates of the Grid Current Points  $(V_m, V_m)$  and  $(V_m, I_m)$  on the voltage and current characteristics respectively.

In the above algebra, the exact form (4.1) of the fundamental voltage equation was used instead of the form (4.2) which had previously been of most use. This was because the lines AK, OK, in Fig. 10, whose intersection K was in effect being

investigated, are nearly parallel, and to use an approximate equation for one of them would give quite incorrect results. It should be noted further that there is in any case no simplification to be achieved by any approximation of the form  $\mu + 1 \approx \mu$  as there was when slopes and gain, etc., were being considered in Sections 2, 3, 4 and 5. The exact result in this case is also the simplest. It is also interesting to observe that  $g_m$  does not appear in Equations (7.1) and (7.2).  $R_a$  is the only valve parameter involved.

**7.3 Interpretation of  $V_m$  and  $I_m$**

It should be noted that  $V_m$  and  $I_m$ , as well as being the co-ordinates of the Grid Current Point on the current characteristic, are the maximum D.C. voltage and current outputs, respectively, of the valve. They are also the maximum peak-to-peak A.C. outputs, (i.e., "signal" outputs) provided the valve is being swung completely to cut-off; but this is not always the case. For example, if an absolutely linear amplitude response is required, the curved "tail" of the characteristic must be avoided, and the maximum peak-to-peak outputs available will be slightly less than  $V_m, I_m$ . In particular, if only positive-going video signals are being dealt with, the valve will usually be biased to the bottom of the straight portion of its characteristic and the maximum "signal" outputs will be less than  $V_m$  and  $I_m$  by the amounts of the "standing" (i.e., no-signal) cathode voltage and current respectively. (This condition is usually achieved by returning the grid-leak to H.T. negative—i.e., the bias point in Fig. 10 is at  $P_0$ ).

It will also be seen that  $V_m$  is the maximum D.C. input voltage that can be applied to the valve (without driving it into grid current) and that the maximum permissible A.C. input voltage for distortionless working (in the "idealised" case) is  $V_m + V_{ht}/\mu$ . ( $V_m$  is usually a sufficiently good approximation to this as well, unless  $R_c$  is small.) Finally,  $V_m$  is the maximum permissible positive-going signal input when the grid-leak is returned to H.T. negative.

**7.4 "Short-Cut" Proof of Equations (7.1) and (7.2)**

The results (7.1) and (7.2) can be obtained directly from the fundamental triode Equation (1.1). What is required is firstly the value of the current through the valve when

the input and output voltages have reached equality, and secondly, an expression for what that common voltage then is. Let these unknown quantities be  $I_m$  and  $V_m$  respectively. Then clearly the grid and anode voltages of the valve under this condition are  $V_g = 0$  and  $V_a = V_{ht} - V_m$ , respectively, while by hypothesis  $I = I_m$ . Substituting these values in Equation (1.1) gives  $I_m = (V_{ht} - V_m)/R_a$ . But  $V_m = I_m R_c$ . Solving these two equations for  $V_m$  and  $I_m$  leads immediately to the results  $V_m = [R_c / (R_a + R_c)] V_{ht}$  and  $I_m = V_{ht} / (R_a + R_c)$  which are the Equations (7.1) and (7.2) previously established.

**7.5. A Mnemonic Circuit**

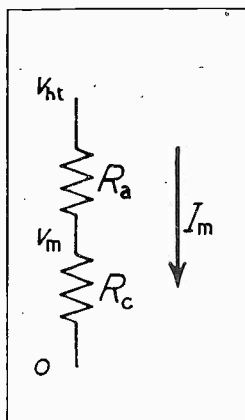

Fig. 13. Mnemonic circuit for maximum outputs with given  $R_c$

with the Equations (7.1) and (7.2).

**7.6 Power Output**

From Equations (7.1) and (7.2), the (D.C.) power output available with a given value of  $R_c$  is  $I_m V_m = R_c (V_{ht})^2 / (R_a + R_c)^2$ . It can easily be shown that this expression has its greatest value, viz,  $(V_{ht})^2 / 4R_a$ , when  $R_c = R_a$ . This is therefore the condition for Maximum (D.C.) Power Output assuming the necessary input voltage to be available. The corresponding values of  $I_m$  and  $V_m$  are  $V_{ht} / 2R_a$  and  $V_{ht} / 2$  respectively. The latter is also the expression for the necessary input voltage (approximately). The Maximum Undistorted A.C. Power Output is one-eighth of the maximum D.C. power output, that is  $(V_{ht})^2 / 32R_a$ .

It should be noted that the usual condition for maximum power output, viz, "external load equals internal impedance," does not apply generally in the case of the cathode-follower, since the value of the cathode load affects the permissible input voltage. It can easily be

seen that the condition  $R_c = R_m$  is, in fact, only valid if this value of  $R_c$  is sufficient to accommodate the available input voltage. For inputs greater than this, but less than  $V_{ht} / 2$ , the maximum power output is obtained by making  $R_c$  just large enough to accommodate whatever input voltage is available.

**8. The Grid Current Boundary Line on the Current Graph**

Eliminating  $R_c$  from Equations (7.1) and (7.2) leads to an important relationship between  $V_m$  and  $I_m$ , i.e., between the maximum output voltage and the maximum output current available with a given cathode resistance. It is  $V_m + I_m R_a = V_{ht}$ , a result which could also have been written down from Fig. 13. This relationship means, in geometrical language, that whatever the value of the cathode resistance  $R_c$ , the Grid Current Point on the corresponding current characteristic always lies on the straight line whose equation on the  $V_i, I$  graph is  $V_i + I R_a = V_{ht}$ . This is therefore the equation to the locus, on the current graph, of the Grid Current Point as  $R_c$  varies, i.e., to the Grid Current Boundary Line on the current graph. If  $I_1$  is written for  $V_{ht} / R_a$ , the equation to the Grid Current Boundary Line becomes, more usefully,

$$\frac{V_i}{V_{ht}} + \frac{I}{I_1} = 1 \dots\dots\dots (8.1)$$

which shows that the Grid Current Boundary Line joins  $V_{ht}$  on the voltage axis to  $I_1$  on the current axis. Its backward slope is  $I_1 / V_{ht}$  or  $1 / R_a$ .

It should be noted that  $I_1$  is also the point at which the corresponding mutual characteristic cuts the current axis (setting  $V_g = 0$  and  $V_a = V_{ht}$  in Equation (1.1) gives  $I = V_{ht} / R_a$  which is  $I_1$ ). Hence the Grid Current Boundary Line corresponding to an H.T. voltage  $V_{ht}$  can be constructed by taking the mutual characteristic  $V_a = V_{ht}$  and joining its intersection with the current axis to the point  $V_{ht}$  on the voltage axis. Fig. 14 illustrates this construction and shows several current characteristics corresponding to different values of  $R_c$ .

**9. Prediction of the Current Characteristics**

It was shown in the previous section that the Grid Current Point on any current characteristic is its point of intersection with a certain

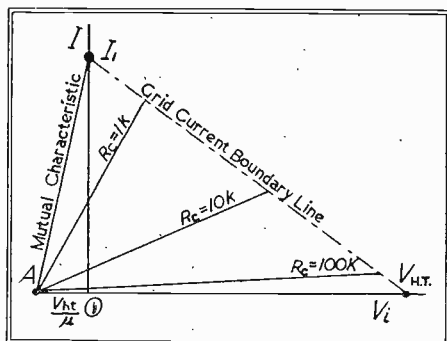

Fig. 14. The grid current boundary line

diagonal line, the Grid Current Boundary Line. But paragraph 6.5 showed that the Grid Current Point on any current characteristic was its point of intersection with a line through the origin, the  $R_c$ -line for that value of cathode resistance. Hence, the Grid Current Point on any current characteristic is, in fact, at the point of intersection of the corresponding  $R_c$ -line with the Grid Current Boundary Line. This determines one point on the required characteristic. A second point on the characteristic is already known, namely, the point A at the foot of the (idealised) mutual characteristic (see paragraph 3.2 or Fig. 6).

The line joining these two points is the required idealised current characteristic in extent as well as position. (To be continued)

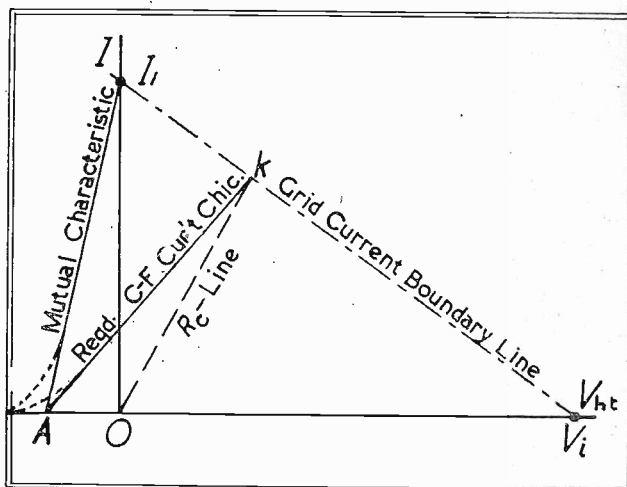

Fig. 15. Prediction of current characteristics

The construction can be summarised as follows (refer to Fig. 15):

- (1) Draw  $AI_1$ , the idealised mutual characteristic  $V_a = V_{ht}$ .
- (2) Join  $I_1$  to  $V_{ht}$ . This is the Grid Current Boundary Line.
- (3) Draw  $Ok$  with slope  $1/R_c$  cutting the Grid Current Boundary Line at  $k$ . This is the  $R_c$ -line.

- (4) Join  $Ak$ . This is the required idealised current characteristic.

In addition, if desired,

- (5) Add a curved tail corresponding to the curved tail on the mutual characteristic to obtain a better approximation to the exact cathode-follower characteristic.

ERRATA—PART I. Equation (3.3): For  $+g_m$  read  $\times g_m$ . Figs. 2 and 5 should be interchanged.

## New Developments in Recording Oscillograph Traces

IT is well known that high speed mechanical or electrical variations can be translated by a standard commercial oscillograph into visible traces on a fluorescent screen. The impermanence of the traces, however, makes difficult any accurate study of the inter-relationship of several phenomena and makes impossible any subsequent checking; and attempts have been made with varying success to photograph these traces by means of standard cameras.

The number of traces which can be so recorded simultaneously is, however, limited in practice by the fact that the space between the screens necessitates moving the camera back so far that the traces are reduced eventually to an impracticable scale. To provide a record on a practical scale where a number of traces are required to be shown side by side, Messrs. Avimo, Ltd., now have in production a series of recording cameras with

built-in cathode ray tubes, the latter so arranged that their traces are photographed through a mirror. In this way, as many as 15 traces plus a timing interval may be recorded on a scale adequate for practical purposes.

In one form of apparatus, designed for the Ministry of Supply, the outputs from a series of pickup units are amplified and recorded on 6 C.R. tubes  $1\frac{1}{2}$  in. in diameter, which are built into the camera.



The maximum length of trace on each tube screen is 1 in., which is reduced to 10 mm. on the film. Provision is made for the use of standard 70 mm. perforated film or paper in 100 ft. lengths, wound on metal spools, and a microscope is provided which permits the viewing of the traces whilst recording is in progress. The cathode ray tubes are each mounted in a mu-metal shield, so arranged that the light from the tube heaters has a minimum effect on the film, and it is possible by an adjustment which is not affected by normal vibration and handling, so to orientate each tube in its mounting that the traces lie on one straight line on the record, at right angles to the direction of film travel. A range of six film speeds is obtainable, approximately 1,  $2\frac{1}{2}$ , 5, 10, 25 and 50 inches per second. In another model, of which a photograph is shown, 15 channels are simultaneously recorded side by side on the film.

# The New Television Camera

— The C.P.S. Emitron

**T**HE C.P.S. Emitron is an electronic television pick-up tube which has been developed since the end of the war in the E.M.I. Research Laboratories Ltd., and gives promise of extending the scope and quality of the B.B.C. television service. Preliminary trials of this new camera tube, such as the Royal Wedding and the "Itma" programme on the occasion of the visit of the King and Queen to Broadcasting House, have been very encouraging.

The Emitron and Super-Emitron which were developed before the war and are still in use by the B.B.C., gave very good quality television pictures and a very reasonable variety of programmes. However, they have several limitations. Firstly, it is necessary to have quite good illumination for transmission of a good quality picture. Studio illumination at A.P. is uncomfortably intense; the stage illumination for broadcasts direct from theatres has to be increased to such a degree that it spoils the show for the audience and frequently outside broadcasts are of poor quality because the light is bad. Secondly, undesirable shading appears in the pictures, even when the light is quite adequate, which must be continually corrected by the operating engineers. When the light is poor this shading of the picture ("tilt" and "bend") becomes uncontrollable.

The C.P.S. Emitron overcomes these defects by applying a method known as Cathode Potential Stabilisation (hence the name C.P.S. Emitron), which was invented by E.M.I. research engineers in 1934.\* As is well known, the Emitron operates as follows: a lens forms an image of the scene to be transmitted on a mosaic of photo-sensitive elements. The light of the image liberates photo-electrons from these minute particles and as these photo-electrons are lost, positive charges are built up on the mosaic which correspond to the light distribution in the image. The mosaic is then scanned by a high velocity beam of electrons which discharges these positive charges in succession.

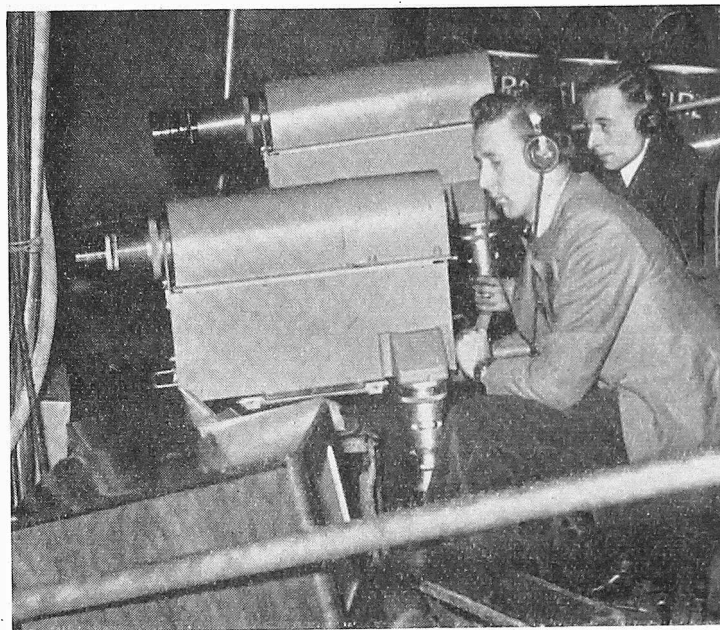

The new Emitron in use at an Edmonton theatre during an evening performance

As each is discharged, an electrical pulse is imparted to a common electrode known as the signal plate, which passes these pulses on to the amplifier. Unfortunately, besides discharging the mosaic elements, these high speed electrons also knock out of the mosaic a large number of secondary electrons which spread across the mosaic and result in reduced efficiency and the spurious signals referred to above.

In the C.P.S. Emitron the mosaic is stabilised at the potential of the cathode from which the beam electrons come, and hence they fall on it with very small energy: so small that they cannot knock secondary electrons out of the surface. In this way the undesirable shading and other spurious signals are eliminated and much higher efficiency attained. A further post-war E.M.I. invention has enabled the sensitivity of the photo-electric mosaic to be very greatly increased, and the fidelity of reproduction of colours to be improved.

Intensive work on these methods (all television research was stopped during the war) has culminated in the C.P.S. Emitron. This tube is

capable of transmitting satisfactory pictures, quite free from shading effects, with normal lighting such as is required for comfortable working and considerably less than is normally used on a theatre stage. This is something like fifty times less light than is required by an Emitron and one-tenth that required by the Super Emitron. Moreover, with quite moderate lighting the aperture of the camera lens can be stopped down to such an extent that great depth of focus can be obtained in the picture. Since shading signals are entirely absent, the camera can be turned from one scene to another without the picture being upset by these troublesome effects, which can be very irritating even with very expert operation.

The C.P.S. Emitron will enable a saving to be made in the power required to illuminate indoor scenes as well as improving the comfort of the actors, and outdoor broadcasts will be possible until dusk. Certainly the poor light would have stopped play in most games before the picture would have become unsatisfactory.

\* Br. Pat. 446661.

# Multi-Lingual Interpreting Systems

C. A. TUTHILL\*

This description of a unique application of audio frequency reproduction is reproduced in a condensed form from the original article in **Audio Engineering** (September 1947), with acknowledgements to the author and publishers.

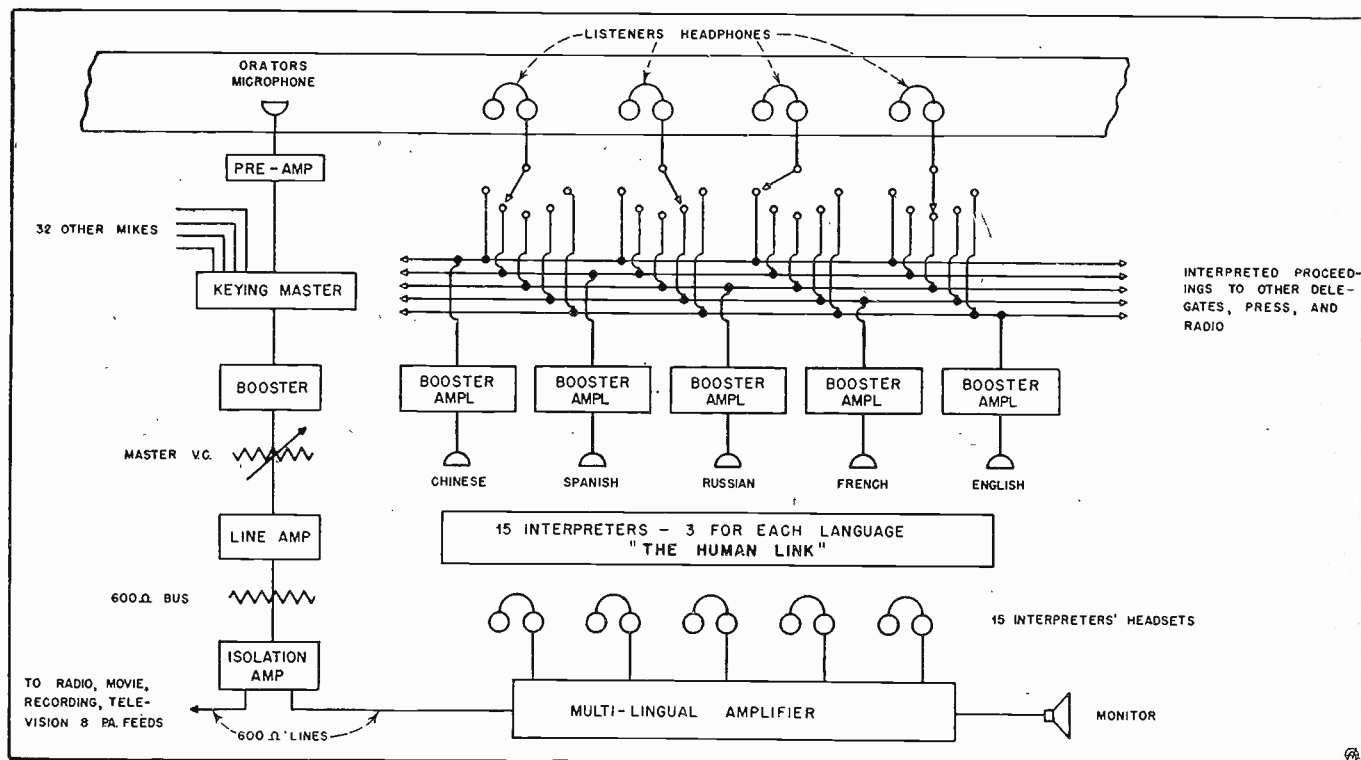

**E**XCEPT in the State Department, little is known in America about simultaneous translation from one into several languages. In Europe two adjoining states—such as Pennsylvania and New Jersey here—speak two different tongues. To countries on the continent it is an old story, but until the United Nations invaded these shores little concern was ever had hereabouts for complex translation.

Until audio interpreting systems were installed in three conference rooms last fall at Lake Success, L.I., many thousands of man-hours were lost during United Nations debates. The meetings would come to a complete halt while trained interpreters repeated in French or English the twenty-minute or half-hour speeches.

This nuisance was partially eliminated one year ago when the electronic method was used with such success that five major languages were poured back into the

ears of the delegates as rapidly as their colleagues spoke.

After the old League of Nations settled in Geneva, nine IBM-Filene-Finlay Translator audio channels were installed there. More recently the prosecutors of the Japanese and German War Trials have used this same equipment. It has been roughly estimated by one of the judges participating at the Nuremberg trials that those hearings would have consumed five or more years were it not for the multi-lingual channels.

## Conference Rooms

At United Nations headquarters, two large conference rooms served by the multi-lingual equipment seat over 50 delegates each around an oval-shaped table. Selector switches and a headphone to the right of each national offers him a listening choice of five languages. Any delegate understanding the spoken tongue need wear no headphone, since both the conference table and

outer areas of the room are covered by a low-level p-a system utilising 48 speakers, with those adjacent to microphones being killed automatically by relays when the microphones are keyed into the circuit.

Across the end of the room opposite the chairman, and elevated enough for good vision, are five sound-proof, air-conditioned booths. Each seats three interpreters who relieve each other in the handling of one language since there can be no interruption of service. In rotation laterally these booths handle: Chinese, Spanish, Russian, French and English. Adjacent to these is an open booth housing rack-mounted variable-gain amplifiers, rectifiers, patch panels and spare equipment. An engineer checks the entire system well in advance of operation and constantly monitors the channels at this point.

## System Operation

Delegates in all major U.N. meeting rooms have microphones before

\* 2345 Broadway, New York 24, N.Y.

them which normally feed all radio, television, newsreel recording, and p-a apparatus. It is from these microphones that the interpreting channels start to function (see block diagram, Fig. 1). From pre-amps on through a keying mixer and its boosters a feed is linked with the multi-lingual input. Here it is balanced, amplified, monitored and distributed to the headphones of 15 highly capable male and female interpreters.

The keying-mixer is the audio nerve centre of the entire system. Six vertical banks of five keys each cut on or off 30 microphones. These accommodate 60 delegates, each microphone serving two people. Two keys are provided for two interpreters' microphones when the room is not equipped for simultaneous interpretation. A further knob and its microphone key allows individual handling of the chairman. The notable feature is that the gain controls for 33 microphones are boiled down to eight knobs. A special knob and key above set the monitoring level, and provide instant comparison if either bus behaviour is in question, and a key instantaneously flips the output to an

alternate line amplifier in case of trouble.

A strategic factor in this arrangement is key designation. The engineer must find the correct key for an active nation in a split second. This calls for distinct labelling of all keys—two nations per key.

The alertness and good judgment of the control engineer contribute greatly to the smoothness of the show. The chairman frequently fails to recognise delegates and they often do not wait for recognition. They do not stand in conference while speaking. Since some are seated with their backs to the engineer, and are often entirely inanimate, he must recognise their voices to cut in the proper microphone. When argument reaches heated cross-fire proportions, he has difficulties indeed.

#### Interpreters

Referring to the block diagram, Fig. 1, we see the human factor linking the translating audio equipment with the original.

The men and women who translate these international orations perform with the precision of pulsing circuits. Justice to their

achievement cannot be done here. To relay truly the original speech, they must introduce no feelings of their own as they translate rapidly. Instead they must convey the genuine intent supported by enough bona-fide expression to hold attention.

Literal word-for-word interpretation being an impossibility on account of idioms, these multi-tongued people lean upon their own judgment for an equivalent phrase which will convey the identical meaning in another language. Despite all this, these human time-delay relays lag but slightly. They often finish within a second or two of the original speaker. These interpreters do an admirable job.

The audio channel picks up again as the interpreters talk into breast-type ribbon microphones. From this point forward the speech is boosted conventionally through variable-gain amplifiers constantly monitored. From the rack-mounted regular and spare amplifiers the interpretations are distributed over audio lines to several hundred selector switches and their headphones. With all seats in the house covered, the audio system is completed.

## Commercial Disk Recording and Processing

AT a meeting of the Radio Section of the Institution of Electrical Engineers held in London on December 9, 1947, an informal lecture on "Commercial Disk Recording and Processing" was given by Mr. B. E. G. Mittell, M.I.E.E. Mr. Mittell stated that at present commercial conditions appeared to confine the disk record to the speed, diameters and groove spacing which were in common usage. Assuming this to be so, the debatable point arose whether the future of the disk record were to be limited in playing time, in frequency range and in dynamic range, and, furthermore, whether it should always be destined to run at an excessive range of linear speed. Non-commercial records already provided interesting departures from the "common usage" bond.

The discussion which followed indicated that there was no fundamental disagreement with the proposals put forward by the speaker. It was thought that a preliminary committee on which the principal

British record producers were represented would have no difficulty in reaching tentative agreement, and that their findings could form the basis of a British Standard.

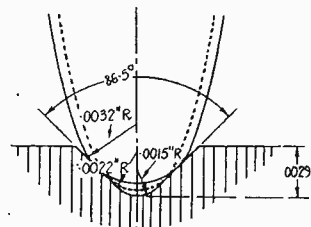

15  
RECOMMENDED STANDARDS FOR PRESENT  
CONDITIONS

Groove wear during playing was discussed and it was stated that sapphire points did not necessarily damage the groove walls. A record which had been played 1,000 times by a commercial pick-up with 38-gm vertical weight on the sapphire point was played by way of proof.

Opinions differed on the expectations of life of sapphire points. Some

thought that wear could be detected after 50 playings, others that 2,000 playings could be obtained with a 30-gm pick-up before the width of the flat reached 0.002 in. This amount of wear could be tolerated on standard records, but would be noticeable when the upper limit of recording was 15 Kc/s.

In the absence of the grinding-in process, which was completed with steel needles in the silent outer grooves of the record, the shape of sapphire and diamond style was of paramount importance in controlling surface noise. The development of lightweight pick-ups and the demand for automatic record changers meant that "permanent" points were essential. Fears of trouble through breakage were largely unfounded. With a cantilever-sprung mounting, giving a vertical compliance, sapphire points could be dropped several inches onto a disk without risk of fracture; alternatively, a simple automatic lowering mechanism could provide the necessary protection.

## CORRESPONDENCE

### A New Gain Unit ?

SIR,—Early in the history of electronics, designers had to tackle the problem of specifying and describing the magnification characteristics of amplifiers. Everyone knows that after much controversy and confusion, the acoustic power-ratio, the decibel, has been generally adopted to indicate the gain in loudness or "volume" achieved with audio-frequency amplifiers. Excellent though this system may be for this particular purpose, it is not ideal for the other application of amplifiers, the driving of oscillographs or recorders whose function is to display amplitudes rather than to transduce power.

In designing or describing an amplifier for this latter purpose it would be more useful to have a convention which would give some idea of what the signal would actually look like on the screen of the oscilloscope or on the record. In present practice, this is achieved by stating the deflection obtained with a given input, for example,  $10 \mu\text{V}/\text{cm.}$  or  $1 \text{ cm.} \equiv 10^{-5}$  volts. This is perfectly clear, but has the disadvantage—slight perhaps, but definite—that it involves either a Greek letter prefix in the first case or a superscript index in the second. Now, a similar problem exists in chemistry: the printing of figures to denote hydrogen-ion concentration. Thus, a "neutral" solution contains  $10^{-7}$  grams of hydrogen-ions per litre. In order to avoid the superscript negative index and the "per" or stroke, the convention is to write only the index, with the minus sign omitted, calling such figures "pH" units. This sign should be written  $P_H$  but, again, the subscript is abandoned in deference to the compositor.

It would seem that a similar logarithmic convention might be useful in electronic engineering; thus, " $10 \mu\text{V}$  per cm." would become  $5 \text{ pV}$ . The inconvenience of a negative pV value would be rare, since  $-1 \text{ pV}$  ( $10^1$  volts per cm.) is the order of deflectional sensitivity of most oscilloscopes at moderate anode voltages without an amplifier. The accompanying table and examples illustrate the use of this system. In addition I should like to include a plea for the general adoption of the Continental system

of using "hertz" for cycles per second. Surely writers, editors and printers are all weary of c/s., cyc. per sec., or worse, "cycles" alone?

#### SENSITIVITY

Deflectional Sensitivity (S) (per cm.)	$\text{pV} \left( = \text{Log} \frac{1}{S} \right)$
1 V $10^0$	0
100 mV $10^{-2}$	1
10 mV $10^{-3}$	2
1 mV $10^{-4}$	3
100 $\mu\text{V}$ $10^{-5}$	4
10 $\mu\text{V}$ $10^{-6}$	5
1 $\mu\text{V}$ $10^{-7}$	6

#### Frequency Response

Cycles per second  $\equiv$  hertz (h)

Kilocycles per second  $\equiv$  kilohertz (kh)

Frequency response of an amplifier can be indicated by figures in brackets following sensitivity rating. These figures are the frequencies at which the response drops by 10 per cent.

Examples:

A DCC amplifier for CRO:

$3 \text{ pV}$  (0-100 kh).

A RCC amplifier for electro-encephalography:

$5 \text{ pV}$  (1 h - 100 h).

—Yours,

W. GREY WALTER, M.A., Sc.D.

Burden Neurological Institute,  
Bristol.

#### Degrees for Ex-Servicemen

SIR,—With regard to degrees for ex-servicemen and those employed in the Engineering Industry during the war, some further information is to hand.

I have once more been in contact with the Ministry of Education who are discussing with the London County Council and the Local Education Authorities in Essex, Herts., Middlesex, Surrey, Kent and Bucks., together with the Technical College Authorities, the question of the introduction of Saturday instruction, possibly in lieu of some evening work. It is considered that, whereas additional Saturday training could perhaps not be achieved because of lack of staff and the natural desire for the teaching staff to have a five-day week, some such arrangement as envisaged might be achieved.

If, however, arrangements such as this are to be made to assist the employees of the engineering industry, the object can only be fully achieved if qualified persons who are engaged in industry are prepared to assist the technical colleges by teaching on Saturday mornings in order to avoid some of the staff difficulties. It is hoped, therefore, that senior engineers will see the importance of training the younger members of the industry, both in physics and engineering, and that they will offer their services to the technical colleges throughout the country and particularly in the counties mentioned above and in the London area. This action will help to retain and increase the prestige and industrial efficiency of the nation.

O. S. PUCKLE.

Hedgeside,  
Holtspur End South,  
Beaconsfield, Bucks.

#### Television Bandwidth

DEAR SIR,—I should like to correct an erroneous impression which is given by W. I. Flach in his review of "Television To-day" by Roy H. Norris, which appeared in your December issue.

Mr. Flach states that the author appears to be confused on the matter of the bandwidth required for the Alexandra Palace transmission, while, in fact, it would seem that on the author's part no such confusion exists.

The point at issue is the discrepancy which exists between the bandwidth of 2.56 Mc/s. as calculated from the formula:

$$\frac{fRP}{2}$$

in which  $l$  is the number of lines (405),  $R$  is the aspect ratio ( $5/4$ ),  $P$  is the picture frequency (25), and the bandwidth actually radiated, which is stated to be approximately 2.75 Mc/s. The author is quite correct in stating that the reason for the discrepancy is that the formula does not take into account the time lost during the line and frame fly-backs.



The formula, in fact, expresses correctly the bandwidth which would be required to give equal horizontal and vertical definition for a theoretical system which employed no synchronising pulses, and which had an aspect ratio of 5:4. (The formula quoted in the review contains an error in that the aspect ratio is shown as 4:5).

If now the picture area in such a system were to be reduced by the addition of blanking pulses to allow for synchronising signals, the bandwidth would be unaffected, but unless the line and frame blanking pulses were equal fractions of the line and frame scanning periods respectively, the aspect ratio of the picture would be changed. In the case of the British system the line blanking period is approximately 15 per cent. of a line, while the frame blanking is approximately 10 per cent. of a frame period\* and the actual picture would then have an aspect ratio of:

$$(5 \times .85) : (4 \times .9) = 4.25 : 3.6 = 4.72 : 4$$

It is this change of aspect ratio which is responsible for the apparent discrepancy.

Also, the British system, which uses an aspect ratio of 5:4 for the picture complete with blanking, is theoretically capable, assuming no synchronising signals or blanking to be necessary, of providing a picture containing 405 lines with an aspect ratio of:

$$(5 \div .85) : (4 \div .9) = 5.88 : 4.44 = 5.3 : 4$$

Inserting this value in the above formula in place of the ratio 5:4, we obtain a figure of 2.72 Mc/s., and this is approximately the bandwidth that is required to transmit a picture containing 365 lines with an aspect ratio of 5:4.

Mr. Flach is again in error for quoting the number of lines seen on a picture as 385. Assuming 20 lines are blacked out during the frame fly-back, the number of lines visible on an interlaced picture is only 365, since 40 lines are suppressed in each picture.

The figure of approximately 2.7 Mc/s. may easily be checked from simple physical considerations. For equal definition horizontally and vertically it must be possible to transmit:

$$365 \times \frac{5}{4} = 456.25 \text{ elements}$$

in the period of one picture line. The duration of a picture line is 83.7 μsecs. and therefore the maxi-

mum number of elements which are required to be transmitted per second is:

$$\frac{456.25 \times 10^6}{83.7} = 5.45 \times 10^6$$

The required frequency band is half this figure or 2.77 Mc/s., which is in reasonable agreement with the value obtained from the formula, bearing in mind that the percentage quoted for the line blanking was only approximate. This latter figure is the more accurate.—Yours faithfully,

G. G. GOURIET:

Oxford.

DEAR SIR.—I have to thank Mr. Gouriet for pointing out a slip in my review of Mr. Norris' book, although I am of the opinion that 90 per cent. of television engineers would have made a similar comment to mine!

On looking the matter up, I find that the formula used is quoted in several text-books and is also taught in radio engineering classes, so I erred in good company.

Mr. Gouriet's figure of 40 lines suppressed should, of course, be 28 lines only, as quoted in the statement on the B.B.C. waveform in ELECTRONIC ENGINEERING.—Yours,

W. I. FLACH.

Hornsey Lane, N.6.

DEAR SIR,—May I thank Mr. Flach for his appreciative review of my book "Television To-day" and also Mr. Gouriet for his championing of my cause.

I stand by the statement that the reason why the upper video frequency radiated by the BBC is higher (2.75 Mc/s.) than the value (2.56 Mc/s.) given by the simple formula is because the latter does not allow for a fly-back time. Mr. Flach's quite correct argument is that the calculation would not be affected by "lost" time if the number of scanned elements was proportionately reduced.

However, as shown in my chapter on the transmitter specification, while the actual number of elements is reduced by about 10 per cent., the active scanning time is reduced by 20 per cent. The rate of scanning is therefore increased by 10 per cent. and the video frequency raised accordingly.

The number of active lines per picture is actually 385 and, although another 20 lines are blacked out, these are, I believe, scanned. The specification states that the active

line length is 5/4 times the distance scanned by 192.5 active frame lines and that the time efficiency is 80.8 per cent.

As regards the B.B.C.'s audio channel, I have an official statement that the upper line is 12,000 c/s. However, I was at one time told unofficially that the response is 4.5 db. down at 14,000 c/s. (referred to zero db. at 1,000 c/s.) and continuous above that. My statements on pages 111 and 175 are correct except for the reference to transmitter bandwidth.

I confess that, in one line I allowed the printer to put R5 instead of R4.—Yours faithfully,

ROY C. NORRIS.

Long Acre.

### The Synchrodyne

DEAR SIR,—A suggestion for a simpler oscillator on the Synchrodyne would be a Transitron circuit, a favourite with many workers.

The figure shows a circuit which works well and avoids difficulties caused by the inclusion of a variable resistance in the feedback network. To operate the screen grid on its negative resistance portion the anode must "bottom" and the screen dissipation must be kept to a

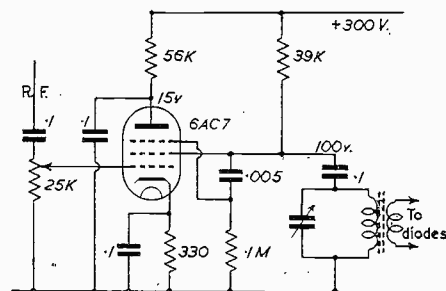

reasonable limit remembering that the anode dissipation is low.

Synchronisation voltage is applied to the grid which is at zero D.C. potential and takes no part in maintaining oscillations.

A more powerful oscillator would result if the L.C. circuit were placed in series with the screen supply, which would then be decoupled to ground. With this arrangement it should be possible to supply the switching power with a low  $g_m$  valve.—Yours faithfully,

J. E. BURNUP, B.Sc.

It is regretted that further correspondence on the Synchrodyne has had to be held over.—ED.

\* This has now been changed to 7%.

## NOTES FROM THE INDUSTRY

### RCMF Exhibition

The 1948 Annual Private Exhibition of British Radio, Television and Electronic Components and Test Gear is to be held in the Great Room of Grosvenor House, Park Lane, London, W.1, from March 2 to 4 inclusive. It will be open to visitors, by invitation only, from 10 a.m. to 6 p.m. daily.

### Radio Industry Council—Press Officer

Mr. Andrew Reid, who handled Press arrangements for Radiolympia 1947, has been appointed Press officer to the R.I.C. and is working from his own chambers at 11 Garrick Street, London, W.C.2. (TEMP Bar 8901-2.)

### A.S.R.E.

Admiralty Signal Establishment, which achieved world fame for its contribution to the development of radar has changed its name to The Admiralty Signal and Radar Establishment.

### French Components Exhibition

The French Radio Components Exhibition is being held in Paris at the Park des Expositions de la Porte de Versailles from February 2 to 7. An interpreter service for visitors will be available.

### Fisk Solariscope

E.M.I. Sales and Service, Ltd., state that the Fisk Solariscope, the prime function of which is to help short-wave listeners to determine the daylight/darkness paths over the earth's surface, is now available to the public at 1 gn. post free, from the Amateur Radio Division, E.M.I. Sales and Service, Ltd., Hayes, Middlesex.

### Mullard Film Strip Service

Mullard have at the disposal of technical colleges, etc., a series of film strip lectures under the general title of "The Radio Valve." Each film strip (of up to 50 illustrations) is accompanied by notes for the guidance of the lecturer. They are distributed for Mullard by Unicorn Head Film Strip Library, British Industrial House, Chenil Galleries, 183 King's Road, Chelsea, London, S.W.3, at a cost of 10s. per strip.

### Selmer Take Over R.S. Amplifiers

The business and goodwill of R.S. Amplifiers, Ltd., has been disposed of to Henri Selmer & Co., Ltd., who will continue to manufacture the current range of R.S. equipment.

### The "Skiastron"

Messrs. Scophony, Ltd., have asked us to point out that the name "Skiastron" is a trade mark registered under the name of their company. This device was described in an article by G. Wikkenhauser, the technical director of Scophony, Ltd., in the January issue of this journal.

### Edison Swan Merger

Edison Swan Cables, Ltd., and Cosmos Manufacturing Co., Ltd., are to be incorporated in The Edison Electric Co., Ltd., one of the A.E.I. subsidiaries. The board of the company will be reconstituted as follows:

Mr. I. R. Cox (chairman); Mr. H. Butterworth (managing director); Mr. J. S. A. Bunting (general manager, cables); Mr. T. Hands (general manager, valves); Sir George E. Bailey; Mr. A. G. Everett; Mr. F. E. C. Miller; Mr. V. L. J. Plascott; Mr. J. W. Ridgeway; Mr. E. Y. Robinson; Dr. H. Warren. Mr. A. G. N. Dixey will continue to be the secretary of the company.

### Millett, Levens (Engravers) Ltd.

This company is able to execute orders for chemically engraved nameplates, scales, dials, etc., in all metals and on ivory. They can also undertake the complete manufacture of metal or plastic panels. Their address is Forester Street, London, E.3.

### New Electronic Process Timer

Model TDX-2 with a range of from  $\frac{1}{4}$  to 60 seconds and an accuracy better than 5 per cent. throughout the range is being offered by Electro Methods, Ltd., 220, The Vale, London, N.W.11. This instrument controls loads to 500 watts up to 250 volts A.C.

### A. C. Farnell, Ltd.—Southern Area Representative

Mr. T. M. Wood who represents "Eddystone" in England and Wales now holds a concession with A. C. Farnell, Ltd., 15 Park Place, Leeds 1, for the supply of their components to Eddystone dealers south of Lancashire, Yorkshire and Cheshire. Initial inquiries may be sent to him at 24 Redhill Road, West Heath, Birmingham, 31.

### Donald Robinson Joins Philips (Amplifiers)

Mr. Donald Robinson has been appointed sales manager of the Amplifier Department of Philips Electrical, Ltd.

He has been connected with the public address equipment business for over 15 years and was the first chairman of the Institute of Public Address Engineers.

### A New Technique in Bridge Measurements

Mr. R. Calvert regrets that in acknowledging the part played by the B.B.C. Research Department in originating the H.F. bridge technique described in the January issue he omitted to quote the existence of B.B.C. Patent No. 566970 covering the design and use of the transformers around which the bridges are built.

### British Standards

BS 1409:1947 gives the letter symbols for electronic valves recommended by the British Standards Institution for use by the industry. These are based on proposals originated by the British Radio Valve Manufacturers' Association, and were given in the August, 1946, issue of ELECTRONIC ENGINEERING, p. 254.

### Publications Received

*Dawe Instruments, Ltd., Harlequin Avenue, Great West Road, Brentford, Middx.*—Two leaflets, one on the transformer turns ratio bridge, type 807B, the other on oscillator detector units, types 403A and 404A.

*Exide Batteries.*—Folder No. M5006 (20th edition) available to the trade from Chloride Electrical Storage Co., Ltd., Publicity Dept., Whitfield House, Whitfield Street, London, W.1.

*Johnson, Matthey and Co., Ltd., 73-83 Hatton Garden, London, E.C.1.*—Publication No. 2053 dealing with the engineering properties and uses of Rhodium.

*Mullard Wireless Service Co., Ltd., Century House, Shaftesbury Avenue, London, W.C.2,* now have available, to equipment designers only, a limited number of a new publication "Valves for Industry and Communications." It is intended as the first of a short series of similar data books and gives information on all current Mullard valves up to 25 watts dissipation for use in industrial and telecommunication equipment.

*Pye, Ltd., Cambridge.*—Leaflet on their R.F. heating equipment models 3/10A and 6/10A.

*Taylor Electrical Instruments, Ltd., 419/424 Montrose Avenue, Slough, Bucks.,* have prepared Publication No. SO.51247 covering the revision of prices and delivery of their products.

*Plessey Co., Ltd.*—Four illustrated radio component brochures have been issued by this company and are available only to radio manufacturers. They describe in some detail current ranges of electrolytic condensers, chokes and transformers, drives and couplings, including tuning motors, vibrators, potentiometers, valve holders and iron dust cores. The address of the Plessey Co., Ltd., is Vicarage Lane, Ilford, Essex.

*A. F. Bulgin & Co., Ltd.,* have recently issued a leaflet showing the many branches of electronic engineering in which their products are now used, together with a list of the Services and other authorities to whom they are supplied.

## FEBRUARY MEETINGS

### Institution of Electrical Engineers

All meetings unless otherwise specified are held at the Institution of Electrical Engineers, Savoy Place, London, W.C.2.

#### Ordinary Meeting

Date: February 27. Time 6.30 p.m.  
Held at: Central Hall, Westminster, London, S.W.1.

Faraday Lecture: "Electricity and Everyman."  
By: P. Dunsheath, C.B.E., M.A., D.Sc. (Eng.)

#### Radio Section

Date: February 4. Time: 5.30 p.m.  
Lecture: "The Application of Frequency Modulation to v.h.f. multi-channel Radiotelephony."

By: J. H. H. Merriman, M.Sc., and R. W. White, B.Sc.

Date: February 10. Time: 5.30 p.m.  
Discussion: "The Maintenance of Television Receivers in the Home."

Opened by: G. H. Watson.  
The Secretary: I.E.E., Savoy Place, W.C.2.

#### Cambridge Radio Group

Date: February 3. Time: 8.15 p.m.  
Held at: The Cavendish Laboratory, Cambridge.

Lecture: "The Cavity Magnetron."  
By: H. A. H. Boot, Ph.D., and J. T. Randall, D.Sc., F.R.S.

Hon. Secretary: J. E. Curran, University Engineering Laboratory, Trumpington Street, Cambridge.

#### North-Western Measurements Group

Date: February 17. Time: 6 p.m.  
Held at: Engineers' Club, Albert Square, Manchester.

Lecture: "Ultra-High-Speed Relays in the fields of Measurement and Protection."

By: W. Casson and F. H. Last, Ph.D., B.Sc. (Eng.).

#### North-Western Radio Group

Date: February 25. Time: 6.30 p.m.  
Held at: Engineers' Club, Albert Square, Manchester.

Lecture: "Some war-time developments in Electronic Circuit Technique."

By: Professor F. C. Williams, O.B.E., D.Sc., D.Phil.

Asst. Secretary: A. L. Green, 244 Brantingham Road, Chorlton-cum-Hardy, Manchester 2.

#### North-Western Students' Section

Date: February 7. Time: 2.30 p.m.  
Held at: The Royal Institution, Colquitt Street, Liverpool.

Lecture: "The Engineering Aspects of Gramophone Record Reproduction."

By: R. G. Whitehead, B.Sc., H. K. Barker, B.Sc., and H. P. Caldecott, B.Sc.

Note: The paper will be followed at 6.30 p.m. by a gramophone recital.  
Hon. Secretary: U. G. Knight, 1 Weston Avenue, New Moston, Manchester, 10.

### Institute of Physics

#### London Branch

Date: February 24. Time: 5.30 p.m.  
Held at: The Institute of Physics, 47 Belgrave Square, S.W.1.

Branch Annual General Meeting, followed by:  
Lecture: "Recent Developments in Microscopy."

By: Dr. A. Hughes.

Dr. H. L. Penman, Rothamsted Experimental Station, Harpenden, Herts.

#### Midland Branch

Date: February 19. Time: 6 p.m.  
Held at: The Imperial Hotel, Birmingham.

Lecture: "Application of Nuclear Physics to Medicine."

By: Prof. W. V. Mayneod.

Dr. J. H. Nelson, Messrs. Joseph Lucas, Ltd., Birmingham.

#### Scottish Branch

Date: February 10. Time: 7 p.m.  
Held at: Natural Philosophy Department, The University, Glasgow.

Lecture: "A Dynamical Model of a Crystal."

By: Sir Lawrence Bragg, O.B.E., M.C., F.R.S.

Hon. Secretary: J. M. A. Lenihan, The University, Glasgow.

### Institution of Electronics

#### North-West Branch

Date: February 6. Time: 6.30 p.m.  
Held at: The Reynolds Hall, College of Technology, Manchester.

Lecture: "The High Vacuum Technique."

By: Dr. R. Witty.

Hon. Secretary: L. F. Berry, 105 Birch Avenue, Chadderton, Lancs.

### Radio Society of Great Britain

All meetings are held at the Institution of Electrical Engineers, Savoy Place, London, W.C.2.

Date: February 13. Time: 6.30 p.m.

Lecture: "Interference—Its cause, effects and cure."

By: W. Hartley.

General Secretary, New Ruskin House, Little Russell Street, London, W.C.1.

### Society of Instrument Technology

All meetings are held at the Royal Society of Tropical Medicine and Hygiene, Manson House, Portland Place, London, W.1.

Date: February 24. Time: 7 p.m.

Lecture: "Infra-Red Methods of Analysis and Control."

By: H. W. Thompson, F.R.S.

Hon. Secretary: L. B. Lambert, 55 Tudor Gardens, London, W.3.

### British Sound Recording Association

All meetings are held at the Royal Society of Arts, John Adam Street, London, W.C.2.

Date: February 27. Time: 7 p.m.  
Lecture: "Recent Developments in Magnetic Recording."

By: P. T. Hobson.

Hon. Secretary: R. W. Lowden, Napoleon Avenue, Farnborough, Hants.

### British Kinematograph Society

#### Newcastle-on-Tyne Section

Date: February 3. Time: 10.30 a.m.  
Held at: Neville Hall, Neville Street, Newcastle-on-Tyne.

Lecture: "The Film in relation to Television."

By: Marcus F. Cooper.

Hon. Secretary: E. Turner, 30 Ettrick Grove, Sunderland, Co. Durham.

#### Brit. I.R.E.

#### London Section

All meetings are held at the London School of Hygiene and Tropical Medicine, Keppel Street, London, W.C.1.

Date: February 12. Time: 6 p.m.  
Lecture: "A Multi-Carrier v.h.f. Police Radio Scheme."

By: J. R. Brinkley.

General Secretary: 9 Bedford Square, London, W.C.1.

#### North-Western Section

Date: February 12. Time: 6.45 p.m.  
Held at: College of Technology, Reynolds Hall, Sackville Street, Manchester.

Discussion: "A New All-Stage Valve."  
Opened by: J. A. Sargrove.

Hon. Secretary: B. E. P. Ritson, 38 Parswood Court, East Didsbury, Manchester, 20.

### The Television Society

#### Ordinary Meeting

Date: February 25. Time: 6 p.m.  
Held at: The Institution of Electrical Engineers, Savoy Place, London, W.C.2.

Lecture: "Camera Tubes."

By: J. A. Jenkins.

#### Programme Group

Date: February 18. Time: 6 p.m.  
Held at: Cinematograph Exhibitors Association, 146 Shaftesbury Avenue, London, W.C.2.

Lecture: "Scenery Design in Television."

By: Peter Bax.

Lecture Secretary: T. M. C. Lance, 35 Albemarle Road, Beckenham, Kent.

#### Constructors' Group

Date: February 13. Time: 7 p.m.  
Held at: Cinematograph Exhibitors' Association, 146 Shaftesbury Avenue, W.C.2.

Lecture: "Some Aspects in the Design of Video Amplifiers."

By: J. E. B. Jacobs.

Group Secretary: A. E. Surson, 22 Union Road, Bromley, Kent.

Recently Published

# MICRO-WAVES AND WAVE GUIDES

H. M. BARLOW, B.Sc.(ENG.), PH.D.

Professor of Electrical Engineering  
University College, London

122 pages with 70 figures

15s. net

CONTENTS: Features of Micro-Wave Equipment—Transmission Line Elements as the Essential Framework of a Wave Guide—Synthesis of Wave-Guide Modes from Plane Waves—Fundamental Equations of the Electro-Magnetic Field—Analysis of Propagation in Rectangular Guides—Analysis of Propagation in Cylindrical Guides—The Coaxial Line as a Wave Guide—Micro-Wave Technique, Measurements and Applications.

CONSTABLE &amp; Co., Ltd.

10 ORANGE ST., LONDON, W.C.2

## THESE ARE IN STOCK

**FUNDAMENTALS OF RADAR**, by Stephen A. Knight. 10s. Postage 5d.

**SOUND MOTION PICTURES RECORDING AND REPRODUCING**, by Cameron. £2 17s. Postage 9d.

**TELEVISION**, by V. K. Zworykin and G. A. Morton. 42s. Postage 8d.

**THE MATHEMATICS OF WIRELESS**, by Ralph Stranger. 7s. 6d. Postage 5d.

**A HANDBOOK OF TELECOMMUNICATION**, by B. S. Cohen. 30s. Postage 9d.

**MICRO-WAVES AND WAVE GUIDES**, by H. M. Barlow. 15s. Postage 5d.

**RADIO ENGINEERING**, Vol. 1. by E. K. Sandeman. 45s. Postage 9d.

**SHORT-WAVE WIRELESS COMMUNICATION**, by A. W. Ladner and C. R. Stoner. 35s. Postage 8d.

**"ELECTRICAL ENGINEER" REFERENCE BOOK**. 42s. Postage 9d.

**RADIO DATA CHARTS**, by R. T. Beatty. 7s. 6d. Postage 6d.

**RADIO SERVICE EQUIVALENTS MANUAL**, by B. B. Babani. 2s. 6d. Postage 2d.

We have the finest selection of British and American radio books. Complete list on application.

### THE MODERN BOOK COMPANY

(Dept. E.1)

19-23, Praed Street, LONDON, W.2.

## Klystron Tubes

A. E. Harrison. (McGraw Hill). 271 pp. 155 figs. 17s. 6d. net.

THIS book has been developed from an American wartime pamphlet designed for the large number of new entrants into the field of electronic devices for use in the centimetre-wave region. Besides dealing with the principles of several kinds of velocity-modulated tubes, about 1/5th of the book deals with such related matters as power supplies and micro-wave techniques.

There is no doubt that Professor Harrison has succeeded in producing a most valuable book for anyone starting either to design or use tubes of the klystron type.

The main part of the book deals clearly with the theoretical principles involved in the various types and explains how the characteristic differences in behaviour from that of conventional oscillators and amplifiers arise. As might be expected from an active member of the Sperry Gyroscope Company's research team, the chapters on frequency multiplication and on multiple-resonator tubes are particularly good.

In a few places the arrangement of the text is confusing; thus at the beginning, after a conventional discussion of the two-resonator klystron amplifier, the section on klystron construction deals solely with reflex oscillators, with no indication of their relation, if any, to the previous section. An excellent description of their principles and properties occurs five chapters later.

The least satisfactory feature of the book is its treatment of references. It is, of course, irritating to students to have their text continually interrupted by names and footnotes of purely historical importance, and the reviewer at least regards the book's notable freedom from footnotes as an important virtue. At the same time it seems quite unfitting to take time off to refer to the first use by Mr. Applegate of the most useful but quite subsidiary diagram that bears his name when no mention whatever is made of the original formulation of the idea of bunching in retarding field oscillators by Clavier, of the first and essentially complete publication of a quantitative description of a velocity-modulation tube by the Heils or of the development by the Varians of the first working klystron. The situation is not improved by the fact that the Heils had used the same method of presentation in their calculations some years earlier.

The bibliography again, though it

includes references up to 1946, is much reduced in value by being simply arranged according to journal of origin and without the slightest indication of what is relevant to which parts of the text. It is a pity but not the author's fault, that most British work was published just too late for inclusion.

The number of mistakes is creditably few, though the remarkable statement on p. 61 that "There are some applications in which a large signal-to-noise ratio might be tolerated if . . ." might be modified in later editions, and the book can safely be recommended to all new, and indeed to most old, workers in the velocity modulation field.

J. H. FREMLIN

## Micro-Waves and Wave Guides

H. M. Barlow, B.Sc.(Eng.), Ph.D. (Constable &amp; Company Ltd.). 122 pp. with 70 diagrams 15s.

THIS small book is a simple and compact introduction to the study of microwaves and is adapted to the needs of those readers who possess little previous knowledge of the subject. The author states in his preface that a "special effort has therefore been made to capture the attention and interest of those whose outlook is essentially practical, to give the kind of explanation that is most satisfying and acceptable to the widest circle of readers."

To achieve this end he wisely includes a relatively large number of clearly drawn diagrams, and it so happens that he adopts those familiar physical and pictorial approaches to the subject which experience in radar training establishments during the war proved to be the most suitable in introductory studies.

The first chapter is introductory in character and includes historical matter as well as discussions of the place of microwaves in the electromagnetic spectrum and the advantages of wave guide transmission systems at microwave lengths.

Most students of electricity are more familiar with circuit theory than with the properties of the electromagnetic field. For this reason the familiar double cylinder transmission line forms a convenient means of linking the field picture with the familiar circuit picture, and for exhibiting the relation of the electromagnetic field to the currents and charges on its conducting boundaries. Thus chapter 2 shows how certain simple modes in wave guides are related to wave propagation on stub loaded twin lines. In Chapter 3, an alternative but familiar approach is used, in which some of the simpler field patterns in rectangular wave guides are

# BOOK

# REVIEWS

synthesised as those that result from the superposition of plane polarised electromagnetic waves in free space. The modes derived in this way are the all-important  $H_{01}$ -mode and the more general  $H_{0n}$ . This allows the author to discuss the phenomenon of cut-off, the possibility of propagating a single mode with all others evanescent, and the flow of wall currents accompanying the  $H_{01}$ -mode. The chapter also includes a description of E-modes and their field patterns, and a pictorial treatment of wave patterns in coaxial cables and circular wave guides by a method with which some readers will already be acquainted. Henceforth the book becomes more mathematical, with Chapter 4 devoted to a derivation of Maxwell's equations of the electromagnetic field from first principles, their formulation in cylindrical coordinates and a mathematical discussion of the properties of an electromagnetic plane wave.

Chapter 5 gives the electromagnetic theory of wave propagation in rectangular wave guides and Chapter 6 that in cylindrical wave guides. This chapter also contains a brief summary of the properties of the J and Y Bessel Functions.

Chapter 8 is the last, and comprises a brief survey of microwave measurements and techniques. With so much packed into so small a compass, the accounts of the individual techniques are very brief, and the reader is probably expected to derive as much help from the diagrams as from the text. The chapter ends with a section on microwave aerials.

There is a very useful bibliography which will assist the reader whose interest has been aroused to extend his knowledge.

The author employs the M.K.S. system of units, but in the unrationalised form. It is perhaps a pity, having taken the progressive step of using this system, not to use the rationalised form of them with its attendant advantages.

The author, in Chapters 4 and 5, calls the ratio of the transverse electric to the transverse magnetic field strength the characteristic impedance of the wave guide, whereas its usual designation is wave impedance. The author's departure from standard practice can hardly be commended because the term characteristic impedance in the case of a transmission line, then refers to two quite distinct ratios— $E_t/H_t$  and  $V/I$ .

This book can be recommended as an attractive and informative introductory text.

L. G. H. HUXLEY

## Wireless Direction Finding

R. Keen, M.B.E. (Iliffe & Sons, Ltd.) Fourth edition. 1059 pp., 630 diagrams. 45s. net.

**I**N spite of the spectacular new applications of pulse technique for radio navigation and the location of obstructions, there must always remain the demand for a means of locating a source of electromagnetic radiation—and that is why a fourth edition of this book has been prepared. Opportunity has been taken to include much recently released material—in particular, systems of navigation using the hyperbolic grid.

Among other new matter are sections dealing with the design and testing of high-frequency radiogoniometers; on transmission-line theory as applied to Adcock aerial systems and on the cause of reduction of resonance effects in Adcock aeriels and feeders. The matter on high-frequency direction finding has been largely rewritten, and new sections on calibration have been added to the ship and aircraft chapters.

Progress in aircraft approach and landing systems has been somewhat limited since 1938, but the section on this subject has been extended and now describes the system—approved for use in Great Britain and Commonwealth countries—developed in the United States as "S.C.S.-51."

## Luminous Tube Lighting

Henry A. Miller. (George Newnes Ltd.). 179 pp. + 104 figs. 2nd edition. 12s 6d.

**T**HIS book deals with discharge lamps, neon signs, manufacturing equipment and materials, and lamp applications; the second edition contains an additional chapter on high voltage (cold cathode) fluorescent lighting. There tends to be a bias towards the use of lamps for decorative and sign work, rather than for their primary use as illumination sources. For the manufacturer of decorative and sign lamps the book may be useful in providing, within a small compass, a broad picture of the discharge lamp field. The book, however, contains too many errors or careless statements to be of much value to the technical reader. It is a pity that the issuing of a second edition was not made the occasion for correcting some of the more obvious mis-statements, particularly the second note on page 132 referring to high voltage wiring regulations, which, if followed literally, might have serious results.

E. D. JONES

## H. K. LEWIS & Co. Ltd.

### LENDING LIBRARY

Scientific and Technical  
Annual Subscription from

**ONE GUINEA**

*Prospectus post free on request*

New Scientific and Technical  
Books and new editions are  
always available

Bi-monthly list of new books  
and new editions sent post free  
to subscribers regularly

### THE LIBRARY CATALOGUE

*Revised to December, 1943*

containing Classified Index of Authors  
and Subjects. Demy 8vo. pp. viii + 928  
To Subscribers - - - 12s. 6d. net  
To Non-subscribers - - - 25s. net  
(Postage 8d.)

Supplement, 1944 to December, 1946  
To Subscribers - - - 2s. 6d. net  
To Non-subscribers - - - 5s. net  
(Postage 4d.)

**LONDON: H. K. LEWIS & Co. Ltd.**

**136 GOWER STREET, W.C.1**

Telephone: EUSton 4282

### IMPORTANT BOOKS

## FREQUENCY MODULATION ENGINEERING

By C. E. TIBBS, A.M.I.E.E.,  
A.M.Brit., I.R.E.

Foreword by  
L. H. BEDFORD, O.B.E., M.A.

Demy 8vo. 310 pages. 172 figures. 28s. net.  
Postage 9d. extra.

"Already in this country Frequency Modulation has been used in special communication projects, and now an experimental broadcast service is planned for early commencement. A textbook on the subject is overdue, and it is thought that this present work will be invaluable to a wide range of engineers."

—Extract from Foreword.

**CHAPMAN & HALL, LTD.**

**37-39 Essex Street, London, W.O.2.**

# ABSTRACTS OF ELECTRONIC LITERATURE

## THERMIONIC DEVICES

### Electrical Discharge through Gases (L. B. Loeb)

During the first ten years after the discovery of X-rays in 1895 most of the fundamental properties of gaseous conduction were outlined and a general understanding of the subject was achieved, particularly by a group of physicists working under J. J. Thompson at the Cavendish Laboratory. Early studies concentrated mainly on the nature and mobility of positive and negative ions in gases; inadequate techniques and lack of gaseous purity led to confusing and contradictory results. Later investigations by Tyndall and Loeb are described which, owing to greater purity of gases, led to a satisfactory solution of the problem. Further work carried out by various investigators on electrical discharge through gases is surveyed, including electron velocities, mean free paths of electrons in gases, the formation of negative ions from free electrons and molecules, and spark breakdown with alternating potentials. A bibliography of 90 references is included.

—*J. I.E.E.*, August, 1947, p. 349.\*

### High-Vacuum Rectifier Ratings (P. Kauzmann)

Rectifier data is presented in graphical form from which it is possible to determine the peak steady-state current, the maximum possible "hot-switching" current, and the dissipations in the diode and in any added series resistors. Capacitive-input filters with large capacitors are discussed together with half-wave, full wave and voltage doubler circuits. A table of operating conditions and efficiency for a group of typical rectifiers is included.

—*R.C.A. Review*, March, 1947, p. 82.\*

### High-Sensitivity Photoconductive Cell (C. W. Hewlett)

The development of thallos sulphide photoconductive cells is outlined. Their construction differs from the normal type of cell in that the active material is deposited over two separate grids which are fixed to the inside wall of the glass envelope. The tube is exhausted to prevent contamination of the thallos sulphide and connexions brought out to a base. The principle on which the cell operates is similar to that of the selenium cell. Operating characteristics are illustrated graphically; peak sensitivity occurs in the region of 0.9 micron, thus rendering the cell particularly useful for response in the infra-red portion of the spectrum. Possible applications, particularly in the field of feeble radiations, are listed.

—*G.E. Review*, April, 1947, p. 22.\*

## CIRCUITS

### A General-purpose Linear Amplifier (W. H. Jordan and P. R. Bell)

An amplifier that is suitable for use in a variety of nuclear-particle counting experiments is described. The high and low frequency response of the amplifier can be varied by means of a three-position switch. In the wide-band position the transient response to a step function is a voltage pulse with a rise time of 0.15 microsec. and a total duration of less than 0.5 microsec. In the narrow-band position a signal of 3 microvolts produces a voltage pulse at the output equal to r.m.s. noise. A pulse-height selector is included for measuring pulses up to 100 volts amplitude.

—*Rev. Sci. Inst.*, October, 1947, p. 703.\*

### Time Modulation (B. Chance)

This paper presents a brief review of the basic processes employed in time modulation and gives representative examples of practical circuits.

—*Proc. I.R.E.*, October, 1947, p. 1039.

### An Improved Method for Coupling Valves at Ultra-Short Waves (A. van Weel)

A method for coupling two electron valves, or one valve with an antenna is described, by which method the difficulties due to the finite inductance of the internal electrode leads of a valve can be eliminated up to very high frequencies. In addition to this the new system provides a very simple way to realise matching of the valve impedances.

—*Philips Research Rep.*, April, 1947, p. 126.

### Bridge Type Electrical Computers

The basis of the new type of calculator under discussion is a Wheatstone bridge which has resistances in two opposite legs proportional to two magnitudes,  $x_1$  and  $x_2$ , and a resistance in the third leg proportional to  $x_3$ . The fourth leg is then proportional to  $x_1 x_2 / x_3$ . To extend the use of the bridge to a general case the resistors in each leg may be replaced by a series of resistors, each of which is proportional to a variable. Such a bridge will then solve certain quadratic equations. The working of a bridge for solving a quartic equation is also explained.

—*Rev. Sci. Inst.*, August, 1947, p. 564.\*

\* Abstracts supplied by the courtesy of Metropolitan-Vickers Electrical Co. Ltd. Trafford Park, Manchester

### Producing Tube Curves on an Oscilloscope

(H. E. Webbing)

Stepping circuit switches grid voltage after each characteristic curve is traced on cathode-ray oscilloscope. In this way a complete family of curves is automatically produced. Equipment makes possible rapid and detailed studies of all factors affecting tube operation.

—*Electronics*, November, 1947, p. 128.

## INDUSTRY

### Electronic Computer for Printing Control (J. W. Ludwig)

Speed of a multicolour web printing press is tripled by application of an electronic-hydraulic system that holds running register accurate from zero to 0.001 in. Register marks actuate a phototube whose output is compared with a sample of a sine wave taken at the same instant.

—*Electronics*, November, 1947, p. 108.

### Metal-Ceramic Seals (N. T. Williams)

To produce a successful metal-ceramic seal, it is necessary to form a chemical combination between the ceramic and some metal applied to its surface. Once the metal is bonded to the ceramic, various methods may be employed to make the metallic surface suitable for brazing. A process is described which is based on a German method. Molybdenum-iron silicates are formed by the firing of mixtures of these metals, in powder form, on to the ceramic at elevated temperatures. To the surface thus formed a nickel powder is sintered to provide a base for brazing materials such as silver, silver alloys and copper.

—*Rev. Sci. Inst.*, June, 1947, p. 304.\*

### Diffusion Pumps (D. G. Avery and R. Witty)

The original work of Gaede, Langmuir, and Crawford on diffusion pumps is briefly described. A critical discussion of this work leads to the formulation of a more complete theory of the action of the diffusion pump, and this is used to explain the practical characteristics of a simple form of modern diffusion pump. In this paper considerations are limited to cases where the working pressure of the pump is less than  $10^{-3}$  mm. of mercury.

—*Proc. Phys. Soc. (Lond.)*, November, 1947, p. 1016.\*

SYNONYMOUS WITH  
**PLUGS & SOCKETS**

PAINTON & CO LTD KINGSTHORPE NORTHAMPTON

**BTH**

*One of the many  
New Applications*

FOR  
**BTH**  
WIRE ENDED  
**CRYSTAL  
RECTIFIERS**

TO METER

WIRE ENDED  
CRYSTAL  
RECTIFIER

R.F. INPUT

• The illustration shows a unit designed to measure radio frequency current up to 0.1 ampere in the range 95 to 105 mc/s.

Send us particulars of YOUR requirements

**BTH RUGBY**

THE BRITISH THOMSON-HOUSTON COMPANY LIMITED, RUGBY, ENGLAND.

A3763



# RM

## Radio Feeder

### 483

Designed to supply radio signals to all classes of amplifiers. Three wavebands. Output, 5 volts across 680 K-ohms. Three valves: 6K8G, 6K7G, 6Q7G. Price: £12 12s., plus £4 1s. 10d. purchase tax.

Send for full particulars

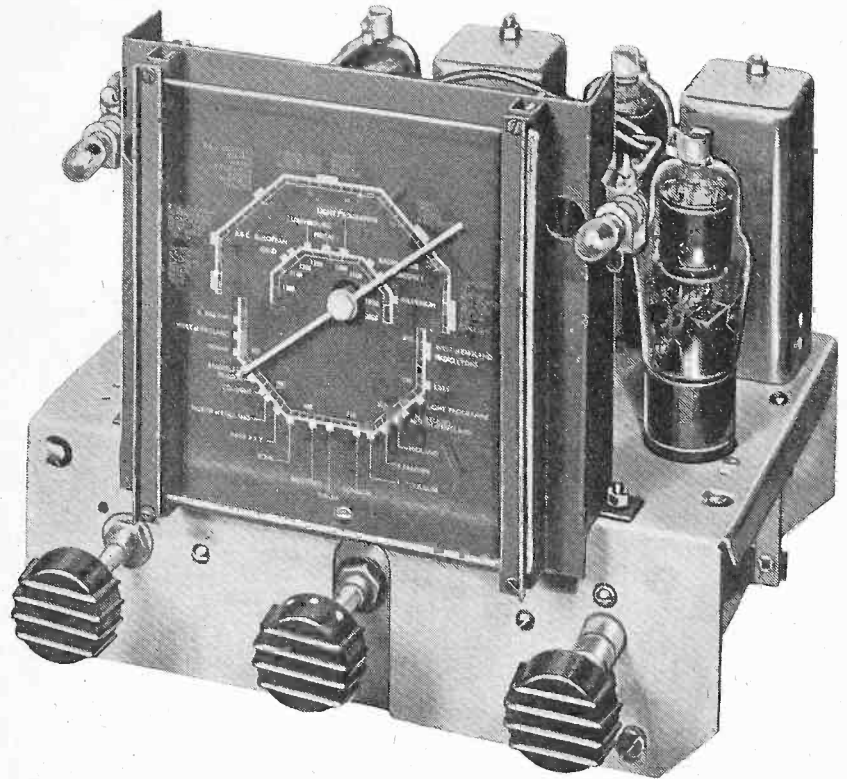

R. M. ELECTRIC LTD., TEAM VALLEY, GATESHEAD, 11.

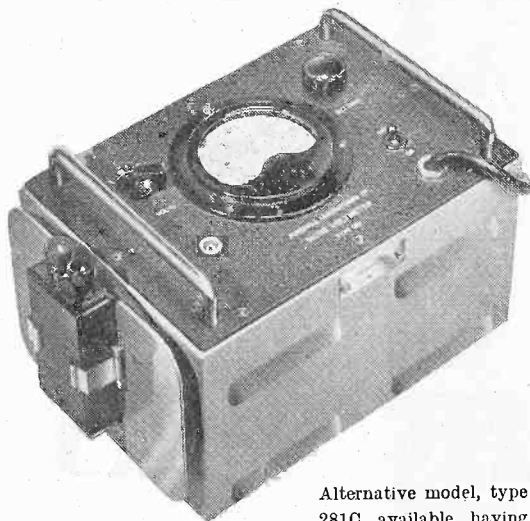

Alternative model, type 281C, available, having additional D.C. voltage range to 300 volts.

## DIODE VOLTMETER

### NORMAL MODEL TYPE 281B

**VOLTAGE RANGE**—Scale A, 0—1.5 v.; Scale B, 0—5 v.; Scale C, 0—15, 0—50 and 0—150 v.

**FREQUENCY RANGE**—50 c/sec. to 250 Mc/sec.

**ACCURACY**— $\pm 2$  per cent. F.S.D. on all ranges.

**INPUT IMPEDANCE**—4 megohms shunted by 14 pF. No D.C. path between terminals. Up to 300 volts D.C. may be super-imposed on the A.C. input.

**ZERO SETTING**—The zero is set on the 1.5 v. range and thereafter remains precisely set on all other ranges.

**STABILITY**—Zero and deflection sensitivity unaffected by normal fluctuations of mains voltage.

**CALIBRATION**—Peak-reading meter operating on negative half-wave of input, calibrated in terms of R.M.S. value assuming sinusoidal waveform.

**PROTECTION**—Application of over-voltage to the input terminals cannot damage the instrument.

**CONSTRUCTION**—Grey painted louvred metal case with engraved black crystalline finish panel. Lifting bars protect the panel.

IMMEDIATE DELIVERY

PRICE £50

# Furzehill

## LABORATORIES LTD.

BOREHAM WOOD, HERTS.

TELEPHONE: ELSTREE 1137





# G.E.C.

## "Flat End"

### CATHODE RAY TUBE



The G.E.C. 9" diameter cathode ray tube 6501 is intended for high quality television reception, and is magnetically focused and deflected. The screen fluorescence is white.

The tube end is made by a special moulding technique, which produces a screen face nearly flat, and more constant in production than is normally possible with bulbs made by the usual blowing technique. A picture size of approximately 200x160 mms. is obtainable with slight masking of the edges and corners. The bulb is made of high insulating glass giving a minimum of screen charging effects.

The electrode gun is designed to give a high picture brightness, with excellent definition for a relatively small voltage drive to the modulator.

Detailed technical data sheet available on request.

**Osram**  
PHOTO CELLS

**G.E.C.**  
CATHODE RAY TUBES

**Osram**  
VALVES

# Pre-heat for Increased Production

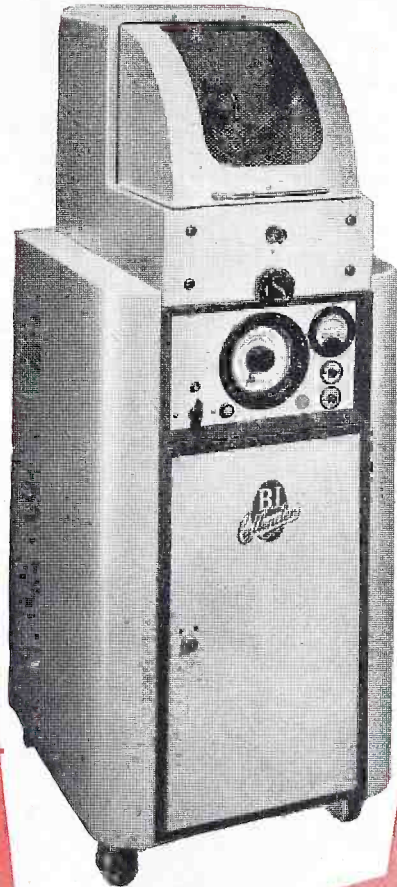

Compression moulding press output can often be increased by 100% using high frequency pre-heating. For phenolic type powders thorough pre-heating gives a great degree of plasticity and makes possible the rapid production of flaw-free mouldings. Lower moulding pressures are possible with pre-heated powder, tool wear is reduced and curing time can be cut by as much as two-thirds.

B.I. Callender's offer a range of high frequency pre-heaters sufficient to meet the needs of most compression moulders. They are robustly built for factory use, fully screened to conform with Post Office requirements and incorporate safety devices to protect operators.

Write for Publication No. 219 which gives full information on all B.I. Callender's High Frequency Heating Equipment.

**B.I.**  
*Callender's*

## HIGH FREQUENCY HEATERS

BRITISH INSULATED CALLENDER'S CABLES LIMITED  
NORFOLK HOUSE, NORFOLK STREET, LONDON, W.C.2

**Y**ou've probably come across the Walter Type 40 dozens of times for we have produced over 2,000 *different* assemblies. Like all Walter switches the Type 40 is 100% British in conception, design and construction and (unlike many other switches) it has built itself a world-wide reputation for reliable operation for long periods. The Type 40 in many of its 2,000 and more forms has found its place in a great deal of Radio and Electronic War Apparatus. It is fitted as standard by leading radio set makers.

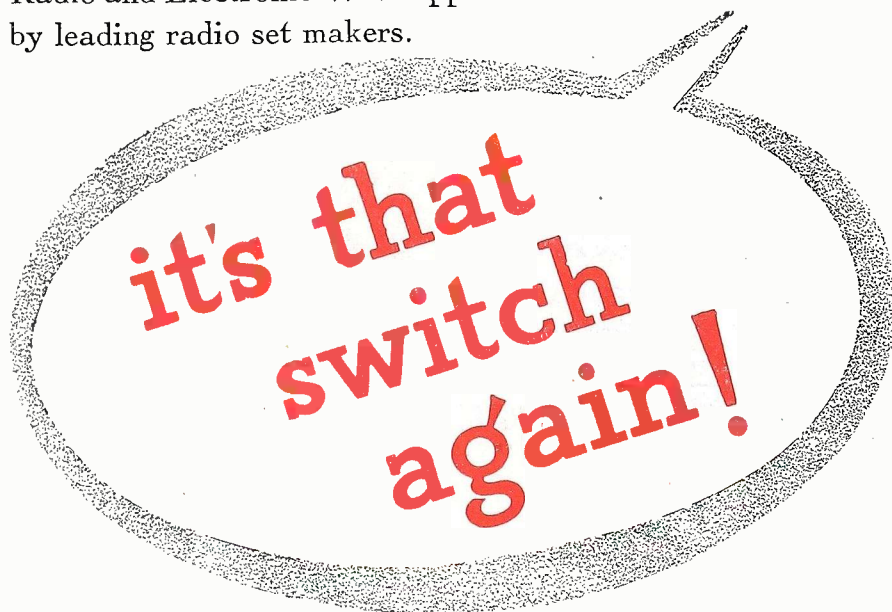

*We* are showing you in this series of advertisements a few of the 2,000 and more applications of the Walter Type 40. Meanwhile, if you have any switch problem let us have a chance to provide the answer you want.

**WALTER Type 40**

made for

**Life**

Walter Instruments Ltd.  
Garth Rd., Lower Morden  
Surrey

Tel: Derwent 4421-2-3

THE SWITCH OF OVER 2,000 ASSEMBLIES

C.R.C.13 R.

RADIO AND TELEVISION COMPONENTS  
are used by all leading set manufacturers



Easy insertion of valve. Firmly retained. Easy withdrawal. Standard fixing centre  $1\frac{1}{8}$ ". Hole diameter  $\frac{1}{8}$ ".

## Clix-type B8A Valveholders

BVA Standard Dimensions

Designed to meet the requirements of the new all-glass type B8A valves. Moulded body . . . Plated saddle . . . Screen . . . and Sockets, ensuring extremely low contact resistance. A valve-retaining latch specially suitable to these new all-glass valves. A feature exclusive to Clix B8A Valveholders.

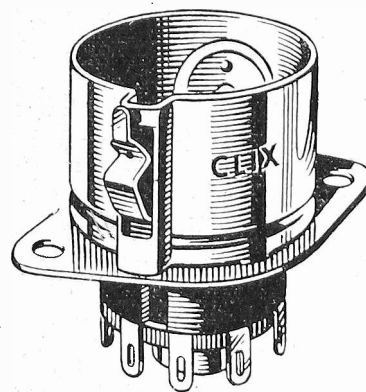

*Clix Valveholders are adequately protected by British and Foreign Patents*

**BRITISH MECHANICAL PRODUCTIONS LTD.**

21 BRUTON STREET, LONDON, W.1

Telephone : MAYfair 5543

Foremost in Valveholder design

## Power & Audio Frequency Transformers

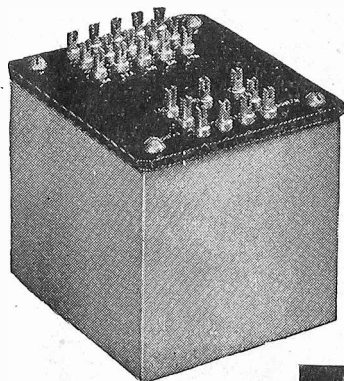

**POWER TRANSFORMERS**  
5VA to 5KVA  
Audio Transformers  
up to 1500 watts  
EITHER

- Open construction in a variety of mountings, windings vacuum pressure impregnated and varnished sealed.
- Canned and bitumen or wax filled.
- Hermetically sealed, oil filled, with pressure compensation.

Application : Microphone, driver, anode to line, line to line, etc.

### SPECIAL FEATURES

- Direct fixing to Transformer structure — no strain on container to cause distortion or leaks.
- No unsightly fixing lugs external to container.
- Male or female threads for upright or inverted mounting at will.

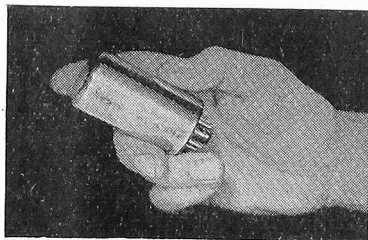

AUDIO TRANSFORMERS—SINGLE, DUAL OR TRI-ALLOY SHIELDED, GIVING NOISE SUPPRESSION UP TO 90 DB RELATIVE TO CONVENTIONAL OPEN ASSEMBLIES.

**Associated Electronic Engineers, Ltd.**

Dalston Gardens, Stanmore, Middlesex.

Tel. : WORDSWORTH 4474/5/6

e. h.

*Miniature or Midget*

ACTUAL SIZE

ACTUAL SIZE

30%

10%

10%

24%

10%

XW 0-75A

NEW TYPES FOR  
MIDGET RECEIVERS  
HEARING AIDS  
METEOROLOGICAL  
INSTRUMENTS  
ETC.

**HIVAC**  
THE SCIENTIFIC  
VALVE  
BRITISH MADE

**HIVAC LIMITED**

Greenhill Crescent, Harrow  
Harrow on the Hill, Middx. 0895

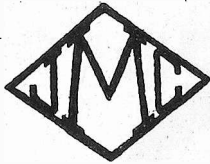

## RHODIUM IN TELE-COMMUNICATION ENGINEERING

Rhodium offers many technical advantages to the tele-communication engineer.

The Johnson Matthey organisation provides a consultative service backed by a processing unit equipped to handle specialised apparatus or quantity produced components.

One of the specialised services of

# Johnson Matthey

JOHNSON, MATTHEY & CO., LIMITED, HATTON GARDEN LONDON, E.C.1

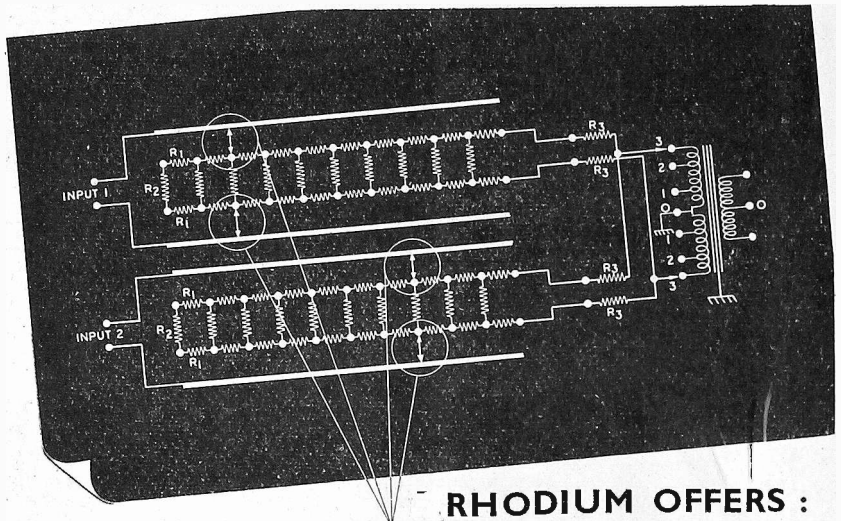

### RHODIUM OFFERS :

- Freedom from contact noise.
- Low contact resistance.
- Low contact pressure.
- Constant contact performance.
- Long contact life.
- Simplified contact design.

Data Sheet No. 2053 gives further information of our services in this field.

## MORE POWER AT LESS COST WITH THE NEW

# MULLARD *SILICA* TECHNIQUE

A marked saving per life-hour is among the major achievements of the new Mullard Silica technique. Unremitting attention to the development and improvement of this range of power triodes has already established them with designers of industrial electronic apparatus. Here are some of their other important features :

**NO COSTLY COOLING SYSTEMS**, the pure fused quartz envelope being radiation cooled.

**UNIFORM CHARACTERISTICS** between valves due to control-of grid emission.

**NO DETERIORATION OF VACUUM**. Softening temperature of valve envelope (1780° C.) permits high temperature pumping and degassing.

**HIGHLY EFFICIENT EMITTER**. Complete evacuation permits the use of thoriated tungsten thus ensuring constant emission.

**ALL SILICA VALVES ARE REPAIRABLE** at a cost of approximately 60 per cent. of their original price.

#### VALVES IN THE RANGE

Valve Type	* Power Output CW	Max. Operating Frequency
TY52-250	750 W	75 Mc/s
TY54-500	1500 W	50 Mc/s
TY55-2000	6000 W	30 Mc/s
TY55-3000	10000 W	30 Mc/s
TX10-4000	9700 W	20 Mc/s

\*Measured at 3 Mc/s.

Mullard engineers will be glad to advise on the applications of Silica valves.

Write for technical data on these and other Mullard valves.

# Mullard

THEMIONIC VALVES AND ELECTRON TUBES

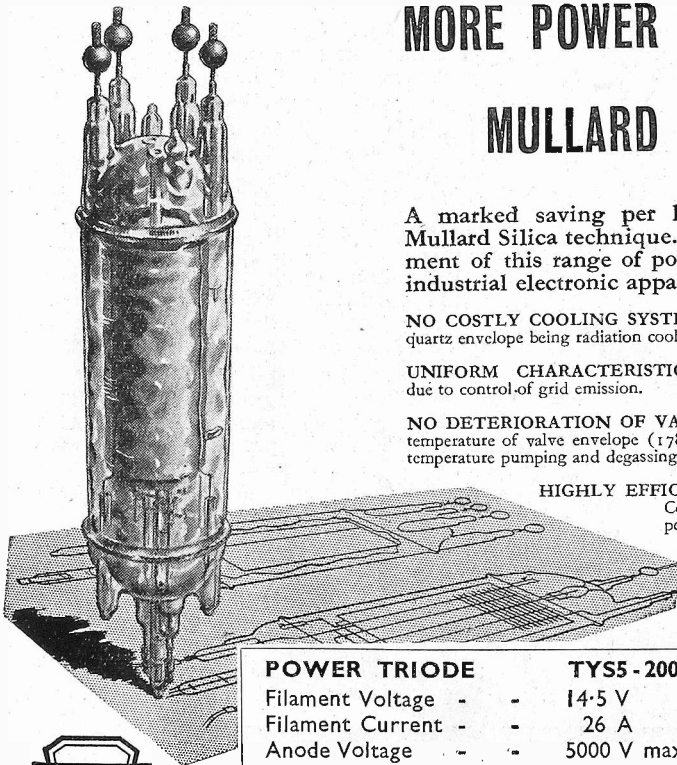

POWER TRIODE	TY55-2000
Filament Voltage	- - 14.5 V
Filament Current	- - 26 A
Anode Voltage	- - 5000 V max.
Output Power	- - 6000 W
Max. operating frequency	30 Mc/s



YOU KNOW  
WHAT THIS  
IS!



What  
is  
this?

Both are T.C.C. Capacitors. The little fellow has been widely known and used for very many years—but the big boy makes you think! It is just one of the many T.C.C. special transmitting types, which are used almost exclusively in all the big radio broadcast transmitters.

This particular example is a 0.003  $\mu$ F oil-filled, mica dielectric job, it handles 20 amperes of carrier frequency, plus 10 KV Audio "Mod" and 16 KV D.C.

Despite the disparity of size and function, there is one important factor common to these, and indeed, to all T.C.C. Capacitors. It is the engineering skill in design and manufacture which established and has maintained T.C.C. leadership in every branch of the capacitor field.

Whether your capacitor problems are "little fellows" or "big boys," submission to T.C.C. technicians will always provide the solution.

**TCC** for Versatility

In the Best Sets you'll see TCC

**THE TELEGRAPH CONDENSER CO. LTD**

RADIO DIVISION

NORTH ACTON · LONDON · W · 3

TELEPHONE: ACORN 0061

# INGENUITY and GOOD ENGINEERING

*Give a 12-foot scale with negligible backlash on a  $4\frac{5}{8}$ " diameter dial.*

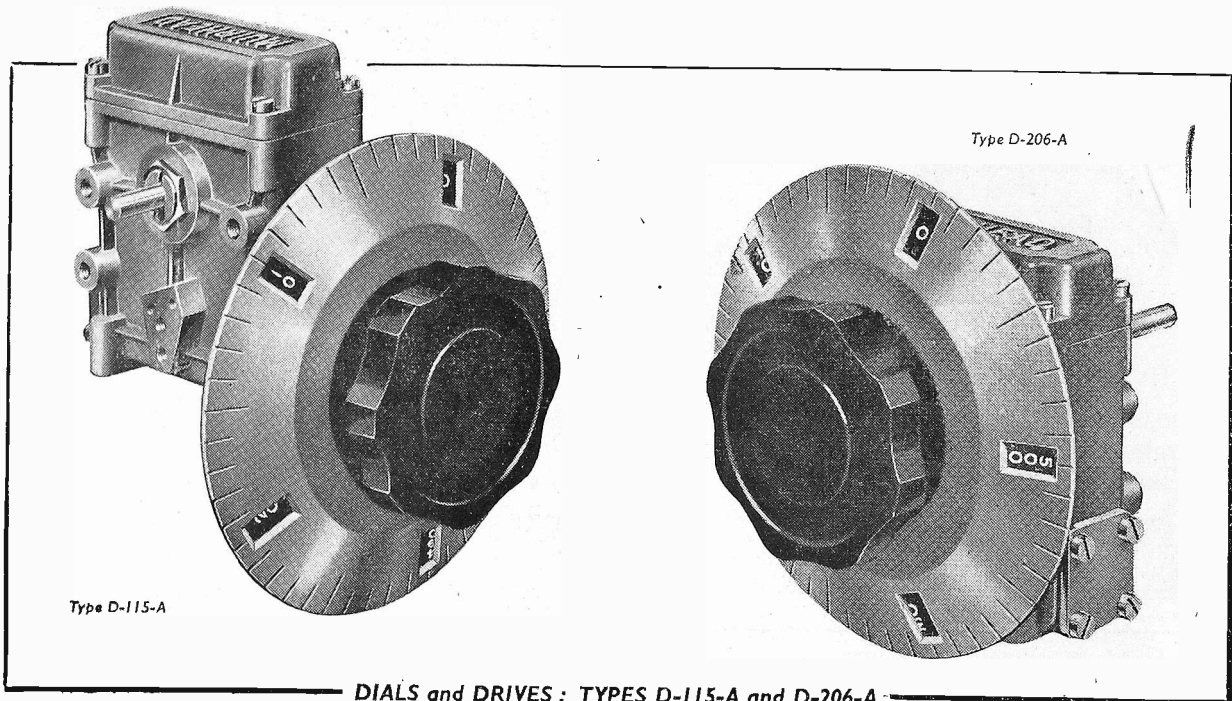

**DIALS and DRIVES : TYPES D-115-A and D-206-A**

TYPE D-115-A employs a 20 : 1 worm reduction gear providing a right-angle drive for two components.

TYPE D-206-A employs a 20 : 1 spur reduction gear providing a single in-line drive.

## OUTSTANDING FEATURES :

High reading and setting accuracy by means of a dial embodying an adding mechanism — effective scale length over 12 feet with 500 divisions . . . Gears spring-loaded to reduce backlash . . . Rugged die-cast construction and substantial bearings for long and continuous service . . . Shafts:  $\frac{1}{4}$  in. diameter and  $\frac{9}{16}$  in. projection . . . Finish: gunmetal with engraving filled white  
Weight:  $2\frac{1}{4}$  lb . . . . *Dial manufactured under licence from the Sperry Gyro-scope Co. Ltd., Pat. No. 419002. Full description in Bulletins B-532-B and B-556-A.*

# MUIRHEAD

*Muirhead & Co., Limited, Elmers End, Beckenham, Kent. Telephone: Beckenham 0041-2*

**FOR OVER 60 YEARS DESIGNERS AND MAKERS OF PRECISION INSTRUMENTS**

**MELTON METALLURGICAL LABORATORIES LTD.**

# Liquid Silver

Platinum & Gold Solutions  
For Metallising Mica Ceramic Quartz etc.

Low Melting Point Solder and Non - Corrosive Liquid Flux (A.I.D. Approved)

IPSWICH ROAD  
TRADING ESTATE  
SLOUGH, BUCKS.

'Phone: Slough 20992

Agents for Australia :

A. S. HARRISON & CO. PTY. LTD.  
85 CLARENCE STREET, SYDNEY

**R.T.S.** RANGE OF PRECISION BUILT transformers & chokes are specified by engineers who require accuracy and reliability to Tropical Standards.

TYPE APPROVED BY THE ROYAL AIRCRAFT ESTABLISHMENT

Retail stockist: Berry's (Short Wave) Ltd.  
25, High Holborn, London, W.1.

R.T.S. ELECTRONICS, L<sup>TD</sup>. KING STREET, EXETER.  
Telephone: Exeter 2132. Cables & Grams: "Television," Exeter.



Products of Quality & Reliability

Made by

**OLIVER PELL CONTROL LTD**

CAMBRIDGE ROW, WOOLWICH, S.E. 18  
Tel: WOOLWICH 1422

MAINS TRANSFORMERS  
A. F. TRANSFORMERS  
SMOOTHING CHOKES  
THERMAL DELAY SWITCHES  
POWER RESISTANCES

## POTENTIOMETERS

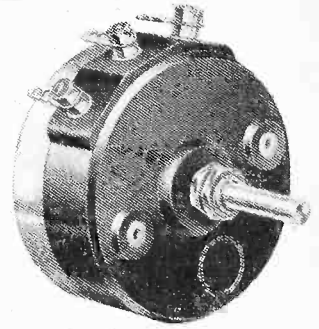

by

# RELIANCE

The **POWER TYPE P.I.W.** Continuous Wire-Wound  
Rating: 20 watts max. (linear)  
15 watts max. (graded)  
Ranges: 10 ohms to 500,000 ohms (linear)  
100 ohms to 250,000 ohms (graded)  
100 ohms to 50,000 ohms (non-ind.)  
Characteristics: Linear, tapered, graded, log., semi-log., inverse log., non-inductive, etc.  
Full details from **RELIANCE** Manufacturing Co. (Southwark) Ltd.  
Sutherland Rd. Higham Hill, Walthamstow E.17  
Telephone: Larkwood 3245

## TELCON RF CABLES

for all Television and Radio Requirements

### CABLE CHARACTERISTICS

CODE	Z <sub>0</sub>	CAPACITY	ATTENUATION
AS72M	120 ohms.	9.5 μF per foot.	At 1 Mc/s 0.5 db/100 Ft
			10 " 1.7 " "
			100 " 5.0 " "

DIAMETER: 0.225 ins.  
"TELCOTHENE" Dielectric  
TYPE: Flexible. PVC Sheath

Further details of this and other R.F. Cables on application

**THE TELEGRAPH CONSTRUCTION & MAINTENANCE CO. LTD.**  
Founded 1964

Head Office: 22 OLD BROAD ST., LONDON, E.C.2. Tel: LONDON Wall 3141  
Enquiries to TELCON WORKS, GREENWICH, S.E.10. Tel: Greenwich 1040

**DAINITE MOULDED RUBBER PARTS**

ENQUIRIES ARE INVITED from the Engineering, Electrical and Motor Industries for Special Moulded Parts in Natural and Synthetic Compounds.

THE HARBORO RUBBER CO. LTD  
DAINITE MILLS, MARKET HARBOROUGH

## BRAY CERAMIC INSULATORS

for L.F. and H.F. Components; also capacitor dielectrics



**GEO. BRAY & CO., LTD. LEEDS, 2**  
Established 1863 Phone Leeds 20981



## Measuring a condenser in circuit

This screen condenser can be precisely measured *in situ* if a connection is made between the neutral terminal and the top of the screen resistor. Where the screen is potentiometer fed, the parallel resistance can be balanced out by adjustment of the power factor control — one of the many unusual facilities provided by this flexible bridge.

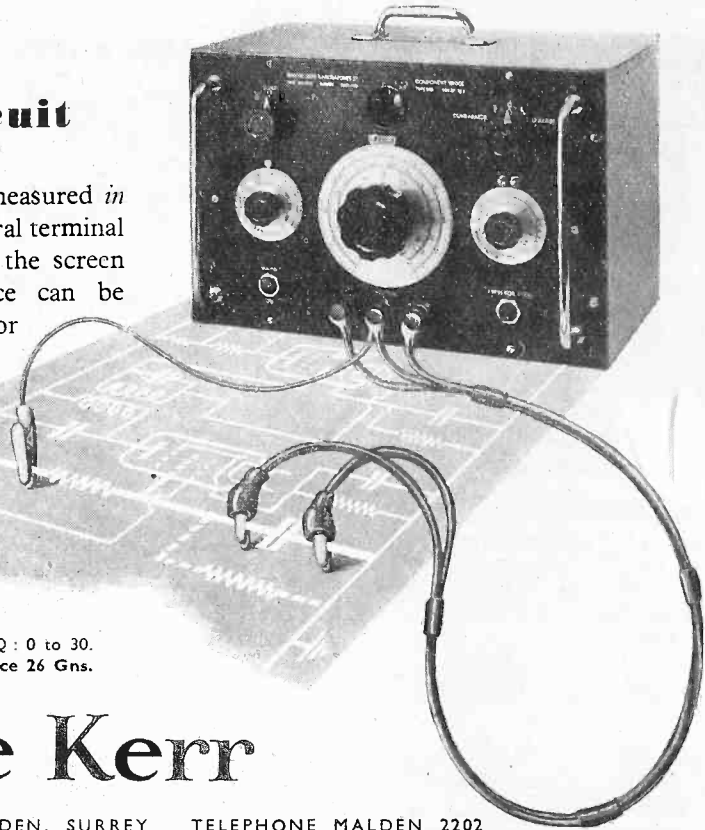

**COMPONENT BRIDGE B101**

CAPACITY : 5 pfd. to 500 mfd. IN EIGHT RANGES.  
 RESISTANCE : 5 ohms to 500 megohms IN EIGHT RANGES.  
 INDUCTANCE : 0.1 Hys. to 5000 Hys. IN FOUR RANGES. Q : 0 to 30.  
 LEAKAGE : 0 to 1.5 ma. PRECISION COMPARATOR. Price 26 Gns.

# Wayne Kerr

WAYNE KERR LABORATORIES LTD., NEW MALDEN, SURREY . . TELEPHONE MALDEN 2202

## TOROIDAL POTENTIOMETERS 10-1000 WATTS

Ceramic Insulation only—and approved for  
 Tropical conditions.  
 Complete Ceramic Rings for strength.  
 Approved by all Government Departments.  
 Reasonable Delivery.

Specialists in ALL TYPES OF TOROIDAL WINDINGS  
**P. X. FOX LIMITED**  
 HORSFORTH • YORKSHIRE • ENGLAND  
 Telephone : Horsforth 2831  
 Telegrams : Toroidal, Leeds

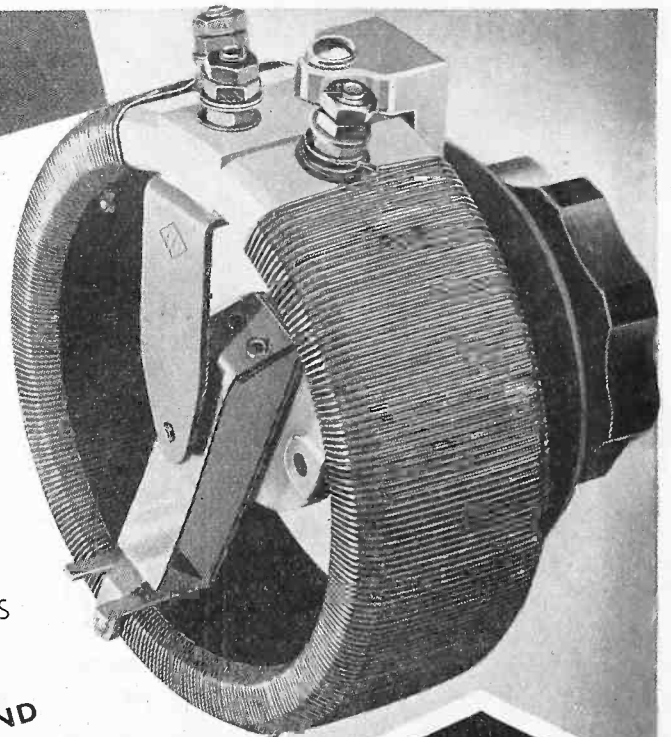

**Dependability**  
*Plus*  
**TRIX**  
*Quality*



Model  
 R.G.A. 633B/R.C.

**GRAMO-RADIO AMPLIFIERS**

Several models are available, incorporating 30-watt or 15-watt Amplifier combined with gramophone player or automatic record changer and radio receiver with monitor speaker.

*AC/DC models also available.*

Write for illustrated list of full Sound Equipment Range for every type of installation.



**THE TRIX ELECTRICAL CO. LTD**  
 1-5 MAPLE PLACE, TOTTENHAM COURT ROAD, LONDON, W.1  
 TELEPHONE: MUSEUM 5B17 GRAMS & CABLES: TRIXRADIO, WESDO, LONDON.

**Partridge News**

**THE NEW PARTRIDGE MANUAL**

The completely revised post-war edition of this new Manual, now available, contains:—

Many useful circuits including New 15 watt high quality amplifier with 40 db of negative feedback over three stages. Also articles on Sound Reinforcing and Public Address, Acoustical Problems, Cross-over networks, etc. A useful appendix is included consisting of six selected design charts.

Price 5/- Post Free.

**AVAILABLE STOCK**

A comprehensive range of mains and audio components is now available from stock, and we can despatch small quantities of these per return. We would stress that before ordering you send for our list detailing these components. Our stock range now covers almost all normal requirements, and by availing yourself of this service you will save the inevitable delay in the production of a special component. We shall be pleased to send you our stock list upon receipt of your address.

Telephone:  Abbey 2244

**PARTRIDGE**  
**TRANSFORMERS LTD**  
 76-8, PETTY FRANCE, LONDON, S.W.1.

**INDEX TO ADVERTISERS**

Advance Components, Ltd.	Front Cover
Associated Electronic Engineers, Ltd.	18
Bray & Co., Ltd., George	22
British Electric Resistance Co., Ltd.	4
British Insulated Callender's Cables Ltd.	16
British Mechanical Productions, Ltd.	18
British N.S.F. Co., Ltd.	8
British Thomson-Houston Co., Ltd.	13
Bryce & Co., Ltd., W. Andrew	8
Bullers, Ltd.	3
Chapman & Hall, Ltd.	67
Cinema-Television, Ltd.	6
Constable & Co., Ltd.	66
Cossor, Ltd., A.C.	10
Davis Supplies, Ltd.	Cover iii
Desoutter Bros., Ltd., Alec	Cover ii
Edison Swan Electric Co., Ltd.	7
Fox, P. X., Ltd.	23
Furzehill Laboratories, Ltd.	14
Gardners Radio, Ltd.	4
General Electric Co., Ltd.	15
Harboro Rubber Co., Ltd.	22
Hill & Churchill, Ltd.	24
Hivac, Ltd.	18
Johnson Matthey & Co., Ltd.	19
Lewis & Co., Ltd., H. K.	67
Measuring Instruments (Pullin), Ltd.	4
Melton Metallurgical Laboratories, Ltd.	22
Micanite & Insulators Co., Ltd.	9
Modern Book Co.	66
Muirhead & Co., Ltd.	21
Mullard Wireless Service Co., Ltd.	19
Multicore Solders, Ltd.	Cover iv
Painton & Co., Ltd.	13
Partridge Transformers, Ltd.	24
Pell Control Ltd., Oliver	22
R. M. Electric, Ltd.	14
R.T.S. Electronics, Ltd.	22
Reliance Manufacturing Co., (South-wark), Ltd.	22
Rogers Developments Co.	2
Savage Transformers, Ltd.	11
Sunvic Controls, Ltd.	5
Tele-Radio (1943) Ltd.	11
Telegraph Condenser Co., Ltd.	20
Telegraph Construction & Maintenance Co., Ltd.	22
Trix Electrical Co., Ltd.	24
Tufnol, Ltd.	12
University Radio, Ltd.	2
Vactite Wire Co., Ltd.	24
Walter Instruments, Ltd.	17
Wayne-Kerr Laboratories, Ltd.	23
Westinghouse Brake & Signal Co., Ltd.	11

**HILL & CHURCHILL,**  
 Booksellers **LTD.**  
**SWANAGE, DORSET**

ENGLISH & AMERICAN  
 BOOKS IN STOCK ON  
**RADIO AND  
 TELECOMMUNICATION**

Catalogue on Application

**EUREKA**  
REGD.  
**& NICKEL-CHROME**

**RESISTANCE  
 WIRES & TAPES**

*ALSO*  
**MOLYBDENUM**  
**WIRES, TAPES & RODS**  
 for  
**ELECTRIC FURNACES  
 LAMPS & VALVES**

and  
**VAC-STEEL  
 PLATINUM CLAD  
 GAS-FREE NICKEL**  
 WIRES : TAPES : BARS & MESH

EXACT TO SPECIFICATION

LET US QUOTE YOU



75, ST. SIMON STREET,  
 SALFORD, 3, LANCS.

Telephone: BLACKFRIARS 9831  
 Telegrams: VACTITE, SALFORD

# ALEC DAVIS Supplies Ltd.

now installed in new

## COMMODIOUS PREMISES

at 18, Tottenham Court Road,  
London, W.1.

It is with pleasure that we announce the opening of our new and spacious premises at the above address.

In consequence we can now offer the widest possible range of reputable radio and electrical equipment of which the following is only a limited selection.

**Test Equipment.**

TAYLOR MODEL 65B. Six band r.f. Oscillator covering 100K c/s. to 46 Mc/s. Effective scale length 27 ins.	£ s. d. 15 10 0
AVO OSCILLATOR complete with dummy aerial, mains operation	13 0 0
TAYLOR MODEL 85AP multi-range meter. Sensitivity 20,000 o.p.v.	19 19 0
AVO MODEL 7 multi-range meter	19 10 0
AVO VALVE TESTER	16 10 0
TAYLOR BRIDGE for resistance and capacity measurements	12 12 0
E.I.C. ELECTROSTATIC 6Kv. METER	9 10 0
INDUSTRIAL ELECTRONICS compact oscilloscope Symmetrical X and Y amplification	£ s. d. 32 0 0

**Components.**

ERIE ½ and ¼ WATT RESISTORS in preferred values	6
ERIE 1 WATT RESISTORS in preferred values	1 0
ATKINS variable dust-cored coils. All ranges	3 7
ATKINS L.M. and S. dust-cored coil packs	2 0 0
WRIGHT and WEAIRE standard 450/475 Kcs. I.F's.	10 0
WRIGHT and WEAIRE midget 465 Kcs. I.F's.	10 6

TCC and DUBILIER condensers at current prices

**Miscellaneous.**

MICROGRAM DE-LUXE portable record player	26 8 9
CRYSTAL TONE portable record player	13 18 3
VITAVOX 12" 10 watt loudspeaker	7 0 0
GOODMAN'S celebrated twin cone L/S	8 8 0
SOLOON oval bit soldering irons	19 6
SOLOON pencil bit soldering irons	1 1 0
Spare elements for above	4 6
WILKINS and WRIGHT COIL PICK-UP	7 11 11
EVER-READY all-dry 4 battery	3 9
EVER-READY BATRYMAX type B101 Midget 67½ volts	16 9
CELESTION 2½" LOUDSPEAKER 2/3 ohm speech coil. Ideal for midget set construction	1 7 0
AGE 5" LOUDSPEAKER, LESS TRANSFORMER	18 0

**SPECIAL**

We are at present building up a stock of components for the construction of the **HOME BUILT TELEVISOR** and a further announcement will be made later in this journal.

**Ex-Govt. Bargains.**

STROMBERG-CARLSON type CCT-46145 receivers. Brand new, boxed and complete with valves. Range 520/1500 Kcs. (Carriage etc. 5s.)	£ s. d. 6 0 0
MOVING COIL headphones and hand-mike (Carriage etc. 5s.)	12 6
4-WAY jacks and plugs (Carriage etc. 6d.)	5 0
PAXOLIN tube ¾" wall, 2½" dia. Any length up to 6½ ft. 9d. per ft. (carr. 1½d. per ft. extra).	
<b>HIGH VOLTAGE CONDENSERS</b>	
0.1 mfd. 2500 v.d.c. wkg.	1 7
0.01 " 5000 " "	8
0.02 " 8000 " "	3 0
4.0 " 1200 " "	6 3
1.5 " 4000 " "	5 0
<b>NEW 75 pF DOUBLE BALL-BEARING VARIABLE CONDENSER.</b> Double ended for ganging. Size 1¼" x 1½" x 1½" high	1 6
<b>NEW 25 pF AS ABOVE</b> but single ended with ¼" spindle	1 6
<b>COMPLETE VIBRATOR POWER PACK</b> 12v. input. Output 210 v. 70 mA. Size 8½" x 3½" x 4½" high	1 1 0
<b>ALL THE FOLLOWING METERS BRAND NEW AND IN ORIGINAL MANUFACTURERS BOXES.</b>	
1½" dia. 0/500 micro amps. White calibration on black scale	10 0
2" dia. 0/1 milliamp. Black calibration on white scale	7 6
2" dia. 0/5 milliamps. Black calibration on white scale	7 6
<b>TWIN METER PANEL FROM T1154 transmitter</b> complete with two meters 0/100 mA and thermo-couple 0/3.5 amps., panel fuseholder etc.	15 0
<b>I.F. TRANSFORMERS</b> in solid brass case finished in flat grey. Freq. 1.6 Mc/s. Size 1½" square x 4½" high. Dust core tuned	10 0
AEROVOX 4 mfd. 1 Kv.D.C. wkg. complete with fixing clip	7 6
PAPER DIELECTRIC 8 mfd. 600 v. D.C. wkg 4" x 2" x 4½" high, with fixing lugs. Well known British manufacture	6 0
<b>OIL FILLED PAPER CONDENSER 100 mfd. 150 v. D.C. wkg.</b>	17 6
<b>METAL L.T. RECTIFIER</b> 12 v. 1½ amp. output. Size 2½" square x 2½" long with fixing feet	4 0
<b>MCR-1 MIDGET RECEIVER</b> employing 1.4 v. valves, with power pack for operation from A.C./D.C. mains 90/250 v. Frequency range 150 Kc/s. to 15 Mc/s. All complete	9 15 0
<b>TELEPHONE SETS D MkV</b> complete with hand-set and in brand-new condition. Canadian manufacture. Batteries not included	4 4 0
<b>SPRAGUE metal-cased wire ended condensers:</b>	
0.1 mfd. 500 v.d.c. wkg.	10
0.05 mfd. 500 v.d.c. wkg.	9
0.02 mfd. 750 v.d.c. wkg.	9

STOCKISTS OF ALL TYPES OF WIRES, CABLES AND FLEXES. MAIL ORDERS AND ENQUIRIES PROMPTLY SATISFIED. **SHOP HOURS 9-5.30 Mon. to Fri. 9-1 Sat.**

**TELEPHONE: ————— MUSEUM 4539**

*U.S.A. manufacturers agree*  
**THAT BRITISH-MADE**  
**ERSIN MULTICORE SOLDER IS**  
*The Finest Cored Solder in the World*

Emerson Radio & Phonograph Corporation, New York City

"After testing your Multicore Solder on our production lines, we found it to be the fastest solder we ever used. One of its salient advantages is its extraordinary effectiveness in the soldering of tarnished metals."

General Electric Company, Schenectady, New York

"The girls on our wiring line are loud in their praises of Ersin Multicore Solder. I find it superior to that which we are now using and the flux is non-corrosive. I have instructed our factory to switch over to Ersin Multicore Solder."

Kellogg Switchboard & Supply Co.

"Some advantages in using Multicore Solder are better distribution of the flux with the metal, elimination of dry joints, increased speed in soldering operations, correct proportioning of the flux, and less waste in use of material. Many of the common troubles in soldering are lessened and the use of this material ensures better solder joints. The flux used is a modified or specially prepared rosin that is more effective than ordinary rosin in that surface oxides are more readily removed before soldering and prevented from reforming during the operation."

Oregon State College, Corvallis, Oregon

"Ersin Multicore Solder has been used with excellent results in this department. I have found it excellent for electrical instrument work as the fluxing action is such that a minimum of solder is used in producing a neat job. I also use Ersin Solder in instrument construction where there is danger of distortion when heating with a flame. Joints made in this manner with Ersin Solder have less solder on the outside of the work due to the excellent penetration of Ersin flux. We also use Ersin Solder in electronic research and find it produces a better joint electrically as well as mechanically with less waste."



Stromberg-Carlson Company, Rochester, New York

"We are using this on radio production lines with very good results. I believe this is being used with greater success than other solder previously used."

"You will be happy to know our Chemical Laboratory has completed corrosive tests on Ersin Solder. We have proved to our own satisfaction that Ersin Solder is not corrosive."

Farnsworth Television & Radio Corporation, Fort Wayne, Indiana

"We are now using your solder in our production at our Marion, Huntington, and Bluffton, Indiana, plants."

General Electric Company, Syracuse, New York

"There has been considerable activity on our part in investigating the merits of Multicore Solder and weighing the extra cost of this material vs. what we are paying for standard core solders. Our research has indicated that in spite of the higher costs for Multicore Solder the material should be used."

Massachusetts Institute of Technology, Cambridge, Mass.

"You may be interested to know that reports which I have received from our technical group indicate that your solder is preferred over most of those we have tried up to this time. Most of our work is on Government contracts for the Army and/or Navy. The experimental and development work in which we are engaged demands materials of high quality and uniformity and we can heartily endorse your solder as meeting these qualifications."

Manufacturers and Service Engineers are invited to write for technical information and free samples.

Despite the fact that U.S.A. is the world's largest manufacturer of cored solder, many leading American radio manufacturers prefer to import Ersin Multicore Solder from England, bearing freight charges and import duties. They find that despite the initial higher cost the use of Ersin Multicore Solder in the manufacture of their equipment effects great savings in material and labour costs. The three-core construction of Ersin Multicore gives high-speed precision soldering without waste, eliminating H.R. or 'dry' joints. It will pay you to use only Ersin Multicore Solder — for economy with quality.

MULTICORE SOLDERS LTD., Mellier House, Alkmarle Street, London, W.1.

REGent 1411