

CHEAPER TELEVISION—THE SMALL-SCREEN RECEIVERS

Television

and *SHORT-WAVE WORLD*

OCTOBER, 1937

No. 116. Vol. x.

1/-
MONTHLY

Easily Built Unit by Unit
Cheapest Yet Possible
Range Tested up to 65 Miles

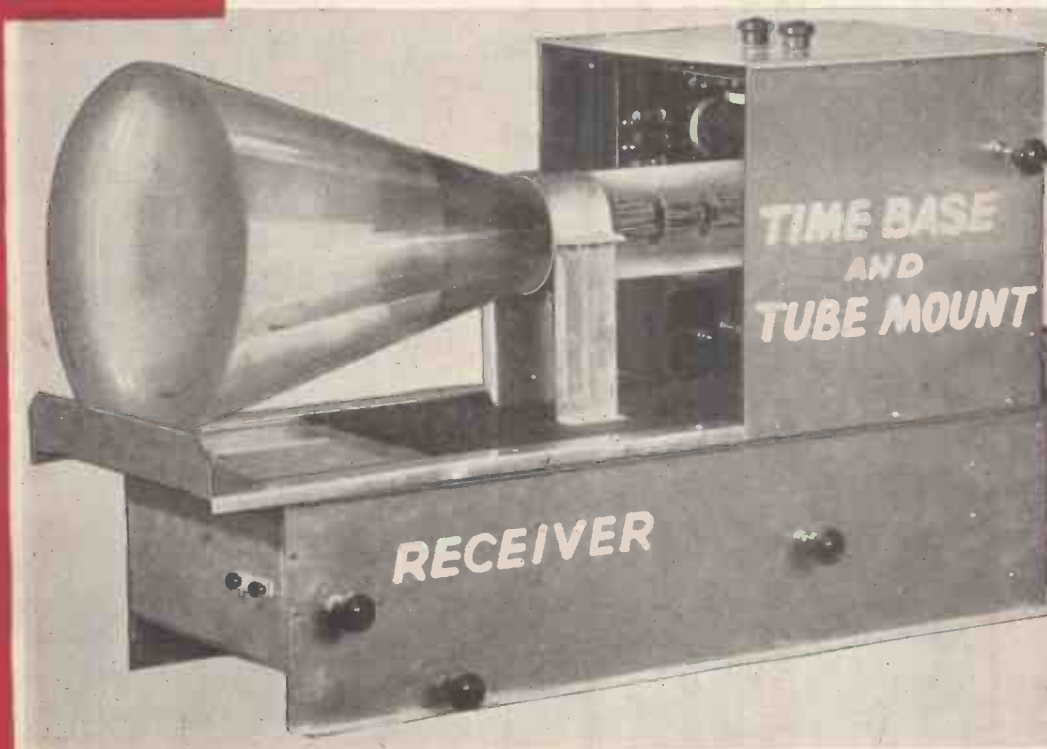

Clear, Bright, Steady Pictures
Very Simple Operation
Standard Valves and
Components

**LOW-
COST
TELE-
VISOR**

**FOR YOU
TO BUILD
AT
HOME**

BERNARD JONES PUBLICATIONS LTD.
CHANSITOR HOUSE, CHANCERY LANE
LONDON W.C.2.

THE FIRST TELEVISION JOURNAL IN THE WORLD

*Cried Smith "From my first crystal set,
To my latest ana oest supernet,
There's just one thing you'll find,
I've kept always in mind,
That's to wire up with FLUXITE you bet."*



See that FLUXITE is always by you—in the house—garage—workshop—wherever speedy soldering is needed. Used for 30 years in government works and by leading engineers and manufacturers. Of Ironmongers—in tins, 4d., 8d., 1/4 and 2/8. Ask to see the FLUXITE SMALL-SPACE SOLDERING SET—compact but substantial—complete with full instructions, 7/6. Write for Free Book on the art of "soft" soldering and ask for Leaflet on CASE-HARDENING STEEL and TEMPERING TOOLS with FLUXITE.

To CYCLISTS! Your wheels will NOT keep round and true unless the spokes are tied with fine wire at the crossings and SOLDERED. This makes a much stronger wheel. It's simple—with FLUXITE—but IMPORTANT.

THE FLUXITE GUN

Is always ready to put Fluxite on the soldering job instantly. A little pressure places the right quantity on the right spot and one charging lasts for ages. Price 1/6.



ALL MECHANICS WILL HAVE

FLUXITE

IT SIMPLIFIES ALL SOLDERING

FLUXITE LTD. (Dept. T.V.), DRAGON WORKS, BERMONDSEY ST., S.E.1

fit the
LAB
VOLUME CONTROL

It will pay you to insist on having the "LAB" Volume Control, for this precision-built component will never develop faults.

LOGARITHMIC or LINEAR TYPES
All values from 2,500 ohms to 2 megohms.

Less Switch	3/-
With Switch	3/6
With Double Pole Switch	5/-

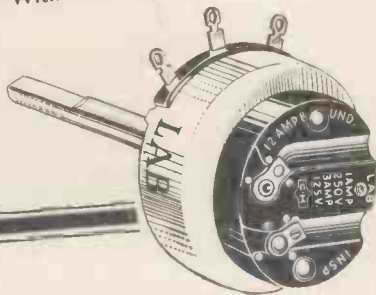

From all good radio Dealers. Trade enquiries to :

RADIO RESISTOR CO., LTD., 1 Golden Sq., London, W.1.



Belling-Lee Television Aerial mounted on a wall

INTERFERENCE SUPPRESSION

Except where signal strength is great, interference is usually present to some extent, and the ignition circuits of motor-cars and public vehicles are the chief offenders. This interference, invariably radiated, demands special attention to aerial equipment.

Where a half-wave aerial is connected by a transmission line to the receiver, and cannot possibly be installed in a position free from radiated interference, every effort has to be made to increase its efficiency as a receiver of signals from the particular direction of the transmitting station, to the exclusion of any other radiation. An increase of signal strength of approximately 2 : 1 can often be obtained in this way, which represents an improvement in signal-to-noise ratio of the same or possibly greater proportion.

Television calls for special aerials. Di-poles with transposed feeders or coaxial H.F. cables are possibilities, but directional types offer greater anti-interference properties. It is desirable to place the aerial as far as possible from sources of interference and preferably high up in view of the quasi-optical propagation of ultra-short waves and to get a high signal-to-noise ratio. Transposed feeders will balance out interference picked up on their route from aerial to receiver.

Apart from special aerials required for television purposes there has to be an efficient means of conveying the picked up energy to the receiver. The Belling-Lee low impedance feeder, type 336, is recommended. This cable (two insulated copper wires laid side by side in special low loss material) has proved to be more efficient than twisted flexes and transposed feeders, and in only rare cases has the more expensive low capacity coaxial cable any advantage over it.

Readers troubled with ultra-short wave interference are invited to write for the latest information. A new and enlarged edition of "Interference Suppression" is now ready. 1s. 6d. post free

BELLING & LEE LTD.
Cambridge Arterial Road, Enfield, Mddx.

BELLING-LEE
SUPPRESSION SERVICE

TELEVISION

The problems of the designer and experimenter find their solutions in the wide range of quality products for U.S.W. working listed in the Bulgin 120-Page Catalogue.

BULGIN QUALITY PRODUCTS

TECHNIQUE

Bulgin caters for the specialist as well as for the general experimenter. The requirements of High Voltage Circuits are adequately met by the Bulgin Range of Insulators and other components.



FLEXIBLE 1/2" SHAFT COUPLING.

List No. E.H. 12
(1 in. long) 1/9 each
List No. E.H. 14
(2 1/2 in. long) 2/3 each



List No. S.W. 59
(Synthetic Resin, 3")
1/- each.



List No. S.W. 45
(Porcelain)
1 1/2" 4 1/2d.
each.



List No. L.14 (Synthetic Resin)
1 7/8" 3d.
each.

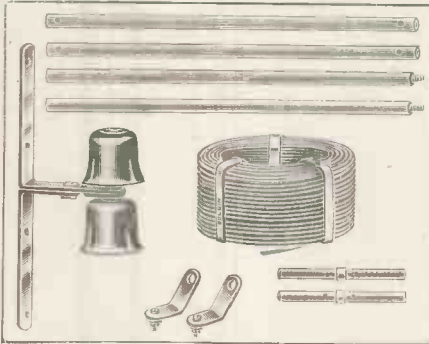

BULGIN SUPER TELEVISION AERIAL KIT
Designed for resonance at 45 Mc/s, this U.S.W. Aerial follows the latest low-loss technique.
List No. L.16 Per Kit 30/-

List No. S.W. 111

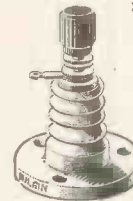

List No. S.W. 114



IN LOW-LOSS PORCELAIN.
List No. S.W. 111 9d. each
List No. S.W. 112 6d. each
List No. S.W. 110 8d. each
List No. S.W. 114 1/3 each

COUPON

To Messrs. A. F. Bulgin & Co., Ltd.,
Abbey Road, Barking, Essex.
Please send, post free, a copy of your new 120-page Catalogue No. 157, for which I enclose 3d. stamps.
Name
Address

ANNOUNCING THE NEW 1938 "Imperial" Twin Chassis All-Wave Receiver

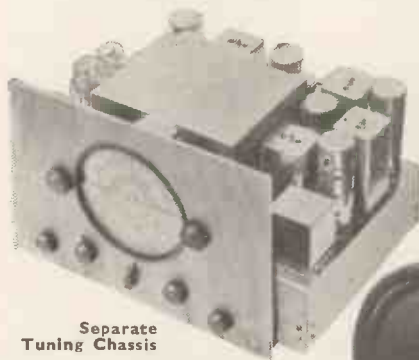

Separate Tuning Chassis

Giant 12-inch Theatre Sonic Loudspeaker

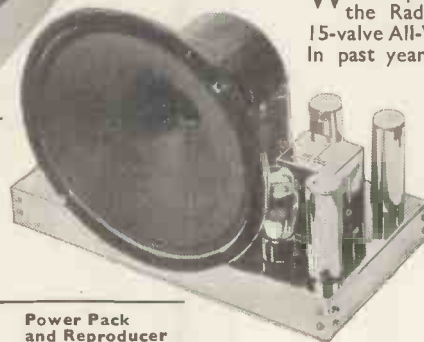

Power Pack and Reproducer

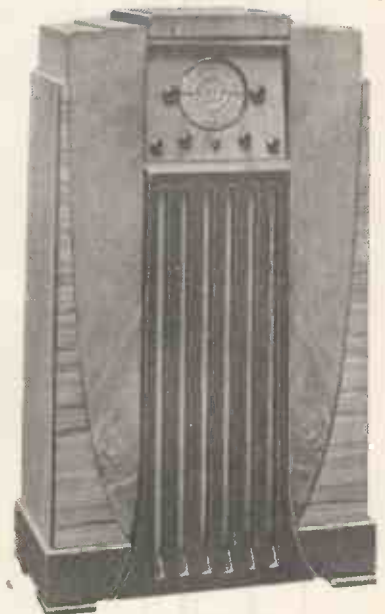

York Console Model.

WE are proud to bring before the Radio public the latest 15-valve All-Wave Radio Receiver. In past years our products have

set an extremely high standard of efficiency, but this latest model is far in advance of previous designs. The beauty of its reproduction NATURAL, in every sense of the word—its super-sensitivity has astounded many of the leading Radio critics. Its station getting capabilities are unsurpassed. London—New York—Java—Melbourne—all have been received with equal

strength and clarity. IT IS THE ONLY RECEIVER ON THE MARKET COVERING SO WIDE A WAVE-RANGE. Before ordering that new Radio, compare your choice with the new "Imperial" All-Wave Receiver. We invite you to call for a demonstration, neither shall we press you to do so. We shall leave it to the performance of the receiver to convince you of its merits. Can we say more? Write, telephone or call for our Illustrated Art Catalogue giving full details of this outstanding Set.

**DEMONSTRATIONS
DAILY AT OUR SHOWROOMS
OPEN 9-8, EXCEPT TUESDAY 9-6
PLEASE MENTION TELEVISION ON YOUR LETTERS.**

**MIDWEST
RADIO (MANUFACTURING) CO. LTD.,
16, OLD TOWN, CLAPHAM, LONDON, S.W.4.
TELEPHONE : MACAULAY 5005**

TELEVISION DEVELOPMENTS

A NEW LARGE DIAMETER TUBE FOR TELEVISION REPRODUCTION



**TYPE 12H
TUBE**

The Ediswan Type 12H tube has a screen diameter of 12" giving a television picture 10" x 7½" without distortion.

The screen is of special material giving a close approximation to a black-and-white picture.

Specification:

Indirectly heated high vacuum tube.
Heater Volts - - - 2.0
3rd Anode Volts - - - 6000
2nd Anode Volts - - - 1200
1st Anode Volts - - - 300
Sensitivity (mm./V.) - - 850/V*
Peak-Peak Modulating Volts - 15

*V=3rd anode volts

List Price £15 . 15 . 0

● We also supply
HIGH VACUUM RECTIFIERS
GAS-FILLED RELAYS
MERCURY VAPOUR RELAYS
for Television Scanning
circuits.

ENTIRELY BRITISH MADE

EDISWAN RADIO VALVES

THE EDISON SWAN ELECTRIC CO. LTD.  155 CHARING CROSS RD., LONDON, W.C.2

R.E.299

USED BY ALL GOVERNMENT DEPARTMENTS

TELEVISION

and SHORT-WAVE WORLD

Special Features

Philips Projection Receiver	581
New Low-cost Televisor for Easy Home Construction	582
The Small-screen Receiver	590
The Televising of Films	594
Miniature Television	599
Baird Scanning Equipment	601
Radio Link	604
High-gain T.R.F. Receiver	613
Short-wave Radio World	617
23-watt Resistance-coupled Amplifier	620
New Valves for Television and Short-wave Constructors	626
The Amateur & Broadcast Interference	632
Johnson Q. Antenna	634

TELEVISION AND SHORT-WAVE WORLD

Proprietors :

BERNARD JONES PUBLICATIONS, LTD.

Editor-in-Chief :

BERNARD E. JONES.

Editor :

H. CORBISHLEY.

Editorial, Advertising and Publishing

Offices :

Chansitor House, 38, Chancery Lane, London, W.C.2.

Telephones : Holborn 6158, 6159.

Telegrams : Beejapee, Holb., London.

Subscription Rates : Post paid to any part of the world—3 months, 3/6 ; 6 months, 6/9 ; 12 months, 13/6.

Published Monthly—1/- net.

(Last Wednesday in every month for following month.)

Contributions are invited and will be promptly considered. Correspondence should be addressed according to its nature, to the Editor, the Advertisement Manager, or the Publisher, "Television and Short-wave World," Chansitor House, Chancery Lane, London, W.C.2.

IMPORTANT

"Television and Short-wave World" is registered at the General Post Office, London, for transmission to Canada and Newfoundland by Magazine Post. Entered as Second-class mail matter, Boston, Mass.

COMMENT OF THE MONTH

An Opportunity for the Amateur

IN this issue we place before our readers the design of a vision receiver in which the requirements of the amateur constructor, both as regards cost and ease of construction, have been prime considerations without, however, any sacrifice of performance. This last feature was deemed to be of such importance that the objectives aimed at can be said to be above the average, particularly as regards range. The design is by Mr. S. West and represents several months careful research.

It can definitely be said that the method of construction is the simplest yet attained. Each stage is practically separate and the constructor therefore has no complicated assembly to make, for the receiver consists of a number of units each of which entails only a fraction of the amount of work involved in a one-valve broadcast set. By careful design it has also been possible to obviate any necessity for elaborate lining up when the assembly is complete, so any amateur of ordinary ability can undertake the work with the assurance that the receiver will give excellent results upon completion. We guarantee that the design is practical and sound.

Cost is an important consideration in amateur receiver construction and it is dependent to a great extent upon the builder. In the present instance we give alternatives both as regards picture size and range and these will, of course, have a bearing on the cost. Fundamentally, the design for each alternative remains the same with certain modifications which will be detailed in the constructional articles. As all the components and valves are standard types many readers will be able to effect a saving by the use of existing components. Also no difficulty will be experienced in obtaining components. It is difficult to give a precise figure of cost, but we can give an indication by saying that in its entirety, constructed for long range reception, the cost, exclusive of tube and valves, is approximately £23, and as has been indicated above we are of the opinion that this figure can be materially reduced under some circumstances.

The complete televisor consists of three main units—vision receiver, time bases and power packs. In this issue we describe in detail the vision receiver, and next month particulars of the time bases and power packs will be given. These units have been considerably simplified and constructors will have no difficulty whatever in building them.

A new enlarged and up-to-date edition of this practical engineering treatise covering all phases of radio communication.

RADIO ENGINEERING

By **FREDERICK EMMONS TERNAN**,
Professor of Electrical Engineering, Stamford University.

813 pages, 9 × 6, 475 illustrations, 30/- net. Second Edition.

THIS book gives a comprehensive treatment covering all phases of radio communication. It is written from a viewpoint of the engineer who is interested not only in qualitative descriptions of radio phenomena, but also in making quantitative analyses for facilitating design and research.

The first part of the book is devoted to the theory of tuned circuits and the fundamental properties of vacuum tubes and vacuum tube applications in the light of their importance and interest to every electrical engineer.

The latter part takes up more specialised radio topics, such as radio receivers and transmitters, wave propagation, antennas, and direction finding. In this part of the book are chapters on radio aids to navigation, sound and sound equipment, and a new chapter on television.

Chapter Headings.

- | | | |
|--|---|--|
| 1. The Elements of a System of Radio Communication | 7. Power Amplifiers | 14. Propagation of Waves. |
| 2. Circuit Constants | 8. Vacuum-tube Oscillators | 15. Antennas |
| 3. Properties of Resonant Circuits | 9. Modulation | 16. Radio Aids to Navigation |
| 4. Fundamental Properties of Vacuum Tubes | 10. Vacuum-tube Detectors | 17. Television |
| 5. Vacuum-tube Amplifiers | 11. Sources of Power for Operating Vacuum Tubes | 18. Sound and Sound Equipment |
| 6. Vacuum-tube Amplifiers (Cont.) | 12. Radio Transmitters | Appendix. Formulas for Calculating Inductance, Mutual Inductance, Capacity |
| | 13. Radio Receivers | |

COMMUNICATION ENGINEERING

By **W. L. EVERITT**,
Professor of Electrical Engineering, The Ohio State University.

727 pages, 9 × 6, 411 illustrations, second edition, 30/- net.

HERE are step-by-step analyses of the major problems confronting the radio and telephone engineer. Every aspect of unilateral and bilateral networks is carefully explained; and, in each case, the author presents what he terms the "machine tools" of network theory—theorems which apply fundamental similarities of simple networks to new complicated structures.

Contents.

Introduction and Classification of Impedance Elements	Modulation and Demodulation
The Function of Networks	Vacuum-Tube Detectors
Network Theorems	Class A Audio Frequency Amplifiers
Networks Using Linear Bilateral Impedances	Class A Radio Frequency Amplifiers
Resonance	Radio Frequency Amplifiers for Transmission (Classes B and C)
The Infinite Line	Oscillators
Reflection	Coupling between Electrical Circuits and Free Space
Filters	Radiation
Coupled Circuits	Coupling between Electrical and Mechanical Circuits
Impedance Transformation	Electro-mechanical Coupling
Equalisers	Appendix: Real Hyperbolic Functions
Bridge Circuits	
Inductive Co-ordination	
Networks Using Unilateral and Non-linear Impedances	
Unilateral or Control Impedances	

FUNDAMENTALS OF VACUUM TUBES

By **AUSTIN V. EASTMAN, M.S.**,
Assistant Professor of Electrical Engineering, University of Washington.

438 pages, 9 × 6, illustrated, 24/- net.

THIS book discusses at length the principal types of vacuum tubes—high vacuum tubes, mercury-vapour tubes, photo tubes, and several special varieties—and the laws underlying each, with engineering analyses of their more important applications.

The tubes are covered in the order of their complexity and in each type of tube the discussion takes up first the high vacuum tube and secondly the gas-filled tube.

In the cases of the more difficult phases, thorough verbal descriptions are given to enliven and give meaning to the more complex mathematical treatises that follow.

Contents.

Preface	Triodes—Oscillators
List of Tables	Triodes—Modulation and Demodulation
Introduction	Multi-element Tubes
Electronic Emission	Photosensitive Cells
Symbols and Notations	Special Types of Tubes
Diodes—Rectifier Action	Appendices
Triodes—Class A Amplification	Author Index
Triodes—Relay Action	Subject Index
Triodes—Class B and C Amplification	

McGRAW-HILL PUBLISHING CO., LTD., ALDWYCH HOUSE, LONDON, W.C.2

OCTOBER, 1937

FIRST DETAILS OF THE PHILIPS PROJECTION RECEIVER

20-INCH PICTURES BY PROJECTION

ALTHOUGH several manufacturers of television receivers have been carrying out research in the design of cathode-ray projection receivers, the Phillips' receiver publicly demonstrated at Radiolympia is the first to be produced as a commercial article and its advent created something of a sensation. H.M.V. also showed a projection type receiver, but this and also the Phillips' receiver were removed early during the course of the exhibition and many visitors were disappointed in not being able to see them in operation.

In the new Philips' projection receiver the television image measuring 2 in. by 1.6 in. is formed on the end of a 4 in. cathode-ray tube and

fiers in a voltage doubling circuit and the whole of the H.T. unit is entirely enclosed in a metal chamber with an interlocking door which breaks the supply voltage on being opened and earths the H.T. terminals of the condensers.

The television receiver is built up on three chassis which are bolted to a framework so constructed that the whole of the receiver can be removed from the cabinet for servicing.

The three units are:

- (1) The television sound and vision receiver and the synchronising amplifier.
- (2) The time bases for frame and line frequencies with the power pack for the amplifiers, but excluding

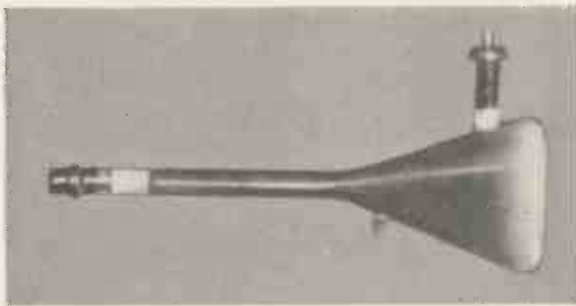

The tube used in the Philips receiver. The diameter of the tube at the large end is 4 inches and of this an area 2 in. by 16 in. is used for the picture.

is brilliant enough to be enlarged 100 times when projected via a 45° angle mirror in the inside of the lid of the cabinet on to a screen measuring 20 in. by 16 in.

The screen is incorporated in the cabinet and comes into view when the lid is raised. This screen is of the back projection type and is made on the 3-ply principle with the etched surface enclosed between two sheets of plain glass to prevent discolouration or soiling of the screen. A slow-motion device is provided to prevent damage to the screen by too rapid closing.

The cathode-ray tube has electromagnetic focusing and deflection and an H.T. voltage of 25,000 volts is used on the anode. This high voltage supply is provided by two H.T. recti-

the extra high tension supply.

- (3) The E.H.T. unit combining the H.T. transformer and condensers, also the cathode-ray tube compartment with the projector lens unit.

A broadcast received is included, but is separate from the television assembly frame and is similar to the standard 785AX type, a 5-valve high fidelity 3-waveband receiver with mono-knob control on the front of the cabinet.

The loudspeaker is mounted high up in the cabinet to give the impression that the sound accompaniment emanates from the screen.

Twenty-eight valves are used in the receiver, twenty-three for television and five for the broadcast set.



The Philips projection receiver which provides a picture 20 ins. by 16 ins.

The circuit of the television receiver commences with a radio-frequency amplifier with a TSP₄ valve for both sound and vision. Separate triode-hexode frequency changers Type TH₄A are used for sound and vision.

The sound is taken to a TSP₄ I.F. amplifier on 7.6 Mc and then to a 2D₄A for detection and A.V.C. From here the sound is fed into the pick-up sockets of the broadcast receiver and controlled for volume and quality by the mono-knob on the front of the cabinet.

The vision after the frequency changer goes to four stages of I.F. amplification on 11.1 Mc with TSP₄ valves and then to a 2D₄A for detection and a Pen A₄ output pentode. A further diode is used to obtain the D.C. control for the cathode-ray tube.

The synchronising signal is taken from the output of the vision amplifier to a further TSP₄ amplifier and a diode which supplies the synchronising impulses to the slow (frame) and fast (line) time bases.

The line frequency or fast time base employs four valves; a Pen A₄ feeding two Pen 428 valves in parallel. The frame frequency or slow time base has two valves, a gas triode, type GT₄H, feeding into a

(Continued at foot of page 589)

A NEW TELEVISOR FOR

MANY UNIQUE FEATURES:

Designed by

- **SIMPLE UNIT CONSTRUCTION**—Does not need special skill in its building.
- **LOW COST**—Cheapest televisor yet offered to the public.
- **STANDARD COMPONENTS**—Obtainable from stock.
- **STANDARD VALVES**—Stocked by most local dealers.

WHAT THE RECEIVER IS—

This televisor is the result of several months experimental work in the provision of a suitable design for amateur construction. Three vitally important points were kept in view—construction must be simple, cost must be low and components and valves must be of types easily obtainable. These objectives have been attained.

The instrument is a vision receiver only, consisting of three main units—receiver, time bases and power packs. Later it is proposed to describe a simple converter for attachment to any ordinary broadcast set for the reception of the television sound, or alternatively an all-wave broadcast receiver capable of tuning in the television sound can be used.

The receiver will be described in its completed form with three H.F. stages which have enabled excellent pictures to be obtained at a distance of 65

AS EASY TO BUILD AS A BROADCAST SET

THE design of a television receiver suitable for use at long range from the transmitter, although perfectly straightforward, is not without its difficulties when it is desired to make it possible for the average home constructor, with limited constructional facilities, easily to follow the design and build for himself with a minimum of difficulty a replica of the original model. This receiver was first designed for long-distance reception, and the very successful attain-

ment of this objective ensured that modifications could be made to render it very suitable for operation at lesser ranges also.

For long-distance reception quite high amplification is required, and this with a minimum of valves, which should preferably be normal types. Although it is possible to secure high R.F. efficiency from Acorn valves, they are expensive and, due to their physical dimensions, awkward to wire into their holders.

There is, however, little object in using normal valves if the number required, together with their associated circuit components, exceed in cost an arrangement using Acorn valves.

Due to the heavy damping imposed by a normal R.F. pentode valve at frequencies around 45 mcs., it is possible to use two or three R.F. stages very lightly damped and to secure an excellent frequency response. Two stages are very easily constructed, and it is by no means difficult to construct three. The overall gain given by two stages is a little higher than that obtainable from a single Acorn stage, as it is necessary slightly to detune an Acorn R.F. stage to secure adequate frequency response. But a big economy is effected by using normal valves.

Leaving this part of the receiver for a moment we will consider the I.F. amplifier.

The simplest form of coupling to employ here is undoubtedly the familiar tuned anode. Such couplings are cheap, simple to construct and adjust, and the necessary inductances can be simply wound by the home constructor.

COMPONENTS AND VALVES

All components and valves used in this receiver are standard types which are readily obtainable from most wireless dealers. This is a great advantage as constructors are assured of being able to obtain supplies without any delay.

ment of this objective ensured that modifications could be made to render it very suitable for operation at lesser ranges also.

For long-distance reception quite high amplification is required, and this with a minimum of valves, which should preferably be normal types. Although it is possible to secure high R.F. efficiency from Acorn

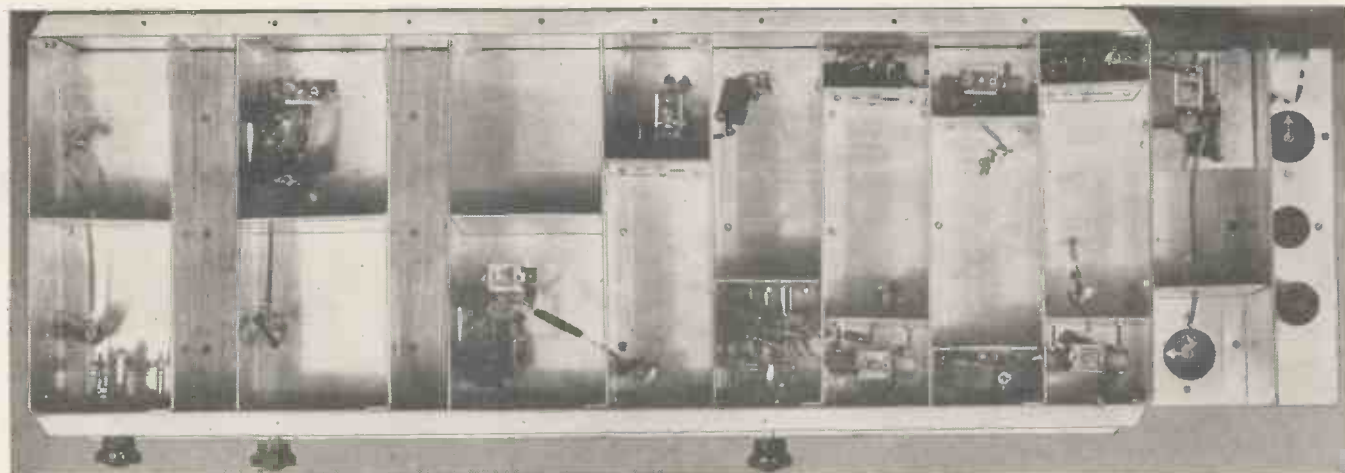

This plan view of the receiver shows how each stage is in a separate compartment, most of the components being secured to the aluminium dividing panels on which they can be assembled before the chassis is built up. Interstage connection is by means of the valves.

OCTOBER, 1937

EASY HOME CONSTRUCTION

S. West

GUARANTEED PERFORMANCE:

AND WHAT IT WILL DO

miles. For shorter ranges the number of H.F. stages can be reduced and how this can be done will be clearly explained; this of course will result in a reduction of cost. In addition either a 10-in. or 7-in. cathode-ray tube can be employed.

The construction is just as simple as any ordinary wireless set and requires no special knowledge. Each stage is almost completely assembled and wired up on small aluminium panels which provide the screening; with this system it is practically impossible to make any error, especially as the stages are separately illustrated very clearly. In addition, lining up is of the simplest character and the time bases are very simple to adjust. The amateur constructor can have every confidence in his ability to build the receiver and get excellent pictures immediately.

- **THREE RANGES**—65, 35 and 20 miles according to number of stages.
- **AMPLE RESERVE OF POWER**—providing clear bright, and steady pictures.
- **NOVEL SYNCHRONISING SYSTEM**—Unaffected by local interference.
- **PRE-SET TUNING**—Ensuring simple operation.

CONSTRUCTED IN COMPLETE SIMPLE STAGES

This photograph shows the receiver, time base and tube housing and comprises the complete receiver with the exception of the power pack which is a separate unit. The entire chassis is built up of sheet aluminium and the only tools necessary for the construction are those ordinarily in the possession of the wireless amateur.



The scanning and synchronising systems employed in this television have been developed by Mr. Paul D. Tyers and are the subjects of applications for patents. Home constructors are, however, at liberty in building this television or having it built for them to use these inventions without any obligations whatever, but this permission does not, of course, extend to commercial interests which must make their own arrangements with Mr. Tyers, who, by the way, in a special article appearing on pages 609 and 610 of this issue explains his system in detail.

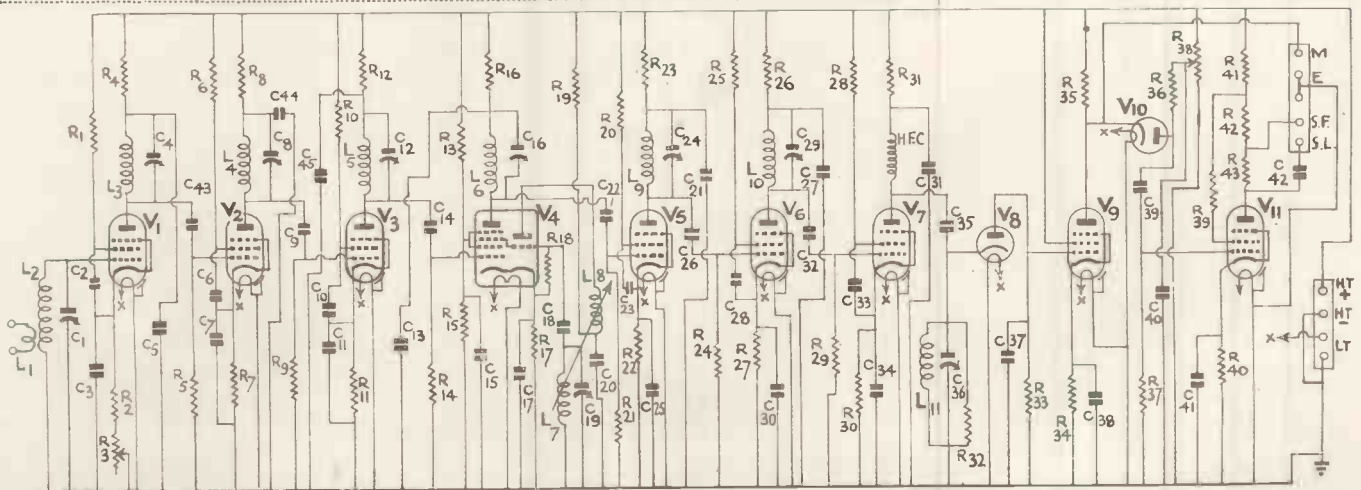

Although three R.F. stages and three I.F. stages are used in the Vision receiver, for Local reception two of the R.F. stages may be omitted and the damping on the I.F. stages may be reduced considerably. The frequency changer is a Triode-Hexode, while the second detector is a conventional low capacity Diode. With three R.F. stages and three I.F. stages, all Tuned Anode coupled, the heavy circuit damping customarily used to secure the wide frequency response necessary in Vision receivers is not required. It is, however, desirable to damp the I.F. stages more than the R.F. stages, as the damping imposed by the valves is very much lower at the I.F. frequency. Actually the I.F. stages are heavily damped as this considerably simplifies the initial adjustments.

DETAILS OF THE CHASSIS

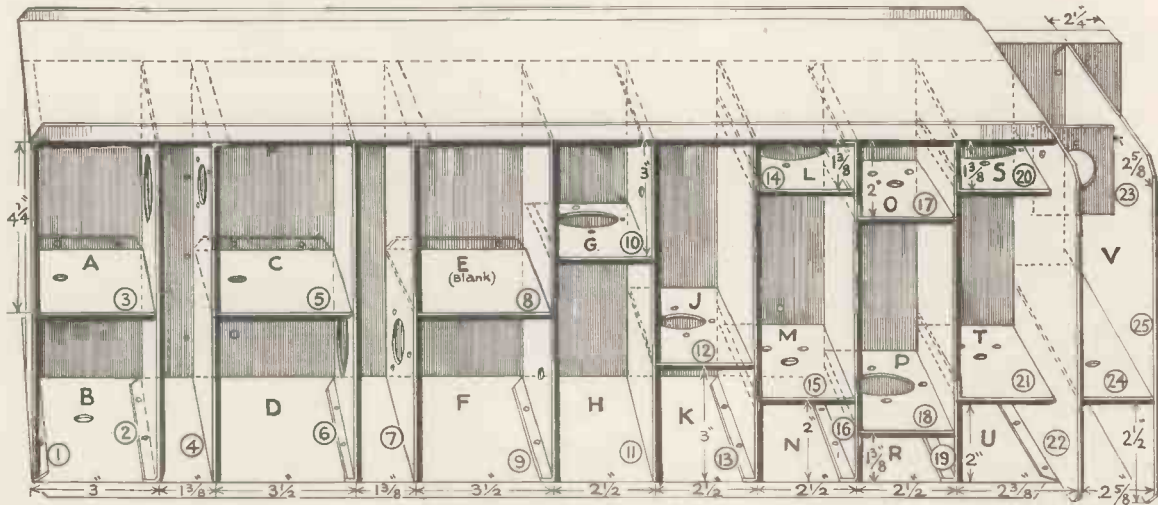

A perspective view of the chassis. The letters are for the purpose of cross reference to the stage details given on the following pages.

This drawing shows the parts required for the construction of the receiver chassis. It will be observed that in many cases these are duplicated. The various parts are held together by means of $\frac{1}{4}$ in. 6 B.A. screws and nuts which permit of easy assembly.

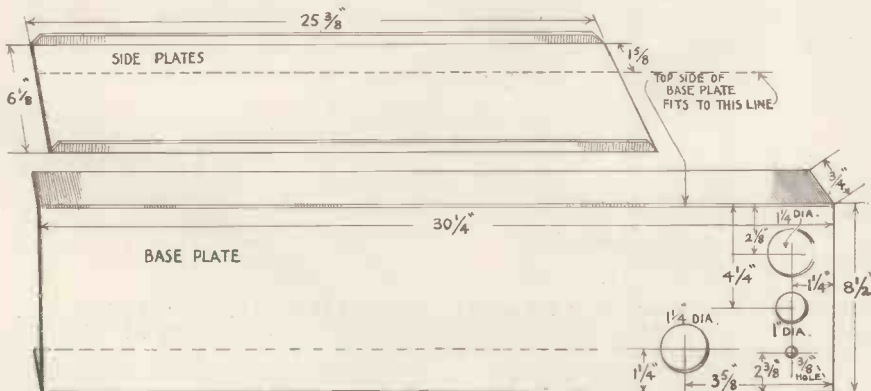
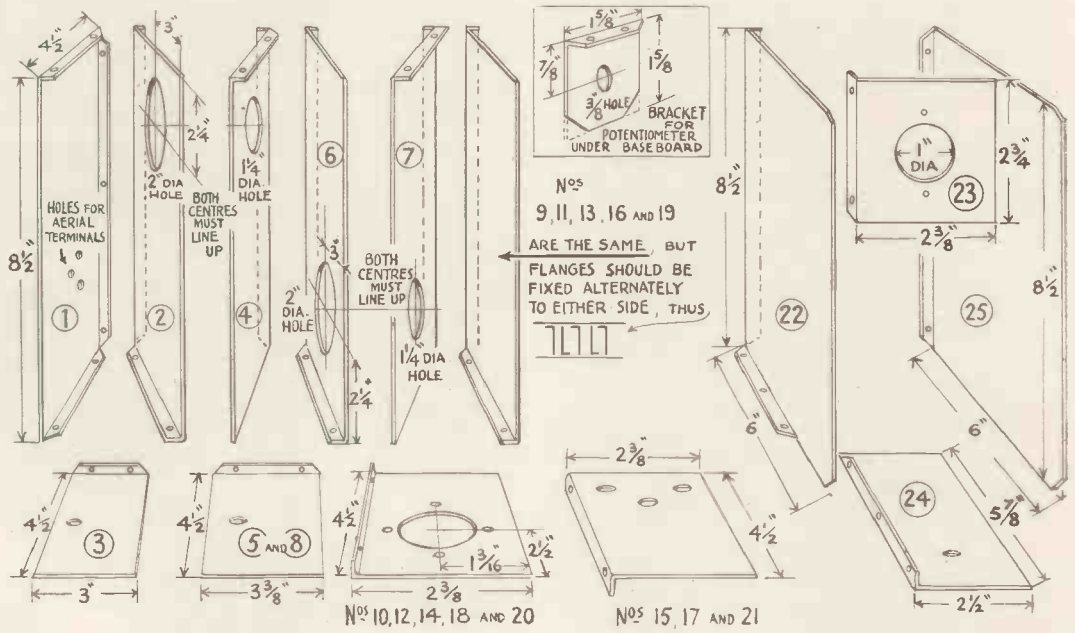

Here are details of the base and sides of the receiver chassis, the edges being turned at right angles for simple assembly.

DUPLICATED STAGES SIMPLIFY CONSTRUCTION

Unfortunately if good response is to be secured, theory indicates that heavy damping is required, and it can be shown that with the required damping for adequate frequency coverage the gain per stage is very

gain secured is then higher than when the circuits are tuned to resonance for reasons which need not be mentioned here.

THE CHASSIS

The chassis of this receiver is constructed of 19-gauge aluminium and may be either home constructed or purchased ready made. The edges of the various parts can be turned up quite easily by using two pieces of angle iron in a vice. It should be noted that the screens are not secured at both ends, a feature which makes them very easy to fit as double alignment of fixing holes and exact adjustment of length is not necessary. Dimensioned drawings are given showing all the necessary particulars.

Three stages of I.F. amplification providing they can be persuaded to furnish sufficient amplification would, from the home constructor's point of view, be very desirable. Almost all possibility of instability disappears, and there are only four circuits to adjust.

It is common practice to use four and five I.F. stages, but in the writer's experience this is not desirable, especially for the home constructor. He has observed that in most cases with home-constructed gear stability is obtained by a quite drastic use of increased bias on one, and often two, stages.

low. Happily there is a simple method of increasing the gain and at the same time retaining an excellent frequency characteristic.

It is well known that it is possible to obtain band-pass characteristics from a number of tuned stages by the simple expedient of staggering the tuning. The

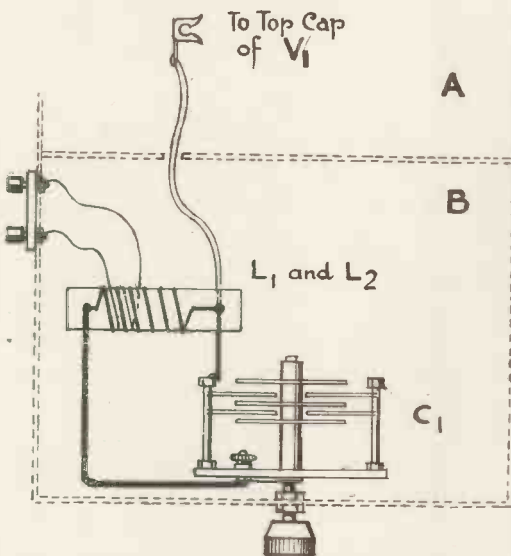

Wiring details of sections A and B, shown in the perspective view of the chassis.

Extended views are given of component assembly and wiring in order to make the drawings clear. As the space is restricted the assembly must be compact and leads kept short.

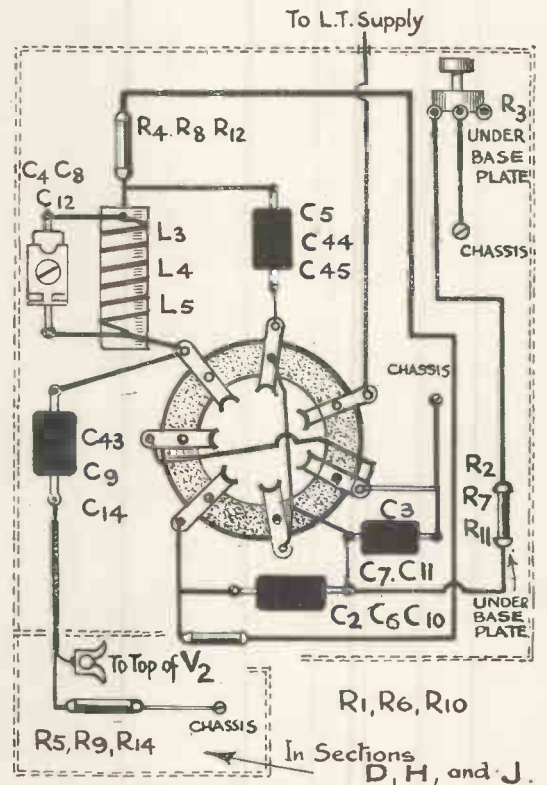

Wiring details of sections C, F, and G. Reference should be made to the circuit diagram for checking the connections.



A photograph of the left-hand side of the receiver chassis showing the components in position. The simple construction will be apparent.

UNIT ASSEMBLY ON METAL PANELS

Let us then assume that we are to employ only three I.F. valves and see the form it will be necessary for the rest of the receiver to take. It is almost certain that we shall need a stage of V.F. amplification, perhaps two.

Now, while it is easy to obtain good results from one V.F. stage, two can be tricky, and a good deal of care must be taken with their layout, also decoupling must

ASSEMBLY OF COMPONENTS

The wiring and assembly of components are very simple as most of the work can be carried out before the chassis is finally assembled, leaving only one or two connections to be made on completion. The only compartment that is likely to present any difficulty is that containing the oscillator stage as this is somewhat crowded, but no trouble will be experienced if the connections are all cut to the correct length before soldering. Each stage should be checked before assembling in the chassis.

be very thorough. This does not accord with the requirements of our design, and in view of this we shall decide to use only a single stage.

So we have our design taking shape. We have either two or three R.F. stages, three I.F. stages and a stage of V.F. amplification. We are assuming the use of a triode-hexode frequency changer and a diode detector.

Tests were made with two R.F. stages, and although such an arrangement is capable of giving good pictures

up to about forty miles, the tests revealed that to ensure consistent results at greater distances a little more amplification was desirable.

Three R.F. stages employing normal valves are, as has been remarked, quite easy to construct, and very little artificial damping is required as that imposed by the valves is practically sufficient; with this number the signal is adequate even under the worst conditions.

Our final design for long range, therefore, becomes a receiver employing three R.F. stages, a triode-hexode frequency changer, a diode detector and one stage of V.F. amplification. We shall also need two further valves for synchronising. A new system is used here that is eminently suitable for television receivers operated under adverse conditions.

Tuned anode couplings are used in both the R.F. and I.F. sections. Single circuits are used in all cases, although it is appreciated that this is rather unusual practice. For that matter the whole design is rather unusual. The writer's only excuse for the arrangement, and in his opinion a very good one, is that it gives excellent results at long distances and under conditions where other arrangements have failed lamentably to provide good entertainment; also, throughout, the receiver has been considered with particular reference to its easy construction and adjustment by the home constructor.

As a matter of interest, extensive tests revealed no difference between this receiver and a more expensive arrangement using a similar number of valves, three of which were Acorns.

A brief word here in connection with the coils. If the constructional drawings showing these are referred to, it will be seen that their turn numbers vary. Care must be taken to use each coil in its correct position for only by so doing is the correct frequency response secured and the task of adjusting the circuits is considerably simplified. Indeed, it will probably be found that almost the only tuning required when the receiver is connected are adjustments to the oscillator and aerial condensers. Of the trimmers it will be found

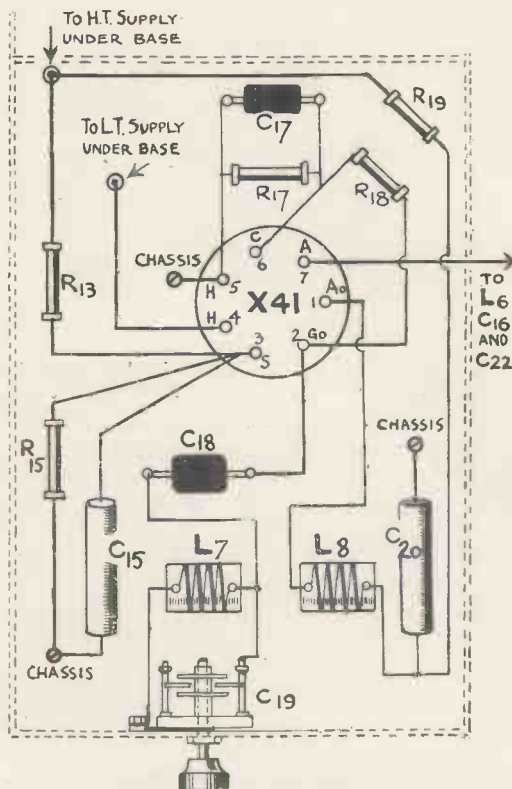

Wiring details of section K indicated in the perspective view of the chassis.

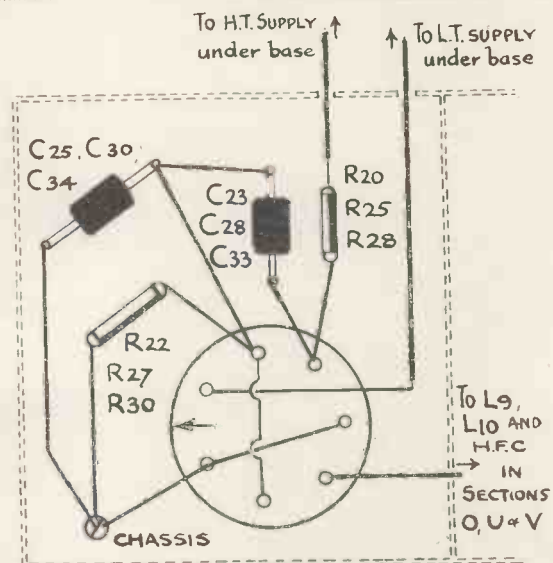

Wiring details of sections L, R, and S.

WIRING IS PARTICULARLY SIMPLE

that the most sensitive to adjustment is the one preceding the frequency changer and that preceding the diode, i.e., the last trimmer of the R.F. section and the last trimmer of the I.F. section.

No particular difficulties are presented in the construction of the receiver. It will be seen that almost the entire assembly of each stage can be made upon the aluminium panels which form the screens. This arrangement allows each to be checked and the possibility of error is very small.

The metal work is carried out in 19 gauge aluminium. The drawings give all dimensions and the photographs will make plain any point concerning which there may be doubt.

The wiring will not be found difficult if the following procedure is observed.

A start is made at the aerial end and each valve com-

partment is completed as far as possible before being bolted to the main chassis. The remaining connections are then easily made with a side removed. Before bolting the aerial end on, the first valve must be fitted as it is not possible to insert this afterwards.

A small point, but one worthy of attention, is to ensure that all connections to the chassis are well made. When bolting down soldering tags and compartment screening, it is well to ensure that clean surface contacts are made. Beware of dry joints, for there is nothing more annoying in an assembly of this description than to find oneself confronted with the task of dismantling half of it to reach a lead that has come adrift.

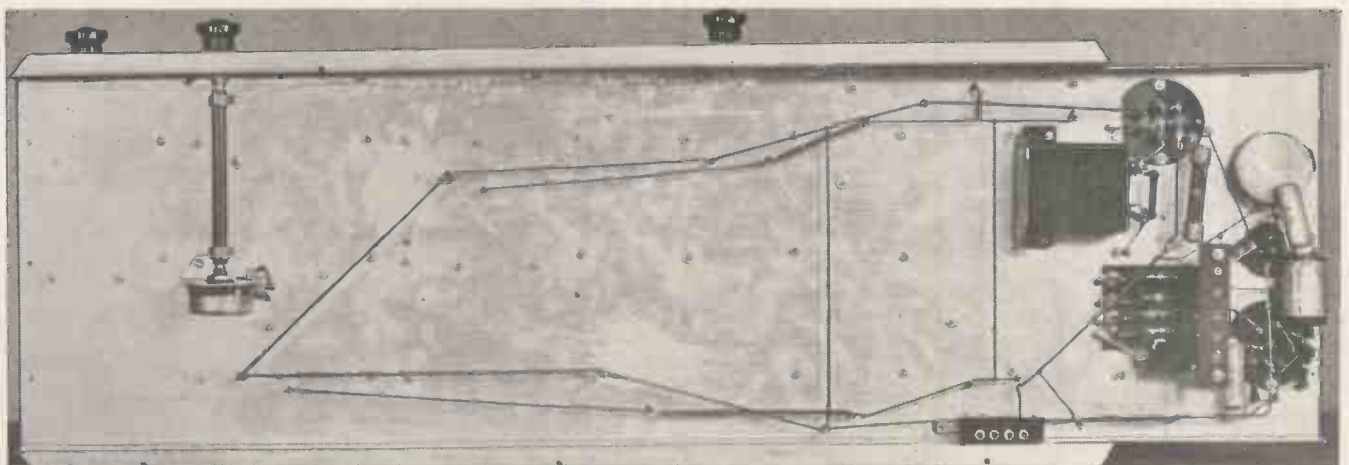
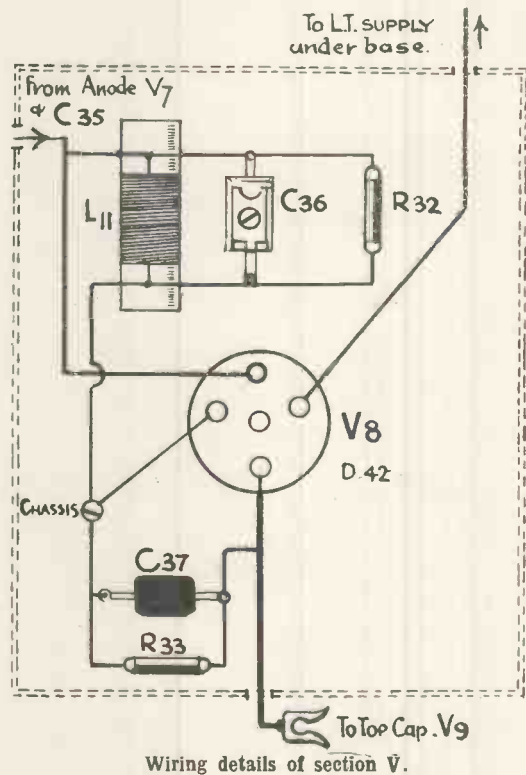
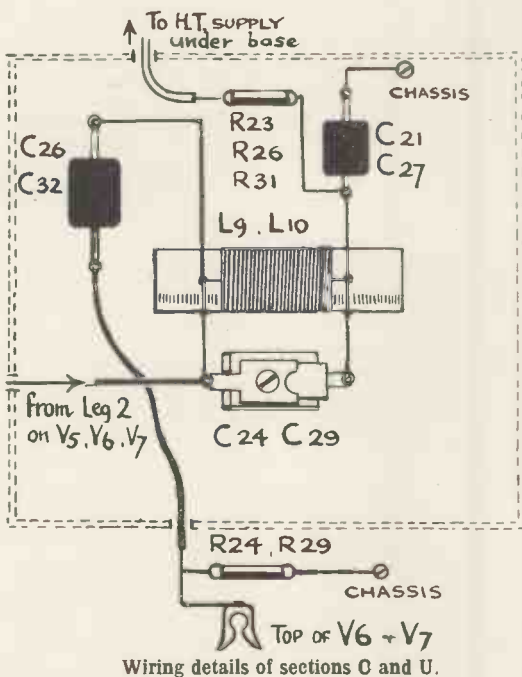

A photograph of the underside of receiver base. Very few components are used and exact details of the assembly and wiring are given on the next page.

SIMPLE COIL CONSTRUCTION IS A FEATURE

In the original receiver bare tinned wire was used throughout. Systoflex covering being used only where leads passed through the screening.

All leads should be kept as short as possible, and it is not advisable to depart from the original layout.

The R.F. inductances are supported by 16 s.w.g. tinned wire and this gauge can conveniently be used elsewhere where extra support is needed. It is essential

adjustment of their coupling should be allowed which can be made by slightly bending their supports.

There are advantages in using a comparatively high I.F. frequency, and no difficulties are encountered by so doing with only three stages. Consequently the I.F. inductances are quite small. These are mounted on short lengths of 4 or 6B.A. rod and are then bolted to the screens.

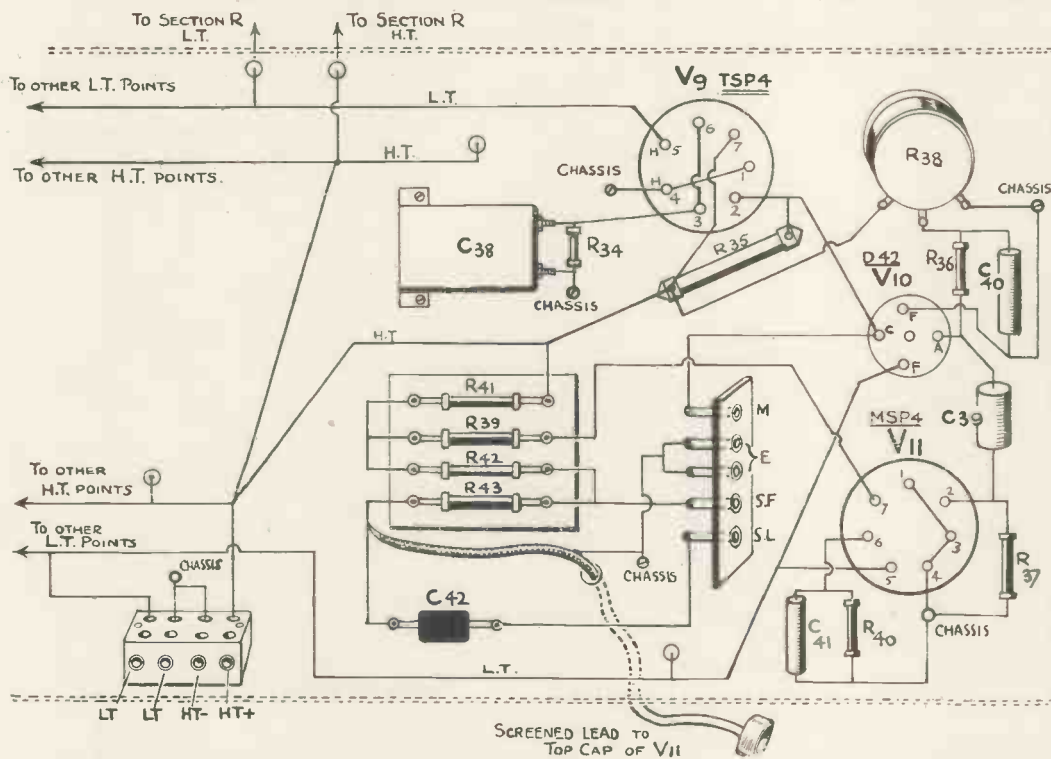

This diagram gives the necessary details of the component assembly and wiring on the underside of the receiver baseplate. Reference should be made to the photograph on the preceding page.

COIL DATA

The coils are of a very simple type and can be either purchased ready made or home constructed. Paxolin formers are employed and the coils are supported by B.A. studding provided with nuts to hold the coils in position. The coils up to 7 turns are wound approximately $\frac{1}{8}$ in. between turns and the remainder are close wound. The following is the data for the construction of the coils.

- L1—2 turns 28 DSC at earth end of L2
- L2—6 turns 24 SWG enamel.
- L3—6 turns 24 SWG enamel.
- L4—6 turns 24 SWG enamel.
- L5—7 turns 24 SWG enamel.
- L6—55 turns 28 SWG enamel.
- L7—4 turns 18 SWG enamel.
- L8—4 turns 18 SWG enamel.
- L9—55 turns 28 SWG enamel.
- L10—55 turns 28 SWG enamel.
- L11—60 turns 28 SWG enamel.

FORMERS— $\frac{1}{2}$ in.-paxolin $1\frac{1}{2}$ -in. long.

to use this gauge for the heater connections in order to avoid the possibility of voltage drop due to the comparatively heavy heater current taken by the valves.

Short stiff leads are soldered to the oscillator condenser prior to mounting it. The oscillator coils are supported by these wires. A little latitude for the

The 7,000 ohms anode load resistance of the output valve must be 3-watt rating, as any change in value of its resistance due to heating will adversely affect synchronism. If a 7,000-ohm 3-watt resistance is not readily obtainable three 20,000-ohm 1-watt connected in parallel will be quite suitable.

The total H.T. consumption of the vision receiver unit is 90 milliamps at 250 volts. The valve heaters require 4 volts at 11 amps.

It is important to note if an existing power pack is to be used, that one side of the heaters is connected to earth; consequently if the centre tap of the heater winding on the mains transformer is connected to earth, this connection must be removed, otherwise damage will be sustained by the winding.

It will be seen that the terminal strip carrying the output and synchronising terminals is mounted on the underside of the chassis, as is also the terminal block for the supply connections. If it is intended to use the receiver with existing apparatus the terminal strip can, within limits, be mounted in a more convenient position.

It can be mentioned here that the receiver is very suitable for use with the associated gear of the "Guaranteed Receiver," described in the October,

OCTOBER, 1937

November and December, 1936, issues, and no alteration is required to the design of these units to obtain excellent results.

Full constructional details of a time base and power supply unit for use with the receiver will be described in next month's issue. Several unusual features are incorporated in the time base, resulting in considerable economy and ease of adjustment. In the following articles of this series the cathode-ray tube and time base power supplies will be dealt with, and in the final article full operating instructions for the complete television receiver will be given.

If it is intended to construct these units, which have

been especially designed for use with the receiver, the terminal strip mentioned above should be mounted as shown.

As shown, with three R.F. stages, the receiver is suitable for use at distances up to 65 miles. For distances up to 35 miles two R.F. stages will suffice, and one R.F. stage for very local service. The alteration necessary will be shown. Although fewer stages could be accommodated on a smaller chassis, this is not considered advisable, as the saving effected would be trivial. It is suggested, therefore, that the chassis dimensions given should be adhered to, regardless of the number of R.F. stages employed.

LISTS OF COMPONENTS, VALUES AND MAKES IN VISION UNIT

RESISTANCES

R1 50,000-ohms ($\frac{1}{2}$ watt) (Erie)	R25 50,000-ohms ($\frac{1}{2}$ watt) (Erie)
R2 100 " " (Erie)	R26 1,000 " " (Erie)
R3 10,000-ohms pot. (Reliance)	R27 250 " " (Erie)
R4 1,000-ohms ($\frac{1}{2}$ watt) (Erie)	R28 50,000 " " (Erie)
R5 5,000-ohms " (Erie)	R29 1,000 " " (Erie)
R6 50,000-ohms " (Erie)	R30 250 " " (Erie)
R7 250 " " (Erie)	R31 1,000 " " (Erie)
R8 1,000 " " (Erie)	R32 5,000 " " (Erie)
R9 5,000 " " (Erie)	R33 5,000 " " (Erie)
R10 50,000 " " (Erie)	R34 100 " " (Erie)
R11 250 " " (Erie)	R35 7,000-ohms (3 watt) (Dubilier)
R12 1,000 " " (Erie)	R36 2 megohms ($\frac{1}{2}$ watt) (Erie)
R13 50,000 " " (Erie)	R37 100,000-ohms ($\frac{1}{2}$ watt) (Erie)
R14 100,000 " " (Erie)	R38 100,000-ohms Pot. (Reliance)
R15 50,000 " " (Erie)	R39 10,000-ohms (1 watt) (Dubilier)
R16 1,000 " " (Erie)	R40 200-ohms ($\frac{1}{2}$ watt) (Erie)
R17 250 " " (Erie)	R41 50,000-ohms (1 watt) (Dubilier)
R18 50,000 " " (Erie)	R42 5,000 " " (Erie)
R19 20,000 " " (Erie)	R43 5,000 " " (Erie)
R20 50,000 " " (Erie)	
R21 1,000 " " (Erie)	
R22 250 " " (Erie)	
R23 1,000 " " (Erie)	
R24 1,000 " " (Erie)	

CONDENSERS.

C1 25 mmfds, variable (Premier)
C2 .0003 mfd. type M (T.C.C.).
C3 0.01 mfd. type 691 (Dubilier).
C4 Trimmer 30 mmfds. max. SW95 (Bulgin).
C5 0.0003 mfd. type M (T.C.C.).
C6 0.0003 mfd. type M (T.C.C.).
C7 0.01 mfd. type 691 (Dubilier).
C8 Trimmer 30 mmfds. max. SW95 (Bulgin).
C9 0.0003 mfd. type M (T.C.C.).
C10 0.0003 mfd. type M (T.C.C.).
C11 0.01 mfd. type 691 (Dubilier).
C12 Trimmer 30 mmfds. max. SW95 (Bulgin).
C13 0.002 mfd. type 690W (Dubilier).
C14 0.0003 mfd. type M (T.C.C.).
C15 0.1 mfd. type 4603/S (Dubilier).
C16 Trimmer 30 mmfds. max. SW95 (Bulgin).
C17 0.01 mfd. type 691 (Dubilier).
C18 0.001 mfd. type 690W (Dubilier).
C19 25 mmfds. variable (Premier).
C20 0.1 mfd. type 4603/S (Dubilier).
C21 0.002 mfd. type 690W (Dubilier).
C22 0.0003 mfd. type M (T.C.C.).
C23 0.002 mfd. type 690W (Dubilier).

C24 Trimmer 30 mmfds. max SW95 (Bulgin).
C25 0.01 mfd. type 691 (Dubilier).
C26 0.0003 mfd. type M (T.C.C.).
C27 0.002 mfd. type 690W (Dubilier).
C28 0.002 mfd. type 690W (Dubilier).
C29 Trimmer 30 mmfds. max. SW95 (Bulgin).
C30 0.01 mfd. type 691 (Dubilier).
C31 0.002 mfd. type 690W (Dubilier).
C32 0.0003 mfd. type M (T.C.C.).
C33 0.002 mfd. type 690W (Dubilier).
C34 0.01 mfd. type 691 (Dubilier).
C35 0.0005 mfd. type 690W (Dubilier).
C36 Trimmer 30 mmfd. max. SW95 (Bulgin).
C37 0.0005 mfd. type 690W (Dubilier).
C38 500 mfd. type 501 (T.C.C.).
C39 .5 mfd. type 4608/S (Dubilier).
C40 0.1 mfd. 350 volts D.C. type 4603/S (Dubilier).
C41 0.1 mfd. 350 volts D.C. type 4603/S (Dubilier).
C42 0.0001 mfd. type 690W (Dubilier).
C43 0.0003 mfd. type 690W (Dubilier).
C44 0.0003 mfd. type 690W (Dubilier).
C45 0.0003 mfd. type 690W (Dubilier).

SUNDRIES.

H.F. Choke type 1020 (Eddystone).
8—Valve thimbles type P41 (Bulgin).
1—Screened valve cap type P65 (Bulgin).
7—7-pin chassis mounting valve holders (Belling-Lee).
2—5-pin chassis mounting valve holders (Belling-Lee).
2—7-pin valve holders type 1024 (Eddystone).
1—Terminal block type 1046 (Eddystone).
1—4-way connecting block (Bryce).
1—Group resistor board. Cat. No. C. 31 (Bulgin).
1—5-way terminal strip (Belling-Lee).
Chassis, nuts and bolts, wire, systoflex, etc.
9—1 $\frac{1}{2}$ in. by $\frac{1}{2}$ in. paxolin coil formers (Wright & Weaire).
1—Extension spindle. Cat. No. 1008 (Eddystone).

VALVES.

V1, V2, V3, V5, V6, V7, Mazda AC/SP3.
V4, Osram X41.
V8, V10, Osram D42.
V9, Mullard TSP4.
V11, Marconi MSP4.

CHASSIS.

1—Aluminium to specification (Mervyn).
--

CATHODE RAY TUBE.

1—Type 10H or 7H (Ediswan).

"The Philips Projection Receiver"

(Continued from page 581)

Pen A4. The H.T. for the time bases and amplifiers is provided by two 1W4 valves.

The main on/off switch for television and broadcast is operated by drawing forward the tilting dial which, in the off position, lies flush with the front of the cabinet. The wavechange and television switch is operated by the moulded ring which encircles the mono-knob on the front of the cabinet.

Controls

For television there are four main controls grouped into two concentric pairs located on a sunk panel

under the lid and in front of the screen. The right-hand pair only need occasional adjustment, as they control the tuning (large knob) and the focus on the cathode-ray tube. The tuning control combines both sound and vision, the correct tuning for vision being the point where the sound accompaniment has maximum volume for a given setting of the volume control.

The left-hand pair are: A large knob for background, which controls the amount of light on the screen by varying the bias on the cathode-ray tube, and a small knob for contrast, which varies the gain of the vision amplifier.

The pre-set controls are located to

the right of the main controls under a small hinged cover to prevent accidental mis-adjustment. The left-hand pair control time-base frequencies, the middle pair control size of picture on the screen, and the right-hand pair control centring of picture on the screen. In every case the small knob controls the vertical and the large knob the horizontal components of the picture.

Excellent pictures were obtainable with this instrument, and the picture being projected on to a flat screen is quite free from any distortion. The extra high sensitivity enables results to be obtained outside the normal service area, provided conditions of local interference permit.

THE SMALL-SCREEN RECEIVER

— A WELCOME INNOVATION

A great deal of interest was aroused at Radiolympia by the introduction of the small-screen and table-model television receivers. Despite the demand there has been for bigger pictures it is apparent that these types of receivers by enabling a considerable reduction in the price to be made will be very popular for home use.

ONE of the chief items of criticism of the television picture during the past twelve months has been regarding the size of the screen. On the face of this criticism it may seem rather surprising that a



The G.E.C. table-model receiver incorporates a converter which allows of it being used in conjunction with an ordinary broadcast set for reception of television sound. It sells at the very low price of £35.

number of makers have introduced receivers this year with screens that are even smaller than those which we have regarded in the past as a suitable minimum. Of course, the true reason for this is to enable a reduction to be made in the price and without this advantage, which the small screen makes possible, it may be assumed that the tendency would be for an increased screen size.

There is, however, much to be said for the small screen. In the past criticism of screen size has come from the general public who, for the most part, have only made the acquaintance of television in public viewing rooms, and more often than not under conditions of viewing distance which exaggerated the deficiencies which may have appeared apparent. There is also the point that the average person does not realise that the definition is limited by the standard of

transmission, and that increased picture size merely means that the picture will have to be viewed a greater distance away.

Home viewing and public demonstration are under entirely different conditions. In the former the audience will rarely exceed half a dozen people, whereas in the latter the number may, and probably will, be any number up to thirty or forty, which necessitates a good proportion of them being some considerable distance away from the screen. Actually, it has been calculated that the ideal size of screen with the present standard of definition is nine inches, with a viewing distance of six to eight feet; any increase of picture size means that the viewing distance will have to be increased if the picture is to be seen without its composition being very apparent.

For Home Use

It is evident, therefore, that there is a very good case for the small-screen receiver and providing that it is used under home conditions without a large audience it will provide adequate entertainment. If this type of receiver suffered at the Radiolympia demonstrations by comparison with the larger receivers it was merely because the majority of viewers were of necessity too far away. Under home conditions the small screen provides an excellent picture and the detail is such that it can be viewed at close quarters in comfort and as much detail seen as with the larger screen.

The fact that this reduction of screen size enabled several manufacturers to produce receivers at prices ranging from £35 to £45 created a great deal of interest, because it has brought television within the reach of the average person. At these prices the cost of a television receiver is very little in excess of a good class broadcast receiver and lower than many radiograms. Running costs are also low which may be assumed to be in the region of about

a penny per hour. Another feature is that the receivers of this type occupy very little space and most of them are described as table models, although special stands are available in most cases.

The Cossor

Cossors have produced a table model which, although small as far as the cabinet is concerned, gives a medium-sized picture as actually a 10-in cathode-ray tube is employed. It is designed for receiving television and its accompanying sound only. The picture, though slightly smaller than that rendered by the Console models, is of ample size for home entertainment and the reproduction is very fine indeed. The price is 45 guineas.

Ekco

The Ekco table model is priced at 45 guineas, and it provides a picture as bright and with as good definition as the larger instruments. The cabinet measures only 27 in. by 19 in. by 20 in. There are only two main controls and the receiver provides television sound and vision. As the viewing angle is wide (120



The Cossor table-model receiver includes television sound and is therefore complete in itself. A 10 in. tube is employed and picture size is ample for home use. The price is 45 guineas.

degrees) half a dozen people can watch in comfort and be sufficiently near the screen to see every detail.

BAIRD TELEVISION LTD.

WORLD PIONEERS & MANUFACTURERS OF ALL TYPES OF TELEVISION EQUIPMENT

★ FIRST IN 1926 ★

★ FINEST IN 1937 ★

Brilliant pictures, freedom from distortion, excellent detail, wide angle of vision, extremely simple operation, high fidelity sound and all-wave radio are among the factors contributing to the first-class performance of all Baird Television receivers. Incorporating all the latest features in television development, every model in the range represents the high-water-mark of achievement.

★ ★ ★ ★

Each television receiver incorporates a Baird "Cathovisor" Cathode Ray Tube which has the outstanding advantage of being completely electro-magnetic in operation. These tubes can be supplied separately with the necessary scanning equipment where desired. Apart from manufacturing processes, stringent tests are made for electrical emission, tube characteristics, filament rating, and screen quality, and following normal picture reconstitution under service conditions, every Baird Cathode Ray Tube, on completion, is subjected to a very high external pressure test. Baird "Cathovisor" Cathode Ray



One of the New Baird Receivers
Model T.11

Tubes are the ideal solution for high quality television pictures.

★ ★ ★ ★

A large number of Flat installations have already been undertaken by the company, and amplifier equipment for this purpose is now available. Vision and sound are provided "on tap" in any room desired, and technical advice will be given by the company's experts on all points.

★ ★ ★ ★

Another new development is the Baird Multiplier Photo-electric Cell, of which there are two main types, suitable for either a concentrated light beam or diffused light. The Baird Multiplier is a chain of electron permeable grid stages, and under service conditions current gain factors of the order of 100,000 can be obtained. Cathode sensitivity is approximately 30 micro-amps per lumen. These Multiplier Cells are suitable for all television and sound on film work, together with many industrial applications where high gain, coupled with sensitivity and extremely high signal to noise ratio, is essential.

Write for latest literature describing:
BAIRD RECEIVERS MODELS T5C, T.11, T.12 and T.13.
MULTIPLIER PHOTOCELLS.
12 in. 15 in.
"CATHOVISOR" C. R. TUBES.
"CATHOVISOR" C. R. TUBE SCANNING EQUIPMENT.
Post free on request.

Head Office :

Laboratories :

**Greener House, 66, Haymarket,
LONDON, S.W.1**

**Crystal Palace, Anerley Road,
LONDON, S.E. 19.**

*Phone: Whitehall 5454

*Phone : Sydenham 6030

The ALL-METAL WAY 1938 EDITION



If you were unable to attend the Radio Exhibition and to secure your copy of the latest edition of "The All-Metal Way," fill in the attached coupon, enclosing 3d. in stamps, and post it now. You probably already know the value of this publication—the standard handbook on metal rectification, but may we draw your attention to the new types of



METAL RECTIFIERS FOR
RADIO AND TELEVISION

together with the reduced prices.

COUPON

Westinghouse Brake & Signal Co., Ltd.,
82, York Road, King's Cross, London, N.1.

Please send me a copy of "The All-Metal Way, 1938" for which I enclose 3d. in stamps.

Name.....

Address..... T

G.E.C. Simplification

The G.E.C. have been able to bring the price down to a very low figure in their table model receiver by an ingenious combination of the vision receiver with an ordinary broadcast receiver. The G.E.C.

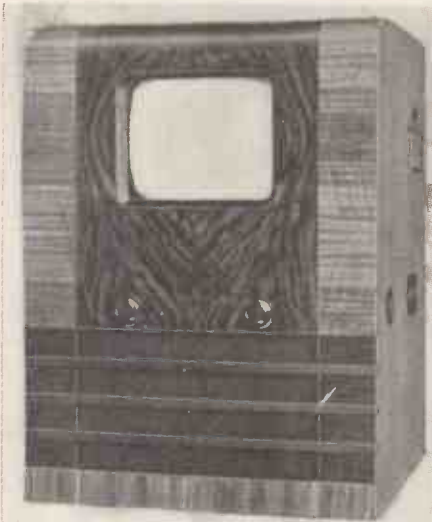

The Ekco miniature also provides television sound and vision and the results are excellent. Priced at 45 guineas it represents very good value.

vision unit connects up to the ordinary radio set without any modification and while it gives on its 6 in. by 4½ in. screen a picture of exceptional clarity the accompanying sound is reproduced on the radio

receiver. This instrument, the first of its kind in the world, has been evolved by the G.E.C. television engineers and was demonstrated at Radiolympia. Already it is in course of production and will be available to the public in a month or two. Priced in the neighbourhood of £35, it will bring television within the means of tens of thousands of listeners within 30 miles radius of Alexandra Palace and from other stations when they are established.

Pye

In the Pye Teleceiver range there is a Minor model which provides a picture 7½ in. by 6 in. Priced at 43 guineas, this is a Console model and except for its size follows upon ordinary lines. The instrument has only two principal controls and the price includes aerial and installation. Magnetic scanning is used in the Pye receiver.

Ultra

The Ultra small-screen receiver provides a picture 7¾ in. by 6½ in., and the price is 38 guineas. This is not a table model but the cabinet is quite small, the actual measurements being 36 in. high, 21 in. wide and 20 in. deep. This receiver incorporates television sound and vision. Magnetic deflection is used and an economy in valves is effected by using Thyatron time base generators for separating the syn-

chronising impulses, a total of fifteen valves being employed.

Receivers of the foregoing types should do much to popularise television, not only by reason of the reduction of the first cost, but also because of their simplicity and low running and maintenance costs. The ordinary television receiver has



The Pye Minor model is a console with a directly viewed picture. Except for picture size it is built upon conventional lines.

proved very reliable and there is no doubt but that the same will be the case with the Junior type of receiver and in the event of replacements being necessary the cost will be trifling.

Book Review

Radio Engineering (2nd Edition).
F. E. Terman. McGraw-Hill
Publishing Co. 30s. net. 796
pp., 474 Figs. in text.

Contents: Elementary Principles of Radio Communication; Circuit Constants; Resonant Circuits; Vacuum Tube Amplifiers; Power Amplifiers; Oscillators; Modulation; Detection Power Supplies; Transmitters and Receivers; Propagation of Waves; Antennas; Navigation Aids; Television.

This is the second edition of Prof. Terman's book which was originally published in 1932. The author states that it has been completely revised in view of the rapid developments which have taken place in radio theory and practice since that date, and it may thus be considered as a new book.

The amount of extra material which has been included in this edition is such as to make it the most comprehensive text-book of its kind and the most up-to-date.

After the usual introductory matter on the theory of radiation and the properties of vacuum tubes (including the beam power tube) we have over 100 pages devoted to the subject of vacuum tube amplifiers. The various classes of amplifiers are described in detail and there are several curves giving the relative performance of amplifiers with varying component values. A section is devoted to negative feed-back. Under power amplifiers a complete worked example is given of Class C amplifier performance, and at the end of each chapter several examples are given having a bearing on the problems discussed.

The chapter on power supply for amplifiers is perhaps one of the most valuable contributions to the subject which has yet appeared. Many experimenters have felt the need for a concise description of the relative merits of the various filter circuits and their effect on the output and efficiency of supply units, and the

literature on the subject is not easily found. A chart on p. 493 gives the relation between the per cent. ripple, peak current, and D.C. voltage for various values of load resistance and although calculated for 60 cycles is of great use to the British radio experimenter.

The chapter on television is a very brief survey of the general principles, but if read in conjunction with the previous matter the reader would have no difficulty in understanding the special requirements of video amplifiers.

The book is remarkably free from errors and has a comprehensive bibliography, the main references being to the I.R.E. Proceedings. This seems to be usual in American text-books.

Whether for American or British readers, Prof. Terman's book is excellent and cannot be too highly recommended. All radio students and experimenters should possess a copy.

THE TELEVISION OF FILMS

This article gives the first published details of the method employed in televising films. In view of the present series of film transmissions from the Alexandra Palace it is of particular interest.

HERE has recently been commenced a series of film transmissions intended primarily for the benefit of radio manufacturers and dealers in order to enable them to make tests and give demonstrations. Details of the manner by which films are transmitted have not been published hitherto and it is the purpose of this article to describe the method employed.

The film used is the standard 35 mm. type complete with sound track. Standard film is prepared to run at 24 frames, that is to say, 24 separate pictures per second, which is a linear footage of 89 per minute. To project standard film two main types of projectors are used termed "intermittent" and "continuous" and, as their names imply, in the former the film passes through the machine in a series of rapid intermittent movements and in the latter with a smooth continuous motion. It is the intermittent type which is used in cinemas, the continuous type never having found

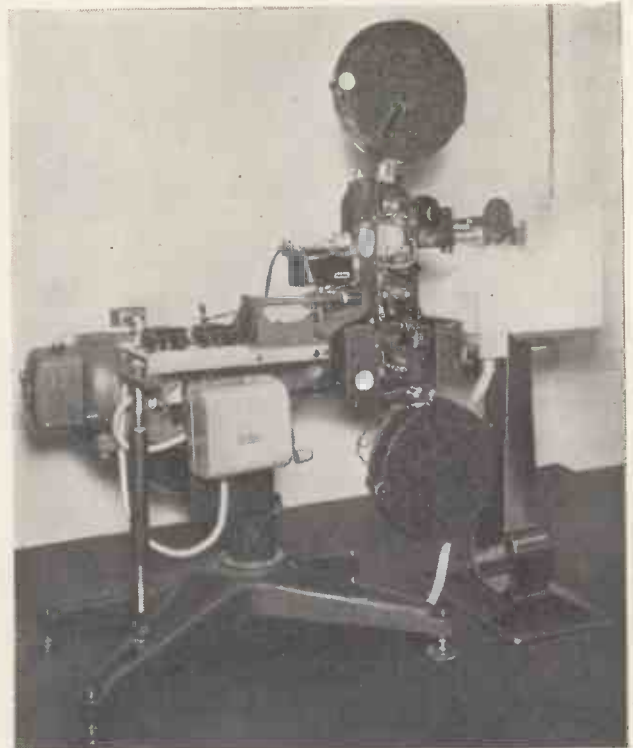

The film projector and scanning camera for televising film pictures.

favour in this country or America, though this type is employed on the Continent.

In the intermittent type of projector the film passes from the top spool box to a continuous feed sprocket A (Fig. 1), into the "gate," through which it is drawn by a series of jerks, coming to rest between each downward movement, due to the intermittent motion of the sprocket X, the continuous take-up sprocket B finally passing the film into the bottom spool box via the sound head. This intermittent movement of the film through the "gate" is arranged so that the film is at rest for a considerably longer time than it is in motion. Owing to the fragility of celluloid and the strain of sudden movement, a ratio of one of motion to three of rest is the optimum.

Next we must consider the shutters which cut off the movement of the film on the screen. A segment inserted in the ratio of one to three as in the black area, Fig. 2A, will give a clear picture, but with a pronounced flicker of 24 per second, which is very noticeable, so an additional segment is inserted as in Fig. 2B, which brings the flicker speed up to 48, which is above the normal power of the eye to resolve. The effect of the shutter is shown diagrammatically in Fig. 3A in the form of a picture on and off the screen for two frames.

Such is a normal projector and we must now see how it fits in with television standards. The great difference is, of course, the frame speed, television being 25 as against 24. This is no serious problem, as increasing projection speed by one frame per second is simply a matter of gearing and the increase in the movement is unnoticeable except to the most expert eye; also the raising in pitch of the sound is not generally noticeable, so the normal film projector is run at 25 frames per second for television purposes.

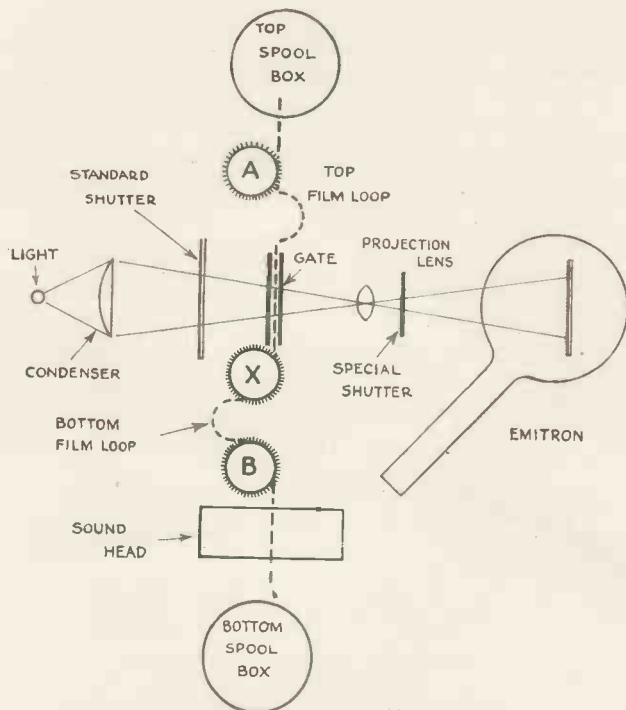

Fig. 1.—Schematic diagram showing the method employed in film transmission.

FLICKER IN FILM TRANSMISSION

Though television is transmitted at 25 frames per second the scanning is interlaced, which means that it is necessary to scan the same scene twice; also while in the case of the film it is only being projected for half of the frame time, in television for the equivalent pro-

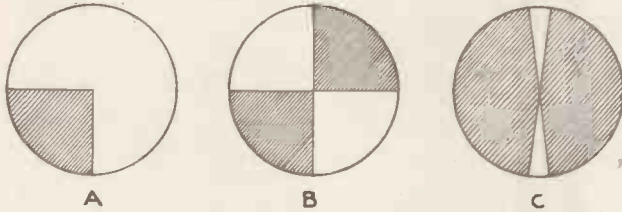

Fig. 2. Effect of shutter speed upon flicker.

jection the actual scanning goes on for approximately nineteen-twentieths of the frame periods. The signal of two television frame periods is shown diagrammatically at B, Fig. 3.

The first thing in transmitting a television picture is to project a light image of the scene to be televised on to the photo-electric mozaic of the Emitron. For a start let us project the film from our standard projector, not on to a normal screen, but on to the mozaic plate. The image of the film will, of course, not have to be magnified more than some six diameters, instead of the more usual hundreds for a normal screen. Turning again to our diagram of Fig. 3A and B, let us start the cycle of operations and try and draw a picture of their resultant at C, Fig. 3.

As no picture has been projected on to the mozaic for the first quarter of the frame time, no signal will result; at the commencement of the second quarter, a picture is projected on the mozaic which results in a signal of rising intensity, the increase in intensity being due to the cumulative storage effect of the mozaic. This signal would cease at the synchronising signal.

Avoiding Flicker

At the commencement of the second scan the flicker shutter will be in operation so that no more light would fall on the mozaic, but a signal would result from the storage effect during the exposure of the previous quarter. During the last quarter a rising signal will again be produced (which one might expect to represent as in the diagram), but it may have suffered somewhat from the second quarter's scanning, it being somewhat doubtful as to the effect of scanning the odd lines on the adjacent even ones and vice versa.

Commencing the second frame, again on the first quarter no picture falls on the mozaic as the shift segment of the shutter is closed, but a signal will result owing to the storage effect, while on the second quarter an existing storage charge is added to as the picture is again projected on to the mozaic and another rising-intensity signal will be produced, and so on with steady and rising signal every other quarter of the frame period.

The result of all this would be a quite impossible picture. It would appear to flicker badly with hori-

zontal black line travelling up or down it. To overcome all this another mechanical shutter is introduced, so arranged as to project a picture on the mozaic only when the mozaic itself is not being scanned, that is to say during the period of frame synchronising and black level signal, the actual shutter running at frame speed with two opposite sectors of about 14 degrees (see Fig. 2C) and so phased with the normal shutter as to open in the middle of its open position, the synchronising pulse being also so placed. As the shutters driving sound and synchronising signal are controlled from common A.C. mains, once set up there is no difficulty in keeping all three in proper relationship.

There has been a certain amount of criticism regarding film transmissions, and it is the opinion in many quarters that the films transmitted by the Baird system with 240 lines were superior to those at present being radiated (apart from flicker); also that the results given by the Cossor film transmitter at the Science Museum are superior to those radiated from Alexandra Palace.

Film transmissions certainly are not technically so good as the direct material from the studio and it is

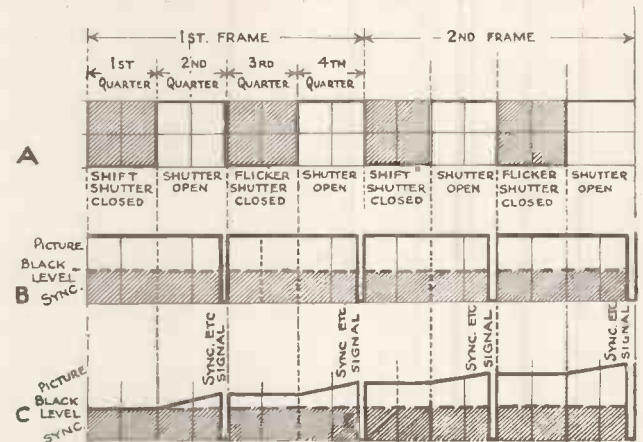

Fig. 3. Diagram of cycles of operation transmitting film.

evident that the present photo-electric mozaics which suffer from electronic leakage and secondary effects will have to be improved or another method found for using them. It would appear that the continuous film projector of the revolving mirror type would be eminently suitable to make the best use of the present photo-electric mozaic.

Coils and Chassis for the Low-cost Televisor

Constructors who do not wish to make their own coils and chassis for the Low-cost Televisor will be interested to know that both these can be obtained from the Mervyn Sound and Vision Co., Ltd., of 4 Holborn Place, London, W.C.2. The coils, which are wound to specification, are supplied ready for mounting and the chassis completely drilled and ready for assembly, which is a simple matter by means of 6 B.A. screws and nuts, which are included with the metal work. The price of the receiver chassis is 45s.

Scannings and Reflections

FOOTBALL TELEVISION

THE experiment at the Arsenal football ground gave viewers an idea of the work which goes on behind the scenes of a first-class football club. (The pictures, which included demonstrations of ball-trapping by Bastin and head-work by Drake, Roberts, Hapgood, Male and others, were picked up by the Emi-tron cameras located at vantage points around the ground, and were transmitted by the mobile television unit direct to the Alexandra Palace. One half of the team watched by television the other members undertaking their training.

This is the first time that a television broadcast has been made from a football ground, and it was an experiment to test the practicability of including football matches in the television programmes. Three cameras were used: one on the stands to give a comprehensive view of the ground, and two others near the goal mouth.

"CARNIVAL"

Members of the Vic-Wells Ballet Company will visit Alexandra Palace on October 11 for an afternoon and evening performance of Schumann's "Carnival," arranged as a ballet by Michael Fokine, with orchestration by Gordon Jacob. It is hoped that all the leading members of the famous Vic-Wells Company will be present, including Elizabeth Miller, Ursula Moreton, Mary Honer, Joy Newton, Harold Turner, Frederick Ashton, William Chappell, Claude Newman and Robert Helpman.

PINEWOOD FILM STUDIOS

The mobile television unit will be stationed at the Pinewood Film Studios, Iver Heath, Buckinghamshire, from September 30 to October 5, to give direct shots of films in the making. Jessie Matthews, Maurice Chevalier, Adèle Astaire, and other stars of the screen will be seen during actual filming, so that viewers will obtain a first-hand impression of how a big picture is built up. Transmission from the film

stages will be given on three nights. The first will show Sonnie Hale directing the new Gaumont-British picture, "Sailing Along," with Jessie Matthews, Jack Whiting, Roland Young, and Barrie McKay. On another evening Monsieur René Clair, the distinguished French director, will be seen at work on a new Jack Buchanan picture with Maurice Chevalier and Adèle Astaire on the set. The third stage shot will show a British Paramount film in production.

During the afternoon transmissions from Pinewood, which will be given daily, viewers will be taken behind the scenes to see the workshops, the power house, the plasterers' shop, and the boardroom of the Pinewood Studios. This is actually the rebuilt saloon of the *Mauretania*. The cutting rooms will also be visited, as well as the twenty-two-acre garden which has figured in many of the films which have come from the Pinewood Studios since they were opened twelve months ago. During the television inspection of the models department it is hoped to stage a train smash. The tour will include the dressing rooms, and it is hoped that such stars as Nova Pilbeam, Will Hay, Lili Palmer, and the boy actor, Desmond Tester, may act as guides. Mr. Alfred Hitchcock, the eminent director, may also face the television camera.

NEW TECHNIQUE

The programme transmitted on September 28, when viewers were given a complete story of the arrival and departure of a great liner at Southampton, was by a combination of studio performance and specially prepared film. A television producer and photographers made a film record at Southampton. The vessel was first "picked up" as it neared Calshot; shots were taken from the captain's bridge and later of the passengers landing, the unloading of the luggage and cargo, and the complicated manoeuvre of turning round in dock until the liner once more had her nose towards Quebec. This is

the first time that a film unit has gone "on location" to secure material for a television programme.

TELEVISION SALES TREBLED

The impetus given to television during the Radio Exhibition by the public demonstrations and by the substantial drop in set prices is already reflected in increased sales. In the first week after the show ended, the G.E.C. received more inquiries than in the previous three months, while orders received for television sets in the past two weeks were three times greater than during any similar period since the television service began.

TELEVISION TRAILERS

High lights of the next week's television programmes are soon to be radiated as a regular Friday feature. In many cases the artists will appear in person in excerpts from forthcoming drama, variety, ballet and other productions. Sometimes film may be included.

The trailers will be presented with all the care that would be expended on the final production and will be handled by the television announcers. (The first trailer may be expected early this month.

TELEVISION AND THE DEAF

Following a suggestion that television appeared to offer great possibilities to those people who were deaf and to whom radio has meant nothing, the General Electric Company has been interesting itself in the matter. As a result a G.E.C. television set was installed at Tower House Home for Deaf and Dumb Men. Recently it was decided to carry the experiment a stage further.

There are in the home a number of men who are not completely stone deaf, and they have been in the habit of listening to the radio by special amplifying headphones. Some of them, however, are unable to distinguish sounds—some of them, for example, cannot tell the difference between music and talks—and so the radio was providing very little enter-

MORE SCANNINGS

tainment. To be able to see at the same time, however, provides an interpretation of the sound.

It has been found in actual fact that the co-ordination of the aural and visual faculties does assist the men to hear, or to understand what they are hearing. Among the patients is an ex-soldier who was deafened in the war, and he has heard for the first time since the G.E.C. attached their special headphones to the television set. It seems likely that headphone television will be a valuable adjunct for teaching deaf children.

Only a small proportion of the men are affected by the sound, and television still continues to give pleasure to those who are totally deaf. According to Mr. D. A. C. Ellwood, superintendent of the Home, the men have been exceedingly enthusiastic about television.

The headphones are attached to the output of the receiver by means of a special matching transformer, which provides means of varying the sound characteristic to suit the traces of aural response shown by the patients. The receiver itself is a 23-valve superhet model with a direct vision television picture. The experiment appeared to offer such chances of success that the television set was presented to the Home by the G.E.C.

The promise of success was indicated in many interesting ways. For instance, some of the deaf men with earphones beat time to the music. At least two men added ten words to their vocabulary. One man watching a girl singing suddenly looked inquiringly at the Superintendent indicating that he no longer understood the words. Actually the girl had just begun to sing in German. When five claimed that they could hear the sounds, the sound was switched off. Three knew at once, and a fourth after a few moments.

THE TELEVISION DEMONSTRATIONS

As a result of the great public interest in television at Radiolympia, many people were unable to find room in the demonstration theatres, and even though three extra television transmissions were given on the last day of the Exhibition thousands of people were disappointed.

These extra transmissions were

only possible with the limited studio accommodation available at Alexandra Palace because the repetition of special programmes for Radiolympia did not involve the rehearsals which are held between the afternoon and evening transmissions, when the normal programme service is working.

COMMERE FOR TELEVISION

The first *commère* in television is Miss Sheila Douglas-Pennant, who introduced artists in Harry Pringle's cabaret on September 27 and October 1 in the evening and afternoon programmes respectively. Miss Douglas-Pennant, who is nineteen years old, has already acted as *commère* in West End cabaret shows. She sings and dances and is an adept at "patter"—an essential qualification for this work.

TELEVISIONING THE NORTH
LONDON EXHIBITION

One of the first outside broadcasts by high-definition television nearly a year ago will be repeated when the cameras range the North London Exhibition in Alexandra Palace on Wednesday, October 13. The feature will be included in the afternoon and evening editions of Picture Page, the television topical magazine.

The North London Exhibition brings housewives and many of their men folk from all over London to see the latest household utensils and

labour-saving devices. Television cameras will visit the cabaret show with glimpses of the Dress Parade.

A WEAK LINK

The introduction of the mobile television vans appeared to herald a new line of development. It was originally thought that these vans would be able to send by radio link to Alexandra Palace anything within the scope of the Emitron camera, for these vans can be operated up to 15 or 20 miles from the transmitter when conditions are good. It is unfortunately this qualification that is the weak link. Although the transmission from Wimbledon was highly satisfactory, the same cannot be said of the proposed transmissions from Hatfield of the Round-England Air Race.

At the Alexandra Palace during one of the periods when these transmissions from Hatfield should have been taking place, although the field strength provided by the mobile transmitter was more than adequate, interference on the same frequency made it impossible for the start of the race to be televised.

What is even more worrying is that during the ensuing three days neither the B.B.C. nor the Post Office with their special detector vans could do more than localise the source of the interference. It was not actually traced to its source, so for that reason the transmissions had to be washed out.



An experiment unique in the history of television and of football was made at the Arsenal ground recently when one half of the team watched by Television the other members undertaking their routine training. From Mobile Television Unit in the Stadium, the pictures were transmitted to the Alexandra Palace, and from there were re-radiated on the normal television wavelength and picked up on a Marconiophone television receiver in the Directors' Room in the East Stand.

As interference on ultra-short waves is rather widespread at the moment and will probably remain so until a Bill is introduced to legalise its suppression by the Post Office, we can anticipate more failures, not due to lack of field strength, but to interference on the transmissions. It must also be remembered that motor car ignition can be particularly troublesome on 5 metres, the wavelength approximately used by these vans, so it will be interesting to see how the B.B.C. propose to overcome this difficulty.

It might be advisable to use a considerably lower wavelength, but this, of course, would only be a satisfactory proposition over comparatively short ranges.

TELEPHONE SERVICE TO TRAWLERS

Any telephone subscriber can now talk to any of the British trawlers which are within 100 miles or so of a Post Office coast wireless station. Most trawlers off the east and west coast are equipped for wireless telephony and keep in contact with Humber radio, near Grimsby, and Seaforth radio, near Liverpool. Subscribers wishing to talk to a trawler merely find out whether the boat is on the east or west coast, and then merely ask for Humber ship telephone service, or Seaforth ship telephone service.

TELEVISION RECEIVER SALES

Price reductions have indicated that the general public are well prepared to buy a television receiver at a reasonable price, despite poor programmes being transmitted. Even though television receivers are still a little more expensive than the average radiogramophone, modern easy hire-purchase terms make this rather unimportant, so for that reason some of the television receiver manufacturers have been able to register greatly increased sales since the last price reduction. The comparatively limited picture size also causes very little comment, and in most instances appears to be adequate for use in the average private house.

A NEW 5-METRE RECORD

Following quickly on the record set up by the British amateur, G5BY, when he received a report from America, come details of a further record from Australia. The well-known amateur, Don B. Knock,

VK2NO, the Radio Editor of the *Sydney Bulletin*, has received a report from the British amateur, Cecil Mallanby, of Pwllheli, North Wales, informing him that his 5-metre transmissions were received when he was in contact with another 5-metre Australian station, VK2HL. The signal report was Q2-4, R2-4 with heavy noise-level, but even so, this is the first Australia-England report.

Cecil Mallanby has also received a number of American stations on 5 metres, and in view of the details given, VK2NO places every reliability on this report.

ANOTHER AMERICAN SHORT-WAVE CHANNEL

As most 1937 all-wave receivers tune down to 13 metres, listeners are finding that the 13-metre commercial channel is one of the most productive for daylight American reception. Both the N.B.C. and Columbia short-wave stations, which operate on 13 metres, can be heard after mid-day at signal strengths equal to that obtained from some of the more powerful continental broadcast stations. At this time of the day, which greatly favours American very short-wave reception, programmes can be received without any background noise level and completely free from fading. In time to come, when all-wave sets generally tune to 7 metres, the 9-metre commercial channel will probably come into its own.

SHORT WAVES FROM TOKYO

In view of the international interest aroused by the trouble in Tokyo, short-wave listeners are endeavouring to locate the Tokyo station which is transmitting special news bulletins. It so happens that the new Tokyo station which operates in the 19-metre commercial channel has an aerial beamed on Europe, so for that reason signals can be picked up with the greatest of ease and with almost unbelievable volume.

Even listeners who have not had any experience of all-wave listening have commented on the ease with which they can hear Tokyo. This idea of broadcasting views on current affairs seems to be growing, for nowadays any international dispute automatically means that the nearest short-wave station is pressed into service so that the world will know at least one angle of the dispute.

BRITISH MANUFACTURERS AND THE SHORT-WAVE AMATEUR

At long last British manufacturers are beginning to realise that the average constructor, both of receiving sets and transmitting equipment, can utilise the equipment originally designed for commercial makers. Consequently, slowly but surely, British amateurs are finding a more or less complete range of components and valves of a type that has long been required. Foremost in developing this new idea of things are the valve-makers, who are now generally producing valves that normally have to be procured from abroad.

To a lesser extent, certain set makers are seeing that a good all-wave receiver, similar to those which amateurs do buy in large quantities from America, is assured of a ready sale, not only in this country, but amongst our colonies. Fortunately for us, our colonial buyers are still keen to obtain British-built equipment, despite the fact that the service is poor and the price usually higher than that asked by the American competitors.

TELEVISION FROM PARIS

Owners of television receivers on the south coast should make every endeavour to pick up some of the programmes which are being transmitted from the Eiffel Tower. This station has an estimated radius of 75 miles, but in view of the fact that it is already exceeding this range with only half its normal power, French technicians are of the opinion that vision may be picked up at 200 miles or so. Already faint signals have been received at Alexandra Palace from the Eiffel Tower so it will be interesting to see just what happens when the power is increased to 30 kilowatts.

W.B. Planoflex Loudspeakers

Constructors interested in obtaining high fidelity reproduction at minimum cost should obtain some information from Whiteley Electrical Co., Ltd., of their Planoflex loudspeaker. In our issue dated September, 1937, on page 555, there was a misprint in which we spoke about using a Planoflex in "Quaily Special" sets. This misprint would not, of course, deceive constructors, who, of course, know that the Planoflex loudspeaker is one of the best of its kind for normal home high-quality use.

OCTOBER, 1937

EXPERIMENTAL MINIATURE TELEVISION

A further article describing the experiments on the construction of a miniature television viewer using the R.C.A. 1-inch cathode-ray tube.

MANY visitors to the TELEVISION AND SHORT-WAVE WORLD's stand at Radiolympia no doubt noticed the power unit and tube chassis of the miniature equipment. The size was chosen with a view to its eventual inclusion in a small table cabinet, but experimenters who wish to make up the units to gain experience may use the "breadboard" type of layout without fear of interference or stray capacities.

The temporary showing of the chassis at Olympia has hampered the experimental work slightly and this month it is only possible to give the constructional details for the chassis, leaving the final component values to be chosen later. These will not, of course, affect the constructional work at all and in general will only mean the alteration of one of the

fixed resistances or condensers.

With a view to simplifying the circuit, the author's* alternative diagram was tried. This is shown in Fig. 1 and will be seen to be of the conventional Thyatron type with a triode amplifier.

Push-pull amplification is useless with the tube used, as one of the deflector plates is permanently connected to the final anode inside the tube. This will also mean that perfect symmetry of the line screen will be impossible, and it may well be that this will spoil the efficiency of the unit

as a television reproducer. The condenser in both the line and picture circuits is charged through a resistance of 3 megohms and discharged through the Thyatron as shown. The output is divided so that a portion only is applied to the grid of the amplifying valve. The output of this valve again is taken to the deflector plates through the isolating condensers shown. The amplitude of the sweep is controlled by the bias of the Thyatron grid, a variable resistance of 50,000 ohms being connected in each cathode circuit.

In the original circuit two type 57 pentodes were specified, the various grids being connected together to serve as an anode.

The valve used was the 6K7, which was tried originally in the first circuit, but the 6J7 would be a closer equivalent.

No data was available on the use of these valves as triodes, but a rough estimate showed that they would probably be satisfactory. The deflection sensitivity of the tube at 350 volts is approximately 0.1 mm. per volt, giving 200 volts required for a sweep of 20 mm.

For reasonable linearity the striking voltage of the Thyatron should not exceed 40 volts and if one-sixth of this is applied to the grid for full swing the amplification of the valve is approximately 35.

Chassis Construction

The chassis is constructed from 1/16th in. aluminium sheet, bent into a hollow box with flaps on each side to a depth of 2 in.

At the ends of the box the flaps are

* The design of this receiver was originally published in America by A. O'Halloran.

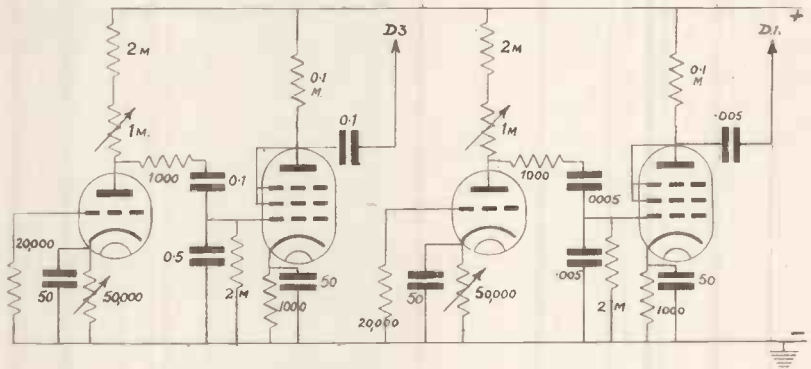

Fig. 1.—Diagram of simplified time base now being tested.

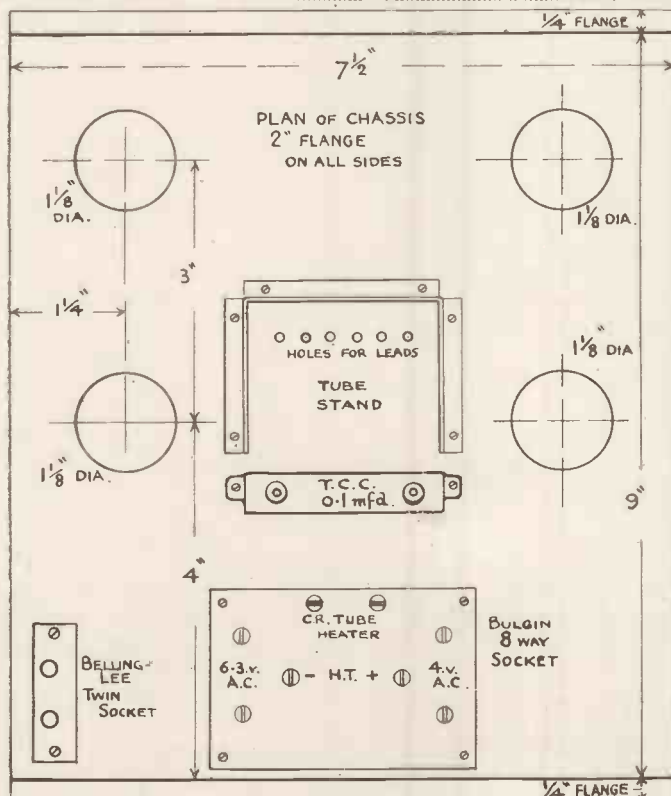

Fig. 2.—Chassis lay-out.

extended by a further $\frac{1}{4}$ in. which is bent out to act as a holding-down flange. The drawing of Fig. 2 shows the layout of the chassis. The tube itself and its controls is held on a separate bracket which is riveted on the top of the chassis in the position shown. The tube should project by about $\frac{1}{4}$ in. in front of the edge of the chassis when it is in place. Before bending up the bracket, cut the circular hole for the tube socket (a chassis type octal) and the $\frac{3}{8}$ in. clearing holes for the potentiometers. The tube socket is held to the metal by two 4 B.A. screws and nuts which pass through two slotted holes. These are to allow of rotation of the tube slightly to centre the trace on the screen. It is important to note the position of a tube when fitted in place. The mounting should be such that a line passing through pins Nos. 3 and 7 is in the horizontal plane, and the position of the slots is such that this is the case.

After the bracket (Fig. 3) has been prepared for mounting, the holes for the two valve sockets on each side of the tube can be cut, together with the clearance slot for the Bulgin 8-way socket.

This last is not essential but makes for a neat job and simplifies the wiring. Alternatively a row of eight terminals can be fitted on the chassis at the back. The synchronising sockets are fitted at the right-hand back corner of the chassis looking from the front. Finally, the holes for the four potentiometers are drilled in the front flap, $1\frac{7}{8}$ in. apart. These holes need careful checking as the clearance between the Dubilier potentiometers themselves will also need the soldering lugs bent forward to avoid touching one another and the potentiometer must be turned so that they are clear of the chassis.

The variable resistances are inserted in the following order: Left-hand side, 1 meg. variable for horizontal speed control, then 50,000-ohm amplitude control. Another 50,000-ohm for vertical amplitude control, and finally another 1.0 meg. on the right-hand side.

The final fitting is a Bulgin multi-resistance group board on the underside of the chassis immediately in front of the tube bracket. (The edge of the group board should be $1\frac{1}{2}$ in. from the front flap.

Wiring

The potentiometer chain for the tube was shown in last month's issue

(Fig. 2, p. 524) and the potentiometers for control are fitted one below the other on the bracket. The fixed resistances can be mounted in the wiring vertically down one side of the bracket. The two condensers shown dotted are the Bulgin tubular type and are also hung in the wiring. In

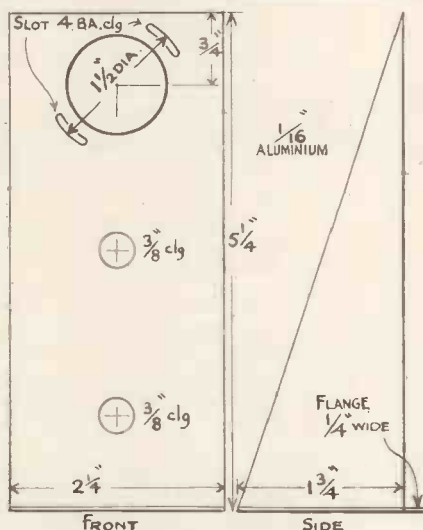

Fig. 3.—Details of tube supporting bracket.

making the connections it should be remembered that the anode is live and *not connected to chassis*. The resistances should be fairly rigid or they will touch the chassis when disturbed. Between No. 5 pin (the grid) and the slider of the potentiometer a 2-meg. $\frac{1}{2}$ -watt resistance must be connected for the modulating input. Finally, when the wiring of the H.T. chain is complete, a T.O.C. 0.1 mfd. condenser is fastened on the chassis immediately behind the tube bracket.

One terminal of this condenser is connected direct to pin No. 5 and the other is left free for the input connection to the tube from the radio receiver.

Dealing with the underside of the chassis, it will be found convenient to pack the tubular electrolytic condensers along the edge of the box. The connections of the eight-way socket are indicated, but these are not meant to be binding.

The resistances for the charging circuit and for the anode of the valves are held in the group-board. Al-

though 3 megohms variable is specified by the author it is a better plan to make 2 megohms out of the three fixed and leave the control to a variable 1-meg.. Experience with other time base circuits has shown that the less the value of variable resistance the better, apart from the finer degree of control provided. The value of fixed resistance will need adjustment after the set has been tried out.

Value of Components

For the H.T. exciter chain:

- 1—50,000-ohm 1-watt (Bulgin).
- 1—10,000-ohm 1-watt (Bulgin).
- 1—50,000-ohm variable (Dubilier).
- 1—10,000-ohm variable (Dubilier).
- 2—0.1-mfd. tubular condensers (Bulgin 500 V).
- 1 octal socket, type V₄ (Clix).
- 1 moulded case 0.1-mfd. 500 V wkg. (T.C.C.).

For the time base:

- 1 5-way group board (Bulgin).
- 2 octal chassis mounting sockets. (Clix).
- 2 5-pin chassis mounting sockets. (Clix).
- 1 8-way plug and socket. (Bulgin).
- 1 Twin socket (or separate sockets) (Belling-Lee).
- 2 1.0-meg. variable resistances (Dubilier).
- 2 50,000-ohm variable resistances (Dubilier).
- 2 2-meg. 2-watt resistances (Bulgin).
- 2 2.0-meg. $\frac{1}{2}$ -watt resistances (Bulgin).
- 2 1,000-ohm $\frac{1}{2}$ -watt resistances (Bulgin).
- 2 1,000-ohm 1-watt resistances (Bulgin).
- 2 20,000-ohm $\frac{1}{2}$ -watt resistances (Bulgin).
- 2 0.1-mfd. tubular condensers (Bulgin).
- 1 0.5-mfd. tubular condensers (Bulgin).
- 1 0.0005-mfd. mica condenser (T.C.C.).
- 2 0.005-mfd. mica condensers (T.T.C.).
- 4 50-mfd. electrolytic condensers 12 volts (Bulgin).

These components do not include the condensers and resistances for the synchronising circuit as these are better determined when the receiver is finally connected. In the meantime a start can be made with the values given above, which are not likely to require alteration. They should be compared with the circuit diagram of Fig. 1.

Read

Television & Short-wave
World

Regularly

OCTOBER, 1937

BAIRD SCANNING EQUIPMENT AND CATHOVISOR TUBE

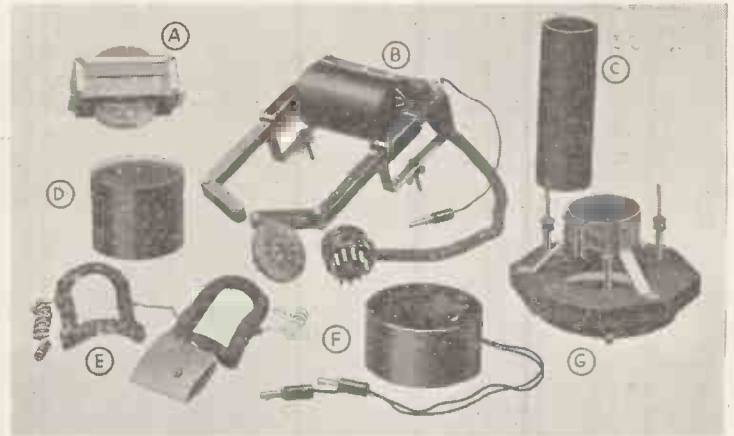

Baird scanning equipment. The letters on the photograph indicate the following units: A, Line scan generator; B, Frame yoke; C, Screening tube and holder; D, Screen; E, Line deflector coils; F, Focus coil; G, Adjustable holder.

THE Baird Company have available a complete scanning equipment for use in conjunction with magnetically focused cathode-ray tubes. This equipment comprises the line deflector coils, the line scan generator, the focus coil, screening tube and holder, and frame yoke.

Line Deflector Coils

The special features of the line deflector coils are as follows:

1. The maximum efficiency of beam deflection for a given input from the line generator is obtained by a patented construction employing a specially designed screen assembly. This confines and directs the magnetic field, reduces external leakage flux, and results in the greatest uniformity of distributed field along the deflection axis.

2. The initial alignment adjustments are very simple to carry out.

3. A neutralising condenser is supplied to cancel out any small oscillatory electrostatic potentials between the coils. This is arranged as an easily adjusted preset control, and correct adjustment results in a uniform horizontal trace.

A valve similar to the Cossor 41MP is utilised as an oscillator in the scan generator circuit. The coils are supplied with a metal screen, elastic coil retaining assembly and colour coded leads.

Line Scan Generator

This transformer is designed for use in conjunction with the line deflector coils, and when used in a circuit utilising suitable constants a most efficient means is readily available for generating a saw tooth cur-

rent wave form for scanning. Due to the special core and windings used, the transformer will handle efficiently the very high frequency harmonics necessary for the production of the saw tooth scanning cur-

rent required in reception of television.

Focus Coil

The focus coil is designed to converge the cathode-ray beam to a point focus on the screen of the tube with maximum efficiency. The coil utilises several unique design

features, one of which is a special metal screen which serves to increase the coil efficiency and gives improved field symmetry, while acting as a protective cover to the winding.

To ensure the utmost reliability of the coil a specially developed paper interleaved winding with bitumen impregnation is used, which results in a compact coil with a very uniform magnetic field having minimum leakage flux. The coil is proportioned to produce minimum spot size with least distortion.

The technical details of the coil are as follows:—

Total wattage consumed not more than $2\frac{1}{2}$ watts.

Current 11 m. amps. at 210 volts, for which the coil is designed to operate most efficiently.

Total ampere turns 350.

Coil resistance 19,000 ohms (approximately).

The Baird Company have now available complete scanning equipment for use in conjunction with magnetically focused tubes. This article gives the details and particulars of the 15-in. Cathovisor tube.



The Baird exhibits at Radiolympia. In the foreground is the largest cathode-ray tube ever made.

**Screening
Tube**

It has been found desirable to shield the electrode assembly in the lower portion of the tube from stray magnetic fields such as those pro-

duced by a suitable anode voltage. This is effected by the correct design of the electrodes, which involves the following: the optimum focusing of the beam so that the resultant screen spot is no larger than is necessary for the degree of picture definition used;

the glass so as to withstand the stresses involved. The glass bulbs are tested to withstand 3 atmospheres external pressure for ten minutes after being annealed.

The "Cathovisor" cathode-ray tube, Type 15 WM₂, has a hard glass bulb with a screen diameter of 15 ins. (38 cms.), total length 33½ ins. (85 cms.), and a neck diameter of 1½ ins. (4.13 cms.). This gives a picture size of 12 ins. (30 cms.) by 10 ins. (25.4 cms.), without distortion.

The technical data concerning this tube is as follows:

Heater volts, 2.2 volts approx.

Heater amps., 2.5 amps.

Peak to peak volts, between black and highlights, 20 volts.

Maximum electro-magnetic sensitivity, 2mm/AT.

Modulator/earth capacity, 2 μF (approx.).

Modulation sensitivity (slope) 17 μA/V (approx.).

Anode volts, 7,000 volts max.

Maximum input power to the screen, 3.5 milliwatts/sq. cm.

Screen colour, black and white.

The tube is completely electro-magnetic in operation.

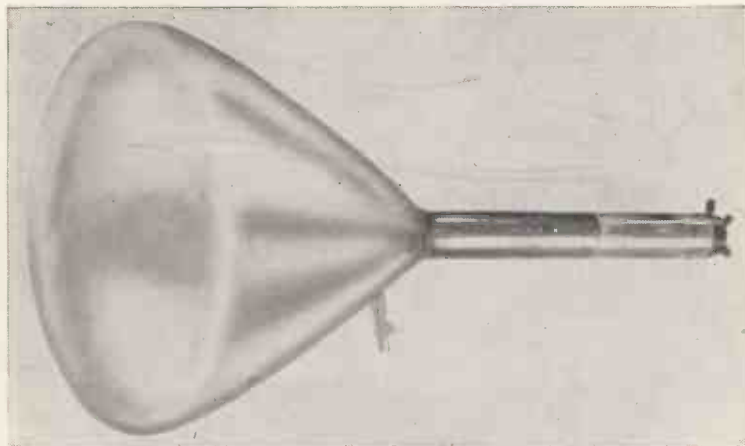

The Baird 15-in. magnetically focused cathode-ray tube.

duced by mains transformers, in order to reduce hum deflection of the cathode-ray beam to a minimum. The screen illustrated has been designed for this purpose. A specially prepared high permeability metal alloy is utilised, carefully proportioned to give the best results. A tube-fixing bracket is supplied for attachment to the lower portion of the focus coil holder, if used.

**Frame
Yoke**

The frame yoke unit comprises the deflecting and oscillatory circuits necessary to produce the vertical or frame scan on the screen of a cathode-ray tube. A common magnetic circuit is used for oscillation and deflection, and this produces a compact unit of high efficiency.

The laminated arms are fitted with adjustable extension pieces and these enable trapezium distortion of the scanning field to be avoided. The yoke is designed for most efficient operation at 50 frames per second, and utilising the recommended circuit (which may be obtained on application), in conjunction with the correct valve, the unit will be found simple to set up and adjust to give satisfactory results.

**The Baird Cathode-
Ray Tube**

The requirements of a cathode-ray tube are the formation of a high intensity electron beam under the

influence of a suitable anode voltage. This is effected by the correct design of the electrodes, which involves the following: the optimum focusing of the beam so that the resultant screen spot is no larger than is necessary for the degree of picture definition used; the beam deflection being arranged so that the scanning field formed on the screen is both rectangular and linear; together with the beam modulation being arranged so that the resulting spot intensity can vary from black to white through all the half-tone values in accordance with the modulation derived from the received signal. Coupled with these electronic conditions are the important practical points of mechanical strength, long working life and freedom from screen flaws and inequalities.

These factors are complied with in the Type 15 WM₂ "Cathovisor" cathode-ray tube. The electrode system is extremely simple and robust and, due to the type of cathode employed and the magnetic focusing, a high intensity cathode-ray beam is produced which results in a very brilliant picture. Screen grain does not impose a limit on spot size due to the special grading of the material used, and picture definition is outstandingly good. The screen is bound to the glass face by an exclusive process which makes it impossible for any powder to come off and fall into the electrode system.

Another special feature of the Baird tube is the relative flatness of the screen face, which reduces pin-cushion distortion to a minimum, while at the same time maintaining a high safety factor for the bulb. This has been brought about by a very careful design of the complete bulb shape and thickness distribution of

**Dubilier Condensers and
Resistances**

We have received from the Dubilier Condenser Co., Ltd., of Ducon Works, Victoria Road, North Acton, W.3, a copy of their latest catalogue of condensers and resistances. A very wide range of these components, including the most popular standard designs of interest to the home constructor and service engineer, is listed, together with full particulars and prices. The catalogue includes a useful resistance calculator, by means of which any two unknown values of potential, resistance, current or power can be ascertained providing two quantities are known. Copies of this catalogue may be had upon application to the above address and mention of this journal.

One of our subscribers in Washington, U.S.A., is anxious to obtain a copy of TELEVISION, dated April, 1929 (now out of print). Will any reader who can supply this copy send a post-card (stating price) to Mr. R. S. Ould, 3747 Huntington Street, Washington, D.C., U.S.A.

Telegossip

By Lumen

THE flow of technical books has begun and in a year or two it will be in full spate. After Pitmans' two heavy guns—Myers' "Television Optics" and Wilson's "Television Engineering," we can expect something big in the way of a counter from their friendly rivals Chapman & Hall. I hear rumours of a book from the Baird camp.

The principal objection to technical books is their cost and the space occupied by them! I have a row of them already and look forward with gloom to the time when I shall have to discard some of the old friends to make room for the up-to-date ones. And the trouble is that one never knows when an old book will be just the thing for an obscure historical reference. One of the most valuable books in my small library is Thompson's "Discharge of Electricity through Gases," although the date is 1898. And while on the subject of old books, let me recommend you by hook or by crook to get hold of copies of "Light Visible and Invisible," by Silvanus Thompson, and "Elementary Lessons in Electricity and Magnetism," by the same author. Their style is so lucid they are a joy to read, and it is surprising the amount of information they contain.

We are pushing on so fast nowadays that we are apt to forget a lot of fundamentals, and ten minutes with these occasionally are as good a refresher as one could wish for.

Sight Without Sound

The G.E.C. baby receiver which operates on vision only reminds me that for the first few weeks on my own set I looked without hearing, due to some interference on the sound side. It was not such a disadvantage as might be supposed. The films were quite satisfying and the only time when the sound was really missed was in the plays. So if the B.B.C. decide to economise they can still dig up some silent films without losing all their audience.

That Fault

Have you noticed the black spot on the film scanning camera—it may be gone by now as I have not looked

in for a week or so, but it was there for some time before and during the Radio Show.

It must have caused some heart-burnings when it first appeared and sent many lookers hunting for obscure faults or cursing tubes for developing bad patches on the screen! To one looker it was a blessing in disguise as it showed up a trace of phase distortion which was unnoticed in the general run of pictures. The edge of the spot had a tiny rim of white which disappeared when the receiver was overhauled.

Non-skid

A friend of mine has a receiver (no free advertisement!) which he says has never slipped a frame since it was installed. Is this a record? He rather spoils it by adding, "Of course it may have slipped when I wasn't looking." Is he going to become one of those maniacs who switch on a set and leave it running all the time regardless of whether he is looking at it or not? We have had them for years in the sound broadcasting—surely they are not going to carry their evil habits into television.

Continued Progress

Each time that I see demonstrations of mechanical-optical systems I become more convinced that the time is not far distant when they will achieve results equal to electronic methods. In the laboratory they are the equal, but there are one or two difficulties to be overcome before apparatus of this kind can be placed in the hands of the public. With the introduction of cathode-ray projection receivers it might appear that one of the chief advantages of a mechanical system—its ability to produce large pictures—has gone, but this by no means follows for the technical difficulties associated with really large screen work by means of the cathode-ray tube appear greater than in the case of mechanical-optical methods.

It is really amazing to note the amount of simplification that has taken place of late in the design and layout of mechanical receivers. But a few months ago they appeared as

complicated assemblies of apparatus which it was difficult to imagine could be housed in any size of cabinet suitable for the home. Reduction of scanner size and careful attention to layout, however, has achieved wonders. I was very much impressed with this point recently when I witnessed a demonstration of reception by the Mihaly-Traub receiver. This, it should be noted, was reception from the Alexandra Palace, and the picture was approximately 20 in. by 16 in., the entire apparatus being housed in a cabinet of about the same size as the average cathode-ray receiver. The pictures were bright and clear, the only defect being a lateral movement of the picture as a whole which took place at irregular intervals. The elimination of this trouble will not present any serious difficulty.

So far as I am aware no amateur attempts to construct a mechanical-optical receiver have been made since the 30-line transmissions ceased, but a careful examination of this receiver showed that there are distinct possibilities and that the work would be most fascinating. Admittedly, it would not be simple, but it would be quite within the ability of those who have well equipped workshops and are capable of reasonably accurate work. If there are any amateurs who have done any work in this direction it will be interesting to hear of their experiences.

A Point to Note

Having occasion recently to dismantle my aerial with which a concentric feeder is used, I was amazed to find that the feeder contained about half a pint of water. On the face of it this was surprising, for examination of the upper end of the feeder showed that it was most carefully sealed with some bitumen compound, and the lower end, of course, was indoors and therefore protected from the weather. The only explanation is that the water had accumulated by condensation and that it had lodged where the feeder made a downward loop. Anyhow, there was no question of its presence or the amount and it seems surprising that it had not affected reception; as a matter of fact no falling off had been noticed though it would seem that any further accumulation would have been bound to have had an adverse effect. The matter is worthy of investigation by those who have used this type of feeder.

THE TELEVISION RADIO LINK

DETAILS OF THE SYSTEM USED BY THE R.C.A.

AN account of the recent television activities of the National Broadcasting Company (U.S.A.) in collaboration with the Radio Corporation of America was given in our May issue. It will be remembered that the studios are located in the R.C.A. Building,

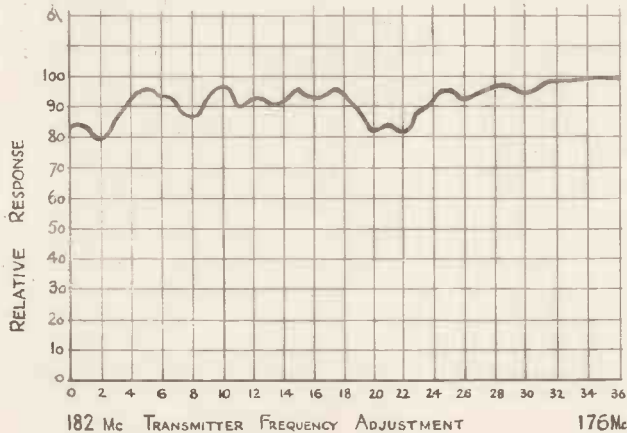

Fig. 1.—Variation of received signal—horizontal one wavelength transmitting antenna at 14th floor level; receiving antenna, two horizontal $\frac{1}{2}$ -wave dipoles end to end spaced $1\frac{1}{2}$ wavelengths between centres.

Radio City, and the transmitter in the Empire State Building, which is approximately 4,600 feet distant. It was necessary, therefore, to provide a connecting link to carry the video frequencies from the studios at Radio City to the transmitter.

Actually both a coaxial cable and radio circuit are used for this link, but it is the latter with which this article is concerned.

The radio link operates on a carrier frequency of 177 mc. which was chosen to be clear from harmonics of the picture and sound transmitters operating in close proximity to the relay receiver. A high frequency was chosen to be free from interference on existing radio services, to allow directive antennas to be used in which space was a limiting factor, and to take advantage of the lower man-made noise level encountered from sources such as elevator contactors, motors, etc. Valves now available make operation above 200 mc. difficult. Ultra high-frequencies are particularly adaptable to distances of this sort, and to the wide modulation band required.

Propagation

Tests

The video frequencies up to 1,500 kc. to be transmitted require the radio circuit to carry a band of 3,000 kc. with double side band transmission. Calculation showed that the combination of the direct and reflected rays at the receiving antenna could cause serious variations in transmission efficiency throughout the extremely wide band, depending upon the location of the points of reflection, and the intensity of the reflected ray or rays.

To obtain more accurate information regarding this

variation in transmission efficiency, propagation tests were carried out over the band of 176 to 182 mc. The results of these tests showed that a reasonably flat response could be obtained by using transmitting and receiving antennas having moderate horizontal directivity. Fig. 1 shows the response curve obtained with a directive transmitting antenna located at the 14th floor level of the R.C.A. Building and a directive receiving antenna at the 85th floor of the Empire State Building.

The antennas now in use at each end of the circuit are electrically equivalent to each other and consist of a one wavelength horizontal radiator, fed at the middle, located in front of a metal reflector. Fig. 2 is a diagram of the transmitting antenna now in use. These antennas are sufficiently broad to pass, without appreciable attenuation, the 3,000 kc. band.

Transmitter

Fig. 3 shows the radio and video-frequency units of the transmitter. A schematic diagram of the complete transmitter is shown by Fig. 4.

The master oscillator, right hand compartment of Fig. 3, consists of two R.C.A.-834 type valves operating in push-pull at a frequency of 177 mc. The frequency of the oscillator is determined by a low power factor concentric resonator to which the grids are inductively coupled. The grid loops which are coupled to the frequency control circuit are in opposite polarity so that the phase of the grid voltages differ by 180° .

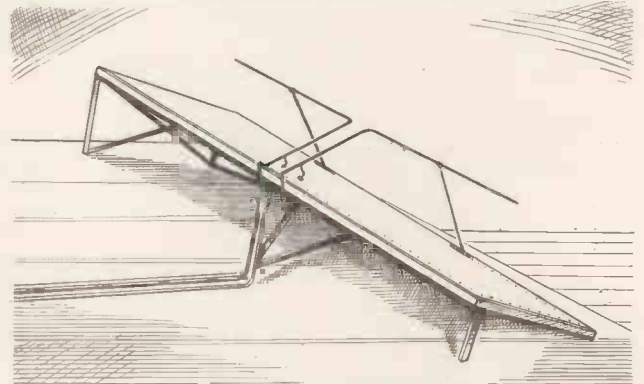

Fig. 2.—Transmitting antenna at 14th floor level.

The ratio of the diameters of the concentric conductors of the frequency controlling circuit is 3.5. A theoretical Q of 11,370 is obtained with an inside conductor diameter of 2.25 in.

By means of special arrangements the resonant frequency of the low power factor circuit is made substantially independent of temperature.

The master oscillator has adjustable impedances in its plate and filament circuits. The grid circuit reactance was adjusted to about the required value by a short wire connected from grid to grid. This wire is in parallel with the grid loops which couple to the low power factor circuit. The plate inductance is a concentric conductor line connected from plate to plate.

At the neutral point on this line the inside conductor is exposed so the power amplifier grid coil may be inductively coupled to it.

The drawing, Fig. 3, shows the master oscillator on the right hand side, the modulator in the centre, and the power amplifier on the left. With such an arrangement the connection from the modulator to the power

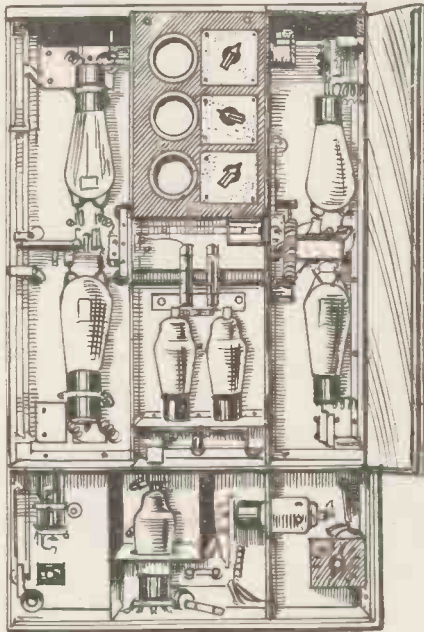

Fig. 3.—The radio and video-frequency units of the transmitter. Left, power amplifier. Right, master oscillator. Centre, modulator. Lower left, monitor. Lower right, modulator amplifiers.

amplifier grid circuit is short and the modulator output capacitance is reduced. However, this makes the link from the master oscillator to the power amplifier rather long. This link is the master oscillator plate inductance and its maximum reactance is fixed by the tube inter-electrode capacities. The correct inductance was obtained by the proper choice of the conductor diameters. A small balanced condenser connected from plate to plate is used for fine adjustment of the master oscillator circuit. Plate voltage is supplied to each tube through an r.f. choke.

The R.F. output stage is a conventional push-pull cross neutralised amplifier. The valves (two R.C.A.-834's) are located as shown in Fig. 3 to make the length of the connections from the grid and plate tube prongs to the neutralising condensers a minimum. This is necessary to prevent parasitic oscillations. The neutralising condensers are the horizontal concentric cylinders at the centre of the power amplifier compartment. The outside cylinders are connected to the plates and are made up of two telescoping tubes for adjusting the neutralising capacitance. The inside cylinders are connected to the grids. This arrangement reduces the stray capacity between the input and output circuits of the power amplifier.

The power amplifier grid circuit is an untuned inductance composed of a short brass strip connected from grid to grid, and closely coupled to the voltage nodal point of the master oscillator plate inductance. The centre point of the grid inductance is directly connected

to the modulator plates. By eliminating the blocking condenser between the modulator and the power amplifier the stray capacitance of the modulator output circuit to ground is reduced. Since the power amplifier grids are connected directly to the modulator plates they are maintained at a positive potential of 250 volts. To give proper operating bias the filaments are maintained at a positive potential of 400 volts by a filament return resistor.

To maintain the symmetry of the power amplifier output circuit the plate inductance is made of two balanced lines in parallel. Slides on these two wire lines are provided for approximate tuning of the power amplifier plate circuit, and a small two-plate variable condenser for the fine adjustment. One branch of the plate circuit is inductively coupled to a balanced 150-ohm load. The power amplifier will deliver to this load a 15-watt carrier.

The monitor step-down transformer is a concentric conductor line one-half wavelength long connected across the output terminals of the power amplifier. At the centre or voltage nodal point on this line a loop is inductively coupled to the inside conductor. This loop is connected to a rectifier which is used to monitor the transmitting R.F. output.

The modulator uses two R.C.A.-802's in parallel. The frequency response curve for each video frequency stage is made flat. The phase shift produced by the resultant plate impedance is proportional to frequency over the transmission band and, hence, does not produce phase distortion. The attenuation and phase shift produced at the low frequencies by the interstage coupling and cathode by-pass condensers are compensated for by choosing a suitable value of plate supply by-pass capacity. The plate supply of each stage has a series resistance or damped reactor to isolate it from the power supply.

The modulator amplifier consists of two stages, an R.C.A.-802 and R.C.A.-6C6. An output level of .45-volt r.m.s. is required to modulate the transmitter 85 per cent.

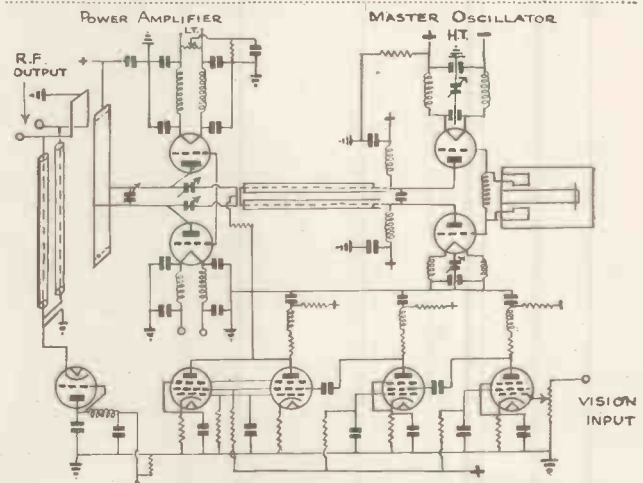

Fig. 4.—Schematic diagram of complete transmitter.

The impedance matching circuit is shown by Fig. 5. It is adjusted to step the antenna input load down to 166 ohms at 177 mc. This is necessary to give maximum efficiency and flat frequency response over the band used.

Receiver

The receiving antenna on the 85th floor of the Empire State Building is approximately 100 ft. from the receiver location. The antenna feed line is composed of two 76-ohm, 13-gauge, coaxial cables, located in a con-

necessary to provide an indicator to show when the signal carrier is tuned to mid-band. This indicator allows the operator easily to find the correct setting of the local oscillator. A 0-1.5 M/a. meter on the front panel shows the plate current of a biased triode detector, which is excited by a high C resonant circuit

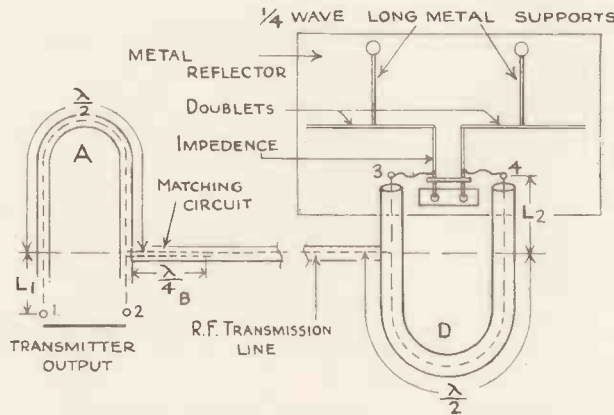

Fig. 5.— Balanced to unbalanced transfer circuits transmitting line and transmitting antenna.

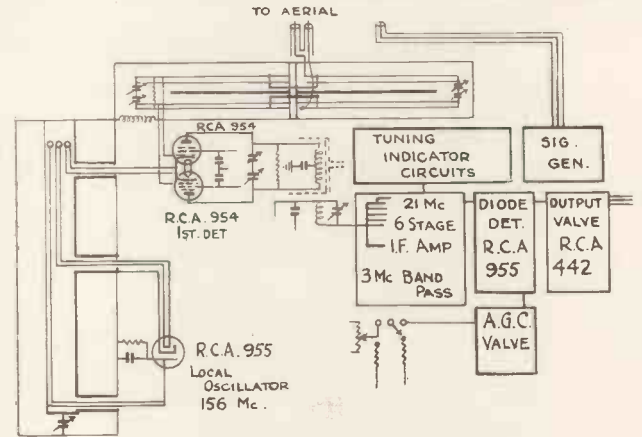

Fig. 6.— Schematic diagram of receiver.

duit running from the receiver rack to the back of the antenna reflector. The use of two cables gives in effect a balanced, shielded, 152-ohm transmission line. Special tests were carried out properly to match the antenna to the feed line at 177 mc. to get the greatest overall efficiency and flattest response with frequency. The transmission line loss was estimated to be not more than 1.9 db. With all adjustments made the cables were sealed off, evacuated, and filled with dry nitrogen under pressure. This process insures the removal of moisture from the cables, and gauges permanently installed show whether the pressure is maintained.

Fig. 6 shows a schematic diagram of the receiver. A balanced concentric line type band-pass transformer, receives 177 mc. energy from the balanced coaxial feed line. The transformer in turn feeds a balanced heterodyne detector consisting of two R.C.A. 954 acorn valves whose cathodes are excited by a concentric line type of local oscillator operating at 156 mc. The intermediate frequency of 21 mc. appears push-pull in the output of the balanced detector stage and is coupled to a single ended 6-stage, band-pass amplifier using coupled circuit transformers. The overall flat band width is 3 mc.

The I.F. amplifier is fed to a linear diode rectifier (R.C.A. 955), which in turn feeds the R.C.A. 42 output valve. Video frequencies are carried from the receiver over a coaxial cable to the transmitter line amplifier.

Automatic gain control of the I.F. amplifier is accomplished by means of a D.C. amplifier driven from a voltage divider across the diode load resistance. This circuit is arranged to feed variable negative control voltages to two valves in the I.F. amplifier. A switch is provided to allow the gain to be controlled manually. A set of switches on the front panel allows the plate currents of the I.F. amplifier valves to be checked on one meter without interrupting the operation of the receiver. The other plate currents with the exception of the automatic gain control valve are shown continuously on individual meters.

Due to the extreme width of the I.F. amplifier it is

having fairly high Q. This resonant circuit is driven by an R.F. pentode fed from the I.F. amplifier. A push-button is arranged to connect a small fixed capacity across part of the resonating inductor, and the resonant frequencies with the push-button out and in are set to be equally spaced about I.F. mid-band. With such an arrangement the tuning indicator meter (0-1.5 M/a.) in the plate circuit of the biased detector will show no change with the push-button out or in when the carrier is accurately tuned to mid-band.

A separate regulated power supply having an effective internal resistance of less than one ohm is used to supply power to the R.C.A. 42 output valve. Thus, objectionable low-frequency resonance often occurring

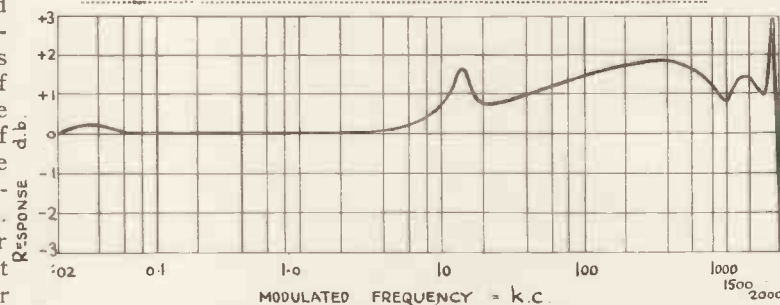

Fig. 7.— Overhaul frequency characteristics of the radio relay.

in ordinary power filters is eliminated, which permits a flat frequency response to be obtained down to 10 cycles or less with the output valve working into a load resistance of only 100 ohms.

In a receiver of this sort having a tuned band-pass input transformer at signal frequency, the problem of properly tuning these two circuits presents itself. The correct tuning to give a flat band pass is not necessarily that obtained by setting each dial for maximum response in the usual way. This problem is overcome by supplying in the receiver rack a shielded oscillator to

(Continued on page 610)

RECENT TELEVISION DEVELOPMENTS

A RECORD OF PATENTS AND PROGRESS *Specially Compiled for this Journal*

Patentees :- Baird Television Ltd. and G. W. White :: Marconi's Wireless Telegraph Co., Ltd. and G. M. Wright :: Standard Telephones and Cables Ltd. :: Radio Akt. D. S. Loewe :: J. E. Keyston

Television Transmitters

(Patent No. 466,715.)

IN a television transmitter the picture signals and the synchronising impulses are superposed on the carrier wave, at the same point in the chain of amplification, by applying them to different electrodes of the same valve.

As shown in the figure the carrier wave is applied at A to the control grids of two valves V, V_I arranged in push-pull. The picture signals, from a source P, are applied in parallel through a tapping T to the same grids, whilst simultaneously synchronising signals from a separate source S are applied, also in parallel, to the screen grids of the same valves.

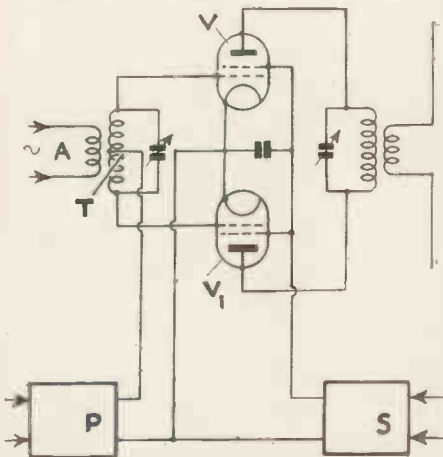

Separation of picture and synchronising signals in transmitter. Patent No. 466,715.

In this way the two sets of signals are kept completely separate up to the point of modulation.—*Baird Television, Ltd., and G. W. White.*

Projection Tubes

(Patent No. 467,918.)

Instead of showing the picture on the fluorescent screen of a cathode-ray tube, it is projected on to an external viewing-screen where the usual restrictions as to size do not apply.

As shown in the figure, the end of the bulb of a cathode-ray tube T is fitted with a glass prism P, through which light from an external source

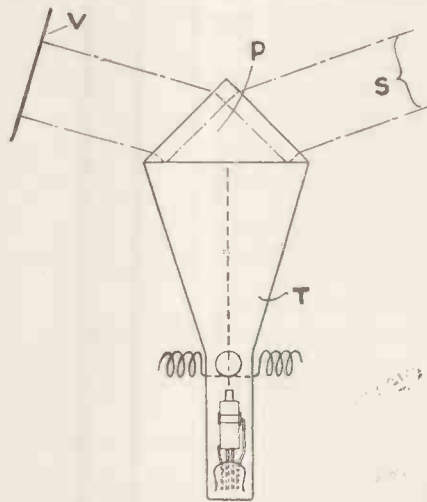

Projection tube making use of external light source. Patent No. 467,918.

S passes on to an external screen at V. The direction from which the ray enters the prism is such that it strikes the lower surface of the prism P at or about the critical angle of internal reflection.

The impact of the electron stream, as it moves across the glass of the prism in scanning is stated to vary the critical angle of reflection so that the amount of light which is reflected depends upon the intensity of the stream. In other words, the emergency is modulated in accordance with the incoming signals as applied to the control grid of the tube. This produces an image of the original picture on the external screen V.—*Marconi's Wireless Telegraph Co., Ltd., and G. M. Wright*

Time Base Circuits

(Patent No. 467,958.)

To generate saw-toothed oscillations, suitable for scanning, it is usual to charge up a condenser

through a high resistance, and to discharge it periodically through a gas-filled tube of the Thyatron type.

According to the invention the charging resistance consists of a pentode valve so arranged that the control grid, the accelerating grid, and the suppressor grid are all subjected to a bias which is varied with any change in the strength of the current passing through the valve. This serves to keep the charging-current constant at all times.—*Standard Telephones and Cables, Ltd.*

Cathode-ray Tubes

(Patent No. 467,995.)

The fluorescent screen F of the cathode-ray tube is deposited on the inner wall of the glass bulb, as shown, and a magnifying-lens L is attached to the outer wall of the bulb. The curvature of the lens is the same as that of the glass bulb over the surface of contact, but its outer side is more sharply curved, so that it

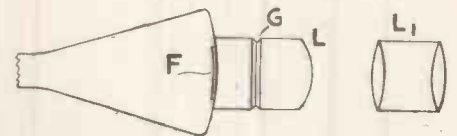

Projection by means of lenses. Patent No. 467,995.

minimises spherical aberration. Actually, the virtual image produced by the lens L has a concave curvature so as to compensate for the convexity of the fluorescent screen.

A groove G is formed around the surface of the lens L, about midway along its length, with the object of reducing total internal reflection of the light, such as might tend to produce "ghost" images of the picture. A projection lens L₁ is interposed between the lens L and an external viewing screen.—*Marconi's Wireless Telegraph Co., Ltd., and G. M. Wright.*

Tuning Controls

(Patent No. 468,437.)

The cabinet of a television receiver is arranged so that the front panel carries only two control knobs, both of which may have a second coaxial shaft. One operates the on-and-off switch, and then cuts out an anode resistance, as the control is further rotated, so as gradually to increase the light intensity. The other knob controls the tuning, and is linked with an indicator marked "sound only," "picture only" and "picture and sound."

The other control knobs, which do not usually require readjustment, are mounted on the back of the panel. These include line-frequency and frame-frequency adjusters, means for regulating the amplitude of the synchronising impulse, and means for intensifying the sharpness of the image point.—*Radio-Akt. D. S. Loewe.*

Television Transmitters

(Patent No. 468,483.)

There is a known type of cathode-ray transmitter in which a primary scanning-beam of electrons is used to set up a secondary beam or "cloud," which then acts on a mosaic screen of photo-electric cells to produce currents representing the light-and-shade values of the picture to be televised.

In a system of this kind, a thin sheet of metal, adapted to give a copious supply of secondary emission, is interposed in the path of the electron stream, just before the mosaic electrode, so that the secondary electrons pass on to the sensitive mosaic surface instead of the primary stream. In this way, the sensitised surface is protected from damage, and possible disintegration, by the impact of the high-speed primary electrons.—*Standard Telephones and Cables, Ltd.*

Electron Multipliers

(Patent No. 468,623.)

An electron-multiplier tube is fitted with two parallel "target" plates, which are arranged at both sides of a thin cylindrical anode and are fed with an alternating voltage from an outside source. The electron stream to be amplified is projected on to the tube through an aperture in one of the plates, and is then caused to strike first against one and then against the other of the two parallel plates. At each impact, secondary

electrons are emitted and go to swell the original stream, so that the strength of the output current finally collected by the anode depends upon the number of impacts made by the stream before it reaches the anode.

This, in turn, depends upon the angle at which the stream is first allowed to enter the tube. According to the invention, this is controlled by means of two deflector plates which are arranged just outside the aperture and are supplied with a control voltage in order to deflect the stream as it passes into the multiplier tube. In this way the stream may be arranged to make two, three, or four impacts, according to the degree of amplification required.—*J. E. Key-ston.*

Summary of Other Television Patents

(Patent No. 465,763.)

Cathode-ray tube in which the electrode system is mounted, in combination with a focusing coil, on a single support of ceramic material.—*N. V. Philips', Gloeilampenfabrieken.*

(Patent No. 465,892.)

Method of supplying operating-voltages, both to a cathode-ray tube and its associated time-base oscillator, from a common source of supply.—*Baird Television, Ltd., and L. A. Merdler.*

(Patent No. 465,966.)

Scanning system for use with a television transmitter of the image-dissector type.—*The British Thomson-Houston Co., Ltd.*

(Patent No. 465,970.)

Means for phasing the synchronising motor in a mechanical scanning system.—*E. Traub.*

(Patent No. 466,031.)

"Light" valve which depends for its effective transferences upon the variable adhesion between minute particles of mica.—*Marconi's Wireless Telegraph Co., Ltd.; L. M. Myers and E. F. Goodenough.*

(Patent No. 466,046.)

Correcting for distortion of the electron stream through a cathode-ray tube which is liable to occur when the filament of the tube is heated by alternating current.—*E. Michaels.*

(Patent No. 466,426.)

Method of making cathode-ray

tubes with thin-walled glass necks.—*Baird Television, Ltd., and A. H. Johnson.*

(Patent No. 466,508.)

Film-scanning system designed to increase the intensity of the light available for producing synchronising-impulses.—*Radio-Akt. D. S. Loewe.*

(Patent No. 466,826.)

Cathode-ray tube fitted with concave deflecting-plates in order to prevent picture distortion.—*E. Ruska.*

Patent No. 467,838.)

Process for making the "mosaic" photo-electric screens used in cathode-ray television transmitters.—*Marconi's Wireless Telegraph Co., Ltd.*

(Patent No. 467,916.)

Rectifying circuit for separating the picture signals from the synchronising-impulses in a television receiver.—*Radio-Akt. D. S. Loewe.*

(Patent No. 468,146.)

Photo-electric cell in which a central electrode is surrounded by a grid-like anode which produces secondary emission.—*The General Electric Co., Ltd., and C. H. Simms.*

(Patent No. 468,191.)

Television system in which all the picture points contained in one scanning line are reproduced simultaneously.—*F. von Okolicsanyi.*

Lectures on Television

A series of lectures on television have been arranged at the following educational centres. They are now commencing, and intending students should join without delay. Further particulars can be had from the Principals.

Borough Polytechnic, Borough Road, London, S.E.1. A sessional course; held on Thursdays, 8-9.30 p.m. Sessional fees for students under 18, 10s., over 18, 20s. Certificates granted to students who pass the examination at the end of the course.

Morley College, 61 Westminster Bridge Road, London, S.E.1. Courses of twenty-four lectures (Elementary and Advanced). On Friday evenings, Elementary 7-8.30 p.m.; Advanced, 8.30-10 p.m. These courses afford students an opportunity to become acquainted with experimental research that has made television possible including principles now applied. Fee 7s. 6d. and entrance fee 3s. 6d.

The information and illustrations on this page are given with permission of the Controller of H.M. Stationery Office.

A NEW SYNCHRONISING CONTROL SYSTEM

Developed by PAUL D. TYERS

THE reception of a high-frequency carrier wave modulated at video frequencies presents no more difficulties than one modulated at audio frequencies. The fact remains, however, that the handling and adjustment of a normal vision receiver is far more complicated than that of a sound set. It was this fact that led the writer to undertake a considerable amount of research into the subject of scanning and synchronising

control almost totally independent of the received carrier strength it is obvious that the initial

This article explains the scanning and synchronising control system employed in the low-cost television receiver described on other pages in this issue.

synchronising impulse must be derived from some circuit which has a positive datum line and furthermore

that the absolute magnitude of the received carrier wave can vary quite appreciably without any possibility of a voltage being produced across the diode load due to picture modulation. It will be obvious, however, that the magnitude of the pulse may still vary.

Now any time base device subjected to a control impulse is dependent upon the magnitude of that impulse and accordingly variation in carrier output would affect the time base. Therefore it is necessary to introduce some other feature which will give a constant pulse.

The proportion of the separated synchronising pulse which itself is of quite low magnitude is applied to a valve having an extremely short grid base so that only a portion of this pulse is again amplified. This is shown diagrammatically in Fig. 2. It will be seen that the portion of the derived impulse can diminish quite appreciably, whilst it can increase to an infinite value without in any way affecting the output of the limiting valve. This circuit combination then delivers a synchronising impulse of constant magnitude.

This arrangement when applied to an ordinary scanning circuit will give control which is really independent of

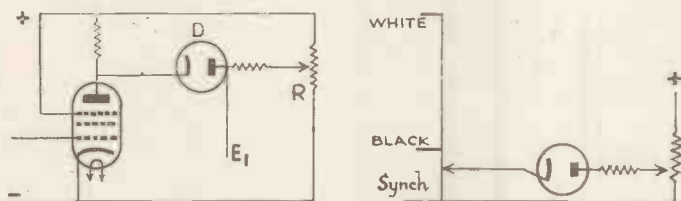

The potentiometer R is adjusted so that D conducts below black level

ising means with a view to producing something which had a far greater inherent degree of stability and required far less attention than a receiver operating according to normal practice.

The system developed seems to satisfy these requirements because the control of the picture on the screen is sensibly independent of very large variation in signal strength, it is not readily upset by interference and it is immune from the effect of quite wide variations in the constants of the circuit in the scanning arrangement. In an ordinary synchronising and scanning system when the line and frame speeds are incorrect, the picture breaks into unrecognisable elements whilst there is a continuous roller blind effect in the frame direction. In the writer's system neither of these effects occur, the picture merely folding up if the adjustment is totally incorrect. If line and frame controls are provided the picture is readily brought into correct shape because it is always visible no matter how badly adjusted may be the line of frame scan. These results are obtained not by one factor alone, but by the combination of three distinct features.

If it is desired to make the syn-

only a portion of the pulse must be utilised. The simplest method of utilising only a portion of the synchronising impulse is to employ some form of biased unilateral conductor. That most suitable appears to be an ordinary diode. Most receivers employ a video stage and therefore a very convenient method consists of connecting the diode between the anode of the video stage and a suit-

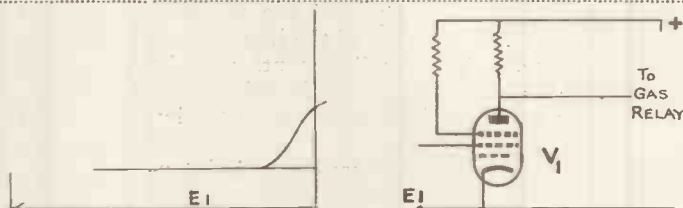

The negative synch pulse of magnitude E_1 is applied to the short grid base of the limiter valve V_1 .

able voltage level obtained from a potentiometer across the H.T. supply. This is shown in Fig. 1. The potentiometer is adjusted so that the diode conducts not at the black level, but at a value considerably below the level. This arrangement will function during the synchronising impulse which will give an output across the diode load proportional to only a portion of the pulse. This means

the variations described, but at the same time it was felt that this was not enough because ordinary gas discharge time base circuits are very sensitive to changes in the constants of the valves and also small changes in the network.

This difficulty was overcome by operating the gas discharge relay in the following manner. The gas discharge valve assumes a very low im-

pedance at the discharge or ignition voltage. The critical zone on a modern argon or helium filled tube is a matter of a few volts. Changing the constants of the resistance, condenser or line voltage will therefore affect the firing point of the tube. But it is always very near to this zone that the ordinary synchronising pulse is applied to the control grid of the tube, when exceptionally stable running is obtained.

Experiments showed that if the synchronising impulse is applied outside the normal critical zone, quite wide variations can be made in the constants of the valves and the general network. It is very important not to apply too strong an impulse to a gas tube as otherwise many difficulties may arise. Further experiment showed that a suitable control voltage on the grid would shift the critical zone. Moreover, in order to obtain stable operation this voltage had to be exceptionally constant.

The other part of the circuit described gives a voltage of exactly the required form. (The charge time of the condenser is adjusted so that the correct voltage is obtained while the anode is outside the critical zone. At this instant the synchronising voltage

is applied to the grid. The absolute magnitude is relatively greater than usual but the effect is just as weak as a smaller impulse applied in the normal critical zone. The result is that very large variations can be made in all constants and one gas tube can be substituted for another without in any way affecting anything. For all practical purposes therefore the system obviates the necessity for line or frame controls.

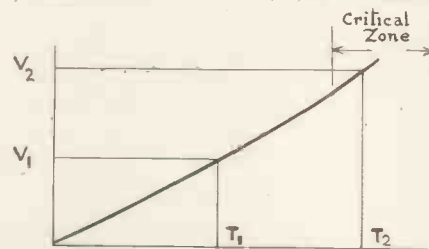

The Gas relay at time T₂ reaches an anode voltage V₂ which lies in the critical zone. Voltage E₁ reversed in phase and limited is applied at T₁ which brings the critical zone down to the region of V₁ and fires the tube.

The above description may give the impression that it is exceptionally easy to produce a scanning and control system on the lines described. Actually the reverse is the case and

unless everything is perfectly correct difficulty is experienced in producing either a good line or a correct interlace.

Elsewhere in this issue a constructional article on a vision receiver appears which it is understood operates on the principle described. The writer has had no connection with the design of the set in question and the fact that the designer has been able to apply the system from only a brief description shows that the circuits are of definite practical value. It has been arranged with the Editor of TELEVISION AND SHORT-WAVE WORLD that the writer will give at a later date a full technical description of how to apply the system to a vision receiver in which all the relevant critical factors will be carefully discussed. It will be shown how the system can be applied so that it in no way affects the frequency characteristic of the amplifier or the form of the scan or the correctness of the interlace. It should be clearly understood that the application of the system introduces several factors which are not present in ordinary technique and accordingly it is necessary to make considerable alteration in standard methods of design.

"The Television Radio Link."

(Continued from page 606)

supply energy over a single coaxial cable to a point on the antenna reflector. The cable termination near the antenna includes a damping resistance, a small radiating rod, and a shunt inductance all combining to produce a correct terminating impedance over the band of frequencies used. With this arrangement the operator can vary the oscillator frequency over the receiver pass band and observe the shape of the (antenna-feed line-receiver) characteristic on the output of the receiver. With a few trials the correct tuning of the input transformer can be obtained. These adjustments may be made when the 177 mc. television transmitter is off the air. These circuits once set require little attention thereafter.

As might be expected a signal of considerable intensity is received at the Empire State Building. Calculation shows that the transmitter power and antenna directivity used should result in a direct ray field strength of approximately 300 millivolts per metre at the receiving antenna. A strong signal is necessary to override local disturbing noises from elevator machinery, etc., which become more troublesome the wider the receiver band width. It might be mentioned that lightning flashes in the immediate vicinity give only moderate clicks in the receiver output.

Signal strength observations made so far show variations in intensity of only a few per cent., indicating that variations in rays reflected from the ground are unimportant.

Overall frequency characteristic measurements have been made from the transmitter input to the receiver

output over a range of from 20 cycles to 2,000 kc. Fig. 7 shows the result of these tests. The irregularities in the curve from 100 to 1,700 kc. are mostly caused by the propagation path as mentioned earlier. The peak at 1,800 kc. is produced by an equalising circuit in the receiver output. It will be observed that the maximum deviation over the desired band of 20 cycles to 1,500 kc., is 1.8 db., which occurs at 400 kc.

Signal to noise level measurements were made at the receiver using a measuring amplifier having an effective band width of 20 kc. These measurements showed a signal to noise level of 44 db. with 85 per cent. modulation at the transmitter. The noise level was almost entirely 60 and 120-cycle power supply hum.

Although the receiver is located near the high-power television broadcast transmitters, no trouble is experienced from interference. Pictures have been transmitted over this circuit without affecting their quality.

Yorkshire Television Association

THE Yorkshire Television Association's winter programme opened on Sunday, September 26, with a lecture on "Electron Optics," by A. Buckley, morse instruction by E. Wood, A.M.I.R.E., and a loudspeaker demonstration by L. F. Virgo, B.Sc.

The following meeting will be held on October 24, when a lecture will be given by H. B. Hunt. Meetings are held monthly throughout autumn, winter and spring when non-members are cordially invited to lectures free. Cards of admission can be obtained from the secretary, A. Buckley, 110 Finkle Lane, Gildersome, Leeds.

STUDIO & SCREEN

A MONTHLY CAUSERIE

on Television Personalities and Topics

by K. P. HUNT

Editor of "Radio Pictorial"

RADIOLYMPIA was a tremendous publicity agent for television in general, and doubtless provided a new sales impetus which is so desirable.

Dodging in and out of the television booths during the currency of the exhibition, I heard many comments on the television shows, and the general impression, I think, was that the majority of visitors were amazed at the quality of the pictures. Many came to the exhibition prepared merely to be tolerant, expecting to see something in the nature of a scientific toy. But they went away realising that television has now taken its place among the other vehicles of entertainment in the country.

At the same time, I believe many people engaged in the industry, or connected with radio, fully appreciated the B.B.C.'s immense difficulties from a publicity point of view in presenting short programmes of only a quarter of an hour, for these really did not convey an adequate impression of the diversity of material now being televised in the regular programmes.

These demonstration broadcasts unavoidably were split up into short sections of about five minutes each, and naturally there was no sustained entertainment value. It should be realised, of course, that the B.B.C. did not pretend that these programmes were up to the standard usually broadcast for home viewers.

Of the whole Radiolympia programmes, probably the most appreciated was the Zoo material, which impressed all by its spontaneity and jollity. The grand finale, in particular, when the animals went into the ark two by two, was a splendid effort worthy of special congratulations to the Alexandra Palace staff.

* * *

The greater ease in working at Alexandra Palace which was anticipated when one standard of transmission was adopted, is now becoming apparent. There is much more elbow room in the studios, and things generally are nothing like so cramped as they were. The scenery can be

shifted about without so much difficulty, and rehearsals and shows do not give the old impression of overcrowding.

Scenery shifting, by the way, has been greatly facilitated by the recent provision of the new sliding doors to the main studio at Alexandra Palace. These doors go nearly up to the ceiling.

Another interesting development which has recently come about at the Palace is the building up of scenery mostly in sections. (This not only



Elisabeth Cowell on her recent holiday. "The only brunette in Denmark."

makes scenery shifting much easier, but it makes the material itself far more versatile than hitherto.

Peter Bax, as readers know, is the presiding genius of scenery at A.P., and his work in this important matter is having far-reaching results on the whole character of the shows now being broadcast. A considerable proportion of the scenery is now in sections, and is put together in a manner reminiscent of an expanding bookcase: it is all like playing a game with huge bricks!

All the scenery used at the Palace is made on the premises in the

carpenters' shop which is situated in what was, I believe, the vestibule of the old Alexandra Palace theatre. Some idea of the extent of the work now undertaken will be gathered from the fact that as many as a dozen people—carpenters, scene painters and the like are employed whole time. Scenery, in fact, seems to be playing an increasingly prominent part in the television programmes, and some interesting experiments have been made.

* * *

The present studio methods still favour scenery painted exclusively in blacks, greys and whites, for it has been established without much doubt that this colour scheme gives the best background effect. Quite recently an effort was made to restrict the costumes of television artists to the same colours, but the experiment was quickly terminated as a complete failure. It needs no imagination to understand that a pretty girl being televised in grey and white clothes, which have the televised appearance of being dirty, gives an effect on the screen which can only be described as deplorable. This, however, was only an experiment and has now been abandoned in favour of clothes for artists embodying the whole spectrum of colour.

This development has resulted in a new branch of activity for Mary Allan, the make-up expert. It is now one of her responsibilities at the Palace to see that the tone colours of studio ensembles are harmoniously correct. She is forever making tests for colour in order to try out the effects of new materials, and has established herself in a new office near the wardrobe.

A great many of the dresses now seen on the television screen are actually made at the Palace, and here again some idea of the amount of work can be estimated from the fact that there are two wardrobe assistants in addition to the two make-up assistants, and the sewing machine can be heard going most of the day.

I was rather surprised to learn that Peter Bax, the well-known stage

manager at the Palace, designs many of the dresses which viewers see. It seems to be part of his general plan to harmonise dresses and scenery in television productions, and the same idea seems to be evident in D. H. Munro's productions of ballet.

Those who remember with delight Mr. Munro's productions of the de Basil's "Ballet Russes" some time ago, will look forward to his next effort in this direction on October 11, when he is producing the Vic Wells ballet.

During the last ten years practically every branch of entertainment has received a tremendous fillip in its evolution, and the extension of public interest in it, as a result of radio and the gramophone. But alone among all these varieties of entertainment the ballet has been accorded no such assistance until now. Television, undoubtedly, will have a remarkable quickening effect upon the general appreciation of ballet, and it is gratifying to see that the B.B.C.'s producers are really taking special pains to make the most of the new medium for this purpose.

So far as I am able to judge, D. H. Munro's balletic efforts up to now have been distinguished mostly for the excellence of the lighting effects. It may not be out of place here to mention that one of the chief difficulties between the old classic ballet and the later Fokine and still more recent schools is the effort at complete harmony of movement, colour and music. It seems that with the attention now being given to this essential artistic harmony in tele-

vision production, viewers may soon enjoy some really outstanding ballet.

Reggie Smith, whom I first heard of about two months ago as a stage manager at A.P., has now been promoted to the position of Director of Television Variety. Those who have been watching his work with enthusiasm will be glad to hear of this. Reggie is a big, jolly fellow, every inch an actor. He has, I believe, played everything except principal boy in pantomime. Incidentally, he still makes noises off when required!

Reggie has an evident genius for presenting small floor shows, several of which recently have been a valuable contribution to the entertainment level of the broadcasts.

The latest recruit to the productions staff is Philip Dorté, who comes from the film world. He is now collaborating with Dallas Bower in arranging the film transmissions from Pinewood and Denham, which are to take place between September 30 and October 5. There will be ten of these transmissions in all, and during the five days the television flying squad will be encamped at the studios. The radio link, of course, will be used for transferring the material to the Palace prior to re-diffusion in the ordinary way.

These programmes will make television history, as it is the first occasion that television cameras have been taken to the film studios, and in addition to all the famous film personalities to be seen by viewers a

number of behind the scenes type of programmes will be broadcast as well.

Stephen Thomas at present seems to be concentrating largely upon period programmes, but his recent highly successful efforts at dramatising songs deserves more than a passing mention. In his "Mizzen Crosstrees," which was broadcast on four occasions but with different songs, he showed us an excellent idea in studio technique which suggests considerable scope. Behind the singer he had a moving film background of angry sea which conferred a most realistic atmosphere. Then in his "Old Kentucky" we saw another instance of effective pictorial backgrounds to the real negroes chanting Southern songs.

Harry Pringle hit the bull's-eye with the third and last edition of "Cabaret Cruise," and I must not forget to mention that the peripatetic Leslie Mitchell braved the fire escape once again in "Fire Up Aloft," and would have jumped into the waiting blanket below had it not been that the authorities refused. So a lusty fireman was seen on the screen doing the daring deed instead.

And what is happening to Jasmine Bligh, the television hostess-announcer? Every day and in every way Miss Bligh is getting blonder and blonder—haven't you noticed it? But it is all according to plan, as I was secretly assured the other day, for it has now been decided that the announceresses, in their colouring, must contrast effectively with each other.

Book Review

Television Engineering, by J. C. Wilson. 490 pp. 276 figs. including plates. Sir Isaac Pitman & Sons, 30s. net.

Contents: Historical; The Eye and Optics; Scanning Methods; Analysis of Finite Aperture Scanning Methods; Photo-sensitivity; Amplifiers, Channels and Filters; Light Modulation; Cathode-rays; Synchronising; Special Television Methods.

After Mr. Myers' "Television Optics" comes Mr. Wilson's book with the above title. Messrs. Pitman are among the leading publishers in the production of books on the comparatively new science.

The author, Mr. Wilson, has wisely

devoted the opening chapters to an account of the earlier mechanical processes and the theory underlying them. Two excellent tables on p. 48 give a résumé of all the various invented systems of scanning and re-constitution, orthodox and unorthodox, and should be consulted by all would-be inventors of new systems.

In a description of unorthodox scanning methods we read: "that form of scanning variously known as intercalated, interlaced, intermeshed, interdigitated, interleaved, interwoven, imbricated, polyply, multi-mesh, non-sequential, skipping-line or laminular."

The book is written for television engineers, and those who are starting the study of the subject from the beginning would do well to brush up their mathematics if they are to fol-

low all the steps in the formulæ. There are one or two minor misprints, such as the negative sign in front of the 7 at the foot of p. 260 and the attribution of the telepantoscope to Castellain instead of Castellani.

A most valuable feature is the list of references at the end of each chapter, which enable the reader to obtain further details on any aspect of the subject outlined in the book. These references combined with the thorough survey of the subject which Mr. Wilson has made will place the book as a standard of reference for many years to come. A number of special television engineering courses will be commencing in the technical schools shortly and teachers and students alike will do well to purchase this book.

OCTOBER, 1937

A High-gain T.R.F. Receiver

By Kenneth Jowers

We present this receiver for constructors wishing to hear amateur transmissions on 10 metres and under, and also for those who wish to pick up the Alexandra Palace sound transmissions at high quality.

AS the possibilities of ultra-high frequency reception have not yet been fully determined wave-lengths below 10 metres offer more scope for experimental work than the remainder of the amateur bands put together. With many experimenters dabbling with ultra-high frequency receivers for television and other pur-

poses, I have been receiving a large number of interesting letters which tend to show that there is no limit to the distances being spanned by U.H.F. signals. The lack of satisfactory results ap-

pears to be due to poor co-operation, but more definitely to unsuitable receivers. The super-regenerator has, for a long time, been the standard receiver for British amateurs, and despite the fact that it is almost useless for picking up weak signals, owing to the background noise level, some of the more advanced English experi-

are ideal in many respects, the fact that long-wave C.W. and other signals can be picked up by virtue of the I.F. frequency used, cause complications to be set up.

During the past year or so I have been experimenting with straight receivers for ultra-short wave working without very much success. The main trouble has been the lack of suitable valves that would give sufficient practical gain, and at the same time would give that gain at high frequencies. Actually the introduction of special valves for television receivers has been a decided help to the amateur constructor, for now there is a multitude of valves suitable for ultra-short wave work. As most constructors are well aware, paper figures giving standard characteristics do not mean very much on ultra-short waves for the practical gain developed by a high-frequency amplifier drops off to an alarming extent below 20 metres. This meant that I had to weed out all the new valves in an endeavour to find a pentode of characteristics that would permit of comparatively high gain with complete stability at frequencies in the order of 30 to 60 megacycles.

The original tests with these new valves were made on the sound signals radiated from the Alexandra Palace, which formed a very reliable stand-by when making comparative tests. Fortunately the valves finally used showed

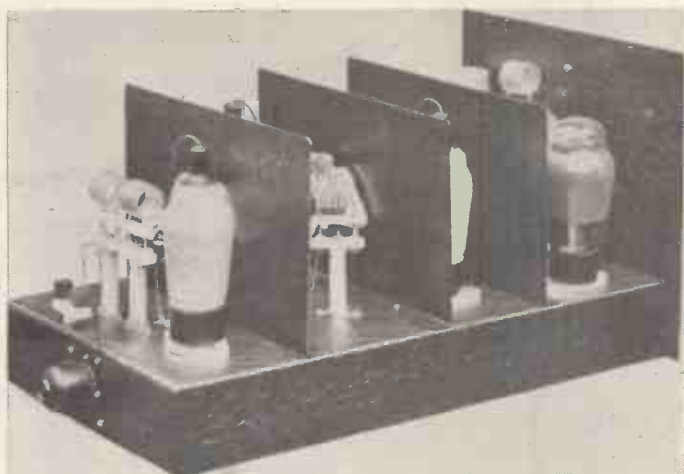

In this illustration can be seen I.3, the output tetrode, and first and third radio-frequency stages.

menters have done surprisingly well. From time to time I have endeavoured to persuade amateurs to construct more efficient U.H.F. receivers using super-het circuits. While these sets are undoubtedly very efficient and

menters have done surprisingly well. From time to time I have endeavoured to persuade amateurs to construct more efficient U.H.F. receivers using super-het circuits. While these sets are undoubtedly very efficient and

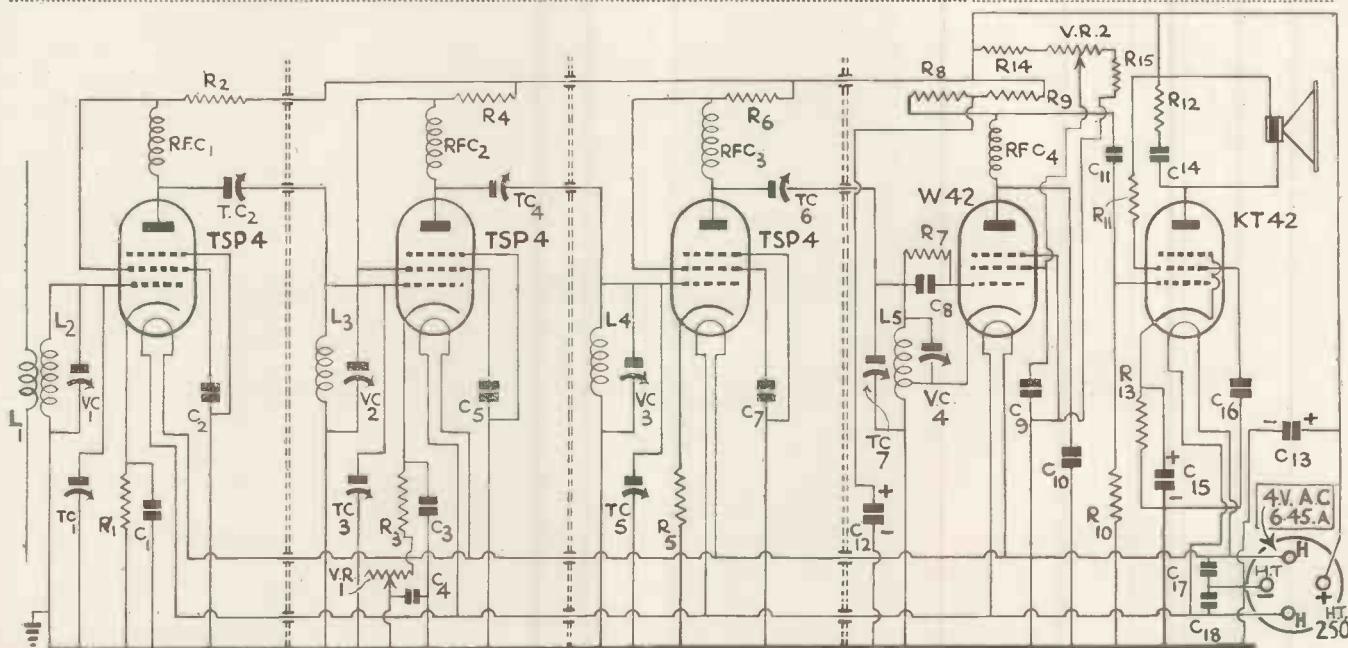

Fig. 1.—Three R.F. pentodes are used as amplifiers, one as an electron-coupled oscillator. One of the new tetrodes is in the output stage.

High R.F. Gain :: Simple Decoupling

such a decided increase in gain over the older type of H.F. pentode that there was little need to make exhaustive tests.

Although it is most unusual to build a short-wave receiver, let alone an ultra-short wave receiver, with three high-frequency stages, after experience in the design of television receivers I realised that the ideal set for real DX on ultra-short waves was a straight set with a maximum amount of radio-frequency gain. Three radio-frequency

value. First of all notice how the screen voltage is obtained. These TSP4's work with 250 volts on both anode and screen and should the screen voltage be obtained through its own series resistance for de-coupling the three stages cannot be perfectly stabilised. So for that reason anode resistances, shown as R2, R4 and R6, having a value of 1,000 ohms are used as common decouplers for both anode and screen. The screen voltage is tapped off at the junction of the R.F. choke and the anode resistor.

is essential, however, that VR1 be a high-grade resistor, and for this reason the Reliance potentiometer is specified without any alternative.

Coils L2, L3, L4 and L5, are all fundamentally similar, being conventional grid coils. They are tuned by VC1, 2, 3 and 4, condensers having a capacity of 15-mmfd. each. As variations in wiring will probably unbalance individual circuits the grid coils have connected in parallel with them trimming condensers, TC1, TC3, TC5 and TC7. These condensers are of the ceramic postage stamp type, having a maximum capacity of 30 mmfd. How these are adjusted will be dealt with later. Coupling coil L1 has four turns irrespective of wavelength between 4 and 10 metres.

Each radio-frequency stage is complete in itself. The anode circuits and

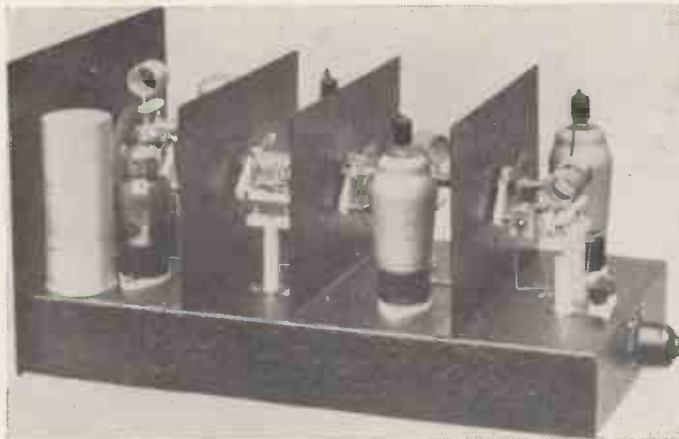

A very good idea as to the layout of the components can be seen from this illustration. The screens are of steel and must be perfectly rigid.

stages were finally put into use and it must be admitted that the original tests in rather hazy-wire fashion did not seem at all satisfactory owing to the extreme difficulty in obtaining stability. By the time the radio-frequency stages had been stabilised so much gain had been lost that at the best one R.F. stage could have been omitted, giving better stability and more gain from the remaining two stages.

Alterations in design, however, not only simplified and cheapened the receiver, but gave a degree of stability that would enable the set to be built in numbers without there being any chance of instability re-occurring.

A special chassis was built for me by Messrs. A. P. A., Ltd., and although this is quite a straightforward and simple affair it will be noticed that the screens are both above and below the chassis line. Several important features came to light during the testing of the receiver, but these points will all be described together when the general construction is described.

3 R.F. Stages

The circuit finally used is shown in Fig. 1. It consists of three radio-frequency stages, electron-coupled detector and one of the new high-output tetrodes in the final stage. The radio-frequency stages may, at first glance, appear to be perfectly straightforward, but do not take the circuit at its face

The screen is then by-passed directly to the chassis through condensers, C2, C5 and C7, which have a value of .01-mfd.

In the first and third radio-frequency stages the TSP4's are automatically biased by cathode resistors, R1 and R5, having a value of 200 ohms. This enables a slight fixed voltage to be applied to the valves so that they operate on the correct part of the curve so giving optimum gain. The second R.F. stage has a slightly different arrangement, for, in addition to the fixed cathode resistor, R3, there is a variable resistance, VR1, having a value of 5,000 ohms. This enables the gain of the second stage to be fully controlled, and if the stages are correctly wired, maximum gain can be obtained from the three stages without instability. It



For those who require high quality reproduction at reasonable room volume we recommend this new WB Planoflex loudspeaker.

associated components are in the screened partition below the chassis, while the grid circuit with coils and condensers, is above the chassis. It

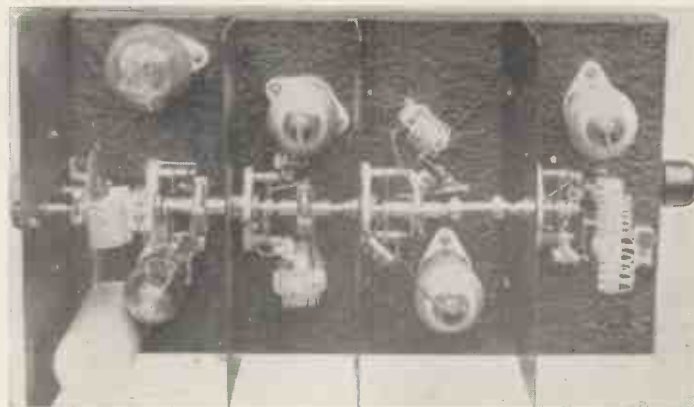

This plan view shows all the components on the top lip of the chassis in the correct positions. Notice how the leads in every case are kept as short as possible.

Efficient Reaction Control :: A Tetrode Valve

can be seen from this that screening is complete, not only between stages but between grid and anode sections of each stage.

Coupling between stages is carried out by means of TC₂, TC₄ and TC₆, which have to be adjusted to give the

100,000 ohms, while ample decoupling is provided by a 25,000 ohms resistor plus an 8-mfd. condenser. At this point it is well to remember that C₁₂ and C₁₃ are in the same container, being a twin 8-mfd. electrolytic.

Obtaining the screen voltage for the

way the voltage is dropped by R₁₄ and R₁₅, but there is a wide manual control of the screen voltage by means of VR₂. In practice, variation of screen voltage controls the amount of regeneration in the detector stage, and in this way reaction is both smooth and effective, which cannot be said for the more conventional types of capacity controlled reaction at frequencies of the order of 50 megacycles.

Tetrode Output

Resistance capacity is employed between the W₄₂ and the KT₄₂ output tetrode. This latter valve is of new design and although it fundamentally uses but two grids, there are two additional minute electrodes employed in the construction which we have shown as a third grid. This is not strictly accurate, but indicates the presence of the additional electrode. Bias is obtained automatically by means of R₁₃, which has a value of 420 ohms. The KT₄₂ operates with maximum voltage on both anode and screen, but in view of the voltage drop across the output transformer primary I find it advisable to include R₁₁ so as to keep the screen voltage slightly below that applied to the anode. Modulation hum is very

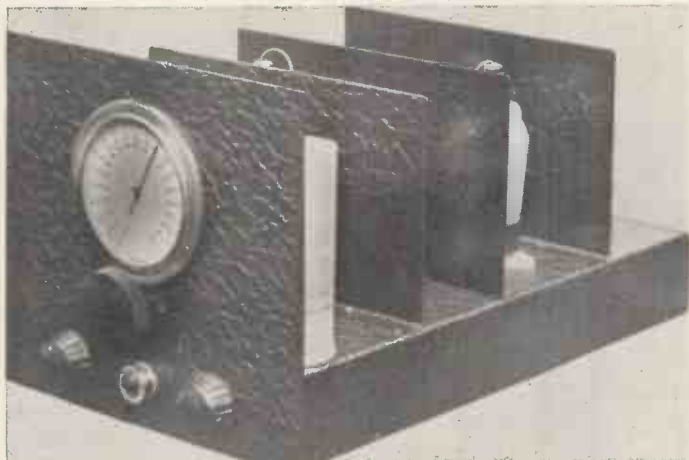

As the tuning drive has to control four condensers it must be absolutely free from slip. Also, as the receiver is comparatively selective the drive must be absolutely free from back-lash and well geared down.

required degree of selectivity by reducing the load on the succeeding stage. These condensers are mounted in the wiring and in such a way that they are absolutely rigid. Actually TC₂ and TC₄ are mounted directly to VC₂ and VC₃ without additional wiring.

Electron-coupled Oscillator

One of the most difficult sections of the receiver was the detector stage. At one time I almost gave up in despair about finding a radio-frequency pentode with a grid top cap connection that would work smoothly as an electron-coupled oscillator in the circuit I had chosen. Finally the W₄₂ pentode with its comparatively low gain turned out to be quite satisfactory provided the circuit constants were rigidly adhered to. It will be seen from the circuit that the cathode of the W₄₂ is returned to earth via one turn of L₅, but constructors will be well advised to connect VC₄ to the cathode of the W₄₂ and take it directly to earth, so making the detector conventional leaky grid arrangement without reaction. Then, after the receiver has been trimmed up and operates smoothly, the cathode can be tapped on to the grid coil and oscillation obtained in that way. It should be remembered, however, that when the receiver is finally in use VC₄ tunes the whole of L₅ and is not merely tied to the cathode as shown in the experimental arrangement.

An R.F. choke and by-pass condenser are essential in the anode of the W₄₂. This by-pass condenser should have a value of .0001 mfd. and is shown as C₁₀. For maximum results the anode load resistance should be

W₄₂ was another problem, and ultimately this was overcome by using a variable resistance VR₂, having a value of 100,000 ohms plus a resistance network made up of R₁₄ and R₁₅, having values of 50,000 ohms each. In this

Components for A HIGH-GAIN T.R.F. RECEIVER

CHASSIS.

1—Complete with screens, sub-screens and panel finished black (A.P.A.).

CHOKES, HIGH-FREQUENCY.

4—Type 1011 (RFC₁, 2, 3, 4, 5) (Eddystone).

COILS.

1—4—turn type 1050 (L₁) (Eddystone).
4—6—turn type 1050 (L₂, 3, 4, 5,) (Eddystone).

COIL HOLDERS.

5—Type 1051 (Eddystone).

CONDENSERS, FIXED.

1—01-mfd. type 4601/S (C₁) (Dubilier).
1—01-mfd. type 4601/S (C₂) (Dubilier).
1—01-mfd. type 4601/S (C₃) (Dubilier).
1—01-mfd. type 4601/S (C₄) (Dubilier).
1—01-mfd. type 4601/S (C₅) (Dubilier).
1—01-mfd. type 4601/S (C₆) (Dubilier).
1—01-mfd. type 4601/S (C₇) (Dubilier).
1—0001-mfd. type 690W (C₈) (Dubilier).
1—01-mfd. type 4601/S (C₉) (Dubilier).
1—0001-mfd. type 690W (C₁₀) (Dubilier).
1—05-mfd. type 4692/S (C₁₁) (Dubilier).
1—8-mfd. 9203/E, (C₁₂) (Dubilier).
1—8-mfd. type 9203/E (C₁₃) (Dubilier).
1—01-mfd. type 4601/S (C₁₄) (Dubilier).
1—50-mfd. type 3004 (C₁₅) (Dubilier).
1—01-mfd. type 4601/S (C₁₆) (Dubilier).
1—01-mfd. type 4601/S (C₁₇) (Dubilier).
1—01-mfd. type 4601/S (C₁₈) (Dubilier).

CONDENSERS, VARIABLE.

1—15-mmfd. type VC₁₅X (VC₁) (Raymart).
1—15-mmfd. type VC₁₅X (VC₂) (Raymart).
1—5-mmfd. type VC₁₅X (VC₃) (Raymart).
1—15-mmfd. type VC₁₅X (VC₄) (Raymart).
7—30-mmfd. type SW 95 (TC₁, 2, 3, 4, 5, 6, 7,) (Bulgin).

DIAL.

1—Type 1070 (Eddystone).

DIAL LIGHT.

1—Type D₉ (Bulgin).

HOLDERS, VALVE.

5—7-pin type V₅ less terminals (Clix).
2—4-pin type V₁ less terminals (Clix).

RESISTANCES, FIXED.

1—200-ohm type 1-watt (R₁) (Erie).
1—1,000-ohm type 1-watt (R₂) (Erie).
1—200-ohm type 1-watt (R₃) (Erie).
1—1,000-ohm type 1-watt (R₄) (Erie).
1—200-ohm type 1-watt (R₅) (Erie).
1—1,000-ohm type 1-watt (R₆) (Erie).
1—100,000-ohm type ½-watt (R₇) (Erie).
1—100,000-ohm type 1-watt (R₈) (Erie).
1—25,000-ohm type 1-watt (R₉) (Erie).
1—25,000-ohm type ½-watt (R₁₀) (Erie).
1—1,000-ohm type 2-watt (R₁₁) (Erie).
1—10,000-ohm type ½-watt (R₁₂) (Erie).
1—420-ohm type 2-watt (R₁₃) (Erie).
1—50,000-ohm type 1-watt (R₁₄) (Erie).
1—50,000-ohm type 1-watt (R₁₅) (Erie).

RESISTANCES, VARIABLE.

1—5,000-ohm wire-wound potentiometer with switch (VR₁) (Reliance).
1—100,000-ohm wire-wound potentiometer (VR₂) (Reliance).

SUNDRIES.

36—6BA bolts, nuts and washers (Bulgin).
2—coils Quickwyre (Bulgin).
4—thimble-caps type P₄₃ (Bulgin).
2—4-pin plugs type P₉ (Bulgin).
1—terminal saddle type 1046 (Eddystone).
2—extension outfits type 1008 (Eddystone).
3—flexible couplers type 1009 (Eddystone).
2—Dials type IP₁ (Bulgin).
4—Insulating pillars type 1029 (Eddystone).

ACCESSORIES

AERIAL UNIT.

1—Dipole aerial kit (Bulgin).

HEADPHONES.

1—Pair Supersensitive (Ericsson)

LOUDSPEAKER.

1—Type Planoflex (W.B.).

VALVES.

3—TSP₄ MET. (Mullard).
1—W₄₂ (Osram).
1—KT₄₂ (Marconi).

5-10 Metre Coverage

noticeable on the television sound signals unless C17 and C18 are connected directly across the power socket which can be seen mounted on the back lip of the chassis.

Before going into some points on the construction of the receiver, the advantages of this type of receiver should be pointed out. First of all it is an excel-

lent receiver for use on the 10-metre amateur band for it has world-wide coverage and, of course, a much lower noise level than can possibly be obtained on even the best super-het receiver. It will also enable amateurs to carry out some really interesting experimental work on 5 metres with a view to determining the maximum range of 5-metre signals. Finally, for those who wish to hear the television sound signals or who wish to incorporate this receiver in a television receiver, it is very suitable for such purposes. In fact, owing to the high quality it is capable of giving, coupled with the wide band width used by the television sound transmitter, constructors will be well repaid to buy a high-quality loud-

speaker specially for use with this receiver. I strongly advise the new WB Planoflex, which, to my way of thinking, is one of the best domestic speakers on the market to-day. It gives quality much out of the ordinary, and once and

for all enables the home constructor to obtain high-fidelity reproduction at normal room level. It has been my experience that far too many speakers are only capable of giving good quality with high output. The base response on the Planoflex is remarkably good and reproduces as near the original as anything I have heard.

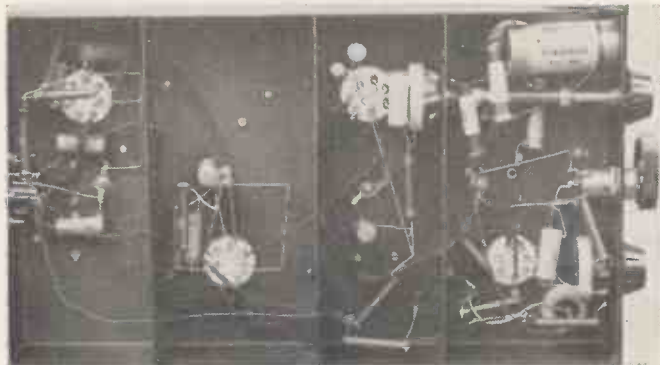

This sub-chassis view shows how the radio-frequency and detector stages are completely isolated. Notice how the heater wiring is kept alongside the edge of the chassis out of the way of the remainder of the wiring.

lent receiver for use on the 10-metre amateur band for it has world-wide coverage and, of course, a much lower noise level than can possibly be obtained on even the best super-het receiver. It will also enable amateurs to carry out some really interesting experimental work on 5 metres with a view to determining the maximum range of 5-metre signals. Finally, for those who wish to hear the television sound signals or who wish to incorporate this receiver in a television receiver, it is very suitable for such purposes. In fact, owing to the high quality it is capable of giving, coupled with the wide band width used by the television sound transmitter, constructors will be well repaid to buy a high-quality loud-

Construction

Now for a few points on the construction. Before assembling any components whatsoever, drill the holes to take the four tuning condensers and the tuning drive. Then drill five holes through the first sub-chassis screen, three through the second, and four through the third. These holes are to take the wires that connect between stages. A valve holder for carrying the power supply is mounted on the back lip of the chassis, while the loudspeaker is also connected to a valve holder on the left-hand lip of the chassis. Do not forget to mount the tuning dial slightly back from the panel and mount it to the base plate and not to the panel. In this

above and below. All earth returns should then be taken to these soldering tags so that each stage has one common earth point. Do not, in any circumstances, rely upon an automatic earth contact. Particularly earth the rotor of the tuning condensers directly to the soldering tag. Finally, join the four soldering tags to H.T. negative.

I can assure constructors that if independent earths are used no amount of juggling will give stability without losing an appreciable amount of gain. Looking at the first R.F. stage, notice that the coils, both grid and aerial, are mounted on stand-off pillars. These coils should be as close together as possible in order to obtain the correct amount of coupling. As it is rather difficult to connect the padding condenser actually across the coil holders it can be connected in the wiring in such a way that a wooden screw-driver can be used for adjustments. Wherever possible solder the padding condenser directly to one side of the tuning condenser.

With the first four valves, that is, excluding the output tetrode, the grid contact is to the top of the valve. This makes wiring short, keeps capacity and losses low, and also enables the whole of the grid circuit to be in one separate compartment.

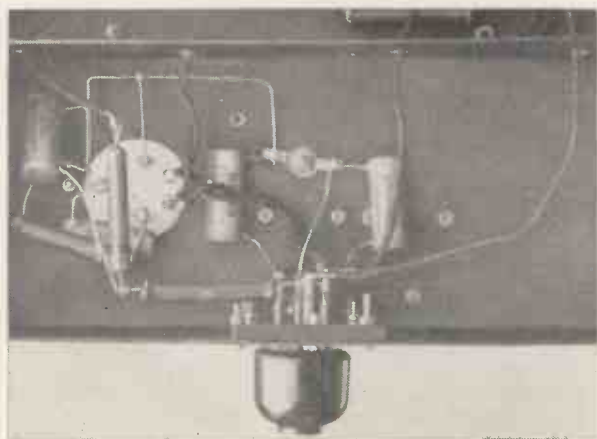

This is the first RF amplifier and note particularly how the earth returns are taken to the common earthing point. This is most important, as fully explained in the text.

speaker specially for use with this receiver.

I strongly advise the new WB Planoflex, which, to my way of thinking, is one of the best domestic speakers on the market to-day. It gives quality much out of the ordinary, and once and

way the drive and scale will fit without difficulty.

Then, before mounting any of the top screens, drill four holes, one in the centre of each compartment; clean away the enamelling on both sides of the chassis and fix a soldering tag both

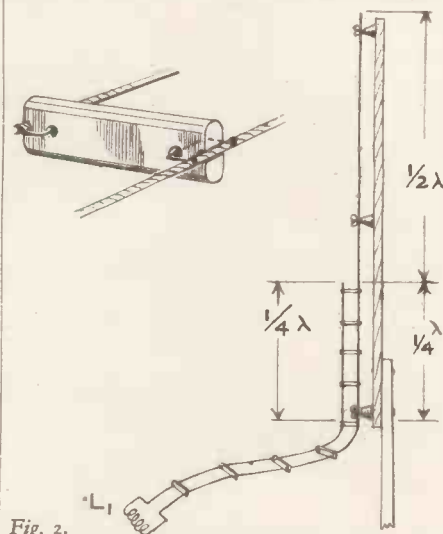

Fig. 2.

This U.H.F. aerial with matching section is very satisfactory for long-distance reception. It overcomes some of the disadvantages experienced with di-pole aerials.

There is a slight variation in the detector stage. The grid of the W42 is connected to the fixed plates of the tuning condenser via a .0001 mfd. grid condenser and R7, a resistor of 100,000 ohms. Also there is hardly sufficient space on which to mount the coil as in

(Continued on page 640)

The Short-wave Radio World

A Folded Bruce Aerial

W6BUQ claims that during the past few months it is becoming increasingly obvious that in order to obtain satisfactory QSO's on 20 metres amateurs are being forced to use either high power or some special type of beamed aerial to give a comparatively heavy

A Review of the Most Important Features of the World's Short-wave Developments

proximately intersects at the centre of the aerial.

Although there are sixteen quarter

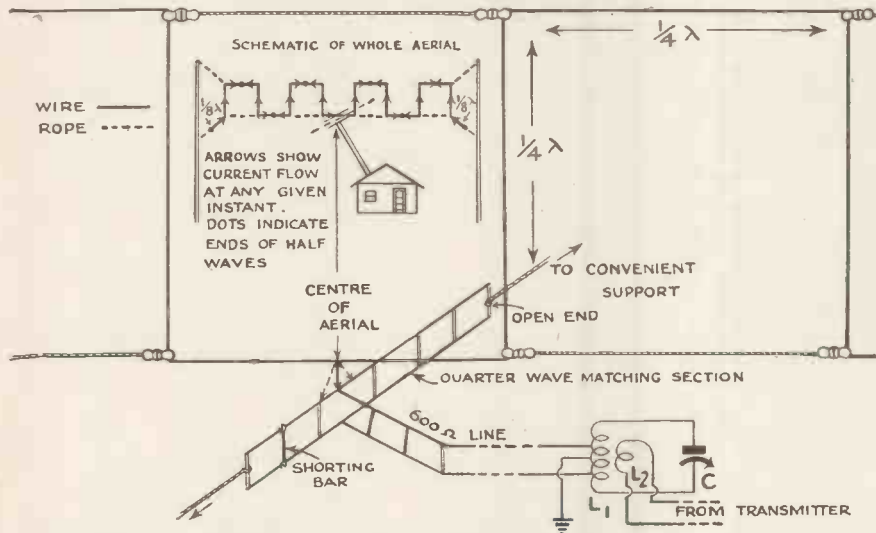

Fig. 1.—A folded Bruce antenna of this kind does not necessarily take up more than the usual amount of space. It has very concentrated broadside radiation in two directions.

field strength in a given area. Unfortunately, amateurs are not in a position to erect the most efficient aerial owing to space limitations, so for that reason a compromise aerial has to be erected.

According to several American amateurs, including W6BUQ, and the well-known Australian authority VK2NO, the most satisfactory amateur aerial is the folded Bruce, which can be most effective on 20 metres and below. In the July issue of *Radio*, W6BUQ describes his Bruce aerial which has been designed to resonate at 14,200 kc. The aerial is made up of a number of quarter waves each quarter being approximately equal to 17.5 ft. Approximately 300 ft. of No. 12 gauge wire are required and erected as shown in Fig. 2. It will be seen from this that the number of quarter wave sections begin and are terminated with a single eighth wave section. A matching stub enables any type or impedance of feeder to be used and for perfect matching to be obtained.

Approximately 135 ft. of ground space is required whilst the bottom of the lowest section should be at least 8 ft. above ground. The quarter wave matching transformer is made up of two 12-gauge wires, 16½ ft. long and spaced approximately 8 in. It should be mounted so that the 600-ohm point ap-

proximately intersects at the centre of the aerial. Although there are sixteen quarter wave sections and two eighth wave sections the wire is not broken at any point. Radiation is very much broadside and our tests have shown that when erected north-west and south-east is an ideal radiator to South America. It should, of course, be appreciated that radiation is broadside in two directions and as the eight vertical sections are in phase with eight of the horizontal sections in opposite phase, radiation is low angle and vertically polarised.

This aerial is also satisfactory for

reception and if the feed wire from the receiver is connected to the exact electrical centre of the aerial coil, then the receiver can be left connected while the transmitter is in operation without detrimental effects.

A Noise-free Receiving Aerial

American listening amateurs appear to have some of the same difficulties as experienced by British amateurs, that is how to cure local interferences and how to obtain maximum signal strength with minimum noise level. A very satisfactory low-noise aerial system is described in the August issue of *Short-wave and Television*, an American publication. The theoretical circuit is shown in Fig. 2 from which it can be seen that the arrangement is quite simple and does not take up much room. The aerial itself consists of two 38 ft. sections with 55-65 ft. feeder lines spaced two inches.

Actually, the two top lengths can to advantage be cut to resonate in the centre of the most important amateur band for this will give a slight increase in signal strength.

The series condensers C and C have to be adjusted simultaneously until minimum noise level is obtained; the positions for the tapping points should also be obtained experimentally for maximum signal strength. The aerial coil can be wound on a standard 2½ in. coil form and wired as explained in the circuit. The American designer of this aerial recommends twisted lamp flex to couple the aerial coil to the receiver, but our experience has been that this system introduces unnecessary loss which can be overcome by utilising some of the Belling-Lee special low-loss 72-ohm cable.

A Two-band Portable Transmitter

We are very interested in a simple portable transmitter described in the

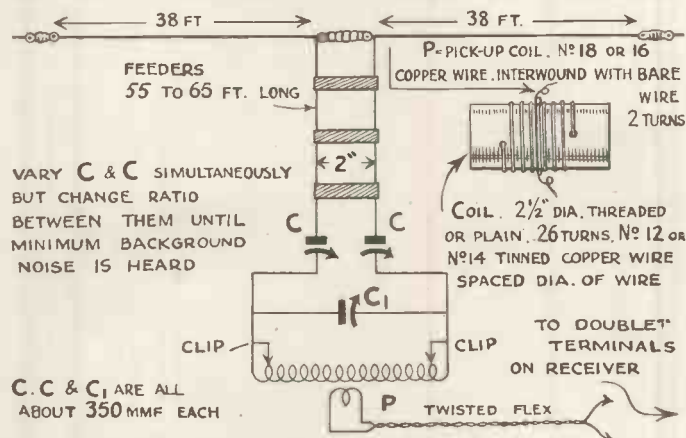

Fig. 2.—The listening amateur troubled with local interference should try this special noise-suppression aerial for which excellent results are claimed.

A Portable TX

::

2 Watts from Batteries

July Radio, utilising two 6L6-G valves on 40 or 80 metres. The circuit is shown in Fig. 3 where it can be seen that three valves only are used. The American idea of portable, however, is not quite the same as our own for an

- C₄—260 μ fd. per section, 1000 volts, split stator.
- C₆—150 μ fd. 100 volt variable.
- C₆, C₇—8 μ fd. 450 volt paper.
- R₁—200 ohms, 20 watts.
- CH—250 ma. swinging choke.
- T₁—1400 vo ts c. t., 250 ma.
- T₂—5 volts, 3 amps.; 6.3 volts, 2.5 amps.

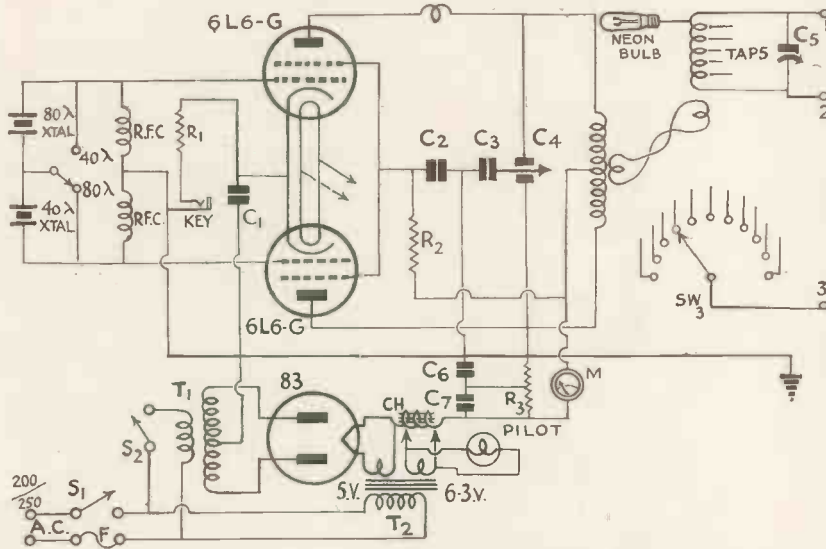

Fig. 3.—Either American 6L6 or the British equivalents can be used in this portable transmitter. Where more convenient the conventional power pack can be omitted in favour of a converter.

American portable is merely something that can be moved about but is generally dependent on a power supply. A British portable is one that is truly portable and is independent of everything else. Examine the circuit in Fig. 3: the transmitter can be used with either a 40 or 80-metre crystal, or for those who like to QSY any two crystals can be utilised for example, two 40's or two 80's or a 40 or a 160 can be connected in circuit as required.

A maximum voltage of 550 is required at which voltage the R.F. output is not less than 50 watts. The total weight including power pack is 55 lb., while those who have access to a higher anode voltage this output can be greatly increased.

We draw the attention of our readers to the switching system utilised in this transmitter. It has much in its favour and can be used to advantage in most amateur equipment.

The designer claims that the circuit is free from self-oscillation and harmonic radiation, while the circuit is such that almost any type of aerial can be used. Both coils are wound on National ceramic coil forms and wound with 12-gauge wire. For the benefit of constructors, the following components are required:—

- C₁—.01 μ fd. 600 volt paper.
- C₂—.002 μ fd. mica.
- C₃—.005 μ fd. mica.
- R₂—10,000 ohms, 20 watts.
- R₃—20,000 ohms, 55 watts, slider type.

- RFC—2½ mh. 125 ma. r. f. chokes.
- M—0-500 ma. d. c.
- Plate coil—18 turns, 2½" dia., slightly spaced.
- Ant. coil—16 turns, 2½" dia., tapped every other turn.
- S₁—Filament control switch.
- S₂—Plate voltage switch.
- S₃—Tap switch on antenna coil.

NOTE: The parasitic choke in one plate lead consists of 6 turns of the hookup wire around a regulation lead pencil.

The valves can be obtained from Messrs. Webbs' Radio, who also can supply the majority of the components.

A Battery-operated Class B Amplifier

During the past few months a number of our readers have inquired as to the best type of amplifier to give maxi-

mum output from dry batteries. The Thordarson Co., of Chicago, have published in their latest manual a very good circuit that gives an output of over two watts with only 135 volts high tension. Three valves are used, the first two valves are of the HL2 type followed by a conventional class B valve such as the Cossor 240B. This latter valve, however, does not require any negative grid bias so that the centre tap on the secondary of T₁ should be connected directly to earth.

Resistance capacity coupling between first and second valves is essential otherwise constructors may have difficulty in eliminating L.F. instability. Where sufficient H.T. current is available, the second HL2 can be omitted in favour of a small pentode of the PM22A type. This will drive the 240B very much harder and with correct loading the output can be increased to approximately 2.5 watts. T₁ is a conventional class B drive transformer that can be obtained from Messrs. Sound Sales, while T₂ is an output transformer hav-

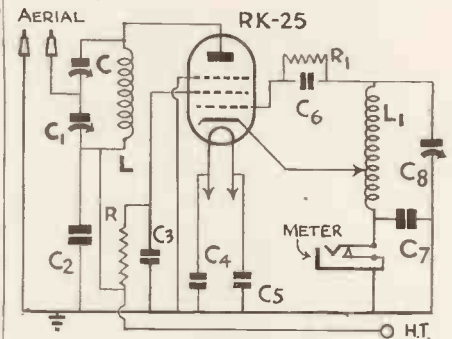

Fig. 5.—Amateurs interested in ultra-short wave transmission will find this single-valve low-power transmitter using a single pentode most efficient.

ing a secondary impedance that will match up to the loudspeaker to be used.

This type of amplifier can be used with either a microphone or gramophone pick-up and will modulate, at 40

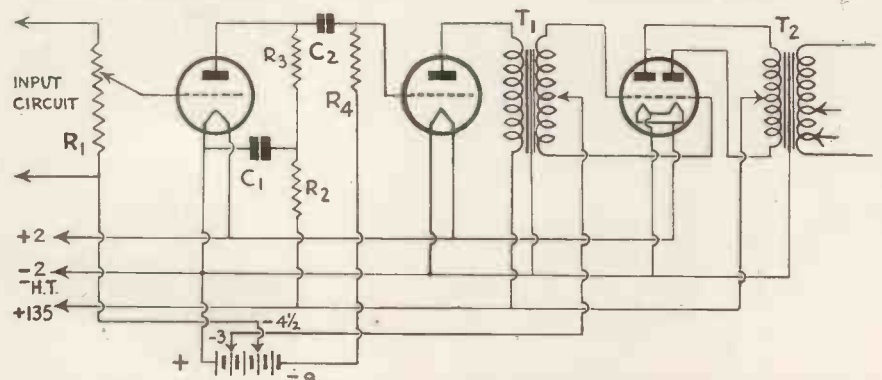

Fig. 4.—With British valves this Class B circuit is capable of giving an output of at least 2 watts.

OCTOBER, 1937

metres, a transmitter having about 4 watts input. The conventional mains unit cannot be used with this type of circuit unless it has a stabilised output. It must be remembered that with a class B circuit the anode current fluctuates between a low minimum and a high maximum value. If a mains unit is employed a suitable way in which to stabilise the output is to use a neon tube arrangement such as the Marconi Stabilovolt.

An E.C.O.

5-metre Transmitter

WE are rather glad to see that there is a general tendency in America to disregard the conventional transceiver in favour of a separate transmitter and receiver on ultra-short waves. It has been proved that DX reception is quite possible on 5 and even 2½ metres, but only if suitable equipment, which includes a receiver far more efficient than the average super regenerator, is used.

In the July issue of the American publication *World Radio* is described an interesting 5-metre portable station designed by W2AIF and W2CPA, both of whom are well-known in this country. The receiver can be dealt with very briefly for it is merely a straightforward 2-valver using type 76 and type 6K7 valves. It is the transmitter, however, that is of particular interest to English constructors in view of the fact that it uses but a single valve and has been designed for a low output around 5 watts.

The circuit is shown in Fig. 1 where it will be seen that RK25 pentode is used as an electron-coupled oscillator. Layout of components is quite important and for this reason the entire grid circuit is beneath the chassis so as to obtain efficient screening from the anode circuit. The grid tank circuit is controlled by condenser C8, but this can be virtually pre-set.

Notice also that the jack is connected in series between the lower end of the grid coil and earth and has in parallel with it condenser C7 so as to complete the grid return. As this meter is more or less directly in the cathode circuit the reading obtained is that for both anode and screen circuits.

C, C1 and L comprise a combined anode tank and universal aerial coupler, actually the coupler is similar in effect to the conventional Pi or Collins' coupler. C and C1 together tune the anode circuit to resonance for the ratio in capacities between the two condensers determines the matching impedance to the aerial.

This type of coupler will match any single wire aerial of almost any odd length. For fixed operation with a two wire feed system a coupling coil con-

sisting of a few turns of wire should be plugged in to the cold end of L.

The transmitter is suitable for valves of the RK39 or 6L6 type, but the RK25 is more satisfactory although the output is considerably lower than with the two alternative valves. The beam power type of valves when used as an electron coupled oscillator at ultra-high frequencies has a tendency to oscillate on wave lengths from 1-10 metres at one and the same time. The designer mentions that with an RK39 radio-frequency output could be obtained even when the coil L was replaced by a shorting bar.

The approximate radio-frequency output is about 5 watts providing the cathode tap on the grid coil L1 is properly located. This point is roughly three-quarters of a turn from the earthy end of the grid coil.

For those interested in phone operation a 6L6 driven by an average gain triode such as a 6C5 will give sufficient audio output to modulate the RK25 quite fully. For mobile work a Mallory electronic converter is recommended, but an alternative is the Bulgin unit, which gives 15 watts output from a 6-volt cell.

We think that this type of transmitter can be most effective when used portable and should be capable of providing contacts over long ranges.

A New Universal Wave-change Switch

ALTHOUGH trolitul, the transparent insulating material for high frequency, has been in use for some time on the continent few British home constructors have had an opportunity of seeing it in practice. It is to be hoped, therefore, that the new

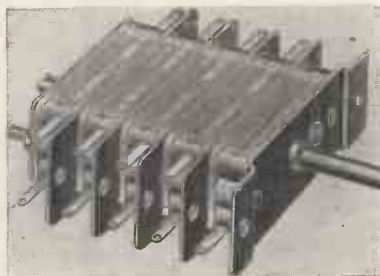

Fig. 1.—A complete view of the assembled switch.

switch by Lanco, shown at the German Radio Exhibition, will become available to home constructors in this country.

The universal switch is put up in kit form at a cost of R.M.42 (£2 2s. approximately) and contains components for building any type of wave-change or multi-contact switch up to 5-way 10-pole.

All the insulating parts are of trolitul and the switch is easily assembled to present a workmanlike appearance. A

single pole mains switch can also be added at the end of the shaft.

The general view of the assembled switch is shown in Fig. 1. It comprises a number of rectangular hollow boxes of insulating material which are strung together on two threaded rods. Each box is slotted at the corners to accommodate the contact strips (Fig. 2), which are slipped in to the desired positions before assembly.

The centre rod carries a corresponding number of insulated cams (Fig. 3),

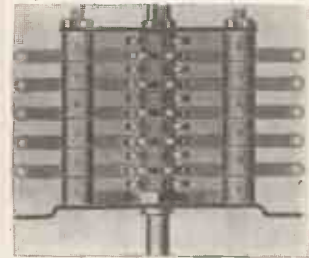

Fig. 2.—How the box is slotted at the corners is shown in this view.

which are selected according to the switching requirements. The centre hole in the cam is specially shaped to prevent slipping on the rod. When the requisite number of contacts have been assembled the whole block is completed by the addition of an insulated end plate and a front and back metal plate. The former is provided with holes for fixing to the chassis. A "click" cam is also provided with a spring to give a positive action to the switch in any one of the five positions. The shaft is left of sufficient length to accommodate a mains switch which can be obtained as either a single- or double-pole.

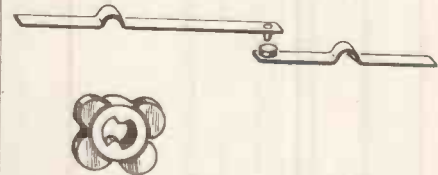

Fig. 3.—The special insulated cam with an unusually shaped centre hole to prevent slipping. Also is shown the make-up of an individual switch.

The complete kit comprises:

- 10 Front and back plates
 - 20 Fixing bolts
 - 10 Shafts.
 - 10 "Clicks"
 - 10 Coloured insulating boxes
 - 40 do. clear
 - 90 Cams
 - 90 Pairs of contact strips
 - 10 Insulated end plates,
- together with
- 5 Pairs of brackets
 - 5 Couplings
 - 10 Knobs.
 - 4 Single pole switches
 - 2 Double pole switches,
- which is sufficient to construct several complete switches.

A 23-watt Amplifier with Resistance Coupling

It appears to be becoming more and more simple to obtain comparatively high-audio output at low voltages. The conventional type of Class AB amplifier, using triode valves, is now very well known, but such amplifiers are fairly expensive when compared with pentode amplifiers where only resistance capacity coupling is required.

An amplifier giving over 20 watts is a valuable asset to the transmitting

To those requiring high audio output we offer this simple circuit which represents the easiest and least expensive way of obtaining outputs in excess of 20 watts.

is in the order of 90 m/A., while the slope is 8.5 m/A/V. When operated Class A a single valve with 250 volts on both anode and screen will give a maximum output of 8.8 watts with 10 per cent. harmonic distortion. With

coupling is used throughout, so materially reducing the cost of the equipment. The first valve is a conventional low-frequency amplifier, followed by a normal triode for phase splitting which feeds into the APP4E pentodes in push-pull.

Owing to the fact that the suppressor grids in the pentode valve are externally earthed there is no need for the normal series grid or series anode re-

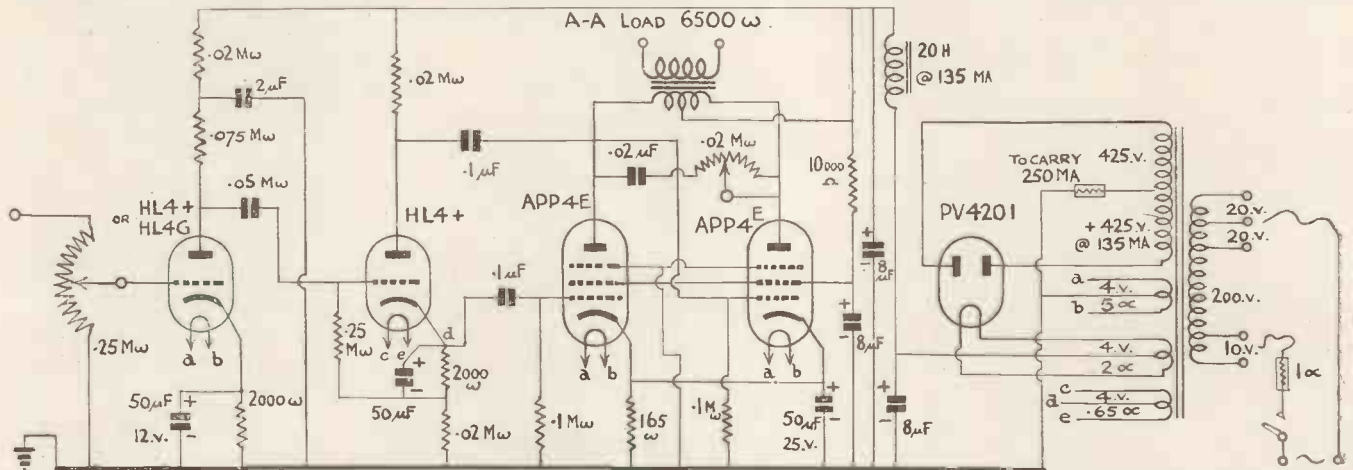

Providing the resistance values are strictly adhered to no difficulty should be experienced in building this amplifier. It is also important to see that the output transformer is suitable for use with valves having an anode-to-anode load of 6,500 ohms.

amateur, or to the service agent needing public address equipment. When such an amplifier can be built very cheaply and in a very small space then it becomes doubly valuable. We feel sure that constructors will appreciate a new amplifier designed by the Tung-sram Electric Lamp Works, Ltd., which, although it embodies the minimum number of components and only requires a maximum voltage of 425, is capable of giving a comfortable 23 watts output. Owing to the use of high-slope pentodes of a special type, resistance-capacity coupling has been employed, for, even with the low gain obtained with this system, there is sufficient input fully to load the pentode valves from what is virtually a single-stage pre-amplifier.

Pentode Output

These pentode valves, type APP4E, have rather interesting characteristics. They have, of course, the usual 4-volt heater with a load of 2.1 amps. The maximum anode voltage is approximately 375, with a maximum screen voltage of 275. The total cathode current, that is, anode and screen current combined,

the same anode voltage, but with two valves in almost Class B push-pull, the output rises to 19.5 watts with an optimum load of 4,500 ohms. By increasing the voltage, as indicated in this circuit, to 400 volts, but keeping the screen voltage constant at 275, the output rises to 28.5 watts. Under such conditions, however, separate bias supply is essential, while both screen and anode voltages should be stabilised.

The bias should be arranged so that the anode current is reduced to 48 m/A. per valve, peaking to 62 m/A. at full load. In the circuit shown the valves do not work in a full Class B circuit. Even though there is a fluctuating anode current this is kept down so that automatic bias is permissible despite the slight fluctuating grid voltage that will automatically be obtained. Actually, in practice, the grid volts vary by 9 volts between minimum and maximum audio output. With such an arrangement, however, 23 watts is the maximum output that can be taken providing distortion is kept down to a reasonable level.

R.C. Coupling

One of the most interesting features of this amplifier is the fact that R.C.

sistors, which again helps to reduce cost. The circuit as shown will develop the full rated output with an input of 2 volts r.m.s., so that for microphone use a single valve pre-amplifier will be required.

The high anode current called for means that the standard type of rectifier will not provide sufficient output, so for that reason a special rectifier, type PV4201, is embodied. This, in conjunction with the specified mains transformer, provides an output of 425 volts at 135 volts m/A. 50 volts are lost through automatic bias, so that a practical 375 volts is actually applied to the anodes of the output pentodes. Screen voltage is obtained through a 10,000-ohm series condenser which should be adequately by-passed by means of an 8-mfd. condenser.

For transmission use, the output transformer should have a secondary suitable to match up with the P.A. load. This is generally about 7,500 ohms, but, of course, varies over very wide limits. For loudspeaker use, however, the transformer secondary should be suitable for matching to a loudspeaker of about 15 ohms.

Providing the mains transformer, output transformer and smoothing choke
(Continued on 3rd page of cover)

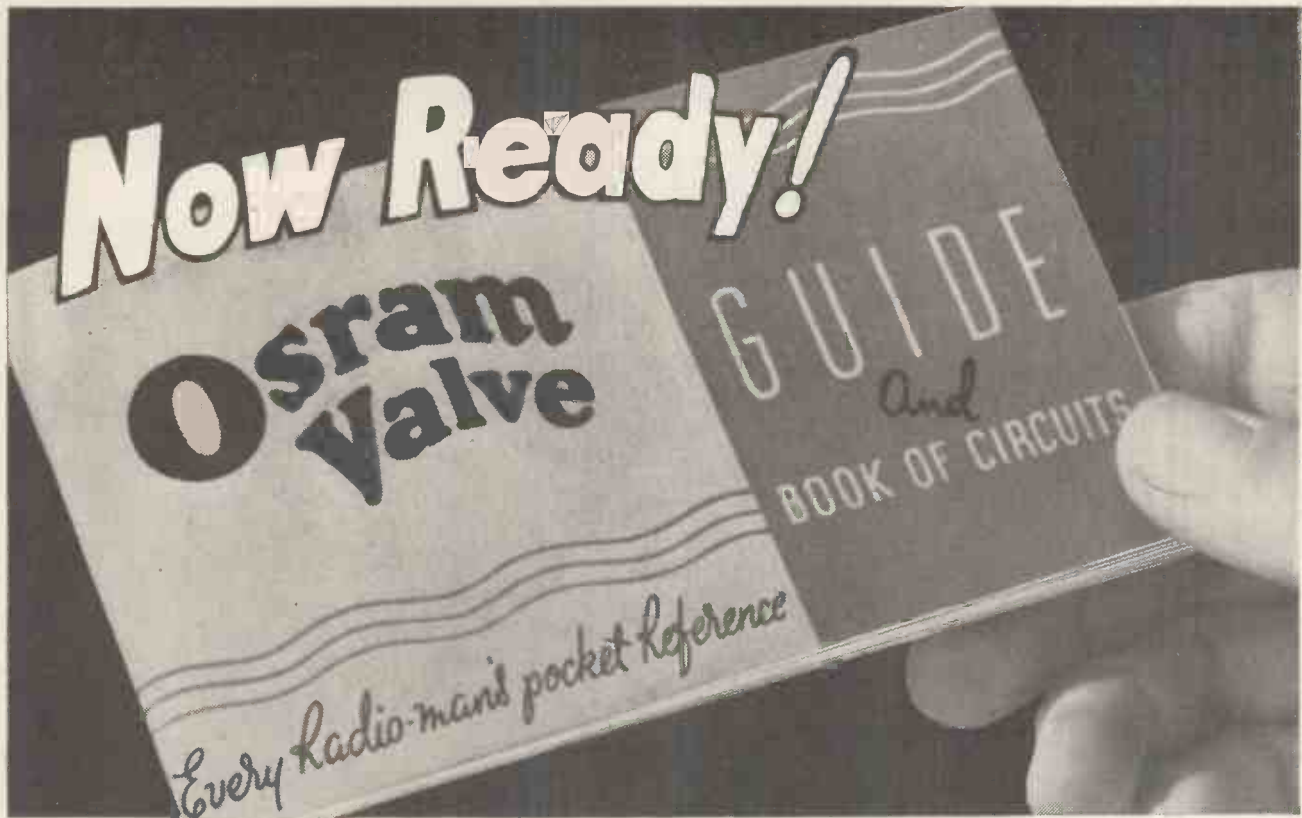

The
NEW
Osram
VALVE
GUIDE
1937 - 1938

THE MOST COMPLETE
Pocket **REFERENCE**
YET COMPILED

This handy little guide will prove an invaluable aid to the radio listener and experimenter in all their valve problems. 68 Pages giving comprehensive and up-to-the-minute information on Osram Valves, and working circuits. Convenient size to fit the pocket. Ask your local Radio dealer for a copy to-day!

Numerous interesting features include:

- 26 pages of tabulated technical data including new "International Range."
- 16 pages of Typical Operating Circuits Comparative Types
- Base-pin connections in diagrammatic form.
- Complete Price List, etc.

Osram
Valves
MADE IN ENGLAND.

Write for your FREE copy without delay

Advt. of The General Electric Co., Ltd., Magnet House, Kingsway, London, W.C.2.

Programmes for Short-wave Listeners

By A. C. Weston

WHEN we have gone back to Greenwich Time short-wave listeners will begin to find the advantage of darker evenings for the slightly higher wavelength. American



W. C. Fields is back on the air through NBC RED network on Sunday evening.

stations can be picked up more easily and earlier in the evening. This does not mean to say that the very short-wave stations will deteriorate, but it must be remembered that coincident with the change in time the days draw in so that there is less daylight on the path on which these short-wave stations travel. All short-wave programmes coming from America will be more easily received from now on, while stations should be heard about two hours earlier than during the summer months.

During October the Pittsburg and Schenectady group of stations provide an unusually fine selection of programmes. So I am going to concentrate on these two groups. First comes the schedule for W2XAD and W2XAF. W2XAD, the General Electric station, operates on 19.56 metres from 4 p.m. to 1 a.m. daily. W2XAF on 31.48 metres is on the air from 9 p.m. to 5 a.m. On Friday the schedule is extended and W2XAF radiates from 4 p.m. to 5 a.m., while on Saturday there is also a slight variation, for W2XAF is on the air from 5 p.m. to 5 a.m. The following programmes are radiated from Schenectady on either W2XAD or W2XAF according to the time of day.

On Sundays, starting October 3, a number of the old favourite programmes are still being radiated, but one of the high spots is Henry Busse and his Orchestra, which is relayed from Chicago at 4.45 p.m. Thatcher Colt still unravels his mysteries at 7.30 p.m., while an entirely new listing is "Tapestry of Melodie," relayed from Cleveland at 8 p.m. Marion Talley is

Concentrate mainly on American stations for short-wave entertainment during October. The darker evenings coincide with a big improvement in reception conditions.

relayed from Hollywood at 10 p.m., while for the first week in October Jack Benny and Mary Livinston are being relayed from Hollywood at 11 p.m., while from the second week onwards, when both America and Europe revert to normal times, this programme will be heard at 12 midnight.

On Mondays, Happy Jack, relayed from Chicago at 5 p.m., is quite a good start for the day's short-wave listening, while another similar programme is Joe White, the versatile tenor, relayed from New York at 6 p.m. Vic and Sade are on the air at 8.30 p.m., taken from the Chicago studio, while comedian Lorenzo Jones, has 15 minutes from 9 p.m. The American Travelogue series,



Lovely Larnardine Flynn can be heard through NBC BLUE network on Tuesday evenings.

in which listeners are taken on an imaginary aeroplane trip to places of interest, is still scheduled for 11.15 on Monday nights. Amos 'n' Andy continue at midnight, after which there is nothing very much of interest from the Schenectady group of stations. In any case, most listeners will by that time have gone to bed.

A brand-new programme is scheduled for October 5 and onwards, entitled "The Escorts and Betty." This comes from New York at 6 p.m. and is followed by "Words and Music" from Chicago at 6.15. The "Story of Mary Marlin" introduces Francis Carlon, who is one of the most popular of the N.B.C. dramatic actresses. She can be heard at 9.30 p.m. most weekday evenings. The Top Hatters, relayed from

Philadelphia, used to present a bright and cheerful programme, so listen to them on October 5 and most Tuesday's at 10.15 p.m. A regular broadcast Monday to Friday at midnight is Amos 'n' Andy, who are now being relayed from Hollywood. Their programme lasts for 15 minutes, which is sandwiched in between their film-making activities.

Wednesday, October 6, and most Wednesdays, brings "Hello Peggy!" at 4.45 p.m. from New York, "Words and Music" at 6.15 p.m., the Command Performance relayed from New York at 7 p.m., and a bright interlude, "Music for the Moment," at 7.45 p.m. Both W2XAD and W2XAF relay a dramatic playlet entitled "While the City Sleeps." This programme originates in Chicago. A programme that is very popular in America, so much so that it is relayed every evening from New York, is entitled "The Goldbergs." Make a special point of hearing these transmissions at 5.15 every weekday. For those who like wild-west thrillers, tune in to "Men of the West" at 7.45 most Thursdays through October. A totally different programme is "Lorenzo Jones Again," relayed from New York via both W2XAD and W2XAF. Zero hour is 9 p.m. October 7. Rudy Vallee's "Variety Hour" is on the air at 1 a.m. on Thursdays, and although it is rather late and a most inconvenient hour, it is well worth hearing. In fact Thursdays offer some very interesting programmes, such as "Show Boat," and Bing Crosby, who is relayed from Hollywood. Most of these programmes last one hour.

On October 8 a programme entitled "Show Time" comes from Philadelphia at 7 p.m. If this follows the pre-



Virginia Payne has made 1,000 radio appearances in Ma Perkins broadcasts via NBC BLUE network. (NBC photo).

G2AW PREMIER

G8FD G8BV

AT

SUPPLY STORES

IDE HILL RESEARCH STATION

This experienced technical staff is entirely at your service.

Manufacturers of

TRANSMITTERS, RECEIVERS, MODULATORS, AMPLIFIERS, COMPONENTS

POST ORDERS

Jubilee Works,
167, Lower
Clapton Rd.,
London, E.5.
Amherst 4723

CALLERS

5C, High Street,
Clapham, S.W.4
Macaulay 2381
165 & 165a
Fleet Street, E.C.4.
Central 2833.

PREMIER SHORT WAVE COILS



13-26,
22-47,
41-94,
76-170
metres.
1/9
each

Four or six-in fitting. On highest grade plastic material. Formers only, 1/- each.

Special Set of Three 4-pin Coils 12-120 metres, 4/-. Premier 3-band S.W. Coil, 11-25, 19-43, 38-86 metres. Simplifies S.W. receiver construction, suitable any type circuit, 2/6.

PREMIER HIGH-FIDELITY MODULATORS AND AMPLIFIERS

3-WATT A.C. 2-stage AMPLIFIER for Mike or Pick-up. Complete Kit of Parts with 3 valves, 40/-. Wired and tested, 55/-.
7-WATT A.C./D.C. 3-stage AMPLIFIER. High-Gain, Push-Pull output. Complete Kit of Parts with 5 matched valves, £4 4s. Wired and tested, £5 5s.
10-WATT A.C. 3-stage AMPLIFIER incorporating Phase-Inversion and Push-Pull Triodes. Enormous gain and straight line reproduction. Complete Kit of Parts, including 5 matched valves, £5 5s. Wired and tested, £7 7s.
30-WATT MODULATOR or AMPLIFIER for A.C. mains, inverse feed-back, beam power, push-pull output. Completely wired and tested, £12 12s. Write for details of our new A.C.-D.C. portable Amplifier.



PREMIER MAINS TRANSFORMERS.

of which we are the actual manufacturers, are known throughout the Radio world as fine, reliable instruments. They are extensively used and recommended by all the leading Radio Technical Journals.

SCREENED PRIMARY WIRE-END TYPE

250 + 250 or 300 + 300 v. 60 m.a. 4v. 1-2a., 4v. 2-3a., 4v. 4v. 3-4a., all C.T.

H.T. 8 & 9. 4v. 1a., 4v. 4a. all C.T. ... each 10/-
350 + 350 v. 120 m.a. 4v. 1-2a., 4v. 2-3a. 4v. 3-4a., all C.T. ... each 13/-
500 + 500 v. 150 m.a. 4v. 2-3a., 4v. 2-3a., 4v. 2-3a., 4v. 2-3a., 4v. 2-3a., all C.T. each 21/-
Terminal Types, as illustrated 1/6 extra.

500 + 500 v. 150 m.a., 15/-.
1,000 + 1,000 v. 250 m.a., 21/-.
1,500 + 1,500 v. 200 m.a., 50/-.
350 + 350 v. 150 m.a., 5v. 2a, 6.3v. 2a, 6.3v. 2a, 13/6.
100-watt auto-transformers. 100-110v. to 200-240v. terminal type, 10/-.
60-watt, 7/6.

Premier new 1938 enlarged Illustrated Catalogue is now ready. Price 6d.

Over 90 pages describing and illustrating every item required for transmitting or receiving, together with transmitting and receiving valve data, original circuits of transmitters, receivers and modulators. Technical articles describing modulation methods, crystal control and master oscillator control, ultra high-frequency transmitters. C.W. and phone receivers for 5 metres. Single Wire fed multi-band aeriels. D.C. test set, etc., etc.
Premier 1938 Radio Catalogue now ready. Price 6d.

THE NEW "PREMIER" SHORT WAVE CONDENSERS

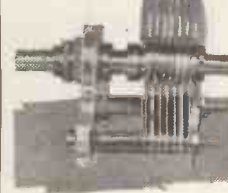

with Trolital Insulation. Certified superior to Ceramic. All-brass Construction, 25-40 mmfd., 1/7; 100 mmfd., 1/10; 160 mmfd., 250 mmfd., 2/6.
Double-spaced 15 mmfd., 2/9; 40 mmfd., 3/6.

AMERICAN VALVES

We hold the largest stocks of U.S.A. tubes in this country and are sole British Distributors for TRIAD High-Grade American Valves. All Conceivable types in stock. Standard types, 5/6 each. All the new Metal-Glass Octal Base tubes at 6/6 each, 210 and 250, 8/6 each. 4-, 5-, 6- and 7-pin U.S.A. chassis mounting valveholders, 6d. each Octal Bases 9d. each.



EUROPA MAINS VALVES

Famous Europa 4 v. A.C. types, H.L., L., S.G., Var.-Mu-S.G., H.F.-Pens., Var.-Mu-H.F. Pens. 1 and 4-watt A.C. directly-heated-output Pentodes. Full-wave rectifiers, 250 v. 60 m.a. A.C./D.C. types. 20-volt .18 amp. S.G., Var.-Mu-S.G., Power, and Pentode. All 4/6 each.

Following Types. Full-wave rectifiers, 350 v. 120 m.a. and 500 v. 120 m.a. 2 1/2 watt indirectly heated Pentodes. Frequency Changers (Octode), Double Diode Triodes, all 5/6 each.
2 1/2 watt Directly Heated Triodes, 6/6 each.

BATTERY VALVES. 2 volts, H.F., L.F., 2/3. Power Super-Power, 2/9. S.G. Var.-Mu-S.G., 4- or 5-pin Pentodes, H.F. Pens., Var.-Mu-H.F. Pens., 5/-. Class B, 5/-.
TAYLOR TUBES. T.20, 17/6. T.55, 45/-. T.56, 27/6. 825, 27/6. 203B, 43/-. 841A, 40/-. 866JR, 7/6. 866, 11/6. 866B, 17/6.

R.C.A. TUBES. 800, 65/-. 801, 29/-. 802 (=RK25), 25/6

MOVING IRON METERS

Any range between 10 and 500 m.A. Also 1.9 or 5 amps. Read A.C. or D.C. [Flush Bakelite case. 2 1/2 in. diam. B.E.S.A. standard specification 89. 5/9 each.



MOVING COIL METERS

0.1 m/A. 100 ohms resistance. Diameter 2 1/2 in., 18/6. Larger model, diameter 3 1/2 in. 22/6. Flush mounting. Bakelite cases B.E.S.A. first-grade accuracy. Multipliers for above, 1/- each.
Tapped M.A. shunts for above M.C. meters. Will read 10 m.a., 50 m.a., 100 m.a., and 200 m.a., 4/- each.
Telsen Multi-Meters, 0-30 m.a., 0-300 m.a., 0-8 v., 0-16 v., 0-250 v. A.C. or D.C., 8/6 each.



OVER 20,000 PREMIER SHORT-WAVE KITS

have now been sold! BECAUSE they are simple, efficient and amazing value. Each Kit is complete to the last screw.

NEW 1938 1-VALVE SHORT-WAVE RECEIVER OR ADAPTOR KIT, 13 to 86 metres without coil changing. Complete Kit and Circuit, 12/6. **VALVE GIVEN FREE!**
DE LUXE MODEL, 14 to 150 metres, complete Kit with Chassis, 4 Coils and all parts, 17/6.

1937 SUPERHET CONVERTER KIT, 13/6.

DE LUXE MODEL, 18/6.

S.W. SUPERHET CONVERTER, for A.C. Mains Receivers, 20/-. A.C. Valve given FREE!

NEW 1938 2-VALVE S.W. KIT, 13 to 86 metres without coil changing. Complete Kit and Circuit, 19/6. **VALVES GIVEN FREE.**

DE LUXE MODEL, 14 to 150 metres, complete Kit and Chassis, 4 Coils and all parts, 25/-. **VALVES GIVEN FREE.**

FREE. 3-VALVE S.W. KIT, S.G., Det. and Pen., 42/-. **VALVES GIVEN FREE!** Metal Cabinet 10/6 extra.

TRANSVERSE CURRENT MICROPHONE (Reisz Pattern)

High grade; large output unit, having an exceptionally fine frequency response with low Hiss Level. The Frequency Range being from 45 to 7,500 cycles, plus or minus 2DB.



Microphone ...	20/-
Transformer ...	5/-
Table Stand ...	7/6
N.P. Floor Stand ...	22/6
N.P. Portable Floor Stand. Folds into 17" ...	42/-
Premier Moving Coil Mike ...	15/-
U.S.A. Moving Coil Mike ...	£5 5s.
U.S.A. Crystal Mike ...	£3 17s. 6d.
U.S.A. Hand Mike ...	22/6

German :: Japanese :: N.B.C. Programmes

vious recipe it is going to be a very good programme indeed. One of the mainstays of this programme is Florence George, who is the vocalist to Lanny Ross and to Raymond Paige and his Orchestra. Barry McKinley has another 15 minutes from 11.15 p.m. on October 8. There is also Lucille Manners, who has 30 minutes to herself at 1 a.m. on the same day.

As usual, Saturday is one of the most lively of the week. First of all, from W2XAD can be heard the "Melody Men" at 4.45 p.m. At 5 p.m. there are the Continentals, while during the evening can be heard the Escorts and Betty, Your Host is Buffalo, Golden Melodies, Week-end Revue, Alma Kitchell, the well-known contralto, finishing with El Chico, a Spanish revue, at midnight. These notes give a fairly good idea as to the wealth of entertainment to be heard through the Schenectady group of stations through October.

Here are some more fine programmes sponsored by the National Broadcasting Company and broadcast through their international station, W3XAL, in Bound Brook. This station operates on 16.8 metres from 2 p.m. until 2 a.m. and on 49.1 metres from 2 a.m. until 6 a.m. for those who care to listen. On Sunday, October 17, I notice that they have the Green Brothers with their Novelty Orchestra, at 4.30 p.m. This programme is being transmitted to Europe via a special directional beam aerial. At 5.20 there is to be the Southernaires, a negro quartet. Gerry Belcher relates some of his interviews at 6.30 p.m., while Milton Cross introduces the Magic Key of R.C.A. at 7 p.m. There is to be a half-hour of romantic melodies at 9 p.m., while, in direct contrast, do not miss Fish Face and Figg's Bottle, at 9.30 p.m.

On Mondays through this station one of the most popular programmes is



Jane Rhodes is a veteran at 16 for she has been on the air since she was 7 years old. She can be heard over the NBC Red network.

Sweethearts of the Air at 3 p.m., but as this is rather early for most listeners, make a point of hearing Club Matinee at 9.15 p.m. This lasts for 45 minutes and includes Harry Kogen's Orchestra, Robert Gately, and has as supporting vocalists, The Cadet Quartet. The Southernaires have another 15 minutes at 10.45 p.m., while a most comprehensive international news bulletin winds up the day at 11.30 p.m.

For those who are able, tune in to the Breakfast Club at 2 p.m. each weekday. Bob Brown is Master of Ceremonies, while the old favourites, Annette King, contralto, and baritone Jack Baker, are in support. Three good programmes come in a run on October 19, starting at 4 p.m. There are the Honeymooners, Three Majors, followed by a snappy musical programme. At 5.15 Grace and Scotty have 15 minutes, while a new listing entirely is Jack Meakin in Springtime at 11 p.m.

On October 20 there is a special treat at 7.45 p.m. Peggy Wood has 15 minutes all to herself and is arranging a new type of musical programme.



One of the most popular NBC dramatic actresses is Frances Carlon who can be heard in the Story of Mary Marlin.

This is followed by Continental Varieties at 8.30 p.m., introducing for the first time, Celia Branz.

Harry Kogen's Dinner Music is very popular and he has now graduated to a 30-minute session starting at 11 p.m., October 20. The National Farm and Home Hour, which is on the air at 5.30 p.m. every weekday, has, on October 21, a special Guest Speaker from the American Post Office Department, who will give some information on the Police Department which is incorporated in the Post Office service. In America anybody who demands money or tries to do any swindling and writes letters about it can be put in prison for using the Federal Mails for the purpose of fraud. How this all works out is going to be told in this programme.

At 8.45 on October 21 a programme

entitled Swing Serenade is listed, followed by Jackie Heller, who has recently broadcast in the Five Hours' Back programme, at 9.15 p.m. Baritone Stuart Gracey, makes his debut at 10.15 on this day, followed by the Kings Men



Florence George is star vocalist in Raymond Paige's orchestra.

Quartet at 10.45, and some more of Harry Kogen's Dinner Music at 11 p.m.

A new type of musical programme is scheduled for 7.15 p.m. on Saturday, October 23, while also on that day can be heard Club Matinee at 9.15, the Little Variety Show, at 10.15, and Nickelodean at 11 p.m. This is an orchestral programme with a host of guest artists.

At the present time, as reception conditions have so greatly improved, make a point of fully testing the scope of your short or all-wave receiver. Programmes from Tokyo on its 19-metre channel are being consistently received in this country, and although they are hardly of entertainment value, they represent a distinct novelty and for those who have not heard the Japanese idea of entertainment now is a good chance to find out.

Programmes from Tokyo are receivable at great strength owing to the fact that special aerials are being used to concentrate the signal into Europe. Actually, I believe, the focal point is Berlin, and as we are in the same direction, obtain the full benefit of this. All Zeesen stations have now increased their power and can be heard almost 24 hours a day. The best programmes, as far as we in this country are concerned, can be received during the latter part of the evening when the station is used with an aerial beamed on New York and programmes are picked so that they are acceptable to the American listeners.

War news, by that I mean the Spanish war and not the Japanese one, can still be heard from Teneriffe and Valencia, both on 40 metres.

New Valves for Television and Radio Constructors

WHILE it is possible to obtain results from a short-wave receiver using ordinary valves, gain can be greatly increased when the inter-electrode capacities are reduced to a minimum with a corresponding high mutual conductance.

Some new valves introduced this season for radio and television constructors have extremely fine constants so that the gain per stage can be greatly increased by their use.

For radio and video frequency stages there is an AC-SP₃ which is a high slope screened pentode. With an anode voltage of 250 and a screen voltage of 100 the slope is no less than 10 ma/V. which enables a higher gain to be obtained than with the normal type of valve. The grid/anode capacity is .005 mmfd. while the valve is priced at 15s.

A New Diode

Most double diodes have too high a self capacity for use in vision frequency amplifiers. A special diode type D₁ has been introduced by Mazda which has been designed to have a low-minimum capacity by bringing out the electrode connections to short pins sealed directly into the glass.

Connections are made by hanging the valve directly in the wiring of the receiver. As with most midget type of valves connections to the D₁ diode should not be soldered, but made by crocodile clips.

A new thyratron filled with mercury vapour instead of gas has been designated the T₁₁. This valve can withstand a much heavier peak current than the well-known T₃₁ which is to be preferred in conventional scanning circuits.

A British valve having characteristics similar to the American 6L6 has also been introduced by Mazda. This valve, the AC₄/PEN, is intended for use in broadcast receivers where a high audio output is required. The valve is a tetrode in which the secondary emission from the anode is suppressed by the space charge of the anode current. The absence of a suppressor grid enables the valve to be used more efficiently and with decreased harmonic distortion. The characteristics of this valve are approximately as follows:—

Heater volts, 4.0
Heater current, 1.75
Anode volts (max), 250
Screen volts (max), 250
Dissipation (max), 16 watts
Mutual conductance, 11

The AC₄/PEN will give an audio output of 8 watts and requires a bias resistor of 100-ohms. The anode load for this output is 3400-ohms, while the

total cathode current is 77 M/a with a grid drive of 4.3 volts.

A very similar valve for AC or DC operation is the PEN.DD402₁ which also includes a double-diode section. Constructors of short-wave receivers will welcome the introduction of the Mazda AC/TH₁, a triode-hexode frequency changer having a conversion conductance of 870. Owing to the



Particularly robust construction is employed in the Mazda beam power tetrode type AC₄/PEN.

special design of this valve it is suitable for use on ultra-short waves.

A special triode for scanning circuits has been called the AC/P₄. This valve has a slope of 7 M/V with an anode voltage of 600. It is fitted with a top cap connection to which the anode is taken and needs a bias resistor of 11,000-ohms.

Owing to the demand for output valves giving a high speech output with low voltage the Tungstram Electric Lamp Works have designed two new pentode valves that give an output in excess of 5 speech watts.

The APP₄E with 250 volts on both anode and screen and an optimum load of 3,500-ohms give 5 watts with 5 per cent. harmonic distortion. The output can be increased to 8.8 watts with 10 per cent. distortion. In such circumstances the total cathode current is 80M/a. These valves can be used in push-pull circuits and with a 400 volt supply and an optimum load of 6,500-ohms the output with 5 per cent. distortion is 28.5 watts.

A variation of this valve is the PP6E which has almost identical characteristics but is fitted with 6.3 volt heater. Under class A conditions the maximum

output is 8.8 watts, while two valves in push pull with 300 volts will give 19.5 watts.

Cossor have designed a complete new range of output petrodes. These new valves have the normal characteristics of conventional pentodes so that they are interchangeable, but due to a lower grid anode-capacity and lower impedance, attenuation of the higher frequencies is reduced, while bass resonance is not so noticeable. The result of using these tetrodes is greatly improved quality and in many instances greater output.

The battery tetrode type 220.OT priced at 11s. has a 2-volt.2-amp. heater and requires a maximum of 150 volts on both anode and screen.

A mains version type 42.OT with a 4-volt 2-amp. heater is priced at 13s. 6d. and this valve has a slope of 7 ma/V and requires 250 volts on both anode and screen. In the DC.AC. range there is the 402.OT with a 40-volt 2-amp. heater, but otherwise characteristic similar to that of the 42.OT.

Transmitting amateurs will appreciate the following data on a new pair of beam power type tetrodes suitable for oscillator, doubler and amplifier positions in a transmitter. The anode lead is brought out to a separate seal at the top of the bulb to reduce inter-electrode capacities, while the bases are of isolantite.

These valves, the RK₃₉ and RK₄₁, are almost identical in characteristics except that the RK₄₁ has a 2.5 volt heater and the RK₃₉ a 6.3 volt heater. They can be operated at full voltage of 500 up to 30 megacycles and at lower voltages up to 60 megacycles. Cathode bias is recommended to protect the valve in the case of excitation failure and a resistance of 400 or 500 ohms will be satisfactory.

When used with a crystal oscillator a 400-ohm cathode resistor and 10,000-ohm grid leak are required. At lower frequencies it may be necessary to introduce slight external capacity in order to start oscillation, but this capacity should not exceed 2-mmfd.

The following are typical operation figures:—

Maximum anode voltage, 500
Maximum screen voltage, 250
Control grid voltage, 60
Anode current, 95 M/a
Screen current, 12 M/a
Grid current, 3 M/a
Maximum R-F input, 84 volts
Grid driving power, .26 watts
Carrier output, 35 watts.

These valves are available from Messrs. Webbs' Radio, Ltd., 14 Soho Street, W. 1.



The New ALL-WAVE LINACORE

DESIGNED by J. B. Engineers after many months research, the ALL-WAVE version of the famous LINACORE TUNER will be welcomed by every 1938 Constructor. Every device known to modern radio has been developed and incorporated to produce a unit of the simplest form, yet which guarantees the best possible results.

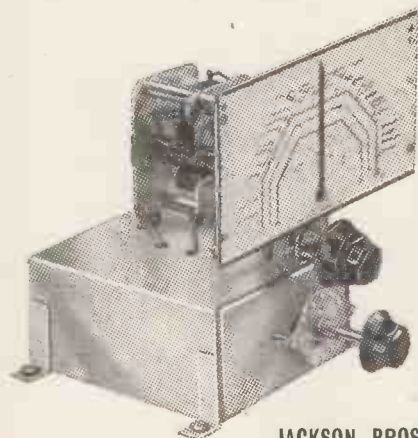

Covers, 16.5-51, 200-550, 800-2,000 metres. Ensures accurate tuning, reduction of noise, whistle and man-made static. Automatic volume control eliminates fading. Amazing quality of world-wide reception of an entirely new order. Complete with gang condenser, switches and coils, each unit is accurately aligned before dispatch.

A.C. mains model Type AW 55/-
Battery model ready shortly.

● "All-Wave Vivid Radio" (Price 3d.) describes, with full size wiring plan, a new All-Wave 7-stage A.C. circuit incorporating the new "Linacore." This is destined to be THE Constructors' Set of the Season. Write:

JACKSON BROS. (LONDON) LTD., 72, St. Thomas Street, London, S.E.1. Telephone: Hop 1837

HIVAC THE SCIENTIFIC VALVE

BRITISH MADE

THE SIGN OF A GOOD VALVE

MONTH AFTER MONTH, and for many months at that, HIVAC have consistently informed readers of this journal of their valve developments—have given details of HIVAC valves specified for apparatus described by "Television and Short-wave World"—have featured the "Midget" and Special HIVAC range for Short-wave work; AND NOW they offer readers

THE 1938 HIVAC REPLACEMENT CHART which gives details of their complete range.

MAY WE SEND YOU A COPY?
Please mark your request (Dept. "T.S.") and post it to:—

HIGH VACUUM VALVE CO., LTD.
111-117 Farringdon Road, London, E.C.1

'AVO' Accurate Testing Instruments BRITISH MADE

Only precision instruments enable you to test accurately and trace radio faults efficiently. "AVO" instruments are outstanding for precision. They are the outcome of a constant effort to provide amateur enthusiasts and radio engineers with instruments of high accuracy and maximum utility at a moderate cost.



THE D.C. AVOMINOR

This accurate moving-coil instrument is 13 metres in one. It has 13 ranges: voltage ranges for measuring H.T., L.T., Grid Bias, Mains and Eliminator Voltages; Milliamp ranges for testing receiving valves and apparatus; Resistance ranges for all resistances measuring. In case, complete with testing prods, crocodile clips, leads and instruction booklet. **45/-**



UNIVERSAL AVOMINOR

This compact precision moving-coil instrument provides facilities for all A.C. and D.C. testing. It has 22 ranges covering A.C. volts, D.C. volts, current, and resistance. All readings are direct. Total resistance of meter, 200,000 ohms, ensuring accurate readings. Complete with testing prods, crocodile clips and instruction booklet. **£5.10s.** Leather Case, 10/-.



THE AVODAPTER

Simplifies valve testing. Enables all valves to be tested under actual working conditions without need for cutting connections and groping about inside the set. Instantly adaptable for 4-pin, 5-pin and 7-pin valves. Price **27/-**

9-PIN AVO-COUPLER

Attachment (not illustrated) renders AvoDapter suitable for 9-pin valves **12/6**

Deferred Terms if desired.

Write for illustrated literature giving full details of all "Avo" Testing Instruments

AUTOMATIC COIL WINDER & ELECTRICAL EQUIPMENT CO., LTD.

Winder House, Douglas St., London, S.W.1. Telephone: Victoria 3404/7.

New Edition! RADIO SERVICING SIMPLIFIED

A new and considerably enlarged edition of this popular text book is now ready. It has been entirely re-written to conform with modern requirements and in the light of present-day standards of knowledge. It takes the reader by easy stages through the whole routine of testing modern radio receivers, and describes in a clear and interesting manner every test, and much other useful information of value to the radio enthusiast. 150 pages, 8½ in. x 5½ in. Numerous illustrations, diagrams and graphs.

2/6 Post Free 2/10

Triodes and Pentodes for Transmitting

Short-wave enthusiasts were quick to realise the advantages of the new valves introduced by the General Electric Co., Ltd. Of these the PT5 transmitting pentode and the DET12 triode are of particular use to amateurs. The PT5 is a directly heated pentode that can be used as an oscillator, a radio-frequency amplifier or doubler. It is arranged with the anode to the top cap



Notice the new Octal base with 8 pins and a locating key on this new Marconi W63 pentode which is the equivalent of the American 6 K7G.

and has the conventional 5-pin base. Characteristics are approximately as follows:

- Filament volts, 4.0.
- Filament current, 1.7 amp.
- Anode volts, 1,250 max.
- Screen volts, 300 max.
- Anode current, 32 mA.
- Screen current, 6 mA.
- Anode Dissipation, 40 watts max.
- Screen dissipation, 10 watts max.
- Mutual conductance, 4.0 mA./volt.

As can be seen from these characteristics, the valve is ideal for use in the average amateur transmitting circuits, and can give, under suitable conditions, a very high radio-frequency output. The inter-electrode capacities are approximately as follows:

- Anode-grid, 0.03 mmfd. approx.
- Anode to others, 15.2 mmfd. approx.
- Grid to others, 24.5 mmfd. approx. (measured with external shield).

The price of this valve is £8 5s. od., which, without consideration, may ap-

pear to be a trifle high, but when one considers the low cost of the modulator, the small amount of drive required, and the fact that it is suitable for multi-band operation with the minimum number of stages, it is good value for money.

A New Triode

Another new Osram valve is the DET12 triode which is a carbon-anode type with anode and grid brought out to top connections. It has a standard 4-pin base and with 120 watts input will give between 75 and 80 watts of carrier. It is rated at 50 watts and will operate down to 1 metre. Characteristics are as follows:

- Filaments volts, 7.5.
- Filament current, 3.15 amps.
- Anode volts, 1,250 max. down to 3 metres.
- 1,125 max. down to 2 metres.
- 1,000 max. down to 1½ metres.
- 750 max. down to 1 metre.
- Anode dissipation, 50 watts max.
- Amplification factor, 10.3.
- Impedance, 5,400 ohms.
- Mutual Conductance, 1.9 mA./volt.

A neutralising condenser of approximately 4 mmfd. is required, while the inter-electrode capacities are approximately as follows:

- Anode-filament, 0.8 mmfd. approx.
- Grid-filament, 2.4 mmfd. approx.
- Anode-grid, 2.6 mmfd. approx.

The price of this valve is £6 13s. 6d. Constructors interested in ultra-high frequency work will appreciate the new ZA1 low-capacity Acorn pentode with indirectly heated cathode. It is designed for operation from 4-volt A.C.

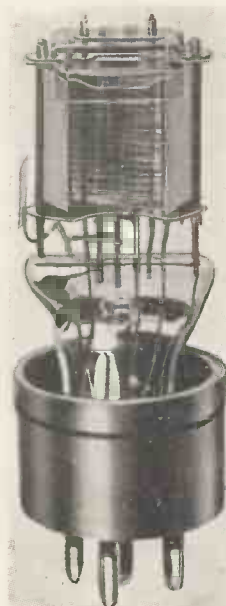

Marconi have introduced a new range of output tetrodes. This is one of the 2-volt battery operated type.

or D.C. supply, consuming approximately .25 ampere. It will handle a maximum anode voltage of 250, maximum screen voltage of 100, and has a slope of 1.4 mA./volt. The anode to grid capacity is approximately .001-mmfd. The price of this valve is £3.

In the Marconiphone range there are a number of new valves of particular interest. Amongst the most outstanding are the X22 battery operated heptode, which is suitable for use down to 12 metres, a W21 battery operated pentode, the KT21 output tetrode, and a KT42 output tetrode for A.C. operation. In the International range is a new tuning indicator type Y63 and a heptode type X64 in which pulling between oscillator and signal circuits is negligible. A special frequency



On the left is the new PT5 transmitting pentode suitable for amateur use. On the right is a triode valve with carbon anode and very low inter-electrode capacity. The type number is DET12.

changer for use down to 15 metres is the new X63, while a large output tetrode is the KT66. This valve, with 250 volts on both anode and screen, will give 8 watts of audio, or two valves in Class AB will give 35 watts of audio with 400 volts on the anodes.

For transmitting amateurs there is the 25-watt pentode type DET8, which is suitable for suppressor grid modulation and can be used down to 15 metres. The maximum anode voltage is 400, while a 4-volt 2-amp heater is employed.

In Tungfram valves they use no less than 60 different materials plus seven different gases, and 35 other elements which enter into the manufacture. These interesting details were noted while we were examining their new frequency changer type TX4. This valve will handle a maximum anode voltage of 300, has a 4-volt 1-amp heater and is suitable for use as a frequency changer on short waves, and is, of course, of the triode-hexode type.

An Effective 5-metre Installation

By G6IH, L. H. Mansell

THE present state of this station is the result of sixteen months' work, building, testing, modifying and re-making. During this period many different aerial systems have been erected and used, some five transmitters and four or five receivers constructed and worked.

Only during the last month has some sort of order, and degree of finality been reached, and it is hoped to do some interesting work in the near future.

The site is on the lower slopes of the Malvern hills, 270 feet above sea level, and on ground that slopes gradually away to the North and East.

A good deal of hope is centred in the two directional aerial arrays carried on the new mast, which is rather out of the ordinary for an amateur station, and probably merits a full description.

It was erected on the spot, which is a rather small back garden, and is all steel for the first twenty feet, and timber for the other forty-two feet, the full constructional height, neglecting the odd two feet of foundation. The base is seven feet six inches square and it tapers to one foot square at the top.

The arms carrying the main aerial, a three section Franklin, are each six feet average length from the tower, and the four smaller arms carrying the half wave di-pole and reflector are four feet six inches. The latter aerial is fed by transformer and co-axial line, and the Franklin array by a non-resonant feeder impedance matched to the aerial, and coupled to the transmitter with a trap circuit for harmonic suppression.

Aerials and reflectors are of half-inch diameter copper tube, and the feeders and quarter-wave phasing arms for the Franklin of 12 gauge copper wire.

All guys are cut into non-resonant lengths, and are also spaced to be out of the direct field of the aerials.

The transmitter is four valve five stage crystal controlled, using a seven megacycle crystal, and has now been tamed so that it warms up and comes on frequency like a broadcast super-het receiver, no

feeding the microphone, microphone to pre-amplifier, latter to main amplifier, main amplifier to modulation transformer in transmitter, and all circuits in connection with the pre-amplifier, which is the most important point for



This is the operating room of G6IH, showing the equipment in use.

difficulty being found in lining the various doublers on their circuit meters or from the direct drive condensers.

The two great difficulties which had to be overcome, were first, to get the final doubler, with its grid on 28 megacycles and plate on 56, to double and feed enough to the final amplifier.

The second snag was to keep H.F. out of the modulator, and finally it has been found necessary to run all wiring in lead sheathed wire, and bond them all together at several points to earth; this has been done to the battery circuit

H.F. pick up, the lead sheathing is even soldered to the tinned iron pre-amplifier case where it enters.

In common with other experimenters on this band, I found the extreme importance of avoiding the smallest source of loss. Tank circuits are arranged with only enough capacity to bring the circuit to resonance. The final tank circuit is of 10 gauge wire and no less than seven full turns $1\frac{1}{2}$ in. diameter spaced four in. long, centre tapped, and fed with the usual H.F. choke soldered

(Continued on page 639)

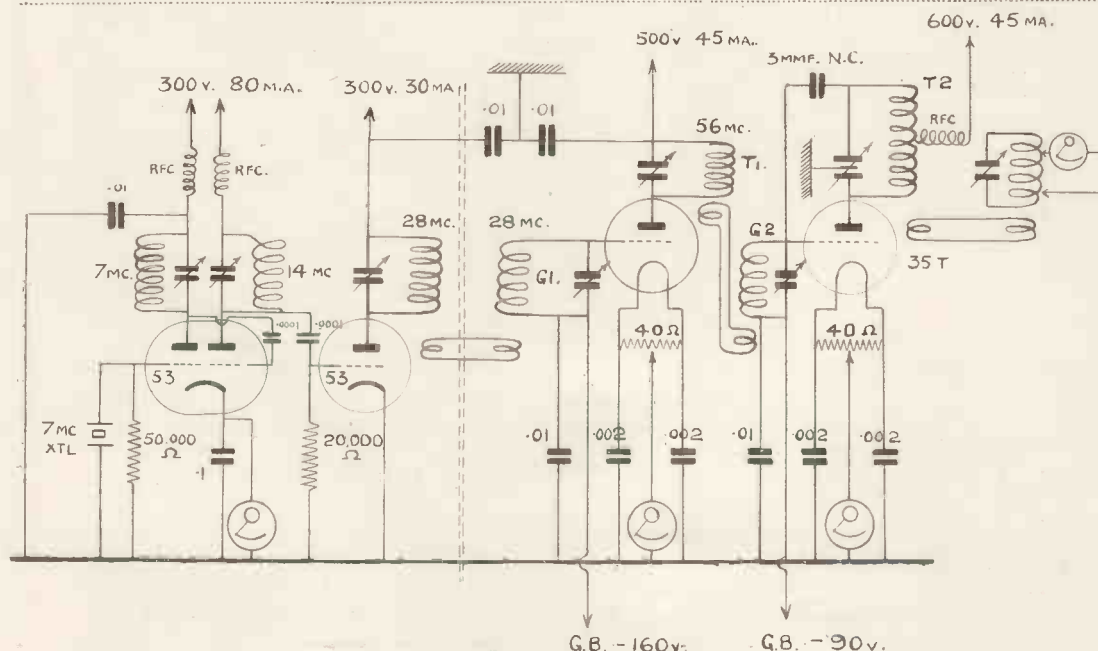

All by-pass condensers are of the mica type. Coil G1 is 9 turns, G2, 6 turns, both 14 gauge and $\frac{3}{4}$ in. diameter. T1 is 5 turns 12 gauge and 1 in. diameter, while T2 is 7 turns 10 gauge $1\frac{1}{2}$ in. diameter and centre tapped.

MERVYN

Have in stock parts for the Television Receiver described in this issue.

THEY ARE SPECIFIED

for the

RECEIVER CHASSIS

in aluminium complete with nuts and bolts ready bent to shape and drilled

Price 45/- POST FREE.

AERIAL and H.F. ANODE COILS
wound on threaded formers ready for wiring.

Set of four. Price 2/3

I.F. ANODE COILS
Set of four. Price 3/-

OSCILLATOR COILS.
Set of two. Price 1/-

Post extra on coils 3d.

Obtainable from the Television Specialists.

THE MERVYN SOUND & VISION CO. LTD.,
4, HOLBORN PLACE, W.C.I.

TELEPHONE HOLBORN 7709.

100% RELIABLE - IF IT'S ELECTRIC SOLDERING

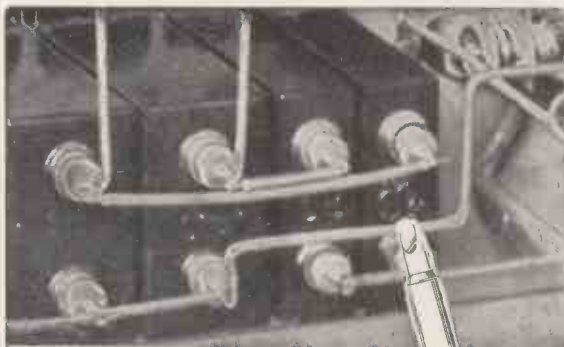

Every contact a neat, simple and lasting job—that's what Solon electric soldering gives you. Maintains constant heat where you want it—element clamped within the bit concentrates all heat at point.

8/6
DOMESTIC
MODEL
65 watts

Sold with Instruction Book
Resin-cored Solder, 6 ft. Flex
and Standard Lamp Adaptor.



W. T. Henley's Telegraph Works Co. Ltd. (Dept. Y4/78a/V.),
Holborn Viaduct, London, E.C.1.

STABILOVOLT

THE SOLUTION
TO UNSTABLE
SUPPLY VOLTAGE

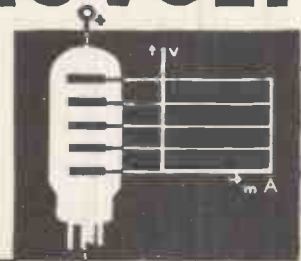

S2b

The Stabilovolt tube is a voltage dividing potentiometer and voltage regulator. The voltages tapped are independent to a precision of about .1% from the supply voltage variations, 1-2% from the varying current intensities tapped, .01% from one another. Currents up to 200 mA, voltages of unlimited values subdivided into parts of 70 volts each. Light in weight, small in size, simple and safe in operation.

Prices: Stabilovolt tubes from £1. 16. 0 to £62. Iron Barretters, for use with above, from 16s. to £1. 7. 6. Full particulars from:—

MARCONI'S
WIRELESS TELEGRAPH CO. LTD.
Electra House,
Victoria Embankment, W.C.2



NATIONAL CRM CATHODE RAY OSCILLOSCOPE.—Complete with 913 Cathode Ray tube and built-in 220/230-volt A.C. input power supply. £5 : 9 : 0

NATIONAL NCI01X.—The finest value in communication receivers. Crystal filter, 12 metal valves, 10-in. speaker chassis, 220/230-volt built-in power supply. £37 : 10 : 0

We are authorised National Distributors, but we can supply all types of communication type receivers.

TRANSMITTING VALVES.—Raytheon RK20, 90/- ; RK23 and RK25, 27/6 ; Taylor T55, 45/- ; Taylor 866, 11/6 ; Eimac 35T, 50/- ; Amperex HF 100, 57/-.

RECEIVING VALVES.—Raytheon or Sylvania types only. All types stocked at competitive prices.

VALVE-HOLDERS.—Ceramic-U.S.A. 4, 5, 6 or 7-pin, 1/- each. National Isolantite, baseboard or chassis mounting in 4, 5, 6, 7-pin, Octal, 2/- each.

NATIONAL TRANSMITTING CONDENSERS.
TMS100—1,000 volts peak working, 8/6 ; TMS100D Split Stator, 15/- ; TMC50—3,000 volts peak, 14/- ; TMC100, 15/- ; TMC100D Split Stator, 26/6.

BIRNBACH "FEED THRU" INSULATORS.—White porcelain, 1/3 each.

Send 2d. in stamps for a copy of our full American lists, including a copy of the New National Catalogue No. 270.

Ready early October

THE QUARTZ CRYSTAL CO., LTD.
(G2NH & G5MA)

63 & 71 KINGSTON ROAD, NEW MALDEN
SURREY Telephone: Malden 0334

The Amateur and Broadcast Interference

THE relations of the phone man with neighbouring b.c.l.'s are none too cordial, particularly on the 160 and 80 metre phone bands. The phone transmitter has a greater capability for interference and is more easily traced. It cannot be cured by the application of a simple filter to the transmitter; each affected receiver must be treated in a different manner.

The situation is naturally aggravated by widespread use of cheap receivers of an unselective type. But even the more

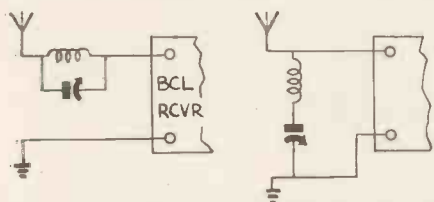

Figs. 1 and 2.—The two most simple wavetraps used to prevent B.C.L. interference.

expensive receivers are not all immune, usually because of some oversight of the designer. Some of these reasons are: no preselection (to produce a cheaper receiver), overload of valves with accompanying cross talk, insufficient oscillator shielding in superheterodynes, etc.

Interference can be grouped roughly into two classes. First is that encountered with a tuned R.F. receiver in all of its various forms (particularly the cheap receiver) and receivers having an overloaded tuned R.F. stage. Usual symptoms are spreading of the signal over the high-frequency end of the dial on the broadcast receiver.

The obvious answer is more tuning ahead of the receiver which means a wave trap. The unit that pops into almost everyone's head when a wave-trap is mentioned is the circuit shown in Fig. 1: a tuned circuit in parallel resonance, which is tuned to the interfering signal and offers a high impedance in the antenna circuit to the interfering signal. This is satisfactory in

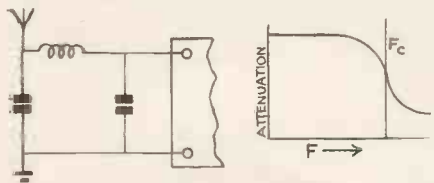

Figs. 3 and 4.—On the left is a typical low-pass filter which has an attenuation curve as shown on the right.

some cases and does tend to reduce interference of the type mentioned, but there is another form requiring no more apparatus which is of more value.

By courtesy of "Radio" we publish this interesting article on interference to broadcast listeners, a topic which is of international interest.

This circuit is shown in Fig. 2 and consists of a series-tuned circuit connected across aerial and earth of the receiver. This acts as a short circuit (approximately) across the aerial and earth at the frequency to which it is tuned. This is of advantage since the first coils in the receiver and associated leads may have sufficient pickup in a strong field to pick up a signal without the antenna connected.

A quick check can be made on all receivers to see whether or not additional tuning will be effective by shorting the aerial and earth connections to the troubled receiver. If the interference still persists, the trouble probably cannot be eliminated by any form of preselection and further investigation will have to be made.

Super-het Troubles

The second class of interference encountered is that which troubles superheterodynes. It occurs when there is not sufficient preselection ahead of the first detector, or when the oscillator circuit is not well enough shielded and isolated (allowing some signal to get into it). The symptoms are repeat

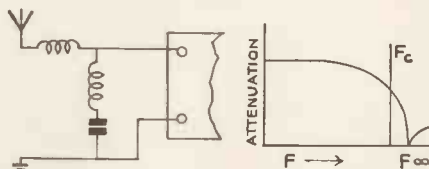

Figs. 5 and 6.—A more effective low-pass filter is shown on the left, which has a cut-off characteristic as shown by the curve on the right.

points at various spots on the dial, from one to a dozen or more, where the interfering amateur station can be heard. The amateur usually "repeats" right on the irate b.c.l.'s favourite station, or at least so it usually seems.

The Effect of Harmonics

The situation is aggravated and complicated by the fact that the oscillator has harmonics and the transmitter has harmonics and the receiver has image response. This can easily lead to a large number of repeat points.

This is the logical place for the insertion of the low pass filter, Fig. 3. It will remove the harmonics, or at least reduce them, since it has an attenuation

curve as shown in Fig. 4. The wavetrap will not prove satisfactory in cases of this type since the harmonics of the transmitter and of the receiver oscillator will not be eliminated.

There is one trouble with the low-pass filter, and that is the way in which the attenuation curve makes its leisurely way toward cutting off the interference. On 160 metres, particularly, if the low-pass filter is designed well to eliminate the signal, the high-frequency end of the broadcast band

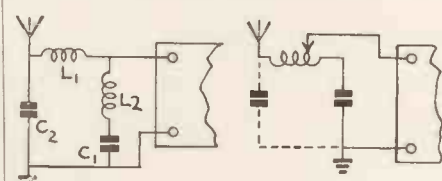

Figs. 7 and 8.—The circuit on the left is most effective when harmonics are unusually strong. A more flexible arrangement is shown on the right.

will be rather weak on the b.c.l. receiver, and while this may be tolerated in some cases, it is not the best solution.

The answer is the use of the "M derived" type of low pass filter, or sharp cut off filter. The circuit is shown in Fig. 5. This has a cut off characteristic as shown in Fig. 6. This filter is more effective in use and just as cheap to construct, as will be shown later.

A Selective Circuit

In cases where the harmonics are strong, the circuit of Fig. 5 may not be entirely effective and the circuit of Fig. 7 can be employed by merely adding one condenser. This will more effectively attenuate the higher-frequency harmonics since it is a combination of low-pass filter and a sharp cut-off low pass filter. Also note that L_2C_1 tune to the transmitter frequency, giving the same action as the circuit in Fig. 2. This makes Fig. 7 the best type

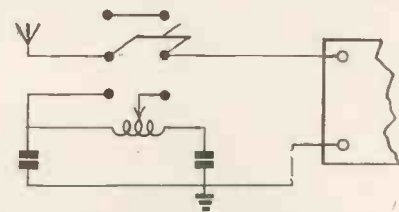

Fig. 9.—As the traps may be detrimental to broadcast reception it is a good plan to embody a switch as shown in this circuit.

of tuning unit for all types of interference.

This may look like rather a com-

plicated circuit, but a cheap form can be made easily from inexpensive components. To make this plainer the circuits of Figs. 5 and 7 are shown redrawn in Fig. 8. The coils of L_1 and L_2 have been combined into one coil with a tap or a variable tap. C_2 , if used, can be about 250 uufd. and C_1 a compression type mica condenser, so doing away entirely with expensive air condensers.

However, by using a coil with a slider, fixed mica condensers can be used in both applications, and the cost may be kept very low by using for L_1 and L_2 one of the so-called "aerial eliminators" which is nothing but a coil with a slider on it. They can be obtained from most radio dealers.

By the use of two 250 uufd. condensers and one of these coils it is possible to build these units in a compact form; the case can be taken off the unit and the wiring changes made and the two condensers mounted inside. There is then just one adjustment, the slider, and once adjusted it need not be touched, since changes of frequency within the same band with the transmitter usually require no change in adjustment of the gadget. The cost is low and the outfit is small and can be hidden inside the receiver cabinet and forgotten.

Just one disadvantage is presented by these units. The reception on short-waves will be impaired by their use. Therefore, if the owner insists on short-wave reception he must either be shown how to disconnect it, or a switch arranged to do so when desired. A small double pole, double throw switch is suitable for this disconnection and a circuit is shown in Fig. 9.

Complete Screening

To carry on to some other troubles, particularly when shorting the antenna and ground will not eliminate the interference: If there is a coil mounted beneath the chassis—particularly the oscillator coil—with no other shielding, and the receiver is in a strong field, the aerial tuning may be futile or a tuned R.F. stage on the receiver itself may do no good. The reason is that many chassis pans are built without bottoms and the solution is to supply one. Galvanized iron sheets (roofing) are cheapest and can be cut to size and slipped under the chassis and usually will produce the desired effect, although it may be necessary to readjust the oscillators circuit due to the tuning effect of the additional shielding in close proximity to the coil.

Another point that should not be overlooked, especially if the amateur has a surprisingly large number of complaints, is re-radiation and shock excitation. This used to be a common form in the old spark days, but seems to have been forgotten lately.

It is possible for guy wires and lighting and telephone circuits to become tuned to or near the transmitting frequency and re-radiate, even at a dis-

tance from the transmitter. Sometimes this makes itself evident by readily observable effects, such as lighting electric bulbs in houses when the switch is turned off, talking in the telephone, and many other phenomena which are individual and freakish. These can be cured by detuning or grounding the circuit by means of a mica condenser. If the field is intense and the transmitter powerful enough, sometimes a hunt with a neon bulb will show R.F. in surprising places. If exploring a lighting or other high voltage circuit an insulating fixed condenser should be used in series with the neon bulb.

It also might be well to use a line filter on the transmitter. This, in its

simplest form, is a couple of fairly large condensers (.01 mfd. or larger) connected in series across the line with the midpoint grounded. Mica condensers will usually be more effective than larger paper ones, and in some cases chokes will be needed, in addition, to afford better isolation. These should be wound of rather large wire, depending upon the load, usually No. 12 or 14 wire being sufficient except for high power.

In some cases a line filter will be effective on the receiver. This is true in cases when the second detector seems to be originating the trouble. The line is feeding it right into the heart of the set and the line should be filtered.

Satisfied with your reproduction? WAIT TILL YOU HEAR THIS!

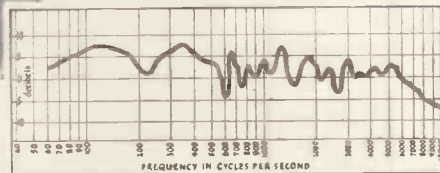
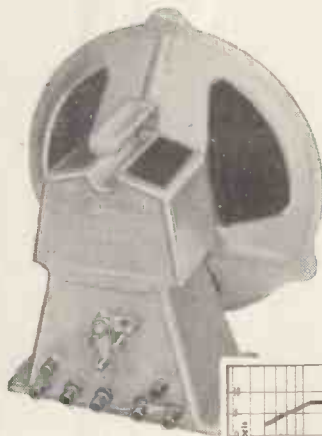

Make no mistake—here is no mere superficial alteration in design.

An observant glance at speech coil, centring device, and cone, will show you a few of the differences; and two or three minutes of listening will show you many more.

Another 600 cycles of top response—complete absence of 300 cycles peaks—slight gain in average sensitivity—it takes a keen ear to analyse this new smoothness and fidelity, but no ear can fail to detect it.

Prices (at present), remain at the old level—17/6 to 45/-. Get your new Stentorian speaker now!

Mr. Kenneth Jowers, the well-known Short-wave Editor of "Television and Short-Wave World" has expressed the following opinion:—
W.B. Loudspeakers embody so many unique features that they should become the automatic choice of all radio constructors and listeners

Kenneth Jowers



ANOTHER NEW

Stentorian

DIFFERENT—& BETTER STILL

WHITELEY ELECTRICAL RADIO CO., LTD. (Vision Dept.) MANSFIELD, NOTTS.

The Johnson Q and Other Antenna Systems

NOW that amateurs at large have realised the importance of correct aerial matching to the feeder lines and also the value of non-resonant lines, the Johnson "Q" and similar types of accurately matched aerials are becoming popular.

Tests have shown that a low-power station with an efficient aerial is capable of putting up a performance equal to, or even exceeding that, given by a station using an input three or four times greater, but using a Zepp radiator.

Also, as so many amateurs are restricted to the use of half-wavelength aerials owing to space limitation, it is important that any aerial put up be of the maximum possible efficiency.

One of the most popular of the small type aerials is the Johnson "Q," which was evolved by E. F. Johnson, the American radio engineer and manufacturer.

Ideal transfer of radio-frequency power from the transmitter to the radiating system is the object of amateur experiments. Zepp feeders are, of course, quite out of the question, particularly in wet weather, for the efficiency

Two highly efficient aerials suitable for erection in limited spaces are described in this article. A full kit ready for erection can be obtained from Epoch Reproducers Ltd.

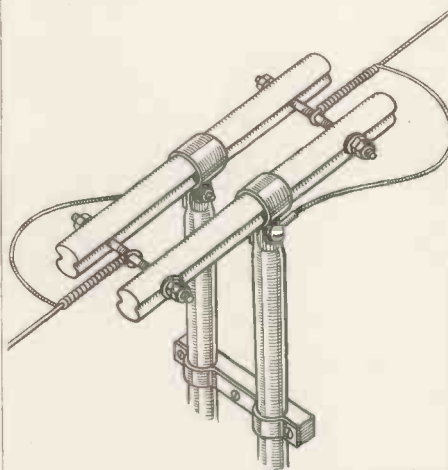

The Johnson "Q" aerial has aluminium tubing to form a quarter-wave matching section. It is erected in this manner.

factor is comparatively low. In the majority of instances, it can safely be assumed that any carefully erected non-resonant line is better than a tuned line, while, in addition, a line such as the 72-ohm low-impedance cable should give maximum efficiency if correctly terminated at both ends.

The Johnson "Q" aerial does give maximum transference of radio-frequency with minimum loss and is suitable for all wavelengths from 80 metres downwards. Owing to the short length of wire required it is generally a practical idea to erect the aerial in such a way that radiation is concentrated in two required directions. Of course, with a half-wave aerial the radiation pattern is very much broadside, so that when erected north and south is ideal for transatlantic radiation.

The "Q" system is roughly that a quarter-wave line of suitable characteristics has the property of matching the impedance of the transmission line to that of the aerial. Broadly speaking the quarter-wave line acts as a matching transformer of conventional type. This enables maximum transference of energy to be obtained and, as the quar-

WODEN HIGH EFFICIENCY SUPER - TRANSFORMERS

FOR ALL TRANSMITTING • RADIO AND TELEVISION REQUIREMENTS

**100%
Guarantee**



**All Amateurs should
use WODEN Transformers**

All Woden Transformers are guaranteed against breakdown.

4 REASONS WHY:-

SIX POPULAR MODELS

1	500-0-500 at 120-150 M/A	6.3 C.T. 4 A	} 39/6
		6.3 " 2 A	
		5.0 " 3 A	
2	450-0-450 at 150 M/A	25/-
3	1250-0-1250 at 250 M/A	60/-
4	20 H. at 150 M/A	19/6
5	20 H. at 250 M/A	25/-
6	5/25 H. Swinging at 150 M/A	14/6

- * GENEROUS "HIGH-PERM" CORE.
- * INDIVIDUAL PRECISION CONSTRUCTION.
- * WHITE PORCELAIN INSULATORS.
- * HEAVY CAST ELECTRO-MAGNETIC SHROUDS PREVENTING INTERACTION.

Let us quote you
NOW!
Trade Enquiries invited

Home constructed Apparatus has a new distinctive look when WODEN Transformers are incorporated.

Write for **FREE**
Descriptive Literature

WODEN SOUND EQUIPMENTS St. John's Square, WOLVERHAMPTON

Tel. 31145

ter-wave matching section is made up of half-inch aluminium tubing, the insertion loss introduced by tuned feeders and twisted pair lines which offsets the gain due to correct matching is overcome.

It is generally agreed that there is only one drawback to a super-efficient aerial of this kind, and that is that the aerial is only suitable for single-frequency operation. However, if the aerial is cut to provide maximum efficiency on the most important frequency, then it can be used as a folded aerial with tuned feeders, or coupled up to form a Marconi aerial on less important bands.

Just how the matching stub is connected can be seen from the illustration on this page, and although the fixing is rather difficult if the amateur tries to build his own matching lines, it becomes very simple when the manufactured lines are employed. These aluminium tubes can be obtained from the Radio Development Company with all the details on how to erect the Johnson "Q" antenna.

Coupling is very simple and if the recommended system is used losses due to the conventional tuning systems are overcome. Under matched impedance conditions the transmission line acts as a pure resistance load and in such circumstances the simplest method of coupling to the P.A. tank coil is to clip the feed lines directly on to the coil

with about one-quarter to one-half of the total inductance left between tapping points.

At 5 metres the quarter-wave system is very satisfactory for the doublet aerial can be formed by merely bending the tubing at right angles. The whole system is then self-supporting

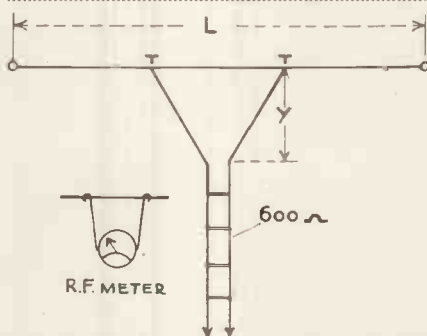

One of the most effective matched impedance aeri- als of the simpler type is this "Y" match to which is coupled 600 feeders.

and does not require any aerial insulators. For portable work the arrangement can be connected directly to the transmitter or designed to be collapsible, if so required.

Another aerial that has proved highly satisfactory and one that gives a more or less concentrated broadside beam is the Y match or pure matched impedance aerial. This, like the Johnson

"Q," is fundamentally half-wavelength long, but where space limitation does not apply, can be increased by the addition of one half-wavelength on each end of the fundamental doublet. The arrangement is shown here.

The total length L is one half-wavelength with twin feeders untuned and of any length connected at the points marked T. It can be seen that the ends of the feeder line are fanned out in a Y shape from the 600-ohm line.

Providing this aerial is accurately cut, it is ideal for single-frequency working and does enable the low-power amateur to make the most of his input.

The total length L is computed from the conventional formula L (in feet)

$$= \frac{492,000}{f} \times 0.95 \text{ where } f \text{ is the frequency in kilocycles.}$$

The portion of the aerial between the two taps where the feeders connect can be obtained from the formula T to T (in feet)

$$= \frac{492,000}{f} \times 0.24.$$

Finally, there is the Y section which can be calculated from the formula

$$Y = \frac{147,000}{f}$$

For those who wish to check the impedance of the feeder line the following formula can be used $S = 150 \times R$ where S is the gap between wires and R is the radius of the wires.

A HIGH-GAIN T.R.F. RECEIVER

FULLY DESCRIBED IN THIS ISSUE—

CABINET
PANEL
SCREEN
CHASSIS

by

Useful list of stock metal parts and aids to construction free on request.

for
**ANYTHING
IN
METAL**



METALWORKS
171c, Battersea Park Road,
London - - - S.W.8

Write or
'Phone :

MACAULAY 4840

ARE YOU ON THE ? 10 METRE ? BAND ?

THE Ten metre band is now open and promises to be the Super D.X. Band for the coming season. Is your present receiver capable of tuning down to 10 metres? If not you are missing one of the thrills of short-wave radio. Also the near-by 13 metre Broadcast Band gives you lunch-hour reception from New York, with amazing consistency. Why not get acquainted with the marvellous COMMUNICATION RECEIVERS handled by A.C.S. Ltd. The complete range is described in detail, in the new illustrated folder which is yours for the asking.

Here are a few of the popular receivers handled.

- NATIONAL NC100, 10-550M. 12 Valves .. £35.
- 1938 SUPER SKYRIDER 5-550 M. 11 Valves .. £32.
- SKY-CHALLENGER 7.5-550M. 9 Valves .. £23.
- HAMMARLUND SUPER-PRO 7.5-240M. 16V .. £72-10
- PATTERSON PRI5, 8-550M. 15 V. £35
- RME 69, 10-550M. 9 Valves £39-15
- RCA ACR 111, 9-550M. 16 Valves £57-10

Write, call or phone to—

A.C.S. LTD. 52/54 WIDMORE RD.
BROMLEY, KENT,

Phone, RAVensbourne 0156/7

CHEAP DAY RETURN TO BROMLEY NORTH 1/6

G2NK. Technical
Manager.

New Ideas for Short-wave Listeners

COLONIAL, and the more enthusiastic British listeners, at last have a receiver made specially for them. One of the most outstanding sets of the year of the

An export model covers 13-555 metres.

The receiver is full of new ideas, such as a die-cast I.F. unit with, band-pass Litz wound coils, a pre-selector stage on all bands, a magic eye tuner,

same company is a low-voltage transmitting condenser suitable for 3,500 volts flash-over. It has a minimum capacity of 14 mmfd. and a maximum of 65 mmfd. Type number is 1083, and the price 17s. 6d.

Skeleton adaptors with a very low capacity are being offered by Clix for use in short-wave converters or for power sockets when short-wave converters are used with a parent receiver. These adaptors are available in 4, 5 and 7-pin types at 9d., 10d. and 1s. Another interesting Clix gadget is a fuse-plug of the 2-pin type fitted with internal fuses for 1s. 8d.

Bulgin are one of the first manufacturers to introduce a complete range of coils for television receivers. There is SW118, an aerial unit with screened primary suitable for coupling a di-pole aerial to the first H.F. stage. The price is 5s. 9d. Secondly comes a television H.F. transformer suitable for a band width of 3 mc., type SW119, price 5s., and finally an I.F. transformer tuned to any frequency between 20 and 8.5 mc., and suitable for a maximum band width of 3 mc. The type number is SW120 and the price 6s. 6d.

Constructors should make a point of obtaining a copy of the latest Bulgin publication, *Radio Progress*, price 1s. This gives constructional details of all

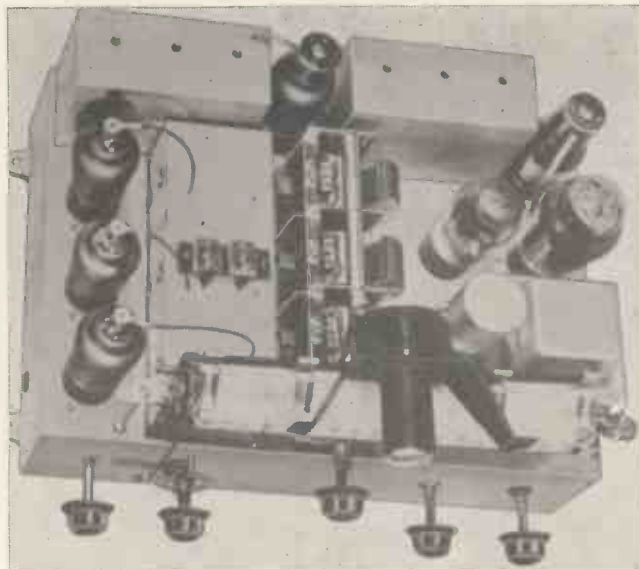

Serious experimenters will appreciate the design of the new Eddystone E.R.A.-7 all-wave receiver. The standard model tunes to over 2,000 metres, while a special export model has been designed to cover all wavelengths from 13 to 555 metres.

specialised kind is the new Eddystone E.R.A.-7, a four-band chassis receiver. It is a 7-valve super-het which tunes from 13-33, 31-85, 200-555, and 900 to 2,100 metres, with a switch selector.

a separate oscillator to eliminate frequency drift, and a 12 in. high-quality loudspeaker. This instrument is priced at 21 guineas with speaker.

Another interesting item from the

RAYMART

CRAFT A CREED

SPECIALISED SHORT-WAVE COMPONENTS ALWAYS IN STOCK

JOHNSON Q ANTENNAE: 20-metre, 39/6; 10-metre, 26/6; 5-metre, 27/6. Full range Bassett Concentric Feeders in stock.

COMMUNICATION Equipment. Send 1½d. stamp for latest bargain list. It will save you pounds.

LATEST 3-GANG low minimum all-wave condensers, fitted airplane dial, 8 and 80:1, 8/6; Yanley 3-gang 3-band switches, 2/11; ditto, 4-gang, 4-band, 3/11.

MOVING COIL SPEAKERS, 8 in., by famous maker, 1,200 ohm field with transformer, 6/11; M.C. Speaker Transformers, 1/11.

We are Sole Distributors for

BLILEY, THORDARSON, TAYLOR TUBES, RME, BASSETT CONCENTRIC CABLE, HOYT METERS, ETC., AND AUTHORIZED DISTRIBUTORS FOR NATIONAL PRODUCTS.

RAYMART SPECIFIED

for the
HIGH-GAIN T.R.F. RECEIVER
CONDENSERS, VARIABLE

you will require the following:—

4, Type VC 15 × 15 mmfd.

Price 1/4 Each

RAYMART SHORT-WAVE MANUAL

48 pages in all, 32 on receivers, transmitters, aerials, circuits, etc., etc., and 16 on short-wave components, 6d., or post free, 7½d. Short-Wave Catalogue, 16 pages, 1½d.

G5NI (BIRMINGHAM) LTD.

44, HOLLOWAY HEAD, BIRMINGHAM
Telephone: Mid. 3254.

FORTY-THREE VITAL POINTS

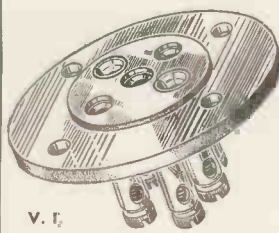

V. 1.

The specification of five 7-pin and two 4-pin Clix Valveholders for the "High-gain T.R.F. Receiver" places the responsibility on Clix products, for no less than 43 vital connection points. You may not have looked at it from this point of view; but it is a fact and one which emphasises the reliability and perfect contact secured through using these well-known and appreciated components.

The specification calls for Clix Valveholders without terminals, but they can be supplied with terminals if desired. We quote the prices for both types.

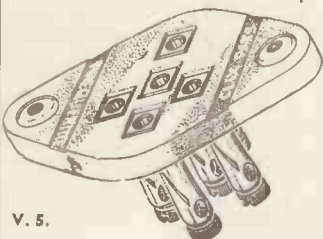

V. 5.

CLIX VALVEHOLDERS AS SPECIFIED FOR THE "HIGH-GAIN T.R.F. RECEIVER."

Type V.1. 4-pin without terminals	5d.	with terminals	8d.
Type V.5. 7-pin without terminals	8d.	with terminals	10d.

Obtainable through all radio dealers.

HAVE YOU HAD THE TWO NEW CLIX FOLDERS "T.S."? FREE.

BRITISH MECHANICAL PRODUCTIONS LIMITED
79^a ROCHESTER ROW LONDON S.W. 1

kinds of receivers, amplifiers, and some test equipment, complete with point-to-point wiring connections. It is excellent value for money. Servicemen should obtain a copy of the Bulgin Radio Service Manual, also is, which includes no less than 250 circuits and diagrams, and deals with topics such as A.V.C., decoupling, ganging, interference suppression, I.F. transformers,

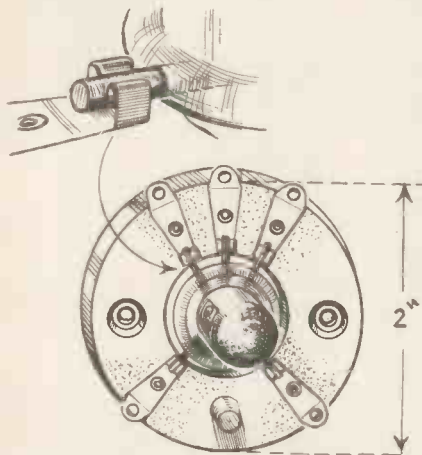

Clix have produced this ceramic Acorn valve-holder. It gives very positive contact.

bridge measurements, and many other interesting topics.

One of the most useful range of test instruments is that of the Pye Company. They manufacture an all-wave signal generator called the Trimeasy. It tunes down to 6 metres and also arranges for the audio frequency output to be modulated at 400 cycles, 150 and 10 kilocycles. The 400-cycle and 150-

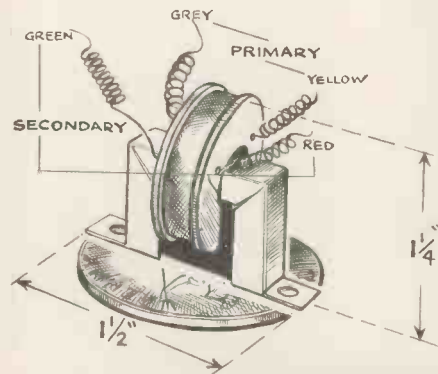

Some idea as to the size of this midget Bulgin inter-valve transformer can be gauged from the fact that it is mounted in this illustration on a penny.

kilocycle modulation is very useful in connection with television when making frame and line synchronising adjustments. The 400 cycle modulation is used in connection with frame adjustments and will produce seven bars upon the raster when the instrument is correctly adjusted to 50 frames.

The 150 kc. modulation is for line speed adjustments giving 14 bars when the instrument is correctly adjusted.

New Times Sales Co

AMAZING RADIO BARGAINS!

EST.

From the OLDEST FIRM for GENUINE RADIO BARGAINS

For nearly 14 years N.T.S. have supplied, by mail, the requirements of the Home Constructor, Experimenter and Serviceman. N.T.S. retain a pre-eminent position as the foremost suppliers of genuine bargains. . . Quality apparatus only at rock-bottom prices. Brand new lines at amazing bargain prices. Every item guaranteed and in perfect condition. Opportunities galore to meet every requirement. N.T.S. short wave apparatus is designed by specialists and backed by a technical service second to none.

1924

SHORT WAVE COILS
Highly efficient, employing low loss formers. Suitable for all circuits. 4- and 6-pin types 9.14, 12.26, 22.47, 41.94 76-170 metres, 1/9 each. 4-pin 150-325 metres, 2/3. 260-510, 2/8. 490-1,000, 3/4. 1000-2000, 3/4. 6-pin 150-325 metres, 3/6. 260-510, 3/6. 490-1000, 3/6. 1000-2000, 3/9. Coil Bases, low loss, 4-pin, 1/6. 6-pin, 1/3. Formers only, 4- and 6-pin, 1/6 each. Threaded 8 t.p.i., 3d. extra.

1/9
Each

H.F. CHOKES. Short wave new type, 10-200 metres, Low capacity wire ends, specially recommended, 9d. each. All wave screened, 2/6.

VARIABLE CONDENSERS. Short wave tuning and bandspreading, all brass single-end, suitable for ganging. .00025 mfd., 3/6. .00045, 2/8. .0016, 3/6. .002 (double-end), 3/6. Polar S.M., .0003, .0005, all brass, 2/6. Ormond, .00035 Log, 1/9. All brass, S/M .0005, with knob and dial, 1/9. Plessey Bar type, S/M 3-gang .0005 mfd., each section 6/11. Telsen and other type .00015 and .00075 diff., 9d. .0005 mfd. solid dielectric tuning with S/M scale 0/100 knob, escutcheon and bracket, 2/6.

I.F. TRANSFORMERS, Leading makes, neat bakelite cases. Ratios 3/1 and 5/1, 3/6. Telsen Audio type, 2/6. Class "B" 2/3. Class "B" chokes, 2/6.

N.T.S. ALL-WAVE DIAL
Two speed 10-1 and 150-1 reductions. With escutcheon and knob, as illustrated, 6/6.
Utility Micro Dial with knob and escutcheon, 7/6.

TELSEN MICA CONDENSERS. .0003 mfd., 6d. .05 mfd., 3d.

TUBULAR CONDENSERS (Non-inductive, all values). .0001 to .001, 4d. .001 to .1 mfd., 5d. .1 to .5 mfd., 6d.

ELECTROLYTIC CONDENSERS. Dubilier Wet, 8 mfd. 450 v., 3/6. Dry, 8-8 mfd. 500 v., 5/6. 4 mfd. 500 v., 4/6. 20 mfd. 50 v., 1/6. Waxed cardboard containers, 50 mfd. 25 v., 1/6. 8+8 525 v. surge, 3/6. 8+4 mfd. 525 v. surge, 3/3.

RESISTORS. Erie, all standard values, 1/2 and 1/4-watt, 4d., 3/6 doz. 1-watt, 5d., 4/6 doz. 2-watt, 8d., 6/6 doz. 3-watt, 9d., 8/6 doz.

VOLUME CONTROLS, POTENTIOMETERS. Well known makes, all values up to 1 meg., 2/6, with switch, 2/6. Varley Power type 25-watts all values, 500-3000 ohms, 3/6.

ELIMINATORS and Trickle Chargers. Save money and time, buy now built up and ready for immediate use, fully guaranteed. All A.C. Models employ metal rectifier.

A.C. Model, Output 120 v. at 12 m.a., 4 tappings 60 v., 75 v., 90 v., 120, 21/6.

A.C. Model provides for all H.T. and L.T. requirements. 4 H.T. tappings. Screen, Det., Medium Power, High Power Output, 120 v. at 20 m.a. **TRICKLE CHARGER** incorporated for 2-volt accumulator, charging rate 1/2 amp., 32/6.

D.C. Model, tapped for Screen, Det. and Power. Output 25 m.a. at 150 v., 15/6.

Trickle Charger, 2 v., 1/2 amp., metal rectifier, 10/6.

AMERICAN VALVES. Over 150 types in stock: Glass, Metal and Octal, from 3/6. Send list of requirements.

VALVEHOLDERS. Chassis type paxolin, 4- and 5-pin, 2 1/2d., 7-pin, 3 1/2d., Octal, 6d. Baseboard 4- and 5-pin type with terminals, 3 1/2d.

MAINS TRANSFORMERS New Types screened primaries 300-0-300v. 60 ma., 4v. 4a. 4v. 4a. C.T. 10/6. 350-0-350, 120 ma.; 4v. 1.5a. C.T. 3-15-0, 3.15v. 4a. 17/6.

CALLERS: We have a large selection all makes at clearance prices.

Something Everyone Needs!
AVOMINOR TESTMETER
Universal A.C./D.C. Model (illustrated) 22 ranges. In bakelite case on rubber feet, with clips and testing prods. Cash or C.O.D. £5/10/0, or 10/- down and 11 monthly payments of 10/- D.C. Mains and Battery Model (10 ranges), £2/5/0, or 2/6 down and 11 monthly payments of 4/4.

Orders over 5/- carriage and packing free. Under 5/- postage extra. Avoid C.O.D. charges by forwarding cash on orders under 5/-. Overseas orders forwarding charges extra.

NEW TIMES SALES CO.

56 (T.I.) Ludgate Hill, London, E.C.4
Telephone: City 5516

ALL-WAVE 5-valve A.C. SUPERHET CHASSIS

List Value 8 Gns. BARGAIN £4/17/6

Cash or C.O.D.

COMPLETE WITH FIVE VALVES, KNOBS AND ESCUTCHEON. Order NOW and secure this wonderful N.T.S. bargain. Stocks are limited.

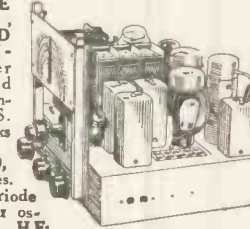

- Input to triode hexode detector oscillator, V.M. H.F. pentode, double-diode-triode 2nd detector triode resistance capacity stage coupled to high-slope output pentode. ● Output 3 watts.
 - Combined on-off switch and volume control.
 - Separate tone control. ● 4-position wave-change and gramo. switch. ● Illuminated slow-motion dial, 80-1 and 9-1 reductions, station names and wave-lengths. ● Overall dimensions: 10" high, 11 1/2" wide, 8 1/2" deep. For A.C. mains 200-250 volts, 40-80 cycles. 10/6 down secures; balance in 11 monthly payments of 10/6.
- Moving-Coil Speaker for above, 27/6. Add 2/6 to deposit.

10/6 DOWN

SPEAKERS, ENERGISED. Brand new, astounding offer. Celestion, 8 1/2 in., 2,500 ohms, Pent. Trans., 4-watt, 12/6. 10 in., P.A. M/C, 1,250 ohms, P.P. trans., 29/6. Other special types in stock.

HEADPHONES. New lightweight, super quality, ideal for short-wave work and testing 3/6. Post 6d.

P.M. SPEAKERS. Goodmans. Limited stock for Power, Pent. or Class "B" (state which), 7/6. 8 1/2 in. for power, pentode, and terminals for low impedance matching for extension purposes, 13/6. Similar speaker for Class "B" and low impedance matching, 13/6.

ALL-WAVE TUNER

Amazing offer of high-efficiency All Wave Tuners, overproduced for leading set manufacturers, to clear at a fraction of list value.

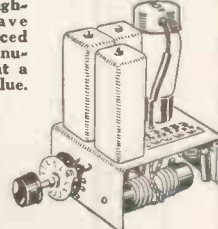

Your opportunity to secure a modern All-wave tuner for use as Bandpass Oscillator on all wavebands, for tuning with 3 x .0005 mfd. ganged condenser and oscillator valve (Osram X41 or similar type) valve holder fitted 130 Kc I.F.s. required. 18-52, 200-550, 900-2,000 metres. Ready wired on metal chassis. Yaxley Type 4-position switch with silver contacts fitted. (Gramo., Long, Medium and Short.) T.C.C. and Dubilier components. Robust construction. Overall dimensions 4 1/2" wide x 6 1/2" high x 6" deep. For immediate attachment to 4 or 5 valve A.C. Superhet type of receiver. Fully tested before dispatch. Less valve.

List Value £2 10 0
OUR PRICE 15/6
Post Free

Write to-day, with 1 1/2d. stamp to cover postage, for free Bargain List and Booklet describing in full, with actual photographs, 5 amazing new N.T.S. Bargain Short-Wave Kits and range of Short Wave Components. Easy to build and operate, these wonderful kits are the last word in 1938 short-wave technique.

FREE!
N.T.S. supply everything Radio and Television (all makes) on the famous New Times Easyway System. Receivers, Components, Eliminators, Speakers, Valves... send us a list of your needs for quotation by return.

W.A.Z. (Worked All Zones)

ONE of the most effective means of gauging the efficiency of a transmitter is to try and work all continents or to work all stations in the British Empire as laid down in the regulations issued by the Radio Society of Great Britain.

Those amateurs who can fulfil these conditions can obtain a diploma certifying just what they have done, which is proof that both the operator and the transmitter are working at maximum efficiency.

A new scheme, introduced by *Radio*, is a continuation of the W.A.C. arrangement, for they have split the world into 40 separate zones. The efficiency of a station is gauged by the number of zones actually worked. To qualify for W.A.Z. stations should work at least 20 zones on phone, and if they want to be anywhere near the top of the list, more than 35 zones on C.W.

For the benefit of those who would like to compile a list of the zones worked, we publish herewith the first section of the 40 zones, the balance of which will be published in the next issue. Readers should keep these lists until they are completed, for they will prove a valuable help when discussing transmitter efficiency.

ZONE 1.
North-Western Zone of North America.
Alaska (K7).
Yukon (part of VE5).
Canadian North-west Territories (part of VE5).
District of Mackenzie.
District of Franklin.
Islands west of 102° W., including Victoria, Banks, Melville, and Prince Patrick.

ZONE 2.
North-Western Zone of North America.
Canada, that portion of Quebec (part of VE2) north of an east and west line drawn along and extended from the southern boundary of Labrador.
Canadian North-West Territories (part of VE5).
District of Keewatin.
District of Franklin, east of Long 102° W., including Islands of King William, Prince of Wales, Somerset, Bathurst, Devon, Ellsmere, Baffin, and the Melville and Boothia Peninsulas.

ZONE 3.
Western Zone of North America.
British Columbia (part of VE5).
W7 except Wyoming and Montana, all W6.

ZONE 4.
Central Zone of North America.

All VE3, VE4, W5, and W9.
Wyoming and Montana (part of W7).
Ohio and Michigan (part of W8).
Tennessee and Alabama (part of W4).

ZONE 5.
Eastern Zone of North America.
All Vel, VO8, W1, W2, W3.
VE2 (Quebec) south of line mentioned in Zone 2.
W4 except Tennessee and Alabama.
W8 except Ohio and Michigan, Bermuda.

ZONE 6.
Southern Zone of North America.
Mexico.

ZONE 7.
Zone of Central America Honduras.
British Honduras.
Guatemala.
Costa Rica.
Nicaragua.
Panama.
Canal Zone.

ZONE 8. West Indies Zone.
Cuba.
Puerto Rico.
Virgin Islands.
Jamaica.
Bahamas.
Barbados.
Haiti.
Dominican Republic.
All Greater and Lesser Antilles except Bermuda and those listed in Zone 9.

TELEVISION.

A NEW COURSE OF INSTRUCTION.

We have pleasure in announcing that our new "Television" Course has met with remarkable success. The enormous demand for the Course has shown, beyond any shadow of doubt, that it fills that long-felt need which we anticipated when we went to such trouble and expense in its preparation.

We shall be happy to send full details of this special "Television" Course on request. Particulars are also available of other Courses in all branches of Wireless, Television, Talking Picture Engineering, etc., and of the easiest way in which to prepare for the A.M.I.E.E., A.M.I.W.T., A.M.I.R.E., etc., Examinations.

We teach by correspondence, and guarantee "NO PASS—NO FEE." Our Technical Consultant is Professor A. M. Low.

Send for full particulars to-day. Free and without obligation.

THE BRITISH INSTITUTE OF ENGINEERING TECHNOLOGY
337, SHAKESPEARE HOUSE, 17/19, STRATFORD PLACE,
LONDON, W.1.

RFP15 — 30/-

Filament Volts ..	4
Filament Amps. ..	1
Anode Volts ..	500
Max. Anode Input ..	25 watts
Max. Anode Dissipation ..	15 watts
Anode Load ..	10,000 ohms
Screen Volts ..	300
Speech Input ..	1 watt
Radio Input ..	6 volts (R.M.S.)

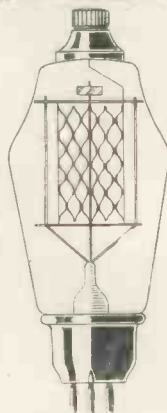

362 RADIO VALVE Co. Ltd.
324/6 LIVERPOOL ROAD,
LONDON, N.7

North 1853.

Specified by  the Experts

SOUND SALES LTD.

WE LIVE AND LEARN

We had a pleasant surprise at Radiolympia when the judges awarded us The Trader "Limited" Trophy Cup for the best Stand, up to 300 sq. ft. in area.

We knew from the many letters we received from the public that the design, appearance and performance of our products had reached a high stage of perfection—BUT until Radiolympia, we did not realise that we were capable of designing an Exhibition Stand which could be classed as an outstanding example of our serious efforts to please the public.



SOUND SALES CHOKES

TYPE WW/CI

PRICE **15/-**

Specified for the
T20 TRANSMITTER

Our New Season's Catalogue "T.S." is ready. 48 pages. 6d. Post Free.

SOUND SALES LIMITED

Marlborough Road, Upper Holloway, London, N.19

Phone: Archway 1661-2-3 (Contr. to G.P.O., etc.)

ZONE 9.

Northern Zone of South America.
Colombia.
Venezuela.
Dutch Guiana.
French Guiana.
British Guiana.
Trinidad.
Curacao.
Tobago.
Grenada.

ZONE 10.

West Central Zone of South America.
Ecuador.
Peru.
Bolivia.
Colon or Galapagos Archipelago.

ZONE 11.

East Central Zone of South America.
Brazil.
Paraguay.

ZONE 12.

South-Western Zone of South America.
Chile.

ZONE 13.

South-Eastern Zone of South America.
Argentina.
Uruguay.
Falkland Islands.

ZONE 14.

Western Zone of Europe.
Portugal.
Spain.
Andora.
France.
Switzerland.
Luxembourg.
Belgium.
Saar.
Germany (except East Prussia).
Denmark.
Sweden.
Norway.
Great Britain.
Irish Free State.
Netherlands (Holland).
Azores Islands.
Faroes Islands.
Gibraltar.
Monaco.

ZONE 15.

Central Zone of Europe.
Italy.
Albania.
Austria.
Leichtenstein.
Poland.
Finland.
Latvia.
Lithuania.
Esthonia.
Czechoslovakia.
Yugoslavia.
Corsica.
Sardinia.
Hungary.
Malta.
Sicily.
San Marino.
Danzig.
Germany (East Prussia only—D calls ending in A—).

(To be concluded in the November issue.)

GALPINS

ELECTRICAL STORES
75, LEE HIGH ROAD, LEWISHAM,
LONDON, S.E.13

TELE : LEE TERMS CASH WITH
GREEN 5240 ORDER OR C.O.D.
ALL GOODS SENT ON 3-DAYS APPROVAL
AGAINST CASH

10-INCH SPARK COILS in case, portable, complete with high-speed contact breaker and condenser, £4 10s. Ditto, with rotary break, £5; 15-inch Spark Coil with condensers, 70s.; 8-inch Spark Coil with break and condenser, £3 10s.; 2-inch Spark Coil with Break, 17/6 each, carriage forward. X-Ray Tubes as new, with tungsten targets, 17/6; with platinum targets, 22/6, packing free.

TRANSMITTING AND AMPLIFIER VALVES. Mullard or Osram Transmitting Valves, 100 watts, 15/-; 250 watts, 22/6; 400 watt, 35/-. As new, Amplifiers, type Philips MC1/50s, 30/-. Rectifiers, D.C.1/50, 20/- each.

G.E.C. PHOTO ELECTRIC CELL, type G.M.C8, as new, 25/-.

STANDARD TELEPHONE LINE TRANSFORMERS, type SS1794 and SS5055, 5/- each; type MS5022, 10/-; Repeater Valves, type ES755/1, 7/6 each.

INDUCTION MOTORS, 1/2 h.p., for 200/250 volt, 1-phase, 50 cycles. Suitable for pumps, sewing machines, cinemas, etc. Condition as new, 22/6, post free.

PHILIPS' HIGH-VOLTAGE CONDENSERS, 4,000 volt working, 1 mf., 10/-; Fully guaranteed.

TRANSFORMERS, CHOKES, all fully guaranteed. Input 200/250 volt, 50 cycles, 1-phase, output 2,000/0/2,000 volts 200 m.a., 11 volts 2 1/2 amps., 4 volts 4 amps. A heavy robust job. To clear, 30/-. Mains Choke, 40 henry, 200 m.a., 15/-. Heavy Duty Speaker Output Transformer, 100 ohm primary tapped secondary, 15/-.

TRANSFORMER, 2 1/2 kilowatt, step up or down, 100/110 volts to 200/250 volts. Guaranteed, £3 10s. Carriage forward.

EX-G.P.O. GLASS TOP highly sensitive RELAYS, type B. Operating current approx. 1 m.a., 7/6 each.

LARGE MOVING COIL METER MOVEMENTS by well-known makers, approx. 10 m.a., full scale, 6/6 each.

CROMPTON DYNAMO, 50/75 volt 15 amp., 4-pole, with pulley, £4 10s. Armstrong Whitworth 25 volt 25/35 amp., 4-pole, compound wound, totally enclosed, speed 1,000 r.p.m., £4 10s. C.A.V. 25 volt 8 amp. shunt wound ball bearing, 32/6. Ditto, 12 volt 12 amp., 17/6. D.C. Motor, 50 volt 1/2 h.p. ball bearing, 17/6. All fully guaranteed.

EX-G.P.O. HEAVY DUTY MORSE TAPPING KEYS, heavy brass fittings, 6/6 each.

X-RAY COIL, 10-in., complete with condenser, 100/250 volts input, nice condition, 50/-. Carriage forward.

LARGE TRANSFORMERS for rewinds, 500 watts, 7/6; 1 kilowatt, 15/-; 2 kilowatt, 25/-.

SWITCHBOARD MOVING COIL AND MOVING IRON METER by Park Royal, Ediswan, etc. 0 to 500 volts, 15/-; 0 to 3,000 volts, 22/6; 0 to 40 volt, 8/6 to 120 volt, 14/-. Above are moving coil M/1 type. Volts 0 to 250 volt, 15/-; 0 to 30 volt, 7/6; 0 to 150 volt, 10/-; 0 to 100 volt, 10/-. Ammeters, 0 to 3 amp., 12/6; 0 to 10 amp., 0 to 30 amp., 0 to 50 amp., 12/6 each; 0 to 400 amps., 20/-.

MAINS VARIABLE RESISTANCES, Sliders type, worm wheel drive; 2,000 ohms, carry 250 m/A., 17/6; 400 ohms 1/2 amp., not w.w. type, 12/6; 10 ohms 4 amp., 10/-; 1 1/2 ohms 20 amps., 15/-; Stud Switcharm type, 150 ohms 3 amp., 15/-; 300 ohms 1 1/2 amp., 15/-; 300 ohms 1/2 amp., 10/-.

WESTERN ELECTRIC MICROPHONES, 2/6. Microphone Transformers, 2/6. G.P.O. Hand-grip Earphones, 1/6. Telephone Hand Generators, 4/-. Post 6d.

"CARTER" ROTARY CONVERTORS, for car radio, etc. Input 12 volts at 2 1/2 amp., output 200 volt 40 m/A., tapped at 90 volts and 45 volts. Complete with all smoothing. Brand new. Listed £5. To clear, 32/6.

MOVING COIL METER MOVEMENTS for recalibrating into multi-range meters, 2 1/2 in. dial. By well-known makers, 5/- each.

ELECTRIC LIGHT CHECK METERS, kilowatt hour type, 200/250 volts, 50 cycle, single-phase. For sub-metering, garages, etc. In new condition, 6/-. Post 1/-.

MAINS CONDENSERS, 2 m.f. 250 volt working, 9d.; 4 m.f. 350 volt working, 2/-. Dubilier Block Condensers, 4 x 2 x 2 m.f. 500 volt test, 2/6 each. T.C.C. Electrolytic Condensers, 8 m.f. 200 volt working, 1/6; 500 m.f. 40 volt working, 4/-; 1,000 m.f. 12 volt working, 6/6 each. Mains Chokes, 20/30 henry, 40, 60, 80, 120 m/amps., price 1/-, 1/6, 2/6, 4/6 each. R.A.F. Cut-outs, 20 volts 3 amps., 1/6. Microphone Buttons, 9d. Vitreous Resistances, 126 ohms 1/2 amp., 1/6; 2,000 ohms, 100 m/A., 1/-; 3,000 ohms 220 m/A., 2/- each. Resistance Mats, 600 ohms 1/2 amp., 4/-; 5 ohms 5 amp., 1/6 each. Bulgin. D.P.D.T. Toggle Switches, 9d. each. Ex-Naval Short-wave Transmitting Condensers, .000024 m.f., 4/6 each. Dubilier 1/2 m.f. 2,500 volt test condensers, 2/- each. Magnetic Triple Action Keys, low-voltage working, 2/- each. Large 80 ohms 3 amp. Rheostats, in teak case, 2/-, 4 oz. Bobbins of 40 gauge D.C.C. instrument wire, 1/3. 9 oz. Bobbins of 26 gauge, 1/-. Mains Power Pack 2 x 30 henry Chokes, 2 x 2 m.f. Condensers, 2/- each.

"An Effective 5-metre Installation"

(Continued from page 630)

directly on to the centre of the coil. The grid coils of the final and 28 mc doubler are silver-plated, and the coil positions, which as this is a small compact transmitter were found to be very important, have been altered at least twelve or more times.

The valve arrangement is as follows : a 53 crystal oscillator feeds its own second triode which doubles to 14 megacycles. This is a capacity coupled to a second 53, doubling to 28 mcs., link coupled to an Eimac 35T, with its anode on 56 mcs. This is link coupled to the final 35T, which works at three times cut off, resulting in high anode efficiency, so with twenty-five watts input to the final amplifier, radiates 6 amp. into the matched impedance antennae array.

The modulator has three stages, the output being two D.O.26 valves in class AB push pull, and it is fed by a single stage pre-amplifier, which also contains the neon oscillator for keying I.C.W.

The note, which is very pure, and cuts through quench in super-regenerative receivers very well, is produced by a little midget neon tube, made by Bulgin, costing 3s. 6d. This tube is fed from the bias supply with about 180 volts and takes half a milliamp. It is perfectly constant, and is the best method of getting a really clear pure note I have found. The output is fed across the microphone potentiometer, so that the intensity of the "Tone" input is under control.

G5NI (Birmingham) Ltd.

The above Company has taken over the business formerly known as "Radio Mart" and with it, the whole of the Agencies held by the latter company. They are exclusive authorised distributors for R.M.E., Collins, Thordarson, Bliley, Hoyt, Taylor Tubes, Bassett Concentric Line, in addition to being authorised distributors for the National Company of Malden. They maintain at their Holloway Head depot in Birmingham a fully equipped "ham shack" where all the latest equipment can be inspected side by side. In addition to their activities on American communication equipment, they are British distributors for the Raymart line of components, which offers high quality equipment at very competitive prices. Amongst their latest additions to the line are Ceramic octal valveholders (they do all American types) in RMX at 1s. each, permeability tuned I.F. transformers, professional type engraved transmitter dials, etc. A cordial welcome is extended to all hams to visit their "ham shack" at Holloway Head.

A High-gain T.R.F. Receiver

(Continued from page 616)

the previous stages, but it quite comfortably fits above the tuning condenser without causing any long leads. Constructors could, however, mount the coil horizontally to the screen immediately behind the panel.

Although this receiver is now absolutely trouble-free variations in component values, particularly as regards valves, will cause most unsatisfactory results to be obtained. Considerable trouble has been taken in finding suitable valves, and although different types with apparently similar characteristics have been tried, those specified give the most satisfactory results and unquestionably the highest gain. This may be due to the circuit constants, but the fact still remains that in this particular circuit the valves should not be changed for those of other types.

Aerials

Although within 70 to 80 miles of the Alexandra Palace the sound programmes can be received at full loud-speaker strength with almost any type of aerial up to and including an ordinary 50 ft. broadcast aerial, a properly erected resonating di-pole is far more satisfactory for real long-distance reception. A suitable aerial, already built, can be obtained from Messrs. Bulgin, while an alternative aerial for

the constructor is shown in Fig. 2. This aerial consists of approximately one half-wave with a quarter-wave matching section. It can be seen from the illustration that a length of wire, three-quarters of a wavelength long has to be mounted on three stand-off insulators in the manner shown. A quarter-wave is then converted into a matching section by means of an extra length of wire, spaced by means of standard type 1017 Eddystone ceramic bar insulators.

The feeder line, which terminates at L₁, actually the coupling coil in the receiver, should be tapped on towards the end of the matching section, but to all intents and purposes, satisfactory results can be obtained with the matching section and feeder line in one continuous length.

Experiments have been made with this receiver in the North of England, and transmissions have been picked up over exceptionally long distances. I cannot give any indication as to the maximum range for so much depends on whether reflectors and directors are used, as these would increase the gain many times. I do feel, however, that for those who wish to hear the Alexandra Palace sound transmissions or long-distance amateur transmissions, that this receiver is most suitable for the job. It will give the maximum permissible gain with a comparatively low noise level; is not difficult to construct, as with a super-het receiver; and, of

course, omits the double tuning, so noticeable in amateur-built U.H.F. super-hets.

The receiver is now in general use in our laboratories where it can be inspected by appointment. No blueprint will be available for constructors should be able to build from the extensive photographs and the full theoretical circuit. Coils can be obtained to cover 4.5 to 10 metres, but for 7-metre reception L₃ and 4 should be six turns, L₅ eight turns, and L₁ four turns.

Amateur Radiotelephony

All interested in phone transmission should obtain a copy of the latest American handbook entitled "Amateur Radiotelephony." It is an entirely new publication of 128 pages, full of the latest phone transmitter circuits for both anode, grid and suppressor grid modulation. Amongst the chapters of particular interest are Class AB and BC amplifiers, modulators, grid modulation, control, control carrier modulation, reverse feed-back amplifiers, and a multi-purpose test set. Amongst the transmitters described are an 80- and 160-metre, a 10-watt 10-metre, a 50-watt 5-band, a grid modulated 4-band, and several others of varying inputs. The publication can be obtained from G5KA, 41 Kinfauns Road, Goodmayes, Ilford, Essex. The price is 3s. 3d., post free.

**You can't afford
to be without
A "GUIDE TO
AMATEUR RADIO"**



The New 5th Edition, just published, contains 164 pages of up-to-date information on short-wave amateur radio.

TELEVISION. TRANSMITTERS. RECEIVERS. POWER SUPPLIES. AERIALS. FREQUENCY MEASURING. THE ULTRA-HIGH FREQUENCIES. MORSE CODE. INTERNATIONAL ABBREVIATIONS AND PREFIXES.

164 Pages. 18 Chapters in all

FULLY REVISED.

6D.

(Post Free, 9d.)

Profusely illustrated—Authoritative information—Well printed

ORDER YOUR COPY TO-DAY

The Secretary,
RADIO SOCIETY OF GREAT BRITAIN, 53 VICTORIA ST. LONDON, S.W.1

**THE
TELEVISION SOCIETY**

President: Sir AMBROSE FLEMING, M.A., D.Sc., F.R.S.

Founded in 1927 for the furtherance of Study and Research in Television and allied Photo-electric Problems.

Ordinary Fellows are elected on a Certificate of Recommendation signed by Two Ordinary Fellows, the Proposer certifying his personal knowledge of the Candidate. The Admission Fee for Fellows is half-a-guinea, payable at the time of election, the Annual Subscription is £1, payable on election, and subsequently in advance on January 1st in each year, but the Annual Subscription may be compounded at any time by the payment of Ten Guineas.

Any person over 21, interested in Television, may be eligible for the Associate Membership without technical qualifications, but must give some evidence of interest in the subject as shall satisfy the Committee. For Associate Members the Entrance Fee is 5/-, payable at the time of election, with Annual Subscription 15/-, payable in advance on January 1st in each year.

Student Members.—The Council has arranged for the entrance of persons under the age of 21 as Student Members, with Entrance Fee 2/6 and Annual Subscription 10/-, payable as above.

The Ordinary Meetings are held in London on the second Wednesday of the month (October to May inclusive) at 7 p.m. The business of the meetings includes the reading and discussion of papers. A Summer Meeting is usually held, and affords Members the opportunity of inspecting laboratories, works, etc. A Research Committee and the preparation of An Index of Current Literature are active branches of the Society's work.

The Journal of the Television Society

is published three times a year. All members are entitled to a copy; and it is also sold to Non-Members, at an annual subscription of 15/- post free.

Forms of proposal for Membership, and further information regarding the Society, may be obtained on application to the General Secretary, J. J. Denton, 25, Lisburne Road, Hampstead, London, N.W.3.

WARD'S BARGAINS

WESTINGHOUSE RECTIFIERS, L.T.4 or L.T.5, with mains transformer and variable resistance, 22/6; Varley D.P.4 output transformers, 1-1 and 25-1, 9/-.
MAINS TRANSFORMERS, 350.0-350 v. 60 m.a., 4 v. 3 amps., 4 v. 25 amps., 12/-; 425.0-425 v. 120 m.a., 4 v. 1 amp., 4 v. 1 amp., 4 v. 7 amp., 4 v. 25 amp., for "W.W." Quality Amplifier, 25/-; L.T. transformers, with two 4 v. 3 a. C.T. windings or 2.5 v. 8 a., 5 v. 2.5 a., 8/6.

BRITISH RADIOPHONE CONDENSERS, fully screened, 110 kc or 465 kc., superhet, or straight type, 3-gang and 2-gang, 7/6.
VALVEHOLDERS, Chassis Type, 4- or 5-pin, 6d.; 7- or 9-pin, 6d.; R.C.A. American valve holders, 4-, 5-, 6- or 7-pin, 9d.

ASSORTED 1-gross Parcels of 1-watt and 1/2-watt Resistances by N.S.F., 12/-.
CONVERSION UNITS for Converting D.C. Receivers to A.C. Mains operation up to 110 watts, improved full-wave type, £2 10s.

VOLUME CONTROLS, with or without switch, by Rotor-ohm, Eric, Electrad, and other good makers, any value, 2/6.
CENTRALAB RESISTANCES, 1-watt type, 6d.; 2-watt type, 1/2; 3-watt type, 1/9; B.I.C. 8 mf. and 4 mf. 550 volts peak electrolytic condensers, 3/3.

3,000 Brand New Wearite 110 kc. Pre-tune I.F. Transformers, type O.T.1, O.T.2 and O.T.2F.; 1/6 each, or offer for quantity.
40 MFD. and 24 mfd. 200 Volts Peak Electrolytic Condensers, 3/-.
WE STOCK All Parts for "Wireless World" Quality Amplifier, Quality Amplifier Receiver, Imperial Short Wave Six, 1936 Monodial Q.A. Super, All-wave Super Seven, etc.

WE CAN SUPPLY Correct Equivalents for Any British Type of Valve, including side-contact Universals, H.F. pentodes, double diode triodes, 3-5-watt output pentodes, 500 v. indirectly heated rectifiers, octodes, double diodes, single diode tetrodes, etc., at an appreciably lower price.
"CORPACT" Capacity Operated Window Signs, £5.

CARRIAGE PAID, cash with order or c.o.d.; send for list.
CHAS. F. WARD 46, Farringdon St. LONDON, E.C.4
Tel: Holborn 9703.

ALUMINIUM CHASSIS for Amateur Televisor as specified ready for assembly, complete. Price 45/-.
COILS wound as specified for the above Receiver Set. Price 6/3, Post 3d.
TELEVISION RECEIVER, complete demonstration model, Vision, Sound, 12 in. C.R. Tube, Time Base and Power Packs, in working order. Price £25.
OSCILLOSCOPE for Wave Form measurements, complete with Cossor 5 in. C.R. Tube, slightly used. Price £8.
CATHODE RAY TUBE, 1in. Screen for Miniature Receiver as described in this Journal. Price 37/6d.
HIGH DEFINITION Apparatus always in Stock.
H. E. SANDERS & CO., 4 GRAY'S INN ROAD, LONDON, W.C.1. Telephone: Chancery 8778.

FOYLES

BOOKSELLERS TO THE WORLD
Stock of nearly three million new and second-hand volumes. Catalogues free on mentioning your interests.
119-125 Charing Cross Rd., London, W.C.2.
Telephone: Gerrard 5660 (12 lines)

INDEX TO ADVERTISERS

A.C.S., Ltd.	635
A.P.A. Metalworks	635
Automatic Coil Winder & Electrical Equipment Co., Ltd.	627
Baird Television, Ltd.	591
Belling & Lee, Ltd.	Cover ii
British Institute of Engineering Technology	638
British Mechanical Productions, Ltd.	636
Bulgin, A. F., & Co., Ltd.	577
Clix	636
Cossor, A. C., Ltd.	Cover iv
Edison Swan Electric Co., Ltd.	578
Ericsson Telephones, Ltd.	629
Eves Radio, Ltd.	629
Fluxite, Ltd.	Cover ii
Foyles, Ltd.	Cover iii
G5KA	Cover iii
G5NI (Birmingham), Ltd.	636
Galpin's	639
General Electric Co., Ltd.	621
Henley's, W. T., Telegraph Works Co., Ltd.	631
High Vacuum Valve Co., Ltd.	627
Jackson Bros. (London), Ltd.	627
Mareconi's Wireless Tele. Co., Ltd.	631
Mervyn Sound & Vision Co., Ltd.	631
McGraw-Hill Publishing Co.	580
Midwest Radio, Ltd.	577
New Times Sales Co.	637
Premier Supply Stores	623
Quartz Crystal Co., Ltd.	631
Radio Resistor Co., Ltd.	Cover ii
Radio Society of Great Britain	640
862 Radio Valve Co., Ltd.	638
Sanders, H. E., & Co.	Cover iii
Sound Sales, Ltd.	638
Technological Institute of Great Britain	Cover iii
Television Society, The	640
Ward, Chas. F.	Cover iii
Webbs Radio, Ltd.	625
Westinghouse Brake & Signal Co., Ltd.	592
Whiteley Electrical Radio Co., Ltd.	638
Woden Sound Equipments	634

MISCELLANEOUS ADVERTISEMENTS

The charge for advertisements in these columns is 12 words or less 2/-, and 2d. for every additional word. All advertisements must be accompanied by remittance. Cheques and Postal Orders should be made payable to Bernard Jones Publications Ltd., and crossed, and should reach this office not later than the 15th of the month previous to date of issue.

AMERICAN A.R.R.L. TYPE Sectional Wood Aerial Masts complete, guy wires, guy insulators, pulley, strainers, 100 ft. cotton rope. All metal galvanised, 50 ft. 62/6d.; 45 ft. 52/6d.; 40 ft. 50/- Extra Creosoting 2/6d. White Painting, 2 coats, 3/- Metalized Fibre Board panels and chassis, 3/16 in. 1/- sq. ft. to size. "Works like wood, screens like metal." 75 ohm approximately, Feeder Cable, twin parallel, 2/9d. 50 ft. All orders Carriage Forward, cash with order. c.C.N.T., Miller & Sons, Tyldesley Road, Atherton.

ENTIRE AMATEUR STATION for sale. 10 W Transmitter Receiver, Valves, including unused RK23 and PX25, and all components. Send for List, Box 14

EXPERIMENTAL TELEVISION SET (Vision only) for sale, 20 Valves, 1 Ediswan 12" Tube. May be seen working on the evening transmissions by appointment. Price £20, no offers. Reply to S.L.M., Box No. 15, Television.

CONDENSERS. Fixed paper, in Metal Containers. 1000volt Wkg. 1mf. 2/6. 2mf. 4/9. 4mf. 7/6. 8mf. 10/6. Bakelite Tubulars. 1000volt Wkg. 1mf. 2/6. 0.5mf. 2/-. 0.25mf. 1/9. 0.1mf. 1/3. 0.01mf. 9d. The Static Condenser Co., 11, Eden Street, Hampstead Road, London, N.W.1. "Makers of Good Condensers."

VALVES AT TWO-THIRDS LIST PRICE. We have still in hand a considerable number of valves of de-controlled types which are available at two-thirds of the list prices while stocks last. These include a practically full range of battery valves, including 4- and 6-volt valves, and also the following A.C. types:—ACSG 4, ACFC 4, ACHL 4, ACPX 4 and ACME 4. For example:—HL 2, list price 3/6d., de-controlled price 2/4d. SG 2, list price 7/6d., de-controlled price 5/0d. ACPX 4, list price 9/0d., de-controlled price 6/0d.—The 362 Radio Valve Co., Ltd., 324-6, Liverpool Road, Highbury, N.7.

PATENT AND TRADE MARK AGENTS

GEE & CO. (Estab. 1905), patents and trade marks throughout the world (H. T. P. Gee, Mem.R.S.G.B., A.M.I.R.E., etc.), 51-52, Chancery Lane, London, W.C.2 (2 doors from Government Patent Office.) Phone: Holborn 4547 (2 lines). Handbook free.

KINGS PATENT AGENCY LTD. (B. T. King, Patent Agent) 146a, Queen Victoria Street, London, E.C.4 ADVICE, Handbook and Consultations free. Phone City 6161.

QUERIES

Queries are answered direct by post, and in every case they must be accompanied by a stamped addressed envelope.

Engineers' Guide

Shows how to qualify in Television, Sound Recording, Radio Engineering and Servicing, Wireless Communications, etc., by studying at home with The T.I.G.B. Write to-day for this Great Guide containing world's widest choice of engineering courses and which alone gives the Regulations for A.M.I.E.E., A.M.I.R.E., A.M.I.T.E., etc.

Free!



THE TECHNOLOGICAL INSTITUTE OF GREAT BRITAIN
160 Temple Bar House, London, E.C.4
(Founded 1917. 20,000 Successes)

To SUCCESS
200 Courses

THE HAMS' BOOKSHOP.
G5KA

for all literature pertaining to the advancement of amateur radio.
JONES RADIO HANDBOOK. All phases of amateur radio completely treated in this book—the most practicable one on amateur radio ever published. 7/- post free.
SUPPLEMENT TO JONES RADIO HANDBOOK. The supplement to the above Handbook (just published) will bring your copy right up to date. Full details of all the latest tubes, transmitter exciter circuits, etc. 1/3d. post free.
"RADIO" ANTENNA HANDBOOK. It is not generally realised among amateurs that a given amount of time and money spent on increasing antenna efficiency will do more to increase the strength of the distant received signal than increasing the power output of the transmitter several times. For those with low power stations who want consistent DX, this is the book: 2/6d. post free. Send for full lists.

G5KA. 41, Kinfauns Road, Goodmayes, Ilford, Essex. Dept. "T."



*from the most
comprehensive range
of*

CATHODE RAY TUBES

Since 1902 Cossor research in the design and practice of Cathode Ray Tubes has always kept ahead of the times. As a result to-day Cossor have available a comprehensive range of Cathode Ray Tubes second-to-none.

Cossor research in the field of Television too, has proved eminently fruitful, and results have amply justified their pioneer work in the use of Cathode Ray Tubes for Television. Progress in this sphere has brought about many types but the Cossor full range of tubes is admitted as being unparalleled in respect of quality, focus and brilliance.

A request for leaflet L.213 to Instrument Dept., A. C. Cossor Ltd., Highbury Grove, London, N.5, will bring full details and data of the range available.

from the

'WIRELESS WORLD'
Editorial 2.4.37.

"It was not until about thirty years later that the cathode ray tube came to be regarded as an every day instrument in the laboratory, although as long ago as 1902 Cossors, the valve manufacturers, were producing their first examples."

COSSOR

CATHODE RAY TUBES

A. C. COSSOR LTD., HIGHBURY GROVE, LONDON, N.5

1/3032