

SIMPLEST HOME-BUILT TELEVISOR

Television

and *SHORT-WAVE WORLD*

MARCH, 1938

No. 121 Vol. xi.

1/-

**ANYBODY
CAN BUILD
THIS
TELEVISOR**

**WE
GUARANTEE
PICTURE
QUALITY**

CHEAP



IMPORTANT DEVELOPMENTS

Announcements by:—

SIR FRANK E. SMITH, Television Advisory
Committee

CAPTAIN C. G. GRAVES, B.B.C. Controller of
Programmes

BERNARD JONES PUBLICATIONS LTD.
CHANSITOR HOUSE, CHANCERY LANE
LONDON W.C.2.

THE FIRST TELEVISION JOURNAL IN THE WORLD



IT'S
SAFER

TO FIT THE

LAB
TESTED

VOLUME CONTROL

LAB Tone and Volume Controls are high-class precision products. They will never develop faults. Each Control is individually tested for noise level, contact efficiency, etc. Supplied with spindles 1 1/2 in. long for cutting to required lengths.

- Without Switch ... 3/-
- With Single-Pole Switch 3/6
- With Double-Pole Switch 5/-

From all Dealers

Write for descriptive leaflet to:

THE RADIO RESISTOR CO. LTD., 1, Golden Sq., LONDON, W.1



Says Smyth "Now here is a clue
That is really quite simple to do
For it says "When you wire
Your set you require
This old"—"Why it's FLUXITE,
how true!"

See that FLUXITE is always by you—in the house—garage—workshop—wherever speedy soldering is needed. Used for 30 years in government works and by leading engineers and manufacturers. Of Ironmongers—in tins, 4d., 8d., 1/4 and 2/8.

Ask to see the FLUXITE SMALL-SPACE SOLDERING SET—compact but substantial—complete with full instructions, 7/6. Write for Free Book on the art of "soft" soldering and ask for Leaflet on CASE-HARDENING STEEL and TEMPERING TOOLS with FLUXITE.

To CYCLISTS! Your wheels will NOT keep round and true unless the spokes are tied with fine wire at the crossings and SOLDERED. This makes a much stronger wheel. It's simple—with FLUXITE—but IMPORTANT.

THE FLUXITE GUN

Is always ready to put Fluxite on the soldering job instantly. A little pressure places the right quantity on the right spot and one charging lasts for ages.
Price 1/6.



ALL MECHANICS WILL HAVE

FLUXITE

IT SIMPLIFIES ALL SOLDERING

FLUXITE LTD. (Dept. T.V.), DRAGON WORKS, BERMONDSEY ST., E.C.4.

BELLING-LEE FUSES

Our policy is to provide all mains fuses with a safety carrier which breaks the circuit on withdrawal and replacements can be made in safety. A great deal of attention is given to creepage distances and breakdown between mains and earth.

CARTRIDGE FUSES.



Length 1 1/2 in.

- Cat. No. No. 1055/60 m/a. Black
- No. 1055/100 m/a. Grey
- No. 1055/150 m/a. Red
- No. 1055/250 m/a. Brown
- No. 1055/500 m/a. Yellow
- No. 1055/750 m/a. Green
- No. 1055/1 amp. Blue
- No. 1055/1 1/2 " " Lt. Blue
- No. 1055/2 " " Purple
- No. 1055/3 " " White

The long straight fuse path totally enclosed, and the method of fitting the fuse, are points in favour of the cartridge type. These Fuses are in accordance with B.S.S. 646 and R.C.M.F. Specifications.

Length 3/4 in.

- Short for Wanderfuse, etc.
- No. 1052/60 m/a. Black
- No. 1052/150 m/a. Red
- No. 1052/250 m/a. Brown
- No. 1052/500 m/a. Yellow

ALL RATINGS AND SIZES
ONE PRICE Each 6d.



Patent

"WANDERFUSE." No. 1028.

Contains a 150 m/a. fuse. For use in the H.T.—lead. No higher than a Wander Plug. Particularly suitable for use in G.B. circuits. Black or red. With 150 m/a. fuse.

Complete 1/-



MAG-NICKEL
DELAY FUSE

Length 1 1/2 in.

These Fuses will withstand twice as much instantaneous overload or surge as the normal type.

- Cat. No. 338/250 m/a. Brown, 3 valve receivers.
- 338/500 m/a. Yellow, 4 to 8 valve receivers.
- 338/750 m/a. Green, Multi-Valve sets, telegrams, television receivers, public address apparatus, etc.

All One Price 9d.

TWIN SAFETY FUSEHOLDER

Reg. Design 767316.



Bakelite moulding, safe and efficient. Impossible to touch fuses unless cover withdrawn, when fuses are accessible, and disconnected from mains, and apparatus is dead. Mount on panel or baseboard. With two 1-amp. fuses.
No. 1033. Complete 2/9

SINGLE OPEN FUSEHOLD



A compact Fuseholder to take 1 1/2 in. fuses. Heavy phosphor bronze clips, soldering tags and terminals. With 1 amp. fuse.
No. 1034. Complete 10d.

FUSED MAINS INPUT CONNECTOR



Heavier type with sockets and plugs to conform to B.S.S., 5 amp. standard. With fuses (1 amp. unless otherwise requested).
No. 1114. 5 amp. (B.S.S.) Complete 4/3

FUSE PLUG



Bakelite moulding, B.S.S. and R.C.M.F. specification, 5 amp. but standard with 1 amp. cartridge fuses. One hole fixing, cord grip, small, ideal for radio receivers, portable lamps, electric clocks, etc.
No. 1278. Price, complete with two 1 1/2 in. fuses, 2/-.

PANEL FUSEHOLDER



Single hole fixing. Insulated from panel. Neat and compact; robust and reliable. Terminals for easy connecting. 1 amp. fuse, or as required.
No. 1064. Complete 2/-

Send for "Radio and Electrical Accessories," 1/2 post free.

BELLING-LEE
FOR EVERY RADIO CONNECTION

BELLING & LEE, LTD.,
CAMBRIDGE ARTERIAL RD., ENFIELD, MIDD.X.

Quick fault-tracing DEMANDS ACCURATE TESTING



British made

- CURRENT**
0-6 milliamps
0-30 "
0-120 "
VOLTAGE
0-6 volts
0-12 "
0-120 "
0-240 "
0-300 "
0-600 "
RESISTANCE
0-10,000 ohms
0-60,000 "
0-1,200,000 "
0-3 megohms

The D.C. AVOMINOR

45/-

Deferred Terms if desired.

Even the smallest degree of distortion in television calls for immediate remedy. Slight faults which might pass unnoticed in radio become, in television, glaringly apparent imperfections. More than ever is an accurate testing meter of first importance—vital to perfect reception.

the world-famous D.C.

AVOMINOR

Regd. Trade Mark

is 13 accurate instruments in one. Circuits, valves, components, batteries and power units can all be tested quickly and easily. In handsome case, with leads, interchangeable crocodile clips, testing prods and instruction booklet.

The UNIVERSAL AVOMINOR

gives 22 different ranges of readings. The best of A.C. and D.C. meters. 3-inch scale. Total resistance 200,000 ohms. Complete with leads, crocodile clips, testing prods and instruction booklet.

THE AUTOMATIC COIL WINDER & ELECTRICAL EQUIPMENT CO., LTD.,

Winder House, Douglas Street, London, S.W.1
Telephone: Victoria 3404-7.

The UNIVERSAL AVOMINOR

- | | |
|-------------------|-------------------|
| D.C. VOLTS | A.C. VOLTS |
| 0-75 millivolts | 0-5 volts |
| 0-5 volts | 0-25 " |
| 0-25 " | 0-100 " |
| 0-100 " | 0-250 " |
| 0-250 " | 0-500 " |
| 0-500 " | |
| MILLIAMPS | RESISTANCE |
| 0-2.5 milliamps | 0-20,000 ohms |
| 0-5 " | 0-100,000 " |
| 0-25 " | 0-500,000 " |
| 0-100 " | 0-2 megohms |
| 0-500 " | 0-5 " |
| | 0-10 " |



£51/-.
leather Case 10/-

Deferred Terms if desired.

● Send for fully descriptive folders post free.

SOUND SALES



CHOKES

In addition to the fourteen standard types of Chokes described in our new Catalogue and priced from ten to fifty shillings each, we are constantly producing numerous other types built to specification. All types are designed on very generous lines and each one upholds Sound Sales' reputation for quality products at reasonable prices.

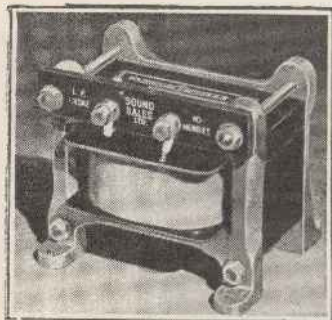

Specified for the
PRE-AMPLIFIER
POWER PACK

Type "W.W." C.I.

15/-

20 Henry Choke.

OUR NEW 56 PAGE CATALOGUE of Amplifiers, All-wave Chassis, Four-band Tuners, Speakers, Radiogram, Feeder Units, Mikes, Chokes, and Transformers, is yours, post free for 6d.

SOUND SALES LIMITED

Marlborough Road, Upper Holloway, London, N.19

Phone: Archway 1661-2-3 (Contrs. to G.P.O., etc.)

AN EXAMPLE:—

THE BULGIN RANGE OF L.F. CHOKES

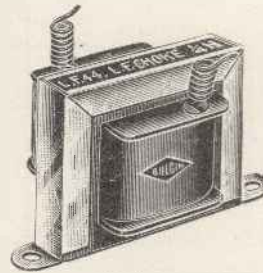

MANUFACTURERS' TYPES

List No.	Type.	Price
LF.44	25-H. at .5-A., 6.1 Ω	6/-
LF.43	Tapped at .05, 1.0, 1.5, 2.0 and 2.5-H. Total 3-H.	7/6
LF.16s	20-H at 20-m/A. 700-Ω	6/6
LF.20s	32-H at 15-m/A. 900-Ω	7/6
LF.39	8½-H at 60-m/A. 400-Ω	7/6
LF.40	25-H at 20-m/A. 750-Ω	7/6
LF.67	5-H at 60-m/A. 210-Ω	7/6
LF.68	7-H at 50-m/A. 250-Ω	7/6
LF.69	10-H at 45-m/A. 300-Ω	7/6
LF.70	15-H at 35-m/A. 580-Ω	7/6
LF.71	20-H at 30-m/A. 660-Ω	7/6
LF.72	30-H at 25-m/A. 1,000-Ω	7/6
LF.73	40-H at 20-m/A. 1,250-Ω	7/6
LF.74	50-H at 15-m/A. 1,500-Ω	7/6
LF.14s	20-H at 50-m/A. 400-Ω	9/6
LF.15s	32-H at 30-m/A. 600-Ω	9/6
LF.17s	50-H at 25-m/A. 1,000-Ω	10/6
LF.18s	10-H at 60-m/A. 320-Ω	10/6
LF.21s	15-H at 100-m/A. 450-Ω	15/-
LF.34s	100-H at 10-m/A. 1,800-Ω	12/-

METAL CASED TYPES

(fitted with terminals)

List No.	Type	Price
LF.18	10-H at 60-m/A. 320-Ω	12/6
LF.14	20-H at 50-m/A. 400-Ω	12/6
LF.15	32-H at 30-m/A. 600-Ω	13/6
LF.17	50-H at 25-m/A. 1,000-Ω	13/6
LF.34	100-H at 10-m/A. 1,800-Ω	15/6
LF.21	15-H at 100-m/A. 450-Ω	15/6

Q.P.P. OUTPUT CHOKE

LF.31 Tapped to feed Speakers of 7,500 and 10,000-Ω 15/-

TAPPED OUTPUT CHOKE

LB.3 Ratios 1:15, 1:1.25, 1:1.5, 1:2, 1:3.5, 55-m/A. max. 16/-

SEND FOR 120 PAGE FULLY ILLUSTRATED CATALOGUE NO. 157M.I. PRICE 3d.

NEW MAZDA

● Each month this page will contain data on special television valves developed by MAZDA engineers for use with EDISWAN Cathode Ray Tubes.

TELEVISION VALVES

TYPE U.21 RECTIFIER

A half-wave rectifier with slow-heating cathode designed to apply the H.T. gradually in cathode ray tube circuits. A sufficient delay time enables the cathodes of valves and tube to attain working temperature before the application of the H.T. voltage.

CHARACTERISTICS

Heater volts	-	-	-	-	2.0
Heater current	-	-	-	-	1.6a
Max. Anode volts	-	-	-	-	4500
Peak Reverse volts	-	-	-	-	12500
Mean Anode Current	-	-	-	-	5.0mA
Peak Anode Current	-	-	-	-	55mA
Delay Time:—After	35. sec.	H.T. is	15%	of	final value.

Price 20/-

TYPE AC/5 PEN

A 'beam power' output valve for use in the output stage of sound receivers. It is capable of delivering a power output of 5 watts with an input voltage of 5.0 r.m.s.

CHARACTERISTICS

Heater volts	-	-	-	-	4.0
Heater current	-	-	-	-	1.75a
Max. Anode volts	-	-	-	-	250
Mutual conductance	-	-	-	-	8.5 mA/V
Optimum load	-	-	-	-	5000 ohms
Base	-	-	-	-	B.V.A. 7-pin

Price 13/6

TYPE AC/5 PEN DD

As above with the addition of a double diode.

Price 16/-

Mazda Radio Valves are manufactured in Great Britain for The British Thomson-Houston Co. Ltd., London and Rugby

EDISWAN CATHODE RAY TUBES

EDISWAN CATHODE RAY TUBES are used by leading set makers and home constructors on account of their exceptional efficiency and brilliance.

The full range now includes 9" and 12" tubes electrostatically and magnetically focussed. Write for full particulars to the Technical Service Department, 155 Charing Cross Road, W.C.2.

THE EDISON SWAN ELECTRIC CO. LTD., 155 CHARING CROSS ROAD, LONDON, W.C.2

R.M.324



TELEVISION

and SHORT-WAVE WORLD

Special Features

	PAGE
Manfred von Ardennes' Laboratory	132
Television in Easy Stages ...	133
Simplest Home-Built Televisor ...	138
Baird Colour Television ...	149
Exposure Meter for Cathode-ray Oscillographs ...	151
More About Brightness Level ...	156
The Ultra Television Receivers ...	160
Two-valve Receiver for 10 Metres ...	163
Operating RME 69 ...	166
Inverse Feed-back Circuits ...	167
Combined Field-strength Meter ...	169
Regenerative Pre-amplifier ...	173
New National Communication Receiver	176
W8JK Beam Antenna ...	178

TELEVISION AND SHORT-WAVE WORLD

Proprietors :
BERNARD JONES PUBLICATIONS, LTD.

Editor-in-Chief :
BERNARD E. JONES.

Editor :
H. CORBISHLEY, (F.T.S.)

Editorial, Advertising and Publishing Offices :

Chansitor House, 38, Chancery Lane, London, W.C.2.

Telephones : Holborn 6158, 6159.

Telegrams : Beejapee, Holb., London.

Subscription Rates : Post paid to any part of the world—3 months, 3/6; 6 months, 6/9; 12 months, 13/6.

Published Monthly—1/- net.
(On the first day of the month).

Contributions are invited and will be promptly considered. Correspondence should be addressed according to its nature, to the Editor, the Advertisement Manager, or the Publisher, "Television and Short-wave World," Chansitor House, Chancery Lane, London, W.C.2.

IMPORTANT

"Television and Short-wave World" is registered at the General Post Office, London, for transmission to Canada and Newfoundland by Magazine Post. Entered as Second-class mail matter, Boston, Mass.

COMMENT OF THE MONTH

Clearing the Air

THE important statements made last month at the dinner given to representatives of the Press by the Radio Manufacturers' Association should do much to clear away a considerable amount of misconception that has existed with regard to television. Statements were made on behalf of the Television Advisory Committee, the B.B.C. and the Radio Manufacturers' Association and it was clear from their tenour that now there is a genuine understanding between these bodies and real appreciation on the part of each that television must eventually become as an important factor in our daily lives as is sound broadcasting at present.

The important facts which emerge from these statements were that a progressive policy of development both as regards entertainment and technique would be pursued, and the assurance that was given the public that television was no longer regarded as being in the experimental stage. It was stated most definitely that no fear need be entertained that receivers purchased now would be obsolete or useless within a few months, or even years, and that the general policy of development was to be directed with this end in view. Improvement in receiver design and methods of transmission there is, of course, bound to be, as with any other commercial article, but there is the promise that no fundamental change will be made for a period of nearly three years. We can go further than this and give the assurance that as the modern television receiver is such an exceedingly adaptable piece of apparatus, no difficulty would be experienced in modifying it for a different standard of transmission should this be decided upon at the end of the stated period.

The Simplest Receiver Yet

IN this issue we present to our readers a design of a complete vision receiver which we claim is the simplest yet evolved. Its only limitation is the size of the picture, a limitation which has been essential in reducing the cost to a very low level. Picture definition and quality, we may say, leave little to be desired and the receiver will provide adequate entertainment for home use. A careful study of the design and circuits will show how really simple is the construction. We place this receiver before our readers in the hope that they will find in it an opportunity of taking practical interest in a fascinating hobby and obtaining a share of the television entertainment which is available.



MANFRED VON ARDENNE'S LABORATORY

The name of Manfred von Ardenne is well known to all workers in television and the following account of the development of his research laboratory during the past ten years will be of interest to readers. The photographs illustrating this article were kindly supplied by him.

The house in the Jungfernstieg where the modern laboratory is housed.

ON February 1, 1928, the apparatus of the original laboratory was transferred to a house in the Jungfernstieg, Lichterfeld-Ost, Berlin, and two definite problems were undertaken for investigation. These were in the development of radio receivers and

the laboratory resumed its work on the investigations mentioned above.

In 1930 the main interest centred round television technique and this work threatened to over-run into all the allied departments of the laboratory. Besides the main aspects of the high-frequency side of the science

The manifold nature of the work undertaken and the improvement in laboratory facilities offered by the enlarged premises have given a new impetus to the keenness of the staff, and the results obtained owe a great deal to this factor.

An important recent development



H.F. and L.F. laboratory. On the left-hand side are generators and potential dividers for L.F. work, with the usual oscillographic equipment. On the right is the H.F. apparatus. Wavemeters can be seen in the foreground.

amplifying valves, but it was found during the course of the first year's work that these problems were more concerned with the whole field of high- and low-frequency technique. The experience gained during the early days, and the apparatus developed, have proved invaluable in the working out of subsequent investigations in the field of electronics, and in the development of cathode-ray oscillographs.

In the early years it frequently appeared that the technique of measurement had become an end in itself, but this was largely the result of temporary financial restrictions. It was not until 1933 that this branch of the work was transferred to an associated commercial company,* and

* (Leybold-von Ardenne—Ed.)

there were the allied investigations into optics, glass technique, electron optics and even microscopy.

Problems presented by industry are frequently brought to the laboratory for solution, and these include research on ultra-sonic waves, physical chemistry and sound films.



Television laboratory. The receiving set for 441 lines can be seen on the left, while in the foreground is an electrolytic trough for plotting field lines. At the back is a film scanner and apparatus for investigating stereoscopic projection.

has been an improved electron microscope possessing new features with great potential possibilities.

Optics laboratory. A long room with benches holding apparatus for investigating spectra, glass stresses, etc. The main instrument cupboard is on the right.



TELEVISION IN EASY STAGES

I.—WHAT THE RECEIVER IS AND WHAT IT DOES

This is the first article of a short series explaining in an easily understandable manner the salient points of television

HERE is one essential feature in a television receiver, whatever its type, and this is the production of a spot of light which is projected on to the viewing screen. The whole picture, in fact, is developed from this spot of light and upon its size depends the detail which it is possible to get into the

must be provided for moving it at an extremely high speed over the screen in successive lines so that the whole screen is covered by the spot—that is, it must have occupied every part of the screen in one-twentieth of a second. Actually, with the average size television screen the speed of the spot necessary to do this is approximately 18 miles a second!

Other requirements are that the intensity of light given by the spot must be capable of variation within periods of exceedingly small fractions of a second during its traverse over the screen and that this variation must be capable of being produced by radio impulses received from a distant transmitter.

There is a third fundamental requirement and this is that the travelling light spot must synchronise exactly to the minutest part of a second with its equivalent at the transmitter.

It can now be appreciated how the production of a television picture differs from that of the cinema. In the latter case, as is well known, successive pictures are thrown upon the screen at the rate of twenty-four a second; they are projected as *entire* pictures, but with

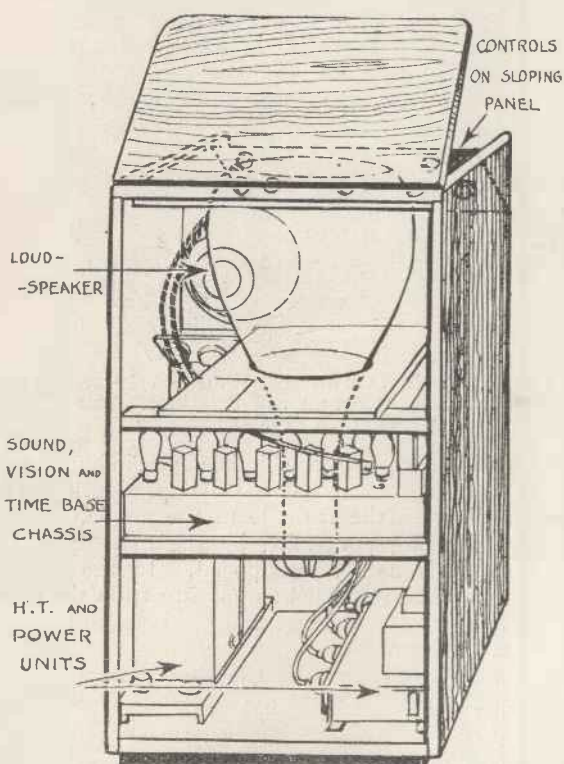

A typical arrangement of the units of a television receiver in which the picture is viewed in a mirror placed at an angle of 45 degrees. The cathode-ray tube, it will be seen, is vertical.

picture. Obviously, if the detail is to be good or as we say "of high definition" then the spot must be very small.

The spot of light is fundamental and it can be produced by a variety of means, but as all commercial receivers that are at present on the market produce this spot by causing a stream of electrons to strike a specially prepared surface and make it fluoresce at the point of impact, this is the only method which we need consider at present.

The Picture is Built Up

Now the production of a spot of light on a screen is a very simple matter, but this spot of light must have other attributes for television purposes. Some means

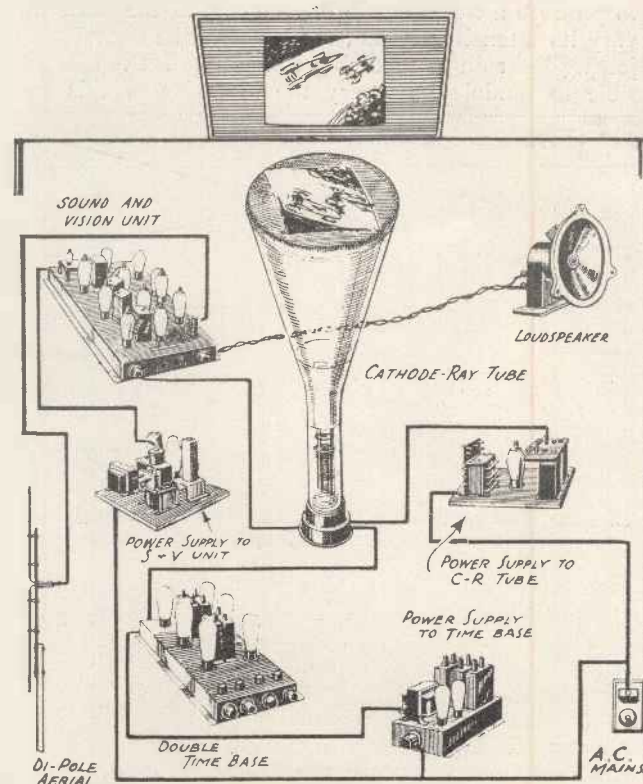

Schematic diagram of the units comprising a complete sound and vision receiver. In practice the power supplies are often combined to form one unit.

HOW THE CATHODE-RAY TUBE WORKS

television it is necessary to *build* the picture up about the same number of times per second merely from a tiny unit of light of constantly varying intensity.

It is well to appreciate exactly why there should be this difference, for obviously it complicates the problem of picture construction. The reason is solely that it is at present impossible to transmit a picture by radio or wire all at once; with sound broadcasting this is possible and it is what may be described as the *ensemble* that is transmitted. With a picture it is therefore necessary to take it unit by unit for transmission and rebuild these units in their proper sequence and with equivalent light intensities in the receiver.

Why Short Waves are Used

Obviously, these conditions increase complication and make the whole process more difficult than would be the case if the picture could be transmitted as a whole. Another factor is that they necessitate extremely high radio frequencies if a reasonable amount of detail is to be transmitted, and for this reason the transmissions have to be on very short wavelengths, which again has certain disadvantages because the range is somewhat limited. Some day it might be possible still further to increase the frequencies employed so that to all intents and purposes the picture would be transmitted as a whole, the time intervals being so small as to be virtually instantaneous. At the present time, however, it does not appear feasible to increase the frequency to any extent.

Now there are several methods than can be employed to produce a travelling light spot and at the same time vary its intensity; it can, for instance, be done by projecting light on to revolving mirrors and it is also possible to modulate or vary the intensity of this light

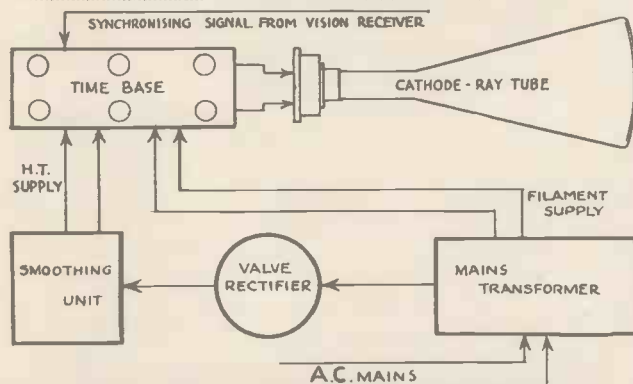

Schematic drawing showing the cathode-ray tube equipment consisting of the time base and power supplies.

either at its source or during its passage to the screen. Systems employing this method are called optical-mechanical and are entirely successful. The most general type of receiver, however, employs a cathode-ray tube which, as it has no moving mechanical parts, rather simplifies the problem though there are certain inherent disadvantages with this method, the chief of which is the limitation of the size of the picture owing to the impossibility of making tubes which are evacuated of any considerable size. This problem of picture size is, however, being tackled in another way, by

producing an intensely bright picture and projecting this optically, though the problem presents certain technical difficulties which up to the present have not been entirely overcome.

The Cathode-ray Tube

Perhaps the simplest way of getting some idea of the construction and principle of the cathode-ray tube is to take the comparison of an ordinary wireless valve,

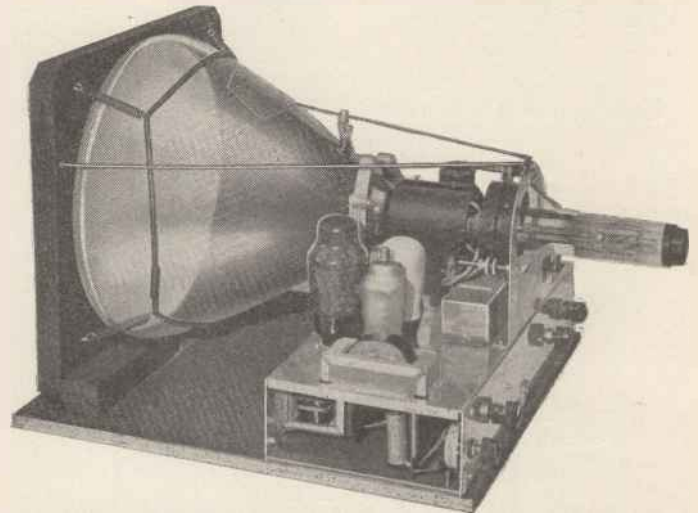

An excellent example of the assembly of the cathode-ray tube with its associated scanning equipment and time base. This is the unit employed in the Baird T11 receiver.

to which in many respects it is very similar. Everyone nowadays knows that a valve produces electrons which pass from the cathode to the anode, their rate of passage being controlled by the grid upon which the wireless signals are imposed. In the valve the electrons may be regarded as passing from the cathode to the anode in cloud formation. They are quite invisible and weightless.

In the cathode-ray tube the same principle is employed, but we go further and instead of allowing the electrons to travel to the anode as a cloud of varying intensity, they are, by suitable means, compressed into a very fine pencil or beam. Also by suitable means the electrons of which the beam is composed are caused to travel at such a high velocity that they shoot past the anode through a hole which is provided in it and impinge upon the end of the tube which may be from a foot to more than two feet distant from the cathode at which they were originally produced.

As stated before, an electron beam is quite weightless and invisible but its presence can be made visible by causing it to strike against a screen of fluorescent material which becomes luminous at the point of impact and the presence of the beam therefore is revealed as a spot of light of the same area as the cross sectional area of the beam. If this spot be moved quickly the appearance on the screen will be a line of light owing to persistence of vision.

The fact that the beam is weightless is a very valuable characteristic for it means that it is not possessed of inertia and therefore it is possible to cause it to swing about at incredibly high speeds without any lag

“DRAWING” THE PICTURE

when the direction of motion is changed as would be the case were it to have weight.

In the electron beam, therefore, we have a means of producing a spot of light of considerable intensity and it is moreover possible to make this spot of light travel over a screen in any predetermined direction and at practically any speed.

Moving the Electron Beam

The beam of electrons can be caused to swing about because in effect it is a conductor carrying current, and it will respond therefore to a magnet or electrostatically charged plate. Both methods are employed and the construction of the tube depends upon the

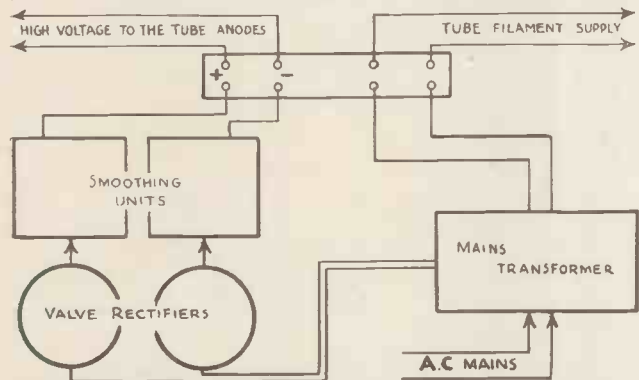

Schematic drawing showing how the L.T. and H.T. supplies are fed to the cathode-ray tube.

choice. In the case of the electromagnetically controlled tube coils of wire are placed round the neck and outside the tube, whereas with the electrostatically controlled type metal plates are fitted inside as two pairs, one pair to produce horizontal deflection of the beam and the other pair vertical deflection.

It must clearly be understood that a television receiver has to perform *two separate functions*, the first the production of a light spot which moves across the screen at a predetermined rate and sequence, and the second the modulation or intensity variation of this light spot in conformity with the variation of the impulses received from the transmitter.

The production of the light spot and its motion is *entirely a function of the receiver*, that is, both the light and the means to provide it with suitable motion are entirely developed in the receiver. The modulation of the light, however, is a result of the received radio impulses and it may be compared with the sound produced by a loudspeaker in an ordinary broadcast set.

There is a third function which the receiver has to perform, and this is to maintain the correct speed of the light spot so that its position on the screen corresponds exactly to its equivalent at the transmitter. This correction is made by means of a triggering action at the end of every line scan and also at the end of each completed frame or picture. This is necessary because it has been found impossible to keep the spot running at precisely the same speed unless some correcting impulse from the transmitter is applied.

We are now in a position to see exactly of what a

television receiver of the cathode-ray type must consist. In the first place there is the cathode-ray tube, and as is the case with a valve this must be provided with high- and low-tension supplies but with the difference that owing to the comparatively great distance that the electrons must travel the high-tension voltage must be very much greater than is the case with an ordinary broadcast sound receiver. The usual voltage, in fact, is round about 4,000. The provision of this high voltage necessitates a special high-tension unit usually termed a power pack and this is so constructed that it also supplies high- and low-tension for some of the valves employed also, the exact provision being a matter of design which may differ with different makes of receiver.

So far then we have the means of providing a spot of light, but this spot of light would be in a stationary position on the screen and would quickly burn a hole in it. (The spot must be kept moving and be made to move in a predetermined manner. As was mentioned earlier, the movement of the spot is brought about by either applying voltages to two pairs of plates between which the beam passes, or passing current through coils which surround the neck of the tube.

The movement of the spot over the surface of the screen must, as has been stated, be in a predetermined manner; it must in fact be exactly the same as at the transmitter and the timing must also correspond exactly. The direction of the spot travel in practice is from left to right starting at the top and after each line is completed there is a very rapid fly-back in order to commence a fresh line. The scanning direction is,

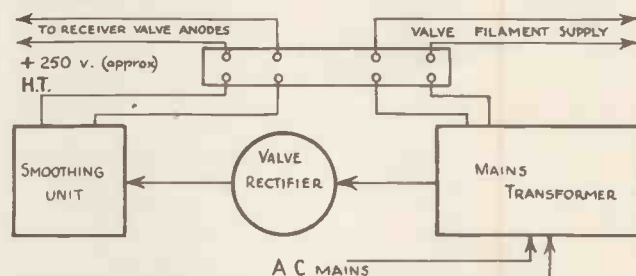

Schematic drawing showing method of supplying low- and high-tension current for the sound and vision receivers.

in fact, exactly as one reads the page of a book—line by line from left to right with a flyback so fast as to be invisible. After the spot has completed one scan of the screen the spot then flies back to the top again to commence another scan, each complete scan representing a picture.

In order to avoid flicker it is usual now to use interlaced scanning—that is alternate lines are scanned and then the spot flies back to the top of the screen and traverses the spaces between these lines. This, however, is a refinement and does not affect the general principles.

The Time Base

The scanning movement of the spot is brought about by means of a unit called a time base, one being used

THE VISION SIGNAL RECEIVER

for the line scanning and the other (operating at a lower speed) for the picture or frame scans. This unit is the only one that has not got its counterpart in ordinary wireless practice and its purpose is solely to provide a suitable movement of the spot.

The operating function of the time base is to build up a gradually increasing electrical potential on the deflector plates of the cathode-ray tube and then suddenly, in fact practically instantaneously, discharge this potential. The gradual build-up corresponds to the traverse of the spot from the left to the right of the screen and the instantaneous discharge to the flyback.

Although the time base has no counterpart in ordinary wireless practice, it is constructed upon ordinary wireless lines and actually comprises an assemblage of condensers, potentiometers and resistances with, of course, valves. As a rule, the time base chassis also contains the cathode-ray tube mount for, of course, the tube and time base are closely associated. The construction of the time base is just as simple as any other wireless unit and with certain variable controls that are provided there is no difficulty in its adjustment to provide the scanned screen.

Receiving the Vision Signal

The next requirement is the reception of the vision signals that are sent out from the Alexandra Palace transmitter. As has been explained, these signals represent the actual scene or picture being transmitted but analysed into a series of units, the radio impulses representing these units following each other with extremely rapid sequence. Apart from the fact that the receiver must be capable of receiving at very high frequencies, it is built upon orthodox lines and it is possible to employ either a straight type of receiver or a super-het, the latter, however, more generally finding favour, especially if the televisor is to be operated at any considerable distance from the transmitter.

Television signals occupy a very wide band width of about two million cycles and for this reason they must be transmitted upon the ultra-short wavelengths. The tuning of the receiver obviously must be very broad to accommodate this high frequency, otherwise the pictures would lose definition. In the case of the super-het receiver it is usual to employ intermediate stages working on a wavelength of 15 to 20 metres instead of the more usual 2,000 to 3,000 as is the case with a normal broadcast receiver. Moreover, as the stage gain is quite low because of the methods employed to obtain very broad tuning, it is necessary to use two or more intermediate-frequency stages.

The diagram shows the valve arrangement of a typical vision receiver and it will be seen that the aerial feeds into a pentode H.F. stage which amplifies at speech frequencies and feeds the slightly amplified signal into a detector stage which usually consists of a double valve of the triode hexode type. The triode portion of this valve is an oscillator which converts the signal into one of about 15 or 20 metres with a slight increase in gain. The signal then passes through two or three broadly tuned I.F. stages, increasing in amplitude in each stage, after which it is rectified by a diode second detector and fed into a normal low-frequency amplifier and then into the cathode-ray tube.

From the foregoing it will be clear that the circuit of the vision receiver is exactly the same as for any short-wave super-het receiver, except that, as the tuning is so broad and the stage gain consequently so small, a larger number of valves are required. Constructionally it follows normal practice.

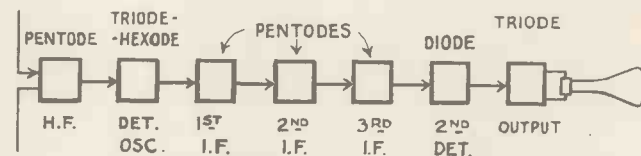

Schematic diagram showing the stages in a vision receiver.

For reasonably short distances, say, up to 35 miles from the transmitting station it is quite practicable to employ a straight receiver consisting of two R.F. stages, a diode detector and two V.F. stages. Further increase in the number of R.F. stages tends to make the receiver unstable, so usually when greater range is required the super-het type of set is employed.

Providing the Power

As there is the cathode-ray tube and a fairly large number of valves in the complete television receiver, it is obvious that suitable power supplies must be provided for the valve and cathode-ray tube heaters and also high-tension. Sometimes the power supplies for the whole receiver are obtained from one unit, but it is more usual to employ one unit for the cathode-ray tube and time base and another for the sound and vision receivers. The usual arrangement of a power unit for the vision unit is a mains transformer providing high- and low-tension, a rectifier (generally a full-wave) valve and a smoothing unit consisting of a choke and two large capacity condensers. This, it will be appreciated, is normal radio practice and the units only differ as regards their output. The vision and sound receiver units usually have an output of 250-300 volts at 100 milliamps. The cathode-ray tube unit, however, is more elaborate because of the greatly increased voltage that it must supply. On this account two rectifier valves are employed, these being the half-wave type. Also two smoothing units are incorporated as it is essential that every trace of mains ripple be eliminated. Condensers and chokes must be of a special kind to withstand the high voltages which are present. The provision of a thermal delay switch is also necessary in order that the heaters of the mercury-vapour rectifier valves can warm up before the high-tension is applied. This delay switch consists of a heater and two dissimilar metals which when heated expand and make contact, thus completing the high-tension circuit after the correct interval of time has elapsed.

From the foregoing explanation it will be clear that in a television receiver there is but little more complication than there is in an ordinary broadcast set—the chief difference is that there is more of it and the number of valves employed is greater, a fact which necessitates increased power.

In continuation of this series for the beginner, next month we intend describing the typical radio units in a vision receiver and explaining the difference between a vision receiver and an ordinary short-wave set and what ultra-short waves are used.

IMPORTANT DEVELOPMENTS

ANNOUNCEMENTS BY SIR FRANK E. SMITH, Television Advisory Committee and CAPT. C. G. GRAVES, B.B.C. Controller of Programmes.

We present below abstracts from two important speeches made on the occasion of the R.M.A. television dinner

SIR FRANK E. SMITH

TELEVISION is not, from a technical point of view, a weakly thing; it will undoubtedly grow into a great industry. On what this country does during the next twelve months the location of the television industry of the world may largely depend, for it will decide

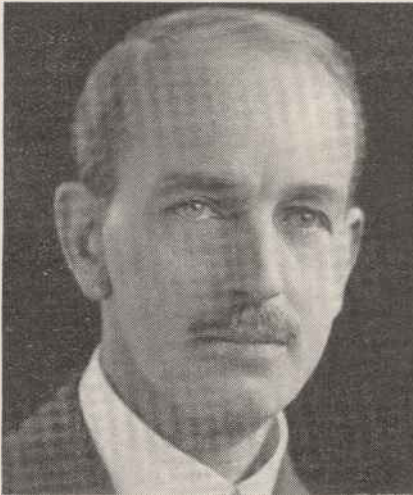

Sir Frank E. Smith, Television Advisory Committee.

whether the television industry is to be located in this country, in America, in Germany, in France or elsewhere. Is it not right that we should do our utmost to ensure that this country, which is to-day in the forefront with regard to television, should have the lion's share?

Recently representatives of the Radio Manufacturers' Association and the Television Advisory Committee met to exchange views. At that meeting the Radio Manufacturers' Association's representatives congratulated the Television Advisory Committee on some of their work, and the Advisory Committee expressed its admiration of the manufacturers' enterprise in producing

excellent receiving sets.

But—and it is a very big but—the number of television receivers at present in use is much too small.

In the London area, that is to say, in that circular area having a radius of about thirty miles and its centre at Alexandra Palace, it is reasonable to expect that there should be in use to-day some tens of thousands of receivers, and in five years' or ten years' time there should be half a million

receivers in use in that area. But in actual fact the total number in use to-day is only a few thousands.

Why are the numbers so small? Is the transmission from Alexandra Palace technically poor and the picture definition bad in consequence? Are the programmes not very good or indifferent? Are the receiving sets unreliable? Are too many adjustments needed, or are the sets too expensive? Or, again, are potential viewers deterred from purchasing sets because they fear that the system of transmission may be changed within a few months? All these questions were considered, and it is clear that neither singly or collectively, are they the real reason for the poor sale of television sets. We are, indeed, convinced that

the principal reason why receiving sets are not selling

in greater numbers is because the public who can afford to purchase at present prices do not realise how good a thing it is that they are missing, or because they do not realise that the present system of transmission will remain unchanged for at least three years.

There is no doubt in my mind that of all the marvellous inventions of man, television is the most remarkable of which we know. I do not wish for a moment to suggest that the developments of television will necessarily be so far-reaching in their effects as the developments of other inventions: I merely claim that, as an invention, television is the most marvellous of all.

And this invention is essentially British! In the system of television now employed, both transmitting and receiving systems employ beams of electrons, and it is well to remember the great work of the Cavendish Laboratory on electrons and the fact that the first cathode-ray tube came to birth in that laboratory.

But it is no use having produced a miracle unless some use can be made of it. What can be the use of television? It can entertain and amuse, it can educate, and it can do nearly all that the theatre and cinema can do.

I confess that I have an axe to grind. The axe I wish to grind is that of British industry. I wish to see a big television industry established in this country, and I

hope that all the units at present involved will help me to grind this axe. It is true to say that in other countries television is just around the corner, but here television has definitely arrived, and in its short life of only twelve months it has grown up appreciably. In ten years' time I have no doubt that the television industry of the world will have an annual turnover of over £100,000,000. What is our share to be of this new industry? I consider it imperative to get ahead now with television. We are first to-day: do let us keep the lead. The next twelve months will, I think, be a critical period.

I am glad to be able to assure you that there will be no change in the present technical standards of transmission for at least three years. The public may therefore purchase without any fear of their sets becoming useless for some time to come.

CAPT. C. G. GRAVES

MR. GRAVES said that the B.B.C. was proud to have been entrusted with the television service, particularly as television at its inauguration was—and still is—further advanced in Great Britain than anywhere else. For this reason the B.B.C. realised the importance of weighing most carefully each fresh step, thus steering clear of rash deci-

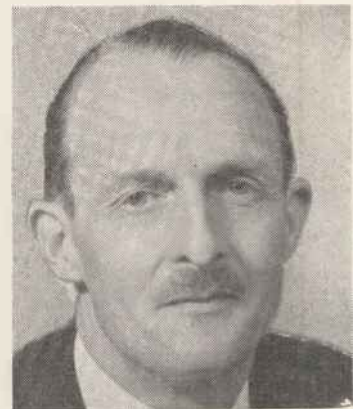

Capt. C. G. Graves B.B.C. Controller of Programmes.

sions which jeopardise progress and endanger the leadership which it was hoped this country would hold.

The B.B.C. was happy in its relationships with the Television Advisory Committee, which, in addition

(Continued at foot of page 139)

AN EXPOSURE METER FOR CATHODE-RAY OSCILLOGRAPHS

Here are details of a simple oscillograph exposure meter that has been developed in the R.C.A. Laboratories. It enables oscillograph photographs to be taken with the correct exposure with varying intensities of trace.

AN important feature of the cathode-ray oscillograph is the ease with which a trace can be photographed. A recurrent trace can be photographed with an ordinary camera, provided the trace remains stationary during a period sufficient for the exposure. Because the intensity of a trace and, hence, its density on the film can be varied

light from a calibrated lamp. The exposure meter shown by Fig. 1 facilitates this comparison. The light from the lamp passes through a colour filter, which passes light of nearly the same colour as that of the trace to be photographed. This coloured light falls on a white diffusing surface of matt paper, which reflects the coloured light to the eye

or the filament current of the lamp until the brightness of the two is the same.

The exposure meter is easily calibrated. The intensity of a trace is adjusted to a low value. The exposure meter is then placed against the screen of the cathode-ray tube and the intensity of the comparison lamp is adjusted until a match is obtained. The filament current of the lamp is then recorded and a photograph of the trace is made. The intensity of the trace is increased slightly and the process is repeated for the same lens speed, magnification, exposure time, and film or plate. A sufficient number of trace intensities are calibrated to cover the working range of the tube.

How the Meter is Used

To reproduce a desired intensity of any portion of a trace, it is only necessary to set the filament current of the comparison lamp at the proper value and vary the intensity of the trace until a match at the desired portion is obtained. It is usually necessary to insert a neutral filter at aperture B of the exposure meter to facilitate calibration of high trace intensities. The location of this filter is shown in Fig. 1.

Fig. 2 shows a number of trace intensities and pertinent data corresponding to each trace. Two calibration readings are shown for each trace: the first corresponds to the intensity at the peaks of the trace and the second corresponds to the intensity at the centre of the trace. The high intensity of the trace at the peaks is due to the low velocity of the spot at these points.

When filament current is used as a measure of the amount of light obtained from the lamp (Fig. 3A) only about one-half the meter scale is useful, because the filament does not begin to glow until the meter reads about half scale. The bridge circuit shown by Fig. 3B is recommended for use when it is desirable to spread the readings over the entire meter

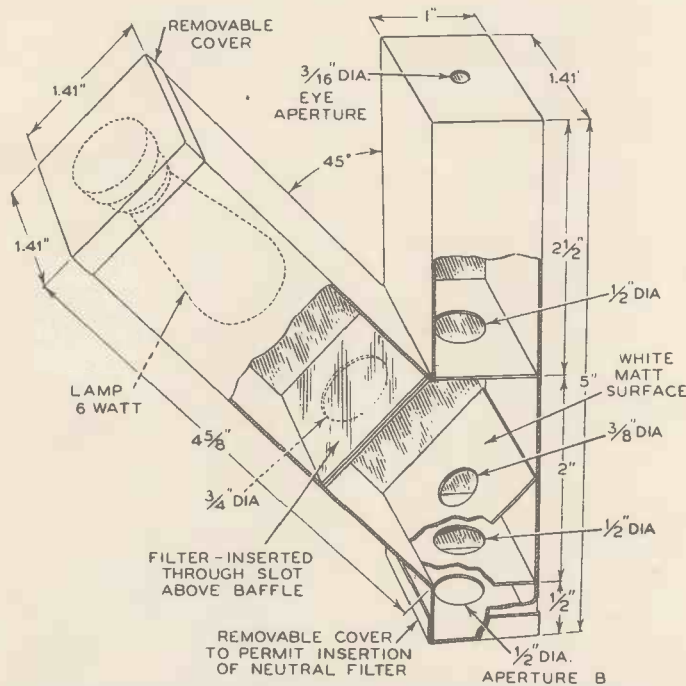

Fig. 1.—Diagram showing the detailed construction of the exposure meter

over a wide range in most cathode-ray oscillographs, it is desirable to have some means for reproducing with fair accuracy a given intensity. This article describes the construction of a simple, inexpensive exposure meter, which facilitates the adjustment of intensity to a predetermined value.

Because the light intensity from a filament lamp can be reproduced easily, the intensity of a trace on a cathode-ray tube can be set to a predetermined value by matching its brightness with that of the filtered

aperture. Thus, the light from the lamp appears to the eye as a coloured oval.

The light from the trace to be photographed passes directly through the hole in the centre of the diffusing surface to the eye aperture. With the proper colour filter in place, therefore, the image at the eye aperture consists of coloured light from the trace to be photographed surrounded by light of nearly the same colour from the lamp. The two components of the image are matched by adjusting the intensity of the trace

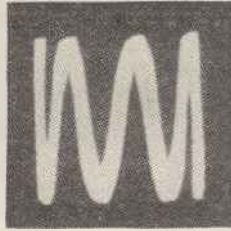
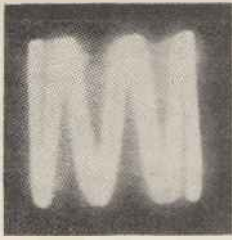
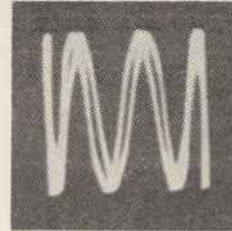

Fig. 2.—Traces of different intensities. Calibration data for these are given in the tables below.



CALIBRATION DATA.*

Trace No.	FILAMENT-CURRENT METHOD Fig. 3A		BRIDGE METHOD Fig. 3B	
	Peak of Trace (Ma.)	Centre of Trace (Ma.)	Peak of Trace (Ma.)	Centre of Trace (Ma.)
1	49	44	15	12
2	45	41	12.5	10
3	41	38	10	8
4	37	34	7.5	6

*These calibration data were obtained under the following conditions: Camera lens, f. 4.5; exposure time, 5 seconds; magnification, 1; film, Verichrome; filter, Eastman Kodak neutral gray filter (10 per cent. transmission) at aperture B of exposure meter. (Magnification is the ratio of size of image to size of object.) This set of calibration data is given only as a guide. Each exposure meter should be calibrated individually, and recalibrated if the lamp is changed.

FILTER DATA.

FLUORESCENT SCREEN TYPE.	NEAREST COMMERCIAL COLOUR FILTER.
Phosphor No. 1—Green (Medium Persistence)	Eastman Kodak No. 58A.
Phosphor No. 2—Blue Green (Long Persistence)	Eastman Kodak No. 43.
Phosphor No. 5—Blue (Short Persistence)	Eastman Kodak No. 47A.

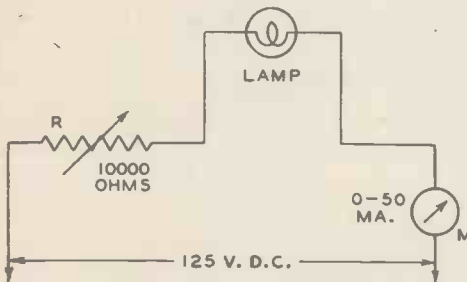

Fig. 3a. Simple circuit for reading lamp current.

scale. (The bridge is balanced by adjusting R_3 with just enough of R_1 and R_2 in the circuit to cause the lamp to glow dimly. R_1 and R_2 are then decreased and R_4 is increased until the meter reads full scale with R_1 and R_2 zero. The amount of light from the lamp is then adjusted by varying R_1 and R_2 . The calibration of the exposure meter is determined in terms of the bridge current (I_m). For higher supply voltages the

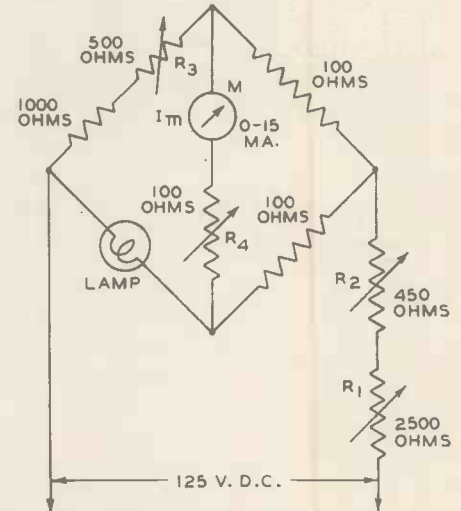

Fig. 3b. Bridge circuit enabling readings to be spread over entire meter scale.

values of the resistances will have to be increased accordingly.

(This exposure meter has been in use for over a year in the R.C.A. laboratory. Its simplicity and ruggedness contribute to its practicability; its accuracy is more than adequate for most purposes.

"IMPORTANT DEVELOPMENTS"

(Continued from page 137)

to having as members eminent scientists such as Sir Frank Smith, also included representatives of the General Post Office, with whom the B.B.C. had always worked in the friendliest co-operation and whose co-operation was essential in the development of television, just as it had been in the development of sound broadcasting. Both through the Television Advisory Committee and directly by meetings at Broadcasting House there was satisfactory liaison with the Radio Manufacturers' Association.

1937 had been a year of experiment and on December 9, in the House of Commons, the Postmaster-General announced financial arrangements which enabled plans to be made for development in 1938. There had been no real difficulty in financing the daily two hours of programmes in 1937 and further development was not

a question of expenditure on artists, etc., so much as on accommodation and staff. It was now possible to take on additional staff, a number of whom had already been engaged.

It had been decided to institute, from April 3, 1938, an hour's programme every Sunday from 9.5 to 10.5 p.m. and it was hoped by the end of the summer to add to this a second Sunday hour. The week-day evening transmissions would also be extended by half an hour whenever practicable.

As soon as

new outside broadcasting gear

became available it should be possible to increase the number of outside broadcasts during the day, some of them additional to ordinary hours of transmission.

The B.B.C. was open-minded as to the time at which broadcasts should take place; hitherto, however, the necessity for allowing sufficient time

for rehearsals between the afternoon and evening transmissions had been the determining factor.

The fusion of television and sound broadcasting was being very carefully considered and there was close co-operation between Alexandra Palace and Broadcasting House

in the planning of programmes as a whole. Arrangements were now being made for broadcasting over the sound system programmes produced at Alexandra Palace, which, if successful, should prove good advertisement for television. There were difficulties, however, which prevented any wholesale action on these lines at present.

The immediate problem was to get television established in the London area. When that was done, and provided, of course, that the means of communication and finance were available, television would be extended to the Provinces.

THE SIMPLEST HOME-BUILT TELEVISOR

Designed by S. West

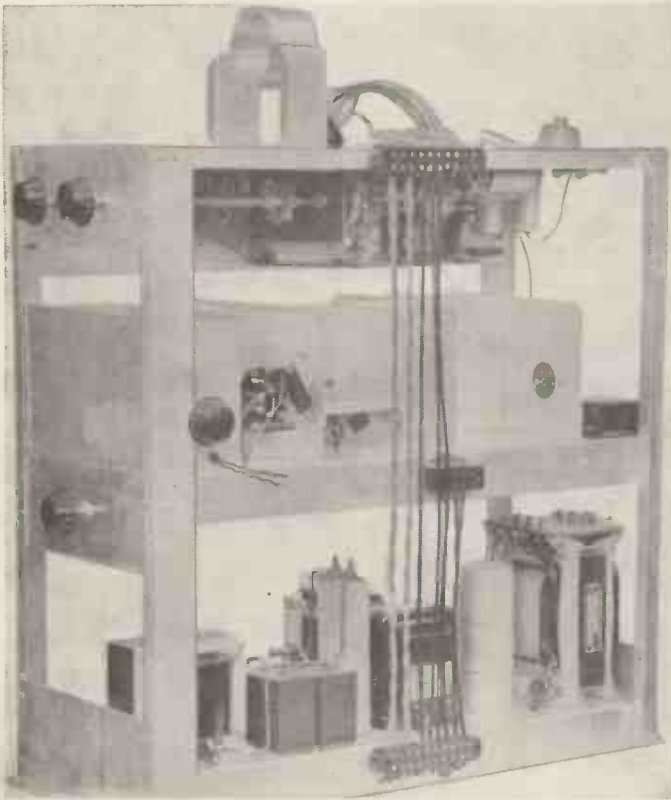

A general view of the complete vision receiver. Chassis construction is of sheet aluminium or steel and is of the simplest type.

LAST month the general form of this new television receiver was detailed. It was shown that a straight receiver having two R.F. stages, a diode detector and two V.F. stages represents the most simple arrangement compatible with efficiency to employ, and greatly reduces the number of valves required. Furthermore, initial adjustments of the vision unit are greatly simplified as there are only three tuning condensers to adjust, two of which are of the pre-set type.

Many tests revealed the sensitivity of this receiver to be high, excellent bright pictures being easily obtained at distances in excess of 30 miles from the transmitter.

Later in this article the full constructional details of the vision unit are dealt with. Before passing on to these actual constructional instructions, however, let us first briefly consider the form the complete receiver takes.

The photographs convey an excellent impression of the finished receiver. Its compact and professional appearance is well revealed.

The Receiving Units

It is seen that the complete vision receiver is divided into three sections.

The bottom deck contains the power pack; in reality this consists of two separate units. The first of these

attends to the vision unit's requirements, the other furnishes the necessary power for the time bases and tube operation.

The second deck contains the vision chassis and finally, as the upper deck, we have the time bases and the C.R. tube's mounting.

Whilst the arrangement adopted permits short interconnecting leads, and for this reason is efficient, it will be apparent that several alternative arrangements are possible. Constructors will have no difficulty in deciding what arrangement is best suited to their own particular needs. However, unless it is desired to utilise an existing cabinet, it is strongly recommended that the

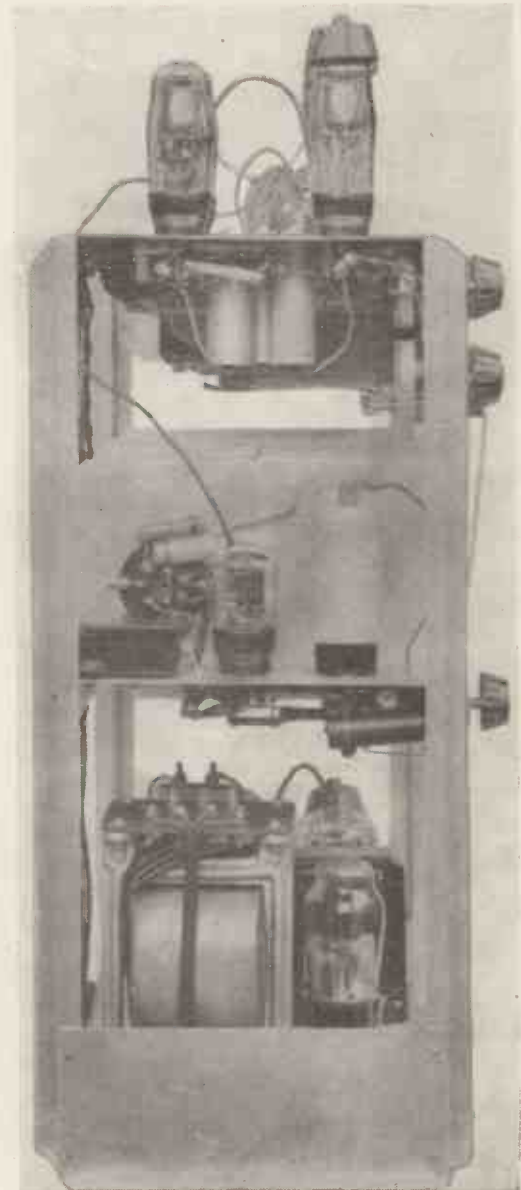

A rear view. As will be seen the entire assembly is very simple.

MARCH, 1938

GUARANTEED PICTURE QUALITY :: CHEAP TO BUILD
FROM STANDARD COMPONENTS :: SIMPLEST YET

In a series of articles that have appeared in this journal during the last few months a good deal has been written regarding the possibility of greatly reducing the cost and complexity of amateur constructed television receivers.

As was revealed last month in an article entitled "Further Notes on the Possibilities of Small Tubes" p.77, the results of a large number of experiments and tests of various apparatus has been collated and a complete television receiver employing a 4 in. tube has been evolved.

A great number of tests has revealed that the range and picture quality secured with this receiver is entirely satisfactory.

Thus for the first time a constructional design for a high-definition television receiver which is capable of furnishing really first class entertainment at a very low cost is presented.

This, the first article of the series, concerns the construction of the vision unit. The following articles in the series will deal with the remaining sections.

Adequate information is contained in these articles to permit any amateur having average ability to construct the complete receiver and be assured of first class results.

TUBE
MOUNT
AND TIME
BASE

VISION
RECEIVER

POWER
PACKS

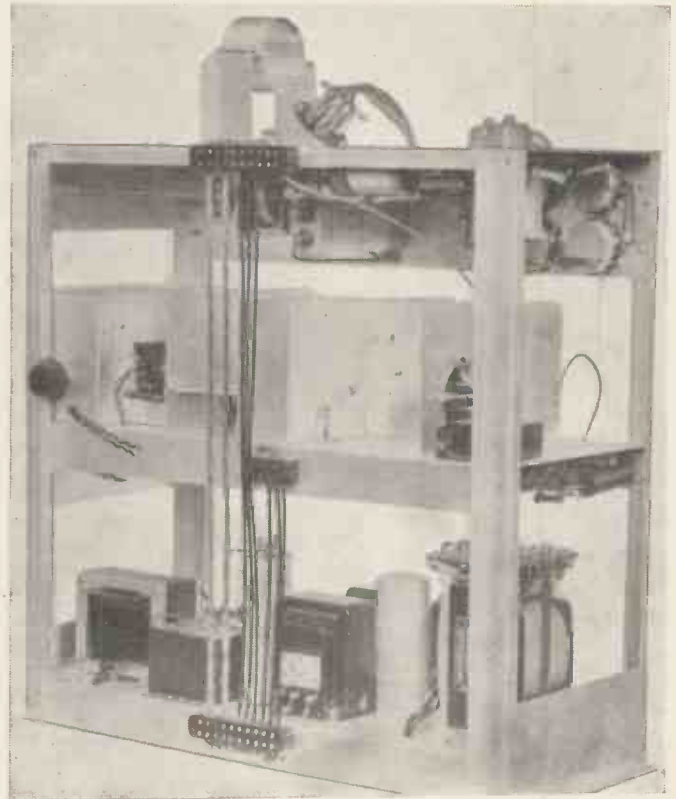

Each chassis unit is easily detachable by undoing a few screws and the wires shown in this picture.

arrangements adopted for the original be adhered to.

Adverting once more to the photographs, it will be seen that only three controls are located at the front of the chassis. These are respectively, the brilliance and focus controls, and the gain, or as it is sometimes termed, the contrast control.

As normally no adjustment of the remaining controls is required after the initial correct settings are found, these are all conveniently grouped at one side of the chassis.

No unusual safety precautions are included in the design to prevent accidental contact with any point at high potential. It was deemed unnecessary to include the elaboration that this would involve. It will be as well to bear this in mind when making any adjustments. Particularly are these remarks applicable to the tube

This is a plan view of the vision chassis with all the components assembled. The reference letters apply to the various sections shown in further detail by other illustrations. This chassis is built up with turned edges secured by screws and its construction is particularly simple. Measurements are given by a drawing in a later page.

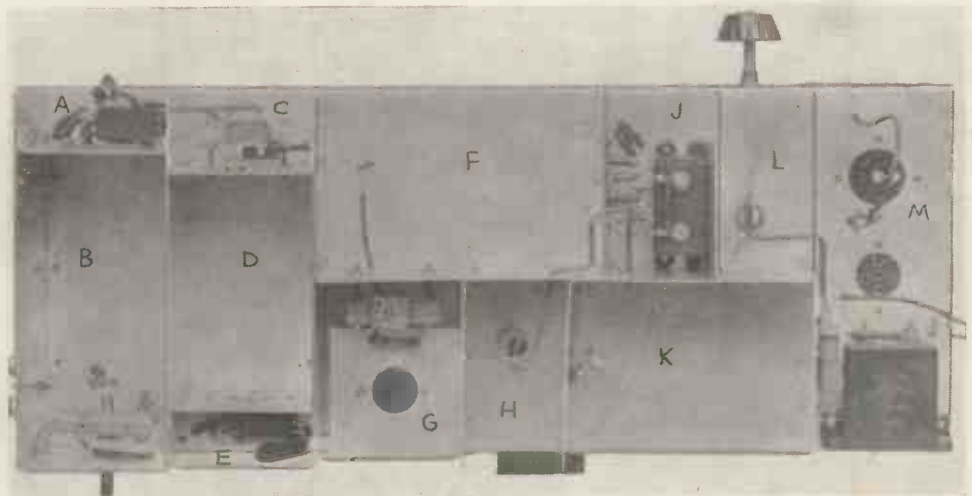

VISION RECEIVER, TIME BASE AND POWER PACK CIRCUITS

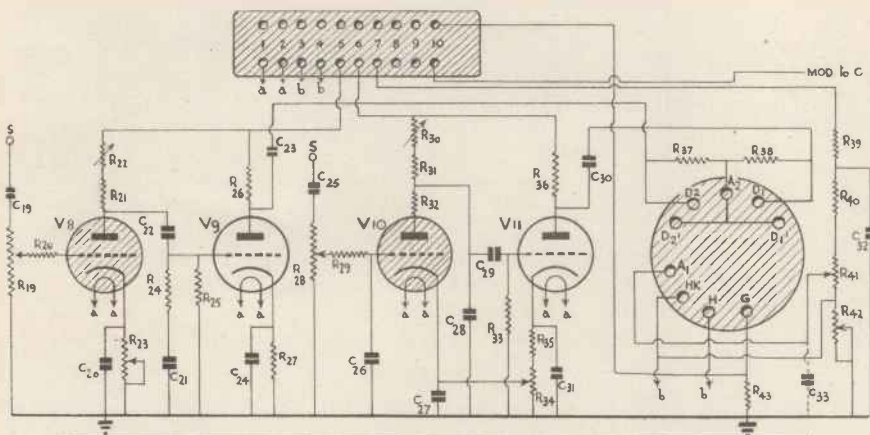
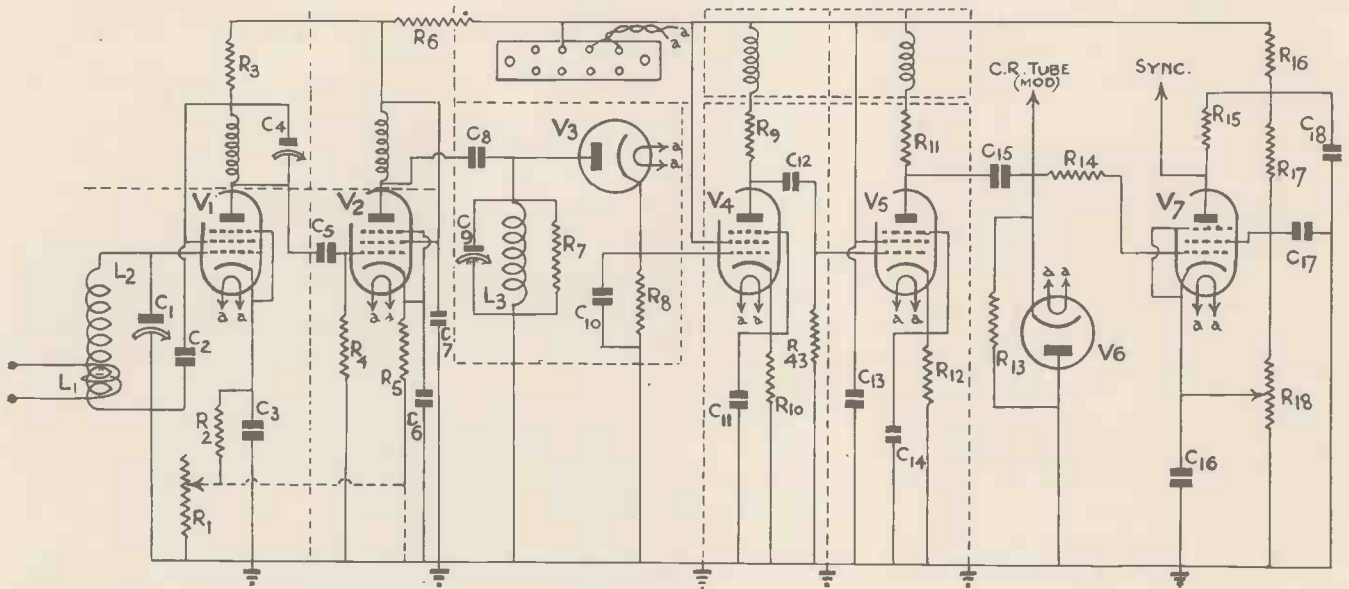

Above—The vision unit circuit. One of the main advantages of a receiver of this type is the fact that within reason the set will always provide some sort of signal no matter how inaccurate the ganging. This makes testing a very simple matter and does not call for special test equipment.

Left—Circuit of time base. Constructors should not have any difficulty in building this time base. The cathode-ray tube base shows the actual connections to be made.

THE DRAWINGS ON THIS PAGE GIVE THE ENTIRE WIRING OF THE WHOLE RECEIVER

The two power packs provide 1,000 volts for the cathode-ray tube and approximately 300 volts for the valves in the vision receiver. V12 is a delay switch to prevent application of the high voltage to the anode of the rectifier valve before the heater warms up.

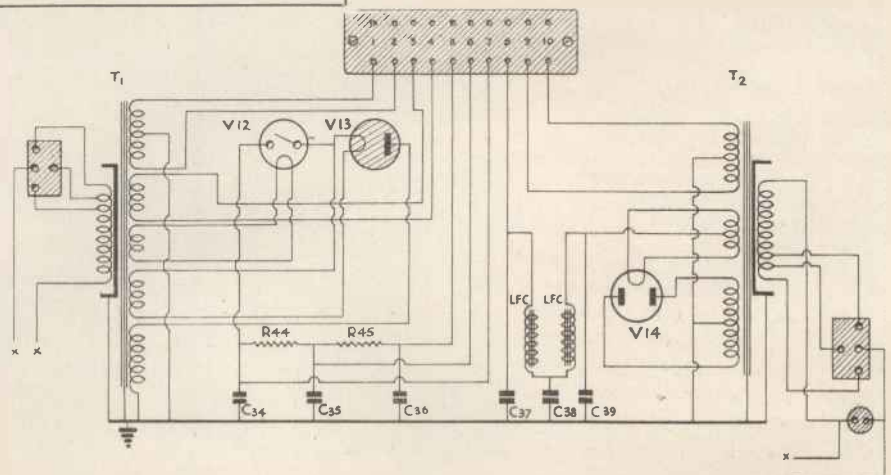

MARCH, 1938

PARTS VALUES AND MAKES FOR COMPLETE RECEIVER

THE VISION UNIT

CONDENSERS.

- C1 15-mmfd. variable (Raymart).
- C2 0.01-mfd. (Dubilier type 670).
- C3 0.01-mfd. (Dubilier type 670).
- C4 Trimmer 30-mmfd., max. (Eddystone type 1023).
- C5 0.0005-mfd. (Dubilier type 690W).
- C6 0.01-mfd. (Dubilier type 670).
- C7 0.01-mfd. (Dubilier type 670).
- C8 0.0005-mfd. (Dubilier type 690W).
- C9 Trimmer 30-mmfd. Max. (Eddystone type 1023).
- C10 0.00002-mfd. (Dubilier).
- C11 500-mfd. 12 v. (T.C.C. Type 501).
- C12 0.1-mfd. (Dubilier type 4603/S).
- C13 0.1-mfd. (Dubilier type 4603/S).
- C14 500-mfd. 12 v. (T.C.C. type 501).
- C15 0.1-mfd. (Dubilier type 4603/S).
- C16 50-mfd. 12 v. (Dubilier type 402).
- C17 0.01-mfd. (Dubilier type 670).
- C18 0.5-mfd. (Dubilier type 4608/S).

RESISTANCES.

- R1 30,000-ohms potentiometer (Reliance).
- R2 100-ohms $\frac{1}{2}$ watt (Dubilier).
- R3 500 ohms $\frac{1}{2}$ watt (Dubilier).
- R4 100,000-ohms $\frac{1}{2}$ watt (Dubilier).

- R5 100-ohms $\frac{1}{2}$ watt (Dubilier).
- R6 1 000 ohms $\frac{1}{2}$ watt (Dubilier).
- R7 10,000-ohms $\frac{1}{2}$ watt (Dubilier).
- R8 3,500-ohms $\frac{1}{2}$ watt (Dubilier).
- R9 3,500-ohms 2 watts (Dubilier).
- R10 200-ohms $\frac{1}{2}$ watt (Dubilier).
- R11 3,500-ohms 2 watts (Dubilier).
- R12 100-ohms $\frac{1}{2}$ watt (Dubilier).
- R13 1-megohm $\frac{1}{2}$ watt (Dubilier).
- R14 500,000 ohms $\frac{1}{2}$ watt (Dubilier).
- R15 150,000-ohms 1 watt (Dubilier).
- R16 10,000-ohms 2 watts (Dubilier).
- R17 10,000-ohms 2 watts (Dubilier).
- R18 5,000-ohms potentiometer (Reliance).

SUNDRIES.

- Ch.1 High frequency choke (Eddystone type 1011).
- 1—Stand-off insulator (Eddystone type 1019).
- 1—Banana plug and socket (Belling-Lee type 1078).
- 5—7-pin valve holders (Belling-Lee).
- 2—4-pin valve holders (Belling-Lee).
- 1—Terminal block (Eddystone type 1046).
- 2— $\frac{1}{2}$ in. Coil formers (Bulgin).
- 2— $\frac{3}{8}$ in. Coil formers (Bulgin).
- 5—Valve thimbles (Belling-Lee type 1175).

THE TIME BASE

CONDENSERS

- C19 0.001-mfd. (Dubilier type 670).
- C20 50-mfd. 12 v. (Dubilier type 402).
- C21 0.001-mfd. (Dubilier type 670).
- C22 0.001-mfd. (Dubilier type 670).
- C23 0.005-mfd. (Dubilier type 670).
- C24 20-mfd. 50 v. (Dubilier).
- C25 0.1-mfd. (Dubilier type 4603/S).
- C26 0.002-mfd. (Dubilier type 670).
- C27 50-mfd. 12 v. (Dubilier type 402).
- C28 0.5-mfd. (Dubilier type 4608/S).
- C29 0.1-mfd. (Dubilier type 4603/S).
- C30 0.1-mfd. (Dubilier type 4603/S).
- C31 50-mfd. 50 v. (Dubilier type 3004).
- C32 2-mfd. 1,000 v. (Dubilier type 950).
- C33 Optional see text.

RESISTANCES.

- R19 50,000-ohms potentiometer (Reliance).
- R20 150,000-ohms $\frac{1}{2}$ watt (Dubilier).
- R21 500,000-ohms 1 watt (Dubilier).
- R22 500,000-ohms potentiometer (Reliance).
- R23 50,000-ohms potentiometer (Reliance).
- R24 1,000-ohms $\frac{1}{2}$ watt (Dubilier).
- R25 1-megohm $\frac{1}{2}$ watt (Erie).
- R26 100,000-ohms 2 watts (Erie).
- R27 5,000-ohms $\frac{1}{2}$ watt (Erie).

- R28 50,000-ohms potentiometer (Reliance).
- R29 20,000-ohms $\frac{1}{2}$ watt (Dubilier).
- R30 2-megohms potentiometer (Reliance).
- R31 500,000-ohms 1 watt (Erie).
- R32 1,000 ohms $\frac{1}{2}$ watt (Erie).
- R33 500,000-ohms $\frac{1}{2}$ watt (Erie).
- R34 2,000 ohms potentiometer (Reliance).
- R35 8,000-ohms $\frac{1}{2}$ watt (Erie).
- R36 200,000-ohms 2 watts (Erie).
- R37 1-megohm $\frac{1}{2}$ watt (Erie).
- R38 1-megohm $\frac{1}{2}$ watt (Erie).
- R39 50,000-ohms 1 watt (Erie).
- R40 500,000-ohms 1 watt (Erie).
- R41 500,000-ohms potentiometer (Reliance).
- R42 50,000-ohms potentiometer (Reliance).
- R43 Optional see text.

SUNDRIES.

- 2—High-voltage valve caps (Bulgin).
- 4—5-pin valve holders (Belling-Lee type 1136/9).
- 2—10-way connecting blocks (Bryce).
- 1—4-way connecting block (Bryce).
- 1—5-way group board (Bulgin type C31).
- 2—9-in. lengths $\frac{1}{2}$ in. diameter steel or brass rod.
- 2—Shaft couplers (Bulgin type 2005).
- 2—Panel bushes (Bulgin type 1048).
- 1—3-way terminal strip (Belling-Lee type 1253).
- 1—Wander plug (Belling-Lee type 1299).

THE POWER PACK

CONDENSERS.

- C35 2-mfd. 650 v. (Dubilier type LEG).
- C36 2-mfd. 650 v. (Dubilier type LEG).
- C37 8-mfd. electrolytic (Dubilier type 32814).
- C38 & C39 8-8-mfd. electrolytic (Dubilier type 9203F).
- C39 1-mfd. 1,500 v. (Dubilier type 950).

RESISTANCES.

- R44 50,000-ohms 15 watts (Bulgin type PR 17).
- R45 10,000-ohms 1 watt (Dubilier).

SUNDRIES.

- 3—4-pin chassis valve holders (Belling-Lee).
- 2—Voltage-selector boards with fused bridges (Clix).
- 1—High-voltage valve cap (Bulgin type P.92).

- 2—Smoothing chokes (Varley_type DP 11).

TRANSFORMERS.

- T1 Mains Transformer (Keston Mfg. Co.).
Primary 200-250 v.
Secs. 4 v. 1 a.
4 v. 1 a.
2-0-2 v. 5 a.
1,000 v. 15 m/A.
2 v. 2.5 a.
- T2 Mains Transformer (Sound Sales).
Primary 200-250 v.
Secs. 300-0-300 v. 90 m/A.
2-0-2 v. 5 a.
2-0-2 v. 8 a.

VALVES, TUBE AND CHASSIS

- V1, 2, 4, 5 Mullard TSP4.
- V3 & V6 Osram D42.
- V7 Osram MSP4.
- V8 & V10 Mazda type T31.
- V9 and V11 Mazda type AC/P.

- V12 Mazda DLS1 vacuum delay switch.
- V13 Mazda type MU2 rectifier.
- V14 Mullard type IW3 rectifier.
- Mullard C.R. Tube type A41-4 (white) or A41-G4 (green).
- Chassis, nuts and bolts and wire, etc. (Mervyn)

socket, the legs of which are not insulated and are, in some cases, at high potential. It can be remarked, however, that at no point does a voltage higher than a little over 1,000 exist, therefore any possibility of a dangerous shock is non-existent.

As we have already considered the circuits employed fairly fully in the articles preceding this series, it is

not necessary again to describe the various theoretical considerations underlying the design. We will, however, briefly review the general form of the arrangement adopted, for in this way a clearer insight into the functions of the various units is obtained. This will greatly facilitate construction and subsequent adjustment.

THE RECEIVER CHASSIS AND COILS

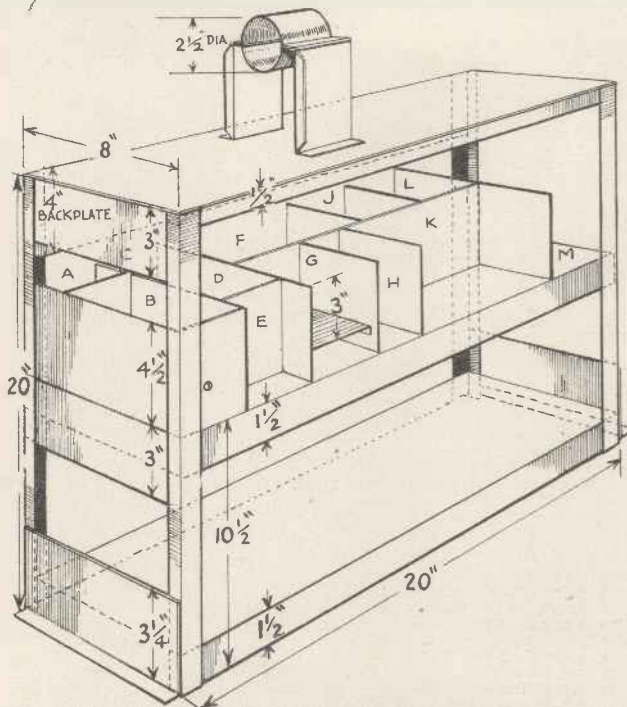

Dimensioned drawing of complete chassis.

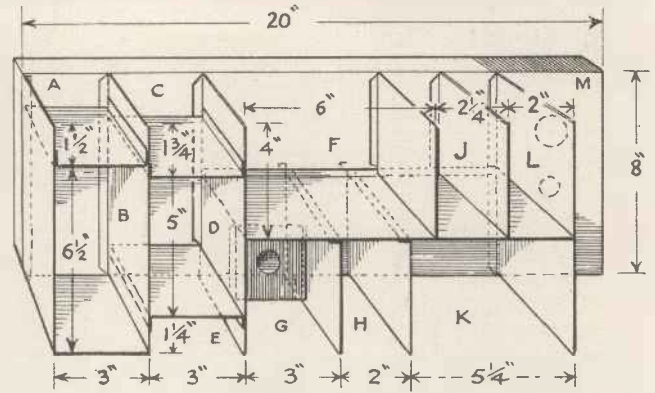

Details of vision unit chassis.

The Vision Unit

The vision unit employs a straight circuit. Seven valves in all are used. Two of these valves function as radio-frequency amplifiers and are followed by a diode valve which rectifies the amplified carrier provided by these two stages. This rectified signal is passed to two further valves operating as video frequency amplifiers. The output from the final video frequency stage is used to modulate the grid of the C.R. tube.

The remaining two valves for which we have not as yet accounted are a diode valve and a screened grid valve. The diode valve functions as a D.C. restorer, the screened grid valve is responsible for synchronising pulses selection. The method favoured is well known and makes use of the fact that by suitably apportioning the valve's electrode potentials a short operating characteristic having an abrupt termination is secured. This short characteristic can only accommodate that part of the signal due to the synchronising pulses, rapid attenuation of any signal higher in amplitude taking place. The effect is further augmented by including a high resistance in series with the grid of the valve.

The Power Packs

The power packs are perfectly straightforward, and for this reason will require little description. One of these furnishes 250 volts at about 80 milliamps for the vision unit. Adequate smoothing is required as the post-detector gain is comparatively high. An indirectly-heated rectifier is employed as this avoids the application of high voltages before the various valve's heaters have attained their normal operating temperature.

The other power unit furnishes a little over 1,000 volts at about 15 milliamps. The full voltage is available for C.R. tube excitation, and roughly 500 volts of it furnishes power for time base operation. In this case the excess voltage is dropped across a power resistance and thereby sufficient smoothing of this supply is provided. A Mazda vacuum-type delay switch is used to switch this voltage.

The Vision Unit Circuit

The circuit for the vision unit is shown earlier. It is seen that seven valves in all are employed and their

The Time Base

The time base employs four valves, two for each scan voltage generated. The arrangement adopted is quite conventional, Mazda type T31 relays are employed to generate the high- and low-frequency saw-tooth oscillations. These oscillations are then, in each case,

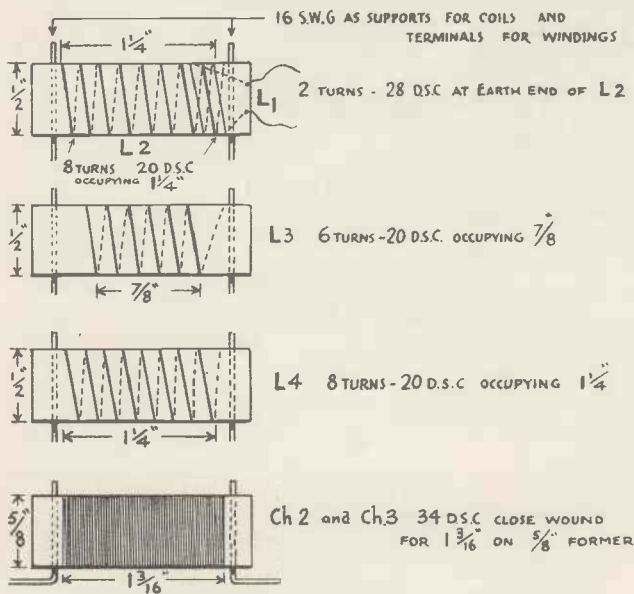

Winding data of coils employed in vision unit.

increased to the required amplitude with triode valves (Mazda type AC/P). For the slow speed scan, the shape of the saw-tooth wave is slightly "faked," otherwise as this deflection voltage is applied to normally disposed deflection plates aspect distortion would result.

BAIRD TELEVISION LTD.

**WORLD PIONEERS & MANUFACTURERS OF
ALL TYPES OF TELEVISION EQUIPMENT**

★ **FIRST IN 1926** ★

★ **FINEST IN 1938** ★

Brilliant pictures, freedom from distortion, excellent detail, wide angle of vision, extremely simple operation, high fidelity sound and all-wave radio are among the factors contributing to the first-class performance of all Baird Television receivers. Incorporating every modern feature in television development, each model in the range represents the high-water-mark of achievement.

★ ★ ★ ★

Each television receiver incorporates a Baird "Cathovisor" Cathode Ray Tube which has the outstanding advantage of being completely electro-magnetic in operation. These tubes can be supplied separately with the necessary scanning equipment where desired. Apart from manufacturing processes, stringent tests are made for electrical emission, tube characteristics, filament rating, and screen quality, and following normal picture reconstitution under service conditions, every Baird Cathode Ray Tube, on completion, is subjected to a very high external pressure test.

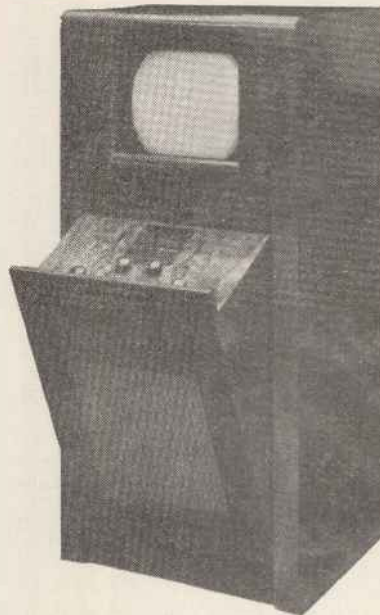

One of the latest Baird Receivers
Model T11

**VISIT
STAND
No.
A709
AT
OLYMPIA**



**VISIT
STAND
No.
A709
AT
OLYMPIA**

21 FEB - 4 MAR
OLYMPIA 6 EARLS COURT LONDON
SEE OUR EXHIBIT

Baird "Cathovisor" Cathode Ray Tubes are the ideal solution for high quality television pictures.

★ ★ ★ ★

A large number of Flat installations have already been carried out and amplifier equipment for this purpose is available. Vision and sound are provided "on tap" in any room desired, and technical advice will be given by the company's experts on all points.

★ ★ ★ ★

Another important development is the Baird Multiplier Photo-electric Cell, of which there are various types. The Baird Multiplier is a chain of electron permeable grid stages, and under service conditions very high current gain factors can be obtained. Cathode sensitivity is approximately 30 microamps per lumen. These Multiplier Cells are suitable for all television and sound on film work, together with many industrial applications where high gain, coupled with sensitivity and extremely high signal to noise ratio, is essential.

Write for descriptive

Literature, post Free

Head Office :

Laboratories :

**Greener House, 66, Haymarket,
LONDON, S.W.1**

**Crystal Palace, Anerley Road,
LONDON, S.E. 19.**

'Phone: Whitehall 5454

'Phone : Sydenham 6030

OF TECHNICAL IMPORTANCE

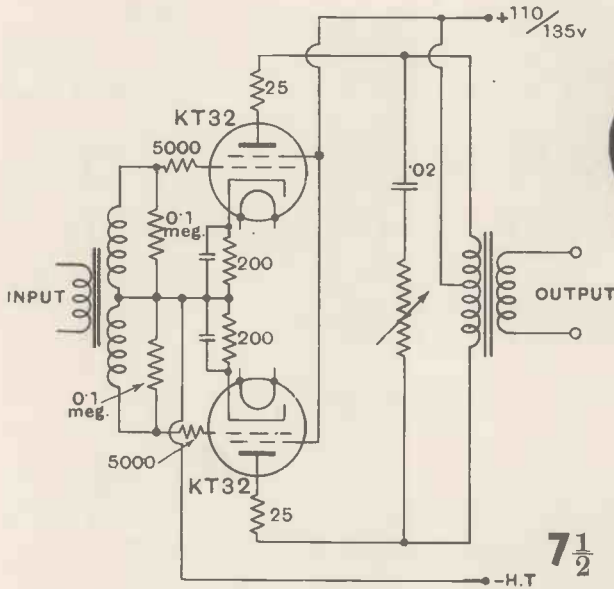

Osram Valves

**7½ WATTS OF UNDISTORTED POWER
OUTPUT AT 135 VOLTS H.T.**

TYPE KT32

(for D.C. and D.C./A.C. Amplifiers and Receivers)

TYPE KT32 CHARACTERISTICS

Heater current	0.3 amp.
Heater voltage	26 volt.
Anode voltage	135 max.
Screen voltage	135 max.
Anode current	.75 m.a. max.
Screen current	5 m.a.
Anode dissipation	10 watts
Mutual conductance	.9.0 m.a./volt

PRICE **13/6** EACH

The Osram KT32 is an aligned grid "beam" power Tetrode specially designed to give a large undistorted power output at low H.T. voltages of the order of 110 to 135 volts.

In a push-pull circuit it is possible to obtain an output of 4 watts for a pair of valves at an H.T. voltage as low as 110, or 7.5 watts at 135 volts.

The KT32 is extremely efficient due to the aligned grid feature, the screen current is only 5 m.a. per valve under maximum condition of output.

Ideal for Universal amplifiers required to operate on all supply voltages down to 110 D.C.

For series heater running with other valves in the 0.3. amp. International range.

The "International" Self-locating Octal base is fitted.

OSRAM VALVES – DESIGNED TO ASSIST THE DESIGNER

Made in England

THE COMPONENT ASSEMBLY

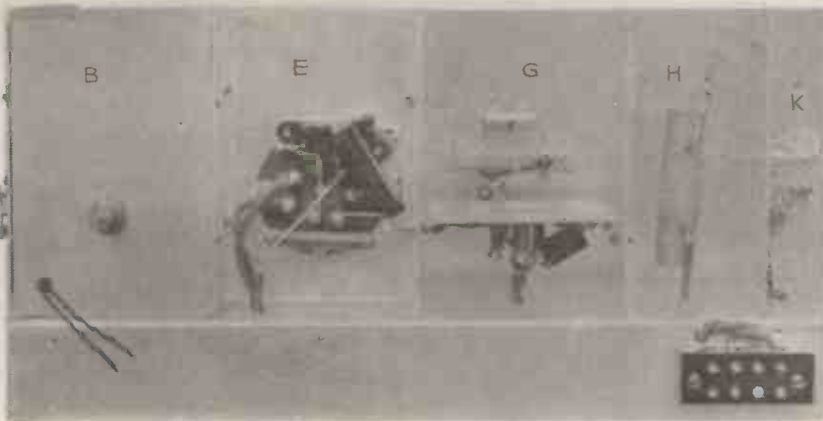

respective functions have earlier been remarked. We have already seen that a video frequency amplifier from the television viewpoint is extremely efficient. For this reason two stages are employed and furnish a concerted gain of about 450 times. This is mentioned at this stage for then the need for employing only two R.F. stages is apparent.

A single R.F. stage employing one of the high- μ R.F. pentodes will, with care, furnish a gain of about seven times. Obviously the gain through two such stages is almost fifty times. The total gain of a receiver employing two R.F. and two V.F. stages is about 22,000 times.

This amount of amplification proves adequate for all locations situated at distances up to 25-35 miles from the transmitter.

Wiring the Vision Unit

The photographs and drawings will make clear the construction and wiring of the unit.

The metal work is carried out in either aluminium or metal sheet. Aluminium is, of course, very much simpler to manipulate and drill. For this reason its use is to be preferred.

It is well known that better R.F. stability is secured



Component assemblies in compartments A and C.

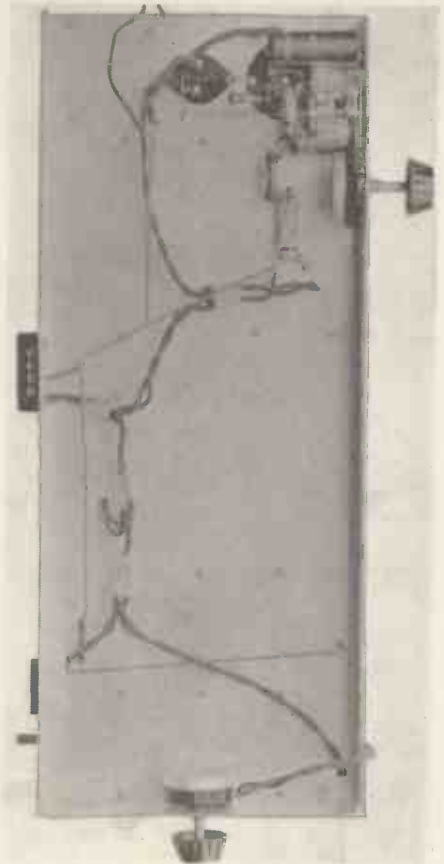

The photograph above shows part of the component assembly of the vision unit and that on the right the underside of vision unit.

when one heater connection is directly made to the chassis and usually this is the arrangement adopted when wiring the heater supplies for a vision receiver. It is perhaps not so well known, however, that when more than one V.F. magnifying stage is used, then, this arrangement for the heater wiring can cause a great deal of trouble. It is often the explanation for an inability to secure good synchronism.

The reason for this is simply that mains hum is

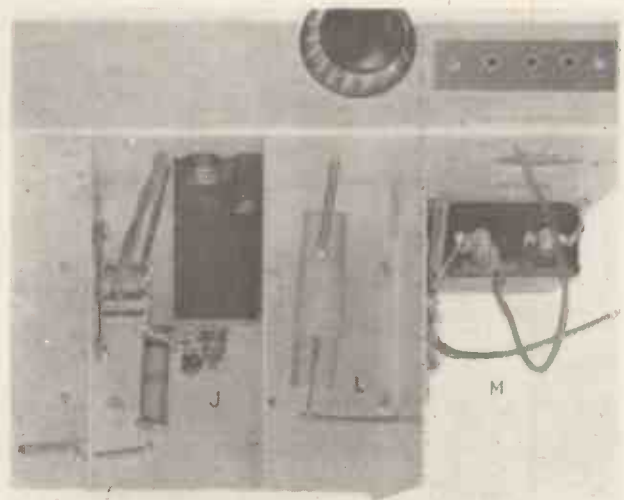

Component assemblies in compartments J, L, and M, shown with the unit turned on its side.

WIRING THE VISION UNIT

provoked, the amplitude of this hum often proving sufficient entirely to take charge of synchronism for the slow speed scan, causing the picture to lock at some intermediate position. It can also adversely affect the line synchronism. Apart from these deleterious effects, even when a sufficiently powerful signal, which can furnish synchronising pulses having sufficient amplitude to overcome the existing hum level is obtained, there is always an annoying dark horizontal area present to mar the picture quality. It is for this reason that twisted heater leads and a centre tapped heater winding are employed.

The Coils

The winding data for the coils and the correction inductances are given in the drawing.

L₁ consists of two turns of silk-covered instrument wire at the earth end of L₂.

L₃ and L₄ are quite straightforward.

The correction inductances Ch₂ and Ch₃ consist of No. 38 s.w.g. d.s.c. instrument wire occupying 1 3/16 in. winding length on a 5/8 in. coil form. The turns are close wound and it should be possible to get approximately 110 turns into this space.

These inductances, as also the coils L₁-L₄, are readily supported when wiring by means of the 16 s.w.g. tinned copper wire used for terminating the windings.

The condenser C₁ tunes the inductances L₂. To permit adjustment of this condenser a slot is filed at the end of the spindle. The trimmer adjusting tool can then be used to rotate this condenser. This trimming tool is simply fashioned from a size 4 or 6 knitting needle. The point is removed and a blade end is fashioned with the aid of a fine file.

The original components layout as revealed by the various photographs should be adhered to, as far as is possible. The R.F. by-pass condensers, C₂, C₃, etc., are soldered directly to the valve holder sockets. All leads are kept short and are preferably taken direct to each appropriate junction. Right-angle bends whilst making for a neat appearance should be avoided.

Actually it is extremely unlikely that any trouble will be experienced due to instability for the radio-frequency gain is quite low.

The resistance R₇ across the coil L₄ is included as the input impedance of the diode valve V₃ is higher than is the impedance of the R.F. valves V₁ and V₂. It is permissible to omit it if slightly higher gain is desired without seriously affecting picture quality.

Care with the disposition of the coupling condensers C₁₂ and C₁₅ is required. These are mounted away from the chassis for otherwise the stray shunt capacities formed will reduce the response at the higher frequencies. Furthermore, the extra capacity so introduced is sufficient to render inaccurate the correction inductance constants.

Modulation is applied to the grid of the C.R. tube direct from the junction of C₁₅ and R₁₃. A convenient way of doing this will be described later. In addition, a connection from this point is taken to the small terminal strip at the side of the chassis. This will permit simple connection of headphones to facilitate the

initial tuning adjustments. An extra socket on this terminal strip serves as the synchronising feed binding post.

Reference to the circuit discloses that no chassis connection is made to the 4-way Bryce connecting block. A little consideration reveals this to be unnecessary for the metal uprights of the complete assembly will complete the earthed circuits. If, as was suggested earlier, a different arrangement is adopted, it is important to bear this fact in mind. Provision to complete the inter-chassis earth connections is then required.

Some doubt may exist regarding the correct connections for the gain control R₁. This control is not actually mounted on the vision unit proper. Reference to the illustration reveals it to be mounted on a small sub-panel at the front of the complete receiver. This will introduce no constructional difficulty; the control is simply attached to a twisted pair having sufficient length to permit this mounting to be made.

As is indicated by the dotted connections in the circuit diagram the potentiometer may control either the gain of a single R.F. stage or its control may be extended to be applicable to both stages. In either case the same resistance value for the potentiometer is entirely satisfactory.

The actual wiring up of the unit will be found straightforward and no difficulty whatever should be encountered if the information conveyed by the diagram and illustrations is intelligently applied.

Tinned copper wire, insulated with sleeving where required, can conveniently be used for the wiring. Twisted 14/36 slide back type wire is very suitable for the heater connections. The usual care in connection with the avoidance of dry joints and the application of excessive heat is observed and where chassis connections are to be made a clean bright surface contact must be assured.

Having completed the wiring the valves may be inserted and if a power pack is available preliminary tests can be conducted.

For these preliminary tests headphones are connected across the appropriate sockets of the terminal strip. It is preferable and in any event it is essential, if it is required to check the functioning of the synchronising pulses filter, to include a condenser having a capacity of about 0.1 mfd. in series with the headphones. It is seen from the diagram that this condenser becomes necessary when the phones are attached to the anode of the sync. separator valve V₇.

Adjustment of the filter stage is carried out with the potentiometer R₁₈. A position for the control is found where the noise due to the picture vanishes leaving only the regular beat due to the synchronising pulses.

Actual tuning of the R.F. sections is extremely simple. The various circuits are in each case adjusted to resonate at the frequency of the vision carrier, i.e., each is tuned for maximum signal. The gain control is preferably reduced during this operation for this will sharpen the tuning and render the task of accurate adjustment simpler.

This completes the construction and adjustment of the vision unit. In the next article of this series the time base and the cathode-ray tube mounting will be dealt with.

Telegossip

A Causerie of Fact, Comment and Criticism

By L. Marsland Gander

TIME and television march on. We enthusiasts are interested now mainly in one thing, namely, when the new expansion plans, of which there has lately been so much talk, will have due effect on the programmes.

I am sorry to open on a doleful note but I must, in candour, comment that the B.B.C. are characteristically making haste slowly. Just before writing these notes I was privileged to make an exhaustive tour of Alexandra Palace. Though I am assured that much progress has been made on paper there was absolutely no sign of a practical start on the alterations and extensions.

The reason, I believe, is still that the B.B.C. do not yet know exactly how much extra the Government intend to grant to television. I freely admit that the B.B.C. must cut its coat according to its cloth. But there is another equally important consideration.

Educating the Public

Recently the B.B.C. Television Advisory Committee and the Radio Manufacturers' Association joined forces to persuade the Press and the public that television is a good, stable and expanding thing. I gave some hints of this move last month.

One of the offerings made on the altar of confidence was a promise that no change would be made in the standard of definition for three years. Now this is a diminishing factor. As time goes on it becomes two and a half years, two years, and so on.

Therefore speed is the essence of the contract.

Another point is that the attacks made in a Big Push must follow one another in quick succession or the ground gained will be lost again. Much time and trouble have been spent in convincing the newspaper editors that television is going to push ahead.

Now are we all to sit down and have a good think about it? Or is there to be immediate and convincing follow-up action. I hope, Mr. Gerald Cock, that you will take this perhaps needless urging in the spirit intended and like the grand leader I know you to be!

As regards this question of the "three years' limit" it is most important that the trade should try to educate the public. Nobody likes to buy an article with a time-limit to its utility. Experts have often told me that moderately simple alterations could be made to existing sets to adapt them to higher standards of definition. Yet statements are repeatedly made which suggest to the hesitant buyer that in 1940 he can just throw his £60 set straight on to the scrap-heap.

Baird Colour Television

After regrets and an apology! I apologise for referring to colour television which I know will be described in detail elsewhere in this issue. But as the outstanding television event of the month I must make some slight reference, and I offer to Mr. J. L. Baird and his technical staff my sincerest congratulations. I saw a demonstration at the Dominion Theatre in the company of Lord Selsdon, chairman of the Television Advisory Committee, Dr. Clarence Tierney, chairman of the Television Society, and others. I shared the opinion expressed to me by Dr. Tierney that the colours, whatever the deficiencies of definition, were more natural than those of most colour films. Lord Selsdon, who in his official capacity is not permitted to make public statements, was plainly as impressed as other members of the audience.

Mr. Baird told me that he is off to the Radio Convention in Sydney, where he will stay just a fortnight. If the part of a pioneer has its trials it also has compensations.

An hour's Sunday programme, as a modest first instalment of the extension plans, begins on the afternoon of April 3. I hear that the most probable inaugural programme will be one from Mortlake where the mobile unit will be resting from the triumph(?) of the Boat Race on the previous day. Mr. Philip Dorté has an amusing project in mind. He is thinking of reproducing some of the historic races of the past, when they

rowed in top-hats, gum-boots and spurs, or whatever they did wear.

The Boat Race

I am a little troubled about the Boat Race. It must be done, but until we have a television equivalent of the launch *Magician* to follow the crews, how? As it is we shall just see a flash of the finish and the exhausted crews coming ashore, with the possibility of panting interviews.

During my recent tour of Alexandra Palace, I paid a visit to the theatre which is to be converted into a super studio. Incidentally, work at A.P. just shows the B.B.C. boys what a sheltered life they lead. Passing from the warmth of the B.B.C. section across the frozen waste of the Great Hall, where the heaters were turned off, to the theatre was rather like a trans-Polar trip.

As I have said it was a disappointment to find that no start has been made on the adaptation, but it was equally surprising to see that it is already such a busy spot.

Properties

This is the carpenter's shop, where they make everything from a hard-boiled wooden egg to a reproduction of the Parthenon. Such a great amount of space is taken up by storage that there will plainly have to be considerable enlargement of the B.B.C. quarters at Alexandra Palace to accommodate the growing stock of property when the great move takes place.

I came prepared for boredom and was soon marvelling at industry and craft. One man stood like the Prince of Denmark, skull in hand. But he was not contemplative; he was modelling a cunning replica in papier maché absolutely indistinguishable from the original. Another was busy on modelling in the same material a Corinthian capital, the intricate ornament which surmounts fluted marble columns. These aforesaid columns were being made of wooden strips which were finally pieced together in a most ingenious way.

Yet another was making a replica of a horse-pistol with which Clive of India vainly tries to take his life. This was a remarkable piece of work and the craftsman has difficulty in

"Television and Short-wave World"
circulates in all parts of the world.

PLANNING THE A.P. THEATRE

persuading me that it could not actually be fired.

I was shown round by Mr. T. Edwards, the master-carpenter, who takes a proper pride in his very efficient team. There seemed to be nothing they could not make—I saw a mandoline, three violins, and an oriental palanquin, a blunderbuss which could be realistically fired with the aid of a puff of french chalk. "No Man's Land" for "Journey's End" was a shock. I had thought it was a section of film, deceived by the smoke, the churned earth and the tumbled wire. Yet here was the model complete. We viewers do not realise the effort behind production. Yet I confess to a pang of regret when seeing the model of futuristic machinery for "RUR," On the screen my first thought was "That would never work in any circumstances." Here, I thought: "What beautiful workmanship!" Moral to the B.B.C. Don't think too much in terms of "Behind the Scenes."

The A.P. Theatre

I was chiefly interested to discover what sort of a studio the theatre will make. It measures from one extremity to the rear of the stage at the other 141 ft. The width is 61 ft. and it is approximately 60 ft. high. First steps will be the levelling of the floor which at present slopes in theatre fashion. Though it is definite that the place will be adapted on film studio lines and not on theatre lines, the fate of the stage is uncertain. This may be included in the general levelling or the studio may end where the stage begins while the rest of the space is devoted to some other purpose. Perhaps the stage could be used for the orchestra.

In any event the converted theatre will make a studio more than twice the size of either existing studios.

I met Mr. Harry Pringle in the corridors and he told me an entertaining story about Koringa, Mr. Bertram Mills' woman fakir. When she came to the studio she had as co-performers three huge pythons and three medium sized crocodiles. At one point in the proceedings an 8-ft. crocodile got out of hand. He made a bee-line for the camera man, snapping fearsome jaws. Koringa had to "step on everything" to pursue and hypnotise him. Croc was duly

subdued. But behold one of the pythons had now decided to make whoopee by wrapping himself round the wire wheels of the camera truck. Once more Koringa had to do her stuff to disentangle the brute.

Koringa's turn must have given some viewers the shudders, for among other things she thrust a dagger through the skin of her throat as, in schooldays, we used to run pins through the upper flesh of the finger.

The New Announcer ?

Also in the corridors I saw the young Empire announcer, R. N. Dougall. Is he to be Leslie Mitchell's successor I wonder? He certainly has the appearance, young, dark and handsome. And the voice. Officially I am told that there are still four candidates in the field.

Mr. Dougall has been doing a certain amount of "Picture Page" interviewing, I was told, so it looks very much like a "try-out."

Whether viewers like it or not it seems certain that amalgamation of the ordinary sound and television programmes is upon us. The first programme which was broadcast to the medium wave audience besides being televised was a "White Coons" show the other day. I am dubious of the success of this attempt to serve two masters and the artists on the screen showed that they were either thinking of one thing or the other. Movement was restricted, for example.

Broadcasting House and A.P.

However, there is to be another "Sound and Vision" show on March 14. Mr. Harry Pringle will be the producer. He told me that there is to be a "Monte Carlo" setting, with a tea garden and cabaret chorus of twelve Beauty Queens, with eight boy friends.

The biggest job for the mobile unit is to be the first broadcast of an athletic meeting from the inter-Varsity sports at the White City on March 12. Viewers will see the 100 yards, pole vaulting, the 120 and 220 yards hurdles, the high and long jumps, and putting the weight. To depict the mile race satisfactorily Mr. Philip Dorté has under consideration the installation of the camera in a central tower, using telephoto lenses.

Throwing the discus and the javelin will also be shown. The whole transmission will last 70 minutes, with ten-minute intervals from 2.30 until 4.

By the way, I understand that the committee of the Amateur Boxing Association was present in force at the last televised display of the Alexandra Boxing Club and apparently are satisfied that television holds no terrors for the amateur boxer. At any rate we have heard nothing more about the ban. As a matter of fact the grounds for the original ban seem vague for, according to Mr. Dorté, no complaint was ever made that the extra lighting or the heat ever caused any inconvenience. So this experimental evening was arranged, two super-Emitrons were on parade, the B.B.C. were on best behaviour and all's well that ends well.

Obstruction

May there be a similar end to the difficulties with the Epsom Grand Stand Association over the televising of the Derby. That any responsible body should be obstructive is regrettable but a common enough experience. Such instances have often occurred in the history of broadcasting and will be repeated in television. It should only be necessary to prove, on the analogy of broadcasting, that so far from keeping people away from the Derby television will stimulate interest and swell the crowds, to overcome the opposition.

I have been taken severely to task, in conversation, for saying that I preferred the television version of "Rush Hour," Herbert Farjeon's revue, to the stage show under the new name of "Nine Sharp." How can I pretend, I am asked, that the small television screen can rival the life and colour of the real stage?

My answer is (and I am prepared to defend myself to the last ditch) that the television producer scored better points and through the necessities of compression skimmed the cream of the show. Also several numbers which I liked very much had been omitted from the stage show, others, which I considered inferior, being substituted. In other words I was discussing the material and manner of presentation rather than the medium. If television does sometimes show us things "as through a glass darkly" it occasionally has a rare essence in its entertainment.

BAIRD COLOUR TELEVISION

Here is an account of the Baird colour television which was demonstrated at the Dominion Theatre, Tottenham Court Road, last month. We understand that the system has been personally developed by Mr. John L. Baird.

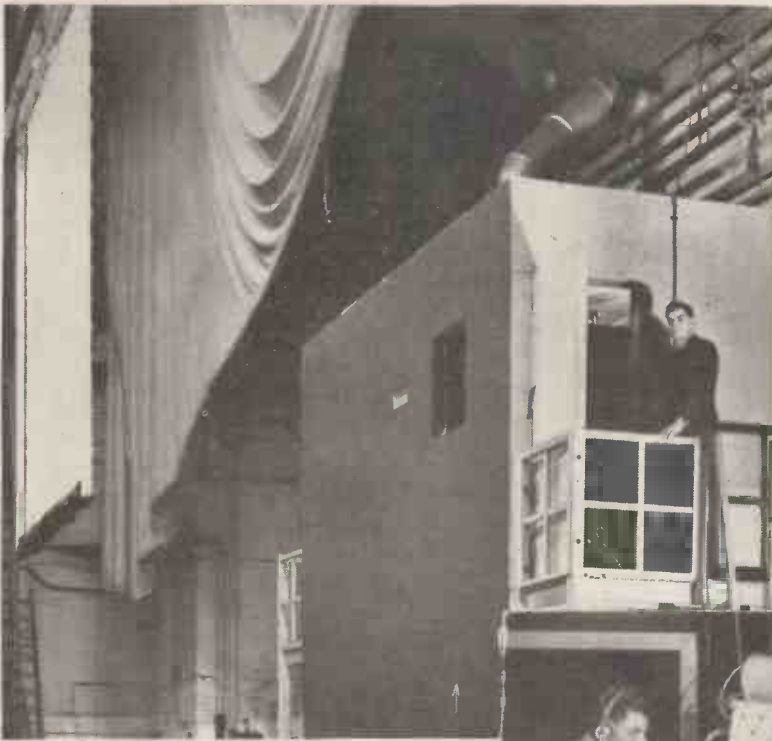

An exterior view of the projector room at the Dominion Theatre. The large screen can be seen at the extreme left of the picture.

REMARKABLE results in colour television were demonstrated by the Baird Company at the Dominion Theatre, Tottenham Court Road, last month. The demonstration was remarkable in several ways and it was the first of its kind ever given, though in 1928 Mr. Baird showed a picture a few inches square in colour at the British Association meeting in Glasgow. This, however, was transmitted by wire.

In this latest development the size of the picture is 12 ft. by 9 ft. and the transmission by radio from the South Tower of the Crystal Palace, a wavelength of 8.3 metres being used. Another special feature of the demonstration was that the colour is exceedingly good and on the whole more pleasing to the eye than are the latest colour films. No claim was made that the definition came up to the standard of the ordinary transmissions and Mr. Baird clearly stated that this was regarded as a preliminary experiment. Even so, the demonstration was most impressive and the results came as a surprise to those who witnessed it.

The present apparatus is shown by the photographs and drawings. It transmits a 120-line picture, the scanning at both transmitter and receiver being by mechanical means. The

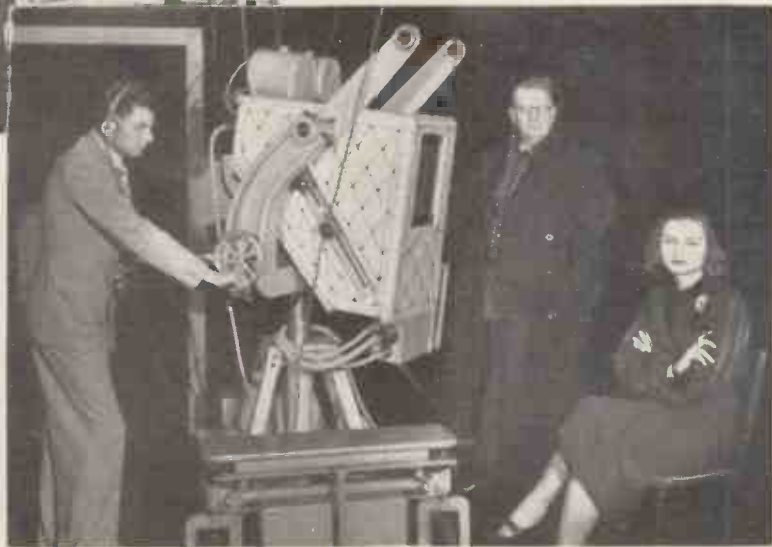

The transmitter at the Crystal Palace. This is mobile and can be used for close-up or distant shots.

transmitter consists of a mirror drum with twenty mirrors inclined at differing angles revolving at 6,000 r.p.m. These mirrors reflect the scene to be transmitted through a lens, causing an image to be formed on a rotating disc with 12 concentric slots at different distances from its periphery. By this means the field given by the 20-line drum is interlaced six times to give a 120-line picture repeated twice for each revolution of the disc. Each of the slots is covered with a light filter, blue, green and red being used alternately, the effect of this being to transmit alternate lines of the picture corresponding to a blue-green image and a red image.

At the receiving station a similar

device is employed, the rotating drum in this case being much larger (12 in. in diameter in place of the 8 in. drum at the transmitter).

Light from a high-intensity arc lamp is concentrated on the moving aperture in the disc and yields sufficient light to fill a screen 12 ft. by 9 ft. The projected picture could be seen from all parts of the Dominion Theatre, which has a seating accommodation of 3,000.

The programme included impersonations of a military officer, a shiek and a Turk. Two ladies exhibited various coloured hats, and the programme concluded with the White Ensign and a coloured photograph of the King. The actual objects televised were afterwards inspected at

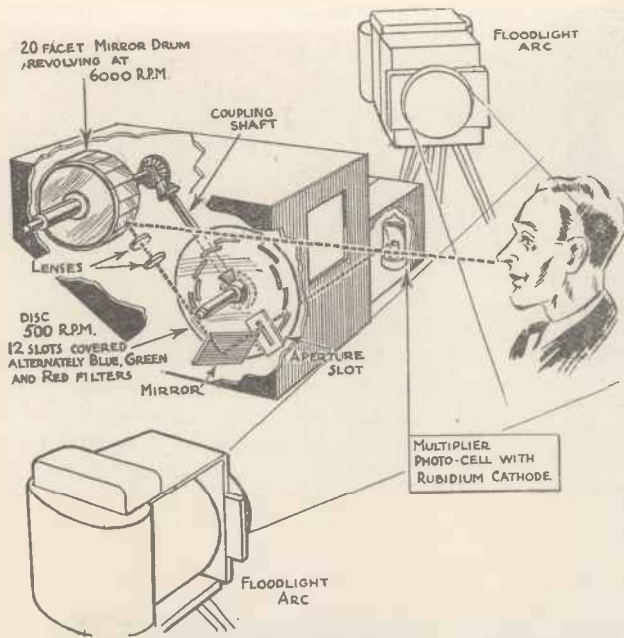

Schematic drawing of the Baird colour television transmitter

the arc crater could be observed. This latter, by the way, takes a current of 150 amps. and the heat generated makes water cooling essential.

The general layout of both transmitter and receiver will be clear from the schematic drawings and it will be seen that the drum and disc are directly coupled together by means of reducing gearing, one motor being used to drive both. The Kerr cell used for light modulation is of the ordinary type with an aperture about

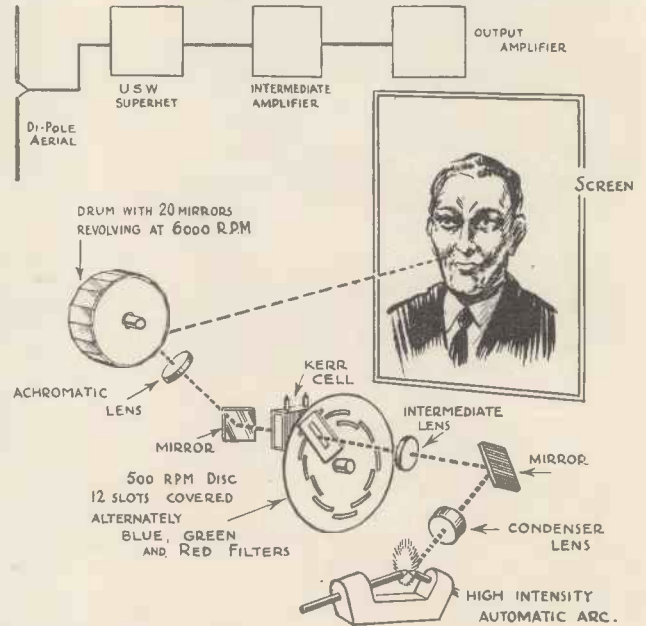

Schematic drawing of the receiver.

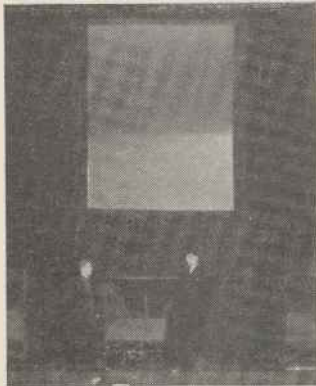

Some idea of the size of the screen will be obtained from this photograph of the stage.

the Crystal Palace, and it was apparent what excellent reproduction had been obtained.

There are some very interesting features about this apparatus and a very large number of practical difficulties had to be solved before it could be put into successful operation. One trouble was in the con-

struction of a mirror drum that at the high speed of revolution would not distort the mirrors or burst. Depending upon the method of securing the mirrors to the drum, they would either bend outwards and become convex or inwards and become concave until a suitable method of construction had been developed. The fire regulations of the L.C.C. had also to be overcome and this necessitated the entire receiver and projector being enclosed in metal cases with only a small peephole through which

3/16 in. square. Other types of cell using both rays were tried, but it was found that gains obtained in one direction were more than lost in others and that the ordinary type gave the best results. Actually the transmitter is mounted on a bogie of much the same type as is used for the Emitron camera and it is therefore reasonably flexible in use. The entire apparatus is a beautiful piece of work and reflects great credit on the production engineers of the Baird Company.

Book Review

Fundamentals of Radio. Terman—McGraw Hill & Co., 21s., 450 pp., 278 figs. in text.

The author's larger book "Radio Engineering" was recently reviewed in these columns, and to those who cannot afford the higher cost of the full text-book, this new abbreviated work will appeal. The author admits that it is an abridged version of "Radio Engineering," but the treatment has been so cleverly done that

nothing of importance has been omitted.

The chapters are divided into: Fundamental Components, Circuit Elements, Vacuum Tubes as amplifiers, power amplifiers and oscillators, Modulation, Radio Transmitters and Radio Receivers.

Although the treatment is elementary, a complete set of problems is appended to each chapter, and the serious student cannot fail to obtain a thorough grasp of the subject in

working them out in conjunction with the notes given.

It is not too much to say that either "Radio Engineering," or its younger brother "Fundamentals of Radio," are vital books to the radio engineer and no one can afford to be without at least one of them.

Radiolympia 1938

The dates for the next Radio Exhibition have now been fixed. The show opens Wednesday, August 24, and closes on Saturday, September 3.

Scannings and Reflections

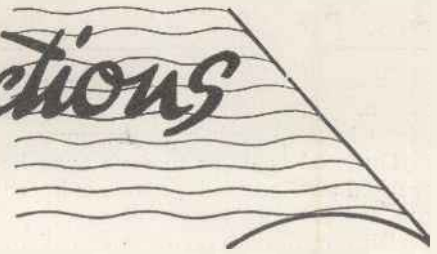

THE LONDON-BIRMINGHAM CABLE

It was alleged at a meeting of the Electrical Association for Women, held in Stafford recently that disagreement between the B.B.C. and the Post Office regarding the charges that were to be made for use of the London-Birmingham cable is hindering the development of television in the Birmingham area. This statement has, however, been denied by an official of the General Post Office in London, who said "There is no truth at all in the suggestion that there has been a discussion about charges between the B.B.C. and the Post Office. There has been no discussion and therefore no dispute. Presumably, if and when a channel is required by the B.B.C., the existing arrangements would be followed. If the B.B.C. are giving an outside broadcast from Birmingham and needed a line, that line would be rented from the Post Office when required."

This denial appears to be borne out by the recent statements that have been made in authoritative quarters to the effect that the installation of a transmitter in Birmingham was not contemplated until more experience had been obtained in the London area. Actually, this cable, although laid, has not as yet been used for telephonic communication.

AMATEUR BOXING BAN LIFTED

The Amateur Boxing Association has lifted the ban which, it will be remembered, it recently placed on the televising of boxing matches of its associated clubs. It is understood that some objection was made to the lighting conditions.

THE DERBY AND TELEVISION

The Derby is not to be televised. The Epsom Grand Stand Association, which controls the racecourse, and with which the decision finally rested, has announced that under no circumstances would permission be given for

the televising of any races on the Epsom Downs. This decision is unfortunate, for tests had proved that excellent reception could be obtained from the site.

MARCONIPHONE BIG-SCREEN TELEVISION

The Marconiphone Company recently demonstrated a receiver with a screen measuring 22 in. by 18 in. The picture is projected through a special $f/1.5$ corrected lens on to a vertical screen, via a mirror placed at an angle of 45 degrees. This screen hinges horizontally on to the top panel of the cabinet when not in use. The projection tube has a diameter of 3 in., and the maximum voltage employed in the receiver is 20,000 volts.

A 7-valve (plus rectifier) all-wave superhet chassis, covering short-wave ranges of 11-35 and 35-100 m. is incorporated, and the A.F. amplifier of this is used for television sound. The total number of valves, including rectifiers, is thirty-seven. This model is intended for clubs, hotels, other similar premises and houses of the larger type. The price is 200 guineas.

R.M.A. TELEVISION DINNER

A dinner was given by the Radio Manufacturers' Association on February 4 with the object of explaining the television position in this country to the leading Press executives. The authorities represented were the Television Advisory Committee, the B.B.C., and the Radio Manufacturers' Association, and the points of view on behalf of these three bodies were put forward. Abstracts from these speeches are given on other pages in this issue. The speakers were: Sir Frank Smith, Secretary of the Royal Society, for the Television Advisory Committee; Capt. C. G. Graves, Controller of Programmes, for the B.B.C.; and C. O. Stanley, for the R.M.A. In the unavoidable absence of Lord Hirst, Lt.-Col. J. T. C. Moore-Brabazon was in the chair, to act as "compère," as he put it.

TELEVISING INTERNATIONAL RUGGER

Television's first Rugger game—the international match between Scotland and England—will be seen by viewers on March 19. Three cameras will be used: one on the north stand, and two opposite the respective twenty-five yards lines. It will thus be possible to cover the whole field, both in comparative close-ups and with plan views. Captain H. B. T. Wakelam's commentary in the National programme will accompany the vision transmission.

TELEVISION IN THE COMMONS

The Postmaster-General, Major Tryon, answering a question by Capt. Arthur Evans (Con., Cardiff S.), as to what reasons he could assign for the public response to television not reaching the standard expected, said that every effort was to be made to provide programmes of an interesting and attractive type.

Transmission standards, he said, would not change for at least three years, and the public, therefore, might buy television sets without fear that they would become obsolete for a considerable time to come. "I am confident," concluded Major Tryon, "that rapid progress will be made with the development of television, and that it will eventually become a normal adjunct of the sound broadcasting service."

ADDITIONAL PROGRAMME TIME

As announced on other pages in this issue, Sunday television programmes are to be inaugurated on April 3 from 9.5 to 10.5 p.m. A second hour will follow as soon as possible, and week-day evening programmes will be extended by an extra half-hour as soon as possible with a view to permanency.

ZEEBRUGGE IN TELEVISION

Alexandra Park lake will be the scene of a miniature naval battle on St. George's Day (April 23), when the attack on the Mole at Zeebrugge is to

MORE SCANNINGS

be re-enacted with models for television. The demonstration will be given in the evening programme.

The models, built to scale, will be worked automatically, and it is hoped to achieve a large measure of realism on the television screen. The episodes will include pre-war scenes in the quiet little port, followed by a foretaste of war with the sinking of a liner by a submarine.

The demonstration will be staged in darkness, but batteries of searchlights combined with the gun flashes should yield all the illumination necessary to make a good picture. It is expected that three television cameras will be used in conjunction with the mobile television unit.

MORE O.B.'s

A considerable increase in the number of outside broadcasts is contemplated and another broadcast van has been ordered. This order has been placed with the E.M.I. Co.

BAIRD COLOUR TELEVISION

A surprise experimental demonstration of colour television was given by the Baird Company at the Dominion Theatre, Tottenham Court Road, on February 4. Full details of the system used are given on other pages in this issue. Transmission was by radio, from the South Tower of the Crystal Palace. The wavelength employed was 8.3 metres.

MANCHESTER AND TELEVISION

On February 7, the Postmaster-General, in the House of Commons, was asked by Mr. W. R. Duckworth (Moss Side—C.) when arrangements would be made to provide a television service for the Manchester area.

Major Tryon replied that the question of extending the television service to areas outside the present range of the London station had been considered by the Television Advisory Committee, who had decided that further research was necessary on certain aspects of the problem. This research was still in progress, and until it was complete the committee would not be in a position to make any recommendation concerning the establishment of additional television stations.

RECEPTION AT 100 MILES

Engineers of the Ecko Company have recently carried out a number of tests of long distance reception.

Birmingham was chosen for the site of reception, which is approximately one hundred miles from the Alexandra Palace. Car interference, it is stated, proved the greatest difficulty, otherwise the pictures would have been good.

THE CAIRO CONVENTION

The International Telecommunication Conference at Cairo is now in full swing and amateurs all over the world are waiting for some of the results to become known.

This convention is perhaps the most important ever held for many countries interested are trying to curtail amateur activity on several wavebands.

The opinion in many quarters is that the amateur is no longer of any real help in the development of radio communication so that the channels allocated to amateurs can be put to more general use.

This may or may not be the case, but the fact remains that with the exception of America and possibly Great Britain most other countries will vote for a curtailment.

One point in favour of the amateur operator is, however, the fact that in time of war a ready made supply of telegraphists are available within a very short space of time so for this reason it is not likely that amateur activities will be stopped altogether.

However, most amateurs will be glad when the results of the conference are known. The amateurs are being represented at the conference by Mr. A. E. Watts, G6UN, President of the Radio Society of Great Britain, and Mr. K. B. Warner, Secretary of the American Amateur Relay League and International Amateur Radio Union. Amateur interests could not be left in better hands.

SUN SPOT ACTIVITY

Although further sun spot activity was expected on February 21 little difference was noticed by short-wave listeners. The conditions did not seem to fall off although some of the more distant stations were not quite so strong as usual.

On the contrary, despite the fact that this year short-wave reception should be more difficult than ever, listeners are finding conditions quite satisfactory.

During the Northern Lights display a little while back Douglas Walters, G5CV, had an interesting ex-

perience. At 11 p.m. he found that even with high power he could not transmit signals over a distance greater than about 10 miles. A report at this distance indicated that his transmission was attenuated from maximum strength down to R3 to R4. This is most extraordinary in view of the short distance being covered.

ULTRA-HIGH FREQUENCY WORK

Experiments below 6 metres have shown that long distances can be covered on these very short waves. In America so much use is being made of the ultra-high frequency channels for communication work that they are now being split up into bands on the lines of more normal short waves. As the amateur allocation is between two commercial bands the use of self-excited oscillators cannot go on much longer. Crystal control on the ultra-highs will then become more general in other parts of the world for with radio at any rate America leads.

J. L. BAIRD GOING TO AUSTRALIA

Mr. J. L. Baird has been invited to go to Australia to attend the anniversary celebrations of New South Wales being held there this year. Mr. Baird sailed on February 26, and we take this opportunity of wishing him a pleasant journey. We are glad that the New South Wales' Government are recognising the work of John Logie Baird for in view of the sensational developments made in the past few years many are apt to forget the pioneer work put in by him in the early days.

A FRENCH AMATEUR RECORD

In view of the publicity that has been given to British and American amateurs who have worked all the Continents of the world on phone in record breaking times it is interesting to note the record made by the French amateur F3JD. He has worked all six radio continents at the same time being able to talk and hear other amateurs situated in Africa, South America, Asia, North America, Australia and Europe in a "round table conference."

Although this record was made last September, the confirmation from each continent has just been obtained. Short-wave listeners will appreciate this feat for although it is possible

AND MORE REFLECTIONS

to hear several continents within a very short space of time it is not very often that all continents are heard at the same time. F3JD has done this and, in addition, has carried on two-way conversations with them.

TELEVISION ACTING

In the *News Chronicle* dated February 18 was an interesting article under the above heading. Joan Miller, the "Picture Page" girl, was interviewed, who said: "The effect of television acting is to make one play for smaller and neater effects. Unlike radio plays, you have to learn your part by heart, often at short notice. It is almost impossible to get a prompt, a prompt being horribly audible. Another difficulty in doing a long play is that of changing clothes, since there is no interval. A cinematographic background, depicting train journeys, etc., taking place, provides a gap."

RADIO STATION LIGHTS
THE HOUSE

A German court has recently found guilty three men who were charged with stealing electric current from the Hamburg radio station. As is well known an inductance placed within the field of a transmitting station's aerial will pick up a percentage of the radiated energy, the amount depending on the size of the inductance and its closeness to the aerial.

If a large number of people were to try this idea a considerable amount of energy could be obtained free of charge, but whether each experimenter could obtain more than enough current than to light a small flash lamp bulb is a matter of some doubt.

There is also the question as to whether this would affect the radiated power of the transmitting station. In some schools of thought it is suggested that this would be the case, and in addition it is claimed that the more people that listen in the less is the signal strength at long distances. These are both interesting points that need more fully explaining.

TELEVISION AT THE IDEAL HOME
EXHIBITION

As usual the Ideal Home Exhibition will be full of surprises, but this year those interested in television should not on any account miss the demonstration that is being staged there.

The British Broadcasting Corporation in conjunction with most of the leading television set manufacturers, are to demonstrate the wonders of modern television.

A glass-walled studio, 2,100 ft. in area, will enable visitors to see the stars as they are actually being televised. From April 14 to 18 the B.B.C. mobile television van will be stationed at the Exhibition so that the programmes from the show can be radiated back to Alexandra Palace. In turn the programmes will be picked up again at the Exhibition where visitors will be able to see the programmes being made and received at the same time.

TELEVISION SOCIETY

The third annual Kerr Memorial Lecture will be held on March 21 next in the lecture theatre of the Institution of Electrical Engineers at 7 p.m.

The lecture will be on "Luminescence and Luminescent Materials" and will be delivered by Dr. L. Levy.

Dr. Levy and his partner, Mr. D. West, are well-known to physicists as workers in the field of luminescent compounds and the demonstration after the lecture will no doubt be of special interest to users of cathode-ray tubes.

Visitors are welcomed and tickets of admission can be obtained from the Hon. Lecture Secretary, Mr. G. Parr, 68 Compton Road, N.21.

Plastic Lenses

A FACTORY just completed at Slough has begun the work of making lenses, for the first time in history, from a material other than glass. Last year a new company, Combined Optical Industries, Ltd., showed at the British Industries Fair the results of several years of research into the uses of highly transparent plastic materials for making lenses by moulding processes.

In refractive index and dispersion the plastic materials used resemble crown glass, while their transparency, especially in the ultra-violet, is so high, it is stated, that the loss of light by absorption is appreciably less. A plastic material of good optical and mechanical properties has the obvious advantage over glass that it enables lenses to be mass-produced with complete uniformity. Whilst hitherto plastics have had the drawback of softness, giving a surface easily scratched, the process perfected by Combined Optical Industries, Ltd., gives a surface hardness that will withstand all normal usage.

A New Baird Receiver

BAIRD Television have produced an entirely new television receiver which represents a very high technical achievement in combined television and radio entertainment for the home. A brilliant black-and-white picture, 13½ in. by 10½ in. in size, viewed in a hinged part-

mirrored lid is produced by the 15 in. "Cathovisor" cathode-ray tube, which is mounted vertically in the cabinet. The picture brilliance is such that viewing is easily possible either in daylight or with ordinary room lighting. The receiver is characterised by extreme simplicity of control.

A single switch brings the all-wave super-heterodyne receiver into operation. This receiver has an output of eight watts with really fine quality reproduction. There is also incorporated in the model the very latest design of Collaro automatic record changer. Nine records of any size can be played in any order and when desired any single record can be repeated any number of times.

The receiver, which is styled the T14, is housed in a luxurious figured walnut cabinet and can be supplied with record storage compartment or cellarette. The prices are 130 guineas with record storage and 135 guineas with cellarette.

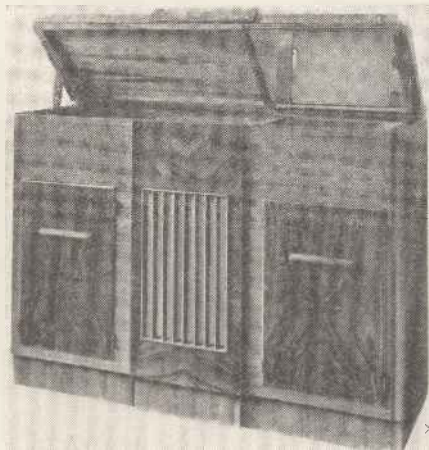

The new Baird T14 Receiver.

FOR THE BEGINNER

MORE ABOUT "BRIGHTNESS" LEVEL RESTORING THE D.C. COMPONENT

This is the second article on the D.C. component and explains how the brightness level of the carrier is reproduced on the cathode-ray tube.

IN last month's article it was shown how the carrier radiated by the transmitter is modulated so that the instantaneous amplitude is always directly proportional to the light value of the particular scene which is being televised.

It was also shown that the voltage developed across the diode detector load was proportional to the carrier amplitude.

This voltage, therefore, not only gives the contrast values in the picture, i.e., the ratio between the maximum and minimum voltages present, but also the background level in terms of a more or less steady voltage.

We may now consider the video amplifier stage and the cathode-ray tube from the point of view of handing on this voltage without alteration, our aim being to reproduce the contrast values plus the background level in actual brightness of the beam on the screen.

In video amplification we have to decide how many stages are desirable, and the factors affecting the choice. Since a higher gain per stage can be obtained from a video amplifier than from a radio-frequency amplifier it would seem at first sight that the more stages the better, but in actual practice the difficulties involved in using several stages are

such that it is preferable to use only one stage. One of the difficulties can be explained as follows:

The diode detector does not give linear rectification at small signal inputs: in other words, its characteristic is curved so that low voltages are not rectified without distortion of the wave form. If the diode is followed by two stages of video amplification, the gain is so high that only a very small input from the diode is required to fully load the tube. With a low input of carrier wave the proportion which is allocated to the synchronising signal (30 per cent. of the carrier amplitude) is so small that it is difficult to make proper use of it and synchronising becomes difficult.

Assuming then that we decide to use a single stage of video amplification we can now consider the voltage relationships at the diode and the grid of the cathode-ray tube. To produce an increase in picture brightness we require a decreasing negative potential on the grid of the tube, or a positive potential in opposition to the tube bias. In passing through the valve stage this potential change is reversed, so that a positive change of potential in the output requires a negative change applied to the grid. To obtain the correct variation on the tube we therefore require an increasing negative potential on the grid of the video amplifier. This is in direct opposition to the usual method of working an amplifying valve where we normally have a nega-

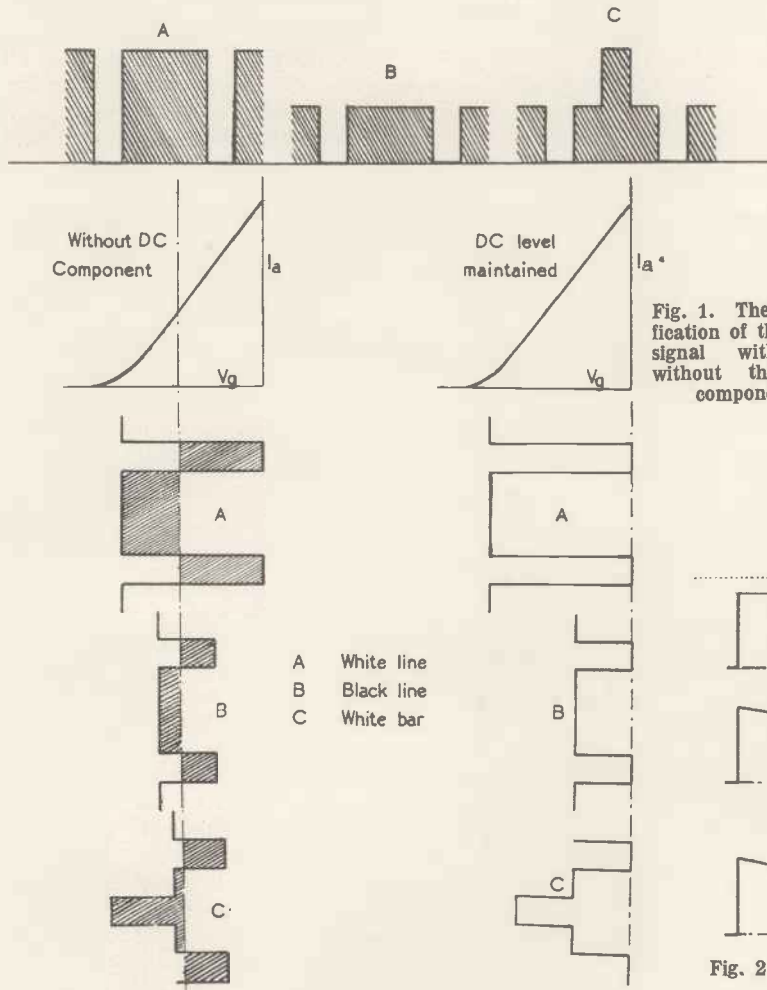

Fig. 1. The amplification of the video signal with and without the D.C. component.

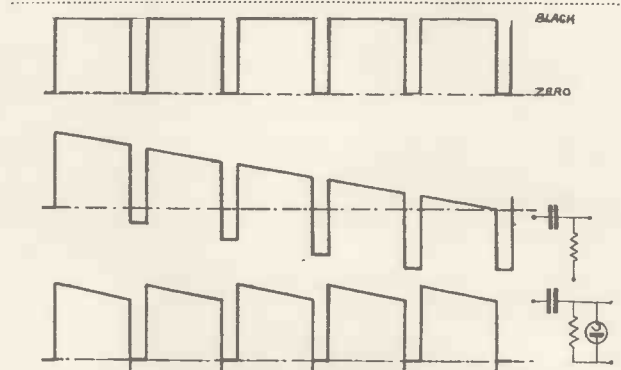

Fig. 2. A series of "black" impulses showing how the condenser potential varies without the D.C. restoration.

MAGNETIC TUBES AND THE D.C. COMPONENT

tive bias which is reduced by the action of the signal.

To handle the change in potential on the grid without distortion we must arrange that under no-signal conditions the grid of the video valve is at zero potential. Then the arrival of the carrier will increase the bias and reduce the anode current in proportion if the characteristic is linear. This condition is shown in the right-hand diagram of Fig. 1. At the top of the diagram three types of signal have been drawn, one a "white" signal containing the synchronising impulse, the next a carrier corresponding to a black signal, and finally, a signal corresponding to a line with a sharp peak of full white in the middle such as would be given by a white line against a dark background.

These three signals are shown applied to the grid of the video amplifier in the drawing of Fig. 1. The "troughs" of the sync. signals, which correspond to zero carrier amplitude, will all lie on the line of zero bias of the valve, and as the signal rises in value the negative bias of the grid increases. The amplitude of the signal will be adjusted so that the maximum height corresponding to the peak white signal will just swing the anode current down to minimum value.

It is useful to compare this action with that of an ordinary amplifier in which the grid is coupled to the diode load through a condenser and leak as shown in the left-hand diagram of Fig. 1. You will remember that in last month's article it was shown that the presence of the condenser prevented the D.C. component being applied to the grid and as a result there are only the A.C. fluctuations. As soon as the signal is applied, the level of potential will alter across the condenser so that the area of wave on each side of the centre line is the same. As the signal is applied in both senses about a mean point, instead of swinging the grid always in a negative direction we must bias the valve to the mid-point of its characteristic as shown.

Actually, when the first voltage impulse is passed on to the grid from the diode load the potential will swing positive or negative by the correct amount, but the charge on the condenser will immediately start to leak away via the grid leak. When

an impulse corresponding to the "peak white" value is applied the total change in voltage is correctly reproduced, but the condenser is still charged to a fraction of the potential initially applied. As a result the second signal will find the grid bias momentarily displaced from the centre working point and it will over-swing the grid beyond the working region of the curve as shown.

The same effect will always be obtained as the nature of the line signal alters from line to line and although the changes in light value will be reproduced in the output of the valve the actual light values would be wrongly shown. The valve is also working under less efficient conditions. In the first case we can handle a swing up to 70 per cent.

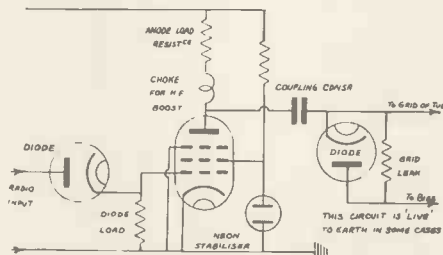

Fig. 3. A complete video amplifying stage showing the D.C. restoring diode and components referred to in this article.

of the maximum available and in a direction in which the valve can operate without distortion, while in the second case we are already biased to a point half way down the curve.

From this we see there is no question that the most efficient method of handling the signal in the video stage is by direct connection between the diode load and the grid of the amplifier. It would be equally satisfactory if we could pass on the signal to the grid of the cathode-ray tube by the same method of direct connection, but unfortunately there are too many practical difficulties.

Electrostatic Tubes

In electrostatically focused and deflected tubes it is usual to operate the tube with the final anode at earth potential, i.e., connected to chassis, which is the negative of the receiver H.T. supply. This means that the grid of the tube to which modulating signal is applied is at 6,000 volts potential negative to the chassis and earth. Hence, direct connection

with the anode of the video amplifier is impracticable. We could certainly overcome the difficulty by insulating the diode and all that follows from the chassis and operating it at 6,000 volts negative potential below earth. This could be done by coupling it to the radio-frequency stages through an air-core transformer insulated to withstand the full H.T. potential, but it is far from satisfactory.

Magnetic Tubes

In the case of magnetically operated tubes it is possible to run with the cathode at earth potential and a direct method of connection would be possible. In this case, however, there is another difficulty connected with the tube. The life of the tube is to a certain extent governed by the emission current which is in turn affected by the bias voltage. If the grid were directly connected to the anode of the video valve it would be impossible to avoid the risk of sudden surges affecting the bias and producing momentary abnormal beam currents. If, for example, the anode current of the video amplifier were reduced to zero the tube bias would be reduced to correspond and the screen would be brilliantly lit with the full emission of the cathode.

These considerations make it essential that the grid of the tube be connected to the video stage through a condenser in the usual way, and at first sight it seems that having gone to a great deal of trouble to preserve the D.C. component up to the output of the receiver we are now compelled to sacrifice it at the last.

Fortunately there is a method by which the effect of the D.C. can be restored, and this is explained in the diagram of Fig. 2. Across the grid leak of the tube we connect another diode, its cathode to the grid terminal. We can now consider the effect of a signal applied to the combination. Taking the simple case of the black line again, with the synchronising pulse, we have seen that the mean potential level will alter across the condenser as the signal goes on. This is shown in greater detail in Fig. 2a.

At the top of the diagram we have a succession of "black" impulses with the synchronising pauses at the end of each line.

(Continued on page 159)

RECENT TELEVISION DEVELOPMENTS

A RECORD OF PATENTS AND PROGRESS *Specially Compiled for this Journal*

Patentees :- Baird Television Ltd. and J. L. Baird :: N. V. Philips' Gloeilampenfabrieken :: Baird Television Ltd. and L. C. Bentley :: Baird Television Ltd. and C. Szegho :: Baird Television Ltd. and L. R. Merdler :: Baird Television Ltd. and V. Jones

Mirror Drum Construction (Patent No. 473,150.)

IN order to produce a well-finished mirror at low cost, a thin sheet of glass is first fixed to the face of a small holder, and a reflecting film is laid over it and worked down to any desired thickness. The back of the film is then cemented to a backing piece. When the cement is dry the first holder is pulled forcibly away, so as to leave the glass surface exposed, with the reflecting film fixed in position between the glass and the backing-piece. The latter can then be fitted to the mirror drum used for scanning.—*Baird Television, Ltd., and J. L. Baird.*

Saving the Screen (Patent No. 473,173.)

It is found that the amount of light given off by the fluorescent screen of a cathode-ray tube is seriously affected by any metal vapour present in the tube, particularly copper or nickel, even in small quantities. When such metals are used for making the electrodes of the tube, a certain amount of vapour is set free from them during the preliminary heat-treatment and exhaustion processes used in the process of manufacture.

This is avoided according to the invention by making the electrodes wholly of chrome-iron or chrome-steel alloy.—*N. V. Philips' Gloeilampenfabrieken.*

Television Amplifiers (Patent No. 473,895.)

It is well known that the effective amplification of a valve can be regulated by varying the load impedance or resistance in the output circuit, but in general this gives rise to corresponding changes in the steady or D.C. voltage applied to the plate. In certain cases, and particularly when the valve is directly coupled to the Wehnelt cylinder of a cathode-ray tube, it is undesirable to alter the steady bias on that electrode.

The figure shows how the effective amplification of the valve can be regulated without affecting the D.C. volt-

age on the plate. The usual anode resistance R_1 is shunted by a variable resistance R_2 in series with a blocking condenser K . (The overall impe-

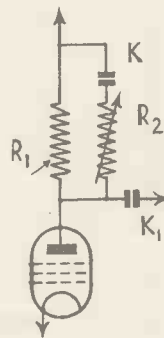

Television amplifier.
Patent No. 473,895.

dance of the anode circuit, and therefore the effective "gain" of the valve, can now be changed by varying the parallel resistance R_2 , though this does not affect the D.C. voltage applied through the resistance R from the H.T. supply to the plate. The output is taken off either directly or through a condenser K_1 .—*Baird Television, Ltd., and L. C. Bentley.*

Increasing Picture Size (Patent No. 474,391.)

The picture is first projected on to a fluorescent screen and is then enlarged by projection on to a second screen mounted inside the same cathode-ray tube.

As shown in the figure the first screen S is transparent, and is coated with fluorescent or phosphorescent

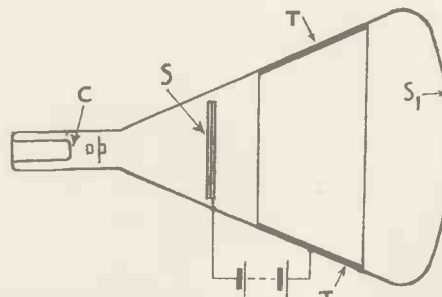

Cathode-ray tube construction for increasing picture size. Patent No. 474,391.

material on the side facing the cathode C . On the other side it is coated with photo-electric material. The electron stream reproduces the picture, in the first instance, in fluorescent light on the near face of the screen S . The light so produced then liberates a stream of electrons from the photo-sensitive layer on the opposite side of the screen.

These electrons are accelerated by the electric field from the conical electrode T , which also acts as a magnifying lens to form an enlarged image on the final viewing screen S_1 . In its passage the electron stream is focused by the magnetic field from a coil (not shown) mounted outside the tube.—*Baird Television, Ltd., and C. Szegho.*

Correcting for Focus (Patent No. 474,399.)

It has been noticed that as the "average" brightness level of a received picture varies, there is a ten-

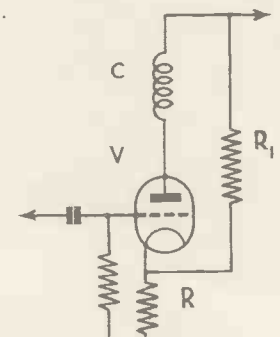

Method of correcting focus.
Patent No. 474,399.

dency for the electron stream through the tube to change its focus too, so that the picture falls off in definition.

To correct this, the current passing through the magnetic focusing coil is made to vary, in the proper sense, with changes in the overall illumination. As shown in the figure, the magnetic focusing coil C is arranged in the output circuit of a valve V , the incoming signals being applied

to the grid. Because the output load is mainly inductive, and also owing to the effect of the biasing resistance R (which is in series with a resistance R₁ shunted across the H.T. supply) the output current through the coil C is controlled by the mean bias on the grid. This, in turn, depends upon the changes which occur, from time to time, in the background illumination of the received picture.—*Baird Television, Ltd.*, and *L. R. Merdler*.

Combined Sound and Picture Receivers

(Patent No. 474,684.)

Both sets of signals (picture and sound) are picked up on the same dipole aerial A, and are fed direct to one of the grids of the "twin" valve

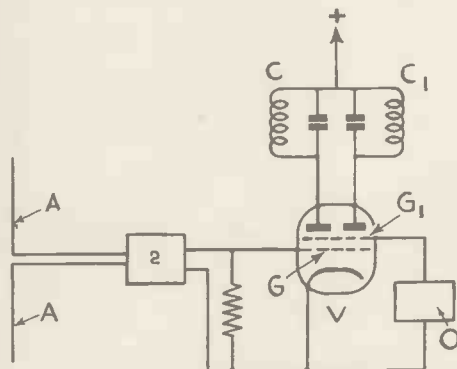

Combined sound and vision receiver.
Patent No. 474,684.

shown in the figure. Local oscillations from O are fed to the other grid G₁.

The valve has two separate plate circuits C, C₁. The circuit C is tuned to the difference or "beat" frequency produced between the picture signals and the local oscillations, whilst the circuit C₁ is tuned to the corresponding beat frequency produced by the sound signals. In this way the two sets of signals are separated, so that each can take its proper path through the subsequent circuits of the set.—*Baird Television, Ltd.*, and *L. R. Merdler*.

"Relaying" Pictures

(Patent No. 475,517.)

In certain cases, for example when the available line or channel is only fit to carry a limited band of frequencies, it may be necessary to transmit a picture at low-definition over this part of its path, and then to "relay" it at higher definition.

For this purpose the picture is first reconstituted on a fluorescent screen, where it forms a "transient" image

at the end of the low-definition line. It is then immediately scanned again at a higher speed, both as regards the line and frame frequencies, by an electron camera, which relays it on to its final destination as a high-definition image.—*Baird Television, Ltd.*, and *V. Jones*

Summary of Other Television Patents

(Patent No. 474,386.)

Television receiver comprising a cathode-ray tube fitted with electrodes for separating the synchronising and picture signals.—*Marconi's Wireless Telegraph Co., Ltd.*, and *D. L. Plaistowe*.

(Patent No. 474,834.)

Preparing the surfaces of electrodes used for secondary emission.—*Baird Television, Ltd.*, and *E. B. King*.

(Patent No. 474,970.)

Scanning system in which compression waves of high frequency are made to travel through a light-cell at an angle to the incident light.—*Scophony, Ltd.*, and *F. von Okolicsanyi*.

(Patent No. 475,008.)

Modulating system for producing television signals suitable for transmission over a line wire.—*Standard Telephones and Cables, Ltd.*, and *M. W. Baldwin*.

the condenser potential will momentarily be negative. This will make the cathode of the diode negative and it will conduct. The condenser will thus discharge through the low-impedance path of the diode, and its potential will immediately fall to the level of the zero line. This is indicated by the little kicks at the end of each line in the downward direction.

Effect of Diode

The effect of the diode is thus to automatically restore the level of the condenser potential at the end of every line and give it a fresh start from scratch, so to speak. The shape of the impulses will then correspond to those originally impressed on the grid through the condenser, with the exception of the slight droop during each line, and this can be minimised by making the grid leak as high as possible.

The same argument applies to a more complex signal which contains both the light and shade variations and the background value, and we can sum up by saying that the presence of the diode restores the D.C. component by correcting the potential of the grid at the end of each line of the picture. The last diagram, Fig. 3, shows the circuit of a complete video amplifier stage with the diode connected. The potential of the diode is very nearly that of the cathode of the tube and the best method of obtaining the heater current for it is to wind a separate heater supply on the tube heater transformer. It is important to remember that the insulation of this winding must be as good as that of the tube cathode winding, and it is usual to mount a small separate transformer near the tube, well insulated from chassis.

If it is not convenient to arrange for this supply, the alternative is to use a metal rectifier of the type used for radio-frequency detection. The characteristics of a metal rectifier are a little different from those of the diode, and it is usually preferable to dispense with the grid leak and rely on the resistance of the rectifier to provide a path for the tube bias. A series resistance of 20,000 ohms should also be connected in series with the rectifier to limit the current through it in accidental surges. This resistance also helps to reduce the shunting action of the rectifier at high frequencies.

"MORE ABOUT BRIGHTNESS LEVEL"

(Continued from page 157)

At the start, when these pulses are applied to the condenser, the potential will momentarily rise to the point shown at the start of the second series of pulses. If the resistance in the grid circuit is comparatively low this potential will leak away, and at the end of the first line it will have fallen according to the slope of the line. The occurrence of the synchronising pulse at this point will send the condenser potential in the reverse direction, and when it ceases there will again be a reversal to the same height as before. A second leakage will now take place and the tops of the impulses will steadily drift downwards, as shown, until the potential is established about the middle line so that the energy at charge and discharge is equal. Now suppose we connect the diode across the leak. At the end of the first line when the synchronising pulse occurs,

The information and illustrations on this page are given with permission of the Controller of H.M. Stationery Office.

THE ULTRA TELEVISION RECEIVERS

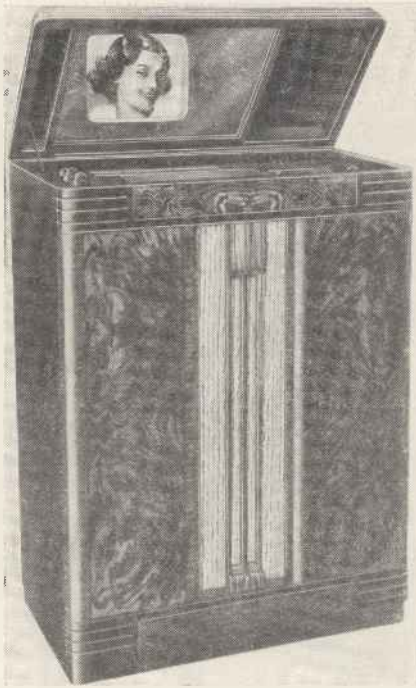

The Ultra Model T40AW with vision and sound and all-wave radio.

ULTRA ELECTRIC, LTD., manufacture three types of television receiver—the T40AW, a de luxe model for sound and vision with all-wave radio; the T30AW, sound and vision and all-wave radio; and the T20, a low-priced receiver for sound and vision only, the last giving a picture 7½ in. by 6¼ in. In each case a magnetically focused and deflected cathode-ray tube is used, the size of the tube being the only point of difference except that with the T40AW the picture is viewed in a mirror in the lid of the cabinet,

special feature of Ultra receivers, which makes for economy in the number of valves used; and the power unit, the chassis of which also carries the moving-coil loudspeaker.

The valve sequence is shown by the diagram and it will be seen that it consists of an H.F., Det. oscillator, three I.F.'s, a diode, and vision frequency amplifier, the first three of which are common to sound and vision, a double channel I.F. transformer being used to feed through a separate sound I.F. valve into a DD/Pen. for the sound output.

The oscillator of the triode hexode frequency changer operates at 39 megacycles, thus giving the lower of the two possible sound intermediate frequencies when a vision intermediate frequency of 6 megacycles is chosen. The sound I.F. amplification is therefore effected at 2.5 megacycles. The vision intermediate frequency amplifier is designed to amplify the lower side band and the T.R.F. circuits, which are very flatly tuned are, therefore, adjusted to 44 megacycles.

The aerial normally supplied with this receiver is a half-wave type resonant at 44 megacycles fitted with a quarter-wave matching section and a 75-ohm balanced feeder. This terminates in a centre tapped aerial transformer primary. The

quency amplifier to the frequency changer grid is over-coupled inductively and resistance loaded. In the anode of the frequency changer are two series circuits, the first having a small "C" and resonant normally at 5.1 megacycles, in series with this a small "L" and large "C" which resonates at 2.5 megacycles. The sound I.F. carrier developed across the dynamic impedance of this circuit is injected by means of a condenser across a resistance connected between the bias of the first I.F. valve and the low H.F. potential end of the vision I.F. secondary winding. This tuned circuit having small impedance at sound intermediate frequency, allows the sound to be passed almost without attenuation to the grid of the first I.F. valve, whilst inductive coupling is arranged between primary and secondary of the vision transformer and also adjustable top capacity coupling.

A similar coupling unit is employed in the second I.F., but in this case the sound resultant present across the 2.5 megacycles resonant circuit is condenser injected into the grid of a separate I.F. valve

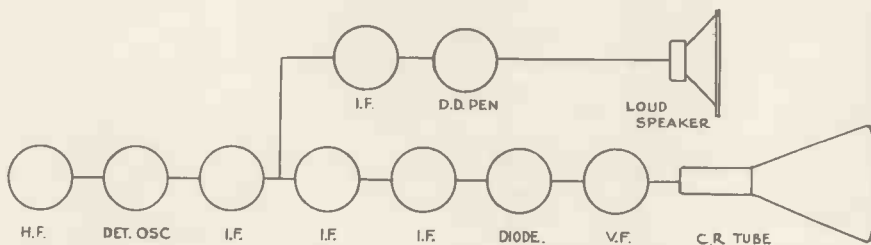

The valve sequence of the sound and vision receivers.

whereas with the other two models the picture is viewed direct.

The television and sound receiver comprises three units: the radio chassis which is a super-het receiver using eight valves of which the first three valves are common to both television sound and vision signals; the cathode-ray tube unit employing thyatron time base generators for separating the signal impulses, a

secondary of this transformer is loaded by the transfer load from the primary, and the electron damping of the first valve. The AC/SP3 high frequency pentode valves used as H.F., I.F. and V.F. amplifiers in the receiver have a static mutual conductance of 10 and a working slope of approximately 7.5 mA. per volt.

The tuned primary-tuned secondary transformer coupling the radio fre-



The Ultra Model T20 sound and vision only, providing a picture 7½ × 6¼.

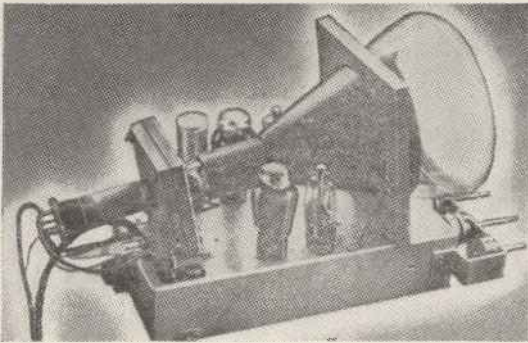

These two photographs show the cathode-ray tube unit and time base on the left and the radio chassis for sound and vision on the right.

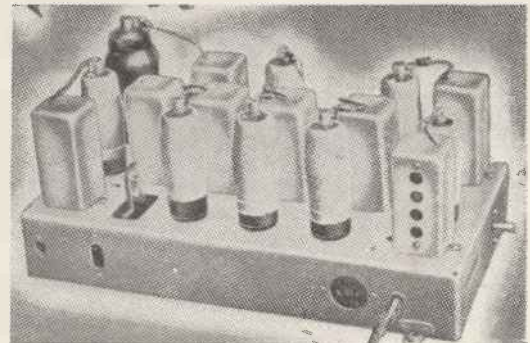

coupled by a further single circuit coupling to a double diode pentode output valve.

At vision intermediate frequencies the impedance of the sound I.F. circuits is very small on account of the high "C" and consequently vision on sound is not experienced as care is taken with high tension de-coupling.

Missing for the moment the next I.F. for vision, we pass to the coupling between the last I.F. valve and the half-wave diode vision demodulator. This coupling is similar to the vision section of the first two I.F. coupling units, and comprises a resistance wire wound primary and secondary coupled both inductively and by an adjustable top end capacity. Exactly the same components are used in all these three units as regards vision I.F.

This arrangement provides an I.F. amplifier substantially flat from 6 megacycles to a little below 4 megacycles with the 50 per cent. of the mean response point at 6 megacycles. The sound amplifier is relatively sharply tuned, and therefore, by adjusting the oscillator condenser on sound the receiver is automatically operated in the correct position for single side band vision reception. Three transformer couplings together, when designed to give a gain of fifteen times per stage can be simply constructed without introducing a considerable dip in the centre of the pass band, and between the second and third I.F. is a single circuit coupling coil, resistance wound, which largely compensates for the drop in response otherwise present in the centre of the pass band. Resonance of the signal frequency circuits at 44 megacycles completes the necessary compensation for this dip, and standard production receivers are expected to have an overall response of ± 1.8 D.B. over the modulation band 25 cycles - 2.15 megacycles. In order to prevent inter-

mediate frequency carrier reaching the grid of the vision amplifying valve a two half-cell pi derived prototype low pass filter is employed. The input and termination impedance of this filter is 3,000 ohms and the values are such that the calculated termination capacity required almost exactly equals the valve input and stray capacities for the vision frequency amplifying stage, which, therefore, produces no attenuation of the upper modulation frequencies.

In view of the nature of the transmissions, positive anode excursion of the vision frequency valve is required for maximum carrier amplitude. The diode rectifier is, therefore, so connected that increasing carrier amplitude produces increasing negative potential across the demodulation load. Then from a consideration of the nature of the transmitted waveform where the synchronising periods are represented by a complete cessation of carrier, and where a certain fixed amplitude of carrier (30 per cent.) represents the black level of transmitted picture intelli-



The chassis of the power unit also carries the moving-coil speaker.

gence, it follows that during all periods of transmission, with the exception of the synchronising intervals, there is a negative potential of at least one-third complete rectified carrier across the demodulation load resistance. Thus by direct connec-

tion between the demodulation load through suitable isolating resistances, the gas discharge triodes generating the line and field sweep voltages receive a positive excursion during synchronising periods of their grid voltage relative to the black signal level of the rectified carrier. A suitable time constant is introduced in the grid circuit of the picture time base to provide line and frame separation.

The primary sweep for both line and frame scans is derived from gas discharge triodes connected across condensers in a straightforward resistance condenser network. The H.T. supply of this part of the circuit is of some 250 volts but in view of the small sweep voltage required to swing the grids of the amplifying valves little difficulty is experienced in obtaining the sufficiently linear primary sweep for practical purposes. In the case of the line scan generator this is coupled through an AC/4 Pen. valve to a pair of hand wound high impedance scanning coils. The AC/4 Pen. is a beam tetrode with a dissipation of some 15 watts. Anode supply to this valve is maintained through a choke which capacity feeds the scanning coils in order to avoid displacement of the scan by direct current through the coils. In order to prevent "ringing" in the scanning coil circuit and also to reduce the peak voltage across the valve during the fly-back period a resistance condenser network is connected across the scanning coils. An adjustment is provided for the resistance value of this network. A variable resistance is in series with the mean brilliance control, the function of which is to allow a wide variation in tube grid bias without necessitating changes in standing bias resistance internal to the unit. A Stalloy shield is then placed around the complete coil structure. Frame deflection is derived by amplification of the gas dis-

(Continued on page 189)

FINDING AND REMEDYING TELEVISION RECEIVER FAULTS—II

Last month the location and remedying of faults in the vision receiver and power supply were dealt with in detail. This article, the second of a series of three, deals with the rectification of time base faults.

UP to the present, with the exception of a brief reference, we have not considered the synchronising arrangement. This is comprised of the valves V_{10} and V_{11} . A detailed description of the functioning of this all important section of the receiver is outside the scope of this article. However, the following brief treatment will ensure an ability to locate an existing fault and also enable the correct operating condition readily to be found.

Reference to the schematic dia-

the anode of the valve V_{10} is a volt or so more positive than the steady voltage existing at the anode of V_9 .

It is now clear that all that part of the modulation above the point X will render the cathode of the diode V_{10} more positive than its anode, consequently it does not conduct. The modulation below the point X, which is the synchronising pulse will, however, cause the cathode of the diode to become negative in respect to its anode, current will flow leaving the anode more negative by an almost

Time Base Faults

Now let us consider the time base. It is not proposed to describe the generation of saw-tooth oscillations fully. This has received adequate treatment already. Those interested are referred to a concise description due to G. Parr, which appeared in the January and February issues for 1936 of this journal, pp. 30 and 91 respectively, or to the more adequate treatment in the above author's recent book "The Low Voltage Cathode-ray Tube and its Applications," chs. 4 and 5. Only those points pertinent to the actual rectification of faults likely to be encountered generally are here dealt with.

Firstly, we will assume that no raster at all is obtainable. It is improbable that this will result in a simple, stationary, concentrated light spot on the screen. It is more likely that a small variably shaped pattern will be observable, the reason for this being that various potentials due to leakage and other effects will be present at the deflector plates causing at any rate some form of spot deflection.

This inability to obtain a raster may be due to any of several possible faults. It is proposed to deal with the most probable of these first, namely, the complete or almost complete absence of high tension.

Before going further into the matter it will be advisable to note particularly that when the H.T. is removed from one time base only, either the frame or line, the effect at the screen will be a single horizontal or vertical line, the length of which may be varied with the controls of the base which is functioning. Obviously when this is so the fault is located in the other time base, or alternatively the connections to this base may be incorrectly made or entirely absent.

H.T. Supply

It is feasible roughly to check for the presence of high tension with a good quality high-reading voltmeter.

(Continued on page 189)

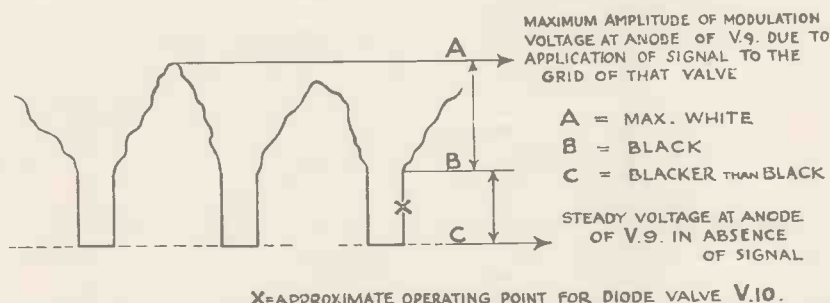

Fig. 3. Graph showing pictorially the voltage at the anode of the valve V_9 in the circuit diagram Fig. 1 shown on page 91 of last month's issue.

gram, Fig. 1, on page 91 of last month's issue discloses that the diode valve V_{10} is connected—its cathode to the anode of the valve V_9 , its anode through the high resistance R_{36} to the slider of the potentiometer R_{38} . Now refer to the drawing, Fig. 3, this pictorially illustrates the form of the voltage at the anode of V_9 . It is seen that this is positive. It is convenient to divide this signal into two parts. The curved line between A-B is the actual picture modulation. Maximum brilliance occurs at A and minimum at B. The synchronising pulses are represented by the signal between B and C. From the cathode-ray tube viewpoint, therefore, they are blacker than black, i.e., they are not visible on the screen of the tube.

It will be obvious that we are able to adjust the voltage at the anode of the diode valve V_{10} to be equal to that existing at the point indicated on the synchronising pulse in the diagram, Fig. 3.

This point is practically represented by a condition reached when

equal amount. In brief the diode effectively allows part or whole, depending upon the setting of R_{38} , of the synchronising pulse to pass to the grid of the valve V_{11} .

As the signal at the anode of V_{10} is negative, the new signal at the anode of V_{11} is positive, which is what we require as will be apparent when we consider the time base operation.

It only requires to mention that the valve V_{11} is so adjusted that the amplitude of each synchronising pulse is identical. This is simply achieved by arranging the valve's operating conditions for a short grid base.

At the anode of this valve, assuming the adjustments to have been made correctly as indicated above, we have the frame and line synchronising pulses. These are applied through simple frequency and amplitude filters to the grids of the relay valve. There they accurately control the firing frequency by anticipating the normal firing time.

A 2-valve Receiver for 10 Metres

This simple 2-valve receiver has been designed by Kenneth Jowers for short-wave listeners who require a simple but effective all-band receiver with a high degree of efficiency on 10 metres.

DURING my visits to short-wave amateurs I have been surprised to find just how many are still using simple 2-valve receivers, and what is more, appear to be obtaining entirely satisfactory results.

It seems that many amateurs prefer

which has greatly surprised me regarding its performance, and although designed in the first instance for the 10-metre band, has proved entirely satisfactory on all other amateur bands. This receiver, therefore, should be ideal for amateur reception for those who pre-

fer band spreading depending on the wave length being used.

This is not at all a satisfactory arrangement, so for that reason this receiver has the band spreading condenser VC₁ tapped well down the coil, and, with a little experimenting, VC₁ can be made to spread any amateur band over its almost entire capacity.

Band Spreading

Amateurs will appreciate this point, for it is extremely useful to be able to make the bands spread 160 degrees or so, irrespective of whether the receiver is being used on 160 or 10 metres. It also enables a much larger condenser to be employed. For this reason VC₁ has a capacity of 40 mmfd. which compares with 15 mmfd. or less, which is used in the average band-spreading circuits, when the whole of the coil is tuned.

The condenser VC₂ has a capacity of 100 mmfd. and is merely a band setter. It should be tuned so that the receiver resonates just below the amateur bands to be used, after which stations are tuned in by means of condenser VC₁.

Reaction, a most important point in a receiver of this kind, is obtained by taking the cathode lead to earth via a small portion of the grid coil. This makes a separate regenerative circuit for oscillation. The amount of regeneration is controlled by means of the potentiometer VR₁, which is across the H.T. supply. This control has a value of 50,000 ohms, and enables the screen voltage on the 6D6 detector to be varied, so governing the amount of regeneration. In this way the circuit will slide in and out of oscillation very smoothly and without any trace of plop. Coil tappings are quite critical, but full details are given at the end of this article.

The third grid of V₁ is earthed directly to chassis, while the filament

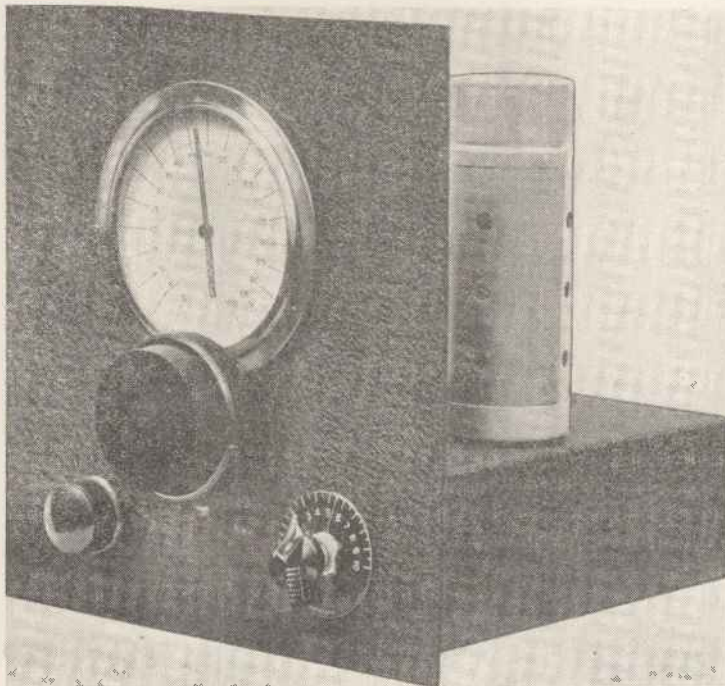

The front view of the receiver showing the band-spreading condenser underneath the main tuning drive. The appearance is quite professional, particularly when the receiver is housed in a black metal cabinet.

an oscillating detector with a single low-frequency stage feeding a pair of headphones, rather than a multi-valve superhet with its comparatively high noise level and necessary beat note oscillator for C.W. reception.

I have, however, received quite a number of requests for a 2-valve receiver of this popular type that would tune down to, and give a good performance on the 10-metre amateur band.

Some of the constructors have been using 2-valve receivers on this band with capacity-controlled reaction, and have found results quite satisfactory, but the majority find difficulty in obtaining adequate sensitivity or smooth reaction control.

While capacity reaction is quite satisfactory on the lower frequencies, below 16 metres or so it is always advisable to use a reaction control that is specifically designed for high-frequency use.

The 10-metre Band

With this point in mind I have been experimenting with a simple receiver,

for a simple type of straight set to a multi-valve superhet.

The circuit of this receiver is shown on this page, where it can be seen that it is quite conventional in many respects, but on the other hand there are several variations from accepted practice. For example, most amateurs when using a band-spreading control, merely connect a small parallel condenser across the main tuning coil. This arrangement gives a varying degree of

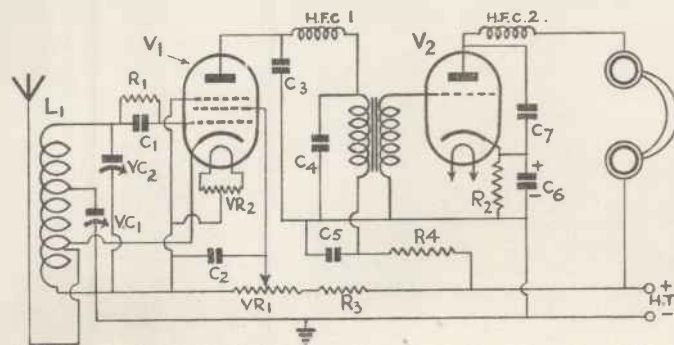

Constructors should not have any difficulty in wiring this receiver from this simple theoretical circuit. The headphones, however, are terminated in a plug and jack, while VR₁ must have an insulated spindle.

Covers 5 Bands

has a resistance across it to the value of 75 ohms, the centre tap of which is also taken to chassis.

During the initial step I found it impossible to obtain satisfactory results unless the detector valve was adequately screened, despite the use of a metal

the anode of V₂, which is a 6C₅, is bypassed by means of a .0001 mfd. condenser, which in conjunction with a HFC₂, provides a final HF filter.

Construction

Construction of this receiver can be very quickly carried out, provided the

taken showing the position of the inter-valve transformer and band-setting condenser. This can quite clearly be seen in the illustration. The balance of the small components are interconnected in the wiring and do not require any additional wiring.

The screen for the 6C₅ is not strictly necessary, but it certainly does make the receiver look more symmetrical, while it effectively screens the input from the output stages. It also obviates the use of any screen for the tuning coil, which would probably be detrimental on 10 metres.

A small indicating dial is used on VC₂, for it will be realised that this condenser is merely a band-setter, and does not have to be tuned very accurately. On the other hand, it is most important that a good slow-motion dial be used to operate VC₁, which has to be calibrated, particularly when the receiver is used in conjunction with a transmitter. For this reason I strongly advise listeners to adhere to the original specification.

As regards the valves these are of the metal type 6D6 and 6D5, but the glass equivalents are equally satisfactory, particularly as additional valve screens are recommended.

The Coils

After the receiver has been wired to the theoretical circuit, the next point of interest is the construction of L₁. Five coils are required to cover 10-160 metres, and all of these can be wound on standard Raymart 4-pin formers, which fit the ordinary English 4-pin valve base.

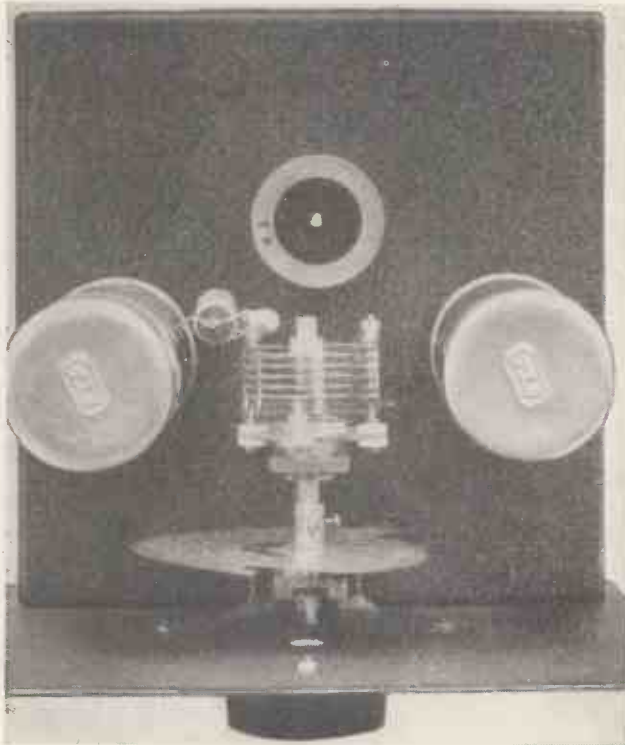

A good idea as to the layout and positions of the components can be obtained from this plan view. Notice particularly the position of the tuning coil.

valve. It was also necessary to have the grid condenser C₁ and the grid resistance R₁ connected into circuit by very short leads. For this reason the detector valve is mounted close to the tuning condenser, so that the fixed plates of VC₂ can be taken straight to C₁ and R₁.

In order to obtain only a small variation in screen voltage, a resistance R₃, having a value of 25,000 ohms, is connected in series with VR₁ and H.T. positive.

That completes the detector stage, but care must still be taken with the low-frequency amplifier. In order to obtain stable operation the anode circuit of C₁ must include a satisfactory H.F. filter. This is made up of C₃, C₄, both having a capacity of .0001 mfd. and HFC₁, a choke of special construction on a ceramic former. The output from this filter is then fed into the primary of the inter-valve transformer.

The anode circuit of V₁ is also decoupled by means of R₄ and C₅, which has a value of 10,000 ohms and 2 mfd. respectively. Bias is obtained for the output valve by means of R₂, which has a value of about 2,000 ohms, and this must be shunted by a condenser having a capacity of 25 mfd. Also notice that

components are mounted in the positions shown. Before wiring the other side of the receiver, I had a photograph

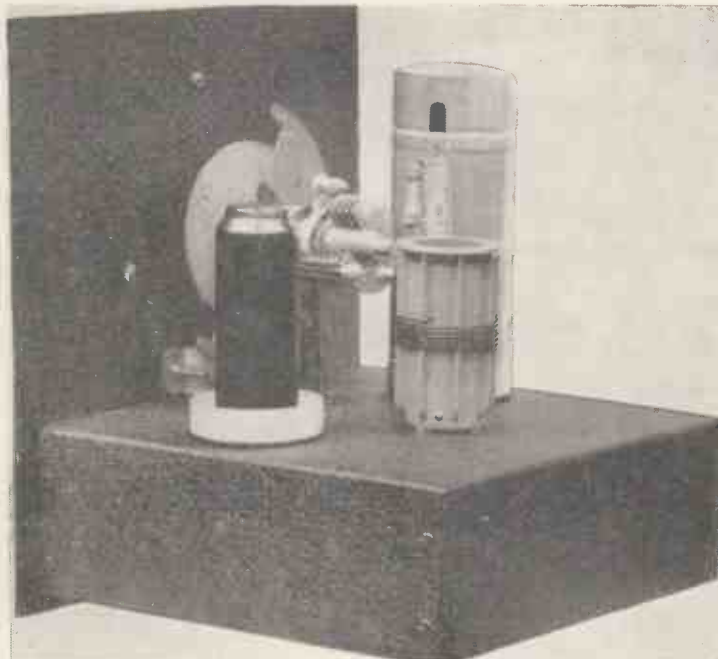

Another view of the back of receiver showing how the condenser VC₁ is mounted.

Coil Building

10-metre Coil

First of all, wind the coil for 10 metres, being the band for which this receiver was designed. All coils are

tap 1/3 of a turn from the earthy end and the band spread tap half a turn from the earthy end.

The 20 metre band requires a coil of 7 1/2 turns with the cathode tap half a

make a cathode tap 1 turn from the earthy end and the band spread tap 4 1/2 turns from the earthy end.

On 80 metres wind on 30 turns, take the cathode to a tap 1 1/2 turns from the earthy end, and the band spread to a tap 5 turns from the earthy end.

The Top Band

The biggest coil is on 160 metres, when the coil consists of 60 turns, with a cathode tap 3 1/2 turns from the earthy end, and the band spread condenser tapped in 32 turns from the earthy end.

I suggest that the coils be wound with connections as shown in the diagram, for this is about the easiest way of making the necessary connections. Of course, the receiver will cover the ordinary short wave commercial channels, but tuning will have to be carried out on VC2, and as this has not a slow-motion drive it is going to be rather difficult.

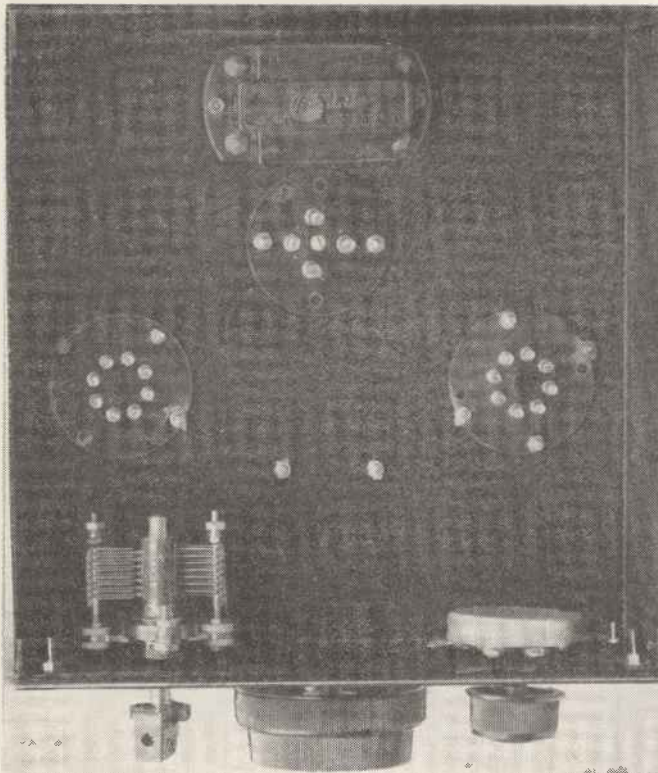

This sub-chassis photograph was taken before the receiver was wired to illustrate the few components that had to be mounted independently and also the position of the inter-valve transformer.

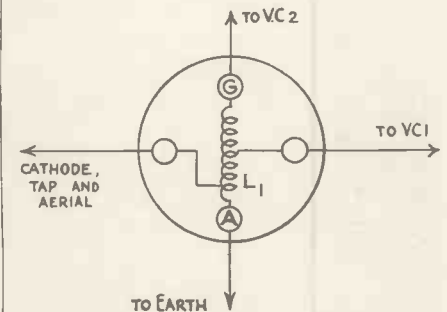

It is suggested that the coil be connected in this fashion.

wound with 24 gauge enamelled covered wire, and cover a winding space of slightly over 1 1/2 in. The 10-metre coil, made up of 3 1/2 turns, with the cathode

turn from the earthy end, and the band spread tap 1 1/2 turns from the earthy end.

For 40 metres wind on 13 1/2 turns,

Short-wave listeners who will require a receiver more for general coverage rather than for amateur band reception, will be well advised to embody two slow-motion drives and to make slight modifications in the lay-out, in order to accommodate the two drives in line.

C.W. Reception

Wire the receiver with 14 gauge copper, for particularly when listening C.W. bad wiring will cause reception to be unsteady. Despite the fact that the receiver is a very simple one, it requires extreme care in construction if it is going to provide maximum results. However, this should not be beyond the capabilities of any short-wave listener.

Components for A 2-VALVE RECEIVER FOR 10 METRES

CHASSIS AND PANEL.

- 1—Steel chassis 6 x 7 1/2 x 2 ins. Finished Black (Peto-Scott).
- 1—Steel panel 8 1/2 x 9 ins. Finished black (Peto-Scott).

CONDENSERS, FIXED.

- 1—.0001-mfd. type 690W (C1) (Dubilier).
- 1—.01-mfd. type 4601/s (C2) (Dubilier).
- 1—.0001-mfd. type 690W (C3) (Dubilier).
- 1—.0001-mfd. type 690W (C4) (Dubilier).
- 1—2-mfd. type BB (C5) (Dubilier).
- 1—25-mfd., 25 volt, type 3016 (C6) (Dubilier).
- 1—.0001-mfd. type 690W (C7) (Dubilier).

CONDENSERS, VARIABLE.

- 1—.00004-mfd. type Tro-40 (VC1) (Premier).
- 1—.0001-mfd. type Tro-100 (VC2) (Premier).

COIL FORMS.

- 5—4-pin type CT4 (Raymart).

CHOKES, HIGH FREQUENCY.

- 2—Type SW-69 (Bulgin).
- DIAL, SLOW-MOTION.
- 1—Type 1070 (Eddystone).
- 1—Type 1044 (Eddystone).

HOLDERS, VALVE.

- 2—Type octal (Clix).
- 1—Type 4-pin chassis, less terminals V1 (Clix).

PLUGS, TERMINALS, ETC.

- 2—Crocodile clips (Bulgin).

- 1—4-way strip type F marked A1, A2 and F (Clix).
- 1—Jack type J2 (Bulgin).

RESISTANCES, FIXED.

- 1—5 megohm type 1/2 watt (R1) (Erie).
- 1—2,000-ohm type 1 watt (R2) (Erie).
- 1—25,000-ohm type 5 watt (R3) (Bulgin).
- 1—10,000-ohm type 1-watt (R4) (Erie).

RESISTANCE, VARIABLE.

- 1—50,000-ohm type potentiometer (VR1) (Reliance).
- 1—75-ohm humdinger (VR2) (Claude Lyons).

SUNDRIES.

- 2—Valve screens type VS (B.T.S.).
- 1/2 lb. tinned copper wire 14 gauge (Webb's Radio).
- 1—Cabinet type 1033 (Eddystone).

SWITCH.

- 1—Type toggle S80T (Bulgin).

TRANSFORMER LOW FREQUENCY.

- 1—Type 1/5 (T1) (B.T.S.).

VALVES.

- 1—6D6 Metal octal (V1) (Premier).
- 1—C5 Metal octal (V2) (Premier).

HEADPHONES.

- 1—Pair type A (S. G. Brown, Ltd.).

Ensure obtaining "Television and Short-wave World" regularly by placing an order with your newsagent.

Operating the R.M.E.69

REPORTS of image frequency interference with R.M.E.69 even with a pre-selector have been noticed from time to time. Generally these reports have only come from users who have tried to re-line the receiver, without knowing the correct procedure.

Some interesting data on this point was given in our January issue, but for those who wish to make the most of this excellent receiver combination some further details have been received from R.M.E. in Peroria.

Image frequency ratio on band 6 at 30 Mc. is about 25-1. This figure varies between 20 and 30, but 25 is an average figure which only changes very slightly with individual receivers. The image frequency ratio on 14 Mc on band 5 is about 175/200-1. These medium image frequency rejection ratios are based entirely on optimum setting of the resonator control or maximum response of the signal at its proper frequency.

A reference in the instruction manual pertaining to the position of the resona-

The R.M.E. 69 receiver is one of the best communication sets of its kind. However it requires properly handling and this article will help in this respect.

tor will absolutely eliminate responses of images on 15 Mc and will practically eliminate them entirely on 30 Mc.

There is, however, about a 60-65 db difference in the response of the two. That is the image and the desired signal when using a DB20 properly on 30 Mc. It must be understood that the DB20 must be tuned to the frequency of the station to be received and not allowed to remain in one position while the band spread control of the receiver is varied. If this is done it will be possible to bring the image in at the same signal strength as that of the desired signal.

It has been found that this is being done in several instances, and a false impression of the performance of the DB20 has been obtained. A brief example of typical operation will help to explain this point.

The DB20 should be arranged so that it indicates a lower frequency is being received with the band spread control variation so that a maximum background noise or maximum signal response is obtained at all times.

If this is not done it is possible when the band spread control has been tuned so that the frequency of reception is about 29 Mc with a DB20 left at 30 Mc the strength of the image will be about the same as the strength of the received signal.

In other words if the band spread control of the R.M.E.69 has been moved from the original position round to a point where it is tuning to 29 Mc and the DB20 control has been left at approximately 30 Mc a station transmitting on 29,930 Kc or approximate that frequency will come in with about the same signal strength as it would if the receiver were tuned back to 29,930 Kc.

Image Suppression

If, however, the receiver band spread control and the DB20 are tuned synchronously to the same frequency the image frequency ratio will become about 2,500-1 which will produce a signal ratio of at least 60 db difference between the signal and the image of another signal.

For all intents and purposes this is equivalent to complete image rejection. In all cases the resonator control should be set so that it produced a maximum signal on the correct frequency. Approximate setting of the resonator control will, of course, produce inferior results.

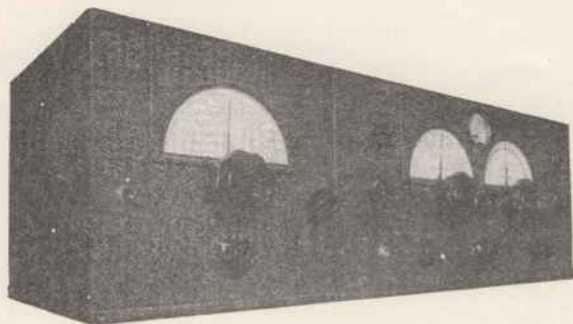

This is the R.M.E.-69 with the DB20 pre-amplifier which cuts out all image interference.

tor control setting with reference to its pointer position has absolutely no infallibility of adjustment in connection with it. It is merely stated that the resonator control should be placed in approximately a certain position because it will be found that its optimum adjustment falls in a certain region around the position indicated.

The actual position should be dictated entirely by the maximum desired signal response at the correct frequency.

Image Response

If it is set at another frequency the image response will increase and naturally it may be possible for its setting to almost approximate the exact tuning for the image. The image response will consequently be approximately the same as that of the desired signal. This applies also to 30 Mc reception.

Therefore the signal should be tuned in and a resonator set on the signal so that it is coming in at a maximum signal strength as indicated by the R meter, and under these conditions the image response will be at minimum both for 30 and 40 Mc reception. The DB20

Band Spreading

The R.M.E.69 receiver for a reception on 30 Mc has its main tuning dial set at approximately 30 Mc. The band spread pointer should be set at 180 degrees at which point the approximate frequency of reception is 30 Mc, since the main tuning dial is accurate to half of one per cent, when the band spread control is set at 180 degrees.

The DB20 is connected ahead of the receiver and its tuning control is set at approximately 30 Mc or at a position around 30 Mc which will give the maximum background noise or signal response with the receiver set as previously mentioned. The band spread control is then used for tuning and if it is tuned so that it is moved to lower numbers on the scale then at the same it is necessary that the DB20 tuning control be similarly adjusted. The pointer on

Mention of "Television and Short-wave World" when corresponding with advertisers will ensure prompt attention.

A New Valve Manual.

We have just received a copy of a new valve manual from the R.C.A. Manufacturing Company, of Harrison, New Jersey. This manual, as is usual with R.C.A. publications, is most comprehensive, and to the amateur who does not know too much about valves and how they work, it is as good as many text-books.

Naturally every R.C.A. valve, including many not known in this country, are fully described, together with operating data. Several chapters are devoted to valve theory, how to calculate impedance and slope, how to work out grid bias and how to use valve curves.

A chapter devoted to circuits embodying R.C.A. valves is also particularly interesting, and altogether, considering the number of American valves used by amateurs in this country, we feel that everyone should obtain a copy of this manual. It is priced at 1s. 3d., post free, and can be obtained from Webb's Radio, 14 Soho Street, London, W.1.

Inverse-feedback Circuits for L.F. Amplifiers

WHEN power output and distortion characteristics of the final stage of an L.F. amplifier are to be determined, it is customary to replace the loudspeaker by a fixed resistance of suitable value. Actually, a loudspeaker does not present the same impedance to an output valve at all

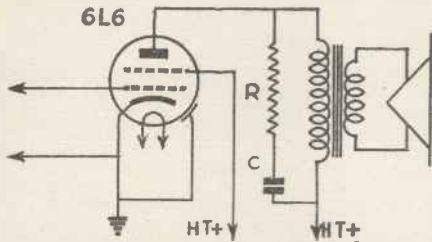

Fig. 1a. Values for R and C are given in the text.

audio frequencies. At the resonant frequency of the speaker, which is usually less than 100 cycles, the impedance of the speaker increases with frequency, because the speech coil has inductive reactance. Unless the variable effects of such a load are reduced by a low-resistance output valve, low-frequency "hang-over" is accentuated by resonance effects in the speaker and high frequencies are accentuated by the rising impedance characteristic of the speaker.

The internal resistance (r_p) of an output valve shunts the anode load (Z_1). When r_p is appreciably less than Z_1 large variations in load impedance do not appreciably affect the output voltage, because the variable load impedance is shunted by the comparatively low resistance of the output valve. When a low-impedance triode is used in the output stage, the resistance of the output valve is high compared to the load impedance so the effects of variable speaker impedance may seriously impair quality. This latter condition exists when tetrode or pentode-type output valves are used without compensating circuits. This article describes the characteristics of two such circuits: (1) the familiar resistance-capacitance filter, which compensates for high-frequency effects, and (2) inverse-feedback circuits, which minimise the effects over the entire audio-frequency range.

Resistance-capacitance Filter

Because the load impedance of a moving-coil loudspeaker acts like an inductance and resistance in series at frequencies higher than the resonant frequency of the speaker, a suitable resistance-capacitance filter, connected as

Some interesting data on inverse-feedback with tetrode amplifiers have been compiled by the R.C.A. Manufacturing Co., Ltd., of America, details of which are given in this article.

shown in Fig. 1 can be used to compensate for the variable reactance of the load. Resistance (R) in Fig. 1 is made equal to the load impedance into which the output valve(s) should work; capacitance (C) is adjusted to give a frequency characteristic which is substantially flat over a desired frequency range.

When R and C are determined in this manner, considerable power may be dissipated in R, especially at the high audio frequencies. For this reason, it may be desirable to increase R and C until a suitable balance between high-frequency compensation and power loss is obtained. The effects of speaker resonance are not reduced by the filter method of compensation.

Inverse-feedback Circuits

Inverse-feedback circuits can be used to decrease distortion at the expense of

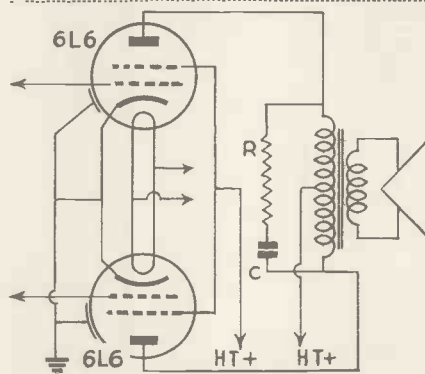

Fig. 1b. The push-pull circuit using tetrodes.

power sensitivity in an L.F. amplifier. Some forms of inverse-feedback circuits cause an increase in the anode resistance of a valve, while others cause a decrease in this resistance. In the following discussion, two forms of inverse-feedback circuits are analysed. The reduction in distortion can be made equal in both forms, although one increases and the other decreases the plate resistance of the tube.

The anode resistance of a valve can be increased or decreased by feeding back to the grid circuit a portion of the alternating voltage appearing in the anode circuit. Thus, in Fig. 2 when the anode voltage is increased by an amount F by means of switch S, the control grid becomes more negative be-

cause of the increased voltage drop across the cathode resistor (R_c); this increase in negative bias reduces the anode-current change. When a signal is applied to the input and the battery (F) is replaced by a suitable load, the effect of the unbypassed cathode resistor is to increase the internal resistance of the valve as measured at the terminals of the load; therefore, the shunting effect of the valve on the load is decreased.

The A.C. voltage developed across an unbypassed cathode resistor is in opposite phase to the input-signal voltage in a single valve amplifier; so the circuit is degenerative. The effects of degeneration in a single valve amplifier are to reduce distortion and power sensitivity; the power output is also somewhat reduced due to power dissipated in the cathode resistor. The fractional loss in power output is R_c/R_1 , where R_c is the value of the cathode resistor and R_1 is the value of the load resistance plus the cathode resistance.

The input signal required for rated output with degeneration is approximately

$$E_d = E_o \left\{ 1 + \left[\frac{g_m R_c}{1 + R_L/r_p} \right] \right\}$$

where E_o is the input signal required for rated output without degeneration, and g_m is the grid-plate transconductance of the tube, at the operating point. The distortion with degeneration is approximately

$$D_d = D_o / \left\{ 1 + \left[\frac{g_m R_c}{1 + R_L/r_p} \right] \right\}$$

where D_o is the distortion without degeneration. For example, when the by-pass condenser is removed from the cathode circuit of a typical single valve amplifier using a type 6L6 valve, the distortion is reduced to approximately one-half its former value; the required input-signal voltage is doubled, and the power output reduced by approximately 10 per cent. No other changes in circuit constants need be made.

The cathode-resistor by-pass condenser should not be removed from over-biased push-pull circuits having a single cathode resistor for both valves

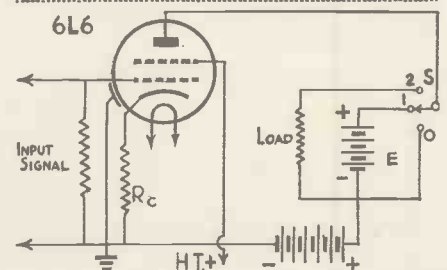

Fig. 2. The anode resistance of the valve can be increased or decreased as required. The method is explained in the text.

Feedback with Single and Push-pull Circuits

because the alternating anode currents of each valve do not cancel in this resistor; the resulting harmonic components of current cause an increase in distortion. The cathode-resistor by-pass condenser may be removed from over-

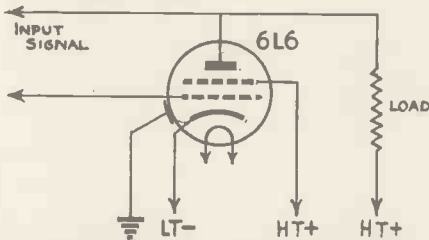

Fig. 3. In this circuit the entire load resistance is common to both anode and cathode circuits.

biased push-pull circuits when each valve has its own resistor. However, the advantage of low valve resistance are not obtained.

When the entire load resistance is common to the anode and the cathode circuit, as shown in Fig. 3, a positive increment in anode voltage causes the same increment in grid voltage. Therefore, the internal resistance of the valve decreases. As in the circuit of Fig. 2 the feed-back voltage, which is the entire voltage developed across the load, is in opposite phase to the input signal voltage. It follows that this circuit is also degenerative. When the circuit of Fig. 3 is used, the internal resistance of the valve, the distortion, and power sensitivity of the amplifier are reduced; the power output and efficiency are not changed.

The circuit of Fig. 3 alters the normal characteristics of the amplifier in such a manner that the output valve acts as though it were a low-resistance triode. The amplifier has all the advantages of a triode, plus the high efficiency obtainable from a good tetrode or pentode. In addition, the circuit may be made sufficiently flexible to permit the valve characteristics to be changed in steps from those of a tetrode or pentode to those of a low-resistance triode.

The circuits of a practical single valve and of a push-pull amplifier using partial inverse feedback to reduce the internal impedance of the valve are shown in Figs. 4a and 4b, respectively. Resistors (R_1) and (R_2) and condenser (C) are connected in series; the combination is connected from the anode of each valve to ground. Nearly all the a-c voltage developed across the load appears across R_1 and R_2 , when the capacitance of C is high. Of this voltage, that due to $R_1(R_1 + R_2)$ is applied in series with the input-signal voltage; this ratio is defined as the percentage degeneration (n). With any percentage degeneration, the valve acts as though shunted by resistance $1/(n g_m)$ where g_m is the transconductance of the

valve. The input signal required for rated output is approximately

$E_d = D_o / \{ 1 + [n g_m R_l / (1 + R_2/r_p)] \}$ where F_o is the input signal required for rated output without inverse feedback. The distortion with inverse feedback is approximately

$D_d = D_o / \{ 1 + [n g_m R_l / (1 + R_2/r_p)] \}$ where D_o is the distortion without inverse feedback. The transconductance of the valve is not changed by the addition of this type of degeneration.

The cathode resistor (R_c) has the same value with and without inverse feedback, because electrode voltages are not changed when this circuit is used. Also, the load impedance into which the valve operates should not be changed when inverse feedback is added. The load resistance that is optimum without degeneration is also optimum with degeneration. Therefore, in order to use inverse feedback in some receivers, it may be necessary only to install R_1 , R_2 , and C .

Circuit Precautions

Although the inverse-feedback cir-

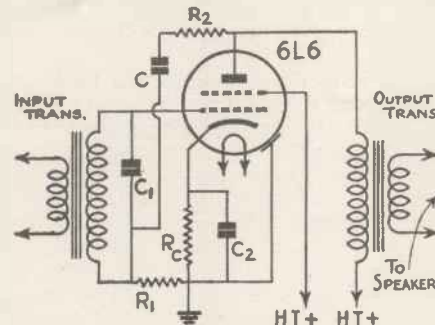

Fig. 4a. Inverse feed back for a single valve.

cuits of Figs. 4a and 4b offer certain advantages, the following precautions should be observed in the design and use of these circuits in order to avoid the possibility of instability, oscillation, or a marked divergence from expected results.

(1) A conventional resistance-coupled input circuit cannot be used with this type of degenerative circuit, because the input-signal voltage must be in series with the feedback voltage for proper operation.

(2) It may be desirable to connect small fixed condensers (c_1) across each secondary of the input transformer in order to avoid the possibility of oscillation due to leakage inductance and shunt capacitance in the input transformer circuit. It is advisable to determine by test whether or not these condensers are necessary.

(3) The blocking condensers (C in Figs. 4a and 4b) should be placed between R_1 and R_2 as shown. When placed between R_2 and anode, the cir-

cuit may oscillate because of the capacitance of C to grid.

(4) It might appear that the primary of the output transformer could be tapped at the proper point or that a tertiary winding could be used to obtain the necessary feedback voltage. Attempts to use such schemes may be unsuccessful because of phase of shifts due to leakage inductance.

(5) This type of circuit is not suitable for use in amplifiers that are designed for grid-current operation, because the relatively high values of R_1 cause appreciable grid-current distortion.

VALUES FOR FIGS. 4a AND 4b.
 R_c = Cathode Resistor.
 C_2 = Cathode-Resistor By-Pass Condenser.
10% Inverse Feedback.

R_1 =	5,000 ohms	10,000 ohms
R_2 =	45,000 ohms	90,000 ohms
C_2 =	0.1 μ i or larger	0.1 μ i or larger
C_1 =	See text	See text

16.6% Inverse Feedback.

R =	8,330 ohms	16,660 ohms
R_d =	41,670 ohms	83,340 ohms
C =	0.1 μ i or larger	0.1 μ i or larger
C_1 =	See text	See text

For this reason the 6L6 tube is well-suited for use in this type of circuit. Preliminary tests indicate that the shunting effect on a speaker load by two type 6L6 tubes with 10 per cent. degeneration is comparable to that which can be obtained by two low-resistance triodes in a similar circuit without degeneration. At the same time, the power sensitivity of the 6L6 amplifier is approximately twice that of the triode amplifier and the inherent high efficiency of the type 6L6 valve is retained.

In one test, a push-pull amplifier using two type 6L6 valves without degeneration was set up under the following typical operating conditions: Anode voltage, 400-volts; screen voltage, 300-volts; grid bias, 25-volts; A-to-A load, 6,600 ohms. With a peak grid-to-grid signal of 50 volts, the power output was 34 watts at 2 per cent. distortion.

When 10 per cent. degeneration was added, using the circuit of Fig. 4b, an output of 34 watts was obtained from the tubes at the grid current point with approximately 1 per cent. distortion.

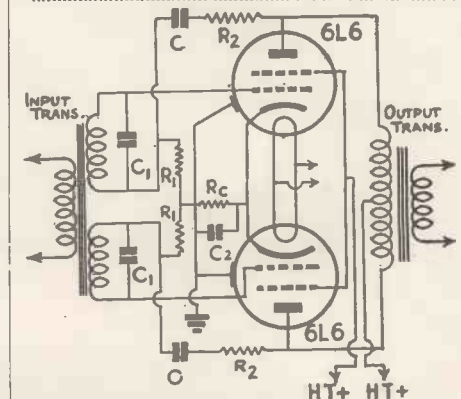
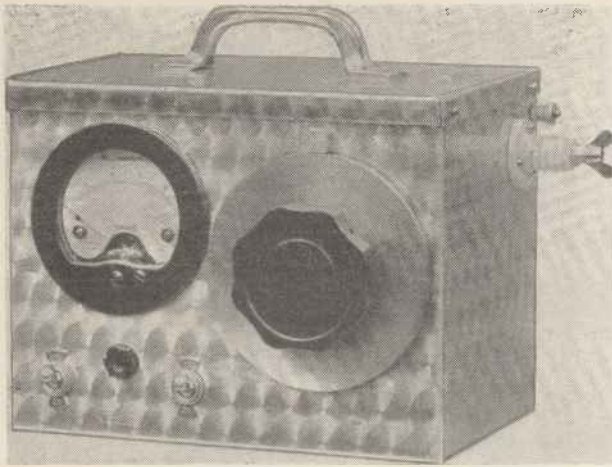

Fig. 4b. Inverse feed back with a push-pull circuit.

A Combined Field-strength Meter Monitor and Neutralising Indicator



The monitor showing switching, 'phone jack and aerial terminal.

BEING mainly interested in aerial design, the present poor conditions for reception are not particularly helpful, for it is getting increasingly difficult to obtain sufficient reports in a short space of time in order accurately to check just where a particular aerial is radiating.

A mains-operated monitor is available, but it has been found quite impossible to make accurate field strength patterns with this monitor, owing to pick-up on the long mains lead.

Battery Supply

To overcome this difficulty a monitor was built that included its own filament supply, and was sufficiently stable to be carried about and still to give very accurate field strength readings.

At the same time the meter did enable me to adjust the transmitter for optimum results, and also to improve the smoothing until all traces of hum had been removed. As is well known, with a mains-operated monitor, it is very difficult to tell whether mains hum is actually present on the carrier, or, if it is being picked up by induction on

the monitor from a near-by transformer.

There is always the filament transformer to consider, so that with any meter connected to the mains, there

anode strapped, so acting as a straightforward diode. Although the filament is rated at 2 volts, a 1.5 volt dry cell of the type generally used in buzzers

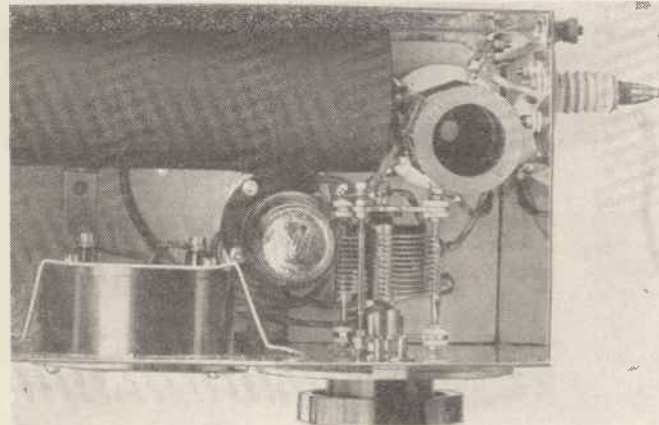

This is how the components are arranged, and notice particularly the bracket holding the bell battery in place.

must always be the doubt that it may not be entirely free from hum.

Diode Valve

The monitor suggested consists of a type 30 triode valve, with the grid and

and door-bells, is quite large enough, and even when under run in this way, the type 30 valve gives ample emission.

Two Wave Bands

In the anode circuit of the diode is a straightforward tapped coil, tuned by a .0001-mfd. condenser, which has a high capacity for a very definite reason. By carefully building the coil, it can be made to cover two wave-bands at a time, which is ample for most purposes.

By the inclusion of a 0.1 mA. meter and a 5,000-ohm load resistance, the meter will monitor telephony, by reason of linear rectification. The entire monitor is built inside an aluminium container which has a tightly-fitting lid, so that the only source of external pick-up is via the terminal for the aerial lead-in. In this way a short aerial connected to this terminal will give the required pick-up, and it can be taken for granted that pick-up is on the aerial, and not on any associated components, which would upset the efficiency of the meter when making field strength checks.

The same remarks apply when using

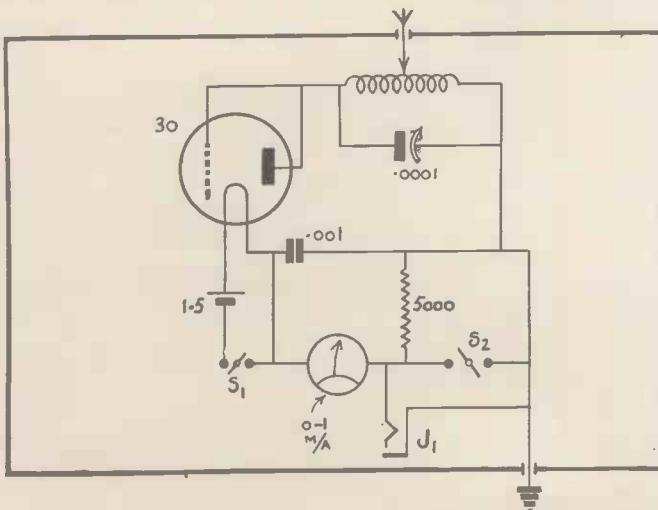

A type 30 valve is used as a diode having the grid and anode electrodes strapped together. Notice the jack switch S2 which cuts out the load resistance R2.

Operation :: Many Uses

the meter for neutralising purposes. A length of stiff wire connected to the aerial terminal, and terminated at the opposite end in a single turn loop, can be used to indicate the presence of any R.F. in a circuit. It is far more sensitive than the neon lamp, or flash lamp bulb check, and has the virtue that it does not throw the circuit out of line.

With this method, which is almost as good as checking by means of a grid meter, the transmitter can be adjusted

otherwise the readings may vary, causing a distorted pattern, while the presence of metal guy wires or fencing will also have an effect on the reading.

Frequency Checking

Another use for this meter is for comparative frequency checking when using a doubler or any frequency multiplying stages. One can tell quite accurately whether a tri-tet oscillator has the anode

condenser are mounted in the wiring, but it is advisable to use fairly heavy gauge wire for this purpose, in order to prevent movement.

Constructing the coil should not cause any difficulty. Use for this purpose a standard type CT4 Raymart threaded coil form, and wind on it 6 turns of 20-gauge enamel covered wire. There should be two-thread spacing between turns. The coil is centre tapped, and this tapping is taken to one filament pin. This coil will cover the 10- and 20-metre amateur bands, but a second coil is required for 40 and 80 metres. For this band wind on 18 turns of 20-gauge enamel covered wire with one-thread spacing. The tapping point should be about six turns from

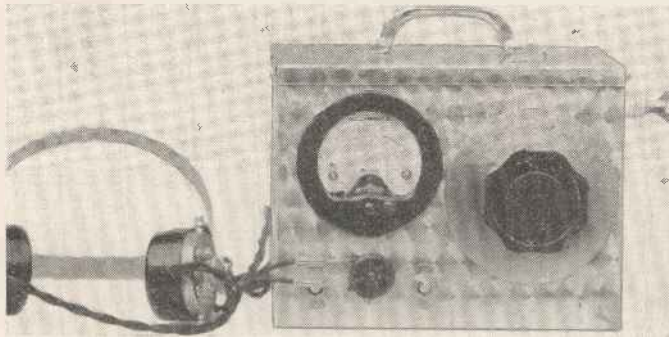

Headphones should only be left in circuit when the meter is being used as a monitor. The long 'phone leads act as an aerial and increase the amount of pick-up. The headphones, of course, can be switched out of circuit.

until there is no deflection on the diode meter. Of course, care must be taken when neutralising in this way for in even small transmitters which are badly neutralised, there may be sufficient R.F. present in the anode circuit to cause the meter to rectify 2 or 3 mA., which would probably damage it.

Field Strengths

When used for making field strength patterns the meter can give a very accurate indication as to the radiation pattern of any given aerial, provided, of course, that there is sufficient free space on either side.

In the next issue I propose to deal quite fully with the correct method of making radiation patterns with this meter, but for those who wish to make a few checks without any delay, here is a rough idea of the suggested scheme.

Leave the transmitter running without modulation, and connect a length of 14-gauge wire, about a foot long, vertically to the aerial terminal on the meter. At a distance of about 3 ft. to one side of the end of the aerial, notice the reading on the meter, then advance 1 ft., at the same time moving to the left 1 ft., and take another reading. Repeat this until the meter reading starts to decrease, and then instead of moving away from the aerial, move towards it, but still going forward all the time. If this is done the whole length of the aerial and on both sides, then a very good idea as to how the aerial is radiating can be obtained. This system may not be accurate, but it does at least give a visual indication of what is happening. It is essential, however, that the meter be kept absolutely level,

circuit actually on 10 metres, rather than on the 40-metre harmonic of 13 metres. It is, of course, quite useless for accurate frequency measurement, but does indicate normal in or out of band working.

The aluminium cabinet is 6 by 4 by 4 in. with a small chassis that loosely fits. The component lay-out can be seen from the illustration where the meter, condenser, switches and jack are all mounted on the panel. The bell battery, which takes up half the chassis, is held in position by a small bracket pushing it against the side of the cabinet.

There is just sufficient space for a 4-pin plug-in coil to be mounted at the side of the aerial terminal, and for the type 30 valve to be mounted between the meter and the tuning condenser.

The resistance and .001-mfd. fixed

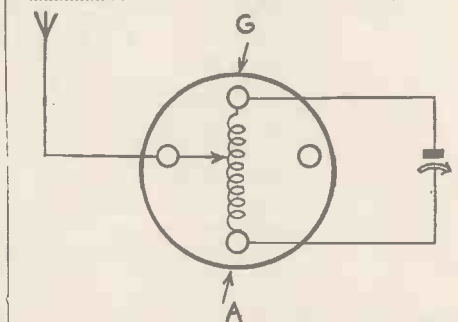

Connect the coil in this way across the grid and anode terminals with the tapping going to the filament pin.

the earthy end. Fifty turns are ample for 160 metres, but use 22-gauge wire.

Four Wave Bands

This set of three coils will cover four amateur bands, and although another coil could be built for 5 metres, this is rather a tricky business, and I prefer to work on the harmonic, which is readily obtained when using the 10-metre coil.

Components for A COMBINED FIELD-STRENGTH METER MONITOR AND NEUTRALISING INDICATOR

CABINET AND CHASSIS.

- 1—Aluminium Cabinet 6 x 4 x 4 with lid and handle (A.P.A.).
- 1—Chassis to fit turned down on four sides 1 in. (A.P.A.).

CONDENSER, FIXED.

- 1—.001-mfd. type 690W (Dubilier).

CONDENSER, VARIABLE.

- 1—.0001-mfd. type 900/100 (Eddystone).

COIL FORM.

- 1—type CT4 (Raymart).

DIAL.

- 1—Type 1077 (Eddystone).

HOLDER COIL.

- 1—Type 949 (Eddystone).

HOLDER VALVE.

- 1—Type 4-pin American chassis mounting (Webb's Radio).

METER.

- 1—0/1 M/a. type 3 in. (Ferranti).

PLUGS, TERMINALS, ETC.

- 4—Insulating pillars type 1029 (Eddystone).
- 1—Insulator type 110 (Bulgin).

RESISTANCE, FIXED.

- 1—5,000-ohm type ½ watt (Erie).

SUNDRIES.

- 1—1.5 volt dry cell (Ever-Ready).
- 2oz. 20 gauge enamelled covered wire (Webb's Radio).

- 1—Jack type J2 (Bulgin).

SWITCH.

- 2—Type S80 T toggles (Bulgin).

VALVE.

- 1—Type 30 (Webb's Radio).

HEADPHONES.

- 1—Pair Type A (S. G. Brown).

The Short-wave Radio World

INTER-OFFICE COMMUNICATION

INTER-OFFICE communication systems appear to be in great demand in America, where the idea first originated. Several schemes have been introduced, but few of these have been suitable for construction by amateurs, or even serious technically-minded experimenters.

We noticed with interest an arrangement of the talk-back communication system in the 1938 manual Radio, which uses standard components and can be easily constructed.

Small permanent magnet loud-

A Review of the Most Important Features of the World's Short-wave Developments

at a distance from the main amplifier, this should also be connected by means of shielded cable.

For convenience the remote loudspeaker-microphone unit can be at any distance from the main amplifier, while two loudspeakers can be connected in parallel, but used in different offices, if required. In such circumstances it is necessary to use loudspeakers of the same impedance.

The arrangement consists of a 6K7 pentode with both grid and anode coils tapped well down. In this way grid damping is greatly decreased, while selectivity in the anode circuit reaches a high level. Both circuits are parallel tuned and have conventional small capacity parallel band-spreaders.

For those who have not had very much experience with R.F. amplification at high frequencies, this circuit seems to be an unusually useful one. There are no complications, such as adjusting the tap point for regeneration, while as both input and output circuits have inductive couplings, then the amount of damping can readily be adjusted.

The designers of this unit claim a voltage gain of 8, and a signal to image ratio of 7; these figures being obtained when used with a receiver having an intermediate-frequency of 456 Kc.

The detrimental grid-loading effect is not entirely eliminated, although it has been greatly reduced by taking the grid to a point about one-third of the way down the coil. By doing so, the Q of the tuned circuit is maintained at a much higher value than that normally obtainable, while at the same time the voltage on the grid is not very appreciably reduced.

The explanation for this is quite simple; the more efficient tuned circuit develops a higher impedance with attendant higher signal voltages, and the tapped coil is virtually a matching transformer, for the grid impedance of the 6K7 at 30 mc. is about 30,000 ohms.

Approximate values in this circuit are C₁ and C₇ 30-mmfd., C₂ and C₆ two-section condenser 25-mmfd. per section, C₃ 0.1-mfd., C₄ and C₅ 0.1-mfd., R₁ 50,000 ohms, R₂ 50,000 ohms.

Coils L₁ and L₂ consist of 6 turns of No. 20 enamelled wire to a winding space of 1/2 in. and a diameter of 9/16 in.

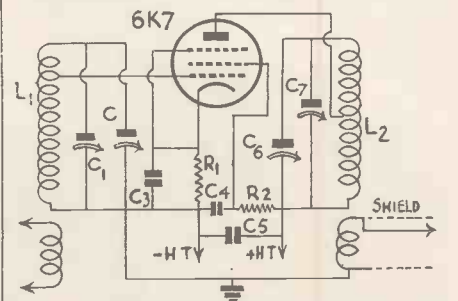

Fig. 2. A pre-amplifier of this type will very greatly increase the gain on the ultra-high frequencies, and tend to reduce noise level and image interference.

The pick-up windings consist of 3 turns of No. 30 d.s.c. close wound.

A LONG-WAVE CONVERTER

As very few of the American communication receivers include a long-

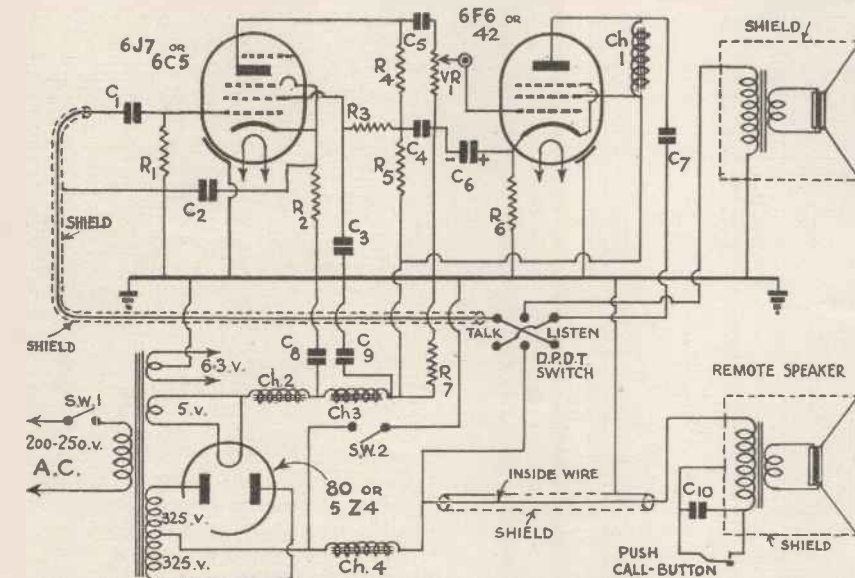

Fig. 1. An excellent circuit for an inter-office telephone system using loudspeakers as microphones or loudspeakers, as required.

speakers are used both as microphone and loudspeaker and are brought into circuit in such a manner that when one unit is in the input circuit, the other is in the output circuit, and vice versa.

The amplifier has sufficient gain so that even when using a loudspeaker as a microphone, there is no need to talk directly into the unit, and even though very small loudspeakers are used the quality is quite satisfactory, due to the balanced input circuit.

In the main amplifier shown by Figure 1 is fitted a line-switch, talk-listen switch, and the loudspeaker, shown in the upper diagram on this page. The remote loudspeaker and the calling button are the only components located in the distant office.

It is most important that the lead from the grid of the input valve to the two-way switch should be shielded for its entire length, as should be the wire from the remote loudspeaker. If this is not done, there is almost bound to be considerable hum pick-up. In addition to this, should the local loudspeaker be

In the stand-by position the filaments are left heated and the "talk-listen" switch left set at the "listen" position. The on-off switch is also left "off."

If the operator wishes to talk to the remote station, the switch is turned to "on" and the talk-listen switch to "talk." When the conversation is finished the switch is turned to "listen" when the remarks can be heard from the remote station.

With this arrangement no H.T. voltage is applied to the anodes of the valves, except when the amplifier is actually in use, although the valve heaters remain in circuit for long periods.

A 10-METRE PRE-AMPLIFIER

W1HRX and W1BZR discuss very fully in the February issue of QST circuit arrangements for some excellent 10-metre pre-amplifiers. One circuit in particular, shown by Fig. 2, seems to be ideal for use in front of receivers that are inclined to fall-off in sensitivity on the higher frequencies.

Automatic Volume Compression

wave channel, the circuit of a converter for 1,000 to 2,000 metres, described in a recent issue of "Short-Wave and Television" should be of interest to users of American receivers.

The circuit is shown by Fig. 3, from which it can be seen that two metal valves are used, one providing a stage

mainly caused by high peaks rather than by a high average audio being employed. With this circuit, designed by W9JHY, over-modulation is practically impossible, once the operation conditions have been set, while there is no perceptible effect on the speech quality.

A pair of 802 pentodes operating as

shown in QST supplies with it some operating data. The arrangement is adjusted in the following way.

Vary R₂ until the two valves draw 60 mA. at no signal input, which gives approximately Class AB operating conditions. With constant tone input measure the voltage appearing from suppressor grid to earth. This should be about 1 volt on a good meter, when the Class C stage has been modulated between 75 and 80 per cent.

Then when the lag of the R₄C₃ circuit is taken into account, the transmitter will not be modulated more than 90 to 95 per cent. The setting of R₆ controls the threshold bias on the 6H6, which if being fed by a high enough voltage from T₂ will easily control the gain of the pentode stage.

As an indication of modulation percentage, or rather of the operation of the compression circuit, a 0-100 D.C. voltmeter can be connected from the suppressor grid to earth, although this will make the gain-change more rapid and tend to upset the ratio of C₃R₄. A variable resistor at R₄ would, however, take care of this variation in ratio.

It is desirable to set the gain control at a point where the compression is not brought into action, for it must be remembered that the system is only a protective arrangement, and it is more than likely the quality will be better without compression voltage on the suppressor grid.

The transformer C₂ has a ratio of about 6-1, but this is not important. It should also be remembered that the 802 pentodes can very easily be used in circuits previously embodying 2A3's.

10 Metres from South Africa

ZE1JR complains that he cannot work British amateurs in South Africa when using the 10-metre band. The trouble appears to be that the G amateurs only look over the American phone band of 28,500 to 29,000.

British amateurs are asked to look out for ZE1JR, who uses a frequency of 28,170 kc.

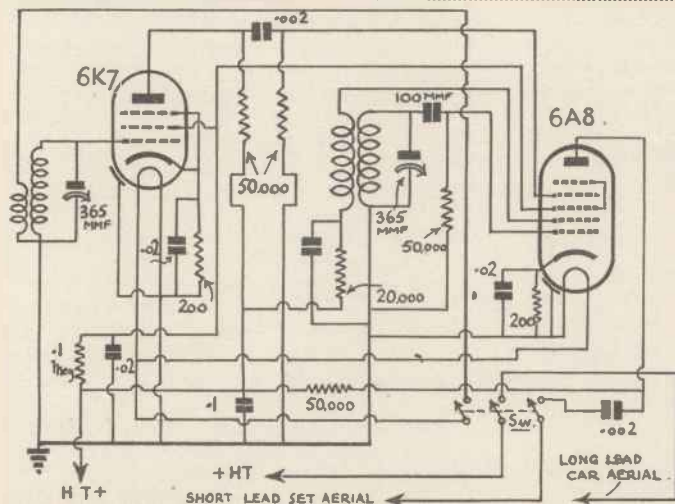

Fig. 3. Those who are using American receivers not including a long-wave channel, will find this converter of interest. It covers the European long-wave band only.

of R.F. amplification of long-wave signals, while the other provides a signal which may be picked up by the receiver at 600-700 kc.

A switching system is employed, whereby the aerial can be switched either to the converter or straight through to the main receiver, without having to disconnect any wiring. In this way the unit can be left permanently connected in circuit and merely switched into use when long-wave reception is required.

Approximately 200 volts high tension is required, and this can either be obtained from a separate supply capable of giving this voltage at a current of 10 mA., or from the main receiver if it is capable of standing the slight additional drain.

A 6K7 pentode is used as an R.F. amplifier, while the detector oscillator is a 6A8, which has an equivalent the Osram X65. Standard long-wave coils can be used in this converter, merely ignoring the switching arrangement, which is more usual in British 2-band receivers.

The switch is of the rotary type, such as a Xaxley, which is obtainable from Messrs. Peto-Scott.

AUTOMATIC VOLUME COMPRESSION

Automatic volume compression is a refinement which will ultimately be embodied in most 'phone transmissions. The main advantage is that the audio output from the modulator can be compressed, enabling a much higher percentage of modulation to be obtained.

As is well known, over-modulation is

Class AB amplifiers are used to drive the Class B grids in the final stage. In the designer's original model the driver is coupled to the Class B input transformer through a 200 ohm line, and the audio voltage appearing across the line is applied to the primary of transformer T₂. The centre tap of this secondary is connected to the anodes of a 6H6 used as full-wave rectifier.

The rectified audio voltage is then suitably filtered, and applied as bias to the suppressor grids of the 802 pentodes. In this way the greater the output signal the greater the bias develops, and in turn the lower the amplification of the 802 stage. The 6H6 cathode is given some initial bias through R₆, so that the automatic control does not function until the signal reaches a pre-determined level.

The author in the original design

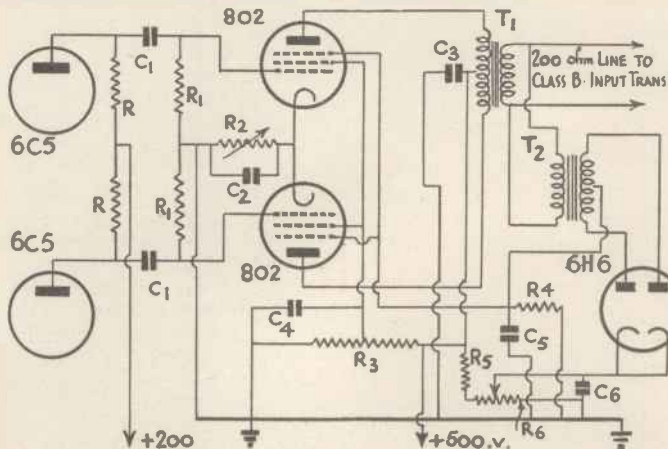

Fig. 4. Transmitting amateurs will appreciate the value of this automatic-volume compression circuit, which can very easily be included in Class B modulator circuits.

A Regenerative Pre-Amplifier

By G5ZJ.

In view of the increasing need for additional selectivity in the amateur bands and the more general use of commercial receivers of the all-wave type this pre-amplifier is of particular interest. It is suitable for all wavelengths from 10 metres upwards.

It is generally assumed that the conditions of the amateur bands would become worse this year owing to sun-spot activity, but although this may prove to be the case, at the present time there are more stations than ever on the 20-metre band to quote but one example. In addition even when the conditions

quite straightforward after the snags had been eliminated. The first valve is a conventional RF amplifier with band-spreading, having the gain controlled by means of a 10,000 ohm variable cathode resistor.

The input circuit is designed for a doublet aerial with low-impedance

In the second stage the RF amplifier has regeneration, controlled by means of a variable screen voltage potentiometer, while regeneration is actually obtained by taking the cathode back to earth through a small portion of the grid coil.

Although it is more usual to have regeneration in the first stage this arrangement was discarded owing to the fact that the amount of regeneration varied with aerial coupling.

This meant that a slight increase in selectivity gave more feed-back which was not always wanted. With the circuit chosen regeneration is only governed by the position of the cathode tap.

The amount of selectivity required in the second stage is controlled by the number of turns on the primary coil and once this is fixed the regeneration remains constant.

By having a variable cathode control in the first stage and a variable screen voltage control in the second providing the lay-out is the same as in the original model the problem of stability will not arise. Small variations in stability can be taken up by these controls. For this reason I feel that this pre-amplifier is ideal for those who have not had any experience with high-gain RF amplifiers and feel doubtful about tackling this unit.

As can be seen from the illustrations the panel is cut for a relay rack and for that reason is rather larger than it need be, but a reduction in size will not affect the working of the unit.

Another good point is the band

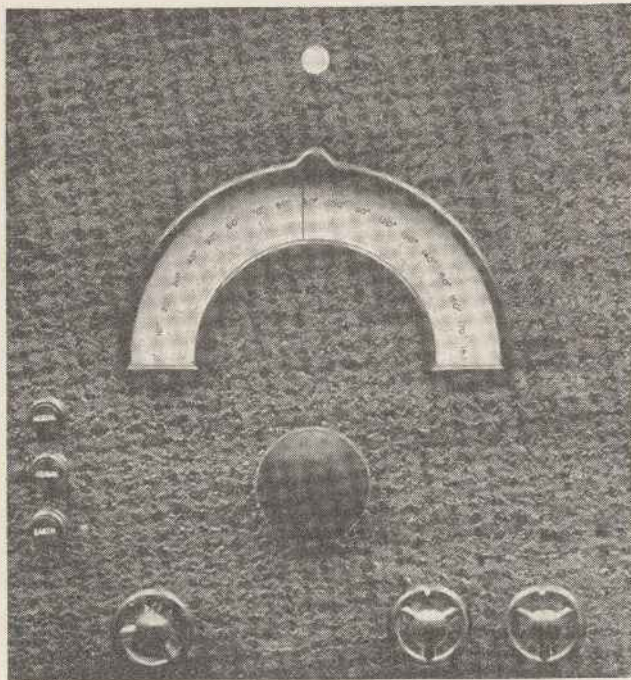

This type of dial matches up closely with the Tobe or RME type and is still obtained although not listed. It has a slow motion ratio of 22/1.

are bad for long-distance reception there seems to be more than the usual quota of local stations.

Without a very selective receiver it is almost impossible to have a satisfactory QSO owing to the interference from other stations. About a year ago I designed a pre-amplifier for use in front of my communication receiver, and although at the time this was quite satisfactory it had, what turned out to be, two bad defects.

The first trouble was the lack of proper regeneration so the maximum selectivity was not obtained, while the other point was the fact that no separate power pack was included.

To overcome these troubles a new pre-amplifier was built some weeks ago which has proved a great advance on the original model. It has stable regeneration and a built-in power pack so that it is quite independent of the main receiver, and it is suitable for any type of set.

The circuit shown in this page is

feeder so as to provide maximum gain minimum noise level. In practice this works out very well.

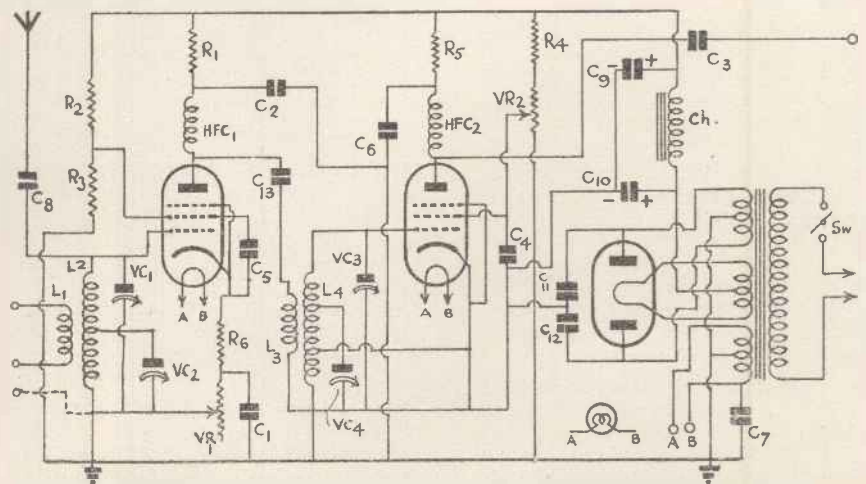

As can be seen from this circuit the unit has regeneration in the second stage only.

The Coil Dimensions

spreading which has been so arranged that the amateur bands cover a very wide portion of the dial despite the use of a large band-spread condenser.

Those who use a small condenser on the lower wavelengths will find that on the 160-metre band they will not obtain full coverage. This method of band

The screening although very complete is very simple and is made up of two bent pieces of steel forming two partitions. These screens will be supplied complete with the chassis and panel from Messrs. A.P.A., Ltd. It will also be noticed that the panel is $\frac{1}{8}$ in. thick which is much too thick for

higher frequencies is simple owing to the permanent accuracy of the calibrations.

All four coils, which are mounted on two coil forms, are very straightforward to build. The two grid coils are identical in each case, while the primary turns must be found by experiment in order to obtain the required degree of selectivity. The fewer the number of primary turns the greater the degree of selectivity and visa-versa.

All coils are wound with 24 gauge wire and are made to take a total space of $1\frac{1}{2}$ in. Coil one requires 60 turns with the cathode tap at the fourth turn and the band-spread tap at the thirty-third turn. This coil will cover the 160 metre amateur band.

The coil for the 80 metre band requires 27 turns tapped at $1\frac{1}{4}$ turns and $14\frac{1}{2}$ turns. On the 40 metre band use 13 turns with taps at half a turn and $4\frac{1}{2}$ turns.

On 20 metres there may be variation, but generally speaking use 7 full turns with a tap at $1/3$ rd turn at $1\frac{1}{4}$ turns. For 10 metres wind on 3 turns with another tap at $1/3$ rd of a turn and the band-spread tap at half a turn.

This pre-amplifier will cut out most second channel interference, more often than not reduce noise level owing to the more efficient working of the AVC in the main receiver and at the same time increase the sensitivity of the receiving equipment by as much as 12 db.

This unit is in use at G5ZJ where it can be inspected by any interested amateur who cares to call.

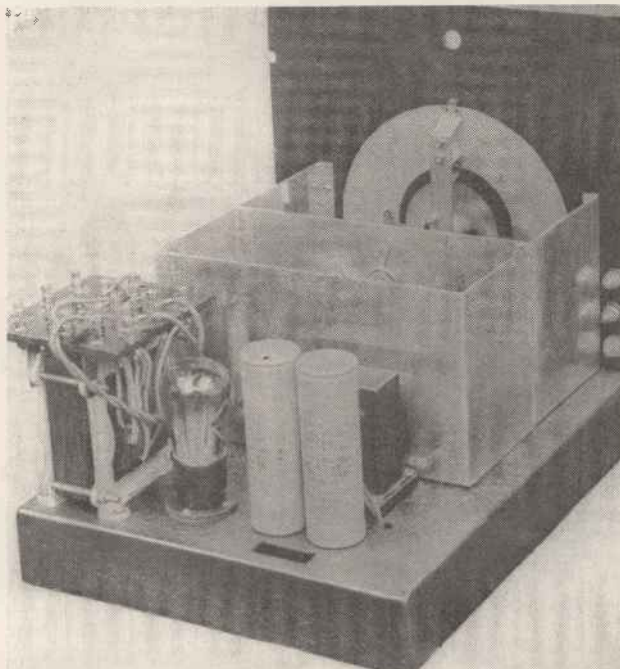

A good idea as to the component layout can be obtained from this chassis view.

spreading has overcome this difficulty, and it is only a matter of adjusting the tap on each band to give the required coverage. The value of the band spread condenser does not enter into the question.

The transformer is a special type made for me and it gives 200 volts at 25 mA. which is more than enough to supply the two screened pentodes used. The D.C. is smoothed by a small low-frequency choke and two 8 mfd. condensers to eliminate all traces of ripple. Of course this is very easily done in a radio frequency stage.

A point to remember, however, is the causing of modulation hum which can be very troublesome but providing the condenser C7 is not omitted modulation hum will not be noticed. As an additional precaution, however, there are also two condensers connected across the anode of the rectifier valve the centre of which is connected to earth.

In no circumstances use any other type of pentode valve unless the grid contact is at the top of the bulb otherwise the unit will probably be unstable while the gain will drop off at 10 metres. This type of valve with a top-cap grid also makes the stages easier to wire with much shorter grid and anode leads.

It will be noticed that the grid leads go straight to the tuning condensers and have a total length of about 1 in.

the average amateur to drill. All my equipment, however, is built on this type of panel for it prevents movement of any kind so that reception on the

Components for

A REGENERATIVE PRE-AMPLIFIER WITH POWER PACK

CHASSIS AND PANEL.

- 1—Aluminium panel $14 \times 10 \times \frac{1}{4}$ in. finished black (A.P.A.)
- 1—Steel chassis $14 \times 12 \times 2$ in. drilled and finished black (A.P.A.).

CONDENSERS, FIXED.

- 1—2-mfd. type 3076, 250 volt. (C1) (Dubilier).
- 1—0.1-mfd. type 4607/S. (C2) (Dubilier).
- 1—0.0005-mfd. type 690W. (C3) (Dubilier).
- 1—0.1-mfd. type 4601/S. (C4) (Dubilier).
- 1—2-mfd. type BB. (C5) (Dubilier).
- 1—0.1-mfd. type 4601/S. (C6) (Dubilier).
- 1—0.1-mfd. type 4607/S. (C7) (Dubilier).
- 1—0.001-mfd. type 690W. (C8) (Dubilier).
- 1—.8-mfd. type 0281. (C9) (Dubilier).
- 1—.8-mfd. type 0281. (C10) (Dubilier).
- 1—0.1-mfd. type 4601/S. (C11) (Dubilier).
- 1—0.1-mfd. type 4601/S. (C12) (Dubilier).

CONDENSERS, VARIABLE.

- 1—40-mmfd. type 900/40. (VC1) (Eddystone).
- 1—40-mmfd. type 900/40. (VC2) (Eddystone).
- 1—100-mmfd. type 900/100. (VC3) (Eddystone).
- 1—100-mmfd. type 900/100. (VC4) (Eddystone).

COIL FORMS.

- 1—4-pin type CT4. (Raymart).
- 1—6-pin type CT6 (Raymart).

CHOKES, HIGH FREQUENCY.

- 2—Type SW69 (Bulgin).

CHOKES, LOW FREQUENCY.

- 1—Type WW/C1 (LFC1) (Sound Sales).

DIAL, SLOW MOTION.

- 1—Type 973 (Eddystone).

HOLDERS, VALVE.

- 2—7-pin type ceramic chassis less terminals (Clix)

A ready built unit can be obtained from Messrs. Peto, Scott Ltd., or Messrs. Spott-Sessions Ltd. Kits of components can be obtained from Messrs. Webbs Radio Ltd., or Messrs. Peto-Scott.

- 2—4-pin type ceramic chassis less terminals (Clix)
- 1—4-pin type V1, chassis less terminals (Clix).

PLUGS, TERMINALS, ETC.

- 2—Insulated terminals, type B, marked Aerial (Belling-Lee).
- 1—Insulated terminal, type B, marked Earth (Belling-Lee).
- 1—Insulated terminal blank (Belling Lee).
- 2—Anode connectors, type 1224 (Belling-Lee).

RESISTANCE, FIXED.

- 1—1,000-ohm type, $\frac{1}{2}$ watt (R1) (Erie).
- 1—75,000-ohm type, 3-watt (R2) (Erie).
- 1—50,000-ohm type, 3-watt (R3) (Erie).
- 1—10,000-ohm type, 1-watt (R4) (Erie).
- 1—1,000-ohm type, $\frac{1}{2}$ watt (R5) (Erie).
- 1—200-ohm type, 1 watt (R6) (Erie).

RESISTANCES, VARIABLE.

- 1—10,000-ohm type potentiometer (VR1) (Dubilier).
- 1—50,000-ohm type potentiometer (VR2) (Dubilier).

SUNDRIES.

- 3—Wheel knobs (Webb's Radio).
- 1—Length screened wire (Bulgin).
- 1—Dial light type D9 (Bulgin).

SWITCH.

- 1—Type S80 T toggle (Bulgin).

TRANSFORMER MAINS.

- 1—Special type to give:
 - 200-0-200 volts 25 m/A. } Premier Supply
 - 2-0-2 volts 1a. } Stores.
 - 2-0-2 volts 2a.

VALVES.

- 2—Type AC/VPB (Hivac).
- 1—Type U10 (Osram).

NOW READY

Premier 1938 New enlarged Illustrated Catalogue, Handbook and Valve Manual! Send 6d. in stamps for 90 pages of Valve Data, Technical Articles, Circuits and Premier 1938 Radio.

PREMIER

SUPPLY STORES

Manufacturers of

TRANSMITTERS, RECEIVERS, MODULATORS, AMPLIFIERS, COMPONENTS

POST ORDERS

Jubilee Works,
167, Lower Clapton Rd.,
London, E.5.
Amherst 4723

CALLERS

5C, High Street,
Clapham, S.W.4
Macaulay 2381
165 & 165a
Fleet Street, E.C.4.
Central 2833.



SHORT WAVE COILS

Low-loss interchangeable coils, 4-, 6- or 7-pin standard and other fittings.

12-26 metres 1/9 41-94 metres
22-47 metres each 78-170 metres
Other wavebands up to 2,000 metres from 2/-.

S.W. Coil Formers as used in above coils, 2 1/2 in. long, 1 1/2 in. diameter, 4-, 6- or 7-pin fitting. Plain or threaded, 1/- each.

S.W. Chokes. 10-100 metres, 9d.; screened 1/6.

Pie-Wound S.W. Chokes, 2/-.

8 NEW PREMIER TRANSMITTERS

10-watt 'Phone Transmitter (as illustrated) 6L6G exciter. Regenerative Crystal Oscillator Doubler. 802 Pentode Amplifier with Suppressor Grid Modulation. Price complete with 4 Tubes and Crystal, £15.

25-watt 'Phone Transmitter. 6L6G exciter. Regenerative Crystal Oscillator Doubler. 801 Triode Amplifier. Grid neutralised grid and anode meters. Price complete with 6 Tubes and Crystal, £21.



10 watt A.C./D.C. C.W. Transmitter. Pentode Crystal Oscillator. Low crystal current. Minimum frequency drift. Price, complete with Valves, Crystal and Key, £4 4s.

Premier Battery Chargers. Westinghouse Rectification.

Complete ready for use. To charge 2 volts at 1/2 amp., 10/-; 6 volts at 1/2 amp., 16/6; 6 volts at 1 amp., 19/6; 12 volts at 1 amp., 21/-; 6 volts at 2 amps., 32/6; 30 volts at 1 amp., 39/6.

TWO NEW MODELS completely enclosed. To charge 6 volts at 4 amps., £3/19/6 To charge 6 or 12 volts at 2 amps., £3/19/6.



SHORT WAVE CONDENSERS

TROLITUL insulation. Certified superior to ceramic. All-brass construction. Easily ganged.

15 m.mfd.	1/6	Double-Spaced
25 m.mfd.	1/9	Transmitting
40 m.mfd.	1/9	Types.
100 m.mfd.	2/-	15 m.mfd.
160 m.mfd.	2/3	40 m.mfd.
250 m.mfd.	2/6	160 m.mfd.
		15 m.mfd.
		40 m.mfd.

All-brass slow-motion Condensers, 150 m.mfd., Tuning, 4/3; Reaction, 3/9.

AMERICAN VALVES

We hold the largest stocks of U.S.A. tubes in this country and are sole British Distributors for TRIAD High-Grade American Valves. All Conceivable types in stock. Standard types, 5/6 each. All the new Metal-Glass Octal Base tubes at 6/6 each, 210 and 250, 8/6 each. 4-, 5-, 6- and 7-pin U.S.A. chassis mounting valveholders, 6d. each Octal Bases 9d. each.

EUROPA MAINS VALVES. 4 v. A.C. Types, A.C./H.L. A.C./L., A.C./S.G., A.C./V.M.S.G., A.C./H.F., A.C./V.H.F., A.C./P., and 1 watt D.H. Pentodes, all 4/6 each. A.C./Pens. 1.H./5/6; A.C./P.X.4, 6/6; Oct. Freq. changers, 8/6; Double Diode Triodes, 7/6; Triode H. ex. Freq. Ch., 8/6; Tri. Grid. Pen., 10/6; 3 1/2 watt 1.H. Triode, 7/6.

UNIVERSAL TYPES. 20 v. .18 amps., S.G., Var.-Mu. S.G., Power, H.F. Pen., Var.-Mu. H.F. Pen., 4/6 each.

13 v. 2 amps. gen. Purpose Triodes, 5/6; H. F. Pens. and Var.-Mu. H.F. Pens. Double Diode Triodes, Oct. Freq. Changers, 7/6 each. Full-Wave and Half-Wave Rectifiers, 5/9 each.

BATTERY VALVES, 2 volts, H.F., L.F., 2/3. Power, Super-Power, 2/9. Var.-Mu.-S.G., 4- or 5-Pin Pentodes, H.F. Pens, V-mu-H.F. Pens, 5/- Class B, 5/- Freq. Changers, 7/6.

PREMIER HIGH-FIDELITY AMPLIFIERS AND MODULATORS
Premier, 1938, Super 3-Watt Amplifier for A.C. or A.C./D.C. mains. 2-stage, high-gain circuit. Complete Kit, with metal chassis, all parts and 3 matched Valves, 40/-. Wired and tested £2 15s.
Premier, 1938, 8-Watt Amplifier for A.C./D.C. mains. 3-stage, high-gain, with Push-Pull output. Complete Kit, with metal chassis, all parts and 5 matched Valves, £4 4s. Wired and tested, £5 5s.
Premier, 1938, A.C. mains 12-Watt P.A. Amplifier or modulator. 2-Beam Power tubes in Push-Pull output, phase inversion high-gain, distortionless output. Complete chassis-built Kit, with 5 matched Valves, £5 5s. Wired and tested, £7 7s.

PREMIER METERS.—Moving Coil 0-1 m/A. full scale, resistance 100 ohms, 3 1/2 in. diameter, flush mounting, 22/6. Multipliers, 1/- each. Tapped shunts: —10, —50, —100, —200 m.A., 4/- each. Moving Iron Meters, 2 1/2 in. diameter, flush fitting. Read A.C. or D.C. All readings from 0-10 m/A to 0-100 amps., 5/9 each. 0-6 volts, 0-16 volts, 5/9 each. 0-250 volts, 8/6. Telsou Multimeters. Read A.C. or D.C., 0-6 volts, 0-16 volts, 0-250 volts; 0-30 m/A, 0-300 m/A., 8/6 each.

POWER PACKS

Completely assembled on steel chassis. Finest components.

Outputs:

120 volts	20 m/A.	25/-	Westinghouse Rectification.
150 volts	30 m/A.	27/6	" "
250 volts	60 m/A.	33/-	" "
300 volts	60 m/A.	37/6	" "
150 volts	30 m/A.	17/6	Valve Rectification.
350 volts	120 m/A.	40/-	" "
500 volts	200 m/A.	65/-	" "
1,000 volts	250 m/A.	£5	" "
1,500 volts	200 m/A.	£6 10s.	" "
2,000 volts	150 m/A.	£7	" "

MODULATION TRANSFORMERS

Primary and secondary impedance to your requirements.

10 watts	14/-
25 watts	18/6
50 watts	26/-

TAYLOR TRANSMITTING TUBES

T.20	17/6	203A	72/-
T.55	45/-	203B	72/-
825	27/6	866	11/6
841A	40/-	866B	17/6
		866JR	7/6



Premier Short-Wave Kits

NEW 1938 1-VALVE SHORT-WAVE RECEIVER OR ADAPTOR KIT, 13 to 86 metres without coil changing. Complete Kit and Circuit, 12/6. VALVE GIVEN FREE!

DE LUXE MODEL, 14 to 150 metres, complete Kit with Chassis, 4 Coils and all parts, 17/6.

1937 SUPERHET CONVERTER KIT, 15/-.
DE LUXE MODEL, 20/-.

S.W. SUPERHET CONVERTER, for A.C. Mains Receivers. 22/6. A.C. Valve given FREE!

NEW 1938 2-VALVE S.W. KIT, 13 to 86 metres without coil changing. Complete Kit and Circuit, 19/6. VALVES GIVEN FREE.

DE LUXE MODEL, 14 to 150 metres, complete Kit and Chassis, 4 Coils and all parts, 25/-.
VALVES GIVEN FREE.

Premier Mains Transformers.—Screened primaries 200-250 volts. Guaranteed 1 year. Wire end types.

HT8 + 9 or HT10 with 4 volts 4 amp., C.T. and 4 v. 1 a. C.T., 10/-. 250-250 v. 60 m/A. or 300-300 v. 60 m/A., with 4 v. 1-2 a., 4 v. 2-3 a., 4 v. 3-4 a., all C.T., 10/-. 350-350 v. 150 m/A., 4 v. 1 a., 4 v. 2 a., 4 v. 3 a., all C.T., 13/-. 350-350 v. 150 m/A., 5 v. 2 a., 6.3 v. 2 a., 6.3 v. 2 a., all C.T., 13/6. Fitted with Panel and Terminals, 1/6 extra.
500-500 volts 150 m/A., 4 v. 2-3 a., 4 v. 2-3 a., 4 v. 5 a., all C.T., 21/-. 500-500 v. 200 m/A., 5 v. 3 a., 6.3 v. 3 a., 2.5 v. 5 a. or 7.5 v. 3 a., all C.T., 25/-. 500-500 v. 150 m/A., 15/-, 1,000-1,000 v. 250 m/A., 21/-. 1,500-1,500 v. 200 m/A., 50/-. 2,000-2,000 v. 150 m/A., 57/6. Fitted with Panel and Terminals, 2/- extra.

Premier Filament Transformers. Primary 200-250 volts, 1,000 insulation test, 2.5 volt. 8 a. C.T., 8/6; 4 v. 5 a. C.T., 9/6; 5 v. 3 a. C.T., 8/6; 6 v. 3 a. C.T., 8/6; 6.3 v. 3 a. C.T., 8/6; 7.5 v. 3 a. C.T., 8/6; 10 v. 3 a. C.T., 11/6.

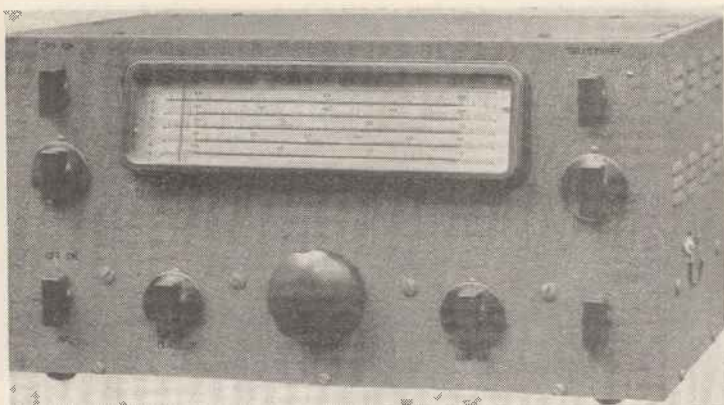

The new National 81X amateur band receiver which has just arrived in this country. It embodies a crystal filter, and uses ten valves.

A New National Communication Receiver

NEW receivers by the National Company are always of interest, particularly when they are suitable for use by British amateurs. We have just been testing a new NC81X, which is the amateur band version of the NC-80X.

Perhaps as far as amateurs are concerned, one of the most important features is the record price of £25, which is low for any National receiver, discounting the fact that the 81X has no less than 10 valves and built-in crystal filter.

Before going into the technical specification of this interesting set, here are some details of the results obtained during extensive tests up against other communication receivers of undoubted efficiency.

Conditions at the present time are rather poor on 10 metres, but during the period when the band is open, that is from about 2 p.m. until 5 p.m., a very large number of long-distance 'phone signals can be picked up at an average strength of R8 with a very big percentage going to R9.

The crystal filter is permanently in circuit, but by means of a phasing control and variable selectivity device, the band width can be varied from 300 cycles to 7,000 cycles. The receiver, therefore, is ideally suited for both 'phone and C.W. reception.

On the 81X receiver only amateur bands are covered, and on 10 metres this band, in common with the remaining four bands, occupies a space of about 8 in. Calibration is extremely accurate, so for all intents and purposes a wavemeter does not become so necessary.

C.W. reception is excellent, for the beat-note oscillator can be varied to produce a very high-pitched note, and when the beat-note is switched into circuit there is no de-tuning effect.

On 20 metres the noise level is extremely low. The audio volume control and R.F. volume control are calibrated from 0 to 10; 10, of course, being maximum gain. With the aerial removed from the receiver, audio gain

at 10 and R.F. gain at 9, there is absolutely no sign of noise level, this with a receiver embodying 3-I.F. stages. A very slight hiss can be noted with the R.F. gain increased to 10.

The 81X produced more signals on 40 metres than any of the other receivers I had previously tried, mainly due to the variable selectivity, which was generally in the maximum position. Calibration on this band was also very good, for several stations were checked up against crystal frequency, and these checks always showed the calibration to be approximately correct.

On this band two 'phone station modulating 100 per cent. and situated at a distance of half-a-mile in one instance, and three-quarters of a mile in the other, occupied only 8 kilocycles on the band with moderate selectivity setting.

The receiver, of course, also covers 80 and 160 metres and on the latter waveband we noticed the one and only harmonic, that being of the Regional programme from medium waves.

The receiver has ten valves but no R.F. stage. The valve line-up is first detector, oscillator, 3 I.F. amplifiers, 2nd detector, A.V.C. rectifier, beat-frequency oscillator, output tetrode and

a rectifier. It is for A.C./D.C. operation on 110 volts, but is supplied with a line resistor for use on normal English voltages. There is also a battery model designed for 135-volt operation, plus a 6-volt heater supply.

Despite the fact that we consider, or have always considered a radio-frequency stage essential with a communication receiver, the 81X has a very high gain, a good signal to noise level, and freedom from image interference. The I.F. channel operates at 1,560 kc., which enables the receiver to be designed so that the repeats fall outside the limited amateur bands.

No R meter has been included, but there are two terminals across which any 0-1 mA. meter can be connected. Details are given showing how this meter can be calibrated to give nine signal levels.

Amongst the controls are a B.F.A. switch, a B.F.O. adjustment, A.V.C. switch, combined audio and volume control and standby switch, combined R.F. gain control and line switch, a rotary wavechange switch, variable selectivity, crystal phasing. There is also provision for the use of headphones, a plug being provided which when used cuts out the loudspeaker.

At £25 the new National receiver sets a new standard in value for money, and is one of the cheapest multi-valve communication receivers available that is of proved efficiency. They are available from Webbs Radio, Ltd.

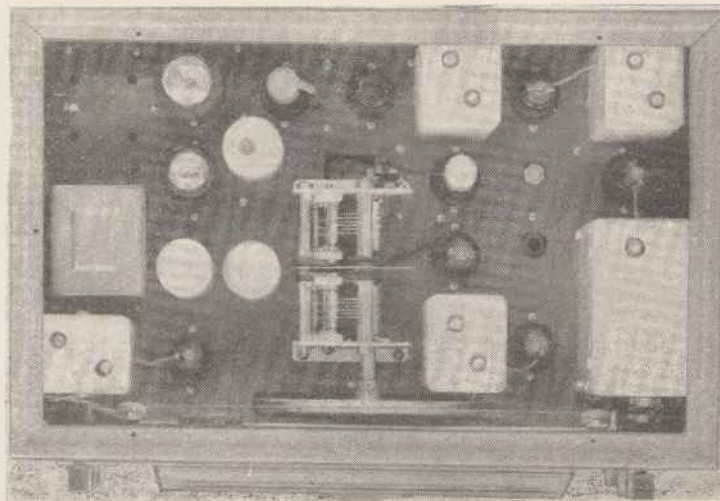

The chassis of the 80X and 81X receivers using a mixture of metal and glass valves.

MARCH, 1938

WEBB'S OFFICIALLY APPOINTED DISTRIBUTORS IN
GREAT BRITAIN BY—
RME, HARVEY & HALLICRAFTERS

RME-69

THE SUPER COMMUNICATION TYPE RECEIVER

WHY CHANGE MODELS ?

ARE brand new models justified every year just because the calendar has changed ?

Should a communication receiver be depreciated in value because of new cabinets, new paint, or new gadgets of no intrinsic value ?

We believe not. The RME-69 is not only one of the most up-to-date instruments to-day, but will remain so within the scope of radio receiver developments as they occur.

PRICES OF RME RECEIVERS

All 230-volt Input with Crystal Gate.

RME-69	£38 0 0
RME-69 L.S.I	£41 10 0
DB-20	£12 10 0

The **DB-20**. A Two Stage Radio Frequency Amplifier Wave Range 9.5 to 550 metres. Built in power pack (230 volt mains). Ideal for use before any efficient All-wave or Communication type receiver.

THE PICK OF THE WORLD

ALL NEW. ALL IN STOCK.

RCA 814 Tubes	£5 0 0
RCA 809 Tubes	17 6
Johnson 6" Transmitter Tuning Handles ...	5 0
Johnson 4" Transmitter Tuning Handles ...	3 6
Taylor T.125 Valves	£4 15 0
Taylor 203Z	£2 12 6
Shure Microphone Stands. Standard model	12 6
De Luxe Model	£1 7 6
75 watt Aerovox Adjustable Resistors ...	6 6
200-watt, 50,000-ohm, 100,000-ohm, Aero- vox, with taps	11 6

VALPEY CRYSTALS

Any frequency (7 M.C. band) from stock.

Mounted in enclosed holder, 15/6.

455 K.C. Crystals, mounted, 27/6.

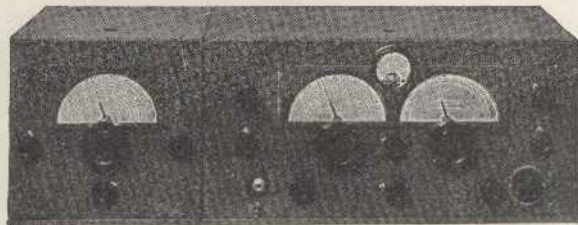

RME-69 L.S.I (With Noise Silencer) and DB-20

NEW RME-501 X U.H.F.

Frequency Expander. Frequency coverage 27.8 to 70 megacycles. Built-in Power Pack. Overall sensitivity less than one microvolt. Accurately calibrated. Release date—uncertain.



RADIO AMATEURS' GLOBE, 12 inch diameter, full colour, continental boundaries, produced by Webb's:— **27/6**

Post Free

GREAT CIRCLE MAP of the World, 30 inches by 40 inches, full colour, every international prefix plainly marked, time zones, continental boundaries. On heavy paper ... **4/6**
On linen, with rollers ... **10/6**

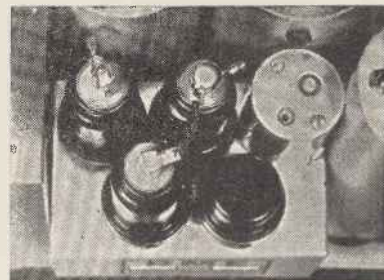

RME Noise Silencer Unit

EVERY HALLICRAFTER RECEIVER IN STOCK

1938 Super Skyrider. The finest 5 to 550 metre Superhet calibrated "R" meter. 1,000 degree band spread. Accurate calibration all bands. Crystal gate model complete, 230 volt mains. **£32.**

HALLICRAFTER SKY CHALLENGER II

New Improved Model of the 1937 Challenger. Incorporates 1,000 degree band spread, crystal gate, "R" meter terminals. Price complete. **£25 0 0.** Available from stock March 1st.

See the NEW HARVEY UHX-10 Transmitter

(Reviewed in February issue)

10 watt R.F. output all bands. 5 to 160 metres inclusive. Transmitter complete, two band operation, **£19.** 230 volt A.C. Power Pack, **£6 10s.** 6 volt Gene Motor, **£9 16s.**

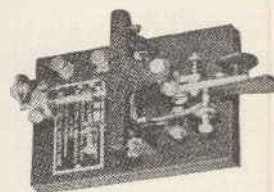

ALL McELROY KEYS REDUCED IN PRICE. Famous McElroy Standard "Bug" reduced from 38/- to **27/6.**

1938 Model de Luxe Bug, 50/- reduced to **38/-.**

New Junior Bug reduced from 22/6 to **17/6.**

McElroy Straight Key, latest model, heavy cast base, large contact. Reduced from 10/- to **7/6.**

McElroy Hummer, 1,000 cycle, mechanic oscillator for morse practice, again available from stock, **10/-.**

HIRE PURCHASE FACILITIES AVAILABLE ON ALL MODELS.

WEBB'S RADIO

(C. WEBB, LTD.)

14, SOHO STREET, OXFORD STREET, LONDON, W.1

Telephone : Gerrard 2089

BIRMINGHAM DEPOT :

41, Carr's Lane. Telephone : Midland 3771

All Post Orders to London address

WEBB'S RADIO, THE HOME OF THE RADIO AMATEUR

Results with the W8JK Beam Antenna

By R. T. Dealey, G6DT

RECENT articles on the W8JK flat top beam which appeared in this journal have aroused considerable interest in this type of transmitting antenna, and it is thought that comparative tests made with other antennas will be of interest to those who may be considering the erection of a W8JK beam.

Tests were made during the period August 1-December 31, 1937, at the writer's No. 2 station, situated at Horn-dean village, ten miles north of Portsmouth, where adequate space is available, but, since the writer must perforce toil for his daily bread in London, operating times were restricted to week-ends and vacation periods, mostly the

Transmitting amateurs who have experienced difficulty in working any DX during the present spell of poor conditions should read this article by G6DT who has been one of the best British stations for some time.

This worked out quite well in practice, but since the tests covered a period during which conditions ranged from very good to decidedly bad, the use of the receiving doublet had to be discon-

effects, one antenna only was in the air at a time, although it was found possible to leave the antennas not in use on the ground in such positions that substitution was a matter of minutes.

The tabulated results represent the average value of R strength reports received in respect of all contacts with North and South America, Australia and the Far East, the latter covering such countries as India, Ceylon, Malay States, Netherland Indies and Philippine Islands:

	N. America	S. America	Australia.	Far East.
1. Windom	6.3	6.6	6.3	5.8
2. Windom plus reflector	7.6	7.5	7.46	Nil
3. W8JK	7.43	7.47	7.3	7.44

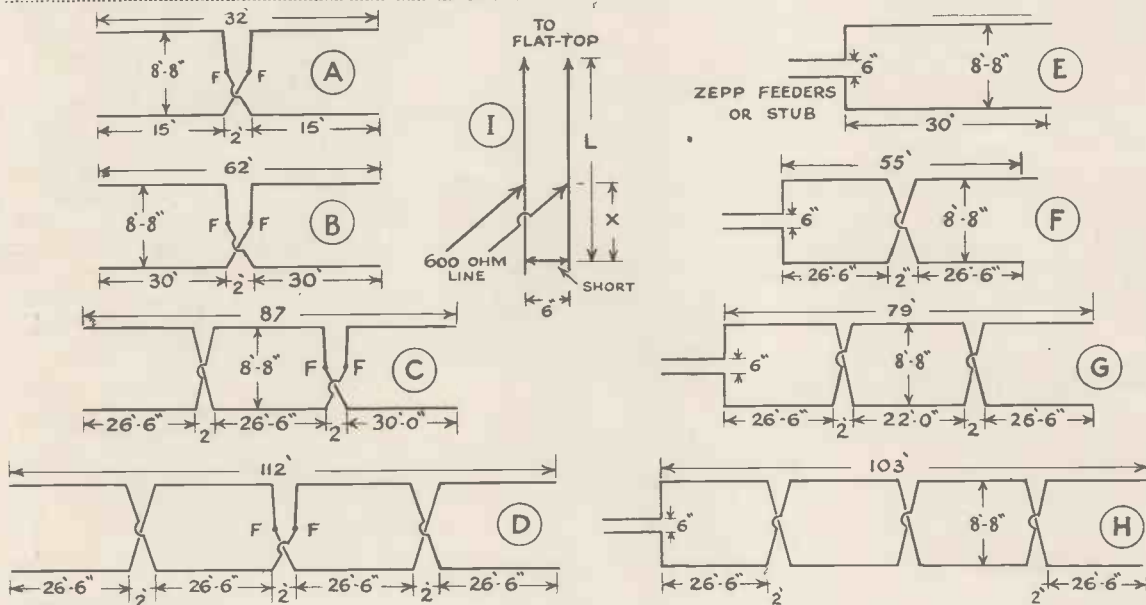

The aerial used by G6DT is shown at Fig. 1B, but the variations in the other aeriels do not alter the results except in some case to effect improvements.

former. Other transmitting amateurs may have noticed a slight increase in QRM at week-ends, so that the antennas under test had to cope with this additional burden.

Telephony Used

All contacts were effected with telephony on the 14 mc. amateur band, the transmitter used being a plate-modulated Taylor T-55 final amplifier with 50 watts D.C. input, this being link-coupled to a separate antenna circuit. The receiver used was an RME-69, fed by an independent receiving doublet, the latter being used by reason of its non-directional properties, since it was desired to call stations theoretically off the line of any directional antenna used in order to check the "beam" effect.

tinued at the end of November, and use made of the transmitting antennas for reception, information having been received from KAI ME that signals were being received in Australia, but answering stations could not be heard.

Three Aeriels Used

Three antennas were used during the test period: No. 1 a half-wave 14 mc. Windom with 66 ft. feeder; No. 2, the same antenna with a 34 ft. parasitically excited reflector spaced 16 ft. to the east in the same horizontal plane, and No. 3 a 60 ft. W8JK antenna with 50 ft. tuned Zepp. feeders. All three antennas were used on a line North 10 degrees West to South 10 degrees East, at an average height of 35 ft., and in order to avoid absorption and other unwanted

In addition to actual contacts, 193 listener reports were received from these areas, of which no less than 107 were from New Zealand, the latter showing an average of R-7.65.

It was intended to use the respective antennas for approximately equal periods, and this was done up till the early part of November, but by that time conditions had so deteriorated that the plain Windom became almost useless as far as DX contacts were concerned, and, after that, one or other of the directional systems was used. The results shown, therefore, rather flatter the Windom, as the reports received during November and December on the two other antennas were of a lower average due to poorer conditions, and accordingly reduce the overall figures for these systems.

PETO-SCOTT

NEW LINES FOR THE ENTHUSIAST

CALLERS

POST ORDERS

All lines featured below are available at our two London Branches, open 9 a.m. to 7 p.m.; Sats. 9 a.m. to 1 p.m. or by appointment. Please call in and let us help you in your choice of apparatus.

All Goods are covered by our guarantee of complete satisfaction. Orders over 10/- sent Carriage Charges paid. Package Free. Overseas Orders, please send full cash or half value of goods, balance and forwarding charges, C.O.D.

TELEVISION RECEIVER

(Described in this issue)

PILOT KIT "A"

£12

(Less Valves and Cathode Ray Tube.) Easy terms available.

Comprises Complete Kit of guaranteed tested components for Vision Unit, Time Base and Power Pack, including ready-drilled tri-unit chassis.

N.B.—The Trophy A.C.3 featured below provides an excellent Sound Unit for use with this instrument.

2 VALVE FOR 10 METRES

SPECIFIED B.T.S. L.F. Transformer, type L.T.135, 4/6. SPECIFIED Peto-Scott ready-drilled steel chassis and panel, black crackle finish, 10/6.

SPECIFIED 2 B.T.S. Valve Screens, 2/6. PETO-SCOTT Metal Cabinet ready for housing of chassis and panel, 10/6.

Complete assembled receiver to designer's circuit, highest grade components only used with valves and housed in steel cabinet, less headphones, fully guaranteed and tested. Carriage Paid, £5 5s., or yours for 10/- down.

REGENERATIVE PRE AMPLIFIER WITH POWER PACK

Completely assembled amplifier. Built by Peto-Scott technicians to designer's circuit, with specified dial and highest grade components, complete with valves but less cabinet, fully guaranteed and tested, £7 19s. 6d.

Complete Kit Prices on application.

SPECIFIED Peto-Scott Steel Panel and ready-drilled chassis, black crackle finish. The pair, 12/-. SPECIFIED B.T.S. type 103 chokes, 5/6.

★ B.T.S. 4 BAND SUPER TUNER 10-2,000 Metres ★

Wave Ranges : 10-25, 25-65, 200-550, 550-2,000 metres. The ideal tuning unit for all multi-valve All-Wave Superhet circuits. It comprises a completely assembled H.F. and Frequency Changer Unit embodying all tuning and decoupling for four wavebands. . . A superlative addition is the incorporation of the new type Duplex Epicyclic dial, with dual-ratio slow-motion drive giving reductions of 9-1 and 80-1 and extra large plate-glass dial with engraved station names and indirect full-vision lighting. B.T.S. trouble-free switches with silver-plated contacts incorporated for wavechanging and gramo. Electrostatically screened coils. Rubber sprung suspension lugs. All components of the highest grade, sprung suspension lugs. Fully guaranteed and tested. Supplied complete with 2 matched B.V.A. valves. Cash or C.O.D. £5 : or 10/- down 10/- down and 11 monthly payments of 10/6.

£5 : 15 : 0

With 2 matched B.V.A. Valves

Yours for 10/- down.

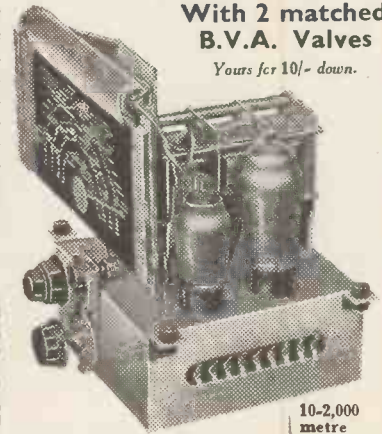

FREE Send for circuit of 9-valve All-Wave A.C. Superhet incorporating the B.T.S. 4-BAND TUNER. Circuit comprises R.F. stage on all wavebands, Triode Hexode frequency changer; Pentode I.F. Amplifier, diode detector and A.V.C., Triode audio amplifier with Triode phase inverter driving 2 output pentodes working in Class A.B. 7 watts Audio Output.

9 VALVE ALL-WAVE SUPER-HET CHASSIS

10-2,000 metres.

This new Peto-Scott 9-valve 4-band A.C. Superhet chassis represents the last word in design, performance and price. World-wide listening at will, ensured by a proved sequence of super-efficient stages and simplified tuning arrangement. No less important, the specially matched High Fidelity Speaker provides to the maximum output, unsurpassed reproduction instantly appreciated by the most critical of listeners. Fully guaranteed and tested.

SPECIFICATION.—Screened R.F. and I.F. valves. De luxe Duplex Epicyclic full vision tuning. Large dial calibrated in station names and metres. Volume and tone control for Radio and Gramo. Four wavebands : 10-21, 20-54, 200-500 and 800-2,000 metres. 9 octal-base British valves, pre-H.F. selector coupled to radio frequency amplifier, transformer coupled to triode hexode frequency changer bandpass I.F. transformer coupled to 2 I.F. amplifiers in cascade, bandpass transformer-coupled to double diode triode providing rectification, automatic volume control and low frequency amplification, phase reversing valve feeding 2 A.F. power pentodes arranged in Class AB push-pull providing 7-watts audio output. Highest grade components. Dimensions : 9 1/2 in. high ; 13 1/2 in. wide ; 10 in. deep. Rigidly tested on actual broadcasting and supplied complete with 10-in. High Fidelity Speaker, all valves, knobs and escutcheon. For A.C. Mains 200-250 volts. 40-80 cycles.

Cash or C.O.D. **£14:14:0** or 21/- down and 15 monthly payments of 20/9.

CHASSIS ONLY, Complete with valves, less Speaker. Cash or C.O.D., £11 19s. 6d. or 21/- Down and 12 monthly payments of 20/-.

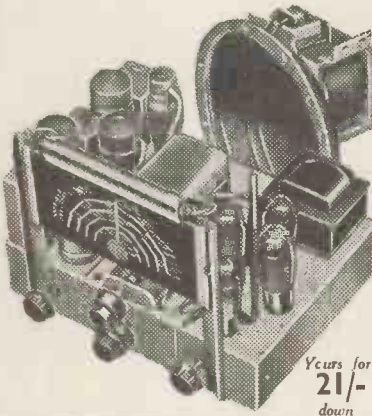

Yours for 21/- down

★ ALL-WAVE CHASSIS ★

8-VALVE ALL-WAVE A.C. SUPERHET

List Value : £12 19s. 6d. Our Price : £9 17s. 6d. or £1 down and 11 monthly payments of 7/9.

4 Wavebands : 13.5-35, 35-85, 200-550, 900 2,100 metres. Automatic Volume Control. Inter-station noise suppression. 4-watt output. All valves employed on short waves. Up-to-the-minute All-wave Bandpass Input circuit. 8 British valves. Radio and gramo. Sides completely isolated by low-capacity switching. Separate volume and tone controls effective on radio and gramo. Tuning scale station and wavelength calibrated. Each chassis accurately gauged before dispatch. For A.C. Mains only, 200/250 volts, 40-80 cycles, with 8 matched valves. Fully guaranteed and tested.

5-VALVE ALL-WAVE A.C. SUPERHET

List Value : £10. Our Price : £6 6s. 0d. or 12/- down and 11 monthly payments of 12/-.

3 Wavebands : 18-50, 200-550, 900-2,000 metres. Automatic volume control on 2 stages. Bandpass on all stages. Mains input filter. 5 British Valves : Latest All-wave A.C. Circuit. 4 position wavechange switch for 3 bands and gramo. Combined on-off switch and volume control. Separate tone control. A.C. Mains, 200-260 volts, 50-100 cycles. Output 3 watts. Fully guaranteed and tested. With High-Fidelity Field Energised Speaker, 5 Valves, £6 6s. 0d., or 10/- down and 11 monthly payments of 12/-.

BUY YOUR VALVES from PETO-SCOTT, ENGLISH & AMERICAN at the RIGHT PRICE

Readers of "Television" are invited to obtain our quotation, first, for all valve requirements. Huge purchases allow us to offer British and American guaranteed valves—all types at prices defying competition.

SPECIAL OFFER.—Three 1st-grade American Valves, comprising types 2101 Output Pentode, 1B4E R.F. Pentode and 1A4E R.F. Tetrode, 2-volt filament. 5/6 the set, post free. Complete with 3 valveholders.

STEEL CABINETS

For short-wave receivers, valve voltmeters, oscillators, etc. Spot welding all joints. Black crackle finished. Lift-up lid. Slotted for leads, etc. Panel size 11 in. wide, 9 in. high, suitable for Chassis or Baseboard 10 in. wide, 9 in. deep. Overall dimensions 11 in. wide by 9 in. high by 5 in. deep.

Cabinet only, type No. S.C.1199. Panel for above (undrilled), 2/-. (Post 3d.) Cabinet and Panel, Post Free, 15/-.

12/6 (Post 9d.)

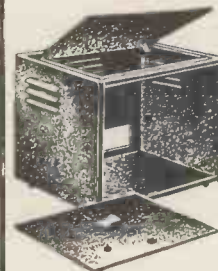

B.T.S. TROPHY SHORT WAVE 3

12-52 METRES.

The Trophy 3 for Battery or A.C. Mains is a definite advance on the Trophy 2, which recently gained the world's record short-wave log. The Trophy 3 is confidently recommended as the ideal receiver, both for the D.X fan and the newcomer to the short waves. It provides alternative loudspeaker or headphone reception of most of those highly interesting short wave transmissions now on the air. ● Self-contained High-Fidelity Moving-Coil Speaker incorporated. ● Simple "One Shot" Coil changing. ● Provision for headphones. ● Effective waverange, 6-500 metres with extra inductors available. ● Simple to operate—only 3 main controls. ● Full vision wavelength calibrated dial. ● Steel cabinet, beautiful black crystalline finish. ● 13 1/2 in. by 8 in. by 8 in. high.

A.C. MODEL
200/250 volts 40/100 cycles

£6.6.0

H.P. Terms : 10/- Deposit and 12 monthly payments of 10/9.

Supplied complete with valves, speaker and 2 One Shot Inductors 12-52 metres. Inductor for Television Sound Channel 3/3 extra.

HEADPHONES. Lightweight type 2,000 ohms each earpiece, with plug fitted, 7/6 per pair. Or Ericcsons Standard type 1,000 or 2,000 ohms, with plug fitted, 16/9 per pair.

BATTERY MODEL
(Less Batteries)

£5.15.0

H.P. Terms : 9/6 Deposit and 12 monthly payments of 9/11.

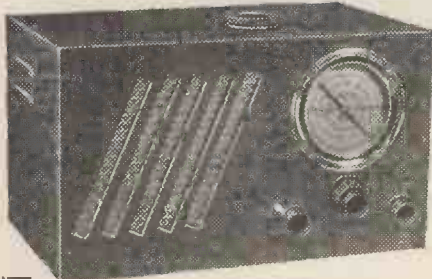

SEND NOW for Complete Specification for any of the popular lines featured, also for Free Bargain lists covering Amplifiers, Short Wave Kits, 1938 famous name sets, etc.

PETO-SCOTT Co. Ltd.,

77 (T.2) CITY ROAD, LONDON, E.C.1.

Clissold 9875-6-7

62 (T.2) HIGH HOLBORN, LONDON, W.C.1.

Holborn 3248

All Postal Orders must be crossed and made payable to the Peto-Scott Co. All currency must be registered.

Established 1819

The figures obtained give a good indication of the superiority of either of the directional systems over the plain half-wave antenna, though the increase in average R strengths may not impress those who do not pause to consider what one R point increase may mean. The R system of reporting signal strengths is not based on any formula, and is usually a matter of personal opinion. Some manufacturers of communication receivers do attempt, however, to establish a definite relationship between the R scale and power gain by incorporating a meter calibrated in R points, and the R.M.E. Company in particular show decibel values in addition. They assume that one R point equals 6 Db: taking zero level as an input of 0.4 microvolt. For those unfamiliar with the logarithmic sequence represented by decibels, it may be said that an increase of one R point (or 6 Db) represents a power increase of four to one; two R points sixteen to one; three R points sixty-four to one, and so on. On this basis it will be seen that the increased signal given in N. America by the reflector system over the plain Windom was 1.3 R points, or 8 Db approximately, representing a six-fold gain. Further reference to the test figures show that, in the other areas, the two directional systems provided gains in signal strength of from three to ten times.

Unfortunately, not all of the reports received during the tests were given by reading meters so scaled, since probably quite a small proportion of the stations contacted used such a receiver, but, in the absence of anything more conclusive, it is thought that the figures obtained may be taken as representing a fairly true picture of the respective merits of these antennæ systems.

Windom Plus Reflector

On balance, the Windom with reflector appears to give the best results, but it must be remembered that this system is uni-directional, and no contacts with the Far East were possible. Apart from this disadvantage, constructional difficulties are great, and 17 ft. spreaders are necessary, unless four-point suspension is possible, as it was in the writer's case. With the W8JK system, however, two-point suspension is quite easy, using 9 ft. spreaders; the writer used 2 in. x 1½ in. deal, not even painted for protection, but bamboo or a lighter wood than deal would be better. By the way, the word "beam" is hardly the right term to apply to this antenna, in the two-section version at any rate; for instance, the western sector covered by the writer's antenna ranges from Canada down to Argentina, with no apparent gradation of signal strength between these points.

The excellent Australian results obtained with the reflector system may convince the doubtful that the early morning path to that country really is over South America, and, if further confirmation is needed, VK3ZL in Ballarat uses a similar, but rotatable antenna for reception, and informed the writer that his array received our signals from a point about 20 to 30 degrees South of East, the direction of South America.

Since the conclusion of these tests, the W8JK antenna used has been permanently installed, and a second and similar antenna has been erected at right angles to the first, on a line West 10 degrees South, for the express purpose of putting readable telephony signals into Africa, particularly south of the equator. That purpose was easily achieved; although having to drive

through the adjacent antenna lying to the south, the first "Test" call on telephony brought an R8 report from VQ4CRE in Nairobi, followed by a similar report from ZU5P, located just outside Johannesburg. A further indication of the success of this antenna, both for transmission and for reception, was a 40-minute contact with ZS3F in S.W. Africa, not a word being lost on either side.

During the recent South African DX contest some thirty stations were worked on telegraphy during the two weekends, though conditions were found to be rather poor. Whilst waiting to work FB8AA in this contest an Alaskan station called CQ, on an adjacent frequency, and was promptly contacted, obliging with an RST 589 report.

As the writer's transmitter is remotely controlled, "send-receive" switching of the antenna is effected by a relay in the link circuit between final amplifier and antenna circuit. With the second antenna in use a further relay was installed to permit the use of either antenna at will, the respective feeder lines being balanced, so as to eliminate re-tuning of the antenna tank circuit. With this arrangement it is possible to assess properly the directional properties of the two antennæ, not only for transmission, but for reception; on recent Sunday evenings at about 17.30 G.M.T., when the "east-west" antenna was bringing in the usual mess of European and North American signals, a change to the "north-south" beam brought comparative peace; African and American West Coast signals, inaudible before, came in at comfortable strengths, practically unaffected by the "east-west" QRM, which became either inaudible or greatly decreased in strength.

Neutralising Triode Valves

By W9LIP

MANY amateurs are experiencing difficulty in effectively neutralising some of the modern low-capacity triode valves.

As no transmitter can be 100 per cent. effective unless every stage working as an amplifier is completely neutralised this very important point should never be neglected.

When the stage is perfectly neutralised maximum DC grid current and minimum anode current occur at the same time. If it is impossible to adjust the neutralising condensers to obtain this condition, it is necessary to look through the stage for trouble. Check all soldered connections; poor connections are of high resistance. Look for shorted turns in inductances. If link coupled reduce numbers of turns in link. In push-pull stages be sure the centre top is at the electrical centre of coils. Use split stator tank condensers wherever

possible. Be sure the grid coil CT is by-passed to ground right at the coil if a split-stator condenser is not used. Long leads from CT of coil to by-pass

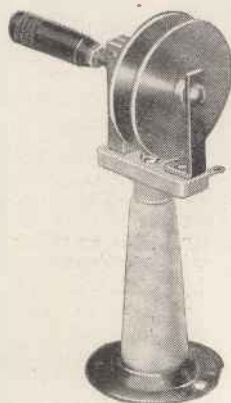

A neutralising condenser of this type, a new Eddystone product, has the low-minimum capacity required when using low-C valves of the Tavlor T-55 or T-125 types.

condenser have a tendency to pick up RF.

Check anode leads—they should be very short. If possible place a shield between the grid coil and plate coil. Use the highest C advisable.

Should there be an indication of RF when the condenser is set at minimum RF and cannot be eliminated, magnetic or capacity coupling is causing this situation. Placing inductances at right angles, shielding stages where necessary, shortening leads to neutralising condenser, or inserting RF choke coils in the grid or anode leads, will eliminate this magnetic or capacity coupling which can be detected by removing valve from socket in that particular stage and checking tank for RF while swinging tank condenser through resonance.

On practically all tuning condensers there are terminals on each side to be used for connections to stator anodes. The anode lead to neutralising con-

(Continued on page 192)

A Career in Television— Your Big Chance

Already there is a shortage of men with sound knowledge of television. Its popularity has emphasised this shortage, but provides a golden opportunity for ambitious men. Television as a career offers good pay, interesting work, and the advantage of getting early into a rapidly expanding industry.

Here is your opportunity. Grasp it. Men with trained practical knowledge are wanted urgently by manufacturers and for servicing.

The International Correspondence Schools TELEVISION COURSE (including Sound Picture Recording and Projection) enables students to gain comprehensive knowledge of the subject in the shortest possible time. It is fully described in a forty-page illustrated prospectus. Details are also given of Radio Engineering, Complete Radio, Radio Service & Sales, Radio Servicemen's and I.E.E., I.W.T., C. & G., and P.M.G. Certificate Examination Courses. This prospectus will gladly be sent free and without obligation. Write for a copy now.

International Correspondence Schools Ltd.
Dept. 62, International Buildings, Kingsway, London, W.C.2.



Founded 47 years ago—860,000 British students—400 Courses of Instruction for every industry, trade, and profession—1,000 text books specially written by I.C.S. for postal tuition—80 Specialist Instructors—branches in all parts of the world—officially recognised by Government Departments at home and overseas.

The new Terman book

A complete elementary treatment
of vacuum tubes and radio

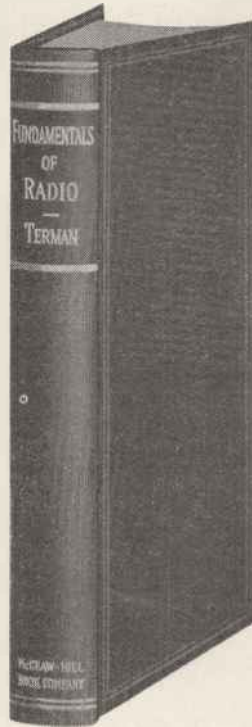

Contents

- Preface
- The Fundamental Components of a Radio System
- Circuit Elements
- Resonant Circuits and Circuit Analysis
- Fundamental Properties of Vacuum Tubes
- Vacuum-Tube Amplifiers
- Power Amplifiers
- Vacuum-Tube Oscillators
- Modulation
- Vacuum-Tube Detectors
- Sources of Power for Operating Vacuum Tubes
- Radio Transmitters
- Radio Receivers
- Propagation of Radio Waves
- Antennas
- Radio Aids to Navigation
- Television
- Acoustics
- Appendix
- Index

Fundamentals of Radio

By **FREDERICK EMMONS TERMAN**

Professor of Electrical Engineering, Stanford University

458 pages, 9 x 6, 278 illustrations, 21s. net.

WHILE this book is essentially an abridged version of the author's well-known **RADIO ENGINEERING**, it is by no means merely a truncated edition of the larger book, but constitutes a carefully unified and almost wholly new text at a more elementary level.

The simplification consists largely in confining the treatment more closely to fundamental principles. This policy has been followed in the belief that the most satisfactory method of presenting a subject in an elementary course is to concentrate on the fundamental concepts, and to avoid diverting attention from these by too much consideration of all the possible consequences, applications, and implications of these principles.

McGraw-Hill Publishing Co., Ltd.
Aldwych House London, W.C.2

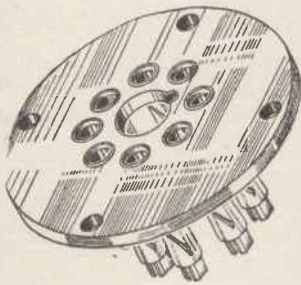

OCTAL



STANDARD

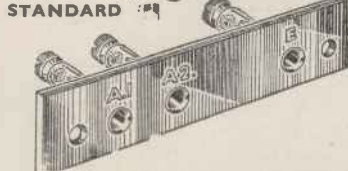

Latest Lists 'T.S.' Free

CLIX VALVEHOLDERS

The greater the number of sockets the more important becomes the need for perfect contact.

All types of Clix Valveholders are fitted with Clix patented turned helically slotted resilient sockets. This is the secret of the perfect full surface contact obtained when using Clix Valveholders.

*As Specified for the
10 METRE RECEIVER*

OCTAL TYPE as illustrated 10d.
STANDARD TYPE 4 pin ... 5d.
(without terminals)

CHASSIS MOUNTING STRIP
with Terminals and Engraved,
A.1, A.2, E. Price 7d.

CLIX SOLID PLUGS
should be used with these
strips.

Price 2d. each



BRITISH MECHANICAL PRODUCTIONS LTD.,
79a Rochester Row,
London, S.W.1.



With the Amateurs

By G5ZJ

Some interesting data is given in this article on two British amateur stations and some new long-distance stations that the listening amateur should be able to receive.

This is the station of G2QY, located at Mill Hill, who is doing extremely well with his low power of 25-watts.

"These amateurs are busy men, and their everyday duties leave them all too little time for amateur radio, much less for answering short-wave listener reports which are rarely of much use. They do not wish for these reports to be sent, and those without international reply coupons will be ignored. Any with replies paid will eventually be acknowledged, although it may be after many months.

"However, if listeners who desire confirmation of reception will enter details on a postcard, leaving space for a signature, this can be forwarded with a self-addressed envelope and a reply coupon. Such reports will stand a good chance of an early acknowledgment and will ease these amateurs of an intolerable burden of correspondence."

These remarks also apply to LA1G in Norway, who, at one period, received no less than 600 reports in a week, most of which were without reply coupons.

Another North London station who has been doing extremely well on C.W. is G6ZO, operated by J. M. Kirk, at Hendon. He was first licensed in December, 1935, and his present transmitter has an input of 25 watts. It is a 2-stage arrangement, using a Tungfram APP4C pentode as either crystal oscillator, electron coupled oscillator or Tri-tet.

The power amplifier is a 4304A running with 25 watts at 525 volts. Link coupling is used between stages and three crystals are used on 40 metres with switching between crystals. There is also a change-over switch for crystal control to electron coupling.

Two power packs are used, one supplying 500 volts with an 83 mercury rectifier, and the second giving 200 volts with a metal rectifier. As with

AMATEURS appear to be in complete agreement, that those who have efficient transmitters the present very bad conditions on 20-metres are rather a blessing in disguise. Admittedly few stations can be heard, but owing to the lack of QRM from the hundreds of American 'phone stations, the weak out of the way ones which would normally not be heard are now coming over very well.

During the past few weeks most of the amateur transmitters I have met appear to be working quite a lot of good DX, which, in normal circumstances, would be quite impossible. This means, of course, that the correct time of day must be chosen most carefully, but by the end of 1938 I anticipate that a lot of records will be broken as regards the number of zones and countries worked by G amateurs.

G. P. Anderson, of Mill Hill, London, has been doing extremely well on his low-power of 25 watts, and has made the most of his transmitter. He operates G2QY, who is very well known in most parts of the world, particularly on C.W. This is proved by the fact that since he obtained his full licence in 1934 he has been W.A.C. and W.B.E. on under 10 watts.

The transmitter at G2QY consists of a 6L6 which can be run as a crystal oscillator, electron coupled oscillator, or tri-tet. For local 'phone work grid modulation is used, the quality of which is practically indistinguishable from anode modulation.

A 3-stage amplifier is used for modulation purposes, with a home-built transverse current microphone. Being primarily interested in C.W. reception, G2QY has a simple 2-valve receiver using a detector and pentode, plus a built-in monitor and beat oscillator.

G2QY is very shortly going again on 5 metres on which band he has been very successful, and he will appreciate reports from any readers who may pick him up. Readers may remember that 2QY's 5-metre receiver was shown on our stand at Radiolympia last year.

A good 'phone contact at the moment is FR8VX, who used to operate FB8VX in Madagascar. The owner of the station is Prince Vinh-San, and the address

for QSL cards is 67, rue Sainte-Anne, Saint Denis.

I have worked this station just recently on 20 metres, and for those who are interested, the QSL card is well worth having. FR8VX tells me that he is active on 10 metres every day at 15.00 GMT. on C.W., and is looking out particularly for G contacts.

While on the topic of QSL cards, literally hundreds of listeners in this country have been sending reports to ZE1JA and ZE1JR, both of Salisbury, Southern Rhodesia.

These two stations are not using rhombic aerials, but their signals in this country and elsewhere give that impression. As they are maintaining regular schedules with amateurs in Europe, reports from listening stations are of little value.



Left is the new Johnson insulator, while on the right the brand new control handle suitable for all 1/4-in. spindles.

A request has just been received by me, via that well-known DX station, G6DT, to ask short-wave listeners not to send reports to ZE1JA and ZE1JR. In his letter he says:



G6ZO only operates on C.W. on the higher-frequency bands. A two-stage transmitter is used with a 4304A in the final stage.

TELCON CABLES for B.B.C Television Broadcasts

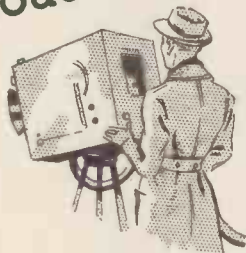

Without Telcon Cable the B.B.C. engineers would have great difficulty in transmitting outside television broadcasts. The "Radio Times" in an article on outside broadcasts for 1938, said: "... these transmissions will have something that previous outside broadcasts lacked—a specially designed concentric cable to connect the transmitter van to the mast. It is more flexible and lighter than the feeders used in the past, and in tests has been found to combine extreme durability with very small electrical loss. This innovation is another thing that will help to make the television mobile unit live up to its name."

Again, Telcon High Frequency Cables amply justify their reputation.

THE TELEGRAPH CONSTRUCTION & MAINTENANCE CO., LTD.,
22, OLD BROAD STREET, LONDON, E.C.2
Telephone - LONDON Wall 3141
Works: TELCON WORKS, GREENWICH, S.E.10
Telephone: GREENWICH 1040

NATIONAL 80X & 81X COMMUNICATION TYPE RECEIVERS

A.C.
D.C.
OR
BATTERY
OPERATED



This is an inexpensive receiver having exceptional operating characteristics. Ten tubes are used in a high gain superheterodyne circuit. The IF amplifier is of entirely new design, operating at a frequency of 1,560 kc, and providing a high order of image suppression, better, in fact, than that obtainable in many receivers having elaborate preselectors. The crystal filter (2nd IF stage) is truly remarkable in its performance, since selectivity is continuously variable between 400 cycles for single signal CW, and 5 kc for high quality broadcast. With such unusual characteristics, the crystal filter remains in the circuit at all times, simplifying tuning considerably.

The tuning system, likewise entirely new, employs a multiple scale dial of the full-vision type, accurately calibrated in megacycles. Several unusual features are incorporated, such as the mirror for overcoming parallax, the auxiliary linear scale (at the bottom) and the adjustable frequency markers.

Automatic plug-in coils are used, controlled by a knob on the front panel, as in the NC-100. This arrangement has proven itself to be thoroughly reliable and efficient. The frequency coverage of the 80X is continuous, except for a small gap at 1,560 kc., from 550 kc. to 30 mc., in four ranges.

The NC-81X is a special amateur model covering the following bands only: 1.7-2.0 mc., 3.5-4.0 mc., 7.0-7.3 mc., 14.0-14.4 mc., and 28-30 mc. The dial is calibrated in megacycles.

NC-80X, complete with tubes, crystal filter, A.C. or D.C., £25 0 0.
NC-81X, Amateur Model, complete with tubes, crystal filter, etc., A.C. or D.C., £25 0 0.
National Speaker Chassis 8 in. PM, £1 0 0.
Note.—Either of the above receivers can be supplied modified for battery operation 6v. heater, 135 v. B. supply.

WEBBS RADIO

14, SOHO STREET, OXFORD STREET, LONDON, W.1.
Phone: GER 2089



Why

use

Dubilier

Condensers?

Do you use them because you have found the new medium calls for components that are absolutely reliable? Do you use them because it necessitates condensers that can be trusted to do their own work without trouble—that will play their part in giving perfect reception? We hope you do.

But if you have not yet had the opportunity to use them for those reasons, we hope you will do so because they are specified by "Television" for all three of their receivers—a rather significant fact.

DUBILIER

DUBILIER CONDENSER CO. (1925) LTD.,
Ducon Works, Victoria Rd., North Acton, London, W.3



New Short-wave Equipment

G2QY, the receiver is a 2-valver with a detector and pentode.

On 40 metres two Hertz aeriels are used, one being half-wave, and the second full-wave, both north and south. On 20-metres three aeriels are extensively used, being half-wave, one-wave

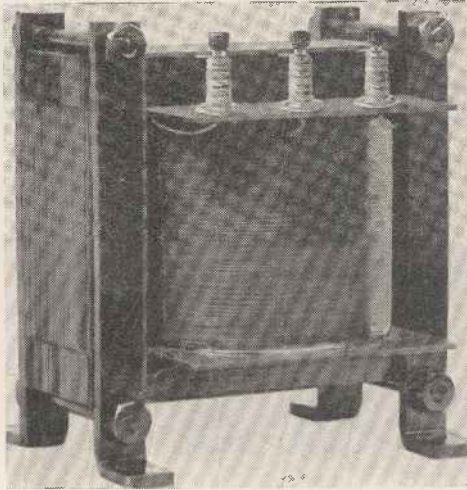

This Kimber-Allen transformer has a tapped secondary giving 500 or 800 volts on either side of centre.

and two-wave Hertz, with half-wave impedance matched wires.

The 10-metre aerial is a 4-wave Zepp, again being north and south and, generally speaking, two aeriels are available at any time.

His results to date are W.A.C. and W.B.E., having worked 41 States, 76 countries and 30 zones.

I found two interesting components among some new stock which has just arrived at Webb's Radio, and these should be just what amateurs are requiring. First of all, there is a new dial, or rather a control handle, made by Johnson, which consists of a handle and calibrated plate appropriately marked. A small one with a 3½ in. plate costs 3s. 6d., while a large one suitable for any transmitter up to a kilowatt, costs 5s. 6d. This is the first time that I have actually seen these control handles in this country.

The second item is a very husky feed-through insulator, which only costs 10d. and will stand several thousand volts D.C. It is ideal for use with metal chassis, in either modulator or high-voltage circuits.

Several other new components have come to light quite recently, which are all of interest to amateurs, irrespective of power rating. Messrs. Kimber and Allen, who make a number of transformers for me, have just produced a mains transformer especially for the low-powered amateur; it gives 500 volts at 200 mA., with an additional section to provide 800 volts at 200 mA.

It enables a station to be built with 500 volt valves, and then to be readily

adaptable for a higher-power output stage using T20 valves. The price of this interesting transformer is 52s. 6d., which is very cheap considering that it is conservatively rated.

Messrs. Peto-Scott asked me if I would like to try one of their new microphones, of which they are very proud. It came along with a chromium-plated stand, and certainly looked quite attractive, being complete with a long cable, microphone switch, and small box which included battery and transformer. My first tests with it over the air were

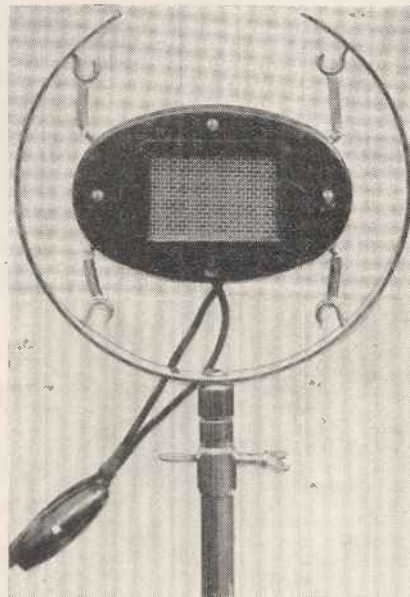

Surprisingly good results were obtained with this new Peto-Scott microphone which is very quiet in operation, and gives extremely good quality.

most satisfactory, for all the reports without exception mentioned that the quality was extremely good, and if anything, rather better than the previous microphone I had been using, which originally cost £16. This is rather startling, for the Peto-Scott microphone costs only 25s. or £2 2s. complete with a telescopic chromium-plated stand.

Amateurs appear to be experiencing quite a lot of trouble in neutralising low-C valves of the RK-39 type. It so happens that Dubilier have produced a



A transformer and battery is included in this cabinet, and is supplied with the Peto-Scott microphone.

small variable condenser with ceramic insulation, with a variable capacity of between 1 and 6-mmf. It has not been designed for amateur use, but quite by accident they have produced one of the most satisfactory neutralising condensers I have ever seen. They have managed to beat the American manufacturers by several weeks, and also have kept the price to a reasonable level.

The Wirral Amateur Transmitting and Short-wave Club, the President of which is G20A, meet on the last Wednesday evening in each month at Beechcroft Settlement, Whetstone Lane, Birkenhead. At the last meeting G8AA lectured on the theory of DX, which proved most interesting to members. Another member of this society has now obtained a full licence with the call sign G3CK.

The honorary secretary of the Edgware Short-wave Society tells me that the new chairman of their society is Mr. P. A. Thorogood, who I have known for many years. This society is very active, and has obtained the call sign of 2DDK. I strongly advise those in that area to get in touch with Mr. G. Yale, at 40 Raeburn Road, Edgware.

I am glad to see that the Surrey Radio Contact Club is still flourishing, and is steadily increasing its membership. Recent lecturers have been G6NF, on frequency measurement and calibration, and also Mr. Stuart Davis, who gave a remarkable demonstration of high-fidelity reproduction and recording. He used a Telefunken pick-up, which has a flat characteristic as against the more conventional rising base, and employed a sapphire point. The amplifier also em-



Dubilier are to be congratulated on producing this variable capacity having the low-minimum of 1-mmf.

bodies a volume expander, a tone corrector and selector unit.

For those who are interested in Australian reception, here are some details as to the transmission time of Sydney, Melbourne and Perth, which will be used during March.

Sydney, VK2ME, will be radiating on Sundays from 06.00-08.00 G.M.T. 10.00-14.00 and 14.30-16.30, using a wavelength of 31.28 metres or a frequency of 9590 Kc.

The Melbourne Station, VK3ME, radiate every week-day between 09.00-12.00 GMT. on 31.5 metres, or 9510 Kc.

VK6ME, Perth, also radiate every week-day, from 11.00-13.00 on 31.28 metres 9590 Kc.

Selected and Specified for the

“FIELD STRENGTH
METER”

S. G. Brown

SUPERIOR HEADPHONES



TYPE "A"

Price **50/-** per pair
ANY RESISTANCE

All instruments of quality must bear a price in proportion to the genius and time attending their invention, and the craftsmanship and labour involved in their manufacture.

Such instruments do not come into being by chance, neither can they be manufactured at small expense, and although the price may appear heavy at first, they are, when their efficiency and value is justly estimated, the cheapest. Instruments constructed for cheapness, and not for efficiency and excellence of workmanship, are the frequent and certain cause of inferior Radio reception.

Will YOU weigh the certainty of the highest degree of SENSITIVITY, FREQUENCY RESPONSE, QUALITY of REPRODUCTION and absolute RELIABILITY for many years, against the outlay of a few shillings more ?

S. G. Brown Ltd., Victoria Rd., W.3. ACO 1174

WHY RELY ON A FRAGILE

FILAMENT, WHEN

A



METAL RECTIFIER

WILL GIVE YEARS OF

Trouble-free SERVICE



Send 3d. to Dept. T. for a copy of "The All Metal Way, 1938."

WESTINGHOUSE BRAKE & SIGNAL CO., LTD.
82, York Way, King's Cross, London, N.I.

Power Supply Filters

The design of filter circuits should be given more consideration by constructors. This article shows up the salient features and has been prepared by the United Transformer Corp. of America.

POWER supplies for modern radio equipment are generally obtained by rectifying an A.C. supply. This process is carried out in two steps. In the first step, the A.C. voltage is converted to a pulsating D.C. In the second step this pulsating D.C. is passed through a filter which smoothes out the pulsations to a point approaching the

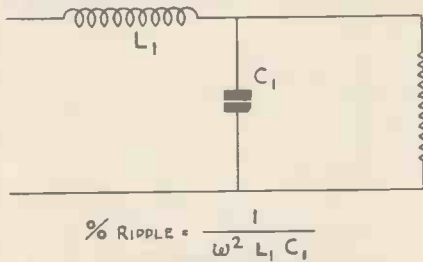

Fig. 1. Calculating ripple value.

smoothness of direct current. The filter unit serves the function of supplying electrical inertia to the change in magnitude of the pulsating current. The pulsations in the rectified D.C. are multiples of the power supply frequency if a half wave rectifier is used and are multiples of twice the power supply frequency if a full wave rectifier is used. Similarly in a three phase half wave rectifier the pulsation frequency is three times the power supply frequency and in a three phase full wave rectifier six times the power supply frequency.

The function of the filter circuit is to attenuate both the fundamental frequency and the corresponding harmonics to a point that is not objectionable. Economic considerations generally determine the extent of this attenuation.

Regulation

Another factor which must be considered in connection with filter circuits is the question of power supply regulation. In addition to the regulation or change between no load and full load caused by the resistance drop in the filter chokes, the regulation of the rectifying circuit or unit itself must also be considered.

As an example, typical half wave rectifier may have a 50 per cent. regulation from no load to full load as compared to a typical full wave rectifier having 10 per cent. regulation. In some filters a condenser is placed immediately after the rectifying unit to assist filtering. Under no load conditions this condenser tends to store the electrical energy so that a peak voltage equal to 1.4 times the R.M.S. voltage applied to the anodes is obtained. As a load is applied, the charge built up on this first condenser is drained and the peak voltage can no longer be maintained,

the D.C. voltage dropping to a point approaching the average value. It is rather difficult to pre-determine in a simple manner the exact D.C. voltage using this type of filter. As the ratio of load current to capacity is increased, the voltage will tend to drop down.

On the other hand, if a condenser having infinite value could be used, the peak voltage would be maintained regardless of load current. A typical instance where the ratio of capacity to load current is high may be found in the anode supply of a cathode-ray tube. In this type of filter a condenser of 1.0 mfd. is generally used and a current of approximately 1 mA. is drained. Under this condition, a half wave rectifier with 710 volts on the anode will effect a D.C. output voltage of 1,000.

To improve regulation, a bleeder is generally used. This consists of a resistance shunted across the D.C. output and in most cases drains approximately 10 per cent. of the full load current. Another device frequently used to maintain good regulation, where the current changes through a wide range, is a swinging choke preceding the first condenser. With proper design, increasing

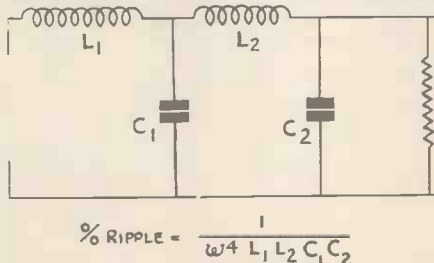

Fig. 2. A more effective arrangement.

load will lower the impedance of this choke sufficiently to allow the voltage to build up across the condenser following. In computing regulation, the IR drop in the chokes must always be considered.

Certain applications such as class-B audio amplifiers produce wide change in D.C. current with a corresponding tendency for poor power supply regulation. In many of these applications, distortion or non-linear modulation may be produced by the voltage fluctuation of the power supply. To offset this condition, the UTC Transformer Co. have developed a form of saturable choke which is inserted in series with the primary of the anode transformer.

A D.C. winding is coupled to this choke and inserted in series with the D.C. load. As the load is increased, the series choke is saturated and more A.C. voltage is impressed across the anode transformer primary which consequently compensates for the additional drop in

rectifier and filter circuit. This form of UTC control unit is termed a Variactor.

As a typical instance of the application of the UTC Variactor take the case of a class-B-46 amplifier. A typical ordinary anode supply for this purpose delivers 400 volts on the anode at no signal and 350 volts on the anode at maximum audio output. Using a Variactor the voltage can be actually made to start at 400 and end up with 405 volts and at full load.

Hum Suppression

After analysing the filter requirements with reference to regulation, the next point is the analysis of the actual hum suppression desired. Since in a rectifying system the attention of all frequencies is desired, a low-pass filter is used which theoretically should have a cut off point at zero frequency. However, this theoretical condition would entail inductance and capacitance elements of infinite value.

For practical purposes, the magnitude of these elements are controlled by economical considerations, but in any case must be sufficiently large to attenuate the lowest frequency present. To exactly determine the ripple at the output of a filter, is a rather complex proposition. Fortunately in all commercial applications the reactance of each condenser is small compared with the reactance of the preceding inductor and the reactance of the load.

Under this condition, the analysis of ripple may be simplified and can be evaluated as indicated in Figures 1 and 2. To simplify this calculation, the chart of Figure 4 has been prepared, from which the attenuation of hum in typical, practical circuits can be readily obtained. In most cases the higher harmonics can be practically neglected as the attenuation of this type of filter varies as the 4th power of the frequency.

To improve the filtering efficiency, resonant or hum-bucking circuits are sometimes used. The most practical device of this nature is the UTC hum-bucking choke. In typical rectifiers the use of hum-bucking chokes will increase

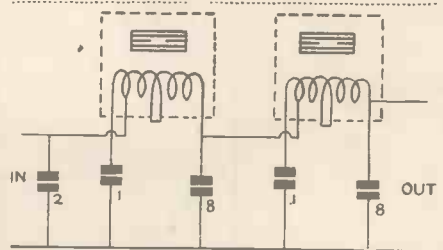

Fig. 3. The hum-bucking circuit.

(Continued on page 188.)

362

BI-PHASE RECTIFIERS

	D.C. Output		
RB 750/150	750 volts	150 M/A	16/-
RB 650/250	650 "	250 "	15/-
RB 500/120	500 "	120 "	10/-
RB 350/80	350 "	80 "	7/6

All above rectifiers have 4 volt filaments and are post free. Ask for lists

THE 362 RADIO VALVE Co. Ltd.
324 LIVERPOOL ROAD, Highbury, N.7
Tel: NORTH 1853

SPECIFIED KESTON PARTS

:—X65 CONVERTOR

6·3v Fil. Transformer 10/-

:—I-10 METRE RECEIVER

28 H choke No. 410A 6/6
4/1 LF transformer No. T77 8/-

:—4 INCH TUBE TELEVISOR

MAINS TRANSFORMER No. T4 35/-

:—TRANSCEIVERS

100:1 mic. trans. No. W44 8/- 204A choke 6/6

KESTON MFG. Co. 69A PARK RD. S.E.21
GIPSY 0979

QRM?



DO YOU KNOW THAT SEVERAL OF OUR COMMUNICATION RECEIVERS

ARE FITTED WITH NOISE
SUPPRESSION DEVICES?

THESE INCLUDE

Hallicrafters Super Skyrider SX17, 13 tubes	£39-10s
Patterson PRI5, 15 tubes, xtal filter	£33
Hallicrafters Ultra Skyrider 3.5 to 55 m.	£34
RCA 111, 16 tubes, 10 to 550 m.	£52-10s.
RME 69 with LSI unit, 11 tubes	£41-10s.

Other fine receivers in our range are

Hallicrafters Sky Buddy	£9
Hallicrafters Sky Chief 1938 Model	£12-10
National NC80X, 10 to 550 m.	£26

Write, call or phone for booklet giving full technical data o all our receivers, transmitters and components to

A.C.S. RADIO, Technical G2NK Manager.

52-4 Widmore Road, Bromley, Kent
Ravensbourne 0156-7

Cheap Day Return to Bromley North, 1/6. (20 minutes from Town)
Open until 8 p.m. (except Weds., 1 p.m.)

TELEVISION.

A NEW COURSE OF INSTRUCTION,

We have pleasure in announcing that our new "Television" Course has met with remarkable success. The enormous demand for the Course has shown, beyond any shadow of doubt, that it fills that long-felt need which we anticipated when we went to such trouble and expense in its preparation.

We shall be happy to send full details of this special "Television" Course on request. Particulars are also available of other Courses in all branches of Wireless, Television, Talking Picture Engineering, etc., and of the easiest way in which to prepare for the A.M.I.E.E., A.M.I.W.T., A.M.I.R.E., etc., Examinations.

We teach by correspondence, and guarantee "NO PASS—NO FEE." Our Technical Consultant is Professor A. M. Low.

Send for full particulars to-day. Free and without obligation.

THE BRITISH INSTITUTE OF ENGINEERING TECHNOLOGY
337, SHAKESPEARE HOUSE, 17/19, STRATFORD PLACE, LONDON, W.1.

Just Published

TELEVISION RECEPTION TECHNIQUE

By PAUL D. TYERS

A practical guide for radio engineers and students, based on accepted alternating current theory. Numerous photographs and diagrams are included. Every theory and conclusion has been thoroughly tested in practice. The book includes particulars of an important new scanning system, obviating the necessity for certain controls normally found in vision receivers. 142 pages. 12/6 net. (by post 12/11).

Order from a bookseller or direct from:

PITMAN, Parker Street, Kingsway, London, W.C.2

ALL "T. & S. W." SETS & INSTRUMENTS BUILT — OVERHAULED — SERVICED

All makes of sets (including U.S. communication receivers) serviced. Send sets for servicing to-day, securely cased and preferably surrounded by wood wool. Quotation without obligation. 15 years experience and thousands of satisfied customers are your guarantees of a good job.

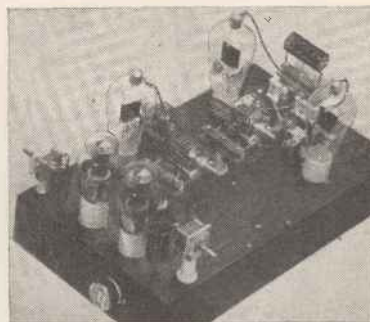

These Instruments and many others can be built with superior workmanship. How about giving us a trial to-day?

G. SCOTT-SESSIONS & CO.

Exchange Works, Muswell Hill, London, N.10
Telephone: Tudor 4101/2.

All sets and transmitters built to tropical specification if required.
OVERSEAS READERS please note Cable Address "Tropiset, London."

RADIOMART

THE SHORT-WAVE SPECIALISTS

We are Sole Distributors for
BLILEY, THORDARSON, TAYLOR TUBES,
RME, BASSETT CONCENTRIC CABLE, HOYT
METERS, &c.,

We are also Authorised Distributors for
NATIONAL. Send us your enquiries.

Large stocks carried.

**OUR NEW 66 PAGE
MANUAL, packed full of
valuable information.
Post Free, 7½d.**

The Contents include :-

- COMPLETE RECEIVING AND TRANSMITTING TUBE CHART OF CHARACTERISTICS.
- 16 TRANSMITTER CIRCUITS FROM SINGLE VALVE CW TO HIGH POWER PHONE.
- CLASS B MODULATORS FROM 8-WATTS TO 250-WATTS (INCLUDING 6L6).
- TRANSMITTING ANTENNAE, INCLUDING DATA FOR JOHNSON Q, BASSETT, DOUBLET, MATCHED IMPEDANCE AND SINGLE WIRE FED.
- CATHODE RAY OSCILLOGRAPH CIRCUITS AND INSTRUCTIONS, HIGH FREQUENCY CONVERTERS (INCLUDING 10-METRES), PRE-SELECTORS 5-METRE TRANSCEIVERS AND TRANSMITTERS.
- METRE/KC CONVERSION CHARTS, AMATEUR PREFIXES, LIST OF SHORT-WAVE BROADCAST STATIONS, Q CODE AND REPORTING SYSTEMS.
- INFORMATION ON MICROPHONES, NEUTRALISATION, CHECKING FOR PARASITICS AND FEED-BACK.
- DOZENS OF HINTS AND TIPS.
- THE GREATEST VALUE AND MOST COMPREHENSIVE MANUAL EVER PUBLISHED IN THIS COUNTRY.

**OUR NEW CATALOGUE shows
dozens of New Short-Wave
Components and is yours for
½d., post free.**

A splendid range of short-wave components is always ready for immediate despatch. The right goods at the right prices.

RADIOMART

G5NI (Birmingham) Ltd.

44, HOLLOWAY HEAD, BIRMINGHAM, 1

Telephone : Mid. 3254.

**SIMPLEST HOME BUILT
TELEVISOR**

*To secure results equal to
the designers you must rely
upon Reliance as specified.*

Type T.W. Wire wound; all valves up to 50,000 ohms.

4/6 each.

Type S.G. Compo. 2 megohms and .5 megohms.

4/9 each.

Folder T.S. Free

RELIANCE

THE PRODUCT OF
SPECIALISED RESEARCH

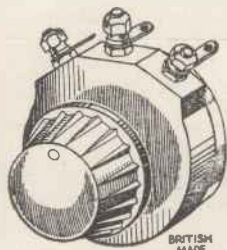

RELIANCE MANUFACTURING CO (SOUTHWARK) LTD
WESTAURY ROAD LONDON E17

"Power Supply Filters."

(Continued from page 186)

the filter efficiency four times as compared to an equivalent amount of inductance and capacity in a standard filter. Figure 3 illustrates a typical hum-bucking circuit.

Cautions

A number of important points must be watched in the use of filter circuits.

peak A.C. voltage applied to the rectifier. This also applies to the first filter choke. It is important in the use of the chart of Figure 4 and the formulas of Figures 1 and 2 that a knowledge of the actual inductance and capacity values be had. Many condensers have been found to be far poorer than their rated capacity, particularly in the electrolytic type. The inductance of filter

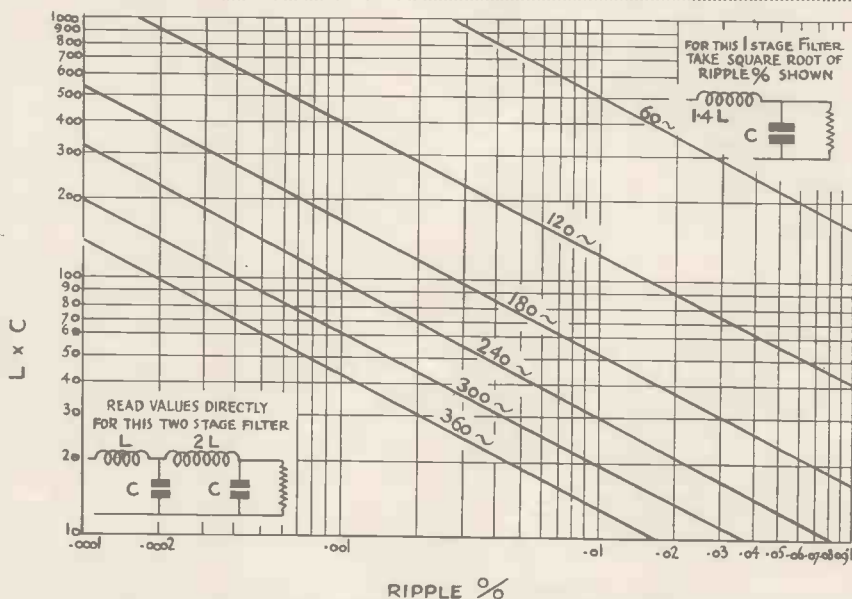

Fig. 4. This chart enables designers to determine the amount of ripple in different circuits.

One important fact is that at least one of the filter inductances should always be placed in the positive leg. If all inductors are used in the negative leg, the distributed capacitance of the transformer winding will by-pass the rectifier and allow a non-filterable residual voltage to appear across the load.

Another important point is the fact that there should be a negligible coupling between the filter inductors. If a co-efficient of coupling of even 1 per cent. occurs between the first and later filter chokes, the amplitude of the higher harmonics across the load becomes very appreciable. To prevent this UTC Linear Standard chokes for use in high attenuation filters are housed in high permeability cast cases.

Choke input circuits are always used in polyphase rectifiers and should also be used with high power single phase rectifiers because of the high ratio of average to peak current that is obtainable with choke input.

The first condenser in a filter circuit should be capable of operating continuously with a D.C. voltage equal to the

chokes varies appreciably with D.C. and many units are not rated with inductance at the actual value of D.C. used.

M E R V Y N

**SIMPLEST HOME TELEVISOR
SPECIFIED IN THIS ISSUE**

VISION CHASSIS, Ready drilled with fixing nuts and bolts **25/-**

SUITABLE COILS similar to and priced as per our advertisement in Dec. issue.

SPECIAL OFFER of High Voltage oil filled condensers, while supplies last

4 M.F., 1,000 Volts .. 9/6
.1 M.F. ,, ,, .. 4/-

Send your orders and list of requirements to—

THE MERVYN SOUND & VISION CO., LTD.
4 HOLBORN PLACE, W.C.1.
HOL. 7709.

MARCH, 1938

" THE ULTRA TELEVISION RECEIVERS "

(Continued from page 161).

charge primary sweep by a pentode valve type AC/2 Pen. Negative feed-back is employed in both line and frame amplifying valves by omission of the cathode bias by-pass condensers.

Velocity controls for the line and picture time bases are brought to the front of the cabinet by means of a dual potentiometer, one of which controls the cathode bias on the line gas-discharge triode, the other controlling the cathode bias on the picture gas-discharge triode. Variable resistances are included in the charging circuit to the time base condensers in order to effect variation of the amplitude.

An iron-cored focus coil with a paraxial gap is employed and this coil carries the complete H.T. load of the sweep and radio circuits except for a small variable by-pass current.

The D.C. Component

It has been found unnecessary to include provision for passing direct current through the scanning coils to provide shift, and the scan is centralised in the mask by moving the tube mounting bracket to the right or left when frame shift is required, and up or down when shift is required in the direction of line scan. To restore the D.C. component in the modulator electrode of the cathode-ray tube a low-capacity diode is used. Whilst D.C. is maintained as far as the anode of the vision frequency valve (with the exception of slight screen regulation) a condenser is employed between this point and the modulator electrode in order to prevent damage to the cathode-ray tube as a result of either valve failure or withdrawal. (The modulator electrode would, therefore, normally receive the right relative changes in voltage from instant to instant, but would receive these changes about a floating datum line, unless some means be provided to ensure that the datum line is restored at frequent intervals. In practice an overall time constant is employed which is long compared with the duration of one scanning line, whilst the diode is so connected that the correct level of mean modulator electrode voltage is

restored at the end of each line. A large capacity electrolytic condenser is connected in shunt across the focus coil in order to prevent points of defocus occurring on the scan of the tube as a result of supply hum. In order to economise in smoothing equipment on the cathode-ray tube anode supply the tube is operated with the cathode at earth potential and not with the anode grounded as is customary with electrostatic tubes.

These receivers are capable of giving satisfactory entertainment from the Alexandra Palace at distances up to 60-70 miles provided local conditions of interference are such that the full gain of the receiver can be utilised.

" FINDING AND REMEDYING TELEVISION RECEIVER FAULTS "

(Continued from page 162).

Reasonable care is desirable by reason of the hoped for presence of comparatively high voltages. Alternatively, where a gas type rectifier is used some indication of its functioning is given by the visible presence of ionisation in the bulb.

In this connection the following is informative.

If when the high voltage is switched to the rectifier's anode, a momentary blue glow ensues, which in a few seconds disperses, then it can fairly safely be assumed that the power unit is in order and the fault exists in the time base. This is plain if it is pointed out that the momentary glow is due to the current required to charge the condensers of the power unit.

It is desirable to interpolate a word of warning here. It is essential if this effect has been noted to discharge the various condensers before attempting any further adjustment.

Secondly, in comparatively rare cases, the ionisation glow may almost completely fill the bulb. This is likely to be accompanied by indications that the mains transformer is labouring. This will almost certainly indicate the existence of a short circuit. The usual procedure to ascertain the reason for this is resorted to.

For normal operation, with the load involved with a conventional time base, the discharge in the rectifier is quite light and is confined to the immediate vicinity of the electrodes.

Assuming examination reveals these things to be in order, then a

Continued on page 192)

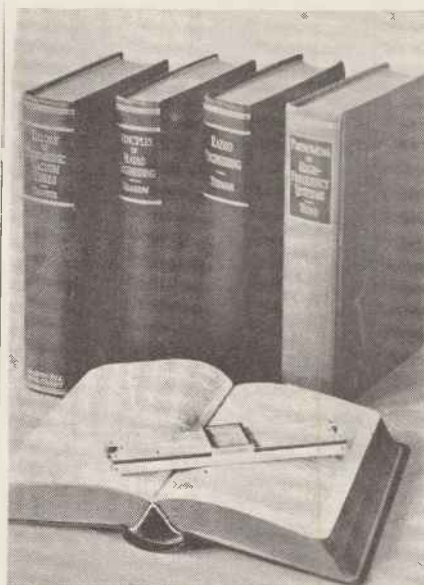

WE KNOW WHERE

We are booksellers, easily stumped by short-wave queries; our minds boggle at television jargon. But we know where the facts are, with an authority and in a profusion to be found nowhere else—in THE RADIO ENGINEERING LIBRARY.

There are five volumes, PRINCIPLES OF RADIO ENGINEERING by Glasgow, PHENOMENA IN HIGH FREQUENCY SYSTEMS by Hund, THEORY OF THERMIONIC VACUUM TUBES by Chaffee, MEASUREMENTS IN RADIO ENGINEERING by Terman and THE RADIO ENGINEERING HANDBOOK edited by Henney, in all 3,000 pages packed with 2,000 plates, diagrams and drawings, advice, data, theory and application.

Technical men call the books "a conspectus of short-wave radio knowledge"; ambitious professionals and enthusiastic amateurs, television technicians and short-wave merchants—all know them to be as necessary a part of their equipment as accurate instruments.

If you do not already own THE RADIO ENGINEERING LIBRARY you will like to know of a new and easier way of possessing these five solid and compact key-books. Thanks to a fresh arrangement, made for the first time, they can rest on your shelves immediately, without outlay. You pay cash if you wish; or a fraction of your smoking-bill, sent along monthly, easily covers the cost.

Use the coupon below or drop a card now for fully-illustrated descriptive prospectus of THE RADIO ENGINEERING LIBRARY to Phoenix Book Company, Ltd., Chandos Street, Strand, London, W.C.

★ Please send a prospectus of Radio Engineering Library

T T

The Triode-pentode in Portable Receivers

By R. C. Frost, 2AXM

THE question of building a receiver suitable for portable work in the National Field Day or in one of the numerous smaller events organised by the local clubs is always of interest. The five-metre band owes much of its popularity for outdoor work to the fact that very compact receivers and transmitters can be built for use on these frequencies, on account of the simple gear required.

An ultra-short-wave receiver with the performance of a two-valver can be built into approximately the same space as that required for a normal one-valve set if use is made of a multi-electrode valve of the triode-pentode type.

Two Valves in One

The pentode section of this valve can be arranged as the ultra-short-wave detector, while the triode section functions as a super-regenerative or quench valve. Such a circuit is very suitable for five-metre work, and the triode-pentode used in place of two separate valves will be found just as efficient.

Multi-electrode valves have many uses other than those for which they were originally designed. How to use a triode-pentode in a portable receiver is described in this article.

Such a pentode detector gives great sensitivity and the circuit is very stable and easy to operate. It also retains the advantages of the separate quench-valve circuit over the self-quenched arrangement, including its greater sensitivity to weak signals, with the compactness of the latter circuit.

Filament current is also considerably reduced, since the two sections of the valve have a common filament, and a small and light midget accumulator is all that is necessary.

A suggested circuit to serve as a

compactness, this variable may be omitted and a fixed amount of quench-valve reaction used.

Portable Work

For portable work on the other short-wave bands, from ten metres upwards, a very compact receiver can be built by using the pentode section of a triode-pentode as a normal regenerative detector, with reaction controlled by a screen potentiometer, and the triode section as an L.F. amplifier. In this case, resistance-capacity coupling between pentode and triode should be used, being most suitable to follow the high-impedance pentode and also taking up far less space than a transformer.

Great sensitivity is obtained by the use of a pentode detector in this way



16 PAGE CATALOGUE

1/2 D.
POST
FREE

NOW READY. The Fifth Edition of our Catalogue. Useful information on Q.C.C. Piezo Quartz Crystals and a wide range of Short-wave Transmitting Apparatus. Numerous NATIONAL products are included and illustrated. Write for a copy now.

THE QUARTZ CRYSTAL CO., LTD.
63 & 71, Kingston Road, New Malden, Surrey
Telephone: MALDEN 0334.

CONDENSERS FOR TELEVISION SET.

Paper Tubular wire ends or Solder Tag, value 0.1 mfd., 800 v.w, 8d. each; value 0.5 mfd., 800 v.w. 1/3 each.
Electrolytic Dry. Tubular: value 50 mfd., 12 p.v., 1/3 each; value 20 mfd., 50 p.v., 1/6, each; value 50 mfd., 50 p.v., 1/9 each.
Blocks. Waxed Carton type, value 8 mfd., 500 p.v., 2/6 each.
Blocks—metal-case type, value 500 mfd., 12 p.v. 3/- each.
Aluminium—can type 4 leads, value 8+8 mfd., 500 p.v., isolated from case, 4/6 each.
Paper—metal case type, value 2 mfd., 800 v.w., 3/- each; value 2 mfd., 1,000 v.w., 5/- each; value 1 mfd., 1,500 v.w., 5/- each.

THE STATIC CONDENSER CO.,
11, Eden Street, London, N.W.1.

The "STATIC" Radio Interference SUPPRESSOR.

Price 10/6

The STATIC CONDENSER CO.,
11, EDEN STREET, LONDON, N.W.1

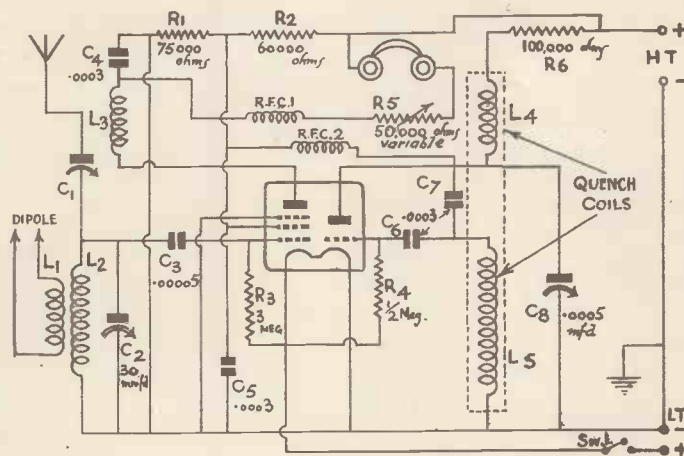

A suggested circuit for a portable receiver using a triode-pentode valve. This type of receiver is ideal for portable work.

basis for a receiver of this type is shown on this page. In the ultra-short wave detector circuit, good-quality components must be used and wiring should be as short and rigid as possible without overcrowding the parts or their connecting wires. It is also well worth using an air-spaced grid condenser.

The quenching circuit, being simply a long-wave oscillator, is not critical and can be made very compact without introducing undesirable effects. A commercial quench-coil unit can be used or this may be home-made, using about 1,000 and 750 turns of fine wire on a 1 1/2 in. former for grid and anode coils respectively, with a .002 mfd. fixed condenser connected across the grid coil.

Ultra-short-wave oscillations should be controlled by a variable resistance in the pentode anode circuit, and quenching oscillations may be controlled by means of a solid-dielectric variable condenser between anode and earth of the triode section. For greater

and adequate signal strength for headphone work is available from this type of single-valver. The fact that the triode section is of fairly high impedance is quite a definite advantage in a small receiver which is not required to operate a loudspeaker.

The New SX17 Hallicrafter

We have just been able to examine the new 1938 Hallicrafter communication receiver, which arrived in this country only a few hours before we went to press. This receiver includes 13 valves, built-in crystal filter, noise silencer, has two radio-frequency stages, and covers from 5 to 550 metres. From reliable reports we understand this receiver has an extremely fine sensitivity figure on the 5-metre band, which is rather interesting in view of the poor performance generally put up by communication receivers under 10 metres.

Premier High-voltage
Transformers

As many amateurs are finding that high voltage low-current operation is more efficient than low-voltage high-current working, the problem of obtaining suitable H.T. transformers becomes a serious one.

We have been checking transformers built by several manufacturers and have found that the new Premier mains transformers are quite satisfactory, give the rated output to within near limits and can withstand gross overloads.

For example, one of the first models tested has a secondary giving 1,000-0-1,000 volts at 250 mA., and is priced at 21s. On test the current was increased to 300 mA. without causing noticeable voltage drop or heating up of the transformer. The core is of a very generous size, designed to prevent magnetic saturation and to reduce hysteresis losses to a minimum. This transformer is tested at 2,000 volts between winding and frame.

A second transformer which is of particular use to those who have purchased a T20 type valve is the model SP750. It gives 750-0-750 volts at 200 mA., and is priced at 20s.

These transformers are, of course, without filaments windings, for Premier feel as we do, that it is much more satisfactory to produce a good transformer for one high-voltage output, than to add a filament winding to it, which increases the price and, of course, the size of the core.

One of the most interesting transformers for the ordinary user is the model ST500, which gives 500-0-500 volts at 150 mA., and is priced at 15s.

The cheapest transformer in the range is the S300, giving 300-0-300 volts at 60 mA., for 10s.

Full information on these interesting transformers can be obtained from the Premier Supply Stores, Jubilee Works, 167 Lower Clapton Road, London, E.5.

A New System of Large Screen
Projection—February issue
ERRATA

12th line down, 2nd column, page 96, read S_2 instead of S_1 .

5th line down, 1st column, page 96, "frame and line" should read "line and frame."

Lines 24-25, 3rd column, page 96, "the inverse of" should be inserted between "slightly less than" and "that of the first surface."

Lines 36 and 38, column 1, page 98, "cathodes" should read "surfaces."

Page 126, line 45, column 1, lines 24 and 39, column 2, "ultra" should be deleted.

GALPINS ELECTRICAL STORES

75, LEE HIGH ROAD, LEWISHAM, LONDON, S.E.13

Telephone: LEE GREEN 5240.

Terms: CASH WITH ORDER OR C.O.D.

All good sent on 3 days' approval against cash.

EPOCH PUBLIC ADDRESS MOVING COIL SPEAKERS, Handle 20 watts 15 ohm and 1,000 ohm. Speech Coils, 15 in. cone, 6-volt Field, 45/-.
LARGE MAINS TRANSFORMERS, Input 200/250 volts, output 2,000/0/2,000 volts, 150 mA., 11 v. 2½ amp. 4 volt 8 amp. Fully guaranteed, 30/-.
HIGH VOLTAGE CONDENSERS, 1 mfd., 4,000 volt working, 10/- each. 1 mfd., 2,000 volt working, 3/- each. 4 mfd., 1,500 test 3/6 each. .005 mfd., 30,000 volt working, oil filled, 12/6 each.
LARGE SPEAKER OUTPUT CHOKE, tapped as used in 200 watt amplifier, 7/6. Interval Transformer, ditto, 7/6 each.
LARGE MAINS CHOKES, 40 henry 250 mA. low resistance, 17/6.
POWER PACKS, consisting of 2-20 hy. 60 mA. Chokes and 2-2 mfd. Condensers, 3/- each.
OSCILLATOR Multiple Quartz, complete with valves and 4 Moving Coil Meters in good condition, £6 10s.
COPPER SCREENED BASE BOARDS, 17½ by 7 in. undrilled, 2/6. 4-valve metal chassis, 18 by 6½ by 3½, drilled, 1/6.

WESTON and other good makes. MOVING COIL METERS, 0 to 5 mA., 2-in. dial, 16/-. 0 to 25 and 0 to 150 mA., 2 in., 14/-. 2½-in. dial, 0 to 3 mA., 20/-. 0 to 50 mA., 16/6. 0 to 200 mA., 14/-. All fully guaranteed.

STEEL CABINETS, useful for transmitting racks, etc. Size, 40 x 24 x 16 in., 12/6 c/f.

STUD SWITCHARMS with studs, very smooth action, 1/6. Quartz Tubes, 10 by 3/16 in., 5/- per doz.

ROTARY CONVERTERS, 12 volt D.C. input, 1,500 volt 150 mA. out, 35/-. Ditto, 750 volt, 100 mA. output, 25/-. A few only to clear, 6 to 12 volt input, 750 volt, 100 mA. out. Need slight overhaul, 12/6 each.

X-RAY TRANSFORMERS, 200/250 volt. 50 cycle 1 phase input, 100,000 volt 30 mA. output, £10. Ditto, 110 volt input, 40,000 volt 12 mA. output, £7 10s.

X-RAY TUBES, brand new, 7 in. dia. Tungsten targets, work from 2-in. to 21-in. coils, 15/-. Packing free, c/f.

X-RAY SPARK COILS, all fully guaranteed, packing free, c/f. 2 in. complete with condenser and high-speed contact break, 19/6. 8 in., complete with condenser, 30/- 10 in. ditto, 35/-. 12 in., ditto, 35/-. 16 in., 55/-.
FLUORESCENT SCREENS (Platinum Cyanide), 12 x 9 in. in frame, in new condition, 30/-. Control Switchboard, to suit above coils, 15/-. c/f. Motor-driven mercury breaks, 100/250 volts, 30/-. c/f.

EX-G.P.O. GLASS TOP HIGHLY SENSITIVE RELAYS, Type B, operating current approx. 1 mA., 7/6 each. Post 6d.

FX-R.A.F. MORSE KEYS, heavy current types, 3/- each.

A.C. INDUCTION MOTORS, approx. ½ h.p., 1,425 r.p.m., 200/250 v. 50 cycles, 1 phase, suitable for pumps, sewing machines or any small power work. Condition new, 22/6. Post free.

SWITCHBOARD VOLT AND AMP. METERS, 4, 6, 8-in. dial, by well-known makers, 0 to 120 volts, 12/6. 0 to 250 volts, 17/6. 0 to 40 volts, 8/6. 0 to 10.02, 50, 100, 150 amms., 12/6. All m/coil, hot wire for A.C., 0 to 120 volt, 12/6. 0 to 250 volts, 17/6. Ampmeters as above for A.C. or D.C., 12/6 each.

EX-R.A.F. WAVEMETERS, 200 to 550 metres, visual type, 3/-. 300 to 2,500 metres, valve type, 7/6 each, with valves. Post free.

MOVING COIL METER MOVEMENTS, 2½-in. dial, by E. Turner, E. Edgumbe, etc. Approx. 4 to 10 mA., full scale for recalibrating into multirange, all test meters, 5/- each. Larger size ditto, 4-in. dial, 6/6. Post 9d. A few only to clear MOVING COIL and A.C., Meter Movements need slight overhaul, 2/6 each.

WESTINGHOUSE RECTIFIERS, (second hand guaranteed) output 500 volts. 250 mA. voltage Doubler Circuit, 22/6. Zenith Resistances, 3,000 ohm, 200 mA., 1/6. 2,000 ohm, 100 mA., 1/-, 125 ohm, 500 mA., 1/6.

CHARGING DYNAMOS, all shunt wound, fully guaranteed, 15 volt 12 amp., 22/6. 12 volt 8 amp., 17/6. 25 volt 8 amp., 32/6. 50/75 volt 10 amp., 60/-. 100 volt 15 amp., 80/-. Regulators to suit any of these Dynamos, 12/6 each.

ELECTRIC LIGHT CHECK METERS, for 200-250 volts, 50 cycles, 1 phase, 5, 10 and 20 amp. for garages, workshops, subletting, etc., 6/- each. Post 1/- Fully guaranteed.

LARGE SLIDER TYPE RESISTANCES, 800 ohm, carry ½ amp., 950 ohm, carry ¼ amp., 12/6 each.
LARGE DIMMER SLIDER RESISTANCES, 1 kilowatt, 20/-. 2 kW, 30/-. With worm wheel, 5/- extra.

VOLTAGE CHANGING TRANSFORMERS, auto wound, 80 watts, 8/-. 120 watt, 10/-. 150 watt, 12/-. 250 watt, 17/6. 500 watt, 25/-. 1,000 watt, 35/-. 1,500 watt, 50/-. 2,000 watt, 60/-. Double wound: 150 watt, 15/-. 250 watt, 20/-. 500 watt, 30/-. 1,000 watt, 37/6. 2,000 watt, 70/-. 3,000 watt, 90/-. 4,000 watt, 110. All fully guaranteed. Small type up to 250 watt from stock, others 7 days' delivery.

TRANSFORMERS by well-known makers, 200/250 volts input, 350 volts 500 mA. output, 17/6; another, 220/240 volt input, 2,000/0/2,000 volt 500 mA., twice, 100/-. Choke to suit 12 henrys, 50/-.
P.M. MOVING COIL SPEAKERS, "Philips" 7-in. cone 2 ohm speech coil. Ideal for extensions, 6/6 each. "Plessey" 5-inch cone midjet speakers with transformer and tone volume control, 8/- each. Magnivox mains energised 1,600 ohm field, 6/6 each.

D.C. MOTORS, 220 volt ½ h.p., 1,000 r.p.m., 20/-. ½ h.p., 2,800 r.p.m., 32/6. ½ h.p., 3,000 r.p.m., 20/-. c/f.
ALTERNATOR, self exciting output 200 volt 1 amp. 500 cycles 1 phase, 3,000 r.p.m. In new condition, 40/-.
DOUBLE OUTPUT GENERATOR shunt wound, ball-bearing, output 2,500 volts 160 mA., also 16 volts at 14 amp. D.C. Can also be used as Rotary Converter, 20 to 24 volt input, full H.T. output, 70/ c/f.

G.P.O. PEDESTAL TYPE TELEPHONES, 7/6 each. Handsets, 4/6. Handgrip Earphones, 1/6. Automatic Telephone, 0 to 9 dials, 3/- each. Bell Boxes, complete with A.C. bell 2 x 2 mfd. Condensers. "Mike" Transformers, 4/- each. Microphone Transformers, 25-50-100 to 1, 2/- each. Western Electric Microphones, highly sensitive, 3/- each.

MAINS CHOKES, 30 henry 150 mA. resistance 300 ohms, 7/6 each. 20 hy. 60 mA., 2/6. 30 hy. 60 mA., 3/6.
HAND-DRIVEN GENERATORS, output 800 volt 80/100 mA., also 6 volt 4 amp. Can also be used as Rotary Converter, 12 volt input, full H.T. output, 40/- c/f.

MAINS TRANSFORMERS by well-known makers. Input 200/250 volt 50 cycle 1 phase, 6 and 30 volt out at 15-20 amp., 17/6. Another, 3-5-8 volt at 20-30 amp., 17/6. Another, 10 volt 5 amp., 10/6. Another, with 3-4 volt 3 amp. tappings all C.T., 7/6. Another, 110/240 volts input, approx. 2 kW output, 4 volt 100 amp., also 80, 10, 20, 30, 40, 50, 60 volts, all twice, 70/-. Fully guaranteed.

TELEGRAPH MORSE INKERS with Sounder, in good condition, 30/-. Ex-R.A.F. 7-valve Receiver Amplifiers, wave-length not known, 7/6 c/p. Radiogoniometers by "Marconi", etc., 15/-. "Sullivan" .0005 mfd. Transmitting Variable Condensers, 10/6. Cossor 2-volt general purpose Valves, 3 for 2/6, as new. 2 mfd. 250 volt working Condensers, 9d. each. Single Earphones, 1,000 ohms, 9d. Bobbins, 1,000 ohms, per pair 6d. Microphone Buttons, 9d. ½ mfd. 350 volt working Condensers, 9d. each. Volume Controls, 1,000, 25,000, 100,000 ohms, 1/- each. Ex-R.A.F. Visual Wavemeter with valve, 1,000 to 9,000 metres, 5/- each. Bulgin Toggle Switches, s.p.c.o., 9d. Ex-Naval Short-Wave Aerial Insulators, 8 in. long, 1/- per pair. Resistance Mats wound with Eureka wire, 600 ohms, carry ½ amp., size 24 x 24 in., 4/- each.

MOTOR BLOWERS, fitted ½ h.p. 110 volt motor D.C. Series wound, ball-bearing, 4-in. inlet and outlet, 35/- c/f.
SIFAM MOVING COIL, 0 to 1 mA. Meters, slightly damaged cases, 12/6. Some with instrument rectifiers, 22/6.

SLIDER RESISTANCES, 2,500 ohms, carry 350 mA., worm wheel type, 17/6. Electrostatic Voltmeters, 2½ in., 2,500 volt, for D.C. only, 12/6. Moving-Coil Meters, 4-in. dial, 2 readings, 0 to 5 and 25 mA., 22/6.
X-RAY SPARK COILS, round type, ebonite covered, 110/230 volt D.C. working, 10-in., 35/-. 8-in., 25/-. 16-in. 55/-. Condensers for the primary of Spark Coils, 8 to 14 inch, 7/6. To suit larger coils, 10/- each.

DUBILIER BLOCK CONDENSERS, 4 x 4 x 2 m. fd. 350 volt working 3/6. 4 x 2 x 2 mfd. 350 volt. working, 2/9 each.

OSRAM TRANSMITTING VALVES, 100 watt, 10/-. 250 watt, 20/-. In good condition.

"VIBRO" MASSAGE MACHINE, fitted ½ h.p. motor for 100/250 volt D.C., complete in carrying case, 50/-.
X-RAY BARGAIN for the Experimenter. A brand new 12-in. Coil, complete in teak case, with tube and meter holders, discharge rods, complete with 7-in. Tube Fluorescent Screen, Mercury motor-driven break, Moving Coil mA. Meter, 2 reading, 0 to 5 and 25 mA. The lot, all fully guaranteed, packing free, carriage forward, £8 10s. 9d.

"FINDING AND REMEDYING TELEVISION RECEIVER FAULTS"

(Continued from page 189)

detailed investigation of the time base is called for.

It will be obvious that if the relay valves are not operating no scan voltages are generated and even when the rest of the circuit is in order no raster will be formed.

Where one base is operating, and the indications given that this is so have been mentioned earlier, interchanging the relays will indicate if one is faulty. The visible scanning line will assume a new axis at right angles to that previously noted.

Similarly the paraphase amplifying valves can be checked. If no variation in raster size occurs with changes of the paraphase valve feed potentiometers (in the specific case of the Low-cost Televisor, these are the potentiometers R8 and R23) a fault is indicated and exchange of valves will show if this is due to a faulty valve or valves.

Finally, it is advisable to ensure that the condensers interposed in the feeds of the deflector plate are in order.

(To be concluded.)

"Neutralising Triode Valves."

(Continued from page 180)

denser must be connected to same tere-denser is connected. If connections are minimal where the anode lead to tank condenser at opposite sides of the tank condenser the resistance of the anodes causes a voltage change and stage will slide out of neutralisation when resetting the tank condenser.

In multi-stage transmitters consisting of two or more triode stages, which must be neutralised and which are supplied with anode voltage from a common supply, it is conventional practice to place a switch in the HT plus supply lead to each of these stages so that anode voltage may be removed from the stage when being neutralised.

However, in a transmitter in which one of the stages (usually the final amplifier) is supplied with voltage from a separate supply, many amateurs remove plate voltage from this amplifier stage, when neutralising, simply by opening a switch in the primary of the anode supply transformer.

With this arrangement, especially in medium to high power transmitters, it seems impossible to effect complete neutralisation. Although complete neutralisation may be obtained, a small light bulb in a pickup loop, coupled to the plate tank coil will light up brightly when the tank is turned to resonance.

This condition is possible when stray RF is induced in the leads and is applied to the anodes of the rectifier. This stray RF is then rectified and finds its way to the plates of the amplifier tubes.

A switch to completely remove all anode voltages from the stage being neutralised, should be connected in the HT plus supply lead to the stage, or it may be connected in the center-tap lead of the H.V. transformer secondary.

Bargains for Experimenters

AMATEUR constructors and experimenters should not on any account forget to write to Galpins Electrical Stores of 75 Lee High Road, S.E.13 for one of the new lists just available. Some of the bargains are too good to miss and at very low prices.

We noticed for example, Epoch moving coil loudspeakers to handle 20 watts of audio for 45s. High voltage condensers of 1 mfd. capacity for 2,000 volt working priced at 3s. each. These are very suitable for use in transmitting high voltage power packs.

Another bargain is two 60 mA. chokes and two 2 mfd. condensers for 3s. the lot. There is also a large range of auto-transformers for use with 110 volt equipment making it suitable for use on 200-250 volt mains.

"HOW TO BECOME A RADIO AMATEUR"

is the title of a

NEW R.S.G.B. PUBLICATION

Contents :—

WHAT IS AMATEUR RADIO ? — MORSE CODE — INTERNATIONAL PREFIXES AND ABBREVIATIONS — THE Q CODE — SIGNAL CODES — THE A.A. LICENCE — THE FULL LICENCE — SELECTED FORMULAE AND DATA — THE PRIVILEGES OF R.S.G.B. MEMBERSHIP.

If you missed the 5th edition of "A Guide to Amateur Radio" get this booklet and learn :—



"HOW TO BECOME A RADIO AMATEUR"

Price **4^d** Post Free

Write to
The Secretary,
R.S.G.B. 53 Victoria Street,
LONDON, S.W.1

TELEVISION DEVELOPMENTS

Are you keeping abreast of modern television developments? Whether amateur or professional you *must* be in touch with the latest trend of research.

The Television Society enables you to meet fellow workers in the field of television, both in this country and abroad.

Founded some 10 years ago **The Television Society** provides a scientific and non-partisan platform for discussion on all aspects of the subject. Meetings are held monthly during the session (October-June) and are reported in full in the Society's Journal which is sent free to all members.

The Society's activities are shortly being enlarged to meet the growing interest in the subject and members will have a unique opportunity of furthering their knowledge by contact with well-known television engineers.

Full particulars of membership qualifications may be had from the Hon. General Secretary :—J. J. Denton, 25, Lisburne Road, Hampstead, London, N.W.3.

THE TELEVISION SOCIETY

(Founded 1927)

President : Sir AMBROSE FLEMING, M.A., D.Sc., F.R.S.

OPPORTUNITIES SECTION

BUSINESS :: EQUIPMENT :: EMPLOYMENT :: MISCELLANEOUS

The charge for miscellaneous advertisements on this page is 12 words or less 2/-, and 2d. for every additional word. Single-column inch rate displayed, 12/6. All advertisements must be accompanied by remittance. Cheques and Postal Orders should be made payable to Bernard Jones Publications Ltd., and crossed, and should reach this office not later than the 15th of the month previous to date of issue.

A Radio Engineering Library

LAST year we mentioned the Phoenix Book Co. in connection with the publication of Hutchinson's Technical Encyclopædia, and this year we have pleasure in again drawing attention to their enterprise in offering to radio engineers the nucleus of a first-class technical library at terms which are within the reach of all.

The Radio Engineering Library comprises five books each written by an acknowledged authority and published by the McGraw-Hill Publishing Company. The titles are:— Principles of Radio Engineering—Glasgow.

High Frequency Phenomena—Hund. Thermionic Vacuum Tubes—Chaffee. Measurements in Radio Engineering—Terman.

Radio Engineering Handbook—Henry.

They are in no sense reprints or abbreviated editions, but are the actual volumes selected as being representative of the best books on the theory and practice of the subject. The Radio Engineering Handbook contains 866 pages of formulæ and tables together with notes on r.f. and a.f. amplifiers, television, photo-cells, and motion pictures.

The set of volumes costs £7, which can be paid in 18 equal instalments spread over a period of 18 months. Alternatively, the payments can be spread over 12 or 3 months, the latter avoiding the nominal charge of 5 per cent. interest. The Phoenix Co. cater specially for those

Simplest Home-Built Televisor

VISION RECEIVER KIT as described in this Journal. Price, less Valves, 45/-.
CHASSIS ALUMINIUM, "Mervyn," complete, 25/-.
TIME BASE KIT for 4-in. Tube, less Valves, price £5 9s. 0d.
TRANSFORMERS for high voltage. Price, 32/6.
LENS for small Cathode Ray Tubes, Plano Convex 6 in non-distorting. Price, 13/6.
MECHANICAL APPARATUS for line scanning always in stock, Kerr Cells, Neons, Cathode Ray Tubes, High Voltage Condensers. Lowest Prices.
DISC RECEIVER KITS, 30-line, a few at reduced price, 31/- post free.

Send your enquiries to
H. E. SANDERS & CO., 4, Grays Inn Road, London, W.C.1. Tele: Chancery 8778.

FOYLES
BOOKSELLERS TO THE WORLD
Enrolments taken for the Scientific Book Club
119-125 Charing Cross Rd., London, W.C.2.
Telephone: Gerrard 5660 (14 lines)

SHORT-WAVE AND TRANSMITTING CATALOGUE
Send now for free copy.
Southern Radio & Elec. Supplies
85, Fisherton Street, Salisbury

who find it inconvenient to expend a large lump sum and their service has proved a boon to many engineers and students who wish to keep abreast of their work by additional study. The Radio Engineering Library is a first-class investment and we recommend it to our readers with confidence. Further particulars can be obtained from the Phoenix Book Co., Chandos Street, Charing Cross, W.C.2.

Sanders, H. E., & Co.	Cover iii
Scott-Sessions, G., & Co.	187
Sound Sales, Ltd.	129
Southern Radio & Elec. Supplies	Cover iii
Static Condenser Co.	190
Technological Institute of Gt. Britain	Cover iii
Telegraph Construction & Maintenance Co., Ltd.	183
Television Society, The	192
Webbs Radio, Ltd.	177, 183
Westinghouse Brake & Signal Co., Ltd.	185

MISCELLANEOUS

AMERICAN A.R.R.L. Type Sectional Wood Aerial Masts, complete, insulated guys, strainers, pulley, rope, all exposed metal galvanised. 45 ft., 67/6; 50 ft., 75/-; 55 ft., 82/6; 60 ft., 90/-. Carriage paid. Creosoting, 2/6. White painting, 2 coats, 7/6 extra. As supplied to Radio Factories, Hams, and for Television Aerials. Ham shacks, etc., to order. Our prices can be beaten, but only at the expense of quality. —2CNT Co. (G6QF), Tyldesley Road, Atherton.

MAGNIFICENTLY constructed television Cabinets, extra heavy walnut, overall sizes 42 in. high, 25 in. wide, 20 in. back to front, fitted with 1/2 in. plate glass first grade mirror in lid, size 20 in. x 16 in., ideal for radio gramophone cabinets; 45/- each; send for photograph, linen cover, wool lined, 3/6 extra.
CARRIAGE extra.—Samson Radio, 4, Praed St., Paddington, W.2. 'Phone: Padd. 7851.

WELL ESTABLISHED Gas Discharge Lamp Manufacturers would like to communicate with Patentees of Television Tubes, Cathode Ray, Valves, etc., with view to manufacturing and commercialising same. Box No. 21.

PATENT AND TRADE MARK AGENTS

GEE & CO., patents and trade marks throughout the world (H. T. P. Gee, Mem.R.S.G.B., A.M.I.R.E., etc.). Estab. 1908. 51-52, Chancery Lane, London, W.C.2 (2 doors from Government Patent Office). 'Phone: Holborn 4547 and 4548. Handbook free.

KINGS PATENT AGENCY LTD. (B. T. King, Patent Agent) 146a, Queen Victoria Street, London, E.C.4 **ADVICE**, Handbook and Consultations free. Phone City 6167.

INDEX TO ADVERTISERS

A.C.S., Ltd.	187
Automatic Coll Winder & Electrical Equipment Co., Ltd.	129
Baird Television, Ltd.	145
Belling & Lee, Ltd.	Cover ii
British Institute of Engineering Technology	187
British Mechanical Productions, Ltd.	181
Brown, S. G., Ltd.	185
Bulgin, A. F., & Co., Ltd.	129
Clx	181
Dubiller Condenser (1925), Ltd.	183
Edison Swan Electric Co., Ltd.	130
Fluxite, Ltd.	Cover ii
Foyles, Ltd.	Cover iii
G5KA	Cover iii
Galpin's	191
General Electric Co., Ltd.	146
International Correspondence Schools	181
Keston Mfg. Co.	187
McGraw Hill Publishing Co.	181
Mervyn Sound & Vision Co., Ltd.	188
Mullard Wireless Service Co., Ltd.	Cover iv
Peto-Scott Co., Ltd.	179
Phoenix Book Co., Ltd.	189
Pitman's	187
Premier Supply Stores	175
Quartz Crystal Co., Ltd.	190
Radiomart	188
Radio Resistor Co., Ltd.	Cover ii
Radio Society of Great Britain	192
382 Radio Valve Co., Ltd.	187
Reliance Mfg. Co. (Southwark), Ltd.	188

THE HAMS' BOOKSHOP (G5KA)

LOG BOOKS. The A.R.R.L. Log Book provides space for all pertinent facts pertaining to transmitting or receiving. There are 38 ruled pages with an equal number of blank pages for notes. Price 1/8d. Three for 4/3d.

JONES RADIO HANDBOOK. The 1938 edition of this famous handbook contains over 500 pages and is a library in itself. This edition is brand new, having been completely revised and rewritten. 7/-, post free.

TELEPHONY HANDBOOK. This book has been expressly written for the "phone man" and the amateur interested in getting on 'phone. Over 100 illustrations show how to construct and adjust all items described. Price 3/6d.

ANTENNA HANDBOOK. The antenna is the all-important factor with every amateur station—it is far more important than the receiver or the transmitter's power. Everything worth telling about antennas will be found in this 100-page manual. Price 2/6d. All prices include postage.

G5KA. 41, Kinfauns Road, Goodmayes, Ilford, Essex. Dept. "T 3."

Engineers' Guide

Shows how to qualify in Television, Sound Recording, Radio Engineering and Servicing, Wireless Communications, etc., by studying at home with The T.I.G.B. Write to-day for this Great Guide containing world's widest choice of engineering courses and which alone gives the Regulations for **AM.I.E.E., AM.I.R.E., AM.I.T.E.,** etc.

Free!

THE TECHNOLOGICAL INSTITUTE OF GREAT BRITAIN
160 Temple Bar House, London, E.C.4
(Founded 1917. 20,000 Successes)

To Success

200 Courses



Mullard introduce a new type of Cathode Ray Tube



TYPE A.41-G4

THIS NEW TYPE of Mullard Cathode Ray Tube has been specially designed to permit the pair of plates nearer the screen to be used with a non-symmetrical deflection circuit, thus considerably reducing the cost of the associated apparatus.

The design of the focusing electrodes enables an exceptionally small spot size to be obtained over the entire screen area.

Price £6 15s.

COMPLETE WITH SPECIAL SOCKET

ABRIDGED SPECIFICATION

Screen Diameter - 4 ins. (approx.)
Heater - - 4 volts, 1.2 amperes
Maximum Final } - 1,200 volts
Anode Voltage }
Deflection - Double Electrostatic
Focusing - - - - Electrostatic

FLUORESCENT COLOUR

A.41-G4 - - - - - Green
A.41-B4 - - - - - Blue
A.41-4 - - - - - White

Full technical information from
THE MULLARD WIRELESS SERVICE CO. LTD.
Cathode Ray Tube Department,
225 Tottenham Court Road, London, W.1