

NATION-WIDE TELEVISION COMING

Television

and SHORT-WAVE WORLD

MAY 1939

No. 135 Vol. XII.

1/-

**YOUR
RECEIVER
AND ITS
INSTALLATION**

**RECEIVER
FOR
MECHANICAL-
OPTICAL
TELEVISION**

**SHORT
WAVES**

**SPECIAL COMMUNICATION
RECEIVER ISSUE**

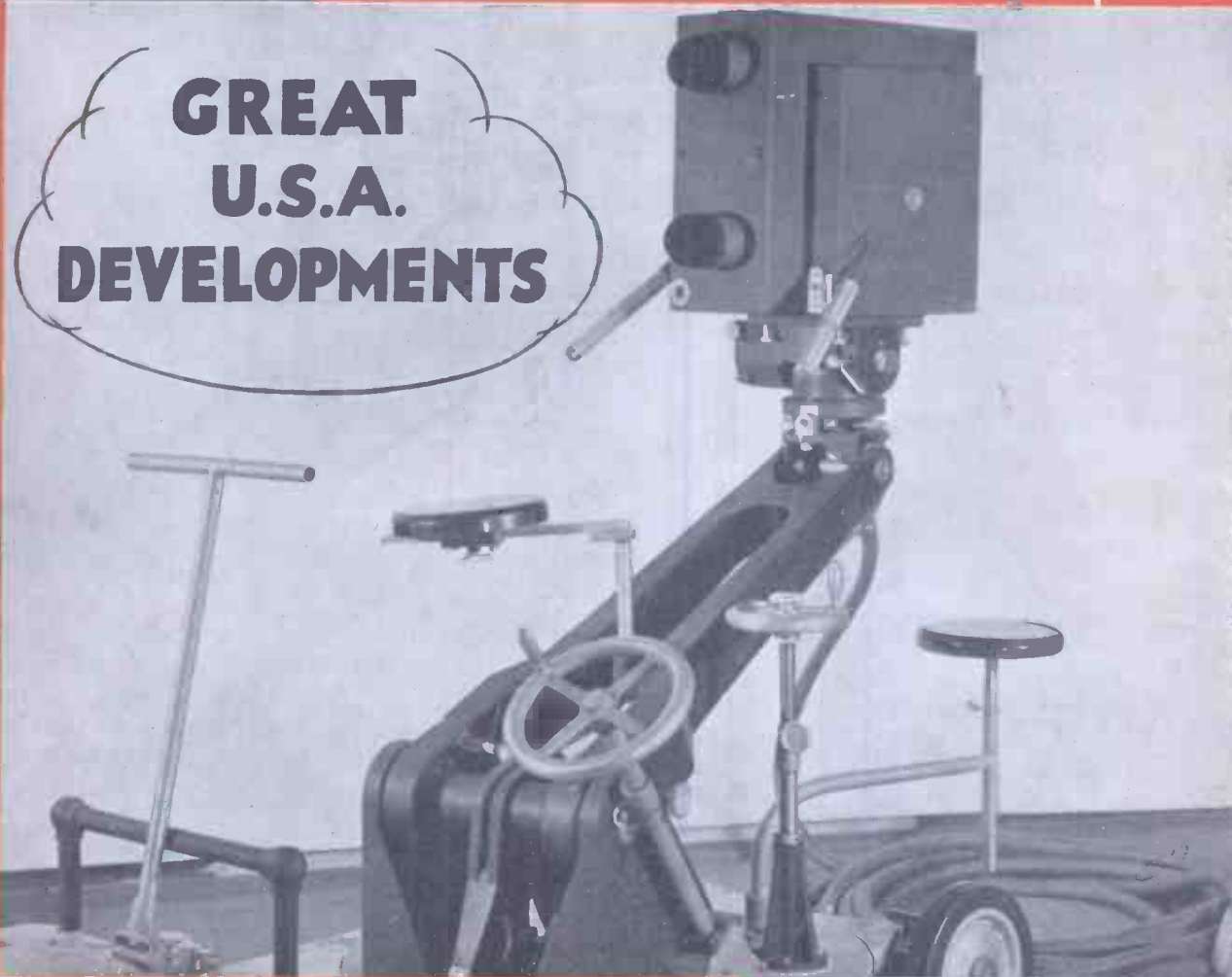

**GREAT
U.S.A.
DEVELOPMENTS**

**BERNARD JONES PUBLICATIONS LTD.
CHANSITOR HOUSE, CHANCERY LANE
LONDON W.C.2.**

THE FIRST TELEVISION JOURNAL IN THE WORLD



Said Peter Augustus De Wet,
"I've found out what's wrong with
this set.

For all it's requiring
Is just a rewiring.
And this time, with FLUXITE you bet!"

See that FLUXITE is always by you—in the house—garage—workshop—wherever speedy soldering is needed. Used for 30 years in government works and by leading engineers and manufacturers. Of Ironmongers—in tins, 4d., 8d., 1/4 and 2/8. Ask to see the FLUXITE SMALL-SPACE SOLDERING SET—compact but substantial—complete with full instructions, 7/6. Write for Free Book on the art of "soft" soldering and ask for Leaflet on CASE-HARDENING STEEL and TEMPERING TOOLS with FLUXITE.

To CYCLISTS! Your wheels will NOT keep round and true unless the spokes are tied with fine wire at the crossings and SOLDERED. This makes a much stronger wheel! It's simple—with FLUXITE—but IMPORTANT.

THE FLUXITE GUN

is always ready to put Fluxite on the soldering job instantly. A little pressure places the right quantity on the right spot and one charging lasts for ages. Price 1/6, or filled 2/6.



ALL MECHANICS WILL HAVE

FLUXITE

IT SIMPLIFIES ALL SOLDERING

FLUXITE LTD. (DEPT. T.V.), DRAGON WORKS, BERMONDSEY ST., S.E.1.

STABLE VOLTAGE

—the only
solution to the
problem of
unstable supply
voltage is the
STABILOVOLT

CURRENTS UP TO 200 mA

Write for new pamphlet giving reduced prices and additional ranges. Full particulars from

MARCONI'S
WIRELESS TELEGRAPH CO. LTD.
Electra House, Temple Place,
London, W.C.2.

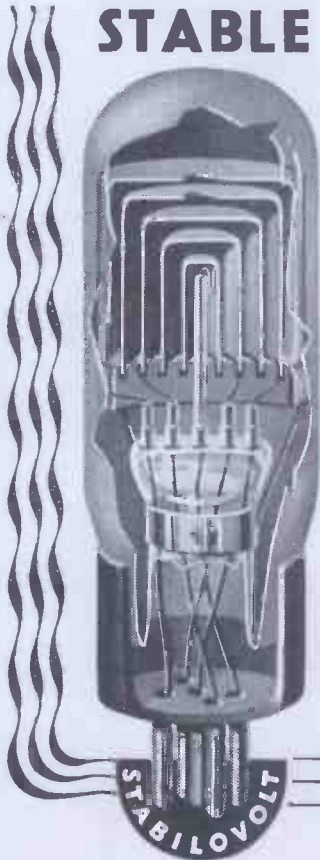

BELLING - LEE
High Tension
VALVE HOLDERS

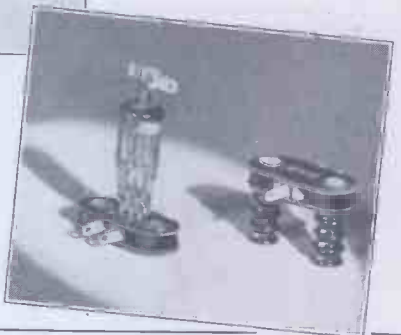
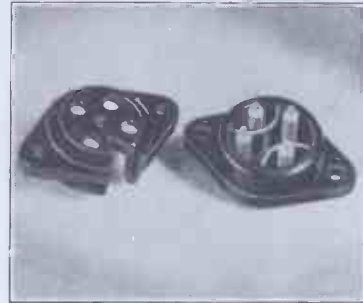

(Reg. Design 821026)

No. 352. Bakelite moulding, specially designed for rectifier valve in Television receivers, etc. Extra long creepage distances, suitable for high volts working. When tested with D.C. plus A.C. superimposed, corona becomes visible in dark at 10,750 volts peak. When tested on 50 cycles A.C. alone, corona visible at 7,300 volts.

Price 1/- each.

No. 365. As above, but with heavier moulding, ensuring extra insulation, suitable for 12,000 volts.

Price 2/- each.

D.I. DIODE VALVE HOLDER

No. 357. Specially made for the new Midget Diode Valves now in use. Silver plated spring contacts with soldering connections. Strongly constructed. Price: 1/- each

No. 357/H. High voltage type with insulated mounting pillars. Price 1/6 each.

STAND OFF LOW LOSS INSULATORS

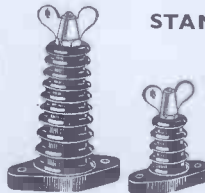

Equivalent shunt resistance in megohms at 50 per cent. humidity when mounted on metal base panel: No 1292, 2 in., 500 at 300 metres, 50 at 30 metres. No. 1277, 1 in., 250 at 300 metres, 50 at 30 metres. No. 1292, 10,000 v. Price 2/- ea. No. 1277, 5,000 v. Price 1/6 ea.

H.T. PLUG AND SOCKET

Suitable for Television and other H.T. Apparatus. Mounted in bakelite, chassis section of one hole fixing type for quick assembly. No. 353. Price 4/6.



Write for Belling-Lee Radio and Electrical Accessories—fully illustrated and with blue prints. Price 1/-.

BELLING & LEE LTD
CAMBRIDGE ARTERIAL ROAD, ENFIELD, MIDDX



Why YOU should use the EDDYSTONE MICRODENSER

for LONG . . . RELIABLE . . . SERVICE

BECAUSE "Eddystone" Microdensers possess unequalled efficiency for high frequency work. Their design embodies all the essential technical qualifications of a really good short-wave condenser, giving results desired by the serious user.

BECAUSE The "Eddystone" specialised all-brass Microdenser construction with its soldered vane assembly throughout effectively prevents increase in H.F. resistance and change in capacity with age, noisy tuning, and reduction of coil "Q."

BECAUSE All "Eddystone" Microdensers have a remarkably low temperature co-efficient. The "Eddystone" long main bearing ensures a smooth and noiseless movement. Tuning range is further increased by very low minimum capacities in all sizes and special DL9 low-loss insulation ensures absolute minimum dielectric losses. All capacities can easily be ganged with precise alignment.

"Eddystone" Microdensers are worthy of prompt selection by the short-wave enthusiast who is seeking a condenser of unquestioned superiority. Visit your Eddystone Dealer now—or write us for his address. 18 mmfd., 3/9; 40 mmfd., 4/3; 60 mmfd., 4/6; 100 mmfd., 5/-; 160 mmfd., 6/-.

Write
to the
makers
for
Complete
Catalogue

USE
FOR BEST RESULTS

EDDYSTONE

SHORT WAVE COMPONENTS

ASK YOUR DEALER

Made by Stratton & Co. Ltd., BROMSGROVE ST., BIRMINGHAM. LONDON SERVICE: WEBB'S¹⁴ Soho St., W.1.



BRITISH
MADE

The word 'AVO' is our
Registered Trade Mark

CRITICAL TESTING

demands the

AvoMINOR

ELECTRICAL MEASURING INSTRUMENT

The D.C. AVOMINOR

ELECTRICAL MEASURING INSTRUMENT

13 Meters in ONE!

CURRENT	VOLTAGE	RESISTANCE
0-6 milliamps.	0-6 volts.	0-10,000 ohms
0-30 "	0-12 "	0-60,000 "
0-120 "	0-120 "	0-1,200,000 "
	0-240 "	0-3 megohms
	0-300 "	
	0-600 "	

In case, complete with instruction booklet, leads, interchangeable crocodile clips and testing prods. 45/-
Deferred Terms if desired.

The UNIVERSAL AVOMINOR

ELECTRICAL MEASURING INSTRUMENT

22 Ranges of Direct Readings

D.C. VOLTS	A.C. VOLTS	D.C. MILLIAMPS.
0-75 millivolts	0-5 volts	0-2.5 milliamps.
0-5 volt	0-25 "	0-5 "
0-25 "	0-100 "	0-25 "
0-100 "	0-250 "	0-100 "
0-250 "	0-500 "	0-500 "
0-500 "		

RESISTANCE
0-20,000 ohms 0-2 megohms
0-100,000 " 0-5 "
0-500,000 " 0-10 "
Complete with leads, interchangeable crocodile clips, and testing prods; and instruction booklet. (Leather carrying case 10/-)
£5 10s.
Deferred Terms if desired.

Radio engineers the world over rely upon "AVO" Instruments for rapid precision testing. In these AvoMinors the same critical testing facilities are available for the benefit of the keen amateur and serious experimenter. Combining high accuracy with unquestioned reliability, they are unrivalled in providing such comprehensive test facilities at so moderate a cost.

A VALUABLE BOOK!

RADIO SERVICING SIMPLIFIED. This book gives the whole routine of testing modern receivers, and explains causes of faults in receiving and amplifying apparatus. Also shows how to use effectively all radio instruments. Price 2/6 (Post free 2/10).

Sole Proprietors and Manufacturers:—

THE AUTOMATIC COIL WINDER & ELECTRICAL EQUIPMENT CO. LTD.

Winder House, Douglas Street, London, S.W.1.

Telephone: Victoria 3404/7

● WRITE FOR FULLY DESCRIPTIVE PAMPHLETS

SEE THAT YOUR NEW SET IS FITTED WITH MAZDA



The
MOST FAMOUS
TELEVISION
SET MAKERS

Fit
MAZDA
CATHODE RAY
TUBES

AND MAZDA SPECIAL VALVES

Mazda Radio Valves & Cathode Ray Tubes are manufactured in Gt. Britain for the British Thomson-Houston Co. Ltd., London & Rugby and distributed by

THE EDISON SWAN ELECTRIC CO. LTD.  155 CHARING CROSS RD., LONDON, W.C.2

For full particulars write to Technical Service Department

TELEVISION

and SHORT-WAVE WORLD

Special Features

	PAGE
The Make-up of a Vision Receiver	260
Installing a Television Receiver	261
Television for a Nation	263
Questions Viewers Ask	268
Why you may not be getting perfect pictures	269
Receiver for Mechanical Television	275
Aerial Feeders for Television	282
Buying a Communication Receiver	290
British and American Communication Receivers	294
2-valve Low-power TX	300
8-valve Amateur-band Receiver	304
Crystal Oscillator Circuits	312

TELEVISION AND SHORT-WAVE WORLD

Proprietors:
BERNARD JONES PUBLICATIONS, LTD.

Editor-in-Chief:
BERNARD E. JONES.

Editor:
H. CORBISHLEY, F.T.S.

Short-Wave Editor: KENNETH JOWERS

Editorial, Advertising and Publishing
Offices:

Chansitor House, 38, Chancery Lane,
London, W.C.2.

Telephones: Holborn 6158, 6159.

Telegrams: Beejapee, Holb., London.

Subscription Rates: Post paid to any
part of the world—3 months, 3/6;
6 months, 7/-; 12 months, 14/-.

Published Monthly—1/- net.
(On the first day of the month).

Contributions are invited and will be
promptly considered. Correspondence
should be addressed according to its
nature, to the Editor, the Advertisement
Manager, or the Publisher, "Tele-
vision and Short-wave World," Chansitor
House, Chancery Lane, London, W.C.2.

IMPORTANT

"Television and Short-wave World" is regis-
tered at the General Post Office, London, for
transmission to Canada and Newfoundland
by Magazine Post. Entered as Second-class
mail matter, Boston, Mass.

COMMENT OF THE MONTH

Nation-wide Television

DEFINITE moves are now on foot to extend the television service so that eventually it will cover practically the entire country. It is evident that the will exists even though the means are as yet somewhat illusory. Opposition to the service, which was so strong a matter of almost months ago, is now practically non-existent and it is satisfactory to find that the desire for extension of the service is apparent in many quarters, including the Post Office, the B.B.C., and the wholesale and retail wireless trades. The real problem is finance, and it is this, of course, which most closely concerns the B.B.C. The Director-General of the B.B.C. said recently: "We have now come to a critical landmark in television work. We have developed the resources not merely with a view to the benefit of a thirty or forty mile radius around London, but as a nucleus of a national system. The speed at which we can go forward depends on two things. Firstly, the result of technical experience as to the means of transmission, and, secondly, the question of finance."

The collaboration of the trade is assured by the recent decision of the Radio Manufacturers' Association to offer, if the B.B.C. will proceed immediately to establish a television station at Birmingham to relay London programmes by means of a radio link, to stand any possible loss. It is estimated that the cost involved would be less than £100,000. To this end a joint committee of wireless manufacturers and traders has been formed which is to be known as the Television Extension Committee, and its chief objects are to make it clear to various authorities concerned the desirability of speeding up the extension of television into the provinces because of the importance of the new industry at home, its export capabilities, and the need for Britain to maintain the lead which it has at present.

Immediate steps are to be the sending of deputations to the Postmaster-General, the Board of Trade, the Department of Overseas Trade and the Ministry of Labour. Negotiations will take a considerable time, but at last there appears to be the likelihood of the first provincial television station coming into being, and this it is generally conceded should be at Birmingham where it would serve a potential audience of three and a half million people. There is, however, some diversity of opinion regarding the actual process of provincial development and it is understood that the Post Office is in favour of formulating a scheme for the entire country instead of piecemeal development by progressive moves from one centre of population to another. The extension of the television service to the provinces will not necessitate extra programme expense as the entire present suggestion is to relay the Alexandra Palace programmes either by cable or radio link.

THE MAKE-UP OF A VISION RECEIVER

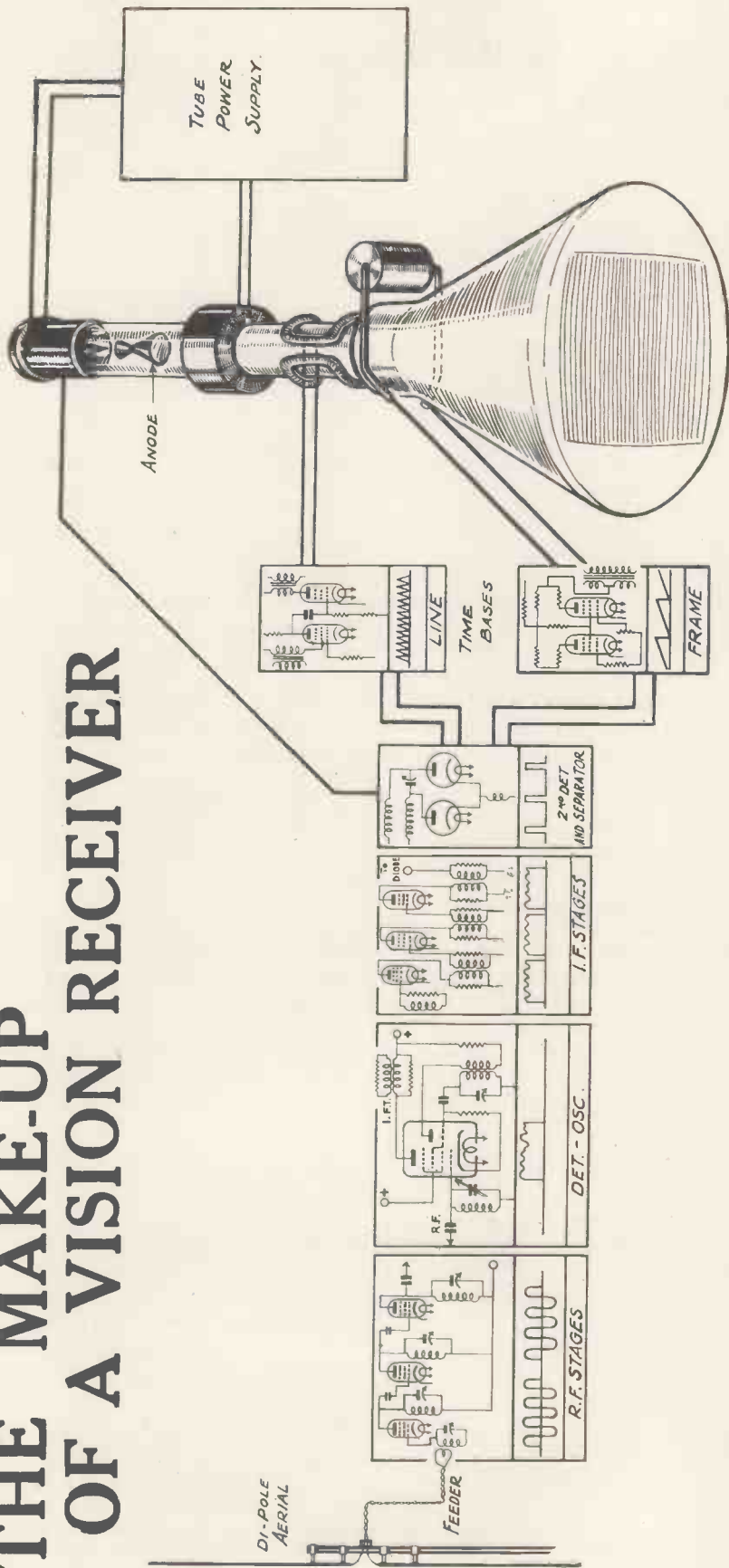

In many respects the vision receiver, at least as far as the second detector, is identical in characteristics to the ordinary short-wave radio receiver.

Extra care is taken in the construction, both electrically and mechanically, while the frequency response has to be infinitely better than that of even the highest quality broadcast receiver. It is unusual for any broadcast set to reproduce signals higher in frequency than 15,000 to 20,000 cycles, but in a television receiver, the circuits must be capable of passing frequencies up to 2 megacycles in order that picture definition should not suffer.

Consequently, as this means very broadly tuned stages and in many cases tuned circuits heavily damped by low value resistors, the gain per stage is very much less than obtained in the normal manner. This primarily accounts for the large number of valves, usually 20, in the average vision receiver.

The vision set can be split for the purpose of comparison into four units, the R.F. stages, mixer and high-frequency oscillator, intermediate frequency amplifying stages, second detector and separator. With the exception of the separator this sequence is exactly the same as in a sound receiver.

A signal is received at a frequency of 45 megacycles and applied to the grid of the first radio-frequency amplifier. This valve amplifies in the normal manner and passes the boosted signal, still with a frequency of 45 megacycles to the grid of the second or even third amplifier. The output from the final R.F. amplifier, which by this time is a fairly strong signal is applied to the grid of the first detector or mixer. This valve is either a hexode and a triode in the same glass envelope or two separate valves, according to the ideas of the designer.

An oscillator output is mixed with the 45-megacycle signal applied to the first detector, but the oscillator frequency is slightly different to that of the detector frequency, in order to produce a lower frequency. The difference depends on the frequency required in the I.F. stages, which is generally in the order of 8 megacycles.

The use of the lower frequency I.F. stages is merely to obtain the maximum amount of gain with adequate band width. With a straight receiver when the signal is amplified at 45 megacycles, as many as 7 R.F. stages are required in order to supply a sufficiently high voltage to the diode detector. However, by amplifying at 8 megacycles the number of stages can

be decreased and, if anything, the voltage applied to the second detector increased.

The second section, that is the detector-oscillator should be considered as a miniature transmitter, for it supplies a signal to the primary of the first I.F. transformer at a given frequency. The third section, the I.F. stages, is also straightforward, except that the transformers must be designed to provide an adequate band width. In many receivers the band width is as high as 5 megacycles in order to obtain maximum definition.

The second detector rectifies the 8-megacycle signal, and applies it to the grid of the cathode-ray tube for modulation. The synchronising signals are applied via the separator valve to the line and frame time bases, the outputs of which, after being amplified, are applied to the frame and line deflection coils around the neck of the cathode-ray tube.

One large power pack is required to feed the receiver, the two time bases, high voltages to the anodes of the tube and low voltage to the heater. Usually, a common power pack is employed, giving all voltages from 4 volts up to 5,000 or 6,000 volts.

YOUR TELEVISION RECEIVER—AND WHAT YOU SHOULD KNOW ABOUT ITS INSTALLATION

ALTHOUGH the installation of a television receiver in the home does not call for any technical knowledge, there are a few points of a semi-technical nature which should receive consideration. If the instrument is installed by a dealer it is probable that he will be

The second point concerning receiver position is that of light. Pictures are now so bright that they can be watched comfortably in subdued light, though naturally almost total darkness is better. Light from a fire, or during the daytime from a chink in a curtain, if this comes from some place behind the receiver can be very disconcerting, whereas from the front it will hardly be noticeable. Obviously then, the receiver should not back on to any source of light which cannot be entirely eliminated without a minimum of trouble. And do not forget that you will probably wish to use the receiver both during the day and at night time.

A second point concerning receiver position, but a minor one, is that of reflected light. It is rarely that a room will be entirely dark and the reflection of the fire, for instance, on the screen can be very irritating. As a rule this can easily be obviated by a slight change of position or by the use of a screen, though the necessity for any accessory of this nature is to be deprecated because there will be occasions when it is not used and viewing comfort will be sacrificed.

The position of the receiver in the house is a matter of personal inclina-

The two remaining factors concerning receiver position are power supply and earth connection. The power requirements vary with different receivers, but an average figure is 200 watts and the supply can, therefore, be obtained from any power point. It is rather heavy for an ordinary lamp socket, and the use of this means should be avoided if possible, but it is not entirely ruled out. One matter of importance in this connection is that if the lead from the power point to the receiver is of considerable length, stout gauge wire, and not ordinary lighting flex, should be used, otherwise there is a possibility of voltage drop taking place and the receiver being starved.

The connection between the receiver and power point should be of a more or less permanent character—that is, the set should not be switched off by pulling out the power



(Photo, Telefunken)

It is impossible to enjoy a television programme viewed under these conditions.

fully aware of these, but your own knowledge will be helpful and possibly enable you to appreciate certain desirable features.

Receiver Position

In the first place, don't regard the receiver as a more or less ornamental piece of furniture which you consider must fit into the scheme of things. Remember that it is the screen that has to be looked at and, therefore, it should be so positioned that it can be viewed in comfort without disturbing other arrangements in the room and, if possible, without alteration of the usual sitting positions. There is a tendency to instal receivers in the back part of the room and though this may be desirable in some ways, it does not make for general comfort and when it is wished to see only a portion of a programme, such a general disturbance is necessary that it may not seem worth while.



(Photo, Fernseh).

If light in the room is necessary it should come from the rear and one side.

tion, but it is advisable to regard it as a utility instrument and put it in a room which is in general use. Only to a slight extent is aerial position concerned with that of the receiver, for it is possible to carry the feeder practically anywhere without detriment. For ease of installation, some consideration should, however, be given to this matter.

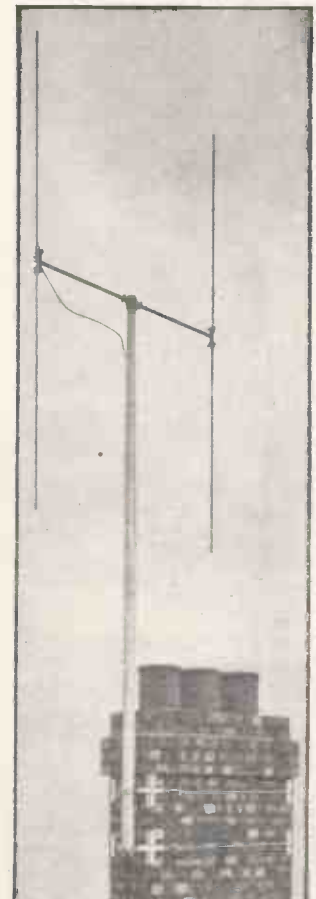

An excellent example of a dipole with reflector. This is the Belling-Lee standard aerial and the ease of fixing should be noted.

THE AERIAL AND FEEDER

plug, but the actual on-off switch on the receiver should be used in every case. If it is desired to remove the lead this should be done after switching off and its replacement made before switching on.

The Aerial

The most difficult installation problem is that of the aerial. With this we are not only concerned with reception but also with interference, and generally some sort of compromise has to be effected. Interference is not really such a bogey as many people suppose, that is assuming reasonable precautions are taken for its prevention.

It is generally accepted that the most suitable type of aerial is the dipole which consists of two metal tubes or rods each 5 ft. 4 in. long placed vertically one above the other and separated by about an inch. This is the simple dipole suitable for use up to distances of about twenty miles from the transmitter, and under conditions where there is little interference, or where it can be placed at such a height that it is above the interference field which, incidentally, mostly comes from cars.

The simple dipole can be made more effective with the addition of a reflector which consists of a metal rod or tube approximately the combined length of both elements of the dipole and placed 5 ft. 4 in. behind the latter. This addition makes the aerial directional, that is, properly erected, the greatest signal strength would be obtained from the direction desired and it would be very much reduced from other directions.

Obviously, under ordinary conditions the aerial and reflector should be placed so that they are directional to the transmitter, but it must be remembered that aerial and reflector will also be directional to interference and, therefore, it frequently happens that some sort of compromise is the best arrangement—that is, so that the directional characteristics enable some of the interference to be cut out without materially reducing signal strength.

It is therefore evident that in aerial erection several factors must be taken into account. Adequate height will give freedom from interference and at reasonable distances, good signal strength. The directional properties of the aerial will provide good signal strength and they can also be used to

minimise interference. Obviously, the location of the aerial will not make any difference to signal strength but by permitting the most suitable orientation it will enable interference to be reduced. It should, therefore, be so located that the field of interference (which is probably the road) is behind the reflector or as nearly so as possible.

In certain circumstances, this will entail the use of a long feeder, but within reason this is not detrimental and in any case it is better to have a good aerial position and long lead in than vice versa.

The Earth and Feeder

From reception point of view an earth connection is not necessary, but it is desirable on the score of safety in case of an internal breakdown of insulation. Even were this to happen, possibility of danger, despite the high voltages present, is exceedingly remote and under ordinary circumstances risk of shock does not exist as the mains connections are always arranged to be automatically broken upon access to the interior of the cabinet.

No special precautions are required with the feeder and either co-axial cable or twin feeder can be used; there appears to be little difference in the merits of either, though some manufacturers recommend one and others the other. As the aerial connections are liable to corrode they should preferably be soldered, but in

any case the joint should be well protected with insulating tape. The feeder should come away from the aerial in a horizontal direction for at least a couple of feet, and it should be secured so that it will not sway about; its close proximity to walls, etc., is immaterial. Wherever possible the feeder should be anchored and precautions taken to prevent it chafing.

Operation of the set is exceedingly simple as the effect of altering the few controls immediately becomes visibly apparent. The novice should only touch the ordinary controls; there are a number of the pre-set type which are not easily accessible and they should be left alone even though some fault may be apparent in the picture. Such a fault may only be of a temporary nature and though its correction may be possible by means of the pre-set controls, it is more than probable that the entire receiver will be put out of adjustment and will require an expert to put it right. If the temptation to adjust the pre-sets cannot be resisted, adjust only one at a time and before moving it note its position so that it can be reverted to after the effect on the picture has been noted.

Finally, do not switch the receiver on and off at short intervals—it is definitely bad for the receiver. Three minutes should be allowed to lapse after the set is switched off before it is switched on again. There is, however, no harm in switching off immediately after switching on if the programme is not to your liking.

TELEVISION AT L.C.C. EXHIBITION

A display of television apparatus is being made by the Norwood Technical Institute at the County Hall in connection with the London County Council Jubilee Exhibition. H. J. Barton-Chapple, of Baird Television Ltd., is giving the two-year course of television lectures at the Norwood Institute, and the exhibit shows some of the apparatus available.



TELEVISION FOR A NATION R.C.A. TO BUILD 20 TRANSMITTERS

FIRST DETAILS OF DESIGN

Owing to the size of America, it is obvious, of course, that television coverage will require a large number of stations compared with this country, even assuming that fullest use is made of cable and relay systems whichever proves the most practicable.

The R.C.A. Manufacturing Company have, therefore, lost no time in preparing the design of a standard type of transmitter which is complete in every way and could be installed at any location. It is understood that twenty of these transmitters are to be manufactured immediately and except for very slight variations demanded by local conditions of use they will be the same.

THE transmitter comprises studio terminal equipment, transmitter terminal equipment, picture transmitter and power supply requirements.

The studio equipment consists of the following units:

- Film projector equipment (35 mm)
- Test projector equipment (35 mm)
- Projector accessory equipment

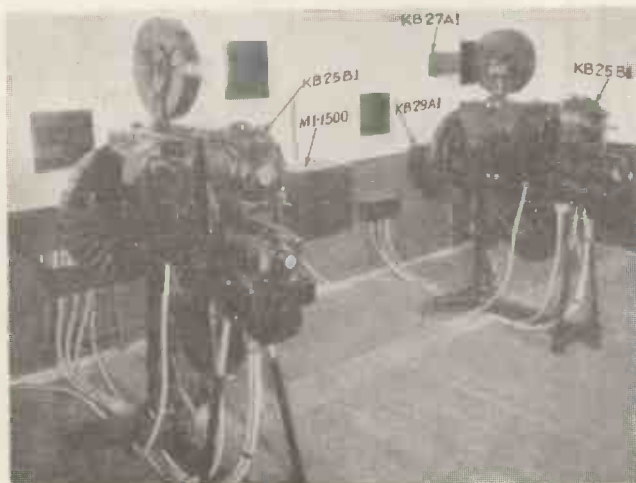

Film projector equipment.



- Film camera equipment
- Studio camera equipment
- Camera accessory equipment
- Amplifier rack equipment assembly
- Monitor equipment assembly
- Camera control equipment
- Miscellaneous equipment.

The equipment incorporates many improvements which have resulted from the experience gained in the manufacture of television equipment now installed both in the United States and abroad.

The apparatus has been designed for use with American standards and the scanning lines per frame are therefore 441, the frame frequency 30 per second, and the field frequency is twice the frame frequency—60 per second. The aspect ration is 4/3.

Synchronising is secured in the usual way by transmitted signal impulses once every line and once every field period. The line and field synchronising signals are of equal amplitude and of different wave shapes. The synchronising signals are generated by an electronic generator, and approximately 20 per cent. of the peak carrier amplitude is used for synchronising. These synchronising signals are combined with the vision signals so that both shall be transmitted on the same carrier. Negative transmission is employed, and the equipment designed for operation in a 6 megacycle channel.

Studio Camera

The studio camera, uses a 6½-in. focal length lens, and transmits a picture of an average scene in daylight at a lens opening of f. 4.5 when the scene has surface brightness of 200 apparent foot candles or more. The studio lighting used with the camera is similar to that needed for motion picture photography, as the scenes televised require a surface brightness of 200 to 1,000 apparent foot candles.

The power output of the transmitter equipment is measured at the output terminals of the transmitter,

American Standards

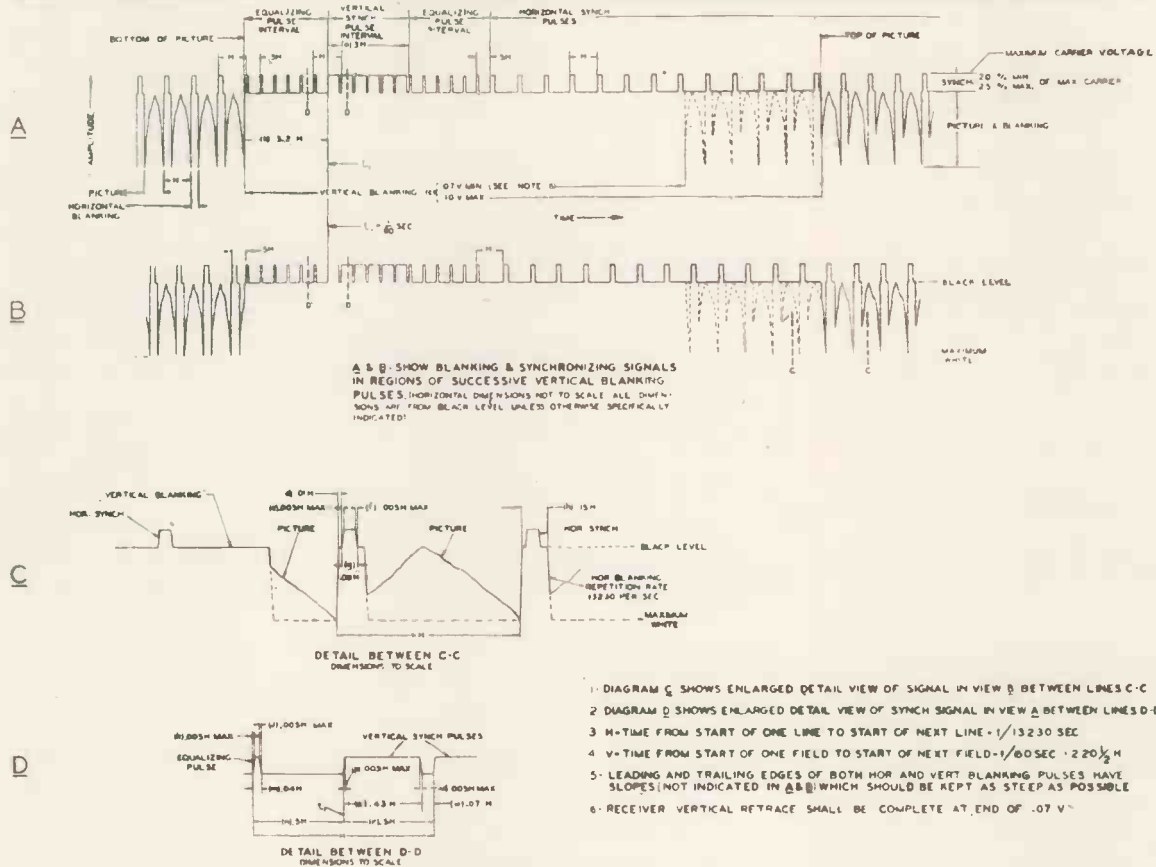

RMA standard T-111 television signal

exclusive of any subsequent equipment, which is capable of full modulation when supplied with a vision-frequency signal, at the input terminals of the modulation, of two volts peak to peak. The impedance at the input terminals of the modulator is normally 75 ohms. Amplitude linearity is sufficient to permit the emission of satisfactory picture signals.

The type 530-A film projector which is part of the equipment is specially adapted for use with an Iconoscope camera. Unequal pull-down periods are provided in the projector intermittent so that 24 frame per second motion picture film may be used to provide 30 frame per second television with interlaced scanning. This is accomplished by mechanically-optically flashing the light image of a complete frame of motion picture film upon the Iconoscope photo-electric mosaic for very brief intervals between flashes of light. Alternate frames of film are flashed upon the mosaic two and three times respectively, at a rate of 60 per second, and, during each dark period, alternate sets of lines are scanned. Drive is supplied by a special self-framing 60-cycle synchronous motor, and a low-intensity arc is employed.

The accessories normally furnished for use with each 35 mm film projector includes the following units:—

Projector control unit for push button control of starting, stopping, braking and remote control of the projector motor.

Projector contactor panel for relay control of starting, stopping, braking and remote control of

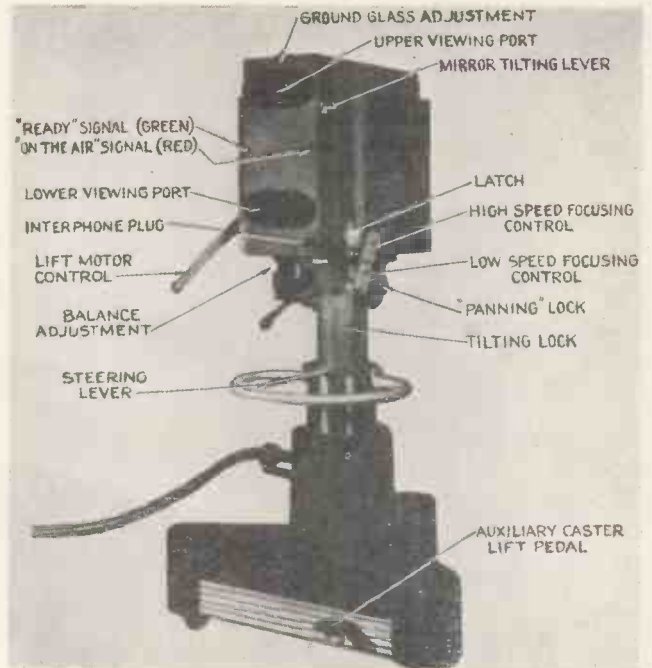

Model KE2B2 studio camera equipment, rear view.

CAMERA EQUIPMENT

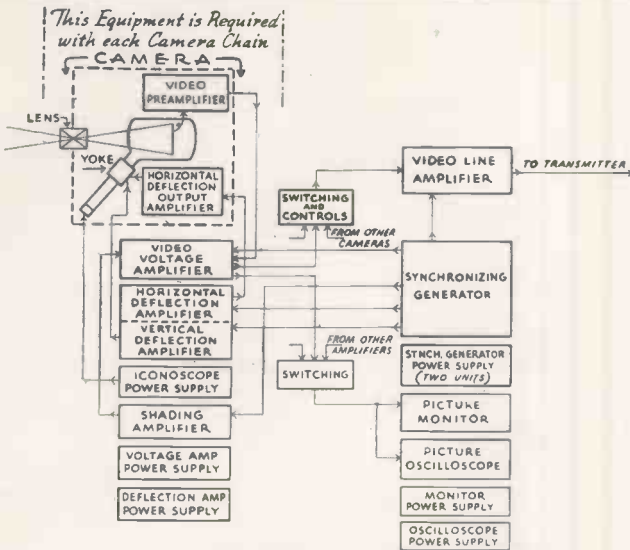

Block diagram of studio units.

the projector motor. Operated by projector control unit or remote control.

Exciter lamp supply unit for picture brightness and sound exciter lamp D.C. supply.

Rectifier for self-framing synchronous motor D.C. supply.

Rectifier for projector arc D.C. supply.

The 502-A film camera is arranged for wall mounting adjacent to a projection port in the wall separating the camera from the film projector. It contains the Iconoscope and preliminary amplifiers. These preliminary amplifiers amplify the video signal from the Iconoscope and the horizontal deflecting impulses from the camera rack equipment before applying them to the deflecting coil of the Iconoscope.

All conductors for the camera are in a single cable 17 ft. long.

The 500-A type studio camera is suitable for mounting on several types of pedestals, depending, of course, upon the particular service required; it contains the optical system, preliminary amplifiers and provision for remote control focusing.

This camera is supplied with either one or both of two types of interchangeable lenses; one type has a focal length of approximately 6½ in. and a maximum aperture of f3.5, and the other a focal length of approximately 18 in. and maximum aperture of f4.5. The type provided depends on particular requirements.

The preliminary amplifiers amplify the video signal from the Iconoscope and amplify the horizontal deflecting impulses from the camera rack equipment before applying them to the deflecting coil of the Iconoscope.

The amplifier rack equipment assembly for any particular studio installation is dictated by the number of film and studio cameras and the operating technique desired. The type 551-A camera rack equipment (film) includes apparatus for performing the following functions for its channel: Amplify the video signal from the camera pre-amplifier; amplify and shape the horizontal deflecting impulses from the synchronising generator so that they may be used to deflect the Iconoscope beam and amplify and shape the vertical deflecting impulses from the synchronising generator so that they may be used to deflect the Iconoscope beam.

They also provide certain voltages for the Iconoscope and for horizontal and vertical deflecting amplifiers.

Relays for switching of the monitor inputs to the several monitor outputs of the camera rack equipment are included in the auxiliary rack equipment. The apparatus also includes an automatic brightness control amplifier for use with each film channel, and in the film projector there is a light source and photo-cell pick-up arrangement to "measure" the relative light transmission for each frame of film. The automatic brightness control amplifier employs this photocell output and the resulting signal controls the height of the blanking pedestal accordingly, that is, in accordance with the average brightness of the scene.

In addition, this auxiliary equipment includes a video line amplifier for the composite signals from the studio apparatus which is suitable for feeding a



Left : Model KE2B2 studio camera equipment, rear view. Camera case open.

Right : Vision rack equipment.

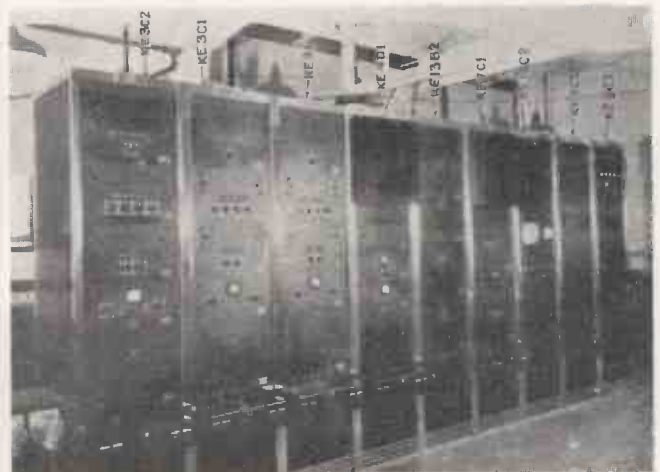

SYNCHRONISING GEAR

co-axial cable having a characteristic impedance of 75 ohms, and delivering a maximum output of approximately 5 volts peak to peak.

The type 650A synchronising generator rack equipment includes apparatus for performing certain functions, as follows: Circuits for generating the required frequencies for synchronising. Circuits for shaping

stallation adjacent to the control console and studio viewing window. Each equipment includes amplifiers, deflecting apparatus, Kinescope for monitoring the television performance and an oscilloscope for monitoring the vision signals. The video signals may be observed on the oscilloscope at either line or frame sweep rates.

The camera control equipment includes apparatus so arranged that the operator seated at the console has within reach the controls needed for film and studio programmes. This console is placed so that the operator may view the studio action through a window just to the rear of the console and view the monitor reproduction on monitors placed adjacent to the console.

The Picture Transmitter

The picture transmitter includes the following components:—

Transmitter Cabinet.

The transmitter cabinet has overall outside dimensions of approximately 72 in. by 85 in. by 35 in., and supplies suitable supporting and shielding enclosures for the radio-frequency and modulator units, the rectifier tube complement and all auxiliary control devices.

Radio-frequency Unit.

The radio-frequency unit is a removable assembly containing all radio-frequency circuits and associated

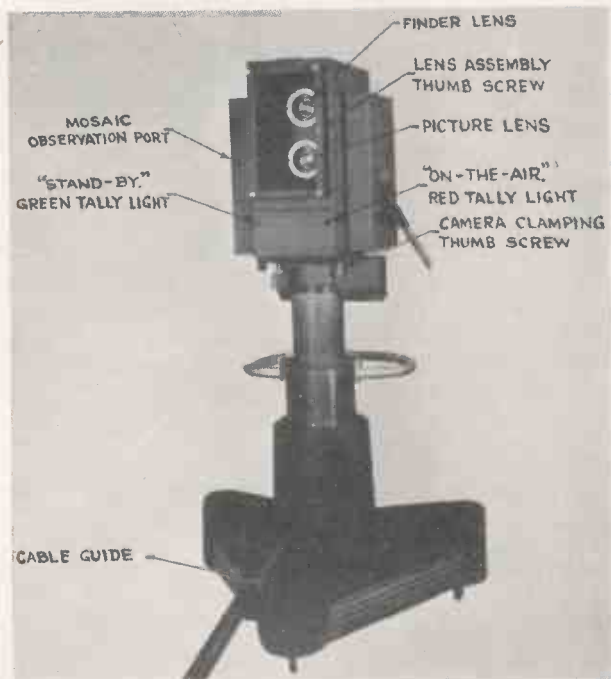

Model KE2B2 studio camera equipment, front view.

and mixing the several signals to produce the synchronising wave shapes. An amplifier system for supplying the several synchronising and blanking signals to the studio apparatus.

The synchronising generator unit produces five types of signals, viz.: Iconoscope vertical driving; Iconoscope horizontal driving; Iconoscope combined horizontal and vertical blanking; Kinescope combined horizontal and vertical blanking; Kinescope combined horizontal and vertical synchronising.

The type 561A synchronising generator auxiliary rack equipment contains apparatus for regulating the power supply rectifiers which supply plate potential for the synchronising generator unit and providing protection and control of the incoming power supply to the synchronising generator and its auxiliary rack equipment.

The D.C. power rack equipments for "Anode" and "Heater" provide power for anode supply; anode potential for the camera amplifiers, video voltage amplifiers and video line amplifier; plate potential for the picture oscilloscope and monitor units, and heater supply for the camera pre-amplifiers.

The studio monitoring equipment includes apparatus for monitoring the television programme at the output of either the camera rack equipment or the video line amplifier. These monitor equipments are mounted in individual frameworks which are intended for in-



Studio camera equipment (Dolly type).

valves. The radio-frequency circuits consist of six stages, namely, a crystal oscillator, two multiplier stages, a low-power amplifier stage, an intermediate amplifier and a power amplifier. The crystal oscillator employs one RCA-807 valve; the first multiplier stage uses one RCA-814 valve; the second multiplier stage two RCA-808 valves, and the low-power amplifier stage two RCA-834's in a push-pull circuit. The intermediate amplifier uses two RCA-833 valves and is the modulated stage. This stage is grid modulated and directly coupled to the modulator. The power amplifier uses two RCA-889 valves and operates as a linear amplifier.

Modulator

The modulator consists of three video-frequency amplifier stages including the modulator stage. The first employs two RCA-807 valves in parallel, the second four RCA-807 valves in parallel and the third, or modulator stage, ten RCA-813 valves in parallel. All stages use direct impedance coupling, and the modulator stage is direct-current coupled to the grid circuit of the intermediate power amplifier. In addition to modulation potentials, the modulator furnishes normal bias to the intermediate power amplifier. An RCA-1-v. diode is used on the modulator grid circuit for re-establishment of the component for D.C. transmission. Two regulated power supply units are included in the modulator unit to supply grid bias potentials for the video ampli-

fier and modulator stages. Each of these rectifiers uses one RCA-5Y3-G and one RCA-874 valve. Structurally the modulator is a separate removable unit.

Rectifier

Units

The transmitter includes three separate high-voltage power supplies. Rectifier frame No. 1 contains components for two three-phase half-wave rectifiers, the first supplying the first five radio-frequency stages and the two video amplifier stages, and the second supplying the modulator stage. All rectifiers use RCA-872-A valves, a total of twelve being required.

Water Cooling

Unit

A water cooling system is provided to maintain the temperature of the cooling water in the power amplifier and water-cooled resistor units.

For satisfactory operation, the studio and transmitter obtain their A.C. power supply from the same power system. The studio equipment requires 110 volts 60 cycles single phase, or 220 volts 60 cycles 3-phase, or both, depending upon the equipment arrangement. The transmitter requires 220 volts, 60 cycles, 3-phase.

A NEW FILM SCANNER

THE big problem of the transmission of motion pictures without distortion or loss of definition—has been solved, it is claimed, by the development by Dr. Peter Goldmark, chief television engineer for the Columbia Broadcasting System, of a new type film scanner which will be placed in operation as soon as the C.B.S. station on top of the Chrysler Building is completed.

In the past the televising of films has been a difficult matter due to numerous technical reasons, but it is stated that with the new scanner motion pictures can be transmitted almost as simply as they can be projected in a cinema.

The principle upon which the revolutionary new scanner works is, of course, only different from that of the standard motion picture projector. In the latter a strip of film is made to pass between a light source and a lens in a continuous series of rapid jerks so that 24 separate photographs or frames per second can be projected while they are at rest. This is necessary because the eye would see only a shifting melange of light and shade if the celluloid were kept in continuous motion.

It is not desirable to do this in scanning pictures for television, first because for such purposes the film must be scanned at the rate of

60 frames per second to eliminate flicker, and second because stop-motion scanning requires a great deal of light, causes wear on the film and necessitates a great number of expensive moving optical parts.

Continuous Movement

Dr. Goldmark and his staff of engineers solved the difficult problem by making the film pass continuously downward before a scanning aperture and lens system and then causing an electronic scanning beam to move upward at exactly the same speed so that a stationary electronic image results. A slotted rotating disc is placed between the film and a number of lens segments. This acts as a shutter and gives light to only one of the segments at a time. The result is that sixty separate stationary frames per second can be produced from film which was originally photographed at 24 frames per second, although the speed of action on the receiving screen is not changed in the least. Moreover the received images will have even illumination and great contrast and character.

The theory behind the continuous motion film scanner is extremely complicated, according to Dr. Goldmark, but the machine itself is

simple in its construction and is no larger than the projector in a cinema. It has no moving optical parts, uses an incandescent bulb instead of an arc for a light source, is comparatively inexpensive to build and operate and all its mechanical parts move at a constant speed so that less precision is required in its manufacture and operation.

The machine can be adjusted while in motion and it even has a unique new device by which shrinkage of film, due to age or weather conditions, can be compensated for. This compensator eliminates the danger of the optical and electronic images getting out of synchronism.

The continuous action scanner has been used for test purposes in the C.B.S. television laboratories for the past year and a half and is the first machine using this principle.

International Meeting on Physics

The Federal Institute of Technology and the Physical Society of Zurich are holding an international meeting on physics on the occasion of the Swiss National Exhibition in Zurich.

The meeting will take place from September 4 to 6, 1939, in the Physical Building of the Federal Institute of Technology, 35 Gloriastrasse, Zurich, 7. Lectures will be given by several well-known television authorities,

? QUESTIONS VIEWERS ASK ?

Price Reduction

Q. With the increased demand for receivers and probable introduction of mass production methods, are prices likely to be reduced in the near future?

A. In many respects mass production already enters into receiver construction as most of the components are wireless types with which, so far as production is concerned, probably the last word has been said. Also it is generally conceded that receivers at present are not produced at an economic price and it is most unlikely therefore that there will be any material price reduction for a very considerable time.

Running Costs

Q. Is a television receiver costly to run both as regards replacements of valves, tube, etc., and current consumption?

A. On the whole the television receiver is more reliable than the average radio set, as the use of the highest grade components is necessary. As it does not get very prolonged use (perhaps a couple of hours a day), valve life is very long. Average tube life has not really been determined but receivers are in use which have been in operation for over two years and the tubes show no sign of deterioration.

Reliability

Q. Can a receiver easily be damaged by ordinary use?

A. Not if ordinary care is taken. Care should be taken in moving it, should this be necessary. Also it should not be switched off and on without allowing a short interval of time. Otherwise, short of violence, it is improbable that it will be damaged in ordinary use.

Reception Distance

Q. What is the greatest distance at which consistent reception can be obtained?

A. Reasonably good reception has been obtained at distances of rather more than 200 miles, but this has entailed the erection of a special aerial. Fifty miles is probably the greatest distance for consistent reception with ordinary equipment though this will necessitate the use of an efficient aerial and a sensitive receiver.

The limit of the ordinary service range can reasonably be stated as 35 miles.

Obsolescence

Q. Is the present type of receiver likely to become obsolete within a short time?

A. Television receiver design is largely based on standardised radio principles and it is improbable therefore that there will be any revolutionary developments as was the case in the early days of broadcasting. Progress will certainly be made, but it is unlikely that it will be at such a rate as to render present-day receivers in any way obsolete before they have been used for a reasonably long time.

The Add-on Unit

Q. What exactly is a television add-on unit. Will this allow of pictures being received in conjunction with an ordinary broadcast receiver?

A. So far as television is concerned the term add-on unit is rather a misnomer. Actually, these units have nothing to do with vision, but in conjunction with an ordinary broadcast receiver enable the accompanying sound to be received. Their use permits of economy in the total cost of the units required for reception of vision and the accompanying sound.

Operation

Q. Does the operation of a receiver require expert knowledge?

A. No. The operation of a television receiver is just as simple as a broadcast receiver and is even within the ability of a child. The effect of the use of the controls is immediately apparent in the picture.

Licence

Q. Is a separate licence necessary for the possession of a television receiver?

A. No. The ordinary broadcast licence covers both the broadcast receiver and the television receiver.

Indoor Aerials

Q. Is it possible to use an indoor aerial?

A. Yes. Provided that it can be accommodated. The total height of a television aerial is approximately 11 ft., and it is essential that it should be used in a vertical position.

Sound Quality

Q. Is it a fact that the sound accompanying television is much better than sound broadcasting on medium and long wavelengths?

A. Most decidedly. Much higher frequencies are used and the quality is, therefore, considerably better. For this reason the best of the ordinary sound broadcasts are also transmitted on the television sound wavelength between 8 and 9 p.m. each evening.

Eyestrain

Q. Does viewing cause eyestrain?

A. Eyestrain is caused by flicker and this is no more evident in a television picture than it is with a cinema picture, in fact the picture frequency is slightly higher with the former. There is, of course, the fact that the picture is small and strain will result if viewed at too great a distance, but under proper conditions no strain will be felt.

Colour Television

Q. Is colour television a probability of the near future?

A. Colour television is theoretically possible and experiments have been made which have given interesting results. There are, however, many practical difficulties and in view of these it appears extremely unlikely that any development can take place for a very long time.

Interference

Q. Is car interference so bad as to mar any enjoyment of the programmes?

A. Only in exceptional circumstances. As a rule it can be almost entirely eliminated or so reduced as to be negligible by suitable disposition of the aerial. The effect on the sound is usually worse than that on the picture.

Guarantees

Q. Television receivers are guaranteed for 12 months. Does this guarantee include both tube and valves?

A. In all cases the tube is guaranteed for 12 months, and as a rule the same guarantee applies to the valves, though some makers only guarantee the latter 3 months. Components are also guaranteed for 12 months, but this does not cover labour charges for the work of replacement.

Picture Size

Q. There has been much criticism of picture size. Is the picture sufficiently large to be viewed in comfort?

(Continued on page 287)

ABC of Television

WHY YOU MAY NOT BE GETTING PERFECT PICTURES

VISION SIGNAL WAVEFORMS

THE designer of a television receiver has a more difficult task than the designer of a radio receiver owing to the special nature of the signal and the necessity for avoiding the least trace of distortion in the various amplifying stages through which it passes.

The definition of "distortion" is a change in shape of a transmitted

frequencies which are a multiple of the fundamental frequency. For example, the wave form of Fig. 1 represents a violin tone when a single pure note is emitted. This wave is actually made up of three waves; one, the fundamental, which is shown immediately below it, then a wave of twice the frequency of the fundamental—the "second harmonic," and finally a wave of three times the frequency—the third harmonic. The shape of the wave is made up by adding the heights of the three components at any given instant. Height "h" is equal to the sum of the heights "a," "b" and "c."

In a complex wave the fundamental is usually the strongest and determines the pitch of the note. The harmonics give the note its characteristic quality or "timbre." It can be imagined that in an instrument like the violin these harmonics would vary from instrument to instrument and no two violins would sound exactly alike. If the height of the third harmonic were increased in the example of Fig. 1 the shape of the wave would be altered as shown by the dotted line, and while the fundamental pitch of the note would remain the same the quality would be different.

When a violin is reproduced through the medium of a radio receiver it is more than likely that the harmonics will undergo alteration, particularly in the higher frequency notes in the treble. Thus the tonal quality of the violin will be altered although the note will still have its characteristic "stringy" tone and will be of the correct pitch.

According to our definition, this is distortion of the note, but the distortion is not sufficient to render the tone unrecognisable as that of a violin. If in the extreme, the value of the harmonics was completely altered, then the note would no longer resemble that of a violin and might sound like an oboe! It will be noted in Fig. 1 that the harmonics bear a definite time relationship to the fundamental, i.e., the third harmonic is nearly at its maximum when the fun-

damental is passing through zero and the fifth harmonic is also at its maximum when the fundamental is passing through zero. If either of the harmonics is displaced in "timing" a different resultant wave will be produced. The time relationship between the waves is known as the "phase" of one with respect to the other, and the shift of the wave is "phase displacement."

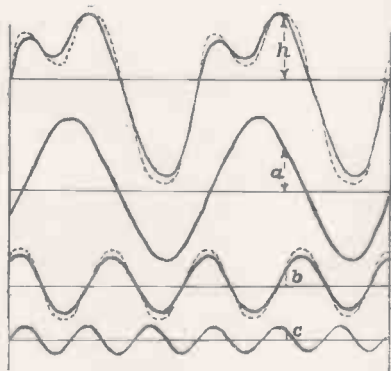

Fig. 1. Waveform of pure violin note.

wave which occurs between any two points in a transmission (or, in our case, receiving) system. It has often been said that there is no such thing as distortionless reproduction in a receiver, and it is a question as to how much distortion is permitted

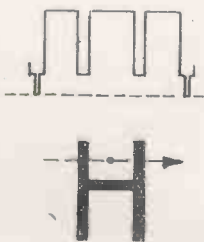

Fig. 2. Letter H and equivalent waveform.

before a noticeable change is made in the quality of speech or music.

We know that musical tones are composed of several frequencies combined to produce a complex wave which is reproduced in sound by the loudspeaker. Such a complex wave may be composed of the fundamental and a given number of harmonics, or

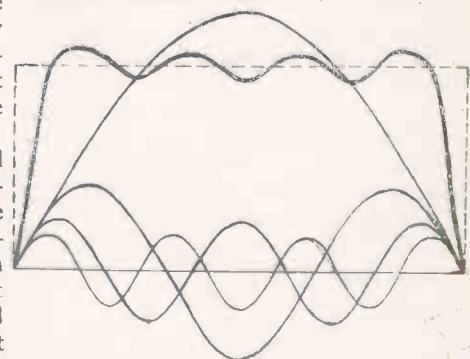

Fig. 3. Harmonics of square-topped wave.

It is thus possible to distort the resultant wave by either an alteration in the amplitude of one or more harmonics or by a displacement in the phase relationship.

Effect of Circuit Components

In all amplifier circuits we have combinations of resistance induc-

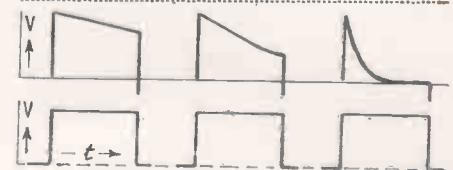

Fig. 4. Effects of different values of capacity and resistance.

tance and capacity. In a resistance, since the current flow obeys Ohm's Law, there is no tendency for voltage variations to be affected by frequency, but with inductances and capacities we have components whose effective resistance is dependent on frequency, for example, the effective resistance of a coil of 1 henry at 1,000 cycles is

SQUARE-TOPPED WAVES

about 6,000 ohms. At 5,000 cycles it is 5 times this value or 30,000 ohms. This means that in an amplifying circuit the effect of the inductance on the fifth harmonic will be five times as great as on the fundamental.

In practice we seldom have to deal with pure inductances and capacities, and their effects are usually modified, but we can draw the general conclusion that the presence of inductance or capacity will distort the applied waveform by its effect on the higher frequency of the harmonics present.

In a typical vision-frequency amplifier the presence of stray capacities will reduce the amplification of the stage as the frequency of the signal rises, and this is one of the difficulties in designing such a stage. The falling off in amplification is usually countered by adding inductance in the circuit, which has the opposite effect. At the same time, care has to be taken that the phase of the harmonics is not appreciably altered or the resulting waveform will be distorted and little overall improvement will result.

Square-topped Waves

In television reproduction we have to deal with a waveform which is seldom found in ordinary sound reproduction, namely, the square-topped wave. The origin of this wave can be seen in the typical example of Fig. 2. Suppose we are reproducing a plain letter such as the "H" shown, against a white background. For the greater part of the time the scanning spot is covering a ground of uniform colour and the signal radiated is of a uniform amplitude. As the spot crosses the vertical bars of the letter the light intensity abruptly falls to "black level" and the steady line representing white level has two dips in it as shown above the letter. This wave form represents only one scanning line and it is repeated for a number of lines until the cross-bar is scanned. The signal thus consists of a number of square-topped waves following each other in rapid succession. In order to reproduce the outline of the H correctly the sharp edges of the wave and the height must be maintained throughout the amplifying stages.

In order to see what may happen to the wave we can first analyse it into its component harmonics. It is a well-known mathematical fact that

any complex wave can be analysed into a fundamental and a series of harmonics, each of which is a pure sine wave. If the square-top wave is analysed it will be found to consist of a fundamental and a series of odd harmonics—the third, fifth, seventh, ninth, and so on to an infinite number. In Fig. 3, one half of a sine

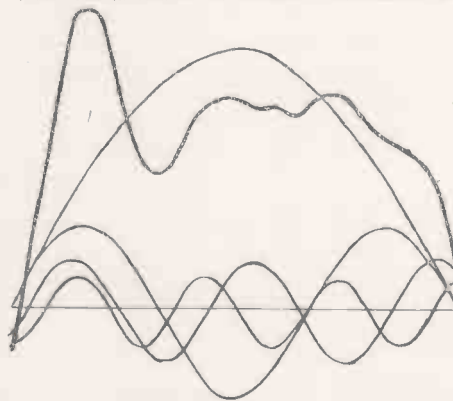

Fig. 5. Effect of alteration of phase in harmonics.

wave has been drawn together with the third, fifth, and seventh harmonics. The amplitudes of these bear a definite relation to the fundamental—the third is $\frac{1}{3}$ rd, the amplitude of the maximum value; the fifth is $\frac{1}{5}$ the maximum and so on. If these harmonics are added to the fundamental in the correct phase relationship the result is the wavy



Fig. 6. Effects of phase distortion on pictures.

curve shown in thicker line at the top of the diagram. This does not appear to resemble the pure square topped wave (shown dotted), but as more and more harmonics are added the ripples become smoothed out and the top approaches the ideal straight line. Theoretically we can make the

addition approach as nearly as we like to the ideal, but practical limitations are imposed by the circuits of the receiver.

For example, suppose the duration of the square topped wave is $\frac{1}{100,000}$ th second. This seems a very short period, but is actually quite long. The duration of one line is $\frac{1}{10,000}$ th sec., and this, therefore, represents $\frac{1}{10}$ th of a line in duration.

On a 12 in. television tube the distance covered by the spot would be approximately an inch! The frequency of the fundamental wave in Fig. 3 to correspond with this would be 50,000 and that of the ninth harmonic 450,000. If the amplifier did not respond to frequencies above 500,000 the harmonics higher than this would be cut off and it would be impossible to reproduce the square-topped wave correctly. As a result the edges of a black object would be blurred and the whole picture would take on a fuzzy appearance.

The case we have just taken is of a comparatively low frequency, and it would be a poor television receiver which did not respond to a frequency of 500,000 cycles. As, however, the duration of the square-topped impulse gets shorter the frequency of the harmonics rises and eventually a very short black portion in the line becomes distorted in the rendering and appears grey.

Effect of Condensers

In considering the handling of square-topped pulses in a receiver, it is interesting to see the effect of the coupling condensers in the amplifying stages. The arrival of a square-topped pulse charges the condenser to a definite value of potential, but if the condenser is connected to a resistance such as a grid leak, the potential will fall due to the discharging of the condenser through the leak. The rate at which this discharge takes place is governed by the product of the capacity and the resistance, and if the condenser is a small one, or if the resistance is low the potential will fall rapidly. The diagram, Fig. 4, illustrates this effect for three different values of capacity and resistance. On the left, a large condenser and high resistance will cause the potential to fall slowly so that at the end

(Continued on page 286)

Scannings and Reflections



ANOTHER U.S. TELEVISION STATION

WLW owned and operated by The Crosley Corporation have applied to the Federal Communications Commission for permission to construct a television station on the 38th floor of the Carew Tower in Cincinnati. The National Broadcasting Company has secured options on three sites for television aerials in Chicago. The necessity of having the aerial located as high as possible has resulted in similar options in other cities throughout the United States being secured.

NEW DUMONT TUBES

Two recent DuMont innovations in cathode-ray tubes are arousing considerable interest in electronic and television circles. First, there is the new egg-shaped bulb which it is claimed provides greatly increased structural strength and therefore a higher safety factor in large tubes, as compared with the conventional straight-sided shape. Risk of breakage, it is contended, is reduced to an absolute minimum with the new type.

The second DuMont innovation is the intensifier type tube which has already been described in these pages. The introduction of one or two gold rings deposited on the inside wall adjacent to the screen, provides for the intensifier electrode which accelerates the electrons *after* deflection. So equipped, the tube gives increased brilliance without corresponding loss in deflection sensitivity. It is claimed that this innovation provides a 60 per cent. increase in deflection sensitivity.

INCREASED RANGE WITHOUT RELAY STATIONS

According to a statement of the Wald Radio & Television Laboratories, Inc., New York City, they hold a patent which will permit the sending of television programmes hundreds of miles by means of "mixed frequencies" without any necessity for costly relay stations.

Another patent the company claims

enables television broadcast to be made with present radio transmitting equipment by utilising the present sound broadcasting wavelengths and enables as many television programmes to be on the air as there are radio broadcasts at present. No technical details are available.

TELEVISION GARDEN LOUNGE AT IDEAL HOMES EXHIBITION

Television is demonstrated daily in the old-world garden-lounge near Philbeach Gardens entrance to the Ideal Home Exhibition, at Earls Court.

At Alexandra Palace transmission-times, visitors can sit at gay tables beneath Continental umbrellas to view reception in 20 of the newest receivers of various types produced by Marconiphone, Ltd. Between these transmissions a newly-produced talking-film "The Miracle of Television" is shown on a cinema back-projection screen set up at the garden-pavilion.

There is therefore television interest at the garden-lounge even outside the television hours of 11 a.m. to noon, 3 p.m. to 4 p.m. and 9 p.m. to 10 p.m.

The garden-lounge is a pleasant, restful spot with a long pergola, shapely bay trees and an illuminated fountain. The television sets demonstrated range in price from 25 to 80 guineas. Nearby the latest radio sets are displayed. The Ideal Home Exhibition will remain open until May 6.

SIR ADRIAN BOULT ON MAY 14

Sir Adrian Boult, the B.B.C.'s Director of Music, has consented to be televised in the series called "The Conductor Speaks" on the afternoon of May 14. Under his direction the B.B.C. Symphony Orchestra of 119 players grew, and is now recognised as one of the finest orchestras in Europe, if not in the world.

When he is televised, Sir Adrian will probably follow the tradition set by Sir Henry Wood, who inaugurated the series on February 11. He will be seen conducting the B.B.C. Television Orchestra of twenty-two players in a rehearsal. After this in-

formal picture of the orchestra and the conductor tackling the overture "Le Roi L'a Dit," by Delibes, Sir Adrian will be seen in close-up for an informal talk on conducting.

The session will conclude with a complete performance of the Delibes overture.

SPECIAL AERIAL FOR C.B.S. TELEVISION

By the time these notes are published the installation of the special television aerial under the burnished needle of the Chrysler Tower will have been completed.

When the Chrysler tower was selected as the future home of CBS television station W₂XAX, Dr. Goldmark, Chief Television Engineer of C.B.S., was confronted with a problem of designing an aerial system suitable to the high location of the transmitter. There, 940 feet above the ground, peculiar wind currents raged summer and winter, and the metal structure of the tower handicapped the electrical design.

Various types of aerial were tested and finally the present horizontal dipole type was decided upon. "Horizontal dipole antennae were chosen," Dr. Goldmark says, "because they offer uniform signal distribution as well as directivity in the vertical plane." Also, they were chosen in conformance with the decision of the R.M.A. Committee which had declared horizontally polarised waves for television signals as standard.

Ultimately there will be sixteen of these special aeriels—eight for sound radiation and eight for visual images. They are being built around that portion of the tower immediately below the needle surmounting it. A distance of less than 100 feet will separate the transmitter from the aerial, thus insuring a minimum of distortion in the transfer of power.

TELEVISION THE DERBY

Conditions permitting, the Derby will be televised on May 24 from start to finish. If visibility is good, it is hoped that viewers will be able to

MORE SCANNINGS

follow the horses from the starting point on one camera until Tattenham Corner is reached, when a second camera will take over to show them approach and pass the winning post.

Cinemas will be permitted, by arrangement with the Epsom Grand Stand Association, to reproduce the B.B.C. television transmission on large screens.

Two television cameras will be erected in the Grand Stand to give a general view of the racecourse, and a third will be mounted on the scanning van near the enclosures. It is hoped to show close-up shots of many typical racecourse characters as the television cameras are slowly "panned" across the "Hill" and racecourse. These pictures will be accompanied by a special television commentary. During the actual race the National commentary will be taken.

Good pictures should be obtained as the horses round Tattenham Corner and come into the finish. It is hoped to show the weighing-in and saddling, and viewers will see close-ups of the owner leading in the winning horse.

It is expected that even better results will be obtained than last year, as the new B.B.C. receiving station at Swain's Lane, Highgate, will be in operation.

FIRE-FIGHTING DISPLAY IN HYDE PARK

Viewers will see a great fire-fighting and A.R.P. display in Hyde Park on June 3, during which a 50 ft. tower will be burnt down and exciting "rescues" will be staged.

The Duke and Duchess of Kent will be present to inspect the four hundred men of the London Fire Brigade who can be spared from their stations, as well as some of the twenty thousand members of the Auxiliary Fire-Fighting Services. The London Fire Brigade is providing 150 vehicles of all types, including engines, trailer pumps, lorries, with 120 A.R.P. appliances.

The B.B.C. mobile television unit will be drawn up on the review ground near Marble Arch to show the whole of the display, which will last one hour.

All the items will be televised and the crowning event will be the burning of the tower. Eight escapes and four ambulances will be involved. Water for the forty-eight trailer

pumps used for the fire-fighting will be taken from canvas pools.

MORE WIRELESS LICENCES

715,825 wireless receiving licences were issued by the Post Office during March, 1939. This figure represents a net increase of 25,208 in the number of licence holders during the month after making allowance for expired licences and renewals.

The approximate total number of licences in force at the end of March, 1939, was 8,968,600 as compared with 8,588,676 at the end of March, 1938, an increase during the year of 379,924.

BRITISH TELEVISION IN U.S.A.

It is probable that Baird big-screen television will be installed in the Roxy and the Embassy cinemas on Broadway, New York.

Complete units have been dispatched and technical experts are accompanying them.

Mr. Isidore Ostrer, chairman of Gaumont-British, said, "We are hoping to offset with cinema and home television some of the huge gains the American talkie equipment manufacturers made when sound films first came to Great Britain."

PRESIDENT ROOSEVELT TO BE TELEVISED

President Roosevelt will appear before the television camera when he gives his address at the opening of the New York World's Fair on April 30. It will be the first time that the President has been televised.

THE BIG SCREEN IN FRANCE

M. Jules Jullien, Minister of Post, Telegraph and Telephone (P.T.T.), formally introduced big-screen television to a large audience at the Marigny Theatre, on the Champs Elysées, Paris, on March 28.

It was announced that, starting on April 15, regular television programmes would be daily transmitted each afternoon and each evening. The programmes will include studio scenes, films, and outdoor transmissions.

After the Minister, M. Jean Perrin, the famous French scientist and physical pioneer, and the well-known French writer Marcel Prevost, spoke of television.

The transmissions which are on 6.52 metres are made from the Eiffel Tower. Although this is the only

transmitter in France, plans are being made for the installation of two others at Lille (North) and Lyons (Centre).

NO BAN ON SUNDAY PLAY

The Postmaster-General was asked last month if he would take steps to prevent the British Broadcasting Corporation televising plays on Sundays, in view of the fact that the living theatre could not perform plays in public on Sundays.

In reply, the Assistant Postmaster-General said the compilation of programmes for both the television and sound broadcasting services is a responsibility of the governors of the British Broadcasting Corporation, and he did not see his way to interfere with their discretion in regard to the inclusion of plays in television programmes on Sundays.

14,000 VIEWERS

D. K. Wolfe Murray, B.B.C. public relations officer for television, stated recently that at present there were 14,000 viewers in the country, and that television sets are selling at the rate of 400 a week, and gave the opinion that television receivers are not affecting sales of radio sets. He had it on the best authority, too, that prices will remain unaltered for a considerable period.

TELEVISION'S OWN GARDEN

Mr. C. H. Middleton is a familiar figure now in that small portion of the Alexandra Park which forms the Television Garden. Plans are being made for a regular series of Saturday afternoon transmissions.

Flowers will be the main attraction this Summer, and during the opening transmission on May 6 the subject will be sweet peas in the different stages of development. The peas have been grown from seed.

The Television Garden is about 300 yards from the studios and cameras connected by cable with the control room can cover the whole garden, including the two small lawns, the rock garden and pool, and the avenue of roses.

£400,000 FOR CINEMA TELEVISION

Intense development of cinema television was foreshadowed by Sir Harry Green, Chairman of Baird Television, Ltd. The occasion was

AND MORE REFLECTIONS

the annual meeting of that company on March 30, when a decision was made to issue £400,000 5 per cent. convertible loan stock.

"All cinemas will install television," he said, "not only in competition among themselves but in self-protection against the home set."

"There is practically no field where television in one form or another will not be required."

Cinema contracts, he added, would keep them busy for the next 18 months.

LAWRENCE OF ARABIA

A television programme dealing with Lawrence of Arabia has been arranged for the evening of April 30.

Touching upon many aspects of the life of this great, and now almost legendary, character, the programme will bring to the television studio some of Lawrence's friends and associates. His amazing variety of activities—the conduct of military operations during the war, life afterwards as a private in the Royal Air Force, experiments with speed boats, literary work, drawing, motor cycling—will be reflected in what will amount to a television "documentary." It is hoped to show photos taken by Lawrence himself in Arabia.

U.S.A. COMMITTEE TO WATCH TELEVISION

A committee has been set up in America by the motion picture industry to watch television development

in relation to the cinema television problems. A survey was made several years ago and this latest inquiry is, therefore, to catch up on recent developments. The chairman is Courtland Smith, formerly head of *Pathe News*, and one-time secretary of the Motion Picture Producers' and Distributors' Association.

P.O. AND MORE TELEVISION STATIONS

Col. Angwin, the new Engineer-in-Chief of the G.P.O., states that the next step will be a system of television transmitters, probably 10 to 20 in number, arranged so as to cover the whole population of Great Britain. Along with this development will come a cheapening of sets, in view of the increase in production, until they are within the reach of the ordinary listener.

MAJOR OPERATION TELEVISED

Recently medical students and nurses in a New York hospital were able to see close-ups of a major operation by means of television equipment. A camera was suspended directly above the operating table and focused on the surgeon's hands. Hospital authorities consider that this is a great improvement on students crowding into a gallery and obtaining only a poor view of the operation.

CINEMAS DEMAND RIGHT TO TELEVISE

The Cinema Retailers' Association, which is seeking permission to use its own transmitting station, are rather concerned that only the start and finish of the Boat Race was broadcast. They claim that had the B.B.C. cooperated with the entertainment bodies they could have placed television cameras in good positions so as to transmit a complete picture of the course.

Mr. Isidore Ostrer, Chairman of Gaumont-British, stated that the Postmaster-General has complete power to give permission for anybody to broadcast and that the cinema trade should be given this permission.

NO TELEVISION FOR CANADA

It is not expected that television stations will be erected in Canada for some time to come. In a statement made by Mr. L. W. Brockington, the Chairman of the Board of Governors of the C.B.C., was mentioned that television broadcasting is not economically suitable in Canada at the moment. Every encouragement is being given to television research, but C.B.C. would prevent exploitation by the premature sale of receiving sets for television. Many problems had to be solved before television could become general in Canada. Transmissions were limited to a range of 30 miles or so and could not be covered over normal wire lines.

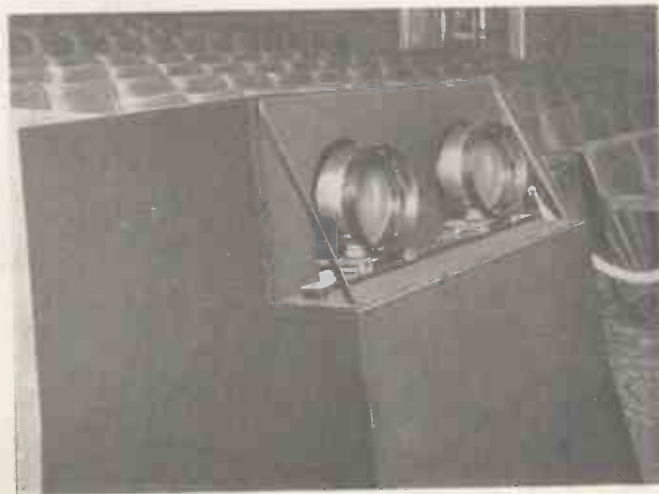
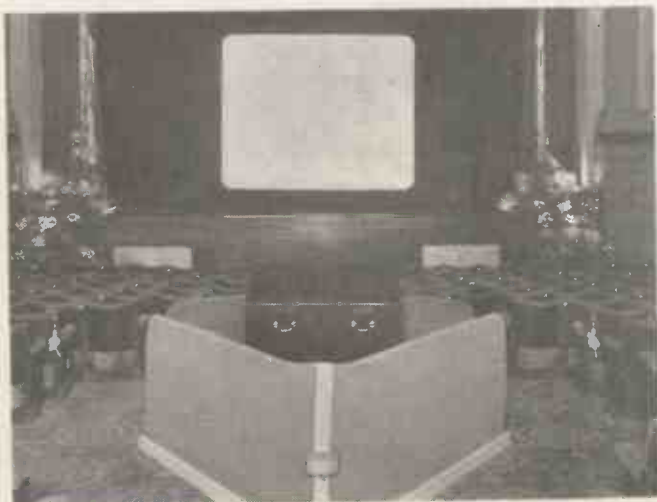

BAIRD BIG-SCREEN EQUIPMENT

The photograph on the left shows the big-screen projector installed in a cinema. On the right is the actual projector which is in duplicate to guard against breakdowns. A full technical description was given in last month's issue.

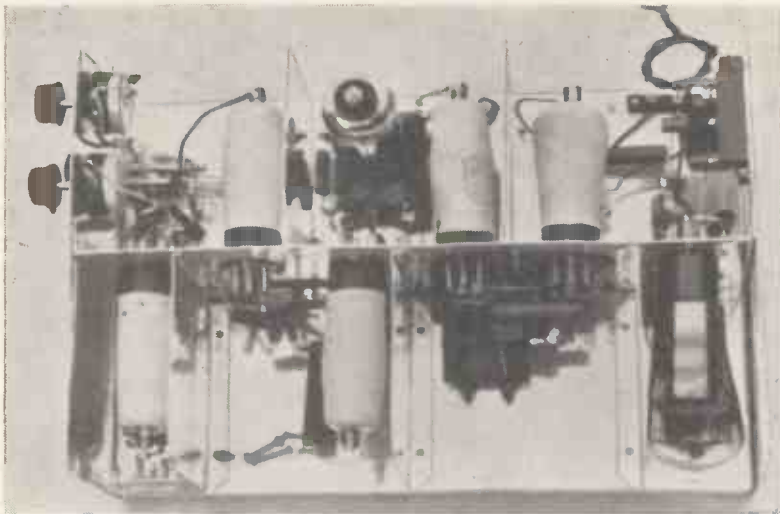

In preceding issues the construction details of a simple mechanical-optical television receiver have been given. This was an experimental type designed to show that amateur construction of a mechanical receiver is quite possible. The present article describes the vision receiver for use in conjunction with the mechanical gear and it will form the basis for further developments by which it is hoped to simplify the construction of the complete receiver.

RECEIVER FOR MECHANICAL TELEVISION

By J. H. Jeffree

LAST month the theoretical considerations involved in the design of a receiver for mechanical optical television were discussed, and it is now possible to deal with the actual construction which is more simple than the cathode-ray counterpart.

The chassis is built up from sheet aluminium, the various parts being fastened together with 6 B.A. screws and nuts. A diagram of the complete chassis is introduced together with dimensioned drawings of the various parts of which it is made up. It will be observed that the various compartments are numbered, and the following information relates to these references. The circuit diagram was given last month and in order to assist constructors photographs showing the component assembly in the various compartments are given.

Compartment 1 contains the first valve and the aerial coil, the ends of the coupling coil being soldered to two pins of a chassis type V holder and the earthy end of the main coil to a tag on the chassis.

Compartment 2 contains the frequency changer, and its tuning grid circuit, the inductance being 3 turns of number 18 tinned copper wire, one inch diameter, spaced 1/10-in. and soldered direct to tags on the 30 uuF. tuning condenser. A lead from the cathode pin in compartment 3 passes through a hole in the partition to compartment 2 and via R5 and C5 in parallel to a point two-thirds of a turn

from the earthy end (connected to the condenser rotor) on the grid coil.

This compartment contains also R2, the contrast control, and R23, the black level control. The lead to the latter from the oscillator cathode in compartment 6 is screened, the screening being earthed, as is also the resistor screen. It is the only wire under the base. R2 should increase and R23 decrease when turned left-handed.

Compartment 3 contains the first I.F. circuit and V3. The inductance L3 is sufficiently supported by R8, which is connected to a tag on the outermost partition screw, and C7.

Compartment 4 contains the second I.F. coupling and the two detectors with L4, L5 and their associated components. The sound detector has a

baseboard type valve holder, to save unnecessary under-base wiring: this holder should be mounted on a card to avoid risk of short circuits to the base. The sound output is taken via C13 to an insulated terminal on the base in this compartment, with an earthed terminal by it for the return lead. The I.F. circuit is arranged similarly to that in the third compartment.

Compartment 5 contains the vision detector (V4) and V.F. stage (V6) bases, with the 1 uF. condensers 14, 17 by-passing their screens. This compartment contains also C18, L7 and C20; L7 is three turns in the heater lead, about 3/4-in. diameter, just before it passes into compartment 6.

Compartment 6 contains the oscillator arrangement and V6 with its

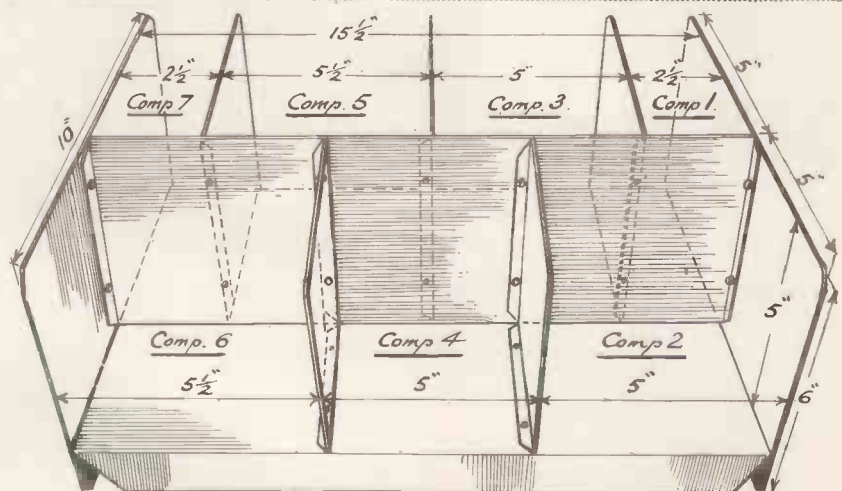

Perspective view of chassis showing construction and principal dimensions.



Compartment 1. Aerial circuit (L1) and V1.

plate circuit, R19 and C16, and the grid choke L6. The oscillator coil is as shown in the drawing L8, the coupling coil of two turns, being wound over it near the tapping, where



Compartment 4. Both detectors (V4 and V5) and L4, L5.

it is at low potential. This coupling should be of properly insulated flex: the coil is of number 22 S.W.G. D.C.C. wire. It is tuned by the compression type condenser, C22, on which it is mounted. From the sixth turn end a lead goes through the partition to the screen terminal of V7.

Further to be noted is L9 in the coupling leads to the light relay. The leads are coiled together, each making $1\frac{1}{2}$ turns, producing a 3-turn coil, $1\frac{1}{4}$ -in. diameter which gives the desired band-pass effect. Except here, the leads are twisted. We may deal here also with the second inductance, L10, of this circuit which is as shown and is mounted on the light relay

itself. If crystals of other than 10 Mcs frequency are used, this inductance should have more or less turns than stated, in inverse proportion to the crystal frequency, but fitted into the same space. It is tuned by a 30 μ F trimmer, and the coupling round it is 3 turns, in the middle.

Compartment 6 also contains the remaining condensers C19, C21 and R22, of the harmonic blocking circuit.



Compartment 2. Frequency changer (V2) and controls (L2, R3 and R23, etc.).

R22 diverges from R19 underneath V6. The heater and plate terminals of V7 and V8 are in parallel. The H.T. and heater supplies are taken to the two terminals on the saddle at the edge of compartment 6, a third, un-insulated, terminal providing for both return leads.



Compartment 5. Bases of V4, V6.

In the photograph, the cathode of V8 is connected directly to earth: but with the valve specified a 2,000-ohm resistor, R25, should be included, otherwise the minimum oscillation will be too great. If, however, an old and inefficient H.L. type mains

triode is available for use here it should be tried, without a cathode resistor: an efficient valve is not really needed.

It is only necessary to add that wiring should be kept short rather than "neat," and the supply leads are better kept close to the chassis.

The set consumes a trifle over 60 mA. at 250 volts, so a standard H.T. unit of this rating will serve to run it. Filament supplies of 8 amps. at 4 volts are, however, necessary. Apart from this a standard design of power pack is adequate.

Sound signals ought to be obtainable on first switching on, and the only adjustments needed should consist in tuning the light relay and oscillator circuits, alternately, till maxi-



Compartment 3. L.F. stage (V3) and L3

imum effect on the light is produced. For this adjustment it is best to turn the contrast control to minimum (i.e. maximum resistance), and the



Compartment 6. Oscillator circuits, L3, L8, etc., and V6.

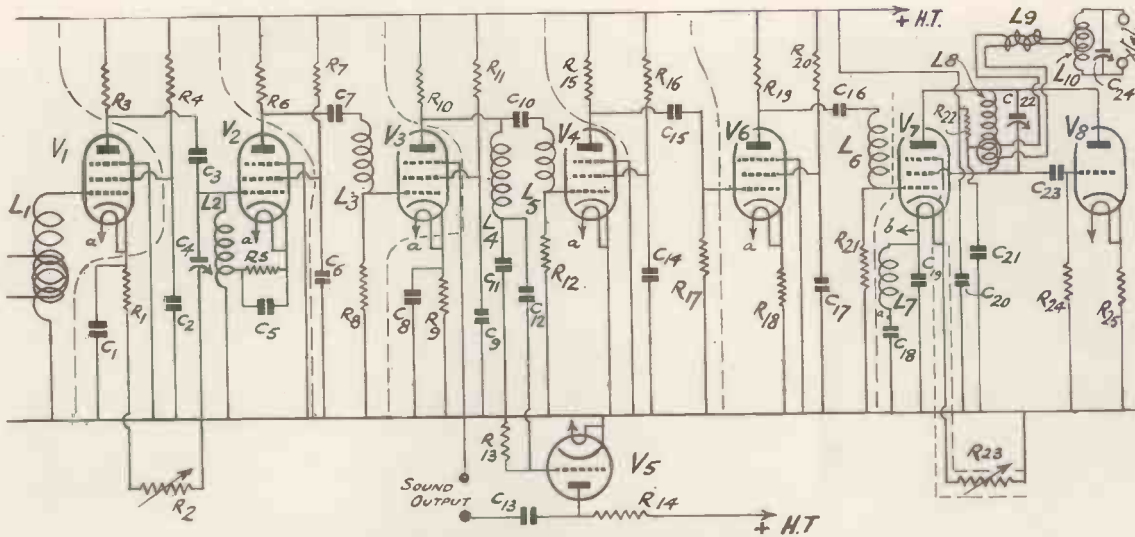

The complete circuit of the radio receiver for mechanical television.

brightness level to zero resistance. The tuning is then adjusted to receive the sound, on its channel, and a picture free from moving horizontal bands (sound interference).

In last month's issue the sound I.F. of this receiver was misprinted in

not, so far, to have been called to account. The statement that a band-pass circuit will oscillate at the midpoint of the frequency response curve is only correct when the coupling is less than critical; otherwise, while this is a theoretically possible point

of oscillation, there are two more favourable points, near the two peaks of the band pass, at one of which it will in practice oscillate. The circuit given, however, is effective which is in part probably due to the reaction of the crystal on the circuits, which makes the simple analysis in any case not rigorous. It is also convenient as permitting a low voltage coupling.

It appears equally satisfactory, as regards this coupling to the crystal, to loop it not over the middle of inductance L8, as shown in the illustrations, but over the coil former outside the 6-turn end of the coil. It can then conveniently be slipped off when desired. When this is done, the lessened coupling thus secured renders unnecessary the 3-turn coil

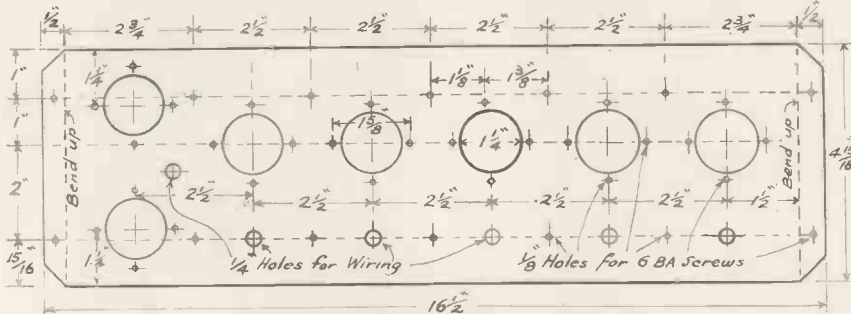

Central partition; drilling diagram.

places as 3.25 mc/s. It is, of course, a quarter of a megacycle, the vision I.F. being either 3.25 or 3.75 mc/s, according to the tuning condenser setting.

There was also a more serious error for which the author is relieved

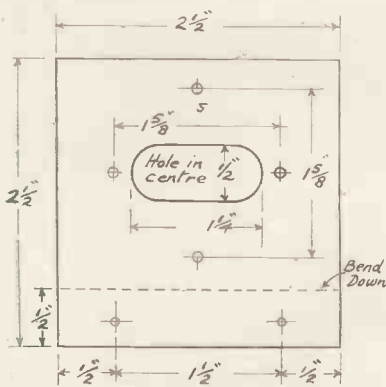

Aerial coil panel.

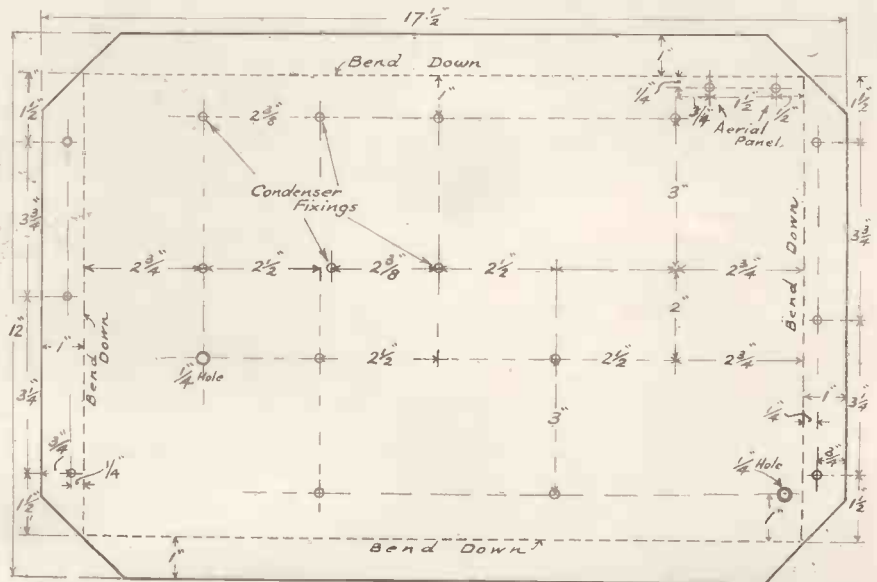

Base: drilling diagram, 1/8-in. holes for 6 BA screws. Two 1/4-in. holes for screened oscillator cathode lead. Two extra 1/8-in. holes in condensers in comp. 5.



Light Relay with L10 attached.

formed in the coupling leads themselves, which then become simple twisted flex. The number of turns at the L8 end, however, is better made three, in this case, instead of two; three, that is, at each end of the coupling. Those at the light relay end (L10) should still be wound round the middle of the coil as shown.

Three turn loop inductance (L9) in coupling leads to light relay.

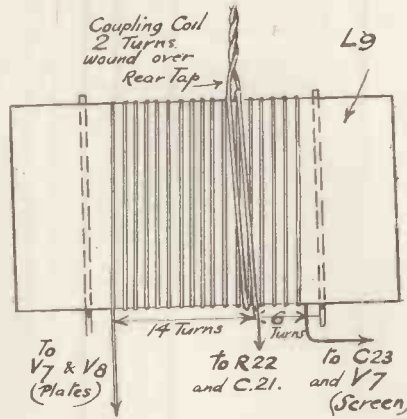
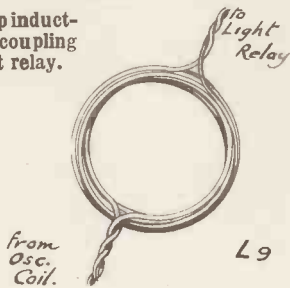

Oscillator inductance (L8) with coupling coil wound over it.

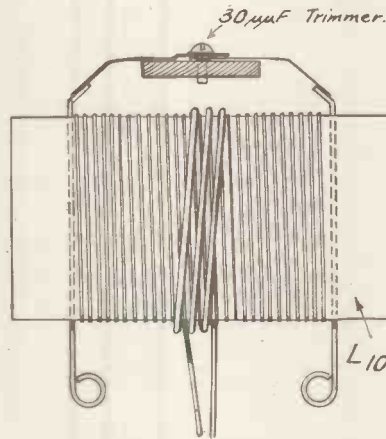

Light relay inductance L10.

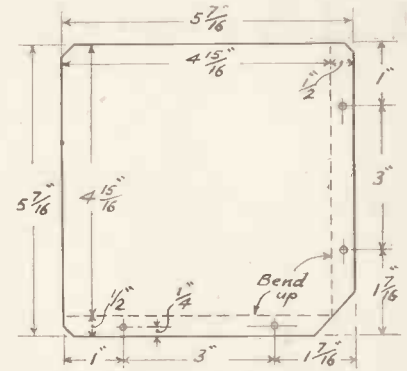

The five transverse partitions.

220 Turns No 36 S.W.G. Enam. in 2" or 1/2" Former



The I.F. coupling inductances (L3, L5)

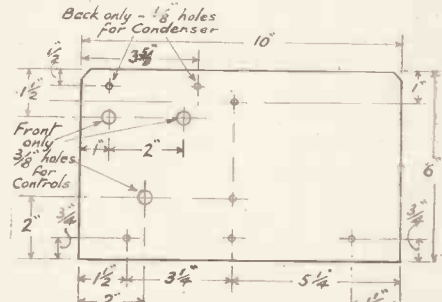

Front and back panels. Fixing holes 1/8 in. for 6BA screws.

Components for Mechanical-optical Receiver

RESISTORS.

- R1— 100 ohms 1 watt (Premier).
- 2— 10,000 ohms small wire-wound volume control (Bulgin) VC46.
- 3— 9,000 ohms 1 watt (Premier).
- 4— 100,000 ohms 1 watt "
- 5— 250 ohms 1 watt "
- 6— 9,000 ohms 1 watt "
- 7— 100,000 ohms 1 watt "
- 8— 4,000 ohms 1 watt "
- 9— 100 ohms 1 watt "
- 10— 9,000 ohms 1 watt "
- 11— 100,000 ohms 1 watt "
- 12— 9,000 ohms 1 watt "
- 13— 250,000 ohms 1 watt "
- 14— 50,000 ohms 1 watt "
- 15— 100,000 ohms 1 watt "
- 16— 250,000 ohms 1 watt "
- 17— 4,000 ohms 1 watt "
- 18— 250 ohms 1 watt "
- 19— 5,000 ohms 1 watt "
- 20— 100,000 ohms 1 watt "
- 21— 500,000 ohms 1 watt "
- 22— 100 ohms 1 watt "
- 23— 5,000 ohms small wire-wound volume control (Bulgin) VC44.
- 24— 4,000 ohms 1 watt (Premier)
- 25— 2,000 ohms 1 watt " (see text)

CONDENSERS.

- C1— .0001 tubular (Premier)
- 2— .0001 tubular "
- 3— .0001 tubular "

- 4— 30 uuF variable, JB 2141.
- 5— .0001 tubular (Premier).
- 6— .001 tubular "
- 7— .001 tubular "
- 8— .01 tubular "
- 9— .001 tubular "
- 10— .000030 mica (T.C.C.)
- 11— .0003 tubular (Premier).
- 12— .0003 tubular "
- 13— .025 tubular "
- 14— 1uF (T.C.C.).
- 15— 0.1 tubular (Premier).
- 16— 0.1 tubular "
- 17— 1uF (T.C.C.).
- 18— 0.1 tubular "
- 19— 0.1 tubular "
- 20— 0.1 tubular "
- 21— 0.1 tubular "
- 22— .000100 compression type F (Premier).
- 23— .000100 tubular "
- 24— 30uF trimmer (Bulgin) S.W.95.

VALVE HOLDERS.

- 5— 7-pin chassis mounting type (Premier).
- 3— 5-pin chassis mounting type "
- 1— 5-pin baseboard mounting type "

SUNDRIES.

5 valve thimbles (Bulgin); solder tags; pushback flex; 18-gauge tinned copper wire; 1/2 gross 6BA screws and nuts; 18-ins. screened cable (Premier); 18-gauge A.C.

sheet 18 x 36 ins.; terminal saddle (Premier); 2 4BA terminals; 1 insulated terminal (Premier).

COIL FORMERS.

- 1— 3/8 in.
- 2— 1/2 in. 2 1/2 in. long.
- 2— 1 in. 2 in. long.

INDUCTANCES.

- L1— (See text).
- 2— (See text).
- 3— (See drawing).
- 4— S.W. pie-wound choke 1350 uH (Premier).
- 5— (See drawing).
- 6— S.W. pie-wound choke 1350 uH (Premier).
- 7— (See text).
- 8— (See drawing).
- 9— (See drawing).
- 10— (See drawing).

VALVES.

- V1— AC/SP3 Mazda).
- 2— AC/SP3 "
- 3— AC/SP3 "
- 4— AC/SP3 "
- 5— AC/HL "
- 6— AC/S2Pen "
- 7— AC/Pen " (5 pin base)
- 8— A.C./H.L. " (see text).

TELEVISION PICTURE FAULTS AND THEIR REMEDIES—VI

By S. West

This concluding instalment of the series deals with interlacing

THE question of ensuring good interlacing of the lines is a somewhat difficult one. It is necessary fully to understand what is demanded of the system to ensure that correct interlacing is possible and perhaps the most important point to realise is that the framing pulses for odd and even frames are identical and occur at a regular rate. That is to say the interlace is not effected by having the pulses for odd and even frames occurring in some irregular manner, as is often thought; it is essential that these occur with extreme regularity, the interlace being due to the fractional relationship between the line and frame frequency.

To make this perfectly plain, consider a picture of five lines. If the frame frequency is 25 per second then the line frequency is $5 \times 25 = 125$ per sec., and the system is a straightforward sequential scanning one, i.e., it is not interlaced. Supposing that the frame frequency is now doubled retaining the original line frequency of 125 per sec., then it is obvious that only $2\frac{1}{2}$ lines occur during each frame, the system being an interlaced one, for alternate sets of lines are spaced by a half line and must therefore be interpolated one set with the other. But the frame frequency is entirely regular. In short, any system in which the number of lines is an odd number so that a fractional relationship exists between the frame and the line frequency is necessarily an interlaced one.

From the foregoing it is apparent that the principal requirement for ensuring interlacing is extremely regular operation of the frame time base and everything possible should be done to render the frame time base stable in operation. Secondly, the sync. filter section and the pulse application network should be capable of providing pulses accurately corresponding in time with the transmitted pulses.

Constant Amplitude

Also it is extremely important to ensure that the amplitude of the pulses is constant irrespective of the modulation depth. If this is not ensured, interlace will not result, even though the timing be perfect, for the change in amplitude of the pulse will move the odd lines in relation to the even lines, or vice-versa and will result, in mild cases, in pairing of the lines or more severely, in a complete lack of interlace. Also in the case of an integrator network the timing will naturally be affected for the change in amplitude will result in the necessary voltage being reached at varying times.

In addition to these precautions adequate H.T. smoothing is necessary and care taken to avoid induced mains hum to the grids of the sync. separator and the blocking oscillator. Adequate precautions must also be taken to remove all trace of the line sync. pulses. Two simple methods for ascertaining whether or no correct interlacing exists are applicable. The best of these is to open up the scan in the vertical direction to permit readily an examination of the line formation. The other plan is to allow the eyes to travel

from bottom to top of the screen when, if interlacing is being effected, the picture will temporarily appear coarse, the lines being plainly visible.

In concluding this series it is probably just as essential to show what constitutes good picture reproduction, as to show faults that have already appeared.

The writer's receiving station is located 100 miles from the transmitter thus rendering it a somewhat difficult task to secure a picture such as is possible with carefully designed apparatus in regions of high field strength. Actually, it is surprising what extraordinary definition can be secured when full use of the frequencies transmitted by Alexandra Palace is made. This was very apparent whilst testing some apparatus, in which every effort had been made to secure adequate frequency response, within 12 miles of the transmitter. Any effort expended in ensuring maximum use of the frequency spectrum transmitted is amply repaid because of this enormous improvement in definition.

It seems desirable in locations where an adequate signal exists to aim at a level response extending considerably in excess of the conventional 2 mcs. and a continual improvement appears to be secured up to 3 mcs.

Despite this difficulty of securing photographs that will accurately show what can be achieved the two photographs Figs. 7 and 8 were shown last month. Fig. 7 is the type of picture which reveals the even illumination resulting from an accurate D.C. control and also is of value for checking the presence of phase and frequency distortion. Fig. 8 is the familiar caption that generally precedes normal programme transmissions. This picture is of particular value for a great deal of information is provided by examining the appearance of this upon the screen. It is perhaps a pity that the B.B.C. do not transmit this pattern for longer periods for the final adjustments of a vision receiver are greatly facilitated employing this modulation. Alternatively, there is no doubt that a carefully designed pattern transmitted for, say 15 minutes prior to the programme, would be greatly appreciated. Adverting to Fig. 8 the following points should be examined. For the B.B.C. indicated with the letter A, the black outline of these letters should be clearly and definitely rendered, both the leading and following edges of the outline being sharply and cleanly defined. The pattern at the centre, indicated with arrows, should be a perfect circle; when this is so the picture proportions are correct. The serrated strip pattern along the base of the caption provides a reliable indication of the response to the very high (vision) frequencies. The very narrow serrations in this strip, indicated with the letter B should be accurately and plainly rendered.

It is perhaps needless to add that the overall screen illumination should be quite even, with an absence of shadows or high-lights. If all these points enumerated above are satisfied one can be reasonably well content with the performance of the equipment as a whole.

RECENT TELEVISION DEVELOPMENTS

A RECORD
OF
PATENTS AND PROGRESS
Specially Compiled for this Journal

Fernseh Akt. :: A. C. Cossor Ltd., E. E. Shelton and B. C. Fleming-Williams :: O. Klemperer ::
Radio Akt. D. S. Loewe :: Baird Television Ltd., V. A. Jones and K. A. R. Samson.

Producing Television Signals
(Patent No. 498,304.)

THE figure shows an electron-multiplier adapted for use as a television transmitter. Light to be modulated is projected through a

made to vary in accordance with the intensity of the applied light-rays. The part of the electrode C₁ to the right of the aperture is coated with a highly-emissive substance, whilst the part to the left is not.—*Fernseh Akt.*

mouth of the dished depression in the grid, to that of the aperture through which the electron stream passes, should preferably be four to one, whilst the depth of the depression should be about half its width.—

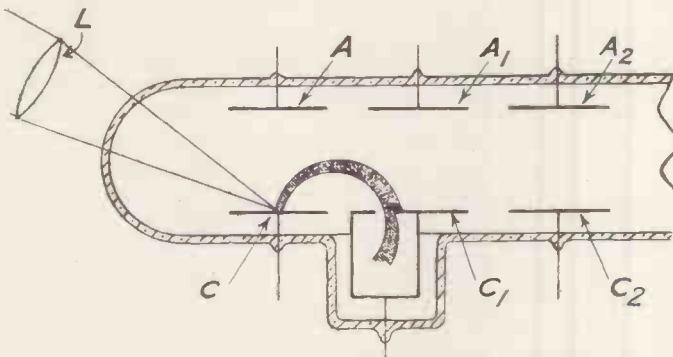

Transmitter tube employing secondary emission. Patent No. 498,304.

lens L on to a photo-electric cathode C, and the liberated electrons are forced by the combined action of the electrostatic field from the upper electrodes A, A₁, A₂, and a transverse magnetic field from an external winding (not shown), to pass through the tube in a series of "hops" from C to C₁, and then to C₂, and so on.

The magnetic field is varied at carrier-wave frequency, and its effect is to control the length of the first

Obtaining scanning component by reflection. Patent No. 498511.

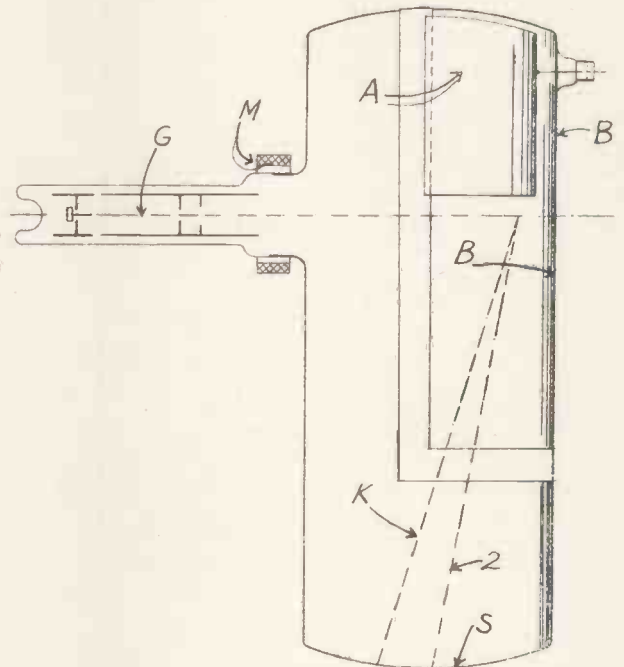

Cathode-Ray Tubes
(Patent No. 498,484.)

A. C. Cossor, Ltd.; E. E. Shelton; and B. C. Fleming-Williams.

The Figure shows the electrode arrangement of a cathode-ray tube, the distinctive feature being the fact that the highest operating-voltage is applied to the first anode A. When this is of the order of 1,000 volts, the beam current is effectively controlled by varying the potential of the "dished" grid G from zero to 30 volts negative to the cathode C.

Deflecting The Stream
(Patent No. 498,511.)

Instead of using a pair of deflecting plates for moving the electron stream to and fro over the fluorescent screen of a cathode-ray tube, the scanning movement is obtained by means of reflection. For instance as shown in the Figure, the stream from the gun G passes in a straight line towards a pair of cylindrical electrodes A and B, set parallel to the walls of the tube. The electrode marked B is preferably a thin metal coating formed on the glass. Each electrode carries a biasing voltage so that the resultant electrostatic field

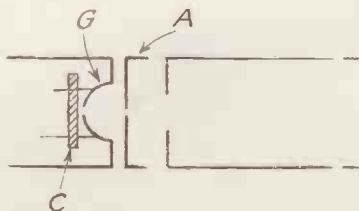

Cathode-ray tube for obtaining high value of beam current. Patent No. 498,484.

"hop" so that, as shown in the Figure, more or less of the electron stream passes through an aperture in the first electrode C₁ into a Faraday cage, where it is effectively removed from the main stream. In this way, the strength of the output current is

The advantage of the arrangement is that (1) an unusually-high value of beam current is obtained for a given solid angle of divergence, and (2) a low degree of aberration is found to be present when the beam is subjected to electron-optical control. The ratio of the diameter of the upper part or

The information and illustrations on this page are given with permission of the Controller of H.M. Stationery Office.

forms an equi-potential surface inside the tube.

When the oncoming electron stream reaches the field, it is first slowed up, and then reflected from the equi-potential surface in the direction of the dotted line marked K towards the fluorescent screen S. If now the potential on the electrode B is varied at scanning frequency, the inclination of the equi-potential surface will also be altered, so that the direction of the reflected stream is now along the dotted line marked 2. In this way one scanning component is obtained by reflection, the other component being applied through a coil M at the end of the narrow part of the tube.—O. Klempever.

Line Synchronising Signals
(Patent No. 498,841.)

An inclined mirror is arranged to reflect the scanning ray, at the end of each line traverse, on to an auxiliary photo-electric cell, which is coupled to its amplifier in the reverse fashion to that in which the main photo-electric cell (handling the picture signals) is coupled to the picture amplifier. In this way the passage of the reflected ray of light across the auxiliary cell is made to produce a synchronising-impulse of opposite polarity to that of the picture signals.

For instance, if the anode of the main P.E. cell is connected to the grid of its amplifier, the cathode of the auxiliary P.E. cell must be connected to the grid of the second amplifier in order to ensure the required phase-reversal. A tangential slot formed in the scanning disc, just outside the area scanned by the spiral apertures, is used to generate the framing-impulses.—Radio Akt. D. S. Loewe.

A " Back-coupled " Light Cell
(Patent No. 499,661.)

A photo-sensitive cathode covers one half of the cell, and a fluorescent screen is laid over the opposite wall. An amplifier of the electron-multiplier type is arranged midway between the two, and in line with a transparent screen or partition which divides the cell into two halves.

The operation of the cell is as follows: When a ray of light falls on to the cathode, electrons are liberated and are attracted by the electron-multiplier. Here they are subjected to intense amplification by secondary emission. On leaving the multiplier, the electrons fall upon the fluorescent screen where they produce the usual glowing light.

The light so produced is radiated

across to the photo-electric cathode, where it helps to increase the original electron emission. The final output therefore depends upon a " feedback " effect between the fluorescent screen and the photo-electric cathode, in addition to the intensifying action of the electron multiplier.—Fernseh Akt.

Light-sensitive Screens
(Patent No. 499,785.)

In some television systems the light produced by a stream of electrons on a fluorescent screen is projected from that screen on to a second screen, say, of the mosaic-cell type, so as to form an " image " made up of electric charges. The latter are then discharged by a scanning-ray, and are used to produce a brighter picture than usual. Difficulties, however, arise in securing an efficient transfer of the light energy from the fluorescent screen on to the mosaic cell screen, and the object of the invention is to overcome them.

For this purpose, a compound screen is used, consisting of a large number of small glass rods arranged in parallel. One end of each rod is coated with fluorescent material. The other end is coated with light-sensitive material, and forms part of the mosaic screen. The fluorescent light is thus transferred through each rod by internal reflection, and so saves a great deal of the loss by dispersion which would otherwise occur.—Baird Television, Ltd.; V. A. Jones, and K. A. R. Samson.

Projection Tubes
(Patent No. 499,815.)

Relates to a cathode-ray tube of the projection type, which is capable of producing, on a screen four centimetres square, an image in which each luminous spot one-tenth of a millimetre in diameter has a brightness of approximately 10 candle-power. Such a picture is capable of very considerable optical magnification without serious loss of detail.

The increased light-intensity is produced by passing the electron stream, in its final stages, through a series of ring electrodes which carry progressively-increasing biasing voltages up to, say, 15,000 volts. The voltages are supplied from a series of potentiometer-resistances which are connected in parallel to each quadrant of each ring. In order to avoid distortion, the current through the potentiometer system must be considerably greater than the discharge current of electrons through

the tube. For instance, if the beam current is half a milliamp, the potentiometer current used to supply the accelerating voltages for the stream should represent approximately 30 watts.—Radio Akt. D. S. Loewe.

Summary of Other Television Patents

(Patent No. 498,566.)

Electron-multiplier in which a separate cloud of electrons are made to oscillate to and from a secondary-emission electrode.—Farnsworth Television Inc.

(Patent No. 498,672.)

Method of preparing mosaic-cell electrodes on a backing-plate made by cutting sections from a bundle of fine wires.—Radio Akt. D. S. Loewe.

(Patent No. 498,703.)

Construction and arrangement of the electrode system of an electron-multiplier.—The General Electric Company, Ltd., and A. E. McLeod.

(Patent No. 498,816.)

Light modulator comprising a piezo-electric crystal which is energised by a high-frequency source at carrier-frequency.—S. Sokoloff.

(Patent No. 498,824.)

Television tube in which the control electrode is subjected to a scanning-stream of constant intensity and also to a " flooding " beam of electrons.—Baird Television, Ltd., and P. W. Willans.

(Patent No. 498,945.)

Means for preventing distortion due to the unequal illumination of different lines in an interlaced scanning system.—The General Electric Co., Ltd., and D. C. Espley.

(Patent No. 499,132.)

Band-filter coupling for a television amplifier giving a uniform cut-off at both ends of the response curve.—Radio Akt. D. S. Loewe.

(Patent No. 499,532.)

Cathode-ray tube in which the evaporation of metallic particles from the cathode is prevented.—The General Electric Company, Ltd., and J. G. Hobday.

(Patent No. 499,425.)

Preventing the radiation of undesirable signal components from the detector to the other stages of a television receiver.—The General Electric Company, Ltd., and D. C. Espley.

(Patent No. 499,828.)

Preventing the formation of undesirable space-charges over the surface of the mosaic screen in a television transmitting-tube.—Baird Television, Ltd., and T. M. C. Lancø.

MAY, 1939

Telegossip

A Causerie of Fact, Comment and Criticism

By L. Marsland Gander

THE radio manufacturers' campaign to persuade the Government to authorise a Birmingham transmitter is fully justified because the Television Advisory Committee has not clearly indicated its intention of pushing on with the scheme without further delay. I believe that at most the committee is only "sympathetic."

Plans for a provincial station should be approved immediately. At present it seems that the Television Advisory Committee intends to await the outcome of lengthy and leisurely experiments with the radio links between London and Birmingham. Yet E.M.I. must be satisfied with the efficiency of their ultra-short wave relay equipment developed with such secrecy at Hayes. They should be able to convince the Post Office that the relays will work.

If they can do so there is no reason why the construction of Birmingham station and of the two intermediate relays should not begin simultaneously. Otherwise it will be the end of 1940 and possibly the end of 1941 before that much discussed provincial station comes into action.

Two relay stations were ordered by the Post Office about a month ago, and delivery is subject to the priority given at Hayes to rearmament orders. One of these is to be situated on a site not yet chosen in the Chilterns, and the second will be about forty miles distant near Daventry. The Chilterns reach their highest point near Wendover at a height of 828 feet, and it is as good a guess as any that the station will be somewhere in the neighbourhood where there is good reception from Alexandra Palace and an unobstructed view towards the north-west.

I hear from a well-informed source that it will be nine months and perhaps a year before the issue of these experiments can be known. Are we to wait till then before there is any decision on the more important subject of a Birmingham station?

A newspaper interview with Col. A. S. Angwin, the newly appointed Chief Engineer, put the whole matter in a new light. He declared that the Post Office was ready for the next step, a nation-wide network of ten or fifteen television transmitters. This

is something infinitely more ambitious than the solitary provincial station which is the heart's desire of the Radio Manufacturers' Association.

But his statement suggests that the Post Office will take its time over the experiments with radio link and coaxial cable until they are thoroughly satisfied with the results, then prepare a comprehensive scheme. My own view is that officialdom would do well to think at the moment in less futuristic terms and to concentrate on the more practicable and more modest request of the Radio Manufacturers' Association.

At the moment television development on the transmitting side is virtually at a standstill. There has been no progress whatever with the scheme for conversion of the theatre at Alexandra Palace. The one ray of hope is the distinct possibility that television will not be overlooked in the Post Office estimates.

America Forging Ahead

But in the meantime everything points to the probability that Britain's long two years' lead will be lost to America. By the time these words appear the N.B.C. transmitter on top of the Empire State Building, New York, will be in action. Soon afterwards Columbia's R.C.A. transmitter on the Chrysler building will be on the air. If these stations are a success, others will spring up in every big town of America. In New York there are at present about 200 television receivers compared with 14,000 in the London area. But it is expected that the American public will be eager purchasers of sets ranging in price from £40 to £90, with a screen measuring 10 inches by 7½ inches. I was surprised that the American manufacturers have not plumped for bigger tubes, but they declare that this size "represents a happy medium of utility and price factors."

Both N.B.C. and Columbia expect that their television programmes will be sponsored by advertisers and have done a great deal of spade-work with the commercial interests, but curiously enough the Federal Communications Commission has not yet licensed any television broadcasting station to operate commercially.

Television Director in U.S.A.

Mr. Gerald Cock, the B.B.C. Television Director, will probably take part himself in the inaugural programmes from the N.B.C. station to the World's Fair. He slipped out of London very quietly on his American trip and will only be away for about a month altogether. I hear that his biggest idea is to fly to Hollywood and make some arrangements with the film Rajahs to bring back material for television.

He is no stranger to California. Strange to say, he was once the owner of a ranch on land now cut across by the famous Sunset Boulevard, but history does not reveal whether he made a fortune therefrom or whether he sold out before the boom.

Mr. D. H. Munro, who leaves for America in the *Georgic* on May 4, will be away for six weeks, and his place at Alexandra Palace will be temporarily taken by Mr. Pat Hillyard.

I hear a strong rumour that Mr. Val Gielgud is to take television drama under his cloak. The story originates in a plan for Broadcasting House to exchange producers with Alexandra Palace next autumn. Eventually, I suppose, Mr. Gielgud will take over all drama productions whether on sound or vision, but that will not happen for some time, perhaps years.

The Questionnaire

The B.B.C. has finished an analysis of about 25 per cent. of the completed questionnaires sent in by viewers. Programme preferences are established in the following order:

1. Plays, with a strong vote for full length productions.
2. "Picture Page."
3. News Reels.
4. Outside Broadcasts.

There was a good deal of support for light entertainment of all kinds. Musical features were not popular; even ballet had more of a following. In answer to the question whether men or women announcers were preferred, the answers were very flattering to Miss Jasmine Bligh and Miss Elizabeth Cowell for they favoured maintaining the status quo.

THE TELEVISION ENGINEER

AERIAL FEEDERS FOR TELEVISION

LONG FEEDERS FOR TRANSMITTING WIDE SIDEBANDS

By E. C. Cork, B.Sc.(Eng.), and J. L. Pawsey, Ph.D.

The following is an abstract of a paper read before The Institution of Electrical Engineers entitled "Long Feeders for Transmitting Wide Side-bands With Reference to the Alexandra Palace Aerial-feeder System." We acknowledge the kind permission of The Institution of Electrical Engineers to publish this paper.

IN order to obtain the wide sidebands required in the Alexandra Palace installation, it was necessary to arrange that the final output circuit of the transmitter should be heavily damped. The damping is due to the losses in the valves and

of 1/100th of the picture width. A sharp edge would be followed by similar striae. Various forms of this distortion were observed in the early experiments at Hayes.

In order to estimate the accuracy of the termination required to avoid objectionable distortion, consider the transmission of a picture containing an abrupt transition from white to black, involving a sudden transition from full carrier to, say, zero carrier. If the final value is not zero the discussion is complicated by interference between the existing steady wave and the distorting waves to be described, but is otherwise unmodified.

Let the transmitter T (see Fig. 1) be of high impedance so that substantially perfect reflection takes place at T of any wave arriving from the direction of the aerial A. During the transmission of the white portion of the picture the aerial current will be due to the resultant of the direct wave, of voltage V_0 , initiated by the transmitter, and, if the aerial does not exactly terminate the feeder a steady reflected wave V_s reflected from A and T in succession. Higher-order reflected waves will be neglected, since they must be of smaller magnitude than the first and it will be shown that the first must be made negligible to avoid distortion.

If l is the length of the feeder and c the velocity of the wave in the feeder, then at a time l/c after the stoppage of the transmitter the voltage of the aerial due to V_0 falls to zero, but that due to V_s persists a further time $2l/c$. This gives rise to a "step" in the decay of aerial current as indicated in Fig. 2. The relative height of the "step," if V_s is small, is given by the reflection coefficient $(Z_a - Z_0)/(Z_a + Z_0)$, where Z_a and Z_0 are respectively the terminating and characteristic impedance of the feeder.

If the aerial is a resonant system then a further important factor must be taken into account. On the sudden decay of impressed volts from $(V_0 + V_s)$ to V_s the aerial current

will not fall instantaneously to the new steady state but will decay with a period and damping determined by the constants of the aerial. This effect would be much less important but for the fact that during the decay the aerial transfers part of its stored

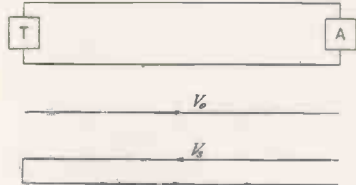

Fig. 1.

circuits, together with the power supplied to the aerial. The damping due to the losses is small, and the major part is supplied by the aerial feeder system. This involves a large mismatch at the transmitter end of the feeder.

On account of the extremely low loss of the feeder and the high degree of mismatch at the transmitter end,

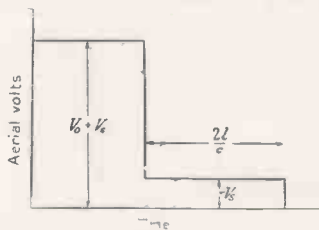

Fig. 2.

a wave, if reflected from the aerial end, passes to the transmitter and arrives again at the aerial scarcely diminished in amplitude, but delayed by twice the time of travel along the feeder.

This time delay is about 1μ sec., during which time the scanning spot on the receiver screen will have travelled 1/100th of the width of the screen, a distance equal to that occupied by about 5 lines in the vertical direction. If the picture contains a thin vertical line it is obvious that reflections will give rise to distortion consisting of "echo" lines displaced from the original image at intervals

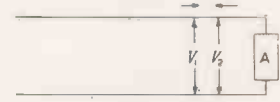
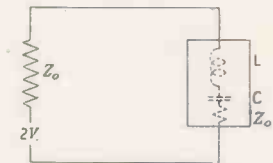

Fig. 3(a).



Figs. 3a and 3b.

energy to the feeder, originating a wave which arrives back at the aerial after a delay of $2l/c$ and causes a further short burst of aerial current.

The delayed burst of aerial current

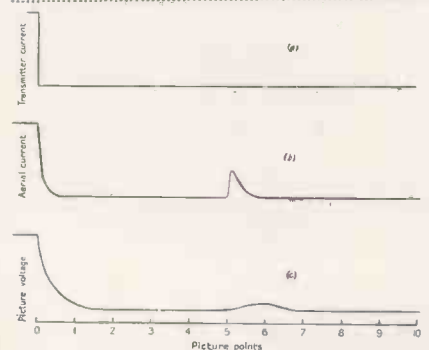

Fig. 4. (a) Transmitter current (envelope). (b) Aerial current (envelope). (c) Receiver picture wave-form.

when acting on a receiver would tend to produce a picture voltage of reduced relative amplitude and extended duration on account of the selective circuits of the receiver. The effects would be the smaller the less the duration of the impulse. Fig. 4(c) shows in a qualitative manner the received picture wave-form on an idealised receiver.

An estimate by Fourier methods of

the amplitude of the disturbance in the picture wave-form due to the delayed burst of aerial current of Fig. 4(b), assuming an idealised receiver with a pass band of $\pm 2\text{Mc./sec.}$ gave a value of about 10% of the preceding steady voltage and indicated that for further increases in the decrement the amplitude would vary inversely as the decrement.

Though this analysis has con-

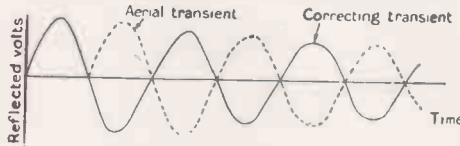

Fig. 5.

sidered the special case of a simple tuned circuit, a similar argument would appear to apply to other forms of resonant aerials.

To reduce the magnitude of the effect the aerial may be made to have a sufficiently high decrement by some means such as the employment of thick conductors, and also a certain amount of correction may be performed by inserting additional circuits which contribute transients in anti-phase to the original transient. A simple form of this latter arrangement in the case of the aerial circuit discussed would consist of a series tuned circuit of the same L and C as the aerial, inserted in series with the feeder at one-quarter wavelength from the aerial. The resulting waves reflected down the feeder are indicated in Fig. 5, and it is apparent that the second circuit may effect a

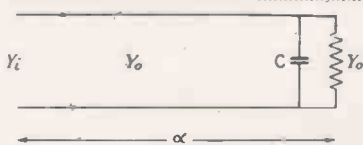

Fig. 6.

substantial degree of cancellation. It is obviously desirable that the two points of reflection in the feeder should be as close together as possible in order that as few half-cycles as possible may remain uncanceled.

Beyond the stage at which the effect of the first transient is over before the arrival of the second no cancellation can be accomplished, but this limit to the distance which may separate the points of reflection is fixed not by the duration of the aerial transient itself, but by the duration of the effect on the final receiver circuit, since two completely isolated transients incident in succession on the receiver in appropriate

phases may produce a resultant less than that due to either alone.

Impedance Irregularities in the Feeder

In a completed aerial and feeder system the impedance at the transmitter is a function of the aerial impedance, together with any impedance irregularities which may occur along the length. Mechanical considerations require the provision of bends, joints, insulators, etc., any one of which may cause an impedance irregularity of appreciable magnitude.

Consider a single insulator in an otherwise uniform and correctly terminated feeder as shown in Fig. 6. If the insulator is substantially free from loss the admittance A introduced by its presence is equal to $j\omega C$, where C is the capacitance introduced and the input admittance is given by

$$Y_i = Y_0 + j\omega C e^{-2j\alpha}$$

and the conductance by

$$G_i = Y_0 + \omega C \sin \frac{4\pi f l}{c} \quad 1$$

The insulator therefore produces a sinusoidal variation of G_i with frequency. In the case under consideration ωC is much less than Y_0 , and the inverse of the conductance, i.e., the parallel resistance R_i is given very nearly by

$$R_i = Z_0 - \omega C Z_0^2 \sin \frac{4\pi f l}{c} \quad 2$$

The magnitude of C for various insulators considered ranged from 0.2 to $2\mu\mu\text{F}$, giving at 45 Mc./sec., for the type of feeder used, a fluctuation in R_i of from 0.5% to 5%, so that the effect of even a single insulator was large.

Equation (2) is important because it enables the magnitude and location of a capacitive impedance irregularity to be determined from measurements of the input resistance of the terminated feeder over a frequency range. Fig. 7 illustrates a possible curve of input resistance against frequency. Since it is sinusoidal it may be inferred that the impedance irregularities are restricted to a small length of feeder and so are probably due to a single cause. The "periodic interval" of the oscillation ($f_1 - f_2$) locates the irregularity at a distance of $c/[2(f_2 - f_1)]$ from the input end, and an inspection of the feeder in this vicinity should show the cause.

If this cause is assumed to be local excess capacitance, which is common, it is possible to locate it accurately without precise frequency

measurement by means of the phase of the resistance oscillation. Inspection of equation (2) shows that the frequencies at which R_i increases through the mean value are those for which the electrical lengths of the feeder to the point are odd multiples of a quarter-wavelength. Let the feeder be short-circuited in the vicinity of the capacitive irregularity, and the frequencies observed at

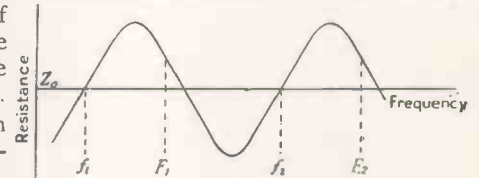

Fig. 7.

which the short-circuited feeder is an odd multiple of a quarter-wavelength. If these frequencies are F_1 and F_2 , etc. (see Fig. 7) then the electrical length to the short-circuited point is less than that to the irregularity by

$$\left(\frac{F_1 - f_2}{f_2 - f_1} \right) \frac{\lambda}{2} = \frac{n\lambda}{2}$$

where n is any integer. It is assumed that the measurement of the "periodic interval" is sufficiently accurate to determine n . Since it may be assumed that the velocity down the feeder is that of light, the physical position of the irregularity is thus located.

Matching Aerial to Feeder

The problem of matching the aerial, which is a resonant system whose impedance varies with fre-

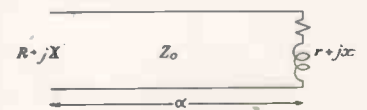

Fig. 8.

quency, to the feeder presents greater difficulty than those so far discussed. If the aerial is matched at the mid-frequency the deviations of impedance may cause a serious mismatch at the side-band frequencies.

In the Alexandra Palace system a transformer was provided to transform the aerial impedance to that of the feeder at the mid-frequency, and means were also provided to cancel partially these residual mismatches. Measurements of the aerial impedance, which was complex and about one-quarter of the characteristic impedance of the feeder, showed

that both the resistive and reactive components varied with frequency.

Considerations of the possibility of simultaneously annulling the reactance and matching to the feeder at the mid-frequency led to the adoption of a transformer section of feeder, the principle of which is described below. Consider the arrangement in Fig. 8, where $Z_i = R + jX$ is the input impedance when the feeder is terminated by the impedance $Z_a = r + jx$. Then

$$Z_i = Z_0 \left\{ \frac{Z_a \cos \alpha + jZ_0 \sin \alpha}{Z_0 \cos \alpha + jZ_a \sin \alpha} \right\} \quad (3)$$

Separating equation (17) into its real and imaginary components and eliminating α , it can be shown that

$$R^2 + X^2 + Z_0^2 - R \frac{r^2 + x^2 + Z_0^2}{r} = 0 \quad (4)$$

Assuming, therefore, that we desire to transform to a given pure resistance R , we obtain, on putting $X = 0$,

$$Z_0^2 = Rr \left\{ 1 - \frac{x^2}{r(R-r)} \right\} \quad (5)$$

given the required value for Z_0 . We also obtain, by substitution in equation (17),

$$\tan 2\alpha = \frac{-2xZ_0}{Z_0^2 - r^2 - x^2} \quad (6)$$

We have therefore determined the constants of a feeder which, when connected in series with the aerial, transforms its impedance at one frequency to a given pure resistance. The operation of the feeder is somewhat similar to that of a $\frac{1}{4}$ -wavelength transformer, transforming from a low resistance r to a high resistance R . Owing to the fact that it is terminated by a resistance with a small positive reactance, there is a length of feeder slightly shorter than a $\frac{1}{4}$ wavelength for which the input impedance is resistive. Further, because it is a considerably mismatched feeder it would, if terminated with a constant impedance, show a varying input reactance over the frequency range. This variation, in the case of the Alexandra Palace aerial, opposes that due to the change of the aerial reactance. In consequence the device tends to cancel the overall reactance of the aerial and to leave a substantially pure but varying resistance. For this reason, and on account of its simplicity, it was decided to make use of this type of transformer.

Further to reduce the effect of the residual reflections at the side-band frequencies due to the variation of impedance with frequency after trans-

formation, a method was adopted of deliberately introducing an irregularity at a chosen point in the feeder which would contribute a reflected wave in anti-phase to that due to the residual mismatch. The choice of the point of insertion and the nature of the irregularity to be inserted depends on the following considerations. To avoid loss of power it is desirable that the inserted irregularity should be purely reactive. Further, it is necessary that the inserted irregularity should have no effect at the frequency at which the aerial is matched to the feeder. In consequence a tuned circuit of low loss suggests itself as the possible form to be adopted.

A parallel tuned circuit across the line would have a positive reactance

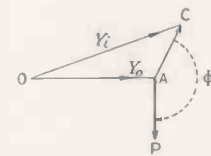

Fig. 9.

at frequencies below the resonance and vice versa. If, therefore, a point on the feeder exists at which the parallel resistance of the feeder terminated by the aerial transformer section is constant, accompanied by a parallel reactance equal but opposite in sign to that of a tuned circuit, the connection of the tuned circuit across this point would cancel the reactance and leave a constant resistance. In this method deviations of the aerial impedance are transformed by the feeder to variations of reactance, which are then neutralised without loss of power by a tuned circuit of appropriate selectivity.

Consider a feeder, matched to the aerial at a frequency f_0 , the characteristic admittance of which is represented by the vector OA of Fig. 9. Let the deviation of aerial admittance at a frequency f_1 be represented by the line AC, then a length α of feeder can be chosen for which the input conductance is equal to Y_0 and the susceptance is negative, being given by AP (see Fig. 9). This requires that $2\phi = 2n\pi + \alpha$, where n is any integer and ϕ is indicated in the figure. If f_1 is greater than f_0 a tuned circuit resonant to f_0 can be found having a positive susceptance at f_1 of magnitude AP. In a similar manner, for a frequency f_2 equally below f_0 another series of lengths of feeder exist, having a conductance

equal to Y_0 and a positive susceptance.

This susceptance could be neutralised by the same tuned circuit if the deviation of admittance from Y_0 were equal to that at f_1 . Since the electrical length of the feeder varies with frequency it is usually possible to find a physical length of feeder at the end of which a suitable tuned circuit would annul the susceptance at both frequencies.

Impedance Measuring Technique

Special forms of impedance-measuring gear were devised, since at these frequencies considerable difficulty is experienced with the appreciable reactance of even the shortest leads, the large effect of small stray capacitances, and the lack of reliable standard resistances. One form was self-contained and portable and capable of measuring resistance and reactance over a wide range of values of impedance and frequency. A second form was designed to attach to the end of the feeder, and was capable of measuring small deviations of resistance from a fixed value.

In both forms the impedance to be measured is placed in parallel across a tuned circuit which is coupled to an oscillator and has a diode voltmeter across the condenser. The circuit is tuned by means of the condenser, and the diode volts are noted. A resistance is then substituted in place of the unknown impedance of such a value as to give the same diode volts when the circuit is retuned. The resistance is equal to the parallel resistance of the impedance, and the change in capacitance of the resonant circuit measures the parallel reactance. The apparatus is enclosed in a copper case to which one side of the tuned circuit is connected.

The portable gear (see Fig. 10a) comprised a variable frequency oscillator followed by an amplifying and isolating stage, the anode of which was tuned. To this tuned circuit the measuring circuit was inductively coupled, provision being made to switch coils in parallel with the measuring circuit in order to change the point of tuning on the condenser. An Isolantite low-loss 150- $\mu\mu\text{F}$ condenser calibrated at low frequencies was used as the measuring condenser.

A method of measuring the residual inductance was devised, so that the equivalent values of the capacitance

at high frequencies were known. The method consisted in noting the apparent value of a small fixed condenser placed in the measuring cups at various points over the range of the variable condenser. The condenser setting for resonance was varied by placing other fixed reactances in

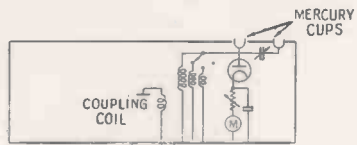

Fig. 10a. Portable impedance gear.

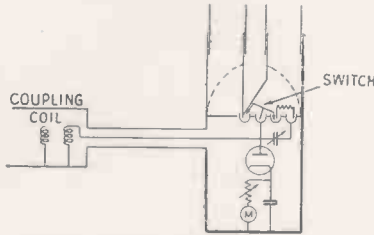

Fig. 10b. Feeder measuring gear.

parallel across the tuned circuit. From the variation of these apparent values the effective inductance of the condenser was calculated and the equivalent capacitances at high frequencies were deduced. Across the tuned circuit a diode voltmeter of variable sensitivity was connected. Mercury cups were provided as terminals, and leads to the case and the terminals were made as thick and short as possible. The apparatus was mains operated.

The feeder-measuring gear (see Fig. 10b) was adapted for measur-

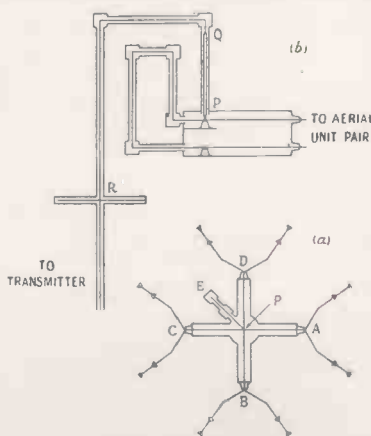

Fig. 11. Arrangement of aerial and feeder connections.

ing accurately small changes in the feeder input resistance. The lay-out of the measuring tuned circuit was modified to reduce the length of feeder connecting leads to a minimum. The inductance of the tuned

measuring circuit was formed of a pick-up coil and a suitable length of screened connecting cable so that the oscillator could be removed to a distance of a few feet.

A box containing the measuring condenser, the diode, and its associated circuits, was clamped on to the end of the feeder and so arranged that a short sleeve over the inner of the feeder could be slipped down into a mercury pool. A switch of the rocking type was provided, connected to the live terminal of the condenser and dipping either into the mercury pool or into a second pool, provided to permit the bridging of a suitable resistance to the case. This switch, on account of its finite inductance, introduced a small error into the measured impedance so that this gear could only be used for the comparison of substantially equal resistances. The diode voltmeter was arranged as before but with the addition of a circuit for backing off the steady d.c. diode current and the provision of a suitable galvanometer to obtain enhanced sensitivity.

The accuracy of the frequency calibration is of considerable importance as the measured variation of resistance with frequency has a period of the order of 1 Mc./sec. If, therefore, we wish to insert an irregularity to compensate for an observed error, it is necessary to know the frequency to an accuracy of about 0.05 Mc./sec., in order accurately to locate the point of insertion from the phase of the oscillation of the input resistance.

The oscillator was arranged to have a very open scale, and the calibration was obtained from the transmitter frequency (45 Mc./sec.) and by short-circuiting the feeder at a distant point and measuring the $\frac{1}{4}$ -wavelength frequencies which gave known frequency differences.

Vision System at Alexandra Palace

The radiating system finally adopted consisted of two rings of full-wave dipoles with the mast in the centre as illustrated diagrammatically in Fig. 11, in which Fig. 11(a) is a plan view and Fig. 11(b) a false section along the line APE. It is seen that the main feeder is brought to a central point P from which radiate lines to the various aerial units. The change from the unbalanced feeder to the balanced aerial system is accomplished by means of a half-wave phase-reversing loop. From the point P (Fig. 11), the point of connection

of the feeder to the aerial, a transforming section of approximately $\frac{1}{4}$ wavelength is used to transform the complex aerial impedance to the characteristic impedance of the feeder at the carrier frequency. Beyond this point the main feeder with normal inner conductor runs 450 ft. to the

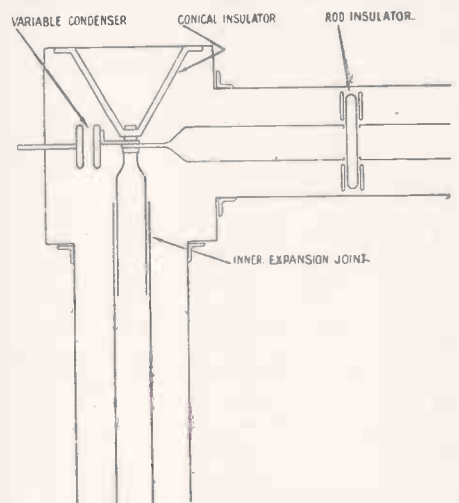

Fig. 12. Arrangement of angle box.

transmitter. A correcting circuit is inserted in parallel with the feeder at approximately 60 ft. from P to reduce the mismatch at the side-band frequencies, and at the transmitter a $\frac{1}{8}$ -wavelength transformer is used to transform the characteristic impedance to 50 Ω , which is more suitable for loading the transmitter.

The Feeder

The main vision feeder runs from the vision aerial platform vertically down to the base of the steel mast, to which it is bonded throughout its length. It passes to the outside of the supporting tower, vertically down to the colonnade, and then about 100 ft. horizontally to a change-over box in the wall of the sound transmitter room. From this box two equal

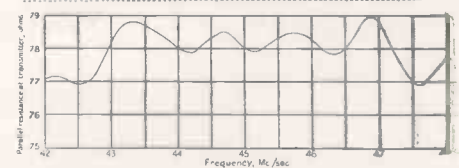

Fig. 13. Impedance, frequency characteristic of the Alexandra Palace vision feeder, terminated with Z_0 4 ft. below R (Fig. 26).

branches lead to the two vision transmitters originally installed in Alexandra Palace. The sound feeder runs beside the vision feeder. Both feeders are laid with as few bends as

(Continued on page 287.)

Our Readers' Views

Correspondence is invited. The Editor does not necessarily agree with views expressed by readers which are published on this page.

Television Transmissions

SIR,

It is generally understood that high-definition television cannot be radiated on longer wavelengths than at present used.

For many years I have been considering the matter from a theoretical standpoint, but I cannot obtain particulars of practical experiments which prove that it is so. I wrote to the Television Advisory Committee last December, suggesting that the assumed difficulties of radiating television transmissions on comparatively long wavelengths may be purely theoretical—but no reply has been received.

If it is a fact that high-definition television can be radiated on considerably longer wavelengths than at present, it would be a simple solution of the question of covering the whole country; and also the receiving apparatus would be more simplified, and less liable to instability. I am aware that this is impossible in theory—but is it impossible in fact?

D'ARCY FORD (Exeter).

Mechanical-optical Television

SIR,

I would like to congratulate you on publishing a description of the Sound and Vision Receiver for Mechanical and Optical Television Reception by J. H. Jeffree.

Since this appeared in April, I have obtained an advance receiver made by H. G. Sanders & Co., which I have installed in Kensington and obtain very powerful reception with an indoor di-pole aerial in any position.

I have the usual trouble from motor-car interference which I hope to overcome when correct aerial arrangements are made.

The receiver is very compact and well laid out and should be of great use to the experimenter in mechanical and optical television.

CEDRIC OUTHWAITE.

London, W.14.

Running the Crystal Oscillator

SIR,

We beg to be allowed the use of a little of your valuable space, to mention one or two points which we believe affect most of the amateur transmitters of this country.

In our opinion, the use of a fuse-

bulb in series with the crystal is of the nature of a "snare and delusion." We base our opinion on the fact that the majority of crystal failures are due to sudden increases of power in the crystal circuit to a value greater than the crystal can stand. Of these, the majority occur at the instant of switching plate supply to the oscillator. In these cases, the amplitude of crystal oscillations is built up to an intolerable value in about ten cycles of the crystal's oscillation. That is to say, within about a millionth of a second, the crystal may be beyond recall. No fuse will blow in this time, whilst even if a hundredth of a second were allowed instead of a millionth, few fuses are good enough to blow at less than ten times their rated current.

Our second point is the tendency to run crystal-oscillators at voltages vastly in excess of that required fully to excite the next stage. A recent example is that of using a 6V6G tritret at Va-350 to drive another 6V6G as neutralised P.A. at the same voltage. Why? We should regret being forced to think that the average amateur is too ignorant to appreciate the fact that, e.g., in the above case, 150 volts would have fully driven the next stage. Is it carelessness? Many amateurs like to use the minimum number of R.F. stages in their transmitters . . . we like to do so ourselves, at G₂CR, but we submit that crystals are too expensive to warrant "economy" by running them at their limit to save using another valve, costing about six shillings. The difference in current consumption between a high power tritret and a low power crystal oscillator and buffer-doubler is negligible.

Finally, when using crystals, it is well to remember that the crystal frequency given on the certificate is the frequency produced when the crystal is used under the exact conditions specified and that changing from a '47 straight pentode to a 6L6 tritret, or running the crystal warm or with a holder different from that in which the crystal is tested, will tend to change the oscillatory frequency and these effects may be additive and be sufficient to put the final frequency outside the band.

In this connection, it is worth while to consider possible retroaction of the

final stage on the crystal oscillator, especially if the output frequency is the same as the crystal fundamental. It is wise, therefore, to have at least one stage of frequency doubling when using any of the higher frequency bands. This confers the additional benefit that crystals can be made to rather better accuracy and reliability for the two low-frequency bands than for the 40 or 20 metre bands, and the crystals are, invariably, more robust. Think, therefore, whether it might not be worth while to use another low power doubler, or low power tritret and gain in stability, safety, and reliability, eliminating that slow, steady creep which is so annoying to anyone using a crystal-gate super on the higher frequencies.

In conclusion, we are ready, and feel that other makers of crystals in this country are also ready, to offer any assistance in their power to any amateur who cares to write, especially if he or she cares to reduce the work by enclosing a stamped, addressed envelope.

RADIO CONSTRUCTION SERVICE
(Newcastle-on-Tyne).

"WHY YOU MAY NOT BE GETTING PERFECT PICTURES"

(Continued from page 270)

of the square-topped impulse the voltage V is very little below the maximum value. Decreasing the value of resistance or capacity causes the voltage to fall more rapidly as in the centre diagram, while on the right, a very small capacity and resistance will cause an immediate discharge of the condenser. Again, translating this effect in terms of light and shade, a small condenser - resistance combination will cause a black bar to shade off rapidly into grey or, a white bar to do the same.

We can finally see the effect of alteration of phase in the various harmonics in the wave. In Fig. 5 the same series of harmonics is drawn as in Fig. 3, but this time they have been shifted in phase as they increase in frequency. The third harmonic is in the same phase as before, but the fifth and the seventh have been displaced in time along the axis. The resultant is shown in the thick line, which has now developed a "hump" at the commencement followed by a dip. If we imagine that this curve takes the place of the wave shown in Fig. 2 it will be seen that a dip downwards in the "black" direction will be followed by a peak which will be greater in amplitude

than the normal flat-topped curve. Translating this in terms of light and shade, we shall obtain a black line followed by an overswing to the white, making the white shade brighter than it should be. This effect is frequently seen on television amplifiers which suffer from phase distortion—black clothes are outlined by a vivid white margin and black letters have a white edge which gives them the appearance of being solid.

The photograph of Fig. 6 shows how phase distortion appears in letters. The black centre of the "O" is followed by an increase in the white portion which stands out.

The eye is so critical to defects in the reproduced picture that it will detect a phase displacement of only a half-millionth of a second on a medium-sized tube!

"AERIAL FEEDERS FOR TELEVISION"

(Continued from page 285)

possible, and those which do occur are right-angle bends in the form of angle boxes.

The feeders consist of concentric copper pipes of 5 in. and 1½ in. diameter, respectively. The characteristic impedance of such a feeder if air-spaced would be 78Ω and the attenuation 1 neper in 4.8 miles. The inner conductor is located by means of steatite low-capacitance insulators in the form of rods passing through the inner and having sleeves slipped over the ends of the rods of such a length as to centralise the inner (see Fig. 12). The rods are ¾ in. diameter and the sleeves 1¼ in. long. The insulators were spaced at equal intervals of ¼ wavelength at 45 Mc./sec. alternatively at right angles, and ferrules were sweated into the holes in the inner to act as guides for the rods and to increase the bearing surfaces. The capacitance introduced by one insulator was 0.4μF, and the reduction of characteristic impedance was 0.35Ω.

The type of angle box used is shown in Fig. 12. It consists of an approximately cubic brass box containing a large conical insulator and a variable condenser in the form of a disc on the end of a threaded spindle. The same Figure shows an inner expansion joint located at the box.

The feeder was laid from the transmitter end, and at the conclusion of suitable sections, usually at an angle box, the feeder was terminated and the variation of input resistance with frequency measured. The final curve of resistance against frequency for the 390 ft. up to the point of insertion of the tuned circuit is shown in Fig. 13. It will be seen that the variation

between 43 and 47 Mc./sec. was not greater than ± 0.5Ω.

At the transmitter end the arrangement transforming the characteristic impedance to 50Ω consisted of a condenser formed by a short length of open-circuited feeder branching from the main feeder about ¼ wavelength from the transmitter.

The design of the aerial transformer is based on the measurements of the impedance between the point P (Fig. 11) and the case. For this purpose a ¼ wavelength at 45 Mc./sec. of normal feeder was connected to the point P and the impedance over a range of frequencies was measured by means of the portable impedance gear. The impedances at P at the various frequencies were deduced from these measurements.

In accordance with the principles discussed a transforming length of feeder with normal outer but 2 9/16 in. diameter inner conductor and 4 ft. 6 in. long was inserted to transform the impedance at 45 Mc./sec. to the 78Ω of the feeder. The impedance is resistive and matched to the feeder at 45 Mc./sec., but there is a substantial variation at the side-band frequencies.

"QUESTIONS VIEWERS ASK"

(Continued from page 268)

A. This criticism arose when many demonstrations were being given in public to audiences of fifty or a hundred. Under these conditions the picture is too small, but receivers are intended for home use and under these conditions the picture size is adequate, in fact the most popular screen size for the home is 10 in. by 8 in.

Location

Q. Is reception possible in all areas?

A. Within a radius of about 35 miles from the transmitter there is no difficulty. At distances in excess of this differences in different areas are noticeable, but a test demonstration can always be arranged.

D.C. Mains

Q. Can a television receiver be used on D.C. mains or with batteries?

A. D.C. mains involve the use of an additional piece of apparatus—that is, a rotary convertor for converting the direct current into alternating current. The use of batteries is quite impracticable, some sort of power supply being essential.

Mirrors and Lenses

We have received from Messrs. Gowllands Limited, of Morland Road, Croydon, Surrey, a copy of a

leaflet giving particulars of their products, which include all types of mirrors and lenses. The extremely wide range covers mirrors for dental, surgical, photographic and scientific instrument trades, galvanometers, reflex, projection and other special types.

Also, bi-convex, bi-concave, plano convex, plano concave, spherical or cylindrical lenses

Lists will be sent on application and mention of this journal.

Television Lectures: Summer Course.

For the fifth year in succession a course of lectures is being given on "Recent Development in Television" on Thursday evenings at 7.30 p.m., till the end of June, at The Borough Polytechnic Borough Road, S.E.1.

This course will be helpful to students intending to study the subject next session as well as interesting others already acquainted with the subject. The lecturer is Mr. J. J. Denton, The fee is 5s. for the course.

The New Spring Callbook

Supplies are now available of the new Spring Callbook which is priced at 6s. post free, from the agent, F. L. Postlethwaite, G5KA, of 41 Kinfauns Road, Goodmayes, Ilford, Essex. This new edition is fully up to date including all G4's. Despite the rapid changes in countries in Central Europe, these are now corrected and countries which no longer exist, as separate entities, have been allocated their new call signs.

Any amateur interested in Dx. or the listening station who needs all the latest call signs and addresses should make a point of obtaining a copy of this new Callbook.

A limited number of the Winter number are still available, price 4s., and these are still valuable despite the fact that one or two of the G4's, etc., are not listed.

The 40-Metre Amateur Band

Two new B.B.C. short-wave transmitters are going to be operated in the 40-metre amateur band. Station GSV will operate on 7249 Kc., and GSW on 7260 Kc. Both these stations are intended for Indian service and will have an input of 100 kilowatts. Amateurs are advised to purchase crystals well clear of these two frequencies for interference to B.B.C. transmissions, despite the fact that they are in amateur bands, will not be tolerated.

Introducing

THE NEW HALLCRAFTERS SKYRIDER



Some years ago, in the wee small hours following a typical ham feast, several well-known amateurs and communications engineers sat around a smoke-filled room discussing the ideal communications receiver. Each had his own pet ideas, but, strangely enough for radio engineers, they were all agreed on several basic principles.

Returning to Chicago, two of the Hallicrafters engineers started to build this ideal receiver as a separate private project of their own, purely experimental. As it grew and passed through several changes and modifications, it became the "pet" of the laboratory.

At the time, there was no thought of making this a Hallicrafters model, although its performance was brilliant. The limitations in the technique of parts manufacture, then prevailing, made it entirely impractical from a production standpoint. But there it stood, its sparkling performance a constant challenge.

In the meantime several things happened. The manufacturing technique for radio parts made tremendous strides in a relatively short time. Much that was impractical is now perfectly feasible. Simpler methods were discovered for accomplishing certain purposes with even better efficiency. Suddenly we discovered that our theoretically "ideal" but "impractical" receiver no longer belonged in that category. It could be built as a Hallicrafters receiver, and at a price well within the average amateur's purse.

To-day we find ourselves building this ideal receiver, different from anything the Hallicrafters have produced in the past—new in conception, new in design, new in performance. Because its design is based on functional principles, and because it embodies the newest developments in the art of building communications receivers, it is extremely unconventional as compared to receivers designed even as late as a year ago.

The Skyrider 23 may not be every amateur's ideal receiver. We all have our preferences. But, it is our belief that the Skyrider 23 more nearly approaches the ideal communications receiver of the majority of amateurs.

ISSUED BY THE HALLCRAFTERS.

R E R 23

★ General Coverage—34 to .54 MC (8.8 to 556 Metres).

GENERAL COVERAGE

★ 8 Band Positions—Band 1—11.0 to 34.0 MC. Band 3—1.7 to 5.2 MC.
Band 2—5.2 to 16.5 MC. Band 4— .54 to 1.7 MC.

BAND SPREAD

Band 80—3.5 to 4.0 MC. Band 20—14.0 to 14.4 MC.
Band 40—7.0 to 7.3 MC. Band 10—28.0 to 32.0 MC.

★ Tube Complement—Total Number of Tubes—11.
1st R.F. —6SK7 2nd I.F. —62K7 B.F.O. —6SJ7
1st Det. —6SA7 2nd Det., 1st Audio—6SQ7 Rectifier —80
H.F. Osc.—6SJ7 Amplified A.V.C. —6B8 Noise Limiter—6N7
1st I.F. —6SK7 Power Output —6F6G

★ Audio Output—5 Watts.

★ Temp. Compensated Permeability-Tuned I.F. Trans. Units (455 K.C.).

★ Completely Shielded, Permeability-Tuned Crystal Filter Circuit.

★ 6 Position Variable Selectivity Switch.

★ Controls :—

Pitch Control	Selectivity Switch	Automatic Noise Limiter
Tone Control	A.F. Gain	Switch Crystal Phasing
Band Switch	R.F. Gain	Control.
Standby Switch	Main Tuning Knob	Phone Jack

★ S Meter calibrated in "S" units and db's.

★ Directly calibrated, indirectly illuminated, "Venetian Blind" Tuning Dial.

★ Modern ventilation grills.

★ Speaker—P.M. Dynamic in separate cabinet of matching design.

★ Cabinet Finish—Machine Tool Grey, Crystal finish with Gunmetal and chrome finish escutcheon.

★ Cabinet Dimensions—Width, 19" ; Height, 9¼" ; Depth, 12½".

Our range of communication receivers and the lately released complete transmitters are evidently well known and, we believe, appreciated by our "amateur" friends in the British Isles. This state of affairs is due to the enthusiasm of our mutual good friends, Webb's Radio of Birmingham and London, and, of course, in part to the real excellence of our products.

We honestly believe that we do manufacture in our works at Chicago the finest communication equipment which it is possible to produce and we know that it is offered to you in England at the keenest possible prices.

Nothing would give us greater pleasure than to conduct you all through our works in order that you could meet the fellows (mainly "Hams") who are responsible for our success, but we know that to be impossible. The next best thing would be for you to inspect the whole range of gear at one of the depots of our **SOLE BRITISH DISTRIBUTORS** whom we know carry every model in stock. Incidentally, Webb's magnificent catalogue which, in our opinion, is ahead of anything published in U.S.A., will give you the whole story and we understand **IT IS FREE**. Contact them. They will take care of your enquiries.

PRICE **£33 10 0**

Matching Speaker **£4 0 0**

2611, South Indiana Avenue, CHICAGO.

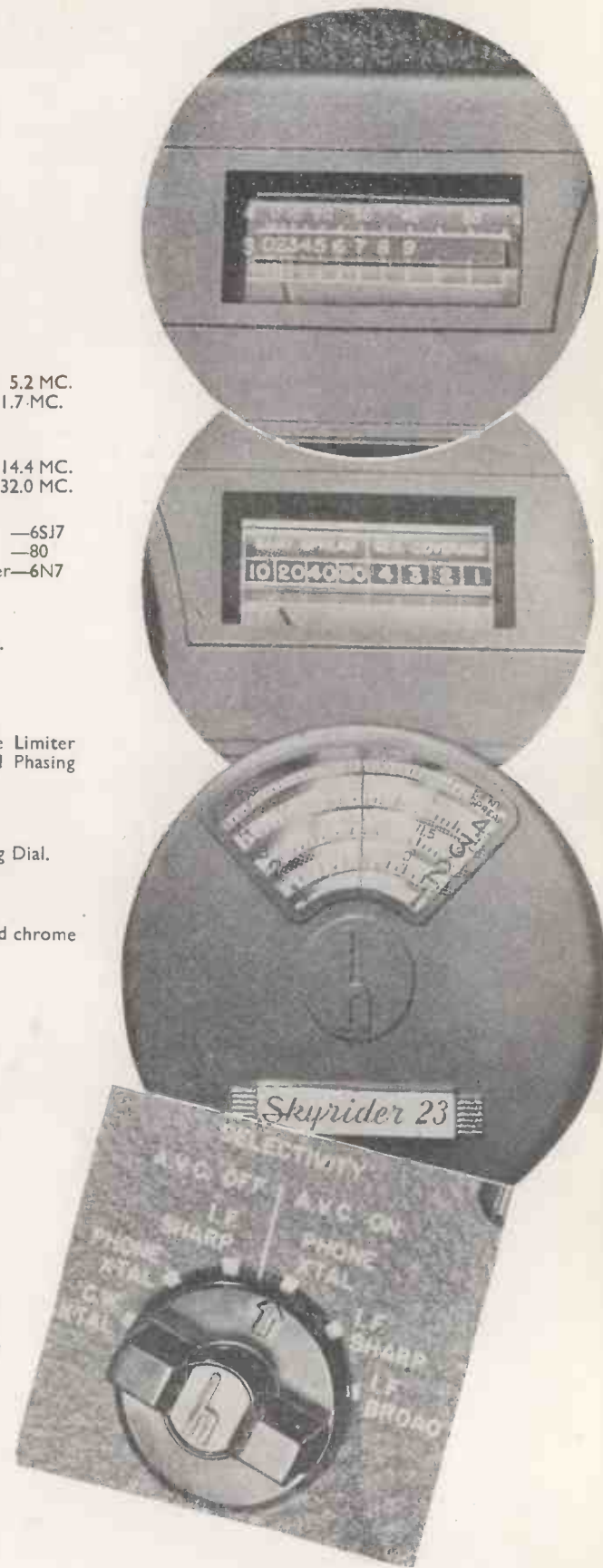

PRICES AND PRINCIPAL FEATURES OF COMMUNICATION SETS

BUYING

A
COMMUNICATION RECEIVER

This special article provides information on all communication receivers of both British and American manufacture which are now available in this country. The receivers vary in price from £3 17s. 6d. for the very simplest type up to £162 for a twin unit designed for diversity reception.

Complete data can be obtained from the suppliers mentioned on page 297.

IF the amateur is to be completely satisfied with the receiver ultimately chosen, there are several small but important features which must be borne in mind. When the receiver is used close to a high powered broadcast or even amateur station it is always advisable to use a receiver in which there is an efficient and adequately screened R.F. stage. Alternatively, if the receiver in mind does not have an R.F. stage there must be compensating features to counterbalance this, such as a special I.F. frequency, or two or three sharply tuned I.F. stages.

double-valve frequency changer will automatically drift, for this is generally taken care of, but the point must be watched.

Notice how much noise is introduced when the B.F.O is switched on and also make sure that the chassis and panel on which the receiver is built are of heavy gauge metal to withstand vibration, otherwise there may be frequency wobble when the receiver is used on C.W. Sets which include their own loudspeaker should also be checked for microphony over certain volume levels, particularly on the higher frequencies. A crystal gate is not a necessity, for either phone or C.W. reception, for in many instances manufacturers are able to gain a very high degree of selectivity by properly designed tuned circuits.

When the receiver is used in a good location such as in country areas, it need not be so comprehensive as when it is used in towns. The reason for this is that in the country areas the gain controls can be more fully advanced without bringing up local noise, while there is not the extreme need for selectivity as when other amateur stations are close to hand. However, selectivity should always be of the highest order on ham bands in order to be able to make the most of DX reception.

Some of the smaller receivers costing only a few pounds are able to give a good account of themselves when used

under proper conditions, so do not immediately feel that these sets with their simple specifications are not suitable for amateur station reception.

PRICE

£3 17s. 6d.—£7 19s. 6d.

A simple battery set covering 16.5 to 52 metres is the *Eddystone All-World Two*, with which it is possible to obtain



Peto-Scott's Trophy-5 which covers 10 to 550 metres.

It will also be noticed that image interference is generally bad on receivers not possessing an R.F. stage or filter unless the I.F. frequency is high so that the images are only located outside amateur bands. In locations where the noise level is high, the receiver must either have a noise silencer or at the very least provision for dipole input so that a noise suppression doublet or similar type of aerial can be employed.

No one can tell whether a dial has back lash by merely checking it on broadcast bands. Always make a point of tuning the receiver to the highest frequency covered and to check the action of the tuning drive on ham bands. Nothing is more annoying than to find the receiver has a fair amount of back lash on the 28 mc. band, for example.

Frequency drift is another detrimental feature which has been overcome in most receivers, but always check this point on sets which include a multi-electrode frequency changer. It does not follow that a set employing a

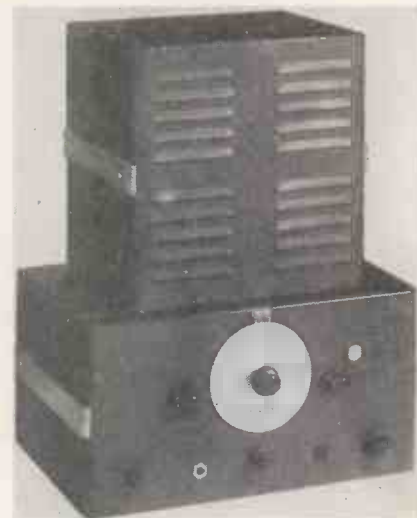

One of the cheapest sets in its class—the Premier 5-V-5 at 8 gns.



A popular set which includes all amateur refinements is the Peto-Scott Trophy-8 priced at 12 gns. It tunes down to 43 megacycles.

RECEIVERS FOR PHONE USE

world-wide coverage on C.W. Despite the abridged circuit, it is extremely sensitive and a good receiver for the beginner. Plug-in coils are used.

The *Trophy* range of sets are becoming well known and the cheapest in this

is selective but should C.W. reception be required an external B.F.O. must be fitted. Alternatively, the I.F. amplifier can quite easily be made regenerative.

A mains version of the *Trophy 3* is

The cheapest receiver for communication use with B.F.O. and full-wave range coverage is the *Premier "5-V-5."* There are five wavebands, illuminated band-spreading, individual coils for each channel, B.F.O., A.V.C., send-receive switch and a most effective aerial matching device. The receiver



Howard receivers are becoming very popular in this country. This is the 438, price £15 10s.



A most effective noise silencer can be built into the RME-69. This is the actual unit.

series is the *Trophy 3*, for battery operation, covering 6 to 550 metres and priced at £5 15s. (less batteries). The receiver has plug-in coils, a limited band-spread action plus a built-in loudspeaker. Noise level on this receiver is particularly low.

Premier's All-wave 6 chassis includes an effective radio-frequency stage giving a high signal-to-noise ratio. There are four wavebands which altogether cover 12 to 2,100 metres. The receiver

is available for A.C. operation. This has the same wave-band coverage as the battery model but the circuit is screened-grid detector and high slope pentode output. Variable aerial coupling device has also been included with slow-motion drive for the reaction control.

PRICE

£8 8s. 0d.—£9 19s. 6d.

is supplied complete with moving coil loudspeaker in a separate steel cabinet, and was designed by amateurs for amateur use.

A good receiver for the phone user is the *McCarthy R.S.639*. A 6-valve superhet with one R.F. stage and covering 12.8 to 2,000 metres. The A.V.C. action on this set is particularly effective while on commercial programme bands it gives a very good account of itself. It is supplied in chassis form for £9.

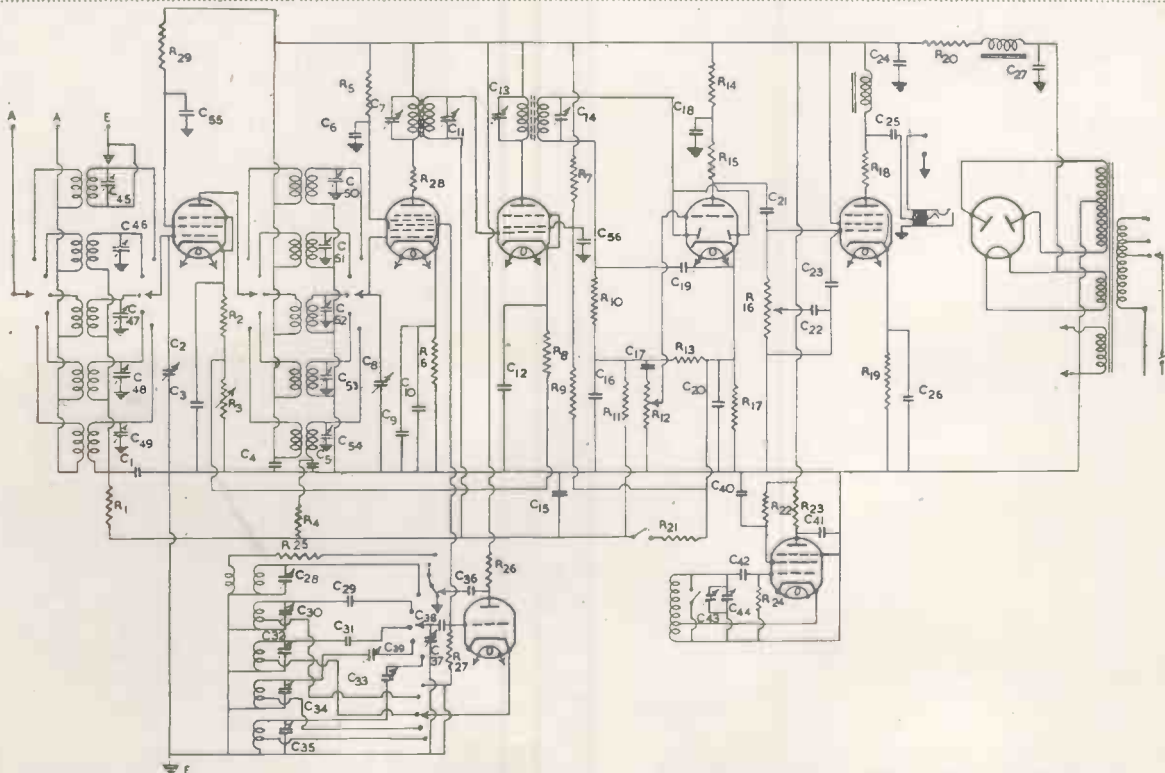

The *Trophy-8* receiver has a single R.F. stage on all bands with an EF8 low-noise valve. This is the complete circuit.

TROPHY - 6 :: HOWARD - 430 :: NEW SKY BUDDY

Two interesting *Trophy* sets have just been introduced. These are the *Trophy 5* and the *Trophy 6*. They are both very similar but the 5 has no R.F. stage. The *Trophy 6* is going to be an

ful set for amateurs who are rather restricted as to the amount they can pay. A real professional 6-valve communication receiver is the *Howard 430* which is suitable for operation on A.C. mains,

the usual switches for B.F.O. send-receive and A.V.C. control.

PRICE

£10 0s. 0d.-£12 12s. 0d.

Hallicrafter's new *Sky Buddy* with electrical band-spreading, provides an exceptional performance on 10 metres.

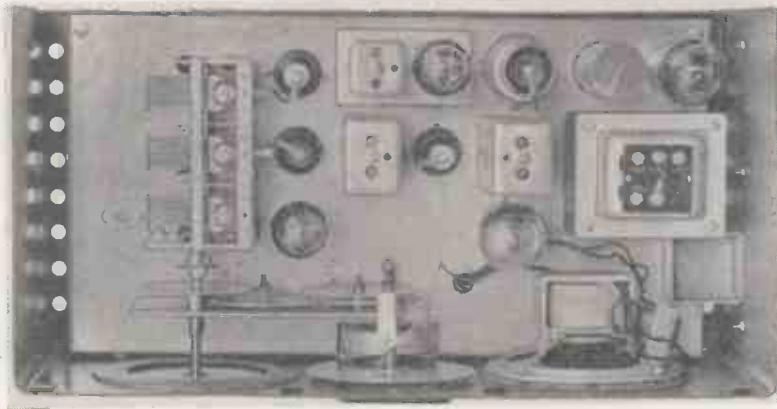

An outstanding receiver is the type Hallicrafter *Sky Champion*. This plan view shows the very trim layout of this particular set. A special band-spreading dial is included.



Almost every amateur at one time or another has owned or tried the *Eddystone All-world Two*. It is still very popular, particularly for C.W. reception.

outstanding set of its class for it has high and very level sensitivity over its entire tuning range. It is only just available, but our tests show that at £9 19s. 6d. it is going to be a most use-

ful or from a vibrator pack if required. Provision is made for doublet input while the coverage is 540 kc. to 43 mc. The band-spread calibration is part of the main tuning drive while there are

It is already proving very popular, for at £10 it is very low priced. It is for A.C. mains, but for £10 15s. can be modified for battery operation.

The *Dual Purpose* receiver intro-

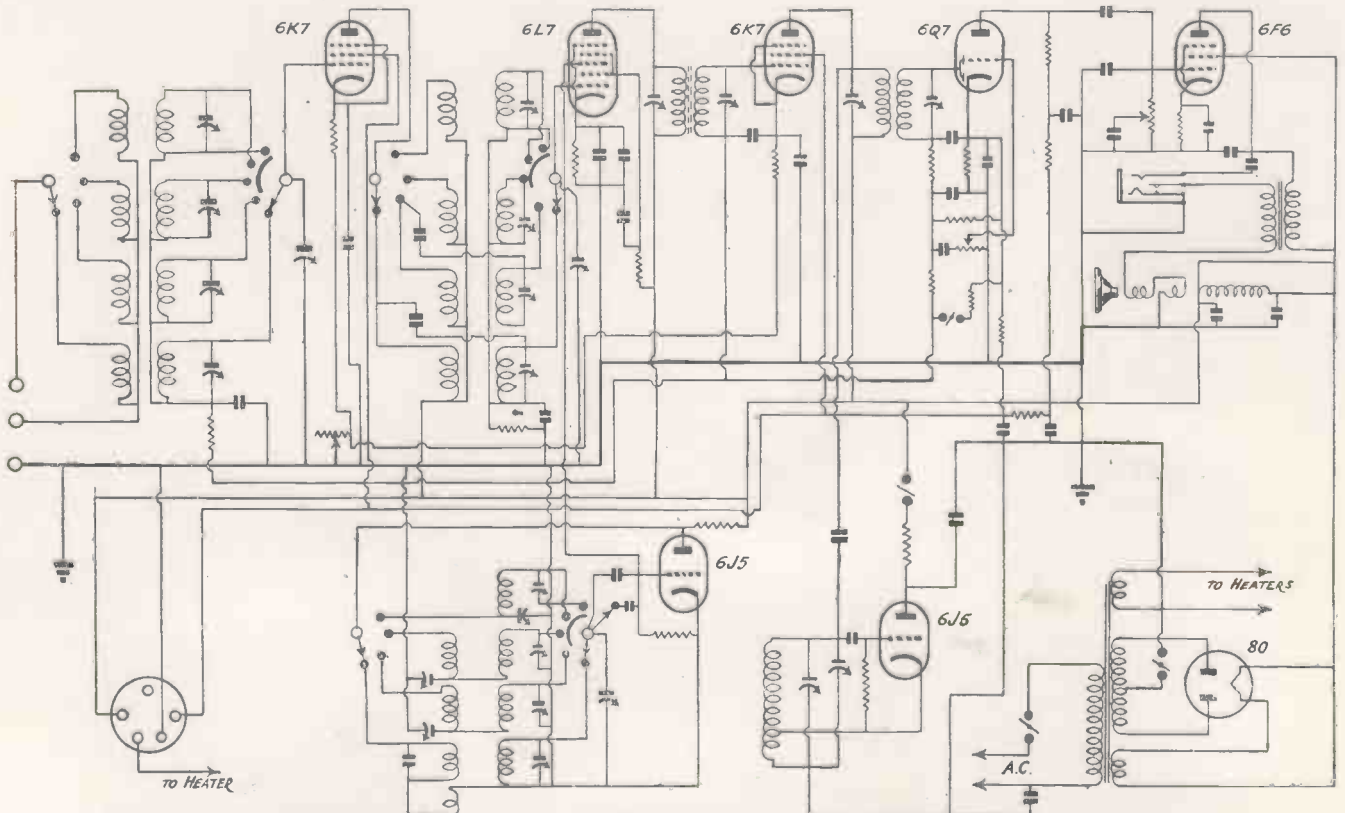

This is the complete circuit of the Hallicrafter *Champion* in which provision is made for an external signal strength meter to be used. The plug in the left-hand corner is provided for this purpose.

A NEW NATIONAL RECEIVER

duced a few months ago by *Peto-Scott* is available as a ready built set or as a kit. The R.F. stage is most effective

Variable selectivity is a very necessary refinement, particularly on amateur bands. It is included on the

age of .54-43 mc. It has a double channel I.F. stage, one of 465 kc. and one of 1,650 kc., the higher frequency being

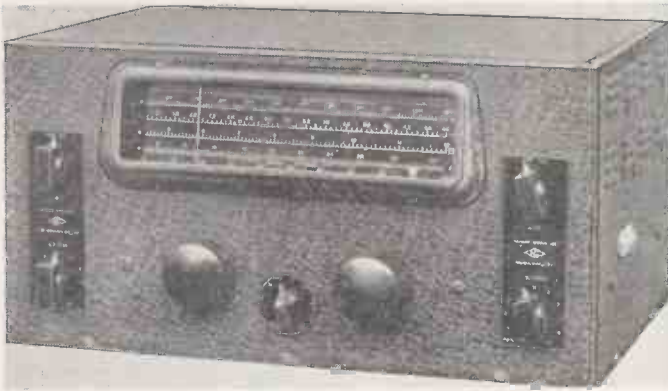

National's new NC-44 is an A.C./D.C. receiver which has an extremely high degree of selectivity despite the fact that no R.F. stage is included. It is a very popular set in its price range.



The R.M.E. DB-20 pre-selector uses two R.F. stages and provides a gain of between 10 and 12 db. when connected in front of the average communication receiver. It is particularly suitable for use with sets which do not include an R.F. stage.

while it will work and still have a high sensitivity level down to 43 megacycles.

Straight sets when they are efficiently designed give an extremely good account of themselves in view of the low noise level. *Eddystone's Every-Man 4* is a shining example of this type of set and as it covers from 9.8 to 175 metres, is very suitable for amateur use.

An 8-valve receiver for phone use with one R.F. and one I.F. stage is the *McCarthy PP7/39*. It is in chassis form and covers 12.8 to 2,000 metres, has push-pull output and gives very fine quality.

Many amateurs are now using with great success the *Peto-Scott Trophy 8* which has a low-noise R.F. stage using an EF8, a B.F.O., all the usual switches, an external loudspeaker, which effectively prevents microphony and peaked sensitivity on ham bands.

McCarty PP9/39, an 8-valve receiver costing £14 14s. od.

Provision is made for an R meter in the new *Howard 438*, which has one R.F., two I.F. stages and a band cover-

used on the lowest wavelength. The crystal is included only in the special model for which a small extra charge is made.

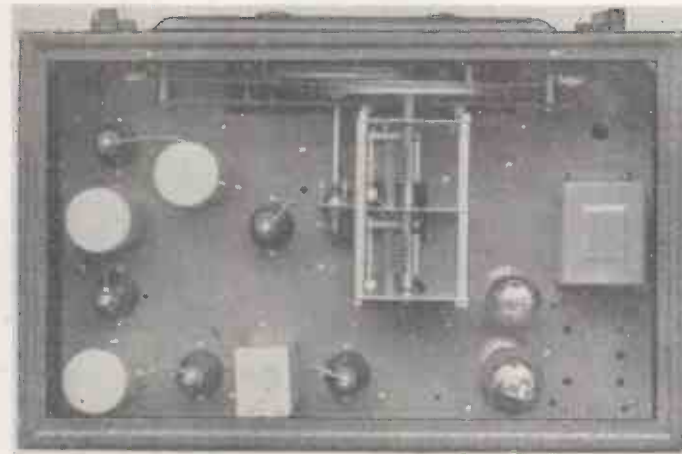

A combination of metal and glass valves are used in the National NC-44 while the set has been simplified as regards construction as this plan view clearly shows.

PRICE

£14 14s. 0d.—£16 16s. 0d.

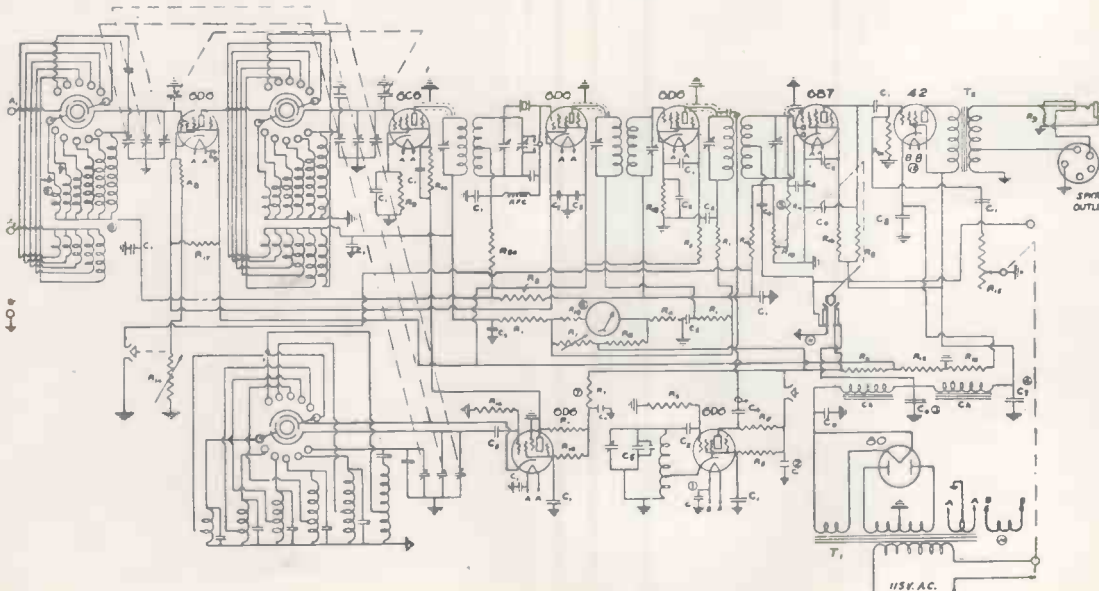

This is the complete theoretical circuit of the RME-69. It is still a popular set in this country despite the fact that it has been available for some years. The design lends itself to modification and manufacturers keep the receiver up to date. Any owner of an RME-69 can return it to the makers from time to time for modernising if required.



The Super-pro is an outstandingly fine example of American communication receivers. Prices vary from £59 upwards.



One of the latest sets available is the National NC-44. It is also available for battery operation.



This Hallcrafters 5-10 covers 4.4 to 11.1 metres but a special police model covers up to 80 megacycles.



One of the most popular sets is the HRO which covers 1.7 Mc. to 30 Mc.



The R.M.E.-70 includes an R meter, crystal filter and noise suppressor. The price is £36 15s. 0d.



National receivers are very popular. This is the NC-100XA. It has a crystal filter and covers 540 Kc. to 30 Mc.

**BRITISH a
COMMUNIC
RECEI**



An outstanding receiver is the new Sky Buddy. It has an electrical band spread 6 valves and tunes down to 44 Mc. It is priced at £10.



The National NC-510 covers 28 to 64 Mc. It uses three acorn valves and is priced at £45.



On the left is the National One-Ten, a four valve super-regenerative receiver priced at £18 10s.

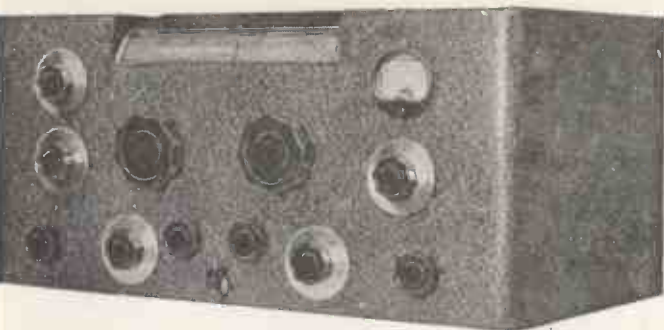

This is the Eddystone E.C.R. which is priced at £45 and uses ten valves.



An excellent low priced receiver for amateur use is this Trophy-8 (shown above). As the type number indicates eight valves are used while the price is 12 gns. complete, covering 7-550 m. in five bands.

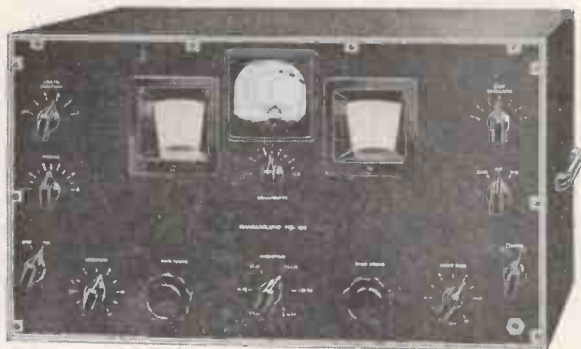

The latest Hammarlund model HQ-120X. It has a coverage of 31 to .54 Mc. and uses twelve valves.

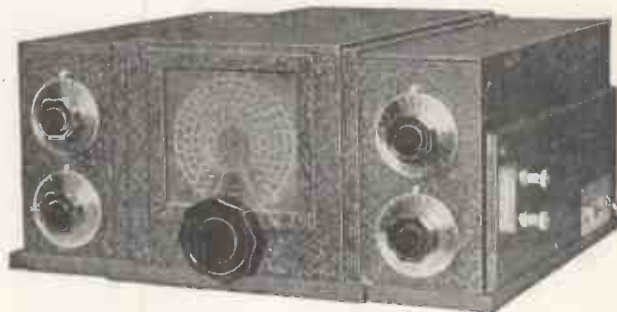

There are very few battery operated receivers of the communication type but here is a very good one, the Eddystone L.P.C.

and AMERICAN COMMUNICATION RECEIVERS



The Howard 430 is the cheapest set in this manufacturer's range at £9 19s. 6d.



This is the Howard 450A which has twelve valves and covers six wavebands.

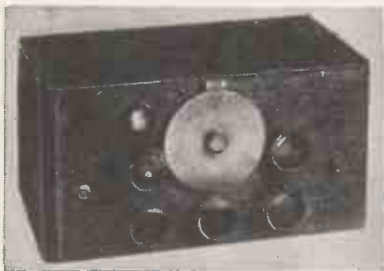

One of the cheapest communication sets available is this Premier 5-V-5. It has five valves and is complete with speaker at 8 gns.



Hallicrafters have just produced the SX-23 which has eleven valves, crystal filter, and eight wavebands. It should be one of the most popular communication sets available.

On the right is a very popular NC-80X. This can be used for A.C., D.C. or battery operation.



THE TOBE-7 :: R.M.E. 70 :: HALLICRAFTER 5-10

The *Premier* 10-valve chassis is supplied complete with a G-12 speaker and covers from 6 to 2,000 metres in five bands. A Magic Eye is included while the audio output is 16 watts. There are two stages of I.F. amplification but the noise level is still tremendously low.

Low-noise "E" series valves are used throughout in the *Philips 361A* receiver which is suitable for A.C. operation or by means of a small converter which can be supplied for D.C. operation. It covers 9.5 to 570 metres.

For some time the most popular set at its price has been the *Hallcrafter Sky Champion*, an 8-valve receiver with one R.F. stage, and provisions for an R meter, covering 45 megacycles downwards. It is for A.C. operation.

Although the *Tobe* receiver was originally designed for kit constructors, it is now available as a factory-built set for £15 17s. 6d. It tunes over the amateur bands only, although there is a special model for the general coverage. This set is still deservedly popular.

The *National NC-44* is for A.C./D.C. operation while there is a similar model for battery operation. Although no R.F. stage is included selectivity is exceptionally good due to special I.F. circuit design. Provision is made for an R meter while the tuning arrangements are particularly good.

PRICE

£18 0s. 0d.—£21 0s. 0d.

It is unusual to find an American set which has exceptionally wide coverage, but the *Hallcrafter Marine* tunes between 18.5 mc. to 140 kc. It is for A.C./D.C. operation and provision is made for an R meter.

The *National 1-10* is a 4-valve super-generative set which has set a standard for results on ultra-high frequencies. It is suitable for portable use and can be run from a rotary converter.

A more ambitious receiver is the *Hallcrafter 5-10* which covers 27 to 68 mc., has a most effective R.F. stage, is fully calibrated and includes a noise limiter of the Dickert type.

Although intended for general short-wave listener use, the *Philips 362A* covers 5 to 580 metres, works well on ham bands, and will receive television sound signals up to quite long distances. A special feature of this set is the unusually low noise level due to a large extent to the use of "E" series valves throughout.

PRICE

£23 0s. 0d.—£29 15s. 0d.

A large battery set is the *Eddystone All-world 8*, which has one R.F. and two I.F. stages covering 9.5 to 2,000 metres. Intended for Colonial use, the amateur without mains supply will find it a good receiver.

There are 11 valves in the *Hallcrafter Commercial*, with one R.F. and two I.F. stages, while there is a tuning indicator of the Magic Eye type.

An important introduction into the amateur receiver class is the new *Hamrad L39*, a 12-valver with all worthwhile refinements, including a crystal filter that can be used on phone. It also has variable selectivity and covers 6 to 60 mc.

For strictly amateur use the *Hallcrafter Ultra* is still popular. This 10-valve receiver has one R.F. and two I.F. stages, crystal filter and variable selectivity. The tuning range is 5.65 to 79.5 mc.

Hallcrafter's SX18 is a most robust receiver and a considerable number of them are in use in this country. It has 9 valves, crystal filter, tunes down to 38 mc. and also covers the broadcast bands.



This is the new *Hamrad L39*, a welcome addition to the British-made communication receivers available. It is priced at £25, and includes a most effective wide-channel crystal gate.

National's two receivers *80-X* and *81-X* are fundamentally similar, having 10 valves, crystal filter, B.F.O. and variable selectivity. However, the *80-X* is for general coverage and the *81-X* for ham-bands only.

A receiver that is not very well known in this country is the *Howard 440*, a 9-valver with one R.F. and two I.F. stages. The minimum wavelength is 7.5 metres, while reception is particularly good on the higher frequency bands.

PRICE

£31 10s. 0d.—£38 10s. 0d.

Howard's latest set is the *450A*, having 12 valves, crystal filter, R meter, variable selectivity and a very wide fre-

quency coverage up to 64 megacycles. It is the most ambitious set in this company's range.

The very latest set available to amateurs is *Hallcrafter's SX23*, a receiver which appears to have everything included at the very lowest price. It includes a crystal filter that can be used on telephony, general coverage or ham bands as required, the latest type of high gain low noise valves, R meter, and an exceptionally wide band-spread arrangement covering 360 degrees on amateur bands. Incidentally, a new innovation is the band-spread dial, which can be accurately calibrated as it is not dependent on the setting of the mains control.

The only receiver *R.M.E.* have intro-

RECEIVER REVIEWS

Many of the receivers mentioned in these pages have been reviewed in detail in recent issues of this journal. Readers who require further information should apply for the back number of the issue dealing with the particular receiver. Write to the Back Number Dept., Chansitor House, Chancery Lane, W.C.2, mentioning the receiver in which you are interested.

duced recently is the *70*, a 10-valver with crystal filter, R meter, variable

selectivity and built-in noise silencer. It is for A.C. operation, and covers the 10 metre band. Ideal for use in locations where noise level is high.

National's NC-100A is a popular set with one R.F. stage and a total of 11 valves. The crystal is particularly effective while the coverage is down to 32 megacycles. The *NC-101X*, by the same company, has 12 valves, covers 10-160 metres, and is fitted with crystal gate and R meter.

The *R.M.E. 69* has an excellent record both in this country and in America. Its main features are low noise, effective R.F. stage and wide band-spreading. It includes a crystal filter and an R meter while a special model, the *LS/1*, has a built-in noise silencer.

EDDYSTONE BATTERY SUPERHET

A new receiver which will shortly be available is the *Hammarlund HQ-120*. It is the first receiver to be produced by this company after the famous Superpro. It includes 12 valves, 2 I.F. stages, has B.F.O. crystal, R meter and variable selectivity. There is also a new band-spreading circuit and an effective noise silencer. The signal strength meter is calibrated in units up to S-9 and to 40 db. above this figure. There are actually two models of this set, one being without crystal.

PRICE

£39 10s. 0d.—£45 0s. 0d.

National's U.H.F. receiver, the 5-10, has acorn valves in the R.F. mixer and oscillator positions. It is also fitted with a crystal and noise limiter.

Two British sets, the *Eddystone E.C.R.* and *L.P.C.* have recently been introduced. The *E.C.R.* has 10 valves, noise silencer, crystal, etc., and is for A.C. operation, while the *L.P.C.* is purely a battery set with 8 valves, one R.F., two R.F. and a crystal filter.

PRICE

£49 15s. 0d.—£162 0s. 0d.

When a reliable communication receiver is required, a set that is often used is the *National HRO*, a 9-valve receiver with plug-in coils, two R.F. and two I.F. stages and a sensitivity of better than 1-microvolt on all bands. The power unit is separate so that the receiver need not necessarily be used on

A.C. mains. All wavelengths can be covered from 10 metres upwards. There are four *Super-Pro's*, all with 16 valves, 2 R.F. stages and 4 I.F. stages, two of which have crystals, and two covering short waves only. The coverage is actually 7.5-240 metres or 15 to 560 metres, with or without crystal, as required.

The largest receiver available in this country is the *Hallicrafter Dual Diversity* which is actually two complete superhets having a total of 25 valves. The coverage is 545 kc. to 45 mc. while it is, of course, only suitable for A.C. mains.

For use with communication receivers there are two excellent pre-selectors,

one the *DB-20*, manufactured by *R.M.E.*, priced at £12 10s., which has two R.F. stages and its own power supply for A.C. mains and the other a two-stage pre-selector, produced by *Peto-Scott*, with two of the "E" series valves, which is for A.C. operation and priced at £6 15s. 0d. Both of these units, of course, include their own power.

Those who already have a good communication set but wish to cover the ultra-high frequencies should bear in mind the new production by *R.M.E.*, the *DM-36*, which is a 4-valve expander covering 5 and 10 metre bands, and can be used in front of practically any communication receiver.

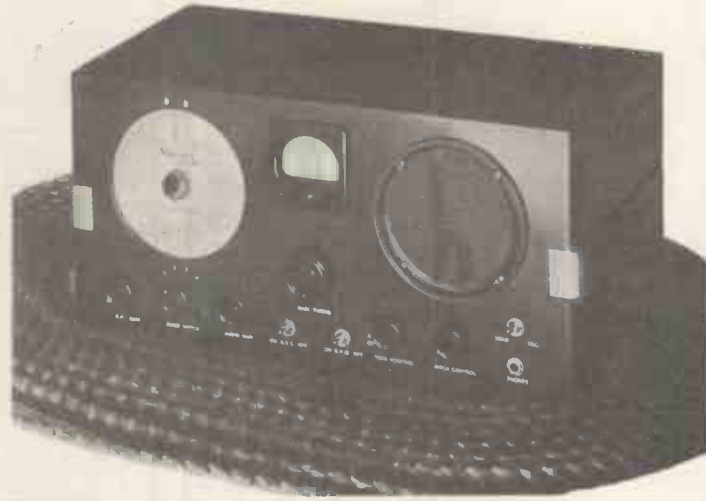

Hallicrafters Marine, a receiver covering 16.2-2150 metres. It is suitable for A.C./D.C. working and uses 8 valves

Communication Receivers can be obtained from these Suppliers

A.C.S. RADIO, 16 Grays Inn Road, London, W.C.1.

Holborn 9894-5.

ANGLO-AMERICAN RADIO (& MOTORS), LIMITED, Albion House, 59, New Oxford Street, W.1.

Temple Bar 3231.

CLAUDE LYONS, LIMITED, 40, Buckingham Gate, London, S.W.1.

Victoria 3068.

HAMRAD WHOLESALE, LTD., 32, St. Lawrence Terrace, Kensington, W.10.

Ladbroke 1166-7-8.

PETO - SCOTT ELECTRICAL INSTRUMENTS (HOLDINGS, LTD.), Pilot House, Stoke Newington Church Street, London, N.16.

Clissold 9875.

77, City Road, London, E.C.1.
41, High Holborn, London, W.C.1.

Clerkenwell 9406.

PREMIER RADIO, Jubilee Works, 167, Lower Clapton Road, London, E.5.

Holborn 3248.

Amherst 4723.

169, Fleet Street, E.C.4.

Central 2833.

50, High Street, Clapham, London, S.W.4.

Macaulay 2381.

QUARTZ CRYSTAL COMPANY, 63, & 71, Kingston Road, New Malden, Surrey.

Malden 0334.

RADIOMART G5NI (B'HAM), LTD., 44, Holloway Head, Birmingham, 1.

Midland 3254.

ROCKE INTERNATIONAL LTD., 11, Great Marlborough Street, London, W.1.

Gerrard 5282.

SHORT-WAVE RADIO, LTD., 97, Park Lane, Leeds, 1.

Leeds 24689.

STRATTON & CO., LTD., Bromsgrove Street, Birmingham, 5.

Midland 3771.

WEBB'S RADIO (C. WEBB LTD.), 14, Soho Street, Oxford Street, London, W.1.

Gerrard 2089.

41, Carr's Lane, Birmingham, 5.

Midland 3771.

Communication Receiver Specifications

Make Model No.	No. of Valves	R.F. Stages	I.F. Stages	B.F.O.	Crystal	R Meter	Variable Selectivity	Wave Range Coverage	Power Supply	Band Spreading	Noise Silencer	Price
Eddystone All-World Two	2	—	—	—	—	—	—	15.5/52	Battery	Yes	—	£3-17-6
P.S.E.I. Trophy Three	3	—	—	—	—	—	—	6/550	Battery	—	—	£5-15-0
P.S.E.I. Trophy Three	3	—	—	—	—	—	—	6/550	A.C.	—	—	£6-6-0
Premier A.W.6	6	1	1	—	—	—	—	12/2100	A.C.	—	—	£7-19-6
Premier 5V5	5	—	1	Yes	—	—	—	12/2000	A.C.	Yes	—	£8-8-0
McCarthy RS. 639	6	1	1	—	—	—	—	12.8/2000	A.C.	—	—	£9-0-0
P.S.E.I. Trophy Five	5	—	1	Yes	—	—	—	10/550	A.C.	Yes	—	£9-0-0
P.S.E.I. Trophy Six	6	1	1	Yes	—	—	—	10/550	A.C.	Yes	—	£9-19-6
Howard 430	6	—	1	Yes	—	—	—	.54 mc./45 mc.	A.C.	Yes	—	£9-19-6
Hallerafter Sky Buddy	6	—	—	Yes	—	—	—	44 mc./545 kc.	A.C.	Yes	—	£10-0-0
P.S.E.I. D.P.C.	6	1	1	Yes	—	—	—	545 kc./43 mc.	A.C.	—	—	£10-10-0
Eddystone E.M.4	4	1	—	—	—	—	—	9.8/175	Battery	Yes	—	£10-15-0
Hallerafter Sky Buddy	6	—	—	Yes	—	—	—	44 mc./545 kc.	Battery	Yes	—	£10-15-0
McCarthy PP. 7/39	8	1	1	—	—	—	—	12.8/2000	A.C.	—	—	£11-11-0
P.S.E.I. Trophy Eight	8	1	1	Yes	—	—	—	545 kc./43 mc.	A.C.	Yes	—	£12-12-0
McCarthy PP. 9/39	8	1	1	—	—	—	Yes	12.8/2000	A.C.	—	—	£14-14-0
Howard 438	8	1	2	Yes	—	Provision made	—	540 kc./45 mc.	A.C.	Yes	—	£15-10-0
Premier 10V.	10	1	2	—	—	—	—	50 mc./140 kc.	A.C.	—	—	£15-15-0
Philips 361AU.	6	1	1	—	—	—	—	9.5/570	A.C. or D.C.	—	—	£15-15-0
Hallerafter Sky Champion	8	1	1	Yes	—	Provision made	—	44 mc./545 kc.	A.C.	Yes	—	£15-15-0
Tobe-7	7	1	1	Yes	—	—	—	Ham Bands	A.C.	Yes	—	£15-17-6
National NC-44	7	—	2	Yes	—	Provision made	—	30 mc./545 kc.	A.C./D.C. or Battery	Yes	—	£16-16-0
Howard 438 Xtal	8	1	2	Yes	Yes	Provision made	Yes	545 kc./43 mc.	A.C.	Yes	—	£17-10-0
Hallerafter Marine	8	1	1	Yes	—	Provision made	—	18.5 mc./140 kc.	A.C./D.C.	Yes	—	£18-0-0
National 1-10	4	1	—	—	—	—	—	1-10 metres	A.C. or battery	Yes	—	£18-10-0
Hallerafter 5-10	8	1	1	Yes	—	Provision made	Yes	27 mc./68 mc.	A.C.	Yes	Limiter Type	£20-0-0
Philips 362A.	9	1	1	—	—	—	—	5-580	A.C. or D.C.	—	—	£21-0-0

Communication Receiver Specifications (Cont.)

Make Model No.	No. of Valves	R.F. Stages	I.F. Stages	B.F.O.	Crystal	R Meter	Variable Selectivity	Wave Range Coverage	Power Supply	Band Spreading	Noise Silencer	Price
Eddystone All World Eight	8	1	2	—	—	—	—	9.5/2000	Battery	—	—	£25 - 0 - 0
Hallierafter Commercial	11	1	2	Yes	—	Ray Type	—	11.5 mc./100 kc.	A.C.	Yes	—	£25 - 0 - 0
Hamrad L39	12	1	2	Yes	Yes	Yes	Yes	0.6/60 mc.	A.C.	Yes	Yes	£25 - 0 - 0
Hallierafter Ultra	10	1	2	Yes	Yes	Provision made	Yes	5.65/79.5 mc.	A.C.	Yes	Yes	£25 - 0 - 0
Hallierafter Challenger SX-18	9	1	2	Yes	Yes	Provision made	—	38 mc./540 kc.	A.C.	Yes	—	£25 - 0 - 0
National 80-X	10	—	3	Yes	Yes	—	Yes	540 kc./30 mc.	A.C./D.C.	Yes	—	£26 - 0 - 0
National 81-X	10	—	3	Yes	Yes	—	Yes	Ham Bands	A.C./D.C.	Yes	—	£26 - 0 - 0
Howard 440	9	1	2	Yes	Yes	Yes	Yes	.54/40 mc.	A.C.	Yes	—	£27 - 6 - 0
National H.R.O. Junior	9	2	2	Yes	—	—	—	1.7-30 mc.	A.C.	Yes	—	£29 - 15 - 0
Howard 450A.	12	1	2	Yes	Yes	Yes	Yes	540 kc./64 mc.	A.C.	Yes	—	£31 - 10 - 0
Hallierafter SX-23	11	1	2	Yes	Yes	Yes	Yes	.54/32 mc.	A.C.	Yes	Yes	£33 - 10 - 0
R.M.E. 70	10	1	—	Yes	Yes	Yes	Yes	.55/32 mc.	A.C.	Yes	Yes	£36 - 15 - 0
National NC-100A.	11	1	2	Yes	Yes	Yes	Yes	.55/32 mc.	A.C.	Yes	Yes	£36 - 15 - 0
National NC-101X	11	1	2	Yes	Yes	Yes	—	10-160 m.	A.C.	Yes	—	£37 - 10 - 0
R.M.E.69	10	1	2	Yes	Yes	Yes	Yes	.55/32 mc.	A.C.	Yes	—	£38 - 0 - 0
Hammarlund HQ-120X	12	1	2	Yes	Yes	Yes	Yes	.54/31 mc.	A.C.	Yes	Yes	£38 - 10 - 0
Hallierafter SX-17	12	2	2	Yes	Yes	Yes	Yes	.54/62 mc.	A.C.	Yes	Yes	£39 - 10 - 0
R.M.E. 69/LS1	11	1	2	Yes	Yes	Yes	Yes	.55/32 mc.	A.C.	Yes	Yes	£41 - 10 - 0
National NC-100XA	11	1	2	Yes	Yes	Yes	—	540 kc. 30 mc.	A.C.	Yes	—	£41 - 10 - 0
National NC 5-10	10	1	—	Yes	Yes	Yes	Yes	28/64 mc.	A.C.	Yes	Yes	£45 - 0 - 0
Eddystone ECR.	10	1	2	Yes	Yes	Yes	Yes	1.6/33 mc.	A.C.	Yes	Yes	£45 - 0 - 0
Eddystone LPC.	8	1	2	Yes	Yes	—	Yes	.530/22 mc.	Battery	—	—	£45 - 0 - 0
National H.R.O.	9	2	2	Yes	Yes	Yes	Yes	.54/30 mc.	A.C. or Battery	Yes	—	£49 - 15 - 0
Hammarlund Super-Pro SP110	16	2	4	Yes	—	Yes	Yes	15-560 metres	A.C.	Yes	—	£59 - 0 - 0
Hammarlund Super-Pro SP110S	16	2	4	Yes	—	Yes	Yes	7.5/240 metres	A.C.	Yes	—	£59 - 0 - 0
Hammarlund Super Pro SP110X	16	2	4	Yes	Yes	Yes	Yes	15/560 metres	A.C.	Yes	—	£63 - 10 - 0
Hammarlund Super Pro SP110SX	16	2	4	Yes	Yes	Yes	Yes	7.5/240 metres	A.C.	Yes	—	£63 - 10 - 0
Hallierafter Dual Diversity	25	2	2	Heterotone	—	Yes.	Yes	545 kc./44 mc.	A.C.	Yes	—	£162 - 0 - 0

A TX Suitable for 160, 80 or 40 Metres A 2-valve Low-power TX.

This simple transmitter uses British valves and will provide a maximum carrier power of 15 watts. It works most efficiently on 160 metres with an input of 10 watts. Designed by KENNETH JOWERS.

RECEPTION on 1.7 mc. band appears to be very good at the present time. I am not sure whether this is due to improvements in receiver design or extra efficiency in transmitters, but during the past three years conditions seem to have changed very much for the better. More stations

Circuit Data

The circuit on this page gives all technical details. The crystal oscillator is one of the Hivac Harries beam-power tetrodes, type AC/Q, which has a 4-volt heater and a 7-pin British base.

in series with the crystal even showed signs of glowing. However, it is most important to make quite sure that the screen potential is stable and does not exceed 250 volts.

Keying carried out in the cathode with a condenser of .001 mfd. across the contacts is quite satisfactory and free from choke, providing choke input is used in the power unit. It will also be noticed that R5, a semi-variable potentiometer, not only acts as a bleeder but provides the required screen voltage.

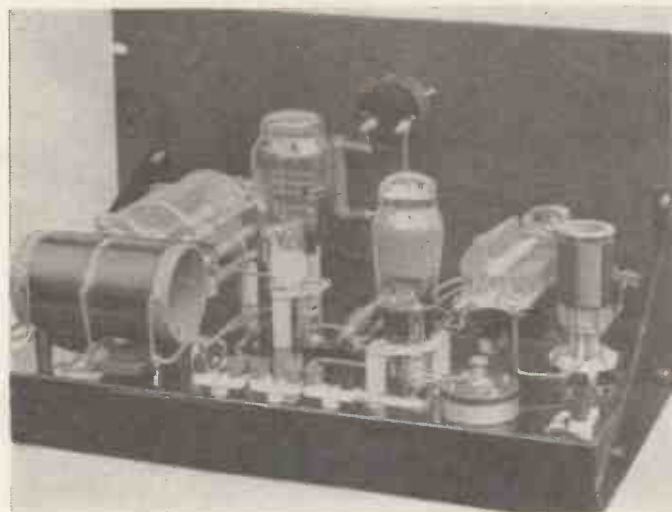

The coil in the crystal oscillator circuit resonates in the 160-metre band and is tuned by a 160 mmfd. condenser. A 60 mA. bulb is connected in series with the crystal, not as a protective device but in order to give some idea of crystal current should it be excessive.



On the R.F. chassis is a meter to read the grid current of the P.A. This is generally 15 mA.

than ever appear to be using this frequency, probably because of the QRM on 7 mc. and the poor conditions which prevail on 14 mc.

Tests on 1.7 Mc.

On 1.7 mc. there is ample scope for experimenters to carry out tests of all kinds, particularly as regards quality and reduction of B.C.L. interference. I have also noticed that the standard of operating on this band is very high indeed.

A transmitter has just been built which uses British valves throughout and provides about 15 watts of carrier, if required. The efficiency with 10 watts input is quite high while when tuned to 7 mc. with appropriate coils and crystal, the equipment is not in any way overrun when the input is 25 watts.

British equipment is used throughout, including valves and crystal, and actually, results have proved that despite opinions to the contrary, properly designed British components are as good as any obtainable.

This simple transmitter has been built on a standard Eddystone chassis and panels, and will ultimately fit into an Eddystone transmitter rack.

It makes an ideal crystal-oscillator and will stand up to 500 volts on the anode and 250 volts on the screen for long periods.

Crystal current with this arrangement is extremely low and at no time even during initial tests has the 60 mA bulb

L1 is a standard 4-pin plug-in coil wound with 46 turns of 20 gauge enamelled wire. The number of turns on this coil are not critical for it is tuned by a condenser having a capacity of 160. mmfd. so providing ample tolerance. However, in practice, only 60 mmfd. are used.

Capacity coupling between stages is

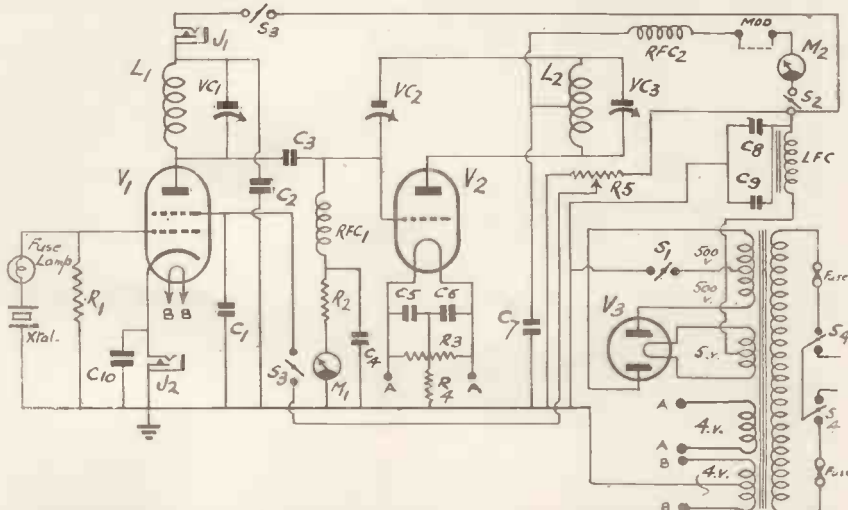

A combined mains transformer is used and the H.T. supply is broken temporarily by means of S1. If further output is required, a 25 per cent. increase in R.F. can be obtained from the C.O. by merely connecting a type 1010 Eddystone choke in series with the cathode.

Osram Valves

MADE IN ENGLAND

A further noteworthy addition
to the 'Octal Base' range

TYPE KTW61

CHARACTERISTICS

Heater Voltage	... 6.3
Heater Current	... 0.3 amp.
Anode Voltage	... 250 max.
Screen Voltage	... 80 max.
Anode Current	... 8.0 mA
Screen Current	... 2.2 mA
Mutual Conductance	2.9 mA/v (measured at Ea 250, Es 80, Eg -3.)
Mutual Conductance	0.02 mA/v. (measured at Eg -25.)
Anode Impedance	... 0.4 megohms approx.

Interelectrode Capacities

Grid-Anode	... 0.0025 micro-mfds. approx.
Grid-Earth	... 7.0 " "
Anode-Earth	... 8.0

(Taken with a close-fitting screening can).

PRICE 10/6

The new OSRAM KTW61 is an indirectly heated variable mu H.F. Screened Tetrode with pentode characteristics designed especially for use as an H.F. or I.F. amplifier for T.R.F. or Superheterodyne Receivers.

The KTW61 is noteworthy for the following reasons:—

1. The mutual conductance of this valve at the working point is high relative to the low anode-grid capacity. Thus the use of the KTW61 greatly increases the stable amplification per stage in an H.F. or I.F. amplifier.
2. The mutual conductance-to-cathode current ratio is high and the valve is particularly good in regard to signal-to-noise. This permits considerable gain to be obtained with a silent background. This feature is of great value in short-wave receivers.
3. It will provide adequate voltage for AVC and at the same time handle large inputs without producing distortion. The rate of grid control may be altered by choosing a suitable circuit.
4. It has a low heater wattage and is suitable for either parallel or series heater operation in A.C. or D.C./A.C. Receivers, 6.3 volt or 0.3 ampere respectively.
5. It is fitted with the self-locating 'Octal Base'—grid to top cap.

Write for descriptive leaflet with characteristic curves and full operating data.

Voltages and Switching

quite satisfactory on the lower frequencies; however, the capacity of C₃ should not exceed .0001 mfd, otherwise there is traces of pulling between stages. Bias

R.F. stage. For C.W. operation, these two terminals are bridged, while for telephony they are connected to the secondary of the modulation trans-

As the actual D.C. voltage is around 450, the anode current should not rise more than 20-25 mA, unless a special licence is obtained in order to exceed the normal input of 10 watts.

After the transmitter has been wired according to the illustrations, next consider the power unit. This has as its chief component a standard Premier transformer which gives 500-0-500 volts and several 4-volt heater windings. One 4-volt winding is for the rectifying valve, a second for the crystal oscillator and a third for the final amplifier. A 150 mA. smoothing choke is required and this is by-passed by two condensers in parallel each having a capacity of 4 mfd. The output is taken directly to the positive side of a 150 mA. meter with the bleeder also connected between chassis and the positive side of the meter. If this resistance is on the wrong side of the meter there will be a continuous current flow of about 20 mA. as the resistance is connected straight across the total H.T. supply.

There are three switches on this power unit, one in series with the primary, a second in series with the centre tap of the high-voltage winding, and a third of the double single throw type which breaks anode and screen voltage to the crystal-oscillator simultaneously.

H.T. voltages are taken to the Tx. section by means of a four-core cable which is terminated at one end in a Bulgin 4-pin plug. On switching on, the crystal oscillator will take about 75 mA. which will drop very rapidly down to 20 mA. as the condenser is swung into resonance.

The condenser should be very carefully tuned so that the maximum grid current in the following stage is indicated. While the crystal oscillator is being tuned it is advisable to switch off the high tension in the final valve. Unscrew the neutralising condenser so as to give minimum capacity, switch on H.T. to the final and the anode current will probably be 100-110 mA. Swing

(Continued on page 320)

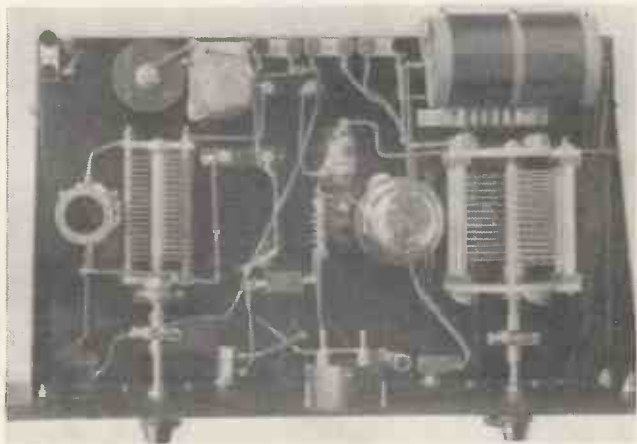

All earth returns are made to a common point as can be seen from this illustration. The R.F. choke in the final amplifier is almost underneath the tank coil in order to keep the leads short.

is obtained automatically for the final stage by means of R₂, a resistance having a value of 5,000 ohms and R₄, a small resistor of 100 ohms, which prevents a very high current surge should there be failure of excitation. With this combination of resistors, the total grid current measured by M₁ is 20 mA. which drops to 15 or 16 mA when the final valve is drawing properly.

Amateurs generally do not bother very much about the efficiency of their 160-metre transmitter. This is rather a mistake for every watt of actual carrier power is of value. It is possible to obtain an efficiency of 90 per cent. if precautions are taken in design and lay-out. For this reason the final valve, a new Tungfram OQ16/600, is provided with a high amplification factor, a comparatively low inter-electrode capacity and a ceramic base. This valve is mounted on Raymart insulating pillars so that the leads are short and direct to the tank condenser. Notice also the new A.C.S. neutralising condenser which is also of the low-loss type and how the grid lead is only 1 in. long from the grid of the valve to one plate of the neutralising condenser.

L₂ has been specially made for this circuit and consists of 40 turns of 16 gauge enamel-covered wire close spaced on a former having a diameter of 2½ in. This coil is a standard Peto-Scott product which is ideal for 160-metre working.

The R.F. choke is mounted almost directly under the centre of this coil with its associated by-pass condenser, C₇, in order to keep the leads of these two components as short as possible. Although the transmitter was designed for C.W. operation, provision has been made for telephony by leaving two terminals in series with the meter and the

former which matches the audio to the R.F. load.

Link coupling is recommended from the tank coil to the aerial coil in order to keep the selectivity as high as possible. There is no need for excessive B.C.L. interference on 160 metres pro-



By mounting the P.A. milliamp. meter on the power pack panel, there is no need to have one blank panel and for the Tx. section to be overcrowded.

viding precautions are taken. This applies particularly on C.W.

It will be found that a two-turn link around the centre of the coil will be ample as any more coupling will cause excessive plate current.

This is the power unit, it has a choke input and variable resistor across the D.C. voltage. There is ample space on this chassis to include a battery if additional bias should be required at any time.

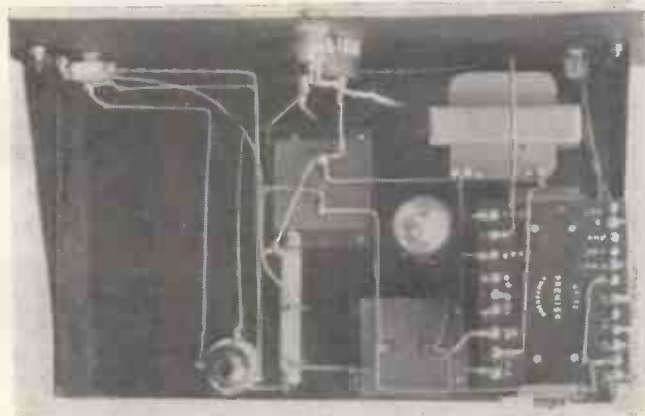

PREMIER 1939 RADIO

NEW PREMIER 1939 "5. v. 5" COMMUNICATION RECEIVER

5-valve Superhet-covering 12-2,000 metres in 5 wave bands.

- Beat Frequency Oscillator
- 2-Speed Band-Spread Control
- A.V.C. Switch
- Send-Receive Switch
- Iron-cored IF's
- Phone Jack
- Over 4-watts Output
- Illuminated Band-Spread Dial

Provision for single wire or Di-pole Aerial. International Octal Valves for 200-250 v. mains (A.C.). Built into Black Crackle Steel case providing complete screening 10½ in. Moving Coil Speaker in separate steel cabinet to match Receiver. Complete with all tubes and Speaker ... **£8-8-0**



PREMIER MOVING COIL METERS

Guaranteed Accuracy within ± 2 per cent.

Model No. 2 (as illustrated), Bakelite Case, 3 in. by 3 in. square, with Zero Adjuster.

0.500 Micro-amps.	31/-
0-1 m/A.	25/-
0-10 m/A.	22/6
0-50 m/A.	22/6
0-100 m/A.	22/6
0-250 m/A.	22/6
0-1 m/A., movements with calibrated scale volts-ohms-m/A.	27/6

VOLTAGE MULTIPLIER RESISTANCES, guaranteed accuracy ± 2 per cent. All standard ranges. 1/3 each.

TAPPED SHUNT to provide readings of 5 m/A., 25 m/A., 250 m/A., and 1,000 m/A., 5/6.

SHORT-WAVE CONDENSERS

Trolitul insulation. Certified superior to ceramic. All-brass construction. Easily ganged.

15 m.mfd. ... 1/6	100 m.mfd. ... 2/-
25 m.mfd. ... 1/9	160 m.mfd. ... 2/3
40 m.mfd. ... 1/9	250 m.mfd. ... 2/6

All-brass slow-motion Condensers, 150 m.mfd., Tuning, 4/3; Reaction, 3/9

Double-Spaced Transmitting Types.

15 m.mfd. 2/9	40 m.mfd. 3/6
100 m.mfd. 4/-	160 m.mfd. 4/6

New Trolitul Split-Stator Condensers 50 x 50 m.mfd. 10/6 each

Premier U.S.A. Quartz Transmitting Crystals, 7 mc. 10/- each. Enclosed holder and base, 3/-.
Cardboard Electrolytic Condensers, 4 mf. or 8 mf. 500 v., 1/6 each, 8 + 4 mf. 500 v., 2/3, 8 + 8 mf. 500 v., 2/6, 4 + 4 + 4 mf. 500 v., 2/6, 16 + 8 mf. 500 v., 3/6.

Tubular Metal Can Electrolytics by famous makers. 4 or 8 mf. dry, 500 v., 2/6 each. 8 mf. wet, 450 v., 2/3. 8 mf. 650 v., Peak dry, 4/-.

Oil-Filled High Voltage Condensers 1,000 volts working: 1 mf. 5/-, 2 mf. 7/-, 4 mf. 10/6. 2,000 volts working: 1 mf. 8/-, 2 mf. 12/-, 4 mf. 14/-.

Bias Condensers, 6 mf. 50 v., 6d.; 50 mf. 12 v., 1/-; 25 mf. 25 v., 1/-; 50 mf. 50 v., 1/9.

Tubular Condensers, all values from .0001 to .5 mf., 6d. each.

U.S.A. Valve Holders, 4, 5, 6 and 7 pin, 6d. each. Octals 9d.

Ceramic U.S.A. Valve Holders, all fittings 1/- each.

Short-Wave Coils, 4- and 6-pin types, 13-26, 22-47, 41-94, 78-170 metres, 1/9 each, with circuit. Special set of S.W. Coils, 14-150 metres, 4/- set, with circuit. Premier 3-band S.W. coil, 11-25, 19-43, 38-86 metres. Suitable any type circuit, 2/6.



The NEW PREMIER 10-15 WATT ALL-BAND TRANSMITTER

Designed to meet the demand for a really compact self-contained T.X., which can be used for 'Phone or C.W. on all bands.

A 6L6 is used as a modulated oscillator in a Tritet circuit, allowing a fundamental and second harmonic operation, without coil changing, from any one Xtal.

A 6C5 speech amplifier is R.C. coupled to a 6L6 modulator, giving approx. 9-10 watts audio. A 400-volt power supply with generous smoothing gives completely hum-free output.

Housed in steel cabinet, in black crackle finish, 12 in. x 9 in. x 8 in.

Complete with Xtal and Coils for 7 **£10-10-0** and 14 mc. operation
Write for details of all Premier Transmitters.

PREMIER 1939 HIGH FIDELITY AMPLIFIERS

A NEW COMPLETE RANGE OF 7 HIGH FIDELITY PA AMPLIFIERS FOR A.C. or A.C./D.C. MAINS OPERATION.

With the exception of the 3-watt models, all Premier Amplifiers incorporate the new Premier Matchmaker Output Transformer, enabling any single or combination of speakers to be used. 6, 8/10, and 15-watt systems are provided with two separate input channels which can be mixed to any level. The 30- and 60-watt systems have 3 input channels. The built-in Pre-Amplifiers ensure that the gain is sufficient for any low level crystal or velocity microphone. The actual gain of the 6-, 15-, 30- and 60-watt amplifiers is over 100 decibels. Tone controls are also incorporated.

	Kit of Parts with Valves.	Completely Wired & Tested.		Kit of Parts with Valves.	Completely Wired & Tested.
3-watt A.C. Amplifier	£2 : 0 : 0	£2 : 15 : 0	8-10-watt A.C./D.C. Amplifier ...	£4 : 10 : 0	£5 : 5 : 0
3-watt A.C./D.C. Amplifier	£2 : 0 : 0	£2 : 15 : 0	15-watt A.C. Amplifier	£5 : 15 : 0	£7 : 0 : 0
6-watt A.C. Amplifier	£5 : 5 : 0	£6 : 0 : 0			

30-60-watt A.C. Amplifiers or Modulators, completely wired and tested, in Black Crackle Steel Cabinet 15/- extra. 60-watt £15 : 15 : 0 complete.

New Premier Self Powered RF Tuning Unit, incorporating a Var. Mu pentode amplifier followed by a power grid detector. Designed for high-fidelity reception. Wave range 200-560 and 800-2,000 metres. £4 : 9 : 6 complete with valves.

PREMIER SMOOTHING CHOKES

60 m/A. 40 hy. ... 6/6	150 m/A. 40 hy. 11/6
80 m/A. 30 hy. ... 7/6	250 m/A. 40 hy. 15/-

PREMIER SWINGING CHOKES

150 m/A. 160 ohms, 3,000 v. insul.	10/6
250 m/A. 80 ohms, 2,000 v. insul.	15/-
500 m/A. 100 ohms, 4,000 v. insul.	18/-

MATCHMAKER UNIVERSAL MODULATION TRANSFORMERS

Will match any modulator to any R.F. load. 50 watts, 17/6; 150 watts, 29/6; 300 watts, 49/6.

MATCHMAKER UNIVERSAL OUTPUT TRANSFORMERS. Will match any output valves to any speaker impedance. 11 ratios from 13 : 1 to 80 : 1. 5-7 watts, 13/6; 10-15 watts, 17/6; 20-30 watts, 29/6. Send for full details.

New Taylor Tubes

T.40. TZ.40. NOW IN STOCK. Price, 24/- each. Prices now reduced on 866 Rectifier, now 10/-; 866 Junior, 7/6; T55, 45/-; 203Z, 52/6; 745, 65/-; T.20 and TZ.20, 17/6 each.

Have you had our 1939 Catalogue, Handbook and Valve Manual? 90 pages of Radio Bargains and interesting Data. Price 6d.

ALL POST ORDERS to:—
Jubilee Works, 167, Lower Clapton Road, London, E.5. Amherst 4723.

PREMIER RADIO

CALLERS to:—Jubilee Works, or 165 Fleet St., E.G.4. Central 2833 or 50 High St., Clapham, S.W.4. Macaulay 2381

A New Receiver for the Ham Bands

Building an 8-valve Amateur-band Receiver

This receiver has been designed to give maximum performance on amateur bands and for this reason employs high efficiency plug-in coils on the higher frequency bands. It gives excellent performance on television frequencies, while the I.F. circuit permits of good selectivity.

IT is not easy to build a multi valve receiver with switchable coils unless one is prepared to go to considerable expense, but it has been my contention that as the average amateur uses his receiver on a particular wave-band for long periods, the so-called inconvenience of plug-in coils is not really serious. Generally speaking, a receiver is left tuned to a wave band which is active at the time the set is in operation. This generally is for hours at a time, so very few amateurs rapidly switch from band to band, particularly when it means changing coils in the transmitter in order to work on these various bands.

This particular set was built in order to give absolute maximum signal strength, selectivity and minimum noise

on the ham bands. It has taken many months to complete in order to eliminate all the snags and difficulties, but it would not take very long for a duplicate to be constructed now that the initial spade work is finished.

Modern equipment being available quite cheaply, the amateur can build a communication set that will give a good account of itself. R.F. gain with the new EF8 can be even better than that given by many ready-built sets, while the noise level of the home built set, properly designed, is exceptionally low.

Band Width

One of the defects of a built set, that is narrow band width in the I.F., is fairly easy to overcome, with the circuit I have employed. On many occasions,

I have found that although selectivity can be of a high order and the signal strength of a station attenuated very rapidly either side of resonance, there is on many occasions a tendency for a skirt to be noticed. By this I mean that although the signal is reduced very quickly, the station does not entirely disappear for some considerable distance from the original frequency.

A Good I.F. Circuit

By using two I.F. transformers back to back, as can be seen from the view of the circuit, this skirt is eliminated. The only alternative is to increase the number of tuned circuits by introducing a second I.F. valve, but this is inclined to increase noise level. As the

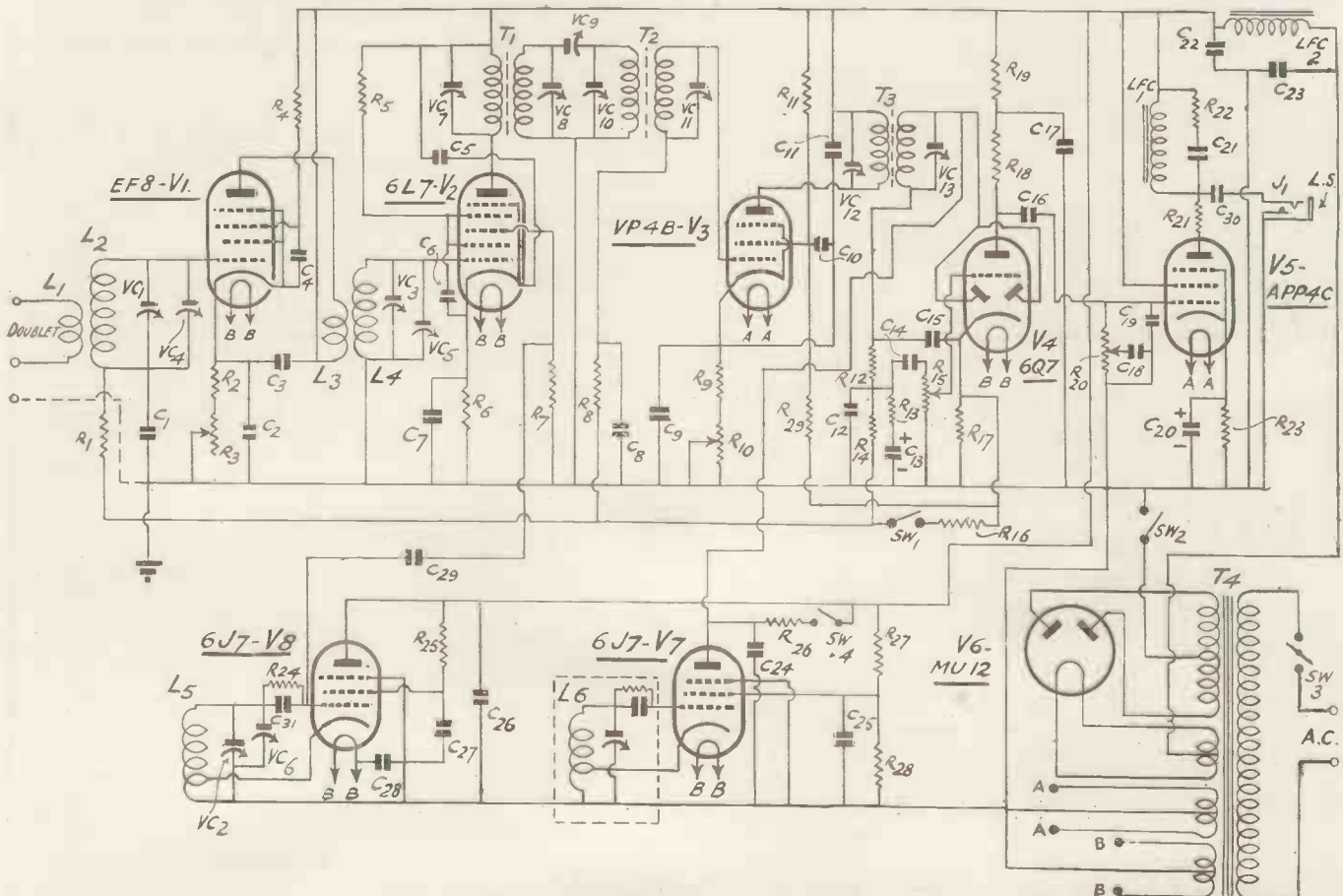

Notice the arrangement of the I.F. transformers, in which two standard units are connected back-to-back. This scheme provides good selectivity without there being any appreciable skirt to the signal.

MULLARD DOUBLE TRIODE TV03-10



This valve is designed for use as an oscillator or amplifier on ultra-short wavelengths. Under normal Class C operating conditions an output of 10-14 Watts is obtainable.

TECHNICAL DATA

Cathodes, indirectly heated - - 6.3 volts. 0.85 amps.
Anode Voltage (at 2 metres) - - - 300 volts max.
Base - - - - - Standard British 5 pin

CHARACTERISTICS, EACH SECTION

Amplification Factor - - - - - 12.5
Mutual Conductance - - - - - 3.2 mA/V
Anode Impedance - - - - - 3,900 ohms
Anode Dissipation - - - - - 5 watts max.

Write for a free copy of the new list of Low Power Transmitting Valves

TRANSMITTING DIVISION

The Mullard Wireless Service Co. Ltd.

225 Tottenham Court Road, London, W.1

Price
25/-
Net

G5NI **DIRECT** DISTRIBUTOR

FOR
NATIONAL
HOWARD
HAMMARLUND
COLLINS
RME, ETC.

IMPORTANT

By buying from an Authorized Factory Distributor rather than a Company who purchases its merchandise in the open market, you get the latest instrument from the Factory and are registered with the Company as having purchased their merchandise. This ensures you maximum manufacturers' service after sale, and, in addition, the Distributor is supplied with the latest service bulletins in order that he, in turn, may pass on the advantages of such service. Remember, we are Authorized Distributors for the lines shown here and import direct from the respective Factories.

We are open to appoint a limited number of Distributors for the above lines and also "Raymart" short-wave components. Only firms capable of stocking and selling this merchandise are required.

RADIOMART

G5NI (B'HAM) LTD.

DIRECTORS: W. H. D. NIGHTINGALE L. NIGHTINGALE

THE SHORT-WAVE SPECIALISTS! The oldest importers of communication equipment. Direct Factory Authorized Distributors also for Bliley, Thordarson, Taylor, Raytheon, Eimac, Helntz & Kaufman Tubes, Hoyt Meters, Ohmite Resistors, Bassett Concentric Cable, etc., and we carry them in stock.

44, HOLLOWAY HEAD, BIRMINGHAM, I. Telephone: MIDLAND 3254

Two Types of Coil

sensitivity of this receiver is approximately 1 microvolt, it will be appreciated that noise in the receiver cannot be tolerated.

This type of construction is quite simple if the grid winding is connected across the filament pins with the primary across grid and anode pins. With

14-gauge wire on the small coils and the windings held rigid by some sort of celluloid cement, such as Durafix, there is no sign of movement while frequency drift or wobble is negligible even with the B.F.O. in circuit.

The R.F. Stage

Refer to the circuit of the receiver. In the first stage is one of the new Mullard EF8's R.F. amplifiers, which is A.V.C. controlled, but in addition has a gain control made up of a variable resistor with a value of 100,000 ohms. In order that maximum gain can be obtained at maximum travel, a fixed resistor, R₂, having a value of 200 ohms, is also included. This makes quite sure that when the gain control is turned fully clockwise, the valve is operating under optimum conditions.

The EF8 is very loosely coupled to the grid of a 6L7 mixer and it will be found that should this stage be over-coupled, there is quite a serious reduc-

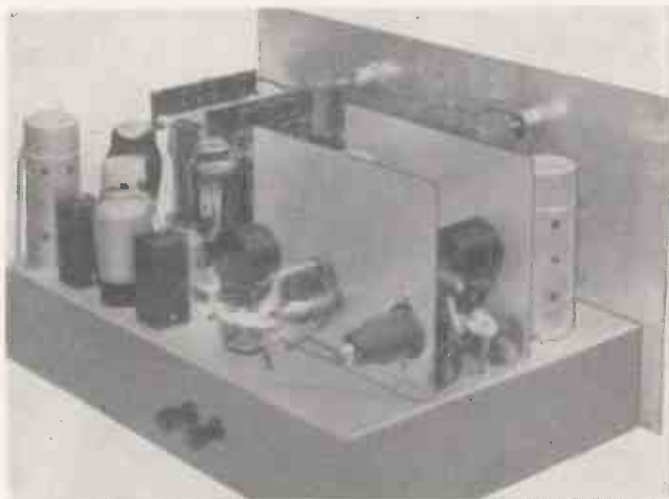

In the foreground is the EF8 R.F. amplifier which provides a high stage gain with a low noise level. This method of mounting is essential in order to provide complete stability.

The theoretical circuit does not fully explain the reasons for the exceptional performance provided by this receiver. Firstly, it was noticed that although plug-in coils wound on standard formers were quite satisfactory on 160 and 80 metres, the decrease in overall gain was most noticeable as the frequency was increased. To overcome this falling off in signal strength where it was particularly required, the coils covering the higher frequencies were air spaced and mounted on valve holders, as can be seen from the illustration. Each holder carries two coils, primary and secondary, with the exception of the oscillator, on which there is only one winding plus a cathode tap.

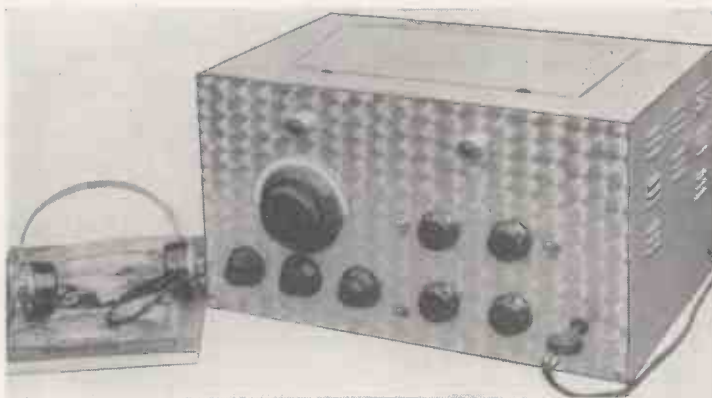

The receiver is fitted with R.F., I.F. and A.F. gain controls, stand-by switch, B.F.O. switch and three band setters.

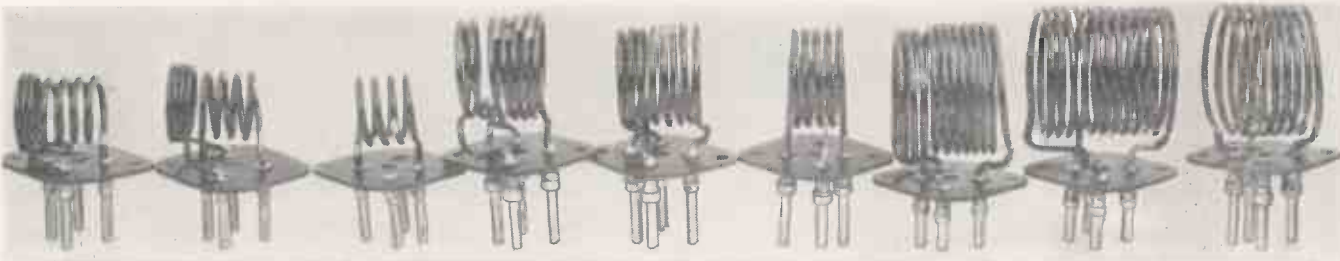

COIL TABLES

Range 1 : 4.5— 8 metres Range 2 : 9.5—17 metres	Range 3 : 16-28 metres Range 4 : 28-70 metres	Range 5 : 70-130 metres Range 6 : 125-190 metres
<p>Range 1</p> <p>L1 - 3T L2 - 4T L3 - 4T L4 - 4T L5 - 4T</p> <p>Tap 1 turn from ground</p> <p>½-in. coil dia. 14 gauge wire.</p>	<p>Range 2</p> <p>L1 - 2T L2 - 5T L3 - 3T L4 - 5T L5 - 5T</p> <p>Tap 2 turns from ground</p> <p>1½-in. coil dia. 14 gauge wire.</p>	<p>Range 3</p> <p>L1 - 4T L2 - 8T L3 - 4T L4 - 8T L5 - 8T</p> <p>Tap 3 turns from ground</p> <p>1½-in. coil dia. 16 gauge wire.</p>

Ranges 4, 5 and 6 are covered by coils wound on standard 1½ in. diameter plug-in formers and need approximately double inductance as compared with range 3 in each case.



Ceramic Crystal Holders.

Fresh supplies of this FB line now available.
Neat ceramic base, hand lapped plates, two sets of legs, to suit any form of valveholder or 2-pin socket.
The finest holder in the World at anything like the price, 7/6d.
We have a Troltitul 2-pin socket for the above, 3d.

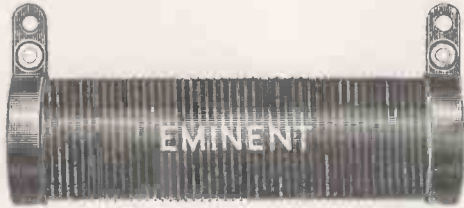

Eminent Resistors.

Fresh supplies are now coming to hand and this most popular line will soon be available in all wattages from 3 to 100.
Certain types are now fully in stock and deliveries are expected hourly of the types that have been difficult to get in the past.
Although we have sold over 27,000 of these resistors in the past four months we have yet to receive news of the first failure under proper working conditions.

All types are priced in our List. Send 1d. stamp for a copy.

NEW RAYTHEON VALVE PRICES.

Don't pay more, it's quite unnecessary.

2A3	5/8	2A5	4/11	2A6	4/11	2B7	5/8	5Z3	3/7	6A3	5/8
6A5	5/8	6A6	4/11	6A7	4/6	6A8	4/11	6B7	4/11	6C5	3/8
6C6	3/8	6D6	3/8	6E5	4/11	6E6	5/6	6F5	4/6	6F6	4/6
6F7	6/9	6G5	4/11	6H6	3/7	6J5	3/7	6J7	4/6	6K7	4/6
6K8	5/6	6L6G	6/9	6L6	7/6	6L7	5/6	6N7	5/8	6N6	6/2
6N7	5/8	6Q7	5/6	6R7	5/6	6Y6	4/6	41	3/7	42	3/8
45	3/7	46	5/6	47	4/11	53	6/2	56	3/7	57	4/6
58	4/6	59	6/9	80	2/6	83	4/6	83V	4/6	89	6/9

These tubes are standard, first grade Raytheons, imported direct from the factory.

We hold large stocks of the other Raytheon tubes, including most of the popular R.K. types for transmitting and the 1851, 1852 and 1853 Television tubes. On all Raytheon lines we can give Traders, Service Men and Dealers excellent Discounts.

We also stock Gammatrons, Taylors and R.C.A. series.

It is impossible to list everything, but we have a five-page List of Ham Lines. Send 1d. stamp for copy.

GENEROUS DISCOUNTS TO TRADERS ON ALL THESE LINES.

We can offer Break-in, Keying and other Relays, from stock. These relays work on 230 A.C. circuits for coil energising.

Transito Bushes.



This handy little ceramic bush, with a spring lock washer to hold it "put," is again available. Takes 12 gauge wire if necessary. 1/- per packet of 10, complete with washers.

Here is a line of dry electrolytics that you can afford to buy. In spite of the price they are good. 550 volt wkg. 750 peak.



In every case the can is "Dead."

2 wire type :

- 8 mfd. 2/-
- 12 mfd. 2/3d.
- 16 mfd. 2/6d.

3 wire type :

- 2 x 8 2/6d.
- 2 x 12 3/6d.
- 2 x 16 4/-

4 wire type :

- 2 x 8 3/-
- 2 x 12 3/7d.
- 2 x 16 4/3d.

Other types in profusion, see our List for full range.

These condensers are the product of the famous French firm of Helgo, and Hamrad have the sole British rights for the Amateur and Replacement trades.



Valveholders in Ceramic, Troltitul, Amenit and Paxolin.
Ceramic, Troltitul and Amenit, all types 6d. each. Paxolin : 4-pin, 2½d. ; 5-pin, 2½d. ; 6-pin, 3d. ; 7-pin, 3½d. Octals, 4d.

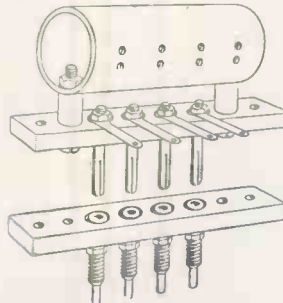

Coil formers. Callt insulation. Former 1" x 2½".
Complete as shown 3/6d.
Without base 2/6d.
Base only 1/-.



Here is a new range of resistors specially designed to save space. Dimensions 1½" long by ½" diameter. Wound on ceramic.

Each value of resistance is rated to carry 36 mills.

Up to 10,000 ohms, 1/6d. 12,000 ohms, 1/7d. 15,000 ohms, 1/8d. 30,000 ohms, 2/2d. 40,000 ohms, 2/4d.

These resistors have been fully tested, at full load, for six weeks' continuous running.

At the conclusion of the test they were still up to standard.

Troltitul Switches.

We are now able to offer an improved type of this popular line.

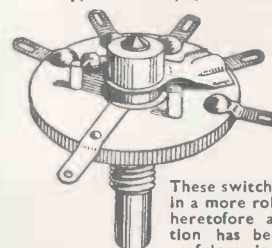

- 2 way, 1/3d.
- 3 way, 1/5d.
- 4 way, 1/6d.
- 5 way, 1/7d.
- 6 way, 1/8d.
- 7 way, 1/9d.
- 8 way, 1/10d.
- 9 way, 1/11d.

Delivery of most types from stock

These switches are now made in a more robust manner than heretofore and special attention has been paid to their usefulness in R.F. switching.

HAMRAD WHOLESALE LTD.

(G-8KZ, G8-ZD. 2FY5)

32 St. Lawrence Terrace, W.10.

LADbroke 1166-7-8

4-volt and 6.3-volt Valves

tion in signal strength. For this reason, it is well worth while experimenting with the primary coil, although should the data on the coil designs be followed no difficulty will be experienced. Actually, the size of the valve base on which the coil is mounted re-

I.F. stage is used in order to keep noise level to an absolute minimum, but by coupling the secondary of T₁ to the primary of T₂ via VC₉, the selectivity is, if anything, better than that obtained with two I.F. stages.

At any rate, the selectivity given is

give appreciably less gain while the later type pentodes, designed for use in American television receivers, are rather difficult to stabilise and in this particular circuit were not found to be of great value.

The second detector circuit is quite

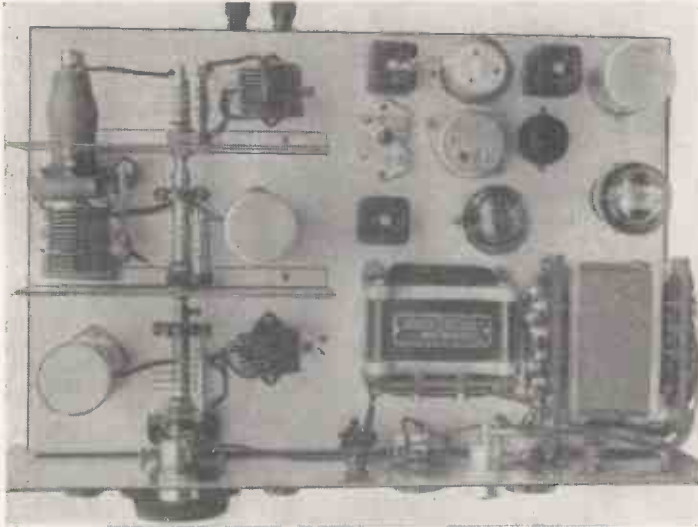

This plan view shows how the components are laid out, particularly in the R.F. and detector-oscillator stages.

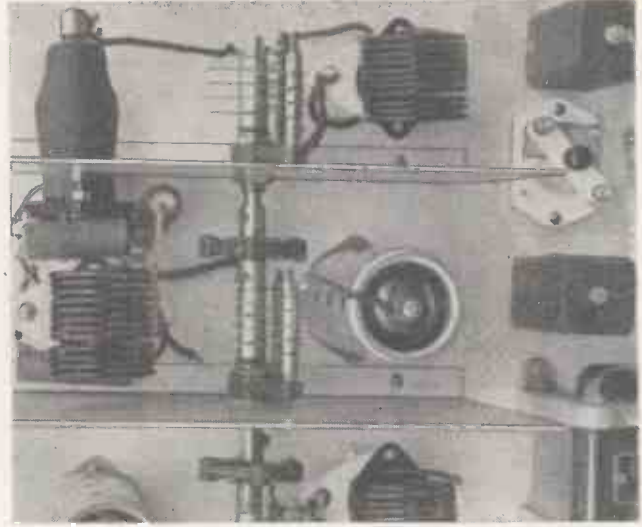

This close-up view shows the detector and R.F. stages and a special coupling condenser on the right which governs the selectivity of the I.F. stage.

sonably well governs the coupling between L₃ and L₄.

Mixer

Originally it was intended to use a triode hexode detector-oscillator but there were always signs of frequency drift until the receiver had completely warmed, which was particularly noticeable on C.W. However, the 6L7 mixer with a 6J7 H.F. oscillator provides a good combination which after a few minutes heating period stays put as regards frequency drift.

As previously explained, only one

more easily used than by having peaked I.F. transformers. A fair measure of selectivity control is obtained by means of VC₉ although when used at maximum capacity, the absence of skirt to the signal is most marked.

Mixed Valve Types

It will be noticed that American and British valves are used in this circuit, the reason being that the VP4B specified for an I.F. amplifier is so very docile. There is no exact American counterpart for the lower slope valves

straightforward being made up of a 6Q7 double-diode triode, having the A.F. gain control in the grid of the triode section. As can be seen S₁ is the A.V.C. switch, which is used to cut out A.V.C. control when the B.F.O. is in circuit. The B.F.O. is actually coupled directly to one of the diodes in the 6Q7 but not so that it applies D.C. voltage to this diode. Actually, the connecting link is terminated in a single turn around the diode lead. This very small capacity coupling is ample, for should it be increased, it is inclined to bring up background noise when in circuit. At this point it is well worth suggesting that should the output from the B.F.O. be heavy, the noise is bound to come up, so that it would be a good scheme to make resistor, R₂₆, variable so that the output from the B.F.O. can be increased if required to beat up a strong signal.

Resistor R₂₀ in the grid circuit of the output pentode is not as it may seem on the surface a gain control, but part of the tone correction circuit which is particularly smooth in operation. The resistance and condenser values, however, must be strictly adhered to.

Headphones are connected in the output circuit of the pentode, and although this is not generally considered the best position, I have found it an advantage to have maximum output available when required. In any case, no D.C.

(Continued on page 310)

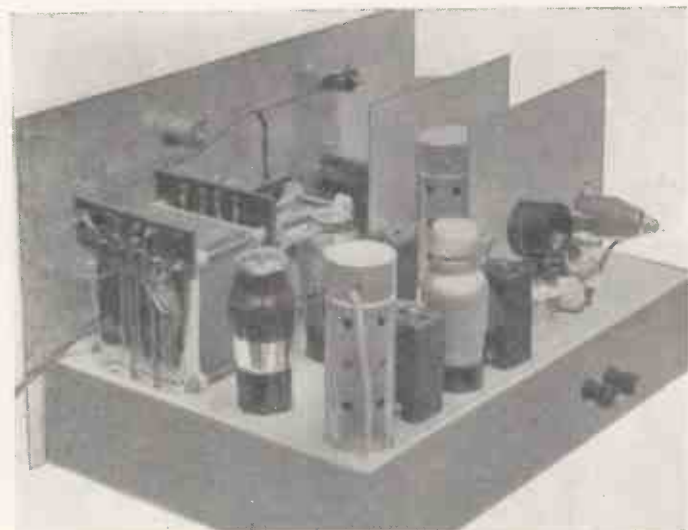

In the foreground of this is the double-diode triode second detector and output pentode. The transformer shown is home-built but a satisfactory substitute is given in the specification.

Radio Society Activities

Will Hon. Secretaries of Radio Societies who wish for news to appear in this column please send the information before the 15th of the month.

The Sussex Short Wave and Television Club.—A series of interesting lectures have been given to members of this society, while a complete series is being arranged for the winter months. Amongst the lectures given was one by E. J. Williams, B.Sc., G2XC, on "Sun Spots and Freak Storms and their effects on radio reception." There has also been a lecture on "Voigt High Quality Amplifiers" and a demonstration of their latest unit. Over 20 members were taken to Murphy Radio, Ltd., and shown over the factory. They were given a lecture and demonstration on television, and also a technical discussion on ultra-short wave topics. The president of this society is the well-known amateur Gerald Marcuse, G2NM, while the honorary secretary, from whom all information can be obtained, is C. J. Rockall, G2ZV, "Aubretia," Seafield Road, Rustington, Sussex.

Romford and District Amateur Radio Society.—New headquarters have now been obtained for this society at the Red Triangle Club, North Street, Romford.

Their meetings are held on Tuesday evenings at 8.30 p.m. A team was entered for the direction-finding competition organised by the Brentwood society and third place was obtained. The secretary is R. Beardow, G3FT, who will supply full information on the activities of this club. His address is 3 Geneva Gardens, Cladwell Heath. Members include nine with radiating permits, 15 with artificial aerial permits and a large number of enthusiastic short-wave listeners. Morse practice is given to all who are endeavouring to obtain a radiating permit or who wish to pick up C.W. transmissions.

Fulham Men's Institute.—A Radio society has been formed by the above institute and includes thirty members. They meet every Monday evening from

Ensure obtaining "Television and Short-wave World" regularly by placing an order with your newsagent.

8 to 10 p.m. and have technical talks and demonstrations, do constructional work and receive Morse instruction. Subscriptions are 1s. 3d. a term or 3s. 9d. a year, and all interested are invited to call or write for details. The instructor-cum-secretary of this club is C. G. Childs who can be reached at the Fulham Men's Institute, Beaufort House School, Lillie Road, S.W.6.

Edgware Short-wave Society.—It is understood that this society will help run the National Field Day 20-metre station organised by the R.S.G.B. Amongst the operators are C6ZO, G2QY, G3HT and G6PM. Discussions are being held as to the type of equipment and aerials to be used and the site has been fixed at Moat Mount, which is close to the Barnet By-pass Road

Southend and District Radio and Scientific Society.—Hon. Secretary, J. M. S. Watson, 23 Eastwood, Boulevard, Westcliff, Essex.

**CETRON
PHOTO ELECTRIC CELLS**

15/- EACH

**UNIVERSAL ELECTRICAL Co.,
221 CITY ROAD, LONDON, E.C.1**

NEW



DM-36 by R.M.E.

AND



DB-20-70

The DM-36 is a unit designed especially for the station which wishes to gain the ultimate in reception on the 5 and 10-metre bands. This unit is new—new in design, use of tubes, and construction.

The DM-36 when used in combination with any good superheterodyne receiver, capable of tuning 10,000 kc. (30 metres), provides an approximate gain of 20 decibels on the 5 and 10-metre ranges. This unusual gain is attributed to several factors. Among these being the use of the new 1852 type tube in the R.F. circuit, the incorporation of ceramic insulation in the construction of the switch sections, and the provision of a dual antenna input circuit providing a means of not only matching input impedances exactly, but also a way in which a permanent 5-metre antenna may be installed along with a lower frequency system.

OTHER R.M.E. UNITS



COMBINATION DB-20-70

Besides the factors contributing to the overall gain of the unit, RME engineers have also paid definite attention to the stability of the DM-36.

From the mechanical standpoint stability is gained by the use of a cast aluminium chassis frame; electrically, a triode oscillator (6L5) in a circuit designed especially for the ultra-high frequencies is largely responsible for the stability.

Other features found are the exceptional band spread for 5 and 10 metres, ease of operation by the placement of all controls on the panel, and the built-in power supply enabling this unit to be self contained.

SEE THESE UNITS AT:

WEBB'S RADIO,

14, SOHO STREET,
OLD STREET,
LONDON, W.

The DB-20, a high gain preselector by RME, is very well known, and the DB-20-70, which is identical to the standard DB-20, is designed to match the panel details of the RME-70.

In combination the RME-70 may be had mounted with the DB-20-70 in one long cabinet. Convenience, appearance, and performance make this unit a true standout. Other combinations are also available.

Additional information on any RME product may be had by calling on your dealer or by writing directly to our factory.

RADIOMART Ltd.,
44, HOLLOWAY HEAD,
BIRMINGHAM, 1

**RADIO MFG. ENGINEERS — 111 Harrison Street
Peoria, Illinois — U.S.A.**

These units will be on display at our distributors in England.

We invite you to give them a thorough inspection.

“Building 8-valve Amateur-band Receiver” (Continued from page 308)

voltage is applied to headphones, as a choke filter circuit is included. Across the choke in this filter is a resistance-condenser network which attenuates top notes to a reasonable level.

As headphones are regularly used with this set, the smoothing circuit had to be such that it completely filtered all trace of A.C. ripple. For this reason C22 and C23 have a combined capacity of 16 mmfd. but should it be found that there is still slight hum, it is advisable to experiment with the position of the mains transformer rather than to add further capacity to the smoothing circuit.

As regards switches, S1 is A.V.C. control, S2 stand-by, S3 mains switch, and S4 B.F.O. switch. These are connected in the conventional manner and have not been made part of the variable resistors, it was found that this occasionally made for long leads and could induce hum into the grid circuit of the double-diode triode.

Coils

Constructional details have been given for coils covering three ranges, which are the important ones as they are mounted on valve holders. However, the constructors can build coils on plug-in formers up to 190 metres, and the appropriate windings can quite easily be obtained by doubling the turns given for range 3. By this I mean range 4 would have twice the amount of turns for R3, and range 5 twice the amount of turns as for range 4. This, however, is inclined to be rather generous for primary turns, so when the coils have been adjusted for coverage the coupling between primary and secondary should be carefully checked. It is also advisable to vary the tap point on L5 which is quite easily done if this coil is wound with tinned copper wire.

Particular care should be taken with the fitting of the screens dividing the R.F. detector and oscillator stages, for these must be rigid. As the band spreading condensers are mounted on the screens, the spindles on the condensers should be cut short so that there is a fair amount of pull on the coupler. It is also essential that the resistors and condensers in the R.F. stage be connected as closely as possible to the valve pins in order to maintain complete stability.

Although the band setting condensers are not fitted with large dials, small graduated scales have been used, while each spindle is fitted with a reduction drive. The oscillator condenser is particularly selective, so that this should be resonated first with the R.F. and detector coils brought into resonance afterwards. This is quite easily done

and afterwards it is merely a matter of calibrating the oscillators, band set condenser in order to know just where the various ham bands are situated on the main tuning dial.

L6 has not been referred to for this is a commercial coil, actually an Eddystone B.F.O. unit, which includes the

setter, mixer band setter, B.F.O. switch, R.F. gain, A.F. gain, phone jack. Above the B.F.O. switch is the stand-by switch, next to which is the I.F. gain, to the right of which is the tone control and the final switch for the mains primary.

Two dial lights have been arranged

Components for

AN 8-VALVE AMATEUR BAND RECEIVER

BEAT-FREQUENCY OSCILLATOR UNIT

- 1—Type 1119 (L6) (Eddystone).
- CHASSIS, PANEL AND CABINET.**
- 1—Steel chassis finished grey type T8 (Peto-Scott).
- 1—Steel panel finished grey type T8 (Peto-Scott).
- 1—Special cabinet with hinged lid type T8 finished grey (Peto-Scott).

COIL FORMS.

- 3—4 pin type CT4 (Raymart).
- 3—4 pin type CF4 (Raymart).

CONDENSERS, FIXED.

- 1—.1 mfd. type 4603/2 (C1) (Dubilier).
- 1—.1 mfd. type 4603/s (C2) (Dubilier).
- 1—.1 mfd. type 4603/s (C3) (Dubilier).
- 1—.1 mfd. type 4603/s (C4) (Dubilier).
- 1—.1 mfd. type 4603/s (C5) (Dubilier).
- 1—.1 mfd. type 4603/s (C6) (Dubilier).
- 1—.1 mfd. type 4603/s (C7) (Dubilier).
- 1—.1 mfd. type 4603/s (C8) (Dubilier).
- 1—.1 mfd. type 4603/s (C9) (Dubilier).
- 1—.1 mfd. type 4603/s (C10) (Dubilier).
- 1—.1 mfd. type 4603/s (C11) (Dubilier).
- 1—.0001 mfd. type 4601/s (C12) (Dubilier).
- 1—.25 mfd. type 25 v. working. 3016 (C13) (Dubilier).
- 1—.03 mfd. type 4601/s (C14) (Dubilier).
- 1—.0001 mfd. type 4601/s (C15) (Dubilier).
- 1—.01 mfd. type 4601/s (C16) (Dubilier).
- 1—.10 mfd. type 4609/s (C17) (Dubilier).
- 1—.01 mfd. type 4601/s (C18) (Dubilier).
- 1—.0001 mfd. type 4601/s (C19) (Dubilier).
- 1—.25 mfd. type 25 v. working. 3016 (C20) (Dubilier).
- 1—.002 mfd. type 4601/s (C21) (Dubilier).
- 1—.8 plus 8 mfd. type 500 v. working 0288 (C22 & C23) (Dubilier).
- 1—.1 mfd. type 4603/s (C24) (Dubilier).
- 1—.1 mfd. type 4603/s (C25) (Dubilier).
- 1—.1 mfd. type 4603/s (C26) (Dubilier).
- 1—.mfd. type 4603/s (C27) (Dubilier).
- 1—.1 mfd. type 4603/s (C28) (Dubilier).
- 1—.1 mfd. type 690W (C29) (Dubilier).
- 1—.1 mfd. type 4609/s (C30) (Dubilier).
- 1—.0001 mfd. type 4601/s (C31) (Dubilier).

CONDENSERS, VARIABLE.

- 1—40 mmfd. type VC40X (VC1) (Raymart).
- 1—40 mmfd. type VC40X (VC2) (Raymart).
- 1—40 mmfd. type VC40X (VC3) (Raymart).
- 1—18 mmfd. type 1094 (VC4) (Eddystone).
- 1—18 mmfd. type 1094 (VC5) (Eddystone).
- 1—18 mmfd. type 1094 (VC6) (Eddystone).
- 2—Trimmer condensers (in I.F. transformers) (VC7 and 8).
- 1—40 mmfd. type UTC (VC9) (Peto-Scott).
- 4—Trimmer condensers (in I.F. transformers) (VC10 to 13)

CHOKES.

- 1—Type WWC1 (LFC1) (Sound Sales).
- 1—LF218 (LFC2) (Bulgin).

DIAL LAMPS.

- 1—Type D0 Green (Bulgin).
- 1—Type D0 Red (Bulgin).

HOLDERS, VALVE.

- 1—8-pin side contact type VH24 (Bulgin).
- 4—8-pin ceramic octal type chassis less terminals (Clix).
- 2—8-pin chassis ceramic type less terminals (Clix).
- 1—4-pin chassis ceramic type less terminals (Clix).
- 9—4-pin type VH43 (for coil bases) (Bulgin).
- 3—4-pin type 1073 (for coil bases) (Eddystone).

HEADPHONES.

- 1—Pair type “A” (S. G. Brown).

KNOBS.

- 4—Type 1089 (Eddystone).
- 3—Type K106 (Bulgin).

JACK.

- 1—Insulated open circuit (Premier).

RESISTANCES, FIXED AND VARIABLE.

- 1—500,000 ohm type 1/2 watt (R1) (Bulgin).
- 1—200 ohm type 1 watt (R2) (Bulgin).
- 1—100,000 ohm variable type B (R3) (Dubilier).
- 1—500 ohm type 1 watt (R4) (Bulgin).
- 1—15,000 ohm type 1 watt (R5) (Bulgin).
- 1—500 ohm type 1 watt (R6) (Bulgin).
- 1—50,000 ohm type 1 watt (R7) (Bulgin).
- 1—50,000 ohm type 1 watt (R8) (Bulgin).
- 1—500,000 ohm type 1/2 watt (R9) (Bulgin).
- 1—200 ohm type 1 watt (R10) (Bulgin).
- 1—5,000 ohm type B variable (R10) (Dubilier).
- 1—300 ohm type 1 watt (R11) (Bulgin).
- 1—20,000 ohm type 1/2 watt (R12) (Bulgin).
- 1—250,000 ohm type 1/2 watt (R13) (Bulgin).
- 1—1 megohm type 1 watt (R14) (Bulgin).
- 1—250,000 ohm variable type B (R15) (Dubilier).
- 1—100 ohm type 1/2 watt (R16) (Bulgin).
- 1—500 ohm type 1 watt (R17) (Bulgin).
- 1—50,000 ohm type 1 watt (R18) (Bulgin).
- 1—100,000 ohm type 1 watt (R19) (Bulgin).
- 1—500,000 ohm variable type B (R20) (Dubilier).
- 1—100 ohm type 4 watt (R21) (Premier).
- 1—10,000 ohm type 1/2 watt (R22) (Bulgin).
- 1—400 ohm type 3 watt (R23) (Dubilier).
- 1—50,000 ohm type 1/2 watt (R24) (Bulgin).
- 1—50,000 ohm type 1 watt (R25) (Bulgin).
- 1—50,000 ohm type 1 watt (R26) (Bulgin).
- 1—50,000 ohm type 1 watt (R27) (Bulgin).
- 1—50,000 ohm type 1 watt (R28) (Bulgin).

SWITCHES.

- 4 Toggle type S80T (Bulgin).

SUNDRIES.

- 3 Coil cans type VS (Raymart).
- 1 Anode connectors type 1224 (Belling-Lee).
- 3 Anode connectors type 1173 (Belling-Lee).
- 2 Terminals type B marked “Aerial” (Belling-Lee).
- 5 Adjustable couplers type 1009 (Eddystone).
- 3 Extension outfits type 1008 (Eddystone).
- 1 Plug type P15 (Bulgin).
- 1 Slow-motion drive for quarter spindle.
- 1 Mains plug type 29 (Clix).
- 3 Slow-motion heads (Peto-Scott).
- 4 Lengths quickwire (Bulgin).
- 1 Coil screened wire (Bulgin).
- 1/2 lb. 16 gauge enamelled covered wire (Peto-Scott).

TRANSFORMERS, I.F.

- 3 Type fixed coupling (Alladin—Webbs Radio).

TRANSFORMERS, MAINS.

- 1 Special type to give:
 - 250-0-250 at 80 mA.
 - 2-0-2 volts at 3 A.
 - 2-0-2 volts at 2.5 A.
 - 3.15-0-3.15 volts at 2.5 A. (Premier).

VALVES.

- 1—EF8 (V1) (Mullard).
- 1—6L7 (V2) (Premier).
- 1—VP4B (V3) (Tungsram).
- 1—6Q7 (V4) (Premier).
- 1—APP4C (V5) (Tungsram).
- 1—MU12 (V6) (Osram).
- 1—6J7 (V7) (Premier).
- 1—6J7 (V8) (Premier).

parallel tuning condenser and grid condenser and leak. No provision has been made for a pitch control for the B.F.O., but it is not difficult to use an Eddystone flexible cable, which can be brought out to the front panel if pitch control is required.

Refer a moment to the illustration showing the controls of the receiver. From left to right along the bottom are R.F. band setter, oscillator band

so that the green one is brought into circuit when the mains have been switched on and the red one when H.T. voltage has been applied.

The dial I have used is not a standard product. It is essential that a reasonable reduction be used of at least 9/1 or 10/1, but a dial having a reduction of about 100/1 is not too satisfactory in view of the low capacity of the band-spread condensers employed.—J.T.R.

TROPHY All British Communication GEAR

NEW PRESELECTOR

All the advantages of the best Preselector at half the usual cost.



- ★ 2 stages using EF8 valves.
- ★ 5 bands—7-550 metres.
- ★ S/M tuning—800° in 1° steps.
- ★ Frequency calibrated scale.
- ★ Self-powered for A.C. 200/250 v.

This new PRESELECTOR can be used with any TROPHY receiver or in front of any mains or battery-operated straight or superhet instrument. Two low-noise R.F. pentodes are employed giving greatly increased range, selectivity, signal strength and considerable image suppression, factors of sufficient importance to merit the use of the TROPHY PRESELECTOR with any existing receiving gear. Three controls, combined on-off Switch and R.F. Gain, Band Switch and Tuning. TERMS: 11/9 deposit and 12 monthly payments of 11/7.

£6. 15s.

Writes V. G. P., of Cambridge:—"I would back my TROPHY 8 against any American similar types offered at much higher prices in this country."

TROPHY 8

- 8 Valves.
- 5 Bands, 7-550 metres. Complete coverage.
- Continuous Band-Spread Dial.
- R.F. on all bands. A.V.C. and B.F.O. switches.
- Stand-by switch.
- Pitch control.
- High impedance output sockets for separate P.M. speaker.
- Headphone jack.

GUARANTEED 12 months, valves included. TROPHY'S are available from all good Dealers and all models are obtainable on easiest terms.

TROPHY'S FROM £5/15/0 UPWARDS

A.C. COMMUNICATIONS TYPE RECEIVER

The TROPHY 8, designed and produced by British specialists in short-wave technique, provides an extremely high order of efficiency. At low cost, the TROPHY 8 fully meets the requirements of the majority, including transmitting amateurs, the large number of short-wave enthusiasts and all those seeking a second receiver for home use for reliable all-world short-wave listening. Complete in cabinet as illustrated, aligned and ready for immediate use on A.C. 200/250 v. supplies. TERMS: 15/6 deposit and 18 monthly payments of 15/6.

12 Gns.

IMMEDIATE DELIVERY



STEEL CABINETS now available at the request of experimenters.

Two types, supplied with lift-up lid and separate heavy gauge un-drilled panel: Type T.8, 17½ in. × 9½ in. × 12 in. deep, 21/- (3/6 extra for part carriage and packing). Type E, size 11 in. wide by 6 in. high by 9 in. deep, 15/-, carriage paid.

77 (T12), CITY ROAD, LONDON, E.C.1. Tel.: CLIssold 9875.
41 (T12), HIGH HOLBORN, W.C.1. Tel.: H L 3248.

SEND NOW for details covering the complete range of TROPHY'S which, in addition to the above, includes 3-valve for battery and A.C. mains, 5-valve and 6-valve (with electrical band-spread) models and a TROPHY 8 for alternate use on 6 volt or A.C. 200/250 v. supplies.

PETO-SCOTT CO. LTD.

COMBINED H.T. POWER PACK

for sound and vision receiver,
time base, and cathode-ray tube

Full details of this interesting circuit are given in "The All Metal Way, 1939." Write to Dept. T. today for your copy.

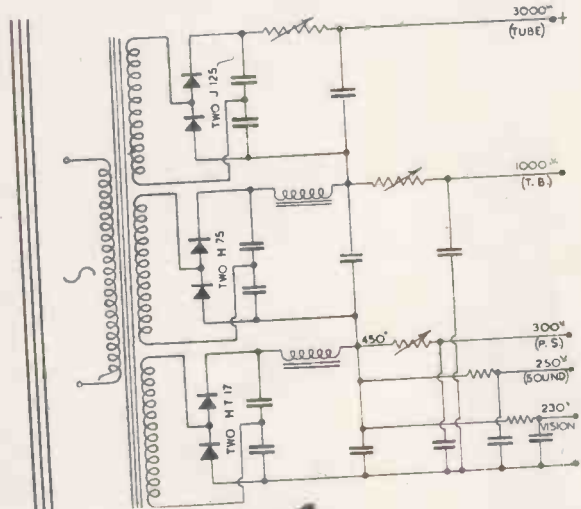

Westinghouse
METAL RECTIFIERS

WESTINGHOUSE BRAKE & SIGNAL CO., LTD., 82, York Way, King's Cross, London, N.1.

Crystal-oscillator Circuits for Experimenters

In view of the increasing interest in crystal control on the ultra high frequencies this part of the article should be of use to amateurs as it discusses Bliley 10-metre crystal units.

THE first part of this article was published in the April issue. The final section of the article dealt with the tri-tet oscillator which is continued below.

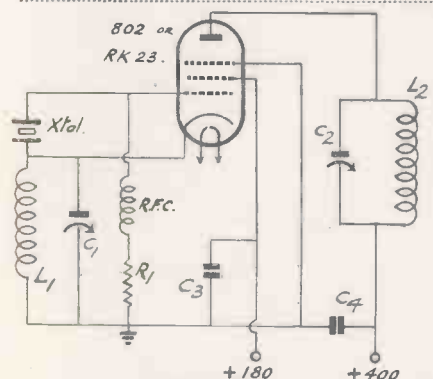

Fig. 4. Tri-tet oscillator-doubler for 5-metre output.

The anode circuit must have a capacitive reactance to satisfy conditions for oscillation. A capacitive reactance can be obtained with a detuned tank, an R.F. choke having a resonant frequency lower than the crystal frequency, or a resistance. A pure resistance, of course, has no reactance, and by itself would not satisfy the conditions for oscillation. The internal anode-to-grid capacity of the valve is in parallel with the resistance, and this provides the necessary capacitive reactance. For the amateur frequencies a 2.5 Mh. or 2.1 Mh. R.F. choke is generally employed while a considerably large inductance is required at lower frequencies.

The crystal current, as in other circuits, will be influenced by the amount of grid bias. Bias, when using pentode or tetrode valves, can be obtained with a grid-leak resistor alone or in combination with a cathode resistor. Best performance is generally obtained with the combination of grid-leak and cathode bias. In the triode circuit grid-leak bias is best. The grid resistor, in either case, should be limited to a maximum of 50,000 ohms for crystal above 1,500 kc., while 100,000 ohms is better at lower frequencies. It is possible to reduce the crystal current by employing a low value grid resistor in series with the R.F. choke. This, however, is not always satisfactory because the circuit may oscillate as a tuned-anode tuned-grid oscillator, with the grid and anode chokes determining the frequency. When adding cathode bias,

the resistor must be considerably smaller than would be employed with other circuits. About 250 ohms is sufficient.

Tuned tanks are not required in the simple Pierce circuit and, therefore, a rather wide range of crystal frequencies can be used without any serious change in circuit values. This is advantageous in some types of transmitters but limits the choice of crystal frequencies to fundamental crystals. Harmonic cuts will oscillate at their fundamental rather than the intended harmonic frequency. The outstanding advantage of the Pierce circuit is simplicity of circuit components. It is limited, however, to low power outputs and requires careful circuit adjustment to prevent excessive excitation.

Pierce Oscillator-multipliers

Pentode or tetrode valves can be used in a crystal-oscillator frequency-multiplier circuit with a Pierce oscillator rather than the conventional triode oscillator as employed in the tri-tet. A circuit of this type is illustrated in Fig. 6. In the Reinartz arrangements of

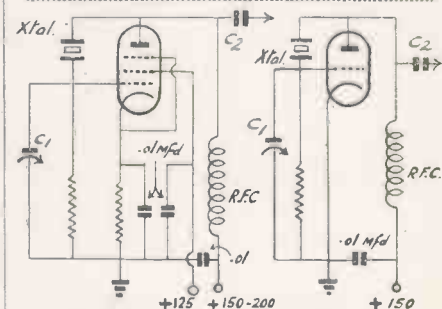

Fig. 5. Pierce crystal-oscillators.

this circuit, the tank, L_2 , C_2 , is tuned to approximately $1\frac{1}{2}$ times the crystal frequency. With the Jones' arrangement, a small R.F. choke is tuned, by an associated condenser, to a frequency in the neighbourhood of 300 kc.

Both arrangements have the same essential characteristics and give outputs comparable to the tri-tet. At frequencies below 4,000 kc., the cathode capacity C_2 may have any suitable value from 100 mmfd. to 250 mmfd. The circuits are quite critical at higher frequencies, however, and the value of C_2 becomes an important factor. For each type of valve, tank L/C ratio, degree of loading, and crystal, there is an optimum value of C_2 which will give greatest power output consistent with

good circuit stability. If C_2 is smaller than the critical capacity, there will be a strong tendency to develop parasitics, especially with beam-power valves, and the crystal current will be high. It is possible for these parasitics to become sufficiently tense to fracture a crystal. Capacities greater than the critical value will result in lowered crystal current and decreased power output. C_2 should preferably be a variable condenser so that best operating conditions can be determined. It should have a value of at least .000025 mfd. In some instances, it may be necessary to increase the capacity to as much as .0005 mfd. for proper performance.

In addition to influencing the crystal current and circuit stability, C_2 affects the power output at harmonics. At the higher harmonics, greatest power output is obtained with low values of C_2 . It must be remembered, however, when operating the circuit on a harmonic with a low value of C_2 , the capacity must be increased when changing to fundamental operation. The conditions for best harmonic output are not correct for fundamental operation and excessive excitation may result.

The oscillator portion of this circuit, like the simple Pierce circuit, has no positive choice of crystal frequency. Harmonic type crystals, therefore, will oscillate at the fundamental rather than the calibrated frequency. When the output is tuned to the crystal frequency, the operating characteristics are similar to the tri-tet, that is, the crystal current rises with load and excessive feedback can result when valves with insufficient internal shielding are employed.

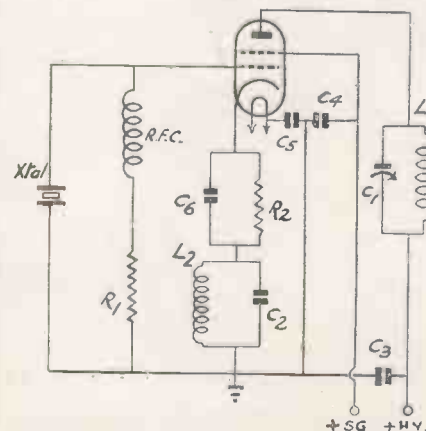

Fig. 6. Pierce oscillator-multiplier circuit.

TELEVISION - -

TRANSFORMERS

SOUND SALES specialise in the design and production of Special Transformers for all purposes, including MODULATION, MAINS, L.F. and all types of low frequency transformers, together with an amazing selection of Chokes, including the famous Type "W.W." C.I. as specified for the 8-valve Amateur Communication Receiver described in this issue. In addition, we are concentrating on the design and production of TELEVISION Transformers for use in the H.T., Time Base and Vision, also Frame and Line circuits.

Since we are enjoying the patronage of nearly every well known Laboratory in the country, this advertisement may only be a reminder to the majority of our Readers, so it is appropriate to conclude by thanking everybody for their patronage, which has resulted in record breaking activities in this section of our works.

MAY WE HAVE THE PLEASURE OF
YOUR ENQUIRIES ?

Specified by  the Experts
SOUND SALES
LTD.

Marlborough Rd., Upper Holloway, LONDON, N.19
(Contractors to the G.P.O., etc.)

Hours of Business— Tel.: Archway 1661/2/3
Monday to Friday, 8.30 a.m. to 6 p.m. SATURDAYS CLOSED

A Radio Message



TYPE "A"
50/- Per Pair

Specified for the
8-VALVE AMATEUR
COMMUNICATION
RECEIVER
described in this Issue.

Used by H.M. Royal Navy, British and Foreign Air Services, the B.B.C., etc., and by radio amateurs throughout the world. Descriptive Leaflet "T-S" Free on request.

S.G. Brown Ltd.
VICTORIA ROAD, NORTH ACTON, W.3
Telephone: ACOrn 1174

...THE ACKNOWLEDGED
SUPERIORITY OF
S.G. BROWN TYPE "A"
HEADPHONES WITH
ADJUSTABLE REED IS
ACCOUNTED FOR BY
THE EXCELLENCE OF
THEIR DESIGN AND
CONSTRUCTION. THEY
CAN BE RELIED UPON
FOR PERFECT RECEPTION
UNDER THE MOST
SEVERE CONDITIONS
OF USE.

SENSITIVITY (Frequency response
approx. 25-16,000 c.p.s.)
MOVEMENT (Dust and damp proof)

THIS MONTH'S SPECIAL LIST OF
DEMONSTRATION SOILED
AND SECOND-HAND BARGAINS

HALLICRAFTERS SUPER SKYRIDER SX-16, little used, perfect condition, crystal model, £24.

HALLICRAFTERS SKY BUDDY S-19, brand new, £7 10s.

NATIONAL NC-80-X, slightly shop-soiled only, complete with speaker in cabinet, £21.

NATIONAL NC-101-X, Ham band special, complete with speaker in cabinet, £26 10s.

NATIONAL NC-100, New, complete with speaker, £26 10s.

EDDYSTONE ECR, new type with noise suppressor, very little used, complete with super speaker, £38.

EKOK Add-On Television unit, practically unused, £17 17s.

NEW COMPONENTS.

A.C.S. "N.K." Transmitter Racks, all welded construction, 2 section, 21 in. table model, 15/-. 3 section, 31½ in, 17/6. These are the strongest racks on the market.

A.C.S. "Rex" neutralising condensers, Trolitul insulation, capacity 1-21 mmfd., 4/6.

All **HAMRAD** and **EDDYSTONE** components available ex stock. Send for full lists of receivers, transmitting and receiving components, etc., to :-



A.C.S. RADIO TECHNICAL
MANAGER **G2NK**
16 GRAYS INN ROAD, LONDON, W.C.1
Telephone: HOLBORN 9894-5

PIEZO QUARTZ
CRYSTALS

* 1.7 m.c., 3.5 m.c., and 7.0 m.c., Amateur Bands.

* **Power Type** Standard Type
20/- post free. 15/- post free.

CRYSTAL HOLDERS:—

* **Type U**, Holder 6/- Base 1/3.
Type A, Open Electrodes 4/6 post free.
Type B, Totally enclosed and dustproof 8/6 post free.

* Specified for the "2-VALVE LOW-POWER 1X."

THE QUARTZ CRYSTAL CO., LTD.

63 & 71 KINGSTON ROAD, NEW MALDEN, SURREY.

Telephone: MALDEN 0334.

SEND FOR NEW 1939 LIST OF
S.W.R. Specialities, Just Issued.

EVERYTHING FOR THE TRANSMITTER

All Eddystone components in stock.

Authorised stockists of:

ALL HALLICRAFTER SETS, Sky Champion 15 guineas. **HOWARDS**, Model 430, 9½ guineas. Model 438, £15. 10. Crystal £2 extra. Model 450A, 30 guineas. **EDDYSTONE**, Model E.C.R. £45. All complete with Tubes and Speaker, Hire purchase terms available.

SHORT WAVE RADIO LTD., 97, Park Lane
LEEDS, I. Telephone: 24689

U.H.F. Oscillators

The bias considerations for the Pierce circuit in general apply to the oscillator portion of these arrangements. For frequency multiplying, a combination of grid-leak and cathode bias generally gives the best performance.

Modified Pierce Oscillators

By connecting in parallel the control-grid and screen-grid of a pentode or tetrode valve in the Pierce oscillator-multiplier circuit, either fundamental or harmonic crystals can be used by tuning the anode tank to the appropriate frequency. This circuit is shown in Fig. 7a. The paralleling of the grids

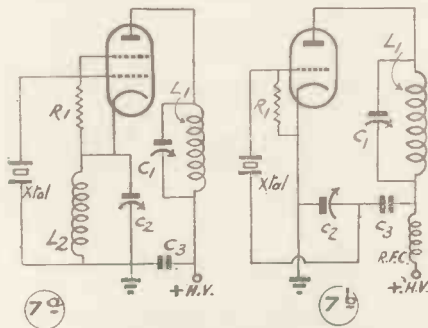

Fig. 7. Modified Pierce oscillators.

forms a high- μ triode valve such that the anode current is nearly zero in a non-oscillating condition and rises as the crystal goes into oscillation. Excitation of the crystal is brought about by the R.F. drop across $L_2 C_2$. Since $L_2 C_2$ is in series with the anode tank, the circuit will oscillate whenever the anode is tuned to an oscillating frequency of the crystal.

An increase in power output can be brought about by by-passing the screen-grid and applying a small positive voltage, while with the increase in output, there is an actual decrease in crystal current. If the screen-grid voltage is raised appreciably, however, the circuit performance reverts to the original Pierce oscillator-multiplier arrangement previously discussed and a harmonic crystal will then oscillate at its fundamental frequency. With a 1-megohm screen dropping resistor, good output can be obtained with low crystal current.

J. L. Reinartz recommends a 5,000-ohm wire-wound grid resistor serving as a combination resistor and R.F. choke. Increasing the resistance to any value greater than 10,000 ohms will bring about high crystal current.

At high frequencies, the modified Pierce circuit is prone to develop self-oscillation. In fact, when a 10-metre crystal is used, the circuit performs in the same manner as a locked oscillator; that is, the circuit will self-oscillate at a frequency determined by the anode

tank, but, when the circuit frequency is brought to the crystal frequency, the crystal will assume control.

Fig. 7b shows a circuit which is electrically equivalent to the modified Pierce circuit just discussed. The capacity, C_2 , functions in the same manner as the cathode tank. The crystal is excited by the R.F. voltage drop across C_2 and therefore, decreasing the value of C_2 will increase the crystal current. If C_2 is made too small excessive excitation can result. The condenser, C_3 , is merely a blocking condenser to prevent the D.C. anode voltage from being applied to the crystal.

By using a pentode or tetrode valve rather than the triode, and operating the screen-grid at a normal potential, there will be a considerable increase in power output. The circuit then becomes a modification of the original Pierce oscillator multiplier arrangement and can be employed as a harmonic generating circuit. With the triode valve, as shown in Fig. 7b, the circuit will function only at an oscillating frequency of the crystal.

Either of these circuits will also develop self-oscillation at high frequencies. Circuits of this general type, therefore, are best limited to crystal frequencies below approximately 5,000 kc.

18 mc. to 30 mc. Crystal Oscillators

At these high frequencies, careful consideration must be paid to the design and construction of the oscillator. Factors which are not serious at lower frequencies rapidly become important as the frequency is increased.

Not all valves are satisfactory as crystal oscillators at frequencies greater than 18 mc. With some valves, especially the higher μ and pentode types, the crystal may be effectively shorted out by the high input capacity. Others, having a low feedback capacity and a large electrode spacing, do not operate efficiently. High frequency triode valves, such as the 955, 6J5G, 6E6 and RK34, give the best all-round performance. Pentodes, in general, are not to be recommended although some types can be employed in the tri-tet circuit with fairly good results.

Parallel feed of the oscillator is seldom successful due to the difficulty of obtaining really good R.F. chokes. This means that the tuning condenser will be at a high potential and must be insulated from ground. The somewhat common arrangement of inserting a mica condenser in the tank circuit to block the D.C. voltage so that the tuning condenser can be grounded is not at all satisfactory. Mica condensers have appreciable losses at very high frequencies and, if used to carry circulating tank current, there will be a serious drop in power output.

All R.F. leads must, obviously, be short and direct. By-pass and tank condensers should be of the best quality. To minimise tank circuit losses, the coil should be self-supporting and wound with heavy copper wire or tubing.

The low anode impedance of the recommended triode valves necessitates the use of a high-C tank for maximum power output. Along with the increased output, the high C greatly improves the circuit stability, in fact pentode stability is approached when the proper tank values are chosen. The cathode tank of the tri-tet must also have a high C, inasmuch as the oscillating portion is a triode.

Circuits designed for use with 18 mc. to 30 mc. crystals are shown in Figs. 1, 4 and 8. The circuits are conventional but all components values should be followed as these have been found to give the best output and stability. The oscillator tank inductances are specified for 10-metre crystals, but for other high frequencies, it is only necessary to choose appropriate coils. With the simple triode oscillator a 955 valve will provide about 1½ watts output while approximately 2½ watts can be obtained with the 6J5G. Either of these valves will give sufficient output to drive an 802, RK23, 807, RK39 or 6L6 valve as a buffer or doubler.

Power Output

The dual-triode circuit is advantageous for frequency multiplying. As a matter of fact, a single RK34 with a 10-metre crystal, is an excellent low power 5-metre transmitter. A 6E7 valve will give an output of about 3 watts on 5 metres with a 10-metre crystal while the RK34 will give about 3½ watts.

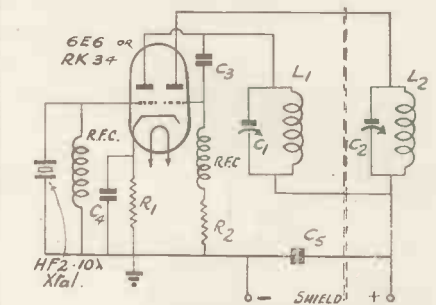

Fig. 8. Double-triode, oscillator-doubler for 5-metre output.

Types 53 and 6A6 valves have been tried but are not comparable to the 6E7 for output or performance.

An 802 or RK23 valve can be used in the tri-tet circuit as shown. The output on 5 metres is approximately 2½ watts with the 802 and 3½ watts with the RK23, while a slightly greater output can be obtained by applying up to 45 volts positive to the suppressor grid.

“Building Television Receivers at Home”

A practical handbook giving precise instructions that will enable any amateur to build Television Receivers guaranteed to produce pictures of present-day standards both as regards definition and brightness. Three designs are provided with a wide range of picture size and the constructional information and illustrations are in such simple detail that they can be understood and carried out quite easily by the average wireless amateur. Results are assured.

CONTENTS INCLUDE :

How a Television Receiver works
Receiver giving pictures up to 12 inches
The Time Base, Cathode-Ray Tube network and Receiver Power Unit
Adjusting the Vision Receiver, the Tube and Time Base Power Unit
Adjusting the Time Base
Adding refinements

Small-picture Receivers
Receiver giving a 4-inch picture. The simplest Home-Built Televisor
Time Base for the 4-inch Tube Receiver
The Power Units of the 4-inch Tube Receiver
Long Distance Reception with a 4-inch Tube
Simplified Receiver using a 1-inch Cathode-Ray Tube

100 ILLUSTRATIONS

112 PAGES

2/6 net

OR

2/9 post paid

FROM ALL BOOKSELLERS

FROM THE PUBLISHERS

BERNARD JONES PUBLICATIONS LIMITED,

CHANSITOR HOUSE, CHANCERY LANE, LONDON, W.C.2

(Proprietors of “TELEVISION AND SHORT-WAVE WORLD”)

Meissner
**1939
PRODUCTS
ARE HERE**

AMATEUR PARTS
WAVE TRAPS
TUNING UNITS
ALIGN-AIRE COILS
R.F. CHOKES
PLUG-IN COILS
CONDENSERS
PUSH-BUTTON
TUNERS
I.F. TRANS-
FORMERS
COMPLETE RE-
CEIVERS
KITS,
ETC., ETC.

“A FAMOUS NAME FOR TWO DECADES”

The Meissner “Signal Shifter” is a variable-frequency electron-coupled exciter unit which permits the amateur to move instantly to another frequency in the band when his signal is being QRM'd. Exceptional frequency stability superior to that of many crystals is obtained. The “Signal Shifter” eliminates one or two stages in the transmitter as the power output is ample to drive a medium power R.F. amplifier or final stage directly on the frequency desired. Every amateur will be delighted with the ease with which this unique device permits him to slide into “holes” in the band, to make his QSO's 100 per cent. It's easily done with the MEISSNER “SIGNAL SHIFTER.”

PRICE
COMPLETE WITH VALVES
£12-10-0

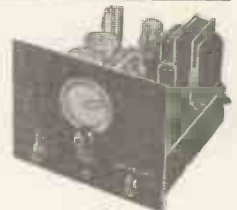

**ALL MEISSNER
PRODUCTS ARE
GUARANTEED**

**BE MEISSNER MINDED
AND GET BEST
RESULTS**

**SEND FOR FULLER
TECHNICAL
INFORMATION**

(Enclose 2d. Stamps)

Special Terms to Manufacturers



ANGLO-AMERICAN RADIO (& MOTORS) LTD.

ALBION HOUSE, 59 NEW OXFORD ST., LONDON, W.C.1. Phone: TEMple Bar 3231

SOLE
AGENTS
FOR

Meissner MANUFACTURING CO.

MT. CARMEL, ILLINOIS, U.S.A.

A MARVEL IN RADIO DEVELOPMENT
MEISSNER REMOTE CONTROL PUSH BUTTON TUNER
Permeability Tuned.

This unit may be used to control your mains receiver from any distance, and gives you the choice of seven stations by merely pressing the buttons. Volume control and on-off switch incorporated. Stations set by merely rotating one small knob for each station. Unique permeability tuning ensures NON-DRIFT. Connects to A and E terminals of set. In beautiful two-toned cabinet, 9½ x 9½ x 1½ complete with two valves, instructions, etc.

Price **£5 17s. 6d.** complete.



MISSNER has facilities second to none for the development and production of almost any electronic equipment. The laboratories alone cover an area the size of many radio factories. The staff of engineers works with equipment some of which is found in no other laboratory in the world!

Every facility of this huge organization is behind every product you buy bearing the Meissner name. Order any item with the assurance that no finer quality is available anywhere at any price!

Using the New HK25 Triode in a Switched-coil Transmitter

Constructors interested in high efficiency or transmissions on ultra-high frequencies should make a special point of obtaining details of the new Gammatron HK24 triode which is now generally obtainable in this country. The valve has considerable possibilities and is of a type suitable for British constructors.

A NEW triode valve of small physical dimensions but of high efficiency has recently been introduced by H.K., Ltd., of San Francisco. This valve, the HK-24, is only 4½ in. overall, including pins, base and top cap anode connections with a maximum diameter of 1⅜ in. It is designed for an anode dissipation of 25 watts, has a 6.3 volt heater, and an amplification factor of 25. It will withstand considerable overload, uses a thoriated tungsten filament, a tantalum vertical bar grid and a tantalum cylindrical anode.

This company have built a simple transmitter with switched coils which will provide quite a high R.F. output on three bands from a single crystal. It is simple to tune, is not unstable, neither does it rely on regeneration for high R.F. output. If required, high speed keying of the oscillator can be used.

To get some idea as to the efficiency of the transmitter, 160, 80 or 40 metre crystals may be used to give outputs on the fundamental, second and fourth harmonics with carrier powers of 50, 35, and 20 watts respectively. The high fourth harmonic output is due to the circuit, C2-L2, which accentuates this voltage giving a peaked waveform.

Crystal Oscillator

The crystal oscillator may safely be operated with 1,000 volts H.T. and a 40-metre crystal, or with 1,250 volts H.T. on a 160- or 80-metre crystal. Under these conditions, the power out-

put from the crystal stage is approximately 20 watts. The value, of course, depends largely on crystal activity.

In practice, the tank condenser C1, has to be tuned slightly to the low capacity side of resonance for best output and minimum crystal current. Condenser C3 is tuned to maximum capacity for operation on the fundamental and second harmonics and for resonance or maximum output of the harmonic amplifier when operated on the fourth harmonic.

It will be found that the oscillator keys excellently with crystals from 1.5 to 4 mc. while 7 mc. crystals, although they oscillate quite well, are somewhat chirpy. If keying is not required, resistors R6 and R7 may be eliminated and J2 earthed directly to ground.

Harmonic Amplifier

Excitation to the amplifier is adjusted with the tap on L1. For fundamental operation the grid current should be 20 mA., and the inductance L1, tapped approximately 30 per cent. from the cold end. For second and fourth harmonic operation the coil tap should be approximately 75 per cent. from the coil end with grid currents 11 and 4 mA respectively. Total cathode current should not exceed on the fundamental 100 mA., on second harmonic 80 mA., or on the fourth harmonic 60 mA. The anode to grid capacity has to be balanced out in the normal way, but the external capacity should be adjusted

by means of C8, but only when operating on fundamental frequency.

Constructors will find that this transmitter is quite satisfactory for coupling to the aerial, although, if greater power is required, it can be used as an exciter to drive a large final stage.

The output at the highest frequency is sufficient to drive a pair of Gammatron 54's or a single Gammatron 254 on 10 metres.

For C.W. operation the anode efficiency of the final stage is approximately 80 per cent. with 1,500 volts applied, or 76 per cent. with a 1,000 volts supply.

Full information on these new valves can be obtained from the advertisers who appear in this issue.

Coil Data

	L1	L2	L3	L4	L5
160 M					
Diameter	1½ in.			2 in.	
Length	2 in.			2½ in.	
Turns	80			58	
Wire	24 d.s.c.			22d.s.c.	
80 M					
Diameter	1½			2	
Length	1½			2	
Turns	36			24	
Wire	20 d.s.c.			16d.s.c.	
40 M					
Diameter	1½	1½		2	
Length	1½	1½		2	
Turns	18	26		14	
Wire	18	20		16	
20 M					
Diameter		1		2	
Length		1½		2	
Turns		22		9	

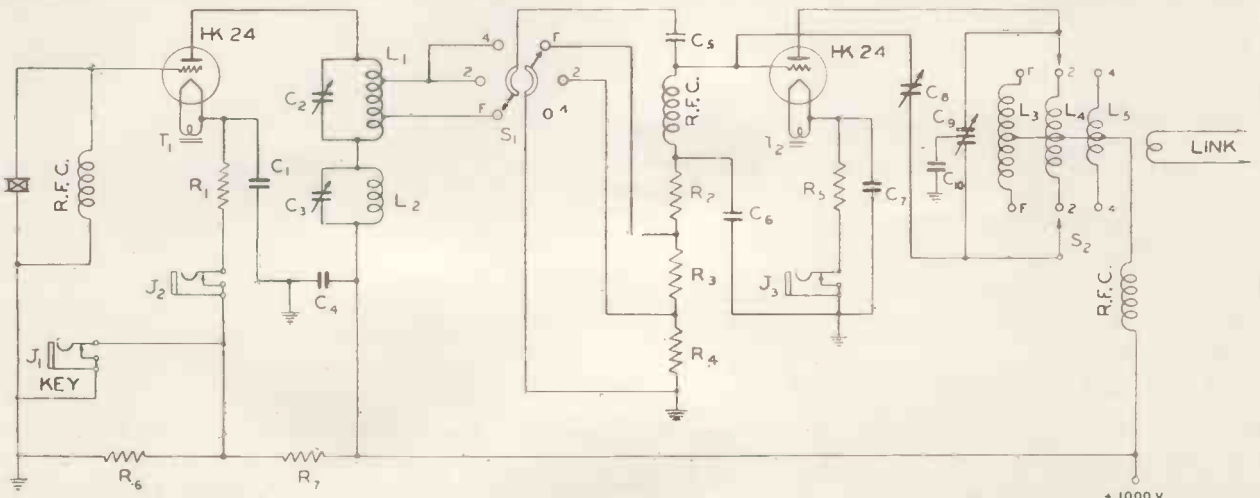

This is the suggested circuit for a simple transmitter for use on three wavebands. Only a single crystal is required, while the output on fundamental frequency is approximately 50 watts.

Connect with CLIX

The PERFECT CONTACT Plug



Specified for the 8-Valve Amateur Communication Receiver described in this issue.

CUT THE CRACKLE

Clix "Flexpin" Plugs enter smoothly and make perfect contact in all B.S.S. sockets.

5 amp. 2-pin "M" type (as illustrated) each 4/12d.

Full range available in 2-pin and 3-pin 2, 5 and 15 amps. to B.S.S.

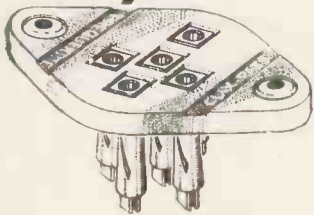

CLIX VALVEHOLDERS

are also specified for the following :—

"A2-VALVE LOW POWER TX"

Two 7-pin Ceramic

"MODULATOR OSCILLATOR"

Two 5-pin Ceramic
One 4-pin Ceramic

"8-VALVE AMATEUR COMMUNICATION RECEIVER"

Six 8-pin Ceramic
One 4-pin Ceramic

Clix Valve-holders embody the perfect contact helically slotted CLIX socket, built on laminated plastic or Frequentite CERAMIC plates — for all standard valves and all conditions of service.

CLIX

Radio & Electrical Catalogue. "T.S." Post Free.

British Mechanical Productions, Ltd.
79a, Rochester Row, London, S.W.1.

Wire	18	14
10 M		
Diameter	1	2
Length	1	2
Turns	10	7
Wire	18	14

Components

- R1 1,500 ohms 10 watt resistor.
- R2 2,500 ohms 5 watt resistor.
- R3 175,000 ohms 5 watt resistor.
- R4 200,000 ohms 1 watt resistor.
- R5 1,000 ohms 10 watt resistor.
- R6 10,000 ohms 10 watt resistor.
- R7 100,000 ohms 20 watt resistor.
- C1 .01 mfd. 500 volt mica condenser.
- C2 50 mmfd. deceiving condenser.
- C3 35 mmfd. midget condenser.
- C4 .005 mfd. 1,500 volt mica condenser.
- C5 .00025 mfd. 1,500 volt mica condenser.
- C6 .01 mfd. 500 volt mica condenser.
- C7 .01 mfd. 500 volt mica condenser.
- C8 1-4mm. neutralising condenser.
- C9 50-50 mm. split stator 2,000 volt condenser.
- C10 .005 mfd. 1,500 volt mica condenser.
- J1, J2, J3 Single circuit closing jacks.
- S1, S2 2-pole, 3-point ceramic switches (ganged if desired).
- T1, T2 6.3 volt 3 ampere filament transformers.

Midland Amateur Radio Society.

This society has been in existence for over 10 years and the membership now exceeds 120, of which 75 per cent. have full radiating permits. This is extremely high and probably accounts for the activities of the society. However, beginners are welcome, and the Hon. Secretary, F. E. Barlow, 2FKU, "Drakeford," Poolhead Lane, Wood End, Tanworth-in-Arden, Warwickshire, will be pleased to send particulars. On March 14 a meeting was held at the Hope and Anchor Hotel, Edmund Street, Birmingham, when a lecture was given by Messrs. Voigt Patents, Ltd.

Irish Amateur Radio Society.—This society meets every Wednesday evening at 8 o'clock at the Galway Arms Hotel, Parnell Street, Dublin. The secretary, David McNeal, will be pleased to welcome any readers or prospective members while further information regarding membership can be obtained from the Hon. Secretary at 12 Merrion Row, Dublin, C2.



Send for FREE "BOOK OF FACTS"

Learn Code at home—

THE CANDLER SYSTEM not only teaches you the right way to send, but the right way to read code sound just as easily as you read print by sight. Courses for Beginners and Radio and Commercial Operators.

CANDLER SYSTEM CO.
London Office (Room 55B),
121 KINGSWAY, W.C.2.

For INEXPENSIVE ACCURACY USE THIS

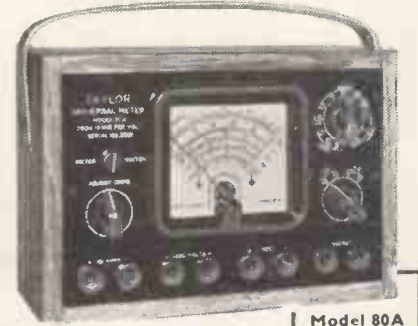

THE 70 RANGE UNIVERSAL TAYLORMETER

is a British Made, fully guaranteed precision-built instrument. Although its cost is unusually low for such a comprehensive meter, its sensitivity, accuracy and reliability leave nothing to be desired. Fitted with a sturdy 4 1/2 in. moving coil jewelled movement it covers D.C. volts 0.002-2,000; A.C. output and volts 0.2 2,000; D.C. current 10 μ A-20 Amps; A.C. current 10 μ A-5 amps; Resistance 0.1 ohms-5 megohms with internal battery. Output, -18 to +60 DB. at the touch of two switches, and an adaptor is available to increase the voltage range to 5,000-10,000 A.C. and D.C.

FILL IN & POST THIS COUPON NOW

TAYLOR ELECTRICAL INSTRUMENTS, LTD.,
45, Foubert's Place, Regent St., London, W.1

Please send full details of the TAYLORMETER.
Name.....
Address.....

- Model 80A
2,000 ohms per volt
A.C. or D.C.
10 GNS.
- Model 80B
5,000 ohms
12 GNS.
- Model 80C
20,000 ohms
14 GNS.
- Low Deposit
Easy Terms
Available

ELECTRADIX for METERS

IF YOU are testing aerial array efficiencies you will be interested to know that we have a range of R.F. Meters, brand new at bargain prices. Weston Turner, Sullivan, R.A.F., Elliott, etc., all panel mounting. Hot Wire and Moving-Coil Thermo from 2 1/2 to 6" dia. Cheap. Call, write or phone your requirements.

TRANSMITTING CONDENSERS. Cyldon .0005 mfd., 800 v., 30/- models, 5/-; Cyldon wide-spaced Bebe, .00025 mfd., 3/6. Polar Compax, .0001 mfd., 1/2.
SWITCHES for Switching Anything. Snap 250 v., 5 amp., indicating, 1/2; 10 amps., 1/6; 20 amps., 1/10. Light duty switches for wave change. Semi-rotary, 6d. Yaxley and Rex Wavechange D.P. 3-way roll contact, 1/3. Bulgin 3-point wave change, 9d. Tune well S.P. on-off, 8d.

STUD SWITCHES. Box panel by R.I. for meter ranges, etc., 7/6. Larger type G.P.O., 4 sets of 10-way studs, 2 arms and rings on panel, 5/6.
R.A.F. Switchboxes, 3-way rocker type, 1/3. 6-way rocker toggle, 2/-; 8-way ditto, 3/6.
7-20 STUD Panel Switch, 2 1/2 ins. sq., 3 amps., 4-pin sockets, 1/9. 10-way D.P. ebonite mount, 8 amps., 5/6. 12-way D.P. 5 amps., 4/-.



20-20 STUD Panel Switches, contact arm and rings for 10 amps., 6/6. Ditto, on iron box, fitted 300 ohm 1 amp., 20 tap resist., 10/6. 5-stud 50 amp. slate panels, new, 25/-.
REMOTE SWITCHES. Delay Switches, 250 v., 15 amp., mercury tube operated 12-volt coil, 30 secs. delay, 35/-.
Mercury Switches for remote control, 6 or 12 volts coil for 5 amps., 230 volts, 16/-; Double-coil, 22/-; S.P., 15 amps., 20/-; D.P., 15 amps., 25/-; Mercury Tubes, S.P., 5 amps., 4/-; 10 amps., 5/-.

TRANSMITTING KEY RELAYS. Creed polarised, platinum 2-way contacts, Cost £7. Few only at 30/- each. Ship magnet key relay for 10 amps., 15/-.
TRANS. VALVES. 30 watt triodes AT40, 4/6. Det 1 S/W., 15/-; T250, £2 10 0.

RELAYS. Single and multiple contact telephone type in 15 models from 5/-; Send for "Relay" List. Genuine G.P.O. Vertical Relays, brass case, glass top, with original platinum contacts. Worth the money. 5/- to clear.

MICRO-AMMETERS for Valve Voltmeters, etc., 0 to 50 microamps full scale, 50 mV. moving coil, 1,000 ohms, 40/-; flush panel, 2 1/2-in. dial. Reads direct signal strength on crystal.

Send for "Radio Electrical" Scientific Illus. List "T." Free.
ELECTRADIX RADIOS
218, UPPER THAMES STREET, LONDON, E.C.4

Telephone: Central 4611

Some Simple Band-spreading Circuits

AMATEURS who have not had very much experience in the building of short-wave receivers or have been dependent on normal types of all-wave broadcast sets, often find it is extremely difficult to tune in

These simple circuits are suitable for beginners and can be added to most straightforward short-wave sets.

means that on the highest wavelength, the channel will have to cover in two or three steps instead of one sweep. It is particularly important with Fig. 2 that the band-spreading dial has a good wide scale so that it can be reasonably well calibrated.

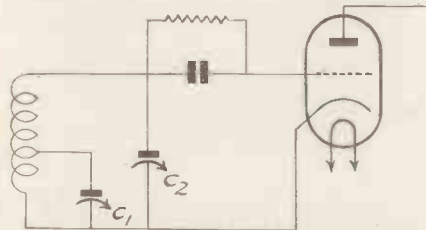

Fig. 1.—A flexible band-spreading arrangement in which the amount of spread can be varied to suit individual requirements.

long distance short-wave stations owing to the small amount of variation in condenser capacity between stations.

Generally speaking, many broadcast sets are not suitable for serious reception of amateur stations or even of ordinary short-wave broadcast stations on the lower wavelength bands. It will be noticed, however, that all communication receivers or sets designed for short-wave use have included band-spreading. This refinement can be added to every receiver and it does make the tuning-in of short-wave stations extremely simple.

A circuit which is very popular is shown in Fig. 1. Condenser C₂ is the normal tuning condenser such as is included in any short-wave set. The value is practically immaterial, but is around 160 mmfd. Condenser C₁ is for band-spreading, and it should be fitted with a good slow-motion drive and an easily read tuning scale.

If the condenser has one set of moving plates connected to earth and the others side tapped on to the coil, the tuning is more widely spread. For example, tune C₂ to 18 metres, with C₁ at minimum capacity. If C₁ has a capacity of 15 mfd. and were connected across the whole of the coil as in Fig. 2 then the channel between 18 and 20 metres would cover only 10 or 15 degrees on the band-spread dial and about two degrees on the main tuning dial.

By tapping the condenser C₁ down

the coil it can be made to have less and less effect and if necessary the channel between 18 and 20 metres could cover the whole channel of the condenser. It will readily be appreciated that should the listener want to receive the 20-metre amateur band instead of it being restricted to 3 or 4 degrees by tapping down the coil and using C₁, the amateur stations can be spread out so that there are reasonably wide gaps between them.

It is impossible to be without condenser C₂ for this is used as a band setter. It is adjusted, with C₁ at mini-

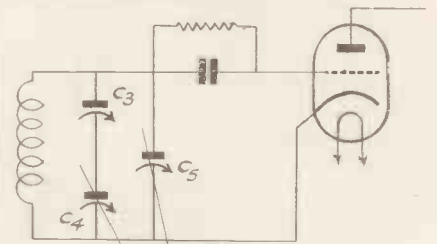

Fig. 3.—With this arrangement, C₃ is the band-spread condenser.

Fig. 3 shows a rather unusual scheme which should gain in popularity amongst those who are building their own receivers. Condenser C₅ is a normal large tuning condenser but across it are two additional condensers, C₃ and C₄. C₄ again has a fairly high capacity of about 160 mmfd. and is mechanically ganged to C₅. This leaves condenser C₃ which is for band-spreading and has approximately the same ratio of travel over the entire capacity of C₅.

Another simple scheme which should be of interest is shown in Fig. 4. In this arrangement, condenser C₂ is the normal band-setting condenser of .00016 mfd. while C₁ and C₆ are band-spreading condensers. C₁ need have a capacity of only 7-10 mmfd. and C₆ a capacity of 35-45 mmfd. The scheme is to switch in the band-spread condenser having the required capacity. Naturally on lower wavelengths the smaller capacity condenser is suitable, whereas on higher wavelengths one would use the higher capacity.

Eddystone manufacture a band-spreading kit made up of a small band-spreading condenser and a band-setting condenser fitted with stops so that any of 10 14 mmfd. sections can be used. In this way the band-spread condenser can be accurately logged against a certain number of 14 mmfd. sections.

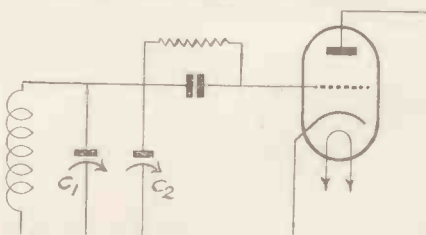

Fig. 2.—This circuit can be added to any short-wave receivers.



This is the Eddystone band-spread kit, using a condenser with 10 fixed capacities of 14-mmfd. each.

imum capacity, until the receiver tunes just below the band required, and then the two or three metre channel above is searched by means of C₁.

In some receivers it is not possible to tap the coil, particularly in commercial sets so that the circuit in Fig. 2 is often more satisfactory. In this circuit condenser C₂ is again the built-in tuning condenser, but with the C₁ as a band-spreading condenser.

Up to 60 or 70 metres, condenser C₁ should have capacity not exceeding 15 to 20 mmfd. but on the lower frequencies such as 1.7 mc. C₁ can be as high as 35 mmfd. This arrangement has the big disadvantage that one band-spreading condenser will not be satisfactory over all wavelengths, for if it is of the correct capacity on 10 metres it will be far too small on 160 metres.

However, amateurs generally make sure that the condenser is correct on the lowest wavelength for it merely

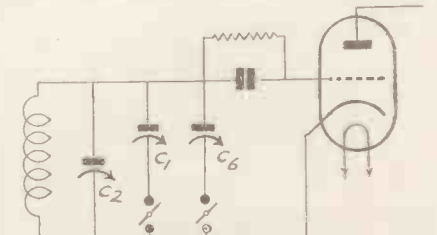

Fig. 4.—By switching in this way, defects of circuit shown in Fig. 2 are removed.

A Simple Aerial Tuner

It is always advisable to have available a simple but efficient switching system whenever tuned feeders of any kind are used. A Zepp aerial, which is still one of the most popular aerials used by amateurs, is invariably fed by 600 ohm tuned feeders. On one frequency these feeders may be parallel tuned but on another band the same feeders will have to be series tuned.

It is, of course, quite simple to have a piece of wire and crocodile clips so as to change condensers from series to parallel, but it is much quicker and more efficient to have a ready built tuner with a switch built in. Generally,

any convenient part of the room rather than close to the window where the feeders lead in.

A 66 ft. Zepp aerial with 49 ft. feeders will work very nicely on 20 metres if the feeders are series tuned and work equally as well on 40 metres when the feeders are parallel tuned. This coupler can be used on both bands and by merely having the switch in the correct position provides series or parallel tuning as required.

Only two condensers are needed of which one is left out of circuit when parallel tuning is required. The link, coupling the aerial coil to the tank coil,

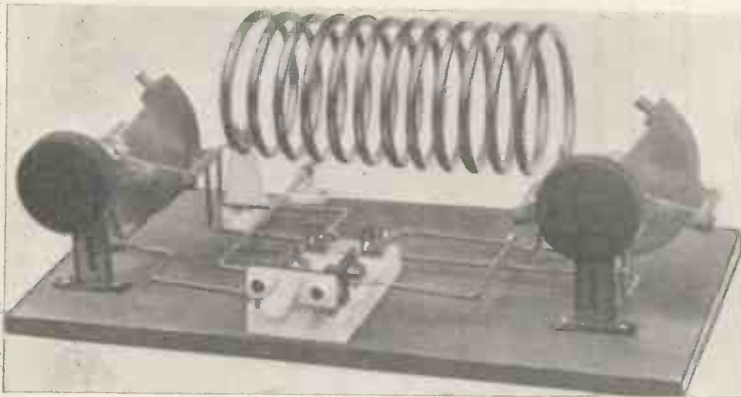

It is intended that this coupler be screwed to the window frame close to where the feeders terminate. The aerial coil can be coupled to the final tank by means of linked and 80-ohm cable.

when using a receiver, if the aerial is accurately tuned, then there is a distinct rise in signal strength, while selectivity of the input circuit is often improved.

Amateurs will find that when they are in trouble with blocking from a nearby powerful station a loosely coupled aerial tuner of this kind will often reduce the blocking to a negligible amount.

It is a bad practice to run tuned feeders inside a room for any length while it is not always convenient to have a transmitter close to the aerial input. However, by link coupling the final tank coil to the aerial coil by means of a single turn at either end and 80-ohm cable, the distance between the transmitter and the aerial coil, becomes quite unimportant. This scheme also enables the transmitter to be placed in

is made of heavy gauge wire so that it is a close and tight fit into the coil. The amount of coupling can easily be adjusted.

Standard Eddystone copper tube coil of 12 turns and two widely spaced variable condensers having a capacity of 100 mmfd. are required. The tank coil is mounted on two stand-off insulators, while the series-parallel switch is mounted in between the two condensers. Close to the end of the coil are two small stand-off insulators spaced 6 in. apart to take the 600-ohm line. No output connections are provided for coupling is merely inductive by means of a single turn link as previously explained.

In order to prevent harmonic radiation, the mid-point of the aerial coil can be earthed to advantage. This is particularly important when operating on

(Continued on cover iii)

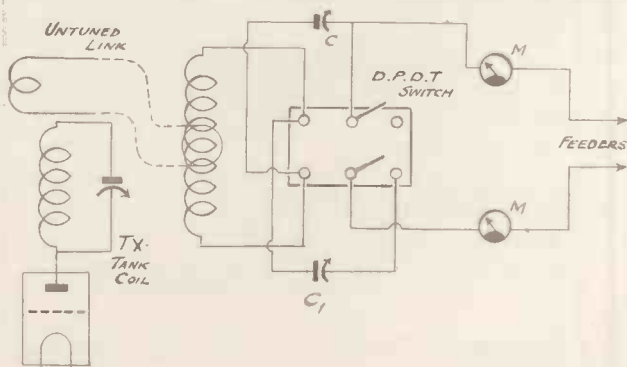

With this circuit only two condensers are required, of which one is omitted when parallel tuning is required. Tapping the mid-point of the coil will prevent radiation of harmonics.

GALPINS

ELECTRICAL STORES

75, LEE HIGH RD., LEWISHAM,
LONDON, S.E. 13

Telephone: LEE GREEN 5240

Terms:

Cash with Order or C.O.D. Charges extra.

EX-NAVAL 1-VALVE BUZZER WAVEMETERS, 200/24,000 metres. Complete in solid teak case. Size: 15 x 10 x 8 (less valve). Tuner unit enclosed in copper tank (Sullivan high note buzzer). Price, 7/6 each, C/forward. Not sent C.O.D.

MAINS TRANSFORMERS for small Arc Lamps, etc., 200/250 volts input, 50 volts 8 amps. output, 10/6 each; another, same input, 250/0/250 volts 150 m/A. and 3 x 4 volt Lt. windings, also a 50 volt 4 amp. winding, 12/6 each, post 1/-.

E. TURNER AND WESTON MOVING COIL m/A. METERS, 2 in. dial. Model 501, 0 to 5 m/A., 12/6; 0 to 50 m/A., 12/6. All fully guaranteed.

MOVING COIL METER MOVEMENTS for recalibrating into multirange meters. Low m/A. deflection, 2 1/2 in. dial, 5/- each; 4 in. and 6 in. dial, 6/- each. Post 1/-. (Note: All these meters are by good makers—Elliott, E. Edgcombe, etc.)

MAINS TRANSFORMERS, all fully guaranteed, for 200/240 volt 50 cycles, 1-phase input; outputs, 1/2 to 5 volts at 1,500 watts, 45/-; ditto, 5 volts at 2,500 watts, 65/-; ditto, from 10 to 220 volts in steps of 10 volts at 3,500 watts, 75/-; ditto, 2,000/0/2,000 volts 150 m/A. and 2 L.T. tappings, 22/6; ditto, 3-4 and 7 1/2 volts at 650 watts, 17/6; ditto, 5 to 20 volts in 6 tappings, 1,250 watts, 40/-; ditto, 200-400 and 700 volts twice at 200 watts, 20/-.

All above double wound. Voltage Changer Transformers, 100/120 volts to 200/240 volts or vice versa. Auto. wound, 250 watts, 17/6; 500 watts, 25/-; 1,000 watts, 35-1,500, 45/-.

Another, 200 volts to 250 volts at 12 kilowatts, 90/-.

All carriage forward.

ZENITH WIRE - WOUND RESISTANCES (Vitreous), .6 ohm 10 amp., 1 1/2 ohm 6 amp., .154 ohm 8 amp., 5 ohms 2 amp., 6 ohms 5 1/2 amp., all 9d. each, post 3d.; 2,500 ohms 170 m/A., 10,000 ohms 50 m/A., 5,000 ohms 170 m/A., 255 ohms 500 m/A., 700 ohms 170 m/A., all at 1/- each post 3d. Also a 4,000 ohms resistance wound on mica, carry 100 m/A., 1/6 each.

ELECTRIC LIGHT CHECK METERS for subletting, etc. 200/250 volts, 50 cycles, 1-phase, 5-10-20 amps., 6/- each, post 1/-. Shilling Slot type, 5 and 10 amps., 15/- each, carriage 1/-.

EX-R.A.F. ROTARY CONVERTERS, D.C. to D.C. 12 volts input, 500 volts 75/100 m/A. output, brand new 25/-, post 1/-; S.H. condition, 20/-, post 1/-.

Also a few with damaged brush, gear windings O.K., 10/- each, post 1/-.

EX-R.A.F. EVERSHERD VIGNOLLES HAND GENERATORS. Useful by using ohmmeter, make perfect meszger, and other testing gear, 800 volts 30 m/A. output, brand new, 35/- each; S.H. in good condition, 25/- each, C/F.

EX-G.P.O. GLASS TOP RELAYS, Type B. Useful as Keying Relays, 5/- each, post 6d. Also a few only that need points which are easily fitted, 2/6 each, P/F.

MAINS SMOOTHING CONDENSERS, T.C.C., 4 mf. 750 volts working, 3/6; T.C.C., 2,000 mf. 25 volts working, 2/6 each; T.C.C., 2 mf. 1,000 V.T., 1/6 each. Philips, 1 mf. 4,000 volts working, 4/6 each. Standard telephone, 1 mf. 400 volts working, 4 for 1/-, post 4d.; or in lots of 100, 12/6, post 1/6.

CHARGING DYNAMOS. All shunt wound and fully guaranteed. 100 volt 20 amp., 1,500 r.p.m., 90/-; another, 80/90 volts 8/10 amps., 1,800/4,000 revs., 70/-; another, 20 volts 8 amps., 27/6. Automatic Cut-outs to suit any dynamo up to 10 amps., 5/6 each (all dynamos carriage forward).

TELEPHONE MAGNETO GENERATORS. Approx. 70 volts A.C., 4/- each, P/F. Microphone Buttons, 9d. each. 30 hy. 150 m/A., Mains Chokes, 4/6 each. 2 mf. 500 volt working Condensers, 1/- each. Western Electric Microphones, 2/-.

Microphone Transformers, 1/6. 1,000 ohm single earpieces, 9d. each.

STEEL CABINETS. Useful as transmitting racks, 40 x 17 1/2 x 24, 12/6 each, C/F. Philips pre-stage amplifiers for A.C. mains 220/240 volts, less valves, 15/- each.

NEON TRANSFORMERS, input 200/250 volts 50 cycles 1-phase output, 10,000 volts 10 m/A., 12/6 each, post 1/-. Ditto, 7,000 volts 8 m/A., 10/-, post 1/-. Ditto, 5,000 volts 5 m/A., 7/6, post 1/-. (All brand new.)

THE 'RACON' MOVING COIL HORN SPEAKER UNITS. 15 ohm Speech Coil 6 volt field handle, 15 watts, 15/- each, post 1/6.

'MAGNAVOX' P.A. MOVING COIL SPEAKERS. 700 and 2,000 field, 15 ohm speech coil. Handle 30/35 watts with horn 42 in., 22 in. flare (new in packing case), 67/6 each, C/F.

“ 2-Valve Low-power Tx. ” (Continued from page 302)

VC₃ until this drops to about 10 mA. and then switch off the H.T. to the valve.

The next job is to neutralise the OQ16/600. Do this by adjusting the condenser VC₂ until VC₃ can be swung 10 or 15 degrees either side of the resonant point without causing any kick or fluctuation in the grid current meter. When this has been done the transmitter is ready for connecting either to a dummy load or radiating aerial.

If connected to a radiating aerial this should be either 66 ft. long or 132 ft. long and preferably used in connection with a counterpoise earth of equal length. When properly tuned there should be an aerial current of .5-6 A., with the aerial and counterpoise each 66 ft. long. The counterpoise should be series tuned and the condenser should have wide spacing for telephony working and normal spacing for C.W. working.

It will be found that with the coil and condenser specified for the final stage that there is an 80-metre output when the condenser is almost at minimum capacity. This output can be boosted by increasing the bias resistor, R₂, to 50,000 ohms and R₄ to 300 ohms.

However, the values as shown are correct for fundamental output.

Before the construction is started amateurs should obtain the requisite licence from the G.P.O. Details re-

garding this will be supplied by the Radio Division of the G.P.O.; the address of which is The Office of the Engineer-in-Chief, Armour House, Aldersgate Street, London, E.C.2.

**Components for
A 2-VALVE LOW-POWER Tx.**

CHASSIS.

- 2—Type 1109 (Eddystone).
- 2—Panels type 1112 No. 6 (Eddystone).
- 2—Pairs brackets type 1110 (Eddystone).

COIL AND COIL FORM.

- 1—Form type CF₄ (Raymart).
- 1—1.7 mc. coil (Peto-Scott).

CONDENSERS, VARIABLE.

- 1—160 mmfd. type TR016T (VC₁) (Premier).
- 1—.0002 mfd. type REX (VC₂) (A.C.S.).
- 1—.0002 mfd. type 1101 (VC₃) (Eddystone).

CONDENSERS, FIXED.

- 1—.002 mfd. type 620 500 v. (C₁) (Dubilier).
- 1—.002 mfd. type 620 500 v. (C₂) (Dubilier).
- 1—.001 mfd. type 620 500 v. (C₃) (Dubilier).
- 1—.002 mfd. type 620W (C₄) (Dubilier).
- 1—.01 mfd. type 691 W (C₅) (Dubilier).
- 1—.01 mfd. type 691W (C₆) (Dubilier).
- 1—.002 mfd. type 620 500 v. (C₇) (Dubilier).
- 1—4 mfd. type LEG 650 v. (C₈) (Dubilier).
- 1—4 mfd. type LEG 650 v. (C₉) (Dubilier).

CRYSTAL.

- 1—1.7 mc. with type U holder (Q.C.C.).

CHOKES, R.F.

- 1—Type SW69 (RFC₁) (Bulgin).
- 1—Type CXT (RFC₂) (Raymart).

CHOKE, L.F.

- 1—Type 40 H. 150 m/A. (LFC) (Premier).

DIALS.

- 2—Standard Indigraph (Peto-Scott).

HOLDERS, VALVE.

- 2—7-pin ceramic chassis type (Clix).
- 1—4-pin type SW21 (Bulgin).

JACKS.

- 1—Closed circuit type J6 (Bulgin).
- 1—Closed circuit type insulated (Premier).

METERS.

- 1—0/30 mA. type H.B. (M₁) (Premier).
- 1—0/150 mA. type 2-in. flush mounting (M₂) (Ferranti).

RESISTANCES, FIXED.

- 1—50,000 ohm type 1 watt (R₁) (Dubilier).
- 1—5,000 ohm type 8 watt (R₂) (Premier).
- 1—Hunding (R₃) (Premier).
- 1—100 ohm type 8 watt (R₄) (Premier).
- 1—40,000 ohm type PR40 (R₅) (Bulgin).

SWITCHES.

- 1—S80T toggle (S₁) (Bulgin).
- 1—S80T (S₂) (Bulgin).
- 1—S80T (S₃) (Bulgin).
- 1—S.P.D.T. toggle (S₄) (Bulgin).

SUNDRIES.

- 4—Terminal saddles type 1046 (Eddystone).
- 2—I.14 (Bulgin).
- 1—No. 32 S.E.S. holder (Bulgin).
- 1—D₉ signal lamp (Bulgin).
- 1—P₉ plug (Bulgin).

TRANSFORMERS.

- 1—Type SP502 (Premier).

VALVES.

- 1—AC/Oa (V₁) (Hivac).
- 1—OC-16/600 V₂ (Tungram).
- 1—UU5 (V₃) (Mazda).

British Throughout

FOR YEARS THE RADIO SOCIETY OF GREAT BRITAIN HAS, THROUGH ITS OFFICIAL JOURNAL, URGED HOME MEMBERS TO

BUY “BRITISH”

A further stage in this policy has been reached in the April issue of **THE “T & R BULLETIN”** wherein full length descriptions appear of an

ALL-BRITISH

THREE STAGE TRANSMITTER

and an

ALL-BRITISH SELECTIVE RECEIVER OF NEW DESIGN.

Constructional and theoretical articles together with the latest news of amateur interest are also included.

A copy of this important issue together with membership details will be sent to any applicant on receipt of a P.O. for **1/-**

Write Today to The Secretary-Editor—

RADIO SOCIETY OF GREAT BRITAIN
5:3 Victoria Street, London, S.W.1.

TELEVISION DEVELOPMENTS

Are you keeping abreast of modern television developments? Whether amateur or professional you *must* be in touch with the latest trend of research.

The Television Society enables you to meet fellow workers in the field of television, both in this country and abroad.

Founded some 10 years ago The Television Society provides a scientific and non-partisan platform for discussion on all aspects of the subject. Meetings are held monthly during the session (October-June) and are reported in full in the Society's Journal which is sent free to all members.

The Society's activities are shortly being enlarged to meet the growing interest in the subject and members will have a unique opportunity of furthering their knowledge by contact with well-known television engineers.

Full particulars of membership qualifications may be had from the Hon. General Secretary:—J. J. Denton, 17, Anerley Station Road, London, S.E.20.

THE TELEVISION SOCIETY

(Founded 1927)

President: Sir AMBROSE FLEMING, M.A., D.Sc., F.R.S.

OPPORTUNITIES SECTION

BUSINESS :: EQUIPMENT :: EMPLOYMENT :: MISCELLANEOUS

The charge for miscellaneous advertisements on this page is 12 words or less 2/-, and 2d. for every additional word. Single-column inch rate displayed, 12/6. All advertisements must be accompanied by remittance. Cheques and Postal Orders should be made payable to Bernard Jones Publications Ltd., and crossed, and should reach this office not later than the 15th of the month previous to date of issue.

INDEX TO ADVERTISERS

	PAGE
A.C.S., Ltd.	313
Anglo-American Radio (and Motors), Ltd.	315
Automatic Coil Winder & Electrical Equipment Co., Ltd.	257
Belling & Lee, Ltd.	Cover ii
British Institute of Eng. Technology	Cover iii
British Mechanical Productions, Ltd.	317
Brown, S. G., Ltd.	313
Candler System Co.	317
Clix	317
Edison Swan Electric Co., Ltd.	258
Electradix Radios	317
Fluxite, Ltd.	Cover ii
Foyles, Ltd.	Cover iii
Galpins	319
General Electric Co., Ltd.	301
G5KA	Cover iii
Hallcrafters	288-289
Hamrad Wholesale, Ltd.	307
Marconi's Wireless Telegraph Co., Ltd.	Cover ii
Mark Davis's Radio & Electrical Store	Cover iii
Mullard Wireless Service Co., Ltd.	305
Peto-Scott Co., Ltd.	311
Premier Supply Stores	303
Quartz Crystal Co., Ltd.	313
Radlomat	305
Radio Society of Great Britain	320
Radio Mfg. Engineers	309
Short Wave Radio, Ltd.	313
Sound Sales Ltd.	313
Stratton & Co., Ltd.	257
Taylor Electrical Instruments Ltd.	317
Television Society, The	320
Webb's Radio	Cover iv
Westinghouse Brake & Signal Co., Ltd.	311

A Simple Aerial Tuner

(Continued from page 319.)

40 metres should there be traces of a harmonic on 20 metres.

The link should be plugged into the tank coil and left out of the aerial coil when tuning, otherwise slight discrepancy in the resonant point will often be found. The presence of the link, however, will enable the same amount of dip to be obtained but this is not of importance.

After the tank coil has been tuned to minimum plug the other end of the length into the aerial coil and tune for maximum feeder current. Should the draw in the final tank circuit be too great then loosen the coupling between tank coil and length rather than between aerial coil and length. There should not be any further need to retune the aerial circuit.

TELEVISION.

MARK DAVIS'S RADIO AND ELECTRICAL STORE offers the following bargains:—

HALCYON TELEVISION and all wave Console Receiver, 10 in. picture complete and brand new. A real good job, listed at 55 gns. Don't miss this wonderful bargain at £28.

MULLARD, modern type Cathode Ray Tube, type E.46 10 brand new in special sprung crates. Listed at 12 gns, obtainable nowhere else in Great Britain at the price, £5. 10., six only left.

Special Shield for above Tube. 15/- Cost, Trade 35/- Time Base and Sync. units suitable for 10 or 12 in. Tubes. Well made and completely wired. Complete with circuit diagram, as used in modern Receivers. A few left only at Reduced price, 30/-.

Special high voltage Condensers, all new and guaranteed. 1. mf. 3,000 volts working, 10/- T.C.C. Tubular types. .01 30,000 working, .01 20,000 volts. 0.02 15,000 volts. 0.01 15,000 volts. 20/- each.

B.I. jelly filled. .02 15,000 working, 30/- each. Chokes, 10 Henry, 250 ohms, 230 mills. (Sound Sales), 3/- each.

MARK DAVIS'S Bargain Parcel of Modern Components, including Three Wave Band Coil Pack, with Circuit. Westinghouse full wave Westector. Ediswan Thermal Delay Switch. Dls. I. short wave and other coils. Three Band Dials and Drives, and a host of other articles too numerous to mention here. All brand new. A wonderful bargain for 10/-. Don't miss this opportunity.

MARK DAVIS'S RADIO AND ELECTRICAL STORE, 22, Lisle Street, London, W.C.2

LIGHT CONTROL

LIGHT CONTROL apparatus suitable burglar alarm, etc., complete with light cell, amplifier, relay and lamp, £2 5s. Box No. 30., Television and Short wave World.

RENT TELEVISION

RENT A TELEVISION and see all the big events as well as hearing them. Large screen model 5/11 per week, inclusive of All Service, Replacement and Dipole Aerial, home demonstrations if required. **MURDOCHS**, Nungate, S.E.15. New Cross 2264/5.

PATENT AND TRADE MARK AGENTS

GEE & CO., patents and trade marks throughout the world (H. T. P. Gee, Mem.R.S.G.B., A.M.I.R.E., etc.), Estab. 1905. 51-52, Chancery Lane, London, W.C.2 (2 doors from Government Patent Office). *Phone: Holborn 4547 and 4548. Handbook free.

KINGS PATENT AGENCY LTD. (B. T. King, A.I.Mech.E. (2 BKT) Patent Agent) 146a, Queen Victoria Street, London, E.C.4. ADVICE, Handbook and Consultations free. *Phone City 6161.

FOYLES FOR RADIO BOOKS

Special Radio Department. New and secondhand books on radio and every other subject. Stock of nearly 3,000,000 volumes. Send for free catalogues.

★ FOYLES ★

113-125, CHARING CROSS RD., LONDON, W.C.2
Telephone: Gerrard 5660 (16 lines)

MISCELLANEOUS

ALL TYPES of Rotary Converters, electric motors, battery chargers, petrol electric generator sets, etc., in stock, new and second-hand.

A.C.-D.C. Conversion Units for Operating D.C. Receivers from A.C. Mains, 100 watts output, £2. 10; 150 watts output £3. 10.

WARD, 46, Farringdon St., London, E.C.4. Tel. Holborn 9703.

SPENCER-WEST TELEVISION PRE-AMPLIFIERS

A number of repeat orders and letters of appreciation confirm the claims made for these units.

One user writes, "... how very pleased I am with the results. It has entirely overcome our troubles and the receiver can be used with video and audio gain controls turned well down instead of full on. It has greatly reduced background noise and gives a very bright and steady picture. In other words it has turned a very poor picture and sound into something of real entertainment value." Sgd. 2BFN, Bedford. The above testimonial and several others were entirely unsolicited. The originals can be inspected. An amplifier as supplied to the above costs 6 gns. complete.

SPENCER-WEST, WORLINGHAM, Nr. BECCLES, SUFFOLK. Telephone: Beccles 3159.

TECHNICAL TRANSLATIONS from Danish, Norwegian and Swedish papers at cheap rates for Television workers. B. J. Aldrich, 32 Cyprus Street, Norwich, Norfolk.

LOUDSPEAKER repairs, British, American, any make, 24-hour service; moderate prices.—**Sinclair Speakers, Alma Grove, Copenhagen Street, N.1.**

TELEVISION pre-amplifier, Spencer-West's 6 gn. model, for A.C. mains used few times only, £4. 2-valve pre-amplifier with power pack A.C. complete £4. 250 ft. in one length K.L.A. concentric cable used experiment only, cost 75/- accept £2. Marconi Tilting television aerial, reduces interference, as new £2. Eddystone 1 valve convertor 15-90 metres, cost 5 gns., £3. Wallis, 49, High Street, Saffron Walden, Essex. Phone 45.

ELECTRICAL SERVICE

CONVERTERS wanted and for sale, E.D.C.C. approximately 200 watts. Easco, 18, Brixton Road, S.W.9.

BOOKS

THE RADIO ENGINEERING LIBRARY, the alpha and omega of radio technology, in six volumes made financially easy to own. Prospectus and details from Phoenix, Chandos Place, W.C.2.

LOUDSPEAKERS

3,000 SPEAKERS from 5s. 6d. each, P.M. and energised 4" to 14", including several Epoch 18". **Sinclair Speakers, Alma Grove, Copenhagen Street, N.1**

A HANDY REFERENCE LIBRARY

of books pertaining to his hobby is necessary to every "ham." Those listed below will start you with your library:—

RADIO AMATEUR'S HANDBOOK 1939 edition contains 560 pages and 819 illustrations. Will solve all your transmitting and receiving problems. Price 5/6d. post free.

"**RADIO**" **HANDBOOK** 1939 edition, 600 pages. 7/- post free

RADIO TELEPHONY HANDBOOK 3/6d. post free.

ANTENNA HANDBOOK, 3/6d. post free.

RADIO PHYSICS COURSE 17/6d. post free.

HINTS AND KINKS, 2/6d. post free.

RADIO AMATEUR CALLBOOK. Latest MARCH edition, 6/- post free.

SPECIAL OFFER. Limited number of Winter Callbooks going at 4/- post free.

G5KA, 41 Kinfauns Road, Goodmayes, Ilford, Essex.
Dept. T.5

TELEVISION.

A NEW COURSE OF INSTRUCTION.

We have pleasure in announcing that our new "Television" Course has met with remarkable success. The enormous demand for the Course has shown, beyond any shadow of doubt, that it fills that long-felt need which we anticipated when we went to such trouble and expense in its preparation.

We shall be happy to send full details of this special "Television" Course on request. Particulars are also available of other Courses in all branches of Wireless, Television, Talking Picture Engineering, etc., and of the easiest way in which to prepare for the A.M.I.E.E., A.M.I.W.T., A.M.I.R.E., etc., Examinations.

We teach by correspondence, and guarantee "**NO PASS—NO FEE.**" Our Technical Consultant is Professor A. M. Low.

Send for full particulars to-day. Free and without obligation.

THE BRITISH INSTITUTE OF ENGINEERING TECHNOLOGY
337, SHAKESPEARE HOUSE, 17/19, STRATFORD PLACE, LONDON, W.1.

HALLICRAFTER'S AMAZING NEW SKYRIDER 23



The SKYRIDER 23 communications receiver sets a new high for frequency stability, selectivity and noise reduction. It introduces a brand-new method of stabilising tuned circuits to reduce-frequency drift.

An improved wide range variable selectivity circuit is used. Selectivity is controlled by a switch in four steps from needle sharp crystal action to broad high fidelity.

The signal to noise ratio is remarkably high, and together with an improved noise silencer makes for very quiet operation.

Eight bands are employed. Four bands for general coverage from 10 metres to 540 metres, and four for band spreading the 80, 40, 20 and 10 metre amateur bands. This new band spread system permits more rapid and accurate operation in the amateur bands inasmuch as there is no band set dial to fuss with. All amateur bands are spread out over the major portion of the 330 degree large tuning dial. A new signal meter calibrating in both S units and decibels is used and is balanced on the panel by a frequency range indicator. Both are indirectly illuminated. The large venetian blind type metal tuning dial is also indirectly illuminated and the numbers are large and legible.

NOTE. Refer also to Hallicrafters double page advertisement in this issue.

Webb's DO carry every Hallicrafter instrument, Transmitter and Receiver IN STOCK.

Model SX-23 with especially tested HALLICRAFTERS

455 KC crystal £33 10 0

Matching speaker £4 0 0

WEBB'S RADIO

(C. WEBB LTD.)

Phone: Gerrard 2089

Birmingham Depot: 41 Carrs Lane

14 SOHO ST., OXFORD ST.,
LONDON, W.1.

FREQUENCY RANGE

32 to .54 MC. (10 to 540 metres).

Band 1-2-3-4—General Coverage (10 to 540 metres).

Band 5-6-7-8—Band Spread (10 - 20 - 40 - 80 metre amateur bands).

TUBE COMPLEMENT

6SK7—1st R.F.

6SA7—1st Det.

6SJ7—H.F. Osc.

6SK7—1st I.F.

6SK7—2nd I.F.

6SQ7—2nd Det. 1st Audio.

6B8—Amplified AVC.

6F6G—Power Output.

6SJ7—BFO.

80—Rectifier.

6N7—Noise Limiter.

Total number of tubes.—11.