

OLYMPIA-NEW SET BUYER'S GUIDE

Wireless Magazine

AND MODERN TELEVISION

Edited by PERCY W. HARRIS M.I.R.E.

GEORGE
NEWNES
LTD. LONDON

Complete Station
Identification
Guide

Dr. N. W. McLachlan on
Loudspeaker
Effects

Unusual Short-
wave Circuits

How to Build :
A Simple Battery
Three-valver,
An A.C./D.C. Two and
A 5-watt A.C.
Amplifier

Special 16-page
Coloured Supplement
"ALL THAT IS
NEW IN RADIO"



All about
RADIO OLYMPIA

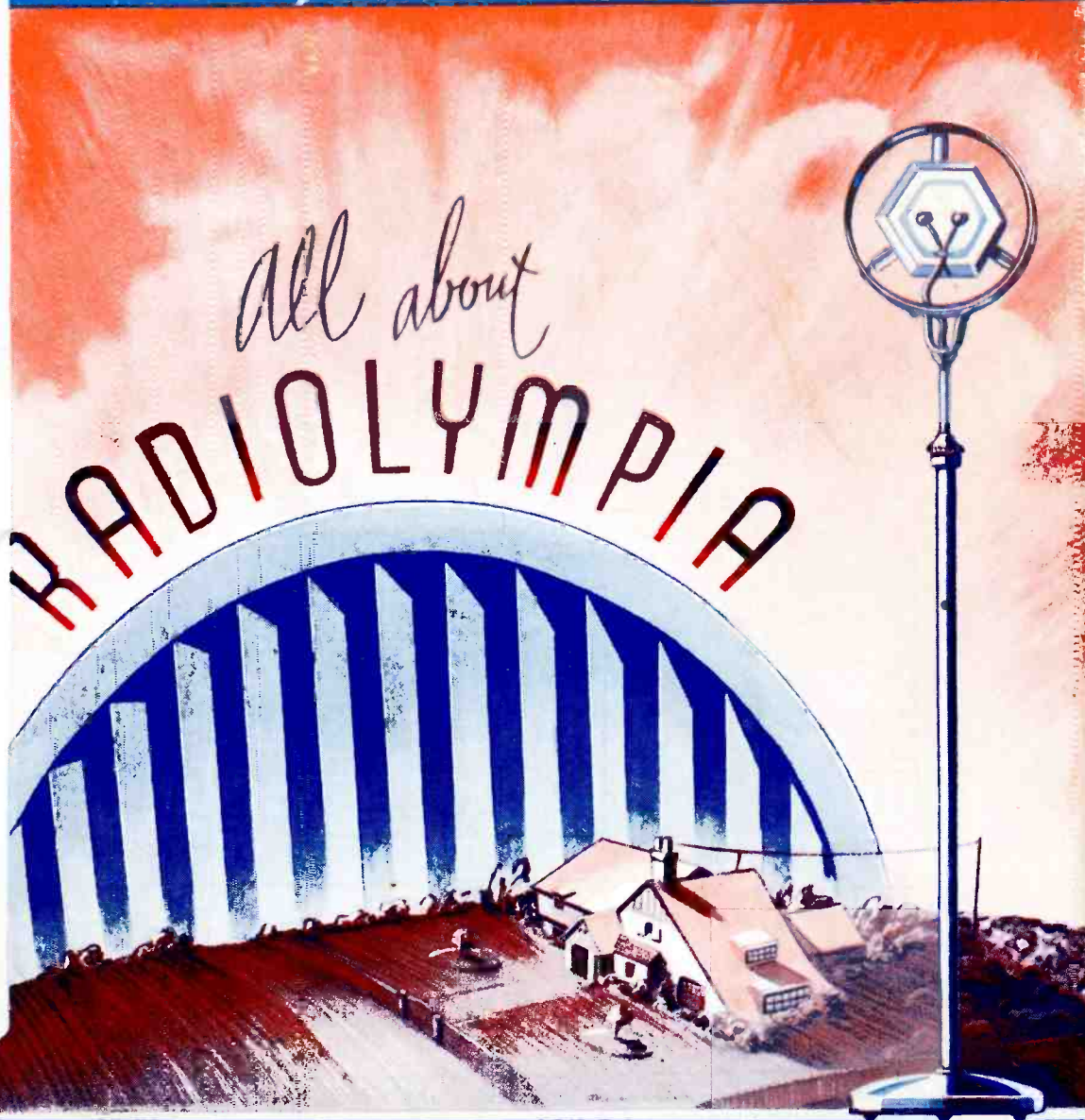

A SIMPLY-BUILT THREE-VALVER

Don't Envy the Engineer!

YOU CAN MAKE EVERY TEST — TRACE EVERY FAULT
with Accuracy and Ease

Valve Testing SIMPLIFIED



The AVODAPTER

(Regd. Trade Mark)

Every valve test can be made externally on the bench, thus doing away with the annoyance of grovelling about inside the set or having to sever connections. Tests are thus made with ease and accuracy, and under actual working conditions. Instantly adaptable for 4-pin, 5-pin or 7-pin valves. **25/-**



The 9-PIN AVO-COUPLER

This attachment renders the Avodapter instantly suitable for testing 9-pin valves. Complete with instructions. **12/6**



"AVO"

TESTING ACCESSORIES
Accurate yet simple, testing is carried a further step forward by this boxed Kit of "Avo" Testing Accessories. It does away with those nondescript lengths of wire which confuse testing. You can test more quickly and are safeguarded against making dangerous mistakes. For use with any testing meters. **2/6**

The fame of the Avometer, the world's most widely used combination meter, has given rise to an insistent demand for other combination instruments which would provide similarly dependable testing facilities for all classes of professional and amateur wireless technicians. In response to this demand, a full series of "Avo" Instruments has been produced to fulfil every need. Each instrument is simple to use, self-contained, and unexcelled for accuracy.

Write for fully descriptive literature if you do not visit Radiolympia.



The WORLD-FAMOUS D.C.

AVO MINOR

(Regd. Trade Mark)

This compact moving coil combination meter gives 10 different ranges of readings in milliamps, volts and ohms. It is invaluable for testing circuits, valves, components, batteries, power units, etc. Provides greater testing facilities with a standard of accuracy unapproached by any other instrument at anywhere near its price. In handsome case with pair of leads, interchangeable crocodile clips and testing prods, and complete instruction booklet showing how to make every test. **40/-**

- CURRENT**
0—6 milliamps
0—30 "
0—120 "
VOLTAGE
0—6 volts
0—120 "
0—300 "

- RESISTANCE**
0—10,000 ohms
0—60,000 "
0—120,000 "
0—3 megohms

DEFERRED TERMS IF DESIRED

The UNIVERSAL AVO MINOR

Regd. Trade Mark

This ingenious instrument has met with a reception that testifies to its usefulness and to its fulfilment of a long-felt need. It gives 22 different ranges of readings. (A.C. and D.C.). Has 3 in. scale. Total resistance 200,000 ohms. Complete with instruction booklet, leads, and interchangeable crocodile clips and testing prods. **£5**

22 METERS IN ONE

D.C. VOLTS		A.C. VOLTS	
0—75 millivolts	0—5 volts	0—5 volts	0—25 "
0—25 "	0—100 "	0—100 "	0—250 "
0—100 "	0—250 "	0—250 "	0—500 "
0—250 "	0—500 "	RESISTANCE	
0—500 "		0—20,000 ohms	0—100,000 "
MILLIAMPS		0—100,000 "	0—500,000 "
0—2.5 milliamps		0—2 megohms	0—5 "
0—5 "		0—10 "	
0—25 "			
0—100 "			
0—500 "			

£5
LEATHER CASE
10/-
Deferred Terms if desired



An Invaluable Testing Manual "Radio Servicing Simplified"

NEW ENLARGED EDITION

This invaluable book explains every phase of fault-tracing and testing in non-technical language. Multitudinous tests are so set forth as to be a matter of straightforward procedure. The comprehensive information and numerous diagrams enable everyone to test sets and apparatus with ease and success. **2/6**

Post Free 2/9

'AVO'

Accurate Testing Instruments

BRITISH MADE

The Automatic Coil Winder & Electrical Equipment Co. Ltd., Winder House, Douglas Street, London, S.W.1

Telephone: Victoria 3404-7

Wireless Magazine

Technical Editor :

AND MODERN TELEVISION

Assistant Editor :

G. P. KENDALL, B.Sc. Vol. XXII : SEPTEMBER, 1935 : No. 128

T. F. HENN.

Edited by Percy W. Harris, M.I.R.E.

ALL THAT IS NEW IN RADIO
Special supplement after page 96
OLYMPIA—HOPES AND FEARS .. Page one
WHAT DO YOU THINK OF THESE NEW SETS?—A page of pictures .. Page four
ALL ABOUT THE NEW SETS .. Page five
THE "W.M." GUIDE TO THE NEW SETS Page seven
HOW PICK-UPS HAVE CHANGED AND IMPROVED .. Page ten
HOME CONSTRUCTION AS A HOBBY Page twelve
ALL ABOUT THE NEW SHORT-WAVE COMPONENTS Page fifteen

FOR THE CONSTRUCTOR

THE CERTAINTY THREE. Designed by the "W.M." Technical Staff .. 90
THE LISTENER'S 5-WATT A.C. AMPLIFIER. Designed by L. O. Sparks and T. F. Henn .. 100
THE YEAR'S BEST A.C. FOUR-VALVE SHORT-WAVER. By G. Howard Barry .. 120
THE UNICORN A.C./D.C. TWO. Designed by G. P. Kendall, B.Sc. .. 134

TECHNICAL ARTICLES

CANCELLING-OUT INTERFERENCE. By P. Wilson, M.A. .. 96
THOSE TRANSIENTS! By Dr. N. W. McLachlan, D.Sc., M.I.E.E. .. 97

Contents

AUTOMATIC GRID BIAS WITHOUT DROPPING H.T. VOLTS. By Charles Lawler, A.M.I.R.E. .. 105
UNUSUAL SHORT-WAVE CIRCUITS FOR YOU TO TRY. By G. Howard Barry .. 107
A NEW DEVELOPMENT IN SOUND RECORDING. By Dr. Alfred Gradenwitz .. 110
HINTS FOR THE SERVICE ENGINEER. Conducted by G. P. Kendall, B.Sc. .. 125
OUR TESTS OF THE NEW SETS. By the "W.M." Set Selection Bureau .. 127
B.T.S. A.C./D.C. SHORT-WAVE KIT .. 128
MCMICHAEL MODEL 135 TWIN-SPEAKER SUPERHET .. 129
EKCO MODEL AD36 A.C./D.C. RECEIVER .. 130
H.M.V. SUPERHET FOUR-FORTY-ONE .. 131
A NEW SUPERHET WITH VARIABLE SELECTIVITY. By Paul D. Tyers .. 142
TESTS OF NEW APPARATUS .. 152

GENERAL ARTICLES

THE 1935 RADIO EXHIBITION. The Editor's Page .. 85
FINDING YOUR WAY ROUND THE ETHER! By J. Godchaux Abrahams .. 87

MIDGET GUIDE TO FOREIGN STATION LISTENING. .. 89
SEEING THE B.B.C. AT WORK. By T. F. Henn .. 94
W.M. SHORT-WAVE IDENTIFICATION PANELS. Compiled by Jay Coote .. 106
RADIO NEWS FROM ABROAD. By Jay Coote .. 112
UNWEPT, UNHONOURED AND UNSUNG. By Jay Coote .. 118
NEWS OF THE SHORT WAVES. By G. Howard Barry .. 119
BETWEEN OURSELVES. By Broadcatcher .. 122
NEW RECORDS FOR YOUR RADIOGRAM. By T. F. Henn .. 144
NEWS OF THE RADIO SOCIETIES. Conducted by G6QB .. 148
IN TUNE WITH THE TRADE. By Examiner .. 154
GUIDE TO THE SET MAKERS .. 156
NOTES AND NEWS .. 158
1935 SHORT-WAVE D.X. CONTEST .. 160
COUPONS: INDEX TO ADVERTISERS .. 160

TELEVISION SECTION

THE PHOTO-ELECTRIC CELL AND HOW IT WORKS. By Morton Barr .. 113
TELEVISION FOR THE BUSY MAN. By Percy W. Harris, M.I.R.E. .. 115
TELEVISION AND OLYMPIA. By Paul Woodward .. 132

Subscription Rates: Inland and Abroad, 15s. 6d. per annum; Canada, 13s. 6d. per annum.

Editorial and Advertisement Offices—"Wireless Magazine," George Newnes, Ltd., Southampton Street, Strand, London, W.C.2. Registered at the G.P.O. for transmission by Canadian Magazine Post.



Here it is!
BIGGER & BETTER THAN EVER

THE STANDARD COMPONENTS GUIDE FOR EVERY KEEN CONSTRUCTOR

This great new Bulgin Catalogue and Manual is by far the biggest and best issued since the House of Bulgin was established. Includes 20 pages of completely new lines, and contains in all 100 fascinating pages of over 1,000 components—components whose reputation for inbuilt quality is a byword in radio. The Manual section is also enlarged and includes details of dozens of ever-useful formulae, wiring circuits, etc., etc. Keep this essential reference book constantly at your side. **SEND THE COUPON.**

Do not miss the Bulgin exhibit on Stand 117 Radiolympia, (Grand Hall)

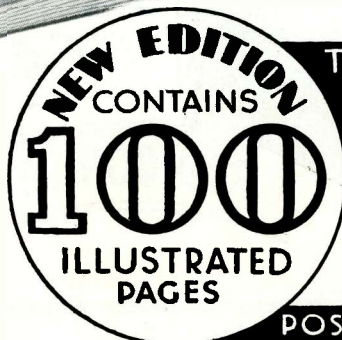

The NEW **BULGIN** CATALOGUE WITH THE BLUE & SILVER COVER

Please despatch post free the new 100 page Catalogue and Manual No. 155B. I enclose 3d. in stamps.

NAME ..
ADDRESS ..

A. F. Bulgin & Co., Limited, Abbey Road, Barking, Essex. Grangewood 3266

POST OFF THIS COUPON NOW!

Get your Copy Immediately

G.E.C. Radio

Advanced designs and a complete range from a compact ultra-efficient battery set to the last word in automatic record-changing radiograms



MADE IN ENGLAND

" FIDELITY RECEPTION "

is a wonderful discovery never before available in any equivalent receiver which makes the receiver comparable with the human ear, by responding faithfully to the essential natural harmonics (overtones) in the music scale on local station reception.

G.E.C. FIDELITY RADIOGRAM 5

Gives exceptional range with normal good-quality reception from all worthwhile stations, and marvellous "fidelity reception." Visual switching. Station name speedometer dial. Accuracy of tuning ensured by Tuneon device. Variable muting effectively suppresses inter-station noise. Auditorium dynamic speaker. Luxury gramophone equipment. The cabinet is gracefully designed in walnut and chromium.

Cat. No. BC.3658 for A.C. Mains 190/250 volts, 40/60 cycles. **CASH PRICE 23 gns.** complete with OSRAM Valves

HIRE PURCHASE TERMS.—Deposit 42/- and 12 monthly payments of 42/- or Deposit 42/- and 24 monthly payments of 22/-.

G.E.C. FIDELITY
RADIOGRAM 5 FOR A.C. MAINS

at Olympia

STANDS
35 · 44 · 63

ILLUSTRATED ARE TWO
TYPICAL EXAMPLES FROM
THE NEW G.E.C. RADIO
RANGE

Write for Folder No. BC.7332, which
describes the complete range of
G.E.C. Radio receivers and loud-
speakers. Sent POST FREE on
request.

*Come and see the
new G.E.C. Radio
Sensations!*

G.E.C. SUPERHET A.C.4

Latest design in four-valve high
efficiency superhets. Concert type
moving coil speaker. Easy-to-read
tilted station dial. Automatic Volume
Control. Tone Control. External
speaker sockets. Internal aerial.
Unsurpassed selectivity. Walnut and
chromium cabinet.

B.C.3640 for A.C. 190/250 volts, 40/100
cycles. **CASH PRICE** com-
plete with OSRAM VALVES **11 gns.**

HIRE PURCHASE TERMS.—Deposit
19/6 and 12 monthly payments of 19/6.

B.C.3645 for D.C. or A.C. Mains 200/250 volts,
25/100c. **CASH PRICE** com-
plete with OSRAM VALVES **11½ gns.**

HIRE PURCHASE TERMS.—Deposit
20/- and 12 monthly payments of 20/-.

G.E.C. SUPERHET DC-AC.4

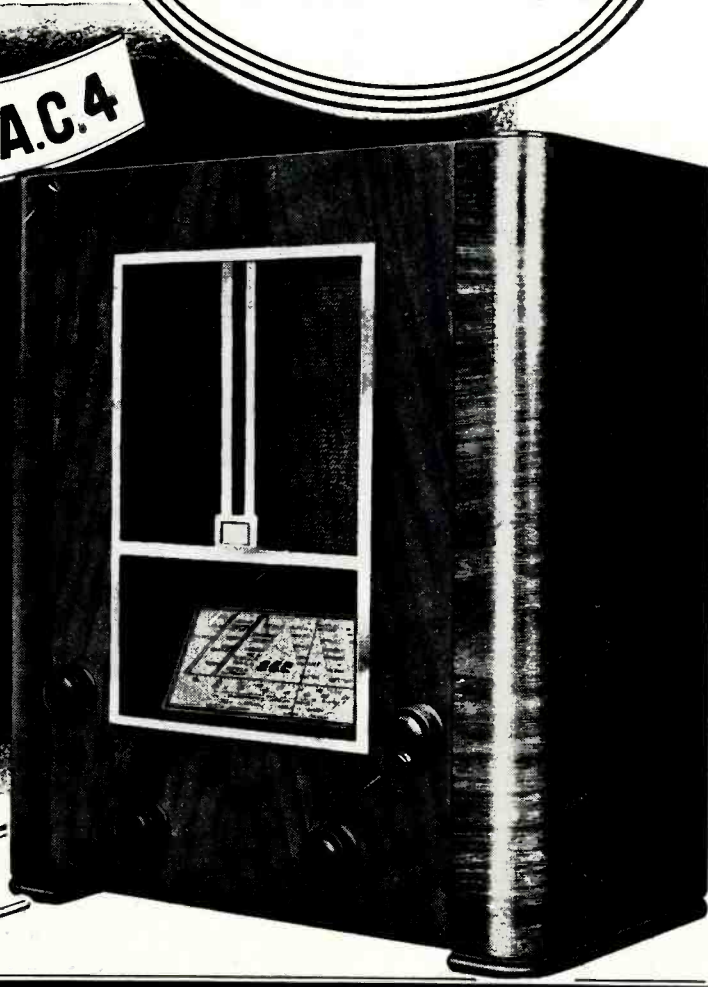

DECIDE UPON A MARCONI



the **REAL** thing

Here is one of the fourteen magnificent models you have to choose from. Model 236 (illustrated) is the latest console incorporating a 4-valve (inc. rect.) superhet circuit suitable for operation on both A.C. and D.C. mains. Its remarkable performance may be attributed to the skill of the Marconi engineers whose experience commenced at the birth of this modern science. It embodies a technique which ensures perfect reception under all conditions and is designed to give an uncommonly natural quality of reproduction.

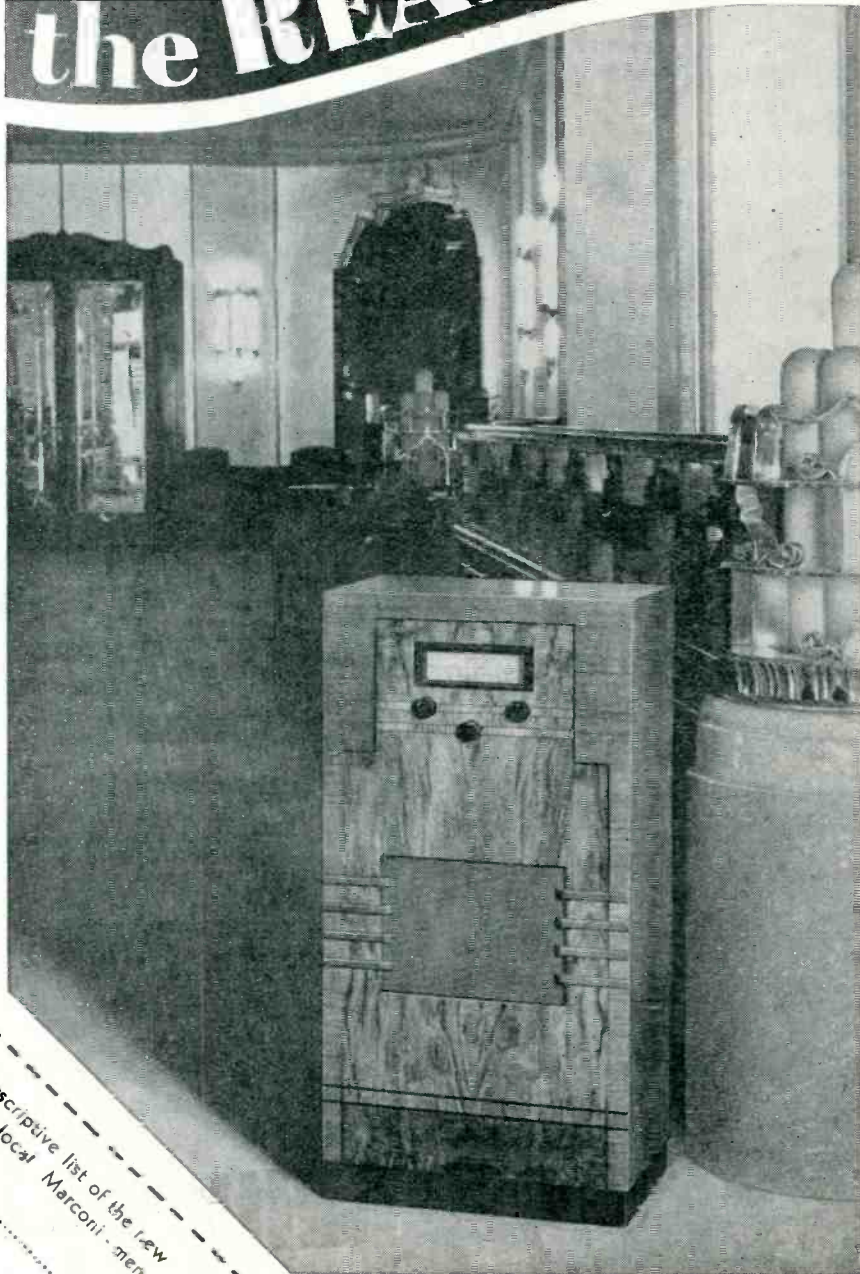

15 GNS

APPLY NOW Please send me illustrated descriptive list of the new Marconi Model 236 and the address of my local Marconi men

Name.....

Address.....

To The Marconiphone Co. Ltd., W.M. Sec.
 Radio House, Ct. Rd.,
 210 Tottenham Ct. Rd.,
 London, W.1.

Advertisers like to know you "saw it in the 'Wireless Magazine'"

Wireless Magazine

and Modern Television

The Editor's Page

September, 1935

The 1935 Radio Exhibition

ONE more year gone by and once again the excitement of seeing what is novel; of examining all the new receivers; of ferreting out all the latest ingenuity in set design, and of building, not castles, but sets in the air, from the latest labour-saving components. It is a great time for every enthusiast, which includes every wireless listener who appreciates a good job well done and who likes to know "how the wheels go round."

It is interesting to compare the Wireless Exhibition of 1935 with some of the first wireless shows when broadcasting was not so broad, and when, unless you were very rich, the only way to get a good set was to build it yourself. I well remember an exhibition at the Agricultural Hall, Islington, when a firm, now famous for its factory-built receivers and then better known for scientific instruments, had just entered the radio-component field.

On the stand was a large National Physical Laboratory curve showing the performance of a new low-frequency transformer—the first "straight-line" curve to be produced. Scarcely anyone believed it, yet such a transformer would be considered a poor performer in these days, although the prices have tumbled down considerably.

Only those who have ridden the hobby since the earliest days are in a position to appreciate the wonderful value not only of modern sets but also of modern components. Valves at 30s. and 35s. each (with lives as short as prices were tall), valve holders at 5s. a piece, no ganged condensers, no matched coils, current consumption of a formidable order (remember, the old valves took at least ten times as much filament current for a fraction of the performance), yet all these difficulties did nothing to deter the home constructor.

In many cases the amateurs of those days are the professional designers of these, and it still takes a lot to beat the thrill of hearing the first signals on the set you have built for yourself.

But whether you build your own or whether you buy a finished set, Olympia values this year represent one further step forward. The Exhibition authorities have strained every nerve to make this the best of all wireless exhibitions, and as a result of the great success

achieved last year in the entertainment side, a real galaxy of talent has been engaged to entertain the non-technical visitor.

Many visitors at the Exhibition this year will be enquiring about television. Many, indeed, may expect to find television sets on general sale. We hope, in this matter, that a common-sense and level-headed attitude will be taken by everyone concerned, and in particular that the various companies exhibiting may instruct their staff in the real facts of the situation.

The position, of course, is not an easy one to explain to the "Man in the Street." On the one hand the publication of the Government Report and the demonstrations given by the Baird company to their shareholders as well as to the general and technical press, have shown that, technically at least, television has arrived.

On the other hand we have, as yet, no broadcasting television station, and to sell television sets before the service exists is comparable with selling motor-cars where there is no petrol available. How soon this service will start depends upon the amount of "drive" that is put into the business by those concerned.

Let us hope that the B.B.C. do not cause too much delay by endeavouring to start with a perfect service. Broadcasting began in a very crude fashion and gradually developed itself into the present remarkably well-organised service as experience showed the way.

The trade, as a whole, is afraid that the public might cease to buy ordinary, or sound broadcasting, apparatus for fear that it would immediately become obsolete with the coming of television. It may help to point out to enquirers who have this idea that "sight" broadcasting and "sound" broadcasting are definite services, and that one does not delay purchasing a motor-car because of the growing popularity of aeroplanes.

The two forms of broadcasting will always exist side by side, one being the companion to the other.

Percy W. Harris.

Simple Ways of Identifying Foreign Stations—See page 87

Your Guide to the Best.. 1936 Pedigree Radio

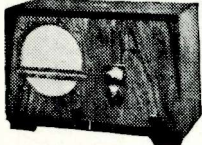

MODEL 148 BATTERY RECEIVER
Three-valve battery-operated receiver with moving coil speaker, pentode output. Complete with batteries. **£7.19.6**

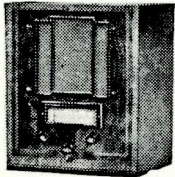

MODEL 146 BATTERY RECEIVER
Four-valve battery-operated superhet receiver with moving coil speaker. Push-pull pentode output. **12 GNS**

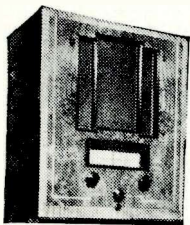

MODEL 340 DC/AC RECEIVER
Four-valve (inc. rect.) universal electric DC/AC superhet with AVC. **11½ GNS**

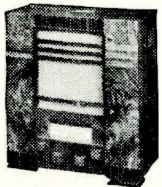

MODEL 441 RECEIVER
Five-valve (inc. rect.) AC superhet receiver with adjustable QAVC. Exceptional value at **12½ GNS**

NOT ILLUSTRATED
Model 540 D C Superhet Radiogram 21 GNS.
Model 180 Speaker 8 GNS.
Model 170 Speaker £4 15 0
No. 11 pick-up unit 32.6

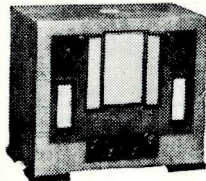

MODEL 442 RECEIVER
Five-valve (inc. rect.) AC superhet receiver with "fluid-light" tuning, AVC and static suppressor. **13½ GNS**

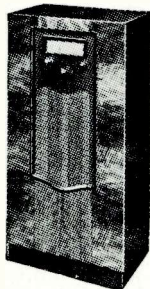

MODEL 341 DC/AC CONSOLE
Four-valve (inc. rect.) universal electric DC/AC superhet with AVC, in latest style console cabinet. **15 GNS**

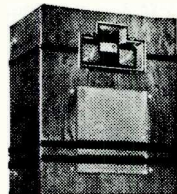

MODEL 463 MAINS PORTABLE
Six valve (inc. rect.) AC superhet portable receiver with "fluid-light" tuning. Built in aerial. Low consumption. **13½ GNS**

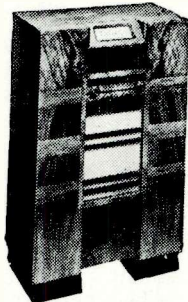

MODEL 444 CONSOLE
Five-valve (inc. rect.) AC superhet receiver with QAVC. Can be operated sitting or standing. **17 GNS**

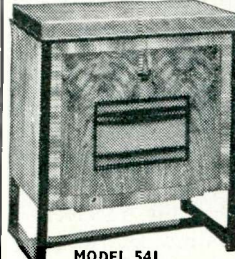

MODEL 541 QAVC RADIOGRAM
Seven-stage five-valve (inc. rect.) AC superhet with Quiet or ordinary AVC at will. Silent-running electric gramophone. **22 GNS**



MODEL 570 AUTORADIOGRAM
Five-valve (inc. rect.) AC superhet with "fluid-light" tuning, AVC, interference suppressor, Automatic Record-Change and latest type electric gramophone. **33 GNS**

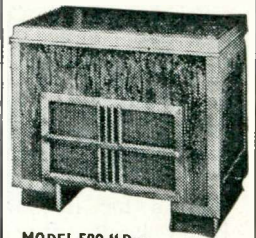

MODEL 580 "Duo-Diffusion" AUTORADIOGRAM
Nine-valve (inc. rect.) AC superhet with "fluid-light" noiseless tuning, static suppressor, QAVC, automatic tone-compensated volume control, and duo-diffusion elliptical cone speaker. Latest type electric gramophone. Quick-change automatic record-changer. **52 GNS**

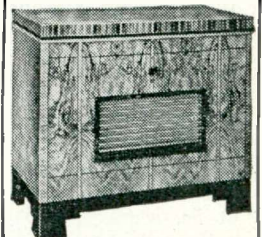

MODEL 800 High-Fidelity AUTORADIOGRAM
Fifteen-valve (inc. two rectifiers) AC superhet, for all-wave reception. The finest instrument ever produced. **110 GNS**

"HIS MASTER'S VOICE"

Radio
STAND NO
77

1936 Pedigree RADIO

Records
STAND NO
82

"HIS MASTER'S VOICE," 98-108 CLERKENWELL ROAD, LONDON, E.C.1

Better service results from mentioning "Wireless Magazine" when writing to advertisers

Identifying the programmes of Europe's three hundred broadcasters is by no means easy, even for the most experienced of listeners. In this special article, which embraces a compact station-identification guide, J. Godchaux Abrahams shows how simple the whole business really is

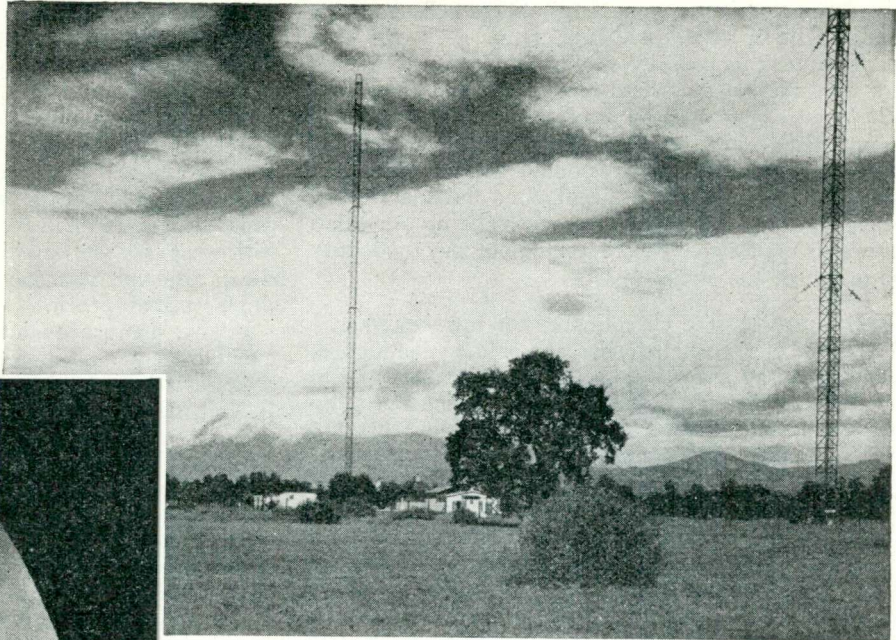

Lusty photo

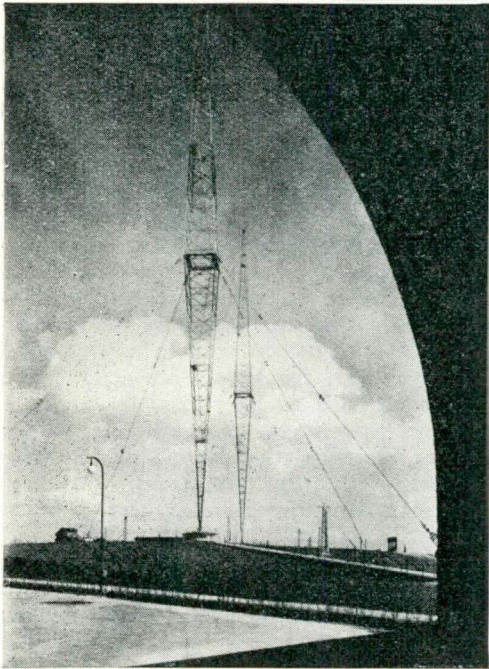

Gulliland photo
(Top right) The 7-kilowatt station at Ljubljana, Yugoslavia, is to be found among the most delightful surroundings. (Above) A really fine view of the masts at the 120-kilowatt Vienna station

Finding Your Way Round the Ether!

By J. GODCHAUX ABRAHAMS

IF you care to look at a list of broadcasting stations you will find that Europe alone possesses some three hundred or more transmitters. It is true that of these quite a large number are either of very low power or situated in districts such as Central or Eastern Russia, from where you will seldom pick up signals. But on the other hand, there are roughly two hundred or more from which, at some time or other, you will receive a broadcast. It may not be of programme value either as regards volume or from the point of view of interest, but your receiver, under favourable conditions, will give it to you for what it is worth.

You may take it that the average wireless receiver today will permit you to listen nightly to fifty or sixty foreign programmes, and such a number is well calculated to puzzle the beginner as to identity, or for the matter of that any listener whatever experience he may possess if his knowledge of languages is confined to his mother tongue—in this case, English.

Although most modern receivers are equipped with scales showing the relative positions of the most important stations, there is no absolute guarantee that the listener at the outset will actually tune in the wanted transmission.

It is not that the indications are inaccurate, but for the simple reason that most stations are separated by a channel of only 9 kilocycles, which on the condenser dial normally represents a very small space; in fact, in many instances only a bare degree or so. It is therefore quite possible to tune in inadvertently the neighbouring occupied wavelength and thus, as an example, Stockholm will be heard when Rome is wanted. How then can either or both be recognised?

The question of wavelength is not one that should trouble us much, except in those sets where the dial assumes the appearance of a clock, as the wavelength readings should give some idea of the channel on which the broadcast has been heard, and this knowledge will narrow the limits of the search.

Then again, we may hear an interval signal, or better still, the call. There is a possibility that it may not at the outset be understood, as unfortunately the names of foreign cities do not always coincide with their English equivalents by which we know them.

Paris is not *Par-riss* to the Frenchman, but *Par-ee*; Warsaw to the Pole is Warszawa (phon: *Varschavva*);

Berlin is *Bear-lean* to the German, and so on. It is for this reason that in the annexed list these calls are spelt phonetically, or as you will hear them.

But we may be unlucky, and at the moment we tune in a transmission may hear neither interval signal nor call. We need not, however, wait for one—the wait may be prolonged—as if we can recognise the language of any speech picked up this should provide sufficient data for classifying the transmission. Is it a Swede, a Belgian or an Italian? If we can make up our mind as regards the tongue, we are well on our way to identify the origin of the signal.

With possibly the exception of the raw beginner, I think that most listeners are able to distinguish between, say, a Latin, Teutonic or Slavonic language, and roughly these are the three groups into which European tongues may be divided. In the first we find French, Italian, Spanish and Portuguese; in the second, German, Dutch or Flemish—there is very little difference here—Norwegian, Swedish, Danish and English; in the last, Russian, Polish, etc.

In order to avoid complicating matters, I have not extended the classification, but in the course of an evening you will also hear Czech, Roumanian, Magyar, and others which, by experience, you will differentiate from those to which you have accustomed your ears. It is not easy to give a concrete idea of what a language sounds like, but the following few pointers may help:

(1) *Latin group*: French, I believe, will be recognised by most readers; Italian is more musical with most

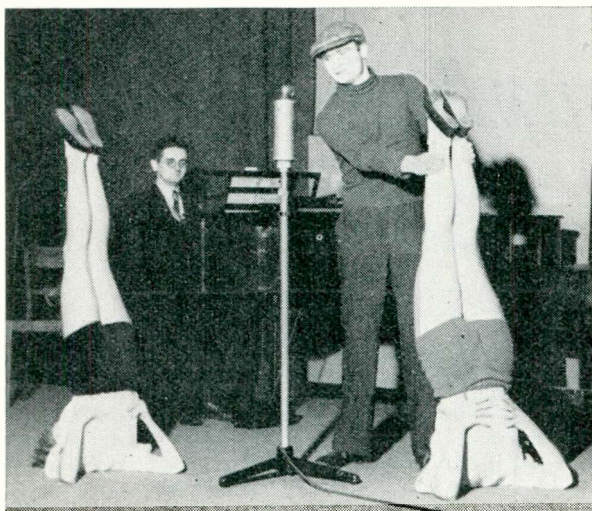

Gulliland photo
A course of physical jerks is broadcast every morning at 6.0 and 8.0 a.m. (local time) from Berlin and Leipzig. Our photo shows Willy Driske, the instructor, with two of his "victims"

words finishing with a vowel (mainly a, e, o, i); Spanish and Portuguese are somewhat rougher, especially the latter. (The Italian announcers—of which the majority are of the feminine gender—enunciate very clearly every syllable; no word is slurred).

(2) *Teutonic group*: German, rough, full of guttural sounds, achs, ung (phon: oong), and hard Z's (tz). Dutch and Flemish are softer and are more akin to English as also is Danish. Swedish and Norwegian are somewhat more melodious; in the former case the announcers adopt a singing intonation.

(3) *Slavonic group*: When once you have heard Russian, as from Moscow or Leningrad on the higher

channels, you will recognise it another time; there is no other language quite like it. The words are full of labials (B's and P's), and rolled R's. Polish is identifiable by its ski's and V's—listen to Warsaw; Czech contains more Z's, D's and B's than any other letter.

Take my advice and tune in some known foreign station and listen for a few minutes to the news bulletin. It will not be waste of time as very soon you will accustom your ears to the sound of the language used. You will not be compelled to do this very frequently before discovering with what ease you can distinguish a language by sounds alone, although you may not be able to understand a single word of speech.

I have many acquaintances who, by adopting this method, are in a position to say when they hear a foreign broadcast that, for instance, it is neither French nor Italian, but may be Spanish or Portuguese.

In the columns on the opposite page the reader will find, in order of wavelength and frequency, the stations most received on any good wireless receiver—even a modest three- or four-valver. When compiling this list I did not include any international channels on which transmitters of *different* nationalities might be working, except in such cases where times of transmission do not clash. Where common waves are concerned such as 251 m.—on which Frankfurt and its relays operate—such an inclusion is possible as synchronisation is fairly successful, and as all stations take the same programme, though not always clear, the signals are good.

In the matter of calls, where several transmitters work in the same network, the reader is referred for particulars to the mother station, from which, in most instances, the original broadcast emanates.

The calls, however, are now given frequently, and as they are phonetically indicated in the guide they should prove of great assistance towards identifying the transmitter or transmission, as the case may be. It is obvious that where a programme is taken by a number of relays the same announcement will be picked up from all, and it is for the listener to establish on which wavelength he has picked up the broadcast.

If then he consults a fully detailed list of wavelengths and frequencies, such as is regularly published in the "Wireless Magazine," (Not this month through lack of space.—Ed.) he will encounter no difficulty in ascertaining through which particular channel the broadcast has been received.

SHORT-WAVE RELAYS

(1) Skamlebaek (Denmark)	49.5 m. (6,060 kcs.);
	31.6 m. (9,493 kcs.).
(2) Madrid EAQ (Spain)	30.42 m. (9,860 kcs.).
(3) Parede CT1GO (Portugal)	24.2 m. (12,396 kcs.);
	48.4 m. (6,198 kcs.).
(4) Ruysselede ORK (Belgium)	29.04 m. (10,330 kcs.).
(5) Zeesen (Germany): DJE, 16.89 m. (17,760 kcs.); DJQ, 19.63 m. (15,280 kcs.); DJB, 19.74 m. (15,200 kcs.); DJD, 25.49 m. (11,770 kcs.); DJA, 31.38 m. (9,560 kcs.); DJN, 31.45 m. (9,540 kcs.); DJC, 49.83 m. (6,020 kcs.).	
(6) Rome IRO (Italy)	25.42 m. (11,801 kcs.);
	31.13 m. (9,637 kcs.).
(7) Paris Colonial, FYA (France)	19.68 m. (15,243 kcs.);
	25.23 m. (11,880 kcs.);
	25.6 m. (11,720 kcs.).
(8) Lisbon CSL (Portugal)	48.78 m. (6,150 kcs.).
(9) Radio Maroc CNR (Morocco)	23.39 m. (12,830 kcs.);
	37.33 m. (8,035 kcs.).
(10) Szekesfehervar (Hungary)	HAS3, 19.52 m. (15,370 kcs.);
	HAT4, 32.88 m. (9,125 kcs.).
(11) Jeloy LKJ1 (Norway)	31.34 m. (9,572 kcs.);
	48.94 m. (6,128 kcs.).
(12) Moscow (U.S.S.R.)	25 m. (12,000 kcs.);
	50 m. (6,000 kcs.).
(13) Vienna OER2 (Austria)	49.4 m. (6,072 kcs.).

MIDGET GUIDE TO FOREIGN-STATION LISTENING

Compiled for "W.M." by J. Godchaux Abrahams

Note: The bracketed number following frequency in kilocycles refers to footnote on opposite Page in which is given the wavelength and frequency of the short-wave station taking the programme

Wave-length Metres	Frequency Kc.	Station	*Call (in phonetics)	Interval Signal	Wave-length Metres	Frequency Kc.	Station	*Call (in phonetics)	Interval Signal
206	1,456	Eiffel Tower, Paris (France)	Eeci Post Nah-see-owe-nal de la Two-er Ay-fell		395.8	758	Katowice (Poland)	Har-low (twice) Pols-key Rah-dee-owe Kat-owe-vee-saty	Hammer striking anvil
209.9	1,429	Radio LL, Paris (France)	Eeci Rah-dee-owe El-El	Musical signal	400.5	749	Marseilles P.T.T. (France)	Allo ! (twice) Eeci Mar-say	Musical signal Bells
215.4	1,393	Radio Lyons (France)	owe Lee-yon		405.4	740	Munich (Germany)	Here Rych-sender Mew-nchen	
236.8	1,267	Nurnberg (Germany)	See Munich		420.8	713 (6)	Rome (Italy)	Eh-yah Rah-dee-owe Roema	Musical signal repeated in three keys
238.5	1,258	San Sebastian (Spain)	Ay ah rhot a ocho oon-ee-own Rah dee-oo San-Say-bass-tee-yan						
240.2	1,249	Nice-Juan-les-Pins (France)	Eeci lay Poste de Niece-Cann-Jew-ong-lay-Pan	Musical signal	426.1	704	Stockholm (Sweden)	See Motala	
243.7	1,231	Gleiwitz (Germany)	See Breslau		431.7	695 (7)	Paris P.T.T. (France)	Allo ! (twice) Eeci Par-ee Pay Tay Tay	
245.5	1,222	Trieste (Italy)	See Milan		437.3	686	Belgrade (Jugo-Slavia)	Har-low Oo-day Rah-dee owe Bay-oh-grard	Musical-box
247.3	1,213	Lille P.T.T. (France)	Eeci Rah-dee-owe Lil Pay Tay Tay	Musical signal	443.1	677	Sottens (Switzerland)	Eeci Rah-dee-owe Swiss Roe-mand	Musical signals Three notes
251	1,195	German common wave Frankfurt programme)	Here Rych-sender Frankfoort		455.9	658	Cologne (Germany)	Here Rych-sender Keuln	Three notes
255.1	1,176 (1)	Copenhagen (Denmark)	Kah-loond-borg Key-ob-en-harvn og Danmark's kort-bolge-sender	Small carillon	463	648	Lyons P.T.T. (France)	Eeci Pay Tay Tay Lee-yon	Musical signal
257.1	1,167	Monte Ceneri (Switzerland)	Rah-dee-owe Svitz-ay-ra Ee-tal-ee-ah-na	Peal of bells	470.2	638	Prague 1 (Czecho-Slovakia)	Allo ! Prar-ha	Harp melody
263.2	1,140	Turin (Italy)	See Milan		476.9	629 (8)	Barcarena-Lisbon (Portugal)	Ay-mee-sora Nah-see-ownal Lees-boa, Port-oo-gal	
265.3	1,131	Horby (Sweden)	See Stockholm		483.9	620 (4)	Brussels 1 (Belgium)	Eeci Brew-sell Ee-en-air	Musical-box melody
269.5	1,113	Fécamp (France)	Eeci Rah-dee-owe Normandee	Musical opening and closing signals	491.8	610	Florence (Italy)	See Milan	
271.7	1,104	Madona (Latvia)	See Riga		499.2	601 (9)	Rabat (Morocco)	Eeci Rah-dee-owe Mar-rock	Metro-nome
274	1,095 (2)	Madrid EAJ7 (Spain)	Ay-ah-hota see-yet-aye Union Radio Madrid		506.8	592 (13)	Vienna (Austria)	Hallo ! Here Rah-dee-owe Veen	Metro-nome
278.6	1,077	Bordeaux P.T.T. (France)	Eeci Bord-o La-fy-yet Pay Tay Tay		514.6	583	Grenoble P.T.T. France)	Eeci Grain-noble Pay Tay Tay	Musical opening and closing signals
283.3	1,059	Bari (Italy)	See Rome		514.6	583	Riga (Latvia)	Hallo ! Lat-vee-ya Reega, Ma-do-na, Kool-dee-ga, Lee-pie-ya	Chimes
288.5	1,040	Rennes P.T.T. (France)	Allo ! (twice) Eeci Rain-Bretagne	Musical signal	522.6	574	Stuttgart (Germany)	Here Rych-sender Stoot-gart	Three notes : C, D, G
291	1,031	Heilsberg (Germany)	Here Rych-sender Keunigs-baig		531	565	Athlone (I.F.S.)	Say Say-o Radio Ath-loo-ane, Atha Clee-ath ar-goos Co:k-ay	
291	1,031 (3)	Paredo (Portugal)	Rah-dee-owe Par-ay-day		539.6	556	Beromuenster (Switzerland)	Here Schwy-tser-isher Landes - sender Bairn, Bar-zel (or) Tsou-rish	Separate interval signals
298.8	1,004	Bratislava (Czecho-Slovakia)	See Prague		549.5	546 (10)	Budapest (Hungary)	Hallo ! itt Rah-dee-owe Booda-pesh	Musical-box
301.5	995	Hilversum (Holland)	Here is Hoyzen (N.C.R.O., K.R.O., etc.)	Trumpet call	569.3	527	Ljubljana (Jugo-Slavia)	Hallo ! Rah-dee-owe Loo-blee-ah-nah	Cuckoo call
312.8	959	Poste Parisien, Paris	Eeci Post Par-ee-zee-yan	Musical box melody	1,154	260 (11)	Oslo (Norway)	Hallo ! Oo-zio hare	Musical signal
315.8	950	Breslau (Germany)	Here Rych-sender Brays-low (as in 'how')		1,224	245	Leningrad (U.S.S.R.)	Sloo-shah-eet-ee-yeh Leningrads-kay-a	Internationale
318.8	941	Algiers P.T.T. (North Africa)	Eeci Pay Tay Tay Al-zhay		1,261	238 (1)	Kalundborg (Denmark)	Kee-ob-en-harvn Karl-oon-d-borr og Danmark's kort-bolge-sender	Musical-box
318.8	941	Goeteborg (Sweden)	See Stockholm		1,304	230	Luxembourg (Grand Duchy)	Eeci Rah-dee-owe Loox-am-boor; Here Rah-dee-owe Loox-am boorg, and in English	
321.9	932 (4)	Brussels 2 (Belgium)	Here Brew-sell	Small carillon	1,339	224	Warsaw 1 (Poland)	Hallo (twice) Rah-joe Pols-key Var-shavva	Musical-box melody
328.6	913	Radio Toulouse (France)	Eeci Rah-dee-owe Too-looze	Gong	1,389	216	Motala (Sweden)	Stockholm Mott-allah	Gong
331.9	904	Hamburg (Germany)	Here Rych-sender Ham-boorg	Musical signal	1,442	208	Reykjavik (Iceland)	Oot-varp-stod Ee-slans Ray-kee-ar-veek	
335.2	895	Helsinki (Finland)	Hew-ome-me-owe (twice) Lar-tee Helsinky Vee-poor-ee	Musical signal	1,571	191 (5)	Deutschland-sender (Germany)	Here dair Doytch-land-sender	Carillon
338.6	886	Graz (Austria)	See Vienna		1,600	187.5	Istanbul (Turkey)	Allo ! Boo-car-ee Ee-stan-bull tel-siz tell-ay-fon-ou	Gong : 77 beats per minute
345.6	868	Poznan (Poland)	See Warsaw		1,648	182	Radio Paris (France)	Poste Nah-see-own-al Rah-dee-owe Par-ee	Musical signal
349.2	859	Strasbourg P.T.T. (France)	Eeci Stras-boor Pay Tay Tay	Deep gong	1,744	172 (12)	Moscow 1 (U.S.S.R.)	Sloo-shah-ee-tay Govoreet Moskva Rah-dee-owe Komin-tare-na	
356.7	841 (5)	Berlin (Germany)	Here Rych-sender Bear-lean	Letter "B" in morse	1,807	166	Lahti (Finland)	See Helsinki (Hilversum programme)	
360.6	832	Moscow IV (U.S.S.R.)	Sloo-shah-eet-ee-yay Rah-dee-owe Moskva Stal-ee-na	Metronome and musical-box	1,875	160	Kootwijk (Holland)	Here is Hilversoom (V.A.R.A., A.V.R.O., etc.)	
364.5	823	Bucarest (Romania)	At-tent-see-owe-nay Ah-eetchee Rah-dee-owe Book-oo-recht		1,935	155	Kaunas (Lithuania)	Allo ! (twice) Rah-dee-owe Cow-nass, Lee-two-va	Musical-box melody
368.6	814	Milan I (Italy)	Eh-yah Rah-dee-owe Mee-la-no, Tor-eno, Jen-owe-va, Fee-ren-zay, Tree-estay	Song of Nightingale					
377.4	795	Barcelona EAJI (Spain)	Ah-key Esta-see-von Ay-ah-hota-oono (EAJI) Rah-dee-owe Bar-cell-own-a	Metronome or three chords					
382.2	785	Leipzig (Germany)	Ar-toong ! Here Rych-sender Ly-psish	Musical signal					
386.6	776	Toulouse P.T.T. (France)	Eeci Too-looze Pee-rain-aye Pay Tay Tay						

* The call is spelt phonetically, thus giving it as heard by the British listener

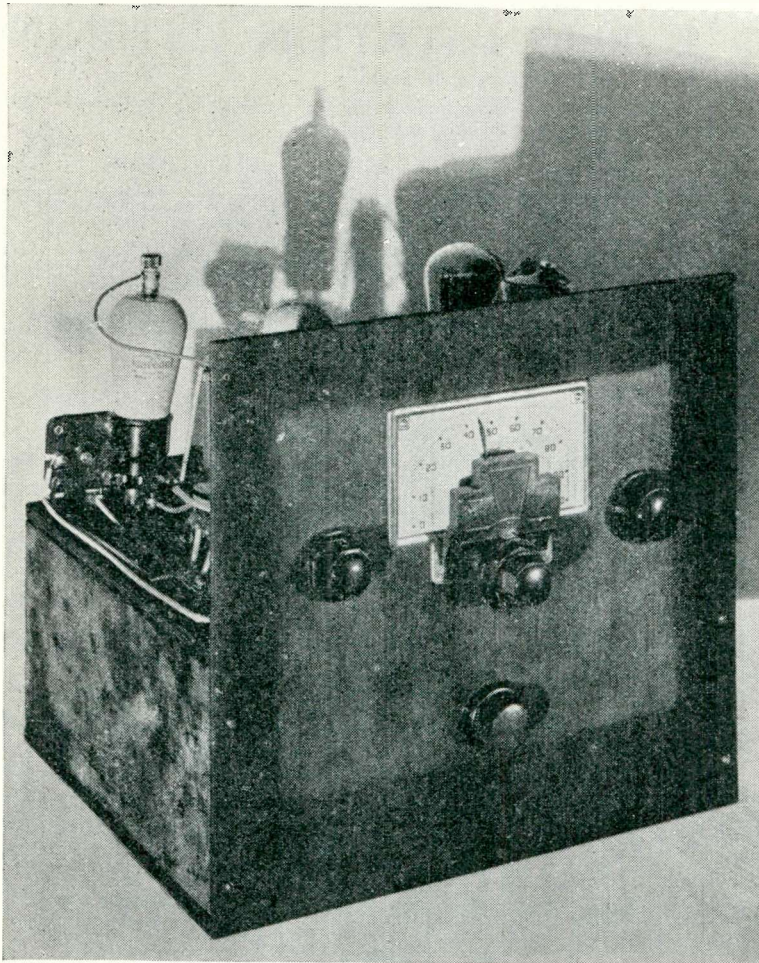

The set is designed on the same assembly principle as the popular "Carrier" short-waver, with a lower compartment holding all the batteries. Of the various controls the knob on the left is the multi-purpose switch governing wave-range, filament on-off and radio-gram. In the centre below the tuner is the reaction condenser while to the right is the volume control

SETS may come and sets may go; fashions may change from crystals to superhets; tastes may veer from one kind of cabinet to another; yet all the way through the three-valve battery set remains a prime favourite. With fewer valves than this there is always the sense of something lacking; with more the cost and complications go up without perhaps sufficient additional advantage to justify them. Even where there are electric mains in the house, the battery type still remains popular, particularly when a good accumulator has already been purchased and when an efficient mains unit is standing idle.

In Demand

The Technical Editor and I have frequent conferences in which we study the trend of construction demand and gather from an analysis of the queries sent in just what is required at the moment. It would

appear from numerous recent requests that another three-valve battery set is in demand; one which is a first-class performer and which can be built at the lowest possible cost, commensurate with quality. The "Certainty Three" will, we think, meet the present demand for an up-to-date set at a very low cost.

The set, as you see it, is a joint effort and the result of a round-table conference. The particular method of constructing the panel and base-board, so as to provide an under-baseboard receptacle for the batteries, is an adaptation of my design for the short-waver which appeared in the July issue.

The circuit is one with which the Technical Editor and I have had a great deal of experience, and we have chosen it as, perhaps, the most easily reproducible with the wide variety of components now available.

A great deal of importance attaches to this matter of reproducibility. It

The

Designed by the

We present the ever-popular three-valve combination of high-frequency stage, detector and pentode in a new guise. Designed in conference after much consideration of requests received from readers the *Certainty Three* represents our effort to provide a real top-notch set at very moderate cost and with extremely simple construction

is, for example, easy to work out a circuit of extremely high efficiency which requires everything to be "just so" in a very tricky and critical layout: if this is departed from its performance may fall off considerably.

While a test report on such a receiver may prove a very attractive affair, it is the results obtained by readers, not in the test room that really count. Consequently we have been very careful in "W.M." to avoid this most delusive snare. You will certainly find no trace of this in the "Certainty Three."

Tuning System

As the heart of a receiver is its tuning coil or coils, so it is just as well to begin by examining the tuning system. Here we are using some recently evolved iron-core coils of high efficiency, the pair being matched and connected together with a common switch that makes ganging easy.

The twin-gang condenser has a panel-controlled trimmer, so that no matter what part of the scale is used, exact matching is assured, accompanied by the high efficiency that can only come from a dead accurate adjustment of tuning.

The variable-mu screen grid valve in the high-frequency stage assures high gain, sharp tuning, and the best form of volume control without distortion, while the detector—a plain three-electrode valve—provides

Certainty Three

“W.M.” Technical Staff and described by the Editor

both detection and reaction for high efficiency in this part of the circuit. Provision is made for a pick-up and one single switch serves to operate the wave-change from medium to long waves and back again; the change from radio to gramophone, and also the switching on and off of the whole set.

The output valve is a pentode coupled to the detector by a transformer and shunted on the output side by a condenser of sufficient size to remove the “peakiness” that so often gives an unpleasant sharpness to the output of such a valve. It is one of the advantages of this particular design that it can if desired be slid complete into a cabinet or used “in the open”—in either case without any trailing battery wires. The only external connections are one pair of wires for aerial and earth and another for the loudspeaker; with, of course, a pick-up when used.

Convenient Height

The height of the set including the batteries is such that it is quite convenient to place a moving-coil loudspeaker on its right or it can form the upper portion of a radiogram with a loudspeaker below it. Acousti-

cally it is always better to keep the speaker away from the receiver itself, and furthermore, numerous readers already have loudspeakers in separate cabinets which they want to use.

If you have a separate speaker; well and good, if not, you can either make it up in a separate cabinet or use the alternative design suggested in which the speaker is placed immediately alongside of the set for convenience when a compact self-contained receiver is required.

The constructional work has been rendered exceedingly simple in this design and practically all wiring is above the baseboard. The set would look neater if much of the wiring were taken below, but this would increase the work without increasing the efficiency, and sim-

plicity is one of the special points both of building and operation of this set.

After you have mounted up all the components cut out some sheets of paper so that they cover as much as possible of the baseboard, particu-

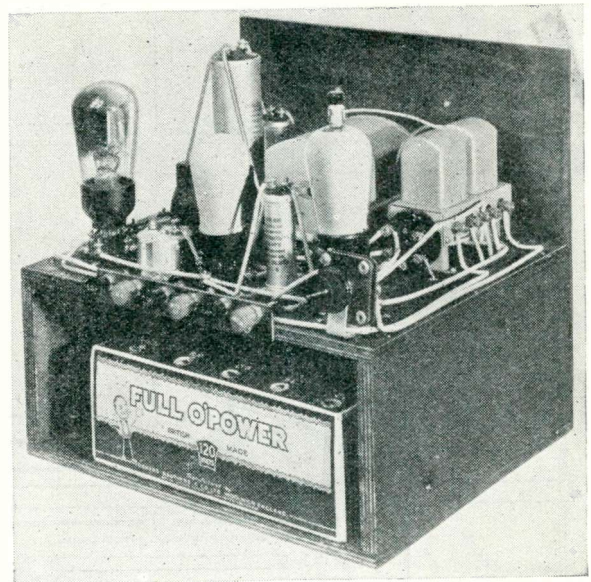

Here you see the set with the H.T. battery drawn forward to show how it slides into the lower compartment. There is space beside it for both the accumulator and G.B. battery

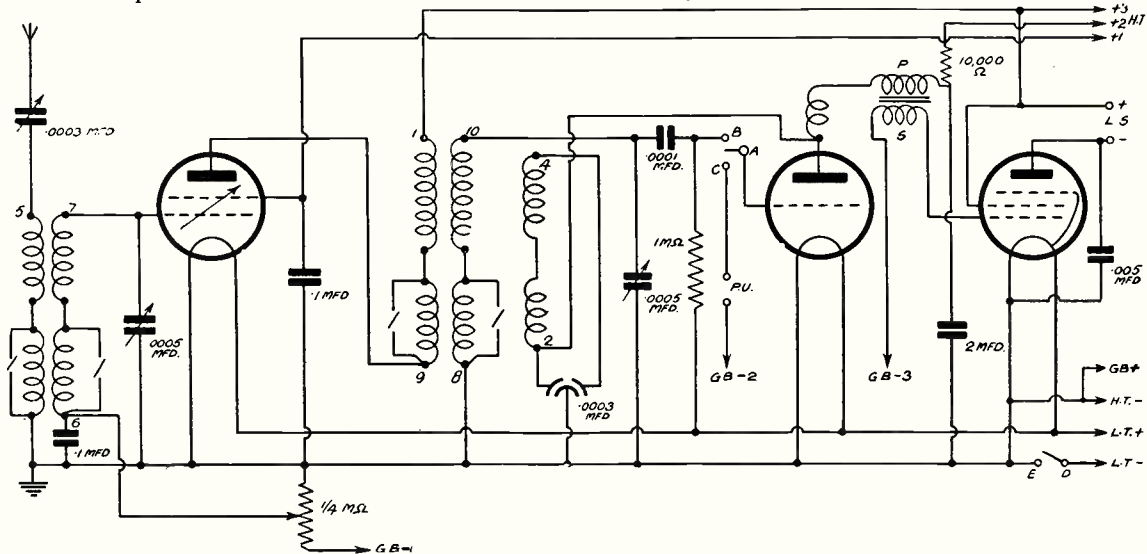

In this diagram of the circuit you can follow out the simple and efficient electrical arrangements. Note the wave-change switching system and the method of volume control by variation of bias on the grid of the variable-mu valve. The various switches shown are actually all controlled by a single knob

positions of which are clearly marked in moulding on the knob. As mentioned before, this switch serves not only as an on-off switch, but as a wave-change switch from medium to long waves and vice versa, as well as for switching the pick-up into circuit when one is used.

How to Tune

On the right of the tuning knob will be seen the volume control, operating on the screen-grid valve and giving a smooth and distortionless control volume.

For the utmost sensitivity, use can be made of the reaction control—placed immediately below the tuning knob. Normally, this can be used at

The view on the right shows very clearly how neatly the layout has been disposed to simplify the wiring of all the vital circuits. The flex lead near the right-hand upper corner is the connection for the top of the variable-mu valve; this should be provided with the usual connector if the valve calls for a special fitting

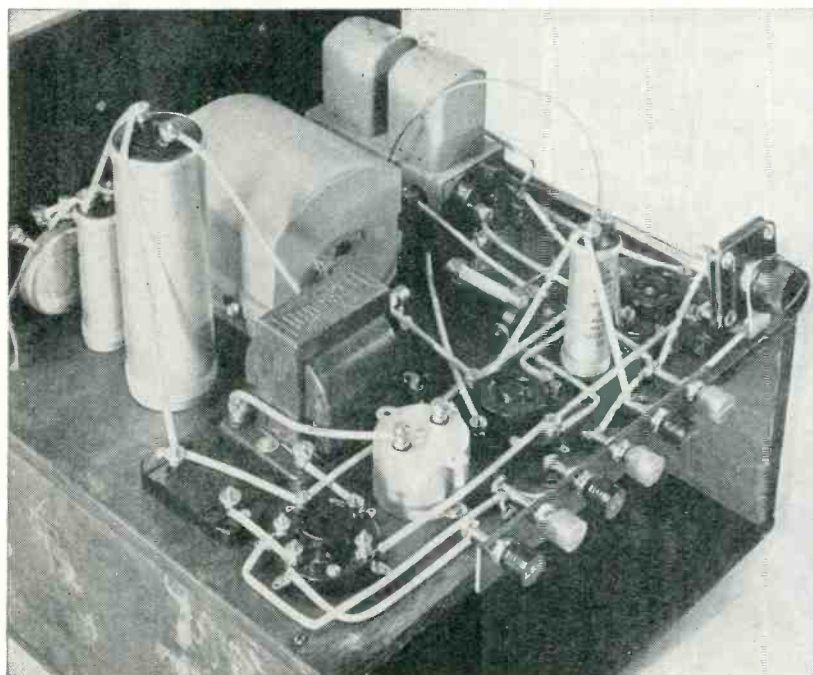
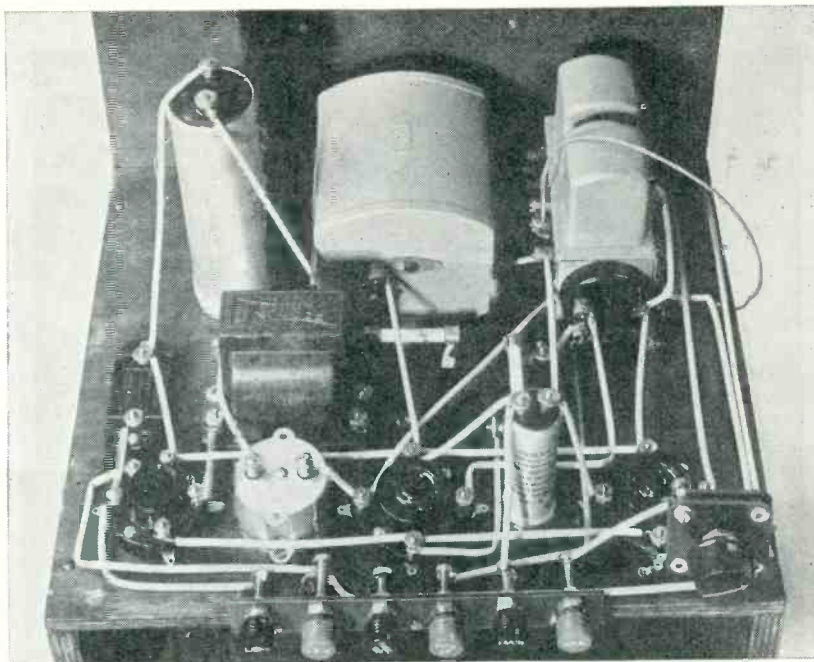

its minimum position (which means that the knob is turned as far as it will go in an anti-clockwise direction), but when a distant station is required or when operating on a very small aerial the knob can be turned progressively in a clockwise direction, yielding an increase of strength up to the oscillation point.

Set at Olympia

Next month some further particulars of this set will be given, but meanwhile this article contains full particulars to enable you to start right away and get the set working before the next number is published! The actual set is being exhibited on our stand at Radiolympia, so come and look at it!

To the left is a view of the output end of the receiver showing the layout of the components associated with the power stage. Note, too, the method of mounting the aerial-series condenser by means of a small bracket on the extreme right

COMPONENTS NEEDED FOR THE CERTAINTY THREE

CHASSIS		£ s. d.	CONDENSERS, VARIABLE		11 0	TRANSFORMER, LOW-FREQUENCY		
Chassis and wooden panel as per blueprint	...	7 6	1—Formo twin-gang with dust cover	...	8 6	1—Ferranti, type AF10		
CHOKE, HIGH FREQUENCY			1—Polar .003-microfarad differential reaction	3 0	VALVE-HOLDERS			
1—Bulgin, type HF8	...	2 3	1—Polar .0003-microfarad solid dielectric	2 6	2—Benjamin 4-pin			
COIL UNIT			RESISTANCES, FIXED			1—Benjamin 5-pin		
1—Graham Farish, type AH/G	...	12 6	1—Amplion 10,000-ohm	1 0	BATTERIES			
CONDENSERS, FIXED			1—Dubilier 1-megohm grid-leak	1 0	1—Full-O'-Power 120-volt high-tension, type H3			
1—Dubilier .0001-microfarad, type 610	...	2 6	RESISTANCE, VARIABLE			1—Exide 2-volt accumulator, type PO3		
1—Dubilier .005-microfarad, type 610	...	3 3	1—Reliance .25-megohm volume control	4 6	1—Full-O'-Power 9-volt grid-bias battery			
2—Dubilier .1-microfarad type BS 9200	...	3 6	SUNDRIES			1—W.B. Stentorian type 36S, standard chassis model...		
1—Dubilier 2-microfarad, type BS9202	...	2 6	Battery leads: plugs; bracket for reaction condenser; anode connector; terminal strips; connecting wire.			VALVES		
			TERMINALS			1—Marconi VS24		
			6—Clix type B, lettered as follows: A, E, P.U.(2), L.S.—, L.S.			1—Marconi HL2		
						1—Marconi PT2		

WHAT THE B.B.C. IS DOING

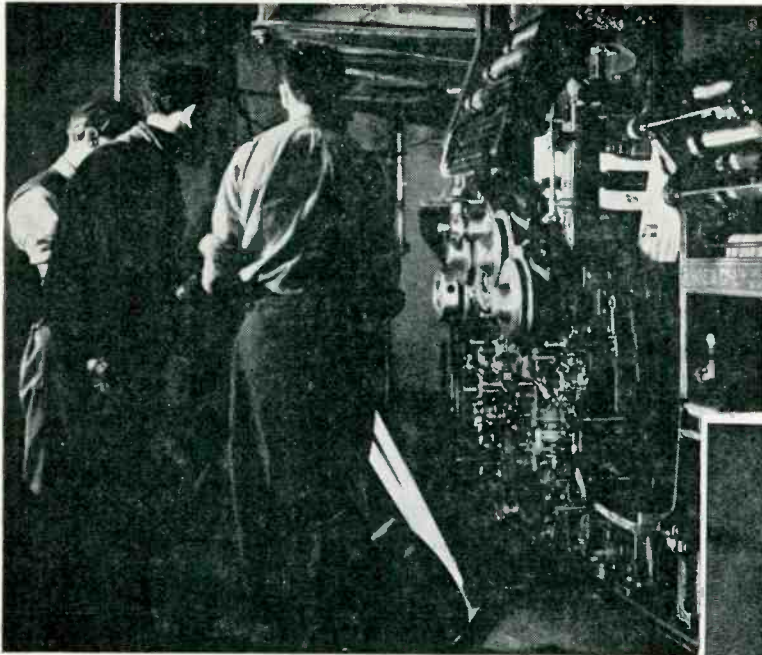

From the film "B.B.C.—the Voice of Britain": a scene showing the printing of the "Radio Times" at the works of Newnes & Pearson Printing Co., Ltd.

Seeing the

By T. F. HENN

I AM often greeted with the request: "I say old chap, can you get me a couple of tickets for a vaudeville show at the B.B.C.?" The chances have always been unusually slender, for the B.B.C. has preferred to work in secret as it were. Studio audiences are not encouraged to the extent that they were.

Anyway, to all who have ambitions to go over Broadcasting House and finish up by seeing a vaudeville show, I recommend the film *B.B.C.—the Voice of Britain*.

The film has been produced by John Grierson and Stuart Legg in conjunction with the B.B.C. It shows the story of how broadcasting works, from the studios and transmitters at one end to typical home receiving scenes at the other.

You see artists at work—Henry Hall and band, Adrian Boult and orchestra, John Sharman censoring Clapham and Dwyer's scripts—advising them to keep to it—and even our old friend Christopher Stone smashing a crooner record in the gramophone studio at B.H.

Christopher Stone has been off the British air for a long time now—and still the B.B.C. has got no one with the same intimate personality to replace him. I regard his absence from our programmes as one of the tragedies of commercialism.

In the film you see the Dancing

Daughters doing their stuff, with a couple of admiring page boys looking on. These two pages seem more human than those I have seen at the B.B.C. ! Gracie Fields "broadcasts"; you see and hear the King and Queen at the launching of the *Queen Mary*; you are shown how broadcasting links up the Empire. You see every aspect of broadcasting, perhaps in a rather confusing way, but the amazing



Christopher Stone as he appears in the new A.B.F.D. film

panorama holds you thrilled as the marvels of a great science are revealed.

You will have the opportunity of seeing how the B.B.C. works in your local cinema very shortly. The film is a full-length one lasting an hour, and is well worth seeing.



You have heard this master provider of light orchestral music many times on the air, Mantovani, leader of his tipica orchestra

Go to Radiolympia if you get the chance, for there, in the theatre, you will see broadcast variety at its best. I won't worry you with artist's names; the full list can be seen in your daily paper or in the *Radio Times*. When you go, or if you hear the shows at home, pay special attention to Harold Ramsay and his Rhythm Symphony.

Rather vague news has just reached me of an Electronic Organ, which Ramsay is playing at Olympia, invented and built by the John

B.B.C. at Work

Compton Organ Co. I am told that the device is a most astonishing development in the field of sound production.

The whole apparatus is contained in a box approximately four feet square and its production has cost £10,000 besides eight years of intense research work.

No technical details of the device are available at the moment, but I am endeavouring to obtain them for next month. As far as I can gather from

information at my disposal, metal discs are engraved with unusual pictures of sound waves, a number of discs forming part of the device, which produces, by some means or other, some very peculiar noises.

If you are coming to town specially for the Radio Show, don't forget the Proms at Queen's Hall. A couple of shillings will gain you admittance to the Prom, where you stand. Besides the usual magnificent performance given by the B.B.C. Symphony Orchestra under Sir

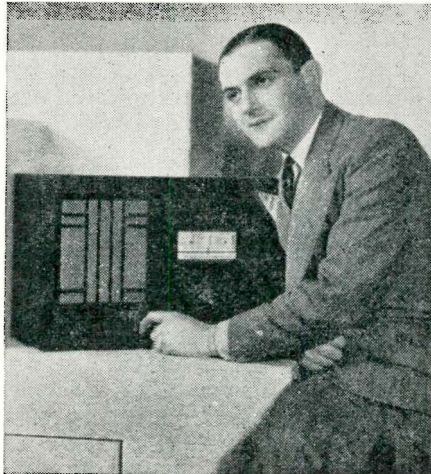

Listen on August 31 to Jack Hylton's Revue
—it will certainly be a good show

Our illustration on the left shows Felix Mendelssohn, a descendant of the famous composer, with his Cossor receiver. The modern Mr. Mendelssohn composes dancetunes!

Henry Wood, you will see London's famous Promsters—people of all nationalities and of all walks in life. The sight is one which will never be forgotten.

I hear that in the autumn it is likely that the B.B.C. Symphony Orchestra will pay another visit to the Continent. You remember that it went to Brussels at the beginning of this year. This second visit will embrace many leading musical centres of Europe and will prove that England has an orchestra as fine as any on the Continent.

I wonder whether you have noticed any change in the quality and balance of programmes emanating from the London studios. Experiments with new mikes have been going on for quite a while, and these have proved that the ribbon type of mike is the best. These ribbon mikes are almost omni-directional, but the one drawback has been that through lack of sensitivity they have needed a preliminary amplifier.

Now I understand the difficulties are all over, the pre-amplifier is not needed and that these mikes will be installed in the provincial studios as well. The advantage of an omni-directional mike is, as you can plainly see, that studio technique is greatly simplified because the difficulties of "balancing" a show or orchestral concert are lessened.

You have read rumours that the B.B.C. intends to appoint a Director of Dance Music—in fact Jack Payne's name has been mentioned. It is true that after every Jack Payne broadcast, the B.B.C. is inundated with appreciative letters asking for more. The truth of the matter is that the B.B.C. has appointed such a director in the person of Eric Maschwitz, the Director of Light Entertainment.

That seems a pretty obvious solution to that problem!

By the way, Henry Hall is to study dance-music presentation in the States. Germany is much nearer—and infinitely better!

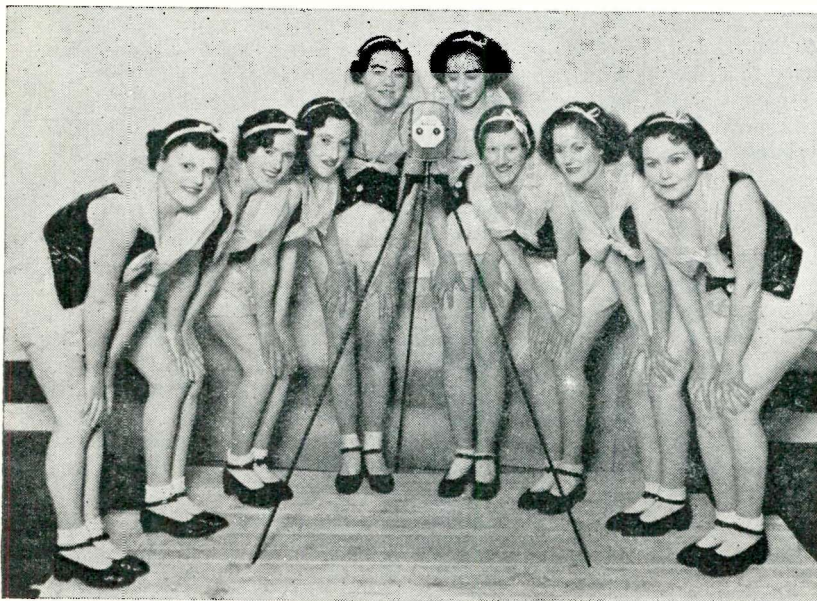

The lighter side of life in a radio factory is illustrated by this Ekco cabaret troupe. All the girls are employed in E.K. Cole's Southend works, some in the coil-winding departments and on the assembly benches, others in the offices

P. WILSON, M.A. Propounds an Entirely New Theory:

Cancelling-out Interference

AS I indicated last month, there are three different aspects to the problem of high-quality reception free from excessive interference.

In the first place, the overlapping of the frequency ranges of adjacent stations makes it necessary, if adjacent station interference is to be avoided, for the signal strengths of the unwanted stations to be reduced to a small fraction of that of the wanted station.

In the second place, this reduction of signal strength must be accomplished without attenuation of high notes, and therefore without cutting the sidebands of the wanted station by excessive selectivity.

In the third place, the pick-up of local interference from electrical machinery must be avoided.

The third problem presents no really serious difficulty. The most satisfactory method, of course, is for the interference to be suppressed at its source, and one day no doubt we shall see the P.M.G., or some other competent authority, adopting measures to that end. Even now, however, by the use of special anti-static aerials the extent of the interference can be reduced to quite small proportions.

Two Difficult Problems, but not Hopeless

The other two problems are much more difficult of solution. But I am optimistic enough to believe that they are not hopeless. In this short article I want to indicate one method of approach that appears to me to be extremely promising in principle. The suggestion is only tentative since I have not yet tried it out practically; in fact, the idea only occurred to me a few days ago.

I have mentioned it to one or two of my expert friends, and they were so attracted by its simplicity that they advised me to apply for a patent. But I gave up all ideas of patents some years ago, and prefer nowadays to publish so that if there should be anything in the suggestion it will be free to all.

It will probably be simplest if I describe the idea as it worked itself out in my mind.

So far as I know, there is at present only one method of reducing the signal strength of an unwanted station adjacent in wavelength to a wanted station without at the same time cutting the sidebands of the wanted station; and that, as I indicated last month, is by means of the directional properties of a frame aerial.

From the present point of view, however, there are two disabilities of a frame aerial, apart from its relative insensitiveness, which, after all, doesn't matter so much. The first is that it does not deal effectively with some types of local interference, especially where that interference is radiated by a house wiring system.

The second is that it is only the direction for *minimum* signal strength which is sharply defined. The latter is particularly unfortunate since it means that unless the two unwanted stations adjacent to the wanted one

happen both to lie in exactly the same direction, one can only deal with one or other of them and not both.

I have often deplored the fact that it is not the setting for maximum signal strength which is sharply defined, but it never occurred to me until the other day to use the actual directional property as a cancellation device. Then it flashed across my mind that if one could only feed into an ordinary receiver with outdoor aerial, a second signal from a frame aerial in such a way as to *subtract* from the first signal, one could set the frame to minimum for the wanted station thereby impairing its signal but little. At the same time all signals not coming from precisely the same direction would be substantially reduced.

The most obvious way of doing this would be to feed the signals from the two sources into the receiver in opposite phase. Clearly, however, the signal from the frame would need amplification first, and the amount of amplification must be under control.

If I have not overlooked any snags, the two requirements should be possible of fulfilment by means of a single variable- μ valve amplifier since the phase at the anode of a valve is opposite to that at the grid.

Outdoor and Frame Aerial to Feed one Receiver

Why not therefore have a highly directional frame aerial coupled to the grid circuit of a variable- μ valve (whose amplification is controlled by bias variation in the usual way) and feed the output from the anode circuit together with the signal picked up directly by another aerial into the receiver proper.

Two possible difficulties occur to me at the moment. The one is, what guarantee have we that the signal will be originally picked up by the two aerials in the same phase. I can't think of any reason why it shouldn't be, but on the other hand I don't know why it should!

The second is that the phase may be modified by the tuned circuits. The actual design of an appropriate anti-interference unit may therefore present a few problems in questions of phase shifting, but they do not appear to be particularly difficult problems.

Readers will see that the idea is at present only in an embryo state, and in the ordinary way I should have delayed any mention of it until I had had an opportunity of trying out some circuits practically. But I am so busy just now that I may not get that opportunity for some time, and I hope that in the meantime some readers will be enterprising enough to try it out for themselves.

If any difficulties are encountered, I shall be glad to do my best to advise on their solution.

My article of last month shows a suitable grid circuit for the anti-interference valve. For the anode circuit I should first of all try resistance-capacity or choke-capacity coupling.

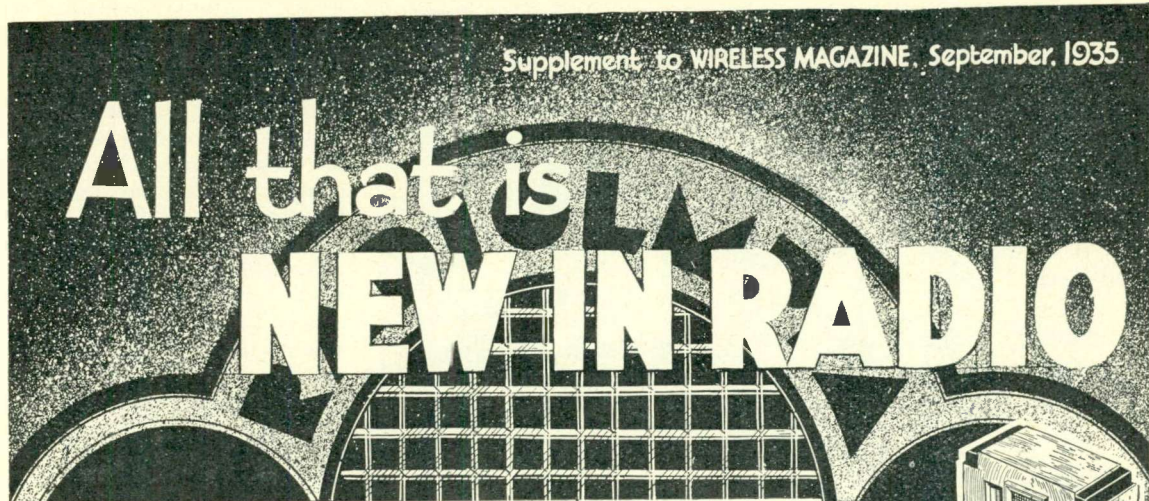

Supplement to WIRELESS MAGAZINE, September, 1935

All that is NEW IN RADIO

CONTENTS

OLYMPIA: HOPES AND FEARS. By the Technical Editor Page One

THESE NEW SETS.—A Page of Pictures Page Four

ALL ABOUT THE NEW SETS. By the "W.M." Set Selection Bureau Page Five

"W.M." GUIDE TO THE NEW SETS. Page Seven

HOW PICK-UPS HAVE CHANGED AND IMPROVED. By P. Wilson, M.A. Page Ten

HOME CONSTRUCTION AS A HOBBY. By Percy W. Harris, M.J.R.E. ... Page Twelve

THE LATEST SHORT-WAVE COMPONENTS. By G. Howard Barry Page Fifteen

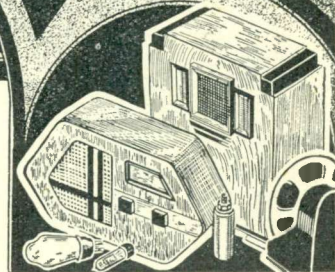

We are pleased to present readers with this sixteen-page supplement describing the new radio sets and components. Our object has been to provide the information in a useful way, giving really worth-while articles on radio progress with dozens of illustrations of the latest apparatus. Our Set Buyers' Guide gives details of no fewer than 260 receivers and it should prove invaluable to those about to invest in a commercially-built receiver for the new season

Olympia: Hopes and Fears

EVERY year I go to Olympia in a mood of mixed hope and pessimism, wondering whether I shall find that those features of current components which annoyed me as a constructor have at last been eliminated, or whether they will still be there in the improved types for the coming season.

Naturally, at the time of writing I have not actually seen the new things, but I have studied much of the advance information supplied by the manufacturers; I think therefore that my impressions may well be of interest to other keen constructors and experimenters.

Early Memories

Valve holders, for example: my views on this question have been somewhat embittered ones since the year 1920 when I bought a specimen of perhaps the first commercially-produced holder.

It was turned from a solid lump

By the TECHNICAL EDITOR

of low-grade ebonite which quickly became a sickly yellowish green colour, the contacts were simply solid brass sockets without resilience of any kind, and the connections were made by soldering to some nasty little brass pegs underneath. Strictly speaking it was neither panel nor baseboard mounting and it quickly earned my undying hatred.

The brass surfaces of the contact sockets continually became corroded, valve pins (the old split ones) required to be opened out at intervals to maintain connection and it gave one all sorts of trouble to mount; moreover it gripped two of the pins so tightly that one had sometimes to use a screw-driver to prise the valve out. It had only one good feature, and that was that in its construction there were no screws and nuts to work loose.

It is interesting to see how some of the worst features of that holder have persisted until comparatively recent times. Only in the last year or so have we seen the abandonment of naked brass for contact surfaces except where a self-cleaning action could be assured.

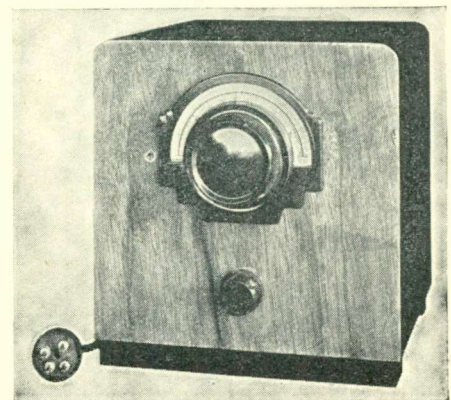

Kolster-Brandes short-wave converter designed primarily for use with K.B. receivers. Note the plug on the left

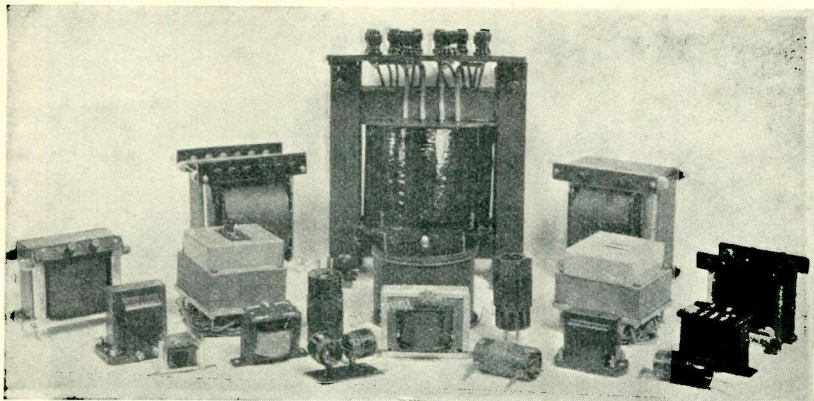

A group of transformers and mains components made by Kingsway Radio, Ltd.

Nowadays one commonly sees some of the less readily tarnished metals used for the contact areas, phosphor-bronze and its relatives offering this advantage as well as that of resilience. Brass is still used here and there, of course, but only where, as in the Clix holders, the construction is such that the mere act of inserting or withdrawing the valve keeps the surfaces bright.

Contact Maintenance

This year it is very cheering to see even greater attention being paid to this vital detail of contact-maintenance. Bulgin, for example, is employing silver-plating on the contact surfaces of certain holders, nickel and chromium plating is being used by other firms. Which of these various methods will eventually prove

now be able to give up that somewhat derogatory habit! This year should furnish pretty convincing proof that the radio manufacturer has now mastered the difficult art of achieving permanent tight assembly of small parts.

Moving-coil loudspeakers form another of my sore subjects. I started to use them when they were the latest thing out, consequently I have a store of painful memories associated with the problems of dust-exclusion, maintenance of centring, and so on. This year I think our hopes will be realised and these two matters will cease to interest the owner of the speaker in any practical fashion; he may take an academic interest in the devices

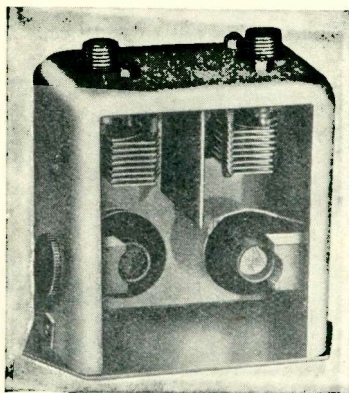

Varley has just marketed an air-core I.F. transformer for 465 k.c., suitable for all-wave superhets

the more practical we cannot yet predict, but the tendency is one that we cannot but applaud.

The loose-nut nuisance too seems to be becoming a thing of the past. There was a time when my first operation on starting to build anything was to go over all the components and tighten up the loose terminals, but I really believe I shall

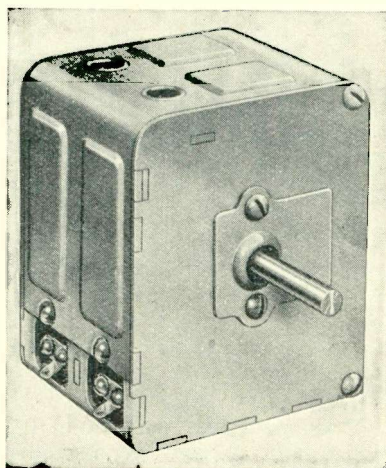

A baby two-gang condenser—the product of the well-known concern, J.B.

adopted by the commercial designers, but that will be all.

The first signs were apparent last season in several cases, but this year it appears that dust-exclusion by one method or another is to be an almost universal feature. Permanent centring too seems to have been mastered by the leading firms like W.B., Ferranti, Celestion and Amplion.

Variable condensers appear to have made some substantial progress in mechanical details and I personally would particularly applaud the evident growth in the use of dust-covers. Anyone who has used up as

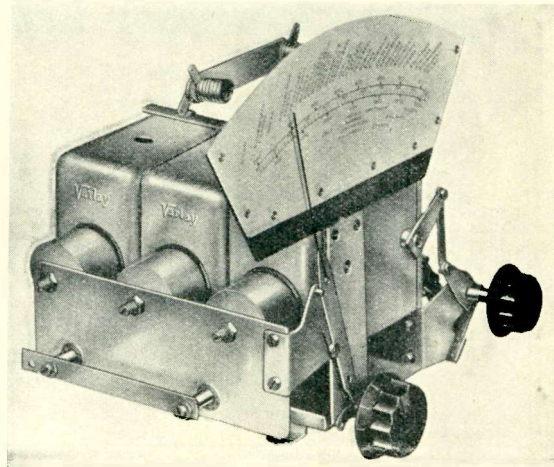

Varley's latest permeability tuner—a three-gang superhet model complete with station and wavelength calibrated scale

many pipe-cleaners as I have in trying to re-condition tuning condensers will not require to be told what a blessing the all-enclosed system can be! I see that such firms as British Radiophone, Graham-Farish, J.B., Polar, Utility and others all give one the impression that they regard the protected type as the standard for at any rate the gang unit.

In tuning coils I find little sign of major changes. Many additional types are appearing, but whether the much-wanted attention has been paid to the problem of producing sets of coils and intermediate transformers capable of yielding a superhet circuit giving a reduced number of whistles I have not been able to discover.

Good Tendencies

Perhaps we may regard it as an encouraging sign that several firms, B.T.S., Bulgin and Varley among others, are introducing 450-k/c. intermediates; these are primarily intended for use in all-wave receivers, but perchance they indicate also a general overhauling of the design

of intermediate and oscillator apparatus.

For broadcast waves I see Varley is introducing some new Permeability tuners ; these should be interesting, for the efficiency of the system is well known. For all-wave circuits there are a number of multi-range coil units appearing from several of the short-wave specialists in one form or another.

Welcome Signs

Given efficient coils of this type one of the most difficult problems of the all-waver will be solved ; perhaps the greatest puzzle is concerned with the needful switchgear for the coils, and I am relieved to note that this seems to have been tackled with due caution and appreciation of its importance.

In the matter of gear for the ultra-shorts it seems that at any rate some of my hopes

and so far none of my fears are going to be realised. There is quite a promising collection of components announced and all of it seems to show signs of knowledgeable design.

Really good dielectric materials (Megacite, Frequentite, D.L.9, and so forth) are being used, proper small-diameter coils are being provided with correctly-spaced pin-fittings and air-mounted bases, and the necessary radio-frequency chokes are included in the range. It certainly seems

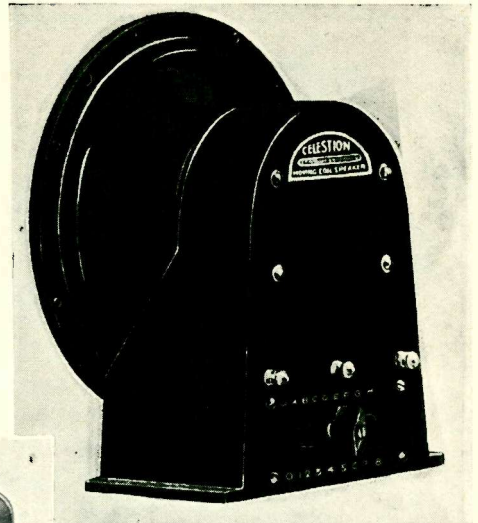

A back view of the Celestion model 8 permanent-magnet loudspeaker showing the matching arrangement—sixteen ratios for high and low impedance matching complete with volume control

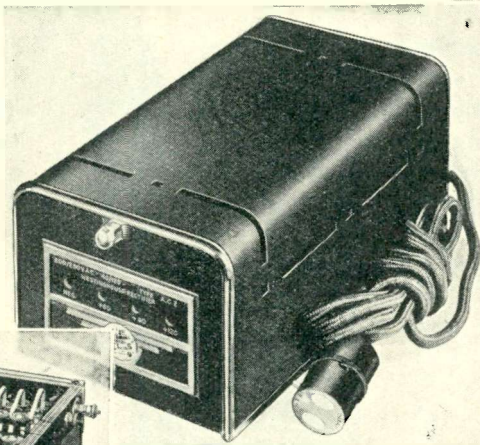

A new A.C. mains unit by Atlas—a firm very well known to " W.M. " readers

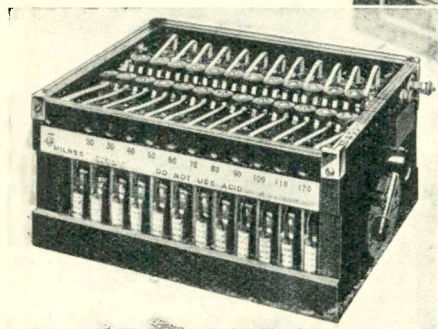

For those who prefer high-tension units to batteries—the Milnes unit

seem doomed to disappointment, the present uncertainty as to the exact system of scanning to be used and other details has made it impossible for the various firms to crystallise their plans. However, here I verge on politics, so I will hold my peace !

PROVINCIAL RADIO EXHIBITIONS

GLASGOW : August 30th to September 7th — Calvin Hall.

MANCHESTER : September 20th to September 28th — City Hall, Deansgate.

that *when* we get some television we shall be able to assemble suitable receivers entirely from ready-made components.

Any hopes we may have had of seeing complete television receivers ready for purchase at Olympia

New Stentorian Loudspeakers by W.B.

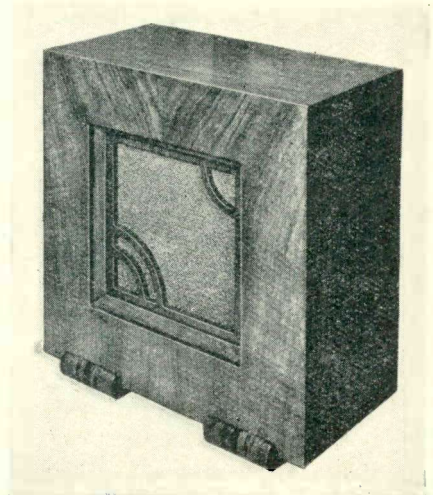
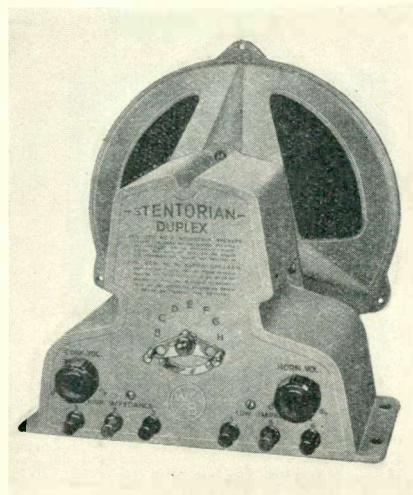
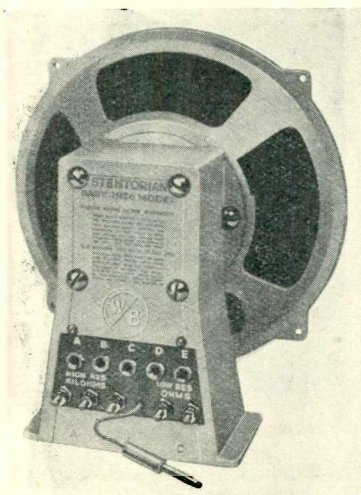

Important improvements have been made by W.B. in their range of Stentorian loudspeakers. There is a new method of centring magnets ensuring great accuracy. Magnets are stronger and larger; the matching transformer has been improved, and the frequency response improved at both ends of the scale. Our illustrations show the Baby chassis, Stentorian Duplex (£4 4s.) and the standard cabinet model (£2 19s. 6d.)

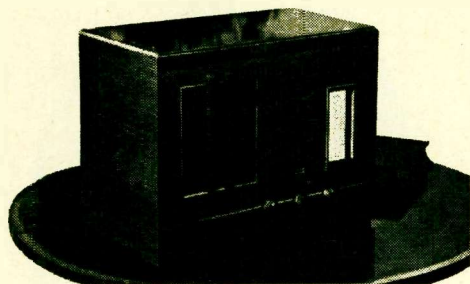

The Invicta battery receiver—in a horizontal cabinet with a station-wavelength calibrated dial

What Do You Think of

These New Sets?

ALL KINDS - MANY PRICES

Here are photographs of nine typical modern sets in which you can see plainly the trend of cabinet design. There is no doubt that set makers are endeavouring to make radio receivers tasteful pieces of furniture, though the square box idea still prevails

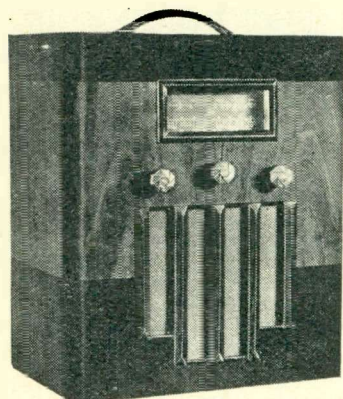

The new Pye T/Q battery portable. This is a handsome and efficient outfit and has a daylight-lit scale

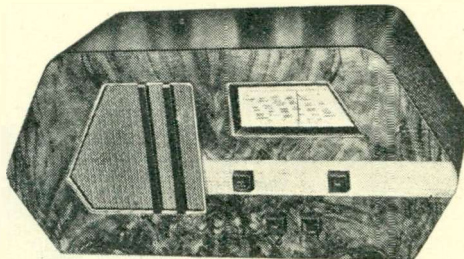

Rather unusual this! It is the new McMichael twelve-guinea A.C. superhet, the model 35

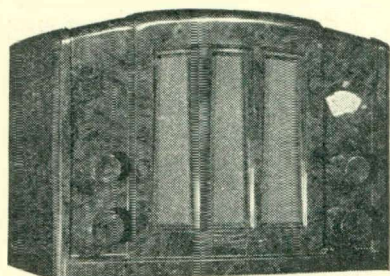

The new Philips two-valve A.C. mains receiver which sells at the very low price of six and a half guineas

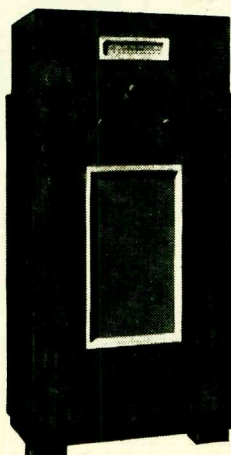

A three-valve four-stage A.C./D.C. superhet console made by Bush Radio. Output is 3.5 watts

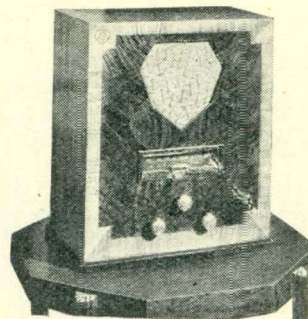

A popular battery set, the MB4 made by the well-known valve firm, Mullard's Wireless Service Co.

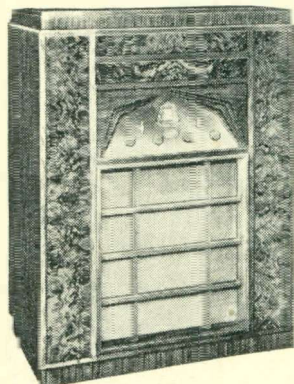

A magnificent example of the radio engineer's craft—the R.G.D. all-wave automatic A.C. radiogram

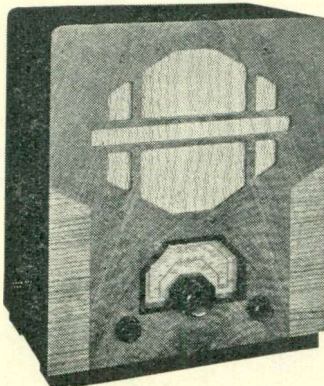

Outstanding among the table sets is the new KB model 430, an A.C./D.C. superhet with large station-calibrated dial

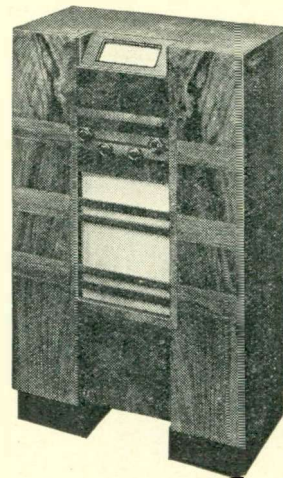

A tasteful design in console cabinet receivers, the H.M.V. four-valve superhet console — marvelous cabinet work!

All About the New Sets

By the "W.M." Set Selection Bureau

ONCE again set makers have "thrown off the great mask of secrecy" and have revealed their latest collection of radio receivers in brand spanking new cabinets of many shapes and sizes. There are many who are still jealously guarding their secrets at the time we are writing this, and they have definitely told us that they intend keeping their secrets covered up until Olympia's doors open on August 14.

Trend of Design

However, the information we have received is sufficient to give us a very clear conception of the trend of design. Perhaps the most important advancement is the introduction of many new all-wave receivers at prices well within the reach of the average set buyer.

We do not intend to describe the new all-wave receivers at this stage—for one thing there is not sufficient space available and there will be

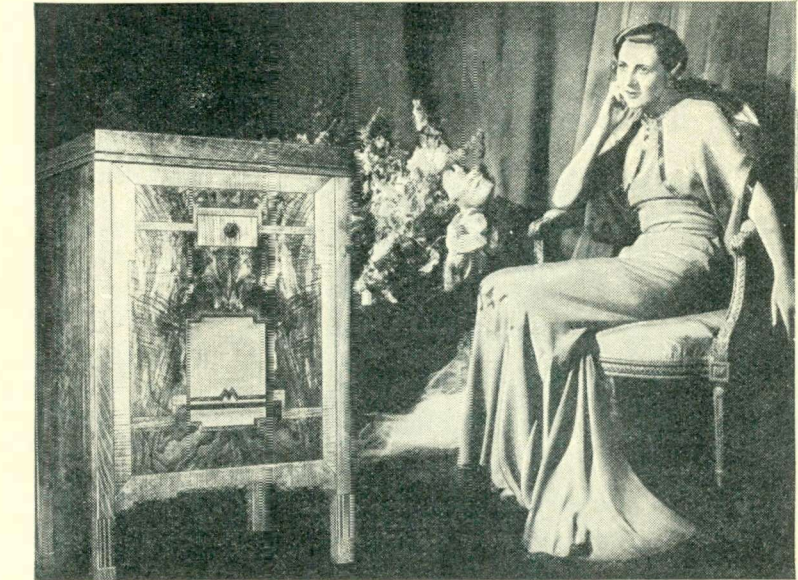

Marconiphone has announced its intention of retaining the model 286—a four-valve superhet radiogram—for the coming season. As you can see, it is a good looking and we know, by our tests, that it functions extraordinarily well

many more when set manufacturers find that such sets are popular. However, a few of the most interesting are Philco, who mark their dials in kilocycles and not wavelengths; Halford Distributors, Ltd., who price all their receivers for the chassis only, leaving the customer to make his own

choice of cabinet out of the many designs available and for which he is charged extra; Alba have an all-wave set which can be obtained in table or radiogram form for A.C. or A.C./D.C. mains, and lastly there is the low-priced outfit by Burndepth—an all-wave universal-mains three-valve and

costing only ten guineas with a battery version at eight guineas.

All the well-known models of such firms as G.E.C., Stratton, All-wave International Radio & Television are being continued, many with technical improvements.

For Yachtsmen

A set that should attract a deal of attention from yacht-owners is the Invicta model FS36 which covers a wave-range of from 90 to 220 metres and 900 to 2,000 metres. Housed in a cabinet of Bermuda teak, this set is already nicknamed the Fisherman's set, for the extra band from 90 to 220 metres covers the fishing news, and the Yacht Telegraph service telegrams broadcast on wavelengths between 130 and 180 metres.

New Sets by G.E.C.

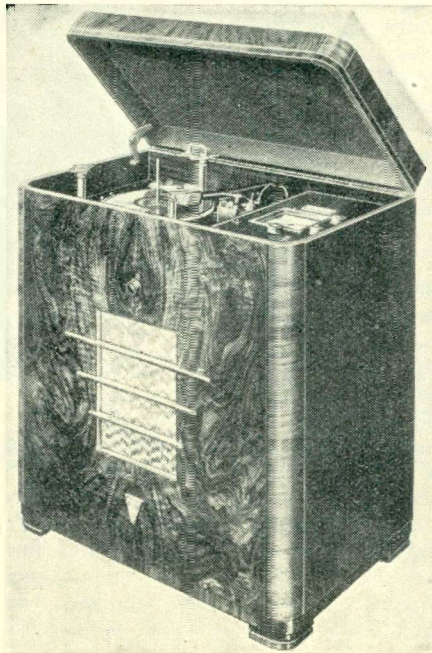
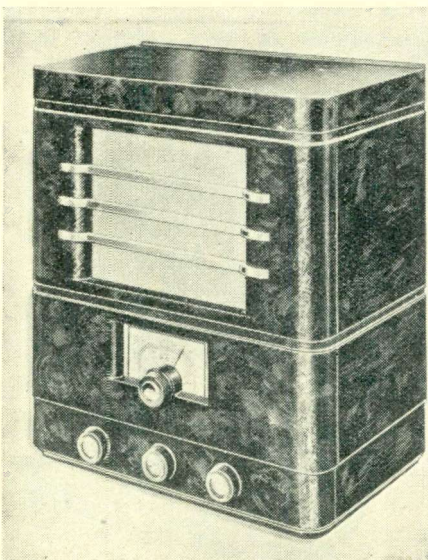

Here are two of G.E.C.'s 1936 receivers. On the left is the A.C. Mains Four—a four-valve (inc. rectifier) straight receiver for A.C. mains operation. The other is a brand new radiogram with an automatic record changer and incorporating the new G.E.C. system of high-fidelity reproduction which works on both radio and record reproduction

ALL THAT IS NEW IN RADIO

There is also to be seen a marked increase in the number of universal A.C./D.C. receivers, which as most of you know will work on either kind of mains without any alteration whatsoever. To those who not unnaturally ask why all mains sets are not A.C./D.C. we would point out that on pages 27 and 28 of our last issue the question is fully

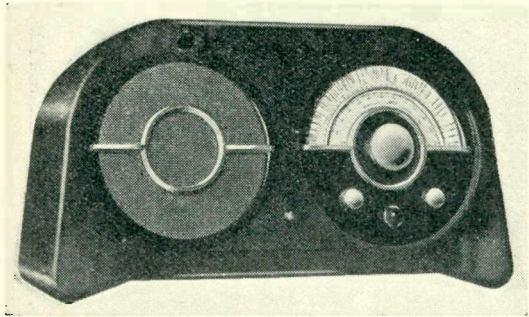

Ekco's new streamlined 8-stage superhet for A.C. mains with its huge station-calibrated scale costs £13 2s. 6d. A battery version in the same cabinet is available. (Black and chromium 10/6 extra)

explained by the Technical Editor.

As we have repeatedly mentioned that the quality of the average commercial receiver left a whole lot to be desired, it is with no small pleasure that we find on looking through the specifications of the new sets that more attention has been paid to output stages of the moderately-priced set.

Better Quality

Most mains sets give an undistorted output of 2.5 watts or more and many are using variable selectivity devices to enable the user to set his controls for minimum selectivity and so get maximum top-note response. The loss in selectivity is nothing to talk about, but the advantages gained in better quality are enormous.

We are letting the many photographs tell the story of the change in cabinet design. Some makers are putting their sets in rather peculiar-shaped contraptions, some are adopting streamline patterns, for example the new Ekco AC86 which boasts of a rather startling design prepared by Mr. Wells Coates and M. Serge Chermayeff, two famous designers.

It is indeed a great pity that set makers will insist on calling the mains rectifier a valve; for example, it is usual to say that so and so is a four-valve set, when actually it embodies three receiving valves and a rectifier. The number who exclude the rectifier

is so small that it might be said that to include the rectifier among the number of the valves is now the general practice.

However, with the multitude of multi-grid valves now used the actual number of "bottles" used in a receiver means very little—in fact practically nothing. Ekco, in fact, some year or two ago started a practice of referring to their superhets as having so many stages, not valves, and this to our mind is undoubtedly the best method of classifying a modern receiver.

On the whole prices this year show very little change. There is a tendency for some makers to reduce. Whilst we are pleased to see the set buyer get full value for his money, we do hope that in reducing prices, makers are not cutting out final testing, which means so much in the way of reliability. Reliability must be the keystone of British radio. The most successful set manufacturer will not necessarily be the one who sells his sets at the cheapest price, but the man who sells reliability and freedom from trouble.

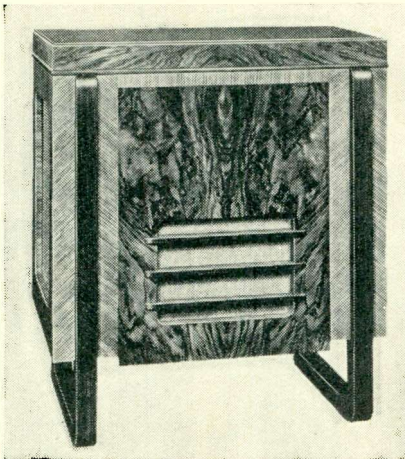

An example of the moderately priced A.C. radiogram—the Ekco model RG86 which costs twenty-two guineas

The straight set is still alive, and if you look through the guide on the next few pages you will find that the popular three-valve sequence of high-frequency amplifier, detector and output valve is listed in the specifications of many makers. There is no doubt that with careful handling such a set will still give good all-round results. Notable among this

year's A.C. models are those made by C.A.C., Cossor, G.E.C., Kolster Brandes, Aerodyne, Mullard, and H.M.V.

Quite a number of set makers have added visual tuning to their receivers, though the numbers have not been so many as we expected. Simplicity of tuning, though, has received a great deal of attention.

Perhaps the most outstanding aid to easy tuning is the Ferranti "All-in" Visible Control dial on which are station names and wavelengths, visual indications of the position of the wave-change switch, tone control, on-off switch and volume control together with a needle device which shows when the set is tuned correctly to a station.

Good Sets Continued

Many firms are continuing sets which they have found by sales and appreciations to be worth it. H.M.V. and Marconiphone, we understand, are introducing some new receivers very shortly but they are continuing many of their present range. H.M.V.'s 110-guinea high-fidelity radiogram is being continued without any modification; both firms brought out table, console and radiogram superhets at Jubilee time and these are being maintained.

Once a set has been tested and found completely satisfactory there is very little sense in putting it in a new box for a new season. The H.M.V. Jubilee radiogram, the model 541, and the Marconiphone model 287 radiogram, both selling at twenty-two guineas, are typical examples of very efficient small radiograms.

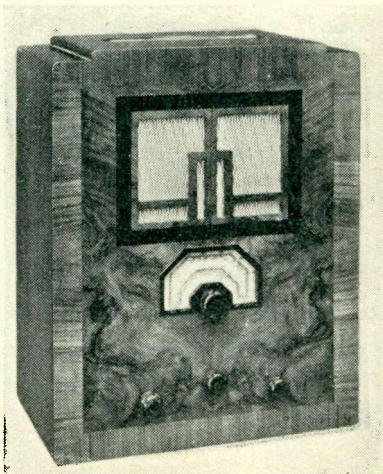

Kolster Brandes latest—a five-valve A.C./D.C. superhet transportable. The price is £15 15s. (or 30s. down and 52 weekly payments of 6s. 6d.)

The "W.M." Guide to the New Sets

We take great pleasure in presenting readers with this price-classified guide to the 1935-1936 sets. We have embodied the essential information of maker's name, model, price, power supply, a description of circuit and whether or not the set has pick up terminals. From the circuit description any wireless man will be able to see at a glance whether or not the set is suitable for a particular listener's needs. Don't forget that you can obtain free advice on the purchase of a new receiver from the "W.M." Set Selection Bureau. A full list of the names and addresses of manufacturers whose sets are listed in this guide will be found on page 156

Brand Name	Model	Price	Power Supply	Brief Description of Circuit	If Pick-up Terminals
UP TO TEN GUINEAS					
Ace	...	£6 19 6	Battery...	3 valves (all pentodes), band-pass input, moving-coil speaker, light-beam tuning	—
Ace	...	£8 8 0	AC or AC/DC 200-250v.	4 valves (including rectifier), circuit as above, but with full-size mains-energised speaker	—
Ace	...	£10 10 0	AC or AC/DC 200-250v.	6-valve (including rectifier superhet with inter-station suppression, full A.V.C., shadow tuning Indicator)	—
Aerodyne	Raven	£4 12 6 (less bat.)	Battery...	3 valves (det., L.F., power), with balanced armature speaker	Yes
Aerodyne	Snipe	£5 17 6 (less bat.)	Battery...	3 valves (variable-mu H.F. pentode triode det., triode output), illuminated station-name and wavelength scale	Yes
Aerodyne	Thrush	£6 17 6 (less bat.)	Battery...	3 valves (variable-mu H.F. pentode, triode det., triode output), permanent-magnet moving-coil speaker, illuminated station name and wavelength scale	Yes
Aerodyne	Robin	£7 7 0	AC mains 200-250v.	3 valves, energised moving-coil speaker, 3 alternative aerial connections, mains aerial illuminated clock face tuning	Yes
Aerodyne	Nightingale	£7 17 6 (less bat.)	Battery...	3 valves (variable-mu H.F. pentode, triode det., pentode output); band-pass input; permanent-magnet moving-coil speaker; illuminated station name and wavelength scale	Yes
Aerodyne	Bluebird A	£8 18 6	AC 200-250v.	3 valves (variable-mu H.F. pentode, triode det., high slope pentode output); energised moving-coil speaker; illuminated station name and wavelength scale.	Yes
	Bluebird B	£9 9 0	AC/DC 200-250v.		
Alba	201	£6 6 0	Battery...	3 valves (H.F. pentode, triode det., pentode output)	Yes
Alba	205	£6 19 6	Battery...	3 valves (H.F. pentode, triode det., pentode output)	Yes
Alba	212	£7 19 6	Battery...	3 valves (H.F. pentode, triode det., pentode output)	Yes
Alba	501	£8 18 6	AC mains	3 valves (variable-mu H.F. pentode, pentode det., pentode output)	Yes
Alba	501	£9 9 0	AC/DC mains	3 valves (variable-mu H.F. pentode, pentode det., pentode output)	Yes
Allwave	Midget	£6 6 0	Battery...	All-wave portable employing 2 valves in a super-regenerative circuit, covering short and medium waves	—
Austin	A.C. Straight Four	£9 9 0	AC mains	4 valves (including rectifier), H.F. pentode, triode grid det., high-slope pentode, energised speaker	Yes
Beethoven	B.63	£7 5 0 (less bat.)	Battery...	S.G. band-pass 3-valve receiver, moving-coil speaker	No
Beethoven	P.76	£7 15 0 (complete)	Battery...	S.G. 4-valve "Minor" portable receiver with new light-weight speaker	No
Beethoven	B.64	£9 19 6 (complete)	Battery...	S.G. 4-valve transportable, moving-coil speaker, built-in aerial, illuminated airplane dial	No
Beethoven	P.96	£10 10 0 (complete)	Battery...	S.G. 4-valve "Major" portable, moving-coil loudspeaker	No
Beethoven	A.C.78	£10 10 0	AC mains	4-valve (including rectifier) portable, frame aerial with provision for external aerial, moving-coil loudspeaker	Yes
Betterset	VP4	£10 10 0	Battery...	4-valve transportable, Mazda S215a, HL2, L2 and Pen220a. Fitted moving-coil speaker	Yes
Blue Spot	III	£6 17 6 (less bat.)	Battery...	H.F. pentode, det., L.F. pentode, permanent-magnet moving-coil speaker, illuminated station name and wavelength dial, unwanted programme rejection	No
Blue Spot	AC/DC4	£9 9 0	AC/DC 200-260v.	All pentode 3-valve circuit plus rectifier, energised moving-coil speaker, mains aerial, unwanted programme rejection	No
Burndept	CN 240	£8 8 0 (complete)	Battery...	3-valve all-wave battery set; moving-coil loudspeaker	—
Burndept	CN 230	£10 10 0	AC/DC 200-250v.	4-valve all-wave receiver; energised moving-coil loudspeaker	—
Bush	S.B.21	£9 9 0 (less bat.)	Battery...	3-valve 4-stage superhet, permanent-magnet moving-coil speaker, automatic grid bias, full vision tuning	—
Burgoyne	5 v. Portable	£5 5 0	Battery...	5 valves (2 aperiodic H.F., det., 2 L.F.) moving-iron speaker	No
Burgoyne	2-P Comet	£6 6 0	Battery...	3 valves (H.F., det., pentode) permanent-magnet moving-coil speaker	Yes
Burgoyne	Moth	£6 6 0	AC/DC 200-250v.	2 valves (det., pentode) energised moving-coil speaker	Yes
Burgoyne	S.G.4	£6 17 6	Battery...	4 valves (H.F., det., L.F., power) moving-iron speaker	No
Burgoyne	Fury	£7 7 0	AC/DC 200-250v.	3 valves (H.F., det., pentode) energised moving-coil speaker	Yes
Burgoyne	Fury Battery	£7 7 0	Battery...	3 valves (H.F., det., pentode) permanent-magnet moving-coil speaker	Yes
Burgoyne	Fury Star	£7 17 6	AC/DC 200-250v.	3 valves (H.F., det., pentode) energised moving-coil speaker, table radiogram model 15 gns.	Yes
Burgoyne	—	£10 10 0	Battery...	5 valve superhet, 7 tuned stages, permanent-magnet moving-coil speaker	No
Burgoyne	Dragon	£10 10 0	AC mains 200-250	3-valve superhet, energised moving-coil speaker	Yes
Cossor	360	£5 15 0	Battery...	3-valve straight, iron-cored coils, matched moving-iron speaker	Yes
Cossor	363	£6 15 0	Battery...	As Model 360, but with 8 in. permanent-magnet moving-coil speaker and economy pentode output.	Yes
Cossor	3535	£7 15 0	Battery...	Valves as above (363), console model single-knob tuning, full-vision scale, matched moving-iron speaker.	Yes
Cossor	436B (class B)	£8 8 0	Battery...	4-valve straight, class-B output, iron-cored coils, detachable full-vision scale, special 8-in. permanent-magnet moving-coil speaker.	Yes
Cossor	368	£8 18 6	AC mains 200/250v.	3-valve straight; energised moving-coil speaker; plug and sockets for extension speaker.	Yes
Cossor	369	£8 18 6	AC/DC 200-250v.	As above with super power output and indirectly heated rectifier; permanent-magnet moving-coil speaker; iron-cored coils.	Yes
Cossor	366A Superhet	£9 9 0	Battery...	4-valve superhet	Yes
Decca	Table Radio	£9 19 6	AC or AC/DC at 10 Gns. AC 100-125v.	4-valve superhet, band-pass pre-selector, 3½ watts output to moving-coil loudspeaker	Yes
Decca	All-electric Portable	£10 10 0	AC 100-125v. 200-250v.	All-electric portable gramophone, 3½ watts output to moving-coil speaker	—
Eddystone	Kilodyne Four (Kit)	£6 19 6 (ex. valves)	Battery...	4-valve straight	Yes
Ever Ready	AD36	£8 8 0	AC/DC	H.F. det., pentode	No
Ever Ready	5012	£7 19 6 (complete)	Battery...	3-valve battery table model, two tuned circuits, permanent-magnet speaker	No
Ever Ready	5010	—	Battery...	3-valve straight battery table model, permanent-magnet speaker	No
Ever Ready	5009	£10 10 0	Battery...	4-valve portable, class-B output, permanent-magnet moving-coil speaker	No

ALL THAT IS NEW IN RADIO

Brand Name	Model	Price	Power Supply	Brief Description of Circuit	If Pick-up Terminals
Ferranti	Una Consolette	£8 10 6	AC/DC...	H.F., det., pentode output, moving-coil speaker, illuminated "All-in" dial ...	No
G.E.C.	BC3536	£5 10 0	Battery...	3 valves, special H.T. economy unit, moving-coil loudspeaker ...	Yes
G.E.C.	BC3520	£6 10 0	AC/DC 200-250v.	3 valves, energised moving-coil speaker, connections for low-impedance extension speaker	No
G.E.C.	BC3636	£7 19 6	Battery...	3 valves (variable- μ S.G. H.F. stage, H.F. pentode det., and economy pentode output), moving-coil loudspeaker, automatic grid bias	Yes
G.E.C.	BC3630	£9 9 0	A.C. mains 190-250v.	4 valves (including rectifier), energised moving-coil speaker, wavelength full vision dial	Yes
Halcyon	3401	£9 9 0	AC/DC 200-260v.	All pentode 3-valve circuit, dual programme cut-out, full vision dial, A.V.C., mains aerial, energised M.C. speaker	No
H.M.V.	Battery Long Three 148	£7 19 6	Batteries	3-valve battery radio ...	Yes
Invicta	C.W.	£6 2 0	Battery...	3 valves (H.F. pentode, det., pentode output); moving-coil speaker ...	No
Invicta	CW/AC	£8 8 0	AC mains	3 valves (H.F. pentode, det., output pentode); moving-coil speaker ...	Yes
Invicta	T.36	£8 0 6	AC mains	Band-pass 3-valve with moving-coil speaker ...	Yes
Invicta	FS.36	£9 19 6	AC mains	3-valve; wavelengths 90/220, 220/570, 900/2,000 metres ...	No
K.B.	431	£5 17 6	Battery...	3-valves (det., R.C. coupled L.F. amplifier, output pentode); moving-coil speaker ...	No
K.B.	433	£6 17 6	AC mains 200-250v.	Loose-coupled aerial circuit; detector, R.C. coupled L.F. amplifier, pentode ...	No
K.B.	429	£8 18 6	Battery...	3-valve straight receiver, "post-selective" band-pass tuning; combined reaction and volume controls; "Fototune" dial; moving-coil speaker.	Yes
K.B.	430	£8 18 6	AC/DC 200-270v.	3-valve tuned radio-frequency circuit; full-vision dial; built-in mains filter ...	No
K.B.	396	£10 10 0	Battery...	4 valves; band-pass input; class-B output; moving-coil speaker; full-vision dial ...	Yes
Knightsbridge	SP4	£9 18 0	Battery...	4-valve suitcase portable, circuit as above, fitted moving-coil speaker ...	No
Milnes	332M	£7 19 6	Battery...	H.F., det., and economy pentode; triode det., pentode output; permanent-magnet moving-coil speaker.	Yes
Mullard	M.B.3A...	£8 8 0	Battery...	3-valve (all pentode) battery receiver; moving-coil speaker; full-vision dial ...	Yes
Mullard	M.B.3	£8 8 0	Battery...	As above, but horizontal model ...	Yes
Mullard	M.B.4	£9 12 6	Battery...	4-valve battery receiver, class-B output; full-vision dial ...	Yes
Pegasus	Super Dynamic 1995 Table model	£9 9 0	AC mains	4-valve superhet, pentode output, 5th valve for mains rectification; energised moving-coil speaker.	Yes
Pegasus	S.H.5 Table model	£8 18 6	Battery...	H.F. pentode I.F. stage, triode 2nd det., triode 1st L.F. amplifier, 700-milliwatt output pentode; permanent-magnet moving-coil speaker.	Yes
Philco	234	£7 10 0	Battery...	3-valve 5-stage superhet; moving-coil speaker illuminated dial ...	No
Philco	267	£8 15 0	AC mains	4-valve superhet ...	—
R.I.	Micron Battery Three	£8 18 6	Battery...	H.F., det., and economy pentode; variable- μ H.F. pentode amplifier; permanent-magnet moving-coil speaker.	No
Ultra	77	£6 19 6	Battery...	3-valve (all pentode) battery set; permanent-magnet moving-coil speaker; clock-face tuning.	No
Ultra	66 Table model	£8 19 6	AC mains 100-130v. or 200-250v	4-valve (including rectifier) screened-grid circuit; 7-in. Concert Grand moving-coil speaker. Console model 11 gns.	No
TEN TO FIFTEEN GUINEAS					
Ace	—	£12 12 0	AC/DC mains	7-valve all-wave superhet 15-2,000 metres, mains-energised speaker ...	—
Aerodyne	Silverwing A	£11 11 0	AC 200-250v.	6-stage superhet, band-pass tuning, full delayed A.V.C., inter-station noise suppression, energised moving-coil speaker	Yes
Alba	Silverwing B	£12 1 6	AC/DC 200-250v.	4-valve octode double diode, high-slope output pentode, valve rectifier ...	Yes
Alba	550	£11 0 6	AC 200-250v.	4-valve octode double diode, high-slope output pentode, valve rectifier ...	Yes
Alba	550	£11 11 0	AC/DC 200-250v.	4-valve octode double diode, high-slope output pentode, valve rectifier ...	Yes
Alba	660	£14 14 0	AC 200-250v.	4-valve octode double diode, high-slope output pentode, valve rectifier ...	Yes
Alba	660	£15 15 0	AC/DC 200-250v.	4-valve octode double diode, high-slope output pentode, valve rectifier ...	Yes
Allwave	Shortwave	£12 10 0	Battery...	H.F., det., oscillator, power, covering short waves ...	—
Atlas	A.13	£13 13 0	AC mains	5-valve 7-stage superhet; triode output giving 2½ watts; A.V.C.; spectrum tuning, with tilting dial. Table model	—
Austin	Battery Super-Five	£15 4 6	Battery...	5-valve table model, superhet, permanent-magnet moving-coil speaker, band-pass tuning	Yes
Beethoven	A.C.77	£12 1 6	AC mains 100-250v.	7-stage superhet, 5 valves (including rectifier), energised moving-coil loudspeaker, internal capacity aerial, illuminated airplane dial	Yes
Betteset	AD4	£12 1 6	Universal	4-valve (including rectifier), transportable, Osram W30, W30, N30 and U30 vclves. Circuit comprises H.F. det., and power pentode. This circuit is built to work in very bad areas electrically	Yes
Blue Spot	AC5	£12 12 0	AC mains 200-260v. or 100-110v. 1 gn. ex.	7-stage superhet, A.V.C., energised moving-coil loudspeaker, full vision tuning ...	Yes
Burndept	CN218	£11 11 0	Battery...	4-valve battery portable superhet; moving-coil speaker	—
Burndept	CN226	£13 2 6	AC mains	5-valve superhet, band-pass input, A.V.C., visual tuning, energised moving-coil speaker	—
Burndept	CN229	£14 3 6	AC/DC 200-250v.	4-valve superhet portable; A.V.C., energised moving-coil speaker	—
Burndept	CN201	£15 15 0	AC mains	Band-pass input; A.V.C.; continuously variable tone control ...	—
Bush	S.B.4	£11 19 6	Battery...	4-valve 6-stage superhet, band-pass tuning, delayed A.V.C., permanent-magnet moving-coil loudspeaker, automatic grid bias	Yes
Bush	S.A.C.21	£12 1 6	AC mains 200-250v.	4-valve 6-stage superhet, delayed A.V.C., high-fidelity energised moving-coil speaker, escalator dial	Yes
Bush	DC/JAC Superhet	£12 12 0	DC/AC 180-260v.	3-valve 4-stage superhet, band-pass input filter, oscillator, four tuned I.F. circuits; P.M. moving-coil speaker	—
Bush	S.A.C.25	£14 3 6	AC mains	5-valve (including rectifier) 7-stage superhet, triode output, giving 3 watts ...	—
Bush	Upright Grand	£15 15 0	AC mains	4-valve (including rectifier) superhet ...	—
Cossor	364 Superhet	£11 11 0	AC mains	4-valve superhet ...	Plug and sockets for pick-up
Cossor	De Luxe Superhet Model 365	£14 14 0	AC mains 200-250v. 40-100c.	4-valve superhet ...	Yes
Decca	Table Radio	£11 11 0	AC or AC/DC at £12 1 6	5-valve superhet, A.V.C., inter-station noise suppressor ...	Yes
Decca	Partrola	£12 12 0	AC or AC/DC	4-valve superhet portable radio-gramophone; output 3½ watts; moving-coil speaker	—
Decca	De Luxe mode	£15 15 0	AC or AC/DC	4-valve straight ...	Yes
Eddystone	Kilodyne Four (Kit)	£13 0 0	AC mains (ex valves)	4 valves (octode, H.F. pentode, double diode, L.F. pentode) ...	Yes
Ekco	AC76	£11 11 0	AC	4 valves (octode, H.F. pentode, double diode, L.F. pentode) ...	Yes
Ekco	AD76	£12 1 6	AC/DC	4 valves (octode, H.F. pentode, double diode, L.F. pentode) ...	No
Ekco	886	£12 1 6	Battery...	4 valves (triode pentode, H.F. pentode, double diode triode, double pentode) ...	Yes
Ekco	AC86	£13 2 6	AC	5 valves (octode, H.F. pentode, double diode, triode, L.F. pentode) ...	Yes
Ekco	ACT96	£15 4 6	AC	6 valves (H.F. pentode, octode, H.F. pentode, double diode, triode, L.F. pentode) ...	Yes
Ever Ready	5001	£12 12 0	Battery...	4-valve (including rectifier) band-pass superhet table model, 7 tuned circuits, mains-energised moving-coil speaker.	No
Ever Ready	5007	£12 12 0	Battery...	Battery superhet table model; Q.P.P. output; tone control; moving-coil speaker	Yes
Ever Ready	5002	£12 12 0	AC mains	5-valve band-pass superhet, class-B output; moving-coil speaker	Yes
Ever Ready	5006	£12 12 0	AC mains	4-valve superhet table model; pentode output; mains-energised moving-coil speaker	Yes
Ever Ready	5008	£12 12 0	AC/DC	4-valve superhet table model A.V.C.; permanent-magnet moving-coil speaker	Yes
Ever Ready	5003	£14 14 0	AC mains	5-valve (including rectifier) superhet with band-pass input, quiet and delayed A.V.C.; 9-in. diameter non-focusing speaker.	Yes

Brand Name	Model	Price	Power Supply	Brief Description of Circuit	If Pick-up Terminals
Ferranti	Nova Consolette	£11 11 0	AC	AC Superhet; 2½-watt pentode output; A.V.C.; illuminated "All-in" dial	No
Ferranti	Nova Consolette	£12 1 6	AC/DC	AC Superhet; 2½-watt pentode output; A.V.C.; illuminated "All-in" dial	No
Ferranti	Lancastria	£13 2 6	AC	AC Superhet, as Nova but with electric tuning and noise suppressor	No
Ferranti	Consolette	£14 3 6	AC/DC	AC Superhet, as Nova but with electric tuning and noise suppressor	No
Ferranti	Arcadia Consolette	£15 15 0	AC	AC Superhet, 2½-watt triode output; A.V.C.; noise suppressor; electric tuning; "All-in" dial.	Yes
G.E.C.	BC3645	£11 11 0	AC/DC 200-250	4-valve superhet; A.V.C.; tone control; internal aerial; moving-coil speaker. Also available for AC only.	No
G.E.C.	BC3650	£14 3 6	AC mains 190-250v.	5-valve superhet; station-name speedometer dial; inter-station noise suppression; auditorium dynamic speaker, "Fidelity Reception."	No
Halcyon	4701	£14 14 0	AC/DC 200-260v	4-valve superhet; 7 tuned stages; silent visual tuning; tone control; moving-coil speaker; image suppression.	Yes
Higgs	B56R	£11 11 0 or 21/- down.	Battery	4-valve battery superhet resembling A56R in specification	Yes
Higgs	U56R	£11 11 0 or 22/6	DC/AC mains (Universal).	As A56R below	Yes
Higgs	A56R	£12 1 6 or 22/6 down.	AC mains 190-260v. 40/100 cycles.	4/5 valve superhet; O.A.V.C.; full vision tuning, calibration in wavelengths and 6 station names; tone control; sensitivity control; band-pass input.	Yes
H.M.V.	Universal Superhet Four 340	£12 1 6	DC/AC	4-valve (including rectifier) superhet	No
H.M.V.	Superhet Fluid-Light Five 442	£14 3 6	AC	5-valve (including rectifier) superhet	Yes
H.M.V.	Superhet Forty One 441	£13 2 6	AC	5-valve (including rectifier) superhet	Yes
H.M.V.	Superhet Battery Four 146	£12 12 0	Battery	4-valve (including rectifier) superhet	Yes
H.M.V.	DC/AC Console Radio 341	£15 15 0	DC/AC	DC/AC Superhet Radio	No
Hylvolstar	Lighttime	£13 2 6	AC/DC 100-250v.	4-valve straight table model, Magnavox M.C. loudspeaker, 2½ watts output. Complete with clock and lamp	Yes
Hylvolstar	Allwave Straight Four	£14 3 6	AC/DC 100-250v.	3 valves (plus rectifier), straight table model, Magnavox mains energised M.C. loudspeaker; covering 16.4-52, 200-560, 800-1,900 m. Also in chassis form £11 0 6	Yes
Invicta	S.H.B.	£10 13 0 (less bat.)	DC/AC	4-valve superhet with delayed A.V.C., moving-coil speaker	Yes
Invicta	45 Universal	£11 11 0	AC/DC mains	5-valve (including rectifier) superhet	No
Invicta	AC/45	£12 1 6	AC mains	5-valve (including rectifier) superhet with quiet A.V.C. and variable selectivity	Yes
K.B.	422	£12 1 6	AC/DC 200-250v.	4-valve band-pass superhet, delayed A.V.C., tone and volume controls, built-in mains filter	No
K.B.	427	£12 12 0	AC 200-250v.	4-valve superhet; six tuned band-pass circuits; variable selectivity and tone control; Fototune dial; delayed A.V.C. Provision for use of K.B. 432 S.W. converter	Yes
K.B.	427A	£12 12 0	100-130v.	Similar to 427, but for AC/DC mains	No
K.B.	426	£12 12 0	AC/DC 200-270v.	Similar to 427, but with additional H.F. amplifier, automatic tone compensation, neon tuning	Yes
K.B.	428	£14 14 0	AC 200-250v.	Similar to 427, but with additional H.F. amplifier, automatic tone compensation, neon tuning	Yes
K.B.	428A	£14 14 0	100-130v.	Similar to 427, but with additional H.F. amplifier, automatic tone compensation, neon tuning	Yes
K.B.	935	£15 15 0	AC mains 200-250v.	5-valve superhet with band-pass I.F. circuits; A.V.C., neon tuning indicator, tone and volume controls, M.C. speaker	Yes
K.B.	425	£15 15 0	AC/DC 200-270v.	5-valve superhet transportable; built-in frame aerial; tone and volume controls; built-in mains filter	No
Magnum	Yacht Radio apparatus	£14 2 0	Battery	3-valve using variable-mu H.F. pentode detector and Q.P.P. output	Yes
McMichael	235	£12 12 0	AC mains 200-250v.	4-valve (including rectifier) 7-stage band-pass superhet, A.V.C., tone control, dynamic moving-coil speaker, provision for extra speaker	Yes
McMichael	535	£12 12 0	AC/DC 200-250v.	5-valve (including rectifier) 7-stage band-pass superhet, A.V.C., tone control, permanent-magnet moving-coil speaker, provision for extra speakers	No
McMichael	135	£15 15 0	AC mains 200-250v.	5-valve (including rectifier) 7-stage band-pass superhet, two balanced duo-dynamic speakers, tone control, magnified station name dial	Yes
Milnes	332A	£10 19 6 (less bat.)	Battery	4 valves, band-pass iron-cored coils, Q.P.P. output, P.M. moving-coil speaker	Yes
Milnes	466	£13 2 6	AC mains	6-stage superhet, A.V.C., automatic tone correction, mains energised speaker	Yes
Milnes	537	£14 19 6 (less bat.)	Battery	5-valve straight receiver, two H.F. stages, tone control, permanent-magnet moving-coil speaker	Yes
Mullard	M.U.35	£12 12 0	AC mains	5-valve superhet, delayed A.V.C., variable tone control, full vision dial	Yes
Pegasus	S.H.6	£11 11 0	Battery	H.F. pentode first dec., separate oscillator, H.F. pentode I.F. stage, second det., L.F. amplifier, 700-milliwatt output pentode, moving-coil speaker	Yes
Pegasus	Table model S.H.7	(less bat.) £12 12 0	AC mains	Octode first det. and frequency changer, two H.F. pentode I.F. stages, single diode second detector and A.V.C., two L.F. stages with 2½-watt output pentode	Yes
Pegasus	1995C	£12 12 0	AC mains	Same as model S.H.7, but in console cabinet	Yes
Pegasus	Super Dynamic S.H.7U	£14 14 0	AC mains	Same as model S.H.7, but fitted for four wavebands—16-32, 30-60, 175-580, and 750-1,900m.	Yes
Pegasus	S.H.7.C	£15 15 0	AC mains	Same as S.H.7 above, but in console cabinet	Yes
Pegasus	S.H.6.B.C.	£14 14 0	Battery	Same as S.H.6 above, but in console cabinet	Yes
Philco	1280	£13 13 0	AC/DC	5-valve superhet, 3-point tone control, auditorium moving-coil speaker, shadow tuning	Yes
Pye	Baby Grand T/Q	£11 0 0	Battery	Straight portable	No
Pye	T.6	£12 12 0	Battery	External aerial battery superhet	Yes
Pye	T.7	£12 12 0	AC mains	External aerial superhet; Q.A.V.C.	Yes
Pye	T.9	£14 14 0	AC mains	De luxe external aerial model	Yes
Pye	TP/B	£15 15 0	Battery	Superhet portable	No
Ultra	25 Table Model	£12 12 0	AC mains 100-130v. or 200-250v.	4-valve (including rectifier) superhet, full A.V.C., concert grand moving-coil speaker, neon tuning. Console model £16 16 0	Yes
FIFTEEN TO TWENTY GUINEAS					
Alba	880	£16 16 0	AC mains	All-wave 5-valve (octode frequency stage, two pentodes, double diode, high-slope output pentode, valve rectifier).	Yes
Alba	880	£17 17 0	AC/DC	Same as A.13 in console form	—
Atlas	A.17	£17 17 0	AC mains	5-valve (including rectifier) table superhet; twin energised speakers	Yes
Austin	A.C. Super-Five	£16 5 6	AC mains	6-valve (including rectifier) table superhet; twin matched energised speakers; "Scanning-disc" tuning; Q.A.V.C.	Yes
Austin	A.C. Super-Six	—	AC mains	7-valve (including rectifier) superhet radio-gramophone; separate speaker giving 5/6 watts "Scanning-disc" tuning.	—
Austin	A.C. Super-Seven	—	AC mains	6-valve (including rectifier) transportable superhet receiver; A.V.C. (delayed); tone control; circuit built to work in exceptionally bad areas of static and general interference.	Yes
Betterset	AD5	£16 16 0	AC or DC (Universal).	3-valve straight	—
Cossor	Radio gram Model 536	£16 16 0	AC mains	3-valve straight	Pick-up incorporated
Decca	Table Radio	£16 16 0	AC mains	6-valve all-wave receiver (18-45, 200-550, 1,000-2,000), 9 tuned circuits A.V.C. inter-station noise suppressor.	—

Continued on page 140

How Pick-ups Have Changed

By P. WILSON, M.A.

and Improved

SOMETIMES when I look back over the changes that have taken place in the past few years I wonder whether there has really been any substantial improvement in our standards of reproduction.

I think of my amplifiers designed and constructed over five years ago, my pick-ups which I had specially made by a scientific instrument maker to my own designs seven

slightly from time to time. The other day I was sorting out some old papers and I came across a sheaf of pick-up response curves including one or two of my standard pick-ups. I was immediately struck by the tremendous improvement shown by my most recent curves, of my standard as well as of commercial models.

Two or three points in particular stood out as plain as a row of pikestaffs.

First of all, the modern pick-up has gained a full octave in the treble.

Secondly, the bass end of the scale seems to be more smoothly and adequately covered.

Thirdly, there is nowadays nothing like the sharp peaks in the response that one used to have to put up with.

It occurred to me to try over one or two modern pick-ups with a few of the early electric recordings. I did not at first choose the earliest 1926-7 recordings since I remembered that many of us gramophone fans of those days had grave doubts about the harsh, hurdy-gurdy character of the recording. When I did come to them, however, I found to my surprise that the harshness, the edginess and the nasality were not there!

Compared with a modern recording the older ones sounded dead and hollow. Strange, seeing that the modern pick-ups I used certainly reproduced more treble. But that was not all. The bass was definitely less than I recollect it of old and the surface noise

was much less. So also was needle chatter.

The few older pick-ups of the same time that I happen to have left had all gone completely out of adjustment; but there was one exception and that exception was a really notable one. I remember that I regarded it as easily the best pick-up of its time and I find even now that it will give most modern ones a good beating. But of that more anon.

High-note Deficiencies

I began therefore to interpret my observations in terms of the old response curves. I don't think it is really very difficult. Let us look at the points in order. Clearly the banishment of harshness and hurdy-gurdy tone has been due primarily to the suppression of violent peaks and troughs in the modern pick-up. The resulting deadness, I think, can only be attributed to a lack of high-note response in the actual recording. A pick-up with one or more marked high-note peaks was necessary to compensate for falling off in recording.

But these peaks then became responsible for the relatively large amount of surface noise and needle chatter one used to hear. They were caused by such a tight clamping of

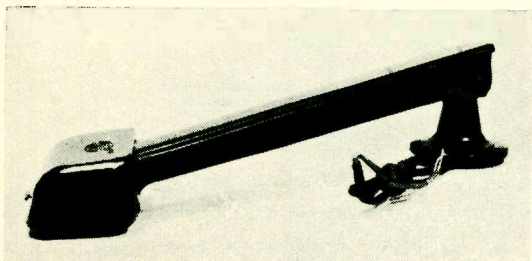

The well-known Graham Furish pick-up—of the electromagnetic type and selling at the extremely low price of 14s. 6d. complete with tone arm.

years ago, my moving-coil loudspeaker which dates back to 1927-8; and I compare them with up-to-date loudspeakers, pick-ups and amplifiers and find in them something which the later instruments often fail to give. There is a solidity of tone coupled with a cleanness of definition and an atmosphere of detail which I value highly.

Continual Improvement

One is always apt to think of the old experiences, just as one thinks of the old tunes as being somehow far more attractive than our modern ones.

But is it so? Are not our moods in a lightly reminiscent vein deluding us? If we are honest with ourselves I think we are bound to conclude that they are.

I mentioned just now that my pick-ups were specially made for me by a scientific instrument maker. One way or another they must have cost me something like £50 apiece, and I have used them as standards of comparison for nearly seven years.

But all the time I have been learning new things about pick-ups and have been modifying them

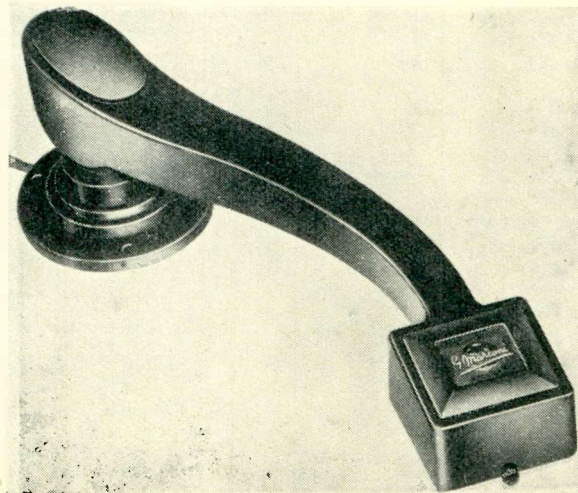

Marconiphone's popular pick-up, which is fitted as a standard to most of this concern's radiograms: known as the model 25, it sells at £1 12s. 6d.

the armature that this became a spring-controlled device and not a resistance-controlled device. This in its turn meant that in order to get the needle to track in the grooves a substantial weight on the record became necessary and record wear was pronounced.

Bass Problems

The one thing the response curves do not appear to account for is the lack of bass now compared with what I recollect. The modern pick-up clearly tracks better and has a better measured bass response. I can only conclude that I used to notice the bass in the early electric recordings because they were such a clear improvement in that respect on acoustic recordings, and the fact that modern recordings are just as much superior to the early electrics now provides a contrast in the opposite way. Possibly too, the fact that in 1927 one had not learned to control spurious bass in moving-coil loudspeakers and their mountings may have something to do with the matter.

Although, therefore, it is hardly fair to try now to make a direct comparison between an old pick-up and a new, because the very lapse

of time and the perishing of the rubber "damping" have made a hash of the old pick-up, yet one can come to quite definite conclusions concerning the respects in which improvements have been made.

Some of the earlier, everyday, pick-ups were really rather crude affairs; a magnet, some pole-pieces, a coil, an armature and a casing, all put together in a somewhat inconsequential way.

The armature was big and clumsy and its mounting was anything but precise. The great thing in those days was to set it up so

The standard Rothermel piezo-electric crystal pick-up is housed in a mottled metal casing. It gives an especially good level response over the audible frequency range. The price is £2 2s.

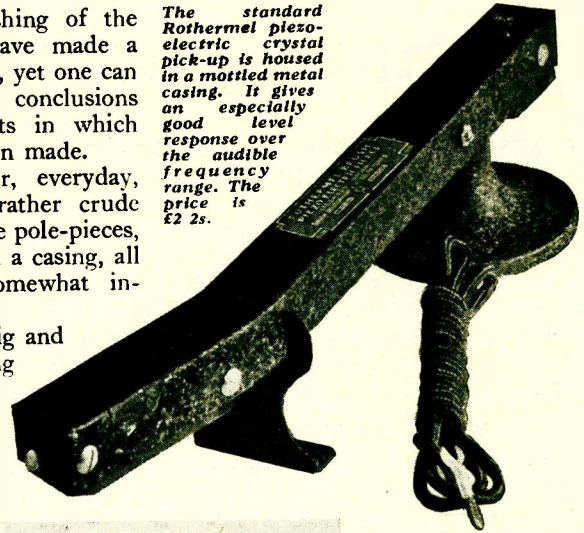

The new B.T.H. Piezo-electric pick-up referred to by the author. The makers claim 97 per cent. perfect tracking with high output and high fidelity reproduction. The price is two guineas

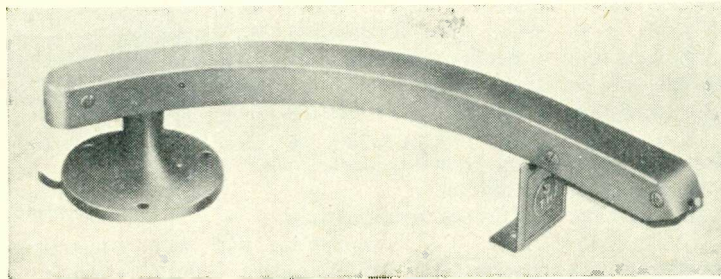

that it would not stick to the pole faces. Sometimes this was done by clamping it hard in a thin sheath of rubber between the lower pole faces: it could then only rock so far as the rubber would "give." This was called "damp-

ing." Very soon the rubber started to perish and then the game was up.

In some models the crudity of this pivot damping was realised and a definite and positive axis of rotation for the armature was provided. Then it was found that even if pole-stiction could be avoided, the high-note response disappeared.

It was very rare indeed to find any appreciable output at 3,000 cycles: when one did find it, it was usually of the nature of a Matterhorn peak that was most objectionable.

Another obvious makeshift was the carrying arm. Compared with the effective mass of the armature it was so light that at low frequencies the whole arrangement went off into vibration, robbing the armature and so causing a trough in the response curve. At these carrying-arm resonances it was a matter of some difficulty to keep the needle in contact with the groove and record wear was considerable.

More Precise Design

The modern pick-up shows many more signs of real knowledge. It has been designed and not merely put together. The armature is now made of special metal of high permeability so that only a small mass is necessary to carry the magnetic flux; this has improved both high- and low-note response, the former because of reduction of hysteresis, the latter because the small mass enables a freer motion to be secured and a heavy carrying arm is less necessary.

However, mass has been added to the arm in the form of a counter-balance so that the pressure on the record is less. Notwithstanding this small pressure the contact between needle and groove is more definite even at low frequencies; this is

Continued on page Fourteen



As you can see the H.M.V. model 11 pick-up consists of a pick-up head for fitting on to the tone-arm of an ordinary gramophone. It is supplied complete with volume control for £1 12s. 6d.

Home Construction as a Hobby

By PERCY W. HARRIS
M.I.R.E.

THERE must be thousands of readers of "Wireless Magazine" to whom the hobby of wireless is a constant fascination, yet who have still to build a set for themselves. Why should they? they ask. Sets nowadays are so cheap that one may just as well get them ready-made, and save a lot of trouble!

Wonderful Value

As to the value of modern commercial sets there is no dispute. Indeed, the margin between cost of production and selling price is so fine that only the best organised and carefully managed firms are able to survive in the cut-throat competition of today.

But after all, we do not *all* wish to buy our suits at the multiple tailors, excellent though their value may be.

It is not fair, when making comparisons between home-built and factory-built sets, to take price alone. When you come down to the purchase of a factory-built wireless set you will find a wide range of prices, all of which represent excellent value, and it by no means follows you will buy the cheapest you find.

You may not even find exactly what you want in the commercial set—it is, for example, by no means easy in these days to find one which does not incorporate the loudspeaker, and it is not always advisable that the speaker should be where the set is.

Apart from the great pleasure of using a set which you have built, wire by wire yourself, one of the greatest advantages of home construction is what may be termed the flexibility of the finished set. The receiver of the enthusiast is always in a state of transition. He reads

one day about a new coupling system supposed to give a better quality reproduction and straight away, with very little expenditure, with only the change of a few wires and perhaps the substitution of one new component, he will change over his existing set to the new method.

If the new scheme is no better it can be easily changed back again; when some further improvement comes along the screwdriver, the pliers and the soldering iron come into play for some new adventure in technique.

It is nearly impossible

to do this with any commercially-built set. First of all, most bought sets today are designed in such a way that the change of a single component may upset the whole design, and secondly, the make-up of the receiver is such that while it is easily assembled with the numerous machine tools and skilled operators in the modern factory the

components themselves are to a large extent inaccessible.

If you were to take two sets both with the same circuit, both with equally good performance, but one designed for factory building and the other for home construction, you would see a vast difference. In home

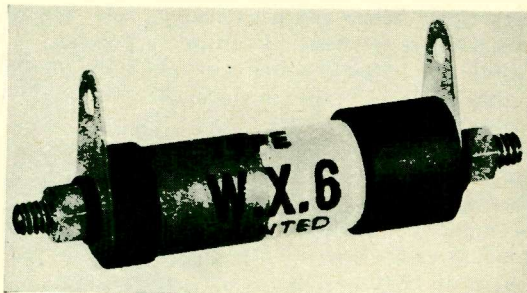

The Westector—a high-frequency metal rectifier for detection, and A.V.C. and battery economiser circuits

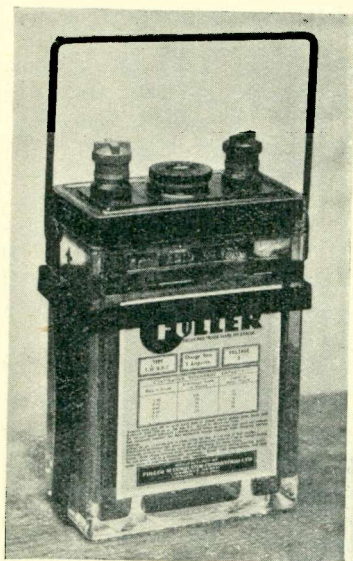

One of the many sturdy 2-volt accumulators made by Fuller

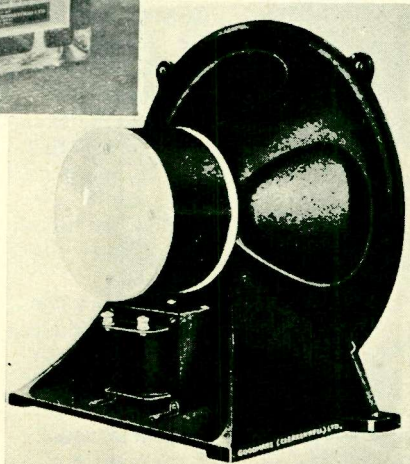

Goodman's auditorium permanent-magnet moving-coil loudspeaker. It will handle an input of 12 watts and costs £8 8s.

construction designs we do not attempt, in the great majority of cases, to pack the components into so small a space as that utilised in the commercial set, but we *do* make every component easily accessible, easily changeable and conveniently placed for wiring.

First Hand

I have been designing wireless sets for home construction for more than a dozen years and, in fact, originated the modern type of constructional article that combines a scale wiring diagram with photographs of the front and back of the set from various angles. From the first I have made it a rule to construct, myself, every set that goes out under my name—a procedure by no means universal among designers! Only in this way has it been possible to find the difficulties facing the home constructor and to remove the majority of them.

And so when I say that today the home construction of sets is *easier than it ever was before*, in spite of the additional complications of the circuit, I speak with first-hand knowledge. For those who do not care for soldering, components are available which, by providing screw terminals instead of soldering tags, completely remove the necessity of this interesting but, to some, troublesome operation.

Intricate wiring is often removed

by the assembly of certain essential parts in a "pack" or "block," while brackets and other forms of mounting allow a set to be made on a flat baseboard and then slid into a cabinet from the back so that the various spindles protrude through holes cut in the wood or various holes in the panel, the knobs being attached afterwards.

Look It Over !

Because these knobs are bigger than the holes through which the spindles protrude they cover up any roughness and inaccuracy in the boring. In the earlier days, when components themselves were mounted directly on an ebonite panel, a slight error in drilling might throw out the whole scheme and make attachment impossible.

If you have not hitherto tried your hand at home construction glance at the description of the "Certainty Three," on pages 90 to 93. Dismiss from your head any ideas of difficulty and forget what some of your lesser-informed friends may have told you.

Look into the matter for yourself, even if you do not wish to build a set now, to see just what has to be done. You will find, for example, that there is a list of components given and a scale plan of how to set them out.

This scale plan is reproduced in miniature form and is generally sufficiently large to enable one to see what to do, but in any case you will find in the present number a coupon entitling you to obtain a full-scale blueprint, actually drawn

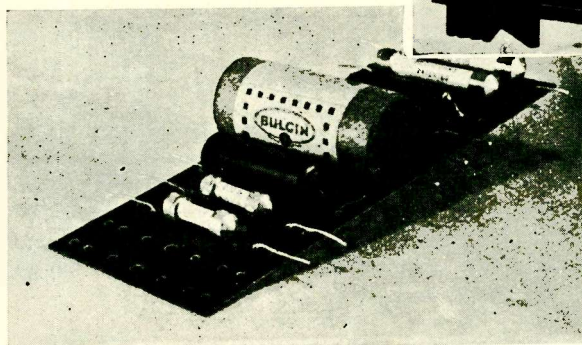
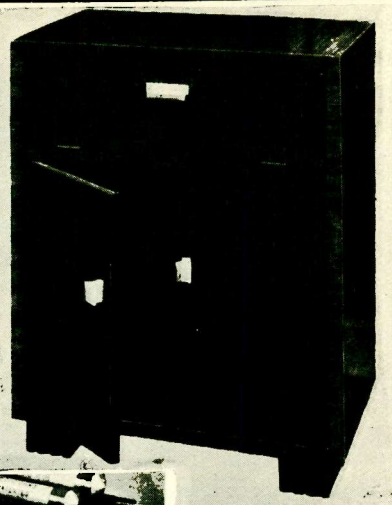

(Left) Bulgin's make paxolin strips for the mounting of resistances and condensers. A typical example is shown here. (Above) An attractive and useful piece of radio furniture for storing a Milnes high-tension supply unit made by Frederick Waterhouse Ltd., Bradford

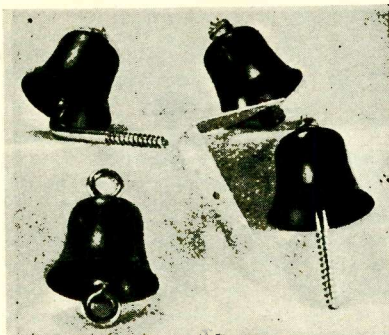

A group of Bulgin aerial gadgets; stand-off insulators, lightning arrestor, etc.

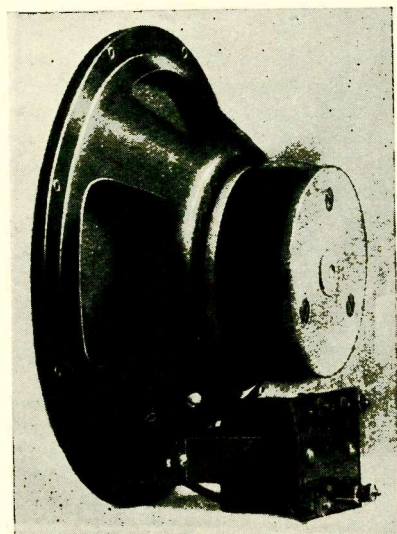

The Junior 8 permanent-magnet reproducer made by Celestion. It is noted for its extreme sensitivity

from the original set, at half price.

With this in front of you, you are practically as well placed as if the original design of set were standing in front of you.

Plywood baseboards are standard for home construction in these days although occasionally metal chassis are used. The various parts are stood in position as shown in the drawing, and screwed down with round-headed wood screws through the holes provided.

After this you merely have to take a reel of tinned copper wire and some insulating sleeving, cut the lengths of wire to join up between terminals, slip over the sleeving and either solder or screw under the terminals the ends of the wires. The designers have had all the headaches—they have had to experiment to find the exact position of the various parts, they have had to work out the wiring so that leads go conveniently from one point to another, and you have little more to do than copy their layout with the same parts they used!

"And when I have done all this, what advantage do I get?" you may ask. Simply this. The set will be a first-class performer and you will have the pleasure of knowing you built it yourself and, if, as I think will happen, you become interested in home construction, you will have assembled a collection of

components the majority of which will be available for use again and again in any other set you may wish to build.

This is a point which is often overlooked. The first cost of a home constructed set when you have to buy everything new, may not be less than the cost of a commercial set of equivalent performance *but*—and this is a very important *but*—the *next* set you build *will cost you much less* than the equivalent commercial set just because tuning condensers, valve holders, valves, low-frequency

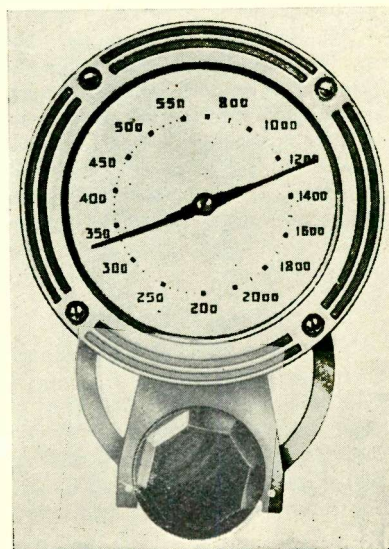

J.B.'s new Airplane dial is calibrated from 200 to 2,000 metres



A typical metal rectifier for high-tension supply to the set or for energising a loudspeaker by Westinghouse

transformers, terminals, baseboards and many other parts are common to all sets.

A further advantage is that in a home constructed set newly invented components or new systems of connections can often be tried out with very little change in the main part of the set. This is why home constructors find it so easy to keep right up to date in their technique. It is not worth the set manufacturer's

while to change his design more than once a year, for not only must he work out a design with the utmost care to suit his quantity production methods, but he must allow for a season's sale of one model before he introduces the next, otherwise the previous one will become obsolete.

The home constructor can change and improve his set within a few days of reading about the new method, for he has neither

factories nor sales

organisations to worry about.

And so, if anyone tries to tell you that home construction is dead, do not believe him. While it is no longer necessary to build your own if you wish to obtain a

good receiver at a reasonable price, none of the main advantages of home construction have been lost and many new ones have come along.

Individuality

Thank heaven the world at large is not yet standardised—we do not all wish to wear the same clothes, to eat the same food, to use only the cheapest of everything, or to be tied for a long period to one kind of set. So long as we retain our individuality just so long will home construction continue.

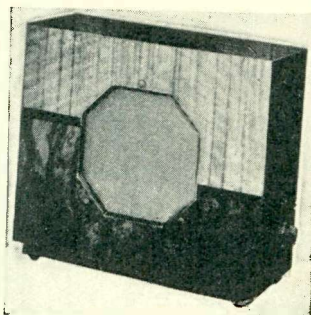

A neat extension loudspeaker, the Bronzian, with volume control marketed by Wharfedale

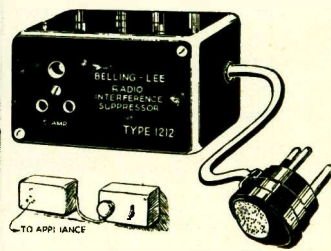

For those troubled with interference caused by electrical apparatus; Belling Lee's plug suppressor

How Pick-ups Have Changed and Improved

Continued from page Eleven

one of the consequences of the freer armature motion. So also is the vastly reduced record wear.

There is now a positive rocking axis for the armature with a certain amount of damping at the fish-tail. The high-note response, besides being stronger, is therefore smoother, and surface noise is not nearly so pronounced.

All these are solid gains. Even so, I am clear that something more remains to be done, though whether it will be done in moving-iron electromagnetic pick-ups I am more doubtful. There is still insufficient damping of the proper resistance character and what there is, being made of rubber, is liable to perish fairly quickly.

Improved Damping

There are much better damping materials available now than rubber. One is known as soft Viscaloid and is an acetate preparation which looks like a cross between celluloid and soft gelatine. I understand that it is commonly used in the best microphones. It is practically unaffected by light, heat or time. But it is rather expensive.

A friend of mine who is an expert on synthetic resins has just made up for me a special preparation from an aluminium soap which seems promising. It is also relatively cheap. However, it is too early yet to judge definitely as to its value. When new it seems to have all the desirable properties but time alone can show how long they will last. Viscaloid, on the other hand, has been under test for several years.

A much more important improvement that has yet to be effected in ordinary moving-iron pick-ups, is the avoidance of amplitude distortion for large displacements of the needle (for example, in bass notes). I only know of three pick-ups where this problem has been more or less successfully tackled.

One is the piezo-crystal pick-up; the second is the meltrope pick-up, the design of which was based on my standard pick-ups previously mentioned; and the third is the H.M.V.-Marconiphone *three-pole* pick-up which was on the market a few years ago.

This latter is the exception I refer to above. The design was by far the cleverest I have seen in electro-

magnetic pick-ups, but unfortunately it was expensive to carry out. The price (if I recollect rightly was three guineas) told heavily against the pick-up in the commercial market and the model was reluctantly dropped.

The three-pole arrangement counteracted the overbalancing pull of the magnet on the armature; only the fish-tail of the armature carried magnetic flux; the magnetic gaps could be made very small without risk and the output was relatively large. In addition the armature motion was quite free and the carrying arm was exceedingly well designed so that record wear was low.

The only criticism I ever had against it was that the mechanical damping arrangements were inadequate and that criticism could easily have been met.

Important Newcomer

For many reasons I should like to see that model restored to favour. But I imagine that the success of the piezo-crystal pick-up is likely to prevent that. By the time these words are in print the new Edison Rochelle Salt pick-up will be available. I have been promised a sample within a week of my writing of this article. At the moment I only know that its sponsors are very proud of it.

All About the New Short-wave Components

By G. Howard Barry and the
"W.M." Technical Staff

SHORT-WAVE enthusiasts will find more to interest them at Radiolympia this year than at any previous Show. That, probably, goes without saying, for there has been a slow but steady tendency for short-wave sets and components to occupy more space each year.

This season the most striking advancement is in the direction of genuine All-wave sets. In many of them the short-wave side takes the form of a built-in converter or adaptor, the switching-in of which is looked after by the ordinary wave-change switching of the set.

Two neat H.F. chokes have also been introduced, both wound on "D.L.9," and the size of the popular wire-end grid-leaks and resistors. The short-wave choke has four small basket-weavecoils, while the ultra-short-wave version employs only a single-layer winding, the turns

being spaced one diameter.

One of the most interesting of the Eddystone additions is the Slow-motion Head—a complete slow-motion drive in a little brass cylinder no larger than a thimble. This should be ideal for the purpose of adding a slow-motion control to a reaction condenser, since the head may be mounted on the panel complete with its

diminutive pointer and scale and its quarter-inch spindle coupled to the condenser-spindle by means of a flexible coupler, one of which, by the way, is also included in the new season's lines.

Of interest for the same kind of work is the new adjustable insulated bracket. Most home constructors are only too familiar with the type of bracket that invariably puts the condenser a quarter of an inch too high for the hole in the panel. Generally, also, it needs insulating from the baseboard in some way; a problem calling for some ingenuity.

Simple Solution

The Eddystone adjustable insulated bracket is a two-piece component consisting of a small metal bracket which supports a strip of "D.L.9," drilled at the top to take the bush of the condenser, volume control, or whatever component it is desired to use.

Last in the Eddystone range comes a new midget condenser. This is a really diminutive affair, which could be mounted in almost any place on the panel, however crowded the latter might be, without getting in the way. Its capacity is not stated, but I should estimate it as about 45 mmfd.

Like the slow-motion head, it is provided with a small scale reading from 0-10, and it will commend itself to the short-wave enthusiast for use in innumerable ways.

From a number of the other firms

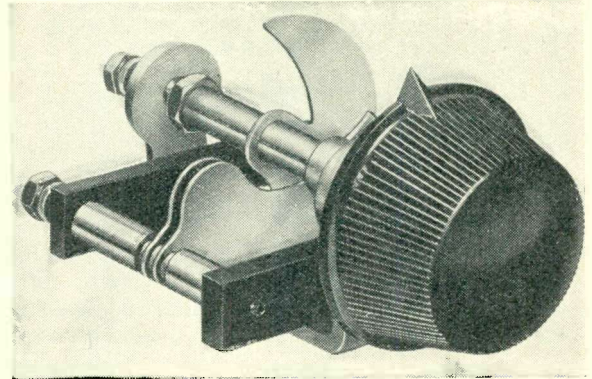

The J.B. panel-mounting variable condenser intended for ultra-short-wave work. Note the special low-minimum arrangements.

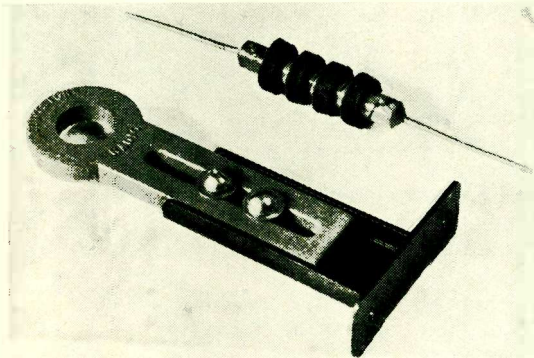

Eddystone new short-wave radio-frequency choke and special stand-off component mounting bracket

Complete details of many of the new short-wave components have not been released sufficiently early to review them fully in this issue. However, we have received news of Eddystone new lines from Stratton and Co.

For Superhets

Among them is a very neat 450-kilocycle intermediate-frequency transformer, completely shrouded and wound with Litz. Housed in a neat box with the modern grey cellulose finish, this transformer is provided with four flexible leads for the connections, and trimmers for both primary and secondary windings are readily accessible through two small holes at the top of the case.

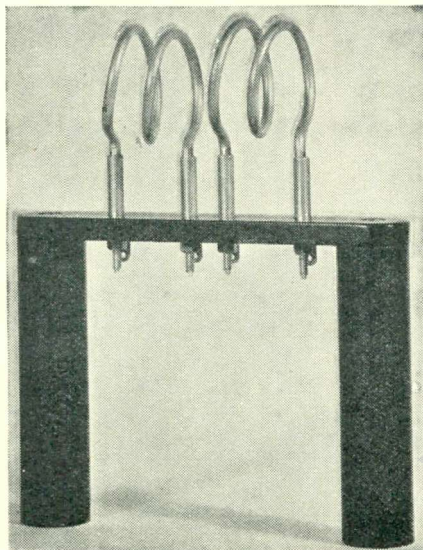

One of the new B.T.S. ultra-short-wave coil combinations intended more particularly for television work

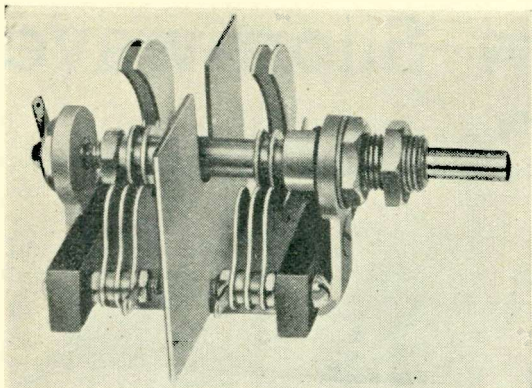

The new J.B. midget type of short-wave twin condenser. Note the large shield between sections

producing special items of short-wave interest we have received advance information of their lines for next season.

New Valve Holder

An interesting new Clix line for short waves is the leg-supported skeletonised valve holder: this is available in all types from 4 to 9-pin, and seems to be mostly made of air! It certainly looks low-loss, but we have not yet had time to make any actual trials.

From Bulgins comes news of several new items, including a base-

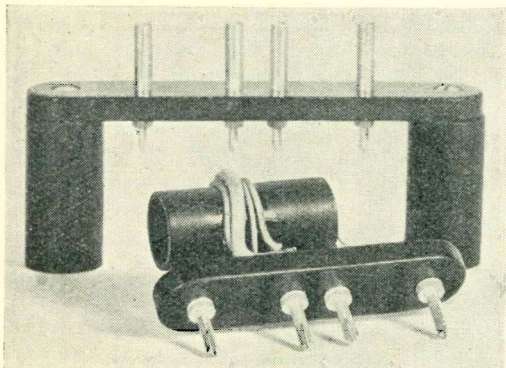

The oscillator unit of the B.T.S. ultra-short-wave receiver kit. This component has been designed with close attention to short wiring possibilities

board valve holder of the 7-pin type. This has Frequentite insulation, silver-plated contact surfaces, and alternative solder-tag or screw-down connectors. Another useful line is a 450-kilocycle intermediate transformer with Litz windings and a built-in pre-set tuning condenser. There is also an addition to the Bulgin range of radio-frequency chokes, wound on a Ceramite former and fitted with wire-end connections for direct mounting.

The J.B. condenser range is being augmented with quite a number of special short-wave types. For example, there is a new midget type made in five sizes running from 15 mmfd. to 45 mmfd., intended for band-spreading, ultra-short circuits, and so forth. This type is insulated throughout with Keramot, and can be obtained with 8 to 1 and 100 to 1 slow-motion drive if required.

Other new J.B. items include a two and three-gang double-spaced Baby type of .00016 mfd. per section, and an air-dielectric pre-set of 50, 75, or 100 mmfd.

Belling and Lee announce some interesting new parts including a useful-looking stand-off insulator priced at 1s. 2d.; special low-loss terminal supports, valve holders employing Frequentite, and a handy stand-off insulating bush.

In addition to existing lines Wearite is introducing a range of small valve-base coils. These are made in three sizes and cover a total range of about 13½ metres to 100 metres when used with a tuning condenser of the conventional .00016 mfd. capacity.

Wingrove and Rogers, tell us that one of their most notable short-wave lines will be the new Type-G tuning condenser. This component will resemble in general construction the well-tried Type-E in being built on a Steatite base, but will differ in having vanes of a special zinc alloy, and in the case of

the two-gang type will have a screen between the two sections.

Enthusiasts of the ultra-shorts will be much interested in the new B.T.S. 5 to 10-metre kit. This was primarily intended for high-definition television, with wide-response 12-megacycle intermediates, but many of the components are of perfectly general application. The kit includes some attractive self-supporting silver-plated tuning inductances, special tuning and trimming condensers, two radio-frequency chokes, and the necessary I.F. transformer

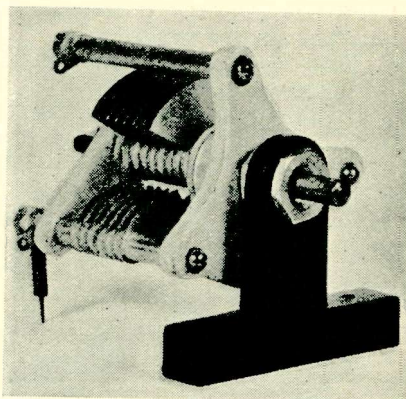

B.T.S. bracket-mounted short-wave tuning condenser with Megacite insulation

Wilkins and Wright announce a special high-efficiency gang condenser possessed of all the desirable features—brass vanes properly bonded, Frequentite insulation, and so forth. Standard capacity is .00015 mfd., and it is available in single, double and triple forms.

From Graham-Farish we hear of quite a wide range of new things of interest. Starting with coils, there is a set of four covering the usual 13 to 100 metres, wound on Steatite formers and fitted with special clip-in connections instead of the more usual valve pins. For use with these there is a single and also a double base, the latter being fitted with a switch so that one may change over from one coil to the other as desired: the idea is to insert the two coils covering the two wavebands in which one is interested at any given time, and go from one to the other as required. Both bases are of Steatite.

Decidedly novel is the new G-F tuning condenser; both sets of vanes are die-cast so that they form one continuous piece of metal.

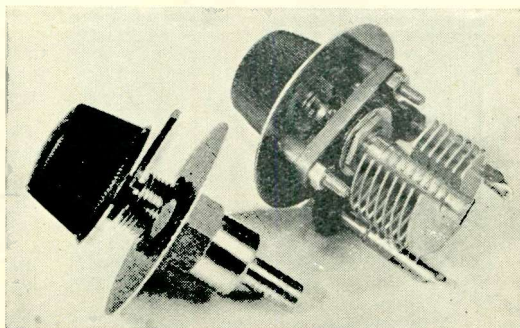

Left, the Eddystone slow-motion attachment for reaction condensers and so on; right, the new Eddystone midget condenser

EVERYONE knows in a broad way what is meant by the term "transient"; it signifies some occurrence of short time duration. Actually everything is of short duration, even our lives, when measured in relation to geological epochs where a million years is a mere trifle. Consequently where the reproduction of speech and music is concerned we must be more precise as regards our definition.

Two Kinds of Sounds

Sounds can be divided into two main groups; (1) those which rise and fall quickly in loudness; (2) those which remain at a steady level, although this may only last for a few seconds. If a loudspeaker is supplied with a steady tone of 1,000 cycles per second (for example a tuning-in note) we all know that the sound level at any particular spot in a room is constant. Of course, if one moves to the side the level varies owing to the standing wave effect caused by reflection from the walls.

When the loudspeaker is switched off the sound does not stop immediately: it decays rapidly until we can



Our illustration shows an unusual place for the extension loudspeaker built into the wall above the mantel-piece with a clock in the middle of the opening. Actually, this model can be obtained from Radio Furniture and Fittings, Ltd.

Those Transients!

Explained by DR. N. W. McLACHLAN, D.Sc., M.I.E.E.

We take great pleasure in presenting readers with a second contribution from the pen of Dr. N. W. McLachlan, this time on the subject of transients—a subject that will form the basis of more articles by this world-famous authority on loudspeakers. In this article, Dr. McLachlan reveals that to give faithful reproduction our radio sets and transmitting stations must be capable of dealing with frequencies up to at least 12,000 cycles per second. However, due mainly to an overcrowded ether, ordinary broadcasts do not contain any frequency above about 9,000 cycles per second

hear it no longer, that is, it falls below the lower threshold of audibility. This decay portion of the sound is regarded as a transient.

The two phases, namely, steady and transient, are illustrated by the curve of Fig. 1. The reverse of the decay effect occurs when the loudspeaker is switched on again, so the sound grows to a steady value, as shown on the left in Fig. 1.

The reader will have no difficulty in understanding that organ playing is mainly of the "continuous" variety, although there are mild transients at the beginning and end of each chord. As opposed to this, speech is mainly of a transient nature, and comes out, so to speak, in a series of jerks or spurts.

Sounds like "p" or "b" are highly explosive, although, of course, there are sounds which border on the "con-

tinuous" type, for example, the "ah" doctors sometimes make us say! Because of the explosive nature of certain speech sounds, some—or should we say most!—loudspeakers give forth a characteristic bellow or boom accompanied by a hard barking or grating sound.

This form of distortion is largely due to resonances in the loud-speaker, and these are excited by impulses. When we consider the matter fully we find that many sounds, whether in music or of the cruder variety in nature, are transient in type—typical examples are pizzicato playing of stringed instruments, drums, piano, harpsichord, sparrows chirruping, dogs barking, whip-cracking, sea beating on the shore, banging a door, closing a book quickly, handclapping, key jingling and so on.

Comparing Everyday Sounds

We are accustomed to associate sounds with particular frequencies. For instance, if we play middle C on the piano, we know what to expect so far as pitch is concerned, unless, of course, the piano is badly out of tune! But we cannot expect the same thing if we slam a door or close a book quickly. The piano wires vibrate mainly at 256 cycles per second, but there are overtones of 512, 1,024 cycles per second, etc.

So far as the book is concerned there is no vibrating member of the musical type, and the sound is unmusical.

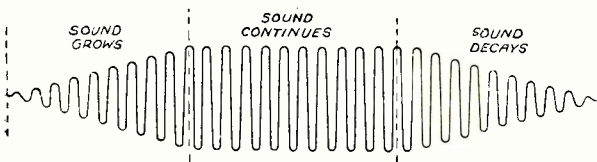

Fig. 1.—The transient regions are those associated with the growth and decay of this type of sound

Pursuing this aspect of transients a little farther, suppose we try to solve the following riddle. It is known from experimental observation that the ear cannot hear sounds lower than about 20 cycles per second and not higher than about 20,000 cycles per second. It is also known that the natural frequency of a glass marble of $\frac{1}{2}$ in. diameter is above 50,000 cycles per second and, therefore, quite outside the audible range. But if we go into a field and drop one $\frac{1}{2}$ in. marble on another, there is an audible sound: why?

Root of the Problem of Transients

To answer this we have to go to the very root of the problem of transients. Imagine that we have a room whose six inner surfaces absorb sound completely so that nothing is reflected. In technical parlance this would be called a room acoustically "dead," and the conditions therein would be akin to those in free air up in a balloon.

In the said room there is a microphone connected to an amplifier and an electrical recording apparatus called an oscillograph; these two items being outside the room, so that they can be manipulated in comfort by an operator. Within the room someone closes a book suddenly, about four feet or so from the microphone, and the acoustical wave-form is recorded by the oscillograph.

For the sake of argument suppose the wave-form is of the form depicted in Fig. 2, this being a special type of transient which starts abruptly and ends quickly. Now this is very different from the wave-forms to which we are accustomed, and as there is no repetition (as in common wave forms), the mystery seems to deepen.

But this is where the mathematician comes to the rescue. As the mathematician's tale appears rather far fetched, the reader is asked to pay particular attention, because it is a fact nevertheless. By means of the result of the analysis about to be stated, we can explain many points in connection with transients in speech and music, electrical interference in radio receivers and atmospherics.

The mathematician says that the impulse represented by Fig. 2 can be represented by an infinite number of frequencies starting at zero (this being the equivalent of a direct current) and extending to infinity (whatever that may be!). We do not merely consider a frequency of, say, 10 cycles per second and various multiples thereof, but every conceivable frequency from 0 to infinity.

"Amplitude" and "Phase"

The maximum value of an oscillation is known as the "amplitude," and the relative position of various oscillations as regards time, is known as the "phase," as shown in Fig. 3. The amplitudes and phases of the various oscillations corresponding to the form shown in Fig. 2, add up to zero before the point 0 and also after the point X.

The mathematician has a method of calculating out the amplitudes and phases. When the amplitudes are

plotted on a frequency base, the result gives what is known as the frequency spectrum. That is to say a transient can be resolved into a band of frequencies, just as so-called "white" light is resolved into all the colours of the rainbow by rain drops or in the laboratory by a glass prism. Each colour represents a certain frequency, although it is very high indeed, being much greater than that of even the ultra-short radio waves.

Frequency Spectrum

To illustrate what is meant by a frequency spectrum, we take the case of a piano note. By special apparatus it is possible to obtain results which, when plotted, give the diagram of Fig. 4. The pitch of the note is 64 cycles per second, which corresponds to two octaves below middle C. This is the fundamental frequency of the string, and it is accompanied by overtones of 2, 3, 4, etc., times 64 cycles per second., these being represented by the vertical lines. The height of each line indicates the relative strength of the particular overtone.

It will be seen that even the nineteenth harmonic of frequency ($19 \times 64 = 1,216$ cycles per second) cannot be neglected. This portion of the diagram is regarded as the "line" spectrum. The shaded parts, which are shown in Fig. 4, represent the "band" spectrum. They consist of bands of frequencies covering a wide range from zero up to about 1,600 cycles per second, beyond which the amplitudes of the components are too small to be of any account.

We see, therefore, although we might be highly sceptical of the mathematician and his frequency spectrum ranging from 0 to infinity, that this actually exists. It will be observed that the band spectrum is most powerful at low frequencies. This part of the spectrum is due to two causes (1) the stroke of the

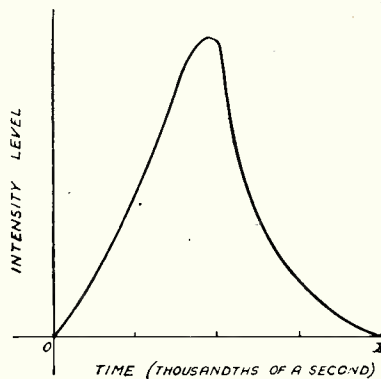

Fig. 2.—Diagram illustrating hypothetical acoustical impulse. The sound starts at 0 and terminates at X

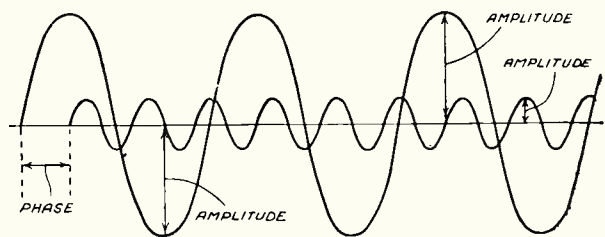

Fig. 3.—Diagram showing "phase" and "amplitude" of oscillations

hammer which impinges on the wire and then rebounds, (2) the decay of the sound as time passes.

With the foregoing information at our disposal we can now solve the riddle of the chinked marbles. When one marble falls on the other the sound output can be resolved into a frequency spectrum similar to that of Fig. 4. In this case, however, the line spectrum starts well above the audible region, so we do not hear what it contains. But the band spectrum starts at zero and extends upwards in frequency.

Since we can only hear sounds within the range 20 to 20,000 cycles per second (many of us have a much more restricted range, say, 30 to 12,000 cycles per second),

the ear picks out the various frequencies in this band due to the impact of the marbles. In like manner we can explain the noise of a book being closed quickly. The acoustical output is mainly a band spectrum, so the ear picks out the audible part of it, and we obtain the well-known aural sensation.

Necessary Frequency Range for Broadcasting

We have already stated that speech and music consist largely of transients, and that these necessitate a wide frequency range to obtain the proper aural effect. It follows, therefore, that the reproducing and transmitting apparatus used for broadcasting, should also have a wide frequency range, say up to at least 12,000 cycles per second. There is another requirement to be met, namely, that of the relative "phases" of the various frequencies which constitute the transient.

If the original acoustical wave-form in, say, a broadcasting studio is to be reproduced identically at the receiver, then not only the amplitudes of the component frequencies must be the same, but their relative positions respecting time must be unaltered. In other words, there must be absence of phase distortion. Now where continuous complex sounds are concerned, experiment shows that provided the amplitudes are correctly reproduced, the relative positions of the component frequencies as regards time, are immaterial.

This happens because the ear behaves in a certain manner, which is quite accommodating so far as sound reproduction goes. But in a transient, where the wave-form is not repeated as in Fig. 4, the question of "phase" may be of considerable importance. The reader will notice that I have said "may," not "will." At the moment there is no published record of the effect of phase alteration so far as our aural perception of transients is concerned.

There is no doubt that, in general, an alteration in the relative phases of the various frequencies constituting a transient will cause a change in the shape of the curve showing the relationship between sound pressure and time, that is a curve of the type exemplified in Fig. 4

Distortion the Ear Will Tolerate

Just as the ear tolerates a certain amount of distortion, where continuous sounds are concerned, it will doubtless be tolerant as regards the distortion of transients, so far as phase displacement is involved. Where talking pictures are in question, the eye is deceived and we imagine the motion to be continuous, whereas actually 25 different pictures are thrown on the screen every second. The illusion of continuity is preserved owing to the phenomenon known as the persistence of vision.

In like manner we can see through close set palings

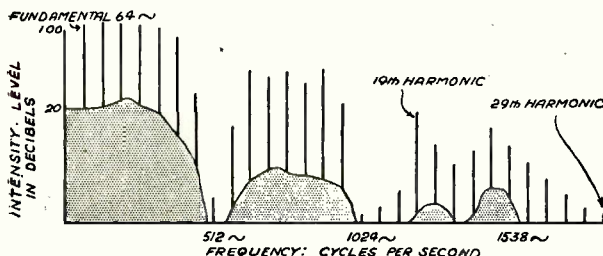

Fig. 4.—Spectrum of piano note, two octaves below middle C. The pitch of the note is 64 cycles per second and this is accompanied by overtones, represented by the vertical lines

when travelling past them at speed. In order to answer the question as to what precisely is the influence of altered phase in transients, we shall have to wait until scientific investigation of the problem has been made. Meanwhile, we can say for certain, that whatever may be the part played by phase, a wide frequency range is required if it is desired to reproduce transients with any degree of accuracy.

The majority—if not all—of transients which emanate from broadcasting studios, and outside broadcasts of various kinds, necessitate frequencies up to 12,000 cycles per second or more. *I believe that hand clapping,*



A sound rich in transients is that of the sea beating on the shore. Such sound is "manufactured" for broadcasting purposes by means of a drum containing lead shot slowly rocked in front of the microphone

paper rustling, and key jingling require a range up to 16,000. The average radio outfit cuts off about 5,000 cycles per second, so transients like paper rustling or hammering are travestied almost beyond recognition. If it were not for the pause in the announcers speech, one would hardly associate the well-known "rumble" with the act of turning over a sheet of paper! So far as extreme range is concerned, from what precedes we can say that if a system will reproduce faithfully the jingling of keys and coins, it can be regarded as pretty satisfactory from the viewpoint of high-frequency response.

Natural Frequencies of Coins

This will be understood more readily when it is realised that the natural frequency of a halfpenny (1 in. diameter : this being useful when a rule is not handy!) is in the neighbourhood of 12,000 cycles per second. The frequency of a shilling is higher, and that of a threepenny bit higher still, whilst its note is very shrill if at all recognisable as a musical sound.

However, when television comes *we shall have—*or ought to have—*receivers which respond from 20 cycles per second to 500,000 cycles per second, so it appears that only the loudspeaker remains to be tackled then.* There is a snag, however, since the ordinary radio transmitters at the broadcasting stations do not transmit anything much above 9,000 cycles per second or thereabouts.

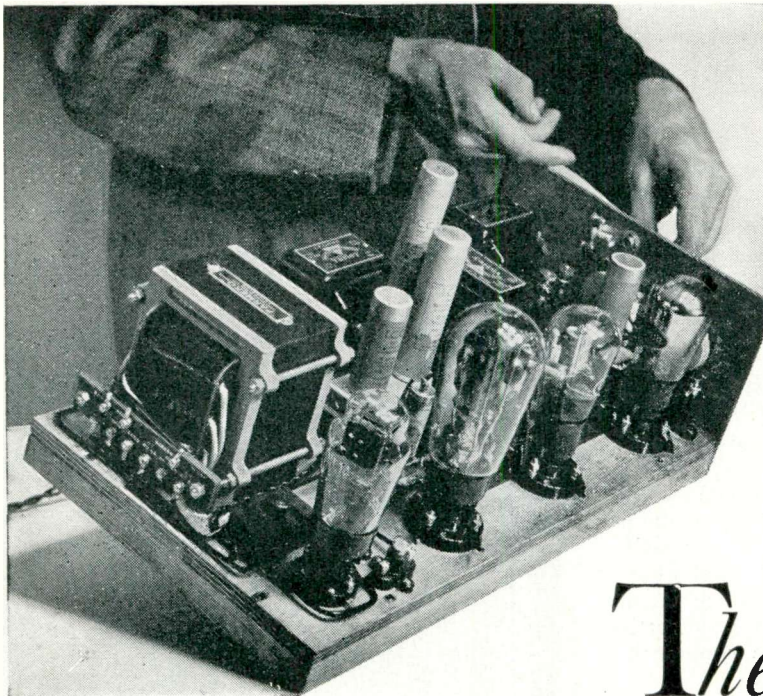

Designed by
L. O. SPARKS
and
T. F. HENN

The Listener's 5-watt A.C. Amplifier

Here we present details that will enable you to build with a moderate outlay an A.C. amplifier capable of giving exceedingly satisfactory results. The undistorted output of just over 5 watts will be found ideal for home use, and sufficient for small public-address work. A radio unit for use with the Listener's Amplifier will be described in an early issue

THIS 5-watt A.C. mains-operated amplifier has been designed with one simple and sincere object: to give good quality of reproduction fully capable of satisfying that so-called musical ear and using the simplest possible form of construction. In other words—a high-class amplifier that *anyone* can build and can be assured of obtaining results similar to those of the original model, which, by the way, is on show at Olympia until August 24.

Reliable Parts

You can see from the list of components that we have used some of the best examples available to the home constructor; reliability had to be a strong feature of the design. And again, we have used these components on a wooden base-board assembly—actually a shallow chassis—all mounted on the upper side and just the heater wires and a few odd wires on the underside.

Our layout has been carefully arranged because we hope, in the

course of the next month or two, to describe a suitable radio unit for use in conjunction with the amplifier.

Although we have used the best of modern components we have not forgotten the question of cost. We

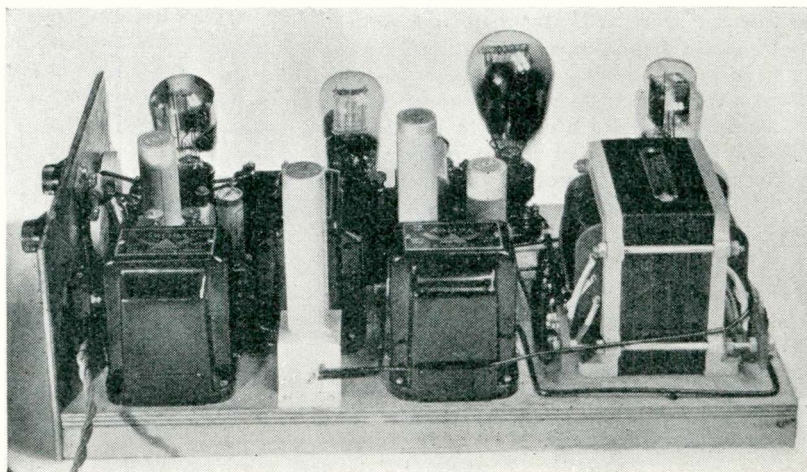

A side view of the Listener's Amplifier which gives a clear conception of the simplicity of the layout. Note the mounting of the electrolytic condenser in the foreground; half a double bracket is used

set a standard of quality and reliability, and this we have accomplished with a minimum cost.

The design is without any frills ; the circuit is as simple as it can be, consistent with the results we set out to achieve. We have used two preliminary stages of straightforward resistance-capacity coupling the amplification of which is more than sufficient to load the output valve when used in conjunction with any average pick-up.

The first valve is an Osram MHL4 and this is coupled to the next valve, an Osram ML4, by means of an anode resistance and a .05-microfarad fixed condenser which, by the way, must be of the mica type having a high insulation value. It will be seen from the circuit diagram that a simple and very effective form of tone control is incorporated in the anode circuit of the first valve.

This tone control system makes use of a 15,000-ohm potentiometer, which actually forms part of the anode-resistance load, and a .01-microfarad fixed condenser. All this tone control does in practice is to attenuate the higher frequencies and so by using a smaller condenser one gets less high-note cut-off. It will be appreciated that the value of this condenser can be varied to suit individual requirements ; the value of condenser we have used will be found adequate for all normal purposes.

All About the Circuit

The first valve is adequately de-coupled by means of a 4-microfarad fixed condenser and a 10,000-ohm resistance. The capacity of the coupling condenser between the second valve and the output valve, .1 microfarad, is such that adequate amplification of the lower register is obtained in conjunction with the grid return resistance of .25 megohm, with little fear of the trouble known as " blocking."

In the grid circuit of the output valve we have inserted a resistance of 5,000 ohms acting as an H.F. stopper to prevent any stray high-frequency currents

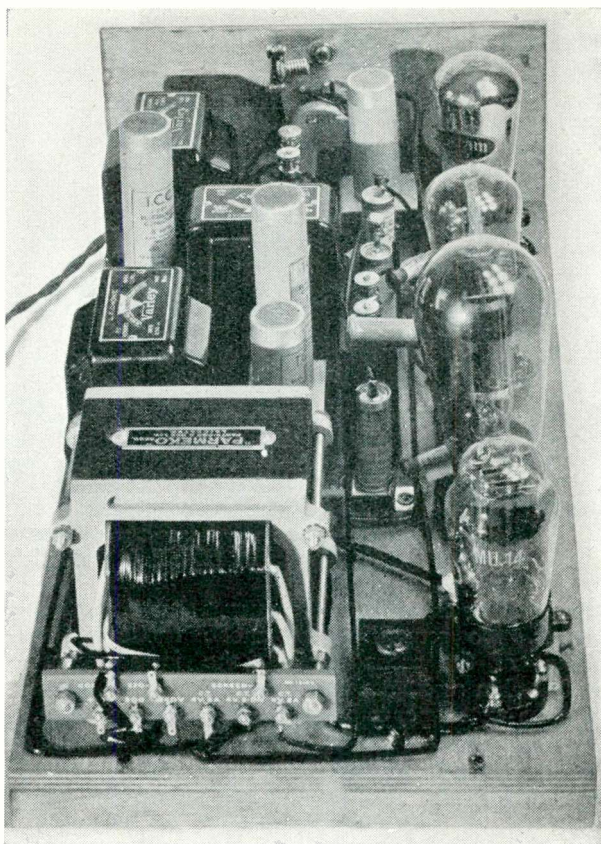

How all the parts are arranged on the wooden chassis can be easily followed from this illustration. The valves are in line on one side, the mains section at the front on the left and the bias arrangement in line down the centre

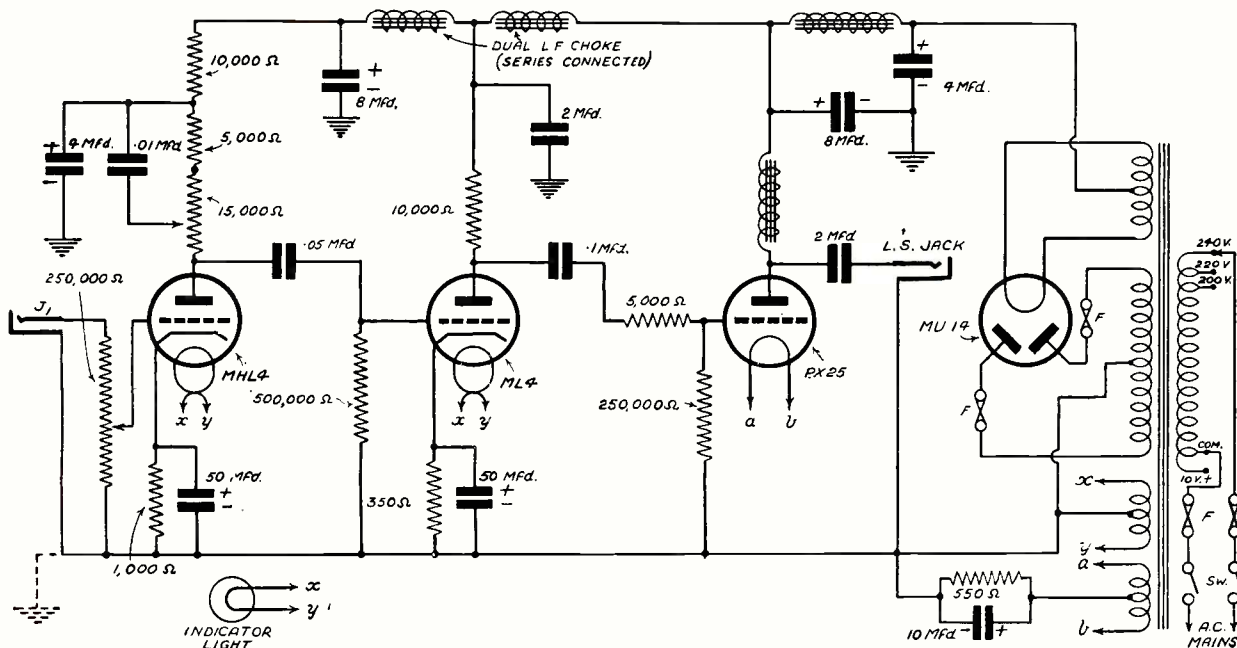

The circuit diagram of the Listeners' Amplifier. It is very simple with two resistance-capacity stages feeding a large triode output valve. A full-wave rectifier is used in the mains portion

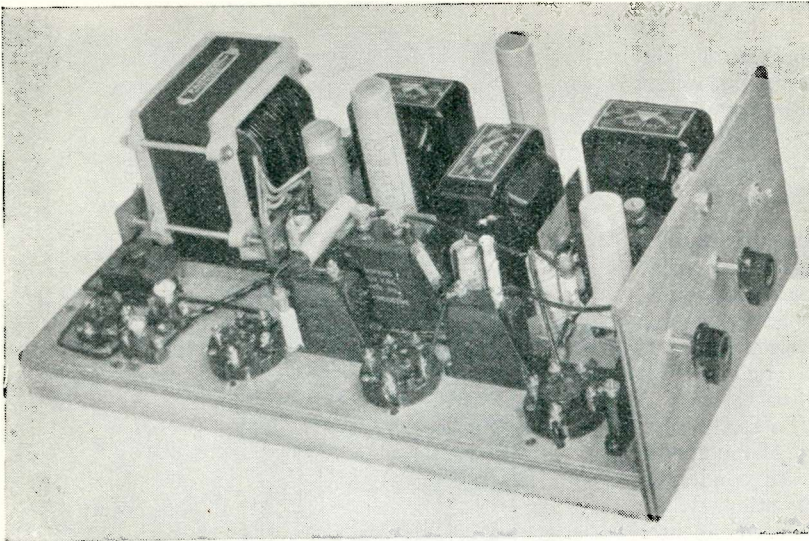

Showing the amplifier with the valves out of their sockets. Note the fuses on the left-hand side. The outfit is built on a shallow wooden chassis under which are the heater and two or three other wires

from getting through to the output circuit. To return to the anode circuit of the second valve; the 10,000-ohm resistance here must be of the 5-watt type, to be on the safe side, for it has to carry about 25 milliamperes at the maximum voltage rating of the valve which is 200.

It will be seen from the circuit that the high-tension feed to this valve is obtained from the centre

tapping of the dual low-frequency choke and no further de-coupling is necessary.

The output valve chosen is the Osram PX25, a triode, which has an actual anode dissipation of 25 watts and is capable of giving a hearty 5-watt undistorted output.

Choke-filter coupling is embodied in the anode circuit of the output valve, the choke having an inductance

of 20 henries when passing a current of 100 milliamperes. As the output valve used only passes a current of a little over 60 milliamperes you can see that "safety first" is our motto.

Smoothing Circuit

We will say very little about the mains portion of the amplifier. There is, however, one interesting feature in the smoothing circuit. If you trace, by means of the circuit diagram, the wire from the centre tap of the heater circuit of the Osram MU14 rectifying valve you will notice that the main smoothing circuit consists of a 20-henry choke, 140-milliamperes rating, and one 4- and one 8-microfarad electrolytic condenser.

The supply to the output valve is taken from the "smoothed" side of this circuit which is also taken to one side of the dual low-frequency choke, the windings of which are connected in series. As we mentioned before, the feed to the anode of the second valve is taken to the centre-tap of this choke, which is also anchored to earth by a 2-microfarad condenser.

The remaining section of the choke is used to provide additional smoothing in conjunction with an

Scale Layout and Wiring

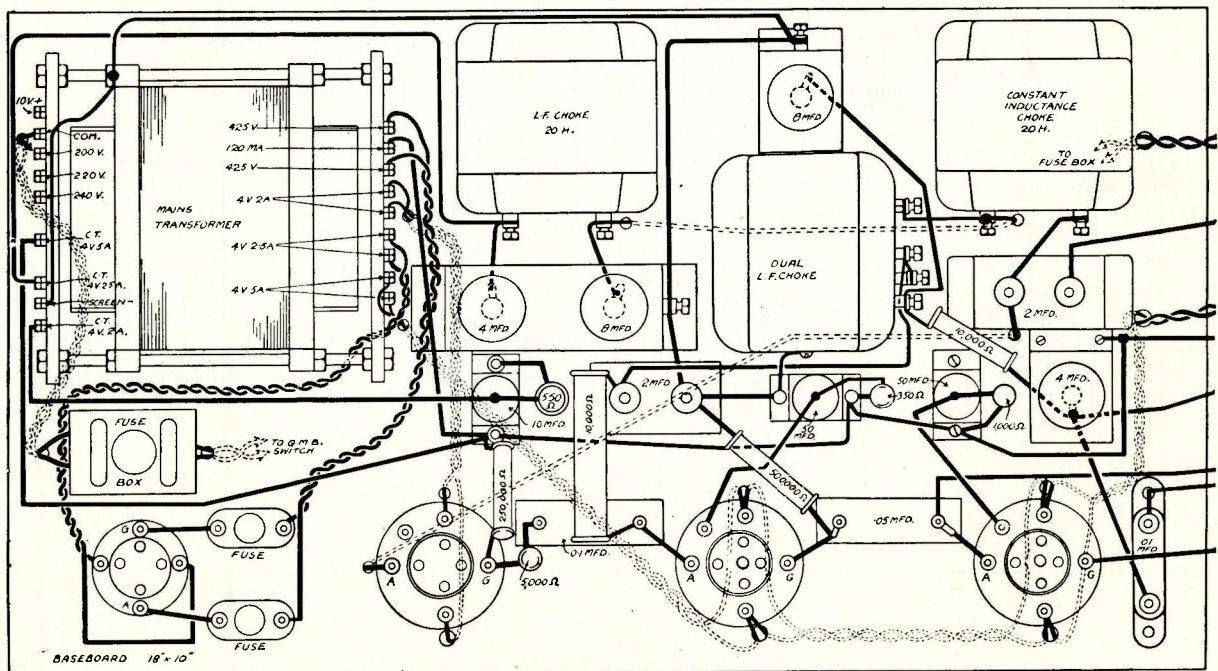

A scale layout of the wiring diagram. A full-size blueprint can be obtained for half price, that is, 9d., post paid, if the coupon on the last page is used before September 30. Full particulars will be found on page 160

8-microfarad electrolytic condenser for the first valve and any valves which may precede this unit—you will remember that we have mentioned that a radio unit for use with the amplifier is to be described later.

The heater winding on the mains transformer feeding the first two valves is capable of supplying an additional 3 amperes.

Remembering our "safety-first" motto we have taken the precaution of fitting ample protection in the way of fuses.

All grid bias is provided automatically by conventional means and needs no explanation.

Full-size Blueprint

The numerous large photographs show better than we can explain how simple the job of building really is. However let us remind you that a full-size blueprint showing the position of every wire can be obtained for half price, that is 9d., post paid, if the coupon, which you will find on the last page, is sent with the remittance to the "Wireless Magazine" Blueprint Department, George Newnes, Ltd., 8-11 Southampton Street, Strand, London, W.C.2. before September 30 next.

Diagram

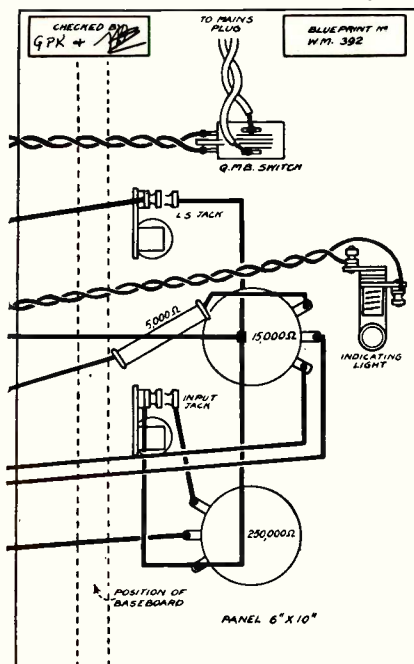

Please mention No. W.M. 392 in your blueprint application

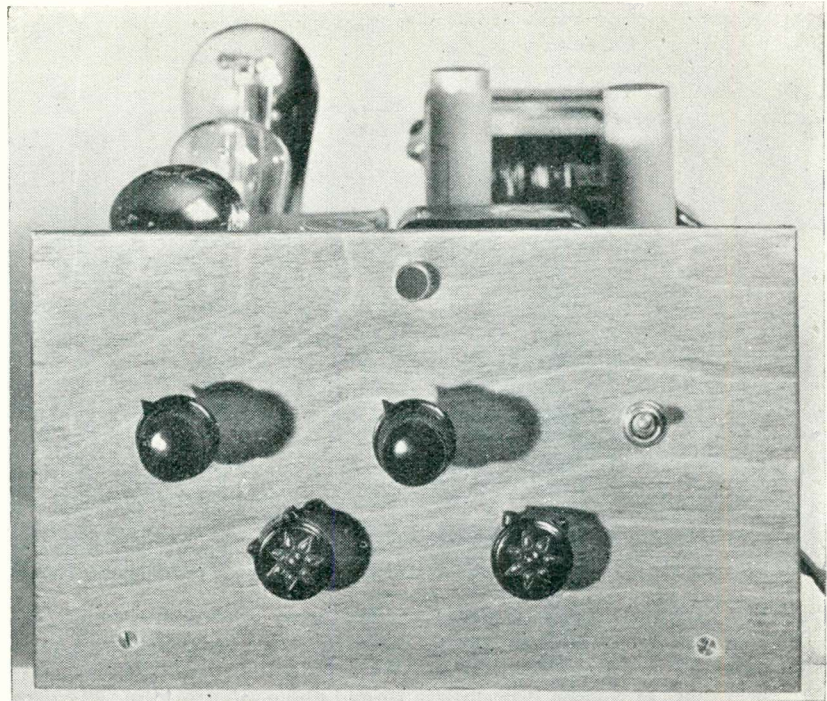

All the controls are arranged on a simple wooden panel at one end of the chassis. Along the top are volume control, tone control and on-off switch, while below are the two jacks, for the pick-up input and the loudspeaker

Here is a tip that applies to every form of home construction no matter what set you are building or what components are being used. When all the components are relieved of their tissue paper, get a screwdriver and a pair of pliers and tighten the shank of every terminal. This is old advice, but very essential.

A few words about the layout. We have not attempted to skimp space; there is plenty of room on the baseboard for everything without overcrowding. For neatness, accessibility and ease of wiring the valves are arranged in line on one side providing a straight-through path for the heater wires, which are put on one side and not directly underneath the valve holders. This reduces to a minimum the possibility of hum through radiation from these wires.

Another old piece of advice: twist these heater wires tightly together. The small panel at one end carries the plugs and jacks for the pick-up and the loudspeaker, the tone-control and volume control potentiometers and the on-off switch together with a small signal lamp as a reminder not to leave the amplifier switched on after use.

This lamp has been incorporated because there is almost no hum; and you know how forgetful some people are! The main volume control takes the form of a 250,000-ohm

potentiometer directly across the input.

We have tried the amplifier with two or three different types of pick-ups of varying sensitivity and in every case the .25-megohm potentiometer provided ample control; in fact it was never necessary to turn the control more than three parts of the way round.

Choosing a loudspeaker to use

COMPONENTS— OUR POLICY

COMPONENTS used in receiver designs published in "Wireless Magazine" are chosen for their suitability, efficiency and reliability. Their selection must not be taken to indicate any more than this, nor that other good-quality components are not equally suitable, save in a few cases clearly indicated where there are no suitable alternatives.

In a large number of cases there exist numerous good alternatives, as a study of the advertisement pages of this journal will show

with this outfit is not difficult. We do suggest that you obtain a loudspeaker that will do justice to the large output. The model suggested in the list of parts is ideal.

For safety's sake and for the

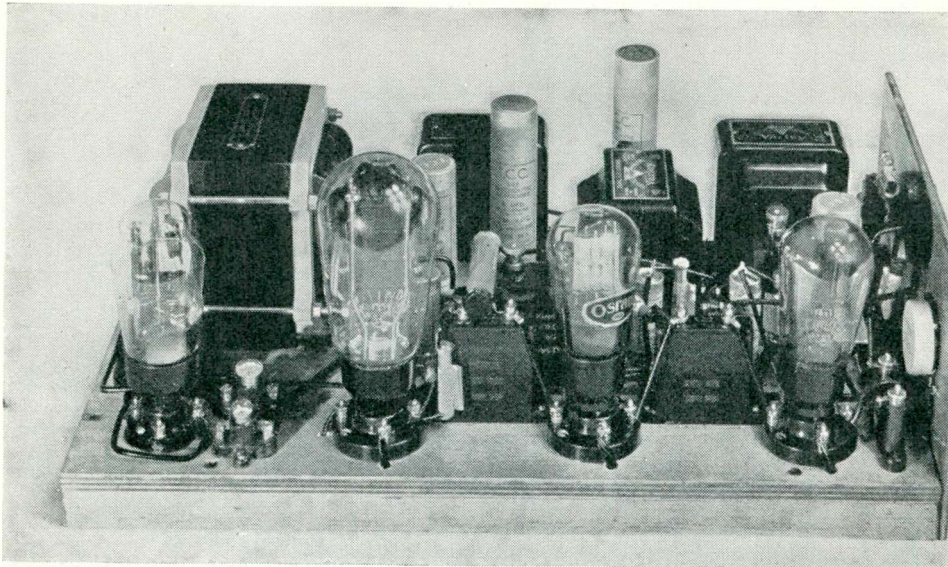

The finished amplifier is really a fine looking outfit, and we can assure you that you will be as equally proud of the results as we are of its appearance. The valves from the left are: the full-wave rectifier, the PX25 output triode, the second low-frequency amplifier and the first L.F. valve. We present this design with absolute confidence

welfare of the valves always switch off before making any adjustments or alterations in the amplifier. It is advisable not to fondle the main transformer when the set is switched on because one can get quite a nasty jolt from 400 volts! And similarly the fixed condensers have a nasty habit of storing quite considerable charges, and here again it is wise to steer clear of possible shocks.

Suitable Cover

Although we have not shown a cover for the amplifier some form of light wooden box providing ample ventilation for the valves, for quite a fair amount of heat is produced, is strongly advised.

The old problem of soldering versus screw terminals is bound to crop up. We can only leave you to decide, but we strongly advise soldering wherever possible.

We have spared no trouble to make this amplifier deliver the goods! We don't profess a straight line curve from Land's End to John O'Groats, but we do claim that the quality is tip-top and that the outfit is reliable. Providing you keep to the list of parts specified you should come up against no trouble whatsoever.

Suitable alternative components can be substituted, but please be certain that in the case of condensers, for instance, they are of the correct working voltage.

Two further points come to our minds: it is wise to make certain that the 5-watt resistance used in the coupling between the second and third valves should be mounted so that it stands well clear of the grid terminal of the coupling condenser.

If any difficulty is experienced in obtaining the brackets for mounting the small electrolytic condensers

there is no cause for alarm: they can be made at home without any trouble providing some fairly substantial aluminium sheet is used.

Radio Unit

By the time you have got the amplifier working we shall be ready to publish constructional details of the radio unit. For the guidance of those readers who are thinking of the £ s. d. question, the amplifier without the loudspeaker but including valves, costs about £13 or £14. The radio unit will cost about another five, and so for about £20 you will have a really first class outfit.

Like Rome, this amplifier was not built in a day. It has been on test for some many days before we were finally satisfied that we could give it our O.K. We do hope that you will get the fine results that we know this job will give!

LIST OF COMPONENTS NEEDED FOR THE LISTENER'S 5-WATT A.C. AMPLIFIER

CHOKES, LOW FREQUENCY		£ s. d.	LOUDSPEAKER		£ s. d.	SWITCH		£ s. d.
1—Varley type DP11...	...	15 0	1—Epoch A.C. energised moving-coil	...	2 6	1—Bulgin double-pole on-off toggle	...	2 0
1—Varley standard, type DP10	...	15 0	loudspeaker, type 667	...		switch, type S104	...	
1—Varley constant-inductance, type DP12	...	17 6	MAINS TRANSFORMER			SUNDRIES		
CONDENSERS, FIXED			1—Parmeko with the following	specification:—			2—Bulgin single-circuit jacks, type J3	2 6
1—T.C.C. .01-microfarad, type 34	...	3 0	425-0-425 volts, 150 milliamperes	4-volts, 2-amperes, 4-volts,			2—Bulgin jack plugs, type P16	3 0
1—T.C.C. .05-microfarad, type 25A	...	5 6	2.5-amperes, 4-volts, 5 amperes,	standard A.C. inputs			1—Bulgin signal indicator, type D34	1 3
1—T.C.C. .1-microfarad, type 25A	...	8 0	...	£3 5 0			Connecting Wire, 20 gauge	
2—T.C.C. 2-microfarad, type 80	...	8 0	RESISTANCES, FIXED			Insulated sleeving		
2—T.C.C. 4-microfarad, type 502	...	8 0	1—Erie .25-megohm, 1-watt type	...	1 0	Wood for chassis as per specification		
2—T.C.C. 8-microfarad, type 502	...	10 0	1—Erie .5-megohm, 1-watt type	...	1 0	on blueprint		
1—T.C.C. 10-microfarad, type 50C	...	2 6	1—Erie 350-ohm, 1-watt type	...	2 0	Brackets for mounting condensers		
2—T.C.C. 50-microfarad, type 12C	...	5 0	1—Erie 550-ohm, 2-watt type	...	1 0	(home-made or Peto Scott) one double		
FUSES			1—Erie 1,000-ohm, 1-watt type	...	2 0	and one double cut in half.		
1—Bulgin double fuse holder and	...	2 6	2—Erie 5,000-ohm, 1-watt type	...	1 0	VALVE HOLDERS		
fuses, type F19	...		1—Erie 10,000-ohm, 1-watt type	...	3 0	2—W.B. five-pin baseboard mount-		
2—Bulgin single fuse holders and	...		1—Erie 10,000-ohm, 5-watt type	...	3 6	ing	...	1 4
fuse bulbs, type 5, bulbs to be	...		RESISTANCES, VARIABLE			2—W.B. four-pin baseboard mount-	...	1 0
Bulgin type C	...	2 0	1—Erie .25-megohm potentiometer,	...	3 6	ing	...	
			without switch	...		VALVES		
			1—Erie 15,000-ohm potentiometer,	...	3 6	1—Osram MHL4	...	13 6
			without switch	...		1—Osram ML4	...	14 0
						1—Osram PX25	...	£1 5 0
						1—Osram MU14 rectifier	...	1 0 0

Automatic Grid Bias Without Dropping H.T. Volts

A change of valve type or alteration in a circuit sometimes makes it necessary to provide an increased amount of grid bias and if there is no reserve of high-tension voltage it becomes a matter of some difficulty by the usual automatic methods. The scheme described in this article by CHARLES LAWLER, A.M.I.R.E., enables quite high bias voltages to be obtained without sacrifice of anode potential

AN excellent scheme for providing grid bias for large amplifiers (or, indeed, small ones) has recently been developed by W. B. Savage, of amplifier fame. The system consists of a small half-wave rectifying valve of suitable voltage rating connected via a centre-tapped heater winding or a potentiometer across its low-tension supply to a tapping in one leg of the high-tension winding.

The position for this tapping point should be chosen so that an A.C. voltage in excess of that required for normal bias is delivered to the rectifier. This is in order to provide adjustment on either side of the optimum position. Fig. 1 shows the general idea adapted for 200 volts maximum bias.

Voltage Control

The output from the anode of the rectifier is then fed through a 1,000-ohm voltage limiting resistance to a reservoir condenser, a convenient capacity for which is 2 microfarad.

A 10,000-ohm resistance and a further 2-microfarad condenser provide the necessary smoothing, and a 40,000-ohm potentiometer is shunted across the output for the purpose of providing voltage adjustment.

The bias is, of course, taken from the moving arm of the potentiometer, and it is a good plan to provide a stop in order that the voltage shall not be taken below a predetermined level.

Various modifications of the scheme will be apparent. Should, for instance, the high-tension transformer not

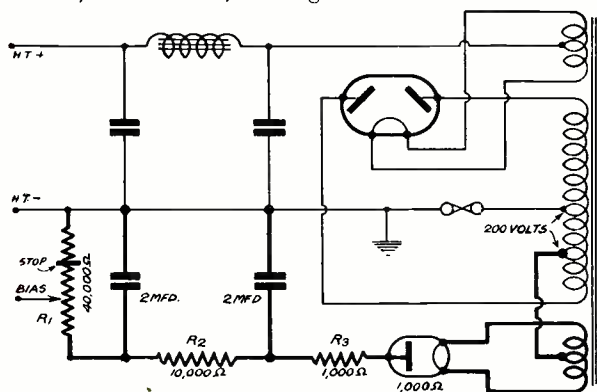

Fig. 1.—This method can be used when there is a spare tap available on the high-tension winding of the power transformer. Extra wiring is shown in heavy lines

have a spare heater winding, a metal rectifier may be employed as outlined in Fig. 2.

If it is not convenient to pick up a tapping from the high tension, a potentiometer, either fixed or variable, can be connected across the winding with a semi-variable potentiometer to provide the output load. Fig. 3 gives a clear idea of the *modus operandi*.

When the potentiometer is used in this position, great care must be taken to provide satisfactory insulation and to ensure that the hand does not come into

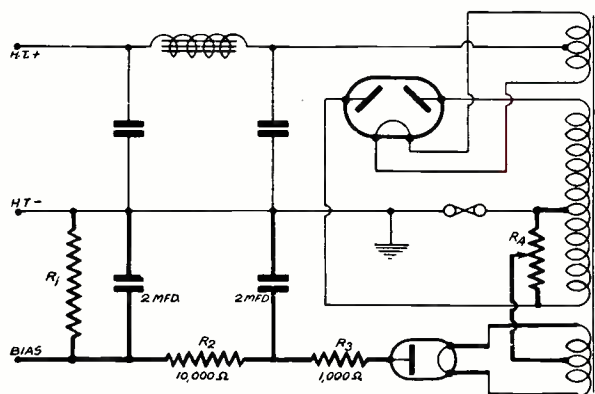

Fig. 2.—When no extra tap is available on the transformer a potentiometer R4 can be used, and will serve in addition as the bias adjustment

contact with metal parts such as the pointer, one-hole fixing boss, etc. In fact, it is best, if possible, to choose a type in which the moving finger is insulated from the spindle.

Suitable Potentiometer Values

In all cases the value of the voltage adjusting potentiometer should be chosen to suit the voltage across which it is required to operate. Since it is required to pass only a few milliamperes the value can be relatively high.

Suppose, for instance, that each leg of the high-tension winding gives 250 volts and that we can afford to draw from it an extra 5 milliamperes, the value of the potentiometer will be arrived at by dividing 250 by 5 and multiplying by 1,000 (50,000 ohms.)

In cases where several different values of bias are required for a number of stages, a semi-variable
Continued at foot of next page

Compiled by JAY COOTE

"W.M." Short-wave Identification Panels

Metres: **RADIO COLONIAL (FYA)** **Kilocycles:**
 19.68 **11,885**
 25.24 (Paris-Pontoise, France) **11,720**
 25.60 **Power: 12kw.** **15,243**

Geographical Position: 02° 06' 41" E.; 49° 03' 41" N.
Distance from London: Approximately 210 miles.
Standard Time: G.M.T. (France adopts British Summer Time.)
Language Used: French.
Announcer: Man.
Call: "Allo! Ici Paris Station d'Etat Radio Colonial."
Interval Signal: Three tones ("F" in morse).
Times of Transmission (B.S.T.):
 Daily: 12.00-16.00 (19.68 metres).
 17.00-23.00 (25.24 metres).
 00.00-03.00 and 04.00-06.00 (25.6 metres).
 English news bulletins are broadcast on the respective wavelengths at B.S.T. 13.30 and 01.00.
 Closes down with the French National Anthem: *La Marseillaise*.

Metres: **BOSTON (W1XAL)** **Kilocycles:**
 25.45 **11,790**
Power: 5 kw. (Mass., U.S.A.)

Geographical Position: 71° 05' 50" W.; 42° 20' 40" N.
Distance from London: Approximately 3,270 miles.
Standard Time: E.D.S.T. (B.S.T. less 5 hours).
Announcer: Man.
Call: "These are the Edison Electric stations W1XAL and WEE1, Boston, operating on 11,790 and 590 kilocycles."
Times of Transmission (B.S.T.): Daily: 22.00-00.30.
 Mostly relays WEE1, Boston (Mass.), of the N.B.C. Red Network (508.2 metres, 590 kilocycles).
 If relays are carried out from other N.B.C. stations the original call and the three-note N.B.C. interval signal will be heard.

Metres: **NAIROBI (VQ7LO)** **Kilocycles:**
 49.02 **6,125**
Power: **0.5 kw.** (Kenya Colony)

Geographical Position: 36° 48' 00" E.; 01° 16' 00" S.
Distance from London: Approximately 4,230 miles.
Standard Time: B.S.T. plus 1 hour 30 minutes.
Announcers: Man and woman.
Call: "This is VQ7LO, the Nairobi station of the East African Broadcasting Company, calling."
Times of Transmission (B.S.T.):
 17.00-20.00 (Sunday).
 11.45-12.15 (Monday-Friday).
 17.30-20.30 (Monday-Friday).
 14.30-05.30 (Tuesday and Thursday).
 17.30-21.30 (Saturday only).
 Frequently relays Daventry Empire programmes and Big Ben chimes. Closes down with good-night greetings and *God Save the King*.

Metres: **CALGARY (VE9CA)** **Kilocycles:**
 49.75 **6,030**
Power: **10 kw.** (Alberta, Canada)

Geographical Position: 114° 30' W.; 51° 15' N.
Distance from London: Approximately 4,370 miles.
Standard Time: M.S.T. (B.S.T. less 8 hours).
Language Used: English only.
Announcer: Man.
Call: "Your station is CFCN, Calgary the Voice of the Prairie in the Province of Alberta."
Times of Transmission (B.S.T.):
 15.00-08.00 (Thursday and Friday).
 15.00-08.00 (Thursday and Friday).
 18.00-06.00 (Sunday and Monday).
 Occasionally on other days from 15.00-06.00.

AUTOMATIC GRID BIAS WITHOUT DROPPING H.T. VOLTS—Continued from page 105

resistance, preferably of the type in which bare spiralled resistance wire is wound on a porcelain or similar type of former, may be employed. Additional clips can be provided at suitable tapping points.

De-coupling must, of course, be provided in such cases, and a convenient way of arranging it is to insert resistances of .25 to .5 megohms in series with each bias lead. The output end of each resistance is then

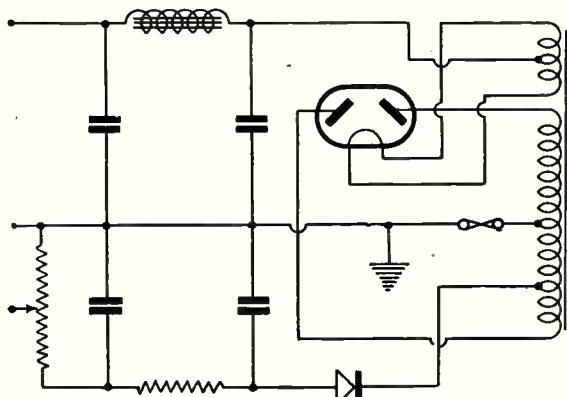

Fig. 3.—The scheme can be applied with the aid of a suitable metal rectifier if desired

earthed via a condenser of from 2 to 50 microfarads, according to usual practice.

The advantages of this method of obtaining grid bias are two-fold. For instance, a welcome economy of volts will be effected in cases where it is necessary to "hook up" a temporary amplifier or power pack and the only available transformer gives sufficient voltage for the high tension with nothing left for bias.

Its greatest importance, however, lies in the fact that a perfectly stable biasing system is obtained.

It is well known that a valve does not draw current from its grid negative supply, the limiting factor in the case of batteries being their normal shelf life, which varies according to humidity, temperature, etc.

Great Degree of Constancy

Thus the load on the grid-bias supply is nil in the case of batteries, and is limited in the case of this stabilised-bias system to the load imposed by the voltage dividing resistance, which remains constant. This means that under all normal conditions of operation the bias voltage will remain at a predetermined value and will be entirely unaffected by fluctuation in high-tension voltage, thus effecting a greater degree of stabilisation than has hitherto been possible.

What You
Should
Know About
Short-wave
Design—
No. 10

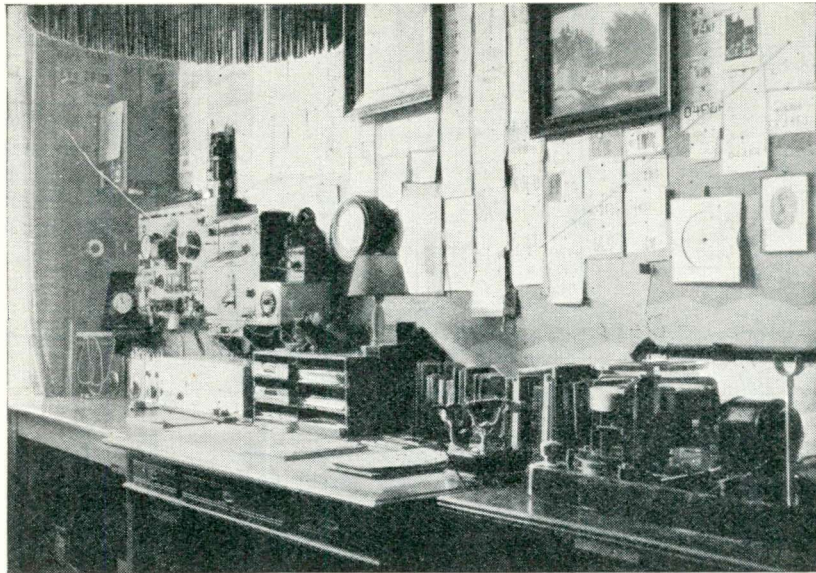

The D.A.S.D., the central organization of German short-wave amateurs, has now obtained official recognition for its members and reliable applicants receive transmitting licences. The number issued up to the present is 320 and it is expected that this figure will shortly be increased to 700. Our illustration shows a typical German short-wave amateur's den

Unusual Short-wave Circuits for You to Try!

By G. HOWARD BARRY

SEVERAL years ago, when short waves were a novelty and "QST," published in America, was the only periodical that ever mentioned them at all, one well-known experimenter gave the world a piece of sound advice. It was put in this way: "All circuits (if they work) are good; but the best one is the one that you like best!"

In other words, it is impossible to say that such-and-such a detector circuit is better than any others; every individual amateur has his own particular preference and, by working consistently on one particular circuit he develops it into something that will suit him better than the others.

We seem to be falling into a rut nowadays, partly because of the activity of the component manu-

facturers, who give us neat little four-pin coils with a grid winding and a reaction coil, and we just insert them into a straightforward reaction circuit and think no more about it.

Readers who are at all experimentally-minded may derive much experience and interest from trying out other arrangements; it will probably so happen that many of them will strike a circuit that happens to take their fancy and, therefore, give very good results.

Fig. 1 shows the circuit that we all use nowadays and a quick glance at it will show that the coils may really be regarded as one continuous coil, split to allow the insertion of the reaction condenser. Only the grid portion is tuned; thus we may have two variable condensers, each with one side at earth potential.

Turn the two coils into one, with a tapping, and tune the whole coil (Fig. 2) and you have the standard Hartley oscillator circuit. Reaction must now be controlled from the

"live" end of the coil, and high tension applied to the anode in series with a choke.

This arrangement has nothing to recommend it as a detector circuit because both condensers are live on both sides; it is, however, a very free oscillator and is extensively used in ultra-short-wave receivers in which it is sometimes difficult to make the circuit oscillate strongly.

Hartley and Colpitts

Fig. 3 shows, in skeleton form, two well-known oscillator circuits, the Hartley and the Colpitts, and the advantages of the latter over the former will be seen at once, for we now have two condensers, each with one side at earth potential. From this can be evolved a useful detector circuit, which when redrawn appears as Fig. 4.

So many varieties of these two fundamental circuits have appeared from time to time that it is often difficult to decide in which class a

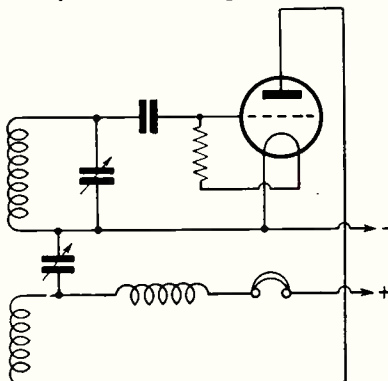

Fig. 1.—The short-wave detector circuit that most of us use to-day

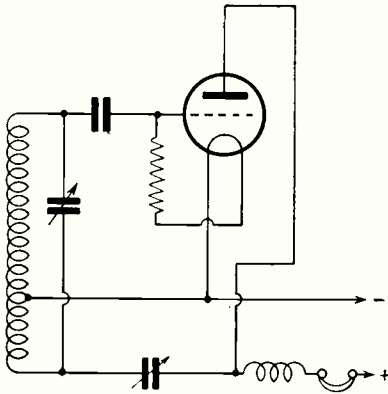

Fig. 2.—Only a little different from Fig. 1. This is the conventional Hartley oscillator circuit

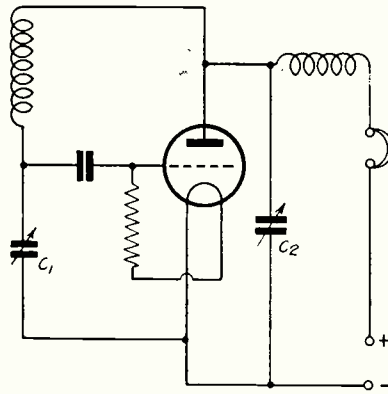

Fig. 4.—A variety of the Colpitts circuit, which suffers from the disadvantage of "chasing"

given arrangement falls. Fig. 4, however, although it may not look like it at first glance, is definitely of the Colpitts' breed, and yet another development of it leads us to the Hofmann circuit, which is extensively used for 5-metre receivers.

The Fig. 4 circuit, as it stands, has one serious disadvantage. The condenser C_2 , between filament and anode, is used for reaction control, but it will obviously have a fairly important effect upon the tuning of the circuit.

Difficult for Beginners

For this reason the arrangement suffers from the phenomenon that I call "chasing." If a signal is tuned in with the receiver in an oscillating state, a final adjustment of the reaction control will necessitate a further touch on the tuning dial, and this, in turn, will mean yet another setting of the reaction!

In practice, of course, an experienced operator will perform these movements smoothly and instinctively, but the novice is apt to find himself in severe difficulties with it.

Fig. 5 shows the Hofmann, or "Balanced Colpitts" circuit, in which the coil has been split at the centre. The condensers marked C_1 and C_2 are really the two halves of a split-stator or series-gap condenser, and reaction is now controlled by a variable resistance in series with the high-tension lead—a perfectly sound method.

The huge advantage of this circuit (common to all Colpitts' arrangements) is that the two halves of the tuning condenser are directly across the grid-filament and anode-filament capacities of the valve. The latter being quite small in comparison with the minimum setting of the average condenser, this arrangement can be

made to work on extremely short wavelengths without going to the trouble of de-basing the valve or taking other extreme measures.

Furthermore, the balance of the circuit is so complete that no chokes are necessary, and chokes, however good they are, may always be regarded with a certain amount of suspicion.

This circuit was extensively used for transmission some years ago, but it seems, recently, to have taken on quite a new lease of life for reception purposes. One sees a bewildering variety of 5-metre receivers described nowadays, but they all appear to use this circuit, the only features of difference being those of layout.

I hope readers will not try out these arrangements with any idea that one of them will suddenly spring to life and give extraordinary results. There will probably be little to choose, either in selectivity or sensitivity, between any of them. The difference lies in that subtle quality which we can only call "handleability"; one, for instance, may turn out to be entirely free from the hand-capacity troubles that have been present in others, or one may give a smoother reaction

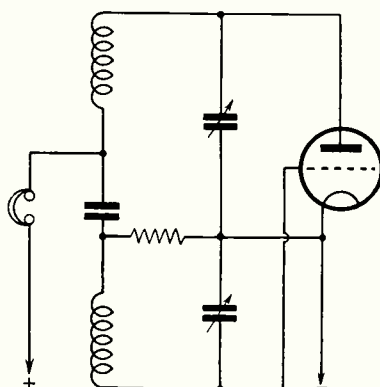
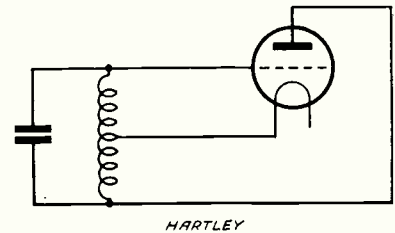

Fig. 5.—The Hofmann or "Balanced Colpitts" circuit

control than you have been accustomed to.

So far these remarks have been more or less confined to detector circuits.

With the advance in the popularity of the superheterodyne for short-wave reception has arisen the demand for really efficient oscillator circuits. While the foregoing notes may all be



HARTLEY

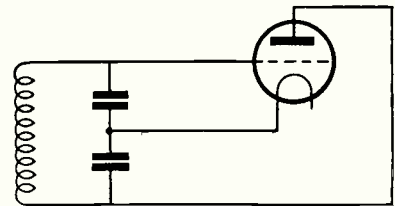

COLPITTS

Fig. 3.—Showing in skeleton form two well-known oscillator circuits, the Hartley and the Colpitts

taken to apply equally to detectors or oscillators, the following circuits will be dealt with from the point of view of the oscillator only.

No longer need we worry about reaction control. Our chief requirement is a circuit that will oscillate steadily and will remain extremely stable in frequency. The more sharply our superhet is intended to tune, the more essential will the use of a stable oscillator circuit become.

One has heard a lot about electronic coupling lately, chiefly in connection with hexodes and heptodes. The ordinary electron-coupled oscillator,

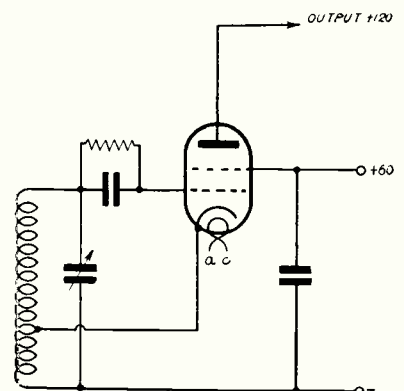

Fig. 6.—Circuit of an ordinary electron-coupled oscillator using an indirectly heated screened-grid valve

however, seems to have been somewhat neglected.

Fig. 6 shows such a circuit, as applied to an ordinary screened-grid valve. The screen, cathode and grid form the three elements of an ordinary Hartley circuit, but the output is taken from the anode. Thus the coupling between the oscillator and the output circuit is purely electronic,

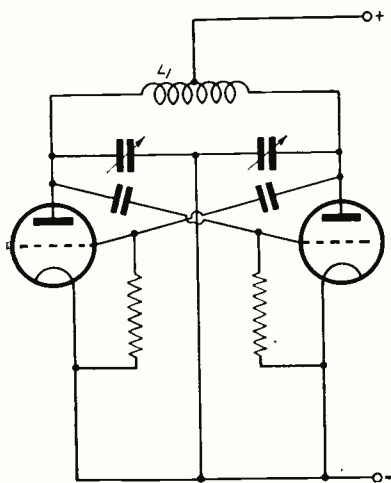

Fig. 7.—A push-pull Colpitts arrangement which will oscillate freely at any frequency from a few cycles to 60 or 100 megacycles

if the screen is kept at earth potential (referring, of course, to high frequency only).

To fulfil this condition of keeping the screen at zero H.F. potential, we must have the cathode, which would normally be in that state, "up in the air"—hence the use of an indirectly-heated valve. An ordinary battery-heated valve would need filament chokes, which make the circuit rather troublesome.

Extremely Stable

The Fig. 6 circuit, with the screen running at about half the voltage applied to the anode, is one of the most stable oscillator circuits yet devised; its stability, in fact, is such that many amateur transmitters are using electron-coupled oscillators instead of quartz crystals, and it is almost impossible to tell one method from the other "on the air."

Practically all the commercially-built Single-signal superhets use electron-coupled oscillators, both at signal-frequency and at the intermediate-frequency, for producing a beat for C.W. reception. Most other oscillators are useless in such receivers on account of their relatively poor stability.

For purely experimental purposes there is much to be said in favour of push-pull oscillator circuits, which are usually more stable than single-ended equivalents on account of the symmetrical distribution of stray capacities. Furthermore, since the valves in a push-pull arrangement may be regarded as working *in series*, it follows that the inter-electrode capacities, which are generally lumped across the tuning inductances or condensers, are also in series with each other and are therefore halved.

Readers may easily evolve their own push-pull versions of practically all the foregoing circuits, but I am showing one (Fig. 7) on account of its extreme simplicity and efficiency. It is really a push-pull Colpitts arrangement, and it will oscillate at practically any frequency from a few cycles to 60 or 100 megacycles!

The one solitary inductance L_1 , which is centre-tapped, may be practically anything from a pair of headphones to a piece of wire a few inches long, and even then the arrangement will still oscillate! Furthermore, it appears to be just as suitable and efficient for generating very low-frequency oscillations as for ultra-short-wave work.

The value of the two fixed grid condensers will, of course, be flexible, but something of the order of .0001-microfarad is suitable for any kind of short-wave work. The circuit may be used as a push-pull detector

if the aerial is coupled to L_1 by means of a second coil.

The use of a split-stator condenser is necessary, but this gives us that desirable ease of tuning which results from a spindle at earth potential. Readers who like making one valve do the work of two will not think much of this arrangement, in which, seemingly, two do the work of one!

Get Experimentally-minded

It is, however, well worth playing with and I am all in favour of encouraging readers to become experimentally-minded. It seems to me that we are in danger of losing the joys of radio by spending time hunting for programmes to listen to. Spend a little more of it on circuits to listen with, and I think you will find that you have been amply repaid!

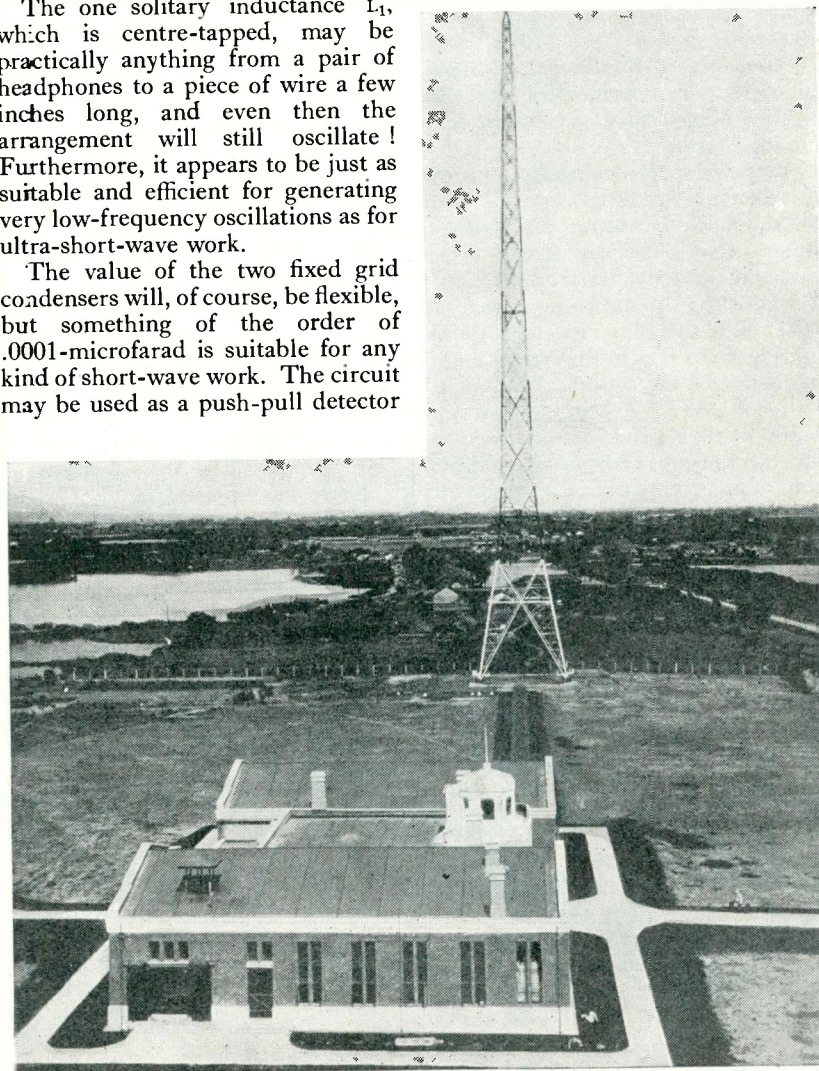

A general view of the short-wave broadcaster at Nanking, China. The huge mast has been painted red and white to make it more visible to airmen. The station is of the high-power variety and was built by the German concern, Telefunken

A New Development in

An Explanation of the New Philips-Miller Recording

UNTIL about ten years ago the only method regularly available for recording sound was by means of gramophone records. The advent of talking films then added another method by which sound is recorded on a narrow band beside the picture frames on the film tape. Other methods, for instance, the use of steel wire or tape (according to an original idea by V. Poulsen, dating back to the beginning of the century) have been invented and adopted in the course of the last few years, though they have not been used on a scale worth mentioning.

Entirely New Principles

The electro-mechanical method developed in the course of many years' joint work by the American inventor, James A. Miller, and Philips Laboratories of Eindhoven, Holland, is based on entirely new principles and should result in something like a revolution in the art of sound recording.

A tape of special composition is drawn along at constant speed below an obtuse-angled chisel, which is cutting a shaving out of the tape. The chisel is fixed to an electro-magnetic system imparting to it a vertical reciprocating motion—in fact, forcing the chisel into the film tape to a depth varying according to the strength and frequency of the sound vibrations to be recorded. A tracing of varying width is thus produced in the film which, thanks to its special composition, can eventually be made to reproduce sounds by means of a photo-electric process.

How the "sound-on-film" tape is made can be seen from Fig. 1. (a) is a carrier of diaphanous

material, for example celluloid, upon which has been laid an equally transparent layer *b*, the composition of which is such that the chisel can easily cut into it. This layer is in turn coated with an absolutely opaque substance *c*, only a few thousandths of a millimetre thick.

The tape is thus uniformly black and absolutely impervious to light to begin with. As the chisel moves up and down in accordance with microphone currents passing through the electro-magnetic system, it cuts a tracing into the soft opaque material and produces on the black tape a transparent line varying in width according to the angle of the chisel point and the depth of cutting.

The width of the tracing cut into the very thin

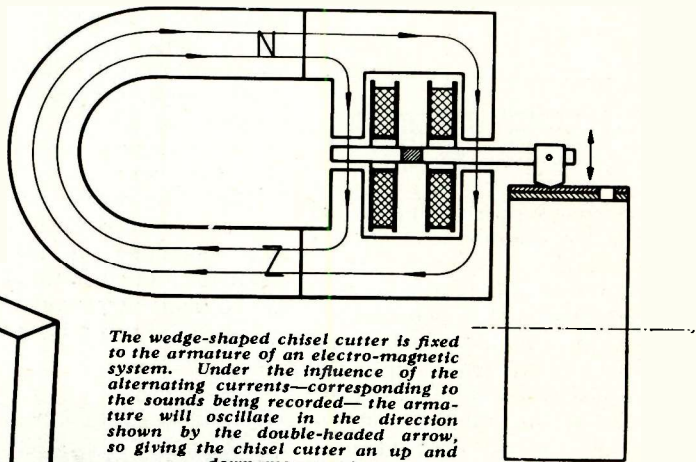

The wedge-shaped chisel cutter is fixed to the armature of an electro-magnetic system. Under the influence of the alternating currents—corresponding to the sounds being recorded—the armature will oscillate in the direction shown by the double-headed arrow, so giving the chisel cutter an up and down movement

black layer is proportionate to the tangent of the angle of the chisel, exceeding many times the thickness of the carrier. In fact, *this width can be made to fluctuate very rapidly with slightly varying depths of cut.*

For instance, with a chisel terminating in an angle of about 174 degrees, the width of the tracing will be about 40 times the depth of cut. In order to cut a tracing of 2 millimetres wide in the black layer, the chisel need only be forced 0.05 millimetres into the film; this is the maximum.

Faithful Pictorial Image

As the chisel moves up and down at the frequency of the sound being recorded, a transparent tracing of variable width is obtained. This tracing is a faithful pictorial image of the recorded sound. The well-known methods of the talking film are employed in changing the recorded sounds back to air waves.

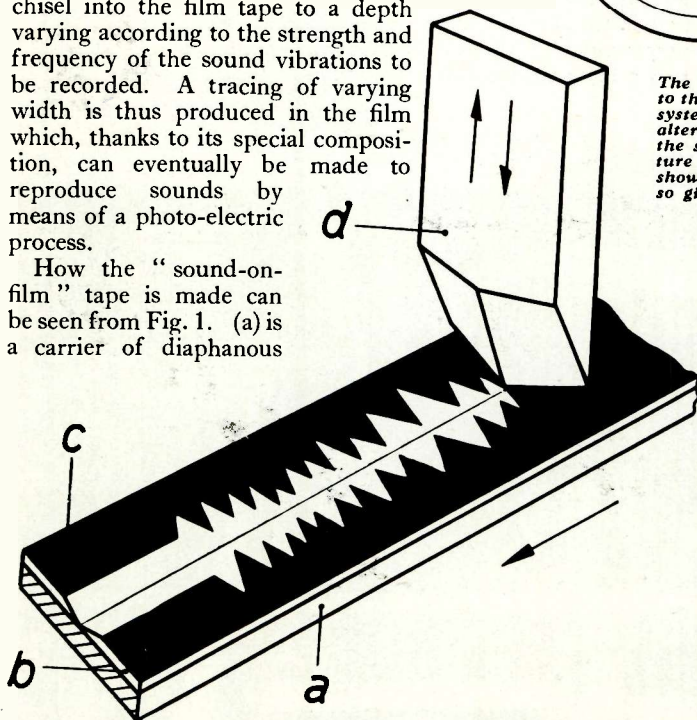

This drawing shows the basic principle of the Philips-Miller recording system. The chisel head moves in a vertical up and down plane and cuts into the black substance laid on top of a transparent carrier tape as the latter is drawn slowly past the cutter

Sound Recording

System

By
Dr. ALFRED
GRADENWITZ

The Philips - Miller recording amplifier used in the process between the microphone and the chisel-cutting head



The amount of energy required to operate the chisel in its up and down motion is quite trifling, the more so as all movable parts of the magnetic system are as light as possible.

In fact, no difficulty is experienced in getting the chisel to move to and fro in a vertical direction at a frequency of many thousands per second, thus enabling even the highest acoustical frequencies to be recorded by the new method. Accordingly, the characteristic curve of the recorded frequencies is particularly satisfactory.

Important Advantage

Another advantage of the new process is that records can be checked immediately after, or even during the recording, without in any way impairing the original as would unavoidably be the case in connection with records of soft materials.

Moreover, since the top black layer contains particles of only colloidal size, a sharp definition between the light and dark portions of the picture is obtained even with the highest frequencies, whereas there is a limit in the case of photographic records because of the dimensions of the grain of the material.

Thanks to this sharp separation between light and dark there are practically no disturbing secondary noises. In fact, even the softest acoustic impressions can be recorded without being spoilt by secondary noises.

It is possible to produce on the same machine copies of the original recording of almost equal quality without the losses inseparable from photographic printing. Photographic prints can also be obtained and, though less satisfactory (because of the grain of the photographic material) are of better quality than purely photographic records.

The new process will be found useful both in radio and in the talking-film industry. In the latter case, the possibility of synchronising can be provided for by tape perforations.

In connection with radio broadcasting, on the other hand, the possibility of recording for a considerable length of time

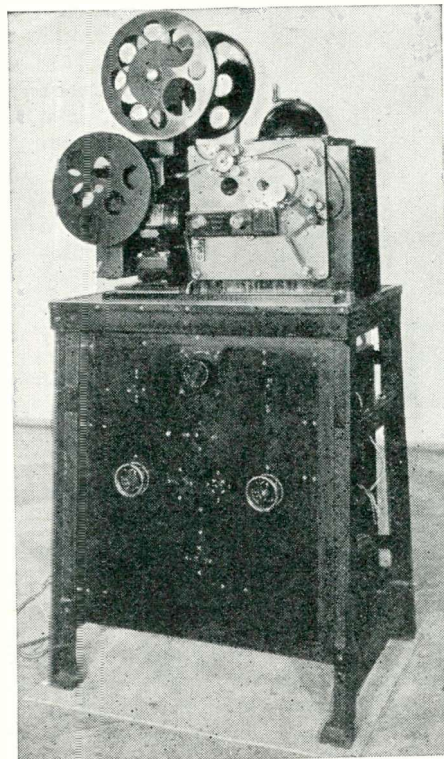

This is the actual sound recording apparatus used in the Philips-Miller system. The tape reels and cutter are mounted on top of the stand, while reproducing equipment is housed underneath

NEXT MONTH

Paul D. Tyers, describes a New Battery Superhet Incorporating a Remarkable Variable Selectivity Device

without any interruption can be easily accomplished. A recording machine comprises two recording devices, which enables a quick change over from one tape to another; hence there need be no break in the recording process, as a new tape can be inserted while one is being recorded.

Radio News from Abroad

Another Luxembourg ! :: New Bulgarian 50 kilowatt :: Boom in French Sponsored Broadcasts :: Berlin's New Anti-fading Aerial :: Heston to Close Down :: Sweden's Golden Voice

BALEARIC ISLANDS

IN view of the success obtained with Radio Luxembourg, it is reported from Paris that an international syndicate is endeavouring to obtain a concession to build a high-power transmitter on the island of Mallorca, with a view to broadcasting sponsored programmes to Spain, Southern France and North Africa.

BULGARIA

To replace the small Radio Rodno broadcasting station, the authorities are installing in a suburb near the capital a 50-kilowatt transmitter to work eventually on 352.9 metres. It is also proposed to build a relay station at Stara Zagora and to transfer the original Radio Rodno plant to Varna, on the Black Sea.

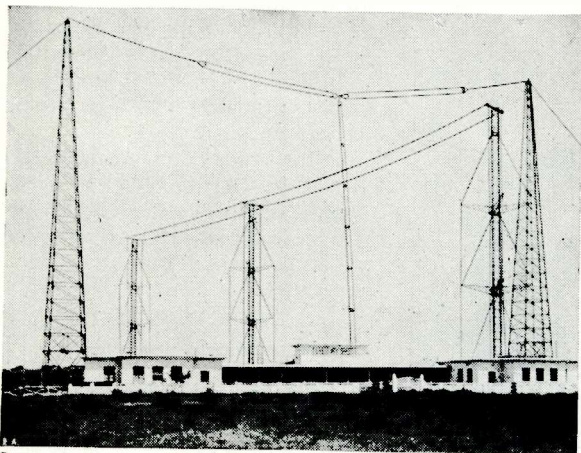

Lusty photo
A view of the recently reconstructed Rabat station in Morocco. The power has been increased to 25 kw.

CZECHO-SLOVAKIA

Brno, on 325.4 metres, has finally adopted a musical interval signal; so far it has been the only Czech station without one. Between items you may now hear the recording of a few bars of a folk song, *Moravia*, played on a piano.

FRANCE

Since the authorities decreed that the State network should not broadcast sponsored concerts or any kind

of publicity matter, the French private stations have seen their revenue increase by leaps and bounds. Radio LL, Paris, having trebled its

By JAY COOTE

capital, now plans the reconstruction of its transmitter to secure higher power and thus an extended range.

GERMANY

The engineering staff responsible for the construction of the long-wave 150-kilowatt German National station at Brueck, near Berlin, are to make use of a new anti-fading aerial system which they claim to be the first adopted for long-wave transmission. In their

opinion, according to tests carried out with the improved aerial, the service range of the station will be equal to that of one of a power at least twenty-five per cent greater.

The Berlin studio, in addition to the humorous programmes broadcast between B.S.T. 06.20-08.30 daily, has decided to brighten up its entertainments between midday and B.S.T. 15.00. Instead of talks and

highbrow concerts, listeners are to be given more military brass bands and dance music. *B.B.C. please note!*

GREAT BRITAIN

The Air Ministry will be suspending shortly the meteorological broadcasts from Heston Airport. As a substitute, the forecasts will be transmitted by a new 2-kilowatt station installed at Brough Hill, near Daventry. It will operate on

1,186 metres and will take over the Heston schedule with possibly some additional broadcasts of interest to aerodromes and aviators in flight.

PALESTINE

Although little has been heard of the work being carried out, the construction of the 20-kilowatt transmitter being erected at Ram Allah, near Jerusalem, is proceeding according to plan. It is anticipated that the first tests will be made in August or September. The wavelength will be 449.1 metres, a channel already used by the B.B.C. North Regional station.

POLAND

Poland will shortly possess a network of eleven broadcasting stations. The two additions to be made to the system are a 20-kilowatt short-wave transmitter and a medium-wave relay station to be installed at Pinsk (East Poland).

RUSSIA

The 500-kilowatt Moscow (1) station has increased its wavelength to 1,744 metres in order to minimise interference with Radio Paris. Although now clear of the French national transmitter, the frequency alteration has resulted in a complete swamping of the Lahti (Finland) broadcasts.

SWEDEN

The "Golden Voice" idea widely advertised by the British Post Office is not a new one; Sweden adopted this system many months ago. Following the last item of the day's broadcast in the Stockholm programme, the listeners are verbally given the exact time. It is received from the Swedish telephone headquarters where its golden-voiced operator has been recorded on film. By means of a ray of light actuating photo-electric cells connected to an amplifier, the instrument automatically transmits the exact hour, minute and second at any moment of the day or night.

The Photo-electric Cell and How It Works

There are many elementary subjects that must be fully understood before a sound knowledge of television working is acquired. Last month, MORTON BARR dealt with present-day theories of the nature of light, and here he describes the development and action of the photo-electric cell—so often called the electric eye



Dr. Vladimir Zworykin, of the Radio Corporation of America, the inventor of the Iconoscope

THE microphone in broadcasting and the photo-electric cell in television are alike in the sense that they both give the programme its passport into the ether. Sound is passed through the microphone in order to change the mechanical vibrations of which it is made up into electric currents capable of riding through space on a carrier wave.

In the same way the light rays from a scene to be televised must start on their way to the transmitting aerial *via* the photo-electric cell. Once launched from the aerial, they still retain their original character as ether vibrations, but acquire a wider range of action, and the added power of being able to pass through obstacles opaque to ordinary light.

Apart from the photo-electric cell as used in television, there are many other devices, such as the selenium cell on the one hand, and the ordinary photographic plate on the other, which respond in different ways to the action of a ray of light.

We know that light consists of ether vibrations of very short wavelength—fitting some hundreds of thousands to the inch—and that matter is mostly made up of electrons in

motion. It is, therefore, only natural to expect some local "reaction" when a ray of light, travelling at a speed of 186,000 miles a second, hurls itself against what is, in effect, just a whirligig of electric charges.

In the modern photo-electric cell, the effect of the light is to release some of the electrons from the molecules to which they are normally bound: electrons set free in this manner form an electric current when they are collected together and made to move in a definite direction.

Something very similar occurs, for instance, at the cathode of an ordinary valve, only in this case the electrons are set free by the action of heat instead of light. Heat increases the state of agitation of the molecules in the cathode wire, until the time comes when some of the electrons belonging to the molecule break free and bubble out into

the open space inside the valve. Here they come under the influence of the positively-charged anode and—subject to the further control of the grid—combine in their millions to form a discharge current through the valve.

Hertz in 1887 and Hallwachs in 1888, were the first to make a systematic investigation of the action of light in liberating electricity from the surface of certain materials. Hallwachs found, for instance, that a polished zinc plate, if carefully insulated, will retain a positive charge of electricity when exposed to the light from an arc lamp, but rapidly loses a negative charge under the same conditions.

Light-sensitive Metals

Later, it was shown that a large number of other substances responded to light in similar fashion, particularly the alkali metals such as potassium, sodium, caesium and rubidium. The liberation of the negative charge occurs in the open air, so that one must imagine it as being triggered-off with sufficient force to counteract the effect of atmospheric pressure.

In 1889 Elster and Geitel constructed the first photo-electric cell of the kind in which a sensitive alkali cathode is enclosed

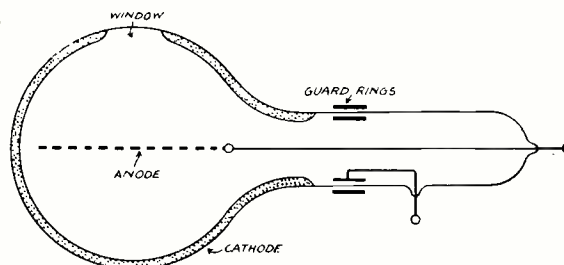

Fig. 1.—An alkali-metal cell in which the cathode consists of a layer of alkali metal deposited on the inside surface of the glass bulb

in a low-pressure glass bulb, together with a positively-charged anode for collecting the discharge current. Later on, in 1899, J. J. Thomson proved that the negative charges so liberated were in fact electrons, i.e. the same "atoms" of electricity which now play so big a part in the modern theory of the constitution of matter.

Our knowledge of the sensitivity of selenium dates back to 1875, when it was discovered that light causes a change in the ohmic resistance of the so-called "moon-element." Although this can be utilised to measure the intensity of

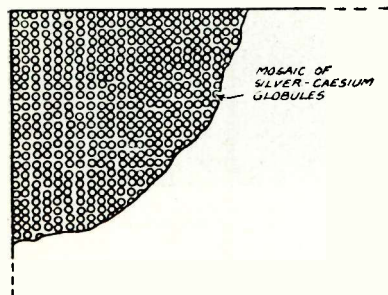

Fig. 2 (a).—The mosaic electrode is made up of numerous tiny globules of caesium-silver deposited on a backing plate of mica

the ray, it should be noted that there is no direct conversion from light into electricity.

Recent research tends to show that the change of resistance is, in fact, due to the effect of the light upon those electrons which remain bound up with the molecules of the selenium. In the alkali metal cell, on the other hand, the light breaks up the molecule to the extent of setting some of the electrons free.

Early Beginnings

The earliest recorded photo-electric effect was that noted in 1839 by Becquerel, whose grandson led the way to the discovery of X-rays. The elder Becquerel found that the E.M.F. of certain voltaic cells alters when light is allowed to fall on one of the cell terminals. This peculiar effect now appears to be allied with the recent discovery of the photo-electric response of the cuprous-oxide type of rectifier. In both cases the light produces a local E.M.F. which sets the neighbouring electrons into motion.

The photo-electric effect used in television to convert light into electricity follows certain definite laws. In the first place the number of emitted electrons—that is the

strength of the current produced—is directly proportional to the *intensity* of the light ray. This is in accordance with what one might expect.

In the second place the *energy* with which the electron is emitted is directly proportional to the frequency, but is independent of the intensity of the incident light. This result so far from being expected, came as a regular bombshell.

In Sir William Bragg's words: "It is as if one dropped a plank into the sea from a height of 100 feet and found that the ripple so formed, after spreading outwards for 1,000 miles, could then react upon a wooden ship by tearing out one of its planks and shooting it up into the air to a height of 100 feet."

Einstein and Planck between them have revolutionized modern physics in attempting to account for this extraordinary state of affairs. Around it, they have built up the new "quantum" theory of radiation.

In the photo-electric cell, shown in Fig. 1, the cathode consists of a layer of alkali metal, such as potassium, sodium, lithium, rubidium, or caesium, or their alloys, deposited on the inside surface of the glass bulb, a window being formed, as shown, to allow the ray of light to enter the cell. The anode is a ring of metal, located in the middle of the bulb.

As the discharge only amounts to a few microamperes (millionths of an ampere) it is necessary to pass the output current through one or more valve amplifiers before using it to modulate a carrier wave. The two guard-rings round the neck

of the cell serve to improve the insulation and prevent leakage.

In a later model, the cathode consists of a very thin coating of caesium laid on an oxide of the same metal, which in turn is deposited on a film of silver spread over the inside surface of the glass bulb. This type of sensitised cathode produces a larger output of current.

A similar composition is used to form the "mosaic" electrode of the Iconoscope cathode-ray transmitter, shown in Fig. 2, one of the latest applications of the photo-electric cell to television. The mosaic electrode (Fig. 2 top) is made up of a multitude of tiny globules of caesium-silver, deposited upon a backing-plate of mica. Each globule acts as an independent cell, which responds to the action of light of varying intensity by emitting electrons and so developing a corresponding electric charge.

Cathode-ray Scanning

The scene to be televised is first focussed on the mosaic, where it forms an electrostatic "image," which is then rapidly scanned by the electron stream from the "gun" or anode of the cathode-ray tube. As each tiny photo-electric cell is discharged it sends out to the amplifier a current proportional to the corresponding light or shade value of the original picture.

The action is in many ways similar to that of an ordinary kinema camera, except that in one case the image is registered by a photo-electric effect which changes from moment to moment, whilst in the other the image is recorded permanently by a chemical process.

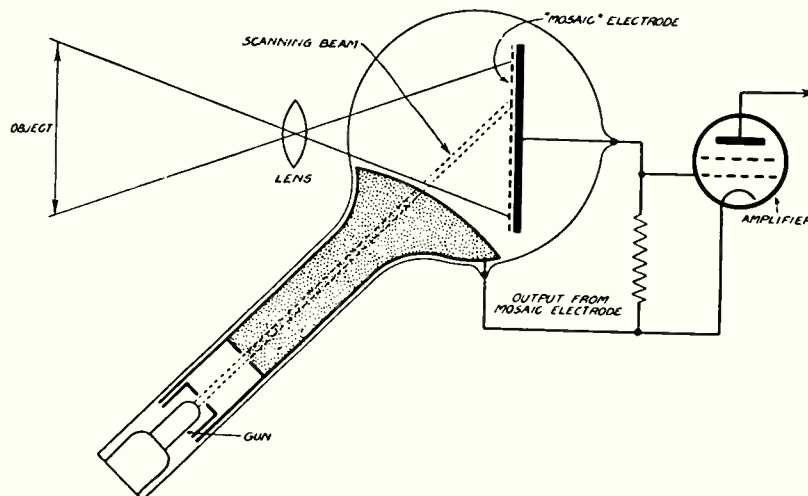
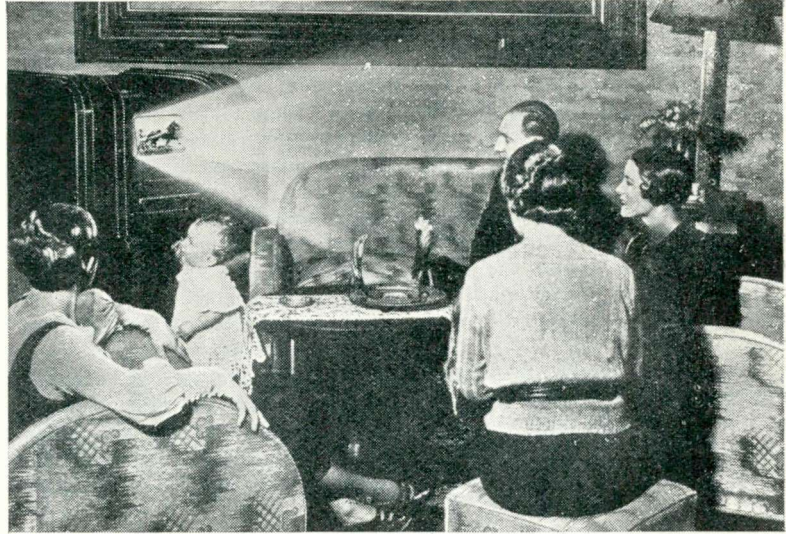

Fig. 2.—The Iconoscope, or photo-electric transmitter, used for televising outdoor scenes where the compact nature of the apparatus is an advantage

In the last six issues of "W.M." we have published a series of articles designed to give the reader who has not had time to specialise in the technical side of wireless a good grounding of the subject in simple language. In this new series, designed to appeal to every set user, the same line of approach is taken and those who have read the previous articles will find "Television For The Busy Man" extremely interesting and a very useful "follow-up"



Gulliland photo
In Italy television has reached quite an advanced stage. Our illustration shows the Safari television receiver which gives a greenish-black and white picture some 19 by 23 centimetres

Television for the Busy Man

By PERCY W. HARRIS, M.I.R.E.

BECAUSE familiarity breeds contempt most people have long since lost most of their surprise at the performance of a broadcast receiver. To thousands, if not millions, a wireless receiver is, nowadays, an essential piece of home furniture which is expected to perform consistently well—and generally does so. The fact that our forefathers would have considered it an invention of the devil does not cause us the slightest concern!

Yet something of the old wonder and surprise that first greeted this modern miracle is returning with the advent of television. However accustomed we are to hearing voices and music almost perfectly reproduced from the other side of the world, there is something particularly fascinating and thrilling in *seeing* a scene which is occurring simultaneously at some place far beyond our normal range of vision.

Technically television is here—commercially we must wait for a few months, but its early arrival as

home entertainment is as sure as the coming of next Spring. So let us see how it all works.

And here, before we go any farther, let me say that the purpose of this series of articles is neither to give the history of television nor to explain who invented this, that, and the other parts of the apparatus. There is always a tendency on the part of the public to look upon some great new facility or convenience as the invention of one man—something which has sprung from his brain as a complete product, and which he has gravely handed out to the rest of the world to exploit.

Wireless broadcasting, as we know it today, is not the work of any one man, and the same remark applies to television. There are many so-called "systems," but this is not the place to discuss them individually. In all the essentials they differ very little and ultimately we shall probably get a blend of all of them.

Sound broadcasting and television broadcasting have many points in

common. Both have a central transmitter comprising a studio where the action takes place, a transmitting plant for radiating the waves from its aerials, then your receiving aerial, a tunable receiving set, and some form of output device. In sound broadcasting we pick up the sound by means of a microphone which converts varying sound pressures into varying strengths of electric current.

Sight Broadcasting

In television or sight broadcasting, as it might be called, we have a device corresponding to the microphone which picks up the picture in front of it and changes this into varying electric currents. Once both sound and picture have been changed into varying electric currents the procedure in both systems remains essentially the same until we reach the receiver.

By this I mean that all I have written in previous articles under the heading of "Wireless for the Busy Man" pertaining to transmission applies equally here, the waves being radiated into space on the definite wavelength, picked up by the receiving aerial, which is tuned to the particular wavelength, and amplified in the high-frequency portion of the apparatus.

Whereas in sound broadcasting these varying electric currents in the receiver are used to produce sounds in the loudspeaker, in a television set these variations are caused to produce a complex pattern on a viewing screen, this pattern blending itself

into a single image corresponding to that at the transmitting studio.

It is this conversion of a scene into a complex electric current and the re-conversion of the complex electric current into a scene, that occasions so much wonder and that seems so truly magical. In the remainder of the present article I want to solve this mystery for you so that in subsequent articles we can see the practical application of the remarkable inventions introduced into the new science.

When you write a letter to a friend you form it letter by letter, word by word, line by line; although when it is finished the sheet full of writing can be seen in its entirety at a glance.

that you do not notice the transition, a series of still pictures.

Now it so happens that a visual impression on the retina of the eye remains there for about a twelfth of a second before it fades away, and so if you make pictures follow one another at a speed of at least twelve to the second the visual impression of one has scarcely passed from the retina before the other takes its place.

In silent picture days, and still today in the case of home cinemas, it is the custom to project sixteen of these still pictures per second in order to obtain the illusion of continuity. For reasons which have nothing whatever to do either with continuity or with flicker the speed

in talkies has been increased from sixteen to twenty-four, but we still have a series of still pictures presented one after the other.

Now there is no known means of taking a picture or photograph and turning the whole of that picture simultaneously into a single electric current of varying strength. Not only can this not be done electrically, but the conception of such a scheme is beyond our mental scope. What we *can* do, however, is to divide the picture into a very large number of units of light and shade—chop it up into a multitude of tiny pieces so to speak—and then re-form it in the same order.

Copying Point by Point

Each tiny piece can be turned into an equivalent electric current and all these little currents set as it were end on end in the receiver. We can, in fact, copy the picture point by point and line by line and arrange for our receiver to present the copy as it is made.

We have already seen that the persistence of light in the eye enables us to get an illusion of reality and if we can present our complete copy dot by dot and line by line at twelve to the second, then it will look as if it is all made at once.

You sometimes see in old curiosity shops pictures formed in grains of coloured sand. Each particular grain is uniform in size, but the grains differ from one another in tint and

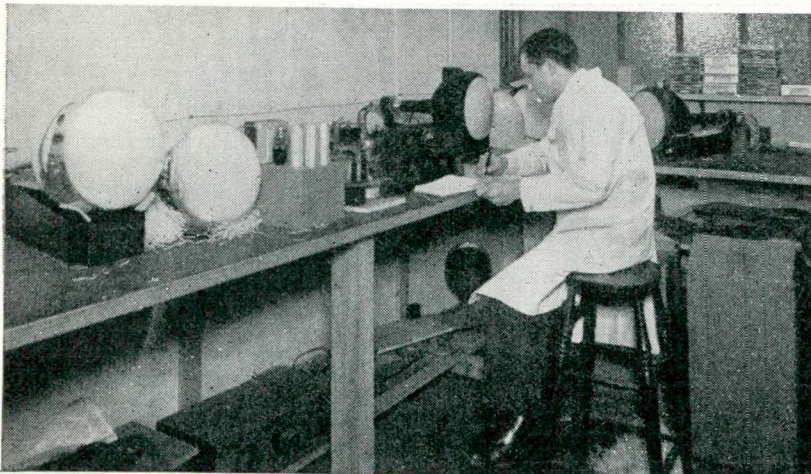

Here is one of the Baird engineers testing cathode tubes. It is these tubes which turn the small electric impulses back into a series of scenes at the receiving end. They form the vital part of the television receiver

Similarly an artist working by means of a small pointed brush and a set of colours gradually forms on his paper or canvas an exceedingly complex yet beautiful picture, which again is viewed at a glance. It is, in fact, an assembly of tiny units that have been put down one after the other on the paper or canvas for the purpose of enabling you to see all at once something which approximates to nature.

An Optical Illusion

Although it is rarely realised and still more rarely stated, the television transmitter and receiver owes a great deal to the cinematograph. When you watch a picture on the screen you get the impression that the various parts of it are moving according to nature, but actually you are witnessing an optical illusion. This appearance of natural movement is obtained by presenting on the screen, one after the other and so rapidly

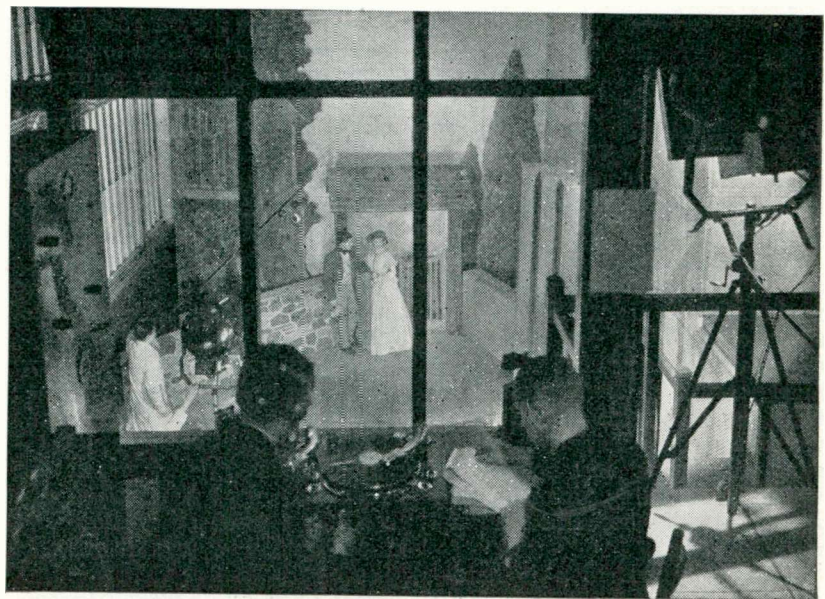

Experiments in many kinds of scenes for television have been carried out at the Baird Television company's studios at the Crystal Palace. Scenes such as that depicted above have been transmitted with great success

colour. If you look at any photograph in this magazine with a powerful magnifying glass you will see it is made up of tiny dots of which there are at least ten thousand to the square inch. These dots are all uniformly black but vary in size. In a solid black area the dots are so large (comparatively) that their edges practically touch one another, so the illusion of blackness is obtained.

Made of Dots

In the very light areas the dots are very tiny with large white spaces between them so that the appearance of this part of the picture is very light. But every picture is made up of the same number of dots to the square inch and only the size of the dots and not their colour varies to produce the illusion of reality.

Let us now imagine that we are trying to send one of these pictures by wireless, which means that we must convert it into electric currents that are subsequently changed into electric waves. I use the term "electric waves" here to the great annoyance of my Technical Editor, who is a great stickler for technical accuracy, and knowing full well that they are not truly *electric* waves and only become electric currents in the receiver; but let that go!

"Transmitting" Dots

We can, if you like, start off by arranging to send a hundred dots in a second the size of each dot determines the strength of the current. Thus, a tiny dot, we will say, gives a weak current and the largest black dot the strongest current. Let us begin at the top left-hand side of the picture and send out a series of pulses varying in strength according to the variations of size of the dots.

If we sent a hundred of these impulses a second and we listen in on an ordinary broadcast receiver, we

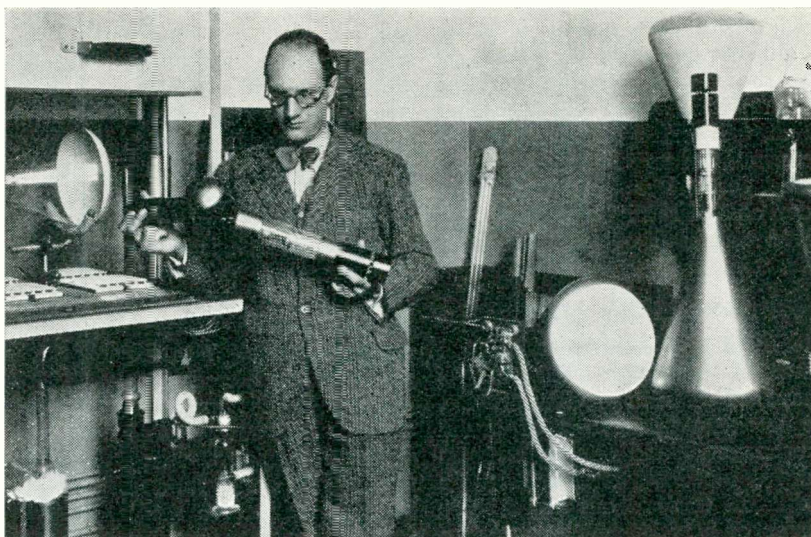

An Italian television engineer, Signor Castellani, with his latest electron scanning tube. When this tube is used in a suitable camera it permits the "photographing" of any scene for transmission by the high-definition process

should hear a buzzing noise. If we send a thousand of them a second there will be a fairly high-pitched whistle of a thousand frequency, although it will not be a pure note because of the variations of strength of the impulses.

Again let us exercise our imagination still further and consider that we are sending out a picture line by

line as little pulses of electric current, the strength of each individual pulse being proportional to the size of the dot, and that there are 240 lines from top to bottom of this picture. A picture cut up so finely as this will show a great deal of detail and will take, of course, a correspondingly longer time to send.

If we send, let us say, a thousand dots per second and the picture is a square one with 240 dots per row and 240 rows, the time taken from start to finish of such a transmission would be approximately one minute, and one minute per picture would certainly not rival a cinematograph in speed!

Practical Difficulties

Obviously, then, we must speed up a great deal if we are to get an illusion of continuity of movement such as is obtained in cinematograph pictures. Remember, to rival the modern professional picture we must be able to send twenty-four complete pictures a second!

And now you are beginning to be in a position to appreciate the *practical* difficulties of television, apart from the theoretical ones. It is not at all difficult to arrange apparatus which will, so to speak, analyse a picture or a scene in front of the camera, point by point, converting

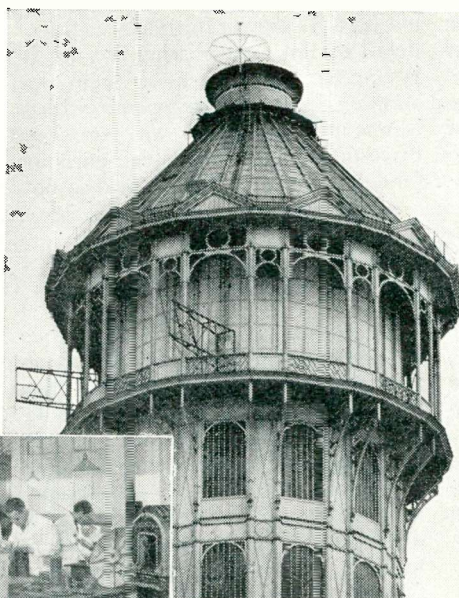

The photograph above shows one of the towers of the Crystal Palace used for experimental television transmissions. The aerial on the top is used for transmitting vision, while both vision and sound are transmitted by those seen on the side. White-coated engineers are seen at work in one of the Baird Television company's workshops in the left-hand picture



the lights and shades into various strengths of current, and it is not so difficult nowadays to make sure that the varying strengths of the currents which send out the ether waves, and which subsequently are reconverted into electric currents, form themselves in the right order on the receiving screen. We solved this kind of problem some time ago.

Speed and Definition Difficulties

The difficulty comes mainly in the matter of speed and definition. As I have explained in previous articles, the practical limitations of sound transmission and reception on ordinary broadcast wavelengths make it difficult to send out and receive sounds of a higher frequency than about six or seven or at the most ten thousand per second.

Keeping in mind our aim to have a very finely detailed picture sent out by wireless and reassembled at such a speed that the whole original is traced over at a speed which must be faster than the twelfth of a second, it is easy to realise that the finer the detail of the picture the faster our tracing point must move in order to get over the ground in the same time.

If we send out a thousand dots a second it would take us a minute, as I have just explained, to send out a single picture. If you accept my figure that on ordinary broadcast wavelengths 10,000 a second is about the most you can send out satisfactorily (having regard both to transmission and receiving con-

ditions) you will see that we are not very much better placed, for a ten times speed will only bring you down to one picture every six seconds, and this is not much use for an illusion of continuity!

To get even *ten* pictures a second (which is below the practical point for persistence of vision) we must send out frequencies *sixty times as high* as the most it is considered practical to send out on ordinary broadcast wavelengths!

This means a frequency of over half a million, and actually very much more for certain rather complex technical reasons. This cannot possibly be done on ordinary broadcast wavelengths for many reasons, and it is because of this that high definition television *must* take place on very short wavelengths.

In order to avoid flicker it has been found necessary to send out at least twenty-five complete pictures per second in modern high-definition television and even fifty has been used at times. Whatever form of detail or dot transmission we use it is impossible to get away from the simple arithmetic of television, which is one of the reasons why you can discount at once any tales you hear (and you will probably hear a lot

of them in the next few months) about some wonderful new invention that enables television of high definition to be sent out on ordinary broadcast wavelengths.

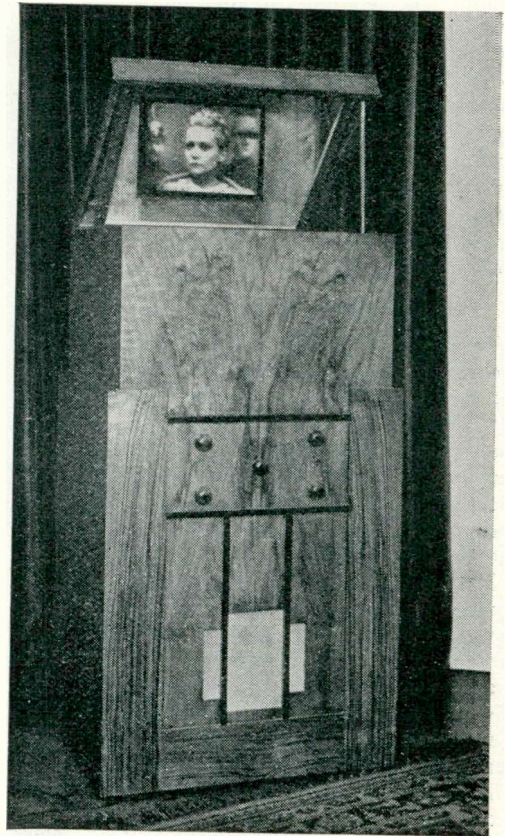

We hope that by Christmas of this year we shall be reviewing television receivers, such as this Baird model, in these pages. The receiver shown above gives a bright black and white picture some 12 in. by 9 in., which is of sufficient size to entertain an audience of thirty people

Unwept, Unhonoured and Unsung!

THE 130th anniversary of the death of Claude Chappe, which took place early this year, recalled little to the general public; barring a few references to this inventor in a Swiss newspaper, no attention was called to the man who first made it possible to transmit messages to relatively long distances.

Claude Chappe, a French engineer born at Brulon in 1763, to whom the invention of the first optical telegraph is attributed, is said to have devised this system of communication with his elder brother Ignace.

This method of signalling (semaphore) was carried out by means of two or three moving arms at the head of a pole; the position of the

arms denoting letters of the alphabet or arithmetical figures. In order that they might be seen from the greatest distance possible, the pole or mast was installed at the summit of a tower. Chappe contended that by means of a chain of such posts, messages could be transmitted over a distance of 50 leagues in fifteen minutes. The tests proved satisfactory, so the system was adopted by the French Legislative Assembly in 1792, and one year later the inventor was given the official appointment of *Ingenieur-Telegraphe*.

Napoleon Bonaparte made use of this method in his campaign against the Austrians, and when a few years later, in 1805, he was proposing to

invade the British Isles, the English erected masts with movable arms on a number of hills between London and the South Coast, with a view to giving due warning of his arrival.

But Chappe did not live to reap any tangible benefit from his invention as, because some doubt was cast on the originality of his idea, he is reported to have taken his life at Paris on January 23, 1805.

So far as can be traced, there appears to be no claim to the invention prior to that made by Claude Chappe, and to him must be given the credit of having devised the *first practical mechanical* method for the distant transmission of messages.

Jay Coote.

How quickly short-wave communication is developing can be seen by comparing this photograph of the short-wave aeri-als at the German station, Zeesen, with a photograph of Zeesen published on page 344 of our June issue. The illustration on the left shows seven of Zeesen's eleven short-wave masts with their complicated network of aeri-als, which are directional to all parts of the world

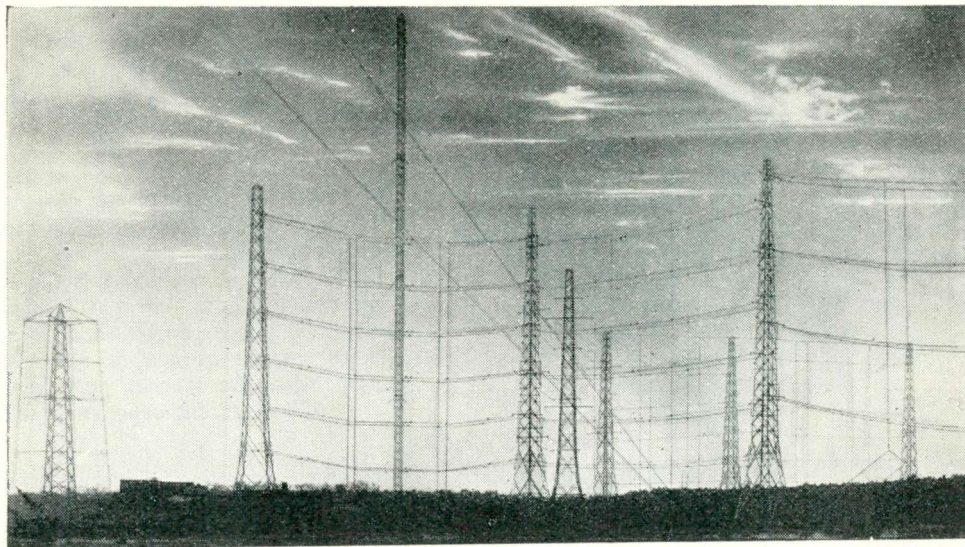

Gulliland photo

News of the Short Waves

WE are just going through one of the most interesting periods of the year from the short-wave man's point of view. Conditions this year happen to be good, but that is not always the case during July and August. Luckily we don't need good conditions before we can find something of interest.

The better-known stations are coming through with their usual consistency but, for some peculiar reason, this seems to be the time when new stations crop up most unaccountably. Sometimes they fade away again; sometimes they stay there!

The glut of Central and South Americans that was a feature of this Spring seems to have disappeared. The strong Colombians and Venezuelans can be heard regularly, night after night, but the strange ones that seemed at one time as if they might become "regulars" have disappeared once more.

The strongest South American, nowadays, is Rio de Janeiro, PRF5, on 31.56 metres. Pernambuco, PRA8, on 49.5 metres, is the only other Brazilian heard with any regularity. The Colombians with their call-signs of the "HJ4ABA" type are so numerous and confusing that there isn't much point in reporting them in detail.

HJ1ABB, however, seems to be testing with W2XAF regularly, the former on 46.5 metres and the latter, of course, on 31.48 metres.

By G. HOWARD BARRY

One reader reports CX1AM, Uruguay, on about 40 metres. This, presumably, is an amateur, and was probably relaying broadcast in the amateur band—a pastime not encouraged by fellow-hams.

Central America and the West Indies continue to provide many transmissions mostly of the "flash-in-the-pan" variety. TI-RCC (Costa Rica) has been logged on 45 metres, and TI-GPH on 51.28 metres. TI-2RC has also been reported as working just above the 20-metre amateur band.

The North Americans are going on much the same as before, except for a perceptible improvement on the 49-metre band, which has been sadly troubled by atmospherics and locals for the last few months. It is beginning to become quieter at the time of writing and some of the lesser-known stations, such as Miami (W4XB), have been coming in quite well once more.

VE9CA at Calgary, Alberta, is listed as working on 49.83 metres and should be a station worth listening for. The Canadian amateurs in Alberta are among the hardest North Americans to receive in this country, but possibly a high-powered broadcast station will get through. VE9CA announces himself as "The Voice of the Prairies."

So much for the Western stations. Those to the East of us are less

numerous and less exciting, the only really consistent ones being the new Japanese stations with their "JV" call-signs. Several of them can be heard working commercial telephony, but they are subject to irregular out-breaks of broadcast. The fact of the matter, just at present, is that any station heard with a musical programme is worth hanging on to. You may think it is Rome, but it's just as likely to be a new station in Japan

Best of the Japs

JVT on 44.44 metres is one of the best of the Japs, although JVA on 15.86 metres has been heard once or twice at colossal strength.

The new station from Java is PLP (Bandoeng), heard once or twice on 27.3 metres relaying the YDA broadcast on 49 metres. All these Javanese stations using "YD" call-signs are working in complete contravention of the allocation of prefixes, but that is only to make things a little more complicated for us, I expect. Their full call-signs are really PK-YDA, etc.

ZLT, Wellington, N.Z., who still appears to be the only New Zealand station (apart from amateurs) that most of us hear, has been logged several times on 27.3 metres. His strength is almost up to that of the Australians, VK2ME and VK3LR. The elusive VP1A in the Fiji Islands (22.94 metres) can be heard every morning at 7 a.m., but is usually not strong enough to make anything of.

The Year's Best

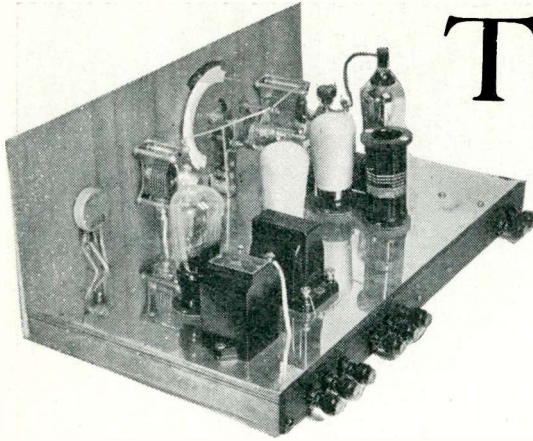

Last month we presented full constructional details of the Standard A.C. Four-valve Short-waver, which was specially designed for "W.M." by G. HOWARD BARRY. Without doubt this is the finest A.C. short-wave design of the year; it is childishly simple to build, it is not expensive, and it does give really efficient results as can be seen from the author's station log on the opposite page. Here the designer tells of recent experiences with the set

ALTHOUGH the weather—and particularly a room facing south—has not encouraged the use of a short-wave receiver for many hours a day during the last month, the Standard A.C. four-valver has been in use quite frequently, and has shown up very well in comparison with my other short-wave receiver.

Stopping Interference

The set and power-pack have remained exactly as they were described last month, with the addition of a mains-filter. The latter has been necessitated by the insistence of a neighbour on using an electric fan with very dirty brushes. This mains filter consists simply of two big high-frequency chokes wound with No. 22 gauge wire, inserted in the mains leads to the power pack, with two 1-microfarad condensers connected in series with the centre-point earthed.

Such a filter does help quite a lot to cut down noise from the mains,

particularly from the annoying "clonks" that emanate from the switches in one's own house.

Conditions during the month have been quite good, and all the stations that one could reasonably expect to hear have been coming through pretty regularly. I have

done a deal of listening during the evening hours and once or twice I have stayed up really late to keep a watch on the 49-metre band; the results will be seen in the list of dial-readings given on the opposite page.

These readings must be taken simply as a rough guide—your own

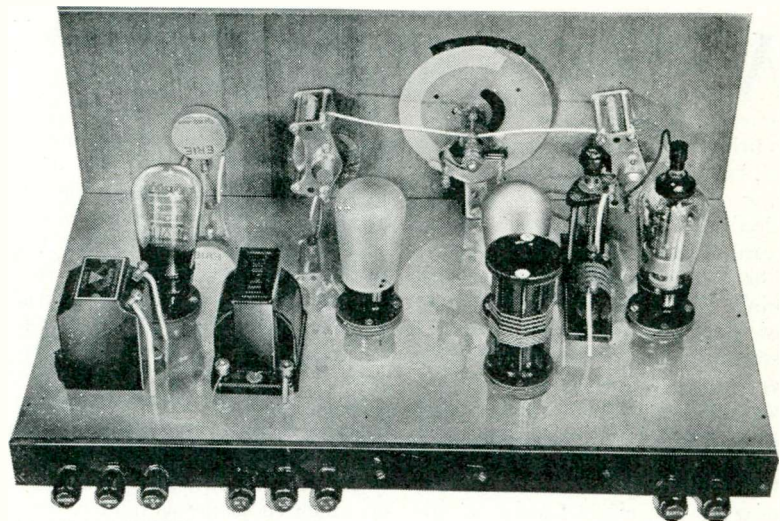

COMPONENTS NEEDED FOR THE A.C. STANDARD FOUR-VALVE SHORT-WAVER

		£	s.	d.			£	s.	d.				
CHASSIS					HOLDERS, VALVE								
1—Peto-Scott chassis to specification	...	9	6	4—Clix 5-pin, Airsprung type	...	4	0	LIST OF COMPONENTS FOR POWER PACK					
CHOKES, HIGH-FREQUENCY					1—Clix 4-pin, Airsprung	...	11	CHOKE, SMOOTHING					
1—Bulgin short-wave choke	...	2	6	RESISTANCES, FIXED			1—Varley 20-henry, type DP10		...	15	0		
1—Eddystone short-wave choke	...	2	9	1—Erie 10,000-ohm, 1-watt type	...	10	0	CONDENSERS, FIXED					
(or home-made; details as in July issue, p. 409)			1—Erie 2,000-ohm, 1-watt type	...	3—T.M.C./Hydra 4-microfarad 400-volt working			...	19	6			
CHOKES, LOW-FREQUENCY					2—Erie 50,000-ohm, 1-watt type			...	RESISTANCE				
1—Varley output, type DP23	...	10	6	1—Erie 30,000-ohm, 1-watt type	...			1—Erie 3,000-ohm 3-watt type (see text last month)	...	3	0		
COILS					3—Erie 1,000-ohm, 1-watt type	...	TERMINALS AND SUNDRIES						
1—set B.T.S. short-wave	...	16	0	RESISTANCE, VARIABLE			2—strips with two Belling-Lee terminals (Peto-Scott)		...	1	9		
CONDENSERS, FIXED					1—Erie 230,000-ohm potentiometer	...	3	6	1—strip with three Belling-Lee terminals (Peto-Scott)		...	1	0
1—T.C.C. .002-microfarad	...	1	6	SUNDRIES			1—Baseboard 12 in. x 9 in., say		...	1	9		
1—T.C.C. .0003-microfarad	...	1	3	Tinned wire for connecting, say	...	9	TRANSFORMER, MAINS						
1—T.M.C./Hydra 1-microfarad 300-volt working	...	2	3	Oiled cotton sleeving, say	...	1	1—Varley semi-shielded, type EP36, giving 325-0-325 v., 2-0-2 v. 2.5 amperes, and 2-0-2 v. 4 amperes		...	1	2	6	
5—T.M.C./Hydra 2-microfarad 300-volt working	...	15	0	1—Belling-Lee anode connector	...	4	VALVE HOLDER						
CONDENSERS, VARIABLE					TERMINALS			1—Eddystone 4-pin, type 501		...	1	3	
1—Polar .00015-microfarad slow-motion short-wave, type C	...	8	6	1—Peto-Scott terminal-strip, with 8 Belling-Lee terminals marked A, E, L.T. (2), H.T., H.T.—, L.S. (2)	...	5	VALVE, RECTIFYING						
1—Polar .0001-microfarad slow-motion short-wave, type C	...	8	3	TRANSFORMER, LOW-FREQUENCY			1—Mazda UU120/350		...	15	0		
1—Eddystone .000015-microfarad short-wave, type 900	...	3	9	1—Ferranti, type AF8	...	11	(or Marconi-Osram U12, Mullard DW3)						
1—J.B. neutralising	...	3	6	VALVES									
1—Eddystone vernier slow-motion drive, type 933B	...	7	6	1—Mazda AC/SG	...	17							
				1—Mazda AC/2HL, metallised	...	13							
				1—Mazda AC/HL	...	13							
				1—Mazda AC/P	...	14							
				LOUDSPEAKER									
				1—W.B. Stentorian, Standard model in cabinet	...	2	4		6				

A.C. Four-valve Short-waver

may not be within ten divisions of them. Such a log is a distinct help, however, in the identification of unfamiliar stations that one may pick up later on.

Compiling the Log

Generally speaking, all reception below 20 metres has taken place between 3 and 9 p.m.; all on 25 and 31 metres between 8 p.m. and midnight; and most of the 49-metre reception between 11 p.m. and 3 a.m. No watch has been kept at the other times of day except for 20-metre amateurs between 6 and 8 a.m.

The editor has arranged for this set to be on show at Olympia. You will find it displayed on the T.M.C. Hydra Stand.

Howard Barry's Log of the Standard A.C. Four-valve Short-waver

COIL B.T.S. Coil No.	STATION	WAVELENGTH	READING (Band - spreader set at 90 divisions and reading taken on main condenser.)
" 46-96 "	HJ4ABE, Colombia	50.6	28
	XEBT, Mexico City	50.0	27.5
	HP5B, Panama	49.75	27
	W4XB, Miami Beach	49.67	26.5
	OXY, Skamlebaek	49.5	26
	VE9GW, Bowmanville	49.22	23
	W8XK, Pittsburgh	48.86	22
" 24-52 "	W8XK, Pittsburgh	48.86	94
	TI-RCC, Costa Rica	45.81	85
	Amateur 40-metre band		70-77
	HBP, Geneva	38.47	58
	PRF5, Rio de Janeiro	31.56	28
	W2XAF, Schenectady	31.48	27
	VK2ME, Sydney	31.28	25
	I2RO, Rome	31.13	23
W8XK, Pittsburgh	25.27	0	
" 13-26 "	DJD, Zeesen	25.49	100
	WIXAL, Boston	25.42	98
	W2XE, Wayne	25.36	97
	W8XK, Pittsburgh	25.27	96
	CT1GO, Portugal	24.20	90
	20-metre amateur band		71-80
	HVJ, Vatican City	19.84	62
	W8XK, Pittsburgh	19.72	61
	W2XE, Wayne	19.64	60
	W2XAD, Schenectady	19.56	59
	DJE, Nauen	16.89	45
	W3XAL, Bound Brook	16.87	44
	PLE, Bandoeng	15.93	35
LSN, Buenos Aires	14.27	23	

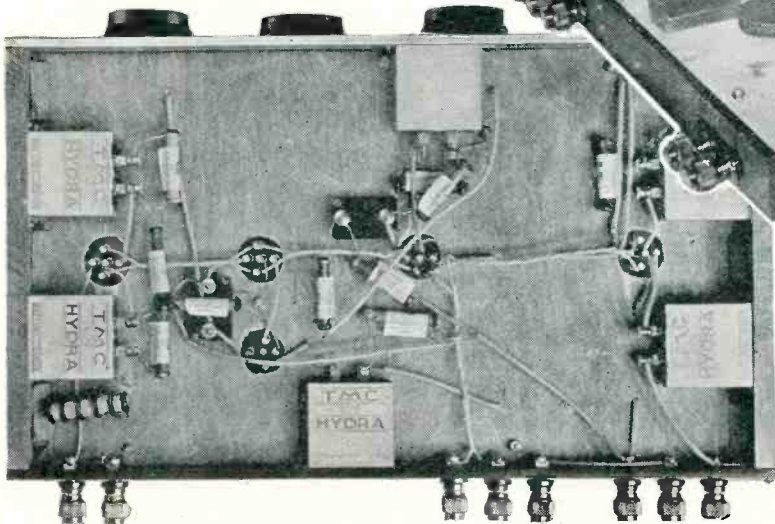
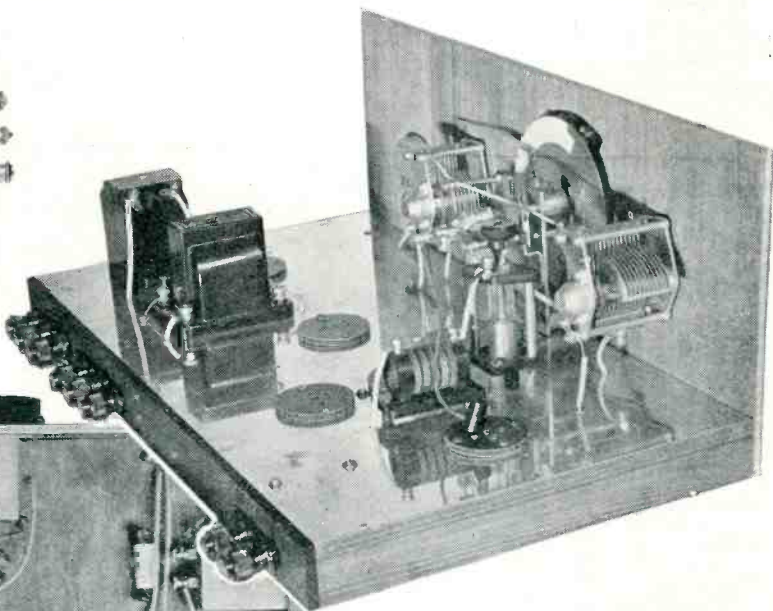
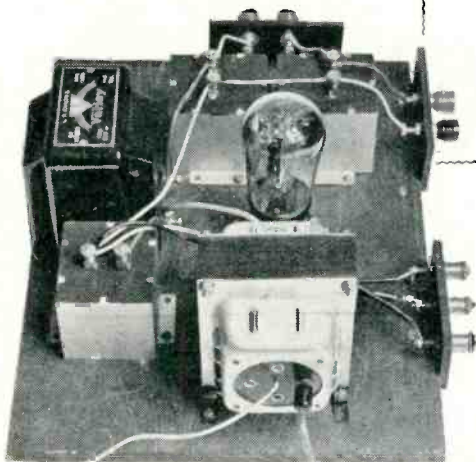

The illustrations on these pages show the simple arrangement of the set and the separate power pack. The set is built up on a shallow wooden baseboard-chassis and most of the wiring—there is very little—is on the underside. Full constructional details were published in the August issue of "W.M.", of which only a few copies are now available. They can be obtained from the publishers, George Newnes, Ltd., 8-11 Southampton Street, Strand, London, W.C.2, price 1s. 3d. post paid. A full-size blueprint can also be obtained, price 1s. 6d., post paid.



Barrett photo

We look forward to meeting you at Stand No. 9 at Olympia, between August 14 and 24. Radiolympia is always worth a visit to see the latest in sets and components. And don't forget that you can get free advice from the "W.M." experts in attendance

Between Ourselves

By BROADCASTER

OUT of the ten bob that you and I and some 7,000,000 other people pay for our wireless licences, the B.B.C.'s share is round about 4s. 9d. The Government, after the manner of Governments, takes several hefty bites at the highly alluring cherry represented by over £3,500,000 of licence fees. First of all the Post Office charges something quite useful—I think it's a shilling a time—for issuing licences. Wouldn't you like to have the job on those terms?

Next, the Income Tax people come along and extract their share of the loot. Last year they charged the B.B.C. £113,000. Lastly, the Government steps in and collars a substantial proportion of what is left. Times are hard and the Government must, as the politicians put it, explore every avenue and leave no stone unturned to raise revenue. But I can't help feeling that an avenue that they might leave unexplored and a stone which might remain unturned are those beneath whose shadow rests the listener's ten-bob note.

There's not a shadow of a doubt that the B.B.C. must have a bigger

share of each of those "ten shillingses." We are seeing already some of the sad results of financial starvation. Every evening, to give one instance, you will find if you switch on your wireless set at 6.30 all the Regional and all the National stations are sending out one and the same programme. That's just a straw showing which way the wind blows. A good many other economy measures have also been found necessary and the sad part from the listener's point of view is that economy spells shorter, less varied, and less attractive programmes.

In the near future the B.B.C. is going to need very much more money than it has ever required before. To begin with there are the improved short-wave services for the Empire. We must have these in order to keep our people in the far corners of the earth in touch with the Mother Country.

If we don't maintain both our transmitting plant and our programmes right up to date, British subjects in out-of-the-way spots will get their news from more powerful and more reliable stations in other countries, and they will come to look to such stations more and more for their entertainment as well.

And on top of all this there is the tremendous problem of the television service. One of the reasons, I imagine, why our own high-definition television service was not started early this summer was that the B.B.C. simply had not the money with which to inaugurate and maintain it. That, too, is one of the reasons why we probably shan't have the London transmitter in full working order before the end of this year or the beginning of next.

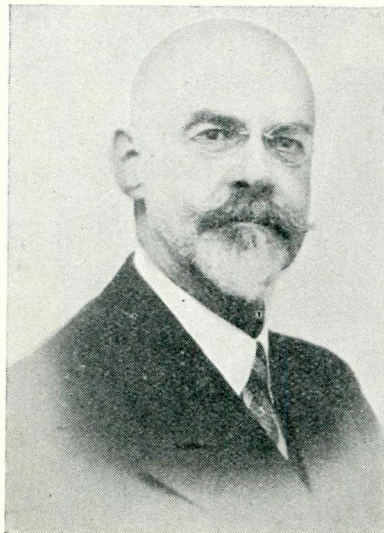

M. Maurice Rambert, who has succeeded Vice-Admiral Sir Charles Carpendale, C.B., as President of the International Broadcasting Union

There is no getting away from the fact that television is going to cost the B.B.C. a lot of money. It's essential, if it is to be the huge success that it must be, for it to cost a heap of money. The transmitting plant must be of the best and the programmes sent out must be worthy of it. Further, it is important that there should be no long gap between the installation of the London plant and the opening of the whole chain of provincial plants one after the other.

It is already proposed that the B.B.C. shall have a bigger share of the licence fees. It is up to us listeners and future viewers to see that this comes about. A lot can be

done by strong and plentiful postcarding your own M.P.

When you read these notes you will either be making arrangements to visit the Olympia Radio Exhibition, or wishing that you could! It's going to be a particularly interesting exhibition in all kinds of ways. If I may so put it, one of the most thrilling things about it is that there probably won't be any great thrills.

("No, Albert, the gentleman has no Irish blood in his veins. Let's read on and see what he means, if he means anything.")

What I am driving at is this. In the last eighteen months or so a complete change has come over the wireless receiving set. In a word, it has abandoned its riotous youth, when it was a piece of electrical machinery requiring expert handling, and has now settled down quietly as a thoroughly domesticated appliance needing far less skill for its operation than the sewing machine. There is little room nowadays for stunts—and stunts provided many of the thrills of former years at Olympia.

Nor are there likely to be any startling new ideas to leave us gaping, as did the screened-grid valve, the pentode, and the moving-coil speaker, each in its day. What we shall find is that the standard receiving set of today contains most of the refinements seen only in the luxury sets of yesteryear, and that, owing to production on the grand scale, we can get far more for our money than was ever before thought possible.

We shall notice a considerable improvement in the general handiness of sets; sensitiveness will be a strong feature, and today's demand for high-quality reproduction will be well met. One other point of importance is the much better and more attractive cabinet work that will characterise the good sets of this season.

If you want to realise to the full the remarkable advance that has been made in radio cabinet work, just turn up an old catalogue or look through the advertisement pages of copies of "Wireless Magazine" of two or three years ago. You will, I think, be very surprised at the contrasts that the illustrations of receiving sets of those days present in comparison with the sets of today.

The stage of wireless cabinet work have been very interesting. In the funny old days if the set had a cover at all it took the form of an oblong box with a lift-up lid. The set, built upon a baseboard with attached panel, slid into the cabinet drawer-fashion from the front. Both this sliding action and the lift-up lid were very necessary to enable one to get at the bowels of the apparatus in order to make the adjustments that were so frequently required.

Early cabinets were emphatically not things of beauty. A visitor to France is always struck by the fact that railway locomotives display to the public gaze all kinds of entrails that our own keep covered up in more seemly fashion. So it was with the old wireless sets. Originally all were battery operated, and if the set stood on the grand piano, there was on the carpet beneath the instrument an array of batteries with trailing tendrils of wire. In that era the receiving set was definitely not popular with our long-suffering better halves.

Then came what I always call the tombstone type of cabinet—rather narrow with straight sides and a



Four miles of graphs have been made at the I.B.U. checking post in Brussels. These graphs give a complete record of the periodicity of fading of Europe's broadcasters for the past few years

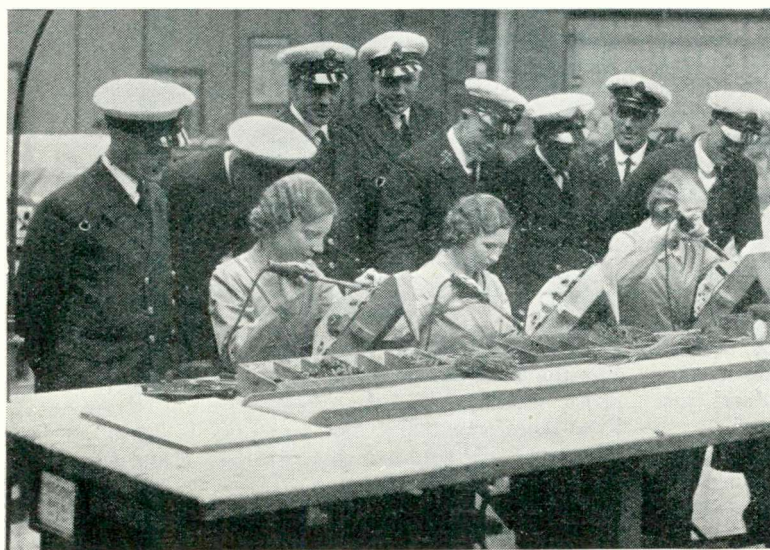

First-hand information for a group of wireless operators from experienced hands at Ekco's Southend-on-Sea factory! Large parties of men off naval vessels were conducted round the Ekco works during the Home Fleet's visit to the Thames Estuary during Jubilee Week

rounded top. This was much better, and one big advantage was that it could contain all the works without any festoons of wire, save for the connections to aerial and earth. It was, though, far from being a joy to the eye.

The real change came when the cabinet makers employed men and women with artistic tastes to design cabinets. Nowadays many of them—the cabinets, I mean, of course—are things of beauty whose presence is welcomed by the lady of the house.

Within a very short time now many of the big stations erected under the French Regional scheme will be in full blast. Their opening has been rather long delayed, but once they are with us we shall find that they were worth waiting for. As I write both the Camphin station at Lille and Lyons-Tramoyes are testing outside programme hours, and I hear that work on two or three of the others is well advanced.



Admiral Byrd, who recently returned to New York after a two-year expedition in Antarctic wastes, is seen here before the Columbia Network's microphone. His talks on his experiences have been broadcast by leading American short-wave transmitters and have been received well in this country

The new Lyons station is sure to be known as "Tramways" by long-distance enthusiasts. It is taking over the wavelength of the old La Doua transmitter, which will presumably go to one of the common wavelengths unless it is closed down altogether. From what I have heard of the new transmitters, Lyons is going to be a jolly good Continental station for British listeners.

La Doua was pretty well heard in the past, but with its 100 kilowatts "Tramways" will put it very much in the shade. And on the long waves we can look forward to fine reception of Radio Paris this winter when the power is increased from 80 to 150 kilowatts. On the long waves, though, there is one rather big "if."

The trouble about the long waves is that pretty well every country in Europe is burning to have a high-powered station working on a wavelength of 1,000 metres or more. The ether was cleared to a great extent when the Eiffel Tower at long last became a medium-wave station, but all kinds of adventures seem to be in store for us in the future. For instance, the 1,875-metre wavelength belongs, according to the Lucerne Plan, to Brasov in Roumania, and Brasov's brand new 150-kilowatt transmitter is ready and waiting to lift up its voice. But our old friend Huizen sat down firmly on that wavelength many moons ago and refuses to budge.

The best way of backing up such a refusal today is to possess the loud voice that comes of ample kilowatts. For this reason the 7-kilowatt Huizen transmitter has now gone right out of business and the 50-kilowatt Kootwijk has taken over the entire programme service. You certainly can't have a 50-kilowatt station sharing a wavelength with one of 150 kilowatts, and just what will happen to Brasov no man can foretell.

Then, as I have just mentioned, Radio Paris is going up to 150 kilowatts, and the Deutschlandsender from 60 to 150 or more. Just to make matters easier Spain has at last decided to go ahead with her Regional scheme, which includes a 150-kilowatt long-wave plant for Madrid. So far as I can see the old problem of putting a quart into a pint pot will be a simple affair with that of fitting the long-wave stations into the long waveband.

Perhaps it will be solved by finding channels for some broadcasting stations on wavelengths of nearly 3,000 metres—and *won't* that make our set designers happy?

The German Government, it appears, has agreed to give television a strong financial backing, which amounts virtually to guaranteeing manufacturers of television receivers against losses. At first sight this seems a most laudable policy, but, as is not unusually the case, there is an outsized fly in the ointment—a fly that calls urgently for the swatter.

The fly is just this: The German Government has realised the enormous value of television for propaganda purposes, and that is why it is so generous with the taxpayers' money. We have already seen what regrettable results can attend the roping-in of broadcasting for propaganda purposes.

One reason why it has been so difficult for delegates at conferences at Geneva, Prague or Lucerne to reach general agreement about wavelength allotments is that so many countries desire an unconscionable number of kilowatts and individual channels for the purpose of disseminating political propaganda both inside and outside their own borders. Broadcasting should be kept for entertainment and the same applies even more forcibly to television. The misuse of either for political ends is nothing less than a tragedy.

This is going to be a memorable year in the history of short-wave wireless. Though there are thousands of enthusiasts for this most interesting form of long-distance reception, short-wave listening has not so far caught on with the British public to anything like the same extent that it has with listeners in some other countries. This has been due to some extent to the fact that in the past the short-wave set was apt to be rather a box of tricks.

As readers of the "W.M." have seen, the up-to-date

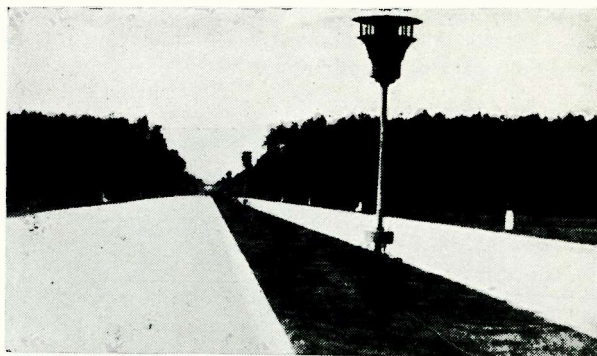

No, this is not one of Mr. Belisha's dual-carriage roadways! It is the railway route between Frankfort and Darmstadt where motor-car trains have the complete right of way. The whole route has been lined with special omni-directional public-address loudspeakers

short-waver is both inexpensive and easy to handle. But the ideal set is the all-waver, which takes in the short, medium, and long bands, tuning from, say, 15 to 80 metres, 200 to 550, and 1,000 to 2,000. Many firms are bringing out such sets this year, and I am sure that they will be popular.

I have already handled some of them, and nothing could be simpler to use. It is a great thing to be able by merely turning the knob of a switch to change over from the ordinary broadcast wavelengths to the short, on which entertainment from practically every civilised country in the world is available.

Our monthly collection of hints and tips, practical notes, news and views for the serviceman deals this time with some interesting new accessory devices, servicing appliances for all-wave receivers, a combined A.C./D.C. measuring and testing instrument and a self-calibrating ohm-meter

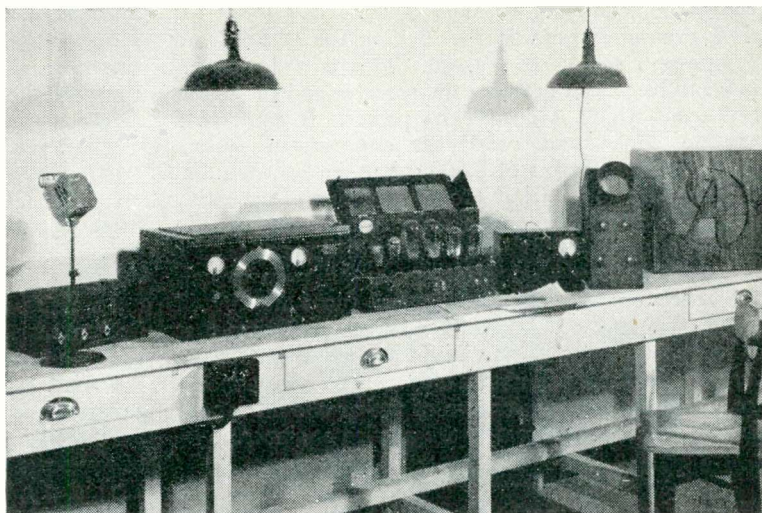

An imposing collection of testing and measuring apparatus in the Ardenne acoustic laboratory. The gear used here includes beat-frequency oscillators, power-level indicators, hum-level meters, cathode-ray oscillographs, attenuators, etc.

Hints for the Service Engineer

Conducted by G. P. KENDALL, B.Sc.

BEFORE dealing with more strictly technical matters I want to refer to one or two news items of interest to the enterprising service engineer which I have noted in sundry manufacturers' publications. First I observe a reminder in a recent issue of the "Philco Serviceman" that supplies of the Philco Technical Information Binder are running low; all concerned with servicing receivers made by this firm should note the need for early application for this useful production. (Price 1s. 6d. from the Philco Radio and Television Corporation, Ltd., Perivale, Middlesex.)

Then in the Bulgin Monthly Bulletin I see details of the VT14 all-valve tester in its latest form; this is a very complete set of plug-in conveniences for inserting meters in the various relevant circuits of a valve when actually working in the receiver and should be capable of saving much time in routine checking work.

With the aid of various reducing adapters it covers practically every type of valve fitting in a very simple fashion. Full details appear in Bulgin's Bulletin No. 8 (new series).

Short Waves Will be Important

The June issue of the "Philco Serviceman" provides the answer to several inquiries I have received for an accurately-controlled short-wave signal generator. The Philco instrument provides a signal of 36 megacycles, held within very narrow limits by a crystal and carrying its own modulation. The generator is put up in a neat all-metal case and sells for £10 10s. complete with two valves, crystal and batteries.

There seems little doubt now that the coming season

will see a very considerable increase in the popularity of the all-wave receiver and it behoves us all to see that we are provided with the equipment needful in servicing this type. For the simpler kinds of set, in particular, some sort of wavemeter will be extremely useful, but beware of the heterodyne type in conjunction with receivers employing a short-wave convertor stage: the number of possible beats between harmonics and overtones in the outputs of the meter valve and of the converter stage almost defies counting unless due precautions are taken.

Essential Precautions

For such work the meter must be of a well designed type with the lowest possible harmonic content, and it *must* be placed as far as ever you can get it from the receiver you are checking up. The idea is to move it away until you find that you can pick up only a single indication, whereupon it is fairly safe to assume that you are getting the fundamental.

No doubt the majority of the all-wave receivers will carry full-calibrated dials, but even in these cases a meter will have its uses for rapid station identification just as it has on the more familiar waves.



Dealing with local interference coming in along the mains leads is a familiar operation to most service engineers and the general principles are well understood. I doubt, however, whether it is sufficiently widely known that it is no longer necessary to make up one's own apparatus for the purpose. For business reasons many will probably wish to go on doing this, but when time is a factor it is well to bear in mind that many

good standard types of suppressors can now be obtained ready for installation.

For example, there is the Belling-Lee "Set-Lead Suppressor" selling at 17s. 6d. This is a device intended to be placed between the receiver and the mains point from which it derives its power. It contains a complete choke and condenser suppression system comprising two chokes of 8,500 microhenries each and three condensers of .01 microfarad, with the necessary pair of fuses and connection devices, all contained in neat and entirely "safe" moulded bakelite case.

The chokes are rated to carry anything up to half an ampere continuously, while the fuses fitted will blow at one ampere. There is thus the assurance that in the event of any short circuit beyond the unit the house system fuses will not be blown. The good appearance, small size and quickness of fitting should render this device a distinct asset to the service engineer.

Useful Ranges

For review this month we have a very interesting little instrument of great potential usefulness in all cases calling for compact and readily portable apparatus—the Universal Avominor. This is a combination meter only a little larger than the ordinary D.C. Avominor and (it measures $4\frac{3}{4}$ in. by $3\frac{3}{4}$ in. by $1\frac{3}{4}$ in.) providing a surprisingly large number of scales.

It will serve as a continuity tester and measure resistances up to 20,000 ohms with the aid of an internal battery, while with the aid of an external source of voltage, resistances up to 10 megohms can be checked. Fairly high voltages are needed on the upper ranges, and a little descretion is naturally required, but subject to this proviso excellent results can be obtained.

On D.C. the intrument covers milliamperes in the following ranges : 0-2.5, 0-5, 0-25, 0-100, 0-500. D.C. voltages can be measured in ranges of 0-.075, 0-5, 0-25, 0-100, 0-250, 0-500. An A.C. the following voltage ranges can be obtained : 0-5, 0-25, 0-100, 0-250, 0-500.

Control Devices

The selection of the various ranges is performed very much as in the case of the smaller instrument—by the insertion of the plug-tipped connecting leads in the appropriate sockets—with the addition of a change-over switch for use when setting for a measurement on D.C. or A.C. There is also a small control on the front for setting the zero of the resistance scales. The connecting devices, by the way, are neatly tucked away in a recess (covered) in the base of the instrument when not in use.

The price is £5, and that strikes me as distinctly moderate when one bears in mind the multiplicity of ranges and the surprisingly high standard of accuracy achieved. In this connection it must be remembered that the instrument is to be regarded as replacing two or even three meters of the more conventional type. In fact its purchase is a distinct value-for-money proposition.

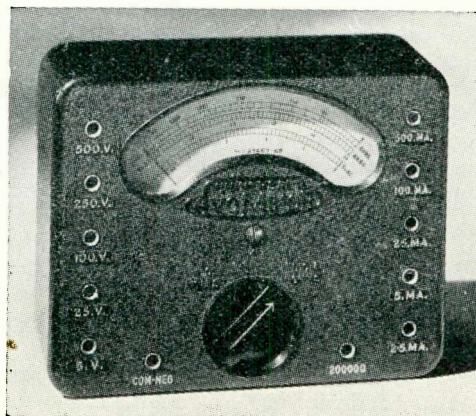

The Universal Avominor: note the system of socket connections for range-selection. The switch provides the necessary change-over between A.C. and D.C. measurements

Last month I made a promise to give details of a home-calibrated ohm-meter device in this issue : well, I find I am even more hard up for space than usual this time, so I hope I may be forgiven if I give only the preliminary matter needed in getting the device rigged up for trial.

First you want a milliammeter of the low-reading type. The ideal scale is 0-1 milliampere, and I will assume that one of these is to be used (it makes the arithmetic much simpler).

Self-Adjusting Instrument

In series with the meter and a battery you place a known resistance and arrange a pair of terminals so that the unknown one can also be brought into circuit. Then if you know the voltage you can calculate the total resistance from Ohm's Law and obtain your result by subtracting the known resistance from the total. That, of course, is a clumsy method and actual calibration with the aid of a few calculations and a piece of graph paper is to be preferred.

The idea of the known resistance is to make the instrument self-adjusting in the sense that no means of measuring the battery voltage directly is necessary when the resistance is correctly chosen. Thus, for general work a resistance of 10,000 ohms may be used, and this will result in a full-scale reading on the meter when the battery voltage is exactly 10.

In practice, therefore, one merely adjusts the voltage until the needle goes to the end of the scale when the measuring terminals of the device are shorted together; it is then ready for use. As a secondary point it may be noted that the presence of the resistance protects the meter from damage when the terminals are thus joined.

Calculating Resistance Values

Since the voltage is now 10 it follows that a reading of .1 milliampere will result when the total circuit resistance is 100,000 ohms, .2 milliampere means that the resistance is 50,000 ohms, .5 milliampere denotes 20,000 ohms, and so on. Now you begin to see how the calibration is arrived at: one simply calculates the total resistance corresponding to each division on the meter scale and subtracts from these figures the known internal resistance of 10,000 ohms. As the last step a graph can be drawn but even a table of currents and resistances will serve.

It will be noted that the scale will be cramped at the upper end, that is above about 50,000 ohms: the effectively useful range with a series resistance of 10,000 ohms really extends only up to about that point. This, however, covers most of the voltage-dropping and de-coupling resistances in a mains set, likewise such things as interval transformer windings.

For the measurement of higher resistances it becomes necessary to employ a higher known resistance and a correspondingly increased test voltage. These, however, are things I must leave for next month.

NO trouble is spared in the organisation of the "W.M." Set Selection Bureau's free service to readers—a service that has helped thousands of listeners to acquire radio receivers consistent with their own individual requirements.

If you are one of our huge constructor brigade we ask you to pass on the news of this free service to your friends. Many new readers, who join our ranks at exhibition time, will be wise if they consult the bureau before they finally choose their new season's receiver.

The advice is given without prejudice. The reader's answers to the questions set out in the panel at the bottom of this page are carefully analysed and a selection of suitable receivers, chosen from those that have undergone tests in our



Radio is now part and parcel of every home. To enjoy its immense entertainment possibilities you must have a set that fully lives up to your own individual requirements. The "W.M." Set Selection Bureau is at your disposal to assist you in making a wise choice. Our illustration shows the H.M.V. Superhet Console Five in a modern home setting.

Our Tests of the New Sets

By the "W.M." Set Selection Bureau

laboratories, is given in our reply together with useful information on any points raised in the reader's letter.

We pride ourselves upon this service, which is entirely free and which has brought many hundreds of letters expressing satisfaction with our helpful advice.

The reports which appear each month are of a general nature and cover a description of the general layout and design of the set in question, together with remarks on its performance. In addition to this the Bureau compiles a much more detailed analysis of the set's specification and its performance under all manner of conditions and it is this detailed information that enables us to suggest suitable sets to suit the whims of different listeners.

There are, of course, many sets tested by the Bureau which are not commented upon. We do not wish to create the impression that such sets are not satisfactory. We have only a limited number of pages

at our disposal for set reviews each month, so that to review all the commercially-made receivers on the market today would be an absolute impossibility.

FREE ADVICE FOR SET BUYERS

To make the most of this free advice service, we ask you to answer the following questions:—

(1) The maximum price you wish to pay, and whether you are prepared to exceed this if there is no suitable set at your desired price.

(2) The locality in which the set will be installed.

(3) The stations required, that is, locals only or a selection of foreigners.

(4) Whether you want an entirely self-contained set or one with external aerial and earth.

(5) Whether battery or mains driven, if the latter, whether A.C., D.C., or A.C./D.C.

(6) Special requirements: Quality needs; appearance, etc.

A stamped-addressed envelope for our reply is your only expense. Address your inquiry to Set Selection Bureau, "Wireless Magazine," 8-11 Southampton Street, Strand, W.C.2.

There are, naturally, a number of sets that our tests prove to be unsatisfactory for recommendation, but in every case we offer suggestions to the set manufacturers concerned and the trouble is more often than not put right.

The standard, on the whole, of present-day receivers is extremely high, though when we make a careful study of a particular reader's requirements it is surprising how few sets there are that incorporate *all* his individual needs.

With regard to question one of the panel; we would stress the point to those who will be taking advantage of this service that if you require a "complicated" specification, for instance, an all-wave receiver to work off 110 volts D.C., you must be fair in the price you are prepared to pay.

Not one but many ambitious listeners have asked us to recommend an all-wave A.C. mains receiver for £7. As much as we would like to help these disillusioned people, we have to reply that such sets cannot be obtained for less than from £15 to £18.

Please be generous on the price question; you can get so much better value for your money if you are prepared to pay a couple of pounds more than the average. And considering the length of time you will be using the set, the extra cost is very little after all is said and done.

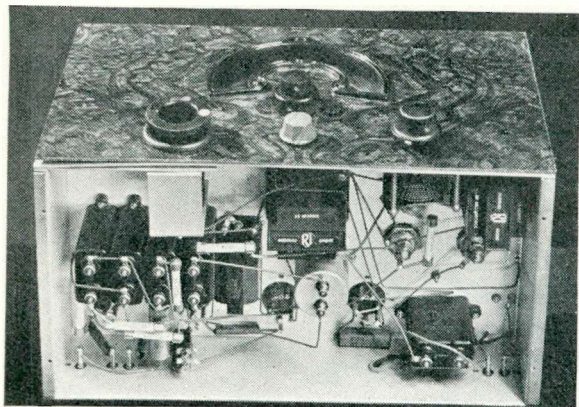

A view of the underside of the B.T.S. four-valve A.C./D.C. kit set. All components are thoroughly reliable and include several makes well-known to "W.M." constructors

As you can see from the title this is a kit set. B.T.S., however, supplied us with the finished receiver together with copies of the building instructions and blueprint which they send out with the components to purchasers.

We have carefully studied this blueprint in conjunction with the finished receiver and can honestly remark that the average man will find the building quite simple. He has, besides the components, the chassis and panel cut and drilled, so really his work amounts to little more than assembling and wiring up.

The circuit is a well-tried one. The popular three-valve sequence of variable- μ high-frequency amplifier, leaky-grid detector and pentode output can, providing some care is taken in the circuit design, be relied upon to give really efficient results. The high-frequency stage is untuned and there is only one tuning coil—this is of the four-pin plug-in type which here is pushed into its socket via an opening in the front of the panel.

Four coils are supplied with the kit covering ranges of from 13 to 260 metres. The coil in use is tuned with a .00016-microfarad tuning condenser equipped with a double slow-motion drive giving 7 or 100 to 1 gearing. Incidentally we were pleased to note that the reaction condenser was also provided with a slow-motion drive.

The detector valve, arranged in the leaky-grid manner, is transformer coupled to the output pentode of the Catkin variety and capable of giving an undistorted output of $2\frac{1}{2}$ watts.

The panel layout is quite attractive. In the centre is the large

motion drive and in the centre at the bottom is the on-off switch. To the right of the switch is the reaction control.

Mains voltage adjustment is accomplished by using the appropriate tapping of the Bulgin mains resistance.

The connecting leads to the mains supply are brought out from the back of the set chassis on which are also sockets for the loudspeaker, two aerial tappings and earth, while there is a plug and jack to permit the use of a pick-up.

Our tests have proved that the set is sufficiently sensitive and selective to enable the average radio listener to get more than satisfactory results.

Our tests endorsed the makers' claim for wide-world reception. Any evening we could log six or seven United States stations—W8XK on 19.93 metres being easily the best in the early evening. At 11.30 p.m. the "star" was Rio de Janeiro (PRF5) on 31.58 metres. Both

B.T.S. A.C./D.C. Short-Wave Kit

signals literally shook the loudspeaker—and we were using a perfectly ordinary 30 ft. outdoor aerial.

All the main European stations—Zeesen, Radio Coloniale (Paris), Moscow and Rome—came through with ease at fine strength. Quality of reception was particularly good and we were extremely pleased to note the complete absence of hum.

All the main European stations—Zeesen, Radio Coloniale (Paris), Moscow and Rome—came through with ease at fine strength. Quality of reception was particularly good and we were extremely pleased to note the complete absence of hum.

BRIEF SPECIFICATION

BRAND NAME: B.T.S.
MODEL: 4-valve A.C./D.C. Short-wave Receiver Kit.
PRICE: £8 8s. excluding valves, cabinet, and loudspeaker.
VALVE COMBINATION: Three-valve "straight" receiver with one high-frequency stage (Marconi or Osram W30), triode detector (Marconi-Osram H30), and pentode output (Marconi-Osram N30). A valve rectifier which comes into use on A.C. mains only, is a Marconi or Osram U30.
POWER SUPPLY: 190 to 250 volts A.C. or D.C. mains.
MAKERS: British Television Supplies, Ltd., Bush House, London, W.C.2.

About tuning: it is very simple and no doubt the ordinary set user who can get fair results on the medium waves would soon become an accomplished short-wave enthusiast after a few sittings with this B.T.S. short-waver.

We do want to stress that in spite of the huge distances that can be covered, the quality of the entertainment provided is comparable with that of the ordinary set, atmospherics permitting.

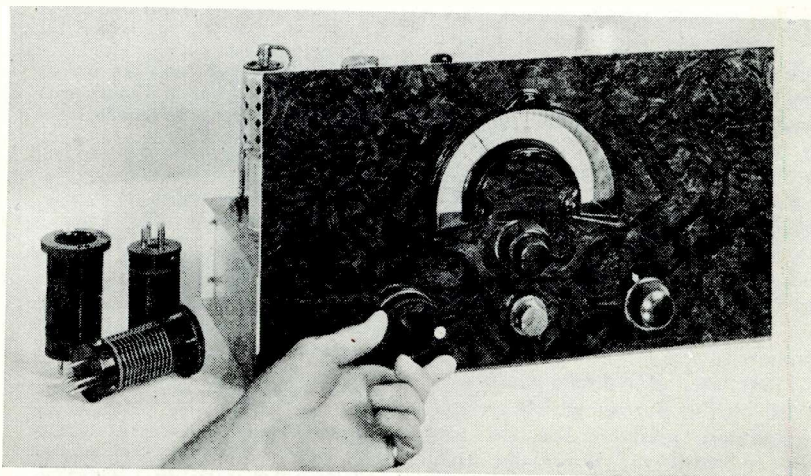

The panel layout is extremely neat and simple. The full-vision scale and main tuner with an on-off switch below are in the centre, with the coil fitting on the left and the reaction control on the right

McMichael Model 135 Twin-speaker Superhet

BRIEF SPECIFICATION

BRAND NAME : McMichael.
 MODEL : 135
 PRICE : £15 15s. (stand £2 2s. extra).
 VALVE COMBINATION : Five valves (including rectifier) in superhet sequence. The arrangement is a triode-pentode frequency-changer (Mazda AC/TP), intermediate-frequency amplifier (Cossor MVS-Pen), second detection and A.V.C. voltage is provided by a double diode (Cossor DD4), and pentode output (Mazda AC2/Pen). High-tension current is supplied by a full-wave rectifying valve (Cossor 442BU).
 POWER SUPPLY : A.C. mains, 200-250 volts, 50 cycles.
 MAKERS : McMichael Radio, Ltd., Slough, Bucks.

ANYONE who has tested the new McMichael 135 will keep a lasting impression of the set's easy tuning and its amazingly good quality. Quality has always been the bugbear of the smaller superhets and when one comes across a medium-priced receiver that literally makes one stop and listen then there is a justifiable excuse for the tester to break into his stock vocabulary of "praiseworthy" adjectives.

No doubt two main features contribute to the 135's fine quality—a well-designed circuit, and the use of balanced loudspeakers in a cabinet designed for its acoustical properties as well as its appearance.

As you can see from the illustrations the set's appearance is indeed somewhat out of the ordinary; the cabinet is of walnut with two octagonal openings on the front, backed with gold silk, behind which are two moving-coil reproducers.

Under a hinged lid are the set's controls; from left to right these are tone control, on-off switch and volume control, wave-change switch and tuner. Of the set's fittings the most notable is the detachable tuning scale marked clockwise with wavelengths and the names of the more important stations.

The scale is illuminated by a light which shines down on it from the underside of the lid. There is no excuse for leaving the set

switched on when the lid is closed, for this light also illuminates a small monogram which you can see very clearly in the centre of the lip of the lid in the bottom illustration.

About the circuit we need say little; the specification panel will show that four valves are used in a typical superhet arrangement with a fifth valve as a mains rectifier.

In our examination of the interior we were quick to notice the clean layout and the meticulous care that must have been expended on the layout and construction. No doubt efficiency demanded that the voltage-adjustment device should be placed in a rather out-of-the-way position, but after all, this is adjusted only once and then forgotten.

Our tests were made on a small outdoor aerial some 30 ft. long in London's southern suburbs.

Our first consideration was hum level. We were entirely satisfied on this score; the hum was of such slight intensity that it was not worth consideration.

Our first tests were made in the



A really handsome piece of furniture as well as a thoroughly recommended radio receiver, the McMichael model 135. With the stand as shown the cost is £17 17s.

late evening on the medium waveband. Of the fifty-two stations marked on the scale about thirty were received at "entertainment value." The automatic volume control system does its work extremely well and greatly enhances the listening value of the 135.

The unusually large tuning scale, some 10 in. square, made logging stations an easy pastime and we were glad to notice the extreme accuracy of both the wavelength and station markings.

In spite of the well-balanced quality of reproduction obtained when the tone control knob was set to give the maximum top-note response the selectivity was in no way impaired. All closely-packed high-power stations could be sorted out and any of them provided a welcome alternative to B.B.C. entertainment.

Long-wave selectivity was equally satisfactory, and we experienced no difficulty in getting Luxembourg clear, or in separating stations at the "top-end" of the scale.

This McMichael is capable of bringing in a fair number of foreign stations in daylight hours.

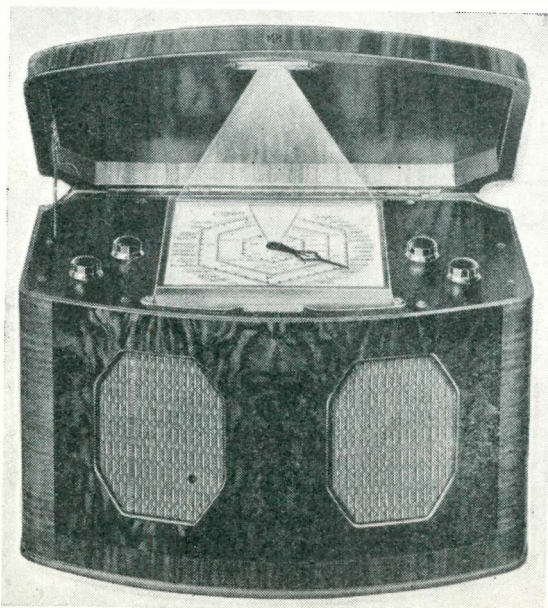

Here is the model 135 showing the layout of the tuning controls and the 10-in. tuning scale, which is easily replaceable in the event of European wavelength alterations. The card is pulled out from the front from under its glass cover.

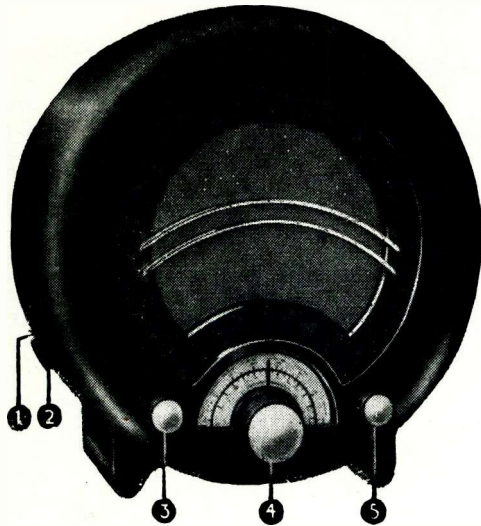

Showing the controls of the Ekco AD36 receiver. (1) On-off switch; (2) wave-change switch; (3) volume control; (4) tuner, and (5) reaction control

WELL, here is a set with a circuit that seems quite strange nowadays — an ordinary straight three-valver. Before we pass any comment, we must congratulate the makers on a really wonderful set—a set that brings quality radio within the reach of all.

There is not the slightest doubt that quality was the prime considera-

BRIEF SPECIFICATION

BRAND NAME: Ekco.

MODEL: AD36.

PRICE: £8 8s. (black and chromium finish 10s. 6d. extra).

VALVE COMBINATION: Three-valve straight set with fourth valve as rectifier. High-frequency amplifier (Mullard SP13), detector (Mullard HL13), and output pentode (Mazda Pen 35/20). The rectifier is a Brimar 1D5.

POWER SUPPLY: Universal (A.C. or D.C.) mains, 200-250 volts.

MAKERS: E. K. Cole, Ltd., Ekco Works, South-end-on-Sea, Essex.

tion of the designers. The quality of this AD36 is not hard to define; there is really brilliant top-note response, the middle is there and so is the bass, the latter without any boom. There was no hum.

For eight guineas one can become possessed of an all-mains receiver with moving-coil loudspeaker giving the standard table-receiver volume of over 2.5 watts. There is no tone control, and you must therefore accept what the loudspeaker gives. You cannot cut top notes—and you won't want to!

The set itself is a straight three-valver—a very efficient arrangement using two tuned circuits. There are three valves—H.F. pentode, detec-

Ekco Model AD36 AC/DC Receiver

tor, and output pentode. The fourth valve is the rectifier.

We are getting used to Ekco's unorthodox bakelite cabinet designs; this one is round with three main controls—volume control on the left, tuner in the centre, and reaction on the right—grouped at the bottom of the loudspeaker fret on the front.

On the left side of the cabinet are the on-off and the wave-change switches—there is no provision for gramophone pick-up. The semi-circular tuning scale is calibrated with names of thirty-one medium and six long-wave stations in addition to wavelengths in steps of 10 metres for the medium, and 50 for the long.

The tuning scale is very easily detached, and should further wavelength shuffles necessitating a new scale occur, one can be fitted with little ado.

As you can see from the photograph, the interior layout consists mainly of a big loudspeaker, four valves, a condenser block and a huge mains dropping resistance on top of the chassis, the rest of the parts, ganged condenser, coils, etc., being accommodated in the very limited space below.

We were rather bold in our tests of this set. We used a 50 ft. outdoor aerial connected to the solitary aerial socket and a poor earth; we have A.C. mains supply.

Having adjusted the wave-change switch for the medium waveband, we switched on. The set took exactly 30 seconds to warm up. We tried selectivity first, giving the set the benefit of careful handling of volume and reaction with the latter advanced as much as possible and the volume control turned down as

far as we could. London Regional spread over "30 metres on the dial." Berlin on 356.7 metres could be heard with a very faint background of the Regional.

London National had even less spread and we easily logged Radio Normandy at full signal strength without any background of the National, only 8.4 metres away. Old hands will know that for a three-valver this degree of selectivity under ordinary conditions is really extraordinary.

With careful manipulation of the reaction and volume control we tuned in over thirty medium wavers

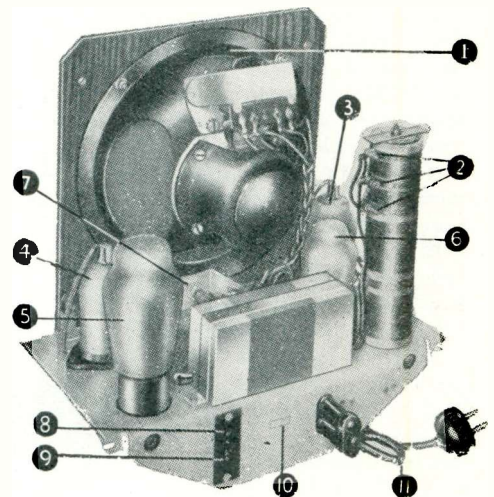

An unusually neat and simply laid-out chassis. The numbers give the key to the following components: (1) loudspeaker; (2) mains-voltage adjustment; (3) H.F. amplifier valve; (4) detector valve; (5) output pentode; (6) rectifier; (7) pilot light; (8) aerial socket; (9) earth socket; (10) serial number, and (11) mains lead

almost clear—twenty were as good as the two locals, except for the unwelcome signals of Mother Nature.

On the long waves Berlin was useless as entertainment when Droitwich and Radio Paris were working. However, we logged Droitwich, Paris, Moscow and Kootwijk free of interference — Luxembourg was slightly troubled by a high-pitched whistle.

Daylight range was particularly good. In fact it is definitely better than that of many of the smaller superhets.

H.M.V. Superhet Four-Forty-One

THIS is probably the most popular set in the H.M.V. range and a real home entertainer. It is a table set of the four-valve superhet type. The time has come when the number of valves in the specification should be supplanted by a full description of the circuit.

In this H.M.V. receiver we have first of all, a heptode frequency-changer, which does the work of two valves—first detector and oscillator—then comes the intermediate-frequency amplifier, a variable-mu

loudspeaker fret, very simply decorated, at the top. Just underneath this is a large tuning scale, calibrated in metres from 200 to 550 and from 1,000 to 2,000 as well as with the names of the principal English and Continental broadcasters, and the four square control knobs.

These four knobs from left to right are the volume control, combined with the switch for bringing the quiet automatic volume control into circuit; tone control; tuner, and lastly the combined wave-change, gramo-radio and on-off switch.

When the Q.A.V.C. is in circuit the sensitivity of the set is somewhat reduced, but the advantages gained are complete silence when tuning between stations and an almost complete absence of background noise and similar crackles, etc.

So much for the technicalities of the model 441. Some tribute must be paid to the interior construction. Our examination of the set chassis revealed a perfect specimen of the commercial set-maker's skill—neatness of layout, compactness coupled with thoroughly good workmanship.

On test we were more than satisfied with the set's capabilities. Most of

our night-time tests were made on an indoor aerial consisting of a few feet of ordinary rubber-covered wire slung round the picture rail. In South London on this aerial we logged no fewer than thirty stations on the medium waveband under these conditions. With the outdoor aerial after dark our medium-wave log just touching the sixty mark; of these stations about forty could truthfully be said to give entertainment.

With the Q.A.V.C. arrangement in circuit and the outdoor aerial we logged about fifteen medium wavers, all giving splendid entertainment.

Long-wave selectivity pleased us immensely. Kootwijk, Radio Paris and Droitwich were entirely free of any interference, and there was but little interference on Zeesen. Luxembourg, the venue of British listeners on Sundays, was received entirely free of whistles or other interference.

Daylight tests were satisfactory. At breakfast time we had the choice of programmes from Radio Normandy, Hilversum, Cologne and a couple of other medium-wave stations, besides all the long-wavers working at that time of the day.

Quality was as good as is possible to get from a table set of the four-valve superhet variety. That is high praise, believe us!

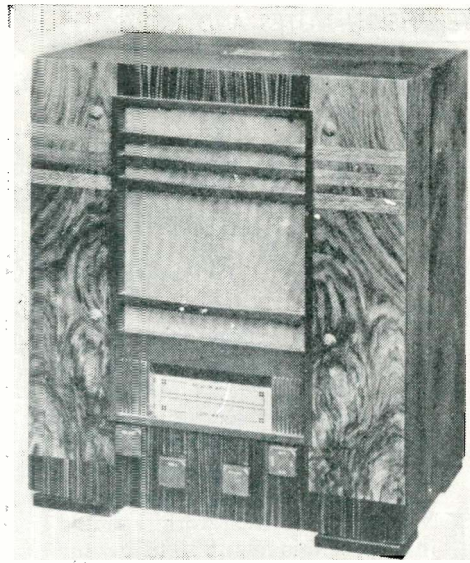

"H.M.V. cabinet being sufficient description of what we all know is a masterpiece of the cabinet-maker's art"

BRIEF SPECIFICATION

BRAND NAME: H.M.V.

MODEL: 441.

TECHNICAL SPECIFICATION: Five-valve (including rectifier) super-het for A.C. mains operation. The four receiving valves are: heptode frequency-changer (Marconi MX40), intermediate-frequency amplifier (Marconi VMS4), double-diode-triode as second detector, A.V.C. and first low-frequency amplifier (Marconi MHDA) and output pentode (Marconi MPT4). The indirectly-heated rectifier is a Marconi U12.

POWER SUPPLY: A.C. mains, 200-250 volts, 50-100 cycles.

PRICE: £13 2s. 6d.

MAKERS: The Gramophone Co., Ltd., 98-108 Clerkenwell Road, London, E.C.1.

high-frequency pentode and this is followed by a double-diode-triode, which performs three separate jobs—second detection by one diode, provision of voltage feedback for automatic volume control, while the triode acts as the first low-frequency amplifier.

The last valve is a power pentode which delivers the bountiful undistorted output of 2.5 watts. So you see that although only four receiving valves are used, they actually do the work of seven.

The set chassis itself is housed at the bottom of an H.M.V. table cabinet—"H.M.V. cabinet" being really sufficient description of what we all know is a masterpiece of the cabinet-maker's art. It is of walnut with really delightful figuring.

Pride of place on the front is given to a square

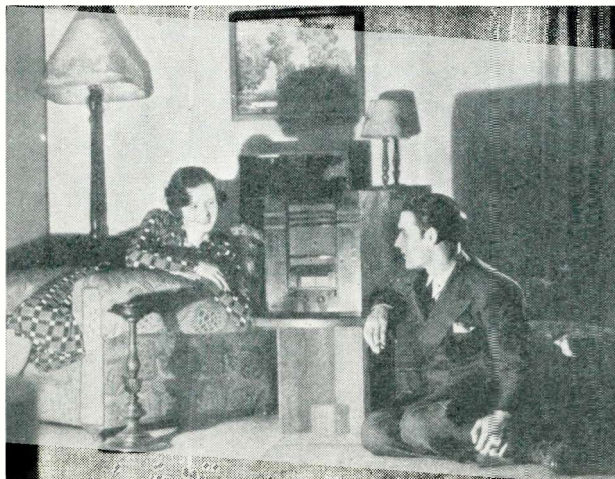

"This is the most popular set in the H.M.V. range and a real home entertainer"

Television and Olympia

Contributed by PAUL WOODWARD

Our contributor laments that he was not able to walk round Olympia before writing his notes this month, but we think readers will agree that he has nevertheless managed to gather some interesting advance information about matters concerned with ultra-short-wave reception

IN a better organised world I should be able to devote my space this month to telling my readers all about the new things in television I had seen at Olympia ; writing these notes as I must early in the month of August I can but describe what I have been able to discover in advance. Very interesting some of it is, too, for there are clear indications that at last the specialised apparatus for high-definition is going to be available for general use by the home experimenter.

For example, I have received a mass of detailed information from British Television Supplies describing their new ultra-short-wave receiving and viewing kit—so far as I am aware the first of its kind to appear on the British market. It consists of a full range of ultra-short components, from valve holders constructed in Megacite—an ultra low-loss ceramic material—to a special wide-response intermediate-frequency transformer, and would seem to have been worked out with commendable care.

The tuning coils are of the thick wire self-supporting type beloved of the true short-wave experimenter, wound with 15-gauge copper wire, silver plated to reduce the surface resistance and provided with highly efficient plug-in fittings. In their various sizes they cover a range from 5 to 10 metres with quite a small tuning capacity.

A special tuning condenser is also provided, again with silver-plated surfaces and Megacite insulation, and with special contact arrangements for the all-important connection to the rotor. Prices and capacities later.

Suitable radio-frequency chokes are provided in two types, but perhaps the most interesting component is the intermediate-frequency transformer ; this consists of a unit incorporating the necessary primary and secondary windings and a pair of low-loss air-dielectric trimming condensers.

It is designed to work on a frequency of 12 megacycles (25 metres) and to cover a maximum modulation bandwidth of $2\frac{1}{2}$ megacycles. Coupling between primary and secondary is variable so that the precise band-width may be adjusted to suit the response conditions desired.

I was interested to note that the literature supplied describing this kit of components includes quite a lot of useful information about the time-base and general driving circuits for the associated cathode tube. Altogether, B.T.S. give the impression of making a really creditable attempt to smooth the path of the would-be home constructor of high-definition apparatus.

New Ultra-short-wave Components

New lines of special value on the ultra-short waves, and hence of importance in high-definition work, are being introduced by, among others, Eddystone, J.B., Graham-Farish, and Bulgin. It should be possible now to assemble a high-definition receiving circuit entirely from ready-made components of good design, for between them the firms I have just mentioned provide all one needs in the way of special parts.

An interesting addition to the range of special high-voltage valve rectifiers intended for cathode-tube work is to be found in the new series of Westinghouse metal rectifiers developed for the same purpose.

Very long and slim in their proportions they remind one of the simpler kind of ebonite aerial lead-in insulators, so far as appearance goes ; electrical details suggest that they will form a very neat solution of the high-tension problem.

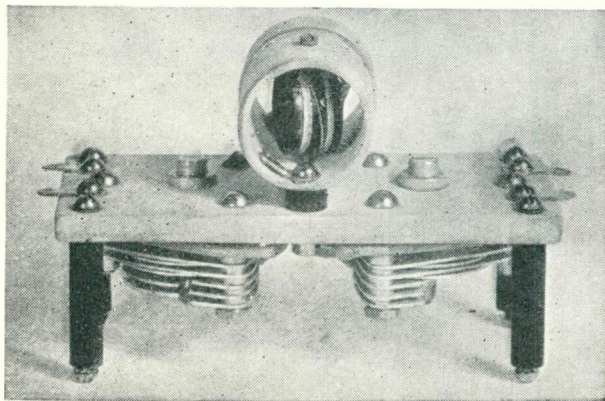

An important item in the new B.T.S. ultra-short-wave receiving kit; the intermediate-frequency transformer with variable coupling between primary and secondary

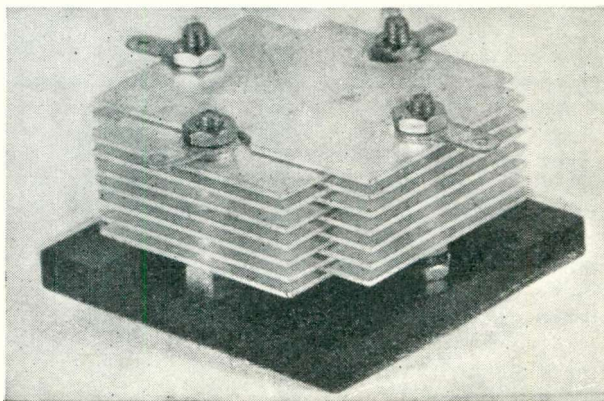

It will probably come as a surprise to many to find what elaborate precautions against losses are taken with ultra-short-wave gear; this B.T.S. air-dielectric fixed condenser is an example

X41

a New Star
FOR SHORT WAVE RECEPTION



OSRAM X41

The
Osram
X41

The latest development in frequency changer valves for modern A.C. Superhets.

The Osram X41 is a combined Triode-Hexode Valve—which employs the electron coupled principle of frequency conversion without the disadvantages of other forms of frequency changers.

SPECIALLY SUITABLE FOR SHORT WAVE RECEPTION including also simplicity and highest efficiency of operation on the B.B.C. wavelengths.

**SEE THE G.E.C. STANDS—
 35 - 44 - 63
 AT RADIO OLYMPIA**

THE A.C. RANGE INCLUDES

amongst other well tried Osram Valves

NEW X41	Triode Hexode.	20/-
NEW VMP4G	HF or IF variable-mu Screen Pentode	17/6
NEW D41	Double Diode	5/6
or MHD4	Double Diode—Triode	15/6
NEW N41	Power Pentode	18/6
or		
NEW DN41	Double Diode—Pentode	21/-
MU12	Indirectly Heated Rectifier	15/-

Osram
Valves

WRITE FOR
 NEW OSRAM
 VALVE GUIDE

MADE IN ENGLAND

Sold By All Radio Dealers

"A TONIC TO ANY SET"

Advt. of The General Electric Co., Ltd., Magnet House, Kingsway, London. W.C.2.

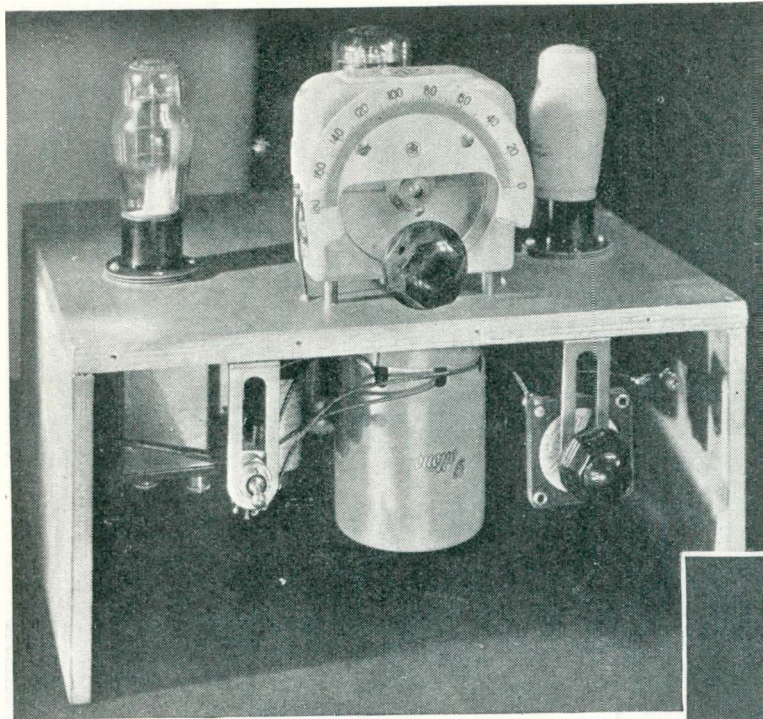

The word "Unicon" was coined to express the idea of universal economy and that is just what this neat little receiver offers. It works on either alternating- or direct-current mains of any voltage above (and including) 200; gives excellent results for a member of the small set class, and really pleasing quality. Simplicity and neatness of construction are assured by the special "W.M." semi-professional system

The Unicon A.C./D.C. Two

By G. P. KENDALL, B.Sc.

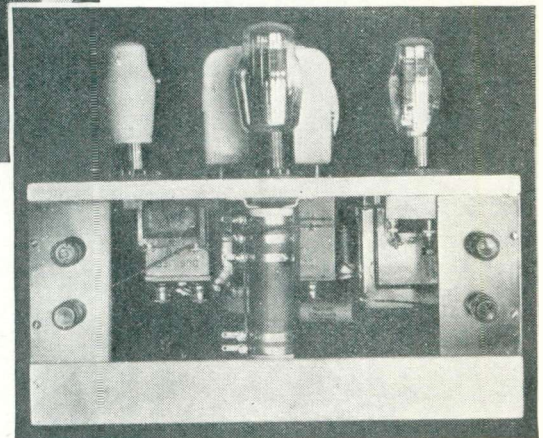

The main controlling resistance for the heater circuits is conveniently placed at the back of the set where it is readily accessible

THEY tell me that sets of the detector and low-frequency type are now dead: that is one of the reasons which decided me to produce the Unicon Two, for when the learned folks come to a conclusion like that, I have observed that it is by no means safe to think it proves that the public no longer want sets of this particular type.

In the case of the detector and low-frequency receiver it seems very probable that the conclusion was a hasty one; recent advances in coil design have enabled one to effect a very marked improvement in the selectivity and sensitivity of these small sets, and I believe it is still distinctly useful for certain specific purposes.

Main Uses of the Small Set

Let me outline my idea of those purposes right away and so, perhaps, save quite a few readers the trouble of reading any more of this article! It seems to me that the main application is in those cases where the local programmes are recognised as forming the main interest, and economy in first cost is a prime consideration.

I do not wish to give the impression that I think the type will not give some account of itself on the foreign programmes, but merely that I do not consider it

really well adapted to the purpose under the congested conditions of today.

An efficient aerial is essential, and the question of locality must also be taken into account. At short distances from a Regional transmitter, for example such a receiver is not to be advised. I should be inclined to place the minimum distance at twelve miles, but this can be reduced somewhat if the user will employ a wavetrap, or will be content to cut down his aerial coupling until he can readily separate the two local transmissions; in such conditions, of course, there is little scope for foreign reception.

There, I hope I have now said enough *against* the type to eliminate any risk of the present instrument being built under a misapprehension by any reader to whom it might prove a disappointment.

High Degree of Economy

It is to be noted that the receiver does undoubtedly offer a high degree of economy in first cost. It is distinctly cheap to build, and its running costs are likewise moderate for its type; it can be used for about five hours for the cost of one unit of electricity.

Again, it is delightfully easy to build. It is true that this feature results in part from its construction

NOW - ANOTHER MOMENTOUS ADVANCE!

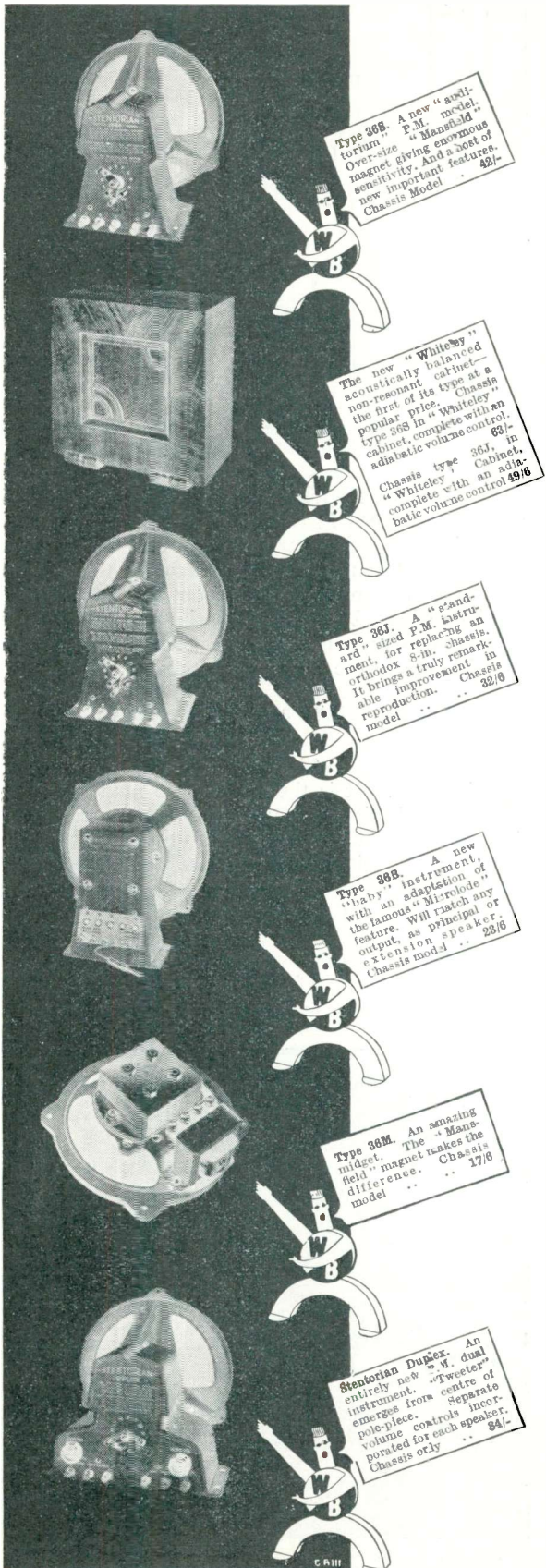

Type 365. A new "Stentorian" P.M. model. Over-size "Mansfield" magnet, giving enormous sensitivity. And a host of new important features. Chassis Model ... 42/-

The new "Whiteley" acoustically balanced non-resonant cabinet—the first of its type at a popular price. Chassis type 368 in "Whiteley" cabinet, complete with an adiabatic volume control. Chassis type 36J, in "Whiteley" Cabinet, complete with an adiabatic volume control 49/6

Type 36J. A "standard" sized P.M. instrument, for replacing an orthodox 8-in. chassis. It brings a truly remarkable improvement in reproduction. Chassis model ... 32/6

Type 36B. A new "Baby" instrument, with an adaptation of the famous "Miroloide" feature. Will match any output, as principal or extension speaker. Chassis model ... 23/6

Type 36M. An amazing "midget." The "Mansfield" magnet makes the difference. Chassis model ... 17/6

Stentorian Duplex. An entirely new "M. dual" instrument. "Tweeter" emerges from centre pole-piece. Separate volume controls incorporated for each speaker. Chassis only ... 34/-

⚡ Bristling with new and important improvements on orthodox design—larger and more powerful than before, the 1936 "Stentorians" represent an historic triumph for W.B. research engineers. These startling new models enable the "quality" enthusiast to attain a "laboratory" standard of reproduction at a price which only the great W.B. resources, coupled with important new methods of precision manufacture, could bring within the realms of possibility.

⚡ Whether your receiver be a modest two-valver or a full-sized quality instrument, you *must* hear the difference a 1936 Stentorian will bring. The impressive volume, beautiful balance of tone, and new incisive realism will give you a new conception of what radio reproduction should be.

Ask your Radio dealer to-day, and hear one for yourself. You will be amazed!



1936 STENTORIAN

Whiteley Electrical Radio Co., Ltd., Radio Works, Mansfield, Notts. (Control Dept.)

Sole Agents in I.F.S.: Kelly & Shiel, Ltd., 47, Fleet Street, Dublin.

Mention of the "Wireless Magazine" will ensure prompt attention

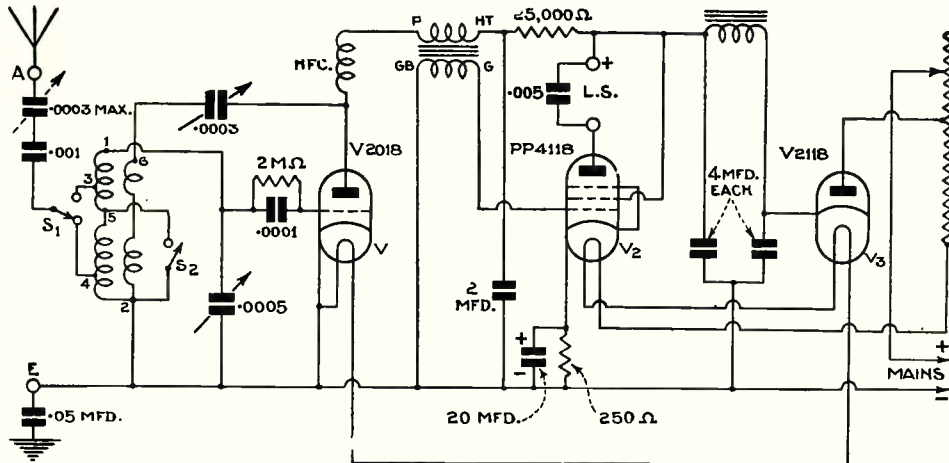

The circuit employed in the Unicon Two. It is to be noted that the two switches marked S1 and S2 are in the actual receiver combined in one component

on the "semi-professional" system recently introduced in "W.M.", but essentially it is a special characteristic of the detector and low-frequency circuit. Screening is unnecessary, there is no call for a metal or metal-coated chassis, and the layout can be guided by considerations of convenient and simple construction rather than by the stringent electrical requirements of the straight high-frequency or superhet circuit.

No Delicate Preliminary Adjustments

Once built, the set requires no delicate preliminary adjustments, but can be put straight into service; there is no ganging, no oscillator tracking, no precise setting of voltages and operation is simplicity itself.

The general idea of the electrical design will be apparent from a perusal of the circuit diagram. The tuned circuit contains a high-efficiency iron-core coil unit of the modern compact type with capacity-controlled reaction. The effect of a variable aerial coupling is given by a series condenser of the adjustable compression type in the aerial lead, thus providing some control of selectivity.

Wave-changing is effected by means of a separate switch, and here it may be noted that a somewhat unusual but extremely valuable feature is provided :

the switch gives a change-over action on the aerial tapping so that on long waves the coupling is altered to a value giving better selectivity than can normally be obtained when the lead is left attached to a point on the medium-wave grid coil.

Following the detector is quite a conventional low-frequency transformer coupling to the output valve. A certain measure of decoupling is provided, consisting of a 25,000-ohm series resistance and 2-microfarad shunt condenser—a simple arrangement quite adequate to the needs of the circuit.

Output Stage and Loudspeaker

The output stage employs a pentode valve, self-biased in the usual fashion, with direct connection to the loudspeaker. It is therefore to be noted that the terminals and leads for the loudspeaker are all "live." This would not be advisable in the case of a receiver intended for use with a separate loudspeaker, but since any universal instrument is best regarded as a proposition for an all-in cabinet I have assumed that such a housing will be provided for the Unicon Two.

While we are dealing with the question of safety, by the by, one or two further points should perhaps be explained. It may be mentioned that the aerial and

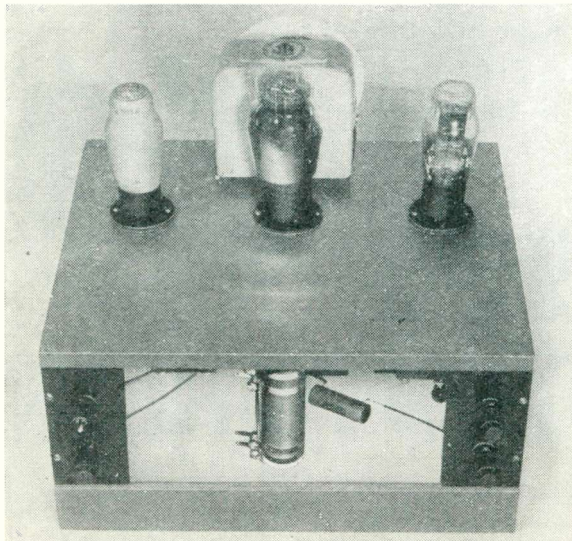

This rear view of the finished set scarcely does it justice: the original wooden chassis achieves a very pleasing appearance with the aid of a coat of aluminium paint

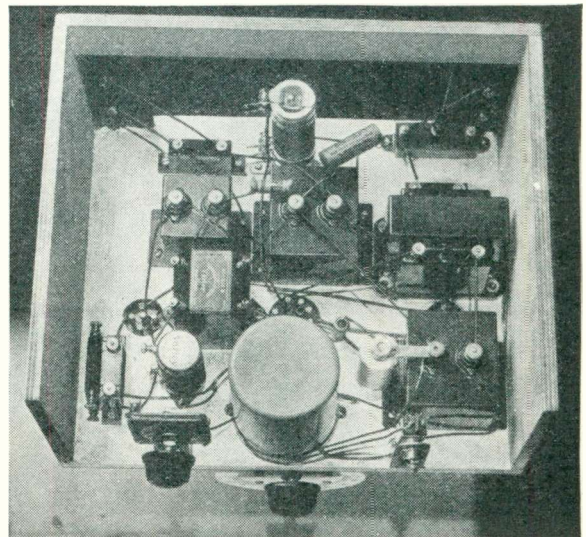

Sets built on the "W.M." semi-professional plan are extremely easy to build since all the wiring is done from one side of the chassis and the layout generally is very simple to follow



See them on
STAND 59
NATIONAL RADIO
EXHIBITION ♦ OLYMPIA

“Still keep going when the rest have stopped”

Exide AND **Drydex**

BATTERIES

Obtainable from Exide Service Stations or your dealer. EXIDE BATTERIES, EXIDE WORKS, CLIFTON JUNCTION, NR. MANCHESTER. Branches at London, Manchester, Birmingham, Bristol, Glasgow, Dublin & Belfast.

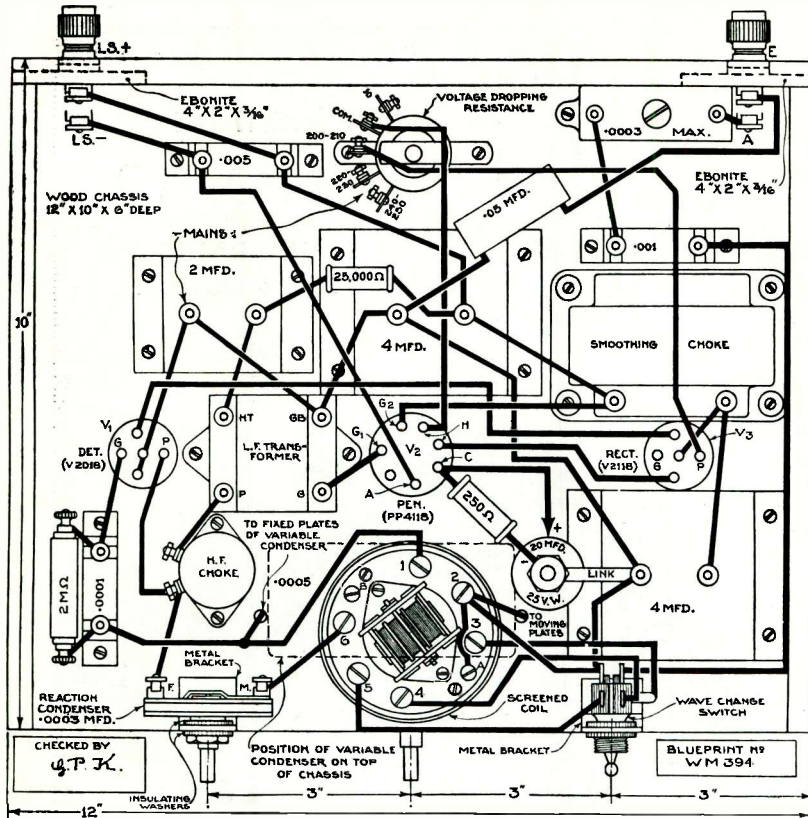

A full-size blueprint of this wiring diagram is available at half price (6d. post paid) until September 30 on application to the "Wireless Magazine" Blueprint Dept., George Newnes, Ltd., 8-11 Southampton Street, Strand, London. Quote No. WM394

earth terminals are *not* live; to eliminate risks of shorting the mains it is necessary to provide full protection at these points. It has been done in the normal manner with series condensers.

With the solitary exception of this pair of terminals it must be realised that every point in metallic contact with the internals of the receiver is liable to be live. No such points should be touched when the set is

switched on, and care should be taken to see that the heads of the grub-screws securing the knobs of the various panel controls are covered over with a dab of sealing wax.

The high-tension supply comes from a comparatively

simple form of smoothing circuit and a direct-fed valve rectifier. Here the aim has been to provide just adequate smoothing at the minimum cost, with results I will mention in a moment.

The valve heaters are all connected up in series and fed from the mains through an adjustable resistance designed to provide them with the correct 180 milliamperes of current when the mains lead is connected to the appropriate point on the row of little terminals at the resistance. It will be understood that only one of the mains connections is attached to the resistance in this manner: the other goes to one terminal of the 2-microfarad condenser nearest to the detector valve. (I shall be explaining matters of mains connection more fully next month when dealing with the fitting of a fuse unit and on-off switch inside the cabinet.)

Question of Hum

The general smoothing and heater-supply arrangements are just adequate on fair to good mains. They provide then quite pleasantly quiet operation with only slight hum. To

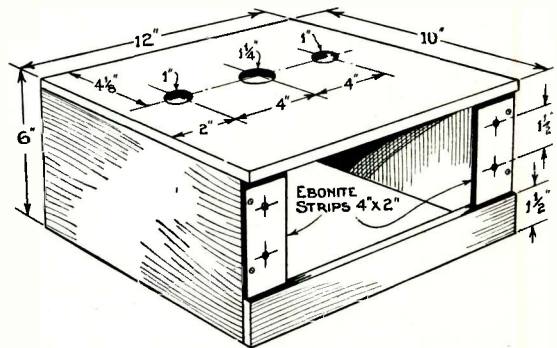

Those who like woodwork will find these dimensions render the construction of the wooden chassis quite simple

COMPONENTS NEEDED FOR THE UNICON TWO

COMPONENTS NEEDED	£ s. d.	RESISTANCES, FIXED	
CHASSIS		1—Amplion 250-ohm ...	1 0
1—Wooden chassis frame to specification ...	6 6	1—Amplion 25,000-ohm ...	1 0
CHOKES		1—Bulgin mains, type MR25 ...	8 6
1—Varley Junior high-frequency choke ...	9 6	1—Graham-Farish 2-megohm grid leak ...	10
1—Ferranti smoothing choke, type B10 ...	11 6	SWITCH	
COIL		1—Bulgin, type S98 ...	2 3
1—Goltone coil unit, type GIC2 ...	9 6	TRANSFORMER, LOW-FREQUENCY	
CONDENSERS, FIXED		1—Varley Nicore No. 2 ...	11 6
1—Dubilier .0001-microfarad, type 820 ...	1 8	VALVE HOLDERS	
1—Dubilier .001-microfarad, type 820 (500-volt working) ...	3 0	2—Clix 5-pin ...	2 0
1—Dubilier .005-microfarad, type 820 ...	2 3	1—Clix Continental 7-pin ...	1 1
1—Dubilier .05-microfarad, type 4508 ...	1 4	SUNDRIES	
1—Dubilier 2-microfarad, type LSB ...	4 6	4—Belling-Lee terminals, marked A, E, LS(2) ...	2 0
1—Dubilier 4-microfarad, type LSB ...	16 0	2—Small Terminal plates
1—Dubilier 20-microfarad, type 401 ...	2 6	Flex for mains connection
CONDENSERS, VARIABLE		Mains plug
1—J.B. .0005-microfarad single Nugang with cover ...	10 6	Wire, sleeving, etc.
1—Graham-Farish .0008-microfarad Litos reaction ...	2 0	LOUDSPEAKER	
1—Formo .0003-microfarad compression ...	1 6	1—W.B. Stentorian standard model 2 ...	2 0
		VALVES	
		1—Tungsram R2018 ...	10 6
		1—Tungsram PP4118 ...	14 9
		1—Tungsram V2118 ...	10 0

get the hum down further means spending a little more money and I doubt whether many constructors would think it worth while.

However, for the benefit of those who are critical in the matter I shall be dealing with the point next month; at the same time I shall explain what additions are necessary to cope with noisy mains.

The idea here, I would add, has been to present the set first in its simplest and most economical form. It can be tried in this shape and then additions made only if the hum level is found unsatisfactory. In this way there is a possible saving for those constructors blessed with reasonably clean mains supplies.

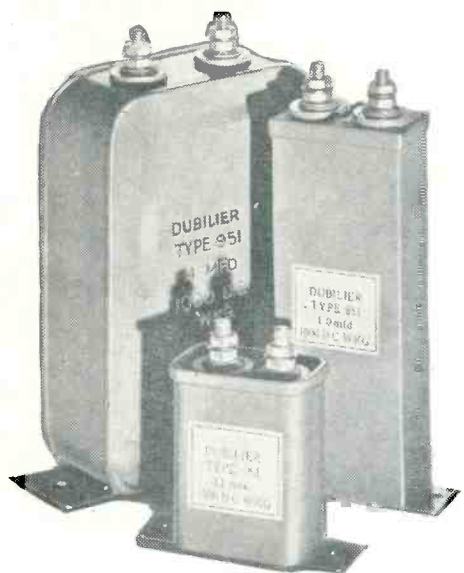

DUBILIER

... contributes a new feature to the technique of radio and amplifier design by producing a range of new Oil-Immersed Paper Dielectric Condensers, which will come as a boon to designers of apparatus for Television, Radio and Low-frequency Amplifiers, using the higher voltages.

Each condenser comprises a multiple paper dielectric element, impregnated and oil-immersed and hermetically sealed into a sheet metal container. Leakage of oil is impossible, but expansion is adequately accommodated. In capacity and working voltage these condensers are small and most compact. Their low price enables a capacity value hitherto prohibitive to be used in resistance capacity coupled amplifiers.

TYPE 951		
0.1 mf.	1,500 v. wkg.	10/9
1.0 "	" "	13/-
2.0 "	2,000 v. "	17/6
4.0 "	" "	21/-

DUBILIER

CONDENSER CO. (1925), LTD,

Ducon Works, Victoria Road, N. Acton, W.3.

ASK AT STAND 74
OLYMPIA FOR THESE
FOUR BOOKLETS

FERRANTI'S COMPONENTS RIO2

FERRANTI VALVES

FERRANTI RADIO METERS RIO3

FERRANTI RADIO TRANSFORMERS RIO4

OR WRITE DIRECT TO
FERRANTI LTD.
RADIO WORKS,
MOSTON,
MANCHESTER.
10.

(Send 1½d for one
or 3d for all four)

FERRANTI

W.M. Guide to the New Sets—Continued from page Nine of the Supplement

Brand Name	Model	Price	Power Supply	Brief Description of Circuit	If Pick-up Terminals
Decca	Cabinet Radiogram	£20 9 6	AC, or AC/DC at 20 gns.	6-valve superhet cabinet radiogram for medium and long waves A.V.C. inter-station noise suppressor.	—
Ever Ready	5004	£17 6 0	AC mains	Superhet console model; 7 tuned circuits; pentode output; tone control; mains-energised moving-coil speaker.	Yes
Ever Ready	5011	£19 8 6	AC mains	6-valve all-wave superhet; pentode output; A.V.C.; table model	No
Ferranti	Arcadia Console	£19 8 6	AC mains	As Console but in console cabinet	—
Halford	A.W.6	£17 6 6	AC/DC	6-valve all-wave receiver for universal mains; 2½ watt output; cabinet made to order outfit.	Yes
Higgs	A56R	£20 9 6 or 37/- down	AC mains, 190 to 260v., 40/100 cycles	Same chassis as A56R; incorporating induction motor, variable speed and automatic stop.	Yes
H.M.V.	Console Superhet Five 444	£17 7 6	AC mains	Superhet radio	Yes
H.M.V.	Superhet Portable Fluid-Light Six 463	£16 16 0	AC mains	Superhet radio	Yes
Hyvoltstar	Miniature Radiogram	£16 16 0	AC/DC 100-250v	4-valve straight radiogram; Magnavox moving-coil loudspeaker; B.T.H. pick-up (piezo pick-up 1 gn. extra)	—
Hyvoltstar	Allwave Superhet Five	£17 17 0	AC/DC 100-250v	4-valve superhet plus rectifier; A.V.C.; Magnavox energised loudspeaker; covers 18.5-52, 200-560, 800-1,900 metres Also in chassis form, 13½ gns.	Yes
Hyvoltstar	Allwave Superhet Six	£18 18 0	AC/DC 100-250v	5-valve superhet plus rectifier; A.V.C.; Magnavox moving-coil loudspeaker; covering 16.5-52, 200-560, 800-1,900 metres. Also in chassis form 14½ gns.	Yes
Hyvoltstar	Allwave Straight Four Radiogram	£19 8 6	AC/DC 100-250v	As table model; B.T.H. pick-up	—
K.B.	398	£16 16 0	Battery	6-valve superhet; class-B output; A.V.C.; tone control; moving-coil speaker	Yes
K.B.	383	£19 19 0	AC/DC 200-250v	6-valve superhet; variable selectivity; adjustable quiet delayed A.V.C.; neon tuning; Console cabinet.	Yes
Milnes	332A	£19 14 6	Battery	Chassis as 332A (Page nine of Supplement)	—
Pegasus	S.H.7.U.C.	£17 17 0	AC mains	Same as S.H.7.U, but fitted in Console cabinet	Yes
Philco	1280	£17 17 0	AC/DC	5-valve superhet; 3-point tone control; moving-coil speaker; shadow tuning	Yes
Pye	SE/JU	£16 0 0	AC/DC	Superhet; external aerial	Yes
Pye	TP/AC	£16 16 0	AC mains	AC superhet; external aerial; Q.A.V.C.	Yes
Pye	SE/AC Console	£18 18 0	AC mains	Superhet for external aerial; extra large loudspeaker	Yes
R.I.	Ritz	£15 15 0	AC mains	9-stage superhet; 4 valves plus rectifier; full delayed A.V.C.; 10-in. energised loudspeaker.	Yes
R.I.	Airflo	£16 16 0	AC mains	Same as R.I. Ritz	Yes
Ultra	66 Radiogram	£16 16 0	AC mains, 100-130v or 200-250v.	Chassis as 66 table model	—
TWENTY TO FORTY GUINEAS					
Ace	—	£25 0 0	AC mains 200-250v.	6-valve (including rectifier) superhet radiogram with inter-station suppressor, full A.V.C., shadow tuning indicator	—
Allwave	Commander	£30 0 0	AC mains	7-valve double superhet type, permanent-magnet moving-coil speaker, covering from 12-560 and 800-2,000 metres	—
Allwave	Table	£35 0 0	AC/DC	7-valve (including rectifier) superhet, also obtainable in radiogram form for £52 10 0	—
Atlas	A.22	£23 2 0	AC mains	6-valve 7-stage superhet; push-pull output giving 6 watts; delayed A.V.C., spectrum tuning with tilting dial. Console model	—
Atlas	A.24	£25 4 0	AC mains	5-valve 7-stage superhet radiogram, same chassis as A.13	—
Atlas	A.39	£40 19 0	AC mains	6-valve 7-stage superhet radiogram, same chassis as A.22	—
Beethoven	R.G.717	£23 2 0	AC mains	Circuit as for A.C.77	—
Blue Spot	AC5G	£22 1 0	AC 200-260v. or 100-110v. 1 gn. extra	Circuit as AC5. Mains aerial	—
Burndept	CN225	£33 12 0	AC 200-250v.	5-valve superhet radiogram; band-pass input, A.V.C., visual tuning	—
Burndept	CN203	£33 12 0	AC/DC 200-250v.	6-valve superhet radiogram; A.V.C.	—
Decca	Cabinet Radiogram	£25 4 0	AC	7-valve all-wave radiogram (18-45, 200-550, 1,000-2,000m.), 9 tuned circuits, A.V.C., inter-station noise suppression	—
Ekco	RG86	£23 2 0	AC	Same as AC86	No
Ekco	CR75	£21 0 0	Car Battery	Detector Oscillator, I.F. pentode, double diode, pentode, output pentode	No
Eddystone	All World Four	£22 10 0	Batteries		Yes
Eddystone	Sphinx	£23 0 0	Batteries	4-valve straight	Yes
Eddystone	Sphinx	£27 10 0	AC mains	4-valve straight	Yes
Eddystone	Super-Six	£33 0 0	AC mains	5-valve superhet	No
Ever Ready	5005	£25 4 0	AC mains	Superhet radiogram, 7 tuned circuits, pentode output, tone control, energised moving-coil speaker	—
Ferranti	Arcadia Radiogram	£27 6 0	AC	As consolette, with combined tone control and scratch filter	—
G.E.C.	BC3558R	£22 1 0	AC mains 190-250v.	5-valve superhet radiogram, energised moving-coil speaker, shadow-band tuning, delayed and amplified A.V.C., internal aerial.	—
G.E.C.	BC3658	£24 3 0	AC 190-250v.	5-valve superhet radiogram, chassis as BC3650 Fidelity model	—
G.E.C.	BC3659	£37 6 0	AC 190-250v.	As above, with automatic record changer	—
Halcyon	4701G	£25 0 0	AC/DC 200-260v.	Radio-gramophone with same chassis as 4701 table model	—
Halcyon	4701 GA	£36 15 0	AC/DC 200-260v.	Same as 4701G with automatic record changer	—
Halford	S.W.8	£29 8 0	AC	8-valve short-wave receiver, cabinet to order	Yes
Halford	A.W.8	£31 10 0 (less cabinet)	AC/DC	8-valve all-wave receiver, 4½ watt output, cabinet made to order	Yes
Halford	A.W.10	£34 13 0 (less cabinet)	AC	10-valve all-wave receiver, 4½ watts, cabinet made to order	Yes
Hartley Turner	M12	£40 19 0 (chassis fam)	AC mains 200-250v.	Straight A.C. receiver with two H.F. stages and 12-watt undistorted output designed to give high fidelity reproduction	—

Continued on page 150

Free Advice for Set Buyers—See page 127

Wireless
Magazine
**AGAIN SPECIFIES
TUNGSRAM**



This month
for the
"W.M."
**UNICON
TWO**

R2018 10/6 PP4118 14/9
RECTIFYING VALVE
V2118 10/-

The Tungram Valves specified in this notable new set are not "special editions." They are identical in every way to those you can buy from *your* dealer. Tungram's new factory and specialised production methods ensure a standard of uniform excellence, from stock, that satisfies the expert *every time*.

TUNGSRAM
BARIUM VALVES
72 OXFORD ST., W.1

Factories in London, Austria, Czechoslovakia, Hungary,
Italy and Poland.

**An Outstanding
Feature of**



**T.M.C. BRITISH MADE HYDRA
CONDENSERS**

Make a particular point of seeing the T.M.C.-HYDRA Stand when at Radiolympia. Several important new models — just released — will be displayed, and there will be a full range of T.M.C.-Hydra Condensers on view, which accurately and reliably meet every need of Radio and Television. T.M.C. Engineers will be in attendance to help you with any queries regarding condensers.

STAND No. 29

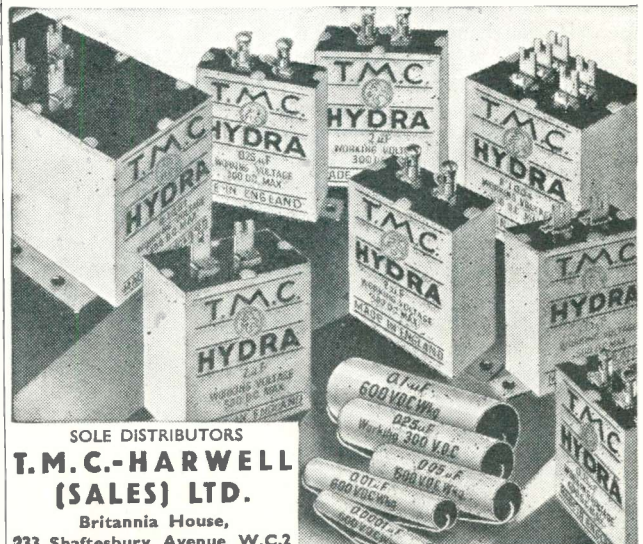

SOLE DISTRIBUTORS
**T.M.C.-HARWELL
(SALES) LTD.**

Britannia House,
233 Shaftesbury Avenue, W.C.2

(A few doors from New Oxford Street). Telephone: Temple Bar 0055 (3 lines)

Made by TELEPHONE MANUFACTURING Co.Ltd.

Mention of the "Wireless Magazine" will receive prompt attention

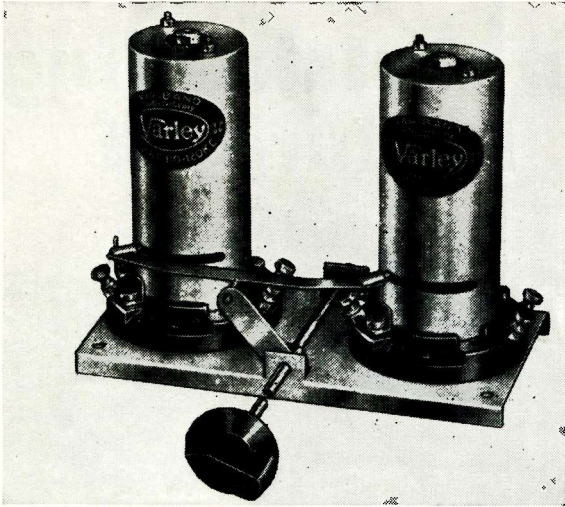

An interesting example of the new tendency in superhet design: the Varley variable-coupling intermediate unit for 110 to 120 k/c working

A New Superhet With Variable Selectivity

PAUL D. TYERS explains the latest tendencies in superhet design with particular reference to the important question of selectivity

WHEN the power of broadcast stations was increased and when the number of transmitters multiplied at such an alarming rate, the superhet came into its own. This was because it provided an easy means of obtaining high selectivity.

The efficiency and value of the superhet remained unchallenged because it provided the only simple practical solution to the selectivity problem. It has taken the general public a long time, however, to realise that there is a very intimate relation between selectivity and quality.

Stenode Limitations

The Stenode system developed by Dr. Robinson is one solution to the selectivity quality problem. A Stenode receiver, however, necessarily involves additional valves and amplification in order to apply correctly the tone-control circuits. In the practical Stenode receivers worked out by the author and others during the last few years, provision was made for obtaining variable selectivity by adjusting the coupling in the intermediate-frequency transformers. The adjustments carried out were invariably with a view to increasing the selectivity beyond the normal limit, and this, of course, was accompanied by corresponding adjustment in the tone-control circuits.

Now the pendulum appears to be swinging in the other direction. Listeners seem to require a receiver which normally gives reasonable selectivity without tone correction, and at the same time require means

for providing a practically level response up to 10,000 cycles or more, so that the local station may be listened to on a high-fidelity amplifier and first class loudspeaker.

The receiver which provides this control can rightly be described as one of variable selectivity. In my opinion, however, this is perhaps not a very good definition because variable selectivity is incidental to the required result. What one is aiming at chiefly is variable quality.

In the Stenode receiver variable selectivity was given with fixed quality. In the new type of receiver we obtain both variable quality with consequent variable selectivity.

Selectivity is obtained in a receiver by the use of a number of tuned circuits. The sharper the resonance curve the greater is the selectivity of any tuned circuit. By coupling together two tuned circuits or a number of tuned circuits and varying the sharpness of each circuit and the degree of coupling, it is possible to obtain a resultant resonance curve or wave-shape of almost any desired form. The well known band-pass effect is obtained by suitably coupling tuned circuits of the correct decrement.

Certain types of coupling give asymmetric effects in which the wave-shape is lopsided. Quite apart from the actual inductance and decrement of the circuits, the frequency has a marked effect upon the change of wave-shape with change of coupling.

It can be shown very easily that the simplest method of varying the band-pass effect so as to obtain a flat top

over a desired frequency band with a very sharp side or skirt is to use circuits tuned to a fairly high intermediate frequency.

From the constructor's point of view this is rather unfortunate because the majority of home-constructed superhets work on frequencies of the order of 110 or 117.5 kilocycles, and very few home constructors appear to use frequencies such as 465.

Inexpensive Solution

If, therefore, the design of a receiver were contemplated using the latter frequency, the home constructor would have to purchase a great deal of new apparatus. The expense would therefore, be somewhat heavy. Experiments have shown, however, that very satisfactory results can be obtained at a frequency of 110 kilocycles.

This means that any constructor who has a superheterodyne condenser for 110 or 117.5 kilocycles together with the necessary pre-selector and oscillator coils can build a variable-quality receiver with very little expenditure. Accordingly it is proposed to describe next month the construction of a "variable-quality" receiver on these lines making use of a special type of variable intermediate-frequency transformer that has been the subject of investigation and test for the last eighteen months.

Such a receiver can be relied upon to give ordinary superhet selectivity and what is known as satisfactory quality, and at the same time it can be adjusted to give an audio response up to the loudspeaker limit.



Atmosph Eric, the innocent one, who tells the world that Interference is about 95 per cent man-made, advises you to

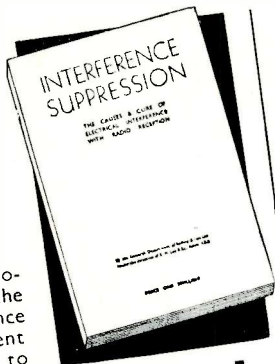

get this new book
 AUTHORITATIVE · COMPLETE · UP-TO-DATE
 Accepted as the standard work on the subject
 COVERS THE GROUND AND CLEARS THE AIR

The manual includes a descriptive list of the new Belling-Lee suppression devices.

Price, One shilling from radio dealers. 1s. 2d. post free.

BELLING & LEE LTD
 CAMBRIDGE ARTERIAL ROAD, ENFIELD, MIDDLESEX

Please send, post free, a copy of "Interference Suppression." 1s. 2d. remittance enclosed.

Name

Address

W.M., 9-35

POLAR

TYPE "C" SHORT-WAVE
 CONDENSERS

Specified for the
 STANDARD SHORT-
 WAVE FOUR

See the complete range of Polar and N.S.F. Products on Stands 48 & 49

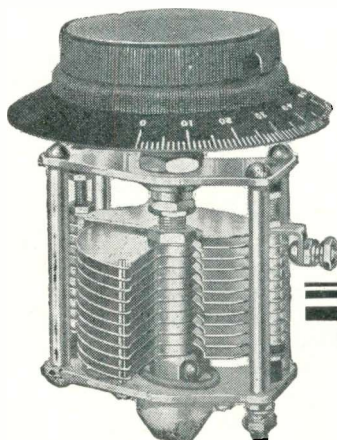

Fast and slow motion. All brass. Double spacing. Silent phosphor-bronze ball bearings.

- One .00015 required ... 8/6
- One .0001 required ... 8/3
- Also made in .00025 ... 9/6

—and for the
"CERTAINTY 3"
 One POLAR COMPAX CONDENSER IS SPECIFIED. Price 2/6

WINGROVE & ROGERS, Ltd.
 188/189 Strand, London, W.C.2
 Phone: Temple Bar 2244.
 Works: Old Swan, Liverpool.

7292

B.I.

HIGH VOLTAGE CONDENSERS

for

RADIO AND TELEVISION

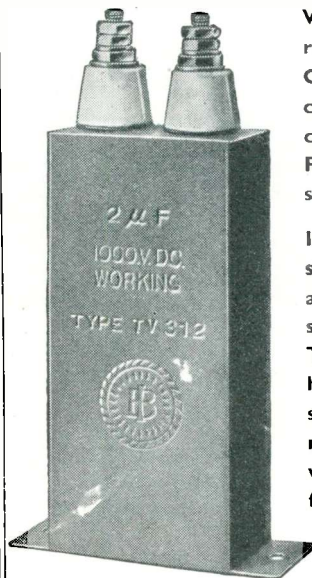

We can offer a complete range of High Voltage Condensers in all capacities and for all working conditions met with in Radio and Television sets.

In accordance with our standard practice, these are impregnated with a special Petroleum jelly. The insulated terminals have ample creeping surface, and we recommend these condensers with the utmost confidence.

BRITISH INSULATED CABLES LIMITED

Cablemakers and Electrical Engineers

PRESCOT—LANCS.

Tel. No. PRESCOT 6571

London Office: Surrey House, Embankment, W.C.2

Tel. No. Temple Bar 4793-45 & 6

Mention of the "Wireless Magazine" will ensure prompt attention

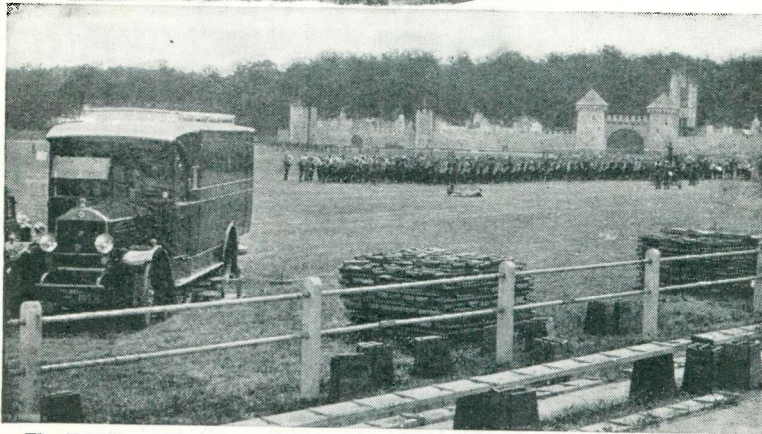

The H.M.V. mobile recording outfit in the Rushmoor Arena when records were made of stirring music by the massed bands. The records are reviewed this month. At the extreme top of the page is a photograph of Arthur Tracy, the famous American singer and radio star, who is now on a visit to this country

New Records for your Radiogram

By T. F. HENN

detail is really remarkable. (4s. each.)

Decca has produced two beauties! Sir Henry Wood with the Queen's Hall Orchestra has recorded Bach's *Tocatta and Fugue in D Minor* on K768, and Grainger's delightful *Handel in the Strand* and *Mock Morris* on K767. The label of the first record announces that Bach's work was arranged by Klenovsky.

You may remember that the identity of this Klenovsky person was unmasked some short while ago. It is none other than Sir Henry himself. The reason he chose to arrange under a non-de-plume was that he thought the name more impressive than his own. Sir Henry ought to have known better! Every evening from now until the second

Saturday in October thousands are cheering him at Queen's Hall and millions are being thrilled at home.

If you do want a permanent record of the Proms, you could do no better than to acquire these two specimens. The *Tocatta* is always played once during the season and Grainger's works are frequently heard in the ordinary programmes.

You remember that last month I warmly welcomed Dick Crean's *March Medley*. You can guess how pleased I am to receive yet another medley; this time he has called it *Charm of the Waltz*. The Palladium orchestra makes a wonderful show here. All the good old waltz tunes—*Gold and Silver*, *Scene du Bal*, *Thoughts*, *Nights of Gladness*, *Love's Dream After the Ball*, and, of course the *Blue Danube*—are delightfully played. The number is H.M.V. C2760 (4s.).

The London Theatre Orchestra on a Columbia record (DX700) provides a welcome change in a medley of the hits that have emanated from the shows of *Revuedeille*

Continued on page 146

IT is really still midsummer and taking things all round I think the record companies are doing us well. All of them are turning out really attractive records.

Those of you who were fortunate enough to get to the Jubilee Tattoo at Aldershot this year will remember the magnificent playing of the massed bands for many a day to come. Those of you who were unfortunate enough not to go are well compensated by two splendid records issued by H.M.V.

These records (C2768 and 9) give, to quote the book, "wonderful thrilling 'memories in sound' of many of the most thrilling moments of this great pageant." I consider that H.M.V. has excelled itself with these records. I have almost all the military tattoo records that have been issued, but these struck me as possessing a new note in the way of faithful recording.

You cannot but be thrilled by the bands playing *The British Grenadiers*, *Here's a Health Unto His Majesty*, *Sing as We Go*, and the beautiful epilogue. I have tried them over on my new amplifier and the

BANISH JUMBLED STATIONS

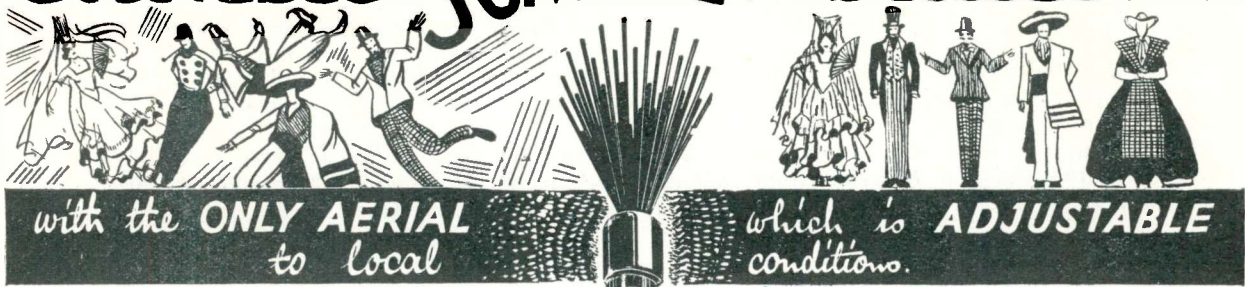

Stations arrive in chaotic confusion

To-day, there is such a wide variety of wave-lengths that no aerial of constant length can give you satisfactory reception of all the transmissions. That is why the No-Mast "SHORLON" 7-in-1 Variable Aerial was invented. It is the only aerial which is adjustable to local receiving conditions and which will definitely ensure your receiving your programmes one at a time. Each station comes to you as individually as though it were sealed away in a water-tight compartment. No overlapping. No

but are passed to your Set one at a time

one programme ruining another. You have 7 different aerials to work with, all controlled by simply plugging-in to the correct socket. Almost automatic. The No-Mast "Shorlon" is easily fixed . . . and "stays put" for a lifetime. Can't go wrong. Never wears out. Gives any Set up to four years old the performance of a 1936 receiver. Send coupon below for interesting booklet describing how great is the influence of your aerial on your radio pleasure.

NO-MAST 5⁶ SHORLON 7 IN 1 VARIABLE AERIAL

Free

To Central Equipment Ltd.,
188 London Road,
Liverpool.

Please send me your FREE
BOOKLET on SHORLON.

Name.....
Address.....
.....

EIGHT

VARLEY COMPONENTS USED IN SETS DESCRIBED IN THIS ISSUE OF "WIRELESS MAGAZINE"

LISTENERS 5-watt AMPLIFIER

Dual L.F. Choke (DP11)	15/-
Standard L.F. Choke (DP10)	15/-
Constant Inductance (DP12)	17/6

UNICON TWO

Junior H.F. Choke (BP2)	3/6
Nicore II Transformer (DP2)	11/6

A.C. STANDARD 4-VALVE SHORT WAYER

Nichoke II (DP23)	10/6
Standard L.F. Choke (DP10)	15/-
Mains Transformer (EP36)	22/6

This remarkable fact speaks more eloquently than any words of the reliability of Varley products, and the trust which is placed in them by famous set-builders.

Whichever set you are building, send first for the Varley Catalogue, which will give you all the information you need, and will also be a useful permanent reference.



Bloomfield Road, Woolwich, S.E.18.

Telephone : Woolwich 2345

NEW RECORDS FOR YOUR RADIOGRAM

Continued from page 144

during its many phases at the Windmill Theatre. If you have a taste for light orchestral records this is one to be considered (4s.).

Another outstanding record is a violin solo played by Sandler. You know by now how perfectly delightful his solos are during his Sunday evening broadcasts. Well, he has recorded the *Pizzicato* from Delibes' *Sylvia Ballet*, and *Toreador and Andalous* on Columbia DB1567.

Serious music fiends will know of Zoltan Kodaly's *Hary Janos Suite*. The suite is a number of musical excerpts from the opera of the same name, and depicts the fantastic adventures of one, Hary Janos. It is a Hungarian superstition that if a listener sneezes when a tale is told the speaker has not lied. You will notice a big sneeze at the beginning of the work.

It is a marvellous colourful work and is superbly played by the Minneapolis Orchestra under Eugene Ormandy (H.M.V. DB2456-7-8, 6s. each).

There is a school of record enthusiasts who admire and collect good healthy songs of the popular ballad type. A beauty has just been released; Harold Williams singing *Glorious Devon* and *Chorus Gentlemen* on Columbia DB1564 (2s. 6d.). Two good old songs sung in a way that makes crooners seem, what shall we say . . . strange?

A more serious record of a songster is Heinrich Rehkemper singing *Papagena*, *Papagena* and *Colombao Tortorella*. If you are a Mozart fan you should certainly make a point of hearing these two delicious trifles from *The Magic Flute* (Decca-Polydor CA8204, 4s.).

Now for a few real lively records—not dance music. Ken Harvey with his banjo gives us *The World is Waiting for Sunrise* and *A Musical Journey from New York to California* on H.M.V. B8351 (2s. 6d.). This artist

is a wizard; his train effects, which appear on the second side, are made by Harvey on the banjo. Amazing!

Another is the band of H.M. Coldstream Guards playing *The Soloist's Delight* and *Marche Heroique de Szabady* (Massenet) on H.M.V. C2758 (4s.). The first item shows some remarkable solo work by some of the bandmen. The Guards are good!

Les Allen sings *Lullaby of Broadway* and *The Words Are In My Heart* on Columbia DB1569 accompanied by Sidney Torch at the organ and a guitar. Les is still the idol of thousands and at the time of writing I do not know whether he has been booked to appear at Olympia. If public popularity is considered by those responsible for engaging the artists, he should be among the first of those booked for the theatre.

The Street Singer (Arthur Tracy) is over here, and like all American stars when they appear over here, is a great success. He has been recording for the Decca people for many years. *Marta* was the first of his great hits and I still have the original recording. Fortunately the B.B.C. has seen its way clear to let him broadcast in a little show of his own, and at the

time of writing it appears that the Street Singer will take the British ether by storm.

However, Decca has released three of his records and among them is *Marta* backed with *Call Me Darling*. The number is F5608 and the price 1s. 6d. So if you would like to know more about this singer and hear the strains of his piano-accordion—he plays wonderfully well—Decca is at your service.

By the way, there are two exceptionally good Regal-Zonophone records, only a shilling each, that are worth getting. One is Reginald Dixon at the Tower organ Blackpool, playing *The Whistler and His Dog* and *Teddy Bear's Picnic* (MR1750) and two marches, *The Premier* and *San Marino* played by the massed brass bands of the Leicester Festival (MR1752)

Here are the three best dance records of the month:

*** *Call Me Sweetheart* and *Jump on the Wagon* (foxtrots), played by Harry Roy's band with Miss Elizabeth Brooke now Harry's wife, as vocalist. Parlophone F191, 1s. 6d. Congratulations Harry, and all the very best for the future.

*** *The Dixie Band* and *Fare Thee Well, Annabelle* (foxtrots), by the same band on Parlophone F188 (1s. 6d.).

** *Fascinating Rhythm* and *Hesitation Blues*, by Nat Gonella and his Georgians on Parlophone F192 (1s. 6d.).



A new portrait of Sir Henry Wood by Sir William Rothenstein. Sir Henry is conducting the Prom concerts again this year and two of his latest Decca recordings are reviewed in these pages



A favourite broadcaster, though not heard very frequently, is Alfredo. Here you see him with members of his orchestra trying out their latest records on an H.M.V. 110-guinea Autoradiogram—a splendid instrument that the makers are continuing in its present form for the new radio season

Write for full particulars

See the full range of **GARRARD** Radiograms at **STAND No 57**

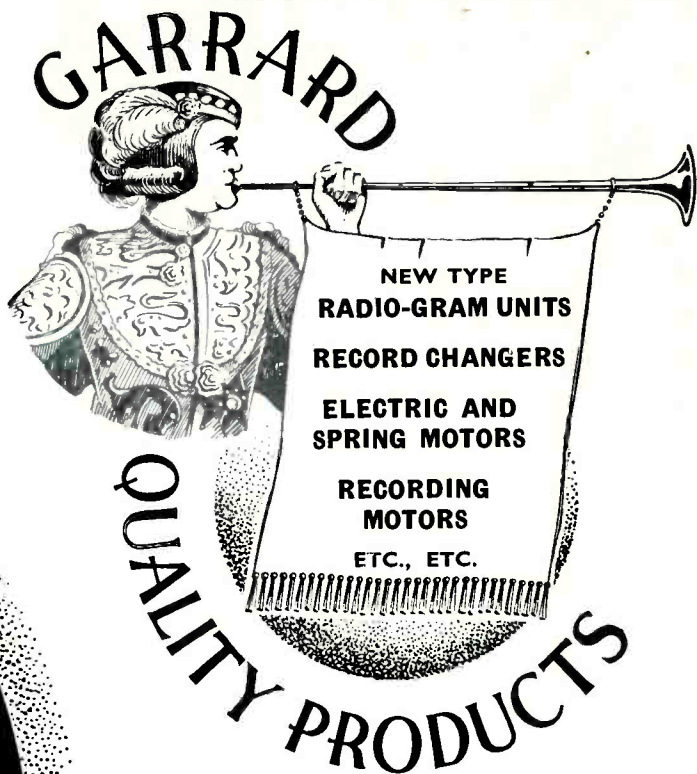

GARRARD ENGINEERING & MANUFACTURING CO., LTD.
SWINDON, WILTS. Telephone: Swindon 534 & 535 (2 lines) Telephone: Regent 7596 17 GRAFTON ST., W.1

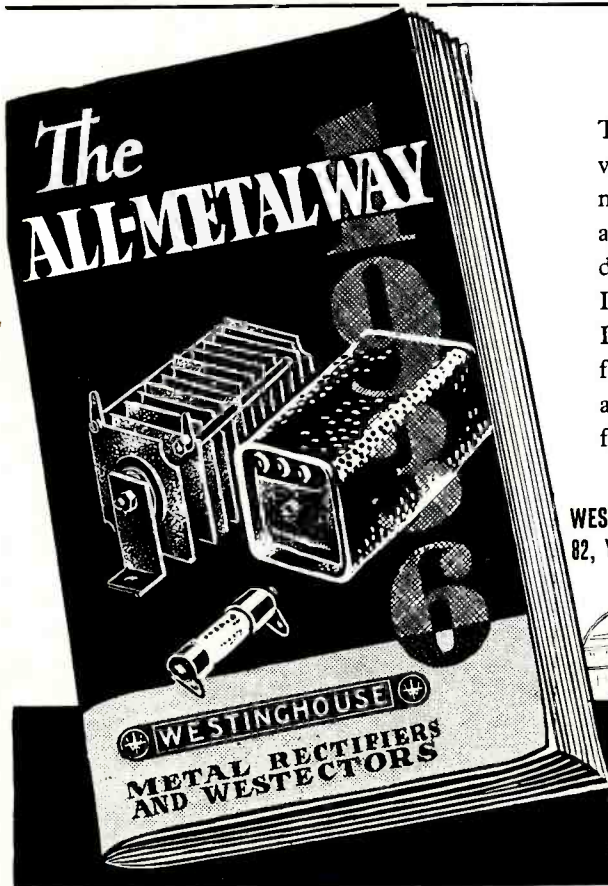

There's one booklet you mustn't fail to get when you visit Olympia "The All Metal Way, 1936." It's more than a catalogue of Westinghouse Metal Rectifiers and Westectors—it's a treatise on A.C. Mains Radio, distortionless detection and Automatic Volume Control. It contains chapters on trickle-charging both H.T. and L.T. accumulators, operation of moving-coil loudspeakers from the A.C. Mains, Universal Receivers, etc., etc. Get a copy from Stand 101, and while you're there, don't forget to ask for any technical information you may require.

WESTINGHOUSE BRAKE & SIGNAL CO., LTD.
82, York Road, King's Cross, London, N.1

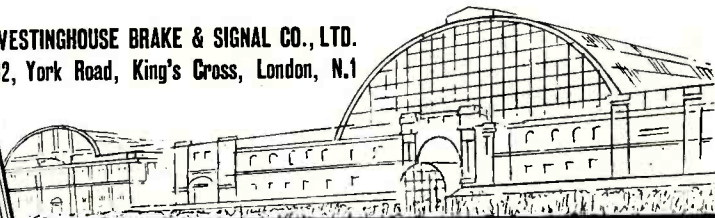

Get a copy on STAND 101

Better service results from mentioning "Wireless Magazine" when writing to advertisers

News from the

Conducted by
G6QB

Radio Society of Great Britain

THE R.S.G.B. is in evidence at Stand No. 202 at Olympia with a comprehensive display of modern short-wave apparatus, both for transmission and reception. As usual, the stand will serve as a meeting-ground for members, as well as being a kind of shop-window and recruiting office combined.

If any reader wishes to know anything about the R.S.G.B. he will find no difficulty in getting his questions answered at Stand 202.

The Annual Convention, as usual, is being held at the end of the Show period. Outstanding items in the programme include the following. On Thursday, August 22, there is a visit at 2.30 p.m. to the Dollis Hill Laboratories of the G.P.O. At 7 p.m. there is a "gathering of the clans" at Stand 202 at Olympia.

On the next day (Friday the 23rd), 10.30 a.m. sees the programme opening with a visit to Brookman's Park; after lunch the party proceeds to the works of Standard Telephones and Cables, Ltd., at New Southgate. At 6 p.m. there is the annual *Conversazione* and running buffet at the Florence Restaurant.

The Big Day

Saturday, August 24, is the big day. Opening with a delegates' meeting at 9 a.m., the morning continues with the general business meeting at 11 a.m. (both at the Institution of Electrical Engineers). The Convention photograph will be taken at 1.50 p.m., the year's trophies are presented at 2.15 p.m., and at the 2.30 meeting Mr. G. Parr will lecture on "Cathode-ray Tube Developments."

The day finishes with the Annual Convention Dinner at 6.15 p.m. Sunday will be mostly occupied by informal station visits, since many provincial members will not be returning home until the Monday.

Other R.S.G.B. news includes the publication of the results of this year's B.E.R.U. contests. The winner of the Senior event was Lieut. Eric Cole (SU1EC) of Cairo, and the runner-up Mr. George Merriman (VS6AH) of Hong Kong.

Radio Societies

Under this heading we publish reports every month of the activities of short-wave and transmitting societies. We shall be pleased to give publicity to any announcements of forthcoming events, etc., and secretaries of short-wave societies, whether national or local, are asked to make the fullest use of this space.

The Junior event was won by Mr. J. S. Nicholson (VU2JP) from South India, with SU1EC occupying second place.

The highest points gained by a British station in the Senior event was G6HP, operated by the late Mr. H. D. Price, whose tragic death in the Baird company's laboratories immediately after the conclusion of the B.E.R.U. contest was recorded last February.

The Receiving Contest was won again by Mr. C. G. Allen (BRS 250), of London, S.E.16, with Mr. R. W. Rogers, of Southport, as runner-up.

Ten-metre news has been quite thrilling during the past month, and by the time these notes appear in print it seems possible that every continent will have been linked up on this waveband. Next summer, for certain, will see some really startling results. The possibility of the appearance of a reflected wave on 5 metres is suggested by the results that many members have been obtaining on that wavelength recently.

Thames Valley Amateur Radio and Television Society

The above society held a very successful field day earlier in the season using three portable stations manned by the membership. Situated respectively at Box Hill, St. George's Hill, and the Hog's Back, these three held a kind of informal competition, all work being carried out on the 40-metre band.

A 5-metre field day was contemplated, and has probably taken place by the time this appears in print. The membership is nearly 50, of which one-third are active transmitters. Short-wave enthusiasts in

the Thames Valley district should get into touch with Mr. J. N. Roe (G2VV), "Minydon," Ridgway Road, Farnham, Surrey, if they are interested in the activities of the society.

Winchester Amateur Radio and Cinematography Society

I am asked to announce the formation of the above society. All inquiries should be addressed to the Hon. Sec., Mr. A. Howard, 6 Romsey Road, Winchester, Hants.

Derby Wireless Club

The Derby Wireless Club is arranging its winter syllabus, and for the weekly meetings (on Thursday evenings) an interesting series of lectures on subjects connected with radio and television has been arranged. Communications to the Hon. Sec., Mr. R. H. Hodgkinson, Field House, Duffield Road, Darley Abbey, near Derby.

South London and District Radio Transmitters' Society

At the last meeting of the S.L.D.R.T.S. the speaker was Mr. T. C. McNamara, of the B.B.C., who gave a description of the Droitwich station. The talk was fully illustrated with lantern slides and members' questions were answered afterwards. It is hoped that the Society will be able to arrange for its members to visit Droitwich in the near future.

Meetings throughout the coming season will be held on the first Wednesday of each month at 8 p.m., breaking into informal discussions at 9.30 p.m.

NEW EDDYSTONE PARTS FOR SHORT WAVE ENTHUSIASTS!

Every experimenter will be concentrating on ultra short waves this year. Television on short waves is due at any moment and the 5 metre field is attracting keen attention from the amateurs.

We bring some new Eddystone lines before you with confidence. They are of the highest grade materials, finest workmanship, and will give every satisfaction.

VISIT US AT
OLYMPIA STAND 30



ULTRA SHORT WAVE H.F. CHOKES (Left)

No. 1011 2.5- 10 metres. Price 1/3
No. 1010 5 -180 metres. Price 2/-

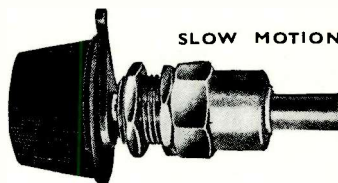

SLOW MOTION DRIVING HEAD

9-1 reduction ratio complete with 180° engraved scale 1 1/2 in. Price 3/-

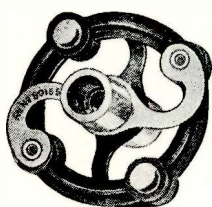

FLEXIBLE COUPLER
Completely flexible. D.L.9 insulation. Coupling diam. 1 5/8 in. Metal bushes take 1/2 in. spindle.

Price 1/6

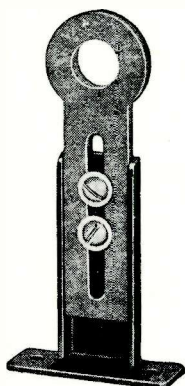

ADJUSTABLE INSULATED BRACKET

Adjustment 2 1/2 in. to 3 3/8 in. Hole 7/16 in. clearance. D.L.9 insulation.

Price 1/6

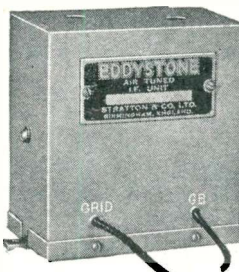

AIR TUNED I.F. TRANSFORMER

Litz wound. Tuning range 400-500 K/cs. Band width 7 K/cs. No. 1014. Price 13/6

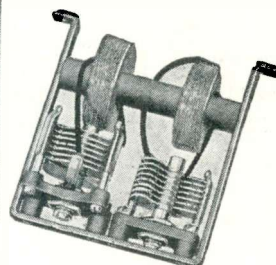

WRITE FOR NEW LIST OF
EDDYSTONE
HIGH GRADE COMPONENTS

STRATTON & CO., LTD. Bromsgrove St., Birmingham
London Service: Webb's Radio Stores, 14 Soho St., Oxford St., W.1

HAVE YOU HEARD THE "NEW 66" ?

EXCLUSIVELY RECOMMENDED FOR
"THE LISTENER'S 5 WATT AMPLIFIER"

IT IS BEING DEMONSTRATED ON
STAND 47

SEE THE AMPLIFIER on the
WIRELESS MAGAZINE
STAND 9

EPOCH

MODEL
66/120F FOR USE
ON D.C. MAINS
£4 12 6

MODEL 66/120J
FOR A.C./D.C. MAINS
£6 12 6

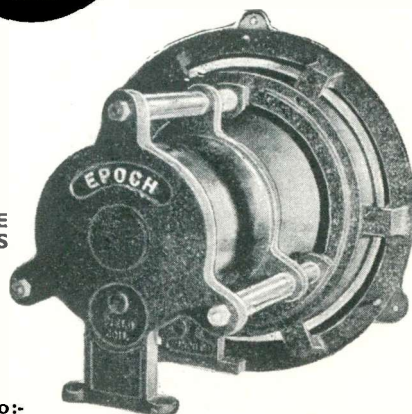

Write for FREE New Illustrated Catalogue to:-
RADIO DEVELOPMENT CO., (Prop. Epoch Reproducers Ltd.)
ALDWYCH HOUSE, ALDWYCH, LONDON, W.C. 2.
Telephone—HOLBORN 9111

Better service results from mentioning "Wireless Magazine" when writing to advertisers

"W.M." Guide to the New Sets—Continued from page 140

Brand Name	Model	Price	Power Supply	Brief Description of Circuit	If Pick-up Terminals
Hartley Turner	S7	£28 10 0 (completely assembled & tested)	AC mains	Kit set; 5-valve superhet with valve rectifier, designed to give finest possible reception from near stations. 7-watt output	—
Hartley Turner	S12	£30 10 0 (completely assembled & tested)	AC mains	As S7, but giving 12-watt output	—
H.M.V.	Superhet Fluid Light Auto-radiogram 570	£34 13 0	AC	Superhet radiogram	—
H.M.V.	Superhet Five-Forty-One Radiogram 541	£23 2 0	AC	Superhet radiogram	—
Hylvotstar	Allwave Superhet Seven	£25 14 6	AC/DC 100-250v.	6-valve superhet plus rectifier, A.V.C., Magnavox energised moving-coil loudspeaker, neon tuning; covers 13.5-27, 26.5-52, 200-560, 800-1,900m. Also in chassis form £22 1 0	Yes
Hylvotstar	Allwave Superhet 5 Radiogram	£24 3 0	AC/DC 100-250v.	As Allwave Superhet Five chassis above. With Garrard automatic record changer for £33 12 0	—
Hylvotstar	Allwave Superhet 6 Radiogram	£25 4 0	AC/DC 100-250v.	As Allwave Superhet Six chassis above. With Garrard automatic record changer, £35 14 0	—
Hylvotstar	Allwave Superhet 7 Radiogram	£31 10 0	AC/DC 100-250v.	As Allwave Superhet Seven chassis above. With Garrard automatic record changer, £42 0 0. Special De Luxe Console, £52 10 0	—
Hylvotstar	Allwave Superhet Ten	£34 13 0	AC/DC 100-250v.	9-valve superhet plus rectifier; A.V.C., Magnavox energised moving-coil speaker. Covers 15-31, 25-70, 200-560, 800-1,900m. In chassis form, £30 9 0	—
Hylvotstar	Allwave Superhet 10 Radiogram	£42 0 0	AC/DC 100-250v.	Chassis as Allwave Superhet Ten above. De Luxe Console with Garrard Automatic Record changer, £63 0 0	—
Invicta	AC145 Radiogram	£22 1 0	AC mains	5-valve (including rectifier) superhet radiogram	—
K.B.	383A	£26 5 0	AC/DC 200-250v	As K.B. 383 but with dual speakers and Console cabinet	Yes
Milnes	446 Radiogram	£22 2 6	AC mains	Chassis as 466 above	—
Milnes	537 Radiogram	£23 15 6	Battery	Chassis as 537 above	—
R.G.D.	704C	£39 18 0	AC mains, 195-250v., or D.C. mains.	7-valve superhet; twin energised moving-coil loudspeakers; A.V.C.; meter type tuning indicator.	—
Ultra	25 Radiogram	£22 1 0	AC mains, 100-130v. or 200-250v.	Chassis as 25 table model	—
OVER FORTY GUINEAS					
Autotrope	1, Series F	£68 5 0	AC mains	Dual station radiogram; output 5 watts	—
Autotrope	1, Series E	£92 8 0	AC mains	Superhet radiogram, medium and long waves; fluid light tuning; dual speakers; push-pull amplifier, output 6 watts.	—
Autotrope	1, Series G	£102 18 0	AC mains	Dual speakers, paraphase type amplifier, resistance coupled throughout; output 15 watts.	—
Autotrope	1, Series A	£144 18 0-£168 0 0, (according to cabinet)	AC mains	Custom-built 12-valve superhet radiogram in various cabinets. Medium and long waves; fluid light tuning; dual speakers; paraphase type amplifier, resistance coupled throughout; output 15 watts.	—
Ferranti	Gloria Radiogram	£47 5 0	AC mains	Note: All fitted with Autotrope record changer, playing 1-30 records, any make, any size, one or two sides.	—
Ferranti	Gloria Autogram	£54 12 0	AC mains	As Arcadia, with 6-watt push-pull output stage	—
Halford	A.W.9	£52 10 0 (less cab.)	AC mains	As above; with automatic record changer	—
Hartley-Turner	RGM12	£73 10 0 & £81 18 0	AC mains 200-250v.	9-valve all-wave receiver; 12 watts 12 in. Epoch Auditorium speaker; cabinet made to order.	Yes
Higgs	XA56AG	£47 5 0	AC mains 190 to 260 volts 40/100 cycles.	Same as M12 receiver with Hartley-Turner loudspeaker, turntable and piezo-electric pick-up.	—
H.M.V.	High-Fidelity 15-valve Autoradiogram 800	£115 10 0	AC mains	Incorporating a 6/7 valve all-wave superhet chassis, automatic record changer and large loudspeaker.	Yes
H.M.V.	Duo-Diffusion Autoradiogram Nine 580	£54 12 0	AC mains	Superhet radiogram	—
Philco	98 Radiogram	£52 10 0	AC mains	Superhet radiogram	—
Philco	680	£105 0 0	AC mains	Chassis as current Model 98 Philco All-wave Superhet	—
R.G.D.	704 Auto Radiogram.	£57 15 0	AC or DC mains 195-250v.	15-valve high fidelity all-wave radiogram; automatic record changer	—
R.G.D.	Non-Auto. 705 Auto Radiogram.	£50 8 0	AC mains 195-250v.	7-valve superhet radiogram; triode output stage; twin energised moving-coil loudspeakers; A.V.C.; meter tuning; piezo crystal pick-up.	—
R.G.D.	Non-Auto. 1204 Auto Radiogram	£87 3 0	AC mains 195-250v.	8-valve superhet all-wave radiogram; triode output; tone control; variable selectivity control; twin energised moving-coil speakers; piezo crystal pick-up.	—
R.G.D.	Non-Auto. 1202 Auto Radiogram	£79 16 0	AC mains 195-245v.	12-valve superhet radiogram; inter-station noise suppressor; tone control; three-position selectivity control; twin energised moving-coil speakers; piezo crystal pick-up.	—
R.G.D.	Non-Auto. 1203 Auto Radiogram	£112 7 0	AC mains 195-250v.	12-valve superhet radiogram; triode for inter-station noise suppression; A.V.C.; single knob visual tuning; tone control; selectivity control; two energised moving-coil speakers and one special moving-coil H.F. unit.	—
R.G.D.	Non-Auto. 1203 Auto Radiogram	£105 0 0	AC mains 195-250v.	13-valve superhet all-wave auto-radiogram; inter-station noise suppression; separate push-pull amplifier; two energised moving-coil speakers and one H.F. horn unit.	—
R.G.D.	Non-Auto. 1203 Auto Radiogram	£126 0 0	AC mains 195-250v.	13-valve superhet all-wave auto-radiogram; inter-station noise suppression; separate push-pull amplifier; two energised moving-coil speakers and one H.F. horn unit.	—
NOT PRICED AT TIME OF GOING TO PRESS					
Marconiphone	292	...	AC only	9-valve superhet radiogram	—
"	289	...	AC only	5-valve superhet radiogram	—
"	287	...	AC only	5-valve superhet radiogram	—
"	286	...	DC only	4-valve superhet radiogram	—
"	264	...	AC only	5-valve superhet table set	—
"	296	...	AC only	5-valve superhet table set	Yes
"	223	...	AC/DC	4-valve superhet table set	Yes
"	297	...	AC only	5-valve (including rectifier) AC/DC superhet	No
"	262	...	DC only	4-valve superhet console	Yes
"	279	...	AC only	6-valve superhet table set	Yes
"	273	...	Battery	5-valve superhet transportable	Yes
"	257	...	Battery	4-valve superhet table set	Yes
"	284	...	Battery	3-valve straight table set	Yes

Order Your October "W.M." Early: On Sale Friday Sept. 20

IN A CLASS BY THEMSELVES
IS THE VERDICT OF USERS OF

FULL O' POWER

RADIO BATTERIES

*solely by reason of their superior
quality and performance*

Buy **Full O' Power**
by **SIEMENS**

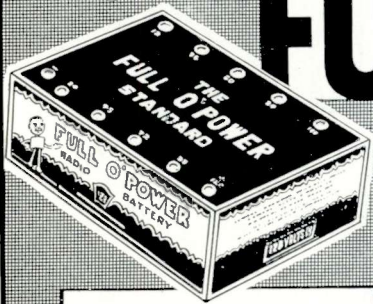

**FULL O' POWER
BATTERIES**
*are specified for the
CARRIER SHORT WAVE
and CERTAINTY THREE*

SIEMENS ELECTRIC LAMPS AND SUPPLIES LIMITED, 38/39, Upper Thames Street, London, E.C.4

362 ENTIRELY BRITISH
VALVES With

THE FAMOUS 362 SIX MONTHS'
REPLACEMENT GUARANTEE

Cheaper in many cases by 50%

DO NOT FAIL TO INSPECT OUR VERY INTER-
ESTING EXHIBIT ON STAND 212 IN THE
GALLERY. MEANWHILE SEND FOR OUR
LATEST LIST—POST FREE.

THE 362 RADIO VALVE CO., LTD.,
STONEHAM WORKS :: LONDON, E.5

Telephones: Clissold 1294 & 6607

£150 IN CASH PRIZES

£75 Here is an opportunity for you this summer if you
have a Miniature Camera (that is, one taking a
picture not bigger than 2½ ins. square). You are given right
up till October 31st to produce a good photo, and the
prize money in the competition in "HOME PHOTO-
GRAPHER" amounts to £75.

£75 If, on the other hand, you possess a Movie Camera,
there are big cash prizes, totalling £75 in "HOME
MOVIES," and you are also allowed until the end of
October to produce your film.

Full particulars in

"HOME PHOTOGRAPHER"
and **"HOME MOVIES"**

Out Now.

6D. EACH.

The Pick-Up
of the Future

**THE ROTHERMEL-BRUSH
PIEZO-ELECTRIC PICK-UP**

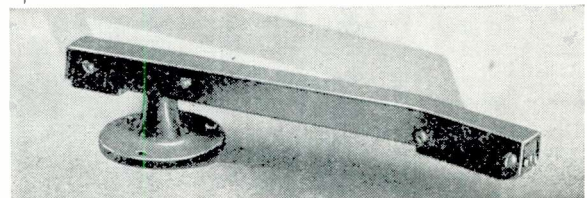

Acclaimed by the leading authorities as the greatest advance in design and performance that has ever been made, the Rothermel-Brush Piezo-Electric Pick-up gives a response of from 42 to 8,500 cycles with an output of 2 volts R.M.S. No other pick-up available can equal this performance. There is only 1½ ozs. weight on the record, thus ensuring an entire absence of wear and tear. This new and revolutionary non-magnetic and non-resonant pick-up represents the finest value available and because of its outstanding performance has been adopted by many prominent manufacturers of high-fidelity radio-gramophones.

See Rothermel-Brush Piezo-
Electric devices on STAND 54 at
Radiolympia

MODEL S.8.

42/- R.A.R. Rothermel LTD

Write for complete lists
featuring "Rothermel-
Brush" Piezo-Electric
Pick-ups, Speakers,
and Microphones, etc.,
post free.

Rothermel House,
CANTERBURY ROAD, HIGH ROAD,
KILBURN, LONDON, N.W.6.

'Phone: Maida Vale 6066.

Mention of the "Wireless Magazine" will ensure prompt attention

Conducted by the "W.M." Technical Staff

TESTS OF NEW APPARATUS

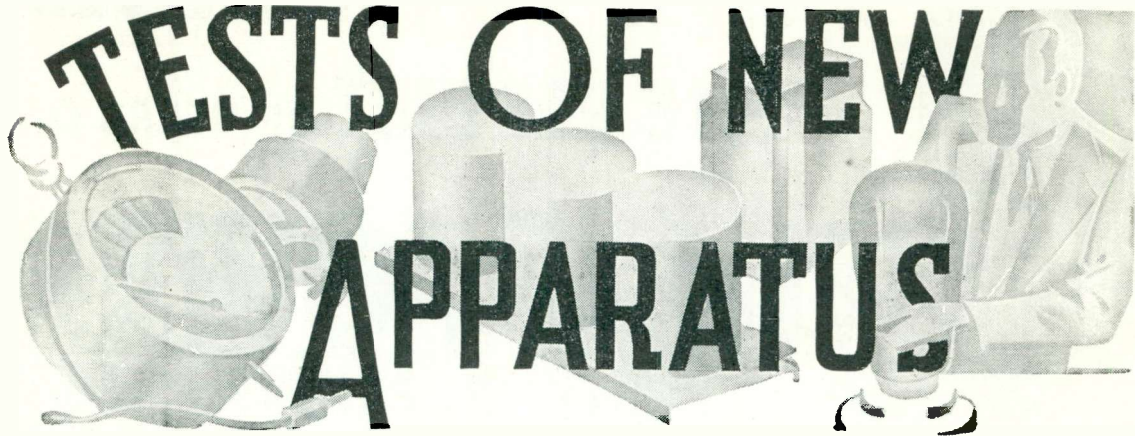

W.B. Senior Stentorian Permanent-magnet Moving-coil Loudspeaker :: 362 Output Valves

W.B. STENTORIAN SENIOR SPEAKER

Description.

W.B. HAVE introduced a new loudspeaker known as the Stentorian Senior, 1936 model. The speaker is built on somewhat similar lines to previous productions.

The diaphragm is carried on a very stout die-cast chassis. The chassis ring is fitted with a felt inset for baffle connection and there are three lugs for fixing purposes. The chassis, however, is carried on another die casting which forms the main cradle for the magnet, input transformer and switches. The moving coil is fitted with a back suspension comprising a fairly conventional type of spiral spider.

Dust protection is provided on all sides of the gap. Wadding is lightly placed round the front of the gap and is held in position by a small bakelite moulding screwed to the centre pole of the magnet.

Switches are provided for accurate matching and there is also another switch for connecting the loudspeaker either as a high-resistance or low-resistance extension model when required. There are three terminals which, in conjunction with the switch, give suitable loadings for any type of output including, of course, push-pull working.

Finally there is a pair of strapped terminals for a volume control connection. The whole loudspeaker is finished in light buff lacquer.

Observations

The general construction of the speaker is very sound and there is little we criticise.

The response of the loudspeaker is quite representative and the resonances, which are naturally there, are not particularly marked. The top resonance occurs in the region of 3,000 cycles and the bass resonance is well away from any point which would accentuate hum when used with a mains receiver.

The response is well maintained in the lower registers and at the same time the upper radiation is quite satisfactory.

Practical tests of the loudspeaker show that the performance is representative, the inevitable slight colouration only really being noticeable on speech. The speaker will handle quite a large volume without overloading.

The wide degree of matching which

the various terminals and switches make possible makes the loudspeaker particularly attractive to the home constructor as it can be correctly used with any type of output.

Measurements

Transformer resistance 212 ohms.
Low resistance . . . 830 ohms.

The loudspeaker is made by the Whiteley Electrical Radio Co., Ltd., and costs £4 4s.

362 OUTPUT VALVES

Description

TWO of the latest 362 output valves are the PX25—a power triode—and the ME25—a pentode. The latter is fitted with a directly-heated cathode.

In appearance both valves are similar, being fitted into long glass envelopes with a reduced neck at the top. This retains mica anchorage pieces. Both valves use four hairpin filaments, and in each case a rectangular grid formation is utilised. The anode is the special perpendicular slat type in which strips of metal are arranged at an angle with respect to the other electrodes.

Observations

The electrode assemblies are accurately arranged and the valves appear to

Continued on page 153

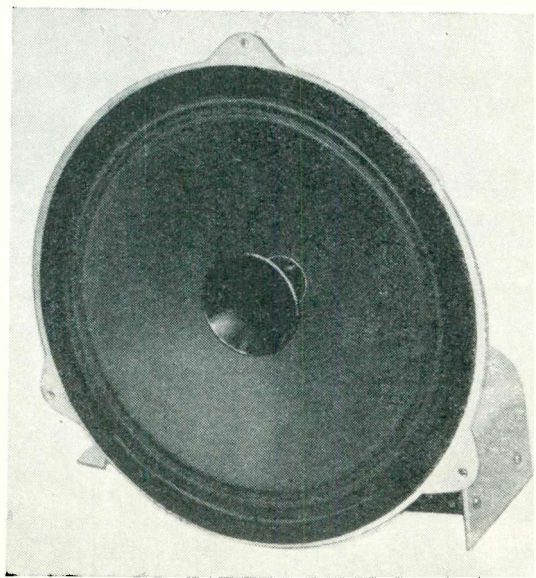

Front view of the Senior W.B. Stentorian loudspeaker showing the dust-proof cap in the centre of the cone

PETO-SCOTT

FIRST with EVERYTHING NEW at

OLYMPIA

Once again this year, only Peto-Scott will be able to give you FIRST and IMMEDIATE DELIVERY of EVERYTHING NEW in RADIO and TELEVISION . . . send us a list of your needs and we will quote you per return.

IMMEDIATE DELIVERY
CASH — C.O.D. — H.P.

PILOT AUTHOR KITS

Pilot Author Kits for sets featured in "Wireless Magazine" and all other Technical Journals are only obtainable direct from Peto-Scott for Cash, C.O.D., or H.P. **SEND FOR DETAILED PRICED LISTS OF PARTS.**

CERTAINTY 3

Described in this Issue

KIT "A" Authors Kit of first specified components, including Peto-Scott plywood chassis and Ready Drilled and Polished Plywood Panel, less valves, cabinet, and speaker **Cash or C.O.D. £3 : 12 : 6**
Carriage Paid.
Or 12 monthly payments of 6/9

KIT "B" As for Kit "A" but including set of 3 specified valves, less cabinet and speaker. Cash or C.O.D. Carriage paid. **£5. 4s. 0d.**
Or 12 monthly payments of 8/6.

KIT "C" As for Kit "A" but including valves and Peto-Scott Certainty 3 Cabinet, less speaker. Cash or C.O.D. Carriage paid **£6. 19s. 0d.**
Or 12 monthly payments of 12/8.

Peto-Scott Plywood Chassis and Ready Drilled and Polished Walnut Panel . . . **s. d. 6 : 6**
Set of 3 specified valves . . . **£1 : 11 : 6**
W.B. type 36S. speaker . . . **£1 : 3 : 6**

UNICON A.C./D.C.2

Described in this Issue

KIT "A" Authors Kit of first specified parts, including Peto-Scott Plywood chassis with ebonite terminal strips, less valves, and speaker **Cash or C.O.D. £5 : 2 : 6**
Carriage Paid.
Or 12 monthly payments of 9/6

Peto-Scott Plywood Chassis with ebonite terminal strips . . . **s. d. 5 : 0**
1 set of 3 specified valves . . . **£1 : 15 : 3**

"W.M." NEW STYLE S.W. ADAPTOR

Described in June Issue

KIT "A" Author's Kit of first specified parts, including Peto-Scott Metaplex Baseboard and Ready-drilled Metaplex Panel, but less valve. **Cash or C.O.D. £2:9:6**
Carriage Paid
Or 11 monthly payments of 5/-.

PETO-SCOTT Co. Ltd.,
77, W.M.7. City Rd., London, E.C.1
Telephone: Clerkenwell 3446/7.
West End Showrooms: 82 W.M.7. High Holborn, W.C.1. Telephone: Holborn 3248.
PLEASE SEND ME your New Season's Catalogues, including (Strike out that not required).
Peto-Scott 1936 Radio
Peto-Scott Speaker and Accessories
Peto-Scott Short Wave
Peto-Scott "Easiway" General Radio.

NAME

ADDRESS

..... W.M.7.

TESTS OF NEW APPARATUS

Continued from previous page

to be quite soundly constructed. The manufacturers point out that the dissipation of the PX25 can be brought up to 40 watts, while that of the ME25, the pentode, can be set at 30 watts. These are ratings which are slightly higher than general for valves of this type. Tests carried out over a limited period, however, indicated that the valves did not appear to be damaged in any way by this high dissipation or by a correspondingly increased A.C. output.

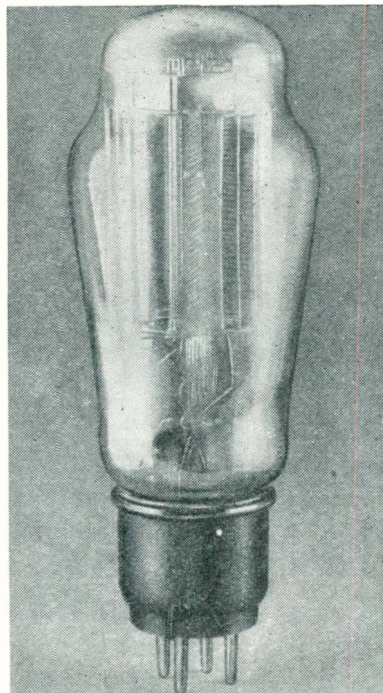

The 362 PX25 triode. Note the unusual appearance of the electrodes in the dome-shaped bulb

They can, in fact, be considerably overrun without any signs of apparent danger, and accordingly they should prove very useful where a little greater output than usual is required or where high peak outputs are necessary for short periods.

Measurements PX25

	Nominal	Actual
Filament voltage, 400 volts on the anode.	4 volts	
Filament current	2 amperes	2 amperes
Mutual conductance	6 m.a./v.	6.6 m.a./v.
	ME25	
Filament voltage at 250 volts on the anode.	4 volts	
Filament current	2 amperes	2 amperes
Mutual conductance	4 m.a./v.	3.3 m.a./v.

The valves are made by the 362 Radio Valve Co. The prices are PX25, £1; ME25, £1 10s.

PITMAN'S

Books for RADIO and TELEVISION ENTHUSIASTS

Ready Shortly

POPULAR TELEVISION

By H. J. Barton Chapple, Wh.Sc., B.Sc., A.C.G.I., D.I.C., A.M.I.E.E., Hon.M.I.W.T.

If you are considering buying or making a Television Receiver, get this book first. It is the latest work on the subject. Gives a complete, easily-mastered explanation of the principles and methods.

Crown 8vo. **2/6** net. 126 pages

RADIO UPKEEP AND REPAIRS FOR AMATEURS

By Alfred T. Witts, A.M.I.E.E.

One of the most successful radio handbooks on the market. A complete guide to faults and defects, and their remedies, especially written for the ordinary listener.

Crown 8vo. **5/-** net. 187 pages

RADIO RECEIVER SERVICING AND MAINTENANCE

By E. J. G. Lewis.

This book was especially written for dealers, service men and keen experimenters. Everything connected with wireless servicing, maintenance and repair is exhaustively described and is set out for immediate reference.

Crown 8vo. **7/6** net. 193 pages

THE SUPER-HETERODYN RECEIVER

By Alfred T. Witts, A.M.I.E.E.

Every Superhet enthusiast should make sure of obtaining a copy of this instructive book. It explains the principle and construction of this type of set together with its evolution and present trend.

Crown 8vo. **3/6** net. 136 pages

★ All these books can be obtained from your usual bookseller or direct from the publishers (postage extra).

PITMAN
Parker St., Kingsway, W.C.2

Chosen for Stability throughout Radiolympia

- and for these Two Latest Sets - the
- 'Listener's 5-watt A.C. Amplifier' and
 - 'A.C. Standard 4-valve Short-waver'
- See this set on the T.M.C. HYDRA Stand, No. 29

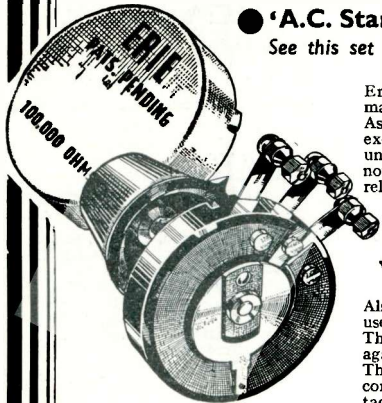

Erie Resistors are used by all the leading manufacturers and specified by all designers. As a result of years of research and their exclusive composition they give unequalled stability; neither heat nor damp affect their lasting reliability. Insist on Eries!

1/-
Per Watt
in all
Values

The ERIE VOLUME CONTROL

Also specified for the above two sets and used by the foremost set manufacturers. This better variable resistance safeguards against the most frequent source of trouble. The Erie resistance element and precision construction give smooth and positive contact, without hop-off noises, for a life-time's use. All sizes: 50,000 ohms to 2 megohms.

At all Radio Dealers Or with built-in mains switch, 5/-

See Erie Resistors, the Erie Volume Control and other Erie products at RADIOLYMPIA. Stand No. 15

ERIE RESISTORS

FREE Send for the helpful "Erie Resistor Service Instruction Booklet."
THE RADIO RESISTOR CO., LTD.
1 Golden Square, Piccadilly Circus, London, W.1

In Tune with

New Literature

MATTER OF CONNECTIONS

RADIO SHOW time is the beginning of the season when constructors start looking round for new ideas for their new season's sets. As a general rule the matter of connections always seems to be left to the last, to take care of itself. Why, I cannot imagine.

To my mind, the bits and pieces, such as mounting strips, anode connectors, and the like, play a very important part in the design of a receiver. One can do all sorts of queer things if only one had the gadgets with which to play about. That is my reason for drawing your attention early to the new Clix leaflets in which heaps of handy connectors, plugs, mounting strips, terminals, all kinds of valve-holders and so on are described.

Even if you are not contemplating a new receiver and intend to "hot up" an existing model, then I would stress the importance of making sure that all your connections are good. Crackles can more often than not be traced to faulty joints and terminals, etc.

Take a straight tip from me and ask for this Clix literature. **476**

G.E.C. CAR RADIO

THE story has usually been told that car radio is ideal for entertaining one during runs to the seaside and country during the summer months. Personally, I find that I get more enjoyment from my car radio during the winter months. Dark and dismal runs can be made



There was a wireless-enthusiast—of Crewe Had **NOTHING** to learn—he **KNEW!** In **THIS** he is right—He always uses **FLUXITE**—In the "**GUN**"—so easy—why don't **YOU?**

See that **FLUXITE** is always by you—in the house—garage—workshop—wherever speedy soldering is needed. Used for 30 years in government works and by leading engineers and manufacturers. Of Ironmongers—in tins, 4d., 8d., 1/4 and 2/8.

Ask to see the **FLUXITE SMALL-SPACE SOLDERING SET**—compact but substantial—complete with full instructions, 7/6.

Write for Free Book on the art of "Soft" Soldering, and ask for Leaflet on **CASE HARDENING STEEL** and **TEMPERING TOOLS** with **FLUXITE**.

TO CYCLISTS! Your wheels will **NOT** keep round and true unless the spokes are tied with fine wire at the crossings **AND SOLDERED**. This makes a much stronger wheel. It's simple—with **FLUXITE**—but **IMPORTANT**.

THE FLUXITE GUN is always ready to put **Fluxite** on the soldering job instantly. A little pressure places the right quantity on the right spot and one charging lasts for ages. Price 1/6.

ALL MECHANICS WILL HAVE



FLUXITE

IT SIMPLIFIES ALL SOLDERING

Fluxite Ltd., Dept. 352, Dragon Works, Bermondsey St., S.E.1

"THE CERTAINTY 3"

Complete Kit **SPECIFIED** parts. (No alternatives)

45/6 CASH or **5/3** MONTHLY
C.O.D.

"5 watt A.C. AMPLIFIER"

SPECIFIED Kit all components. (No alternatives)

£7 CASH or **17/-** MONTHLY
C.O.D.

HOSTS OF OTHER BARGAINS—KITS, PARTS, RECEIVERS, etc. **LISTS FREE**

MELFO-RAD QUEENS HOVE

SEE OLYMPIA, STAND NO. 9

By F. J. CAMM

Editor Practical Motorist, etc.

THE PRACTICAL MOTORIST'S ENCYCLOPÆDIA

Principles, Upkeep and Repair of every part of the Car

JUST PUBLISHED
With **442** illustrations **3/6** NET

From all Booksellers

GEORGE NEWNES LIMITED

SEND TO US FOR THESE CATALOGUES!

Here we review the newest booklets and folders issued by six manufacturers. If you want copies of any or all of them, just cut out this coupon and send it to us. We will see that you get all the literature you desire.

Please indicate the numbers (seen at the end of each paragraph) of the catalogues you want below:—

My name and address are:—

Send this coupon in an unsealed envelope, bearing id. stamp, to "Catalogue Service," **WIRELESS MAGAZINE**, 8-11 Southampton St., W.C.2.
Valid till September 30.

the Trade

Reviewed by EXAMINER

very pleasant when one has the means of getting a little of the B.B.C.'s occasional cheer to liven things up.

G.E.C. has just entered the car-radio market with an outfit employing a five-valve superhet arrangement. All valves are of the 13-volt heater type and are fed directly from the car accumulator. The high-tension supply is obtained from a small rotary transformer running off the same source. An energised moving-coil loudspeaker is also used, and here again the energising current is taken from the car battery.

In spite of the heavy demands made on the battery, the total current drawn is only in the region of 4.5 amperes. The control unit fits on the steering column and a complete suppression equipment is provided. Price, too, is very reasonable, being only nineteen guineas for the complete installation.

If interested, ask for number **477**

WESTINGHOUSE RECTIFIERS
FROM this old-established concern comes a huge broadsheet on which is listed a complete galaxy of gear of interest to the radio-minded man. For the constructor there are full particulars of the range of metal high-tension rectifiers—the rectifier that never wears out—the small Westectors used for the rectification of high-frequency currents, and units suitable for trickle charging.

For the more ambitious there are chargers for car batteries, and going a step farther we have big chargers suitable for the radio dealer.

You can get a copy of this broadsheet free by merely sending the coupon which you will find at the bottom of the facing page. **478**

COSSOR RADIO 1935-1936

A NEAT folder describing the whole range of Cossor receivers for the new season has arrived—one of the first, of course.

Of particular interest is the range of super-ferrodyne models, all of which employ one-knob tuning and efficient iron-core coils. The sets range from a simple battery three-valver employing two high-frequency

Continued on page 157

HEAR-THERE AND EVERYWHERE

Wherever you may be, you need not miss the broadcast items you particularly wish to hear. A small, lightweight portable solves the difficulty, and is made possible by the new HIVAC "MIDGET" Valves.

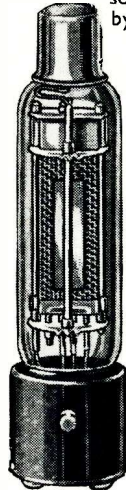

X 5 G
Actual
Size

Remember that the Midgets are perfect miniature HIVAC Valves with a performance out of all proportion to their size.

S.G., two G. P. Triodes, and Power types are now made, constituting the only "Midget" range available. Their low consumption (0.06 amps) requires only midget L.T. and H.T. batteries greatly reducing weight and size of sets.

Send for the Complete HIVAC VALVE GUIDE, "W. M.," which gives essential details of all HIVAC valves, Battery, Mains and Midget types, also Replacement List giving HIVAC equivalents to other makes.

STAND S27 OLYMPIA

HIVAC

THE SCIENTIFIC VALVE

BRITISH MADE

HIGH VACUUM VALVE Co., Ltd.,
113-117 FARRINGTON ROAD, LONDON, E.C.1.

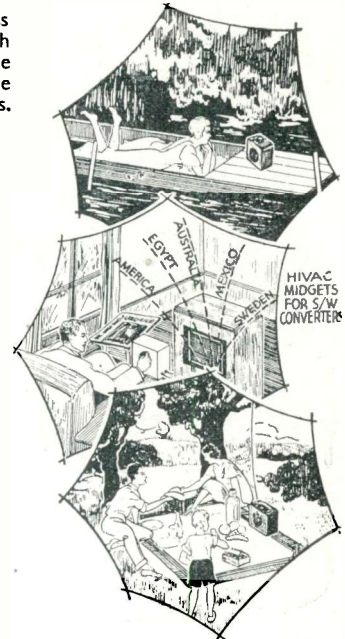

J.B. FOR THE "UNICON TWO"



—and the "A.C. Standard Four-valve Short-waver."

The tuning condenser which has been chosen for the "Unicon Two" is the famous J. B. "Nugang." In this condenser is embodied all the well-known J. B. features, and the dial and drive are built in as an integral part.

For the Short Wave Set, the J.B. neutralizing condenser has been used.

Single Nugang Condenser,		
Catalogue No. 2081	...	10/6
Neutralizing Condenser, Cata-		
logue No. 1050	...	3/6

JACKSON BROTHERS (London) Ltd.,
72, St. Thomas Street, S.E.1.
Telephone : Hop 1837

B.T.S. NEW

ULTRA-SHORT and SHORT WAVE APPARATUS

Designed for wide band frequency response, with that extra care and attention to choice of materials and special construction essential to successful ultra-short-wave working. Each incorporates Megacite, the new low-loss high-power factor insulating material exclusive to B.T.S. Metal parts silver plated.

OLYMPIA
STAND
14



Type UFD. Padding Condenser 3/8.

Type UTC. Trimming Condenser 2/9.

Type UT/2. Tuning Coils and Holder 2/9.



Type UIF/18. Intermediate Frequency Unit 9/6.



Type U/O/67. Tuning Condenser 7/6.



Type UO. Oscillator Coil and Holder 9/6.



Type UH. Valve Holders from 1/-.



Type UER. H.F. Coils 1/6.

A selection of the latest B.T.S. U.S.W. Components which may be seen at Olympia

SPECIFIED

A.C. STANDARD SHORT WAVE
4 B.T.S. Short Wave Coils, 13/190 metres, 16/-

FROM ALL DEALERS
If any difficulty, send direct



Short Wave and Television Specialists
BRITISH TELEVISION SUPPLIES, LTD.
BUSH HOUSE, Dept. "W.M.", LONDON, W.C.2.

GEORGE NEWNES Limited
are
The Publishers
of
Books about Wireless
Ask any bookseller for a Newnes book if you want a Wireless Book.

Guide to the Set Makers

See pages Seven-Nine of Supplement and 140 & 150

- Ace:** Ace Radio, 2-5 Dingley Place, City Road, London, E.1.
Aerodyne: Aerodyne Radio, Ltd., Tottenham, N.17.
Alba: A. J. Balcombe, Ltd., 52-58 Tabernacle Street, London, E.C.2.
Allwave: Allwave International Radio & Television, Ltd., 242 High Street, Bromley, Kent.
Atlas: H. Clarke & Co., Ltd., Atlas Works, Patricroft, Manchester.
Austin: City Accumulator Co., Ltd., 18-20 Norman's Buildings, Central Street, London, E.C.1.
Autotrope: Anson & Hopwood, Ltd., 41 Cheval Place, London, S.W.7.
Beethoven: Beethoven Radio, Ltd., Beethoven Works, Great College Street, Camden Town, London, N.W.1.
Betteset: Betteset Radio, Ltd., Clarendon Works, Montague Street, Worthing, Sussex.
Blue Spot: British Blue Spot Co., Ltd., 94-96 Rosoman Street, Rosebery Avenue, London, E.C.1.
Burgoyne: Burgoyne Wireless (1930), Ltd., Great West Road, Brentford, Mx.
Burndep: Burndep, Ltd., Light Gun Factory, Erith, Kent.
Bush: Bush Radio, Ltd., Woodger Road, Shepherd's Bush, London, W.12
Cossor: A. C. Cossor, Ltd., Cossor Works, Highbury Grove, London, N.5.
Decca: Decca Record Co., Ltd., 1-3 Brixton Road, London, S.W.9.
Eddystone: Stratton & Co., Ltd., Eddystone Works, Bromsgrove Street, Birmingham.
Ekco: E. K. Cole, Ltd., Ekco Works, Southend-on-Sea, Essex.
Ever Ready: Ever Ready Co. (Great Britain), Ltd., Ever Ready Works, Hercules Place, Holloway, London, N.7.
Ferranti: Ferranti, Ltd., Hollinwood, Lancs.
G.E.C.: General Electric Co., Ltd., Magnet House, Kingsway, London, W.C.
Halcyon: Halcyon Radio, Ltd., Valetta Road, London, W.3.
Halford: Halford Radio, Ltd., 39 Sackville Street, London, W.1.
Hartley Turner: Hartley Turner Radio, Ltd., Thornbury Road, Isleworth, Mx.
Higgs: Charlton Higgs (Radio), Ltd., Westbourne Place, Hove, Sussex.
H.M.V.: The Gramophone Co., Ltd., 98-108 Clerkenwell Road, London, E.C.1.
Hyvoltstar: Universal High-Voltage Radio, Ltd., 28 Southampton Street, London, W.C.2.
Invicta: Orr Radio, Ltd., 79a Parkhurst Road, London, N.7.
K.B.: Kolster-Brandes, Ltd., Cray Works, Sidcup, Kent.
Knightsbridge: See Betterset.
McMichael: McMichael Radio, Ltd., Slough, Bucks.
Magnum: Burne-Jones & Co., Ltd., Borough High Street, S.E.1.
Milnes: Milnes Radio Co., Ltd., Victoria Works, Church Street, Bingley Yorks.
Mullard: Mullard Wireless Service Co., Ltd., Mullard House, 111 Charing Cross Road, London, W.C.2.
Pegasus: Pegasus, Ltd., Low Mills, Lower Wortley, Leeds, 12.
Philco: Philco Radio & Television Corporation of Great Britain, Ltd., Aintree Road, Perivale, Greenford, Middlesex.
Pye: Pye Radio, Ltd., Radio Works, Cambridge.
R.G.D.: Radio Gramophone Development Co., Ltd., 18 Frederick Road, Birmingham.
R.I.: Radio Instruments, Ltd., Purley Way, Croydon, Surrey.
Ultra: Ultra Electric, Ltd., Erskine Road, Chalk Farm, London, N.W.3.

NEXT MONTH

Details of Radio Unit
For Use with the
Listener's 5-watt Amplifier

Tests of Five New
Commercial Sets

Building a Modulated
H. F. Oscillator

Latest Television News
and Many Articles of
Interest for ALL Listeners

"W.M."—THE MAGAZINE FOR
EVERY RADIO USER!

REDUCTION IN PRICE of the FAMOUS UNIVERSAL OSTAR GANZ VALVES.

The large demand and popularity of the Ostar Ganz Valves enable us to offer them at a cheaper retail price. The public recognise them as the valves of the future—they last longer, consumption is cheaper and they are more efficient. Valves for every purpose—without equal for short-wave receivers or Television work. The most advanced valve, though not shown at Olympia. Write for particulars.

OUR VERSION OF CONVERSION

Have a model equal to Olympia's best. Let us convert your present set into a Universal All Mains AC/DC Receiver, at moderate cost. The improved results will astonish you. Technical experts carry out conversion. Send us your set (carriage paid) for free quotation, or write for full particulars from Conversion Dept.

FREE TO RADIO ENTHUSIASTS

We have KITS for every type of set or radio instrument, such as Amplifiers and Transmitters, etc. Prices within the reach of all. Our experts give FREE advice if required. Take advantage of this unique offer (even unskilled enthusiasts) by sending for our interesting leaflets.

EUGEN J. FOREAT (Dept. E)

28-29 Southampton Street, Strand, W.C.2. Telephone: TEMple Bar 8608.

AN EXHIBITION IN YOUR OWN HOME

Hyvoltstar All Waves All Mains AC/DC Receivers can be had on approval to test and examine under your own conditions in your own home. Not a mass produced article. Undoubtedly the finest radio value on the market for 1936. Supreme for world-wide selectivity, quality of tone, volume and appearance. Take advantage of this unique offer and see for yourself why the critics praise HYVOLTSTAR. Wide range of attractive models at moderate cost. Each set is personally constructed by our own engineers, each customer's requirements dealt with personally if you call or write. Write for Leaflets of our Receivers, Radiograms and Amplifiers.

Universal High Voltage Radio, Ltd.
28-29, Southampton Street, Strand, W.C.2.
Telephone: TEMple Bar 4968.



DEVELOPMENT



Four-pin, Five-pin — then Seven-pin and now Nine-pin valves are utilised in modern receivers.

The question of efficient contact becomes more important as the number of pins increases.

Only by the use of the "Clix" patented features can perfect contact be guaranteed—contact which un-biassed laboratory tests have proved to be more than four times as efficient as any other.

STAND 115
OLYMPIA

CLIX

Two New 1936 Clix Folders "W.M." Free on request.
LECTRO LINX LTD.
79a Rochester Row, London, S.W.1.

In Tune with the Trade

Continued from page 155

pentodes and a triode output, costing £5 15s., to A.C. and A.C./D.C. models costing only £8 18s. 6d.

Another Cossor speciality is the two thermometer sets, a battery and an A.C. model, in which a novel, yet simple, form of visual tuning indicator is employed.

The star piece of the Cossor range is undoubtedly the model 365, a de-luxe table superhet for A.C. mains. All these sets, and more besides, are described in this leaflet which is yours for the asking. **479**

VARLEY'S LATEST

THE serious experimenter will find much to interest him in Varley's latest catalogue. Of special interest are the new three- and four-gang superhet permeability tuners, the Variband intermediate-frequency unit (110 kilocycles), which consists of two I.F. transformers with variable coupling, an intermediate-frequency transformer known as the Air-tune for 465 kilocycles embodying Litz-wound iron-core coils.

These are only the main items of interest. In addition there is the

Visit Stand No. 9

at Radiolympia!

full description of Nicore components, potentiometers, resistances, transformers, pick-ups and so on. Every constructor *must* have a copy of the Varley book on his shelves. **480**

WIRELESS TABLES

THE tables I am referring to are those for making a table receiver look like a handsome console model. They are made by Electrico, of Croydon. There are models for all H.M.V., Marconiphone, Murphy, Philips, and, in fact, all leading sets. My fancy was drawn towards a de-luxe bookcase model made of solid walnut. There are two bookshelves at the bottom and at the top is a handy drawer for storing your "W.M." and the programme papers.

Strangely enough these tables, in spite of their good finish, are not expensive; the bookcase table only costs thirty-five shillings, and if you don't want the drawer you can get it for seven shillings and sixpence less. **481**

This 28-Page Booklet—Free



It gives full information regarding various Courses of Instruction in Radio work.

The Radio Industry is progressing with amazing rapidity. Only by knowing thoroughly the basic principles can pace be kept with it. I.C.S. Instruction includes American broadcasting as well as British wireless practice. It is a modern education, covering every department of the industry.

OUR COURSES

Included in the I.C.S. range are Courses dealing with the installing of radio sets and, in particular, with their **Servicing**, which to-day intimately concerns every wireless dealer and his employee. The **Equipment Course** gives sound instruction in radio principles and practice. There is also a **Course for the Wireless Salesman**.

The **Wireless Engineering Course** deals with Radio telegraphy and telephony in their numerous applications in commerce, shipping, etc.

Then there are **Preparatory Courses for the City and Guilds, I.E.E., and I.W.T. Exams.**

We will be pleased to send you details and free advice on any or all of these subjects. Just

Write to-day
for our

"RADIO" BOOKLET

This will not place you under any obligation.

INTERNATIONAL CORRESPONDENCE
SCHOOLS, LTD.

Dept. 89, International Buildings, Kingsway,
London, W.C.2.

SPARE-TIME AGENT

Wanted In Nearly Every District

For complete range of battery and all-electric A.C./D.C. radio sets.

Prices from 79/6 to £20

Cash or Hire Purchase

Excellent Commission

For Full Particulars—

Write your name and address in the margin, and post this advertisement in 1/2d. unsealed envelope to

Electrocets, Solihull, Birmingham.

POTENTIOMETERS

Control of volume should be entirely free from unwanted noises. In Reliance Volume Controls this is achieved by an exceptionally springy contact exerting a light but firm pressure over a very small area of resistance element.

Wire-wound, 5 to 4/6
100,000 ohms - - 4/6
Composition Tracks:
0.5 ohms to 5/9
megohms - - 4/9

RELIANCE

SPECIFIED for the
CERTAINTY THREE

THE PRODUCT OF
SPECIALISED RESEARCH

Folder "W.M." Free.

RELIANCE MANUFACTURING CO. (SOUTHWARD) LTD.
WESTBURY ROAD, LONDON, E.17

Inexpensive long-life METERS...

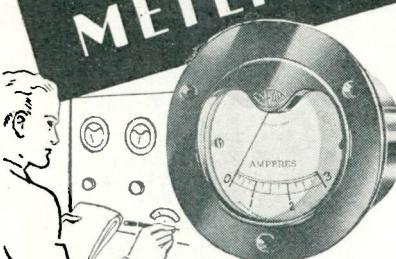

for all your radio tests!

MAGNETIC CONTROLLED D.C. ONLY.
 Attractively priced and finished, these meters are widely used for all general purposes. Semi-flush panel fitting, 2 1/2 in. overall; 2 in. hole in panel.

Voltmeters. Available up to 20 volts at 7/6
 30-0-30 at 7/-
 Or up to 10 amps at 7/6
Milliameters. In all useful capacities from 5 to 300 mA. 10/-



Post this Coupon today
 Please send your fully illustrated list No.
 Name
 Address

(Use Block Letters.)
SIFAM ELECTRICAL INSTRUMENT CO., LTD.
 Hollydale Road, London, S.E. 15.
 Phone: New Cross 2169.

A SIFAM TEST'S A SAFE TEST

The A.C. STANDARD 4-VALVE SHORT-WAVER

Complete kit of first specified parts, valves and speaker
 PRICE £13 0s.

The 1935 A.C. STENODE RECEIVER

Complete kit of first specified parts, valves and speaker
 PRICE £15 10s.

The 1935 RADIOGRAM

Complete kit of first specified parts, valves, speaker, pick-up and gramophone motor
 PRICE £21 0s.

All carriage paid, cash with order or C.O.D.

CHAS. F. WARD,
 46 Farringdon Street, London, E.C.4
 Telephone: Holborn 9703

Notes and News

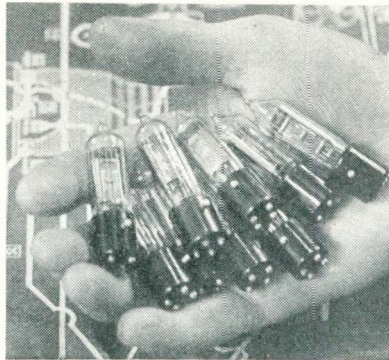

One handful of midgets—representative samples from the Hivac range

PLEASE note that the two T.C.C. 8-microfarad electrolytic condensers specified in the list of parts for the Listener's 5-watt A.C. Amplifier should be type 802 and the price 6s. each.

Here is more news about the Show which arrived after the main section of the issue had been passed for press.

From Columbia comes news of their return to the set market. The range of sets to be marketed for the season includes table, console and

radiogram versions of a four-valve A.C. superhet and a five-valve battery superhet, which we hope to test in a very early issue of "W.M."

R. & A. loudspeakers on show at the Reproducers & Amplifiers, Ltd., stand at Olympia will consist of three permanent-magnet models. A special matching transformer fitted to the Alpha model (55s.) gives no fewer than sixty-five different matching ratios. The transformer can be obtained separately for 18s. 6d. and will handle a D.C. current of 50 milliamperes in its primary windings.

Service engineers would do well to visit the Weston Electrical Instrument Co., Ltd., for there they will see a complete range of testing instruments ideal for servicing requirements.

We learn that in addition to the midget types of valves described on page 295 of our May issue, the Hivac valve manufacturers have just brought out a power valve with the impedance figure of 5,000 ohms.

Continued on next page

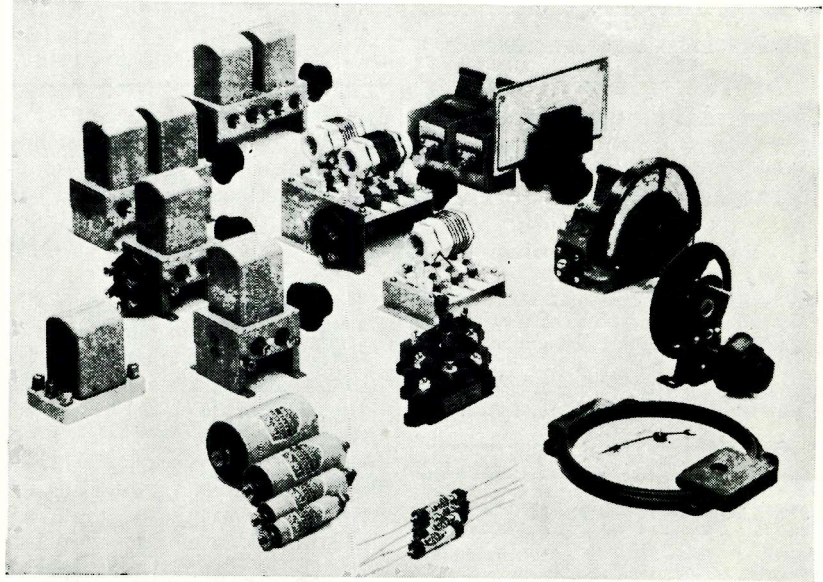

Here is a group of components by Formo that you can inspect on the Graham-Farish stand at Olympia. Provided fifty shillingsworth is purchased, they can be paid for on a new easy-term scheme just introduced by this concern

THE ONE AERIAL FOR THE MODERN SET

PIX INVISIBLE AERIAL

Pix, London, S.E.1

Neat
 Efficient
 Blends with
 furnishings
 Self-Adhesive

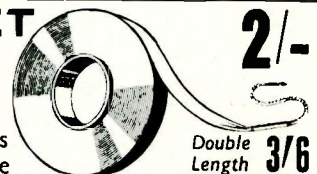

2/-

Double Length **3/6**

IRREDUCIBLE MINIMUM

In the Clix Short Wave Valveholder for Base-board mounting, the top plate consists of a very thin Bakelite sheet possessing excellent insulating properties and great mechanical strength.

The curved slots shown provide the longest leakage paths possible between sockets without impairing the ability to withstand hard usage.

STAND IIS
OLYMPIA

CLIX SHORT WAVE VALVEHOLDERS

4-pin ...	1/9
5-pin ...	2/-
7-pin ...	2/3
9-pin ...	2/6

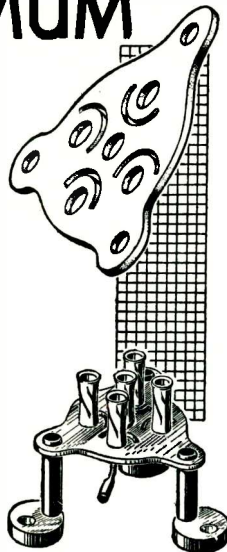

CLIX SHORT-WAVE VALVEHOLDERS

Send for two new 1936 Folders "W.M." Free.
LECTRO LINX LTD.
79a Rochester Row, London, S.W.1.

Still more Entertainment!

Do you know the music of Japan, South America, Morocco and Java—all strange and wonderful to British ears? Do you wish to enjoy the Colonial programmes and American broadcasts? All these are awaiting you on the Short Waves, and the best economical way of ensuring world-wide reception is with the

UNIT SHORT-WAVE CONVERTER

For any set, battery or mains. Can be used as superhet converter or short-wave adaptor. No alteration to receiver. 100-1 Tuning Dial. Price, 47/-, with Coils 13-80 metres. Change-over switch 8/W to normal, 3/- extra. Send for fully descriptive leaflets "W.M."



UNIT RADIO 47/- Cash or C.O.D.
347 CITY ROAD, LONDON, E.C.1.

ELEMENTS OF LOUD-SPEAKER PRACTICE

By N. W. McLachlan
D.Sc., M.I.E.E.

pp. 168 92 Figs. 5s. net

NOISE

By the same Author

pp. 160 70 Illus. 6s. net

OXFORD UNIVERSITY PRESS

These interesting valves will be dealt with fully in our October issue, published September 20.

Graham-Farish, Ltd. inform us that they are putting into operation an interesting new easy-terms scheme whereby any constructor will be able to obtain Graham-Farish and Formo components for small weekly payments providing his order amounts to not less than £2 10s.

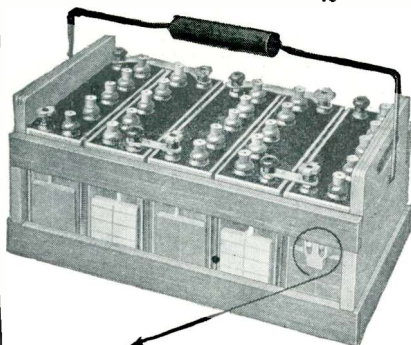

A high-tension unit made by Dagenite. Note the tell-tale device on the side

This he can do not merely direct from the manufacturers, but through his local dealer if desired.

Will readers please note that the price of the Full O'Power 120-volt high-tension battery specified for the Carrier Short-waver, the model H3, is now 10s. 6d. and the grid-bias battery 9d.

Siemens will be showing a full range of their Full O'Power batteries at Olympia, and a visit to their stand will be time well spent.

Marconi's Wireless Telegraph Co., Ltd., has concluded an agreement with British Radiostat Corporation, Ltd., and has acquired rights under present and future patents controlled by the latter company, including exclusive licensing rights under the Stenode broadcast reception (sound and television) patents in Great Britain and Ireland.

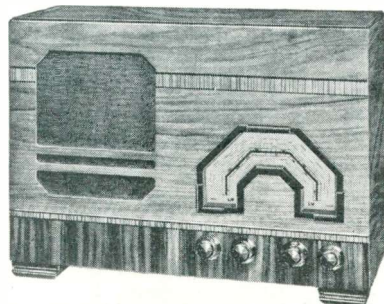

A new Aerodyne receiver—the Nightingale, a three-valve battery receiver with pentode output stage costing £7 17s. 6d., excluding batteries

Interesting technical folder, describing Iron-Cored Tuning Coils on request

Radio enthusiasts should send for our FREE 64 page Catalogue

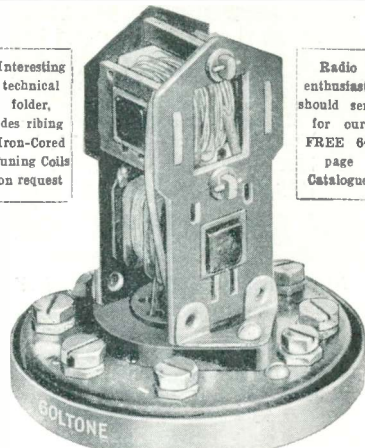

"GOLTONE" IRON-CORED COIL TYPE G.I.C.2 SPECIFIED EXCLUSIVELY FOR THE "UNICON TWO"

described in the August and current issues. Six types available. Each 9/6. Complete with metal screening can. "Goltone" G.I.C. coils, were used and specified for the P.T.P. Three in "W.M." June 1935. Obtainable from first-class dealers—if any difficulty write direct.



"PARMEKO"

MAINS TRANSFORMER as specified for 5 WATT AMPLIFIER

Price
£3-5-0

Partridge & Mee, Ltd.
Aylestone Park, Leicester.

When replying to Advertisers please mention
WIRELESS MAGAZINE

**BLUEPRINT
COUPON**

Valid only until Sept 30,
1935 (or until Oct. 31
1935, for overseas readers)

FOR ONE BLUEPRINT ONLY

If you want a full-size blueprint of any one of the sets constructionally described in this issue for half price, cut out the above coupon and send it, together with a postal order, to Blueprint Department, WIRELESS MAGAZINE, 8-11 Southampton Street, Strand, London, W.C.2.

This coupon is valid for one blueprint only at the price indicated:—

THE CERTAINTY THREE (page 90),

No. WM393, price 6d., post paid.
LISTENER'S 5-WATT A.C. AMPLIFIER
(page 100), No. WM392, price 9d.,
post paid.

UNICON A.C./D.C. TWO (page 134),
No. WM394, price 6d., post paid.

**INFORMATION
COUPON**

Valid only until Sept. 30,
1935 (or until Oct. 31,
1935, for overseas readers)

If you want to ask any questions, cut out the above coupon and send it, together with a postal order for 1s. and stamped, addressed envelope, to the Information Bureau, WIRELESS MAGAZINE, 8-11 Southampton Street, Strand, London, W.C.2.

Note that not more than two questions may be asked at a time and that queries should be written on one side of the paper only.

Under no circumstances can questions be answered personally or by telephone. All inquiries must be made by letter so that every reader gets exactly the same treatment.

Alterations to blueprints or special designs cannot be undertaken: nor can readers' sets or components be tested.

If you want advice on buying a set, a stamped, addressed envelope only (without coupon or fee) should be sent to the Set Selection Bureau, WIRELESS MAGAZINE, 8-11 Southampton Street, Strand, London, W.C.2

New R.A.P. Receivers

AS we are about to close for press we receive details of the new range of R.A.P. receivers, marketed by the Central Equipment Co., Ltd., of Liverpool.

These receivers—there are four—are all moderately priced and described by the makers as “handsome as any which have ever left the test bench, irrespective of maker or price.”

The range consists of the Transatlantic—a five-valve all-wave superhet for A.C. or A.C./D.C. mains priced at twelve guineas; the Continental, a five-valve A.C. or A.C./D.C. superhet for the medium and long waves priced at nine guineas; the European, a five-valve battery superhet using an intermediate-frequency of 473 kilocycles and covering the usual medium and long wavebands. The battery consumption is 11 milliamperes and the price 9 guineas.

Last, but by no means least, is the Oriental radiogram priced at 18 guineas for A.C. mains and 19 guineas for A.C./D.C. mains. All these sets will be on show on the Central Equipment Co.'s stand at the Radiolympia.

**1935 Short-wave
DX Contest**

THIS contest is open to every short-wave listener, irrespective of whether he is a member of the International Short-wave Club or not, but contestants must reside in this country. The contestants have to listen to as many short-wave stations as possible during the period of the contest, report their reception to the stations heard and ask for a verification of their reception. Only one verification from each station will count, except where different wavelengths and call signs are used.

The contest opens on September 1 and closes November 30, 1935, allowing three months for the contestants to listen to the stations. Two months will be allowed after the close of the contest for the contestants to receive verifications from the more distant countries.

Many valuable prizes will be awarded to those who receive the greatest number of verifications.

Full particulars, together with the entrance form, can be obtained by sending a ½d. stamp to I.S.W.C., DX Contest, 82 High Street, Clapham, London, S.W.4.

**INDEX TO
ADVERTISERS**

	Page
Automatic Coil Winder & Elec. Equipment Co., Ltd.	Cover ii
Belling & Lee, Ltd.	143
British Insulated Cables, Ltd.	143
British Television Supplies, Ltd.	156
Bulgin, A. F., & Co., Ltd.	81
Central Equipment Co., Ltd.	145
Cole, E. K., Ltd.	Cover iv
Chloride Electrical Storage Co., Ltd.	137
Dubilier Condenser Co., Ltd.	139
Electrocets	157
Ferranti, Ltd.	139
Fluxite, Ltd.	154
Garrard Eng. & Mfg. Co., Ltd.	147
General Electric Co., Ltd.	82, 83, 133
"Home Photographer & Home Movies"	151
High Vacuum Valve Co., Ltd.	155
H.M.V.	86
International Correspondence Schools	157
Jackson Bros., London, Ltd.	155
Lectro Linx, Ltd.	157, 159
Marconiphone Co., Ltd.	84
Melfo-Rad	154
Newnes, Geo., Ltd.	154, 156
Osram Valves	133
Ostar Ganz	156
Oxford University Press	159
Partridge & Mee, Ltd.	159
Peto-Scott Co., Ltd.	153
Pitmans	153
Pix Aerial	158
Radio Development Co.	149
Radio Resister Co.	154
Reliance Mfg. Co.	157
Rothermel, Ltd.	151
Siemens Electric Lamps & Supplies, Ltd.	151
Sifam Electric Instrument Co., Ltd.	158
Stratton & Co., Ltd.	149
Telephone Mfg. Co., Ltd.	141
Tungram Valves	141
Unit Radio	159
Universal High Voltage Radio Co., Ltd.	156
Varley (Oliver Pell Control, Ltd.)	145
Ward, Chas. F.	158
Ward & Goldstone	159
Westinghouse Brake & Saxby Signal Co., Ltd.	147
Whiteley Electrical Radio Co., Ltd.	135
Wingrove & Rogers, Ltd.	143
362 Radio Valve Co., Ltd.	151

**Another Fine Issue
of "W.M." will be
On Sale**

Friday, Sept. 20th

Order Your Copy Now!

"Wireless Magazine" Blueprint Service

These blueprints are full-size. Copies of appropriate issues of "Practical Wireless," "Amateur Wireless," and of "Wireless Magazine" containing descriptions of most of these sets can be obtained at 4d. and 1s. 3d. each, respectively, post paid. Index letters "P.W." refer to "Practical Wireless" sets, "A.W." refer to "Amateur Wireless" sets, and "W.M." to "Wireless Magazine" sets. Send, preferably, a postal order (STAMPS OVER SIXPENCE UNACCEPTABLE) to "Wireless Magazine" Blueprint Dept., Geo. Newnes, Ltd., 8-11 Southampton Street, Strand, W.C.2.

CRYSTAL SETS

Blueprints, 6d. each.

Four-station Crystal Set ... 31.3.34 AW427

STRAIGHT SETS (Battery Operated)

Two-valvers: Blueprints, 1s. each.

Iron-core Two (D, QPP) ... 12.8.33 AW396

Three-valvers: Blueprints, 1s. each.

Transportable Three (SG, D, Pen) ... Feb. '32 WM271

Multi-mag Three (D, 2 Trans) ... June '32 WM288

Fercy Harris Radiogram (HF, D, Trans) ... Aug. '32 WM294

£6.6s. Radiogram (D, RC, Trans) ... Apr. '33 WM318

Simple-tune Three (SG, D, Pen) ... June '33 WM327

Tyers Iron-core Three (SG, D, Pen) ... July '33 WM330

Economy-pentode Three (SG, D, Pen) ... Oct. '33 WM337

All-wave Three (D, 2LF) ... Jan. '34 WM348

"W.M." 1934 Standard Three (SG, D, Pen) ... Feb. '34 WM351

£3.3s. Three (SG, D, Trans) ... Mar. '34 WM354

Iron-core Band-pass Three (SG, D, QP21) ... June '34 WM362

1935 £6.6s. Battery Three (SG, D, Pen) ... Oct. '34 WM371

Craduating to a Low-frequency Stage (D, 2LF) ... Jan. '35 WM378

P.T.P. Three (Pen, D, Pen) ... June '35 WM389

Carrier Short-wave (SG, D, Trans) ... July '35 WM390

Class-B Three (D, Trans, Class B) ... 22.4.33 AW385

New Britain's Favourite Three (D, Trans, Class B) ... 15.7.33 AW394

Home-built Coil Three (SG, D, Trans) ... 14.10.33 AW404

fan and Family Three (D, Trans, Class B) ... 25.11.33 AW410

£5.5s. S.G.3 (SG, D, Trans) ... 2.12.33 AW412

1934 Ether Searcher: Baseboard Model (SG, D, Pen) ... 20.1.34 AW417

1934 Ether Searcher: Chassis Model (SG, D, Pen) ... 3.2.34 AW419

P.V.H. Mascot with Lucerne Coils (Det, R.C., Trans) ... 17.3.34 AW337A

Pentaquester (HF, Pen, D, Pen) ... 14.4.34 AW431

£5.5s. Three: De-luxe Version (SG, D, Trans) ... 19.5.34 AW435

Lucerne Straight Three (D, RC, Trans) ... 9.6.34 AW437

"Wireless League" Three (HF, Pen, D, Pen) ... 3.11.34 AW451

Four-valvers: Blueprints, 1s. 6d. each.

Quadradyne (2 SG, D, Pen) ... Feb. '34 WM273

Calibrator (SG, D, RC, Trans) ... Oct. '32 WM300

Table Quad (SG, D, RC, Trans) ... Nov. '32 WM303

Calibrator de Luxe (SG, D, RC, Trans) ... Apr. '33 WM316

Self-contained Four (SG, D, LF, Class-B) ... Aug. '33 WM331

Lucerne Straight Four (SG, D, LF, Trans) ... Feb. '34 WM350

£5.5s. Battery Four (HF, D, 2LF) ... Feb. '35 WM381

The "HK" Four (2HF, D, LF) ... Mar. '35 WM384

"A.W." Ideal Four (2 SG, D, Pen) ... 16.9.33 AW402

Crusaders' A.V.C. 4 (2 HF, D, QP21) ... 18.8.34 AW445

(Fentode and Class-B outputs for above; blueprints 6d. each) ... 25.8.34 AW445A

Five-valvers: Blueprints, 1s. 6d. each.

Super-quality Five (2 HF, D, RC, Trans) ... May '33 WM320

New Class-B Five (SG, D, LF, Class B) ... Nov. '33 WM340

Class-B Quadradyne (2 SG, D, LF, Class B) ... Dec. '33 WM344

1935 Super Five (Battery Super-het) ... Jan. '35 WM379

Mains Operated

Two-valvers: Blueprints, 1s. each.

Economy A.C. Two (D, Trans) A.C. ... June '32 WM286

Consolectric Two (D, Pen) A.C. ... 23.9.33 AW403

SPECIAL HALF-PRICE OFFER

Blueprints of the following "Wireless Magazine" sets described in this issue are obtainable at the special price, given below, if the coupon on facing page is used before Sept. 30.

Listener's 5-watt A.C. Amplifier WM392 ... 9d.

Certainty Three WM393 ... 6d.

Unicon Two WM394 ... 6d.

Three-valvers: Blueprints, 1s. each.

D.C. Calibrator (SG, D, Push-pull Pen) D.C. ... July '33 WM328

Simplicity A.C. Radiogram (SG, D, Pen) A.C. ... Oct. '33 WM338

Six-guinea AC/DC Three (HF, Pen, D, Trans) A.C./D.C. ... July '34 WM364

Mantovani A.C. Three (HF, Pen, D, Pen) A.C. ... Nov. '34 WM374

Home-lovers' New All-electric Three (SG, D, Trans) A.C. ... 25.3.33 AW383

S.G. Three (SG, D, Pen) A.C. ... 3.6.33 AW390

A.C. Triodyne (SG, D, Pen) A.C. ... 19.8.33 AW399

A.C. Pentaquester (HF, Pen, D, Pen) A.C. ... 26.6.34 AW439

Four-valvers: Blueprints, 1s. 6d. each.

A.C. Quadradyne (2 SG, D, Trans) A.C. ... Apr. '32 WM129

All Metal Four (2 SG, D, Pen) A.C. ... July '33 WM329

"W.M." A.C./D.C. Super Four 2 I.F. ... Feb. '35 WM382

My 1933 Radiogram (S.G., D., 2 I.F.) ... May '35 WM386

AC/DC Straight A.V.C. 4 (2 HF, D, Pen) A.C./D.C. ... 8.9.34 AW446

SUPER-HETS

Battery Sets: Blueprints, 1s. 6d. each.

Super Senior ... Oct. '31 WM256

1932 Super 60 ... Jan. '32 WM269

Q.P.P. Super 60 ... Apr. '33 WM319

"W.M." Stenode ... Oct. '34 WM373

Modern Super Senior ... Nov. '34 WM375

1934 Century Super ... 9.12.33 AW413

Mains Sets: Blueprints, 1s. 6d. each.

1932 A.C. Super 60, A.C. ... Feb. '32 WM272

Seventy-seven Super, A.C. ... Dec. '32 WM305

"W.M." D.C. Super, D.C. ... May, '33 WM321

Merrymaker Super, A.C. ... Dec. '33 WM345

Heptode Super Three, A.C. ... May '34 WM359

"W.M." Radiogram Super, A.C. ... July '34 WM366

"W.M." Stenode, A.C. ... Sep. '34 WM370

1935 A.C. Stenode (A.C. Super-het) ... Apl. '35 WM385

1934 A.C. Century Super, A.C. ... 10.3.34 AW425

SHORT-WAVERS (Battery Operated)

One-valvers: Blueprints, 1s. each.

New Style Short-wave Adapter ... June '35 WM383

Roma Short-waver ... 10.11.34 AW452

Two-valvers: Blueprints, 1s. each.

Home-made Coil Two (D, Pen) ... 14.7.34 AW447

Three-valvers: Blueprints, 1s. each

Experimenter's 5-metre Set (D, Trans. Super-regae) ... 30.6.34 AW438

Experimenter's Short-waver ... 19.1.35 AW463

Four-valvers: Blueprints, 1s. 6d. each.

"A.W." Short-wave World Beater (HF, Pen, D, RC, Trans) ... 2.6.34 AW435

Standard Four-valve Short-waver (SG, D, 2LF) ... Mar. '35 WM383

Mains Operated

Two-valvers: Blueprints, 1s. each.

Two-valve Mains Short-waver (D, Pen) A.C. ... 10.10.34 AW453

"W.M." Band-spread Short-waver (D, Pen) A.C./D.C. ... Aug. '34 WM363

Three-valvers: Blueprints, 1s. each.

Emigrator (SG, D, Pen), A.C. ... Feb. '34 WM352

Four-valvers: Blueprints, 1s. 6d. each.

Gold Coaster (SG, D, RC, Trans), A.C. ... Aug. '32 WM292

Standard A.C. Four-valve Short-waver (SG, D, RC, Trans) ... WM391

Trickle Charger ... 5.1.35 AW462

Amplifiers: Blueprints, 1s. 6d. each.

Enthusiast's Power Amplifier ... May & June '35 WM387

"PRACTICAL WIRELESS"

F.J.C. 3-valve A.V.C. (Transfer Print) ... 4.11.33 PW32

Luxus A.C. Superhet ... 14.10.33 PW33

A.C. Quadpak ... 2.12.33 PW34

Sixty-shilling Three ... 2.12.33 PW34A

Nucleon Class-B Four ... 6.1.34 PW34B

Fury Four Super ... 27.1.34 PW34C

A.C. Fury Super ... 10.2.34 PW34D

Leader Three ... 10.3.34 PW35

D.C. Premier ... 31.3.34 PW35B

A.C. Leader ... 7.4.34 PW35C

Atom Lightweight Portable ... 2.6.34 PW36

Ubique ... 28.7.34 PW36A

Four-range Super-mag. Two ... 11.8.34 PW36B

Summit Three ... 18.8.34 PW37

Armada Mains Three ... 18.8.34 PW38

Midget Short-wave Two ... 15.9.34 PW38A

All-pentode Three ... 22.9.34 PW39

£5 Superhet Three ... 27.10.34 PW40

A.C. £5 Superhet Three ... 24.11.34 PW43

D.C. £5 Superhet Three ... 1.12.34 PW42

Hall-mark Three ... 8.12.34 PW41

Universal £5 Superhet ... 15.12.34 PW44

A.C. Hall-mark 4 ... 26.1.35 PW45

Battery Hall-mark 4 ... 2.2.35 PW46

Universal Hall Mark ... 9.2.35 PW47

Hall-mark Cadet ... 23.3.35 PW48

Short-wave Converter-Adapter ... 23.2.35 PW48A

F. J. Camm's Silver Souvenir (All-Wave Three) ... 13.4.35 PW49

F. J. Camm's A.C. All-Wave Silver Souvenir Three ... — PW50

"Wireless Magazine" Blueprint Service George Newnes, Ltd., 8-11 Southampton Street, Strand, W.C.2

*'Three-way Diffusion' and
'Clear-Cut Reality'
make this new*



EKCO Radiogram supreme

For 22 guineas you can buy this Supreme 8-stage Superhet Radiogram. Ekco Model RG86 exclusively incorporates these wonderful features:

1. **'Three-way Sound Diffusion'** —the greatest advance ever made in Radio Acoustic Reality.
2. **'Clear-cut reality' reproduction.** Such perfected clarity has never been achieved before.

Magnificent two-tone Walnut cabinet of modern design and sturdy construction. Will grace any home. Easy Payments are available over a period of one or two years. Write for full details of Ekco **22 GNS.** Radio to:

E. K. Cole Ltd., (Dept. W.M.I.)
Ekco Works, Southend - on - Sea.

EKCO