

WIRELESS WORLD

MONTHLY 3^D

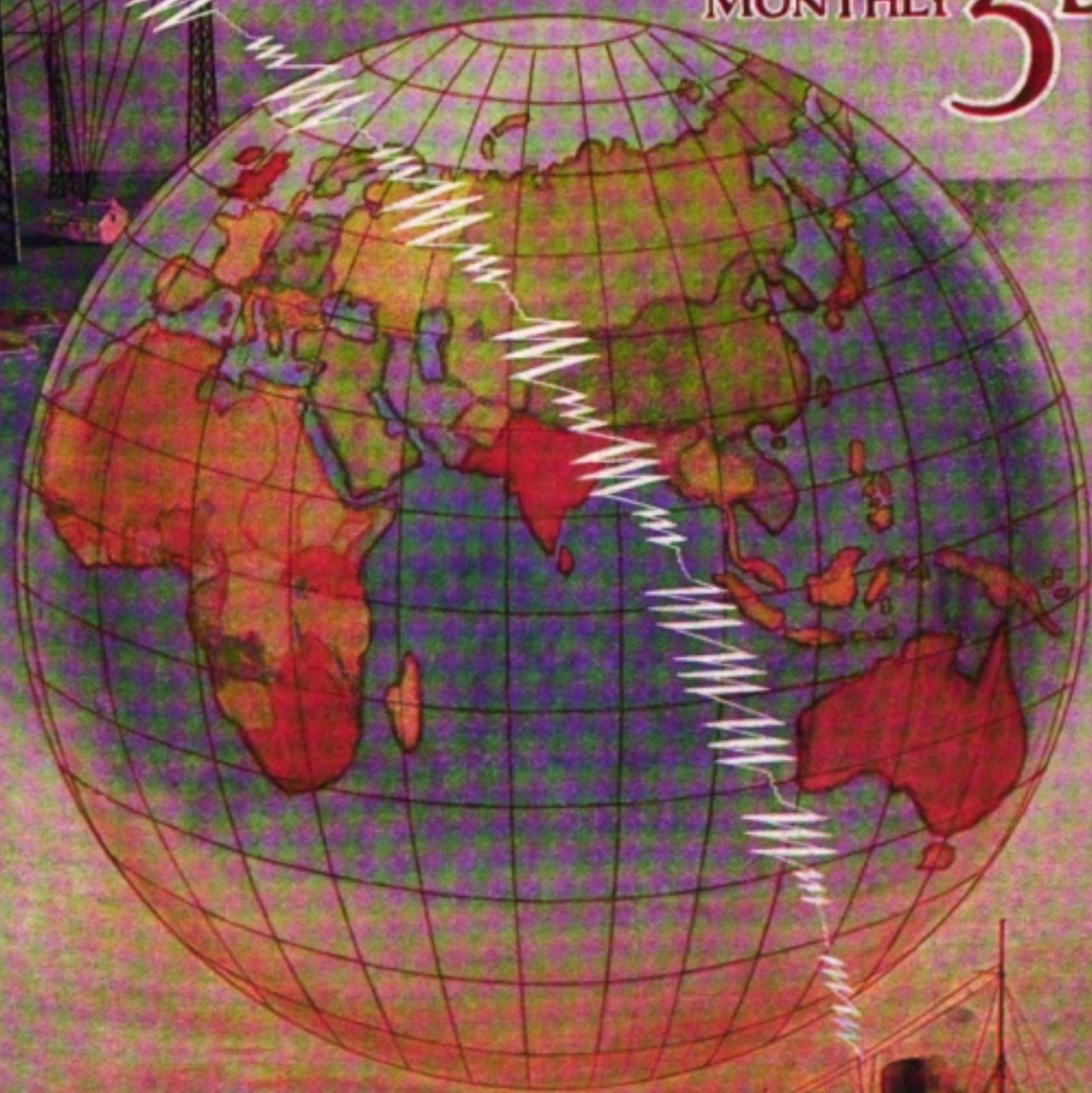

Sullivan Instruments

Sullivan "Universal" Galvanometers and Shunts for Land and Sea Use

Testing and Signalling Instruments of every description for Submarine Cables.

SULLIVAN TELEPHONE RECEIVERS for Wireless Telegraphy and Telephony, as used by the principal Governments and Wireless Telegraphy Companies—resistance values from 5 to 15,000 ohms.

Fast Speed Wheatstone Automatic Transmitters and Receivers, guaranteed at 400 words per minute, and Wheatstone Apparatus generally.

Precision and Standard Measuring Equipments for D.C. and A.C. (high frequency) determinations, Condensers of Low Power Factor, etc.

All instruments guaranteed, and accompanied, if desired, with Certificates of Accuracy from the National Physical Laboratory at cost price.

H. W. SULLIVAN,

Winchester House, London, E.C., England.

Works: Liverpool House, Middlesex Street, London, E.C.

Telegrams: "Deadbeat, London."

Telephone: { Office: 3518 London Wall.

{ Works: 3518a " "

Codes: Western Union (Universal Edition); A.B.C. (5th Edition); Engineering (2nd Edition). "

Silk and Cotton Covered H.C. Copper Wire, Resistance Wires, Fuse Wire,
Binding Wires, Charcoal Iron Core Wire, Asbestos
Covered Wire

P. ORMISTON & SONS, 79 CLERKENWELL ROAD
LONDON, E.C.
Established 1793. 13259 Central.

Braided
and Twisted Wires, Bare
Copper Strand & Flexibles of any Construction, Wire
Ropes & Cords, down to the finest sizes, in Galvanized Steel, Phosphor Bronze, etc.

NORMAN, SMEE & DODWELL

MANUFACTURERS OF HIGH-CLASS VARNISHES for Coach
Builders and Decorators, Railway Carriage and Locomotive Builders, and
Ship Builders Special Insulating Varnishes for Electrical Purposes

Offices and Factory: MILES LANE, MITCHAM, SURREY.



"Wireless" TELEPHONE RELAY

IMPROVED FORM will MAGNIFY CURRENT over 100 TIMES.

For INCREASING the RANGE of a Receiving Station.
For RECORDING Messages and TIME
SIGNALS.
For operating LOUD SPEAKING TELE-
PHONES.
For working CALLS and RELAYS.

Also BEST RECEIVERS made for Wireless and other RELAYS
and Loud Speakers.

For Particulars and Prices apply Patentee and Sole Manufacturer,

S. G. BROWN, 4 Gt. Winchester St., London, E.C.



Please mention "The Wireless World" when writing to Advertisers.



Vol. 2.—No. 22. (New Series)

January, 1915.

Subscription 5/0 per annum post free. Price 3d. Post Free 5d.

The Post Office Year

FROM all quarters comes evidence of the satisfactory growth in the commercial use of wireless telegraphy. The Annual Report of Lloyd's Register of Shipping, which we summarised last month, showed a remarkable increase in the number of ships having wireless installations, 2,750 vessels recorded on the Society's Register at the end of the past year having such installations, as compared with 1,932 at the end of the previous year. Supplementary evidence of this growth is furnished in the Report of the Postmaster-General on the work of the Post Office for the year ended March 31st, 1913. At the end of March 31st, 1913, 646 ships registered in the United Kingdom were carrying wireless apparatus under licence from the Postmaster-General. Twelve months later that number had increased by no fewer than 233. Thus, the latest official statistics show that 879 British ships are carrying wireless apparatus. This is by no means an unduly large proportion of the British mercantile marine, if we take numbers only. But, as anyone can discover who will go to the trouble of making the calculation, the vessels carrying wireless apparatus represent an appreciable percentage of the gross tonnage of British shipping. The Postmaster-General's statistics only bring us up to the end of last March, since when, as the pages of this magazine have shown, the rate of increase in the installations on ships has been well above the average.

The revised International Radio-Telegraphic Convention and the regulations

agreed upon at the International Conference held in London, in June, 1912, were brought into operation during the year covered by the Postmaster-General's Report, and the classification of ships fitted with wireless telegraphy in accordance with the regulations of the Convention has been carried out. Official figures are not available to indicate the proportion of British ships equipped in the various classes prescribed by the Convention, but we expect this data will be forthcoming after it has been possible to note the effect of the Regulations and of the Safety of Life at Sea Convention, the principal features of which are embodied in a Bill prepared by the Board of Trade, which has been before Parliament.

Of no less interest are the figures showing the public use of wireless telegraphy for communicating with ships. The number of radio telegrams dealt with by the Post Office coast stations during the past year was 57,252 (48,904 inwards and 8,348 outwards), as compared with 51,109 last year—an increase of 12 per cent. These figures relate only to messages from the public passing between the Post Office wireless stations and ships on the high seas. They do not relate to any other class of message sent, nor is there included the traffic passing through Marconi stations. On the whole, the figures are not unsatisfactory, but when the public is made to realise the advantages of this service we have no doubt that there will be a considerable increase in the volume of traffic.

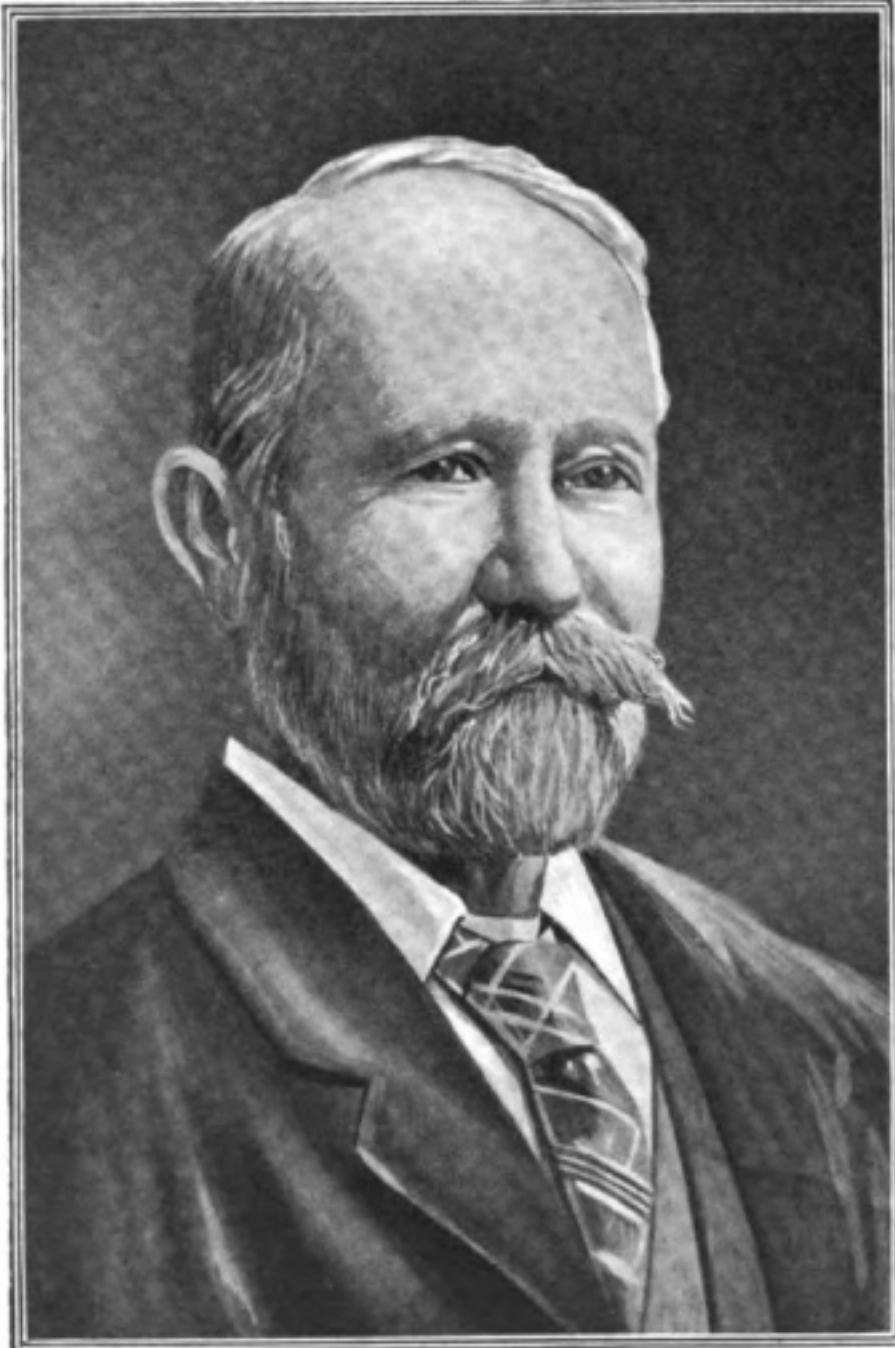

HON. W. G. SPENCE

Personalities in the Wireless World

HON. WILLIAM G. SPENCE.

Postmaster-General of the Commonwealth of Australia.

MANY of Australia's finest statesmen have been drawn from the lower social grades of her immigrants. It is advisable to speak of grades rather than classes, for the mention of the lower classes has always a tinge of superiority in its tone, as though it were an axiom of agreement between writer and readers that those comprehended under this title were persons of an inferior grade mentally and physically, as well as statically. This would in the highest degree be untrue of such men as Australia's late Premier (the Hon. Joseph Cook) or of the present Premier (the Hon. Andrew Fisher) or of the present subject of our sketch, the Hon. W. G. Spence; for, though each of these men started life as a miner, each has been endowed with a wonderful personality, intellect of no mean order, and a capacity for organisation which has stood the country of their adoption in good stead—and a man possessing these qualifications is rich even without a banking account, and he holds the *passe-partout* of all society.

The Hon. William Guthrie Spence was born in the Orkney Isles in 1846. He was taken to Australia at the age of six, so that to all intents and purposes he is an Australian, and as such he has proved himself worthy of the land that reared him. His earlier years were spent in the famous gold fields of Victoria just when that district was attracting adventurers from the ends of the earth. But after the manner of Scotsmen young Spence was not content to merely dig for a livelihood. He joined the Amalgamated Miners' Association, and under its influence made a special study of the social economy affecting his fellow-workers. For over fifteen years he held the position of Secretary to that organisation, and throughout the time he worked steadily to attain the amalgamation of all Miners' Unions, for he held that their interests were identical, whether they dug for gold, copper, silver or coal.

Later he became associated with the workers in the pastoral industry, the rough and ready shearers of Australia's great flocks of sheep. Here his talent for organisation had more scope and he was not slow to avail himself of this advantage. As a result, his skill in organisation and his general practical ability combined to establish one of the most active unions of workers in the Commonwealth. When Mr. Spence took up their case the sheep shearers were poorly paid and their conditions of life and labour most unsatisfactory. Under his guidance many of their hardships were remedied and a general improvement in their condition set in. They ultimately were embodied in the Australian Workers' Union, which was, in a measure, the forerunner of the political Labour Party in Australia. Since then this party has held office in nearly every State at different times. Mr. Spence himself was first elected to Parliament as a member of the New South Wales State House of Assembly. He subsequently transferred his energies to the Federal or Commonwealth Parliament, and now his appointment as Postmaster-General marks the latest stage in a career of great public usefulness and industry.

Mr. Spence is well qualified to undertake his new task. He knows Australia from one end of the Continent to the other, and, as a result, he is well aware of the needs of intercommunication between State and State, district and district, and his observant nature has not allowed him to overlook the advantages of wireless telegraphy as a humanising agent by its power of linking the outposts of civilisation with the great commercial centres, and especially is he aware of the value of such a service in the maritime and commercial world. With such qualifications at his command, combined with his great administrative ability, Mr. Spence is likely to prove a most successful Postmaster-General for Australia.

On the Capacity of Radio-Telegraphic Antennæ—II.*

By Prof. G. W. O. HOWE, D.Sc.

THE writer has calculated the capacity of a number of antennæ by the application of the formula

$$V = 4\pi r \sigma \left[\sinh^{-1} \frac{l}{d} - \sqrt{1 + \frac{d^2}{l^2} + \frac{d}{l}} \right]$$

and finds that the error is less than 1 per cent. if the length is more than eight times the extreme width, which will generally be the case. If the length is only four times the width the error amounts to 3 per cent., while it reaches 7.5 per cent. if the length is only twice the width, the actual capacity being less than the calculated.

This correction has been applied in the calculation of the capacities given in the

following tables and curves, which are accurate to within 1 per cent.

TABLES OF CAPACITIES PER LINEAR FOOT IN MICRO-MICROFARADS.

TABLE V. (See Fig. 8.)
Two parallel wires. $n=2$.

Values of d/r .	Values of l/d .				
	20	50	100	150	300
100	3.4	2.87	2.55	2.42	2.205
250	3.11	2.66	2.40	2.275	2.08
500	2.93	2.525	2.29	2.17	1.995
1,000	2.76	2.40	2.19	2.08	1.92

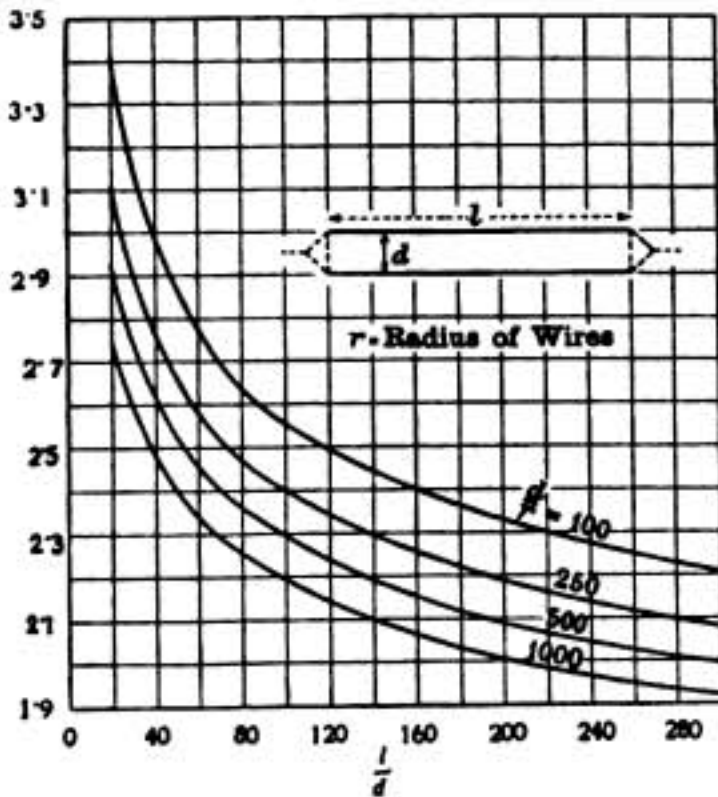

Fig. 8.—Two Wires. Capacity per Foot in Millionths of a Microfarad.

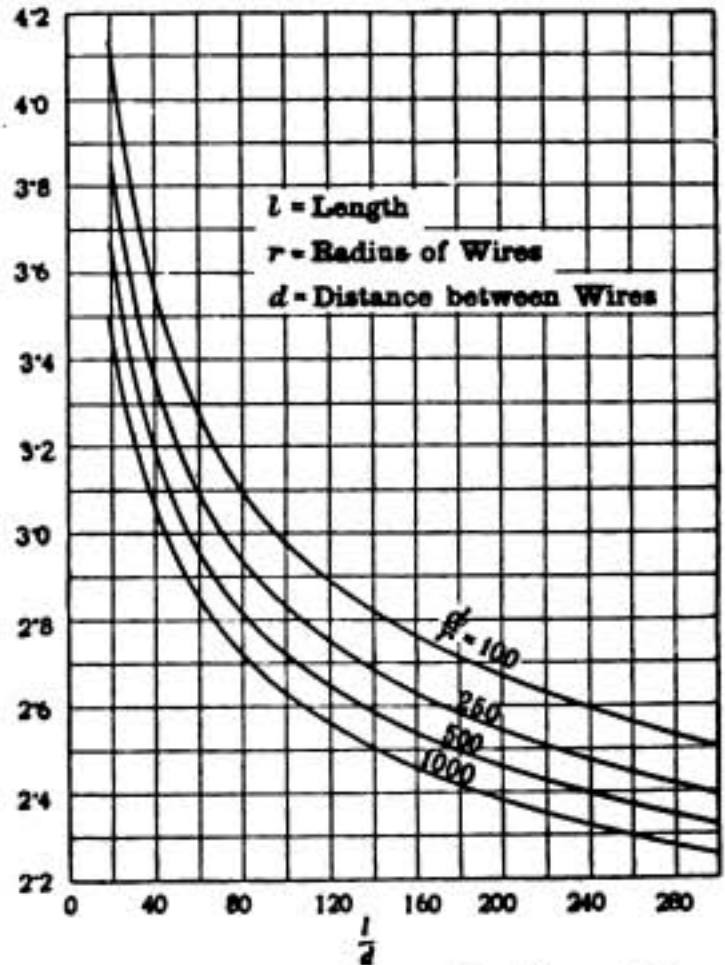

Fig. 9.—Flat Antenna with Three Wires Capacity per Foot in Millionths of a Microfarad

* Paper read before the British Association at Sydney, N.S.W. The first section appeared in the W.W. for December, 1914.

TABLE VI. (See Fig. 9.)
Three parallel wires. $n=3$.

Values of d/r .	Values of l/d .				
	20	50	100	150	300
100	4.15	3.40	2.98	2.79	2.50
250	3.87	3.20	2.83	2.655	2.39
500	3.68	3.07	2.725	2.56	2.32
1,000	3.50	2.945	2.63	2.48	2.25

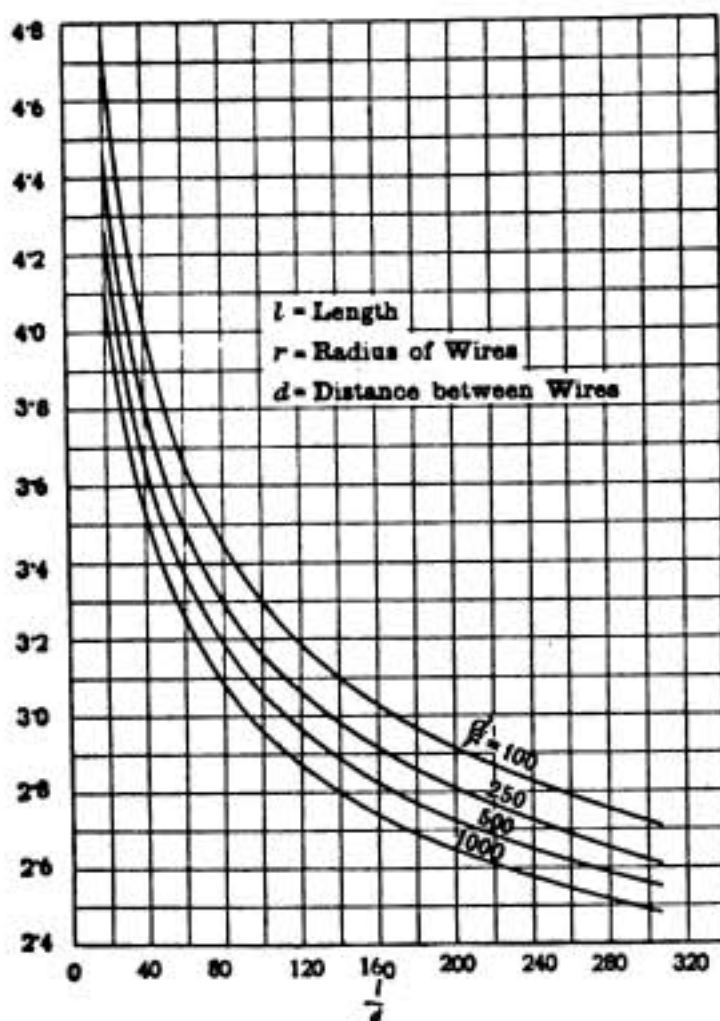

Fig. 10.—Flat Antenna with Four Wires. Capacity per Foot in Millionths of a Microfarad.

TABLE VII. (See Fig. 10.)
Four parallel wires. $n=4$.

Values of d/r .	Values of l/d .				
	20	50	100	150	300
100	4.75	3.81	3.3	3.06	2.72
250	4.45	3.62	3.155	2.94	2.62
500	4.25	3.49	3.06	2.855	2.56
1,000	4.1	3.375	2.96	2.77	2.49

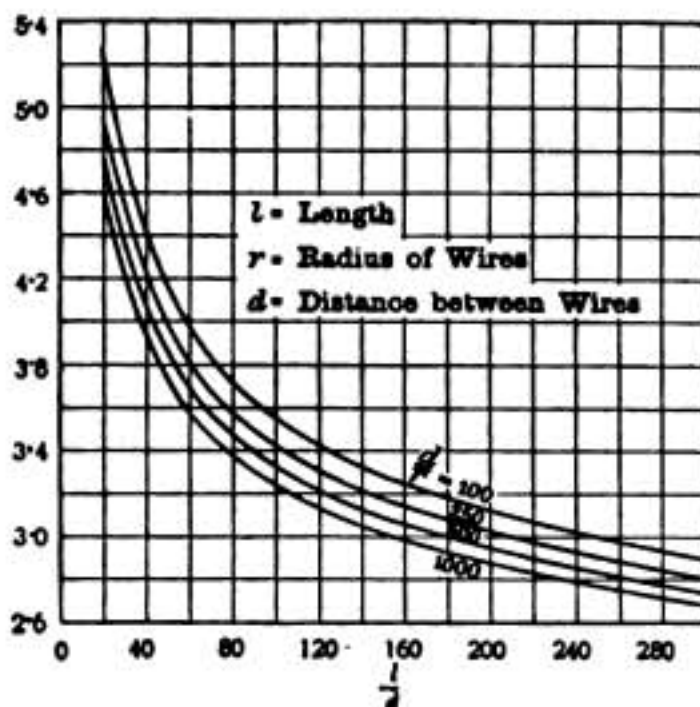

Fig. 11.—Flat Antenna with Five Wires. Capacity per Foot in Millionths of a Microfarad.

TABLE VIII. (See Fig. 11.)
Five parallel wires. $n=5$.

Values of d/r .	Values of l/d .				
	20	50	100	150	300
100	5.26	4.15	3.56	3.28	2.895
250	4.96	3.98	3.425	3.17	2.80
500	4.76	3.845	3.325	3.085	2.74
1,000	4.60	3.73	3.24	3.01	2.68

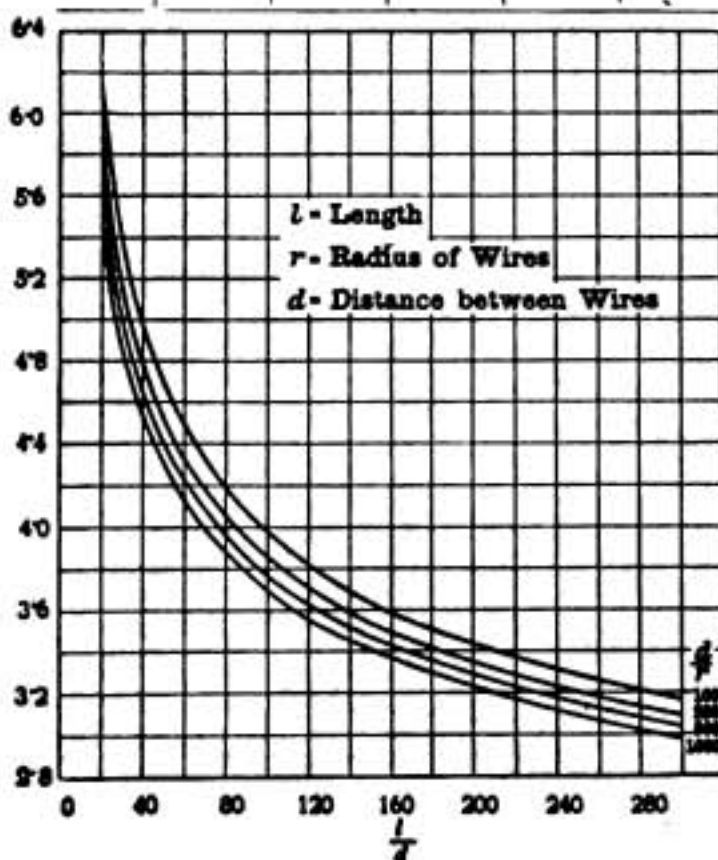

Fig. 12.—Flat Antenna with Seven Wires. Capacity per Foot in Millionths of a Microfarad.

TABLE IX. (See Fig. 12.)
Seven parallel wires. $n=7$.

Values of d/r .	Values of l/d .				
	20	50	100	150	300
100	6.15	4.69	3.98	3.635	3.17
250	5.87	4.52	3.86	3.53	3.09
500	5.65	4.40	3.77	3.46	3.04
1,000	5.48	4.31	3.69	3.40	2.98

TABLE XI. (See Fig. 14.)
Twelve parallel wires. $n=12$.

Values of d/r .	Values of l/d .				
	20	50	100	150	300
100	8.0	5.77	4.71	4.29	3.65
250	7.72	5.61	4.61	4.20	3.59
500	7.5	5.50	4.55	4.15	3.55
1,000	7.31	5.40	4.47	4.09	3.50

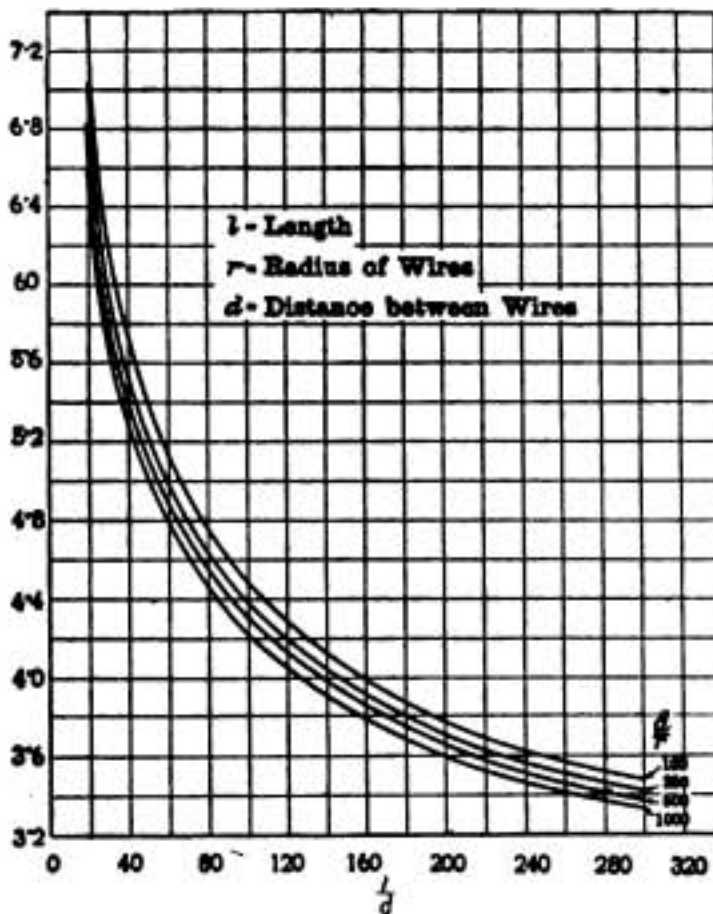

Fig. 13.—Flat Antenna with Ten Wires.
Capacity per Foot in Millionths of a Microfarad.

TABLE X. (See Fig. 13.)
Ten parallel wires. $n=10$.

Values of d/r .	Values of l/d .				
	20	50	100	150	300
100	7.35	5.4	4.48	4.05	3.48
250	7.04	5.22	4.38	3.965	3.42
500	6.83	5.12	4.30	3.91	3.37
1,000	6.62	5.02	4.225	3.845	3.33

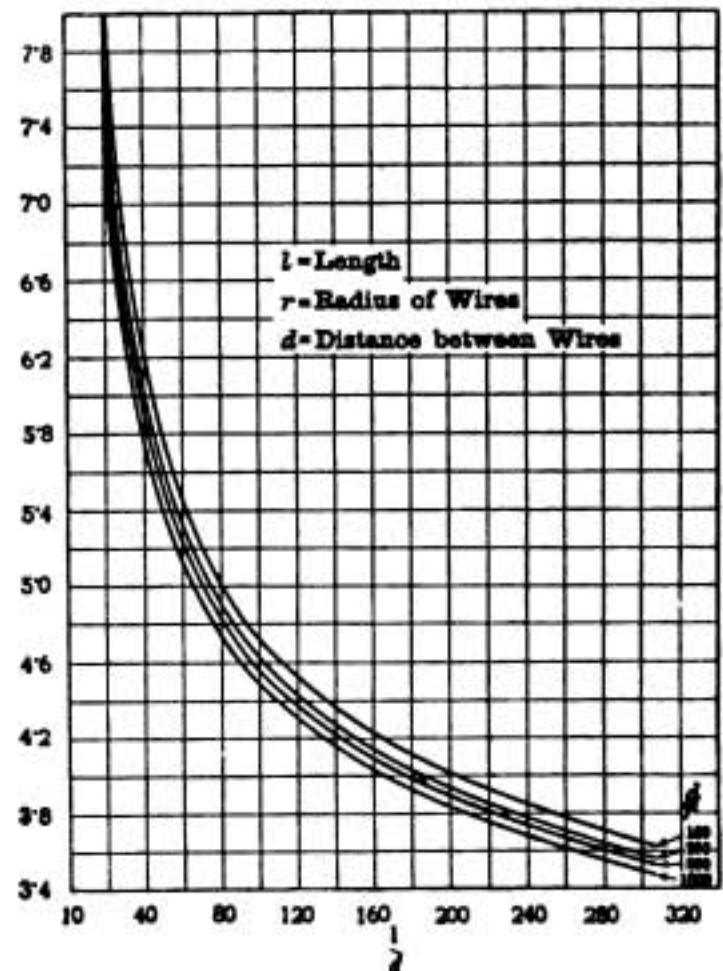

Fig. 14.—Flat Antenna with Twelve Wires.
Capacity per Foot in Millionths of a Microfarad.

In order to show the effect of varying the number of wires in such antennæ, a typical example was taken of an antenna 200 ft. long. The radius of the wire was taken as 0.05 in., and the capacity was found from the curves for various numbers of wires from 1 to 12. The results are shown in Fig. 15. In the first case (curve A) the assumption was made that the wires were 2 ft. apart, each additional wire adding 2 ft. to the width of the antenna. In the second case (curve B) the over-all width was assumed to be constant, and equal to 10 ft., the number

of wires being increased by decreasing the distance between them.

The results are very striking. In the first case increasing the number of wires from 2 to 12, and the over-all width from 2 ft. to

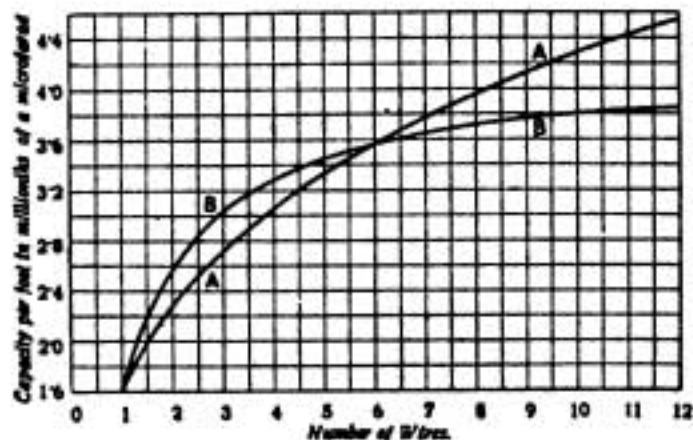

Fig. 15.

22 ft., exactly doubles the capacity, whereas in the second case the same increase in the number of wires only gives 50 per cent. greater capacity.

It is a comparatively simple matter to calculate the actual way in which the total charge must be distributed between the wires of a three-wire antenna (on the assumption that the charge on each wire is uniformly distributed), in order that they shall have the same potentials at their mid points, which could therefore be connected.

Let σ_1 = surface density of charge on outer wires and σ_2 = surface density of charge on middle wire.

Let V_1 = potential at mid point of outer wires and V_2 = potential at mid point of middle wire.

Now

$$V_1 = 4\pi r \sigma_1 \log_e \frac{l}{r} + 4\pi r \sigma_2 \log_e \frac{l}{d} + 4\pi r \sigma_1 \log_e \frac{l}{2d}$$

$$V_2 = 4\pi r \sigma_2 \log_e \frac{l}{r} + 4\pi r \sigma_1 2 \log_e \frac{l}{d}$$

but when the mid points of three wires are connected $V_1 = V_2$, that is,

$$\sigma_2 \left(\log_e \frac{l}{r} - \log_e \frac{l}{d} \right) = \sigma_1 \left(\log_e \frac{l}{r} - \log_e \frac{l}{d} - \log_e 2 \right)$$

and

$$\frac{\sigma_1}{\sigma_2} = \frac{\log_e \frac{d}{r}}{\log_e \frac{d}{r} - \log_e 2}$$

For example, if $r = 0.119$ cm. and

$$d = 76.25 \text{ cm.}, \frac{d}{r} = 640, \log_e \frac{d}{r} = 6.46,$$

$$\frac{\sigma_1}{\sigma_2} = \frac{6.46}{6.46 - 0.69} = \frac{6.46}{5.77} = 1.12.$$

Hence the density on the outer wires is 12 per cent. greater than on the middle wire. The same method could obviously be applied to any number of wires.

FOUR-WIRE AERIAL OF THE BOX TYPE.

In this type the wires, in section, occupy the four corners of a square, as shown in the figure; d is the side of the square.

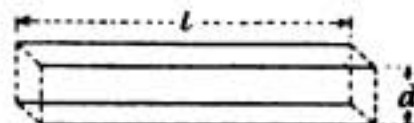

Fig. 16.

Assuming, as before, a uniformly distributed charge σ , the potential of any wire due to its own charge will have an average value

$$4\pi r \sigma \left(\log_e \frac{l}{r} - 0.309 \right);$$

the average value of its potential due to the two nearest wires will be

$$2 \times 4\pi r \sigma \left(\sinh^{-1} \frac{l}{d} - \sqrt{1 + \frac{d^2}{l^2} + \frac{d}{l}} \right)$$

and that due to the wire diagonally opposite will be

$$4\pi r \sigma \left(\sinh^{-1} \frac{l}{\sqrt{2}d} - \sqrt{1 + \frac{2d^2}{l^2} + \frac{\sqrt{2}d}{l}} \right).$$

Hence the average potential of the wire and therefore of the whole aerial will be

$$4\pi r \sigma \left\{ \log_e \frac{l}{r} - 0.309 + 2 \left(\sinh^{-1} \frac{l}{d} - \sqrt{1 + \frac{d^2}{l^2} + \frac{d}{l}} \right) + \sinh^{-1} \frac{l}{\sqrt{2}d} - \sqrt{1 + \frac{2d^2}{l^2} + \frac{\sqrt{2}d}{l}} \right\}$$

$$= 4\pi r \sigma \left(\log_e \frac{l}{r} + Y \right)$$

where Y can be calculated, once for all, for various values of d/l .

For all practical aerials $\sqrt{1 + \frac{d^2}{l^2}}$ may be taken as unity with little error.

If $\frac{l}{d} =$	20	50	100	150	200
$Y =$	7.58	10.22	12.26	13.48	14.33.

B

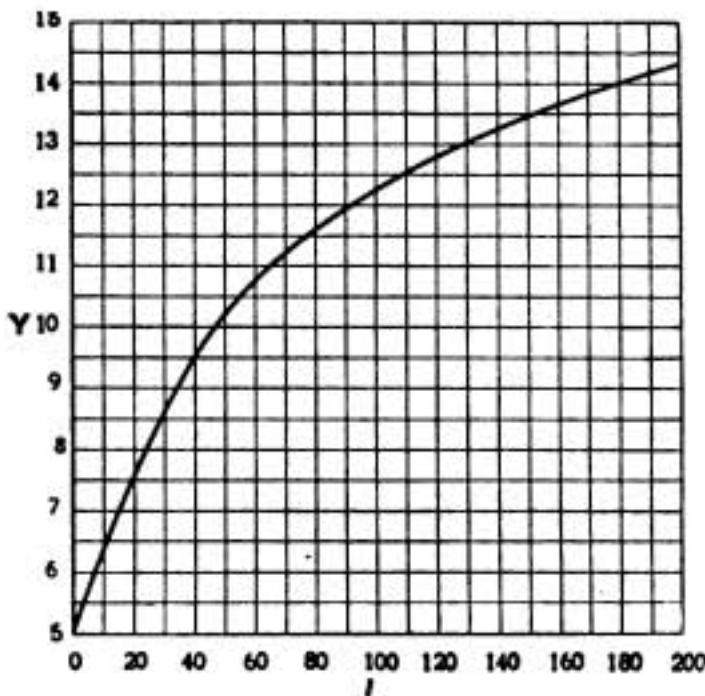

Fig. 17.

These are plotted in Fig. 17, from which Y can be found for other values of l/d .

The capacity is given by the formula

$$C = \frac{2l}{4\pi r \sigma \left(\log_e \frac{l}{r} + Y \right)} = \frac{2l}{\log_e \frac{l}{r} + Y} \text{ electrostatic units}$$

$$= \frac{2}{\log_e \frac{l}{r} + Y} \times \frac{30.5}{0.9} = \frac{67.78}{\log_e \frac{l}{r} + Y} \text{ micro-mfds. per foot.}$$

The values of the capacity for different values of l/d and d/r are given in the table and plotted in Fig. 18.

TABLE XII. (See Fig. 18.)
Capacity per foot in Micro-microfarads for Four-wire Box Type Aerial.

l/d .	Values of d/r .						
	25	50	100	250	500	750	1,000
20	4.92	4.69	4.47	4.22	4.05	3.95	3.88
50	3.91	3.76	3.62	3.46	3.34	3.27	3.22
100	3.38	3.27	3.16	3.04	2.94	2.89	2.86
150	3.13	3.03	2.94	2.83	2.75	2.70	2.68
200	2.97	2.88	2.80	2.70	2.63	2.585	2.56

THE INCREASE OF CAPACITY DUE TO THE PROXIMITY OF THE EARTH.

If the wire is not far removed from the earth its potential will be lowered, due to the induced negative charges on the earth, and the capacity will, therefore, be increased.

The amount of this increase can be calculated very simply with an accuracy more

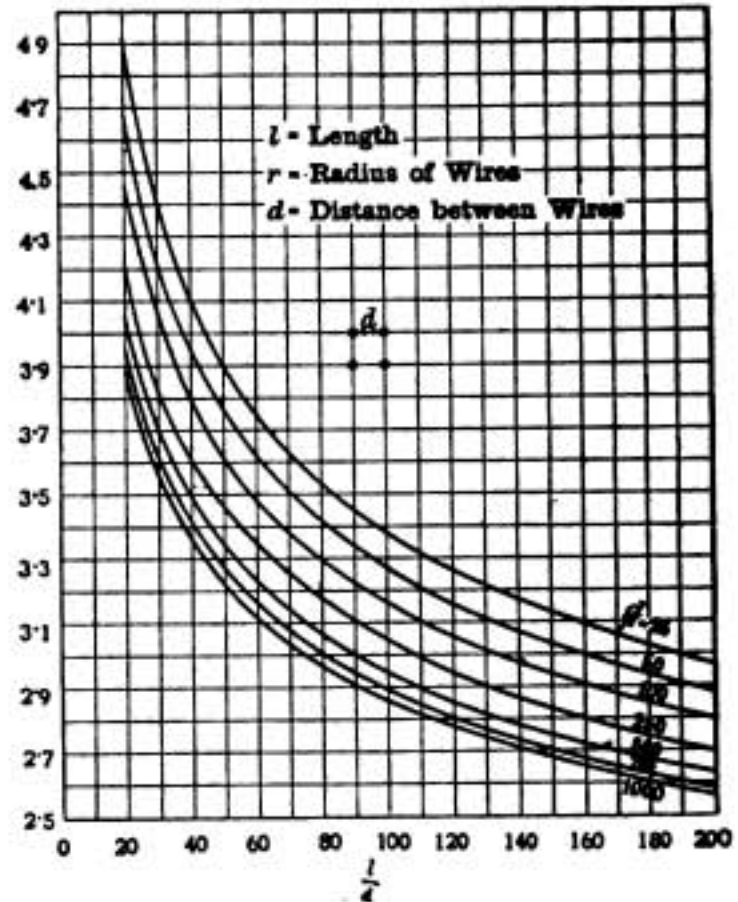

Fig. 18.—Four Wire Box-type Antenna. Capacity per Foot in Millionths of a Microfarad.

than sufficient for all practical purposes. If the wire is suspended horizontally at a height, h , above the earth and charged positively, the effect of the negative charges on the earth will be exactly the same as if they were concentrated on a horizontal wire at a depth, h , below the earth's surface and the earth removed. This is, of course, a simple application of Kelvin's method of images, and its truth is fairly self-evident from Fig. 19. Now, in most practical

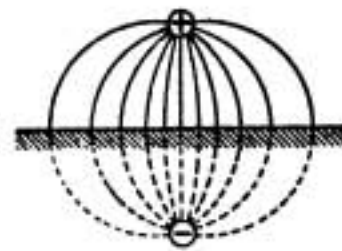

Fig. 19.

antennæ the height is so great compared with the length that little error is made by assuming that the negative charge is concentrated at a point at the centre of the image, and calculating the potential due to this charge at the centre of the actual antenna. This will be $-\frac{Q}{2h}$ and the average potential of the antenna will be lowered by this amount.

If the height is not great compared with the length, or, in any case, if greater accuracy is required, the formula can be employed which we have established for the average potential of a wire due to a uniformly distributed charge on a parallel wire, viz.,

$$2 \left(\sinh^{-1} \frac{l+d}{d} - \sqrt{1 + \frac{d^2}{l^2}} \right),$$

if the charge is 1 unit per centimetre of length. In the present application $d=2h$.

In Table XIII. the values of the above expression are given for different values of l/d .

TABLE XIII. (See Fig. 20.)

$\frac{l}{d} = \frac{l}{2h}$	$E = 2 \left(\sinh^{-1} \frac{l+d}{d} - \sqrt{1 + \frac{d^2}{l^2}} \right)$
0.5	0.48
1.0	0.94
2.0	1.64
4.0	2.62
5.0	2.98
10.0	4.20
20.0	5.46

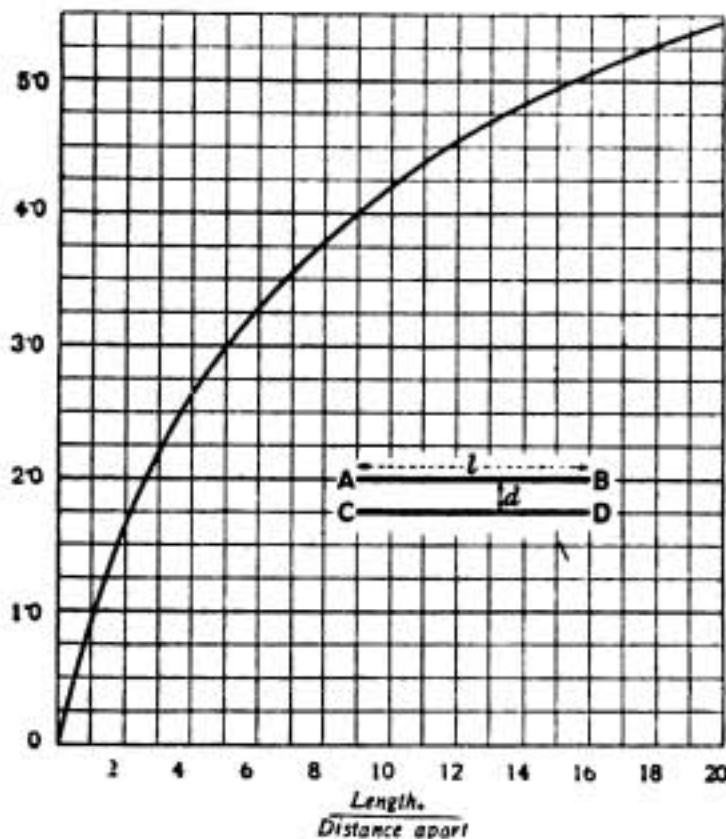

Fig. 20.—Average Potential of Wire, CD, due to Unit Charge per Centimetre on Wire AB.

In a multiple antenna of n parallel wires the potential will be n times as great for the same value of σ , if we assume that the over-all width is small compared with the height.

For a single wire antenna we have, therefore,

$$Q = 2\pi r l \sigma; \quad \frac{Q}{2h} = 4\pi r \sigma \times \frac{l}{4h},$$

and the average potential

$$V = 4\pi r \sigma \left(\log_e \frac{l}{r} - 0.31 - \frac{l}{4h} \right).$$

For the capacity in micro-microfarads we have

$$C = \frac{2\pi r l \sigma}{4\pi r \sigma \left(\log_e \frac{l}{r} - 0.31 - \frac{l}{4h} \right)} \times \frac{10}{9} \\ = \frac{l_{\text{cms.}}}{2 \log_e \frac{l}{r} - 0.62 - \frac{l}{2h}} \times \frac{10}{9},$$

or, more accurately,

$$\frac{l_{\text{cms.}}}{2 \log_e \frac{l}{r} - 0.62 - E} \times \frac{10}{9},$$

where E is found from Fig. 20.

For a flat multiple-wire antenna,

$$V = 4\pi r \sigma \left\{ n \left(\log_e \frac{l}{d} - 0.31 \right) + \log_e \frac{d}{r} - B \right\} - \frac{Q}{2h} \\ = 4\pi r \sigma \left\{ n \left(\log_e \frac{l}{d} - 0.31 \right) + \log_e \frac{d}{r} - B - \frac{n l}{4h} \right\} \\ = 4\pi r \sigma \left\{ n \left(\log_e \frac{l}{d} - 0.31 - \frac{l}{4h} \right) + \log_e \frac{d}{r} - B \right\}$$

and $C = \frac{17n}{n \left(\log_e \frac{l}{d} - 0.31 - \frac{l}{4h} \right) + \log_e \frac{d}{r} - B}$

micro-mfds per foot length.

(See Table IV. and Fig. 6 for values of B .)

Or, more accurately,

$$C = \frac{17n}{n \left(\log_e \frac{l}{d} - 0.31 - \frac{E}{2} \right) + \log_e \frac{d}{r} - B}$$

For four-wire box-type antennæ

$$\frac{Q}{2h} = \frac{2\pi r l \sigma \times 4}{2h} = 4\pi r \sigma \times \frac{l}{h}$$

$$V = 4\pi r \sigma \left(\log_e \frac{l}{r} + Y - \frac{l}{h} \right)$$

and $C = \frac{68}{\log_e \frac{l}{r} + Y - \frac{l}{h}}$ micro-mfds. per foot

(See Fig. 17 for values of Y .)

Or, more accurately,

$$C = \frac{68}{\log_e \frac{l}{r} + Y - 2E}$$

To indicate the magnitude of the increase in capacity due to the proximity of the earth, we shall calculate one or two examples.

(a) Single wire, 155 ft. long and $\frac{3}{8}$ in. radius—

$$\frac{l}{r} = \frac{155 \times 12}{3/32} = 39,700; \log_e \frac{l}{r} = 10.6.$$

Neglecting the effect of the earth, we have

$$C = \frac{155 \times 30.5}{21.2 - 0.62} = \frac{4,720}{20.6} = 229 \text{ e.s. units,}$$

or 255 micro-mfds.

Now, assuming $h = 155 \text{ ft.}, \frac{l}{2h} = 0.5$ and

$$C = \frac{4,720}{20.1}, \text{ which is an increase of } 2.5$$

per cent., while if $h = 77\frac{1}{2} \text{ ft.}, \frac{l}{2h} = 1$ and

$C = 240 \text{ e.s. units, or } 266.7 \text{ micro-mfds.},$
 which is an increase of 4.7 per cent.

(b) Flat multiple-wire antenna; length = 155 ft., diameter = $\frac{3}{8}$ in., number of wires = 10, distance between wires = $2\frac{1}{2}$ ft.

$$\frac{l}{d} = \frac{155}{2.5} = 62, \log_e \frac{l}{d} = 4.12,$$

$$\frac{c}{r} = \frac{30}{3/64} = 640, \log_e \frac{c}{r} = 6.45,$$

$$R = 9.8.$$

Neglecting the earth,

$$C = \frac{17 \times 10}{10(4.12 - 0.31) + 6.45 - 9.8} = \frac{170}{34.75} = 4.9$$

micro-mfds. per foot of length.

If $h = 155 \text{ ft.}, \frac{nl}{4h} = \frac{10 \times 155}{4 \times 155} = 2.5$ and $C = \frac{170}{32.25}$

$= 5.27$, an increase of 7.5 per cent.,

whereas, if $h = 77\frac{1}{2} \text{ ft.}, \frac{nl}{4h} = \frac{10 \times 155}{4 \times 77.5} = 5.0$ and

$$C = \frac{170}{29.75} = 5.72 \text{ an increase of } 17 \text{ per}$$

cent., or, more accurately, by using Fig. 20, 5.67, an increase of 16 per cent.

Hence the error introduced by neglecting the proximity of the earth is much greater in multiple-wire antennæ than in single wires, and, as shown in the example, may reach a figure by no means negligible.

(To be concluded.)

PROBLEMS OF RADIO-TELEGRAPHY.

A SPECIAL report on the meeting of the British Association in Australia appears in the *Electrician*, from which we publish below a summary of the points discussed which relate to wireless telegraphy:—

Sir Oliver Lodge opened a joint discussion between the Physics and Engineering Sections on "Radiotelegraphy." He dwelt on the scientific rather than the engineering aspects of the subject, and referred especially to the use of radiotelegraphy in studying the atmosphere and on the use of the science of the atmosphere for explaining radiotelegraphy. One of the great problems was how do the waves get round the curved surface of the globe. Diffraction—that is to say, the slight bending round obstacles which waves were always capable of—had been shown by Macdonald very recently to account, possibly, for a portion of the effect, but the theory of Eccles seemed to be necessitated by the observed fact that the strength of long-distance signals sometimes varied greatly from moment to moment. This theory ascribed the chief share of the transmission over great ranges to the effect of the electrical state of the atmosphere on the propagation of electric waves. It was based on a remarkable mathematical result that the velocity of propagation of electric waves was greater in air containing free electric ions than in ordinary non-conducting air. Now, the upper layers of the atmosphere being vacuous and more conducting than the lower caused the upper parts of a vertical wave-front to travel faster than the lower and thus the wave-front tended to fall forward as it travelled and so tended to follow the curvature of the earth. Recently Fleming had pointed out that if the earth's atmosphere were of pure krypton the mere change of specific inductive capacity which accompanied diminution of density as we rose in the earth's atmosphere would suffice to make a wave travel round the earth.

"FREAK" SIGNALS.

The second considerable problem concerned those exceptional circumstances which produced so-called "freak" signals. On some nights these augmentations in the strength of signals were very transient,

sometimes they lasted an hour or more. Most of them could probably be explained by supposing that at night the waves were propagated chiefly by continued reflection under the boundary of the upper ionised atmosphere, as in the case of the transmission of sound waves round a whispering gallery. We might suppose that usually the reflecting surface was puckered somewhat irregularly, but that occasionally it presented for a time a very regular surface. On these latter occasions we got "freaks." Here it might be mentioned that the ionisation of the upper atmosphere by the sun, together with the supposition of the topmost reflecting layer, gave at least a partial explanation of the variations observed in signals at sunrise and sunset.

The third great problem was that of the nature and origin of strays—the natural electric waves which at times confused the signals transmitted by artificial electric waves. Most of them were due to lightning discharges, but other causes were not impossible. For example, some proportion of strays might come from the sun, or it might be that some of our strays were precipitated by the jets of alpha particles emitted more or less erratically by the sun. By the collation of systematic observation at many places the Committee for radiotelegraphic investigation hoped to settle this point.

RADIOTELEGRAPHIC PHENOMENA.

Dr. Eccles then gave a *résumé* of a contribution sent to the discussion by Mr. J. G. Balsillie. The chain of 19 stations distributed round the coast of Australia afforded an unparalleled means for investigating many radiotelegraphic phenomena. All the stations intercommunicated at night and most pairs of adjacent stations intercommunicated in the day, on a wave-length of 500 or 600 metres. It had been found that the night signals between fixed adjacent stations were three times stronger than day signals as measured by shunted telephones, and that signals over land were about the same strength as over sea. The intensity and number of strays heard at any station increased from day to night in approximately the same ratio as the signal strength. A number of curves were shown representing the strength of signals and strays during day

communication between Melbourne and Adelaide, 410 miles overland, through a typical 24 hours in winter. With a wave-length of 600 metres communication was impossible between 8 a.m. and 5 p.m., but was good in the hours of darkness. With a wave-length of 850 metres communication was always possible, the strength being 5 at noon (minimum) and 10 at midnight (maximum). As a general rule signals were strong and steady when strays were strong, and signals were variable (sometimes with a more or less regular period of about a minute) when there were few or no strays. The strength of signals was affected by wind, especially during a dust storm, but chiefly in the direction from which the wind was blowing. Another and very remarkable rule demonstrated by the Australian stations was that if signals from north to south were above the normal strength, then signals from south to north were below normal, and *vice versa*. This asymmetry had not been detected in east and west signalling. Among the curious phenomena which had been observed was that termed the "wiper," which was almost peculiar to the Hobart station. It appeared to be an oscillatory discharge, which sounded like the grinding of a piece of metal on a stone. It started weak, rose to a maximum in two or three minutes, and then died down. It was heard only at sunrise and sunset.

NIGHT AND DAY PROPAGATION.

Prof. G. W. O. Howe pointed out that an American experimenter had shown some years ago that the signals received at Boston from Glace Bay were greatly affected by the occurrence of sunrise and sunset at both the sending and receiving stations, which could be explained only partially by theory. He showed a curve, published by Spanish experimenters in the Madrid and Barcelona stations, from which it appeared that the signal strength rose to a sharp maximum about midnight. The curves of Mr. Balsillie showed, on the other hand, a fairly constant signal strength throughout the hours of darkness. During the voyage from England he had taken the opportunity of listening to signals received by the ship's apparatus, and had noticed that at Fremantle the signals received from the Cocos Islands and those

from Sydney were of about the same strength; which supported Mr. Balsillie's observation that the propagation of long-distance messages overland was approximately the same as over sea. At sea he had made many observations on atmospheric disturbances on the Indian Ocean and had found that they increased rapidly in number and strength after sunset, but the phenomena described by Dr. Eccles, that a minimum of X's appeared shortly after sunset, did not occur. The curves showing Mr. Balsillie's observations on signal strength at different times of day supported Marconi's observation that with long waves the difference between day and night propagation became small. At about 6,000 metres day signals were good as at night.

Sir Oliver Lodge remarked that the Barcelona-Madrid observations seemed capable of explanation. Imagine that planetary space was permeated with free ions which could be picked up by the earth's atmosphere as the earth moved in its orbit. At midnight in Spain the atmosphere immediately above was subject to a tangential bombardment of ions, which reproduced a state of affairs analogous to that due to the slanting rays of the sun at sunrise and sunset. The high maxima of signal strength which were known to occur at these times might therefore be expected at midnight.

THE WHISPERING GALLERY.

Dr. Eccles, referring to Sir Oliver Lodge's remarks on the theory of reflection and refraction at ionised layers, pointed out that there was little evidence except that afforded by wireless telegraphy to suggest that the upper layers of the atmosphere were, in fact, permanently ionised. The conclusions drawn by some observers from the ionisation of the Föhn and other vertical winds were not accepted universally, and thus the fact that the characteristic green line of the aurora spectrum was always visible in the night sky all over the earth was almost the only experimental evidence of ionisation. Schuster's theory of the diurnal variations of terrestrial magnetism demanded, however, some degree of conductivity in the upper atmosphere. Concerning the reflection of signal waves from

the night sky, which lead to the whispering gallery view of propagation, it was interesting to note that in a recent paper Lord Rayleigh had shown that the same effect could be obtained even if the boundary between the unionised and the ionised air was not sharply marked; it was only necessary to have the transition layers arranged like the coats of an onion with the ionisation increasing as we went outwards.

The fact that the energy density of the waves was greater at greater elevations was supported by Marconi's reception of Clifden signals at Buenos Aires by aid of high kites and also by some information communicated to the speaker while passing through Pago in the Samoan Islands. Here the American Government had very recently erected a small receiving station on the top of a lava mountain about 1,000 ft. high. The station picked up signals from land stations in Alaska, the United States, Australia and New Zealand, from Yap, and even from small ship sets along the coast of Mexico. The station stood on very dry lava, and thus there is no "earth"; and the antenna was virtually a Lodge aerial perched, as it were, on a cone of glass. An opportunity arose of testing the dielectric properties of this lava. The ship was moored with a mountain called the "Rainmaker" directly between it and Honolulu, over 2,000 miles away. The ship was about a quarter of a mile from the almost perpendicular face of the mountain, which was an unsymmetrical wedge of lava 1,800 ft. high and about a mile thick at the base. On listening in at the proper time the night press messages from Honolulu were heard on the ship's apparatus almost as strongly as they had been the night before on the open sea 200 miles nearer to Honolulu. Evidently the lava was very perfectly transparent to electric waves 600 metres long. The speaker also described some of the conclusions he had reached concerning the dependence of strays on meteorological conditions. Regarding "freaks," he was satisfied that what would be called a "freak" on the Atlantic Ocean was the normal thing on the Pacific. Ship sets of 2 kw. were expected to work 2,000 miles regularly at night, even in the summer: while in the winter distances of from 3,000 to 4,000 miles were occasionally accomplished.

Punta Arenas &



MOUNT BALMACEDA
PATAGONIA

WINTER COSTUME.

Its New Wireless-Station

By
Hilton Keith.

PUNTA ARENAS, or Sandy Point as we should call it in English, is the only Chilean town in Patagonia. It lies on a wind-swept mountain slope on the northern side of the Straits of Magellan, about midway between the Atlantic and Pacific Oceans. The surrounding country is some of the wildest in the world: its scenery is indescribably wonderful and depressingly grand. Nature has worked in her own wild way in the moulding of these lands, and man is obviously an unreckoned guest. A trip through the canals of Patagonia will not easily be forgotten. The steamers glide through narrow passages of glassy ink-black water. On either side towering above the ship are gaunt snow-clad mountains, broken here and there by great green glaciers which loom like giant emeralds set in frosted silver. The effect of a sunset on this silent white land is one of extreme beauty and impressiveness. The awful grandeur of Nature's handiwork is borne home to the shivering individual who, silent and wondering, gazes fascinated

at the land where man's efforts have so far failed to leave their mark.

One might be apt to think that wireless would be new to these wild parts. Not so though, for the Argentine Government have linked up all their settlements in Patagonia and in the island of Tierra del Fuego with a system of medium-powered stations. These carry on an immense amount of Government traffic, but at present do not handle any private messages.

The Punta Arenas station recently erected by Marconi's Wireless Telegraph Co., Ltd., for the Chilean Government is designed to carry out a regular service with a similar station now in course of erection at Puerto Montt. The latter station is a great distance to the north and itself in direct connection with the rest of Chile by rail and line telegraphs. A small set is also installed at Punta Arenas, to deal with ship traffic and also possibly to open a service with Port Stanley in the Falkland Islands.

Punta Arenas is the business centre of a

huge sheep-raising district, and enjoys the unique distinction of being the most southerly town in the world. It is also a coaling station for shipping plying between New Zealand and Europe *via* South America. Coal of an inferior quality is mined locally, but the greater quantity comes from Australia. The climate is extremely severe, yet all Patagonians look the picture of health. An all-too-well-filled cemetery tells of the sad fate of the weaklings. On account of its geographical position, the town enjoys almost endless daylight during the summer, but has to suffer long dreary hours of darkness during the winter. During this season the land lies deep under snow and the so-

different from his neighbour. Chilean law rules the town, yet often will a Chilean speak sarcastically of going from Punta Arenas to *Chile*! Until recently it was a free port, but since the imposition of duties on certain imports there has been a considerable falling off in trade.

Many Englishmen live in and around Punta Arenas, and a well-arranged British Club is the means of keeping them in close touch with one another. The British run a "Soccer" football team, and last season won the Municipal Cup, beating all other nationalities. It is interesting to note that out of the six members of the Marconi engineering staff that were engaged in the

work on the erection of the station, four played regularly for the British team. Football is of necessity a summer game in this part of the world. A tennis court at the works of the South American Export Co. was within easy distance of the station, and many victorious sets have the Marconi staff played there. Sunday race meetings are held as often as the weather permits, and one can while away one's time—and money—trying to "pick winners."

The site on which the station has been erected lies three miles to the north of the town at Tres Puentes, so called on account of three bridges in the vicinity. The

position has been well chosen and is eminently suitable for a high-power wireless station, being of level damp grass-covered ground.

The plant is housed in a ferro-concrete building of generous dimensions. Steam heaters and fire hydrants serve every room. A separate store is situated a short distance from the main building with large oil tanks let into the ground beneath the floor. A pipe line connects these tanks with the main building. A comfortable and commodious dwelling-house is provided for the staff.

The station includes two transmitting plants: one of 100 kw. and one of 5 kw. Four distinct aerials are necessary, two for radiating the two lengths of 100 kw. waves,

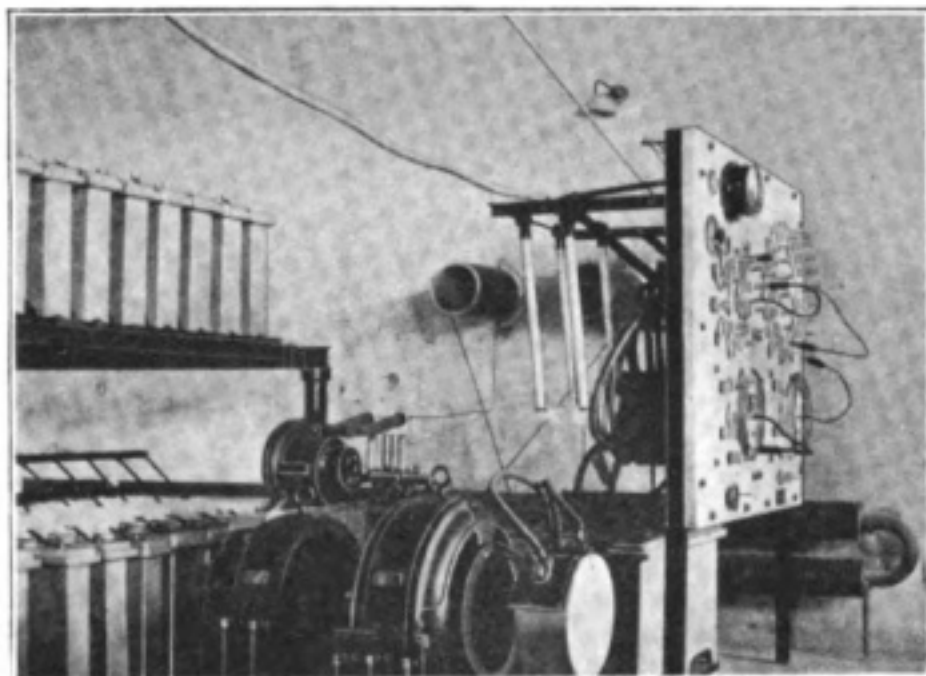

5 k.w. Transmitting Plant, with portion of 100 k.w. Condenser Bank on left.

called summer is merely a name for part of the year. A summer in Patagonia would strike the Londoner as a very delightful winter's day, sunny and yet with a touch of frost in the air. The sea varies but three degrees in temperature from summer to winter. The mountains which rise to the north-west of the town are snow-capped at all times, and an almost ceaseless wind sweeps down over them, chilling the sunniest days.

The population is extremely cosmopolitan, Austrians predominating. As one picks one's way down muddy cobbled streets, the variety of languages displayed on the street signs is positively bewildering. It appears as though each storekeeper had tried to be

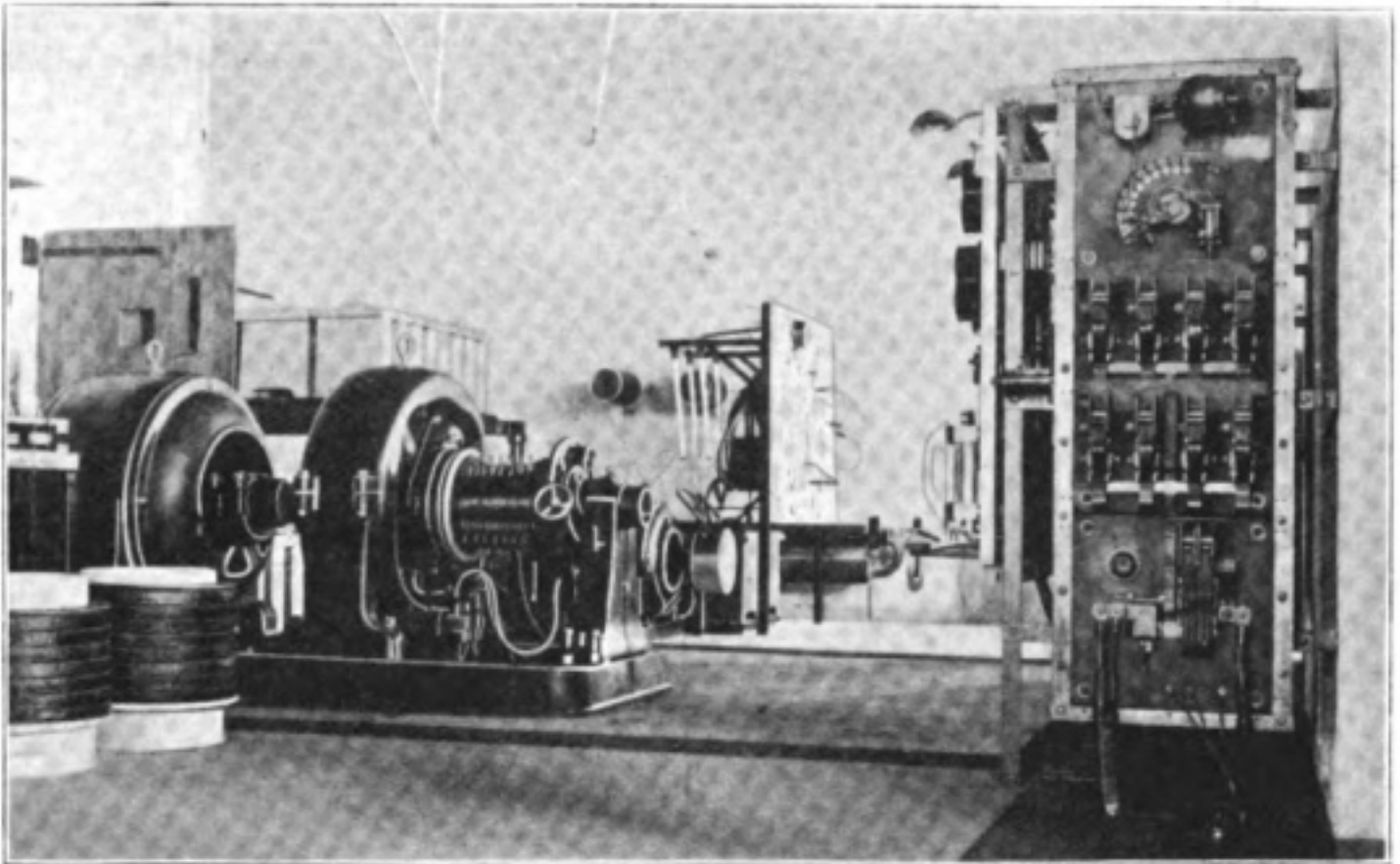

100 k.w. Motor Alternator ; 5 k.w. Transmitter ; A.C. Switchboards, etc.

one for the reception of long waves, and the fourth for the five kilowatt set. All the aerials are of the inverted "L" type and directional for Puerto Montt. The wires are slung with porcelain insulators from triatics, which are supported by a system

of seven 250-ft. steel masts and two shorter leading-in masts. The aerial wires are not fastened to the insulators, but run through a small block, thus allowing an adjustment of the sag so that undue strain shall not take place during heavy gales.

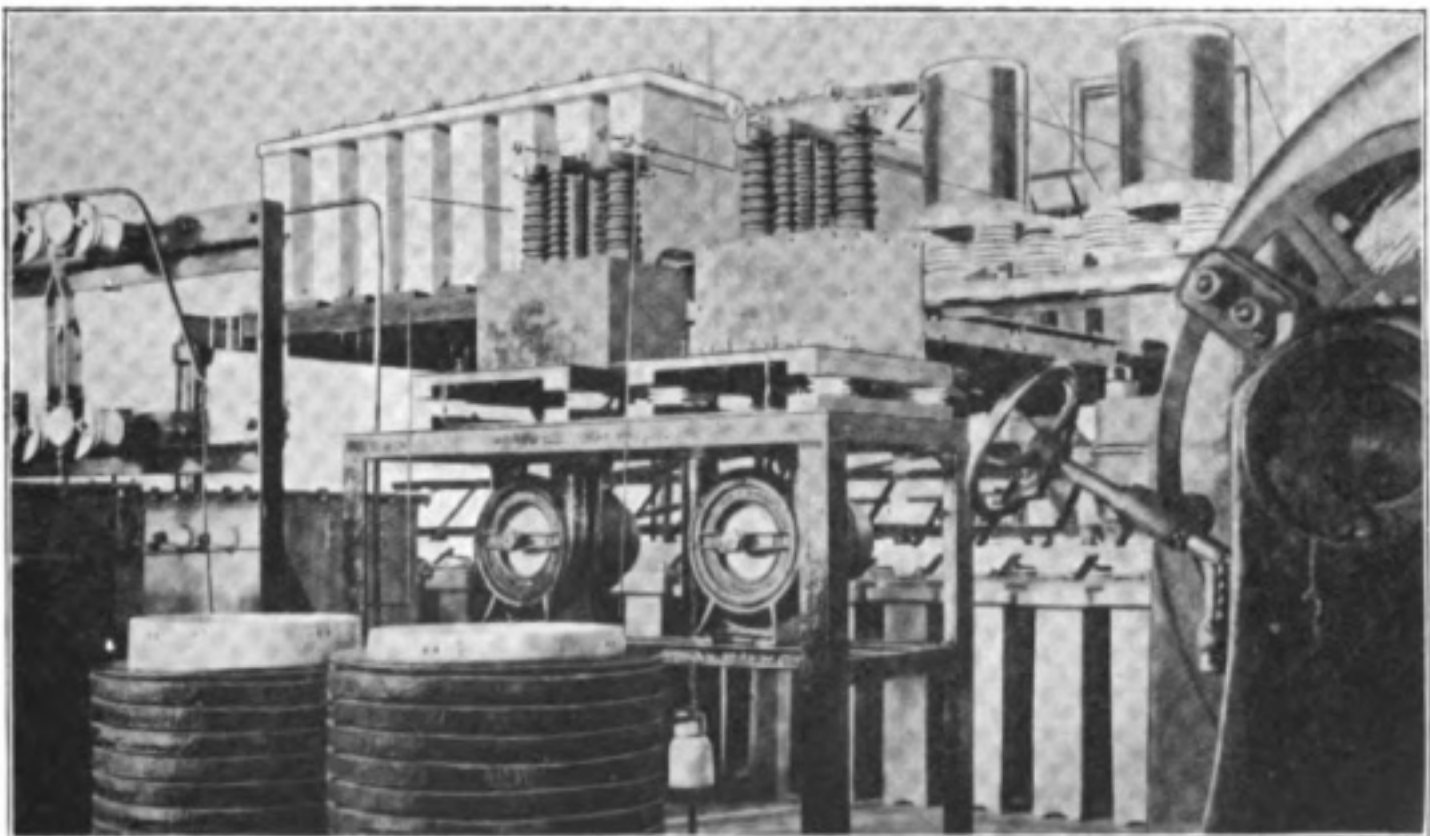

Portion of the Transmitting Room, Punta Arenas, showing 170 h.p. Motor, H.F. Chokes, Signal Switches, Air Blasts, Transformer, etc.

The aeri-als are arranged in one or more loops, the open ends of which are led to separate porcelain leading-in insulators fixed through the side of the building. Each aerial is thus provided with two leading-in insulators, and current may pass from one to the other by traversing the loops formed by the aerial wires. Normally the two insulators of each aerial are joined together and one or other of them connected to transmitting or receiving jigger, as the case may be. Should a silver frost coat the outside wires with a dangerously heavy load of ice,

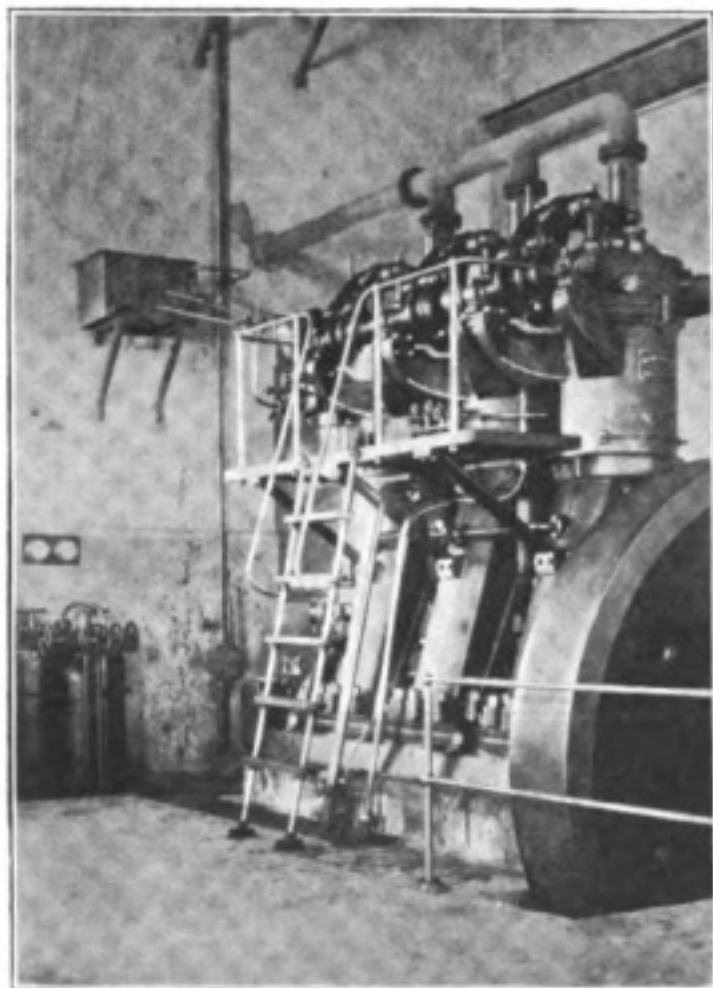

The Prime Mover. 270 h.p. Oil Engine, with Air Starting and Injection Bottles on left.

the loop ends may be opened and current passed along the aerial wires to heat them and thaw off the ice. The aeri-als are then connected again to the wireless apparatus.

The earth is in two semi-circles spaced equally on either side of the building. Wires are also buried below and parallel to the aerial, extending slightly beyond the end masts. The earth wires were buried in furrows made with a primitive ox-drawn plough. A somewhat singular use for so antiquated an article as a farmer's plough!

Power is obtained from a Diesel oil engine,

which has three cylinders developing 270 h.p. at 200 r.p.m. Fuel is pumped from the oil storage tanks to a working tank fitted to feed the engine by gravity. A well and water tanks for the cooling system are situated outside the engine-room, and circulation is effected by means of an electrically driven pump.

Directly coupled to the engine is a continuous current generator, which delivers 140 kw. at from 200 to 360 volts. Energy is stored in an accumulator battery of nearly 2,000 ampère-hours capacity. The cell elements are burned together and contained in lead-lined wood boxes.

The usual switchboard gear for charging is situated in the engine-room.

Both large and small transmitting sets are housed in the same room and controlled by automatic starters from the operating-room, which is situated at the extreme far end of the building. Both alternator and disc discharger are driven by motors, their phase relation being adjustable. The automatic starter for each set controls motor, blowers, signal switches and spark house ventilators, usually collectively, but if desired for testing, singly. Either set can therefore be run up simply by moving over a tumbler switch in the operating-room.

Alternating current of 220 volts at 200 cycles is put on to four 25-kw. transformers as the motor speeds up. A bank of five 25-kw. transformers is provided with arrangements for the use of any four, the fifth being spare. Leads connect from the transformer secondaries through special air core inductances to the signal switches. On depressing the operating key, current at 10,000 volts is passed through air core H.F. chokes into the condenser bank. The latter consists of 416 new pattern Poldhu pots, giving a capacity of approximately 1.25 microfarads. The pots are placed in twelve groups and two tiers. The containers are of white earthenware, cast with insulating feet and oil sealing rims. The plates are of the familiar Poldhu foil type and attached to special screw terminals fixed in the lids. Copper strip connectors join each pot to the bus bars or its neighbour. These leads are run non-inductively and separated by white porcelain channels.

Two wave-lengths are provided for, 5,000 and 3,000 metres. The necessary change is

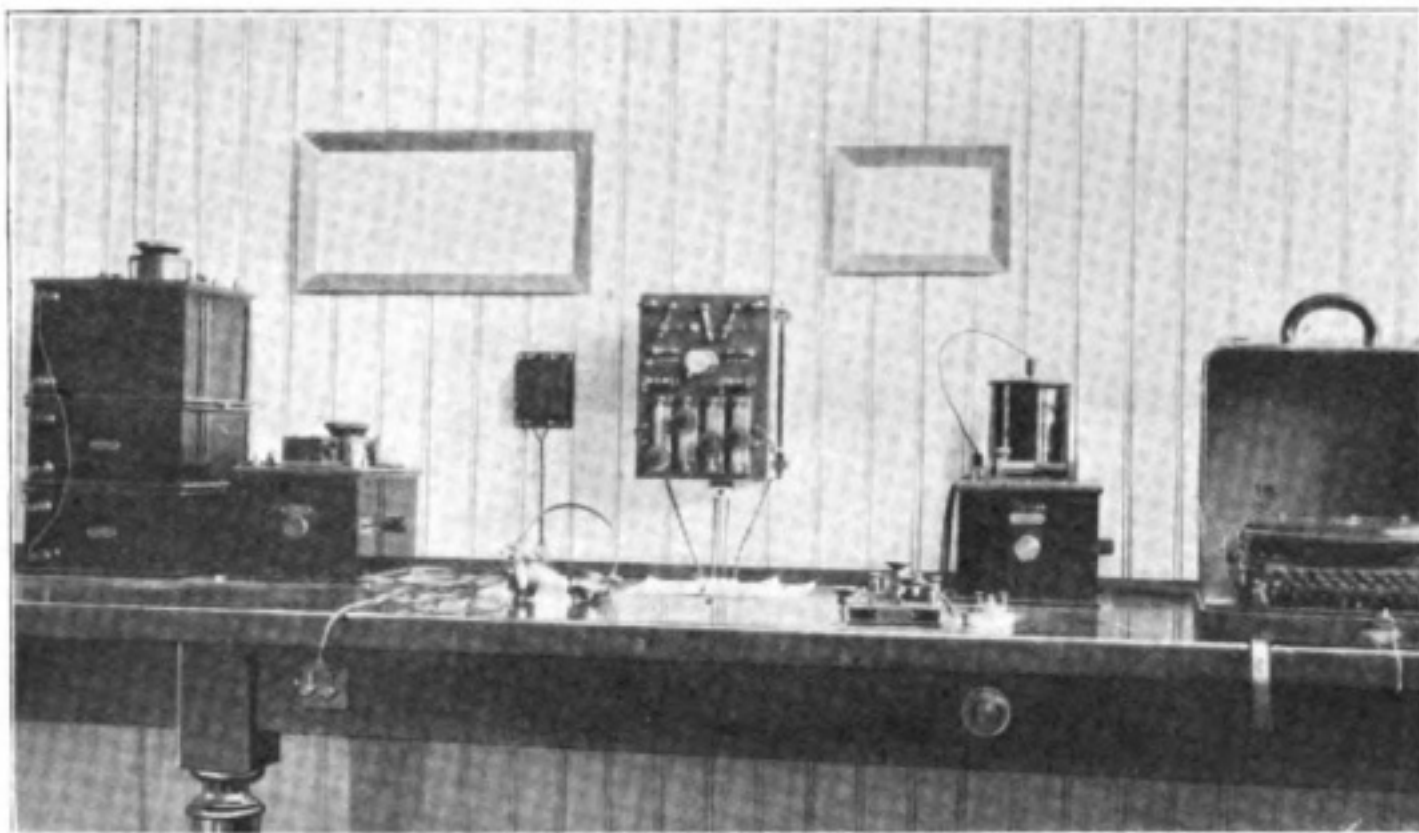

Long Range Receivers.

effected by special switchgear which alters the number of turns in the jigger primary, either one or four being used. The jigger primary is of the anchor ring type with twisted conductors to ensure uniform current density throughout the conductor.

A 36-inch radial disc discharger controls the condenser discharge and gives a spark every half period at the precise moment when the condensers have received their maximum charge. A massive concrete spark house encloses the disc, but its work-

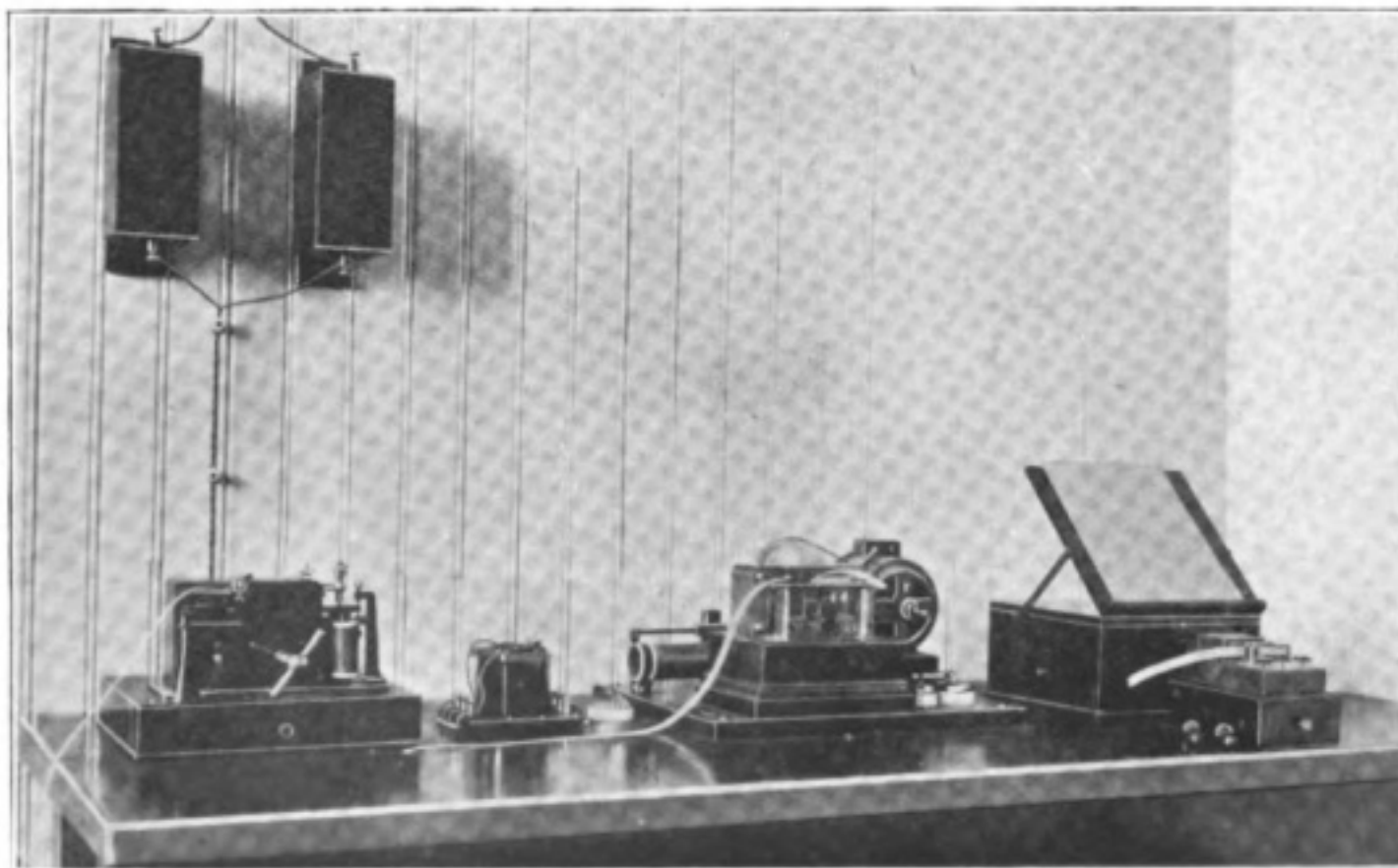

Perforator ; Motor-driven Wheatstone Automatic Relay and Spark Recorder, with its Chokes on the wall.



PUNTA ARENAS,
FROM THE QUAY.



SEMAPHORING.



PLOUGHING IN EARTH WIRES.



USING OXEN TO MOVE ENGINE FLYWHEEL.



THE PLAZA AT "SANDY POINT."

ing is visible through a coloured glass inspection window fitted in the door, the interior being provided with a light and reflecting mirror. Copper dust is removed by a ventilating fan and fresh air sucked in from outside the building. There is ample room to walk around the disc and a light crane running inside the spark house facilitates its possible removal. The H.F. leads to the side electrodes are large diameter stranded conductors of the "elephant trunk" type. They pass through sound-proof porcelain insulated stuffing boxes. The disc itself is highly insulated and great care and ingenuity have been displayed in the design of many minor details in view of the high power it has to handle.

Both aeriels are connected to adjustable aerial inductances, and thence lead to a special switchboard. This enables either one or the other to be connected to the jigger secondary, the one not in use being earthed through a condenser or inductance. The same jigger secondary is used for both waves. Its coupling is adjustable whilst transmitting.

A Coltano type earth gap switch disconnects the transmitting aerial from the ground whilst receiving. This is operated by a send-receive switch in the operating room. An ammeter is connected across a portion of the earth lead with two carefully calibrated shunts, which affords a means of comparing the energy radiated by either length of wave.

The 5 kw. transmitting apparatus is almost exactly the same as that installed at Arica, Antofagasta and Coquimbo. A full description of these sets appeared in THE WIRELESS WORLD (November, 1913). The frequency is higher than that of the 100 kw. set, being 360, which gives 720 sparks per second.

Both sets are provided with twin marble panel switchboards, on which are mounted switches, cut-outs, voltmeters, ammeters and a frequency meter. A safety switch with lock and key is fitted in the A.C. primary circuit, and a test key is also provided for operating the signal switches from a point near the A.C. instruments.

The apparatus in the receiving room is arranged in four groups. Automatic as well as manual transmission is provided for with either set. Perforator, motor-

driven Wheatstone and relay are mounted on a separate table. A spark recorder is also placed near at hand, affording a useful check on the operation of the Wheatstone and relay. A description of the working of a spark recorder has already appeared in these pages. The 5 kw. aerial is used to actuate the recorder. A three-way switch is so connected that in one position the aerial is connected to the 5 kw. receivers, whilst in the opposite position it is led to the spark recorder. A mid-way neutral position leaves the aerial disconnected from either instrument and only separated from the earth by the small gap in the earth arrestor terminal.

On the main table is arranged the 100 kw. manual key, the long range receiving apparatus and the 100 kw. remote control switch. The receivers are standard pattern and afford efficient reception over a large range of wave-length—1,000 to 7,000 metres. Either crystal or valve or both may be used as the detector. When receiving a send-receive switch connects the receiving aerial to the receivers, opens the earth gap in the transmitting aerial and breaks the signal switch circuit. The reverse conditions are effected whilst transmitting.

The 5 kw. operating key, remote control switch, together with short wave valve and magnetic receivers are conveniently installed at some little distance from the 100 kw. receivers. A system of change switches at the far end of the table allows of transmission on either one or other of the sets either automatically or manually. Facilities for charging the valve batteries are provided in the operating room. A switchboard for thawing ice off the receiving aerial is fitted immediately below the two leading-in insulators. Care has been taken to avoid any induction in receiving circuits, and the very elaborate earthing of all cables has been entirely successful. A sufficient distance between the various units of the receivers is also maintained, thus avoiding undesirable direct induction between jiggers. Double windows and heavily silenced walls reduce extraneous sounds to a minimum.

Adjacent is a land line room for despatch and reception of messages to and from the town. A retiring room for operators, an

office for the engineer in charge, stationary and electrical stores and lavatories are also within the main building.

A 15-ton crane is installed to operate at any point within the engine room, in which is situated a singularly well-equipped workshop, boasting power-driven lathe, drilling machine and grindstone. A light railway runs the entire length of the building along the passage way. This greatly facilitates the handling of heavy material. All wires are lead covered and laid in cableways covered with checker plating. Each wire is earthed at frequent intervals. The lighting system is carried out with Simplex fittings. It is arranged to light every desirable point and switched to allow of economy in current. Porcelain insulation wherever practicable is an outstanding feature. Every machine is capable of withstanding the roughest treatment, and spares for every possible breakdown have been lavishly provided. A great deal of thought has been given to the arrangement of the plant, and its designers have accomplished a very great number of marked improvements.

As regards the erection, the work, long delayed, went very smoothly once it had got fairly started. The weather was favourable, and what the labourers lacked in knowledge they made up for in willingness. The masts had been completed many months before the building was ready. Their erection was successfully accomplished without mishap, but not without some anxious moments. Patagonia is not a pleasant place to have a steel mast depending, perhaps, on temporary guys in a gale that renders conversation an impossibility and chills one's very marrow.

The control of labour gangs from a distance was greatly facilitated by the use of semaphore signalling. The value of bullocks for heavy work is inestimable.

The opening of the service is eagerly awaited, for the land line connecting to Buenos Ayres leaves much to be desired, both in regard to accuracy and speed. It is satisfactory to know of the great grey desolate building at Tres Puentes, wrapped in its snowy gown of winter, yet blazing lights across the wild white world without and flashing forth its messages of joy and sorrow, of business and pleasure!

OVERSEAS NOTES.

ARGENTINE REPUBLIC.

A German report on electrical matters in the Argentine, which appeared just before the outbreak of war, points out that "there is a special future before wireless telegraphy in the Argentine, because of the costliness and unreliability of other means of transmitting news, particularly in the thinly populated districts." The report draws attention to the improvement and extension of the telegraph lines, but, "storms and floods often cause serious interruption not merely on branch lines, but also on main lines." It is also pointed out that a number of German wireless telegraph stations were installed inland in Argentine and Paraguay, and that "the Marconi Company derived considerable benefit from the Argentine law, which ordered wireless apparatus to be installed on all ships (including river steamers) frequenting the ports having fifty people on board."

* * *

CANADA.

According to the *Telegraph Age*, the Canadian Government's station at Cape Race, N.F., is to be enlarged and improved. All wireless stations on the Newfoundland and Canadian seaboard were taken over by the Admiralty on the outbreak of war. Since that time the Cape Race Station has been operated to full capacity.

* * *

ITALY.

The Priest Domenico Argentieri of Aquila, Italy, gave a demonstration in Rome recently with a form of portable wireless telegraph apparatus which, it is claimed, is capable of receiving messages from high-power stations over distances up to 1,250 miles.

* * *

UNITED STATES.

At the recent convention of the Association of Railway Electrical Engineers, in Chicago, Dr. F. H. Millener, of the Union Pacific Railroad, described experiments in wireless telephone communication with moving trains from fixed stations. He proposes to use as "extended aerials" the telegraph wires along the right of way, insulating them thoroughly and providing condenser shunts for the high-frequency currents around the telegraph keys. The transmitting equipment adopted employs a bank of arcs to produce the high-frequency current.

Aerials and their Radiation Waveforms. IX.

By H. M. DOWSETT.

THE LODGE AERIAL RESONANCE EFFECT.—The Lodge aerial has certain limitations. Its earth resonance effect is most marked when the aerial circuit between the two capacity areas is completed by the shortest lengths of connecting cable. The best wave-length for given areas is therefore definitely fixed.

If aerial inductance is added to increase the wave-length, it destroys resonance to a corresponding degree. If the lower capacity area is then dropped nearer the earth to make the period of the lower part of the aerial circuit again agree with the period of the top part, resonance will be restored, but it will not be so good as in the original case. This is due to phase difference existing between the two parts of the circuit, introduced by balancing an inductance in the top part against a capacity in the bottom part.

The radiation from the Lodge aerial is not of a character suitable for transmission over great distance. It does not send off a wave with a great body projected well into space. It parts with its energy in small quantities.

These characteristics favour efficient working over short distance and easy country, but they are not qualities which assist when there are intervening obstacles to pass over or through, which deflect and absorb energy from the wave.

For very long wave-lengths, practical considerations of supporting masts and ground space, the difficulty of keeping low the ratio of diameter of capacity areas to height between areas—which affects the radiation efficiency—and also the difficulty of obtaining a fairly homogeneous character of earth over a wide area, are against its use.

Yet it is an important aerial, and the principle of its action should always be kept in mind.

Conditions of resonance, for instance, may

exist in the Marconi aerial circuit, Fig. 1, if the ground is favourable.

EE represents an area of earth plates, or earth nets, laid on the surface of badly conducting soil. Suppose that some distance below the surface, under the dry top stratum, D, there is a water bearing stratum, W, then this constitutes an earth condenser below the aerial, which—according to its electrical dimensions—may have the power to assist or oppose the oscillations in the aerial circuit.

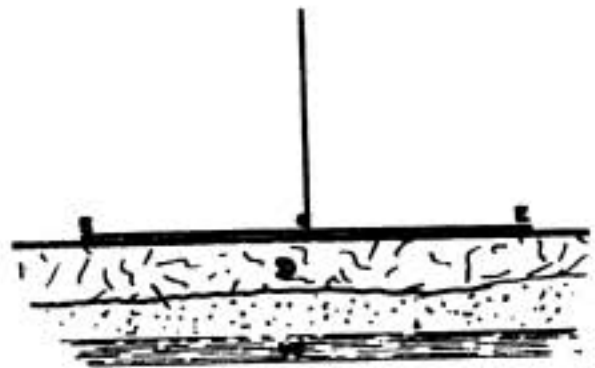

Fig. 1.

The South Downs may be taken as an example which offers typical ground of this character. In certain places the top stratum is of chalk, which covers a layer of greensand, and below the greensand occurs the clay. The dielectric constant of dry chalk and sand may be anything from two to five times that of air, and its specific resistance may run to a high figure.

Or again, the earth dielectric may be a limestone, and the conducting stratum below it a wet shale.

Even the more familiar Marconi aerial system shown in Fig. 2 may, under certain exceptional conditions, experience an earth condenser resonance effect. The plates may be buried in sand or gravel through which the rainwater percolates, its final level being determined by some lower impermeable stratum or by the natural saturation level of the district.

At some time or other the rising or falling of the level of the under surface water may, for a short period, introduce earth condenser resonance. Under such conditions the radiation from the aerial would be accompanied

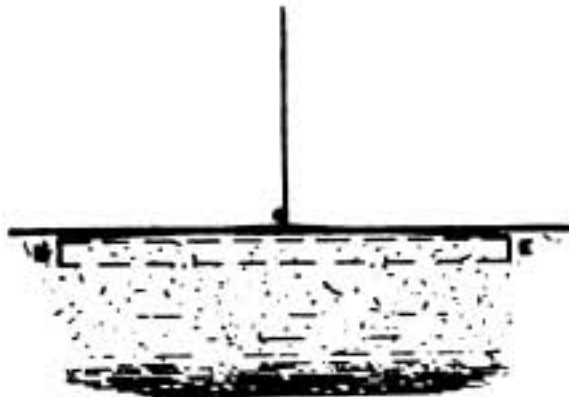

Fig. 2.

by an independent wave radiation within the surface crust of the earth, naturally of much less power, and much higher damping, but of considerable use while it remained in existence because of its tendency to reduce the spread of the aerial wave energy into the earth followed by its subsequent dissipation.

Should, however, the earth condenser be out of resonance with the aerial circuit, it would exert a damping effect on the aerial oscillation.

The remedy would be to destroy the condenser action altogether, by driving an earth connection down to the bottom conducting layer.

Auxiliary earths in a dry soil are useful for this reason, if for no other—they tend to destroy any possible earth condenser action, which only in an exceptional and infrequent case is likely to assist the aerial radiation.

An interesting example in which earth resonance might prove helpful is afforded by the Bellini-Tosi directive aerial.

This aerial is now only used in the Marconi-Bellini-Tosi system of directive recep-

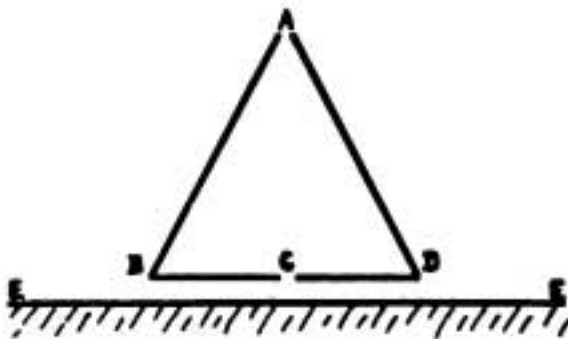

Fig. 3.

tion, but some six years ago it was installed for directive transmission and reception

between Dieppe, Havre, and Barfleur, with good results.

However, the characteristics of the original open top, triangular aerial are such that it sacrifices its radiative to its directive efficiency. Any improvement therefore in its radiative qualities might, under certain conditions, prove very useful.

To introduce earth resonance, the capacity ABC, ADC, Fig. 3, should equal the capacity ABC, EE, or ADC, EE.

Now if ABCD is an equilateral triangle and EE is a perfect conductor, there will be a constant ratio between the length BD and the height of BD above EE, which will give equal capacity between the two parts of the aerial and either part to earth, for any area of the triangle.

To determine this ratio the apparatus shown in Fig. 4 was made up.

The capacity between the two parts of the zinc triangle measured 1.57×10^{-6} mfd.

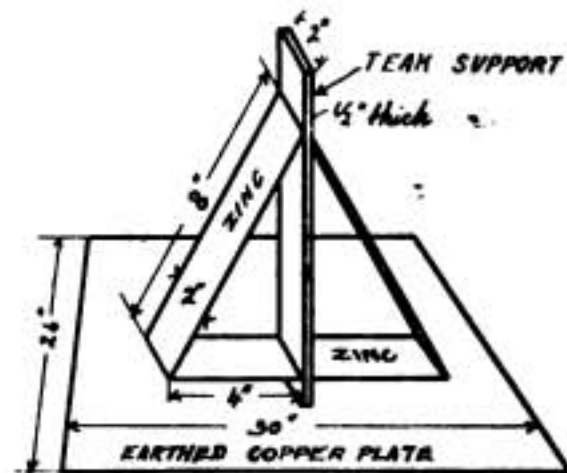

Fig. 4.

and the height of the base above the earth plate to give resonance capacity was found to be .43 in. This gives a ratio for a perfect earth of 18 : 1. The ratio will be larger the poorer the earth, and under working conditions may be quite double this.

Now the figures available for the Dieppe transmission give the length of the aerial base line as 55 metres, and height above the ground as 2 metres, so that the ratio was 27.5 : 1. Then the conditions appear to have been distinctly favourable for earth resonance to have assisted transmission in this case. This would have been at the expense of the directive efficiency of the aerial, but probably to an extent which did not matter.

CORRESPONDENCE.

Aerials and their Radiation Wave-forms.

To the Editor of THE WIRELESS WORLD,

SIR,—In reply to Dr. Erskine-Murray's criticisms of my article in the September WIRELESS WORLD—

My object in Fig. 2 was simply to illustrate the difference in the electric intensity at the surfaces of two plates of unequal area, and in Fig. 3 to show that a section taken through the electric field between a wire and a plate, and cutting the wire along its length, would show more lines leaving the wire section than end on the plate section. The diagrams as drawn were quite suitable for illustrating these facts. Certainly the strain lines would be curved and not straight, but their actual shape does not come into the argument.

In Fig. 4 the reader's attention is directed to the sectional field at ABC through the middle of the condenser. The object of the diagram is to illustrate the fact that the intensity of the field between two inclined plates is inversely proportional to the distance from B or the line where they tend to meet. The static field certainly on the accepted view should show a distortion outwards at the middle of each curve; but again this does not affect the point the diagram was intended to illustrate.

Dr. Murray states that in the kinetic case of an aerial inductively charged "it is also known that true radiation does not begin until outside a sphere having a radius of about three-quarters of a wave-length, and that therefore all the ground inside this is in the aerial earth circuit."

By the term "true radiation" is generally meant—radiation which has *completely* broken away from the aerial. This certainly cannot occur for a fundamental wave of an earthed aerial until half a wave-length has been generated. But radiation *starts* immediately the quarter-wave has been formed—that is, when the electric energy has completed its flow up the aerial and can go no farther. It can, however, go farther in space, which it proceeds to do, accompanied at the same time by a flow down or breaking away from the aerial.

At a quarter-wave distance along the earth the difference in phase between magnetic field and electric field practically disappears so that the wave-front then assumes its final character. One can, therefore, quite legitimately represent the earth kinetic field for a quarter-wave in the aerial extending for a radius equal to the length of the aerial, as I have done, if for simplicity the aerial is supposed to have negligible capacity.

Zenneck's diagram—No. 12 in my article—showing a quarter-wave kinetic field, and Fleming's diagram of a static field before spark discharge, are of the same order. Abraham's equations for the field of a linear oscillator, which are applicable to a vertical wire aerial—as Dr. Murray must be aware—allow one to calculate such a field right up to the surface of the oscillator. This is illustrated in the well-known diagrams drawn by F. Hack.

Perhaps Dr. Murray has in his mind the theory of the Hertz oscillator, which is only expected to be valid outside a sphere of small but definite radius round the oscillator. But this is a limitation of the theory only and has nothing to do with the region at which radiation begins.

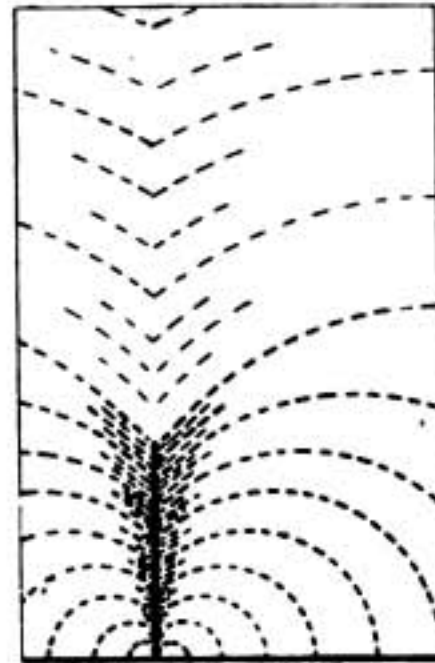

Fig. 1.

Concerning the nature of the static field at a great distance from the aerial, the arguments against my view advanced by Dr. Murray are not so strong as they would at first sight appear. For instance, assuming the aerial to have an appreciable capacity, the strain lines above the aerial would follow the contour of those which start from the aerial, and would bend down to it as shown in Fig. 1, but they would not be attached to it. Again, the suggestion that there may be a charged region in the space immediately above the aerial, linked by strain lines with an oppositely charged region on the earth,

C

is not so incredible when one remembers that it is not the surface of the conductor which is the truly essential factor in the aerial earth condenser, but the surface of the dielectric in touch with the conductor. The charge which is said to be taken by the aerial is actually held by the dielectric; and this refers more particularly to the dielectric immediately above the end of the aerial where the thickness to which this effect permeates is greatest.

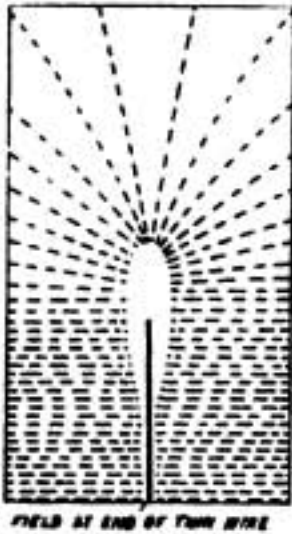

Fig. 2.

A static - charged aerial must actually have a small space of dielectric above it, from which strain lines originate and stretch to the earth, lines which are not in touch with the aerial, Fig. 2. However, to assume that this effect extends to any considerable distance beyond the end of the aerial is a very different matter, and the total weight of

evidence no doubt is against it.

There remains Dr. Murray's theory, which he states has the support of Sir Oliver Lodge, that the initial wave sent off by Plain Aerial has an enormous length, a length determined by the interval between charge and discharge. There are no grounds to justify such a view.

The strain lines may go on expanding to infinity if necessary, but that by itself will add nothing to the capacity of the aerial earth system; and if there is no increase of capacity there is no increase of wave-length. Capacity is determined by the ground area covered divided by the mean length of the strain lines. Both factors will increase in the same proportion, and therefore the capacity will remain the same.

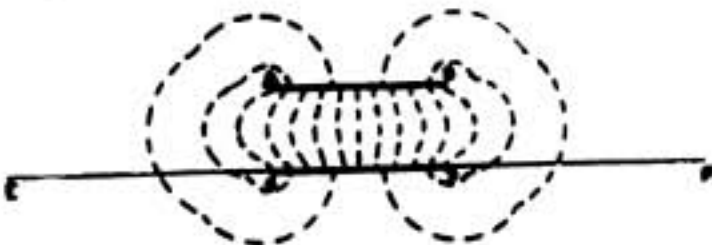

Fig. 3.

I do not suppose Dr. Murray will say that a further increase in capacity may be

expected between the two plates, AB and CD, Fig. 3, after they have reached the same potential difference at all points, due to further expansion of the lines of strain; but he does say that if the plate, CD, is extended indefinitely, then the strain lines will expand indefinitely to cover it, and in doing so the capacity will increase indefinitely.

This is a question which can be settled by test. The following table shows the variation of capacity with increase of area of the plate, EF, the area of the plate, AB, remaining constant. In order to get measurable values a glass dielectric was used between AB and EF.

It will be seen that the capacity tends to reach a constant value which is about $2\frac{1}{4}$ times the capacity given by plates of equal area.

AB	EF	Capacity
Sq. inches	Sq. inches	Mfds.
2	2	3.08×10^{-3}
2	3	3.42×10^{-3}
2	4	3.87×10^{-3}
2	6	6.73×10^{-3}
2	9	6.84×10^{-3}
2	12	6.84×10^{-3}

Thickness AC = $\frac{1}{4}$ -in. window glass.

A reference to Fig. 3, again, makes the reason for this increase clear. The strain lines from the top of AB have been shortened by the extension of CD to EF. This has caused a rearrangement of the density of the lines and an increase in the total capacity. This is the only cause tending to increase the capacity by extending EF. There comes a time when any further extension of EF affects only the weakest field of the condenser so that the increase in capacity becomes negligible.

In the case of a static-charged aerial there is no gradual shortening of the lines in this manner to put up the capacity. The earth is always in position and the lines can only expand along it, increasing in length as they go. There is, therefore, no increase in capacity to be expected above what can be measured by a high-frequency charge.—

Yours, etc., H. M. DOWSETT.

Chelmsford,

December 4th.

The ENGINEERS Note Book

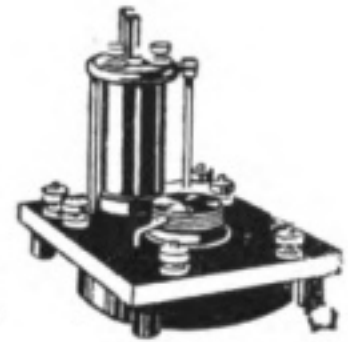

[Under this heading we propose to publish each month communications from our readers dealing with general engineering matters of various kinds in their application to wireless telegraphy, and we would welcome criticisms, remarks and questions relating to the matter published under this heading. We do not hold ourselves responsible for the opinions and statements of our contributors.]

Notes on Oil Engines.

It occasionally happens the man in charge at an out-of-the-way station encounters little difficulties in engine management which could be easily overcome by one having special experience in such matters. These notes are prepared with a view of helping the engineer in charge to attain smooth running and easy manipulation with internal combustion engines. It would be impossible to compress all the special features of various engines into one article, and it is perhaps better to refer to one well-known type, although the remarks will have a general bearing on all types of oil engines. As many of our readers are interested in the "Gardner" engines we will take that make of engine as a basis for our principal remarks.

Fuels.

Many fuels suitable for use with internal combustion engines are of a special nature, while others may be broadly classified together, and can be used in the same engine with little or no modification. To begin with the lighter fuels, generally called spirit by manufacturers, and known under various terms by users, such as petrol, essence, gasoline, benzine, and, in certain parts of the world, naphtha. These may be broadly classified as fuels which will give off inflammable vapours at ordinary temperatures without heating, and engines for use with such fuels are usually constructed with a carburettor, although, in some instances, a fuel feeder and atomiser are used in place of the carburettor. Engines using such fuels

are, comparatively speaking, easy to build, and conform in general principle to that of the ordinary gas engine, except that for general convenience and safety, electrical ignition is usually employed. The next heavier fuel is ordinary petroleum, or kerosine as it is called in many places, and frequently paraffin oil. The specific gravity of this fuel is about 0.8-0.825, and the flash-point anything from about 75° F. up to nearly 200° F., according to the amount of purification it has received. It will be obvious that the more dangerous or volatile types of petroleum are best suited for use in engines, and that highly-refined oils have many of the useful constituents taken from them, from the engine standpoint. Whatever petroleum is used, it is a known fact among manufacturers that it must be heated in order to produce the correct vaporisation, and, furthermore, that the margin of correct heating or of overheating is a remarkably small one. This causes trouble to the user and the manufacturer of an oil engine, especially if the vaporisation of the fuel is effected by the heat of the exhaust, as if the arrangement is such that correct vaporising heat is attained when running at full load there will be insufficient heat units passed to the vaporiser when running light or at a medium load, and conversely if correct at a medium load overheating will take place when the engine is developing all its power. For this reason certain types of the "Gardner" engine have been fitted with vaporising burners, thereby rendering them capable of greater elasticity of load than is possible by any other means.

The essential feature of a good fuel is freedom from tar or similar constituents. There are plenty of suitable and good oils to be obtained in all parts of the world, but unfortunately sellers have so many different names registered as brands that it is difficult to give more definite information than the specific gravity and flash-point.

Next in the list of fuels comes the intermediate or solar oils. These are really heavy kerosine, and occupy a position between the crude oil and the kerosine. Lastly, there is the crude or residual oil, which is a really heavy, practically unrefined article, varying considerably in its density and general composition, according to the locality and the wells from which it is obtained.

In case there are some whose interests are in gas engines we may conclude by mentioning ordinary town's gas, which is of very varying composition and heat value, but is usually capable of giving power in an engine without any serious modification to the valves or ignition. The poorer gases, generally called suction or furnace gas, are developed specially in a small plant by the user, the more frequent fuels being non-tarry anthracite coal or charcoal. In some cases coke is used, and, under suitable conditions, practically any material which will burn and produce gas can be employed to generate power if a suitable gas-producing equipment is installed. It would, however, be futile to endeavour to use a generator made for anthracite coal with the husks of coconuts or clippings from vines: a quite special plant would be necessary for such fuels.

Without entering into any details as to the chemical composition of the gases, we may say that similar generators will serve for anthracite, charcoal or coke, but for the two latter fuels a size larger equipment would be necessary in order to match the power produced from anthracite. Where hard charcoal of good quality can be obtained it is almost an ideal fuel.

Alcohol Fuel.

Contrary to expectations the alcohol engine is not generally classified amongst those using spirit, for which reason its constructional details and system of operation partake more nearly of the oil engine than

of the spirit. Manufacturers of alcohol engines distinguish them under their correct title. It may not be generally known that this fuel is almost ideal for an internal combustion engine; it can be produced cheaply, and the main obstacles to its more extensive use are the possible misapplication of the fuel as an intoxicant, difficulties with excise authorities, and a certain amount of trouble in producing an alcohol that is undrinkable, but unimpaired for engine use. The chief diluent of alcohol is water, and as but little water can be used with advantage in an engine it is advisable to have the spirit as near proof as possible; 90° is quite a satisfactory fuel, and although much weaker spirits can be accommodated they are more troublesome in getting rid of the watery vapour advantageously before use in the cylinder. It is necessary the manufacturer should know if alcohol is to be used as a fuel in the engine, and also have some idea of the quality of the spirit. It is not, however, impossible to construct an engine which will use as an alternative one of the petroleum spirits, although such a compromise does not tend to the best and most economical use of the respective fuels.

Possibly the next useful classification is that of the engines themselves, and in case there are any readers who wish for the information we will briefly describe the various types and their special peculiarities in our next issue.

Melbourne radio station is now transmitting time signals, in accordance with the scheme approved by the International Time Commission of Paris, at the hours of noon and midnight, Melbourne time—which is ten hours ahead of Greenwich mean time. Full particulars of the manner in which these time signals are emitted will be found on pages 557-560 of the "Year Book of Wireless Telegraphy and Telephony" for 1914.

The Marconi Wireless Telegraph Company of America have recently supplied to the United States Army Transport Service three 5 kw. quenched spark gap sets, to be installed on the Government transports *Logan, Sherman and Sheridan*.



*"The operator seemed to be able to get any ship except the one he wanted" (p. 635). **

WITH one foot thrust into an angle to brace himself against the motion of the ship, the twin telephone-receivers about his head, and one hand on the transmitting key, while the other hovered over screws and armatures, the young wireless operator was trying to get into tune. He had had the pitch, but had either lost it again, or else something had gone wrong on the ship from which that single urgent call had come. The pear-shaped incandescent made cavernous shadows under his anxiously-drawn brows; it shone harshly on dials and switchboards, on bells and coils, and milled screws and tubes; and the whole white-painted room now heeled slowly over this way, and then steeved as violently back the other, as the liner rolled to the storm.

The operator seemed to be able to get any ship except the one he wanted. As a keyed-up violin string answers to tension after tension, or as if a shell held to the ear should sing, not one Song of the Sea, but a multitude, so he fluctuated through level after level of the diapason of messages that the installation successively picked up. They were comically various, had the young operator's face not been so ghastly anxious and set. "Merry Christmas . . . the Doric . . . buy Erie Railroads . . . Merry Christmas . . . overland from Marseilles . . . closing price copper . . . Good-night . . . Merry

Christmas"—the night hummed with messages as a telephone exchange hums; and many decks overhead, and many scores of feet above that again, his own antennæ described vast loops and arcs in the wintry sky, and from time to time spoke with a roar that gashed the night.

But of all the confusion of intercourse about him, what followed is a conference that the young wireless operator did *not* hear.

The spirits of the Special Committee on Ethereal Traffic and Right of Way were holding an Extraordinary General Meeting. They were holding it because the nuisance had finally become intolerable. Mortal messages tore great rents through space with such a reckless disregard of the Ethereal Regulations that not a ghost among them was safe. A spectre would be going peacefully about his haunting; there would come one of these radio-telegraphic blasts; and lo, his essence would be shattered into fragments, which could only be reassembled after the hideous racket had passed away.

And by haunting they meant, not merely the old-fashioned terrorising by means of white sheets and clanking fetters, nor yet only the more modern forms of intimidation that are independent of the stroke of midnight and the crowing of the first cock, but also benigner suggestions—their gentle promptings to the poets of the world, their whispered inspirations to its painters, their care for the integrity of letters, their impulses to kindness, their spurs to bravery, and, in

* Reprinted from "Pears' Annual," 1915.

short, any other noble urging that earth-dwellers know, who give their strength and labour for the unprofitable things they believe without ever having seen them.

A venerable spirit with a faint aura of silver beard still clinging about him spoke.

"I think we are agreed something must be done," he said. "Even now one of the most amiable junior ghosts of my acquaintance, on his way with a *motif* to a poor, tired musician, was radio'd into flinders, and though his own essence is not permanently harmed, his inspiration was shocked quite out of him, and may never be recovered again."

"That is so," another bore witness. "I happened to be projecting myself not far from this spot, and saw the whole occurrence—poor fellow, he had no chance whatever to escape. It was one of these 'directive' messages, as they call them, and no ghost of his grade could have stood up for a moment against it."

"But it is the universal messages, sent out equally in all directions, that are the most serious menace to our state," another urged.

"Quite so. We have a chance of getting out of the way of the directive ones, but the others leave us no escape."

"Look! there goes one now," said another suddenly pointing; "luckily it's far enough away."

There was an indignant clamour.

"Vandals!" "Huns!" "Hooligans!" "Shame!"

Then a female spirit spoke. It was known that she owed her condition to a motor accident on earth.

"I remember a name the grosser ones used to have for those who exceeded the speed limit in their motor-cars. They were called road-hogs. In the same way the creators of these disturbances ought to be called ether-hogs."

There was applause at this, which the young wireless operator, still seeking his pitch, mistook for the general radio-commotion about him.

"Yes," the female spirit went on (she had always been a little garrulous under encouragement), "I was afflicted with deafness, and in that horrible instrument they call an Insurance Policy I had to pay an extra premium on that account; dear, dear,

the number of times my heart jumped into my mouth as their cars whizzed by!"

But at this point two attendant spirits, whose office it was, gently, but firmly, "damped" her, that is, merged into her and rarefied her astral coherence; they had heard her story many, many times before. The deliberations continued.

Punitive measures were resolved upon. With that the question arose, of whom were they to make an example?

"Take a survey," said the spirit with the aura silver beard; and a messenger was gone, and immediately came back again, with the tidings that at that very moment a young operator, in an admirably susceptible condition of nerves, was seeking to compass a further outrage.

"Good," said the venerable one, dismissing his minion again. "We have now to decide who shall haunt him. The Chair invites suggestions."

Now the selection of a haunter is always a matter for careful thought. Not every ghost can haunt everybody. Indeed, the superior attenuations have often difficulty in manifesting themselves at all, so that in practice a duller spirit becomes their deputy. Thus it is only the less ghostly ghosts we of earth know, those barely yet weaned from the breast of the world, and that is the weakness of haunting from the ghostly point of view. The perfect message must go through the imperfect channel. The great ghosts may plan, but the coarser ones execute.

But as this is not unknown on earth also, we need hardly dwell on it.

Now the Committee had no more redoubtable haunter in certain respects than it had in the spirit of an old Scottish engineer, who had suffered translation in the middle days of steam. True, they had to watch him rather carefully, for he had more than once been suspected of having earthly hankerings and regrets; but that, a demerit in one sense, meant added haunting-efficacy in another, and no less a spirit than Vanderdecken himself had recommended him for a certain class of seafaring commission. He was bidden to appear, and his errand was explained to him.

"You understand," they said a little severely when all had been made clear. "Your instructions are definite, remember, and you are not to exceed them."

"Ay, ay, sir," said the blunt ghost. "I kened sail, and I kened steam, and I ha' sairved on a cable ship. Ye canna dae better than leave a' tae me." There was the ring, at any rate, of sincere intention in his tone, and they were satisfied.

"Very well," said the presiding spirit. "You know where to find him. Be off."

"Ay, ay, sir; dinna fash yersel'. I'll gi'e the laddie a twisting!"

But at that moment a terrific blast from the Cape Cod station scattered the meeting

try—shove that Merry Christmas fool out—B-a-i-n . . . No, but I think—I say I think—she said so—perhaps she can't transmit any more . . ."

Dot, dash—dot, dash—dot, dash—

Again he was running up and down the gamut, seeking the ship that had given him that flickering uncertain message and then—silence.

A ship on fire—somewhere—

He was almost certain she had said she was on fire—

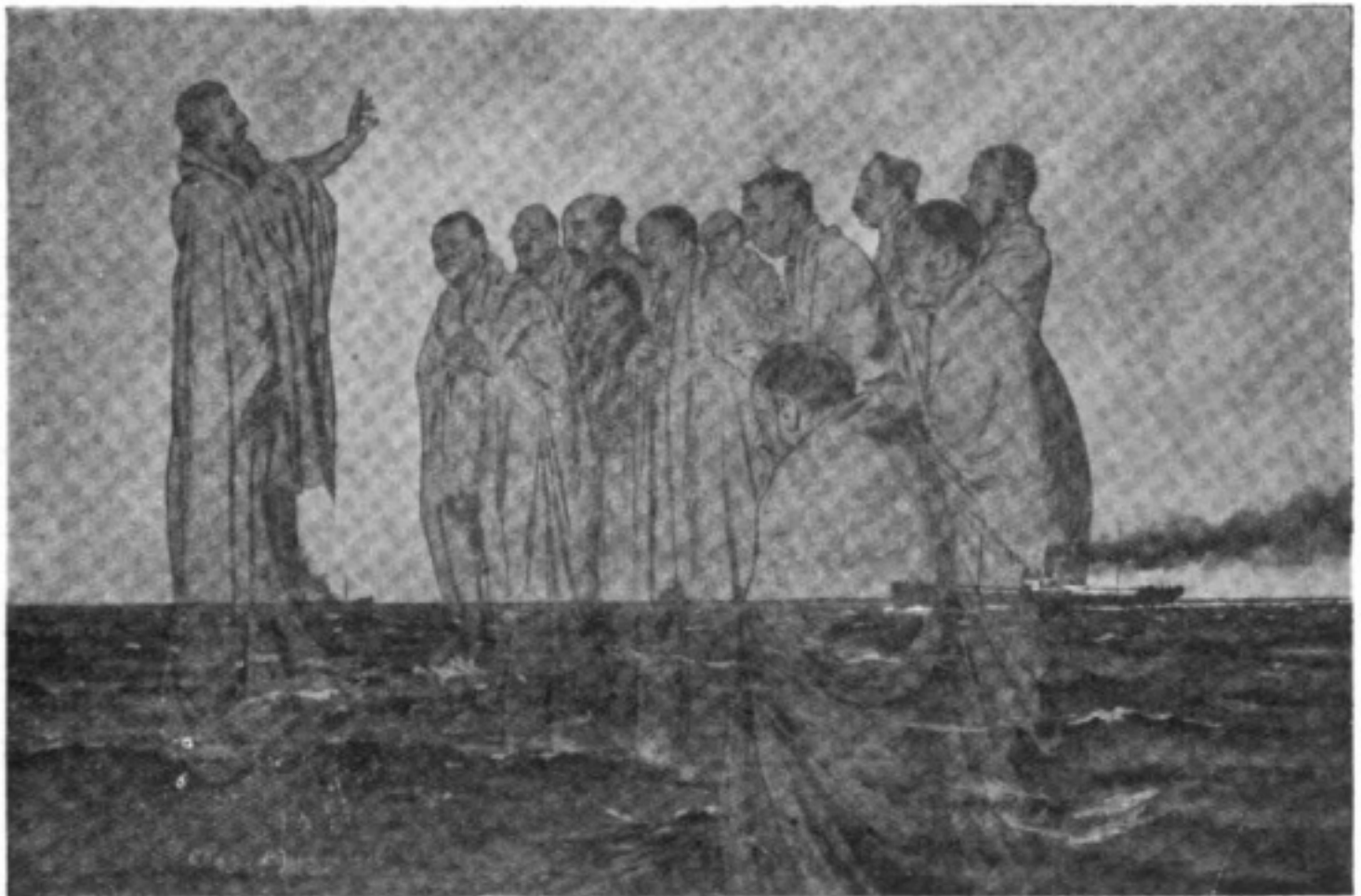

The Spirits of the Special Committee on Ethereal Traffic and Right of Way were holding an extraordinary meeting" (p. 635).

as if it had been blown from the muzzle of a gun.

And you are to understand that the foregoing took no time at all, as earthly time is reckoned.

"Oh, get out of my way, you fool! I want the ship that called me five minutes ago—the *Bainbridge*. Has she called you? . . . Oh, Lord, here's another lunatic—wants to know who's won the prize-fight! Are you the *Bainbridge*? Then buzz off! . . . You there; have you had a call from the *Bainbridge*? Yes, five minutes ago; I think she said she was on fire, but I'm not sure, and I can't get her note again! You

And perhaps she could no longer transmit—

Anyway, half a dozen ships were trying for her now.

It was at this moment, when the whole stormy night throbbled with calls for the *Bainbridge*, that the ghost came to make an example of the young wireless operator for the warning of Ethereal Trespassers at large.

Indeed, the ships were making an abominable racket. The Morse tore from the antennæ through the void, and if a homeless spectre missed one annihilating wave-length he encountered another. They raged. What was the good of their being the Great

Majority, if they were to be bullied by a mortal minority with these devastating devices at its command?

Even as that ghostly avenger, in a state of imminent precipitation, hung about the rocking operating-room, he felt himself racked by disintegrating thrills. The young operator's fingers were on the transmitting key again.

"Can't you get the *Bainbridge*? Oh, try, for God's sake. . . . Are you there? Nothing come through yet? . . . *Doric*. Can't you couple? . . ."

Lurch, heave; crest, trough; a cant to port, an angle of forty-five degrees to starboard; on the vessel drove, with the antennæ high overhead describing those dizzy loops and circles and rending the night with the sputtering Morse.

Dot, dash—dot, dash—dot, dash—

But already that old ghost, who in his day had known sail and steam and had served on a cable ship, had hesitated even on the brink of manifestation. He knew that he was only a low-grade ghost, charged rather than trusted with an errand, and their own evident mistrust of him was not a thing greatly to strengthen his allegiance to them. He began to remember his bones and blood, and his past earthly passion for his job. He had been a fine engineer, abreast of all the knowledge of his day, and what he now saw puzzled him exceedingly.

He told himself all the things that we mere mortals tell ourselves when we want to persuade ourselves that our inclinations and our consciences are one and the same thing

And in the meantime he was peering and prying about a little moving band of wires that passed round two wooden pulleys geared to a sort of clock, with certain coils of wire and a couple of horse-shoe magnets, the whole attached to the telephone clasped about the young ether-hog's head. He was tingling to know what the thing was for.

It was, of course, the detector, the instrument's vital ear.

Then the young man's finger began to tap on the transmitter key again.

"*Doric* . . . Anything yet? . . . You're the *Imperator*? . . . Are you calling the *Bainbridge*?"

Now the ghost, who could not make head or tail of the detector, nevertheless knew

Morse; and though it had not yet occurred to him to squeeze himself in between the operator's ears and the telephone receiver, he read the transmitted message. Also he saw the young man's strained and sweating face. He wanted some ship—the *Bainbridge*; from the corrugations of his brows, a grid in the glare of the incandescent and the glassy set of his eyes, he wanted her badly; and so apparently did those other ships whose mysterious apparatus harrowed the fields of ether with long and short —

Moreover, on board a ship again that wistful old ghost felt himself at home—or would do so could he but grasp the operation of that tapping key, of that air-wire that barked and oscillated overhead, and of that slowly-moving, endless band that passed over the magnets and was attached to the receivers about the young ether-hog's ears.

Whatever they thought of him who had sent him, he *had* been a person of no small account on earth, and a highly-skilled mechanic into the bargain.

Suddenly he found himself in temptation's grip. He didn't want to haunt this young man. If he did, something might go wrong with that unknown instrument, and then they might not get this ship they were hunting through the night.

And if he could only ascertain *why* they wanted her so badly, it would be the simplest thing in space for a ghost to find her.

Then, as he nosed about the detector, it occurred to him to insinuate a portion of his imponderable fabric between the receiver and the young man's ear.

The next moment he had started resiliently back again, as like pole repels like pole of the swinging needle. He was trembling as no radio-message had ever set him trembling yet.

Fire! A ship on fire!—

That was why these friendly young engineers and operators were blowing a lot of silly ghosts to smithereens!—

The *Bainbridge* on fire!

What did all the ghosts of the universe matter if a ship was on fire?

That faithless emissary did not hesitate for an instant. The ghostly Council might cast him out if they liked; he didn't care; they should be hogged till doomsday if, on all the seas of the world, a single ship was on fire! A ship on fire? He had once

seen a ship on fire, and didn't want, even as a ghost, to see another.

Even while you have been reading this he was off to find the *Bainbridge*.

Of course, he hadn't really to go anywhere to find her at all. Low-class and ill-conditioned ghost as he was, he still had that property of ubiquity. An instantaneous double change in his own tension and he was there and back again, with the *Bainbridge's* bearings, her course, and the knowledge that it was still not too late. The operator was listening in an agony into the twin receivers; a thrill of thankfulness passed through the ghost that he had not forgotten the Morse he had learned on the cable-ship. Swiftly he precipitated himself into a point of action on the transmitter key.

Long, short—long, short—long, short—

The operator heard. He started up as if he had been hogged himself. His eyes were staring, his mouth horribly open. What was the matter with his instrument?

Long, short—long, short—long, short—

It was not in the telephone. The young man's eyes fell on his own transmitter key. It was clicking up and down. He read out "*Bainbridge*," and a bearing, and of course his instrument was spelling it out to the others.

Feverishly he grabbed the telephone.

Already the *Doric* was acknowledging. So was the *Imperator*.

He had sent no message—

Yet, though it made him a little sick to think of it, he would let it stand. If one ship was fooled, all would be fooled. At any rate, he did not think he had dreamed that *first* call, that first horrifying call of "*Bainbridge—fire!*"

He sprang to the tube and called up the bridge.

They picked them up from the *Bainbridge's* boats towards the middle of Christmas morning; but that unrepentant old seafaring spectre, returning whence he had come, gave little satisfaction to his superiors. Against all their bullying he was proof; he merely repeated doggedly over and over again, "The laddie's nairves o' steel. Ower and ower again I manifested mysel' tae him, but it made na mair impression on him than if I'd tried to ha'nt Saturn oot o' his Rings. It's my opeenion that being a ghaistie isna what it was. They hae ower mony new-fangled improvements in these days."

But his spectral heart was secretly sad, because he had not been able to make head or tail of the detector.

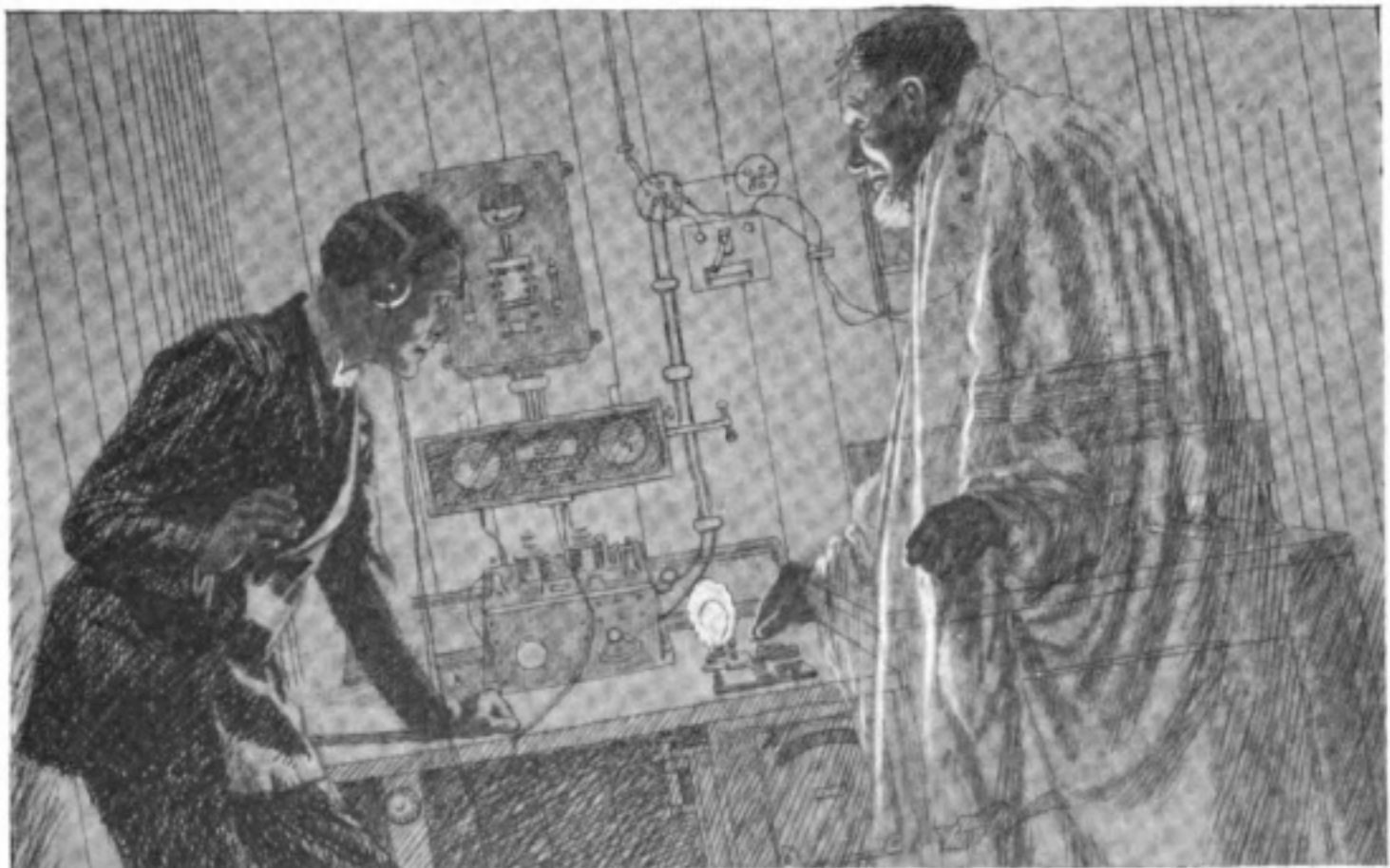

"The young man's eyes fell on his own transmitter key. It was clicking up and down" (p. 639).



NOTES OF THE MONTH

THERE is a paragraph in the Postmaster-General's Report (to which reference is also made on another page) dealing with the new wireless station in Scotland, for the purpose of maintaining communication between towns in the north of England and Scotland. This new station will also be available for communication with ships at sea, and at a subsequent stage it is possible it may be used for the transmission of telegrams to and from places on the Continent. But perhaps the unique feature of the station at this moment is that it will demonstrate the practicability of wireless telegraphy for inland communication and possibly foreshadow developments in this respect in this country and elsewhere.

One other feature of the section in the Postmaster-General's Report dealing with wireless telegraphy is the appreciable increase in the number of amateur stations. During the year 1,111 new licences, covering 1,195 stations, were granted in the United Kingdom, under the Wireless Telegraphy Act, for the purpose of experiments or the reception of time signals, while 90 licences for experimental stations were cancelled or expired. In 41 cases permission to conduct temporary experiments was given by letter. On March 31st last there were in existence 1,963 licences for this purpose, as compared with 942 on March 31st, 1913. The rapid increase in the number of applications is responsible for the introduction of new conditions during the year, with the view to ensure that licences to conduct experiments should only be issued to persons having the necessary scientific qualifications. We understand that an inter-departmental committee has now been appointed to consider the conditions which should be applied to such licences in the future.

Already we have urged in these pages that it is to the interest of wireless telegraphy that amateurs and prospective students should not consider that the practical use of wireless telegraphy is a *sine qua non* of wireless efficiency. If we may speak in the terms of a physician, it seems to us that on this matter the public pulse is erratic, the promulgation of law prohibiting the actual sending of messages has unsettled them, and even if they had not abandoned their plans, interest in them is at a very low ebb. Such an attitude seems to us somewhat unreasonable, inasmuch as none of the leading spirits in the wireless movement have given the remotest evidence that they themselves are slackening in their work. On the contrary, Dr. Fleming continues his lectures on wireless telegraphy at University College, all the colleges and schools devoted to this subject throughout the United Kingdom are holding classes as usual, the Wireless Society of London continues its session unperturbed, as do also most of the societies in the suburbs and counties. It seems to us that the chief delinquents are the beginners, and those who are not sufficiently well acquainted with the whole scope of this great subject and think that when they cannot use their antennæ and detectors they have lost all that is worth while following up.

* * *

Again we urge these despondent ones to take heart of grace. There is a tremendous amount of theory and preliminary practice work which has to be done before even the preliminary stages of efficiency are reached. Everything points to the fact that as soon as this war is concluded the use of wireless telegraphy will increase by leaps and bounds. A forecast of one particular aspect of this work will show this; maritime enterprise—and by enterprise we mean development—

is now, to some degree, checked, but the shipping world is anticipating the capture of much of the German trade. Think what that means as regards the augmentation of our present mercantile fleets.

Then again it will be necessary that all vessels be equipped with wireless telegraphy, and the demand for operators will be greater than it has ever been before. To those men who have prepared themselves to take up this profession, Opportunity will be bountiful, but it will be no good waiting for the day. Success comes to those who have anticipated Success, who go to meet Fortune and do not rest like Micawber of ancient fame "waiting for something to turn up." We hope that what we have said will encourage many who have a taste for maritime life and a leaning to wireless telegraphy to consider well the advantages offered to the wireless operator, and, after consideration, if they decide to take up the work, to take *immediate* steps towards efficiency.

The censorship restrictions on commercial telegrams which were imposed on the outbreak of war have now been relaxed to the extent of permitting the use of code in telegrams exchanged between the United Kingdom, on the one hand, and British Possessions and allied or neutral countries outside Europe, on the other. The latest regulations came into operation on December 14th, and authorised the following codes: A.B.C. Code, 5th edition; Western Union Code; Scott's Code, 10th edition; Lieber's Code; Bentley's Complete Phrase Code (*not* including the separate mining and oil supplements); Broomhall's Imperial Combination Code (*not* including the special rubber edition); Meyer's Atlantic Cotton Code, 39th edition. Neither private supplements nor the numerical equivalents of the phrases in published codes are admissible. It should be specially remembered that groups or series of numbers and similar expressions (*e.g.*, prices of stocks) are not necessarily admissible because they appear in code. If the decode would not have passed the Censors, neither will the coded message be passed.

All messages in code have to be passed by the Censors in the same manner as telegrams in plain language. In the case of wireless telegrams, special arrangements have been

made which will reduce delay to a minimum, but the public can help to expedite the transmission of telegrams by attaching a translation of each coded message to the telegraph form.

So important a factor in business is telegraphy that the annual cost of cabling represents a large portion of the expenditure of a business house. By making use of the wireless service and conducting their transatlantic telegraphic correspondence by means of marconigrams firms can appreciably reduce their telegraph bills—a reduction which, in the case of the North American Continent, is no less than 33½ per cent. of the cost of cabling. For instance, the wireless rates to New York, Montreal, etc., are: Ordinary marconigrams, 8d. per word; deferred, 4d. per word; night letters, 2s. 6d. for 13 words, each additional word 2d.; week-end letters, 4s. for 25 words, each additional word 2d.

The position of electrical engineering in the world's social organisation formed the subject of the inaugural address delivered by Dr. A. H. Railing before the Birmingham section of the Institution of Electrical Engineers. This address marked a departure from the beaten track which was no less welcome than it was striking. Taking the broadest view of human society and its environment from the dawn of history to the present day, Dr. Railing endeavours to trace the progress of civilisation from its rudimentary beginning and to show that electrical engineering, by virtue of its unique characteristics, sets the crown upon the work. It may be asked: In how far has electrical engineering already contributed to human development by, shall we say, improving human progress and efficiency? It could only be a power for civilisation if it increased mankind's efficiency by making better use of matter and of available energy, by increasing the space that could be inhabited by man, by increasing the physical or mental power of each individual, and by increasing the efficiency of human society. That the influence of electrical engineering has been effective in these directions, unconsciously perhaps, has for long been common knowledge.

Maritime Wireless Telegraphy

TO those who harp on the good old days and lament over the decadence of the manhood of England the events of the last few months must come as a series of shocks. Enough heroism and daring has been displayed on the battlefield and on the high seas to show that England's heritage has not passed away and her sons can perform as great feats of daring and courage as did their sires of old. Already reports have appeared in these pages of great deeds done in naval warfare and of death faced bravely for the nation's honour, but on this occasion it is ours to chronicle one of the most remarkable stories of daring crowned with complete success that has yet been placed before the public. We refer to the dash made by Captain Kinneir, of the ss. *Ortega*, through an uncharted strait in order to escape from the clutches of a German cruiser and bring 300 French reservists safely to France.

To preface the actual story of the chase the following details of the *Ortega* should be mentioned. She belongs to the Pacific Steam Navigation Company, and her task was to take the French reservists on board at Valparaiso and convey them home. She is a twin-screw steamer of 7,970 tons burden, and is fitted both with Marconi wireless and with submarine signalling apparatus. As regards her wireless she carries two operators so that a continuous watch is kept on board. This is necessary, as besides being a passenger vessel, she also carries Royal Mails.

She was in the neighbourhood of Punta Arenas at the time war broke out, but it was not till August 7th that the declaration of hostilities had any effect on her procedure; on that date, however, the captain gave instructions to the wireless operators, Murphy and Wellington, that they were not to make unnecessary communications and were not to give to passing vessels any information regarding the steamer.

On August 14th the *Ortega* arrived at Valparaiso, and there she took on board the 300 French reservists. But before this she was aware that German warships were in the neighbourhood and that considerable activity prevailed in wireless communication.

More than once one or the other of the operators overheard communications passing between the station on a German warship and another station, and on every such occasion a report was immediately sent to the captain. Nothing further happened till August 21st, when the *Ortega* left Valparaiso for — (destination unknown), which marked the commencement of one of the most adventurous travels in the records of the sea. The injunction of Captain Kinneir that no wireless messages should be transmitted without his special sanction was faithfully carried out, and the precaution was very necessary. Nearly every day one or another vessel sent wireless "feelers" to try, if possible, to locate the *Ortega*, but as that vessel made no declaration of her whereabouts all such efforts were unsuccessful.

Shortly after the *Ortega* left Antofagasta it was apparent by the number of battleship calls received in the 'phone that they were in a dangerous zone, so that secrecy was of tantamount importance. On September 17th Coronel was left and the vessel headed for Punta Arenas. Nothing happened that day, but on September 19th Murphy, the chief operator, heard someone sending a message in code whose spark sounded like that of a battleship. It was very strong. Towards the end of the message the transmitting station gave "O.K., Mr. —. Dritte Gruppe," this referring presumably to the third group of code letters with which the sender was working. The captain was immediately informed of this German communication, and Murphy was able to reckon by the strength of the signals that the battleship was within twenty miles. Ten minutes later another German code message was received, and the signals were louder still. Three-quarters of an hour later a German battleship was seen bearing down on the *Ortega*. She was a cruiser of the *Dresden* class, with a speed of at least twenty-one knots an hour. Now the *Ortega*, although an excellent ship in its way, was not built for fast seamanship, and was only guaranteed to make something like fourteen knots per hour. Captain Kinneir, under these circumstances, decided on a heroic venture. He called for volun-

teers to assist in stoking his vessel, and received a hearty response. Firemen, engineers and helpers stripped to the waist, set to work with a will and to such good purpose that before long the vessel was urged to make a good eighteen knots. Then the master headed his ship for Nelson's Strait, where he knew the German battleship dare not pass.

The enemy endeavoured to stop his plan, and two shots were fired across the *Ortega's* bows, but they did no harm, and before very long the ship was in Smythe's Channel, leading into Nelson's Strait, where it was impossible for the enemy to get at her.

Although out of reach of shot the ship was far from being out of danger, for Nelson's

sound every yard of the passage, and good seamanship contrived to bring the vessel into Punta Arenas safe and sound and with not even a scratch on any one of her plates.

The adventures of the voyage were not concluded even when Punta Arenas was reached, but these were of a friendly kind; although coming as they did after her former experiences, they must have been a little trying to the ship's company's nerves.

After leaving Punta Arenas, and when she had made two days' voyage, she was held up by a battleship on September 25th. This was at about eight o'clock in the morning, when in these regions the sun had not yet risen. A little later and the battleship's searchlights were turned full on her, and then the

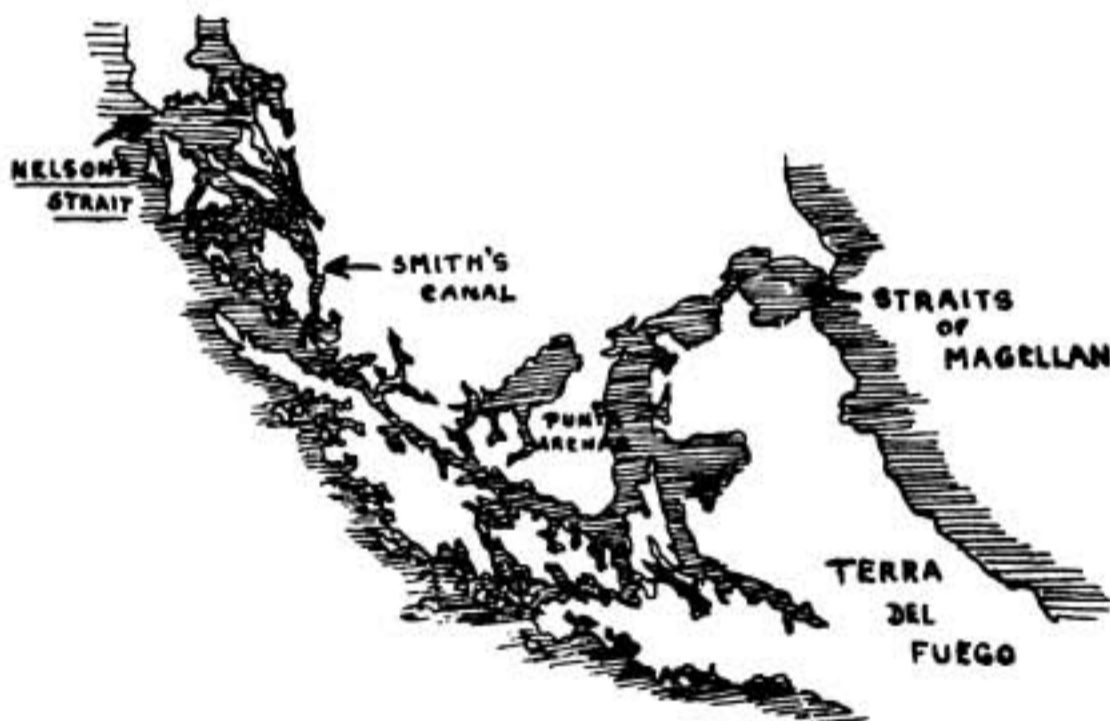

Sketch Map of the route of the *Ortega* through the Nelson's Strait to Punta Arenas.

Strait is entirely uncharted and the narrow, tortuous passage constitutes a veritable nightmare for navigators. It bristles with reefs and pinnacles, is swept by fierce currents and tide-rips, and with the cliffs rising sheer from the water on either side affords no chance of anchorage. The testimony of Mr. O'Sullivan Beare, the British Consul at Rio de Janeiro, is sufficient to show the nature of the passage. Once he made his way through these hazardous waters in a small sealing schooner and found the adventure perilous enough. What, then, must it have been for a ship of nearly 8,000 tons? The master of the *Ortega*, however, managed to make his way safely, employing the expedient of sending boats ahead to

name of the aggressor could be distinguished. She was H.M.S. *Glasgow*, and the *Ortega* was safe in her charge. A boat was sent off from the *Glasgow* and visited the *Ortega*. Eventually it happened that some messages were required to be sent from the liner to the battleship; this was done, but in the midst of the sending of the messages another battleship broke in and ordered the *Ortega* to cease transmitting. Before the order could be complied with another more peremptory message was received to the effect that if the *Ortega* did not cease sending immediately the aggressive battleship would sink her. In these circumstances it was policy to comply with the request, and soon the interrupter came into view on the starboard bow. She

was a British vessel, and when she found out who the "enemy" was she resumed her way, and the *Ortega* continued her journey also.

Only one other incident occurred during the rest of the voyage, and that was when nearing Santos a battleship was sighted, and with a wisdom born of experience the *Ortega* turned back to anchorage till the danger was past. Finally, on October 20th, she came to port at Liverpool.

Already at Rio de Janeiro, Captain Kinneir had made a statement to the British Consul-General, who forwarded his reply to the Foreign Office. As a result the Pacific Steam Navigation Company received the following letter:—

Admiralty, Nov. 7th, 1914.

To the Secretary,

Pacific Steam Navigation Co., Ltd.,

31, St. James Street, Liverpool.

SIR,—I am commanded by My Lords Commissioners of the Admiralty to request that you will represent to the directors of the Pacific Steam Navigation Company

that they have received through the Foreign Office a copy of a dispatch from his Majesty's Consul-General at Rio de Janeiro regarding the escape of the R.M.S. *Ortega* during a recent voyage from Valparaiso to Rio de Janeiro from pursuit by a German cruiser.

My Lords desire to place on record their appreciation of the courageous conduct of the master, Captain Douglas R. Kinneir, in throwing off his pursuer by successfully navigating the uncharted and dangerous passage of Nelson's Strait.

I am, etc.,
(Signed) W. G. GREENE.

The French Government have also acknowledged the courage which saved them 300 of their reservists, and have presented Captain Kinneir with a gold watch in token of their appreciation. But to our thinking the fame of such an adventure is worth the peril and the struggle beyond any consequent reward.

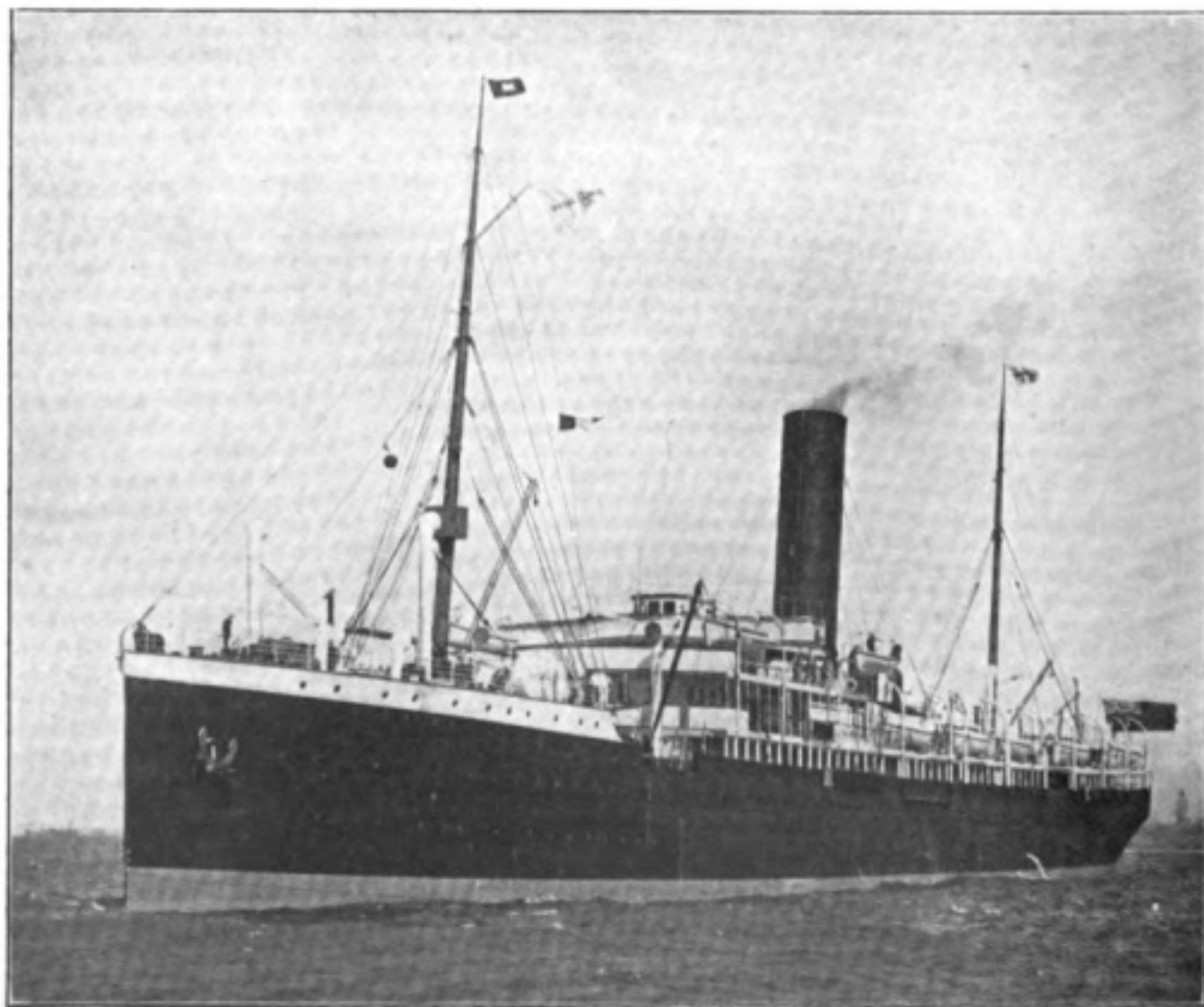

SS. Ortega.

Among the Operators

Mr. G. E. Baxter, the manager of the Bolinas Station (California), has sent an open letter to his friends in the employ of the American Marconi Company, containing some interesting sidelights on social life at Bolinas. The following extracts are typical of the tone of the letter :

" Mr. Haraden Pratt, of the Engineering Force, is promoting a club called the ' Early Risers,' or the ' Perhaps We Will ' Association. His idea is to benefit the health and self-will of the camp by getting up at 5.30 a.m. daily, and walking many miles into the hills, returning for breakfast. At the present writing, he has captured one follower in the person of ' Slim ' Bartlett, who has been absent the last two mornings, but who shows signs of weakening.

" Every day finds some of the boys on the tennis court, vieing with each other in long-distance drives, as a rule. On Sunday, however, the big tournament is pulled off between the Operating and Engineering forces. We don't like to talk about ourselves, but we are thinking of annexing the cognomen ' Champions.' After the tennis match, a few take a dip in the surf, which is reported to be ' not a bit cold,' although some of the more timid ones regard this with scepticism.

" Pennies are being laid away for the purchase of a sun dial, or an hour glass, which is to be presented to ' Red ' Roy. Very often he loses all track of time, and, consequently, does mysterious, unheard-of things, such as arising an hour before breakfast, or reporting for duty a half hour early."

* * *

That wireless operators do not always have to go through a wreck at sea to add their names to the list of heroes has been demonstrated by the experience of H. W. Everett, operator in charge on board the Mexican steamer *Korrigan III*, stationed at Santa

Rosalia, Mexico. His adventures are recorded in a letter to the American Marconi Company on October 30th, from which the following is quoted :

" On the night of October 6th, about fifty Yaqui soldiers in charge of a Mexican officer tried to capture the *Korrigan III* as we were leaving Santa Rosalia for a northern port to load firewood.

" The officer in charge told the Captain to stop and then without further warning started firing on us. The *Korrigan III* was riddled with bullets, four of which passed through the wireless room. I was in the room at the time, but was unhurt ; neither was there any harm done to the apparatus. The soldiers were at a distance of 50 ft., so you can understand the force which a Mauser rifle would have at that distance. Bullets passed through iron plates as if they were made of paper.

" The Major who was in charge of the forces here tried to stop them and was killed. From then up until the present time there has been no order here. Stores have been abandoned by their store-keepers. Four of the soldiers the other day saw a man coming from the mines and promptly shot him.

" Most of the Mexican employees are hidden in the interior, and what few of the Europeans who were here are leaving. The other night one of the revolutionary leaders came on board and ordered me to send a 150 word message for him to La Paz for nothing. He had a soldier with him armed with a rifle, and he himself occasionally put his hand on the butt of his pistol as a reminder for me to get busy."

Everett states that he has been advised by a commander of an American vessel to get out of Mexico, but he prefers to stick to his post and render service to his employers, the Compagnie du Boleo, at a time when good means of communication is so much desired.

CARTOON OF THE MONTH



The Wireless Spy

Wireless Telegraphy in the War.

A résumé of the work which is being accomplished both on land and sea.

ONE event has taken place during the past month which, when the history of the war comes to be written, will stand out as a decisive landmark in the struggle and of wireless. The striking victory off the Falkland Islands has established in the popular mind, as nothing else has done, the overwhelming supremacy of the British Fleet. With hardly a word of comment in the Press or a remark from the public, a situation was developing in the South Atlantic which was to end in the defeat and dispersion of the German squadron in the Pacific, the disappearance of the last serious menace to the freedom of our distant maritime commerce, and a visible tightening in the siege of German commerce. The historian of the war will be able to show us in its true perspective the part played by wireless telegraphy in bringing about one of the most striking achievements of the past four months. He will also be able to show (what we can but dimly realise at present) that in the new conditions of warfare on a world-wide theatre, when the possibility of a decision by means of a crushing naval offensive seems to have vanished, wireless telegraphy has greatly reinforced this country's enhanced power of slow pressure and her ability to penalise the enemy's commerce.

The report of an interview which General Liman von Sanders had with a representative of a Hungarian paper on December 12th lends emphasis to this point. The General is chief of the German Mission to Turkey, and he was explaining to the interviewer how difficult was the situation in Egypt—for the Turks—and he added:—

"The wireless telegraphy of the British keeps them constantly in communication with their Fleet and they can watch every step of the Turks."

Comment on this statement is surely unnecessary.

It is not difficult to estimate the serious loss which Germany has suffered through the destruction of her wireless chain. If it were,

the memorandum on events in the German colonies during the first three months of the war would greatly lighten the task. This document is published by the German Colonial Office, and it illustrates very remarkably the complete interruption of German communications. The introduction says:—

"Soon after the outbreak of war all communication with the colonies by sea was broken, and all German transmarine cables were cut by the English, so that even telegraphic communication with the whole of our colonies was rendered impossible. The only remaining means of communication was wireless telegraphy, but the first warlike measures of the English were directed to depriving us of this means also. On August 12th fell the wireless station Yap, and soon afterwards the station Naru. Tasigata (Samoa) fell on August 29th and Bitapaka, in New Pomerania, on September 12th. During the night of August 24th the great station of Kamina, in Togo, had to be destroyed by us in order to prevent its capture. So vanished all possibility of further direct communication with the African protectorates which hitherto had been able to communicate *via* Kamina. As a matter of fact, there had from the very beginning been a disturbance of the system, which prevented us from receiving any reports from the Governor of East Africa after the outbreak of war. And so the material which we have here collected and which, in the main, reached Berlin by circuitous routes and very late, and is mostly derived from private letters or from enemy newspapers, must necessarily remain fragmentary, and some of it must also be regarded as untrustworthy."

The colonies are then taken in order, beginning with East Africa. Reading on, we find that Togo is described as having been in the most unfavourable situation of all the German possessions in Africa. The Acting Governor, Major von Doering, had

D

to devote all his efforts to maintaining the wireless station at Kamina, and moved all his forces there on August 8th, after Great Britain had refused the proposal that Togo should be declared neutral. On August 25th Togo had to be surrendered unconditionally. A German planter has supplied the Colonial Office with some account of what happened previously. After the British occupation of Lome the Germans destroyed the wireless station at Togblekofe and the railway bridge over the River Sio, but the British restored the bridge. The natives gave the Germans false reports about the movements of the enemy. There were engagements on August 15th and August 22nd. On August 24th the Germans destroyed the wireless station at Kamina, and then surrendered. The partition of Togo between the French and British is described.

With regard to German South-West Africa it is remarked that the last German wireless message was sent on August 18th, when the Governor reported that there had been no attack on the colony up to that date.

The German reports with regard to the South Sea colonies are of little interest. On August 12th an Australian squadron appeared and demanded to be informed of the position of the wireless stations. The information was refused, and the fleet departed, but returned on September 10th. The rest of the news is taken from Australian newspapers. The Governor of Samoa held a council of war on August 5th, and it was decided that in case of an attack the colony must be surrendered unconditionally. The German Colonial Office learnt from America on September 26th that the British had occupied Apia on August 29th.

Behind the Scenes.

Of the actual work of wireless with the Army in the field we have still no authentic details, and we doubt very much whether any will be made known until after the war is over. This is as it should be. From time to time we obtain a glimpse of what is being done, as, for example, in the interesting account by a *Daily Mail* correspondent of the British bombardment of Zeebrugge, who said: "it is believed that the naval gunners got their range by wireless from the coast, for their shots proved extremely accurate in a very short while." But by far the most

interesting reference to wireless at the front occurred in the detailed and extremely valuable account of the King's week in France contributed by the unofficial "Eye-Witness" on December 8th, who for once enabled us to peep at some portions of the work being carried out by the General and Administrative Staffs at General Headquarters. "Eye-Witness," describing the King's tour of some of the offices where what may be called the brain work, the control and the maintenance of the Army are carried out, said:—

"After an inspection of some of the motor-cyclist dispatch riders attached to the headquarters of the Army Signal Units, which body of men, as Sir John French pointed out, had performed most arduous and valuable duties during the whole campaign, his Majesty visited the Army Signal Headquarter Office. This spot is really the nerve-centre of the Army in the field, for into it radiate the tentacles along which flash messages from every part of the field of operations, from the base and from England. By telegraph, air-line and cable, by wireless, by telephone, and by motor-cyclist does the information reach this office, the total number of messages of all natures from all quarters handled in one day averaging about 3,000, of which the majority are far longer than the average telegram of peace time. The



General Lieutenant Freiherr V. Lynker, the first General Inspector of the Lines of Communication.

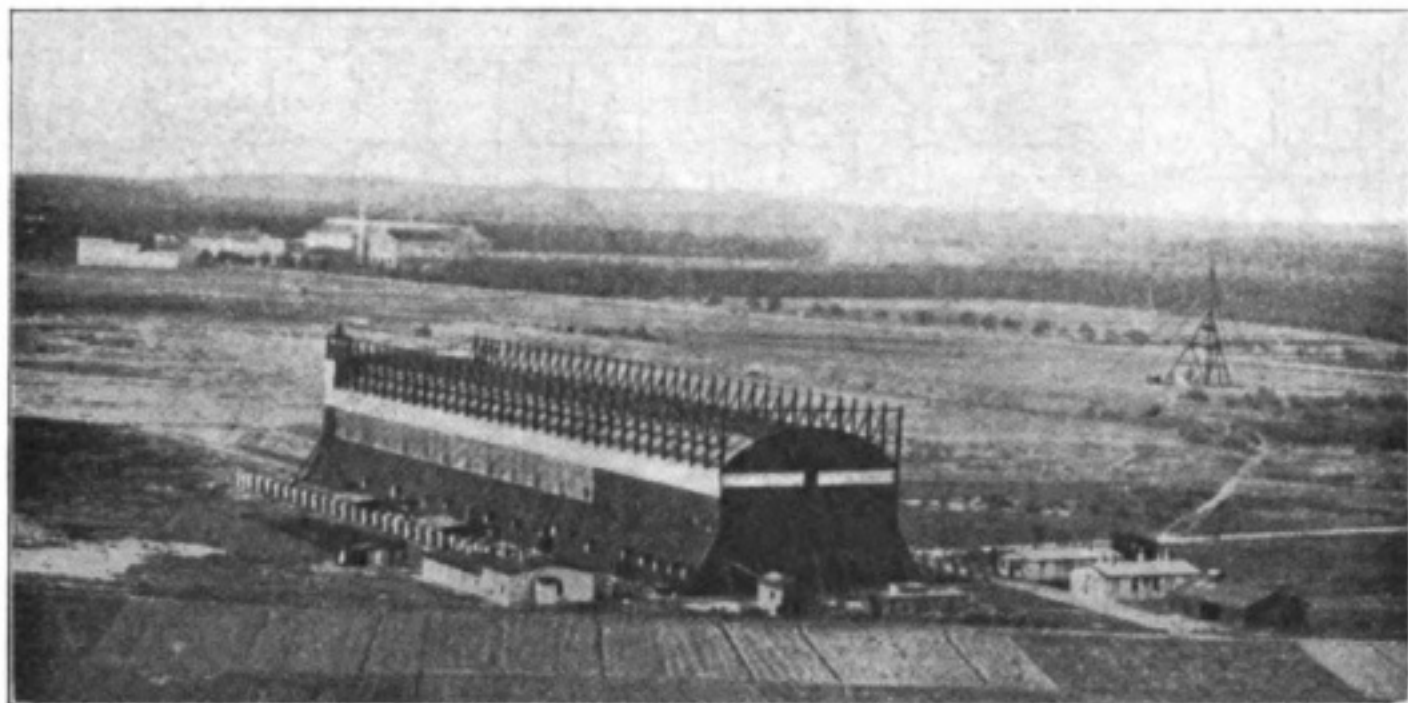

German Airship Snea and Wireless Station (on right).

whole building pulsed with the tick of machines of different kinds. In one room the King watched the operators busily perforating long strips of paper with the noisy 'puncher' so that the messages could be sent off by the Wheatstone high-speed apparatus. In another he saw several of these machines, which can send at any speed up to a maximum of 600 words a minute, and some duplex machines, by which means messages can be sent along the wires in both directions at the same time."

Of the "perfection" of the German "military machine," which was to strike terror into the heart of any nation that declined to submit to its action, we have heard a good deal. But this very widely advertised monster stands in danger of being overrated. Wireless forms a small detail of the German military organisation, but a very significant detail. It has been applied to aircraft, and every effort has been put forth to ensure satisfactory results. Whilst admitting that, we cannot go the length of an aeronautical contemporary who declares that "the aerial wireless service of Germany is at once the most complete and efficient in the world—if, indeed, it have its counterpart in any other country." When fuller details of the achievements of the British and French "aerial wireless" services are known, we think our contemporary will have to considerably modify its opinion. The situation in regard to wireless on aircraft

was discussed in the November, 1914, issue of *THE WIRELESS WORLD*, and we have at present nothing to add on the subject. It may be of interest, however, to append a few notes concerning the arrangements of the Germans in this respect. It will be seen from the map on page 650 that wireless stations are provided at all the airship bases established on the German frontiers. Very few of these stations are included in the official lists or in the "Year Book of Wireless Telegraphy and Telephony," and we conclude from this omission that the places shown on the map were chosen as bases for portable or fixed stations to be erected on the outbreak of war. Incidentally, this is further evidence of Germany's preparedness for the war.

What a Zeppelin properly equipped with a wireless transmitter and receiver can accomplish may be gauged from the fact that in 1913, during the Upper Rhine reliability trials, the old "Viktoria Luise," which took part in the trials, remained throughout their duration in constant wireless communication with the base at Frankfurt over distances of 120 miles, and with other stations up to 200 miles, so that a regular wireless service for her passengers was maintained.

The wireless equipment of the newer naval and military craft is far more powerful. The aerials consist of a 3 mm. phosphor-bronze wire, unwound to the required length (the full length being 750 feet) from a spool,

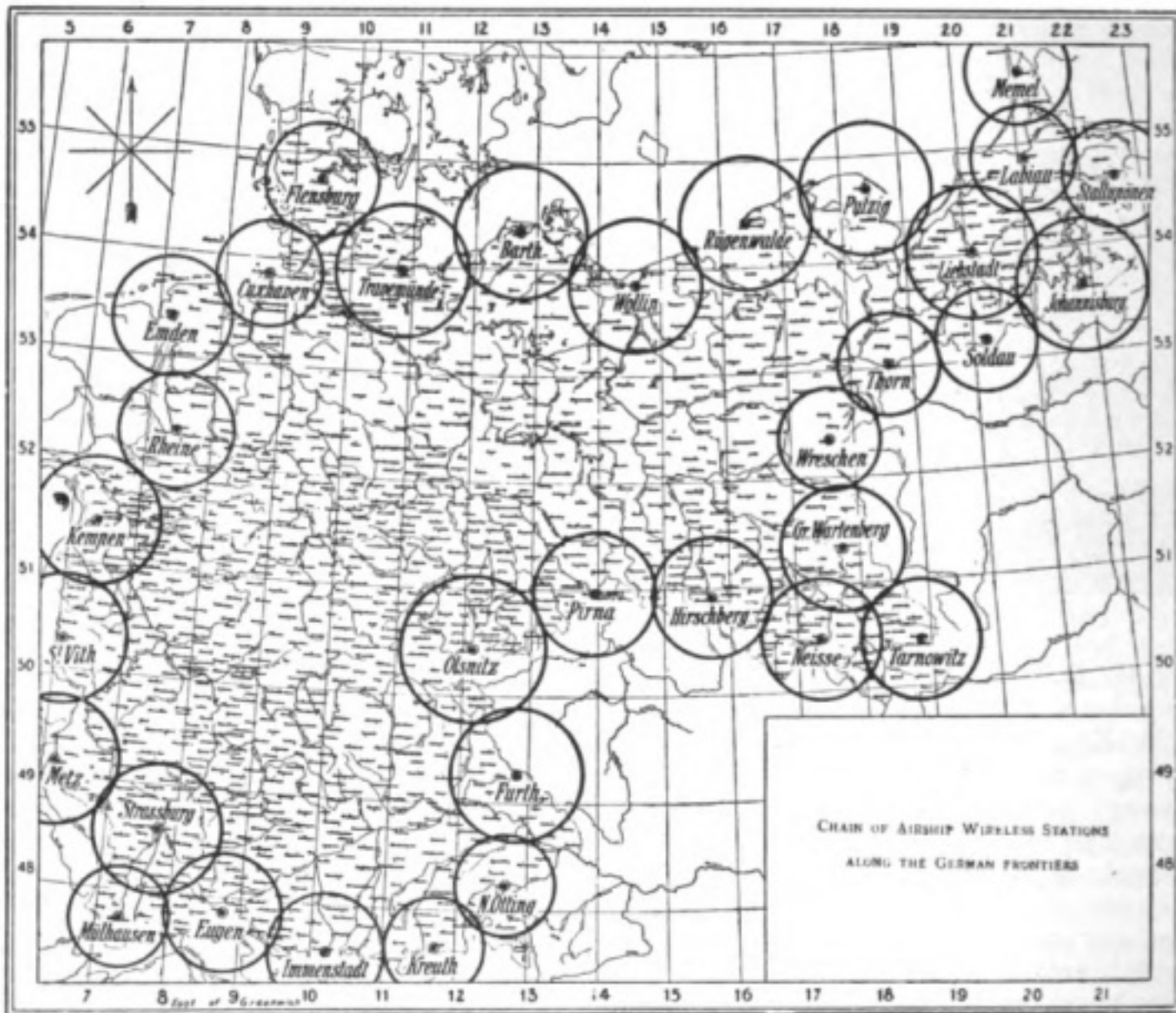

and floating freely in the air when the airship is aloft. The apparatus itself is extremely compact, and derives the necessary power from a small dynamo driven off the engines. It weighs complete just 150 lb., or, including the dynamo, 270 lb.; has a minimum range of 120 miles and can encompass wave-lengths varying between 300 and 1,200 metres. It is claimed that the danger from sparks during the process of transmission has been wholly eliminated and that the theories which ascribed to this cause the burning of the naval Zeppelin at Johannisthal have been proved to be devoid of the slightest foundation.

Every large aerodrome in Germany, both military and civilian, has its wireless station, some of which, such as those at Johannisthal, Cologne, Friedrichshafen, Frankfurt (belonging to the "Delag"), and at Mannheim (property of the Schütte-Lanz) are very powerful. But in addition, the construction

was begun some time ago of a series of wireless stations forming a ring right round the German frontiers. These stations are set out in detail in the accompanying map. Their purpose is twofold: first, to enable German airships to remain in constant wireless touch with a German base during their expeditions; and, secondly, to provide them with what may be described as a wireless compass, enabling them to fix their position when out of sight of land with quite a fair degree of accuracy as a result of wireless signals from one or more of these wireless stations.

German Influence in South America.

Our reference last month to the German influence upon the wireless situation in South America has aroused widespread interest, and a correspondent to the *Morning*

Post writing on the subject gave the following supplementary details:—

“Five years ago there were only about 50 wireless stations in the whole of South and Central America. To-day Argentina alone has more than 120 stations, and upwards of 30 new ones are projected. Brazil has nearly 100 stations, Chile about 44, Uruguay 24, and Paraguay 10. Bolivia has put in hand the erection of seven stations, and with her central situation and extremely high natural elevations will have a vast range of calls. Peru has been in communication with her interior districts for several years past by wireless telegraphy, the most powerful of her dozen stations being those at San Cristobal, near Lima, and at Iquitos. Ecuador proposes to establish a station in the Galapagos Islands, as well as at Guayaquil, Quito, Esmeraldas, and other places. In Colombia stations are already operating at Cartagena and Santa Marta, and others are to be installed at Bogota, Buenaventura and Medellin.”

In the course of a lengthy statement made in the House of Commons by Mr.

Charles Roberts, on November 25th, the attitude of the Governments of the Republics of Colombia and Ecuador in regard to neutrality were made clear.

In the case of Colombia, the principal cause of complaint has reference to the high-power wireless telegraph station at Cartagena. Mr. Bowle, his Majesty's Chargé d'Affaires at Bogota, has repeatedly endeavoured, since the outbreak of war, to induce the Colombian Government either to remove the German staff from the station and to institute strict control to prevent the passage of messages of an unneutral nature, or, alternatively, to close the station completely. He has also made every effort to secure the adoption of measures by the Colombian Government which will effectively prevent the use of wireless installations by belligerent merchant ships lying in Colombian ports.

As the reports received from Mr. Bowle left it in doubt whether the steps taken by the Colombian Government, in consequence of his urgent and repeated representations, were of an effective nature, Captain Gaunt, Naval Attaché to his Majesty's Embassy at

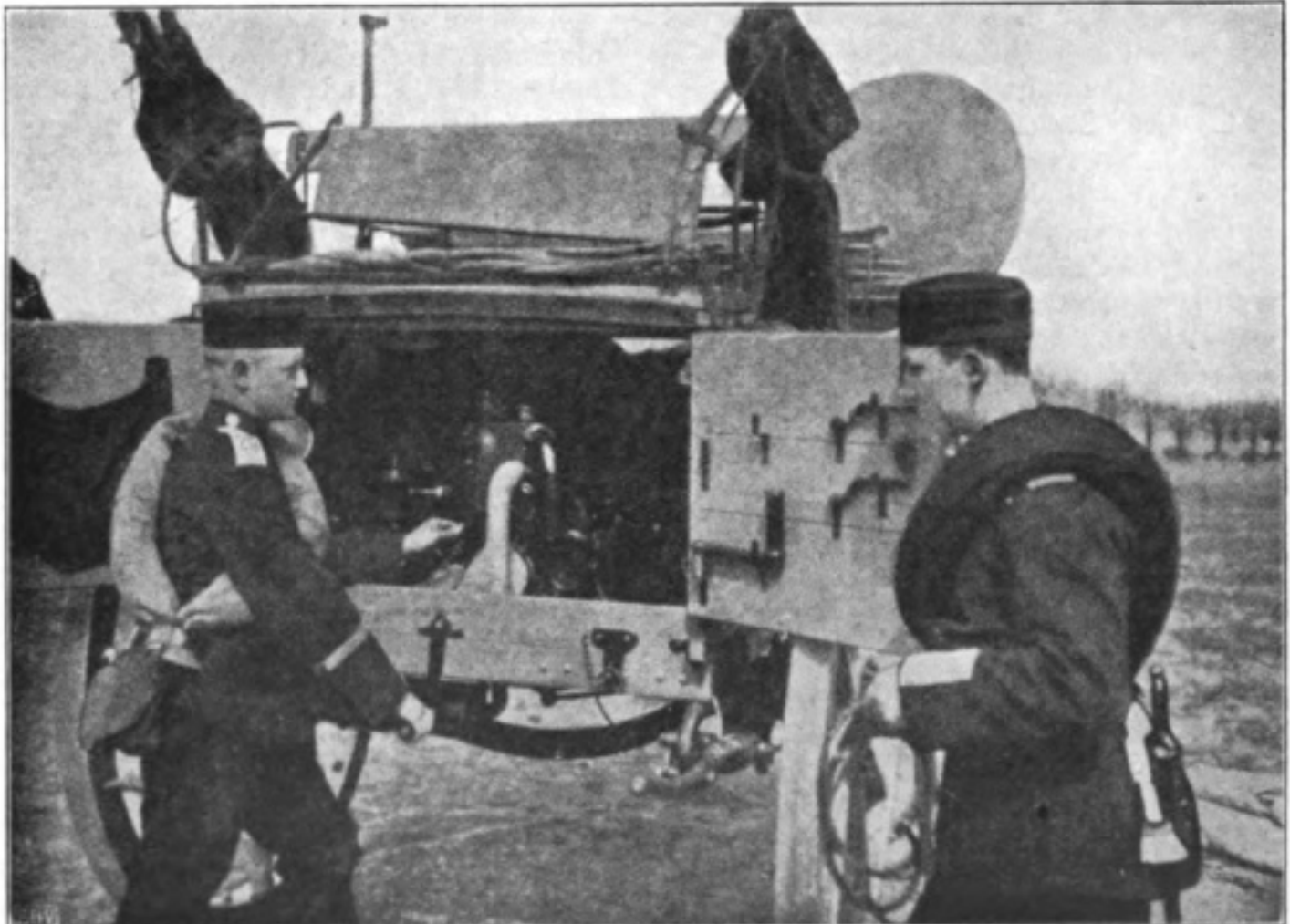

Portable Wireless Telegraph Station with the German Army.

Washington, was sent to Colombia for the purpose of ascertaining the true position. Captain Gaunt reported, under date of September 28th, that the wireless station at Cartagena was working nominally under censorship, but was in reality entirely subject to German influence, of which he considered it very important to obtain the removal. He also reported, under date of October 8th, that German steamers in Colombian ports, though their wireless installations had ostensibly been dismantled, had been continuing to use them with the attachment of a muffler.

It appeared to his Majesty's Government that further representations to the Colombian Government, through his Majesty's Chargé d'Affaires at Bogota, were unlikely to be of any avail, and they therefore decided to appeal, in conjunction with the French Government, to the good offices of the United States Government, asking them to use their influence at Bogota to secure a more correct observance of the obligations of Colombian neutrality, and stating that, in the event of Colombia continuing in her existing attitude, the Allied Governments might be obliged in self-defence to take such measures as they deemed necessary for the protection of their interests.

A similar communication was also made to the United States Government in respect of Ecuador, the grounds in this case being:—

1. That the Ecuadorean Minister for Foreign Affairs had himself informed Mr. Jerome, his Majesty's Chargé d'Affaires at Quito, and his French colleague, on October 4th, that German warships had converted the Galapagos Islands, belonging to Ecuador, into a naval base; and

2. That the Ecuadorean Government had failed to comply with the request of the British and French Legations that proper control should be exercised over the wireless station at Guayaquil to prevent its use as an intelligence centre for belligerents.

Mr. Jerome and his French colleague were both of opinion that further diplomatic protests to the Ecuadorean Government would be useless, and his Majesty's Government, not being prepared to acquiesce in the disregard of Ecuador's obligations of neutrality, judged it expedient to refer the matter to the United States Government, as explained above. The latter have consented

to make a communication to the two South American Governments, but at the time of writing the result of their action was not known.

The Note addressed to the United States Government by his Majesty's Ambassador at Washington contained no assertion of the nature mentioned in the question.

On December 5th the *Daily Telegraph* published a letter from the Ecuador Consul at Southampton, who said: "If German warships had installed wireless stations in deserted districts of the coasts of Ecuador or Colombia, there is not necessarily a break of neutrality on the part of their respective Governments, but it constitutes an abuse of power by the warships and a serious offence to the inviolability of Ecuadorean or Colombian territory. In short, neutrality has not been broken by Colombia and Ecuador, but by those who have installed the wireless stations. . . . When the British and French Governments communicated to Ecuador and Colombia their fears with regard to the wireless stations, both Governments offered to investigate the matter, and I am perfectly sure that those Governments have fulfilled their promises."

On December 8th a telegram from Bogota, Colombia, announced that the Minister for Foreign Affairs had given orders for the removal of the high-power wireless telegraph station at Cartagena

An Operator's Letter.

Mr. Maurice Scott, a wireless operator on board the auxiliary cruiser *Otranto*, gives the following account of the Chilian battle, in which the *Good Hope* and *Monmouth* were sunk, in a letter to his relatives in Belfast:—

We sighted smoke about 4 p.m., and having heard loud German wireless signals, knew it was the enemy. Our squadron formed into battle array, and it was a fine sight to see our ships, each flying two white ensigns and the Union Jack, going into action. The enemy had two armoured cruisers, a bigger and much superior type to the *Good Hope*, and two light cruisers. With their modern guns, etc., it has been calculated that their firing must have been ten to one. Our guns were so small as to be out of range, and the *Glasgow* ran huge risks to try and bring her small guns into action. Firing began at 7.15, and after ten minutes the admiral signalled for our skipper to go, saying it was the best thing we could do. We were a big target, and gave them an easy rangefinder, and it was, of course, useless our going close in: we should have gone under with the first shell.

They fell all around us those first ten minutes, and it was a miracle we were not hit. Our three put up a splendid fight, and it nearly broke the captain's heart, and, in fact, everyone on board, to see them beaten and being unable to do a thing. Both the *Good Hope* and *Monmouth* took fire, and we fear both are lost with all hands, and the *Glasgow* had three holes put in her, but escaped with four wounded.

It lasted fifty minutes, and no one can possibly imagine who has not seen it how awesome and ghastly it was. Sir Christopher Cradock was our admiral, and I shall never cease to respect the way he went into action. He was a Yorkshireman. The merchant cruisers were, of course, not meant to go into battles like that, but it was awful to have to run away from the others and leave them to it. I would love to be in the scrap when the *Scharnhorst*, *Gneisenau*, *Leipzig*, and *Dresden* are sunk. It's an awful thing to wish from the humane point of view, but we would like to get our own back for the *Good Hope* and *Monmouth*.

Amateurs and Wireless.

A court-martial was held at Hull on December 6th on Archibald George Cocks, of the Bungalow Aerodrome, Filey, who was charged with having wireless apparatus in his possession without permission.

With reference to this trial, we have received the following communication from Mr. J. B. Tucker, hon. sec. of the Birmingham Wireless Association:—

To the Editor, WIRELESS WORLD.

SIR,—I should be glad if you would publish this letter in your next issue, as I am anxious that it should serve the purpose of dispelling any bad impression which might be caused among this gentleman's friends through seeing only the average newspaper reports, as well as acting as a warning to any amateurs who may still have wireless apparatus in their possession.

The President of the Court stated:—

"(a) That no charge of communication or attempted communication with the enemy was being brought forward.

"(b) That Mr. Cocks's character was not doubted, and that no evidence as to the same need be brought."

The G.P.O. witness read a letter to the Court from the Postmaster-General stating that as the accused was a British subject he had no desire to press the case.

The same witness also stated that the portable set in question was only capable when connected with the necessary aerial and in its present condition of transmitting

for one mile. The necessary aerial and station in general were, of course, dismantled in the ordinary way by the G.P.O. people at an earlier date, when all amateur wireless stations were similarly treated. The station, therefore, was "reasonably incapable of being worked."

The President also stated that no importance was attached to the Morse code charts, etc., found in the premises.

Mr. Cocks only committed a small technical offence. Nothing was secret, and he had had no correspondence with the G.P.O. regarding his licence for this actual set.

The sentence was six months' imprisonment, four months of which was remitted, owing to his already having been seven weeks in custody, thus leaving two months to be served. The unwarrantable severity of this sentence is obvious.

A short time ago a German was sentenced to three months' detention without hard labour for having a wireless station on the Essex coast. The full injustice of Mr. Cocks's sentence is apparent also from the following facts. The German referred to was an unregistered alien, and his apparatus was connected to the mains and was capable of sending over 100 miles.

Mr. Cocks has held a licence for wireless telegraphy for several years.

The Defence of the Realm Act was passed on October 16th. The house was visited by the military on October 18th. Mr. Cocks was arrested on the 21st, and the particulars of the Act were posted in Filey on the 23rd, several days after the actual arrest.

Could anything be more unjust for a small technical offence? I might add that the matter is not being allowed to drop.

In view of the above facts, the position is full of danger for every amateur throughout the country, especially as I personally could give several instances where the Post Office authorities have, with their own knowledge, left such things as detectors, variable condensers—in fact, enough apparatus to make up several portable sets. The Postmaster-General's letter was evidently totally ignored, and unless something definite can be done with regard to this matter, then, in justice to Mr. Cocks, surely by now most amateurs in this country ought to be in prison.

Sidelights.

Here is a story which a party of Englishmen travelling from the Far East to London had to tell of Captain von Müller, late of the *Emden*. One night, while the British cruiser *Yarmouth* was escorting a merchant ship out of Singapore, the wireless operator received calls from a ship some distance away. He answered them, and to his surprise found that he was in communication with the German cruiser *Emden*. Thus spake the wireless :—



A correspondent writes to the *Bystander* (from which this illustration is reproduced) that on his homeward voyage his steward each morning brought him the wireless news, and that the following is drawn from life.

“*Mornin’, Sir, the Alleys is at Yppers an’ yer bath’s ready.*”

“Captain von Müller and the ward-room mess send their compliments, and would be obliged if the *Yarmouth* would let them have the result of the inter-regimental Rugby football match.”

The result of the match, which had taken place that afternoon, was duly given, together with an intimation that it would not be very long before British sportsmen in the East had the pleasure of the captain’s company at all field and track events.

* * *

A Dutch official report states that it has been proved that the German merchant

steamer *Preussen*—in the harbour of Sabang (Dutch East Indies)—although not registered to carry “wireless,” had installed inside her rigging concealed antennæ, which were connected with a secret receiver in an officer’s cabin. The commander of the *Preussen* was put under arrest, and the ship was at once seized, the installation being a violation of the law of the use of radio-telegraphy by belligerents. The wireless instruments appear to have been installed only a few days before the discovery.

* * *

An Order in Council containing the new Regulations under the Defence of the Realm (Consolidation) Act has been issued.

Previous orders have been revoked, and it is stated that the ordinary avocations of life, and the enjoyment of property, will be interfered with as little as may be permitted by the exigencies of the measures required to be taken for securing the public safety and the defence of the Realm, and ordinary civil offences will be dealt with by the Civil tribunals in the ordinary course of law.

In addition to the prohibitions against the possession, use, or sale of wireless apparatus, it is provided that no person shall, without lawful authority, be in possession of any searchlight, semaphore, or other apparatus intended for signalling, or display, erect, or use any signal. Any person who knows that some other person is acting in contravention of any provision of these regulations must inform the competent naval or military authority of the fact. As to the trial and punishment of offences, it is provided that any person alleged to be guilty of an offence may be tried either by a court-martial or before a Court of Summary Jurisdiction, and if tried by court-martial the sentence may be of penal servitude for life or any shorter period.

* * *

From conversations with the survivors of the *Pegasus*, destroyed by the *Koenigsberg*, it was gathered that the *Pegasus* had been looking for the *Koenigsberg* from the day on which war was declared. “Of course,” said one of the bluejackets, “she was armed with heavier guns, and could steam away from us, but all the same, we had repeatedly challenged her to fight, calling her up on the wireless to come on. I am sure if we had

encountered the *Koenigsberg* on the open sea the old 'Peggie' would have put up a splendid fight, even if she had been out-matched in the end."

* * *

A wireless dispatch of 800 words will be sent weekly by the Canadian Government to the clergy of the Magdalen Islands in the Gulf of St. Lawrence, until May, to keep the islanders informed each Sunday of the latest war news and other world events. The people will see no newspapers until May.

* * *

Lieutenant-Commander Norman D. Holbrook, the hero of the daring achievement of Submarine B11, is brother-in-law to Lieutenant-Commander R. L. Nicholson, R.N., attached to the staff of Admiral Sir John Jellicoe, in H.M.S. *Iron Duke*, for wireless duties.

* * *

The court-martial held at Woolwich on November 17th on Harold Fochtenberger (THE WIRELESS WORLD, December, 1914, pp. 576-7), who was accused of having wireless telegraph apparatus in his possession without permission, passed sentence of six months with hard labour, but this was remitted, and a sentence of three months' detention without hard labour was substituted.



L. H. Atkinson (the badge on the right arm is that worn by naval wireless telegraphists).

Roll of Honour.

We regret to learn that among those who lost their lives on H.M.S. *Bulwark* was Mr. Leonard H. Atkinson, the wireless operator. Mr. Atkinson, who was 21 years of age, entered the Royal Navy on May 9th, 1910, and joined the Shotley Training Establishment the day the present King came to the throne. After three months he passed out of this establishment, gaining 100 per cent. marks, and was sent to Devonport for advanced training, his choice falling upon wireless telegraphy. In May of the following year he was passed out into the Fleet, having gained second prize out of 50 lads for mechanical training and rated boy telegraphist. He joined the *Venerable* in June, 1911, one week before the Coronation Review, at which he was present. The autumn of the same year was spent at Gibraltar. At the commencement of 1912 he was drafted to the *Hecla* (parent ship of the Fourth Destroyer Flotilla); then, on June 5th, he was sent to Chatham to join the *Bulwark*, on which ship he remained until his death.

During the time he was on the *Bulwark* he was made ordinary telegraphist and telegraphist, and during the last two or three weeks had completed his examination as leading telegraphist; the result of this has not been made known. On his 21st birthday on November 8th, he gained his stripe for three years' men's service.

Examination Questions and Answers.

We announced in the August number of THE WIRELESS WORLD our intention to publish a general criticism of the answers given by candidates to the questions set at the examination in Wireless Telegraphy, held under the auspices of the Marconi Co. during the early part of last year. Owing to extreme pressure upon our space and the drain which the war has made upon our staff, it has not been found possible to carry out that intention, but we hope to do so before the present series of Instructional articles come to an end. This will serve as a guide to candidates who enter for the next examination.

Practical Hints for Amateurs.

RADIO-PHOTOGRAPHY.

By MARCUS J. MARTIN.

In this, and in succeeding articles, the author will explain as simply as possible the various systems that have been devised for radio-photography, i.e., transmitting photographs, drawings, etc., from one place to another without the aid of artificial conductors.

THOSE who desire to experiment on this subject must have at least a good elementary knowledge of optics, chemistry, photography, mechanics,

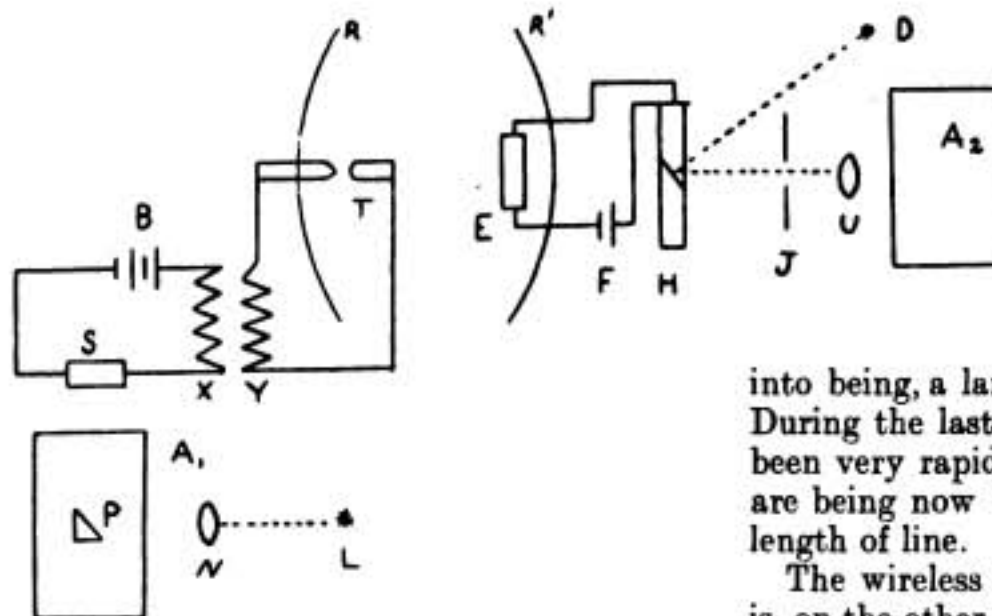

Fig. 1.

and electricity; photo-telegraphy calling for a knowledge of all these sciences. There are, no doubt, many wireless workers who are interested in this subject, but who are deterred from experimenting owing to a lack of knowledge regarding the direction developments are taking, besides which, information on this subject is very difficult to obtain, the science of photo-telegraphy being, at the present time, in a purely experimental stage. The wireless transmission of photographs has, no doubt, a great commercial value, but for any system to be commercially practicable, it must be simple, rapid and reliable,

besides being able to work in conjunction with the apparatus already installed for the purposes of ordinary wireless telegraphy. For short distances (i.e., anything up to 300 miles) the photo-telegraphic systems designed for working over artificial conductors are all that can be desired. Some good specimens of transmitted photographs illustrate an article written on this subject by Professor Korn, which appeared in *THE WIRELESS WORLD* for September, 1913.* As far back as 1847 experiments were carried out with a view to solving the problem of transmitting pictures and writing by

electrical methods over artificial conductors, but no great incentive was held forth for development owing to lack of possible application, but owing to the great public demand for illustrated newspapers that has recently sprung

into being, a large field has been opened up. During the last ten years development has been very rapid, and some excellent results are being now obtained over a considerable length of line.

The wireless transmission of photographs is, on the other hand, of quite recent growth, the first practicable attempt being made by Mr. Hans Knudsen in 1908. It may seem rather premature to talk about the wireless transmission at a time when the systems for transmitting over artificial conductors are not perfectly developed, but everything points to the fact that for long-distance transmission a reliable wireless system will prove to be both cheaper and quicker than transmission over ordinary land lines and cables.

The effect of capacity and inductance—properties inherent to all telegraph

* The examples given were all transmitted over metallic conductors. See *THE WIRELESS WORLD* for October, 1913.

systems using metallic conductors—on the transmission of photographs was briefly described in articles published in *Electricity* for August 1st, 1913, and August 7th, 1914. In these articles it was pointed out that the capacity of one mile of submarine cable was equal to about twenty miles of overhead line, and as the effect of capacity in a circuit is to retard the current and reduce the speed of working, it is easy to see that if there is any great length of cable included in a circuit, the speed and distance of effective transmission are greatly reduced. The time taken to transmit a photograph over the London-Paris telephone lines is about ten minutes, depending, of course, on the size of the photograph, but the same photograph would require about two hours over an Atlantic cable. The expense, both initial and working, would also be very great, as it would be necessary to have two cables in order to provide a complete metallic circuit.

It is evident, therefore, a reliable wireless system would secure a great victory, as the photo-telegraphic apparatus would be merely an accessory to the existing wireless installation. There have been numerous suggestions put forward for the wireless transmission of photographs, but they are all more or less impracticable. One of the earliest systems was devised by De'Bernochi of Turin, but his system can only be regarded interesting from an historical point of view, and as in all probability it could only have been made to work over a distance of a few hundred yards it is of no practical value.

Fig. 1 will help to explain the apparatus. A glass cylinder A', is fastened at one end to a threaded steel shaft, which runs in two bearings, one bearing having an internal thread corresponding with that on the shaft. Round the cylinder is wrapped a transparent film, upon which a photograph has been taken and developed. Light from

a powerful electric lamp, L, is focussed by means of the lens, N, to a point upon the photographic film. As the cylinder is revolved by means of a suitable motor, it travels upwards simultaneously by reason of the threaded shaft and bearing, so that the spot of light traces a complete spiral over the surface of the film. The light, on passing through the film (the transmission of which varies in intensity according to the density of that portion of the photograph through which it is passing), is refracted by the prism, P, on to the selenium cell, S, which is in series with a battery, B, and the primary, X, of a form of induction coil. As light of different intensities falls upon the selenium cell, whose resistance alters in proportion, current is induced in the secondary, Y, of the coil and influences the light of an arc lamp, of whose circuit it is shunted. This arc lamp, T, is placed at the focus of a parabolic reflector, R, from

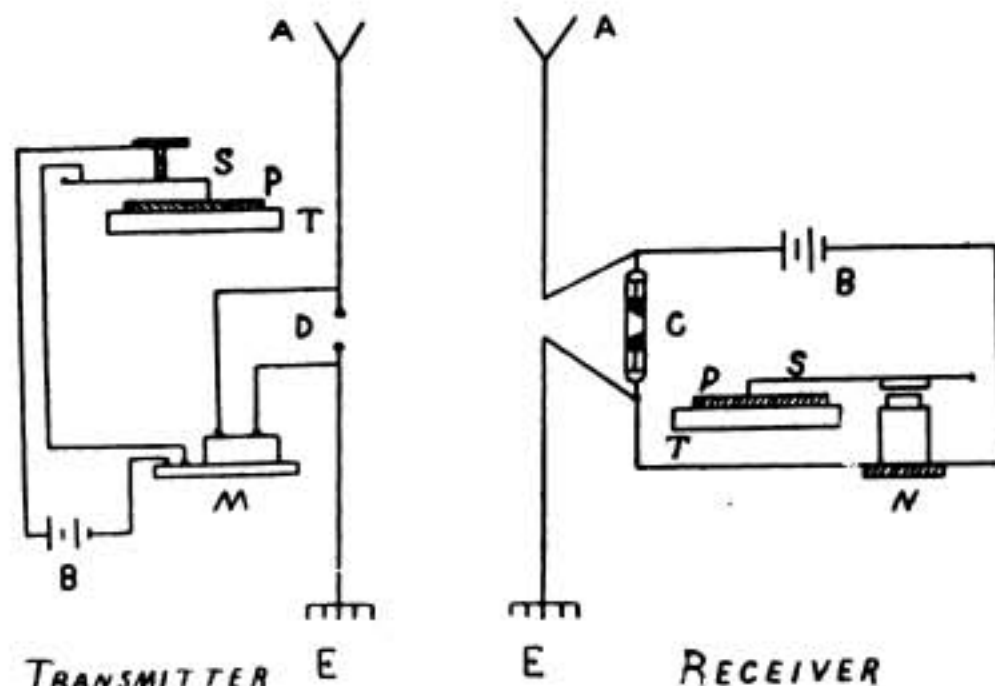

Fig 2.

A. Aerial; B. Batteries; C. Coherer; D. Sparkgap;
E. Earth; M. Spark Coil; N. Magnet;
P. Plates; S. Springs; T. Tables.

which the light is reflected in a parallel beam to the receiving station.

The receiver consists of a similar reflector, R', with a selenium cell, E, placed at its focus, whose resistance is altered by the varying light falling upon it from the reflector, R. The selenium cell, E, is in series with a battery, F, and a mirror galvanometer, H. Light falls from a lamp, D, and is reflected by the mirror of the galvanometer on to a

graduated aperture, J, and focussed by means of the aplanatic lens, U, upon the receiving drum, A², which carries a sensitised photographic film. The two cylinders must be revolved synchronously. The above apparatus is clever, but cannot be made to work over a distance of more than 200 yards.

A system based on more practical lines was that invented and demonstrated by Mr. Hans Knudsen, but the apparatus which he employs for receiving has been discarded in wireless work, as it is not suitable for working with the highly tuned systems in use at the present time. Knudson's transmitter, a diagrammatic representation of which is given in Fig. 2, consists of a flat table, to which a horizontal to-and-fro motion is given by means of a clockwork motor. Upon this table is fastened a photographic plate which has been prepared in the following manner. The plate upon which the photograph is to be taken has the gelatine film from three to four times thicker than that commonly used in photography. In the camera, between the lens and this plate, a single line screen is interposed, which has the effect of breaking the picture up into parallel lines. Upon the plate being developed, and before it is completely dry, it is sprinkled over with fine iron dust. With this type of plate the transparent parts dry much quicker than the shaded or dark parts, and on the iron dust being sprinkled over the plate it adheres to the darker portions of the film to a greater extent than it does to the lighter portions; a picture composed partly of iron dust is thus obtained. A steel point attached to a flat spring rests upon this plate, and is made to travel at right-angles to the motion of the table. As the picture is partly composed of iron dust and as the steel needle is fastened to a delicate spring it is evident that as the plate passes to and fro under the needle, both the spring and the needle are set in a state of vibration. This vibrating spring makes and breaks the battery circuit of a spark coil, which in turn sets up sparking in the spark-gap of the wireless apparatus.

The receiver consists of a similar table to that used for transmitting and carries a glass plate that has been smoked upon one side. A similar spring and needle is placed over this plate, but is actuated by means of a small electro-magnet in circuit

with a battery and a sensitive coherer. As the coherer makes and breaks the battery circuit by means of the intermittent waves sent out from the transmitting aerial, the needle is made to vibrate upon the smoked glass plate in unison with the needle at the transmitting end. Scratches are made upon the smoked plate and these reproduce the picture on the original plate. A print can be taken from this scratched plate in a similar manner to an ordinary photographic negative.

The two tables are synchronised in the following manner:—Every time the transmitting table is about to start its forward stroke a powerful spark is produced at the spark-gap. The waves set up by this spark operate an ordinary metal filings coherer at the receiving end which completes the circuit of an electro-magnet. The armature of this magnet upon being attracted immediately releases the motor used for driving, allowing it to operate the table. The time taken to transmit a photograph, quarter-plate size, is about 15 minutes. Although very ingenious this system would not be practicable. The results from the above apparatus are said to be very crude.

In the next article of this series it is proposed to deal with a method of preparing the photographs that has been tried and found to give excellent results, both in transmission by wireless and over ordinary conductors.

AN AMATEUR WIRELESS SET.

By C. E. McCLUNAN.

TO those interested in wireless telegraphy I think this description of a home-made set will be of interest.

My aerial consists of two pine poles, each pole being made up of two poles 20 ft. and 25 ft., spliced and held in position by iron bands. The spreaders are made of 1½-in. curtain pole 6 ft. long; two porcelain insulators are attached to the spreaders by thick pieces of galvanised iron wire. The aerial, which is of the twin "inverted L" type, is 150 ft. long from spreader to spreader; the wire used is No. 14's bare copper wire. One end is fastened to one of

the poles by means of a pulley, the other end is fixed.

The instruments, which are practically all home-made, consist of a loading coil, direct-coupled tuning coil, silicon detector, variable condenser, fixed condenser, buzzer, and a double-head telephone receiver 1,500 ohms resistance. The instruments I made I will describe. The loading coil I made from a wooden cylinder 5 in. diameter, 2 ft. long; after soaking it in paraffin wax it was wound with No. 28 S.C.C. copper wire; it was then tapped off, and the leads brought down and connected to a twelve-stud switch. A large terminal is fixed to the top for the aerial lead.

The tuning coil was constructed out of a wooden cylinder 5 in. diameter 12 in. long, wound with No. 25's enamelled copper wire; two $\frac{3}{8}$ -in. square brass rods were fitted on each side of the coil, and were fastened to the upright supporting the coil. The sliders are made of ebonite, the contact with the coil being through a spring making contact with the brass rod and a piece of $\frac{3}{16}$ ths brass rod with a tapered end which makes contact with the coil.

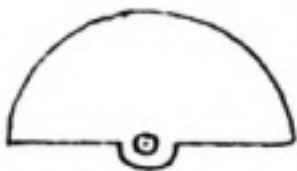

Fig 1



Fig 2

The detector is of the crystal type, silicon being used for the crystal. A gold point is brought down on to the crystal through the action of a copper spring, the pressure being regulated with a micrometer threaded screw. The next instrument I made was the variable condenser, which consists of 17 zinc plates $\frac{1}{16}$ in. thick; there are 9 fixed and 8 movable. Fig. 1 is a sketch of the movable, Fig. 2 of the fixed. The fixed plates were mounted on $\frac{3}{16}$ -in. brass rods, which were screwed at both ends and were separated by fibre washers $\frac{1}{4}$ in. thick; they were fastened down both top and bottom with brass nuts and washers. The movable plates were fixed on to a brass spindle $\frac{5}{16}$ ths diameter, threaded at both ends, the plates being also separated with $\frac{1}{4}$ -in. washers; they were all then clamped together with two brass nuts and washers.

The spindle was slightly recessed at the bottom end to allow the plates to revolve on a pointed brass screw, which was also made to act as a terminal; the screw was fixed through the base of the condenser. The leads were taken from one of the rods through the fixed plates, the other from the screw. The fixed condenser consists of four tin-foil sheets, 5 in. \times 4 in., separated by sheets of paraffin-wax paper, the whole being mounted in a box made from a cigar box. I find in my experiments that a fixed condenser improves a great deal the clearness of the signals. The buzzer was not home-made, so I need not describe it, but I have found it to be one of the most useful instruments in my receiving station.

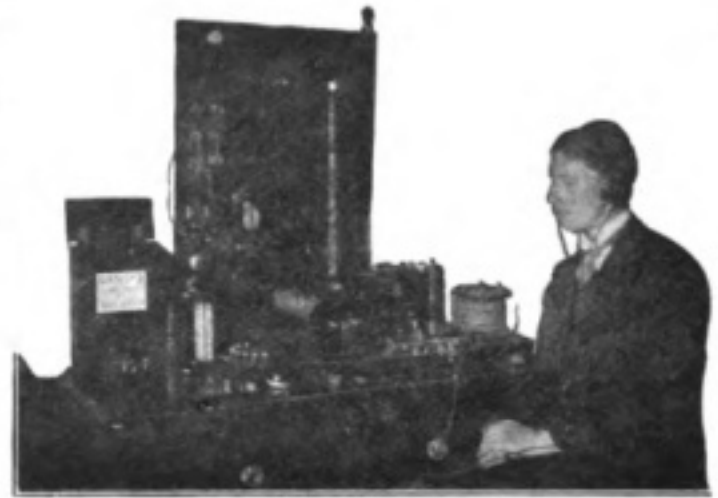

Mr. McClunan and his Wireless Set.

My transmitting apparatus consists of a 2-in. spark coil worked off 12 volts, the spark-gap having pointed conductors which give a good crackling spark. The connections for the receiving set are the same as those given by Mr. Gantly in the March issue of THE WIRELESS WORLD, which produced excellent results. For an earth I use the water main. My instruments were connected up on a Saturday morning, and in the evening I tuned in and listened for FL, the Eiffel Tower, and all my labour was crowned with success, as I heard the evening's press at 8 o'clock being sent into space with its peculiar crackling note. Since then I have received hundreds of ships' messages, together with Norddeich, Cleethorpes, and many others. I owe a good deal of my success to the practical hints and suggestions which I have obtained from THE WIRELESS WORLD.

THE AMATEUR HANDYMAN.

A VARIABLE CONDENSER.

By A. D.

THE plates used in the construction of the condenser described here are cut from thin zinc sheeting, the size of the stationary plates being 6 in. by 4 in. The number is left to the discretion of the amateur, who must be guided in his choice by the capacity required. To each of the long edges on the top of these plates (omitting the uppermost one) is attached a piece of wood $\frac{1}{2}$ in. broad and $\frac{3}{16}$ in. thick.

This arrangement is held together by four rods passing through the zinc and wood and fixed with nuts at each end (see accompanying illustration) The plates are all electrically connected, and, by means of a wire soldered to each, are brought to a terminal on the top.

The diagram shows a space between the plates for the other movable plates to slide into; these are 7 in. by 3 in. in size, insulated on each side by thin ebonite sheeting or micanite fixed by shellac varnish. The plates are held together at one end by a rod passing through holes in the zinc and a series of collars $\frac{1}{8}$ in. in length, the ends of which are threaded and a nut screwed on one end and a suitable handle to the other. This forms quite a serviceable variable condenser, connections being made, one to the terminal on the stationary plates, and the other to the nut on the moveable plates when in use.

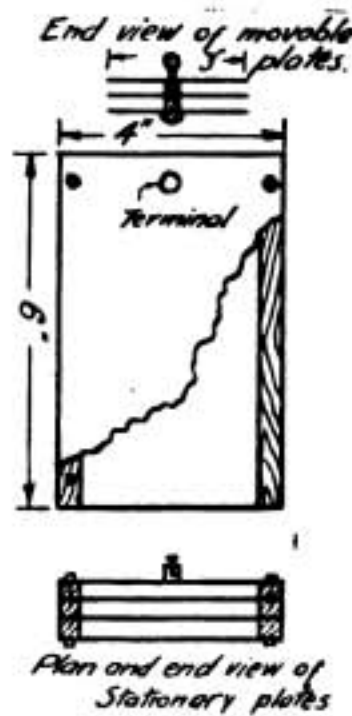

A WORD FOR THE ROTARY CONDENSER.

By HARRY TRUSSELL.

ALMOST without exception, amateurs when describing their stations refer to the difficulty of construction of condensers of the variable rotary type.

This is not my experience, for the instrument which I constructed has rendered excellent service.

The materials required are a piece of well-seasoned mahogany 8 in. by 8 in. by 1 in., a piece of sheet-zinc, 80 copper washers or "roves," such as are used for rivets, five long,

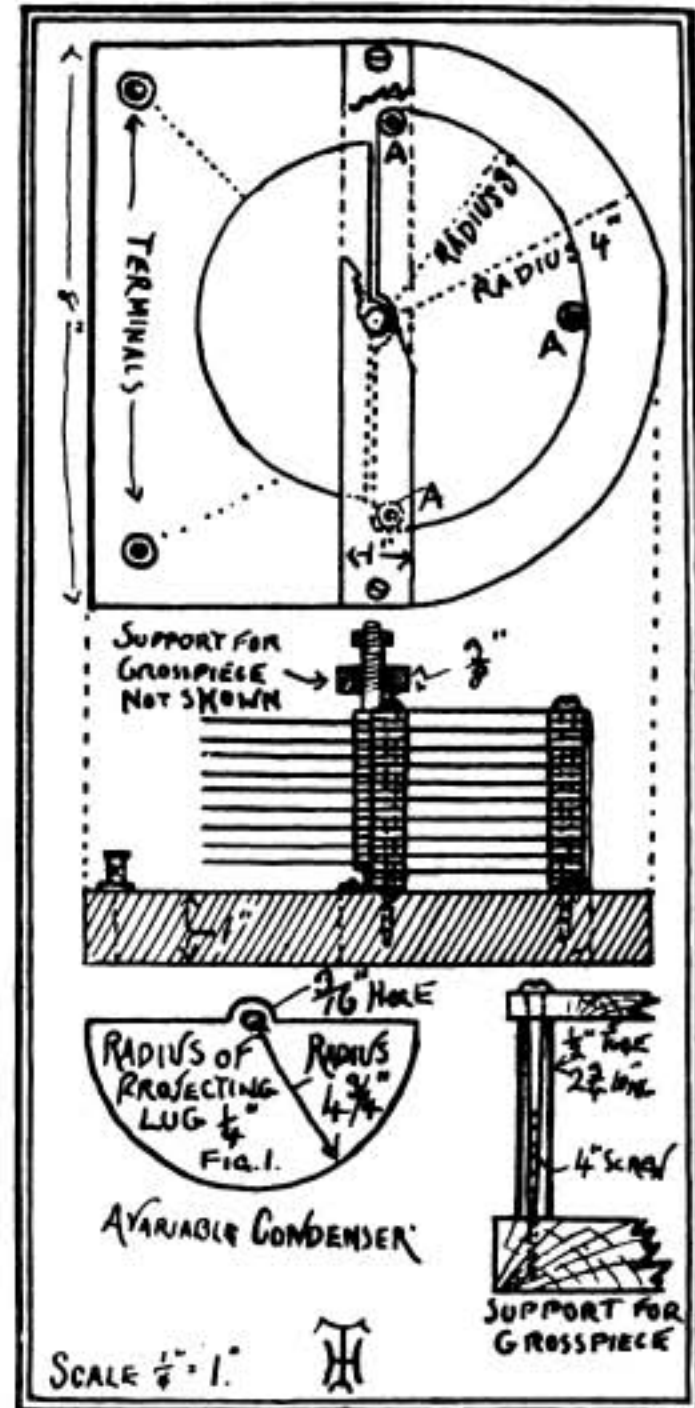

thin round-headed brass screws, 4 in. will do well, and a length of 3-16ths brass rod. The base-board should first be planed up true and then impregnated with wax or given two or three coats of shellac and placed on one side. Now scribe on the zinc five circles 6 in. in diameter, and cut out with a pair of shears. With a 3/4-in. "centre-bit" (an old one will do) cut, in the centre of each circle, a hole. These pieces should now be cut diametrically in half, giving us ten vanes,

these to be the stationary ones. Across the base draw lightly two lines, intersecting in the centre. Dead over the centre screw a brass disc $\frac{3}{4}$ in. diameter, this having a 3-16ths hole in the middle. Under one of the screw heads holding this should be clipped a piece of wire to make contact. This should be taken under the base, sealed in a groove and connected with a terminal set in the left-hand corner of the base. A templet should now be cut as Fig. 1 of thin wood. Lay this on the zinc, scribe round and cut out. Nine such vanes are required. The next operation requires carefully carrying out. Get all the vanes, place them in a tin, in a fairly hot oven and heat them to a good temperature, without melting them. Remove from the oven, and with a household flat iron on a *flat* surface iron them down. If this is properly performed the vanes will be as flat as the proverbial pancake. Now take the stationary vanes and clamp them all together in the vice and drill a 3-16ths hole in the positions shown at A in the plan. Take one of these vanes, lay it on the base with the semicircle embracing the brass disc screwed thereon, and with a fine bradawl make holes in the base to coincide with those drilled in the vane. Now fix the stationary vanes permanently by inserting screws in each hole in one vane, thread on two washers on each screw, another vane, two more washers, and so on. When the last vane is reached place on three washers, invert the whole, place the points of the

screws in the bradawl holes and screw down tight. This makes a very firm job. For the revolving vanes cut a piece of 3-16ths rod 4 in. long, and 3-16ths from one end pin to it a collar 3-16ths wide. The opposite end should be threaded for about 1 in. and a nut provided to fit. The crosspiece providing the upper bearing of the revolving vanes is cut from $\frac{3}{8}$ -in. mahogany 8 in. long and 1 in. wide. The central hole is bushed with a piece of ebonite tube $\frac{1}{4}$ in. in inside diameter. When assembling these vanes start with one washer close to the collar, and continue as described until the last vane is reached, then one washer and then a piece of tube $\frac{1}{4}$ in. outside diameter, about $\frac{3}{4}$ in. long, should be placed on. This tube should be made a nice fit in the ebonite bush in the crosspiece, which should then be placed in position. Finally, the nut should be screwed down tight and the whole erected with supports as shown. In placing the washers in position, note that the "dishings" caused by the punch are all placed the same way. Whilst erecting, the vanes may appear alarmingly close, being little more than $\frac{1}{8}$ in. apart, but provided ordinary accuracy is observed no trouble should arise. The washers are $\frac{1}{2}$ in. diameter. The instrument could be considerably simplified by cutting the vanes as simple semi-circles. The cost worked out at just 1s. 11d., the minor parts all coming from "scrap." The fixed vanes should be placed slightly behind the centre line on base board.

Among the Wireless Societies

Barnsley.—At the November meeting of the Barnsley Amateur Wireless Association, the second of the WIRELESS WORLD series of instructional articles was studied.

* * *

London.—The annual general meeting of the Wireless Society of London was held at the Institution of Electrical Engineers on Friday, December 18th. The President, Mr. A. A. Campbell Swinton, was in the chair. Under the articles of association, the officers may remain in office for three years, and it is in this way that no change is being made in the principal officials. There are, however, four changes on the committee.

The accounts show a credit balance of £44 13s. 10d.

Prof. G. W. Osborn Howe delivered a lecture on "High Frequency Resistance of Wires and Coils." It was of an advanced mathematical character—notwithstanding Prof. Howe's assurance that it was all exceedingly simple—and such workers as Mr. W. Duddell, F.R.S., and Mr. E. H. Rayner, of the National Physical Laboratory, confessed a difficulty in discussing it without having an opportunity of studying the lecturer's arguments in detail. Prof. Howe first explained that high frequency currents are not distributed uniformly over the cross-section of conductors, but he pro-

posed to deal with the problem in a different way from that adopted in Prof. Sir J. J. Thomson's recent book. The basis of his lecture would be the application of the so-called telephone transmission formulæ to the calculation of skin effect; he was, in fact, going to apply this formulæ, usually applied along the line, into the conductors themselves. His first example was two strips of copper one centimetre apart, and he showed mathematically how the leakage current at any depth—which was equal to the voltage at that point—could be ascertained. In this particular instance the leakage current was really the actual current, after the manner of the "slab" experiment of Prof. Sir J. J. Thomson, and thus the so-called leakage represented the current density in the conductor at any particular point. Thus it followed that the current density at any depth could be ascertained in terms of the current density on the surface. With a frequency of 1,000,000 at a depth of $\frac{1}{15}$ mm. the current density was 0.37 that at the surface.

With a round wire, as long as the penetration was not very deep, the same formulæ could be applied, but it did not apply if the penetration was deep. The formulæ which he gave held good, he said, for a penetration which did not exceed one-third the radius, and the same results had been obtained as with Lord Kelvin's formula, within a very small error, and it could be applied, with a frequency of 1,000,000, to copper wires exceeding 0.4 mm. in diameter. It could also be applied to steel rails used as the return on single-phase railways. Here, however, permeability came in, which was rather uncertain, as it depended upon the magnetisation and differed from point to point, but with a frequency of 50, and taking the specific resistance of steel to be 20 microhms and the permeability at 1,000, then by the formulæ it would be found that the penetration into the steel rails was of the order of 1 to $1\frac{1}{2}$ mm. This was the figure ascertained some years ago in Paris by Boucherot.

Prof. Howe next explained that the ordinary telephone transmitter formulæ does not apply to round wires at low frequencies, because in these circumstances, with alternating current, the penetration is to the centre of the wire; and it was therefore necessary to tackle the problem after the

manner of the telephone engineer—viz., graphically. He showed a vector diagram by which he said it was possible, whether the frequency was high or low, to work out the skin effect on straight round copper wires. With flat wires wound round layers, in the form of a solenoid, the problem was very much the same as with straight wires, although it was not quite so easy when the coils were a short distance apart.

With round wires wound in this way, however, the difficulties were enormously increased, and he did not see any way of applying the ordinary telephone formulæ. This had claimed the attention of some of the leading authorities and mathematicians for the last few years—viz., what is the resistance of alternating current of a coil of round wire?—and the results had been most divergent. Each worker said his formula applied and others did not. He had read all the recent papers on the subject and plotted the results in the form of curves, and it was most disappointing.

Mr. W. Duddell, F.R.S., in the course of a few remarks said he had always found it best to make his own experiments to find out what was the high frequency resistance. The difficulty, however, was what was meant by the high frequency resistance of a curve. What we actually measured was some quantity which, multiplied by the square of the current, gave the losses, and that could be obtained by various methods; but with insulated wires he was not at all sure that the class of insulation did not have a great deal more effect on the losses than the skin effect on the wire itself. He had made experiments on various insulating materials from this point of view, and perhaps a list of the properties of certain materials would be useful in enabling the most unsuitable to be avoided.

Notice to Club Secretaries.

Secretaries of wireless societies will oblige by furnishing us with the names and addresses and other particulars relating to their societies for publication in the "Year Book of Wireless Telegraphy and Telephony, 1915."

We should also like to hear from secretaries of wireless societies whose names did not appear in the Directory in the 1914 edition of the "Year Book."

Administrative Notes.

The Argentine delegates who represented their country at the International Radiotelegraphic Conference in London in 1912 have presented a report which was considered at a meeting held in Buenos Aires on June 19th this year. Although the consideration of the report is somewhat belated, there is sufficient of importance in it, if we are to judge from the extracts published in the *Revista Telegrafica* of Buenos Aires, to warrant general attention.

It appears that the Argentine delegation submitted a proposal the object of which was to establish a wireless service round the navigable coast of the country in order to increase safety at sea. The report states that the proposal might lead to the assumption that the stations round the Argentine coasts were able to render good service to shipping, and that vessels plying on Argentine rivers were equipped with suitable apparatus, so that in the event of any mishap relief would be immediately forthcoming. This, however, is not the case, for the report regretfully confesses "that the wireless service round our coasts could not be in a worse condition, as was evidenced on the occasion of the recent grounding of the *Highland Piper*, whose call of distress was answered only by the Uruguayan station at Cerrito."

It is pointed out that transatlantic vessels refuse to communicate with the Argentine shore stations, as calls generally receive no response. A further objection to communication is that the rates for Argentine stations are higher than those for the Uruguayan stations, and it is instanced that a wireless telegram for Buenos Aires sent through the Monte Video station, thence by cable, is cheaper and more rapidly delivered than if sent direct from the ship to the Argentine station at Darsena Norte.

Ships' operators, it is said, complain of slackness at the shore stations, whose operators are not under any discipline, for the simple reason that there is no authority to impose that discipline and to see that it is properly adhered to. A large number of

Argentine river vessels are not equipped with wireless, and the explanation of this is that their owners are unable to obtain information regarding the service.

According to the report from which we have quoted, "the wireless service does not fulfil its purpose because it is inadequately staffed." As regards the responsible authorities, the report states: "We are unable to state who they are as we have not the information, but we are of opinion that the matter should receive special attention on account of its national and international importance." The report complains that the *personnel* occupying the minor posts are ignorant of telegraph legislation and tariff rates; they do not attach to their work the importance which they should, for the reason that no one will trouble them if they neglect to attend to their duties.

In the Government telegraph service an operator who fails to respond to a call after a period of five minutes is liable to a heavy fine, as well as a bad mark in his service conduct book; in the Argentine wireless stations, on the other hand, such negligence is not visited by any punishment. The report states that the wireless service should become a branch of the Administration of Posts and Telegraphs; in this way it would serve as an auxiliary to the land lines, and might relieve the South American traffic over these lines.

If this were done the wireless service would become of value, and even self-supporting. A saving would be effected by the abolition of dual staffs, and, more important of all, the service would become more efficient, and there would no longer be any reason for foreign criticism, which is at present well-founded.

* * *

The Siasconset station (U.S.A.) has been temporarily closed to public service. The

**Stations
Opened and
Closed.**

South Wellfleet (short-distance) station has been reopened, and the service hitherto performed by Siasconset will be transferred to South Wellfleet. The Faro Recalado Coast station (Argentine) has been reopened for public service.

F

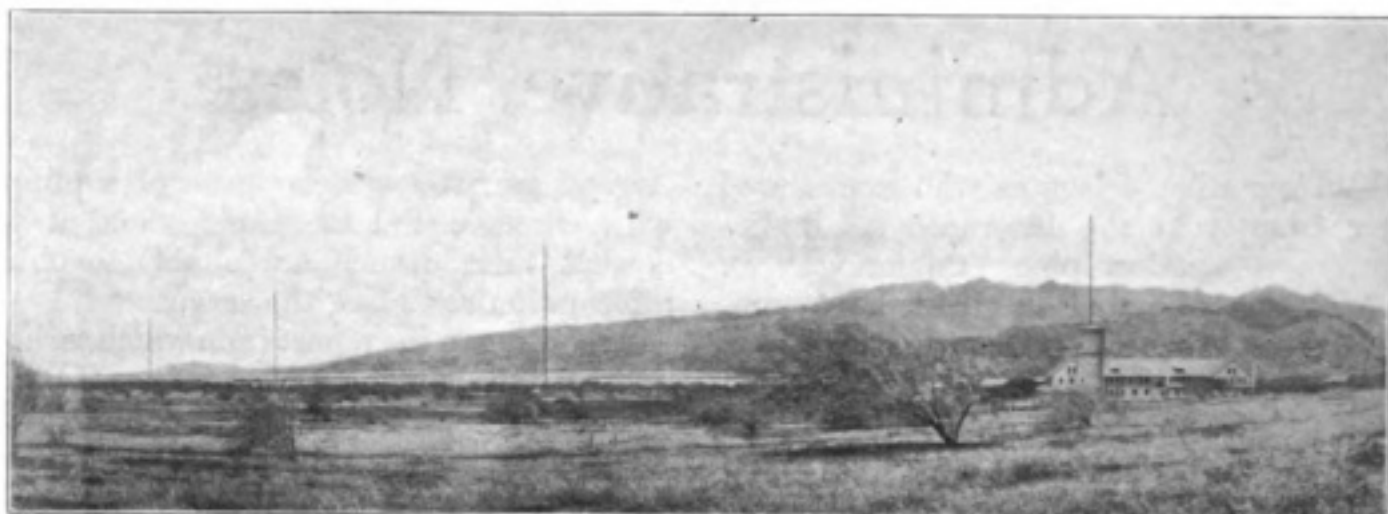

A Panorama of the Marconi Station at Honolulu, showing Power

THE TRANS-PACIFIC

“PEACE hath her victories not less renowned than war”; and the formal opening of the Trans-Pacific stations of the Marconi Wireless Telegraph Company of America at Bolinas and Marshalls, Cal., and at Kahuku and Koko Head, Hawaii, was a victory over place and time the like of which only the living generation has experienced, and it is doubtful whether our sons or yet our grandsons will witness another triumph on so gigantic a scale. It almost passes comprehension to think that a sign controlled by nothing more than the pressure of a finger should travel through space and be received undiminished at the Edge o’ Beyond.

Looked at from this light, the inauguration of such a mighty enterprise as the opening of the first link in a Trans-Pacific chain of wireless communication is an event of the first importance, and therefore September 24th, 1914, must be looked upon as a landmark in the history of progress.

At Bolinas, Cal., the Marconi Company entertained a number of guests for the opening ceremony. These included the Mayor of San Francisco, the Vice-President of the Panama-Pacific International Exposition, and representatives of all the great trans-oceanic steamship companies, besides many of the foremost men among the great industrial concerns of America. The wonderful stations were open for inspection, and perhaps the best idea of their enormous power may be gathered from the following technical description of their apparatus.

They have an installation of 300 kilowatts and a voltage of 13,000. There are nine steel masts, each 300 feet in height and carrying thirty-two wires, each 2,000 feet in length, from which the messages are flashed across the seas. The duplex system is used at Bolinas, messages being received and sent at the same time. This is accomplished by means of the station at Marshalls, twelve miles to the north of Bolinas on Tomales Bay, where the incoming messages are not blurred by the noise of the sending station. The current is received on underground cables from the Pacific Gas and Electric Co.’s transmission line at a voltage of 2,200 and 60 cycles. It is first transformed to 440 volts, all the mechanical parts of the plant being operated at that voltage, including the motor that drives the alternator, changing the current to 210 cycles and 2,000 volts. It is then stepped up in transformers to 13,000 volts, at which voltage it charges the condensers and is sparked across the discharger, which is mechanically connected with the alternator by a shafting and run at 1,800 revolutions a minute, the number of studs in the discharger giving a spark frequency of 420. From the condenser banks to the discharger the current, instead of being carried on copper wires, is transmitted over continuous copper sheets more than a foot in width.

At Honolulu another large gathering was also entertained, the guests including Governor Pinkham and 200 representative men of Hawaii. A special train took the guests



House and Operating Buildings and the Aerials, which stretch a mile.

WIRELESS STATION.

from Honolulu to Kahuku, a distance of about sixty miles. A dinner had there been arranged for them, during the course of which Governor Pinkham opened the station for service from a seat at the head of the table by pressing a silver key mounted thereon, which set the wireless machinery in motion. The first message sent was to President Wilson, then one from the Mayor of Honolulu to the Mayor of San Francisco, who was a guest at the Bolinas Station in California. Shortly after this a message was received from Mr. Marconi, which ran as follows: "Please accept for yourself and convey to Taylor (Supervising Engineer of the Marconi Company) and all those associated with him my warmest thanks for their effective work in forging the first link in the Pacific chain." Other interesting telegrams followed, amongst them being one from the American Secretary of War, Washington, to General Carter, another of the guests at Honolulu.

In the course of the opening ceremony Governor Pinkham made an admirable address.

The great plant at Kahuku, which is literally the largest wireless station in the world, is a system to wonder at; the huge concrete power house with its bewildering mass of machinery, its huge coils, its mysterious glass tanks, its spark room, where red danger signs flame on the walls and where an incautious intruder would emerge with deafened ears, all create an atmosphere which is best described as indescribable.

Already the Marconi offices at Port Street have become the centre of great activity, and the amount of business done during the few weeks that it has been open for public use testify to the great need for such a service.

The rates and conditions of service are as follows:

GREAT BRITAIN—HONOLULU.

Ordinary full rate, 2s. 3d. per word.

Night letters, 11s. for 13 words, including prefix and 6d. for every additional word.

Week-end letters, 14s. 6d. for 25 words, including prefix, and 6d. for every additional word.

Messages for Honolulu and all other places in the island of Oahu are delivered free. Messages for Hawaiian islands beyond Honolulu are accepted only at sender's risk.

Messages for the islands of Hawaii, Maui and Kauai may be forwarded beyond Honolulu by mail or by wireless telegraph, the charge for the wireless transmission being 8d. per word in addition to the rate to Honolulu. In the latter case "via wireless" must be signalled in the service instructions of messages to be forwarded by wireless telegraph to destination, in addition to the indicator "Via Marconi." There is no charge for mailing.

Messages for other Hawaiian islands can only be forwarded by mail from Honolulu.

The name of the island must appear in the address of every message going beyond Honolulu.

INSTRUCTION IN WIRELESS TELEGRAPHY

(Second Course)

(VI.) Transmitting-Condensers.—II.

[The article in the March number completed the first course of instruction. The present is the sixth of a new series of articles, which will deal chiefly with the application of the principles of wireless telegraphy. Those who have not studied that series are advised to obtain a copy of "The Elementary Principles of Wireless Telegraphy," which is now published, price 1s. net, and to master the contents before taking up the course of instruction. An announcement concerning the second examination appeared on page 333 of the August number of THE WIRELESS WORLD.]

Determination of Capacity.—If C is the capacity of a condenser in farads, V the voltage to which it is charged, then the energy stored in the condenser is $\frac{1}{2} CV^2$ joules, the joule being the electrical unit of energy when the units of current and voltage are the ampere and the volt respectively. As there is a certain maximum voltage strain at which any given dielectric will break down, it follows that there must be a limit to the amount of energy that can be stored in a given condenser. Glass is practically universally used in transmitting-condensers, so that, in what follows, we shall confine ourselves to condensers with glass as the dielectric. Glass breaks down under a voltage strain of about 250,000 volts per cm. of thickness, which would give a limiting voltage of 50,000 for glass plates 2 mm. thick. This value cannot be taken as anything like the safe voltage at which the glass of a condenser can be worked—first, on account of irregularities in the thickness of the glass; and, second, because the glass plates are much more liable to puncture round the edges of the metal plates. Probably 4,000 to 5,000 volts would be a safe working voltage for glass 2 mm. thick. Let us take a condenser having a plate area of 1 square metre, thickness of plate, 2 mm., and dielectric constant 7.

Capacity of condenser

$$= \frac{10,000 \times 7}{4 \times 3.14 \times 2 \times 9 \times 100,000} \text{ mf.} = .031 \text{ mf.}$$

Maximum energy storage

$$= \frac{1}{2} CV^2 = \frac{1}{2} \times .031 \times 4,000^2 \div 1,000,000 = .25 \text{ joules.}$$

Suppose, now, we halved the plate area, but doubled the thickness of the glass plates, so that the volume of glass in the condenser

would still remain the same—*i.e.*, 2,000 c.c. The capacity of the condenser would now only be one-quarter of its original value, but the maximum voltage it could safely take would be doubled—say, $C_2 = \frac{1}{4} C_1$ and $V_2 = 2 V_1$. Hence the new energy capacity $= \frac{1}{2} C_2 V_2^2 = \frac{1}{2} [\frac{1}{4} C_1 \times (2 V_1)^2] = \frac{1}{2} C_1 V_1^2$ —that is, the energy capacity is unchanged by the rearrangement. Roughly, then, we may take it that the volume of glass to be used in a condenser is fixed by the energy to be stored in the condenser at a single charge. As we have seen above, this volume of glass can be made up in various capacities by alteration in the thickness of the plates, or by dividing the original condenser into two equal parts, and connecting these in series, which is exactly equivalent to doubling the thickness of the plates. Our calculation shows us that in an ordinary plate condenser about 8,000 c.c. of glass is necessary for every joule of energy to be stored.

The next question to be settled is to what capacity the required volume of glass is to be made up. Take the ordinary synchronous disc, or quenched gap set, in which the condenser is charged and discharged once every half-cycle of the alternating current. If this occurs N times per second, each time the condenser, C , being charged to a voltage, V , the total power supplied to the condenser is $N \times \frac{1}{2} CV^2$, and this must be the power of the set P —*i.e.*, $P = \frac{1}{2} NCV^2$.

If we consider any given set for supplying the power, consisting of alternator and transformer: (1) The power, P , is fixed; (2) the voltage, V , to which the condenser is charged is fixed by the transformation ratio of the transformer, and this is usually made so high, in the first place, that it cannot be increased to any great extent

without leading to difficulties in the insulation of the transformer; (3) the number of times, N , the condenser, will be charged is fixed by the alternator frequency (this will usually be once every half-period of the low-frequency current).

Hence in the equation, $P = \frac{1}{2} NCV^2$, all the quantities are fixed except C , so that we can get C from

$$C = \frac{2P}{NV^2}$$

and the volume of glass required is got from the energy to be stored at each charge, which is P/N . These two things completely determine the condenser to be used in the case of the usual commercial station. The primary circuit is completed by adding a sufficiently large inductance for coupling purposes, so that the wave-length of the primary circuit is fixed, and the aerial is designed to work on that wave-length. With the amateur, however, it is more probable that the wave-length on which he has to transmit is fixed; that is, the product, LC , of the primary circuit is fixed, since $\lambda = 1885 \sqrt{LC}$. He must therefore determine whether the value of the capacity found will allow the primary inductance to be made large enough.

Let us take the case of an amateur set, in which the primary condenser is to be charged by means of an induction coil and discharged through a rotary gap. The conditions in this case are only very roughly similar to those holding in the case of the synchronous disc set, but the example will be of more interest to the majority of readers, and will be sufficiently accurate to indicate the order of magnitude of the quantities involved.

- Discharges per second = 200.
- Maximum condenser voltage = 4,000.
- Wave-length for transmission = 200 metres.
- Assume power available on the high tension side = 50 watts.
- Average energy in condenser per charge = $50/200 = .25$ joules.

We have seen previously that such an amount of energy would require about 2,000 c.c. of glass, the glass being 2 mm. thick to withstand a strain of 4,000 volts. This gives a plate area of 10,000 square cm., and a capacity of .031 mf. The capacity could, of course, be calculated direct from the equation—

$$C = \frac{2P}{NV^2} = \frac{2 \times 50}{200 \times 4,000^2} = .031 \text{ mf.}$$

Also, since the wave-length to be used is 200 metres, we have for the primary inductance—

$$200 = 1,885 \sqrt{L \times .031}$$

$$L \times .031 = \frac{1}{8}$$

$$L = .37 \text{ microhenries.}$$

This inductance would be something like two circular turns of wire of 10 cm. diameter, the adjacent turns being 1 cm. apart, and, judging from general practice, would do quite nicely. The capacity could therefore be made .031 mf., as specified, of 10,000 square cm. of glass 2 mm. thick.

Photographic whole-plates are about 2 mm. thick, and are 18 cm. by 23 cm. Allowing 1 cm. overlap each side the metal plate gives a working plate area of $16 \times 21 = 336$ square cm. per plate. Hence, about thirty such plates would be required. It would be better to make the condenser up in two halves, each consisting of fifteen glass plates interleaved with metal plates. In each condenser the alternate metal plates would be connected together to form one side of the condenser.

Transmitting Jiggers.

735. The jigger is simply a type of transformer, suitable for the high-frequency oscillations concerned, by means of which

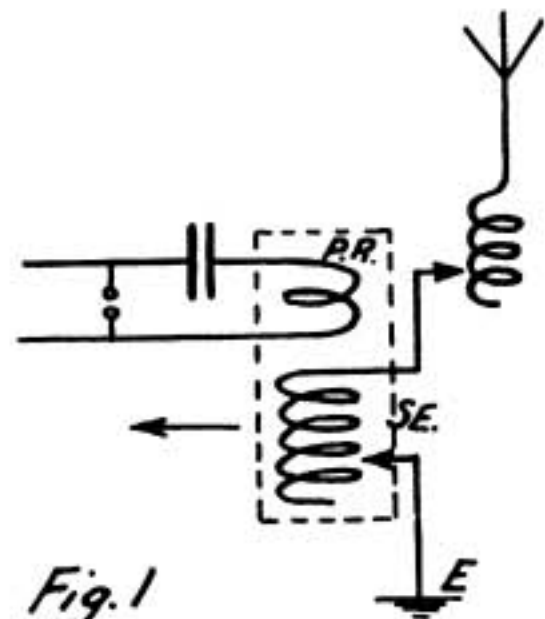

the energy is gradually transferred from the primary circuit to the aerial circuit. It consists of two coils of wire, one being the inductance of the primary circuit, and the

other being in the aerial circuit, their position being shown diagrammatically in Fig. 1. The primary coil has very few turns, one, two, or three being the usual number, whilst the number of turns in the secondary can be varied up to about twenty. These two coils are arranged so that one can be moved relatively to the other. In the small Marconi sets one can slide past the other in the direction shown by the arrow. Exactly the same purpose would be served by sliding one away from the other along their common axis or rotating one relative to the other. Either by moving the coils closer together or by increasing the number of turns in the jigger secondary the coupling between the two circuits can be increased, so that the energy is more rapidly transferred to the aerial circuit, but if the coupling is made too tight the circuits oscillate to two frequencies (see *Elementary Principles*, pp. 92-8), and two wave-lengths are radiated, making it difficult to get sharp tuning at the receiving end. The International Wireless Convention has made it illegal for any station to be so tightly coupled that the two wave-lengths radiated shall differ by more than 15 per cent., and the usual value on a station will be less than 10 per cent. Providing this limit is not exceeded, the coupling is tightened to give the maximum current in the aerial, as indicated by a hot-wire ammeter or a shunted lamp.

The great point in the design and construction of a jigger is to keep its resistance as low as possible. Now, high-frequency currents tend to keep to the surface of a wire. This is due to the fact that the total inductance (self and mutual) of a longitudinal filament in the interior of a wire is greater than that of a similar filament on the outside of a wire, on account of the increased reaction of the other filaments on the filament under consideration. This slight difference in inductance has a very marked effect at high frequencies, since the choking effect is proportional to the frequency, and results in the current keeping to the surface of the wire where the inductance is less. The current does not keep wholly to the surface of the wire, as the resistance would then become too high, but compromises between the decrease of inductance and the increase of resistance. This surface effect is lessened by making the

jigger of wire consisting of several strands of finer wire twisted together. For small amateur sets 7/19 cotton-insulated wire will do quite well. Even in this case there is still a tendency for the current to use only the outside wires. Hence, in the case of larger jiggers—say, for a power of 5 kilowatts—either the jigger primary, or both primary and secondary, are wound with a cable having a hemp rope centre, this being covered by a layer of wires, each wire, of course, going the whole length of the core. For very large powers, 100 kw. and over, this is not good enough. The hempen cores are replaced by large wooden coils, on which an outer skin of wires is laid. Each wire of this skin travels the whole length of the coil, encircling the core one or more complete turns in its journey, so that all the wires may be of the same length. These wooden coils may be as much as 12 feet in diameter, while the diameter of the cross-section of the wooden core is about 1 foot. Each of the outer wires is itself stranded, so that in these ways all the metal used is in active service, and the resistance of the jigger is kept as low as possible.

736. The Auto-Jigger.—A modified type of jigger, much used by amateurs, is known as the direct coupled, or auto-jigger. In this the jigger primary is simply a turn or two tapped off the jigger secondary itself, as shown in Fig. 2. It has just the same

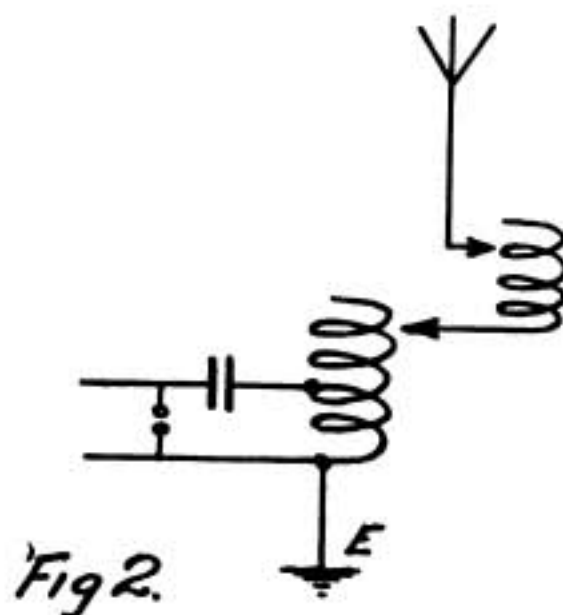

characteristics as the more usual inductively coupled jigger, so that it does not require separate treatment.

Contract News

The following vessels have recently been fitted with wireless installations by Marconi's Wireless Telegraph Company:—

Name of Vessel.	Owners.	Call Letters.	Type of Installation.
<i>Burmese Prince</i>	Prince Line, Ltd.	GRP	1½ kw. and emergency set
<i>Anglo-Australian</i>	Lawther, Latta & Co. (Nitrate Producers Steamship Co., Ltd.).	GTQ	" "
<i>Anglo-Patagonian</i>	" " " " " "	GRC	" "
<i>Anglo-Bolivian</i>	" " " " " "	GRA	" "
<i>Lunka</i>	British India Steam Navigation Co., Ltd. ..	GLM	" "
<i>Colaba</i>	" " " " " "	GBT	" "
<i>Sir Harvey Adamson</i>	" " " " " "	MUK	" "
<i>Manchester Corporation</i>	Manchester Liners, Ltd.	YYB	" "
<i>Oanfa</i>	Alfred Holt & Co.	GTL	" "
<i>Nessian</i>	F. Leyland & Co., Ltd.	CPV	" "
<i>Katherine Park</i>	Park Steamship Co., Ltd.	GRU	" "
<i>Mary Park</i>	" " " " " "	GRH	" "
<i>Austrian Prince</i>	Prince Line, Ltd.	YYJ	¼ kw. and emergency set
<i>Moorish Prince</i>	" " " " " "	YYK	" "
<i>Welsh Prince</i>	" " " " " "	YYM	" "
<i>Siamese Prince</i>	" " " " " "	YYN	" "
<i>Portuguese Prince</i>	" " " " " "	GRS	" "
<i>Anglo-Saxon</i>	Lawther, Latta & Co. (Nitrate Producers Steamship Co., Ltd.).	GUB	" "
<i>Anglo-Colombian</i>	" " " " " "	GUA	" "
<i>Anglo-Mexican</i>	" " " " " "	YYC	" "
<i>Anglo-Californian</i>	" " " " " "	YYH	" "
<i>Devena</i>	Cairns, Noble & Co.	GRD	" "
<i>Fremona</i>	" " " " " "	GSN	" "
<i>Jacona</i>	" " " " " "	GUV	" "
<i>Iona</i>	" " " " " "	GTU	" "
<i>Borderdale</i>	James Little & Co.	GTE	" "

Orders have been received by the Marconi Co. to equip the following vessels:—

Name.	Owners.	Type of Installation.
<i>Glenartney</i>	Caledonia Steamship Co., Ltd.	2 kw. and emergency
<i>Mary Park</i>	The Park Steamship Co., Ltd.	1½ " "
<i>Explorer</i>	The Charente Steamship Co., Ltd.	" "
<i>Inventor</i>	" " " " " "	" "
<i>Tactician</i>	" " " " " "	" "
<i>Collegian</i>	" " " " " "	" "
<i>Politician</i>	" " " " " "	" "
<i>Calchas</i>	Ocean Steamship Co., Ltd.	" "
<i>Goldmouth</i>	The Anglo-Saxon Petroleum Co., Ltd.	" "
<i>Strombus</i>	" " " " " "	" "
<i>Natica</i>	" " " " " "	" "
<i>Ulysses</i>	" " " " " "	" "
<i>Kanella</i>	" " " " " "	" "
<i>Patella</i>	" " " " " "	" "
<i>Cardium</i>	" " " " " "	" "
<i>Mitra</i>	" " " " " "	" "
<i>Conch</i>	" " " " " "	" "
<i>Volumnia</i>	The Volumnia Steamship Co., Ltd.	" "
<i>Brodmount</i>	The Brodmount Steamship Co., Ltd.	" "
<i>Toku Shima Maru</i>	Nippon Yusen Kaisha	¼ kw. and emergency
<i>Den of Ewie</i>	Chas. Barrie and Sons	" "
<i>Brisbane River</i>	The British Empire Steam Navigation Co., Ltd. ..	" "
<i>Dorington Court</i>	Cressington Steamship Co., Ltd.	" "

The Marconi Wireless Telegraph Company of Canada, Ltd., announce the equipment of the following vessels:—

Name of Vessel.	Owners.	Type of Installation.
H.M.C.S. <i>Sheerwater</i>	Canadian Government (Dept. of Naval Service)..	1·7 kw. and emergency set
<i>Bloodhound</i>	Murray and Crawford	¼ kw. and emergency set
H.M.C.S. <i>Tuna</i>	Canadian Government (Dept. of Naval Service)..	" "

They have also received instructions from Messrs. Bowring Bros. to equip three of their vessels, the *Viking*, *Eagle*, and *Terranova* with ¼-kw. and emergency sets.

The Library Table

"MODEL ANSWERS TO TEST QUESTIONS IN WIRELESS TELEGRAPHY." London: The Wireless Press, Ltd., Marconi House, Strand, W.C. 1s.

Some two months ago we directed attention in these columns to a series of Test-Question Cards issued by The Wireless Press, Ltd. There is now available the above book, which furnishes an unfailing key to the question cards. The answers set out in the book should be used for comparison purposes in order that the accuracy of the student's knowledge may be checked. At the same time, an intelligent study of them will give the student a thorough grounding which should enable him to answer any questions that may be put. This course of instruction is so inexpensive that it deserves to be given a trial, and if the measure of success achieved by the compilers is to be gauged by sales, then The Wireless Press questions and answers is an unqualified success.

"FROM THE TRENCHES."

Most of the war correspondence appearing in the newspapers is made up of accounts gathered by correspondents who are very far removed from the actual battle lines, with the result that the narratives make up in vividness what they lack in fact. This is not the fault either of the correspondent or of the newspaper for which he is writing; it is merely one of the consequences of modern conditions of warfare. The scale of the fighting in Europe is far too vast for a single eye-witness to cover, even if he could be near the line of battle, and to supplement the bare official bulletins issued at varying intervals (except from Paris, Petrograd and Berlin), we have to content ourselves with accounts of more or less exciting personal experiences and attempts to describe the atmosphere of countries under the war cloud. In spite of the difficult conditions,

it must be admitted that a goodly proportion of the war correspondence is very ably done, and many of the dispatches sent by Mr. Geoffrey W. Young to the *Daily News and Leader* rank among the best we have read. Some of these dispatches have been republished in the form of a book, under the title "From the Trenches," published by Mr. Fisher Unwin, 1 Adelphi Terrace, London (paper cover, 2s.; cloth, 2s. 6d. net), and a very interesting volume it makes. It takes us up to the long-drawn-out battle of the Aisne, and the graphic story is interspersed with short summaries of the various movements as they developed, within the period covered by the author.

"KEEP SMILING."

"The object of this little book is to show that we can be every bit as romantic as the Germans when we like—can, in fact, beat them in their own lyin'. All goods manufactured in Germany can be made just as well here."—We quote the preface of this admirable little book issued by Eveleigh Nash for Messrs. Walter Emanuel and John Hassal. The sub-title of the book is "More News by Liarless," which we take it is a skit on certain items among the war news originating in Germany and daily issued to the public by The Wireless Press, and which has already become famous. It would only be possible to give an adequate review of this book by reproducing it in full for our readers, as letterpress and cartoons are so blended together that neither is complete without the other. Since we cannot do this, we advise our readers to spend 6d. and secure the book for themselves. They will not regret the money. For ourselves it delights us to see how cleverly the style and mannerisms of the German bulletins have been "hit off," but then Mr. Hassal and the witty author of "Punch's" weekly "Charivaria" have rarely disappointed us.

QUESTIONS AND ANSWERS

Readers are invited to send questions on technical and general problems that arise in the course of their work or in their study to the Editor, THE WIRELESS WORLD, Marconi House, Strand, London, W.C. Such questions must be accompanied by the name and address of the writer, otherwise they will remain unanswered.

A. C. W. (Kentish Town) asks whether it is possible to transmit by a powerful station waves strong enough, when brought through a suitable receiving apparatus, to supply an electric motor of, say, 60 h.p., at 500 volts, or a group of six motors at the same voltage, with a current strong enough for continuous working.

Answer.—The transmission of power by electromagnetic waves as distinct from the transmission of telegraphic signals has not, up to the present, received much attention. One problem is to devise an aerial or other radiator which will transmit energy in one direction only, instead of in all directions. Certain forms of aeriels are better in this respect than others, but none are suitable for the transmission of power. It will, we anticipate, be many years before 60 h.p. can be transmitted any considerable distance by electromagnetic waves, and it would need a machine of special design to be driven in this manner.

A. M. (Alloa) has tried experiments with a magnetic control using an electrolytic detector, but has experienced considerable trouble from the spark that forms at the electromagnetic contact. He asks how he can construct a non-inductive resistance such as is mentioned in the chapter dealing with the detector testing in Mr. Bangay's book. He has been using a current of about half an ampere, 3 volts, with ordinary doorbell electromagnets.

Answer.—To make a non-inductive resistance, first decide on the value of resistance required. A resistance of about 15 ohms is suitable for an ordinary pattern electric bell electromagnet, but it is best to obtain the most suitable value by experiment. For this test connect the resistance wire across the coils and adjust its length until the spark is suppressed, taking care not to have too small a resistance, which would only run the battery down.

Now double the resistance wire (which must be covered) and, commencing with the looped end, wind it round a suitable bobbin or small piece of wood, etc., bringing the two free ends out separately and connecting them to the coils as before.

Any of the ordinary resistance wires may be used and the gauge should be the smallest which will carry the current. The current can be calculated from the E.M.F. of the battery and resistance of the shunt and magnet coil circuits.

J. A. W. (Eccles) asks if the following formula is correct for calculating the length of wire required for aerial tuning inductance of a wireless receiving circuit:—

18 S.W.G. 2½—multiplying constant for same.

$$L_2 = \left(\frac{W}{4 \times 2\frac{1}{2}} \right) - \frac{1}{2} L_1$$

L_2 —Length required in feet.

L_1 —Length of receiving aerial in feet.

W —wavelength of transmitting station in feet.

Answer.—Your formula is quite wrong. To obtain the necessary inductance with a minimum resistance the wire is always wound into a coil. The inductance of a coil depends on its length and radius and not (except to a small amount) on the size of wire used. Your formula does not take account of either of these dimensions.

In order to calculate the additional inductance required it is necessary to know the capacity or inductance of the

aerial. There are formulæ for calculating either of these quantities, but except in the case of single wire aeriels they are very complicated. It is easier to measure the inductance of the aerial as follows:—

First, measure the wave-length of the aerial as it is without additional inductance or capacity. Let this wave-length be W metres.

Next, measure the wave-length when an inductance of known value is connected in series with the aerial; let the wavelength be U metres.

$$\text{Then we have } W^2 = (1885)^2 L_1 C_1$$

$$\text{and } U^2 = (1885)^2 (L_1 + L_2) C_1$$

$$\text{Whence } U^2 - W^2 = (1885)^2 L_2 C_1$$

Where L_1 = inductance of aerial in microhenries.

C_1 = capacity of aerial in microfarads.

L_2 = added inductance microhenries.

From the last equation we find C_1 , and putting its value in the first equation we obtain L_1 .

Now, using the same formula calculate the additional inductance required for the wavelength it is desired to receive.

The inductance of a coil of wire wound on a circular former is given by:—

$$L = \frac{\pi^2 n^2 d^2 l k}{1,000} \text{ microhenries.}$$

n = No. of turns of wire in 1 centimetre length of coil.

l = length of coil in centimetres.

d = diameter of coil in centimetres.

k is a factor depending on the ratio of the diameter to the length of coil

if $D = \cdot 10 \quad \cdot 5 \quad 1\cdot 0 \quad 1\cdot 5 \quad 2$

$\frac{L}{l}$

$K = \cdot 96 \quad \cdot 81 \quad \cdot 69 \quad \cdot 60 \quad \cdot 53$

The best way is to calculate the inductance of several lengths of winding and plot a curve to find the length which gives the inductance desired.

M. F. C. (Lisbon) has an electrolytic detector with an inductance of thin copper wire insulated and mounted in a cardboard cylinder, 10 in. long by 3½ in. in diameter. He asks whether he can replace this detector by another crystal, and what crystal he may use. His 'phones are high resistance, 2,000 ohms. He proposes to work an inverted L aerial about 150 ft. long and 50 ft. above the ground, for receiving only, and he asks whether this will enable him to receive signals over long and short ranges.

Answer.—You can certainly replace your electrolytic detector by a crystal. Any of the usual crystals may be used, but we advise carborundum with a potential applied to increase the sensitivity. Your aerial is a fair-sized one, but to get long-distance stations the larger you are able to make it, the better. The wire used should preferably be silicon bronze or phosphor bronze, stranded, since these are stronger than copper and better able to stand the effect of wind.

S. W. (Leeds).—We do not know of any method which has been tried for controlling a high-frequency spark by means of a microphone. You would probably meet with no success in trying to make the microphone work your spark coil, since this requires a break in the primary circuit to give a spark, not a mere alteration in resistance as would be given by the microphone.

The following method might be tried. Connect the spark coil to a high-frequency circuit, consisting of a small Leyden jar condenser and an inductance of four or five turns, wound on a large diameter former. Inside this inductance place a secondary coil of many turns, the space between the two coils being $\frac{1}{2}$ in. to 1 in. all round. The best number of turns must be found by trial. Connect the two ends of this inductance to the spark gap where you wish the spark to appear, with the microphone in one lead. It is best to connect this circuit to earth as shown. The spark coil must be working all the time and the spark gap

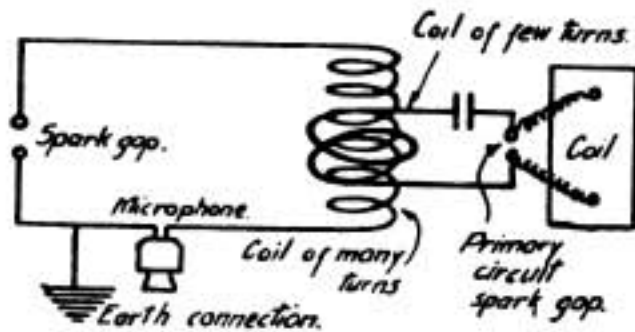

on the secondary altered till the spark just does not pass. Now, on speaking into the microphone, the resistance of the circuit will be altered and a spark may pass. A considerable amount of experiment may be necessary to get the apparatus to work. Perhaps several microphones in parallel might be better than one. The leads from the secondary coil to sparkgap must be well insulated, preferably suspended in the air by small insulators tied to strings.

Ruhmer's book on wireless telephony is the best.

With reference to your query as to the meaning of antenna circuit, the word antenna is another name for aerial, and hence the term means the aerial circuit, i.e., the capacities, inductances, etc., which are connected to the aerial.

A. R. (Swinton) has made a magnetic detector, but is unable to receive any buzz in the 'phones when he tests with the buzzer. He has had fairly good results with

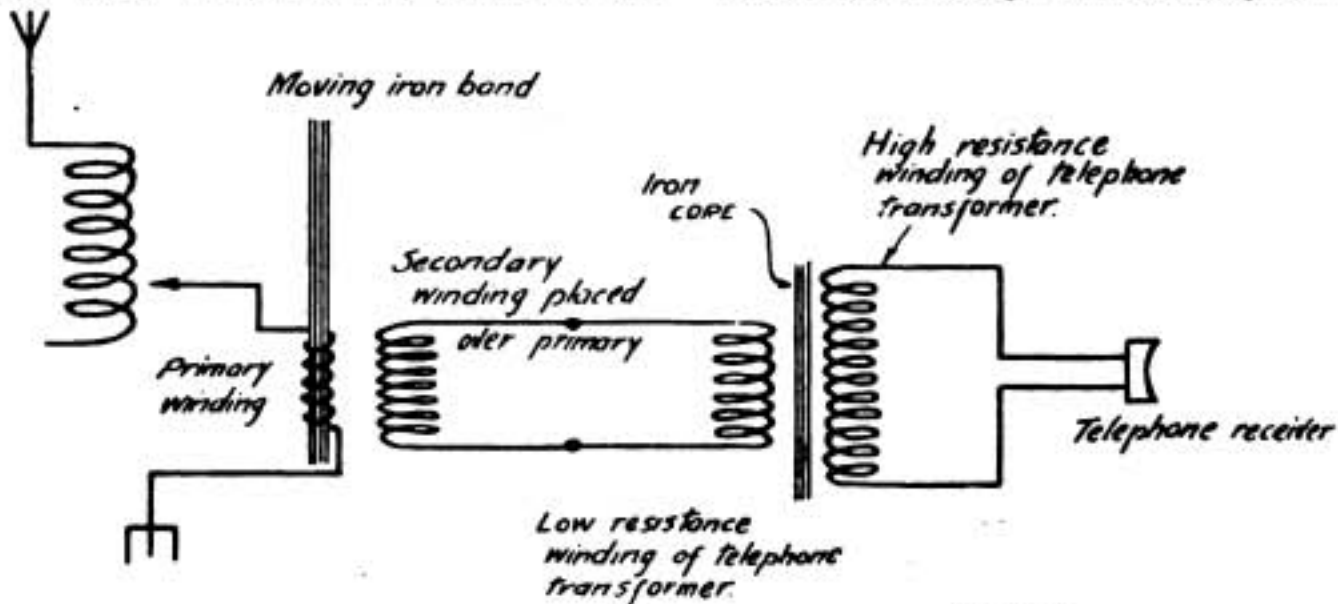

Fig 1.

crystal. He uses double-headed 'phones, with a total resistance of 4,000 ohms, and asks if these are wound at too high a resistance for the magnetic.

Answer.—In your letter you do not give any description of the circuit used with your magnetic detector and hence we are unable to tell exactly where you are at fault. However, for a start, your telephones are unsuitable, but they may be adapted for use by means of a telephone transformer. Connect the high resistance winding to the telephones and the low resistance winding to the secondary coil of the magnetic detector.

An ordinary ignition coil may be used as a telephone transformer to commence with, but the low resistance winding has usually not enough turns on it for best results. The circuit should be as Fig. 1.

From the details you give your inductance is too small for receiving Clifden. It would probably require another coil of the same size connected in series or, better still, wind a new coil half as long again as the one you have and use it. We should expect signals to be weak owing to the

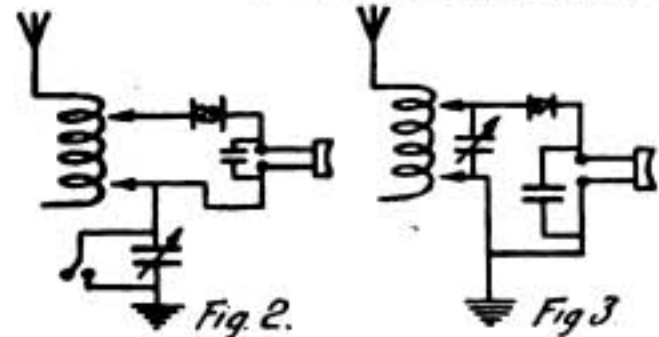

resistance which such an inductance has and the small size of your aerial. Your sketch of the crystal circuit appears incorrect in one particular. What is the short-circuited condenser for? If it is an aerial tuning condenser for reducing wave-lengths it should be in the earth lead (Fig. 2). If it is a detector-tuning condenser it should be connected as in Fig. 3.

A. C. (Brighthouse) enquires whether, in constructing an oscillation transformer, for receiving a certain wave-length, say 1,000 metres, the secondary has to be capable of tuning to the same wave-length or to a greater wave-length than the primary. (2) If the secondary is longer than the primary, a portion of the secondary would project beyond the primary. Would this portion be loosely coupled and would it be detrimental to reception? (3) Should the secondary be of larger or smaller diameter than the primary, and are large or small diameter tubes best for winding the coils on?

Answer.—(1) The design of the secondary coil of an

oscillation transformer should be such as to make its inductance of a value suitable to the particular detector in use. The secondary coil and the condenser across it will, of course, tune to the same wave-length as the aerial together with the tuning inductances and jigger primary gives—that is, to the wave-length of the signals to be received. If a high-resistance crystal, such as carborundum, is to be used, as large a voltage as possible is required at the ends of the jigger secondary. This will be obtained by using as small an external condenser as possible across it. It must not be forgotten that the actual coil itself has

a distributed capacity along its length, in somewhat the same way as that of an aerial. Hence even with no external condenser such a coil has quite a definite natural wave-length. For a low-resistance crystal, such as zincite or galena, high voltage is not so necessary, and they therefore work better with a larger tuning condenser. Hence, for working with carborundum, the jigger secondary will be bigger (not referring to dimensions, but rather to number of turns) than when working with zincite. (2) The coupling, and therefore the reaction of one coil on the other, depends on the proportion of the total magnetic flux due to a current in one coil that is wholly or partly linked with the other; the greater this proportion is, the tighter being the coupling. It does not matter whether one portion of a coil is only loosely coupled, it is the coils as a whole that have to be considered.

(3) It is usual, but not essential, to make the secondary on a larger diameter tube than the primary. In winding inductance coils, the aim should be to obtain the required value of inductance with the minimum number of turns, and therefore of resistance, other conditions being fulfilled. It can be shown mathematically that this result is obtained when the length of the coil is about three times its diameter.

G. V. (Naples) inquires concerning the theory of the synchronous disc of the standard Marconi installation. The working of the apparatus can be looked at from two rather different standpoints: first as a particular use of resonance, and second as a case of charging a condenser through inductance and resistance. Since, however, the condenser is discharged once in every half period, resonance does not really come into play very much, and for this reason, as well as on account of its greater generality, we prefer the second point of view. The conditions to be fulfilled, when the condenser commences to discharge, are, first and most important, the condenser should have just attained its maximum voltage, and second, the alternator E.M.F. should be zero, or at least very small, to lessen any tendency to arcing. If we are considering a theoretical sinusoidal wave of E.M.F. these conditions are both fulfilled by making the inductance of the value required by resonance, and setting the disc so that the discharge will just commence at the maximum condenser voltage, when the alternator E.M.F. will be zero. This requires that the disc studs shall be nearly opposite to, and approaching, the fixed studs at this instant. Hence the studs will be exactly opposite one another slightly less than 90 electrical degrees ahead of the maximum of the alternator E.M.F., usually about 85 degrees. The dual test of the quality of a setting is the high frequency power developed and the steadiness of the spark.

T. B. (Malta) sends us particulars of his installation, with the request that we should criticise it, as it will not receive ship signals from a greater distance than 60 miles.

(1) The aerial, which is only 30 feet high and 40 feet long, is rather small, even for tuning to ship waves. (2) The zinc wire that is being used for aerial wire is, of course, simply iron wire with a very thin coating of zinc. Now iron, on account of its peculiar magnetic properties, is the worst possible wire to use. The result of these properties is that so far as high frequency currents are concerned only a very thin layer (about a thousandth of a millimetre or so) is used for carrying the current. The resistance of an aerial made of iron wire is, therefore, many times greater than that of a similar one of copper wire. If copper wire is not available aluminium wire will do quite well. (3) The aerial tuning condenser is all right as to capacity (004mf.), but it should be in some way variable, say, by arranging that some of the plates will slide in and out. Also it should be placed in series with the aerial, and not in parallel with the A.T.I. and jigger as shown in the diagram. (4) For the reception of ship signals (600 metres) a smaller jigger secondary wound with coarser wire than No. 42 would be a great improvement. As it is at present there will be such a large amount of loose end on the secondary, when tuned to 600 metres, that much of the energy that should go to working the detector is lost in this loose end,

unless there is a considerable capacity across the working portion of the secondary. Such a capacity does not work the crystal at anything like its best, the ideal condition being a complete jigger secondary that just tunes to the waves without any condenser. A suitable secondary for use with the present condenser (0002mf.) can be made of a coil about 3½ inches in diameter and 6 inches long of No. 28 wire.

T. H. (Stockport).—Could you inform me how to wire up a detector-tester of three terminals, underneath base, in series with the crystal?

Answer.—Sorry, but we do not quite understand what kind of thing your "tester" is. We do not like the idea of any kind of tester in series with the crystal; much the best form is some arrangement for producing artificial signals in your oscillatory circuits—*as*, for instance, by "buzzing" a few turns of your earth-lead (*see* "Elementary Principles on the Tuning Buzzer"). If you care to let us have a description of your tester we will see if we can find a reasonably good way of using it.

H. J. S. (Lee) proposes winding a secondary coil for his jigger 7 in. long by 10 in. in dia. with No. 36 d.c.c. wire. He proposes to wind it in three layers, one above the other, and asks for our opinion on this. He also asks for a method of winding and tapping off, so that there will be no idle part of the winding connected to the conductive part of the coil to set up oscillations. He proposes to wind 300 turns in each layer, with six to eight tappings off.

Answer.—We strongly advise you to do nothing of the sort, but to wind the whole inductance in a single layer. The simplest way of avoiding an "overhanging" inactive length is to divide the coil up into several sections—with a gap of say ½ in. between each—joining the various sections on *as* required by a tie-clip clipping on to pins, the ends of the section windings being twisted round and soldered to these. Or if you do not like tie-clips and want a more "finished" arrangement, arrange plug sockets and plugs, providing a spare hole for the plug to stay in when it is not needed to connect up that particular section. By this subdivision of the secondary you can dispense with tappings and sliders, if you like; for you can have a variable condenser whose maximum value is so small that it gives you a good high potential-difference for your crystal, and yet whose variation is enough to give the complete overlapping ranges. The value we recommend for such a condenser is of the order of 0003 mfd at the maximum adjustment, and such a condenser can be of a very simple form.

Diary of Meetings.

THURSDAY, JANUARY 7TH.

Liverpool Wireless Association.—Discussion on "Wireless Telephony" at Creamery Café, 56 Whitechapel.

MONDAY, JANUARY 11TH.

North Middlesex Wireless Club.—Demonstrations with an Harmonograph, at Shaftesbury Hall, Bowes Park, London, N.

WEDNESDAY, JANUARY 13TH.

Barnsley Amateur Wireless Association.—Annual Meeting, Shaw Lane Cricket Ground.

TUESDAY, JANUARY 19TH.

Stoke-on-Trent Wireless Club.—Mr. F. Pamment on "Wireless Telegraphy in War," at the Y.M.C.A. Buildings, Hanley.

THURSDAY, JANUARY 21ST.

Liverpool Wireless Association.—Meeting, 56 Whitechapel.

Marconi Patents in America

Upheld in Action Against De Forest Co.

THE Marconi Wireless Telegraph Co. of America obtained on November 13th, from Judge Hough, in the Federal District Court, New York, a preliminary injunction against the De Forest Radio Telephone and Telegraph Co. and the Standard Oil Co., in its patent infringement suit. This prohibits the defendants from installing on the boats of the Standard Oil Co. the wireless apparatus of the De Forest Co., which the Marconi Co. contends may be used as an infringement of its own patent.

In the argument of the application of the Marconi Co. the De Forest Co. and the Standard Oil Co. had complained that since the Marconi Co. had made an arrangement with the National Electric Signalling Co. it had raised its rates for the use of its apparatus to \$100 a month for each ship. L. F. H. Betts, counsel for the Marconi Co., explained in a statement the reason of the advance. He pointed out that some time ago his clients had brought suit against the National Electric Signalling Co. in the Brooklyn Federal Courts concerning the validity of its own patents, which had been granted to Sir Oliver Lodge and Mr. Marconi. These were sustained, and the High Court of Chancery in England and the French Courts gave similar decisions.

About the same time the National Electric Signalling Co. of Pittsburgh brought similar suits in Pennsylvania against the Telefunken Wireless Telegraph Co. concerning two of its patents, which had been granted to Fessenden. These were sustained by the Circuit Court of Appeals of the Third Circuit, and the National Co. then proceeded to sue the Marconi Co. on these patents.

"Such being the case," Mr. Betts went on in his statement, "the National Co. and the Marconi Co., each having valuable patents, decided that it was for the interests of the public, as well as themselves, for licences to be granted to each other under these patents, so that each might be in a position to supply

to steamship companies the most efficient apparatus.

"It was also represented to the court that the Marconi Co. had acquired and was maintaining at great expense a large number of shore stations, to which none of the steamship companies or the De Forest Co. contributed, although the law required such shore stations to handle business from all ships, even if they were equipped with competing apparatus."

It was on account of this that the Marconi Co. raised its monthly rental for its apparatus to \$100, with the result that the Standard Oil Co. asked the De Forest people to devise a wireless set which would not infringe the Marconi Co. patents if they could. This the De Forest Co. tried to do, and their attempt led the Marconi Co. to begin its patent infringement suit. Both defendants filed numerous affidavits, the two principal contentions being that the De Forest apparatus was not an infringement and that a preliminary injunction should not be granted because of the advance in rates by the Marconi Co.

JUDGE'S TRIBUTE.

In granting the preliminary injunction, however, Judge Hough made it clear that he did not consider the \$100 a month an unreasonable rate. He said:

"I am convinced that down to the present time the expense of operation (and of litigation) has been so enormous that complainant has received no fair return from the invention, which, under decisions now ruling, I must hold to be of the greatest value and worthy of praise and regard."

Then considering the circumstances of the Standard Oil Co.'s ships, he pointed out that there is a great difference between them and those of a vessel which is compelled by law to carry wireless apparatus. In the court's opinion the Standard Oil Co. "is not bound to have wireless apparatus on its ships; it wants that apparatus for its own safety and

profit, and I cannot say, and indeed do not think, that \$100 a month is too much to pay for a device without which it is a matter of common knowledge the insurance premiums on a large and laden vessel would be greater by more than the amount of complainant's fees. I am not, therefore, disposed to withhold relief by reason of complainant's action in raising rates in this, the only, instance really before the court."

GROUNDS FOR THE INJUNCTION.

Then, in dealing with the De Forest wireless apparatus, Judge Hough had no doubt that it was a practical infringement of the Marconi patents, although it was possible to use it in such a way as to avoid any infringement. He said:—

"A reading of the affidavits leaves me in no doubt that the defendant radio company sold delivered to the Standard Oil Co. on board certain of its vessels a signalling apparatus which when put together and used in the normal way—the easiest way—and the most effective way—would infringe both the patents in suit. The whole defence amounts to this—viz., that the defendants can take and have taken an infringing set of apparatus and so arranged or co-ordinated it as to avoid infringing.

"It seems to me that it would be (under familiar cases) proper to grant a preliminary injunction here on the sole ground that this apparatus vended and used by defendants was capable of infringing and would, when ordinarily used, be operated and so adjusted as to infringe."

Judge Hough then discussed technically the points of difference between the De Forest and the Marconi apparatus, upon which the former relied as a defence, and said:—

"If the defendants' device diagrammatically shown in the affidavits, be considered with respect to the receiving claims of the Marconi patents, complainant admits that, if used exactly as shown, no infringement is proved. It is on this head that the capacity for infringement is important. I do not believe that a non-infringing device, which could be made more efficient by an operator after he gets to sea or just before starting by making it infringe, would be permitted to remain in a non-infringing and less efficient form. The injunction may issue as prayed for."

PATENT RECORD.

(September—November, 1914).

20319. September 29th. Wm. H. Shephard and A. McKechnie. Line or wireless telegraph system. (*Provisional.*)

21388 October 22nd. British Thomson-Houston Co., Ltd. Wireless signalling systems. (*Provisional.*)

21474. October 24th. T. Wm. Stratford-Andrews and Axel Orling. Receiving arrangements for wireless telegraphy. (*Provisional.*)

21872. November 2nd. Charles Horton. Wireless or radio-telegraphy. (*Provisional.*)

22609. November 16th. Lucien Rouzet. Regulating device applicable to self-induction coils or to winding of Tesla transformers used in wireless telegraphy or other application of high frequency. (*Provisional.*)

22807. November 20th. Manrico Compare. Wireless control system. (*Provisional.*)

22843. November 20th. Eugene Victor Gratze. Method or system for transmitting power or motion. (*Provisional.*)

22879. November 21st. Ettore Bellini. Apparatus for directed wireless telegraphy and telephony. (*Complete.*) (Convention date, June 24th, 1914, France.)

The *Electrical World* of New York announces that Dr. P. Cooper Hewitt has completed the preliminary work on a new development of his well-known mercury-vapour lamps and rectifiers. The main features of this invention, as outlined in our contemporary, involve (a) improvement of the vacuum-tube rectifier for feeble high frequency currents such as occur at a wireless receiving station, and (b) the development of an oscillator or converter which efficiently transforms direct current of low or high voltage into sustained alternating current of any frequency. Although the rectifier is now said to be in such form that it may be used as a wireless receiver of sensitiveness considerably greater than that of the most delicate electrolytic detectors, since the incoming energy is not only rectified but amplified, it is the oscillator which Dr. Hewitt believes to be of the greater commercial importance, both in wireless signalling and in the transmission of power. Technical details of the apparatus have not yet been disclosed, but we gather that a characteristic of the oscillator is that the frequency of oscillation may be varied instantaneously over a wide range of values, which feature should increase the importance of the device in its application to wireless.

Trade Note.

One of the conditions set out by the Convention on Safety of Life at Sea was that all ships equipped with wireless telegraph apparatus should carry an emergency lighting set, working independently of the main generator. Immediately shipowners set about to comply with the new regulations, but a plant suitable for this purpose was yet to be designed. John I. Thornycroft & Co., Ltd., who, as manufacturers of oil-driven motors have obtained a world-wide reputation, were approached upon the matter, and after many expert consultations devised a plant which is likely to meet all requirements. The Canadian Pacific Railway Company have already had it installed on their new steamers *Missanabic* and *Mctagama*. The motor is of the Thornycroft six-cylinder type, using paraffin fuel. It possesses a forty-kilowatt generator, so that there is a large reserve of power for "overload." The vaporiser is also of Thornycroft pattern, and its temperature can be easily varied to suit all grades of fuel, so that the set may be started immediately on petrol and switched over to paraffin within five or ten minutes, or started on paraffin by lamp. A special type of fuel filter is fitted, which can be cleaned without stopping the engine. The cooling water is circulated by a rotary gear pump round a closed system, and passes through a cooler on leaving the engine.

Perhaps it seems strange that suction from the pump is not taken direct from the sea, and the water after circulating the engine passed overboard; but it should be remembered that these sets, as they are intended for emergency purposes, require to be installed on practically the highest part of the vessel, frequently as much as 80 feet above the sea level; and, consequently, this more apparent method of engine cooling is quite out of the question.

The generator is direct coupled to the engine free wheel and is of the two-bearing pattern. The machine is of standard "protected" type and is plain shunt wound. Its voltage is 110. The plant is installed in a steel compartment on deck and is entirely self-contained. The switchboard is mounted on one wall of this compartment, consequently all lights can be controlled from this spot.

To conclude, the main features of this admirably conceived apparatus by Messrs. Thornycroft are compactness, absolute silence in running, great economy of fuel, small quantity of cooling water required, comparative lightness of equipment, and the simplicity with which it can be started and controlled. Such qualifications combine to make a plant which is a model of its kind.

Marconi Rifle Club.

A Marconi House Rifle Club has been formed, and the inaugural meeting was held at Marconi House on December 9th, 1914, Captain Sankey being in the Chair. After a short explanation by Captain Sankey the establishment of a Miniature Rifle Club was unanimously decided upon, and a programme of club rules and range rules was

adopted. The following officers were unanimously elected for the ensuing year: President, Captain H. Riall Sankey; Vice-President, Mr. C. B. Clay; Secretary, Mr. H. W. Corby; Treasurer, Mr. F. Atkin. The Committee will be composed of the following: Mr. H. W. Allen, Mr. A. Capelaere, Mr. N. E. Davis (representing Engineers' Department), Mr. R. H. Hill (representing Transfer Department), Mr. Stapleton (representing Field Station Department), Mr. A. R. Williams and Mr. A. W. Torode (representing Accountant's Department).

The Chairman announced that the Committee would subsequently appoint shooting superintendents, and with this the business of the meeting was concluded.

The following is a short *résumé* of the rules adopted: The annual subscription required of ordinary members to be 2s. 6d.; this shall be due on January 1st each year, or in case of a new member on election. Only members of the Marconi staff and of the affiliated companies of 16 years and upwards are eligible, and no alteration in the rules can be made without the approval of the National Rifle Association. No competitor may load until he has taken up his position on the firing point, nor leave the point without first having unloaded his rifle. At the words "cease fire" all rifles must be unloaded, and remain so until "all clear" is given. The range shall only be used during hours to be fixed by the Committee.

Personal.

Mr. T. M. Stevens has been appointed acting superintendent of the Marconi Wireless Telegraph Company of America at Baltimore, Md., in place of Mr. C. J. Pannill, who has joined the United States Government Radio Service, with headquarters at Radio, Va. Mr. G. W. Nichols is acting district superintendent at Boston in place of Mr. T. M. Stevens.

MORSE CODE CARD, showing Alphabet, Numerals, Abbreviations, etc., at a glance. Price 2d. post free.—THE WIRELESS PRESS, LTD., Marconi House, Strand, W.C.

ANY BOOKS reviewed in the WIRELESS WORLD or other magazines, will be forwarded per return upon receipt of remittance covering cost of book and postage.—THE WIRELESS PRESS, LTD., Marconi House, Strand, W.C.

MARCONI OPERATORS and others studying Wireless Telegraphy will find our series of Test Cards and books of Model Answers of considerable assistance in attaining proficiency. Full particulars on page xiii of this issue.

MAP OF THE WORLD, showing principal Wireless Stations. Price 1/8 post free. THE WIRELESS PRESS, LTD., Marconi House, Strand, W.C.

FINAL DIGEST FOR WIRELESS STUDENTS. First edition, 9d. Second edition, enlarged and improved, embracing handbook. Complete Guide to Government Examination. Useful to Operators. 2/6 net, post free 2/7½. *Liverpool Daily Post*.—"Full directions to Candidates for the Government Examination."

The Journal of Commerce.—"There is much matter in the book which Students will find it impossible to get elsewhere." Sole publishers: WALLASEY SPECIALITY CO., 11 Leasowe Avenue, Wallasey, Cheshire.