

WIRELESS WORLD

MONTHLY 3^D

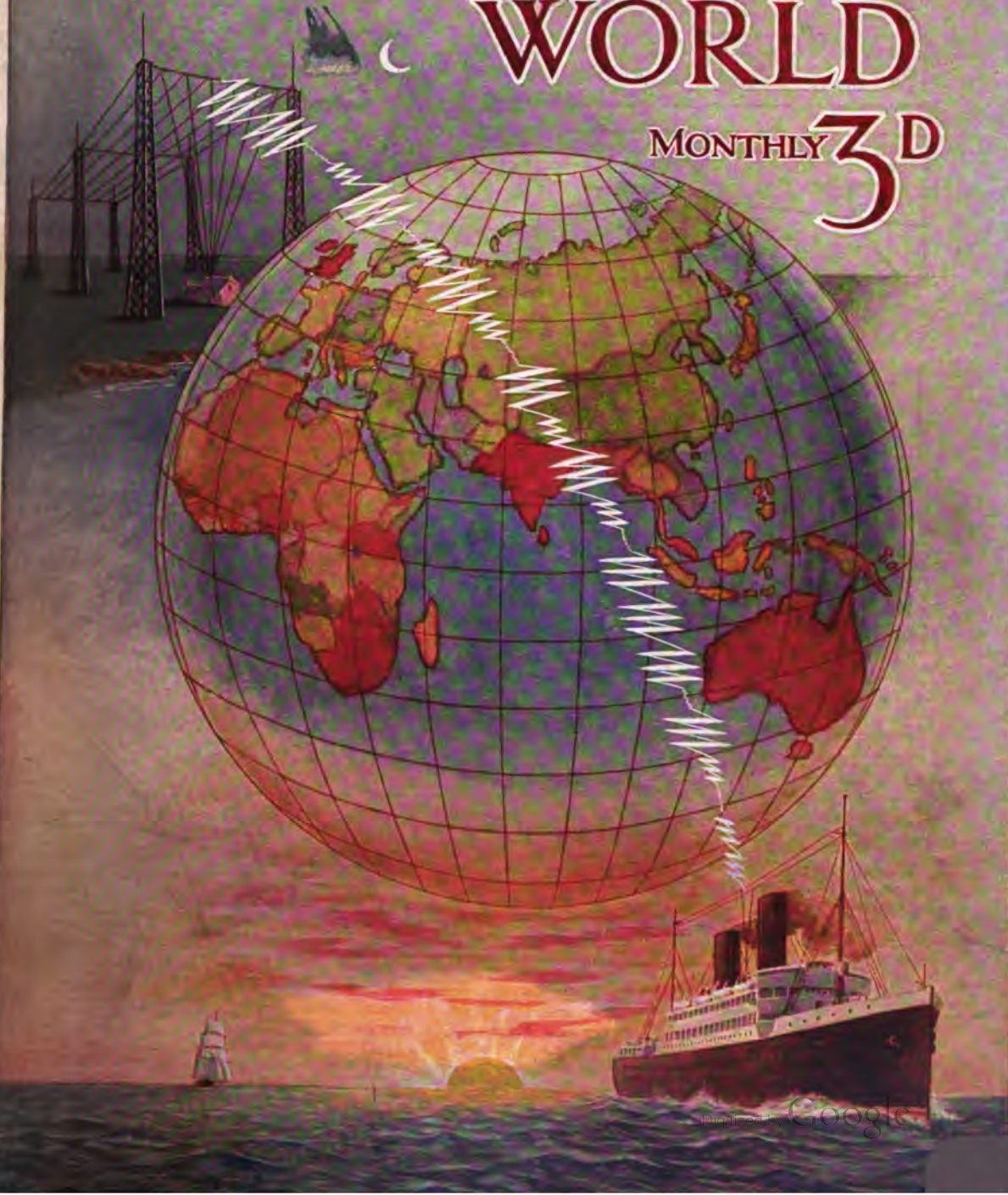

SULLIVAN INSTRUMENTS

Sullivan "Universal" Galvanometers and Shunts for Land and Sea Use.
SULLIVAN TELEPHONE RECEIVERS.

Fast Speed Wheatstone Automatic Transmitters and Receivers, guaranteed at 400 words per minute, and Wheatstone Apparatus generally. Precision and Standard Measuring Equipments for D.C. and A.C. (high frequency) determinations, Condensers of Low Power Factor, etc.

H. W. SULLIVAN WINCHESTER HOUSE, LONDON, E.C., ENGLAND.
Works: LIVERPOOL HOUSE, MIDDLESEX ST., LONDON, E.C.

Telegrams: "Deadbeat, London."

Telephone: (Office: 3518 London Wall.
(Works: 3518a)

Silk and Cotton Covered H.C. Copper Wire, Resistance Wires, Fuse Wire, Binding Wires, Charcoal Iron Core Wire, Asbestos Covered Wire

P. ORMISTON & SONS, 79 CLERKENWELL ROAD
LONDON, E.C.
Established 1793. 13259 Central.

Braided and Twisted Wires, Bare Copper Strand & Flexibles of any Construction, Wire Ropes & Cords, down to the finest sizes, in Galvanized Steel, Phosphor Bronze, etc.

NORMAN, SMEE & DODWELL

MANUFACTURERS OF HIGH-CLASS VARNISHES for Coach Builders and Decorators, Railway Carriage and Locomotive Builders, and Ship Builders Special Insulating Varnishes for Electrical Purposes

Offices and Factory: MILES LANE, MITCHAM, SURREY.

Willcox's

Undertake Supply of all Requisites

for Engine Rooms, Power Plant, Machine Shops, etc.

We shall be pleased to supply Electrical and other Engineers with copy of our enlarged

736 pp. CATALOGUE

on receipt of application on business form.

Our Specially Refined Lubricants are in use on every class of Machinery.



SEND
US
YOUR
INQUIRIES

W. H. WILLCOX & CO., LTD.
32/8 SOUTHWARK STREET, LONDON, S.E.

Please mention "The Wireless World" when writing to Advertisers.

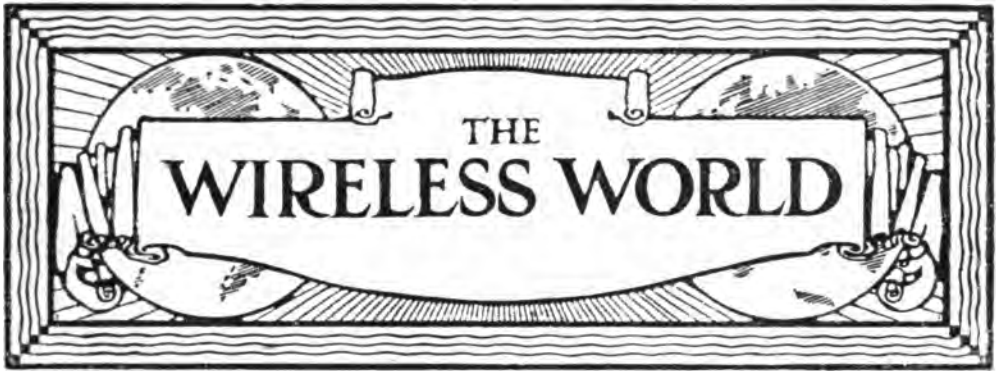

Vol. 3.—No. 26. (New Series)

May, 1915.

Subscription Price 3d.
5/0 per annum Post Free 5d.
post free.

UBIQUITY

The Birthright of Wireless Telegraphy.

TO be "Jack of all trades" continues to be popularly associated with the traditional corollary of being "master of none." Because "wireless" can fulfil extraordinary functions it is occasionally assumed by superficial observers to be less capable of performing ordinary service. Because it alone can summon aid to ships in distress, or put aviators, whilst in full flight, into connection with earth, it sometimes appears to be adjudged less capable of performing the task of conveying press and business messages to and fro across the Atlantic. Of course, there are thousands of people perfectly well aware of its powers in the sphere of such everyday, prosaic, business transactions. This fact is emphasised by the opening of the new Fenchurch Street Office, which, after all, is but a response to a real demand for the facilities it offers. But, had it not been for the idea which links wireless with the romance of the (hitherto) impossible, it is quite within the bounds of probability that that demand would have become long since too insistent to have been denied, and would, ere now, have forced the Marconi Company to supply the City with the cheap facilities for long-distance telegraphic communication, at length brought to the door of business men located in the city of London.

At such a time as this, when the thoughts of the whole world are directed to war, the fact that looms largest in the attention of the general public is that wireless telegraphy is daily proving its utility as a means of

establishing communication with ships at sea, both naval and mercantile, with aeroplanes and aircraft, with submarines, and on the battlefield. The public imagination has been fired by the revelation of what it can do in regions hitherto untouched, somewhat to the exclusion of recognition of its utility in familiar fields.

Many parts of the globe still remain in a somewhat savage or undeveloped state, awaiting the benefits which "wireless" brings in its train. We refer here not merely to outlying parts of His Majesty's Empire and to those portions of "the dark continent" of Africa still mainly "tenanted" by savages, swamps and jungles, but to countries like some of the Central States of South America, whose development has been retarded by lack of the means of communication which wireless is now opening out to them. Only the other day the ruler of the Republic of Ecuador, in his annual presidential address, laid emphatic stress upon the beneficial results of the new long-distance station erected within their boundaries.

In fact, it is immaterial whether we look at the manifold activities of the civilised world or let our vision range geographically over the various parts of the globe: whether we confine our attention to the earth or extend it to the air or to the sea—we still feel that a stage has been reached in the development of wireless telegraphy which justifies our contention that ubiquity forms its most striking characteristic.



COMMANDER
F. G. LORING, R.N.

Personalities in the Wireless World

COMMANDER F. G. LORING, R.N., M.I.E.E.

THE name of Commander Loring is so well known to all who are interested in wireless telegraphy that a few notes in connection with his life and work are certain to be a welcome addition to the biographical library of wireless celebrities published month by month in our pages.

Commander Frederick George Loring, R.N., M.I.E.E., Inspector of Wireless Telegraphy at the General Post Office, has had a distinguished and varied career, and is still a man in the prime of life, having been born on March 11th, 1869. He is the eldest son of the late Admiral Sir William Loring, K.C.B. Following in his distinguished father's footsteps he entered the Navy at the age of 13, and served in various parts of the world, notably in Australian and Pacific waters.

In 1891 Lieutenant Loring was appointed to the Royal Yacht—a service which carried with it special promotion on its termination—and two years later was serving on board H.M.S. *Victoria* when she was rammed and sunk on June 22nd, 1893, by H.M.S. *Camperdown* off the coast of Tripoli. This disaster occurred during the middle of a fine afternoon, and the *Victoria* went down in less than 15 minutes, carrying with her many lives, among whom was the Commander-in-Chief of the Mediterranean Fleet, Vice-Admiral Sir George Tryon. Lieutenant Loring was instrumental in saving two lives on this occasion, and for his gallantry was awarded the Bronze Medal of the Royal Humane Society. With regard to the sinking of the *Victoria*, it is a strange fact that when she was re-commissioned at Malta, a few months before the catastrophe, the Maltese, who are a very superstitious race, were loath to serve on her, and many Maltese bandsmen and servants of the first commission positively refused to re-engage for the second commission, despite the fact that the *Victoria* was the Flagship of the Mediterranean Squadron.

Disaster was freely prophesied for the

ship, and many persons were reported to have received warnings in dreams concerning her. But strangest of all is the fact that on the very day the *Victoria* was sunk rumours were rife in Malta that a very serious accident had befallen the ship, long before any information could possibly have reached the island in those pre-wireless days.

In 1894 Lieutenant Loring was selected to undergo two years' special training in electrical engineering in order to qualify as a Torpedo Officer, and on the completion of this period he received an appointment on the Staff of H.M.S. *Defiance* (Captain H. B. Jackson). Here he first came into touch with wireless telegraphy, and was a witness of Captain H. B. Jackson's early attempts in this direction.

One of the first ships to be fitted with a permanent installation of "wireless" was H.M.S. *Alexandra*, to which ship Commander Loring was appointed in 1900.

In 1902 he was offered the appointment of Officer-in-charge of Naval Shore Wireless Telegraph Stations, which he accepted, and since that date has been exclusively employed on radio-telegraphic duties.

Being offered his present important post as Inspector of "Wireless Telegraphy" at the General Post Office in 1908, Commander Loring retired from the Navy after receiving the thanks of the Admiralty for his valuable services in the cause of radio-telegraphy.

During the tenure of his present office Commander Loring has twice served as delegate at important "Wireless" Conferences—viz., as Admiralty Delegate at the International Conference of Wireless Telegraphy held in Berlin in 1906, and as Post Office Delegate at the International Conference in London in 1912. In addition to this, Commander Loring served as Adviser to the Board of Trade in matters connected with "wireless" at the "Safety of Life at Sea" Convention of 1914, at the termination of which he received the special thanks of Lord Buxton for his eminent services.

Resonance Phenomena in the Low Frequency Circuit

By H. E. HALLBORG

PART II

FIG. 3 is an outline of a method used by the writer of charting a low-frequency circuit, and thereby obtaining a complete graphical record of its inductance characteristics. It shows the relation between total secondary inductance as ordinates, and series connected inductances, primary and secondary, as abscissa. The three curves shown give, respectively, the value of the alternator inductance referred to the secondary, the value of alternator and transformer referred to the secondary, and the value of alternator, transformer and secondary loading coils referred to the secondary. Any condition of the circuit is at once available. When the iron is worked at moderate densities, as in the units above mentioned, it was found that the curves are quite straight lines, and only a few readings were necessary to locate the entire curve. With this data at hand, the value of condenser for resonance, the point of best operation, and even the general shape of the resonance curve can be closely approximated.

Fig. 4, taken by the *primary ampère*

method, shows the actual tuning curves of the 300-kw. alternator-transformer circuit at New Brunswick for various settings of the secondary loading coils. It will be noted that as the circuit is stiffened by adding loading coils the primary current amplitude falls, and the resonance effect is sharpened.

The decrease in primary current amplitude is probably due to added resistance as coils are inserted, and to the large increase in resistance due to the smaller number of condensers required as the inductance is increased, as previously pointed out. The stars

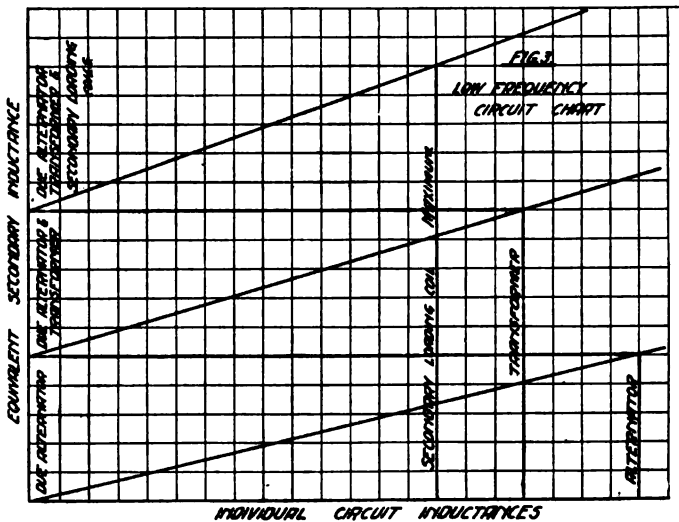

Fig. 3.

indicate actual operating points at different wave-lengths. Since these operating points fall quite within the middle ranges of the loading coils, it is evident that it is possible to make factory adjustments as above outlined, with a high degree of accuracy.

Fig. 5 is an application of the *primary ampère method* and the *secondary voltage method* to a 2-kw., 500-cycle, 110/18,000 volt open core transformer designed for a

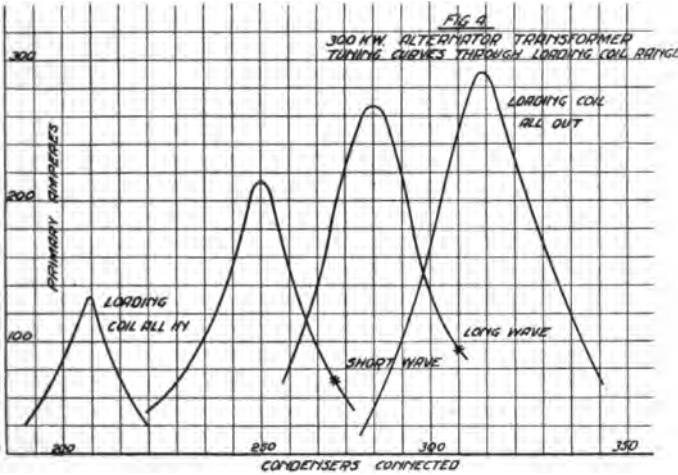

Fig. 4.

synchronous rotary spark set. It will be noted that the point of resonance taken by the two methods does not occur at the same condenser value; but that the *secondary voltage method* gives an inductance value somewhat less than the value obtained by the *primary voltage method*. From the alternator-transformer constants of this particular circuit—namely, 3.4 ohms synchronous impedance, and 2.8 ohms transformer impedance—we deduce for the equivalent secondary inductance by the Ratio² transformation the value 19.7 Henrys. The value of capacity for resonance should therefore be 0.0051 mf. However, the curves show this inductance to be about 30 per cent. greater than the figure deduced by the Ratio² method. For a loosely coupled transformer, such as the one under consideration, Seibt deduced the expression $L_2 = \frac{1}{\omega^2 C (1 - K^2)}$ for the value of secondary inductance for resonance with capacity, C, and coupling factor, K, equal to 0.7. Solving for K from the data above given, we get a value about 0.5. This figure is more nearly in conformity with the writer's experience and results on open core units. With closed core transformers, K is unity, or at least nearly enough so for all practical purposes. The operating point for best results is shown by a star. The natural frequency of the circuit corresponding is 407 cycles, or 18 per cent. below the alter-

nator frequency. The variation of primary voltage and current with frequency changes is also shown. These curves are quite similar, as is to be expected, since they are linked together by the relation $E = 2\pi f L I$, where $2\pi f L$ is the generator impedance, and I , the current flowing.

Fig. 6 is of interest since it demonstrates quite conclusively that alternator synchronous impedance has an effect on resonance similar to any inserted inductance of equivalent value, and must be considered as

such. Curve A is the resonance condition when no reactance is inserted in series with a transformer and a 2-kw., 500-cycle alternator of 0.5-ohm synchronous impedance. Curve B results from connecting a reactance of 3 ohms in this alternator-transformer circuit. Curve C is the result obtained by using the same transformer with another alternator whose synchronous impedance is 3.4 ohms, or roughly the sum of the impedances of curve B.

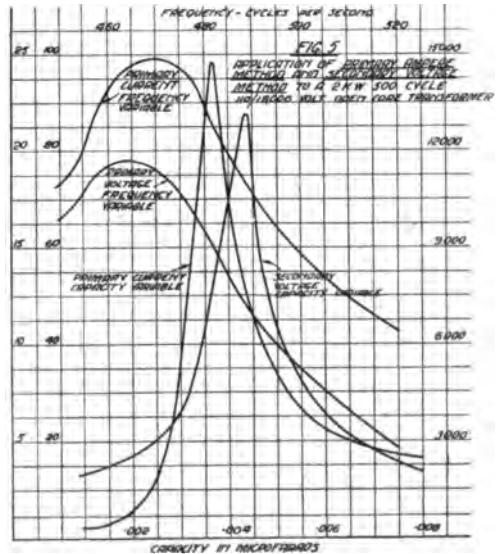

Fig. 5.

Fig. 7 illustrates the effect on resonance of adding resistance in series with the secondary circuit of a 7.5-kw. open core transformer. The resistances inserted were carbon rods of 700 ohms each. The curves become rapidly flatter as the resistance, or damping, is increased. The amount to completely wipe out resonance is approximately such that the rated output is all consumed in the resistance. Resistance has no effect on the resonance curve other than broadening the tuning, so to speak.

Fig. 8 shows the effect of resistance inserted in the primary of a 2-kw., 500-cycle, 110/18,000 volt transformer circuit. These curves are striking examples of the correctness of the deduction that inserting a resistance R_1 in the primary circuit has an equivalent secondary effect of $\text{Ratio}^2 \times R_1$. Resonance is wiped out surprisingly fast. In this experiment the point of resonance moved slightly to the left in the direction of increased inductance, since the rheostat used was slightly inductive. The curves were made by the secondary voltage method.

Fig. 9 represents the conditions found to occur in a 5-kw., 500-cycle, 110/12,500 volt open core transformer tested by the secondary voltage method when a step-by-step primary inductance was inserted. Secondary voltage rise becomes sharper, and its

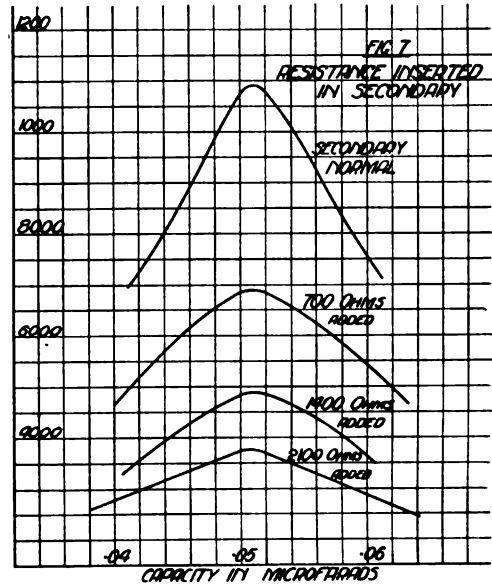

Fig. 7.

amplitude greater as more primary inductance is inserted. We have noted in Fig. 4 that the primary current falls off with increased inductance; hence the secondary current must likewise drop. If the secondary voltage is to be considered as resulting simply by the building up of voltage across inductance of the secondary by the relation $E_s = 2\pi f L_s I_s$, it is evident that a condition such as here shown can only result when the secondary inductance increase is more rapid than the secondary current decrease. This is probably the case with open core transformers having liberal copper and a relatively weak coefficient of coupling.

Fig. 10 demonstrates the desirability of detuning the alternator-transformer circuit of a quenched spark transmitter with respect to the alternator frequency. The natural frequency of this circuit is seen to be 450 cycles, or 50 cycles lower than the alternator. This setting represents the working point nearest resonance with this particular set for a perfectly clear note. It was also the most efficient operating point. A detuning of 100 cycles or 20 per cent. is nearer the average condition.

Fig. 11 shows a simultaneous set of primary voltage and primary current readings for one of the settings made on the

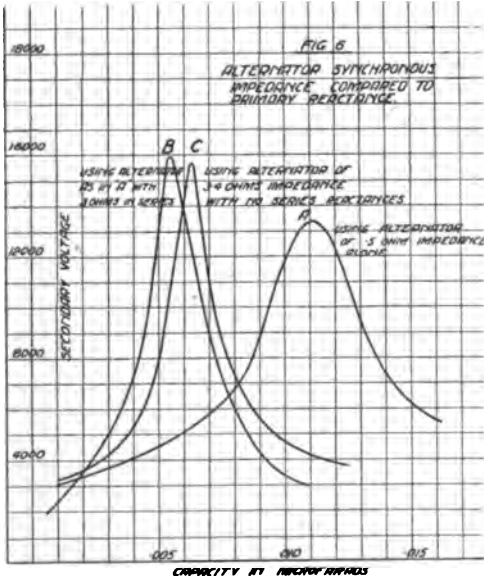

Fig. 6.

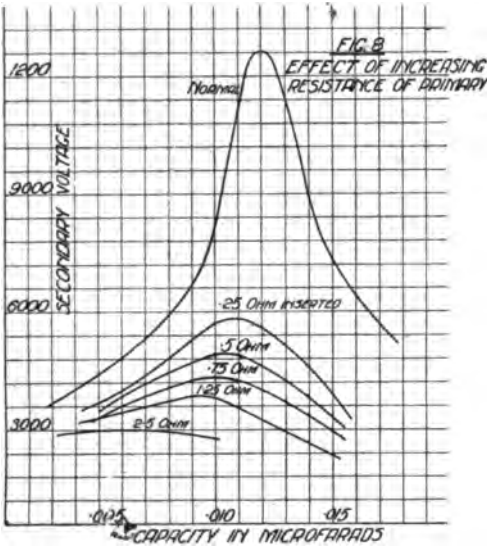

Fig. 8.

300-kw. set at New Brunswick, and shown in Fig. 4. The primary voltage curve checks quite closely with the voltage calculated from the simple relation $E_1 = 2\pi f L_1 I_1$, or is merely the product of alternator synchronous impedance and the current flowing. A few calculated points are shown by circles.

Fig. 12 is a record of the simultaneous primary and secondary currents of the 300-kw. set at New Brunswick during a resonance setting as above. These curves were taken to determine the extent of the variation of transformer ratio during resonance. The two curves are plotted against the same ordinates by multiplying the secondary current by the winding ratio, and plotting primary amperes direct. It is apparent that no wide change of ratio occurs.

Some vital facts may be gleaned from the

data presented in regard to the design of transformers for this class of work. Quite evidently, low resistance values in both primary and secondary are desirable. Further, it has been demonstrated that the total circuit inductance is the value of prime importance from the point of view of resonance. We have also noted that this circuit inductance may be made up of a number of separate small inductances, or concentrated in the alternator and transformer alone. For a particular specified capacity value in the oscillating circuit the most efficient arrangement is that in which the total inductance is made up in the alternator and transformer only. Both copper and iron losses are thereby reduced; but the arrangement lacks flexibility if a wide range of capacity is to be used. Usually this is not the case. Flexibility, if desired, is most easily obtained by means of primary variable reactance, or, better still, from the point of view of efficiency, by varying the mutual inductance of the transformer, thereby regulating its flux leakage.

The choice between open and closed core transformers for wireless work has long been a point in dispute. The open core transformer has the advantage of simplicity. It has also the inherent high leakage charac-

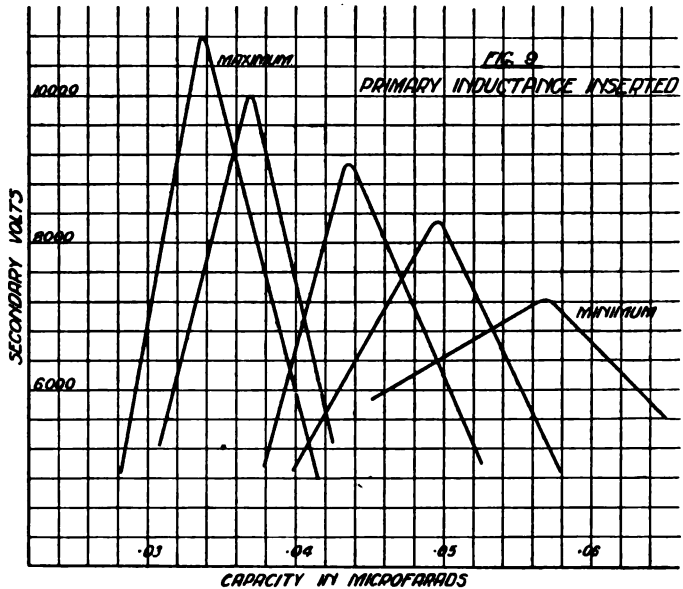

Fig. 9.

teristic sometimes so desirable. It requires more iron and wire for a given output than the closed core unit. Assuming the same magnetic flux density in a similar unit of each type, the copper loss in the closed core unit will be less, since less wire is needed; and for the same reason its iron loss is lower, since the volume of iron is less, although the flux densities are the same. The closed

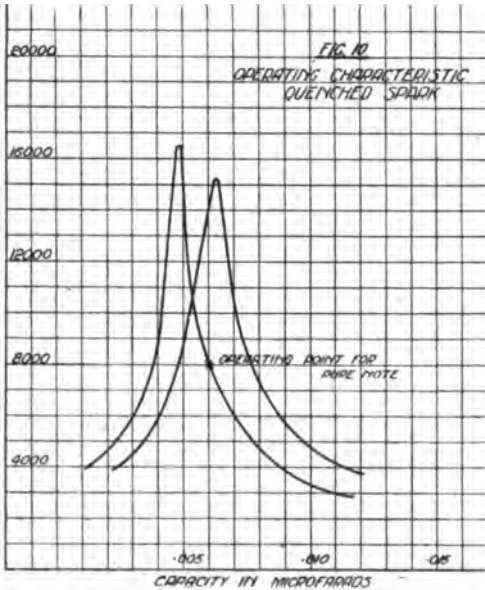

Fig. 10.

core unit, therefore, is more efficient. A considerable saving in space in favour of the closed core type also results. This saving, as we have just noted, is effected in both core and coils. High leakage may be obtained in the closed core type by careful disposition of the windings without resort to magnetic shunts or other devices. It is apparent for these reasons that the closed core transformer is the more economical type both electrically and mechanically.

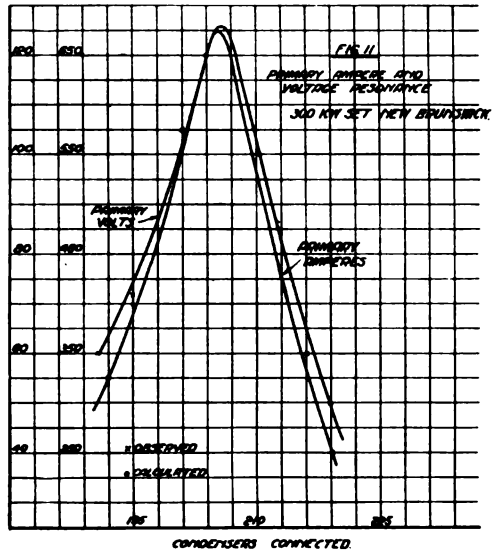

Fig. 11.

[Presented before the Institute of Radio Engineers on the evening of November 4th, 1914, Columbia University, New York.]

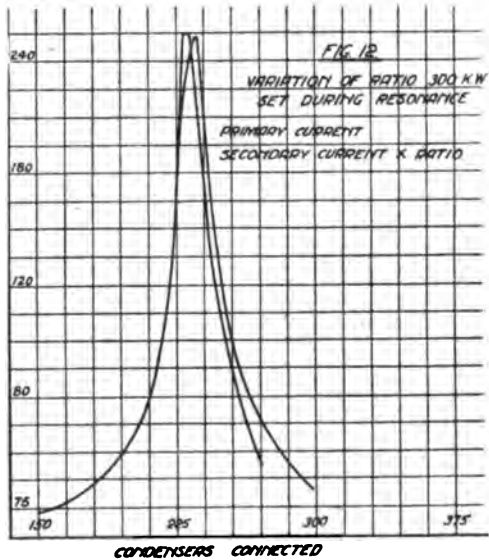

Fig. 12.



Digest of Wireless Literature

ABSTRACTS OF IMPORTANT ORIGINAL ARTICLES DEALING
WITH WIRELESS TELEGRAPHY AND COMMUNICATIONS READ
BEFORE SCIENTIFIC SOCIETIES.

THE INSTITUTE OF ELECTRICAL ENGINEERS.

The following is an abstract of a paper on "Some Experiments on the Induction Generator," read before the Students' Section of the above Institution by Mr. W. H. Date, B.Sc.(Eng.), on March 17th:—

The author begins by mentioning how little is known about induction generators; this fact causing him to write the present paper.

First consider what constitutes an induction generator. An ordinary polyphase induction motor whose rotor is mechanically driven above synchronism is capable of acting as a generator provided its stator terminals are connected to a polyphase generator which supplies the exciting current necessary to maintain the rotating field. Hence an induction generator is not self-exciting. Apart from this difference, the performances of induction and shunt-wound continuous current machines are very similar: each develops a torque which increases very nearly in proportion to the decrease of speed from no-load speed, and each, if driven at a higher speed than this, is capable of acting as a generator.

It may be mentioned that the property of an induction motor of acting as a generator at speeds above synchronism is used on some railways to return power to the line on a down gradient, thus providing an economical method of braking.

The author suggests that this method of regenerative braking might also be advantageously employed on comparatively slight gradients if a pole-changing switch be provided for increasing the number of poles. The effect of this would be at once to decrease the speed of the rotating field, with the result that the machine would commence to generate and pump current back into the line at a much lower speed of the rotor.

Mention may be made of the following

interesting experiment. An induction generator driven by a shunt-wound motor was connected to a three-phase generator driven by a d.c. motor. The supply was then cut off from this motor, which, however, still continued to revolve, being driven by the three-phase generator, now acting as a synchronous motor, on power supplied by the induction generator. The same thing occurs if the three-phase generator is replaced by a rotary converter and the d.c. supply is cut off.

The importance of these experiments must be obvious to all station engineers who have to deal with alternators running in parallel. The disastrous effect that may overtake the plant if any one of the generators should be suddenly deprived of its excitation is entirely avoided if the machines be fitted with the amortisseur circuits, thereby converting them into induction generators when required. Further, there is no danger nor waiting when synchronising.

A modified form of the Hopkinson test can be carried out if one pulley is made smaller than the other, so that the machines run at different speeds.

The author then discusses the phase relations of the various currents, and constructs vector diagrams.

Then follows a description of tests made on a 1 h.p. 3 ph. 60 cycle 60 volt motor, running at 1,650 revs. per minute. The machine was run both as a generator and as a motor, the change from one to the other being made gradually, by increasing the power supplied to the driving motor. With reference to the well-known Heyland diagram, it was found that the readings for the motor and generator gave a practically complete circle. Similar results were obtained from a single-phase machine.

In conclusion, the scope and advantage of the asynchronous generator based on the results obtained from the experiments will

be summarised as far as possible. First and foremost, perhaps, we have seen that in a system supplied by induction generators the troubles of hunting and synchronising cease to exist. Every station engineer is aware of the dangers of hunting and synchronising with synchronous generators; with the induction generator it becomes exceedingly simple to parallel a machine on to the bus-bars. In consequence the switchboard controlling a set of induction generators would present none of the complications met with in a station of synchronous generators.

From a mechanical standpoint also there appear to be some rather striking advantages. The rotor of the induction generator would be squirrel cage, thus doing away with slip rings, and as such could be built to stand higher centrifugal stresses than in the case of the revolving field. Further, an accurate balance of the rotor could be obtained far more easily than is the case at present, since the distribution of material in the rotor would be symmetrical. It is evident then that the induction generator is especially suitable for turbine speeds.

With the machine in parallel with a synchronous motor, we have seen that the voltage, frequency, and power factor are all capable of easy regulation, and that the generator will stand a heavy overload.

The author puts forward the suggestion that a station equipped with these machines driven by turbines and running in parallel with high-speed synchronous motors would be cheaper to instal, and would possess the above advantages over a station employing synchronous generators.

TRANSMISSION BY DAMPED AND CONTINUOUS OSCILLATIONS.

In the *Bulletin* of the Bureau of Standards, Vol. II., No. 1, there is an interesting note by L. W. Austin on wave-lengths and transmission by damped and continuous oscillations. The testing of the recently erected high-power United States naval radiotelegraphic station at Arlington, Va., has given another opportunity for carrying out experiments on the relation between the currents in sending and receiving antennas at varying distances, and at the same time for investigating the relative advantages of transmission by means of damped and continuous oscillations. At present the observa-

tions on the transmission of different wave-lengths over great distances are too meagre in number to settle the question of the relation between the attenuation of the signals and the wave-length. It is certain, however, that the attenuation even over sea-water is very much decreased as the wave-length is increased. The comparisons made of the efficiency of arc and spark transmission have indicated that for distances of the order of 3,700 kms. or more continuous oscillations are on an average superior. The evidence is not complete enough to prove that this superiority always exists. It is apparently connected in some way with the reinforcement of the signals from the upper layers of the atmosphere, and is subject to the vagaries of this portion of the received energy. The indications seem to be that the superiority of the continuous oscillations is greater in winter than in summer.

MEASUREMENT OF HIGH FREQUENCY ALTERNATING CURRENT.

In a paper read before the Royal Society, Messrs. A. Campbell and D. W. Dye describe some important investigations on the measurement of alternating currents of high frequency, and give some simple practical methods of obtaining precision. The authors commence by referring to the importance, both from a scientific and practical point of view, of accuracy in such measurements, and point out that whilst by the methods at present in use it is comparatively easy to measure currents of the order of 0.1 ampère, many difficulties present themselves when we have to deal with currents of 1 to 50 or 100 ampères.

Dealing firstly with thermal instruments, the paper states that the most common method of measuring a high-frequency current is to pass it through a conductor and observe the rise in temperature of this as shown by its expansion or change of resistance, or by means of one or more thermojunctions in contact with it or near it. The last method, that of a heater and separate thermopile, was investigated by one of the authors many years ago, and was used later to measure the voltages induced in small search coils by alternating magnetic fields. The separate heater system was used by Mr. Duddell in his beautiful application of Mr. Boy's radiomicrometer to current

measurement; and his thermo-galvanometer still represents the high-water mark in efficiency. Whilst, however, the self-contained thermo-junction and moving coil no doubt give the highest efficiency, the use of a thermopile connected to a separate galvanometer has several advantages, especially in laboratories where economy of instruments has to be considered.

The authors next describe the thermopiles they used, mentioning that the most frequently used couples were either iron-constantan or magnanin-constantan. The iron-constantan couple has two strong points in its favour: it gives a voltage almost exactly proportional to its temperature, and the temperature coefficient of its voltage sensitivity is very small. On the other hand, the high thermal conductivity of the iron is not desirable and its magnetic properties may give trouble.

Some interesting particulars are also given of the behaviour of a separate heater and thermopile immersed in oil. It has been found that several important factors have to be taken into consideration in connection with the thermal expansibility, the viscosity, and other properties of the liquid. Current transformers are next dealt with, and a description of air-core transformers suitable for use in measuring large alternating currents is given. The authors next give the methods used and the results obtained in testing air core transformers, each transformer being tested at a number of frequencies.

There is a very general belief that the use of iron in high-frequency measuring instruments is almost impossible, since hysteresis and eddy current effects become so pronounced when the magnetic cycle is repeated at such frequent intervals. In the case of current transformers, however, this is quite a mistake, for most excellent results can be obtained by the introduction of iron cores, and it is not even necessary to use specially thin iron sheet or wire in making these.

In dealing with general conclusions the authors state that it is evident from their experiments that properly designed air-core transformers, when used with due care in conjunction with thermal ammeters, afford a simple means of measuring currents of the order of 1 to 50 amperes with good accuracy

at frequencies from 50,000 up to 2,000,000 cycles per second. Iron-core transformers, which have some advantages in ease of construction, can also be designed to fulfil the same purpose and to give very satisfactory results.

LEEDS ASSOCIATION OF ENGINEERS.

At a recent meeting of the above Association, Mr. H. F. Yardley read an interesting paper on Wireless Telegraphy, before an appreciative audience. Mr. Yardley commenced by outlining the history of wireless telegraphy from the time that Faraday made his initial experiments with induction, and next dealt in simple language with the subject of waves and wave-motion. He went on to compare the waves of light with those used in wireless telegraphy, showing that the main difference was one of wave-length, the waves in wireless being about a million or more times longer than those of light. Mr. Yardley then informed his audience of the different methods of producing the electric waves, starting from the experiments of Heinrich Hertz and running through the early and later experiments of Marconi. A description was then given of the Marconi, Poulsen and Telefunken systems, the lecturer explaining the differences in construction of apparatus, etc., by which these systems are distinguished. Some mention was also made of the Marconi transatlantic station at Clifden.

Details of the apparatus were described in clear and simple language, the connection between the various parts being dealt with in an interesting manner. Finally the lecturer made reference to practical working and the difficulties which present themselves to the operator and experimenter.

At the conclusion of the lecture Mr. Rainforth, the president, remarked that Mr. Yardley had dealt with a very complicated subject in a very simple manner, and various members asked questions, to which the lecturer gave reply. On the proposition of the Vice-President, a hearty vote of thanks was passed to Mr. Yardley for his interesting and very instructive paper.

WIRELESS AND THE MERCURY VAPOUR ARC.

In the March number of *Modern Mechanics*, Mr. Robert G. Skerrett writes concerning the

work of Dr. Peter Cooper Hewitt and the Mercury Vapour Arc in its relation to wireless telegraphy. The article is entitled "A New System of Radio Communication," but perusal of it shows that the novelty lies only in a mercury vapour arc being utilised as a generator of oscillations and a specially modified form as a receiver. Dr. Hewitt, in the course of an interview, stated that he had discovered that "there are nearly forty things going on inside the tube of a mercury vapour arc," although in the beginning he thought there were only three. Some of the comparisons alleged to have been made by Dr. Hewitt between the "spark-gap" oscillators and the mercury vapour arc call for some comment. As an example we quote the following:—

"The spark-gap oscillators are costly affairs: the big rotor for this work weighing five tons in one of the Transatlantic plants. It is built well-nigh as carefully as a watch and, to carry the comparison further, is pretty nearly as delicate. Constant heavy work is apt to derange it. Mechanically the Poulsen arc is much simpler, but the difficulty lies in the fact that the carbons between which the flame is made burn out rather quickly and are expensive to replace. . . . I have found that I can get from a mercury vapour arc oscillator, weighing not more than two pounds, an uninterrupted flow of Hertzian waves that will reach as far as those generated by the sparking machine in which the rotor weighs quite 10,000 pounds."

We presume the rotor referred to is the rotary spark discharger of a very large wireless plant. A plant sufficiently large to require such a heavy disc would be capable of radiating some hundreds of kilowatts. A mercury vapour tube weighing only two pounds and which can utilise even one hundred kilowatts must be a remarkable invention!

Again, we cannot agree with the statement that the Poulsen arc apparatus is mechanically simpler in a large plant. Further, the difficulty lies in many directions other than that of the carbons burning away and being expensive to replace.

At the conclusion of the article it is stated that in the mercury arc transmitter and the mercury arc receiver Dr. Hewitt has the

essentials of a successful long-distance system of wireless telephony.

OBITUARY.

DEATH OF AN EMINENT TELEGRAPH EXPERT.

We regret to have to record the death of Sir John Cameron Lamb, formerly Second Secretary of the Post Office, which took place on March 30th at his residence in Hampstead. Sir John (then Mr. Lamb) entered the Post Office in 1864, and was one of a group of young men who eventually took a large share in the development of the service as it exists to-day. In 1870 he was selected with others to assist in negotiations for the acquisition of the Inland Telegraphs, which up to that date had been entirely in the hands of private companies. In 1888 he carried out most of the arrangements in connection with the introduction of sixpenny telegrams. As a result of the growth of the telegraph business between England and the Continent, and the necessity of cheapening the rates to meet commercial requirements, it became increasingly apparent that the public interest demanded that cables connecting this country with France, Holland, Belgium and Germany should be owned by the respective States, and in 1884, and again in 1888, Mr. Lamb attended conferences with the officials of the various telegraph administrations concerned, and negotiated agreements for the joint acquisition and working of the cables. Mr. Lamb took part in three international telegraph conferences—in 1890 in Paris, in 1896 at Buda Pesth, and in 1903 in London. He was appointed Third Secretary of the Post Office in 1896, and in the following year became Second Secretary. Mr. Lamb was the Senior British delegate at the first International Conference on Wireless Telegraphy, held in Berlin in 1903. From 1892 to 1897 he served as a member of the Royal Commission appointed to consider the establishment of electrical communication with light-houses and lightships. He received the C.M.G. in 1890, the C.B. in 1895, and had the honour of knighthood conferred on him when he retired from the Post Office in 1905, after more than forty years' service.



Palma—the capital of the Island of Majorca.

LIFE ON THE SÓLLER STATION.

A narrative of everyday experiences in the Majorca (*Balearic Islands*).

By E. BLAKE.

IN these days of Cook's tours it is surprising that there should be in the Mediterranean, only two and a-half days' travel from Charing Cross, an island about which the majority of English people know practically nothing; an island populated by a proud, intelligent, and historic race with a grammar and literature of its own; a people which has given soldiers and statesmen to Spain, which possesses railways, telephones, and telegraphs (not to mention the wireless station), and which is a strenuous and enthusiastic imitator of

the English in the matters of boxing, "bridge," tennis, and five o'clock tea. I refer to Majorca and the Mallorquines. The average Briton would probably stoutly deny his ignorance of Spain, but confess to haziness in regard to the Balearic Islands. Madrid? Oh, bullfights—and all that! Seville? Marmalade oranges! Barcelona? Why, of course, that is where the nuts come from! Spain generally? Guitars, daggers hidden in señoritas' garters, bombs, onions, and King Alfonso! But Majorca! Was there not an Admiral

Byng who was shot? . . . no, that was Minorca. . . .

Here is an island of mountain torrents and mountains clothed wellnigh to their summits with olive-gardens; of rich valleys where the date, the fig, the orange, lemon, and grape flourish prolifically with a minimum of human labour; an island where the air is like wine and fragrant with the scent of almond and orange blossom. To reach this great orchard you follow the ordinary route through Paris and Port Bou to Barcelona, travelling thence by mail steamer to Palma, the capital of Majorca. From Palma an hour's journey by rail through the heart of a mountain-range brings you to Sóller, a town of semi-tropical beauty, set in the hollow of the hills. Three miles from here is the sapphire-coloured sea lapping the little fishing village of El Puerto de Sóller,

and a coast which by reason of its magnificence is the despair of artists.

The wireless station is situated on the top of Punta Grossa, a rock some 700 ft. high, overlooking Sóller Bay, and at the time of which I write we three British operators lived there together with a cook, a labourer, and a mule. When I left the staff had been augmented by two dogs, several generations of cats who held no very narrow views on the subject of consanguinity, a stud of guinea-pigs and one lonely hen. The labourer also had a private snail-farm which supplied him with breakfasts when the hen forgot her duty. Our only neighbours were the two lighthouse-keepers who tended the penny-farthing oil-lamp which was supposed to be a guide to mariners.

It must be admitted that when the glamour



Wireless Station at Sóller, showing base of Sectional Steel Mast.



El Puerto de Sóller.

of the scenery began to lose its power and we wearied of tramping over the rough volcanic rock which was the chief geological feature of the district, we were rather at a loss for spare-time occupations. At times we had had attacks of bottle-shooting with pistols, and a herd of half-wild pigs which often invaded our domains with disastrous results to our earth-wires, gave us sport, for we stoned them relentlessly. In El Puerto was an antediluvian motor-boat which we coaxed into a semblance of activity and in this we sometimes went clanking round the coast, listening to the irregular explosions of the motor as one might to the heart-beats of a dying man, wondering which would be the last. The bathing was splendid, and possible during about eight months of the year, commencing from February. There lived in the bay a healthy breed of small octopuses, but we had the luck to escape meeting any of these. The only fishing which seemed to pay for the trouble was of the "seine-net" variety, and of shooting there was none worth the name. Still, for the artist, the photographer (oh, yes! *you* are an artist also) and the archaeologist the island is a veritable Tom Tiddler's ground, though with regard to photography one has to take one's chance with the local chemist. He is really an alchemist.

There are plenty of mountains, but the inducement to climb them is small, for Spanish sunshine and, maybe, a breath of the sirocco straight from Algeria incline one more to indolence and the sucking of oranges than to stepping heavenward with

a blistered nose for reward. We did actually scale the highest peak, some 6,000 ft. high, accompanied by mules and guides, and everyone agreed that the drinks were the best part of the expedition.

In winter our amusements were very few, for the island receives its yearly supply of rain during the first quarter. The town of Sóller afforded us nothing in the way of diversions. The inhabitants are people of simple tastes and retire early. Their clubs, *fiestas*, which are holidays brightened by mild flirting with fans, cheap sweets and a brass band, and gambling constitute their chief pleasures. We used to sit in our little living-room and quarrel as only exiled Britons can, discuss all questions of Time and Eternity, and indulge in an enthralling card-game called *siete y media*, by the playing of which for half a day one might win or lose twopence-halfpenny. As a more serious employment, apart from official duty, one could sit in the springless cart behind Juanina the mule, and partly wobble, partly bump, down into Sóller for the mails. The zig-zag path down the cliff was just about as wide as the cart and was stayed with boulders. On the right hand the cliff mostly rose up sheer and on the left it dropped sheer. There was a two-foot mud wall (*adobe*), mostly broken down, along the left-hand edge of the path (going downward) and the joy of the ride lay in the fact that Juanina had for many years been employed in walking blind-folded round a water-distributor. Mules thus engaged proceed counter-clockwise, so that by long habit Juanina had an irresistible, incurable bias towards the left. Thus her



Sóller—set in the hollow of the hills.

helm was in a permanent state of hard-a-starboard, and only a concentrated mind working in sympathy with an unslacking pull on the right-hand rein saved one from driving off into space.

Britons like to live as Britons wherever they are, and we at first found serious differences existing between Mallorquin fare and that to which we were accustomed. We hankered after the fleshpots, and all we could get was lean, mountain-fed mutton. For six months we ate dry bread until a local trader was induced to import butter—at 2s. 6d. a pound. Save as an occasional medicine, tea is not used in those rural parts, but by perseverance we got it, at 5s. a pound. Fruit and vegetables are plentiful and extraordinarily cheap. Tomatoes grow in the open fields in rows like potatoes in England, and one often sees loaded grapevines forming the hedges of a public lane. Fig-trees flourish rooted in the crevices of bare rock, and it is as inconceivable that they should find nourishment there as it is that the gnarled, dead-looking trunks, some of them centuries old, which cover the hillsides should be olive trees capable of bearing, sometimes, a double yearly crop of fruit.

The less said about the tobacco the better; the Government supplies it. It is said that the Mallorquins are inveterate smugglers, and I do not blame them, for even hardened smokers draw the line somewhere.

I said that the people are a historic race. Tacitus it is, I believe, who mentions the slingers of the Balearic Islands, who as

mercenaries in the ancient wars took only women and wine as payment. Slinging is to this day an accomplishment of which the peasants are proud. When the Moors overran Spain, including Majorca, they were distinctly unpopular with the people of Sóller, who on more than one occasion kicked them out of the district. One great battle was fought in Sóller bay, when the Moors, who arrived in ships, were met with fusillades of cannon-balls and "pot-legs" from the entire village. A landing was effected, but the Sóllerenses were "all over them," and the heads of the raiding expedition were captured and executed in the market-place. The old cannon still lie behind El Puerto. Every three years there is a special holiday in honour of the event and the battle is re-enacted in costume. Even the various sailing strategies of the Moors are carefully imitated by those who constitute the invading force, and the young bloods have a glorious debauch of gunpowder, finishing with a first-class rough-and-tumble as the "Moors" leap ashore. One of these celebrations took place during my stay there, and while I was carefully focussing the pirate king the tide of battle rolled over me, and the subsequent appearance of my negatives was sketchy and nebulous. Their value to the daily illustrated Press would be enormous, for they can be used to illustrate such subjects as "Foggy Weather in the Vosges," and "Wurtembergers looking for bread-cards during an earthquake."

The Mallorquines speak an obvious mixture of Spanish, French and Italian, very similar to the Catalan tongue. The question of which has the *pukka* language and which a dialect is still an acute one between the people of the island and the inhabitants of Cataluña, and from time to time evokes some pretty wit in the newspapers. The people are a healthy, happy, and contented lot, not overburdened with education or ambition. They are great lovers of their country and fully alive to its marvellous beauties, and as long as the various crops do well and there is a bullfight now and then, all is well indeed.

Not even in Sóller, which thinks Barcelona is the hub of the world, can one escape the ubiquitous boy-scout, who is there with his bare knees, broomstick, and badges, endeavouring to burnish the glory of Spain.



The Path was staved with boulders.

To give the reader an idea of what life is like in the sleepy village of El Puerto de Sóller, I conclude with a summary of a typical week, in which for obvious reasons I clothe fact with fancy.

Monday.—Oldest inhabitant appears with brand new seat to his trousers. The knife-grinder receives a telegram; mass-meeting outside his house and local paper comments favourably, incidentally dragging in the glory of Spain. Three babies arrive—two Pedros and a Maria.

Tuesday.—Local policeman observed cleaning his rifle; Revolutionary Club at once denounces Government. Narizroja, the tavern-keeper, lays in a new cask of wine and a bottle of Benedictine; receives gold medal from local Chamber of Commerce and newspaper alludes to new spirit of enterprise animating noble bosoms of sons of glorious Spain. Three babies arrive; two Dolores and a José.

Wednesday.—Local policeman leans up against an entirely different post; Conservative Club thereupon passes vote of lack of confidence in Government. Revolutionary Club buys cartridges. Four babies arrive—two Pedros, a Dolores, and a Maria.

Thursday.—Exciting day. Two pieces of paper blow past and a dog goes off at a tangent. This being too much for nerves of oldest inhabitant, he runs amuck. Two babies arrive—José and Catalina.

Friday.—A priest pulls a boy's ear; powder play by Revolutionary Club. Three members of same arrested several times in rapid succession by Mayor in name of: (1) God and the King; (2) his honour; (3) his duty to Spain; (4) the memory of the immortal Cervantes. Liberal Club, frantic with joy, stands Mayor much vermouth. He makes a speech on patriotism, the Cuban question, the glory of Spain, and the new by-law concerning goats' milk; bursts into tears and gives his sword away to the billiard-marker. Two babies arrive—Pedro and Maria.

Saturday.—Commandante of Marine puts on collar and officially looks at the weather. All political clubs censure Government, but policeman now being up against his usual post has quietening effect, and only one man is shot. Mayor discovers that brand new seat to oldest inhabitant's trousers corresponds to the missing portion of one of his (the Mayor's) potato-sacks.



Among the Olives.

Oldest inhabitant swears by the imperishable lustre of the glory of Spain and the finger-bones of Raymond Lully* that he has seen no sack. Not the Mayor's sack. And even if it *were* the Mayor's sack, what of it? He would spit upon the Mayor's shadow. Thus! Pah! Pork! Son of a—a Magdalene! To accuse him, Don Manuel Alfalfa y Algarroba, whose parents were gentlefolks and took baths! Ay, Dios mio! señores, was ever a Spanish caballero thus unjustly . . . Is led off to bed. Four babies arrive—two Josés, one Antonio, and a Marietta.

Sunday.—Profound peace. Priests drift about like fat bumble-bees. Commandante of Marine puts on collar and milks his mother-in-law's goat. Oldest inhabitant tells Revolutionary Club once again his great story entitled "How I drew gore from a sergeant of carabinieri in '39." Revolutionary Club goes out *en masse* and darkly regards local policeman from beneath beetled brows. Man accidentally shot in Conservative Club simply because he mentioned to knife-grinder that he would give five pesetas for a sight of his (the knife-grinder's) heart and liver. All babies baptised, including three Saturday night stop-press editions—Pedro, Catalina, and Aldebaran.

* Raymond Lully was a Majorcan soldier of fortune turned monk. His cell is one of the show places of the island.

The ENGINEERS Note Book

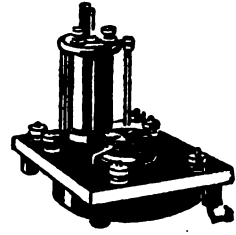

[Under this heading we propose to publish each month communications from our readers dealing with general engineering matters of various kinds in their application to wireless telegraphy, and we would welcome criticisms, remarks and questions relating to the matter published under this heading. We do not hold ourselves responsible for the opinions and statements of our contributors.]

Starting by Hand.

ENGINES up to about 50 B.H.P. which are fitted with an efficient compression release and hand-turning gear are easily started by one man of average strength, but a hint may not be out of place—viz., that something more than getting the engine round is essential for easy and expeditious starting. It is assumed that careful looking round and oiling, as per instruction book, will always be part of the routine when starting up, so that the engine may be in a proper condition, then after placing the compression release lever in the starting position, the attendant should commence slowly pulling the engine round, preferably starting from a position when the handle is being pulled towards him rather than pushed away. At the second revolution, when the inertia of the moving parts has been overcome, special effort should be made not only to increase the speed to a maximum, but to overcome the compression and ensure a good spark from the magneto. If the engine does not respond to this treatment, take a rest, and again examine matters to see that the vaporisers are correctly heated and the fuel-feed valves acting, etc., and then proceed as before. Continual turning round is absolutely unnecessary and futile, besides being very tiring, and is never likely to get the engine to work. It is just for this reason that occasionally one hears of a man pulling an engine round for a long time with no result, and then asking some-

one who is fresh to have a turn, and it starts immediately. Knack, coupled with intelligence, is really of far more value than brute force. It should be noted that the method of starting up an oil engine is quite different from that usually adopted for starting up a petrol engine, which is suddenly jerked over the compression.

Starting by Compressed Air.

As the frictional resistance of the larger engines would be too much for one man to conveniently overcome and attain a sufficient speed for getting under way, it is usual to fit a compressed air equipment which operates as follows:—A suitable service of pipes is led from a shut-off valve to distributing valves operated from the camshaft, and it should here be noted that the compressed air is only used for the purpose of turning the engine round, in exactly the same manner as the hand turning above described, therefore no attempt should be made to start against a load, and the compression release should be used so that no energy may be wasted in overcoming the high compression; in fact, unless the compression release is used, there is every possibility of back firing, which would defeat the end in view. Certain marks will be found on the rim of the flywheel and the gears which drive the lay shafts of the engines. By hand barring the engine has to be brought into such a position that these marks are in a line, thereby placing the cranks in the best position for making the most of the compressed air. After

priming the vaporisers, and seeing that everything is in order, the compressed air valve should be turned on sharply, and immediately the engine is heard to take up its ignition, this valve should be closed and the half-compression lever put into the working position.

A word or two on keeping the air receiver well charged may be advisable, and to that end it is a good practice to always start the air compressor and re-charge the air receiver previous to putting the engine upon her working load. There should be a stop valve on the receiver as well as one on the engine, and, when properly charged, both should be closed to prevent leakage. In case a joint is suspected of leakage, a drop of oil or thick soapy water smeared round will instantly reveal its position by the gradual formation of a bubble, and it should be remembered that the minutest leak in the air service is sufficient to rapidly lose all pressure from the receiver. The little air compressor itself should receive careful attention from time to time; it should be kept thoroughly clean, well lubricated, and the valves in perfect order.

Various Engines.

The above remarks apply to almost all types or fuels, but for suction gas outfits it is specially necessary to make sure gas is delivered right up to the engine before attempting to turn on any compressed air for starting, as otherwise the receiver would be exhausted before the service pipes had been sucked clear of air.

Suction Gas Plants.

Another word of warning on the subject of Suction Gas Plants is that the gas itself is exceedingly poisonous, and therefore the generating house and engine room should be both thoroughly and efficiently ventilated, and a card hung up in each place showing the symptoms and remedies for gas poisoning. One of the most important is fresh air, but with any ordinary care no danger need be anticipated; it is only the careless or inexperienced who are likely to be affected.

We have pleasure in reproducing below a letter which we have received from a reader of THE WIRELESS WORLD concerning the "Engineer's Note-book" for March. The letter has been submitted to the writer of the Notes in question, and his reply is

appended. We welcome such criticisms as these, as they add considerably to the interest of the articles.

"*The Editor, THE WIRELESS WORLD.*

"SIR,—Allow me first of all to express my appreciation of the excellence of the current number of THE WIRELESS WORLD. You invite criticism of the 'Engineer's Note-book.' While agreeing with the first part of the section 'Engine Maintenance,' which is excellent, I may be allowed a word or two on the last part *re* bearings.

"The method suggested of slacking back the cap nut is hardly a good one, I think, because if first of all you tighten the nut on the cap with the fingers the bearing is loose, and tightening the outside lock-nut on it will make it also slightly more loose and throw the strain of the bearing on the cap and bolts, instead of the solid block of a good bearing.

"May I suggest a better way is to fit a thin paper liner the shape of the cap, and over the bolts, and then to tighten up the bearing, tight, and try the fit of the pin, but no engineer, fitter or erector worthy of the name would leave a bearing needing to be further fitted by either method, which is at best a makeshift.—Yours faithfully,

"W. E. DENSLow."

The writer of "Notes on Internal Combustion Engines" has much pleasure in replying to the criticism of adjustment of bearing, and much appreciates the kindly spirit in which it was proffered. He is perhaps the better able to make his defence, having been trained in the practice of marine steam engines, and therefore can appreciate the origin of the comments on our methods—which it must be distinctly understood apply *solely* to internal combustion engines.

Your correspondent's method is perfectly correct as applying to bearings taking their thrust and pull evenly as in steam, but with internal combustion engines the bearing only receives working thrust, and there is no "pull" whatever; in fact, the caps only serve the purpose of preventing the journal jumping away from its bearing. Even on the non-working stroke there is the "compression" which keeps the bearing and journal in contact, and on many multi-cylinder engines it is common practice to

only have bottom bearing between cranks and a cap to each end bearing.

Another feature is that instead of a comparatively even applied turning effort, as in steam, the impulse of an internal combustion engine is more of the nature of a blow, which in a new engine has a gradually hardening effect on the white metal lining and may necessitate adjustment far more frequently than with steam, and this adjustment must always be of the nature of a micrometer adjustment: hence the method adopted. It would obviously be impossible to be continually renewing or refitting linen strips between cover and housing.

In conclusion, we would say that the method has been perfectly successful on a very large number of engines, and may add, moreover, that it is accepted as perfectly good practice by the Admiralty, War Office, and other Government Departments at home and by the Consulting Engineers for the India Office, Crown Agents for the Colonies, and many foreign governments and private firms of high standing, when it is applied to internal combustion engines.

One slight correction is necessary—viz., we recommend bringing the surfaces in contact *first* by tightening with a spanner, then adjusting finger tight, and then tightening back on to the lock-nut, which does give just the correct clearance without unnecessary slackness.

IN LIGHTER VEIN.

Our irresponsible expert sends us the following announcement:—

BERLIN, February 31st.—It is rumoured that a new company has been formed to acquire the apparatus on interned German ships. The title is to be "The Benighted Wireless Company."

From over the sea comes an account of an invention by a scientist in the United States. He possesses an electric dog, which follows him about and is controlled by means of a selenium cell and an electric light. We, ourselves, in the editorial offices have an electric cat, which follows us about and is controlled by a piece of cat's meat. Its electrolytic is milk.

WIRELESS POETRY.

"LIGHT from an inside source" is shown, with regard to an operator's life, in a recent issue of the *Marconi Service Magazine* (San Francisco). We give below three verses extracted from a poem headed "This is the Life."

Said Billy McGee,
Who worked in a shop,
"What's to hinder me
From becoming an Op.
And ditching this grind
For a job at sea?
And I've a mind
To quit, by gee"—
And so he did.

Then Billy McGee
To Marconi went
And off to sea
Was shortly sent
On the *Flee Maru*,
Of the Muggins line,
With uniform new
And buttons "ashline"—
And so was he.

And Billy McGee,
Most all the trip
With pail on knee
And pale of lip,
Sighed for the shop,
But sighed in vain,
For seas will slop
And stomachs will strain—
And so did Bill's.

"WIRELESS WORLD" INDEX AND BINDING CASES.

The Index to Volume II. of THE WIRELESS WORLD is now ready, and will be sent free of charge to any reader requiring a copy, provided a penny stamp is sent with the application to cover cost of postage.

Cloth cases for binding the first volume of THE WIRELESS WORLD have also been prepared, and these are on sale at 1s. each (postage 3d. extra). A limited number of bound copies of Volume II. of THE WIRELESS WORLD are available, price 4s. 6d net each copy (postage 6d. extra).

Applications for binding cases and copies of bound volumes should be sent with full remittance to the Wireless Press, Ltd., Marconi House, Strand, London, W.C.

Administrative Notes

United Kingdom.

We are informed that from March 18th, 1915, the Seaforth Wireless Station will be closed to commercial service.

* * *

United States.

The Bureau of Navigation has issued the following note on the subject of wave-lengths and interference in the official "Radio Service Bulletin":

With the opening of many high-power stations during the last two years the Bureau has received complaints of interference, particularly on the longer wave-lengths. Heretofore, in the issuing of licences, in very few instances have wave-lengths requested by commercial companies been refused. However, some consideration now must be given to the distribution of wave-lengths, especially among high-power stations. The Act of August 13th, 1912, to regulate radio communication, was designed to execute, on behalf of the United States, the International Radiotelegraph Convention, and thus to promote the orderly exchange of radiotelegrams. Section 2 of the Act empowers the Secretary of Commerce to specify the wave-length or wave-lengths which may be used by commercial stations, and hereafter particular attention will be given to this matter, and in most cases only one or two wave-lengths above 1,600 metres will be authorised for high-power stations. The attention of those concerned is particularly invited to the London Radiotelegraph Convention service regulations, Article 35, paragraph 2, concerning the use of the 1,800-meter wave-length. Applicants desiring the use of additional wave-lengths must submit with Form 761 a detailed statement of the purpose for which additional wave-lengths are desired, and such statement will be considered with regard to wave-lengths assigned to other stations.

A request for several wave-lengths for the purpose of passing from one wave-length to

another to avoid interference will not be considered.

* * *

Antarctic.

The steam yacht *Aurora* of the Imperial Antarctic Expedition will probably winter in Macmurdo Sound in the Ross Sea, and remain there until the early part of 1917. Steamers of the New Zealand Shipping Company, Shaw Saville, and other lines, which run direct from New Zealand to South America, pass within 2,000 miles of the steam yacht *Aurora's* proposed base. Operators on these steamers may on occasion be able to establish communication with the *Aurora*, and deal with any traffic that the ship may have to dispose of.

* * *

Panama.

An arrangement as to the operation of wireless telegraphy at Panama Canal has been made between Sir Cecil Spring-Rice, the British Ambassador, and officials of the United States State and Navy Departments, under which certain hours of the day will be set aside for the uninterrupted use of the air by warships, and during the remainder of the time the shore stations will handle their messages without interference from the British naval operators.

* * *

Ratification of International Convention.

The British Government has notified the International Bureau at Berne that the Radiotelegraphic Convention of London, together with the final Protocol and Service Regulations, has been ratified by Greece, Morocco, and Brazil, dating from July 24th, 1914, November 2nd, 1914, December 18th, 1914, respectively. It is also notified that Guatemala, Panama, and Colombia have agreed to the Convention of London from July 10th, 1914, July 14th, 1914, and August 25th, 1914, respectively.

Wireless Telegraphy in the War

A résumé of the work which is being accomplished both on land and sea.

WE reproduce below an excellent view of Cumberland Bay, in Juan Fernandez, the spot in the "Robinson Crusoe Island" where, guided by wireless, the three British cruisers—*Kent*, *Glasgow*, and *Orama*—discovered and destroyed the German "commerce destroyer" *Dresden*. The island was discovered in 1563 by the Spaniard whose name it bears, and was, for five years, the solitary abode of Alexander Selkirk, a Scotch buccaneer, whose story is supposed to have suggested Daniel Defoe's famous novel referred to above.

We drew attention in our April issue to the imaginative fictions which our enemy circulates all day long and every day by wireless, and so good an opportunity as the sinking of the *Dresden* did not fail to draw from

them a characteristic piece of fiction. Juan Fernandez belongs to the Republic of Chile, whose relations with Great Britain have been most cordial, both before and since the war. The clumsy German attempt to create friction between Englishmen and Chilians over this incident fell remarkably flat.

* * *

Our evening contemporary, the *Globe*, in a recent issue printed, in one of their leaderettes, some remarks from which we extract the following:

"For once we find ourselves in complete agreement with a correspondent in the *Westminster Gazette* in his protest against the adulation which 'Eye-Witness' so frequently bestows upon the enemy.



Cumberland Bay, Juan Fernandez.



German Submarine Craft, showing Antennae

“Nothing, it seems to us, could be better calculated to improve German morale than these acknowledgments of German bravery and skill. If the authorities responsible for the dissemination of news in England would let us have the German *wireless uncensored* the end they have in view would be much more speedily and safely attained. There can be no question here of betraying secrets to the enemy. A little more common sense and a little less reticence would be all to the good, particularly in stimulating recruiting.”

We may remark that our contemporary appears to be a little unfair to those whom he is pleased to call “the authorities.” A good many of the deletions made by them in the German official wireless messages consist of paragraphs deliberately fabricated by Germans in order to sow dissension between the various countries with whom they are at war. To allow such baseless fabrications to be circulated in the English Press would effect no good object, and would, indeed, be playing the game for these malicious Teutonic “kite flyers.”

* * *

We have often had occasion to refer to the advantages gained by ourselves and our

Allies through the employment of wireless in the present war. But the captain and crew of the French steamer *Auguste Conseil* are unfortunately not able to speak with whole-hearted appreciation! The *U29*, which was responsible for the destruction of this French vessel, in the course of the farcical attempt at “blockade,” which the Germans vaunt so much, appears to have owed some of her successes to the employment of radio-telegraphy. Captain Léon Gouin, who was a passenger on the unlucky steamer, said that not only did he observe that *U29* was fitted with wireless apparatus, but he actually witnessed the use of it by the German commander. We reproduce above a photograph showing how antennae are fitted on submarine craft.

* * *

The supreme importance of wireless telegraphy in linking up outlying portions of King George’s Realm, Dominions and Colonies was further brought home on the occasion of the terrible explosion which occurred in the Shetland Islands about the middle of April. Nature, by storms and seas, seems to have done her best to cut off the inhabitants of the Shetland and Orkney Islands from the mainland. But radio-

telegraphy makes light of such obstacles, and a large number of the public have doubtless heard for the first time from the columns of the newspapers that "the only communication with the Islands is maintained by wireless."

* * *

Considerable interest was aroused during the earlier part of the war in what all the newspapers denominated the "Treasure Ship." Few people can, even now, understand how it was that the *Kronprinzessin Cecile*, with her two millions in gold and six hundred thousand pounds in silver managed to escape the cruisers seeking for her. The full story has recently appeared, and, as wireless was responsible for the success of her elusive feat, perhaps readers of the WIRELESS WORLD may be interested in the narration of how it was done. At the time of the declaration of war, she was 107 miles west of Plymouth, *en route* for Bremen, *via* Plymouth and Cherbourg. With German thoroughness every eventuality had, for years, been provided for. In common with all other commanders of German liners, Captain Polack was in possession of sealed orders which had remained unopened on board his ship for about two years. At ten o'clock on the night of August 1st he received the following message by wireless:—"Eberhard has suffered an attack of catarrh of the bladder. (Signed) Siegfried." He immediately went to his cabin and opened his sealed orders. The translation read "War has been declared between Germany, France and Russia. Turn back." Lights were dimmed, port-holes covered, and the *Cecile* hurried at full



The Wrecked Generators at Duala.

speed back to the United States. More explicit wireless telegrams reached him during the next twenty-four hours, and the result was that, *thanks to wireless aid*, the enemy's treasure ship eluded British cruisers, and put into Bar Harbour on August 4. These sealed orders from the German Admiralty had been distributed amongst the captains of merchantmen as far back as the spring of 1908.

* * *

In the Cameroons the earlier land operations of the British were not very successful. The first expedition, after succeeding in occupying Tebe, was repulsed from the German station at Garua, and compelled to retire into British territory. But, whilst these events were taking place on land, H.M.S. *Challenger* and *Dwarf* had reconnoitred the mouth of the Cameroons river, and the approaches to Duala, the chief town. On September 26th the above-mentioned ships bombarded the town, and the following day both Duala and Bonaberi surrendered unconditionally to an Anglo-French force under the command of Brigadier-General C. M. Dobell, D.S.O., A.D.C. Little damage was done to property by the naval bombardment, but the enemy destroyed their wireless station and instruments before evacuation. Our illustrations will indicate the thoroughness with which this was done. The whole place was set on fire; the roof fell in and completed the destruction that had been begun by smashing the commutator and the motors, besides destroying the switchboard and connections. The station had been placed about two and a half kilometres from the town itself. The wireless tower was visible from the sea for a distance of ten miles. At the time when the warships were preparing for their cannonade there



The Fallen Wireless Tower at Duala.



What remains of the Station Buildings at Duala.

was much speculation among the crews of the various vessels in the port as to when it would be knocked down by the bombarding ships. The Germans themselves, however, saved the enemies the trouble, and destroyed the tower at 8.30 a.m. on September 27th, just previous to the surrender.

* * *

We were all of us glad to hear the news of the safe arrival at Queenstown of the Harrison liner *Wayfarer*, which constitutes, up to the present, the largest victim of the German-submarine pirates since the starting of their egregious "blockade." There appears some little doubt, even now, as to whether the injury done to her was wrought by a torpedo or a mine, and the authorities are very properly not allowing any information to be given for the present. But whatever may have been the cause of her disaster, her safety is due to the fact that she was fitted with wireless, and that, in consequence, help was speedily forthcoming in response to her signals. Another British ship which avoided disaster "by the skin of her teeth" was the ss. *Theseus*, a vessel owned by Messrs. Alfred Holt and Company, and belonging to their well-known Blue-funnel Line. She was chased for some hours by one of the pirates. An engineer, writing to the Marine Engineers' Society, at Liverpool, gave a very interesting account of the chase, which was published in the *Journal of Commerce*. In this case the vessel would

seem to have been in some measure indebted to the presence on board of five engineers in addition to her own full complement. As soon as the word was passed that the enemy was signalling "Stop and abandon ship," the Chinese crew started deserting the stoke-hole and engine-room. The engineers buckled to, and "a few seconds later they were awaiting the orders of the officers in charge of the engine department." Speed and good handling resulted in the escape of the steamer, but when our engineer correspondent came on deck he was able to perceive the effect of the fusillade of shots fired in the course of the pursuit. He ends up his interesting letter in the following significant terms: "The only regret we have to record is the fact that no wireless was fitted, so as to have enabled other ships to be warned of the danger."

* * *

Officials at the Admiralty hear a great deal that does not find its way to the outside world. A delightful story is going around there anent the way in which the news of the Heligoland Bight fight first reached headquarters at Whitehall. It appears that wireless telegraphy played a naturally important part in this brilliant little engagement, and a number of the messages which flew from ship to ship whilst the messages were in progress were picked up by the wireless operators at headquarters. Most of them consisted of "odds and ends" of



The Nerve Centre of the British Navy.

messages—little bits of eager exhortation. One of the sentences thus intercepted ran, "Bear round sharp to starboard and you will catch them." This and similar items, pieced together with other orders that came through, seem to have been the first intimation to the British Admiralty that the "real thing" was going on. We can easily imagine the excitement which must have prevailed amongst those acquainted with these isolated facts before the definite official intimation of the engagement arrived. It is small wonder that the wireless installation of the Admiralty roof should possess, under existing circumstances, a fascinating interest for Londoners and visitors to London. As one passes down Whitehall, or crosses the Horse Guards Parade, folks are often seen pointing out the aerials to one another. It must certainly be a feeble imagination which would fail to be thrilled by the thought of what these wires could tell us if they were at liberty to speak. They form, indeed, what we may aptly term the nerve-centre of the British Navy.

* * *

Our enterprising contemporary, the *Zodiac*, has secured what is known amongst

journalists as a real "scoop" for their March number. This consists of a full story of the *Emden's* last effort, the destruction of the wireless station at the Cocos-Keeling Islands. In our Vol. II., No. 21, of December 21st, 1914, we published a note with a view of these islands; and our contemporary is now able to print a full narrative of the incident, together with many illustrations. The landing of the German boat party to the various vital points is very dramatically narrated, and the description of the three dynamiting attempts necessary before the wireless mast was finally dislodged from its resting place (*see illustration, page 95*) indicate how excellently the work had been originally done by the contractors. The work of demolition was most thoroughly carried out. The engine room was wrecked; the dynamos and all the apparatus ruined beyond repair. The switchboard and all the receiving and sending apparatus were smashed to atoms, the latter presenting a spectacle chaotic to behold. Even the unoffending seismograph house, on the outskirts of the town, was demolished. We have reproduced at various times many illustrations of wireless masts

in all their glory and pride of place, and it may be interesting to our readers to see a reproduction from a photograph of Mr. R. A. Cardwell, of the Cocos-Keeling mast after its treble dynamiting by the *Emden* party. It would not be possible for us to extract the account of the battle between the *Emden* and the *Sydney* as described in the *Zodiac* article, but such a thrilling incident is one that does not often fall to the lot of a wireless operator to witness.

* * *

Newspaper readers have got so accustomed to trace the influence of the science with which Marconi's name is indissolubly connected in every phase of activity, that, whenever an account of an adventurous nature appears, they expect, as a matter of course, to find some reference to the subject in the narrative they are perusing. We recently read the thrilling experience through which Singapore passed during the late military riots there. This account forms a veritable tale of adventure such as we were used to read in boyish days in the pages of our favourite author, the late Mr. G. A. Henty. The sequence of events seems to have been: first, a feeling of discontent worked upon by "dark conspirators"; secondly, the opportunity afforded by the three days' festival of the Chinese, signalled by the firing of pyrotechnic bombs and crackers—just the ideal surroundings for consummating an insurrection. Up to a point the mutiny seems to have been not unskillfully engineered; possession of ammunition was secured, and the guards of the prisoners of the war-camp overpowered. The loyal regulars on the spot appear to have been exceedingly few in number, and the only assistants immediately available were civilian volunteers. Murder and riot ensued, and the situation seemed black indeed. At this point

in the narrative the newspaper breaks into the heading "WIRELESS APPEALS FOR AID." The whole situation was immediately changed. Instructions were issued to the police stations to take measures for safeguarding the women and children. The French cruiser *Montcalm* landed a party of 190 men and two machine guns; the Japanese cruiser *Otawa*, in response to the same signals, landed 75 men, and the *Tsushima* a further complement. The Russians responded to the same appeal, and our allies, joined by "handy-men" from H.M.S. *Cadmus* and local volunteers, speedily dominated the situation and restored order. Singapore, like many another



The Dynamited Mast—Cocos Islands.

place, owes a debt of gratitude to wireless telegraphy.

* * *

We are constantly publishing instances of the gallantry displayed by wireless operators under various circumstances of difficulty and danger in different parts of the world. The general public is, as a rule, not slow to recognise their services; but up to the present official Government recognition has been less generous. It is therefore pleasant to notice that the roll of recipients of the D.S.O. in a recently published list includes the names of Theodore Frank Perrow, Petty Officer Telegraphist, O.N. 238640 H.M.S. *Gloucester* for "services rendered during the chase of the German cruisers *Goeben* and *Breslau* by H.M.S. *Gloucester*, August 6 and 7, 1914."

THE MARCONI COMPANIES BENEVOLENT FUND.

THE second annual general meeting of the members of the Marconi Companies Benevolent Fund was held at Marconi House on April 7th, 1915.

Captain H. Riall Sankey took the chair, and amongst those present were Mr. W. W. Bradfield, Mr. H. W. Allen and Mr. W. R. Cross.

The annual statement of accounts was submitted and approved. No claim had been made on the fund up to December 31st, 1914, at which date 493 employees of the

Marconi Companies had joined the Staff Superannuation Fund. The number of members had since increased to 543.

The Report of the Committee of Management was unanimously adopted, and the Members' Trustees were re-elected—namely, Messrs. E. C. Richardson and W. S. Purser for Marconi's Wireless Telegraph Company, Ltd., and Messrs. W. R. Cross and W. J. Collop for the Marconi International Marine Communication Company, Ltd.

Wireless in the Courts.

RECENT police court activity in connection with the illegal possession or use of wireless apparatus appears to have been confined to Newcastle.

On March 2nd a Newcastle dealer in electrical and mechanical appliances named Rowland Hill Barnett was charged at the local police court with having in his possession "certain apparatus intended to be used as component parts of apparatus for the sending and receiving of messages by wireless telegraphy contrary to the Defence of the Realm Regulations." The proceedings, it was admitted, were taken at the express request of the military authorities.

According to the evidence for the prosecution, the defendant had exposed for sale in his shop window a wireless spark coil. The military authorities wished to emphasise the necessity for a person who had anything to do with wireless telegraphy to have a licence.

Mr. Barnett's solicitor, in defence, stated that Mr. Barnett was well aware that he must no longer sell the parts of Marconi installations, but he did not understand that it was any offence to keep these parts in his possession. The parts shown in the window were induction coils, which were used for vacuum tubes and X-ray apparatus generally. The Bench, who were of the opinion that Mr. Barnett had unwittingly offended, fined him £10 and costs.

In the same police court, on March 23rd, a 17-year-old youth, William Horsley, of 8 Tenth Avenue, Heaton, was charged, under the Defence of the Realm Act, with having in his possession, without written permission, the component parts of a wireless apparatus. The youth was employed in the drawing office of Sir Charles Parsons' works, and the Deputy Town Clerk, who prosecuted, said that though the case was regarded as a serious one, the police and Post Office authorities were satisfied that Horsley was an amateur in wireless telegraphy. The defendant had imagined that when he had dismantled the aerial he had done everything that was necessary under the Act. In August Horsley and his father, who was an engineer employed at North Shields, understood that they must remove the aerial, but they failed to register the apparatus or its parts at the Post Office. The entire outfit, with the exception of the receiver, was home-made. The receiver was described as a very sensitive one by Mr. H. R. J. Dunthorne, assistant engineer at the General Post Office, Newcastle, who said it was capable of receiving messages from places as far distant as Berlin, and from other high-power stations. As far as could be judged the instrument had not been used recently. A fine of 20s. and costs was imposed by the magistrate.

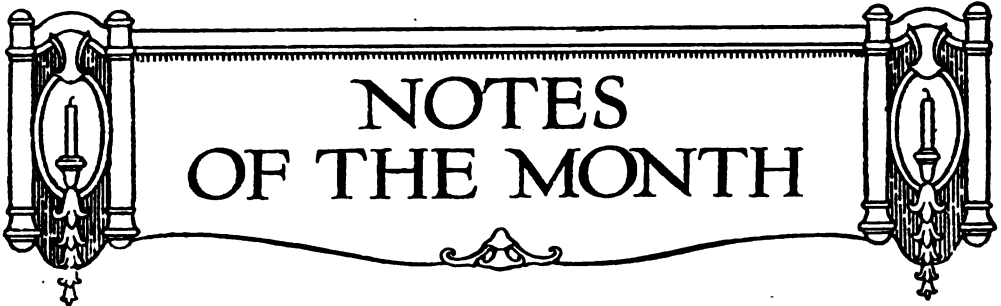

NOTES OF THE MONTH

THE mystery surrounding the sudden recall home of Major George Langhorne from his post as United States Military Attaché in Berlin has been cleared away by the disclosure that the German Government has been using Major Langhorne's name to send extremely pro-German reports to the United States by wireless, in an effort to deceive the Allied Governments. It is now discovered that Major Langhorne was shown every courtesy by the Germans, and was allowed to visit all the fronts and make extensive observations in the various fighting areas. He frequently sent long descriptive accounts of these observations to his Government by wireless in plain language, which all nations could receive *en route* and understand. In the hope of misleading the enemy the Germans craftily inserted false information and pro-German sentiments in Major Langhorne's messages, and the Allies were for some time at a loss to understand how a man of Major Langhorne's calibre and intelligence could send such reports to his Government. However, these German tactics soon broke down, and the deception was discovered when one of Major Langhorne's messages was addressed to the War College, Annapolis. As no such college has ever existed at Annapolis, the United States immediately instituted an investigation. When the truth was finally arrived at it was apparent that to call the German Government's attention to the fraud would be embarrassing to both countries, as no proof was actually forthcoming that Germany had officially sanctioned the deceit. Major Langhorne's withdrawal was the easiest way out of the difficulty, and Colonel Kuhn was appointed in his place.

* * *

The United States Bureau of the Census reports that from 1907 to 1912 the number of messages sent increased from 154,617 to

285,091, or 84.4 per cent. Employees increased from 176 to 958, or 444 per cent.

* * *

Mr. R. A. Germon, chief operator on the s.s. *Korea*, has written to us from Yokohama, under date of February 17th as follows:

"In an article in the January issue of **THE WIRELESS WORLD**, entitled 'Problems of Radio-Telegraphy,' it is stated that a remarkable rule demonstrated by the Australian stations was that if signals from north to south were above the normal strength, then signals from south to north were below normal, and *vice versa*. The article then goes on to say that this asymmetry had not been detected in east and west signalling. I conclude that this latter statement refers only to observations made by the Australian stations. For, it is a phenomena noticed by operators on almost every trans-Pacific ship, running between San Francisco and Japan, that at certain times of the year when it is possible to hear the Japanese Government station at Choshi and the Marconi station at San Francisco at the same time, when signals from the former will fade so as to be almost inaudible, those from San Francisco will come in above normal strength, and *vice versa*. This has been particularly noticeable this last voyage. We were able to copy press from San Francisco at 3,720 miles, and during the whole of that time Choshi was working with some Japanese ship. His signals, though, were so weak as to cause no interference. Hardly was press time over, than Choshi signals came in very loud, while San Francisco faded away almost completely. I have noticed the same effect when midway between the San Francisco and Honolulu stations.

"As to the remarks in the same article regarding the comparative range of trans-

"mission on the Atlantic and Pacific Oceans, I might mention that the record distance made by this ship is 4,200 miles and 3,600 has been done many times by this and other ships."

* * *

Last year, after the commencement of the war, it was decided that the McGill University in Montreal should establish a class in wireless work with the object of preparing young Canadians for this branch of the Naval and Military Service in case they should be required by the Dominion or Imperial authorities. A class was accordingly organised under the direction of Prof. L. V. King (of the Physics Department) and Prof. A. Gray (of the Electrical Engineering Department). Prof. A. S. Eve (of the Physics Department), who is an officer with the McGill Regiment, laid the requirements of the class before the Naval and Military Departments at Ottawa, with the result that the Government lent the university two Marconi military sets, which are light, compact, and easily portable. A temporary aerial was erected, but it was found that it was not strong enough to withstand the winter storms, and was finally taken down. It was then decided to erect a permanent aerial at the expense of the university. This work is being undertaken not only with the sanction, but with the active co-operation of the Dominion Government. When completed it will give McGill University one of the highest and longest aerials in Canada. One end of the 450-foot stretch of antennæ will be attached to the top of the power-house chimney, which stands 150 feet above the ground, which again is a considerable height above the lower part of the city, while the other will be attached to the Engineering Building, where the receiving apparatus is kept. The possession of this aerial will give the wireless class opportunities for practice in taking messages. The area for receiving will be about 2,500 miles, while with the equipment on hand messages can be sent about 1,000 miles; but for the present the sending of messages will not be permitted for fear of conflicting with the Admiralty's wireless operations on the Atlantic coast.

* * *

Readers may be interested to hear that Marconi's Wireless Telegraph Company, Ltd., has now arranged, in co-operation with the London County Council, con-

tinuation classes for the boy messengers under their control. These classes, which are held at convenient hours during the day, so as to fit in with the duties of the boys concerned and obviate any expenditure in fares, &c., comprise English, Geography, Calculation, Topography of London and general tuition, and are under the charge of a London County Council schoolmaster. Each boy is charged a small fee, but in the event of his attending not less than 75 per cent. of the classes held during the year, the Council provide the second year's tuition free, and the Marconi Company return the full amount. All stationery, books, etc., are provided free by the Council, and the classes themselves are held at Marconi House.

* * *

Those who in the past have so steadily advocated the superiority of cable communication will, perhaps, pause on reading the Postmaster-General's announcement that *within four hours* of the outbreak of war we had severed every German cable that ran from Germany westwards or eastwards under the sea. Germany has thus been almost entirely dependent on her wireless service for communication with many parts of the outside world.

Even assuming, for the sake of argument, that the German fleet was active and had some measure of control over the ocean, the difficulties and delays in repairing a cut cable in war time, when one end lands on hostile or neutral country, would be infinitely greater than the re-erecting of a wireless station that may have been damaged or destroyed through an act of war, provided the enemy can get near enough to it to do so.

* * *

There is a glorious tradition in the British Army which has, ever since its institution, linked two words together, so that, with the rarest possible exceptions (which only go to prove the rule) it is commanded by persons entitled to the honourable hyphenation of "officer-and-gentleman." Major Samuel Flood-Page, who passed away on April 7th last, was an admirable example of the older school of the British officer—a gentleman in his retirement as truly as in his service, and his decease will be very widely lamented.

He was born in the Isle of Man in 1833

and was the son of the Rev. S. Flood-Page, his mother being the daughter of Colonel Shaw, who saw considerable military service, and whilst in the 60th Rifles was wounded in the taking of Quebec in 1759. After receiving his education at Christ's Hospital and Rossall, Major Flood-Page became a cadet in 1854, and in the following year was gazetted to the 2nd Madras European Light Infantry. He served in India and Burmah and was gazetted first adjutant of the Queen's Own Edinburgh Rifle Brigade, afterwards serving for 12 years as Adjutant of the London Scottish. He was the first executive officer of the National Rifle Association, remaining on the council of that body for 40 years. At one time Major Flood-Page held the office of secretary and manager of the Crystal Palace, and in that capacity organised the Electrical Exhibition of 1882. About this time a revolution in electrical lighting took

place by the introduction of the carbon incandescent lamp, which provided light in much smaller units than was possible with the arc lamp, and Major Flood-Page, after leaving the Crystal Palace in 1882, devoted his energies to promoting the commercial utilisation of the new illuminant. As general manager of Edison's Indian and Colonial Electrical Company, he visited Australia in order to introduce the incandescent lamp in that country, and on his return in 1883 was appointed secretary and manager of the Edison and Swan United Electric Lighting Company, a position he retained till 1892, when he became a director.

During the latter part of his life Major Flood-Page interested himself in wireless telegraphy, and in 1899 joined Marconi's Wireless Telegraph Company, Limited, as Managing Director.

He was from the very start fired by enthusiasm both for Mr. Marconi personally and for the future of his invention. He shared in the labours and agitations of the early days when Mr. Marconi was preparing to demonstrate the possibilities of transatlantic wireless transmission. It is but

a very few weeks ago since, in the course of an interview, he narrated with pride to one of our staff how largely instrumental he was in the selection of Pol-dhu in Cornwall, as the *locale* of the first long-distance wireless station. He remained to the day of his death a staunch supporter of THE WIRELESS WORLD, and in his latter days nothing gave him more pleasure than to narrate, for the



The late Major Samuel Flood-Page.

benefit of its readers, reminiscences of past incidents in the development of wireless.

To the very last he remained an active member of the Boards of Directors of several of the Marconi Companies.

He was buried in the family vault at Wimbledon on April 9th, and a memorial service was held at the Church Army Church, Upper Berkeley Street, where the gallant officer was for some years churchwarden. Prebendary Carlile gave an address and several directors and heads of departments from Marconi House were present.

CARTOON OF THE MONTH



Wireless Entanglements for Trenches.

Maritime Wireless Telegraphy

ONCE again "Wireless" has come to the rescue of those in distress on the sea, and has been the means of saving lives that otherwise must have been lost on the storm-tossed Atlantic. The s.s. *Denver*, an American-built vessel of 4,549 tons, belonging to the Mallory Line, was bound from Bremen to New York. When 1,300 miles from the latter port, on March 22nd, it was discovered she was leaking badly, from some, as yet, unknown cause, and was in imminent danger of sinking. She sent out a "wireless" call for help at 3 p.m. on that day, and the liners *Manhattan*, *Megantic*, *St. Louis*,

lowered from the doomed ship, which conveyed the officers and crew and the few passengers safely on board the vessels standing by to render aid. Fifty-four persons were taken on board the *Manhattan*, and the remainder on the *Megantic*. The first news that the *Denver* was in danger reached the American continent via the Canadian Marconi Company's powerful station at Cape Race, and communication was maintained with the vessels at the scene of disaster until the *Denver* sank, and all on board were saved. It is interesting to note that the *Denver* was one of

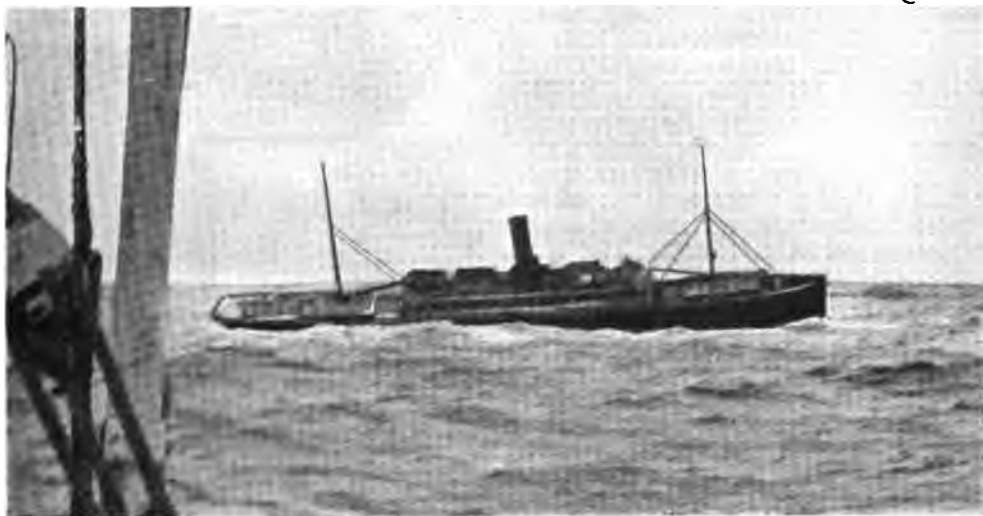

Sinking of s.s. Denver.

Lacome, *Corsican*, *Maryland*, *Vestris*, and others received the signal and hastened to the rescue. The roughness of the weather and the darkness of the night prevented a prompt location of the imperilled steamship, but she was sighted about noon on the 23rd by the *Manhattan*, *Megantic*, and *St. Louis*.

The *St. Louis*, which was eastward bound, had spent practically the entire twenty-one hours searching for the *Denver*, and had gone considerably south of her course in the quest. On the arrival of the rescue steamer's three boats were immediately

the ships which has added in a small degree to the international complications between Great Britain and America. When she sank she was on her return voyage from Bremen, whither she had carried a cargo of cotton. On her voyage to the German port, it will be remembered, she was seized by a British cruiser and taken to the Orkneys, being subsequently released and allowed to proceed on her voyage. The illustration which we reproduce was taken from the deck of one of the rescuing steamers, and depicts the *Denver* in the act of sinking.

The Wireless Transmission of Photographs.

By MARCUS J. MARTIN.

Article 2.

THERE are only two methods at present available for receiving the photographs, and both have been used in ordinary photo-telegraphic work with great success. They have disadvantages when applied to wireless work, however, but these will no doubt be overcome with future improvements. The two methods are: (1) By means of an ordinary photographic process; and (2) by means of an electrolytic receiver.

In several photo-telegraphic systems the machine used for transmitting has the cylinder twice the size of the receiving cylinder, thus making the area of the received picture one quarter of the area of the picture transmitted. The extra quality of the received picture does not compensate for the disadvantage of having to provide two machines at each station, and in the writer's opinion results quite good enough for all practical purposes can be obtained by using a moderate-sized cylinder—so that one machine answers for both transmitting and receiving—and using as fine a line screen as possible for preparing the photographs.

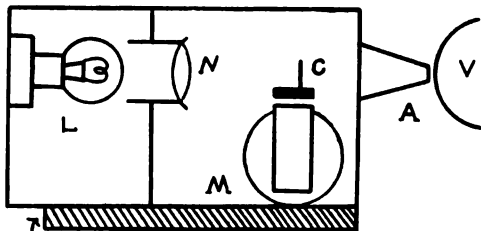

Fig. 22.

The writer, when first experimenting in photo-telegraphy, endeavoured to make the receiving apparatus "self-contained," and one idea which was worked out is given in Fig. 22. The electric lamp, L, is about 8 c.p., and is placed just within the focus of a lens which has a focal length of $\frac{3}{4}$ inch.

When a source of light is placed at some point between a lens and its principal focus the light rays are not converged, but are transmitted in a parallel beam the same

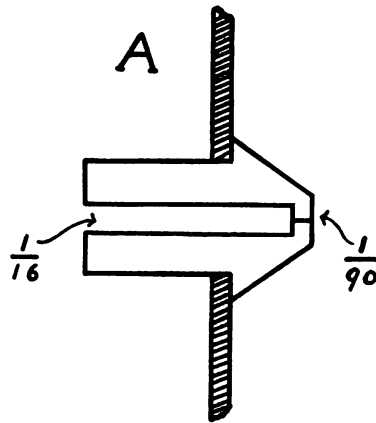

Fig. 23.

size as the lens. It has been found that this arrangement gives a sharper line on the drum than would be the case were the light focussed direct upon the hole in the cone, A. An enlarged drawing of the cone is given in Fig. 23. The hole in the tip of the cone is a bare $\frac{1}{90}$ th inch in diameter (the size of this hole depends upon the travel per revolution of the drum or table of the transmitting machine used), and in working the cone is run as close as possible to the drum without being in actual contact. The magnet, M, is wound full of No. 40 S.C.C. wire, and the armature is made as light as possible. The spring to which the armature is attached should be of such a length that its natural period of vibration is equal to the number of contacts made by the transmitting stylus. The spring must be strong enough to bring the armature back with a crisp movement. The spring and armature are shown separate in Fig. 24.

The shutter, C, is about $\frac{1}{4}$ inch square and made from thin aluminium. The hole in the centre is $\frac{1}{8}$ by $\frac{1}{8}$ inch, and the movement of the armature is limited to about $\frac{1}{32}$ inch. In all arrangements of this kind there is a tendency for the armature spring to vibrate, as it were, sinusoidally if the coil is magnetised and demagnetised at a higher rate than its natural period of vibration. This

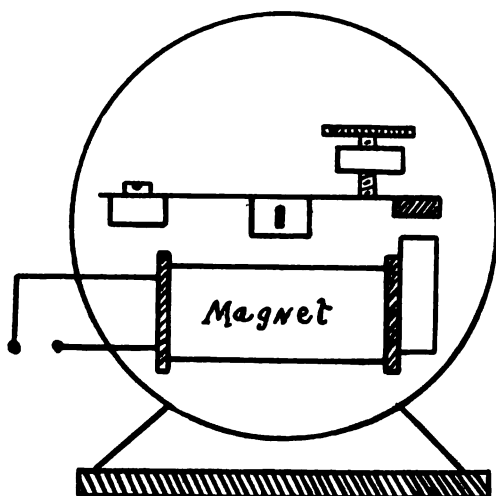

Fig. 24.

causes an irregularity in the rate of the vibrations which affects the received image very considerably. A photographic film is wrapped round the drum of the machine, being fastened by means of a little celluloid cement smeared along one edge. This device, although it will work well over artificial conductors, is not suitable for wireless work, as it is too coarse in its action. It can be made sensitive enough to work at a speed of 1,000 to 1,500 contacts per minute with a current of 0.5 milliampère. It is impossible to obtain a current of this magnitude from the majority of the detectors in use, so that if any attempt is made to use this device for radio-photography it will be necessary to employ a Marconi coherer (filings), as this is practically the only coherer from which so large a current can be obtained. There have been many attempts made to receive with an ordinary filings coherer, but as was pointed out in Article 1, these have now been discarded in

serious wireless work, being only used in small amateur stations or experimental sets. As the reasons for this are well known to the majority of wireless workers there is no need to enumerate them here.

In all photographic methods of receiving, the apparatus must be enclosed in some way to prevent any extraneous light from reaching the film, or better still, placed in a room lighted by only a ruby light.

Fig. 25 gives a diagrammatic representation of apparatus arranged for another photographic method of receiving. The machine shown in Fig. 11, Article 3, is used in this case. A is the aerial, E earth, P primary of oscillation transformer, S secondary of transformer, C variable condenser, C' block condenser, D detector, X two-way switch, T telephone. A D'Arsonval galvanometer, H, is also connected to the switch, X, so that either the telephone or the galvanometer can be switched in. The D'Arsonval galvanometer can be made sensitive enough to work with a current as small as 10^{-7} of an ampère. The screen, J, has a small hole about $\frac{1}{8}$ inch drilled in the centre. Under the influence of the brief currents which pass through the coherer every time a group of waves is received the mirror of the galvanometer swings to and fro in front of the screen, J, and allows the light reflected from the source of light, M,* to pass through the aperture in the screen on to the lens, N. Round the drum, V, of the machine is wrapped a sensitised photographic film, and this records the movements of the mirror, which correspond with the contacts on the half-tone print used in transmitting. Every time current passes through the galvanometer the light that is received from M passes through the aperture in the screen, J, and is focussed by the lens, N, to a point upon the revolving film. As soon as the current ceases the mirror swings back to its original position and the film is again in darkness. Upon being developed, a photograph similar to the negative used for preparing the metal print is obtained. If desired, the apparatus can be so arranged that the received picture is a positive instead of a negative.

* Nernst lamps are the best to use, as they produce abundantly the blue and violet rays which have the greatest chemical effect upon a photographic film. Carbon filament lamps are very poor in this respect.

The detector used should be a Lodge wheel coherer or a Marconi valve receiver, as these are the only detectors that can be used successfully with a recording instrument. If the swing of the galvanometer mirror is too great, a small battery with a regulating resistance can be inserted in order to limit the movement of the mirror to a

Another system, and one that has been tried as a possible means of recording wireless messages, is as follows: The wireless arrangements consist of apparatus similar to that shown in Fig. 25. Instead of a Lodge coherer, a Fleming valve is used, and an Einthoven galvanometer is substituted for the reflecting galvanometer. The Eint-

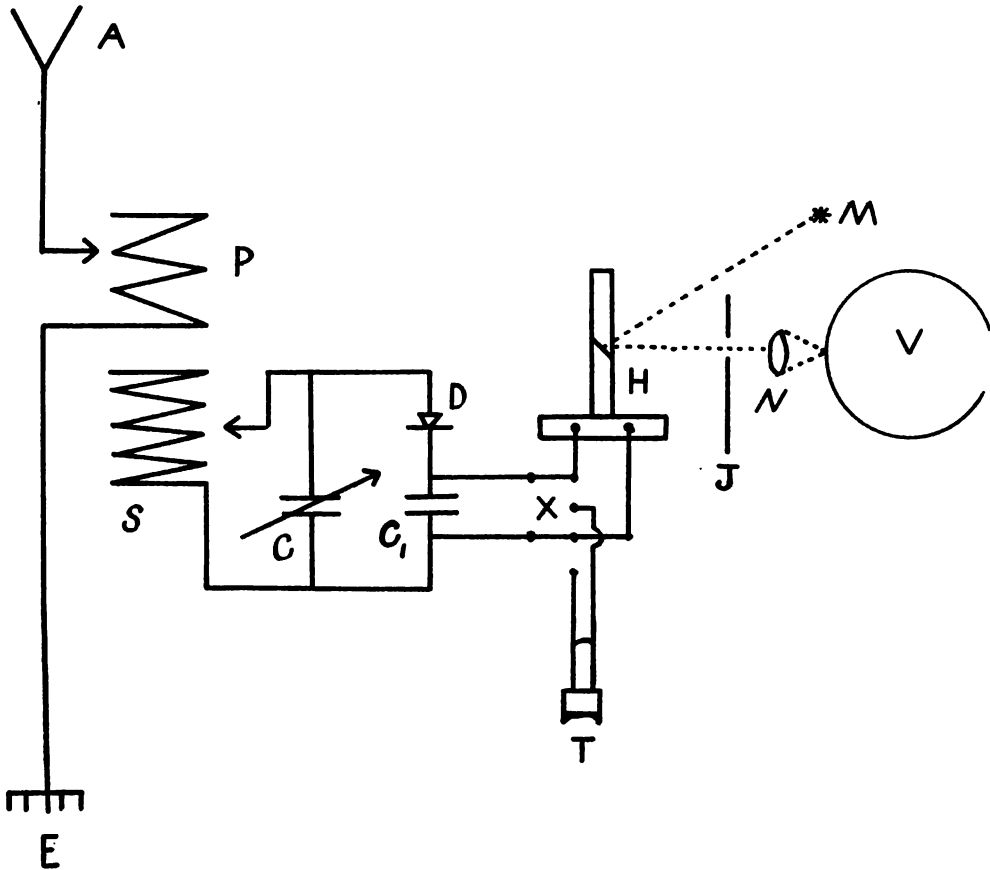

Fig. 25.

very short range, the current, of course, flowing in an opposite direction to the current flowing through the coherer.

In this, as in all other methods of receiving, the results obtained depend upon the fineness of the line screen used in preparing the metal print, and, as already shown, the fineness of the screen that can be used is dependent upon the mechanical efficiency of the entire apparatus.

hoven galvanometer consists of a very powerful electro-magnet, the pole pieces of which converge almost to points. A very fine silvered quartz thread is stretched between the pole pieces as shown in Fig. 26. A hole is bored through the poles and one of them is fitted with a sliding tube which carries a short focus lens, N. The light from M passes through the magnets and a magnified image of the quartz thread is

thrown upon the ebonite screen, J. This screen is provided with a fine slit, the lens, R, concentrating the collected light upon the revolving film. The connections for the complete receiver are given in Fig. 27. The following method is given more as a suggestion than anything else, as I do not think it has been tried for wireless receiving, although it is stated to have given some good results over ordinary land lines. It is the invention

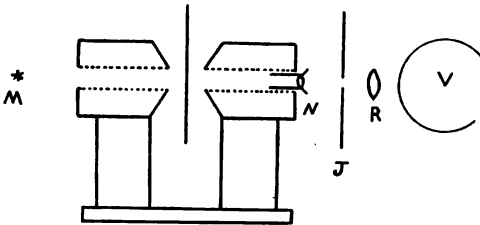

Fig. 26.

of Charbonelle, a French engineer, and is quite an original idea. His method consists of placing a sheet of carbon paper between two sheets of thin white paper, and wrapping the whole tightly round the drum of the machine. A hardened steel point is fastened to the diaphragm of a telephone receiver, and this receiver is placed so that the steel point presses against the sheet of paper. As the diaphragm and steel point vibrate under the influence of the received current marks are made by the carbon sheet on the bottom paper.

Over a line where a fair amount of current is available at the receiver the diaphragm would have sufficient movement to mark the paper, but the movement would be very small with the current received from a detector. This difficulty could, no doubt, be overcome to a certain extent by making a special telephone receiver with a large and very flexible diaphragm and wound for a very high resistance. The movement of an ordinary telephone diaphragm for a barely audible sound is, measured at the centre, about 10^{-6} of a cm. With a unit current, the movement at the centre is about 1/700th part of an inch. Greater movement of the diaphragm could be obtained by connecting a *telephone relay* to the detector and using the magnified current from the relay to operate the telephone. The telephone relay consists of a microphone, C, Fig. 28, formed of the

two pieces of osmium iridium alloy. The contact is separated to a minute degree partly by the action of the local current from F which flows through it, and also through the winding, W, of the two magnet coils. The local current from F assists in forming the microphone by rendering the space between the contacts conductive. The vibrating reed, P, is fastened to the metal frame (not shown), which carries a micrometer screw by which the distance between the contacts can be accurately regulated. It will be seen from Fig. 28 that the local circuit consists of a battery, F (about 1.5 volts), the microphone contacts, C, the winding, W, milliampere meter, B, and the terminals, T, for connecting to the galvanometer or telephone, all in series. On the top of the magnet cores, N, S, is a smaller magnet, D, wound with fine wire for a resistance of about 4,935 ohms, the free ends of the coil being connected to the detector terminals. The working is as follows: Supposing the current from the detector flows through the coil, D, in such a way that its magnetism is increased, the reed, P, will be attracted, the contacts opened, and their resistance increased. It

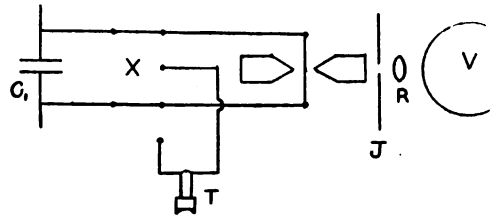

Fig. 27.

will be seen that the current from F is passed through the coils, W, in such a way as to increase the magnetism of the permanent magnet so that any opening of the microphone contacts increases their resistance, causes the current to fall, and weakens the magnets to such an extent that the reed, P, can spring back to its normal position. On the other hand, if the detector current flows through D in such a direction as to decrease the magnetism in the permanent magnets, the reed, P, will rise and make better contact owing to the removal of the force opposing the stiffness of the reed. Owing to the decrease in the resistance of the microphone

the strength of the local current will be increased, the magnets strengthened, and the reed, P, will be pulled back to its original

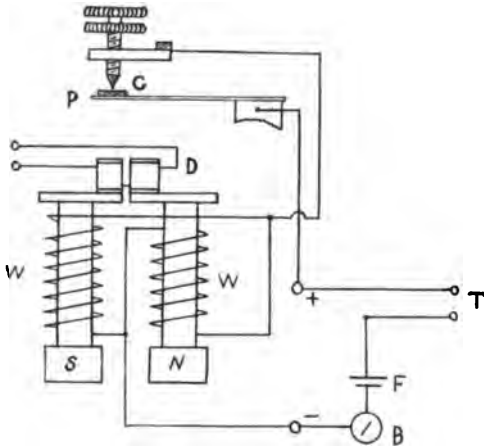

Fig. 28.

position. This relay gives a greatly magnified current when properly adjusted, the current being easily increased from 10^{-7} to 10^{-2} amperes. This relay is very sensitive, but it needs very careful adjustment in order that the best results may be obtained.

ANOTHER HONOUR FOR SENATOR MARCONI.

IN the absence in Canada of the President of the Royal Society of Arts (the Duke of Connaught), the Chairman of the Council, Colonel Sir Thomas H. Holdich, at a meeting of the Council, held on 12th April, presented the Society's Albert Medal to Senator Marconi "for his services in the development and practical application of Wireless Telegraphy." The medal, which was instituted in 1863 to commemorate the Prince Consort's presidency of the Society, is awarded annually as a reward for "distinguished merit in promoting arts, manufactures and commerce."

Institute of Electrical Engineers.

We are informed by the committee of the Institute of Electrical Engineers that the annual general meeting of the Students' Section has been postponed from April 28th to May 5th, at 7.45 p.m., when the president of the institution, Sir John Snell, will deliver an address.

Doings of Operators.

The Wireless Telegraphist's Narrative of the "Falaba" Outrage.

WE left Liverpool on Saturday, March 27, at 6 p.m., and the weather that night and the following morning, although not rough, still subjected us to the discomfort of a lumpy sea.

On Sunday morning, after erecting the aerial, I was carrying out my usual duties in the wireless cabin when the chief officer entered hurriedly and informed me that the ship was being pursued by a submarine, as to the nationality of which we had our suspicions. I thereupon gave a call to St. Just station, informing them of the fact and of our position, and was immediately answered in spite of some interference, apparently from the submarine. I had scarcely done this when the ship was stopped, and I was told by the chief officer that nothing further

could be done and I had better get into the boat. Before leaving I had just time enough to send out the SOS signal, which was immediately picked up and passed on. Thirty or forty of us managed to get into the boat, but we had no sooner commenced to descend when (by some means or other which I did not observe) we were precipitated on to the surface of the water with such a shock as to smash the boat, and throw us all into the sea. Some six or eight of us succeeded in struggling over the debris and wreckage into another boat astern of the vessel. The submarine had at first appeared some fifty yards off on the port side, and her captain hailed us through a megaphone, shouting in excellent English, "Get into the boats; I am going

to sink your ship." After this he went round to starboard, and at a distance of some hundred and fifty yards fired a torpedo which hit the ship immediately under the wireless cabin. This took place whilst we were in the very act of struggling into the lifeboat at the stern, at a time when the starboard deck of the liner was still black with passengers. A trawler, which was not more than a mile and a half from us, could without any risk have been permitted to save every passenger and the whole crew by being allowed to come alongside; but, with callous disregard of any humane



Mr. Taylor—Wireless operator of the "Falaba."

principles, the vessel was torpedoed at once. Nothing in the whole incident has struck me more forcibly than two facts. First, the daring with which the German submarine approached to within fifty yards, pointing plainly to the fact that her captain knew perfectly well we had no concealed guns on board. Had we possessed even one, his audacity would have entailed inevitable destruction to the under-water craft under his command. Secondly, that the German captain had evidently made up his mind that the incident should not pass without involving loss of life. There was no smoke of any steamer on the horizon, the only vessel other than the *Falaba* being the trawler already mentioned. It is a noteworthy fact that there was no panic on board; indeed, when the submarine first appeared the passengers were laughing and treating the whole matter as a joke. The shock of the

explosion from the torpedo sent up a column of water some hundred feet and almost wrecked our boat. It should be mentioned that but for the presence of mind of a passenger (Mr. D. J. Ryder, of Plymouth), who displayed considerable skill in getting a rope fast round the bottom of the boat to hold it together, we should have gone completely to pieces. For the next three and a half hours those of us who were able took turns in holding this rope in position as we drifted away from the scene of the disaster. The unfortunate ship, after being struck, listed heavily to starboard, while the luckless passengers who still remained on board slid off into the sea, vainly endeavouring to save themselves by clutching any form of support on deck. The captain, who was, of course, the last to leave, gave three blasts on the hooter and jumped off the wreck with his papers. All the reports concerning jeers from the crew of the submarine I can fully corroborate, as we drifted quite close by them and they could easily have helped us had they wished. Our earnest appeals, however, met with nothing but taunts and laughter. It was impossible to hear the words they uttered; but the tone and attitude of the six or eight men visible upon the deck of the submarine spoke eloquently of the spirit with which the whole of the operation was conducted. About the time when the submarine first came alongside, the sea, which had been choppy before, increased considerably, and you can picture the plight in which we found ourselves—up to our waists in water, in a bitter temperature, holding on for dear life to the rope whose strands formed the only tie binding us to life, shivering with the cold, our hands so numbed that two of my fingers have scarcely recovered, amidst the sneers and floutings of the Germans. We saw, about this time, one of the boats containing about thirty of our companions capsized by the heavy seas without a chance of our doing anything to save them. So trying were the circumstances under which we were placed that one of the black firemen with us jumped overboard to end his agonies, whilst we found ourselves obliged to restrain another from cutting his throat. One of the first-class passengers—a young man of about twenty-four, who appeared to be in delicate health—expired in the boat through exposure. We

ourselves were continually passing fellow-creatures in the last throes of drowning, and I shall never forget the agony of listening to their final and awful cries and watching the heartrending look of horror as they sank from sight. We were finally picked up by the steam trawler *Orient II.*, on board which we received every kindness and consideration that her limited capabilities afforded. We were given hot tea and cocoa, besides some ginger essence heated in order to restore animation to our half-frozen bodies.

For some time, owing to the restrictions of space, most of us were compelled to remain on deck of the rolling trawler, continually drenched by the heavy seas which were running. Finally on our arrival at Milford Haven we were provided at the Seamen's Home, and through the medium of a local outfitter, with the necessary supply of dry clothes, and you can easily understand how glad we were to receive them.

The only souvenir I possess of the ill-fated *Falaba* is the bronze key and tab of my wireless cabin.

* * *

Members of the Marconi Company's staff will regret to learn that Mr. J. Pringle, the Company's representative at Calcutta, was recently taken ill with smallpox (modified form), and was compelled to spend some time in hospital. Mr. Pringle has now, however, fully recovered, and has resumed duty.

With a view of temporarily lightening Mr. Pringle's labours in these busy times, the Company has sent Mr. H. J. Tattersall to Calcutta, where he will assist in the inspection and fitting work which is being carried on at that port. It is intended at a later date to establish another depôt on the Indian coast, and it is very probable that Mr. Tattersall will remain in India for the purpose of taking up the position of Resident Inspector at the proposed new depôt.

* * *

Operator H. T. Clarke, who is at present serving at the Front, and from whom an interesting letter was published in the April number, writes again from "Somewhere in France" to say that he is still keeping fit and well. He mentions that the worst of the weather is apparently now over, although they are having the usual April showers. Mr. Clarke sends his kind regards to his friends on the staff.



Wireless Staff at Colombo.

The above illustration shows the staff of the Colombo Wireless Station. Mr. J. R. Stapleton, the officer in charge, is seen seated in the middle of the group.

HONOUR FOR MR. A. A. CAMPBELL-SWINTON.

Mr. A. A. Campbell-Swinton, M.Inst.C.E., who recently accepted the office of President of the Wireless Society of London for the second time, has been recently nominated by the council of the Royal Society for election as one of its members. This is a very high distinction, for the society, dating back to the stirring times of civil strife which ushered in the Commonwealth, is exceedingly chary of bestowing its honours, and merely to be nominated for fellowship is in itself a eulogistic recognition of high repute in the world of science.

GERMANY AND THE CAMEROONS.

The history of Germany's piratic colonisation forms as romantic a drama as ever was played at Drury Lane. In 1884 a certain Dr. Nachtigal was sent to West Africa to report on commercial questions, and such was the pusillanimity of the British Government of the day that this German freebooter, for he was little more, actually carried letters of recommendation from the British Government. He showed his appreciation of British courtesy by attempting to filch some French territory. Disappointed by Gallic vigilance, he passed over to the Cameroons, stealing a march on the British consul by a few days. The syren song of this German nightingale (Nachtigal), plus a little bribe of one thousand pounds, secured the goodwill of the leading chieftain, who made over his country to Germany

My Rural Wireless Station

By A. H. JOHNSON.

THE following is a description of my wireless telegraph installation which I have made in my spare time during the past twelve months, and I should like to say that considerable pleasure has been derived from the construction of the same, and that the outlay was very small.

Although I have not yet learnt the Morse code, I have, by writing down the dots and dashes and translating afterwards, read the following stations: Dri-ped, Billericay, Café-au-Lait, Wapping, Zambuk, and several stations having the call letters: GNR, LNWR, GPO, LSD, RIP, ASS, and PTO.

I shall be glad if any of your readers could tell me where these stations are situated, as they do not stand in my copy of "Little Tot's Wireless Guide."

As my father is a county policeman, I am in the fortunate position of not requiring a Postmaster-General's licence, and my father has given me permission to erect my aerial on the roof of the police office, so that we can keep the villagers supplied with war news.

I will begin by describing the aerial. It is of the inverted X type, and constructed of $\frac{4}{8}$ desiccated-bronze wire, a material which is not acted upon by the sulphurous fumes of the atmosphere, and does not present the difficulties of jointing as with aluminium.

The aerial must not be stretched too tight when erected in the summer time, for when the cold weather sets in the wire contracts and frequently breaks down the mast. If it is erected in the winter time, it will be found that the wires sag when the hot summer sun beams upon them. They must not be allowed to sag too much, because people have been known to fall over them. The correct tension of the aerial wire may be calculated from the following:

$$\sqrt{\frac{\text{Cos angle of Sag}}{\text{Temperature}}}$$

This formula is true for all places between the Arctic Circle and the Tropic of Cancer.



My father collected this for me on his rounds.

If the wires are well greased when put up, it will be found that the speed of the messages is greatly facilitated. My aerial is used for sending and receiving, it performing both operations with ease. I have read that it is necessary to insert a *lightning arrester* in the aerial circuit, but not knowing what it was, I asked my father, and he said there was no such thing — "at least, not in the police force."

My lead-in wire comes through a clay pipe (one I got at the "Gnat and Lobster Arms") which is passed through a hole in the window frame. If the bowl of the pipe is turned downwards outside, it will prevent the rain from coming into the "Instrument Room," for such is the title I have painted

on the door. It also prevents the rain from washing off the messages. Before I discovered the clay pipe dodge, I found that the little "irons," for such is what the electric particles are termed, used to bump their heads on the window frame and fall down in a heap outside in an exhausted condition. On one occasion, when a station had been

sending v 's continuously for a week, we could not open the door, for such a heap of "irons" had accumulated.

I will now describe the receiving apparatus. The lead-in wire passes through to the aerial-tuning inductance or loading coil, so named after the "loadstone," because its principal function is to attract the messages. My coil is made of bare copper wire and twine wound alternately on a phonograph record box, which enables me to get many "tunes."

As the natural λ of my aerial is sometimes too great to receive signals from *small* stations, I have to resort to a device popularly known as a "condenser," but in the more advanced electrical circles as a "Moscicki Jar." This piece of apparatus is joined to the free end of the tuning inductance.



We can keep the villagers supplied with war news.

Not having any Moscicki jars with which to make my aerial tuning condenser, I used 3-lb. marmalade jars, but as these only had a resistance of 1.5 mhos, I threw in a few assorted microhenries to bring the capacity up to 39.370 μ volts. By using various sized microhenries, one can easily alter the λ to suit any station, and a boxwood rule tied to the side of the jars forms an easy mode of calculating the necessary amount. As the ratio of the jars to the resistance is half a mho to the pound, it will easily be seen that a more satisfactory result is attained by increasing the number of jars instead of the microhenries, as they must not be packed too tightly. In any case, not less than one jar should be used.

Some difficulty may be experienced in obtaining the microhenries, as these are only to be found in the Ural Mountains, and are consequently now very scarce, but I have found that microfarads may be used in their place, and form a cheap and satisfactory substitute. These may be obtained from almost all grocers and oilmen, the price ranging from 3d. a dozen for the smooth ones to 6d. a dozen for the woolly variety. The ones most suitable for any individual station is best found by experiment.

Small blocking condensers were made from tinfoil (my father used to collect this for me when on his round) placed between waxed paper like a ham sandwich.

After the condensers comes the detector. This piece of apparatus is for dividing up the signals—i.e., retaining the dots and dashes and preventing the spaces from entering the 'phones. There are many types of detectors, but I have obtained the best results from zincite and iron jelloids. Zincite may be used in contact with almost anything, the best substances being: Bornite, erubescite, stalactite, blow-me-tite, sit-tite, and set-em-alight.

There is another type of detector known as the magnetic, and I am fitting one to my set. It consists of a brass band which passes through the loading coil. The noise made by the brass band frightens away the spaces, but allows the dots and dashes to pass (providing they have, as it were, the right password). A German silver band does not work well, as it frightens everything away.

The reason I am making a magnetic

detector is because it is not so easily liable to mechanical disarrangement. You see, the charge-room is next to my instrument room, and when my father walks about it upsets things.

Next comes the telephone receiver in which the signals are heard. The telephone was an invention of Alexander Graham Bell, who was born in Edinburgh 1847. The telephone is an extremely delicate instrument, and unless one has had a thorough training in mechanics, it would be better to purchase this part of the installation rather than to attempt to make it. Mine was made by tying a piece of vellum over the end of a round tin box, the bottom of which had been removed. Through a hole in the centre of the vellum is passed a piece of string, a knot being made in the string on the inside. The string should be about 4 ft. long, and the free end tied to the detector. Two telephones of this description may be used, one for each ear: one receiving the dots and the other the dashes, thus enabling signals to be received much faster.

The detector is finally joined to "earth"—a much better plan than that of joining the earth to the detector, as the signals should always be received in one direction—viz., from the aerial to the detector, thence to earth.

According to Sir Erskine Oliver, Professor Fleming Lodge, and other leading authorities on wireless, it is stated that a receiving installation is not complete without a jigger, but my experiments have proved to me that this is wrong. I made a jigger, but I soon got tired of jiggering it up and down, so I put it on a piece of elastic tied to the gas bracket and worked it with my foot. As I did not hear any signals with it, I came to the conclusion that it must have shaken them off. This completes the receiving apparatus excepting for the wave-meter—an exceedingly delicate instrument which can only be calibrated at the seaside, the description of which is entirely beyond the scope of this journal.

The sending portion of my installation, sometimes called the transmitting plant, next commands your attention. In this case we also have tuning inductances and condensers, but on a much larger scale. There are many methods of making high-tension electricity. Our forefathers em-

ployed a cat's skin and glass rod, but the modern practice is to employ a voltaic pile, an efficient piece of apparatus having low internal resistance and unequalled recuperative power. It is very durable and suitable for all climates, whether tropical or arctic. A voltaic pile is easily and cheaply made by placing alternately pennies and two-shilling pieces, between which are placed small pieces of cloth previously soaked in salt water, also like a ham sandwich.

Join the voltaic pile across the inductance and condenser, having first inserted a Morse key, by means of which the signals are transmitted. After a wire has been led from the sparkgap to "earth," or lower capacity, we

shall be in a position ready to transmit. Hold the Morse key firmly between the thumb and first two fingers of the right hand, and a copy of the Morse code in the left hand. When it is desired to send a dot, depress the key and say "iddy," and when a dash, say "umpty." Thus any word may be signalled into space.

I forgot to mention that the usual wireless joints should be used when required in the transmitting connections.

Shortly I hope to be able to send the Editor a photograph of my apparatus, so that those interested can form a better idea of the construction of a modern wireless installation.

Among the Wireless Societies

Notes on Meetings and Future Arrangements.

The Institute of Radio Engineers.

—A record-making number of over 200 attended the March meeting of the above institute at 71 Broadway, New York, at which Mr. Edwin H. Armstrong presented an exceptionally interesting paper on "Recent Developments in the Audion Receiver." Mr. Armstrong described in detail the regenerative receiver with which his name has been identified, and outlined its use both as an amplifier and a "beats" receiver for sustained waves. The paper was discussed by Messrs. John Stone Stone, who spoke of some early work with amplifiers, and John L. Hogan, jun., who gave the results of some comparisons of sensitiveness and reliability between a number of forms of heterodyne receiver, including the audion types.

At the next meeting, to be held at Fayerweather Hall, Columbia University, N.Y., on April 7th at 8.15 p.m., Dr. Irving Langmuir will present a paper on "Applications of Thermionic Currents to Radio Telegraphy and Radio Telephony." Dr. Langmuir's work with thermionic currents in very high vacuum tubes is well known. He will outline the theory of such currents in

these tubes, describe several pieces of apparatus which have been built for receiving radio signals, and also some devices for producing electrical oscillations and controlling them for radio telephony.

Interested non-members of the Institute are invited to attend.

* * *

London S.M. and E.E.—Special Notice.—A short Paper Competition for members will be held at the Caxton Hall, on Friday, May 7th. Particulars of the awards to be competed for and the conditions governing the competition may be obtained by post from the Secretary, Herbert G. Riddle, 37, Minard Road, Hither Green, S.E.

* * *

The Wireless Society of London.

—On Tuesday, April 20th, Professor E. W. Marchant, D.Sc., gave an interesting lecture on "Methods of Measurement of the Strength of Wireless Signals." Owing to the meeting taking place whilst we were going to press, we are unable to deal with the lecture in this issue, but we hope in the next number to give our usual report.

The Amateur Handyman

HOW TO MAKE A TELEPHONE RECEIVER.

By J. W. HOBLEY.

A TELEPHONE receiver is not, as many amateurs appear to think, a difficult instrument to construct, and there is no reason why anyone who can handle tools should not, by following the instructions below, be able to make a 'phone which will be highly sensitive, light, and comfortable to use.

To reduce the weight of the instrument the case should be of aluminium, and if one of the size shown in Fig. 1 cannot be obtained it can easily be made from a casting. The pattern may be turned from beech, or other hard close-grained wood, and $\frac{1}{8}$ in. should be allowed all over for machining. In the sectional drawing of the pattern, Fig. 5, the "draft," which is necessary to enable it to

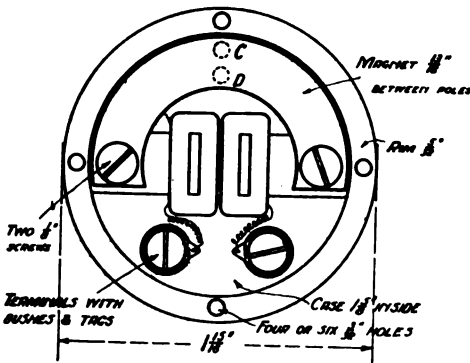

Fig. 1.

draw cleanly from the mould, is slightly exaggerated. With the aid of a lathe, self-centring chuck, and a Λ -pointed chisel the aluminium casting can easily be turned to size, and if a light final cut is taken a fine surface which will not require polishing is easily produced.

It should be noted that the size of the important parts only has been shown; the other parts can be made proportionally without difficulty.

The ear-piece can be turned from sheet ebonite of the requisite thickness, according

to whether it is to be screwed to fit the case in the ordinary way, or secured by counter-sunk screws through the top as shown in

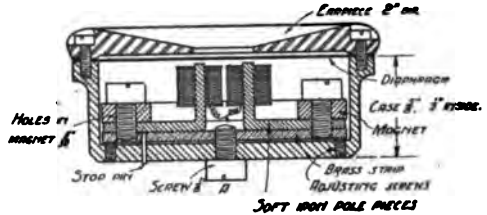

Fig. 2.

Fig. 2. If four or six screws are used the latter way is quite efficient, and the ebonite should be at least $\frac{3}{8}$ in. thick. As the shape of the ear-piece is of importance, both for comfort and efficiency, I have indicated the design which will be found best.

The diaphragm is cut from ferrotype plate, about $\frac{3}{100}$ in. in thickness, which can usually be obtained from a chemist. In Fig. 2 it is shown clamped between the ear-piece and the rim of the case. Small holes for the screws to pass through must be drilled in it, and care should be taken to remove the burrs.

The pole-pieces should be made from a strip of good quality iron plate and must be annealed after they have been drilled, tapped and bent to the shape shown in Fig. 2. The strip should be $\frac{1}{8}$ in. by $\frac{3}{8}$ in. wide. The length of the flat part is approximately $\frac{5}{8}$ in. and the turned up piece should be long enough to clear the diaphragm by $\frac{1}{8}$ in. before the adjusting screws are moved.

To economise space and to allow the wire to be as close to the pole-pieces as possible,

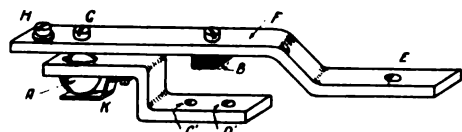

Fig. 3.

and also to enable the pole-pieces to come within $\frac{1}{4}$ in. of each other, spools are not used, but thin brass or german silver cheeks

about $\frac{5}{32}$ in. by $\frac{1}{8}$ in. long are soldered direct to the pole-pieces, and are lined with silk for insulation purposes.

The magnet is semi-circular and is not laminated. The shape shown will be found quite efficient. It is much easier to make and is lighter than the circular laminated ones so often used.

As it is a most important part to make I describe the method rather fully. Obtain a piece of tungsten or magnet-steel $\frac{3}{8}$ in. by $\frac{1}{2}$ in., full, and bend or forge to the shape shown in Fig. 1, using a template cut from stout tin to work by. Anneal thoroughly and drill the holes as shown, then file and bring smooth all over. To harden, carefully bring the piece up to a bright cherry red in a clear fire, and plunge into cotton oil, keeping it

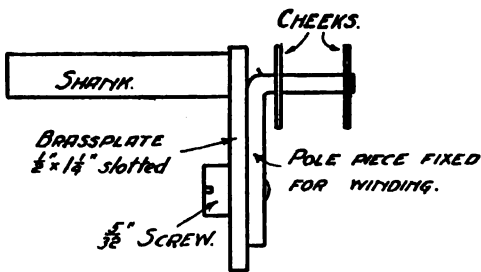

Fig. 4.

under until quite cool; finish by polishing bright, particularly on the sides. Tempering will not be necessary. To magnetise, take an electro-magnet capable of holding 8 lb. or 9 lb. with 4 volts, $1\frac{1}{2}$ amps., and place the magnet to be across the poles for ten minutes with the current on. It is advantageous to tap the steel all over with a lead or brass hammer, and also to make and break the current twenty or thirty times. Immediately before stopping the current and before the piece is removed from the electro-magnet, a keeper of soft iron should be placed across the poles of the new magnet. If the processes described above have been properly carried out a really good permanent magnet will be the result.

As separate spools are not used it is necessary to attach the pole-pieces to a special holder, Fig. 4, for the winding operation. The holes through which the clamping screws pass should be tapped $\frac{5}{32}$ in. and a short screw be used to fasten it to the holder.

The bottom cheek on each pole-piece should have a hole drilled or filed down from the slot on the outer side for the inside ends of the windings to pass through; these ends are twisted together when the 'phone is ready. If a hole is first pricked through the silk it acts as a guide and prevents the wire from becoming chafed and short-circuiting. The top-cheek should be soldered within at least $\frac{1}{2}$ in. of the end of the pole-piece, as it is important that the coils should be as near the top as possible. The winding should preferably be done on a lathe by holding the shank of the special holder in a chuck, but with a little ingenuity it can easily be done by a hand-driven arrangement.

Enamelled copper wire answers perfectly for the coils. It has advantages over silk-covered wire in that breakages are at once apparent, and more wire can be wound in a given space; an important consideration in the case of a 'phone. About 1,500 w. can be wound on per instrument if No. 47 gauge is used, with the cheeks $\frac{1}{4}$ in. apart, but much higher resistance can be obtained by using 49 gauge or by lowering the bottom cheeks. The outer ends of the coils are soldered to brass tags fastened under the heads of the terminal screws. The terminals should be insulated by bushes and washers turned from $\frac{1}{4}$ in. ebonite tube.

A simple arrangement to enable the 'phone to be adjusted is shown in Fig. 2. The magnet, instead of being attached directly to the case, is screwed to a piece of hard-drawn brass $\frac{3}{8}$ in. by $\frac{3}{32}$ in. thick, with the ends of the pole-pieces between, thus clamping them to the magnet and forming

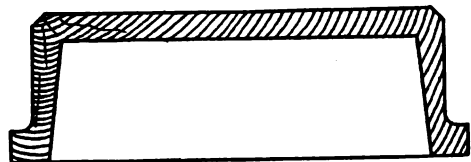

SECTION OF PATTERN FOR ALUMINIUM CASE.

Fig. 5.

a complete unit, which is secured to the case by the central screw, A. The two short screws shown in Fig. 2, which should

be tightly fitted, come into contact with the brass strip, and thus allow the pole-pieces to be tilted or pressed nearer the diaphragm.

To enable the receiver to rest comfortably on the ear a ball and socket joint or some similar arrangement is necessary. A simple device for the purpose is shown in Fig. 6. The bottom piece is secured to the outside of the case at C D, Fig. 1, by two screws through the holes, C' and D', Fig. 6. The arm, F, is turned the opposite way so that the ebonite stop, B, comes between the terminals. The ball, A, is kept in position by the spring, K, and the straining cord of the flexible can be attached to screw, H.

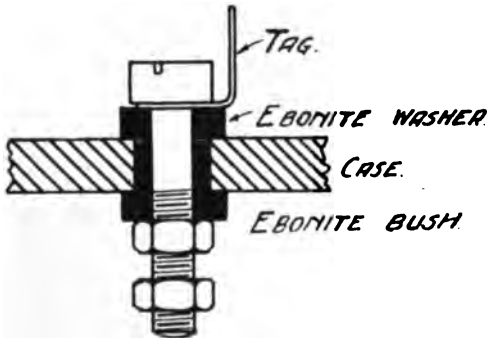

METHOD OF FORMING TERMINALS.

Fig. 6.

The whole, with the exception of the brass ball, can be made from aluminium strip, $\frac{1}{8}$ in. by $\frac{5}{8}$ in. wide.

The weight of the receiver should be not more than $2\frac{1}{2}$ oz., and if a head band of hard drawn aluminium is used this and two 'phones will weigh about $7\frac{1}{2}$ oz.

I do not consider a receiver made in the way described is a good one unless Paris can be read at a distance equivalent to 20 ft., on an aerial 100 ft. long and having a mean height of 36 ft.

The cost of the material per 'phone, including wire, is about 1s. 9d., and the time taken to make one is comparatively little. The results obtained will be found both pleasing and satisfactory, and will well repay the trouble of making.

GOVERNMENT APPRECIATION OF MARCONI COMPANY'S WORK.

Readers of this magazine will be interested to hear that Marconi's Wireless Telegraph Company has received a letter from the Director of Navy Contracts expressing approbation on behalf of the Admiralty for the manner in which Government work has been carried out. The text of the Admiralty letter reads as follows:

" . . . on behalf of the Admiralty I wish to express approbation of the energy displayed by your company, its sub-contractors and employees, which has resulted in the exceptional speed with which this material has been collected and shipped.

" I am, Gentlemen,
" Your obedient Servant,
" PERCY MINTER,

" For Director of Navy Contracts."

As will probably be realised by readers of THE WIRELESS WORLD, the staff at Marconi House and the works has since the commencement of war been working under exceptional pressure, and this official recognition of their loyal services is gratifying to all concerned. At times like these, when we are continually hearing complaints as to lack of zeal on the part of industrial organisations, it is refreshing to turn to another side of the picture. Many institutions have thrown themselves with real patriotism into doing work of public utility and have deserved as well of their country as if they had directed their energies to fighting in the field.

* * *

The Marconi Company has also received the following letter from the Secretary of the Admiralty:

" I am commanded by my Lords Commissioners of the Admiralty to forward the following extract from a letter dated 14th March, 1915, from Commander Colpoys C. Walcott, R.N., on being relieved in command of H.M.S. *Empress of Asia*: ' With regard to Mr. Stevens, the wireless work on this ship has always been very efficient, and the keenness of Mr. Stevens has been reflected in his junior officer, Mr. Elliot, also the wireless yeoman. I submit herewith Mr. Stevens' name for any promotion it may be in my power to recommend this officer for, in the Marconi Company or otherwise.' "

Amateurs' Experience.

An Amateur Station in West Africa.

The following description of a thoroughly practical amateur station has been received from Mr. E. R. Macpherson, of Wilberforce, Sierra Leone, British West Africa. Since receiving the manuscript we have had a further letter from Mr. Macpherson informing us that his apparatus has constantly been used by the authorities for military purposes during the present war, with great success.

THE following description and photograph of my "receiving cabinet," will probably be of interest to readers of THE WIRELESS WORLD.

I have been a very keen student now for several years, and have followed with interest every evolution in radio work. I make all my own apparatus myself, with the exception of the 'phones, of course. It will be noticed how I have mounted all the various instruments, so that they can be easily

seen and reached. On the left are the tuning inductance, jiggers (with "four-way" switch to cut out No. 1 jigger), and the shunt condenser. The three detectors are mounted on felt in the top compartment. Underneath them are the switches and potentiometer. In the compartment on the right are situated the batteries and buzzer. The batteries also supply current for a small lamp on a long flexible lead. This enables me to adjust the detectors, and also to examine any part of the cabinet at night. The buzzer is suspended in mid air by its own leads, thus eliminating any mechanical vibration. A lightning arrester is fitted above the detectors. The whole cabinet is of native hard wood, well seasoned. All leads are of heavy stranded "flex," with their ends sealed, and all that can be soldered are soldered. The cabinet measures

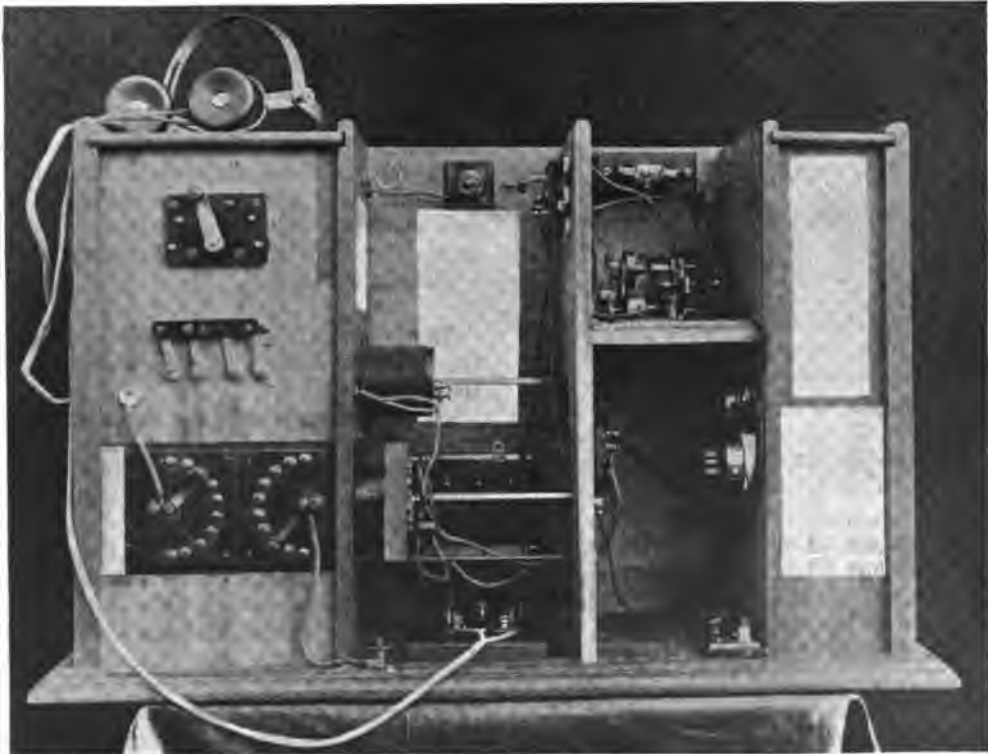

Mr. Macpherson's Apparatus.

30 in. long by 11 in. wide by 20 in. high, and fits into a water-tight case for travelling. Packed up it weighs about 40 lb. I find that using two jiggers with their primaries and secondaries in series gives very close tuning for long waves; and with both couplings pretty loose, "strays" are considerably reduced. Wave-lengths up to 5,000 metres can be tuned in. As regards

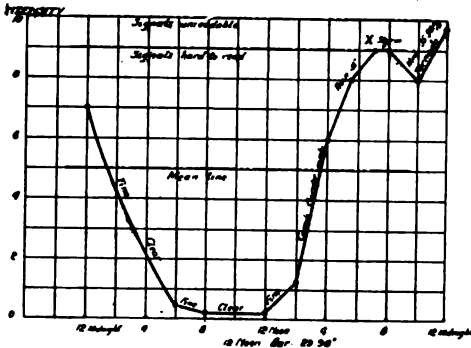

Fig. 1.

detectors for long-distance work I favour galena (with cat whisker contact), partly because I have been lucky in hitting upon good pieces. One piece that I am using now is "ultra" sensitive. The "perikon" combination I place second, and for everyday short distance work, silicon and gold point. Galena is particularly useful for twilight observations of X's. The X storms in these latitudes at times are terrific, and absolutely put the lid on any receiving work. On the other hand freak nights are not uncommon, and from my present station here (800 ft. above sea) I have read EAC (Cadiz) and EAL (Las Palmas) easily. The antenna I am using now is of the fan-shaped type, consisting of four strands, each 200 ft. long, radiating north-east from an 80 ft. pole. My "earth" is the water-pipes, and I also use my zinc roof as a counterpoise in addition. When I was stationed in Jamaica, B.W.I., I favoured a directive triangular-shaped aerial, with wire netting as a counterpoise. This used to give excellent results, as I was able there to read the time signals from NAA (Arlington, U.S.A.), every night at 10 p.m. I was greatly interested to see that the British Association for the Advancement of Science were disbursing forms to all British radio stations for "Observations on Strays," thus standardising the methods of observation; a most praiseworthy effort! For

some months past I have been keeping a daily curve of the X's myself, noting at the same time the meteorological conditions. I enclose a copy of May 8th, 1914. (Fig. 1) This is a typical curve for this time of year, dropping down in middle of day and going up at night. It will be remarked that, fundamentally, my idea is on the same lines as Form I., as now issued by the British Association for the Advancement of Science with the exception that on Form I. the X's are further analysed into "grinders," "clicks," and "sizzles." At present, here, we are getting mostly "grinders." One is very puzzled in studying the relationship (if any?) between "strays" and the local meteorological conditions. X storms here seem to be very local, and "appear" to travel along the longitudes rather than the latitudes. I have been experimenting with all shapes and kinds of aerials, and I find that for an amateur who is constantly on the move as I am, a triangular-shaped directive aerial (for receiving only) is the best, with a wire-netting counterpoise. The excess of moisture here at this time of year is appalling! Our "rains" are now in full swing and I am obliged to keep a

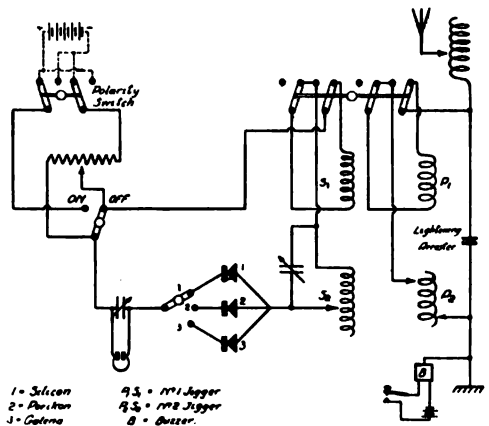

Fig. 2.

charcoal stove constantly burning near my cabinet to prevent "earthing." I am keenly interested in X observations, as communication in this part of the world is seriously interfered with at times. I feel convinced that there is much more to be done in the shape of aerials, etc., to reduce "strays." I should like to say much more about my experiments, but I want to confirm my results by exhaustive tests first.



Exterior of Fenchurch Street Office.

Additional Wireless Facilities for City Men

The Marconi Company opens an Office in Fenchurch Street.

THERE has just been opened in the heart of the City of London a new office specially designed for the acceptance and handling of Transatlantic and other wireless telegrams. This marks a most important step forward in the commercial development of the enterprise with which Mr. Marconi's name is indissolubly linked.

For some years past the Marconi Company has been engaged in handling an ever-

increasing amount of traffic of this description, and the development thereof has now reached such a point as to justify them in launching out on the present scale. Old superstitions die hard, and, strange as it may appear to the better informed, it is nevertheless the case that even at this time of day, when huge volumes of long-distance messages are being regularly handled both for Governments and private firms, some business men are still possessed by an idea

that wireless trans-ocean messages are handled by relays through ships and not direct. The opening of this handsome and well-equipped office should go far to dissipate once and for all any such illusion; as well as the obsolete idea that radiotelegraphic long-distance messages can only be transmitted at night. The Marconi service under modern conditions is equally available by day and night at all hours, a fact of which all users of this service have long been aware.

INCREASED FACILITIES.

The office, which forms the subject of our remarks and illustrations, was opened for public service on April 12th last. Already a large amount of traffic is handled there, and unmistakable signs point to the fact that the business world of the City of London recognises in it what, despite the fact that the phrase has become somewhat hackneyed, cannot be better described than "a long-felt want." Nothing is of greater importance to the extension of business than the provision of increased facilities of communication, particularly when such increase is accompanied by substantially decreased cost. We would, therefore, remind our readers that not only

does the well-appointed building just open represent to commercial men an increase in facilities for their business transactions; but it also provides them at that decreased cost (in most cases amounting to 33½ per cent.).

CONVENIENCE AND EFFICIENCY.

As many of our readers are aware, until quite recently the telegraphic business transacted by the Marconi Wireless Telegraph Company has been centred at their headquarters in the Strand, although a certain amount has for the convenience of the City been localised in that district. There is every reason, therefore, to expect a heavy increase in the volume of traffic brought in, and it is hoped that our pictures and printed particulars will indicate that the Company is fully prepared to handle it in the most efficient manner possible.

The situation is particularly central, occupying as it does a corner position in Fenchurch Street, just at its junction with Gracechurch Street, and practically facing Lombard Street. Thus conveniently placed the new office is in a position to collect, by means of its messenger service, telegrams





A View of the Instrument Room.

from all parts of the City in a minimum of time, whilst the more westerly parts of London can still be most conveniently served from Marconi House.

The telegrams, as soon as they have been accepted by the counter clerk, are forwarded by pneumatic tube to the instrument room. Thence they are immediately despatched to Clifden, County Galway, by *special direct private wires*. The point just italicised will indicate that there can be no delay involved in retransmission, and, whilst it is not desirable in our present remarks to enlarge upon the technical equipment of the great Irish high-power station, we may remind our readers of its well-tested capacity for traffic.

A "LOOK ROUND."

Let us suppose we enter the building from the street. We first find ourselves in the Accepting Office, which is tastefully panelled and furnished in mahogany. In front of us stands a curved counter so arranged as to utilise the space available to the best advantage, and admit as large a number of clients as possible being attended to simultaneously. The white walls are lined with

a composition giving an embossed effect, and surmounted by cornices and ceiling supports of white moulded wood reflect the light admitted by the large plate-glass windows, and render the conditions under which business is transacted excellent from an eyesight point of view. The holophane electric pendant provides ample illumination after sunset, and is supplemented by electric standards disposed round the counter. Neither clients nor staff need have any fear of eye strain either by day or night. The floor space on which we stand is covered with a patent composition, which, being jointless, can be easily kept in a thoroughly clean and sanitary condition, however heavy may be the traffic handled. That metal pipe which we see at the back of the counter is the Lamson pneumatic tube, which conveys the messages to the instrument room.

Passing behind the partition at the back of the counter, we reach a room adjoining the Accepting Office, a room destined for the registration of addresses and other clerical work and in direct communication with the messengers' lobby. Here we notice a desk allotted to the messengers' superintendent, the office telephone exchange,

a further Lamson tube connection and seats for the waiting messengers.

TO ENSURE CONTINUITY.

Descending to the basement we discover a workshop containing facilities for small repairs, and passing through this we enter a further office wherein is located the motor generating set which supplies current to the Clifden wire. This generating set is reproduced in duplicate and so arranged that to change from one set to another shall be made at regular intervals. In this way both sets are maintained continually in working order, so that in the event of a possible breakdown an immediate change over can be made and the work continued without any interruption. The electricity supply is brought into the office from two distinct mains, each of which is linked with the services of a different supply company. Here again we have fresh evidence of the care taken to ensure absolute continuity of working which characterises the whole equipment of the establishment. Should any part of the machinery perchance break

down another is immediately ready to take its place. In the immediate vicinity of the power room we shall notice the electrically-driven blower for the pneumatic tube, and our inspection of the remainder of the basement shows that it has been devoted to providing accommodation for the messengers.

INSTRUMENTS AND ORGANISATION.

Our visit now takes us upstairs to the regions situated above the Receiving Office. Here are located the Superintendent's Bureau (a corner of which may be seen in our illustration), the instrument rooms, an office devoted to general clerical work, and operators' retiring room. Our inspection of the instrument rooms produces a most favourable impression. We find them to be commodious and well lighted, and our picture will show that the windows are especially spacious. At the left hand of the desk by the window (see illustration, page 120) we find operators handling messages on the Clifden main lines, whilst on the right hand side run the special wires leading to the General Post Office. The separate desk



Marconi House Circuit and Punching Apparatus.



Mr. W. S. Purser (Assistant to Traffic Manager) on left with Mr. G. E. Clarke (Superintendent) conferring.

standing on the left is occupied by the chief operator on watch, whilst on the right hand sits the service clerk. In one corner of the instrument room we notice the termination of the pneumatic tubes from the counter and messenger department close by a desk occupied by a clerk busy decoding abbreviated telegraphic addresses.

TIME SAVING.

Everything possible is done throughout the establishment to save even the tiniest scrap of time. Seconds are of value in telegraphic work, and the long row of pigeon-holes that we notice here contain printed envelopes for all the most frequently used names and addresses. As soon as the Marconigram is ready it is placed in the envelope, and the pneumatic tube transports it almost instantaneously into the hands of the waiting messengers below.

We now pass into the further extension of the instrument room, running at right angles to the portion already noticed and described above.

Against the wall, close by the window, we observe the switchboard. By its agency all the various lines can be changed over, tested, or put into communication with different instruments. Through its medium the

current from the generating machines in the basement below (which we have just visited) is also regulated and led to the instruments. At the desk we see on the left an operator is hard at work sending a message over the private wire to Marconi House (*see illustration page 121*). Immediately to the right has been located the slip-punching apparatus for Wheatstone working.

DUPLEX WORKING.

It is sufficient for technical experts if we state that all the telegraph wires which have been examined and described are worked on the duplex system, but it may be as well to add for the benefit of those less versed in scientific detail a few words to indicate the important fact therein implied. It means that messages can be sent and received simultaneously. Each wire under this arrangement has its capacity doubled.

STAFF ARRANGEMENTS.

Despite all the mechanism which is employed in modern industry, and which necessarily plays a large part in such an enterprise as the one which we have been inspecting, the human element has lost none of its importance. In this new office of the Marconi Company the staff has been well considered, and every attention has been paid to their comfort and convenience. A special room has been provided for the exclusive use of the staff members wherein each telegraphist possesses his own locker, whilst a large table is available for reading, writing, meals, etc.

SHARE MARKET REPORT.

London, April 19th, 1915.

Owing to the favourable developments of the business of the various Marconi companies, the speculative account open in their shares at the end of July, 1914, has now been eliminated, the stock having been taken by investors.

The annual report of the American Company shows considerable progress has been made, in spite of the world-wide disturbance of the last nine months, and its issue was followed by considerable buying from the United States.

Prices are: Marconi Ordinary, $1\frac{7}{8}$; Marconi Preference, $1\frac{1}{8}$; American Marconi, 10s. 9d.; Canadian Marconi, 5s. 6d.; Marine Marconi, $1\frac{3}{8}$.

INSTRUCTION IN WIRELESS TELEGRAPHY

(Second Course)

(X.) The Receiving Circuit.

[The dislocation of our arrangements, due to the war, has prevented us from completing, in our last Volume, the second course of Instructional Articles. These are being continued in the third Volume, and we hope to arrange for the Examination (full particulars of which are given on page 333 of our issue of August, 1914) to be held in the early autumn of this year. The present is the tenth of the second series of articles, which will deal chiefly with the application of the principles of wireless telegraphy. Those who have not studied the first series are advised to obtain a copy of *The Elementary Principles of Wireless Telegraphy*, which is now published, price one shilling net, and to master its contents before taking up the second course of instruction.]

753. One of the calculations most frequently required in wireless telegraphy is that of the inductance of a coil, and a simple method is described below.

For the coils which are most often used—namely, those wound in a single layer of wire on a cylindrical former—there are several formulæ by which the inductance can be calculated with a sufficient degree of accuracy for practical purposes.

A formula which is very often quoted for such a coil is

$$L = \pi^2 d^2 n^2 l$$

where d = diameter of coil in centimetres.

l = length of coil in centimetres.

n = number of turns *per centimetre*.

(the inductance being expressed in "centimetres.")

This formula is, however, not at all suitable, since it is only correct for a coil of which the length is many times the diameter, a relationship which does not hold for the majority of the coils used in wireless telegraphy.

754. Professor Nagaoka has obtained a formula which is accurate for coils of all ratios of length to diameter, which is

$$L = \pi^2 d^2 n^2 l K$$

where all the terms have the same meaning as in the previous formula, and K is a factor depending on the ratio $\frac{\text{length}}{\text{diameter}}$.

He has compiled tables giving the values of K for the above ratio between 0.1 and 10. These tables are to be found in "Calculations of alternate-current problems" by Louis Cohen, and in "Formulas for the calculation of mutual and self-inductance," by Rosa and Grover, Bureau of Standards, U.S.A.

The writer has found it convenient when using this formula to employ the following

table for the inductance of a coil wound with 20 turns per centimetre on formers of diameter from 4 to 18 centimetres:—

The inductance of a coil wound with a different number of turns per centimetre, say m , is obtained by multiplying the inductance for a similar coil wound with 20 turns by the factor m^2

20².

Thus, if there be 10 turns per centimetre the multiplying factor is $\frac{1}{4}$, and for 30 turns per centimetre it is 2.25.

It will be noticed that the values are in microhenries and not centimetres of inductance as the former unit is more convenient.

It may happen that the dimensions of a coil are outside the limits of the table—*i.e.*, the diameter may be greater than 18 centimetres. In this case take the value for a coil half the diameter and half the length and multiply by 2³=8, or take a third of the dimensions and multiply the value by 3³=27, the result being multiplied by $\frac{m^2}{20}$.

755. The inductance given by the above formulæ are what is known as "current-sheet" values. That is, they are correct for a coil wound with flat strip, the turns of which touch without making electrical contact—*i.e.*, the insulation is infinitely thin. For coils wound with ordinary round wire which have insulation of appreciable thickness or which are separated by air spaces, a correction must be made to obtain accurate results. Where the insulation is not thick compared with the conductor, and the coil has a large number of turns, this correction is small, but for other cases it is appreciable.

TABLE SHOWING INDUCTANCE IN MICROHENRIES FOR COILS WOUND AT 20 TURNS PER CENTIMETRE. Diameter in Centimetres.

Length in cms.	4.	5.	6.	7.	8.	9.	10.	12.	14.	16.	18.
1	23.02	31.56	40.55	49.98	59.78	69.88	80.26	—	—	—	—
2	66.37	93.11	122.0	152.5	184.7	218.0	252.5	324.5	399.0	478.2	559.0
3	118.1	169.0	224.1	283.5	346.3	388.6	479.9	623.3	783.9	932.2	1095
4	173.6	251.9	338.3	431.7	531.3	636.2	745.2	974.0	1221	1478	1744
5	232.1	339.7	460.1	590.5	718.6	881.4	1038	1369	1723	2094	2482
6	291.7	430.3	587.0	761.0	945.0	1201	1350	1793	2270	2795	3295
7	351.7	522.8	717.1	932.2	1165	1415	1681	2243	2847	3493	4183
8	413.1	616.9	850.2	1109	1392	1695	2016	2707	3454	4249	5113
9	474.7	711.4	984.5	1291	1624	1982	2362	3203	4079	5025	6049
10	536.8	807.4	1120	1472	1858	2274	2718	3681	4725	5857	7050
12	661.0	997.4	1395	1842	2344	2870	3443	4699	6074	7546	9133
14	785.7	1193	1673	2216	2810	3475	4185	5740	7450	9315	11290
16	910.9	1389	1951	2593	3301	4091	4937	6803	8876	11140	13600
18	1037	1583	2231	2972	3800	4711	5697	7879	10310	12980	15850
20	1162	1779	2512	3352	4295	5332	6462	8966	11780	14860	18190
22	1287	1975	2794	3734	4821	5960	7228	10060	13250	16750	20560
24	1414	2172	3005	4115	5289	6588	8000	11160	14730	18670	22940
26	1536	2367	3357	4502	5789	7381	8778	12270	16230	20610	25370
28	1666	2565	3642	4883	6288	7845	9683	13390	17730	22550	27810
30	1792	2761	3922	5264	6790	8480	10330	14500	19230	24500	30260
32	1920	2958	4207	5652	7288	9111	11110	15620	20750	26460	32730
34	2044	3155	4489	6037	7793	9519	11930	16730	22260	28650	35200

To make this correction, having calculated the inductance from the formula or table, subtract from the result $2\pi ndl [A+B]$ where all the terms have the same meaning as before, the inductance being in centimetres, and A and B are given below. Complete tables of the functions A and B are to be found in "Calculations of Mutual and Self-inductance," mentioned above.

VALUE OF TERM A DEPENDING ON THE RATIO $\frac{d}{D}$ OR DIAMETER OF BASE TO COVERED WIRE.

$\frac{d}{D}$	A.	$\frac{d}{D}$	A.
1.00	+ .5668	.75	+ .2691
.95	+ .5055	.70	+ .2001
.90	+ .4515	.65	+ .1261
.85	+ .3943	.60	+ .0460
.80	+ .3337	.55	— .0410
.50	— .1363	.25	— .8294
.45	— .2416	.20	— 1.0526
.40	— .3594	.15	— 1.3404
.35	— .4928	.10	— 1.7457
.30	— .6471		

VALUE OF TERM B DEPENDING ON TOTAL NUMBER OF TURNS OF WIRE ON THE COIL.

Number of Turns.	B.	Number of Turns.	B.
1	+ .0000	40	+ .3148
2	+ .1137	50	+ .3186
3	+ .1663	60	+ .3216
4	+ .1973	80	+ .3257
6	+ .2329	100	+ .3280
8	+ .2532	200	+ .3328
10	+ .2664	300	+ .3343
15	+ .2857	400	+ .3351
20	+ .2974	1.000	+ .3365
30	+ .3083		

756. As a numerical example, we will calculate the inductance of a coil wound, at 24 turns per cm., with No. 28 S.W.G. single wound silk wire, on a former 18 cms. diameter, 16 centimetres long.

From the table the inductance of such a coil wound at 20 turns per cm. is 13600 microhenries.

Hence, for 24 turns per centimetre, inductance = $\frac{13600 \times 24 \times 24}{20 \times 20} = 19580$ mhs.

Applying the correction diameter of No. 28 wire = .0376 cms., or it could be wound at 26.6 turns per centimetre $\therefore \frac{d}{D} = \frac{24}{26.6} = .9$ nearly, whence A = .4515.

Total number of turns of wire = $16 \times 24 = 384$.

B = .3350.

\therefore Correcting term

$$2 \times \pi \times 18 \times 24 \times 16 [.4515 + .3350] = 38160 \text{ centimetres} = 38.2 \text{ microhenries.}$$

Hence inductance = 19540 microhenries to four significant figures, and the correcting term is small.

As another example, take a similar coil, but wound with 3 turns per centimetre with wire of diameter .25 cm.

The diameter of the former must be measured to the centre of the wire, and hence

we will assume the diameter of the former to be 17.75 cms., which with the wire gives a mean diameter of 18 cms.

From the table

$$\text{inductance} = \frac{13600 \times 9}{400} = 306 \text{ mhs.}$$

But $\frac{d}{D} = .75$, hence $A = .2691$.

Total number of turns = 48 and $B = .3178$.

$$\text{Correcting term} = \frac{2\pi \times 18 \times 3 \times 16 \times .5869}{1000}$$

= 3.186 mhs., which is more than 1 per cent. of the total.

The inductances given by the formula are only strictly accurate for very low frequencies, but are not far out even for the high frequencies met with in wireless telegraphy. There is not any simple formula which can be used in place of the one quoted for high-frequency calculations.

Since the current in such cases tends to concentrate near the inside of the coil, the result will be more accurate if the inside diameter of the wire coil be taken instead of the diameter to centre of wire.

For diameters in between those given in the table, a convenient method is to plot the figures on squared paper from which the result for any diameter can be read off.

757. The formulæ given in paragraphs 753 and 754 will be quite sufficient for working the inductance of coils wound on cylindrical formers. The only other shape of former which is used to any extent is a "spherical" one, which is sometimes used for a coupling coil in which variation in coupling is effected by turning a handle and not by sliding the coils to and fro. There is no general formula suitable for this case, since the winding may cover a large or small amount of the surface of the former, and the ratio of the diameter of the outside turn to the diameter of the sphere may vary according to the exact shape of the former.

If, however, the inductance be calculated for a cylindrical former of diameter equal to that of the middle turn and overall length equal to that of the actual winding, an approximate value for the inductance will be obtained.

It is to be noted that, supposing a coil is wound on such a former and the inductance is measured, then for another winding on

exactly the same size former and same overall width, the inductance will be exactly proportional to the ratio of the squares of the numbers of turns.

MUTUAL INDUCTANCE.

758. In paragraph 751 it was stated that a knowledge of the mutual inductance between two windings wound separately on one former is of use in designing a receiver.

The calculation of this is easily made if the windings are of the same number of turns per centimetre.

In Fig. 1 let A and B be the two windings. Calculate the inductances of a coil C which would exactly fill the space between A and B.

Calculate also the inductances of coils equal in length to A+C and B+C and A+C+B. These values can be written down from the table above especially if the figures given are plotted on squared paper to allow for cases where the lengths are not even centimetres.

Then, if the inductance of C be L_C ,
 A+C be L_{AC} ,
 B+C be L_{BC} ,
 A+C+B be L_{ABC} ,
 and the mutual inductance between

A and B be M_{AB} ,
 we have $M_{AB} = \frac{1}{2} \{ (L_{ABC} + L_C) - (L_{AC} + L_{BC}) \}$

A knowledge of the mutual inductance between a primary and secondary coil would be of use, but unfortunately, there is no general formula for the purpose. At least three or four formulæ would have to be given to meet every case, and these formulas are themselves complicated.

When the primary is right inside the secondary (or *vice versa*) an approximate value is given by

$$M = \frac{4\pi^2 a^2 n_1 n_2 l}{1,000} \text{ microhenries.}$$

where a = radius of inner coil and l its length and n_1, n_2 are the respective number of turns per centimetre.

The result will be too large, as it assumes the outer coil to be very long.

CAPACITY.

759. The calculation of the capacity of a condenser is not always such an easy matter for accurate results as the inductance of a

coil, since, in most condensers the plates are very close together and it is difficult to measure the small distance to, say, within 1 per cent., unless expensive instruments are available. Moreover, the dielectric coefficients of insulating materials varies to a large extent from sample to sample and figures taken from a book for any material, such as mica, ebonite, paraffined paper, etc., may not be correct for the sample of which the actual condenser is made. In a fixed condenser the pressure to which it is subjected when built up will affect the capacity and in variable condensers the clearance between moving plate and sheet of insulating material has to be taken into account.

Hence, only approximate values can be obtained and, therefore, simple formulæ which are only approximate in correctness will be given.

The capacity between two parallel plates, whose surface is A square centimetres and distance apart d centimetres is

$$C = \frac{A}{4\pi h} \times \frac{1}{9 \times 10^9} \text{ microfarads}$$

if air is the dielectric, and

$$C = \frac{KA}{4\pi h} \times \frac{1}{9 \times 10^9} \text{ microfarads}$$

for a dielectric with a dielectric constant (specific inductive capacity) of K .

For a condenser built up of a number of plates the capacity is $(N-1)$ times the capacity of a single pair of plates, where N =total number of fixed+moving plates.

For semi-circular plates, such as are largely used in variable condensers.

$A = \frac{\pi r^2}{2}$ where r =radius of the plate, and therefore

$$C = K \frac{\pi r^2}{8h} \times \frac{1}{9 \times 10^9}$$

for a pair of plates.

760. Another form of condenser is the tubular design.

The capacity is

$$\frac{Kl}{4,145,400 \left(\log_{10} \frac{R_1}{R_2} \right)}$$

where R_1 =diameter of outside tube (measured inside the tube);

R_2 =diameter of inside tube (measured outside);

and K =dielectric constant of the medium, which for air=1.

The above formulæ neglect the corrections due to the "end effects." These corrections

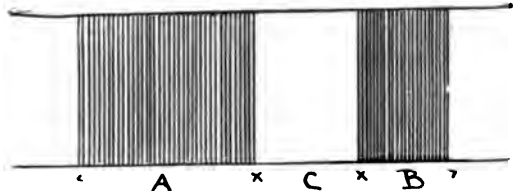

Fig. 1.

have only been worked out for circular plates, which are not used in radiotelegraphic work, and the difficulty of making the small measurements to the required degree of accuracy renders these corrections of little practical value. The capacity of any condenser should, therefore, be determined experimentally.

Although there are methods for measuring the inductance of coils of very great accuracy, these values can be calculated to an even higher accuracy by appropriate formulas, of which the one given in paragraph 754 will be found to be quite sufficient for the coils used in making receivers.

Having calculated the inductance of a set of coils the capacity of any condenser within moderate limits, can be determined if a wavemeter is available, by measuring the wave-length of the circuit formed by connecting the capacity and inductance in parallel.

Capacities between .00005 and, say, .1 microfarad can be measured in this manner, which is, however, not suitable for condensers of much smaller capacity owing to the distributed capacity of the inductance.

DECREMENT.

761. For a receiver to be efficient it must be designed so that it does not appreciably increase the damping of the signals.

The decrement of a closed oscillating circuit (*i.e.*, a circuit which does not lose energy by radiation into space) is given by the formula :

$$d = \frac{8.33R\lambda}{L \times 10,000}$$

where R is in ohms, λ in metres, and L in microhenries. R is the resistance of the

coil at the frequency corresponding to the wave-length of the circuit.

The above formula is based on the assumption that the whole of the damping is due to the ohmic resistance of the inductance. But in addition to this the condenser may introduce a loss which will increase the decrement. For condensers constructed with air dielectric or the best quality of mica or ebonite the decrement is usually very small, but for dielectrics such as glass or celluloid; or paraffined paper, mica or ebonite which are not absolutely freed from the last traces of moisture, etc., the decrement may become large, some of the energy being wasted by electrostatic hysteresis or the low insulation resistance.

Since the decrement depends on the physical state of the dielectric at the time it is not possible to give a formula to calculate it. The usual method is to find by experiment the value of resistance which will introduce the same decrement into the circuit and use this in the formula given above.

762. In ordinary receivers the decrement due to the resistance of the inductance is quite small. Thus, if we wish to receive a wave-length of 300 metres using a capacity of 0001 microfarads our inductance would be 253 microhenries.

If the high frequency resistance of this coil were 2.5 ohms, which is the approximate value for No. 26 S.W.G. wire, the decrement due to it would be

$$\frac{8.33 \times 2.5 \times 300}{253 \times 10,000} = .0025.$$

the coil being taken as 5 cm. dia. wound with 80 turns.

It must not be forgotten that every circuit used between the aerial and detector adds to the damping. Also the detector itself, since it absorbs energy from the closed detector circuit increases the damping, in the same way, and therefore each circuit must have a small decrement in order that the total decrement may be small.

THE YEAR BOOK OF WIRELESS TELEGRAPHY AND TELEPHONY.

The new volume is now ready and has been increased to 800 pages, with the addition of special articles on general subjects, contributed by eminent authorities, such as Col. F. N. Maude, C.B., and Mr. Archibald Hurd.

MARCONI HOUSE RIFLE CLUB.

A COMPETITION was held in March for various medals, etc., presented by the National Rifle Association and the Society of Miniature Rifle Clubs. Each competitor was required to shoot three series of ten shots each, the highest possible score being 150. Thirty-nine members of the club competed, and the result was declared by the committee as follows:

First: Mr. F. K. May (score 128), Donegal Badge and *Daily Express* Medal; *Second*: Mr. A. E. Moore (score 126), Bell Medal; *Third*: Mr. W. Marsh (score 125), *Daily Mail* Certificate; *Fourth*: Mr. F. Atkin (score 124), *Daily Telegraph* Certificate; *Fifth*: Mr. H. W. Corby (score 124), Lord Roberts's Medal.

A LUCKY ESCAPE.

MANY and varied are the experiences recounted by our soldiers and sailors, but perhaps one of the most curious was told by Private Benjamin Driscoll, who was formerly employed by the Marconi Wireless Telegraph Company, Ltd., in their Chelmsford Works. Private Driscoll, who was a Reservist, was called up on August Bank Holiday, and went to France on December 19th. In a letter home he emphasised the need of a cigarette case, and on February 28th he received from his brother a nickel one, which he placed in the left pocket of his overcoat. During the attack on Neuve Chapelle he was struck by a bullet, which by good chance passed through his cigarette case, and in consequence only inflicted a comparatively slight wound. While lying on the ground from the effects of this, a stray bullet struck him in the right arm, and he was eventually picked up and taken to a hospital at Boulogne, and later on to the 3rd London General Hospital at Wandsworth. Blood-poisoning unfortunately set in from this second wound, but, in spite of this, Private Driscoll is wonderfully bright and cheery, and is quite confident that he will recover.

We are sure all of our readers will join with us in congratulating Private Driscoll on his remarkable escape.

The LIBRARY TABLE



“MAGNETS AND ELECTRIC CURRENTS.” By
J. A. Fleming, M.A., D.Sc., F.R.S.
London: E. & F. N. Spon. 5s.

This is the third edition of a work first published seventeen years ago, and the fact that there is still a demand for it is evidence of the clear and able manner in which the subjects it professes to deal with have been treated.

In the preface the author states that “it has not been considered necessary to enlarge the book or alter its scope. It deals with the fundamental and elementary principles on which electrical engineering is based and these are not subject to variation. Hence considerable stress is laid at the outset on quantitative measurements and numerical values.”

The work is admirably suited to those who are commencing the study of electrical engineering, either with a view to a complete course of instruction in the subject or, as we hope is the case with many of our readers, for the purpose of obtaining a wider knowledge of the fundamentals which underly or are associated with the fascinating subject to which this journal is more particularly devoted.

There are ten chapters dealing with magnets and magnetism, units, magnetic force and flux electric currents and their measurement, electro-magnetic induction and electro-magnets, and alternating currents. The last two chapters are devoted to electrical measuring instruments and the generation of electric currents.

The whole are treated with only the most

elementary mathematics, in a clear manner. For illustrating many of the subjects numerical examples are given.

The methods for making experiments in proof of the various laws stated are given, together with practical hints on the construction of simple apparatus for the purpose.

A large number of useful tables of constants, which are a feature in Dr. Fleming's text-books, are included.

The various memory-aids for the laws as to direction of currents, forces, etc., are stated and, in many cases, illustrated.

There are one or two points in which alterations might, with advantage, have been made in preparing this edition.

On page 290 it is stated that certificates of the resistance of coils can be obtained from the Cavendish Laboratory, Cambridge.

We do not know whether, for special purposes, this is still possible, but the granting of certificates of this nature and of many other electrical quantities has, for several years, been one of the chief functions of the National Physical Laboratory.

The details, which are fully set out, for the construction of the Clark cell might well have been replaced by similar information concerning the Weston Cadmium cell, which has, for all practical purposes, replaced it, and which does not even appear to be mentioned. The Carden voltmeter is not a type which readers are likely to meet with, and therefore the description and illustration might have been replaced by those of more modern instruments.

The great and ever-increasing complexity of the science of electro-magnetism makes it necessary for even an elementary text-book to deal with a large number of subjects which, whilst of the greatest theoretical importance, have not as yet any practical bearing on everyday electrical engineering. The beginner is apt to become confused and bewildered if, with a view to a knowledge of engineering, he commences his studies with a general text-book, and often, after having made a way through it, treats those parts which appear to have but a slight bearing on the subject from his point of view as of mere theoretical importance and beneath the consideration of a practical man. This mistaken view can be obviated if his studies commence with a work which treats of the subject from an engineering point of view, laying special emphasis on the fundamental points without a clear comprehension of which knowledge of the subject must be superficial and scrappy.

Dr. Fleming's book is such a work, and can be confidently recommended to all who are beginning the study of electrical engineering.

* * *

SUBMARINES, TORPEDOES AND MINES.

By W. E. Dommett. London and New York: Whittaker & Co.

However necessary may be the censorship for the safety and welfare of a belligerent country in wartime, it has one grave disadvantage. The ability of the people of that country to view things in their true perspective is atrophied, and in some cases entirely lost. On the other hand, the feeling of uneasiness in this country at the beginning of hostilities, inspired by the frequent stories of havoc wrought by German howitzers, passed all rational limits through the inadvisability of any reassuring newspaper articles on the capacity and construction of our own siege guns.

Even at this moment many persons are under the impression that Germany is alone in the possession of submarines that count; that she only can use these vessels to advantage, and that her "Unterseeboot" fleet is growing like a family of guinea pigs.

The public are naturally asking for the whereabouts of our "B's," our "C's,"

our "Ds," and our "E's." This for good reasons may not be told. Happily, however, for our sense of proportion there has been passed for publication the popular little treatise which is the subject of this review. It is rich in reassuring facts.

We learn therein that, as far as can be ascertained, the number of submarines in commission in January was: British 95, French 95, German 33, Japanese 20, and Austrian 5. Also that 25 more may be completed for the British Navy during the war.

That Germany has not outstripped us in the construction of boats of considerable size is indicated by the details given of the "F" and "G" classes. The "F" class has surface and submerged speeds of 20 and 12 knots respectively, and an armament of six torpedo tubes and four quickfiring 22 pdr. guns. The radius of action is 1,000 miles. The "G" class has a speed of 24 and 18 knots respectively, and a radius of action of 2,800 miles. This class will carry a complement of three executive officers, two engineer officers, one surgeon and forty-six men, also an armament of two 4-inch guns and eight torpedo tubes. The wireless equipment of these boats will provide for "the sending and receiving of telegraphic and telephonic messages."

How great are the strides made with these new classes may be judged by the capacity of the propelling machinery. Whereas the "E" class (the latest pre-war class) had engines of 1,800 and 900 H.P. respectively for surface and submerged work, the "F" class will have engines of 5,000 and 2,000 H.P., and the "G" class engines of 6,500 and 2,400 H.P., the last providing an underwater cruising radius of 900 miles.

Contemporaneously with the building of the "F" and "G" classes, one private yard is stated to be engaged upon the construction of a "super-submarine" named the *Nautilus*. This craft is to be capable of cruises in excess of 3,000 miles.

For a fuller understanding of the use and limitations of the submarine there are chapters on torpedoes and mines, the handmaids and principal foes in submarine warfare. So interesting are these that we look for the day when the author may tell us more.

QUESTIONS AND ANSWERS

Readers are invited to send questions on technical and general problems that arise in the course of their work or in their study to the Editor, THE WIRELESS WORLD, Marconi House, Strand, London, W.C. Such questions must be accompanied by the name and address of the writer, otherwise they will remain unanswered.

H. D. (Royston) asks:

(1) I am using a $\frac{1}{2}$ kw. transformer and my source of power is 100 volts 60 mains. I have a $\frac{1}{2}$ h.p. A.C. motor of 4,000 revs. per minute, and wish to use this coupled directly to a rotary gap. Can you tell me how the latter should be designed in order to obtain the best results, how many studs should there be, &c. ? Also please say if, with such an arrangement, I should be able to get a high musical note.

(2) Can you please tell me the method of calculating the length and diameter of a coil of inductance which is required to receive a wave of a certain length? Can you give me a formula for calculating this for any given wave-length which it is desired to receive? Also please explain how the natural wave-length of the receiving aerial would figure in these calculations.

Answer.—Your best plan to obtain a musical note is to make your rotary gap so that it gives two sparks per half cycle or 240 per second. This will be obtained from a rotating disc provided with four studs, running at 3,600 r.p.m., which, being a little less than that of your motor, allows of some regulation.

A good plan would be to make a disc with eight studs, four of them being removable, and try it with eight and four. The best results will depend on the wave form of the supply and inductance of the transformer. Care must be taken that the studs are quite tight when running.

The note of 240 per second which would thus be obtained from four studs is not high, although it is quite a good one to receive; and the eight-stud note of 480 would be better from this point of view if the arrangement suits the supply and the rest of the circuit, which is a matter for trial.

You will find full information as to the calculation of inductance of a coil in the instructional article of the February, 1915, number, which also shows how the value of inductance required to tune to a given wave-length for a certain sized aerial is calculated.

WOLTERS enquires as to what can be done if the iron band of a magnetic detector broke and no crystals were available for receiving signals.

The only way of using the detector is to repair or replace the band, since the windings of the instrument are not at all suitable for working with crystals, if they were available. The only point to be regarded in repairing the band is to see that the strands of iron wire overlap at the join. There is no necessity for the iron wire to be continuous as long as there is always some iron in the band under the magnet poles as the band travels. If a butt joint be made there will be an interval of silence as it comes under the poles, during which time no signals can be received.

PARRY.—(1) You will find full information as to the calculation of the inductance of a coil in the instructional article in the February, 1915, number of THE WIRELESS WORLD at page 734. The curves given are suitable for both receiving and transmitting circuit inductances.

(2) The article "The Life of a Naval Wireless Operator" appeared in the September, 1914, number.

(3) For particulars as to age limit, &c., for wireless operators, your best course is to write direct to the Admiralty, giving full particulars.

(4) We do not know of any book on "How to Become a Wireless Operator." For a thorough knowledge of the theory of wireless telegraphy you cannot do better than obtain "Hawkhead's" handbook. You will, of course, also require proper instruction in the Morse code, which is best obtained from one of the institutions devoted to it.

"FISH" (Dublin) is interested in the standard $1\frac{1}{2}$ kw. Marconi installation, and wants to know: (1) If speeding up the converter gives greater power; (2) what are all the results of speeding up the machine; (3) how many times per cycle the main condenser is charged; (4) why there is no means of putting the high-tension circuit in tune with the low-frequency circuit. As these are practical questions which are frequently asked by students, we have pleasure in dealing with them.

Answers.—(1) This is a question that cannot be answered by a direct "yes" or "no," as there is a certain critical speed by means of which the best results are obtained in each particular installation. With a badly-adjusted $1\frac{1}{2}$ -kw. set, increasing the speed may either increase or decrease the radiated power, depending on whether the original speed has been above or below the best speed of working. (2) Speeding up the machine increases the frequency of the alternating current and increases the spark frequency. As before stated, increasing the speed may either increase or decrease the efficiency. As the speed is raised by weakening the field current, too high a speed will cause the starter handle to fly back, owing to insufficient current passing through the coil of the "no-load" release. These are the most important results. (3) This depends on the form of discharger. With a fixed discharger, twice per cycle, but if the gap is small the condenser may be charged and discharged a greater number of times. With a rotary discharger the number of charges and discharges per cycle depends on the number of teeth on the disc, if this is driven on the same shaft as the converter. If the disc is being driven by a separate motor (a procedure adopted in many installations) of course both the speed and the number of teeth have to be taken into consideration. With both forms of disc discharger the condenser can roughly be said to be charged and discharged as many times per cycle as the fixed and moving electrodes come together in the time. (4) There is no need of any device for tuning the high-tension circuit with the low tension, as when the low frequency iron-core inductance and the speed of the converter are properly adjusted the low-frequency circuits are correctly tuned.

LT. A. H. W. T. (Shrewsbury) referring to the Instructional Article for March, and speaking of the inductively-coupled receiver, asks whether in the event of the secondary tuning condenser being of zero value, the detector is not in a closed oscillating circuit introducing a high resistance.

Answer.—We would refer A. H. W. T. to para. 745 of the article in question, which points out that each coil has a definite wave-length, due to the distributed capacity. The secondary will thus oscillate freely apart from the detector, which will act in exactly the same way as if the inductance was shunted by a separate condenser. Our correspondent also finds difficulty in obtaining sharp secondary tuning, although the secondaries have been wound for very small ranges of wave-length. We think it probable that he has not allowed for this distributed capacity when designing the coils. In reply to a question as to whether with sharp tuning the maximum strength of signals should be received with moderately loose or tight coupling, this depends on the damping of the wave which is received. Generally speaking, the strongest signals should be received with a moderately loose coupling.

N. J. W. writes: "The main condenser plates of the 11-kw. Marconi installation are tested to a strain up to 27,000 volts. Now, taking an alternating current supply to the primary of the transformer of 150 volts, and presuming the ratio between the primary and secondary to be 1-300, this will give a potential across the secondary of the transformer of 45,000 volts. By putting the secondaries in series we get twice that voltage. I should be interested to know why it is that the condenser plates will stand this excessive voltage."

Answer.—N. J. W. starts his argument with wrong suppositions. With secondaries in parallel the ratio is 1-150 not 1-300; further the usual alternating voltage at the primary of the transformer is not 150, but 70 to 75. If N. J. W. will work through his calculation again, starting with this figure, he will see that the secondary voltage will be well within 27,000 volts. With regard to the secondaries being placed in series, this is done when the two halves of the condenser are connected in series. If our correspondent will refer to the Instructional Article No. 5, which was published in the December 1914 issue, he will see that if we connect two units of a condenser in series we double the potential to which the condenser can be raised before puncture occurs. In cases where a primary alternating voltage higher than 70-75 volts is used, the transformer is specially wound for a different ratio of transformation.

FOREIGN NOTES.

Spitzbergen.

IN the course of an interesting paper on "Spitzbergen in 1914," by Dr. W. S. Bruce and Dr. R. N. Rudmore Brown, which was read before the Royal Geographical Society in London, on March 22nd, mention was made of the Norwegian wireless stations in these high latitudes.

The authors stated that in 1911 Norway erected a powerful wireless installation at Green Harbour with 60 metre masts, at a cost of over £10,000. This station communicates direct with the one at Ingö, in the north of Norway, erected for the purpose, but it can also receive messages from Christiania, Paris and Berlin, and even Poldhu, in Cornwall. It is from the Green Harbour Station that the meteorological data are sent daily to our Meteorological office. A staff of six men is maintained here all the year round; but, except for the convenience of mining camps and the amusement of summer tourists, the station is of little use and certainly can never pay a fraction of its initial cost and annual upkeep. The wireless station is also a Norwegian post office. Letters are carried to Tromsö at unfrequent intervals during the summer by a subsidised motor sloop. However, this service is of little utility since the large mining camps send and receive their own mails with greater frequency and regularity by their own cargo boats. The subsidised Government service is chiefly used by the smaller

mining camps and by occasional exploring parties. Norway's only object in erecting this wireless station and maintaining her post office and mail service was to increase her stake in the country. It should be mentioned that two smaller wireless installations exist in Spitzbergen, but these can only communicate with Europe *via* the Norwegian station.

Philippines.

Mr. S. W. Beach, formerly of the Bureau of Posts at Manila, writing to the *Telegraph and Telephone Age* (March) gives many interesting observations and facts concerning affairs in these insular possessions of the United States. Referring to the telegraph and telephone systems he states that when the American Government took possession of the Philippines sixteen years ago there were only 720 miles of lines open. There are now between six and seven thousand miles of telegraph wires and cables alone, and the city of Manila has an extensive modern telephone system owned by a private corporation, and throughout the islands the various provinces operate telephone lines connecting the principal towns. Some of these telegraph lines, says the writer, penetrate hostile districts and were built under an armed guard. The wireless station at Jolo is protected day and night by armed sentries. Mr. Beech remarks that operating the telegraph under these circumstances is no joke, but it has proved an excellent investment, not from a monetary standpoint, but that it has brought those isolated semi-civilised districts into a closer relation with the outside world and has opened up inter-island trade in a wonderful manner.

United States.

On August 25th last the United States Navy Department placed a ban on all amateur and restricted radio plants on the Pacific Coast as a precautionary measure for the enforcement of President Wilson's neutrality proclamation. Now that war vessels of the belligerent nations have virtually disappeared from the Pacific Ocean the Navy Department have removed the embargo, and Admiral Charles F. Pond, supervisor of the Twelfth Naval District, has unsealed no less than 1,400 amateur wireless telegraph stations in California.

PERSONAL PARAGRAPHS.



Mr. John Forster.

CHINAMAN RUNS "AMOK."—A letter received from Captain Head, of the s.s. *Cardium*, dated Abadan, February 9th, contains practically all the information we have regarding the sad stabbing affray which took place on his ship, whereby the wireless operator, Mr. John Forster, together with the third and fourth engineers, lost their lives. The incident took place when the ship was in the Persian Gulf. Captain Head writes: "The stabbing was done by the Chinese mess-room boy, who seems to have gone suddenly mad. He first

"went into the galley and stabbed the chief cook "with a big fork. He then seems to have picked "up a galley knife, and rushing aft stabbed the "three victims in their sleep, afterwards shooting "himself with the second engineer's revolver "and jumping overboard. I was on the bridge "at the time, and the first thing I knew about "the affair was when I saw the Chinaman go "overboard. We stopped and put out a boat, "but saw nothing of him after a few minutes. "We put into Jask to land the three wounded "members of my staff, where they received every "possible attention from the English doctor there." Operator Forster, whose photograph we reproduce, lived at Chester-le-Street, co. Durham. He entered the Marconi Company's service on October 7th, 1914, and was appointed junior operator on the s.s. *Briton*, shortly afterwards. In December last he was appointed operator-in-charge of the



Mr. H. E. Cutbush.

installation on board the s.s. *Cardium*, on which ship he met with his tragic death on February 4th.

It is our sad duty to record still another death on the operating staff—namely, that of Mr. B. F. Emery. Mr. Emery, of Thrapston, Northants, joined the Marconi Company on June 4th, 1912, and served as wireless operator on board the s.s. *Canada*, *Orana*, *Novara*, *Angora*, *Egra*, and *Arankala*. For some time he had been stationed on the Indian coast, and entered hospital at Bombay on January 29th suffering from suppurative appendicitis. Owing to his critical condition it was impossible to perform an operation for several days, and, although there was a temporary rally after the operation had been performed, Mr. Emery passed away on February 16th. The funeral service was conducted at the Sewari Cemetery, Bombay, by the Rev. Mr. French, a representative of the British India Steam Naviga-



Mr. B. F. Emery.

tion Co. being present together with a few fellow-operators from ships in port. On behalf of the staff we extend our deepest sympathy to the late Mr. Emery's parents.

We have also to record the sad death of another member of the operating staff, Mr. H. E. Cutbush. Mr. Cutbush, who was a resident of Norwich, was born in April, 1894, and joined the staff of the Marconi Company on October 21st, 1912, as learner in the London School. He afterwards served on board the s.s. *Caledonia*, *Numidian*, *Sicilian*, and *Karoo*. On March 19th Mr. Cutbush, together with the second officer and third engineer of the *Karoo*, was practising with a miniature rifle. At the moment when the second officer and third engineer were both holding the rifle it was accidentally discharged, with the result that Mr. Cutbush was shot, and he died in hospital at Alexandria on March 23rd. A Consular Court of Inquiry at Alexandria brought in a verdict of "Accidental Death," and no blame attached to anyone. The burial took place on March 23rd at the cemetery at Alexandria. Mr. Cutbush's death will be mourned by the many members of the staff to whom he was known, and their deepest sympathy is extended to his parents in their terrible loss.

We regret to record the death of Mr. Denis Wood, of Egerton Park, Worsley, who entered the service of the Marconi International Marine Communication Co., Ltd., on July 21st, 1913, as a learner in their London school, and afterwards served on board the s.s. *Columbian*, *Ashtabula*, *Egha*, and *Lusitania*, as wireless operator. Mr. Wood was recently appointed for special Admiralty duty, but before being able to take up his work in this connection, fell ill with pneumonia, and died on March 18th, aged 21.

It is with much regret that we have to announce the death of Mr. Theodore M. Church, which took place on April 2nd at the Reception Hospital, Winn Road, Southampton. Mr. Church, who has been on military service since the commencement

of the war, joined the operating staff of the Marconi Company in June, 1913, afterwards serving on the s.s. *Avon* and *Etonian*. At the time of going to press we have received only a brief intimation of Mr. Church's death, but in the June issue we hope to be able to give more particulars. Meanwhile, we take this opportunity of expressing, on behalf of the staff, our deep and sincere sympathy with the late Mr. Church's relations in their sad bereavement.



Mr. T. M. Church.

The Société Anonyme Internationale de Telegraphie Sans Fil deeply regret to announce the death of two members of their staff—Georges Guyaux and J. van Schoubroeck—who were both on active service with the Belgian Army.

M. Georges Guyaux was born at Vitruval on May 27th, 1888. He graduated at the Polytechnic Institute of Brussels as a Mining Engineer and was attached to the staff of the Société Anonyme Internationale de Telegraphie Sans Fil as Assistant Engineer from October, 1913. When war broke out he took service as gunner in the 63rd Battery, 15th Brigade, and was in the several engagements at Liège, Wareme-Huy, Louvain, Antwerp, and on the Yser in Flanders. On October 13th last he was transported to the hospital at Shorncliffe, where he died on the 13th of the following month.

M. Joseph van Schoubroeck, who was born at Diest in 1889, was a shorthand-typist in the Traffic Department at Brussels since 1908. He also, on the outbreak of the war, was called up for service as a sapper in the Royal Engineers and was drafted to one of the first line forts at Antwerp. After the fall of that city he saw service in Flanders. When the attack on the farm "La Violette," near Ramscapelle, was made early in January, young van Schoubroeck volunteered for the dangerous work of throwing hand-grenades. After having accomplished his mission, and during the fighting that followed, he was struck in the spine by an expanding bullet and died at La Panne Hospital on January 13th, a few minutes after having been decorated for bravery.



Mr. Denis Wood.

COMPANY NOTICES.

MARCONI WIRELESS TELEGRAPH COMPANY OF AMERICA.

Preliminary Report and Statement of Accounts for the Fiscal Year ended December 31st, 1914.

THE following report has been issued by the Directors of the Marconi Wireless Telegraph Company of America to the Stockholders of the Company:—

The Directors of the Marconi Wireless Telegraph Company of America draw attention to the enclosed notice showing that the annual meeting of this company, in accordance with the laws of the State of New Jersey, and the by-laws of the corporation, will be held on Monday, April 19th, 1915, at twelve o'clock noon, at the registered office of the Company, Nos. 243 and 245, Washington Street, Jersey City, N.J.

The balance-sheet and the profit and loss account for the year ended December 31st, 1914, prepared by Messrs. Arthur Young & Company, accountants and auditors, is hereto annexed and submitted to the stockholders.

The results for the year 1914, as shown by the profit and loss account, will, we believe, be found perfectly satisfactory to the stockholders. We feel, taking into consideration the conditions prevailing during the latter part of the year, that the showing is exceptionally good.

The net earnings of the company show \$271,888.71; and after placing in reserve \$59,511.24 against depreciation of apparatus, plant, etc., "through obsolescence or inadequacy resulting from age, physical change or supersession by reason of new inventions and discoveries," as described by the Interstate Commerce Commission; and \$50,000.00 towards the creation of a reserve fund which we expect to add to from time to time against amortization of the amount standing to the account of patent rights, goodwill, etc., and an additional amount of \$12,500.00 for contingencies; making a total of \$122,011.24; there is left a balance of \$149,877.47 as net earnings, which is carried over and placed to the credit of the profit

and loss account, and which, added to the balance on hand January 1st, 1914, gives a surplus of \$364,571.01.

The above does not include any operation affecting the transoceanic high-power stations, the operation of which we were about to begin when the European war was declared. The war has interfered with and, until its conclusion, will continue to interfere with our transatlantic service and, to a considerable extent, with our transpacific service.

A full report on the workings of the company, approved by your directors, will be submitted to and discussed at the annual meeting, and copy thereof will be mailed to stockholders of record.

Those who are unable to attend the meeting, but who wish to be represented thereat, will kindly fill out and return the enclosed proxy.

By order of the Directors.

JOHN BOTTOMLEY,
Secretary.

• • • • •

The balance-sheet appears on p. 135, and the following is the summary of operations for the year ending December 31st, 1914:—

GROSS EARNINGS FROM OPERATIONS	\$756,572.75
<i>Deduct:</i>	
GENERAL OPERATING AND ADMINISTRATION EXPENSES	634,958.25
NET EARNINGS FROM OPERATIONS	\$121,614.50
<i>Add:</i>	
Income from Investment of Surplus Funds	150,274.21
NET INCOME FOR YEAR before charging Reserves	\$271,888.71
<i>Deduct:</i>	
RESERVES:	
For Depreciation of Coast Stations	\$30,037.74
For Depreciation of Ship Stations	29,473.50
Against expiration of Patents	50,000.00
For Contingencies	12,500.00
NET INCOME FOR YEAR after charging Reserves, Carried to Balance Sheet ..	\$149,877.47

Marconi Wireless Telegraph Company of America.

Balance Sheet, December 31st, 1914.

ASSETS.		LIABILITIES.	
CURRENT ASSETS:		CURRENT LIABILITIES:	
Cash:		Accounts Payable	\$404,228.48
At Banks and on Hand	\$88,436.26		
At Banks on Deposit	560,000.00		
Call Loans with Bankers	190,000.00		
Accounts Receivable	838,436.26		
Investments at Cost (Market Value March 20th, 1915, \$1,402,947.50):	393,334.70	Shares subscribed for not yet issued.	\$10,000,000.00
Railroad Bonds and Notes	\$1,101,427.75	Shares in Treasury	597,980.00
Municipal Bond and Notes	300,000.00		
Work in Progress, Materials and Supplies	1,401,427.75		
	\$51,637.84		
STOCKS IN SUBSIDIARY COMPANIES	\$2,984,836.65		
	18,970.00		
FIXED ASSETS:			
Real Estate	\$314,506.19	For Depreciation of Coast Stations:	
Buildings, Coast Stations, Machinery and Equipment	4,013,873.75	As at January 1st, 1914	\$188,387.37
Ship Stations	294,735.06	Add:	
		Amount set aside from 1914 Profits	30,037.74
			\$168,425.11
	4,623,117.00	For Depreciation of Ship Stations:	
	77,243.70	As at January 1st, 1914	\$11,589.72
	2,763,006.25	Add:	
		Amount set aside from 1914 Profits	29,473.50
			41,063.22
DEFERRED CHARGES		Against Expiration of Patents, amount set aside from 1914 Profits	50,000.00
PATENTS, PATENT RIGHTS AND GOOD-WILL		For Contingencies:	
		As at January 1st, 1914	\$24,314.68
		Amount set aside from 1914 Profits	12,500.00
			36,814.68
		SURPLUS:	296,303.01
		Balance per Certified Accounts, January 1st, 1914..	\$214,693.54
		Add: Net Income for year ended December 31st, 1914
		(after charging \$122,011.24 Reserves) 149,877.47
			364,571.01
			<u>\$10,467,172.50</u>

New York City, March 24, 1915. We have examined the Accounts and Records of the Marconi Wireless Telegraph Company of America, and as a result thereof have prepared the above Balance Sheet and accompanying Summary of Operations for the year 1914, which in our opinion correctly set forth the financial position of the Company at December 31st, 1914, and its Operations for the year ended that date.

ARTHUR YOUNG & Co,
Accountants and Auditors.

Marconi's Wireless Telegraph Company, Limited.

AT a meeting of directors of the above company held on March 24th, it was resolved "That a dividend of 7 per cent., less income tax, upon the 250,000 7 per cent. Cumulative Participating Preference Shares be, and the same is hereby declared, in respect of the year 1914; that the said dividend be payable on the 19th April, 1915, to the shareholders registered on the books of the company on the 31st March, 1915, and to holders of Share Warrants to Bearer; and that the Transfer Books be closed from the 1st to the 7th April, 1915, inclusive."

The company has continued since the outbreak of war in full control of its business, but its stations have been largely devoted to Government work. For this reason the new direct public service with New York, which it had been contemplated would have been opened in the summer of last year, has had to be postponed. In other respects the company's business has been necessarily disturbed, and considerable business which was pending in many foreign countries has been delayed or deferred. This, however, has been substantially compensated for by Government and other business directly resulting from the War; the works and all the company's staff have been working under the highest pressure throughout the whole period.

A number of matters, including the question of compensation and payment for services, being still in abeyance, the directors are as yet unable to estimate with sufficient reliability the results of the business of last year to warrant them at this moment in declaring an interim dividend upon the ordinary shares. They are, however, of opinion that there is no reason for deferring the dividend upon the preference shares.

The directors contemplated being in a position to give shareholders information with regard to other matters of importance

concerning the company's business, but as these still remain under negotiation, it has been resolved not to delay further this announcement and the payment of the dividend.

Warrants for the dividend upon the registered shares were forwarded by post on April 17th.

THE YEAR BOOK OF WIRELESS TELEGRAPHY & TELEPHONY, 1915, now ready. Price 3/6 net; post free in United Kingdom 4/-; Abroad 5/-.—**THE WIRELESS PRESS, LTD.**, Marconi House, Strand, W.C.

THE ELEMENTARY PRINCIPLES OF WIRELESS TELEGRAPHY, by R. D. Banfay. Price 1/2 post free. A book eminently suitable for the beginner.—**THE WIRELESS PRESS, LTD.**, Marconi House, Strand, W.C.

HANDBOOK OF TECHNICAL INSTRUCTION FOR WIRELESS TELEGRAPHISTS, by J. C. Hawkhead. Price 3/6. A complete Course for the P.M.G.'s Certificate.—**THE WIRELESS PRESS, LTD.**, Marconi House, Strand, W.C.

BINDING CASES for Volume II. of **THE WIRELESS WORLD** are now ready. Price 1/3 post free.—**THE WIRELESS PRESS, LTD.**, Marconi House, Strand, W.C.

COPIES of Volume II. of **THE WIRELESS WORLD**, cloth bound, bevelled boards, are now on sale. Price 4/6 net. Postage for United Kingdom, 8d. Abroad at Foreign Parcel Post Rates. As only a limited number are prepared, orders should be placed at once.—**THE WIRELESS PRESS, LTD.**, Marconi House, Strand, W.C.

SPECIMEN COPIES.—We shall be pleased to send entirely free of charge a few specimen copies of **THE WIRELESS WORLD** to the friend of any reader likely to be interested in the magazine. Send a postcard to Sales Manager, **THE WIRELESS WORLD**, Marconi House, W.C.

MORSE CODE CARD, showing Alphabet, Numerals, Abbreviations, etc., at a glance. Price 2d. post free.—**THE WIRELESS PRESS, LTD.**, Marconi House, Strand, W.C.

ANY BOOKS reviewed in the **WIRELESS WORLD** or other magazines, will be forwarded per return upon receipt of remittance covering cost of book and postage.—**THE WIRELESS PRESS, LTD.**, Marconi House, Strand, W.C.

MARCONI OPERATORS and others studying Wireless Telegraphy will find our series of Test Cards and books of Model Answers of considerable assistance in attaining proficiency. Full particulars on page xiii of this issue.

MAP OF THE WORLD, revised March, 1915. Showing location of over 700 Wireless Stations. Price 1/8 post free. **THE WIRELESS PRESS, LTD.**, Marconi House, Strand, W.C.

YEAR BOOK OF WIRELESS TELEGRAPHY AND TELEPHONY, 1914. Twelve copies only available, otherwise out of print. Price 3/- each, post free. **THE WIRELESS PRESS, LTD.**, Marconi House, Strand, W.C.