

WIRELESS WORLD

MONTHLY 3^D

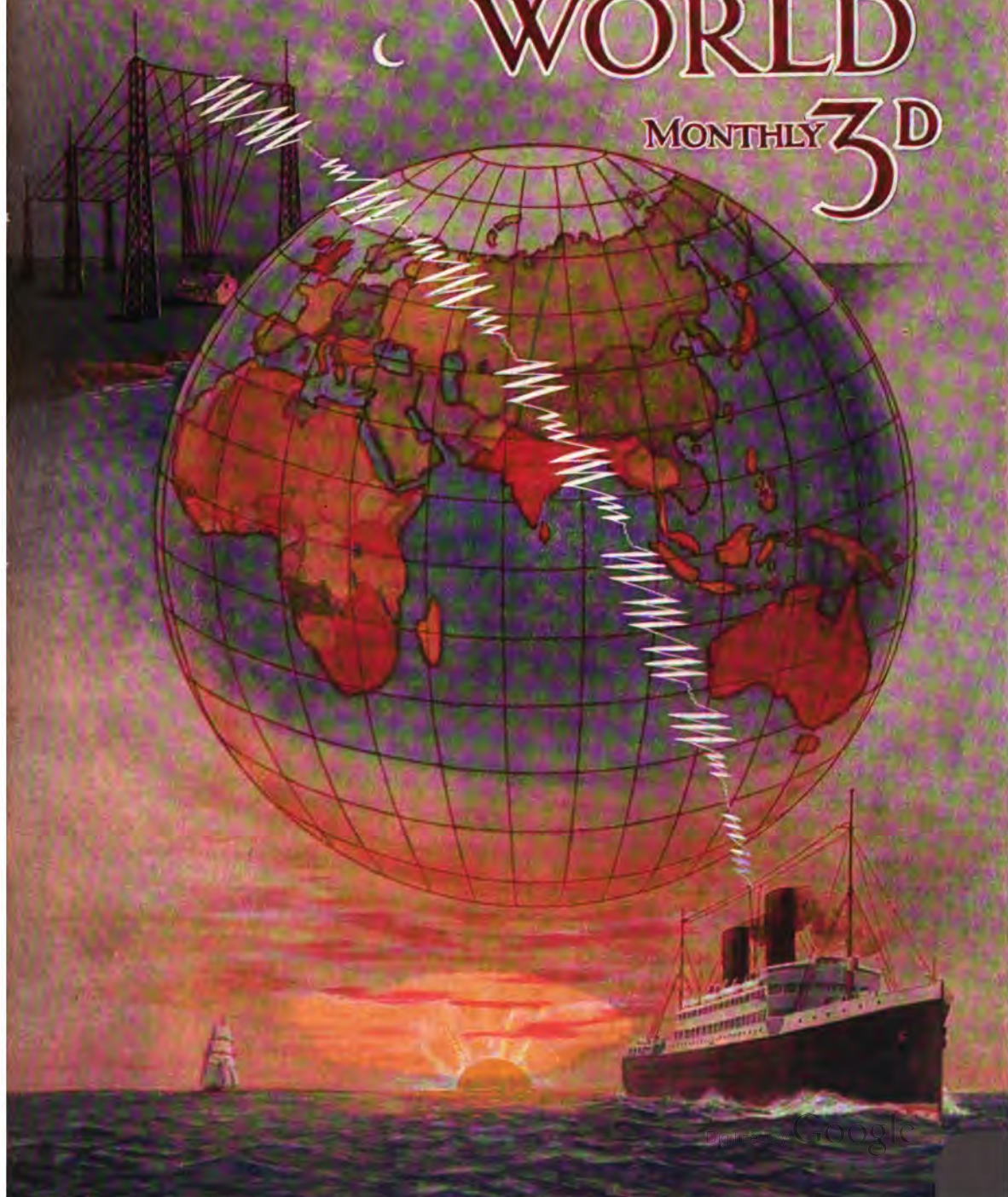

SULLIVAN INSTRUMENTS

Sullivan "Universal" Galvanometers and Shunts for Land and Sea Use.

SULLIVAN TELEPHONE RECEIVERS.

Fast Speed Wheatstone Automatic Transmitters and Receivers, guaranteed at 400 words per minute, and Wheatstone Apparatus generally. Precision and Standard Measuring Equipments for D.C. and A.C. (high frequency) determinations, Condensers of Low Power Factor, etc.

H. W. SULLIVAN WINCHESTER HOUSE, LONDON, E.C., ENGLAND.
Works: LIVERPOOL HOUSE, MIDDLESEX ST., LONDON, E.C.

Telegrams: "Deadbeat, London."

Telephone { Office: 3518 London Wall.
Works: 3518a " "

Silk and Cotton Covered H.C. Copper Wire, Resistance Wires, Fuse Wire,
Binding Wire, Charcoal Iron Core Wire, Asbestos
Covered Wire

P. ORMISTON & SONS, 79 CLERKENWELL ROAD
LONDON, E.C.
Established 1793. 13259 Central.
"Ormiston, London"

Braided and Twisted Wires, Bare Copper Strand & Flexibles of any Construction, Wire Ropes & Cords, down to the finest sizes, in Galvanized Steel, Manganese Bronze, etc.

NORMAN, SMEE & DODWELL

MANUFACTURERS OF HIGH-CLASS VARNISHES for Coach Builders and Decorators, Railway Carriage and Locomotive Builders, and Ship Builders. Special Insulating Varnishes for Electrical Purposes

Offices and Factory: MILES LANE, MITCHAM, SURREY.

WILLCOX'S

Undertake Supply of all Requisites

for Engine Rooms, Power Plant, Machine Shops, etc.

We shall be pleased to supply Electrical and other Engineers with copy of our enlarged

736 pp. CATALOGUE

on receipt of application on business form.

Our Specially Refined Lubricants are in use on every class of Machinery.



SEND
US
YOUR
INQUIRIES

W. H. WILLCOX & CO., LTD.
32/8 SOUTHWARK STREET, LONDON, S.E.

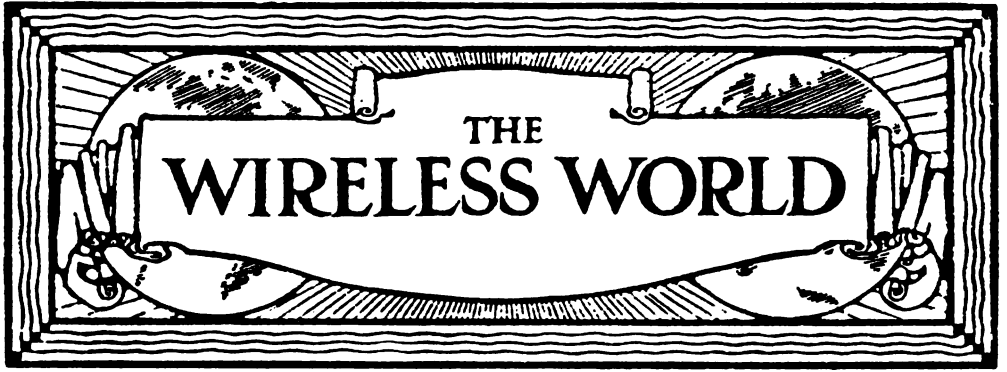

Vol. 3.—No. 31. (New Series)

October, 1915.

Subscription
5/0 per annum
post free.

Price 3d.
Post Free 5d.

NEWS BY WIRELESS

The Overpowering Supremacy of Radio-Telegraphy

ASSOCIATION of ideas is responsible for a good many sub-conscious assumptions. It is not many generations ago since the words "I saw it in print" settled at once the authenticity of a statement. In a sense every item of recent information not intended for exclusive possession may be classified as "news." Actually, when we speak of news, we mean such items as appear, or would fitly find their place, in the public newspapers. Just as other things are affected by the medium through which they are passed, so, also, has the character of the news appearing in public periodicals been modified by the medium of its transmission. In the earlier days of newspapers, reliance had perforce to be placed upon the medium either of the postal service or of special emissaries. It is difficult for us to realise that Englishmen at the time of the Crimean War had to rely for their accounts of the gallant deeds and sufferings of British troops upon the written despatches posted by Russell and the other great war correspondents of that period. "Wired telegraphy" practically killed the "News Letter," and profoundly affected not only the time elapsing between occurrence and narration, but also the manner in which the stories were told. Nowadays we have come to consider recency of occurrence as the very essence of a news item. Judged by this standard "Wireless News" is quite an easy victor. Messages sent in this way are transmitted at the rate of 186,400 miles per second, the same rate of speed as that of light—in other words, practically instantaneously. It therefore only becomes a matter of organisation to render radio-telegraphy

facile princeps in this field of activity. But, from the view of the Press, there is the further consideration of £ s. d., and it must be with some sinking of heart that newspaper proprietors read the recent announcement in the forecast of the next Budget prophesying that the Chancellor of the Exchequer is likely to increase the special land line rates charged for press telegrams. In the matter of cost, radio-telegraphy enjoys the same advantage as it does in that of speed. As if the two advantages of *speed* and *economy* were not sufficient in themselves, there is added to them the additional important factor of *mobility of stations*. A land station is tied to its wire; a wireless station may operate on a train or motor running at full speed, or on ships at sea. It is this latter factor which enables many of the great steamship lines to publish newspapers regularly on board their vessels when thousands of miles from land. Ocean newspapers are even yet in their infancy, but their's is a lusty babyhood, and we are constantly meeting with examples in all sorts of unexpected places. The only recorded instance of the sinking of a British troopship is the disaster which befell the *Royal Edward* in the *Ægean* Sea. From the narrative recently published, we learn that during the course of the voyaging of this transport, two or three of the men on board made themselves responsible for the publication of an interesting little newspaper called *The "Royal Edward" News*. This, we are informed, contained not merely a regular budget of war news picked up by wireless, but also a number of personal items dealing with the experiences of soldiers on board in their former campaigns.



PROFESSOR G. W. O. HOWE,
D.Sc., Whit.Sch., M.I.E.E.

Personalities in the Wireless World

PROFESSOR GEORGE WILLIAM OSBORN HOWE, D.Sc., Whit.Sch., M.I.E.E.

THE eminent figure in the world of Electricity, a photograph of whom we have pleasure in reproducing on the opposite page, was born at Charlton in Kent on December 4th, 1875. His connection with things electrical has been of life-long duration, as he entered the Woolwich works of Messrs. Siemens & Co., Ltd., at the tender age of 14, and, after serving an apprenticeship of five years in their shops, was transferred to the cable department, where he spent two years.

Whilst at Woolwich he attended the evening courses at the Polytechnic, obtaining a Whitworth Exhibition in 1896 and a Senior County Scholarship in 1897. He then withdrew from the service of Messrs. Siemens & Co., Ltd., and attended Armstrong College, Newcastle-on-Tyne, for three years. This college forms the science and engineering section of Durham University, where he obtained the degree of Bachelor of Science, and the Senior Pemberton Scholarship, whilst in the year 1900 he headed the list of Whitworth Scholars. Desiring greater scope, he proceeded to Charlottenburg, in Germany, where he stayed two years in the works of Messrs. Siemens & Halske, designing and testing alternating current machinery.

After this he returned to that firm's Woolwich branch, and spent a year in the designing department, leaving in 1903 to take charge of the electrical engineering department at the Hull Municipal Technical School. In 1905 he received the appointment of Lecturer at the Central Technical College, South Kensington, and became Assistant Professor of Electrical Engineering in 1909. This college now forms the engineering section of the Imperial College of Science and Technology, and is part of

London University, in which Professor Howe is a member of the Boards of Studies in Electrical Engineering and Mining and Metallurgy, and also of the Board of Examiners in Electrical Engineering. Professor Howe's valuable knowledge of electrical science is much coveted, and his services are often requisitioned. He is a member of the Institute of Electrical Engineers, and of the Council of the Physical Society, and, what will appeal particularly to our readers, a vice-president of the Wireless Society of London, a member of the Radio-Telegraphic Research Committee of the British Association, and a member of the British Committee of the International Radio-Telegraphic Commission.

Professor Howe holds the position of secretary to the engineering section of the British Association, in whose service he visited Australia in 1914, reading papers and giving lectures on subjects connected with wireless telegraphy at Melbourne, Sydney, and Brisbane. During his sojourn in the "Land of the Southern Cross" the honorary degree of Doctor of Science was conferred on him by the University of Adelaide. It may be remarked here that the subject of our illustration is also a D.Sc. of Durham University.

Professor Howe is a writer on electrical matters, of no mean repute, and he has published many articles dealing with the various aspects of radio-telegraphy in the technical journals of Great Britain and several foreign countries. Our readers will recollect that some of these papers have appeared from time to time in the *MARCONIGRAPH* and *WIRELESS WORLD*. Professor Howe has read a number of papers before British societies, and his services in the advancement of electrical science have been legion.

The Capacity of Aerials of the Umbrella Type.

By Professor G. W. O. HOWE, D.Sc., M.I.E.E., Imperial College of Science and Technology, South Kensington.

Paper read before the British Association at Manchester, September 10th, 1915.

THE author has recently published* a method of calculating rapidly the approximate capacity of aerials of various types. Although not rigorously correct, the accuracy obtained is more than sufficient for all the purposes of radio-telegraphy, and in most cases will be found to agree with the measured capacity within the errors of observation. In addition to describing the method in general, curves and formulæ were given so that the capacity of aerials of standard types could be determined in a few minutes. The umbrella type, however, was not specially considered, and it has been suggested to the author that the usefulness of the original paper would be considerably increased if curves and formulæ could be given for aerials of this type.

The method is briefly as follows: the whole aerial is assumed to have a uniformly distributed charge, and the average potential taken over the whole aerial under this fictitious condition is then calculated.

The assumption is then made that if the total charge, while remaining unchanged in amount, be allowed to have its own natural distribution, it will assume a uniform potential approximately equal to

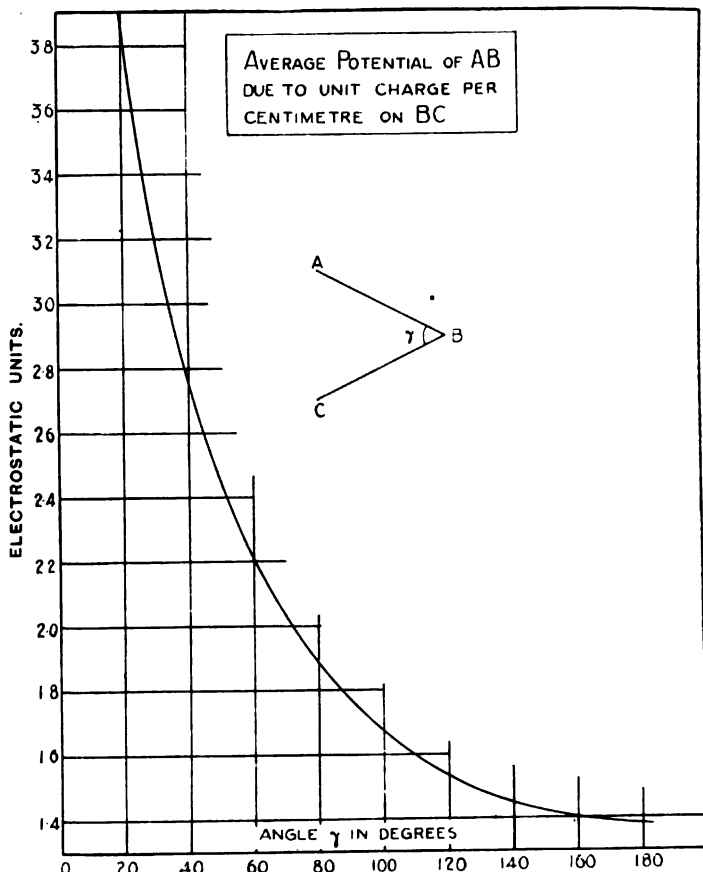

* British Association, Sydney, 1914. *Electrician*, August 28th, 1914. WIRELESS WORLD, February, 1915.

Fig. 1.

this average potential. The proximity of the earth is taken into account by assuming that the image of the aerial in the earth is uniformly charged with electricity of opposite sign, and calculating its effect on the average potential of the actual aerial.

The umbrella type of aerial consists of a vertical wire with a number of radial ribs sloping downwards from the top towards the earth. Both the vertical and sloping elements may consist of single wires or may be made up of a number of wires suitably spaced. We shall consider in the first place the simple case of a single vertical wire and n ribs each of a single wire. The "single wire" may, of course, and usually will, consist of a number of wires stranded together. Let the angle between the vertical and the ribs be α .

The average potential of each rib is made up of five components :

- (1) Due to its own charge ;
- (2) Due to the charges on the other ribs.
- (3) Due to the charge on the vertical wire.
- (4) Due to the image of the ribs.
- (5) Due to the image of the vertical wire.

In the same way the average potential of the vertical wire is made up of four components :

- (6) Due to its own charge.
- (7) Due to the charges on the ribs.
- (8) Due to its own image.
- (9) Due to the image of the ribs.

Our object is to plot curves from which each of these components may be written down at once for any given aerial.

All the nine component potentials can be found from curves given in the original paper, with the exception of the second, third, and seventh. With regard to the second, the average potential of any rib due to unit charge per centimetre of length on any other rib could be found from Fig. 28 in the original paper if the angle between them did not exceed 52 degrees. Since the angle will usually be larger than this, it will be necessary to extend the curve for angles up to 180 degrees, but before doing this it will be convenient to find the angles between various ribs for various values of n and of α . If there are n ribs the angle between any two adjacent ribs may be called $\theta_{1,2}$, while that between any rib and the next but one

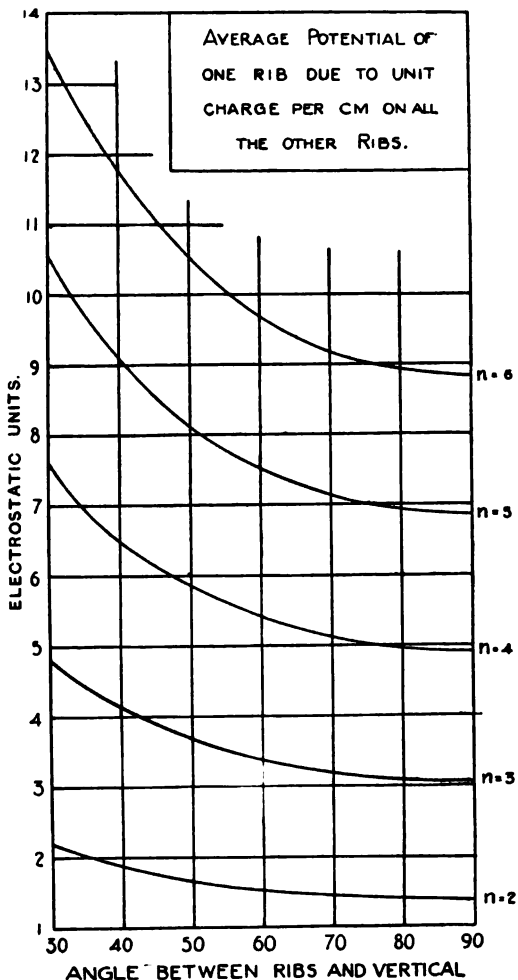

Fig. 2.

may be called $\theta_{1,3}$, and so on. The values of θ are given in Table I.

TABLE I.
Angles between Ribs.

Angle with vertical α	$n=2$		$n=3$		$n=4$		$n=5$		$n=6$		
	θ	θ	$\theta_{1,2}$	$\theta_{1,3}$	$\theta_{1,2}$	$\theta_{1,3}$	$\theta_{1,2}$	$\theta_{1,3}$	$\theta_{1,2}$	$\theta_{1,3}$	$\theta_{1,4}$
90	180	120	90	180	72	144	60	120	180		
75	150	113.4	86.2	150	69.2	133.3	57.8	113.4	150		
60	120	97.2	75.6	120	61	111	51.2	97.2	120		
45	90	75.5	60	90	49	84.5	41.4	75.5	90		
30	60	51.2	41.4	60	34.2	56.7	28.95	51.2	60		

We have previously * shown that when two wires of equal length meet at an angle

* The Electrician, Vol. LXXIII., p. 909.

γ , the average potential of one of them due to unit charge per centimetre on the other is given by the formula :

$$V_{av.} = 2 \log_e (1 + \sqrt{1 + (\operatorname{cosec} \gamma + \cotan \gamma)^2})$$

This has been worked out for values of γ up to 180 degrees, and the results are plotted in Fig. 1. By means of this curve and Table I. the potential of the rib can be found due to each of the other ribs, and by adding these together the total potential due to all the other ribs is obtained.

This is given in Table II., and plotted in Fig. 2.

TABLE II.
Average potential of one rib due to all other ribs with uniform charge of one unit per centimetre.

Angle with vertical α	$n=2$	$n=3$	$n=4$	$n=5$	$n=6$
90	1.385	3.06	4.905	6.86	8.835
75	1.42	3.13	5.02	7.01	9.03
60	1.53	3.38	5.41	7.52	9.69
45	1.76	3.88	6.15	8.55	11.10
30	2.195	4.78	7.585	10.53	13.475

To find the potential of the rib due to the charge on the vertical wire, or *vice versa*, we have the last formula on p. 908 (*loc. cit.*)—viz. :

$$V_{av.} = \sinh^{-1} \beta + \sinh^{-1} \left(\frac{1-\alpha'}{\alpha'} \beta \right) + \frac{\cos \gamma}{\alpha'} \left\{ \sinh^{-1} \left(\frac{\alpha' (1+\beta^2)}{\beta} - \beta \right) + \sinh^{-1} \beta \right\}$$

which may also be written :

$$V_{av.} = \sinh^{-1} \frac{\alpha'}{\sqrt{m^2 - \alpha'^2}} + \sinh^{-1} \frac{1-\alpha'}{\sqrt{m^2 - \alpha'^2}} + \frac{1}{m} \left\{ \sinh^{-1} \frac{m^2 - \alpha'}{\sqrt{m^2 - \alpha'^2}} + \sinh^{-1} \frac{\alpha'}{\sqrt{m^2 - \alpha'^2}} \right\}$$

where γ is the angle between the two wires.

“ $m = \frac{\text{length of uncharged wire}}{\text{length of charged wire}}$

“ $\beta = \cotan \gamma$.

and $\alpha' = m \cdot \cos \gamma$ (*see Fig. 27, loc. cit.*)

The values given by this equation have been worked out for a number of cases and are plotted in Figs. 3 and 4.

We shall now illustrate the use of these curves by calculating the capacity of two aerials of the umbrella type, one a simple portable aerial and the other a larger and more complicated type. Fig. 5 shows the

principal dimensions of an aerial with six ribs, each making an angle of 66 degrees with the vertical. Both vertical wire and ribs have a diameter of 3 mm. We assume a uniform charge of unit quantity per centimetre of wire.

- (1) Potential of a rib due to its own charge (*see Fig. 3 in original paper*) 19.2
- (2) Potential of a rib due to all other ribs (*see Fig. 2 in this paper*)... 9.35
- (3) Potential of a rib due to vertical wire ($m=30/26$; *see Fig. 4 in this paper*) 1.95
- (4) Potential of a rib due to image of ribs (charge = -18000; distance about 42.5 metres) ... -4.2
- (5) Potential of a rib due to image of vertical wire (charge = -2600; mean distance about 36 metres) -0.7

Total potential of a rib ... = 25.6

- (6) Potential of vertical wire due to its own charge (*see Fig. 3 in original paper*) 19.0
- (7) Potential of vertical wire due to the six ribs ($m=26/30$; *see Fig. 4 in this paper*) 13.5
- (8) Potential due to its own image (*see Fig. 21 et seq. in original paper*) -1.0
- (9) Potential due to image of the six ribs (charge = -18000; distance about 35.5 metres) ... -5.1

Total potential of vertical wire = 26.4

We have, therefore, 180 metres of wire at an average potential of 25.6 and 26 metres at an average potential of 26.4, making a total of 206 metres at an average potential of 25.7. The capacity is therefore :

$$\frac{20600}{25.7} = 802 \text{ cms.} = 0.89 \text{ milli-microfarad.}$$

With regard to the last component potential of -5.1, it may be pointed out that, instead of finding it in the approximate manner there indicated from the charge and the average distance as estimated from Fig. 5, it can be calculated accurately by means of the curve in Fig. 4. If the vertical wire were 52 metres long—i.e., twice its actual length, its average potential due to

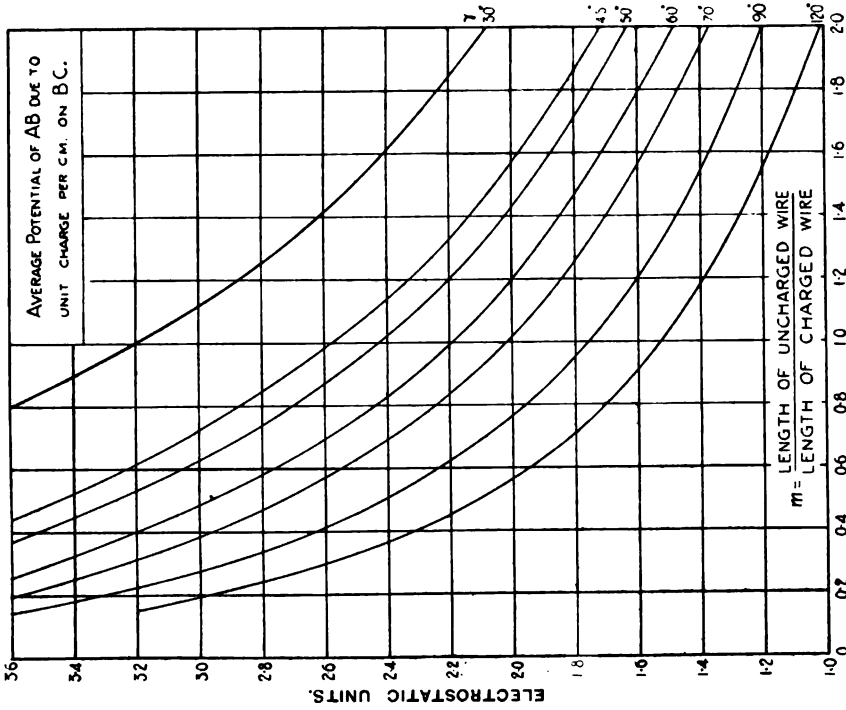

Fig. 4.

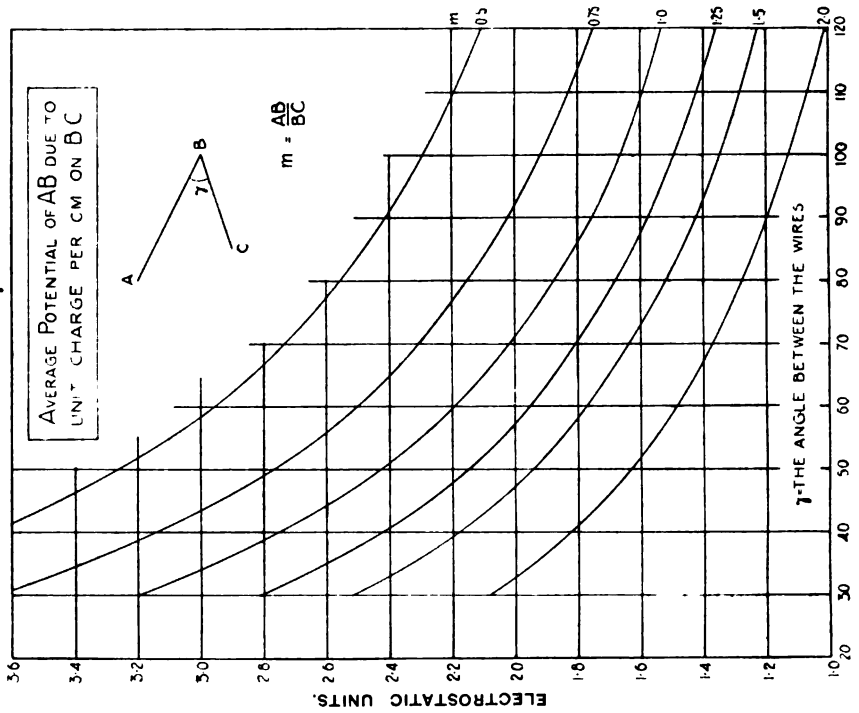

Fig. 3.

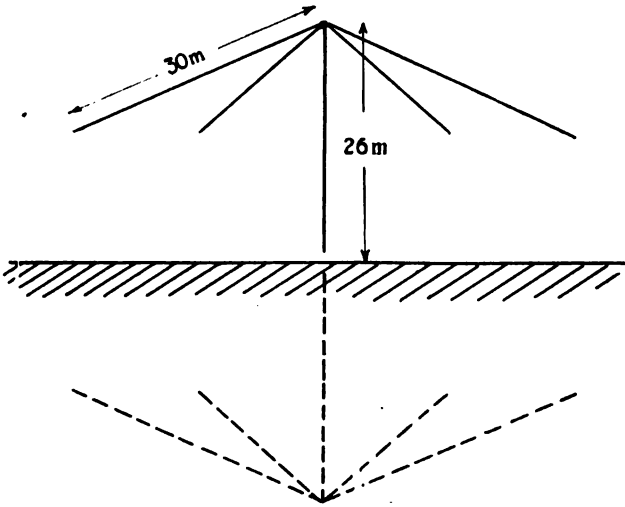

Fig. 5.

the six ribs would be $6 \times 1.55 = 9.3$, since m would then be $52/30$. Since the average potential of the actual vertical wire due to the six ribs is 13.5, that of the other half of the 52 metres, remote from the ribs, must be $2 \times 9.3 - 13.5 = 5.1$. Hence this will be the potential of the vertical wire due to the image of the ribs.

As a second example, we shall calculate the capacity of the antenna shown in Fig. 6; it has five ribs each consisting of four wires situated at the corners of a square of two metres side, the angle between the ribs and the vertical being 60 degrees. To make the calculation more general we shall assume that the ribs consist of 10 mm. wire, while the vertical wire has a diameter of 20 mm. We shall assume that the whole aerial is charged to a uniform surface density, the ribs having unit charge per cm. of length and the vertical wire two units per centimetre. The image is equally but oppositely charged.

- (1) Potential of four-wire rib due to its own charge (see below) ... 36.0

- (2) Potential of rib due to all other ribs (4×7.5 ; see Fig. 2) 30.0
- (3) Potential of rib due to vertical wire (2×2.37 ; see Fig. 4; $m=60/70$) ... 4.7
- (4) Potential of rib due to image of ribs (charge = -20×6000 ; distance = 115 metres) ... -10.4
- (5) Potential of rib due to image of vertical wire (charge = -2×7000 ; distance = 92.5 metres) ... -1.5
-
- Total potential of rib ... = 58.8

- (6) Potential of vertical wire due to its own charge (2×17 ; see Fig. 3 in original paper) ... 34.0
- (7) Potential of vertical wire due to the ribs ($5 \times 4 \times 2.025$; see Fig. 4; $m=70/60$) ... 40.5

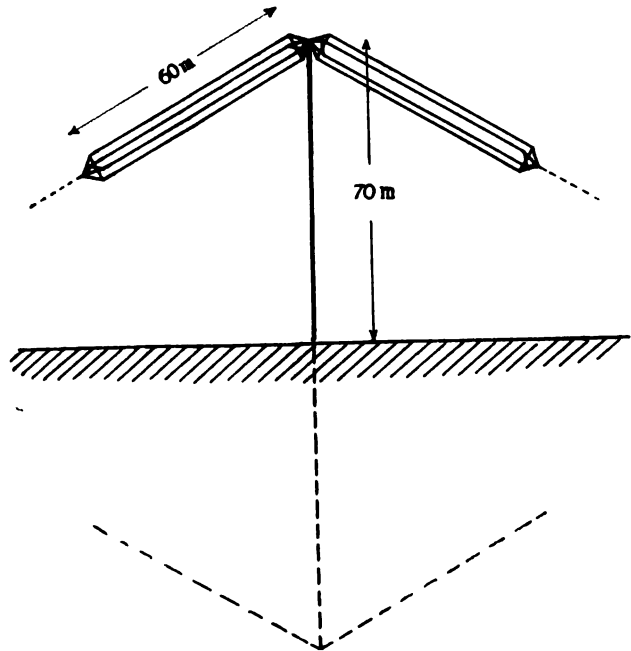

Fig. 6.

(8) Potential due to its own image (see Fig. 21 <i>et seq.</i> in original paper)	—2.0
(9) Potential due to image of ribs (charge = -20×6000 ; distance = 95 metres)	—12.7
<hr/>	
Total potential of vertical wire	= 59.8

With regard to the first item, the capacity of four-wire box type aerials was investigated in the original paper (see Figs. 16 and 17), and it was shown that the average potential is

$$2 \left(\log_e \frac{l}{r} + Y \right),$$

where Y depends on the ratio of the length *l* to the distance *d* between adjacent wires. In our case this ratio is 30, and Y is found from Fig. 17 to be 8.6. Hence :

$$2 \left(\log_e \frac{l}{r} + Y \right) = 2 \left(\log_e \frac{6000}{0.5} + 8.6 \right) = 36.$$

This can also be found directly from Fig. 18 by noting that the average potential of any number *n* of parallel wires is equal to

$$\frac{33.9 n}{\text{micro-microfarads per foot}}$$

which, in the present case, gives :

$$\frac{33.9 \times 4}{3.75} = 36.$$

The last item of —12.7 can also be calculated accurately, as explained in the previous example. The other items will present no difficulty.

Summing up, we have on the ribs a charge of 120,000 units at a potential of 58.8, and on the vertical wire a charge of 14,000 units at a potential of 59.8, giving a total of 134,000 units at an average potential of 59. The capacity is therefore

$$\frac{134000}{59} = 2270 \text{ cms.} = 2.53 \text{ milli-microfarads.}$$

It will be noticed that with the uniform distribution of charge which we have assumed the average potentials of the ribs and vertical wire are nearly equal—viz., 25.6 and 26.4 in the first example and 58.8 and 59.8 in the second. This shows that in the actual condition of uniform potential the charges will be distributed between the vertical wire and the ribs very nearly as we have assumed.

Tests on actual aerials have shown that the values of the capacity as calculated by this method agree with the measured values within the errors of observation and of estimation as to the allowance to be made for connecting wires, etc.

An Appreciation.

IN our September number we published an article by Mr. Bertram Hoyle entitled "The Influence of Temperature and Pressure on the Sensitivity of the Carborundum Crystal Detector." That such an article would be welcomed we had no doubt, and were therefore pleased to find in the columns of the *Manchester Guardian* the following appreciation of it :

"It is a curious circumstance, and one that is quite contrary to the present trend of progress in most branches of engineering, that the wireless coherer has been virtually superseded by a device whose method of action remains to be investigated long after its suitability has been established. Although the crystal detector has for most practical purpose swept everything before it, and despite the fact that many competent people have carried out investigations with regard to it, no clear theory has yet been formulated as to its precise action. The September number of THE WIRELESS WORLD contains an important article in this connection by Mr. Bertram Hoyle under the title of 'The Influence of Temperature and Pressure on the Sensitivity of the Carborundum Crystal Detector.' On account of its calculations and tabulated results the article necessarily looks a little formidable to the reader who wants strictly 'popular science,' but really Mr. Hoyle is as lucid in his treatment as he has been unconventional in research and systematic in recording his results. . . . Amongst the younger wireless investigators Mr. Hoyle, who carries on his work at the Manchester School of Technology, has been conspicuously persevering. Those who heard Professor Marchant's paper on 'The Strength of Wireless Signals' before the Institution of Electrical Engineers at Liverpool last winter will remember that Mr. Hoyle only made any effective contribution to the discussion on that occasion."

Digest of Wireless Literature

ABSTRACTS OF IMPORTANT ORIGINAL ARTICLES DEALING
WITH WIRELESS TELEGRAPHY AND COMMUNICATIONS READ
BEFORE SCIENTIFIC SOCIETIES.

THE HISTORY OF SIGNALLING.

In the *Engineering Gazette* for July 14th an interesting article appears entitled "Naval Progress in a Lifetime," in which the history of signalling is ably reviewed. The writer remarks that it is hardly too much to say that naval signalling has shown greater progress during the past ten years than throughout the past ten centuries. Wireless Telegraphy is now regarded as such a matter of course that its recent introduction is almost forgotten. Flags, lamps and semaphores have still their uses however, and it would almost seem as if after some two thousand years of development the old system only reached its highest pitch of perfection to be superseded.

One Aeneas Tacitus would seem to have been the inventor of a flag system of signalling, as he devised a method by which words could be transmitted by means of flags, but it was very elaborate and slow. At the same time the germ of the heliograph came to life, shields arranged in a stipulated manner sending words by flashes of sunlight reflected from them. In the Middle Ages ships communicated by a primitive use of flags by day and lanterns by night, and when cannon were invented they were also pressed into service. When square-rigged ships came into being someone hit on the ingenious idea of signalling by means of raising and lowering the sail, so many times denoting a word or letter. Elizabeth and her advisers seem to have drawn up some code of signals which, we are told, was first used by the expedition against Cadiz, but means of communication between ships was primitive and slow. Some progress was made towards the end of the seventeenth century, when Admiral Penn and the Duke of York (James II.) arranged some sort of a system, most of the credit

belonging to the former, though it is frequently given to James. But the development of signalling at sea was very slow, though the adoption of balls and cones hoisted in various positions led to some improvement and more certainty, coloured lights being used at night.

It was during the naval wars of the eighteenth century that the necessity of a reliable and quick means of signalling became so apparent, and several officers turned their attention to the matter in the hope of solving the problem. Two famous admirals took up the question, and, presumably because they were both practical seamen and knew what was required, both of them evolved a similar system. One method was invented by Hood's secretary, M'Arthur, and the other by Lord Howe, and the best features of both were combined to form one system. For the first time several flags were hoisted together, their combinations giving the message, whereas before this time they were displayed in different parts of the ship according to their meaning. Twelve flags were used which singly or in combination, says a correspondent of the *Globe*, stood for common naval manœuvres such as "Engage the Enemy," "Anchor," "Chase the Enemy," "Make all sail." Numbers could also be signalled, while the use of inverted and reversed flags had other meanings. M'Arthur also invented a system of night signalling by means of lights.

Then there was the semaphore, which still has its uses, though wireless has practically superseded it. The late Admiral Colomb brought out in 1867 a system of night-flashing signals which alone made it possible to handle modern fleets in the dark, but an attempt to use mast-head semaphores by outlining the arms with electric lamps

was not very successful. Collapsible drums have also been used in conjunction with the Morse alphabet, and now the wireless telephone is being perfected.

* * *

THE PRODUCTION OF METAL COATINGS BY SPRAYING.

In a paper recently presented at the New York section of the American Society of Mechanical Engineers Mr. John Calder described the "Schoop" process for depositing electro-positive metals on iron and steel. This process, which is the latest of its kind, also permits the depositing of many other metals and alloys on coherent bodies, whether metallic or not. To the wireless engineer the process is of value in that amongst other things it enables him to deposit with great ease a highly conducting copper coating on glass for making condensers.

The author first dealt with the other metal-depositing processes, including tinning, galvanising, sherardising and plating, pointing out the defects and limitations which are inherent in these methods. Plating, he said, furnishes a continuous thin metallic web around iron or steel objects submitted to it, providing the shape and size of the article are suitable. It is necessarily limited to small objects. The adhesion of the plated coating is slight, and its continuity is essential for service. The tinned or galvanised coating adheres, due to chemical affinity for clean iron, but its irregularity gives much trouble. The dry zinc galvanising, known as sherardising, gives a better result, but is limited to the application of one metal under heat conditions, which confine it largely to black work and to objects the distortion of which is of no consequence.

The Schoop process takes its name from M. U. Schoop, an engineer of Zurich, who, in collaboration with other inventors, made the metal spray an effective coating agent. In the Schoop process the coating metal adheres to the object chiefly by mechanical union. The metal is discharged in hot, impalpable particles moving with high velocity, and these, when directed upon a prepared object, penetrate the pores of the latter

while the spray is still plastic. The coating thus dovetails itself into the superficial pores of the object and does so in the presence of reducing gas which prevents oxidation at the junction of the metals.

Mr. Calder next outlined the history of metal spraying, and pointed out that the progress of invention in this direction has been chiefly towards making the metallic particles as small and as hot as possible, thereby avoiding oxidation, and reducing the pressure of air used and the cost of the gases employed.

Prior to inventing his present apparatus, Schoop had constructed other forms, which, however, were characterised by certain defects. For example, one of his inventions, which sprayed liquid metal, involved a large non-portable reservoir of hot metal weighing with the auxiliary parts over a ton. The latest of Schoop's inventions, the "pistol," weighs less than four pounds.

The principle of the "pistol" consists in feeding a fine wire of the metal to be deposited into a reducing flame at such a constant speed that the position of the end of the wire remains stationary, the melting rate being exactly equal to the rate of feed. Under such conditions the wire end melts a drop at a time, and each drop at the instant of formation is struck a violent blow by an air-blast. In other words, the "pistol" is a machine gun which automatically manufactures its ammunition from a reel of wire and bombards the object to be plated with plastic projectiles of extremely small size. The resulting fog or spray of fine metallic particles into which the drops are divided takes the form of a diverging cone with a core of reducing gas in which the particles are entrained, and a surrounding sheath of air which is rapidly expanding and cooling. Any suitably prepared object placed in the path of this metallic spray is plated through impact without undue elevation of temperature.

The spray established is essentially a metal plating air-brush, the diameter of which 5 in. from the pistol end is about 2 in. Objects to be plated are operated upon by pointing the pistol normally to the surface to be coated at any moment at about 5 in. distance and traversing the pistol across the surface with a regular motion. A single coating is 0.001 in. thick. The operator's vision easily guides him in dis-

tinguishing between the coated and uncoated portions, and also between a first and second coat. Carbon in all its resistance forms can be freely sprayed with copper, and that metal can be applied in minimum quantity to any piece or portion of a piece of apparatus. The most recent electrical application is the construction of condensers, especially for wireless service. The Schoop pistol will spray an adherent coat of copper on ordinary sand-blasted window glass. Two-thousandths of an inch is sufficient to produce a highly efficient and cheap plate much superior to rolled tinfoil coverings or galvanic deposits of copper on glass. Lead sprayed on glass also furnishes a very cheap and effective condenser plate. The time taken to cover one square foot of surface with the copper spray is one minute ten seconds, and the approximate cost three-halfpence.

* * *

PROGRESS IN HIGH FREQUENCY ALTERNATORS.

A recent issue of the *Electrical Review* contains an illuminating contribution on the above subject, in which the history and principles of high frequency machines are briefly dealt with. The impossibility of securing from arc or spark a train of radio-telegraphic waves of that degree of uniformity desirable in wireless telegraphy, and imperative in wireless telephony, has directed, says the writer, a vast amount of attention towards the discovery of a means of generating very high frequency currents by dynamo-electric machinery. It is impracticable to attain any suitable frequency by adhering to standard alternator design; pole pitch, air-gap, and winding space become impracticably small, and insulation and iron loss difficulties insuperable. No radical progress was made for twenty years after Tesla built his 1 K.V.A. 5,000 cycle machine in 1889. It is true that Alexanderson completed in 1909 a 2 K.V.A., 100,000 cycle alternator, but even this machine, the fruit of five years' labour, gave inadequate power, though it generated currents of the right order of frequency. To combine extra high fre-

quency with reasonable power output it was necessary to employ new principles.

After mentioning the Dolezalek alternator and the Bethenod machines, the author says that resonating particular harmonics of a magnetic field affords one means of obtaining high frequency currents, but the difficulty is to secure sufficient amplitude in high frequency harmonics. The principle which has given the best results so far is that of "cascading" machines or windings, so as to superpose on mechanical rotation the rotation of high frequency magnetic fields. Jarvis Patten proposed in 1894 to use n cascaded single-phase alternators in conjunction with suitable resonating circuits to produce current of n times the frequency of a single machine. Ten years later Latour showed how squirrel-cage machines could be used in this connection, but it was not until 1907 that Goldschmidt effected a radical improvement by utilising a single machine for several successive frequency conversions. The Bethenod and Goldschmidt machines are next compared with interesting results.

M. Bethenod has given his opinion that industrial alternators of acceptable efficiency could now be built for outputs of 100 to 150 kilowatts at 10,000 to 40,000 cycles, running at a peripheral rotor velocity of from 24,000 to 30,000 ft. per minute, but that, since the difficulty and cost of construction increase rapidly with frequency even in the above range, the industrial success of high frequency alternators, as applied to wireless telegraphy and telephony, depends on the adoption of long wave-lengths—probably several tens of kilometres. So far as one can see, the accuracy of this conclusion must be admitted, but the writer well remembers how, a few years ago, one who ranks undoubtedly among the greatest experts of radio-telegraphy "proved" on paper that alternators exceeding a few watts capacity could not be built on the Goldschmidt principle. Moreover, the proof was, at that time, convincing, and its subsequent refutation was only another demonstration of the need for caution in placing limitations on the development of radio-telegraphy in general and high frequency alternators in particular.

A New Link

Further Progress in the World Chain of Wireless.

A YEAR or two ago the world was startled by the realisation that a state of extreme diplomatic tension prevailed between the United States of North America and Japan. To-day, happily, that tension does not exist. In its place there has arisen a desire among the two peoples for closer intercourse and commercial co-operation. Although many leagues of ocean separate the two nations, yet they are neighbours, as the jurisdiction of no other authority thrusts itself between them. Although the two continents are separated by so many miles, topographically a great similarity exists between them. The western part of the United States is a mountainous and broken district freely interspersed with ravines and fertile valleys in which are cultivated large quantities of useful produce. Japan is one of the most mountainous countries in the world. Its plains and valleys, with their foliage surpassing in richness that of no other extra-tropical region, its arcadian hill-slopes and

forest-clad heights, its Alpine peaks towering in weird grandeur above clefts in the mountain range noisy with waterfalls, its lines of foam-fringed headlands, give it a claim to be considered one of the fairest portions of the earth. The commercial development of Japan has been remarkably progressive, and exemplifies the keen businesslike qualities so characteristic of the Japanese. Their very willingness to open up their country to outside trade has probably contributed in no small measure to the success of their efforts. In 1899, principally through the intervention of Britain, the irritating foreign jurisdiction rights over the treaty ports were abolished. Foreigners enjoy equal rights with natives except that they cannot own real estate unless as partners of associations under Japanese law. Such, then, is the country between which and the United States closer commercial relations have been established. This inauguration was in the form of direct wireless telegraphic communication across the wide expanse of



Honolulu Harbour.



Honolulu Wireless Station.

the Pacific Ocean, with but one "stepping stone." Honolulu formed the intermediary. This town is situated on the southern side of the mountainous island of Oahu, one of the Hawaiian Archipelago. Ruggedness and picturesqueness form its chief geographical features. These characteristics are aptly illustrated by the photograph which we reproduce here, and which was taken on board a steamer entering the harbour. In the distance may be seen the bold rocky outline of the mountain chain which culminates in Mount Kaula, 4,060 feet high. The Sandwich Islands are separated from other lands by a broad expanse and great depth of sea, and consequently their natural history has many special features of its own. The unique position of these islands in mid-Atlantic is of vast importance, as they act as a "halfway house" for that huge waste of waters. It is said that the islands were discovered by Gaetano in 1542; they were re-discovered by Captain Cook in the year 1778. From 1779 until 1898 the isles formed a kingdom, although in the early years of this period each island possessed its own king. Subsequently, however, the separate kingdoms were welded into one, and King Kamehameha I. became ruler of the united islands. He died in 1819, and the next

reign is famous for the abolition of idolatry simultaneously throughout all the islands. It was on the chief island of Hawaii that Captain Cook met his death at the hands of the natives in the year 1779. Since 1900 the Sandwich Islands have formed part of the colonial possessions of the United States, and our progressive cousins were not slow in appreciating the advantages possessed by their newly acquired territory.

Over twelve months ago the giant wireless stations at San Francisco, California, and Honolulu commenced to communicate with one another, and since have handled a large amount of traffic daily. Communication between the United States and Japan by wireless was the next step contemplated, and, as announced in the September number of *THE WIRELESS WORLD*, is now an accomplished fact. Crowded as the newspapers are with news of every kind regarding the war, it is not surprising that the importance of this achievement was to a large extent overlooked by the general public. A few moments' consideration will convince the thinking man that wireless communication between these places must rank as one of the greatest achievements in radio-telegraphy.

A message sent by wireless from the Pacific Coast of America to Japan goes first to

Honolulu—over the waters of the Pacific Ocean for more than two thousand miles. At Honolulu it is retransmitted to the Japanese station at Funabashi, which is no less than 3,355 miles from the Sandwich Islands, and thence to its destination by the Japanese land lines. It will help our readers to realise the immense distance traversed by the wireless signals in crossing this last expanse of waters if we consider that this distance is some hundreds of miles greater than that between Berlin and New York.

The Funabashi station is situated some ten miles from Tokio, and is owned by the Japanese Government. The operators are Japanese, too, and we can well imagine their intense interest and excitement when the first signals came through from the distant Pacific Islands.

It was on July 27th that Mr. E. J. Nally, the Vice-President and General Manager of the Marconi Wireless Telegraph Co. of America, received from Japan the first wireless telegram, which read as follows:

“Following from Tokio
“to Mr. and Mrs. Nally:
“Availing myself of
“this opportunity I have
“the honour to offer you
“my sincere congratula-
“tions upon this first com-
“munication. Signed, Jiro
“Tanaka, Director-Gen-
“eral Ministry Communica-
“tions.”

To which he immediately replied:

“Mrs. Nally joins me
“in congratulations and
“thanks for the first
“wireless communication
“between Japan and
“America, and also in the
“fervent wish that this
“most wonderful of all in-
“ventions will still further
“bind the two countries
“in peace and pro-
“gress.”

These communications were followed by a long series of tests for the purpose of perfecting the service and making the multitudinous adjustments which are necessary in establishing a service such as this. It should be remembered that it is always the aim of the Marconi Co. to make their services thoroughly commercial and continuous, and therefore much preliminary work has to be performed. Long messages in both directions dealt with the arrangements for the tests, which were carried out through all hours of the day and night, and proved most successful. Not only could the Japanese station read the Honolulu



Honolulu Station—Some of the Masts.

signals easily, and the Honolulu station those of Funabashi, but the San Francisco station was on many occasions able to read every word that was being transmitted both from Japan and Honolulu. As an example of the successful results obtained, we may give the following extracts from the "log" of San Francisco of signals overheard:

Funabashi to Honolulu: "Are you not disturbed by statics? Much statics here. How is statics there?"

Honolulu to Funabashi: "Static moderate, but your signals loud copy you on typewriter we are not bothered just now it's fine. K."

Funabashi to Honolulu: "OK. that's good min. please and by till call you. See you later."

From Funabashi to San Francisco is nearly 4,500 miles, or practically as far as from London to Cape Town, or Rio de Janeiro! And surely there is an element of humour in the Japanese operator at Funabashi telling the American at Honolulu—some

thousands of miles away—that he will see him soon!

Mention of "static" (the American term for atmospheric) in the above extract reminds us that this is one of the greatest difficulties to be overcome in Pacific long-distance communication. An important series of experiments is now being carried out at San Francisco with a view to reducing still more the trouble caused in this way, although much has been done by providing the stations with installations of very high power. For instance, both San Francisco and Honolulu have 300 kilowatt transmitters, with acrias supported on thirteen steel masts four hundred feet high.

It can safely be prophesied that before many years are past wireless communication will be possible the whole way round the earth. It is not many years since the first radio-telegram was sent across the Channel; and if in the short period which has elapsed since then trans-Pacific communication is an accomplished fact, what may we expect fifty years from now?

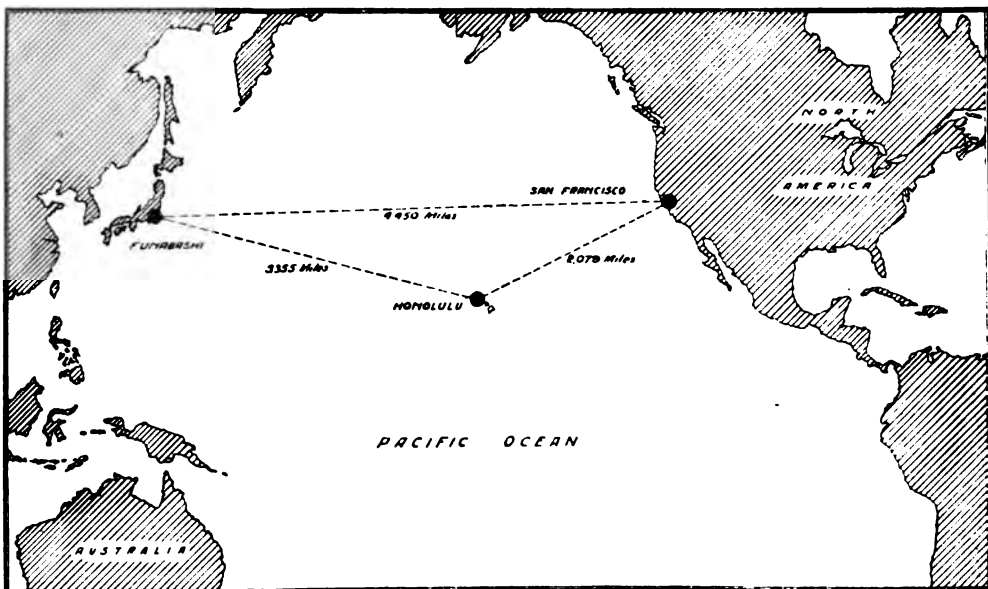

The New Link.

The ENGINEERS Note Book



[Under this heading we propose to publish each month communications from our readers dealing with general engineering matters of various kinds in their application to wireless telegraphy, and we would welcome criticisms, remarks and questions relating to the matter published under this heading. We do not hold ourselves responsible for the opinions and statements of our contributors.]

A Useful Formula for Calculating the Strain in Mast Stays.

It is well known that a wire suspended between two points will form the curve of a catenary. Accordingly the curve formed by a stay of a Marconi mast is part of a catenary.

The equation of a catenary in the convenient system of co-ordinates is the following :

$$y = \frac{m}{2} \left(e^{\frac{x}{m}} + e^{-\frac{x}{m}} \right) \quad (1)$$

where y and x are the co-ordinates and m is a constant.

In the same convenient system of co-ordinates the strain in the wire : T is expressed by :

$$T = w x y.$$

where w is the weight of the wire per unit of length, and y is the ordinate.

To be able to find T in any case it

is necessary to know certain dimensions of the mast ; these dimensions are the following :

(1) w = the weight of the wire per unit of length.

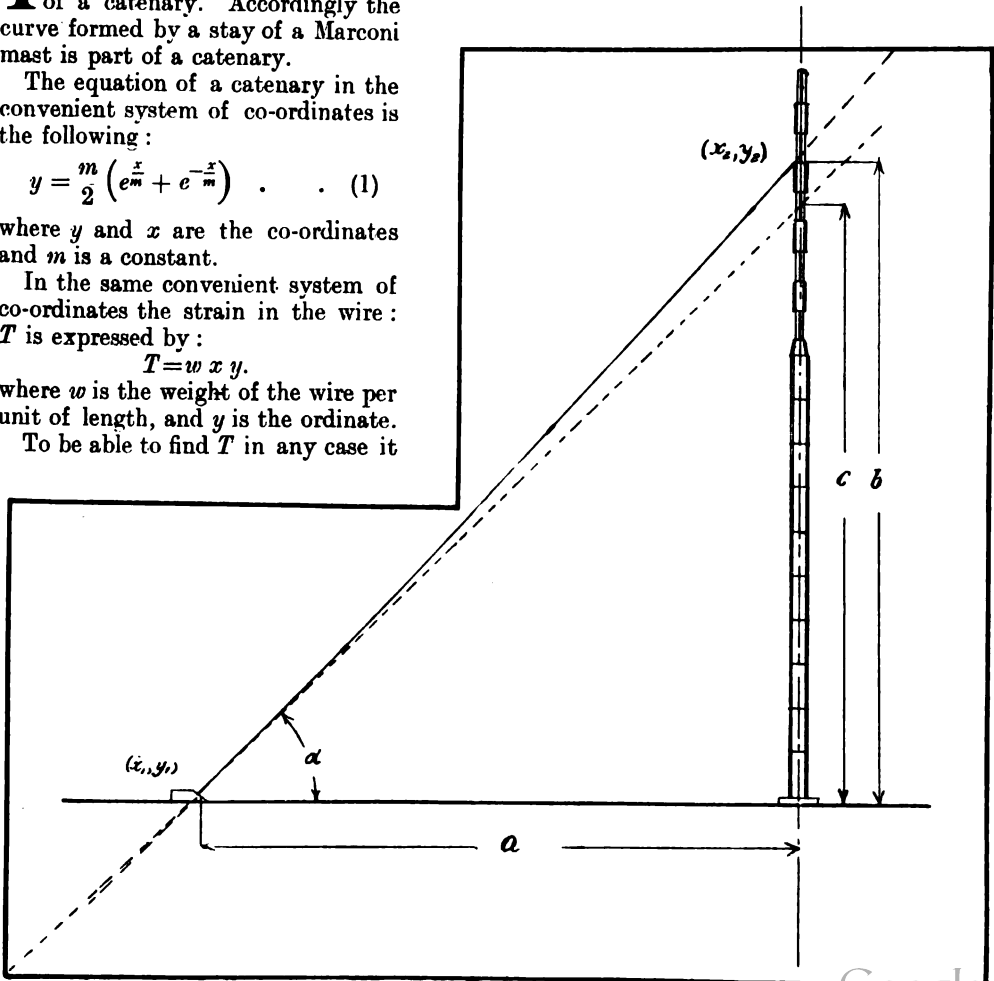

(2) a = the distance from the anchor to the mast centre.

(3) b = the height of the mast from the ground to the attachment of the stay.

(4) The piece $(c - b)$.

This piece is very easy to measure on the Marconi type of mast. If standing at the anchor you look along the stay the direction of the line of sight will be the tangent to the lower portion of the stay, and you will be able to see the point of the mast where this tangent crosses the mast. In other words, you will be able to estimate the length (in number of sections and fractions) of the mast which you can see above this point to the point of attachment of the stay.

Calling the point of attachment of the stay to the anchor (x_1, y_1) , and the point of attachment to the mast (x_2, y_2) , we imagine the catenary formed by the stay as being laid out in the convenient system of co-ordinates.

Accordingly we have :

$$\begin{aligned} x_2 - x_1 &= a. \\ y_2 - y_1 &= b. \\ \frac{dy_1}{dx_1} &= \frac{c}{a} = \text{tang } \alpha. \end{aligned}$$

The equation of the catenary being :

$$y = \frac{m}{2} \times (e^{\frac{x}{m}} + e^{-\frac{x}{m}}) \quad \dots \text{ (I.)}$$

the first differential is :

$$\frac{dy}{dx} = \frac{1}{2} \times (e^{\frac{x}{m}} - e^{-\frac{x}{m}}) \quad \dots \text{ (II.)}$$

From (I.) we get :

$$\begin{aligned} y_2 - y_1 = b &= \frac{m}{2} (e^{\frac{x_2}{m}} + e^{-\frac{x_2}{m}} - e^{\frac{x_1}{m}} - e^{-\frac{x_1}{m}}); \\ b &= \frac{m}{2} (e^{\frac{x_2+a}{m}} + e^{-\frac{x_2+a}{m}} - e^{\frac{x_1}{m}} - e^{-\frac{x_1}{m}}); \\ b &= \frac{m}{2} (e^{\frac{x_1}{m}} \times e^{\frac{a}{m}} + e^{-\frac{x_1}{m}} \times e^{-\frac{a}{m}} - e^{\frac{x_1}{m}} - e^{-\frac{x_1}{m}}); \\ b &= \frac{m}{2} (e^{\frac{x_1}{m}} (e^{\frac{a}{m}} - 1) + e^{-\frac{x_1}{m}} (e^{-\frac{a}{m}} - 1)); \end{aligned} \quad \dots \text{ (III.)}$$

It is to be remembered now that the expansion of e^z is :

$$e^z = 1 + z + \frac{z^2}{1 \times 2} + \frac{z^3}{1 \times 2 \times 3} + \dots$$

and therefore :

$$e^{\frac{a}{m}} = 1 + \frac{a}{m} + \frac{\left(\frac{a}{m}\right)^2}{1 \times 2} + \frac{\left(\frac{a}{m}\right)^3}{1 \times 2 \times 3} + \dots$$

As $\frac{a}{m}$ is a fraction the value of which is

not greater than $\frac{1}{3}$ (this is easy to prove), the fault committed in throwing away the terms of larger order than the second is negligible.

$$\left(\frac{\left(\frac{a}{m}\right)^3}{1 \times 2 \times 3} < \frac{1}{750} \right).$$

We are therefore perfectly right in terminating the series thus :

$$\begin{aligned} e^{\frac{a}{m}} &= 1 + \frac{a}{m} + \frac{a^2}{2m^2} \\ e^{-\frac{a}{m}} &= 1 - \frac{a}{m} + \frac{a^2}{2m^2} \end{aligned}$$

Substituting these in (III.) we get :

$$\begin{aligned} b &= \frac{m}{2} \left(e^{\frac{x_1}{m}} \left(\frac{a}{m} + \frac{a^2}{2m^2} \right) + e^{-\frac{x_1}{m}} \left(-\frac{a}{m} + \frac{a^2}{2m^2} \right) \right); \\ b &= \frac{m}{2} \left(\frac{a}{m} (e^{\frac{x_1}{m}} - e^{-\frac{x_1}{m}}) + \frac{a^2}{2m^2} (e^{\frac{x_1}{m}} + e^{-\frac{x_1}{m}}) \right); \\ b &= a \times \frac{1}{2} \times (e^{\frac{x_1}{m}} - e^{-\frac{x_1}{m}}) + a^2 \times \frac{1}{2 \times 2 \times m} \\ &\quad \left(e^{\frac{x_1}{m}} + e^{-\frac{x_1}{m}} \right). \quad \dots \text{ (IV.)} \end{aligned}$$

From (II.) we have :

$$\begin{aligned} \frac{dy_1}{dx_1} = \text{tg } \alpha &= \frac{1}{2} (e^{\frac{x_1}{m}} - e^{-\frac{x_1}{m}}) \quad \dots \text{ (V.)} \\ \text{tg}^2 \alpha &= \frac{1}{4} (e^{2\frac{x_1}{m}} + e^{-2\frac{x_1}{m}} - 2). \\ \text{tg}^2 \alpha + 1 &= \frac{1}{4} (e^{2\frac{x_1}{m}} + e^{-2\frac{x_1}{m}} + 2). \\ \sqrt{\text{tg}^2 \alpha + 1} &= \frac{1}{2} (e^{\frac{x_1}{m}} + e^{-\frac{x_1}{m}}) = \frac{y_1}{m} = \frac{T_1}{w} \times \frac{1}{m}. \\ m &= \frac{T_1}{w} \times \frac{1}{\sqrt{\text{tg}^2 \alpha + 1}}. \\ \frac{1}{2m} \times (e^{\frac{x_1}{m}} + e^{-\frac{x_1}{m}}) &= \frac{w}{T_1} \times \sqrt{\text{tg}^2 \alpha + 1} \\ \times \sqrt{\text{tg}^2 \alpha + 1} &= \frac{w}{T_1} (\text{tg}^2 \alpha + 1) \quad \text{(VI.)} \end{aligned}$$

Substituting (V.) and (VI.) in (IV.) we get :

$$b = \text{atg } \alpha + \frac{a^2 w}{2T_1} (\text{tg}^2 \alpha + 1).$$

But $\text{atg } \alpha = c$.

therefore :

$$b = c + \frac{a^2 w}{2T_1} (c^2 + 1).$$

or :

$$T_1 = w \frac{a^2 + c^2}{2(b - c)}.$$

If w is lbs. per foot, and a, b and c are measured in feet, T_1 is found in lbs.

If w is in kg. per meter, and a , b and c are measured in meters, T_1 is found in kg.

Example :—In a 400 feet mast $a=200$ feet, $b=215$ feet, and c is found to be 200 feet. The stay is made of 3-inch steel wire rope with weigh 9 lbs. per fathom, or 1.5 lbs. per foot. The stress in the stay is :

$$T_1 = 1.5 \frac{200^2 + 200^2}{2 \times (215 - 200)} = 1.5 \cdot \frac{80,000}{30} = 4,000 \text{ lbs.}$$

WIRELESS AT NEW YORK'S FIRE STATION.

THE praises of the United States as the home of initiative have been loudly sung. The uses nowadays to which Americans turn all sorts of inventions appear very marked, particularly in connection with things electrical. The one topic which is of absorbing interest to the majority of our readers—to wit, radio-telegraphy, has received its whole share of attention by our cousins in the States. It is not intended here to give a eulogy of their deeds, but be it remembered that it is to a large extent due to their love of initiative that we owe many of our modern

realities, whether regarded from the point of view of business or pleasure. The mysteries of sound-reproduction by means of gramophone discs and phonograph cylinders were first brought into play on the other side of the Atlantic. The ordinary-wired telephone was first adapted for commercial use within those shores. The use of electricity as a means of locomotion received its greatest impetus at the hands of progressive Americans, and the unlimited use to which wireless telegraphy might be put has not been overlooked by our friends. Our picture illustrates one of the uses of Senatore Marconi's invention, and shews the wireless instrument at the fire station in New York. The old wired alarm bells, with their constant liability to breakdown at the crucial moment, have been superseded by this greatest invention of modern days. And this is only more or less in the nature of a trial! The different modes of employment of radio-telegraphy steadily increase. Slowly but surely the genius of Marconi is spreading its tentacles into fields hitherto untouched, and its possibilities seem limitless.

The application of wireless telegraphy to such uses is not new, for as far back as 1908 a fire station at Streatham, London, was fitted with a wireless installation. This was done experimentally, but at that time the results did not justify the general equipping of fire stations throughout the land.

WIRELESS INSTALLATION FOR ABERDEEN SERVICE.

According to the *Aberdeen Free Press*, Mr. Esslemont, M.P., has received a letter from the Postmaster-General stating that he hopes the new wireless station near Stonehaven will be completed and in use about the end of September. It is hoped that as the result telegraphic isolation of Aberdeen will now be a thing of the past.

The above statement is significant in that it proves that the Government is fully alive to the uses of wireless telegraphy as a standby in case of breakdown of the wire telegraph. In several other parts of the country wireless can be used in this manner. A year or two ago the cable between Land's End and the Scilly Isles broke down, and wireless was brought into use to effect communication, with excellent results.



Wireless Installation at New York Fire Station.

Administrative Notes.

Alaska.

We are advised that the Marconi wireless service between Astoria and Alaskan points was opened for public traffic on August 7th last. Radio-telegrams are now accepted for Ketchikan, Juneau, Wrangle, Petersburg, Cordova, Sitka, Douglas and Treadwell.

* * *

Austria-Hungary.

The Royal Imperial Ambassador of Austria-Hungary has communicated to the Minister of State in Spain:—

“My Government has just instructed me to advise the Direccion General de Correos y Telegrafos in Madrid that:—

“1. From now on, for technical and military reasons, radiograms from private parties DESTINED for Spain *via* Pola—Barcelona will not be accepted (this regulation does not refer to messages from private parties which ARRIVE at Pola coming from Spain).

“2. Telegraphic communication with the central provinces of the Austro-Hungarian Monarchy near to the field of operations of war is entirely suppressed.

“The above is for the information of all stations and telegraph employees, as, whereas the service from Spain for Austria *via* Barcelona-Pola is still accepted, it is convenient to advise senders of messages that they cannot receive replies from those with whom they communicate.”

* * *

Japan.

It is announced that a public wireless telegraph service is available between Japan and foreign countries, *via* Ochiishi, on the east coast of Hokkaido, and Petropavlovsk, in Kamchatka. Public messages are accepted at any post-office in Japan for despatch to Petropavlovsk at 48 sen (1s.) per word.

* * *

United States.

The superintendent of the United

States Naval Radio Service, announces the completion of the Commercial Traffic Regulations of that service. These books may be obtained from the Superintendent of Documents, Government Printing Office, Washington, D.C., at 25 cents per copy.

* * *

Our American contemporary, *The Wireless Age*, prints the following note in its August issue with regard to Ice Patrol Service:

“The U.S. Coast Guard cutters *Seneca* and *Miami* have been detailed to carry on the International Ice Observation and Ice Patrol Service provided for by the International Convention for the Safety of Life at Sea, London, 1913-14.

“The object of the Ice Patrol Service is to locate the icebergs and field ice nearest to the trans-Atlantic steamship lane. It will be the duty of patrol vessels to determine the southerly, easterly, and westerly limits of the ice, and to keep in touch with these fields as they move to the southward, in order that radio messages may be sent out daily, giving the whereabouts of the ice that may be in the immediate vicinity of the regular trans-Atlantic steamer lane.

“The *Miami* on April 16th relieved the *Seneca*, which had been performing Ice Observation and Ice Patrol Service since February 15th, 1915, and during the months of April, May and June, and as much longer as necessary, these two vessels will alternate on patrol, making alternate cruises of about fifteen days in the ice region; the fifteen days to be exclusive of time occupied in going to and from Halifax. The movements of the vessels will be so regulated that on the fifteenth day after reaching the ice region the vessel on patrol will be relieved by the second vessel if possible, at which time the first vessel will proceed to Halifax, replenish her coal supply, and return in time to relieve the other vessel

" at the end of the latter's fifteen-day
" cruise.

" Having located the ice the patrol
" vessel will send daily the following wireless
" messages in 75th meridian time :

" (a) At 6 p.m. (75th meridian time)
" ice information will be sent broadcast
" for the benefit of vessels, using 600-
" metre wave-length. This message will
" be sent three times with an interval of
" two minutes between each.

" (b) At 6.15 p.m. (75th meridian time)
" the same information will be sent
" broadcast three times in similar manner,
" using 300-metre wave-length.

" (c) At 4 a.m. (75th meridian time) a
" radiogram will be sent to the Branch
" Hydrographic Office, New York City,
" through the nearest land radio station,
" defining the ice danger zone, its southern
" limits, or other definite ice news.

" (d) Ice information will be given at
" any time to any ship with which the
" patrol vessel can communicate.

" Ice information will be given in as
" plain concise English as practicable, and
" will state in the following order :

" (a) Ice (berg or field).

" (b) Date.

" (c) Time (75th meridian time).

" (d) Latitude.

" (e) Longitude.

" (f) Other data as may be necessary.

" While on this duty the patrol vessel
" will endeavour by means of daily radio
" messages to keep ships at sea advised
" of the limits of the ice fields."

* * *

West Indies.

The Marconi Wireless Telegraph Company (Limited) announce that telegrams can now be accepted at their offices and be exchanged between the United Kingdom of Great Britain and Ireland and Bermuda, Turks Island, Jamaica, Antigua, St. Kitts, Dominica, St. Lucia, St. Vincent, Barbados, Grenada, Tobago, Trinidad, and British Guiana at 2s. 2d. per word for ordinary full rate messages and at 1s. 1d. per word for deferred messages in plain language. The rates for Bahamas-Nassau for the same

classes of telegrams are respectively 2s. 2d. and 1s. 0½d. per word. A service at deferred rates is not at present recognised by the islands of Porto Rico, St. Croix, and St. Thomas, but the rates to these islands for ordinary telegrams have also been reduced to 2s. 9d. per word. The above rates are in all cases cheaper than those charged by other companies by 4d. and 2d. per word, and they will be notified by the General Post Office to all provincial offices in the next Post Office Circular.

A READY RESPONSE.

An interesting indication of the promptitude with which assistance came to the torpedoed Allan liner *Hesperian* after she had sent out the wireless S.O.S. signal was afforded on the arrival at Liverpool recently of the American liner *Philadelphia*. The latter vessel picked up the *Hesperian's* cry for aid when sixty miles away. The *Hesperian's* message stated that she was sinking, and gave particulars of the latitude and longitude. Capt. Mills, of the *Philadelphia*, immediately caused a message to be sent in response stating that his vessel would proceed to the rescue. Scarcely, however, had the ship's course been set for this purpose than another wireless was received from the *Hesperian*, stating that the *Philadelphia's* good offices would not be necessary as a British patrol boat had arrived at the scene of disaster, and all the aid needed was already at hand. Thus it would appear that material help was furnished to the stricken liner with a celerity almost rivalling that of wireless telegraphy itself.

SHARE MARKET REPORT.

LONDON, September 17th, 1915.

The market in the various Marconi issues has not been very active during the last month. There has been some investment buying, but prices are inclined to droop.

Marconi Ordinary, 1½½; Marconi Preference, 1½; Canadian Marconi, 5s. 9d.; American Marconi, 16s.; Spanish & General Wireless Trust, 5s. 6d.; International Marine, 1½.

In the Gallipoli Peninsula.

*An Interesting Letter from a Member of the Staff
of the Marconi Company.*

The following letter has been received by the Marconi Company from Petty Officer L. Sanderson, at present stationed for wireless duty at a naval wireless telegraph station on the Gallipoli Peninsula :

" I thought perhaps it might interest you to know how and where some of your old staff are working. C. S. Gordon is on this station with me. When we arrived out here, at the end of April, we were to join H.M.S. *Ark Royal*—the seaplane ship—for observation duty. Our hopes, however, were disappointed, as we were sent from one of the battleships ashore to this station on the Gallipoli Peninsula, and

" here we have remained, and expect to remain until the finish of this campaign.

" Times have been very exciting, and working wireless here is not quite the same as sitting in a comfortable Marconi room on board ship! Our instruments are in a dug-out on a hill side facing the sea, our living ' room ' is next door. We are using a $\frac{1}{2}$ -kw. pack set, excepting that the engine and generator are mounted on a bedplate instead of on the usual pack-saddle frame. It has been about the best working set it has been my fortune to use ; we have had no trouble at all, except very minor forms, since we landed. Our main trouble



Military Encampment at the Dardanelles



European Coast of the Dardanelles.

“ is broken shafts ; we broke the original
 “ steel shaft and have since had to manu-
 “ facture our own from wood, which, needless
 “ to relate, do not last very long. We have
 “ been under a continual shell fire all the
 “ time—shells varying in size from 18
 “ pounder to 11 inch (probably from the
 “ *Goeben*). It is a more or less common
 “ occurrence to have our aerial shot away ;
 “ in that case we do not stop outside to make
 “ neat splices, but tie knots in the wire and
 “ rush for cover again. The last time it hap-
 “ pened a piece of shell made a hole right
 “ through the base of the mast and cut two
 “ stays. The mast is still standing how-
 “ ever. We also had a new reel of aerial
 “ wire cut up into small pieces ! There are
 “ four operators besides myself. I do not
 “ keep a watch, as I have to generally
 “ superintend the working of the station.
 “ When I get any spare time, which is not
 “ often, I take a trip to the trenches and
 “ fire a few shots at sandbags—all I could
 “ see of the Turkish position excepting
 “ dead Turks. My last voyage with the
 “ Marconi Company was coming home with
 “ the Australian troops. I have met them
 “ all here since and renewed many friend-
 “ ships.

“ Our airmen here are very active ; one
 “ or two are always above us. The other
 “ evening there were five up together. We
 “ had a very exciting episode a few days ago.

“ A German aeroplane was flying towards
 “ us when one of our machines was seen
 “ approaching from the south. The
 “ *Deutscher* at once made off, but our man
 “ followed. The last we saw of them, as
 “ they disappeared over the ridge, was the
 “ German being rapidly overhauled ; un-
 “ fortunately we did not see the finish. Our
 “ airmen have certainly established a big
 “ supremacy here.

“ The general opinion is that this cam-
 “ paign will be over soon now. I hope it
 “ will. I shall be very glad when the whole
 “ thing is over. I am looking forward to
 “ coming back to Marconi House and
 “ renewing all the old and pleasant asso-
 “ ciations.

“ Big things are happening here now,
 “ which, of course, the censor will not allow
 “ me to write about. But from all appear-
 “ ances it certainly looks as if the Turks were
 “ getting very fed up. Many prisoners
 “ have been brought in lately, and they look
 “ very ragged and weary, but they have
 “ fought a good fight, although they are
 “ never able to get the upper hand.

“ I would like to send you some photo-
 “ graphs of the station, but regulations do
 “ not permit of them being sent away.

“ We hear occasionally of the good work
 “ being done by Marconi men in different
 “ capacities, and we shall have many things
 “ to yarn about when we all meet again.”

Wireless Telegraphy in the War

*A résumé of the work which is being accomplished
both on land and sea.*

OUR illustration of the Ok Meidan wireless station, situated in the environs of Constantinople, between two and three miles outside the city, gives a very fair idea of the general outside appearance of an installation, which was dealt with in some detail in the October, 1914, issue of *THE WIRELESS WORLD*, page 456. Located on high ground, it consists of wild heath land. The visitor who arrives from the Turkish capital is liable to find himself seriously troubled by clouds of dust. The installation is a powerful one, the aerials being capable of developing a continuous 20-kw. transmission. It was erected prior to the Balkan War, and played an important part during the siege of Adrianople, maintaining communication between the Turkish Government and the beleaguered garrison. In the present war there can be little doubt that it is in constant communication with the great German station at Berlin, and we may feel pretty certain that it is by the agency of these 250 ft. masts that all those "Arabian Night" fictions which the German Government add to their own wireless bulletins come through.

The following extract from an article in a recent number of the *United Empire*, upon "The Aeroplane and War," is of interest.

Speaking of the R.F.C., the writer says :

"What they did want was opportunity and efficiency—more machines and better machines ; opportunities to perfect themselves in their work, to try for possible developments. Take wireless telegraphy, for example. Experiments had been made in Italy and elsewhere, the matter discussed, apparatus designed and, to some extent, tested before 1913. Apparently English officialdom regarded it as a harmless crank, beloved of two or three individuals. However, they were permitted to try. Last summer they tried, tested, perfected as much as might be with available resources, encouraged by their own conviction of the value of the work. Germany, be it noted, has no similar achievement to record. All her big dirigibles, however, are fitted with wireless, and moreover can carry a wireless operator who need not be an aviator. . . ."

The above statement hints at an infinity of energy and organisation since the out-



Ok Meidan, Constantinople, Wireless Station.

break of war, of which no doubt we shall hear more at an opportune moment.

* * *

We read in the *Sydney Sun* (Australia) that the invention of apparatus for controlling a submarine, or aerial torpedo, by wireless is the invention of a Mr. Alban Roberts, and that when the patent was first introduced it was controlled by a Sydney syndicate. As, however, the applications for patents were lodged in Germany before the war broke out, our contemporary appears to consider it not unlikely that, if the idea has been applied to Zeppelins, the Germans must have stolen the invention for their own purposes.

* * *

Our illustration of the s.y. *Mahroussa* recalls the fact that the ex-Khedive of Egypt has "sold his kingdom" not "for a Mass," as did our own Stuart Dynasty, but for the indulgence of a piece of personal spite against England. His private yacht *Mahroussa* was lying at Constantinople at the time when war broke out between Turkey and the Allies. The wireless apparatus on board, which consisted of a Marconi 5-kw. installation of the battle-ship type, was removed by the Turks and utilised ashore. It may be remarked that the power used for this apparatus was provided by a large battery of accumulators, which also served to light the ship when in port. A triple-screw steamer, fitted with Parsons turbines, she is the fourth largest private yacht in the world, her tonnage being 4,500. She did excellent work in connection with the Egyptian "Red Crescent" Mission all through the Balkan War.

* * *

If only German methods were not quite so clumsy, some

of the German ideas, which are quite good, would work out in a more artistically satisfactory manner. But as a rule the clumsiness of the means employed gives the show away.

An interesting example is furnished by the attempt of the German authorities to influence foreign opinion through the insertion of imaginary items in the "news from Berlin sent through the wireless stations of the German Government." It will be remembered that on July 10th, just after the German reply to the United States' note about the *Lusitania* had been received, the German wireless stations radiated the following message:—

"Political, and even naval, circles are beginning to get tired of the daily editorials of the *Deutsche Tageszeitung* against a German-American understanding on the submarine question. The attitude of the *Tageszeitung* is considered sufficient proof that such an understanding is desirable."

Count Reventlow, who is responsible for the *Tageszeitung*, appears to have been at a loss to trace the message ascribed to him. Nothing of the kind had really appeared in the *Tageszeitung*, and the editorial staff of that paper, including their distinguished inspirer Count Reventlow, had to discover it through the medium of the British Press.

* * *

British submarines have recently been making matters a little too lively in the



S.Y. "Mahroussa."



In the Bosphorus.

Sea of Marmora and off the coast line of Constantinople for the fancy of the Turks. The ferry-boats, of which we publish an illustration, ply to and fro on the Bosphorus, and provide in peace time an extensively patronised service along the coast at very moderate rates, so low indeed that it is possible to travel from Constantinople to the Black Sea for the equivalent of a shilling. Owing to the fact that these steamers are unprovided with wireless apparatus they are totally incapable of receiving notice of the presence of hostile submarines, and a certain number of them already have been sent to the bottom. So risky do the Turks consider a voyage in them to be that we understand passengers refuse to go on board unless provided with life-belts. The boats, some of them constructed in England and some in France, form quite commodious steamers, built in two decks.

* * *

We sometimes see it stated in British as well as German newspapers that "the future of the operations elsewhere will be settled on the battlefields of Flanders," but will it? We can understand the reason for hoping so from the enemy point of view, but with the supremacy of the British Fleet still unshaken another solution is perfectly possible. Our illustration of a pack wireless station of the Indian Army operating "somewhere up Euphrates" recalls to our minds an important British expedition from the point of view of locality, though not from that of the size of the forces em-

ployed. An Anglo-Indian Expeditionary Force has for some months past been progressing up the Euphrates from the end of the Persian Gulf. It is excellently organised and equipped, and well provided with "wireless ears." The figure standing on the left side of the photograph is Sergeant Blundell, who has already distinguished himself in the present war.

The news, as far as it has been published, takes us up to the end of July, when the Turkish forces were defeated near Nasiryeh. This is by no means the first important expedition conducted by Englishmen in this part of the world. In 1835 a party



Pack Wireless Station.

of engineers, sappers, miners, and artillerymen started down the Euphrates River under the command of Captain F. R. Chesney and proved the practicability of this route by which the passage from England to Karachi, the nearest port of British India, could be effected by the transit of 1,000 miles less than that occupied *via* Suez. A railway concession was obtained from the Turkish Government, but the project failed, *on account of the overwhelming British influence which would thus be secured over this part of the world.* Political jealousies were aroused and Lord Palmerston gave way. Perhaps Great Britain may reconquer in war what she gave up in peace, so that the rich valley of the Euphrates may yet constitute a most important channel of communication between the Mother Country and her Indian Empire.

* * *

At a time when a "certain section of the Press" has called for the condemnation of the Trades Union Congress for endeavouring to take advantage of the present war to fasten some form of military service on Englishmen the *Spectator* brings out a timely article on "Education and War," pointing out that despite its many drawbacks military service may if properly conducted prove of considerable educative value to the youth of the country engaged in it. They refer to an article in *The Daily News*, published by Mr. H. W. Nevinson, who some years ago went so far as to call the army "the poor man's university." Certainly, "in the Royal Engineers, besides gaining some knowledge of *wireless telegraphy*, land surveying and signalling, the recruit may make acquaintance with the newest instruments from mining and blasting and the management of explosives in general." It is far from our wish to trench on controversial subjects, but this side of the question is not unworthy of some attention.

* * *

In the course of an article dated from Rotterdam from the pen of Mr. James Dunn, reference was recently made to the aerial torpedo invented by a Swedish officer and sold to Krupps. Germany's finished weapon appears to be an important development of the Swedish invention and "resembles" a

miniature airship fitted with propellers driven by electricity and controlled from a Zeppelin by wireless. The German aerial torpedo can theoretically remain in the air for three hours, and can be controlled from a distance of two miles. It is provided with two propellers, and two lifting screws are automatically started at the moment of discharge.

In shape this torpedo of the air, which is about seven feet long, resembles the submarine weapon. It is composed of two cases, the outer of thin chrome nickel and the inner of material similar to that used in Zeppelins. About a sixth of the space at the rear is occupied by an electric accumulator at the bottom and an electric motor generator secured to the top. The machinery is controlled by Hertzian waves acting on the Telefunken system of wireless, and it is claimed that up to a distance of two miles the air torpedo can be steered at will.

* * *

The air torpedo is inflated with water gas and compressed gas, but as it is heavier than the air, two lifting screws work under the body to keep the torpedo in the air, while the motive power is supplied by two propellers. Both screws and propellers are connected with the same shaft, which runs through the body of the torpedo.

* * *

Mr. Godfrey Isaacs' fine speech at the Whitehall Rooms on July 26th must have opened the eyes not only of the shareholders of the Marconi Company, but the wider circle of British newspaper readers, as to the value of the German wireless chain, which has been recently broken up. A full report of the speech was printed in our September issue. But there is one point upon which it might be worth while to enlarge a little here. Mr. Isaacs, after stating that on good authority the German Government was supposed to have spent about two million sterling in their wireless construction, proceeded to point out what an excellent investment that expenditure proved. It snatched scores of million pounds' worth of prizes away from the British Navy. Neutral ports all along the great routes of commerce are stuffed with German shipping interned to evade the strong arm of the British Navy. A journey down the South American coast is an object

lesson in itself. We have pointed out in these columns that this wireless organisation of theirs rendered possible the predatory careers of the *Emden*, *Karlsruhe*, *Königsberg*, and their consorts, besides accounting for our enemy's sole naval success, that off the Chilian coast against the gallant British Admiral Craddock.

The speech of the Secretary of State for the Colonies (Mr. Bonar Law), in his statement in the House on the occasion of his report on the Colonial Vote, devoted a large part of his speech to driving home the same moral as did Mr. Isaacs. He paid no small tribute to the far-sighted expenditure of German money on wireless, when he declared that with regard to their Colonial wireless stations that "it was of the utmost importance that by some means or other, we should either obtain possession of these stations or destroy them." The vulnerability of the cables as compared with the wireless stations has been most strikingly exemplified. The former were cut within a few hours of the declaration of war, the latter have to be reduced piecemeal, and although approaching completion that object has not even yet been altogether attained. New Zealand struck the first blow, and on the last day of August entered into possession of the German wireless station Samoa. The Australian forces followed suit and after some fighting took possession of the German colonies of New Guinea, Bismarck Archipelago and the Solomon Islands, together with their wireless equipment. In Togoland the British and French worked together. Here some very stiff fighting took place before the great wireless station, which formed the objective of the whole expedition, had been destroyed by the Germans to prevent it falling into our hands. After this the Colony surrendered and is now being administered by the Allies. In the Kameruns the success of the Allies has not been so unqualified, but although at present only partial the end is not only certain but approximate. The magnificent campaign conducted in so skilful and successful a manner by General Botha is fresh in the minds of us all. Here again the main objective was Windhoek with its giant wireless equipment. The capture of this important radio-telegraphic station and city decided the fate of the Colony and was

closely followed by the surrender of the German forces. The history of this campaign against German wireless and the Colonies which sheltered it forms one of the most interesting and illuminating contributions to the understanding of the war and Britain's position relative to Germany which has been published since the outbreak of hostilities.

* * *

The occasion of Senatore Marconi's visit to London resulted in several interesting press interviews. The representative of one of our weekly contemporaries appears to have put a series of questions ranging over a very wide field. It appears to be the fashion nowadays to exaggerate the achievements of our German enemies, particularly in a certain section of the press, which called down upon themselves the rebuke of the Prime Minister on this very point, just previous to the rising of Parliament for the summer recess. The interviewer in question in calling Senatore Marconi's attention to the "wonderful" wireless station in German South West-Africa, practically built at a cost of a quarter of a million pounds, by means of which the Colony was able to speak direct "to Berlin" drew from the great inventor the remark that this achievement hardly represented anything very remarkable in view of the development of radio-telegraphy at the present day. Senatore Marconi's reply included the observation that "it has been found quite possible to communicate by wireless direct from Buenos Aires to England, which, if I am not mistaken, is further than from German South-West Africa to Berlin." This achievement is a work of the English Marconi Company, and the Chief's temperate reminder formed an excellent rebuke to the representative of a journal which has recently constituted itself one of the "admirers of all countries but their own."

* * *

Of course, the old suggestion about the possibility of exploding the enemies' shells by means of wireless turned up, like a hardy perennial. "Personally," said the great inventor, "I do not see how this can be done. I do not say that it could not be done, but if I were asked to do it, I should answer 'Not at present.'" The subject of

the rapprochement between England and Italy which may be expected after the war, gave rise to the expression of some well-founded expectations of business to be done in the future. In the past Italy has taken a great quantity of manufactured articles from Germany, but after the end of the present struggle, this trade ought to go largely to England and result in the building up of a most important commercial intercourse between the two great nations, always friendly and now Allies.

* * *

In a recent issue we gave a story of how the "treasure ship" *Kronprinzessin Cecilie* escaped the British cruisers at the end of July last year. The distinguished writer who employs the pseudonym of "Americanus" contributed a remarkable article to a recent number of the *Spectator*, in which he does us the honour of quoting the account we published, and adducing from it fresh damning evidence of German duplicity. He points out that the wireless message to which she owed her salvation signified, when decoded, that war had broken out with England, France and Russia *four days before the event actually occurred*. In other words, war had not broken out; and "Germany was then nominally at peace with the world and through diplomatic agencies was vigorously asserting the

"sincerity of her alleged mediatory efforts to preserve peace."

* * *

The Note to United States recently transmitted by Sir Edward Grey contains a very masterly defence of the British sea blockade determining. The Americans have been insisting upon the well established contention that a blockade must be a reality before neutral countries will submit to be governed by its laws. The British despatch points out that a modern blockade does not require a close ring of warships before the ports it is intended to invest. The great speed of up-to-date warships gives them a wider range, which is immensely added to by *their control of wireless telegraphy*. The situation itself is a novel one and must, therefore, be judged by novel standards, due regard, of course, being made to the principles involved in the ancient rules.

* * *

The aircraft men form the "eyes" of an army, and the wireless sections form its "ears." Just as the Flying Corps are being trained at Marconi House, London, in the wireless branch of their service, so the Royal Engineers are having their wireless sections trained at different points in Great Britain. Our illustration depicts the corps of the Royal Engineers, who are at present undergoing instruction in wireless telegraphy at Glasgow. Here they are being



Copyright by Daily Record, Glasgow

Royal Engineers Wireless Corps.

trained for service in any of the many regions in which the British Army is now operating, and few of us blessed with any imagination can look upon these gallant young sons of the Empire unmoved by the reflection that many of them are likely to suffer in life or limb in various parts of the world before Great Britain and her Allies have been able to curb the lust for power of the Pinchbeck Potentate of Potsdam.

* * *

As far as land operations are concerned, the greatest activities for the moment displayed by the British centre round the Gallipoli Peninsula. Here the game of war is being played in a most strenuous style by the British Imperial and Colonial forces. We print in the present issue an account of what is going on from the pen of the wireless operator in charge of the station at Anzac, which gives a very fair idea of what conditions are like in this part of the world-wide operations of war. Our illustration shows a different scene. The wireless masts are looking down upon, not trenches and bomb shelters, but a team of hockey players engaged in friendly, not deadly, combat upon the sandy soil which, varied by craggy hills, forms the Gallipoli Peninsula.

In our last (September) issue we published on page 373 a portrait of Senatore Marconi in his Italian uniform, and the *Daily Chronicle* has recently printed an interview with him concerning his war experiences with the Italian Army. Italy, it would appear, is probably the best equipped country in the world in the most modern of the weapons of war, and Senatore Marconi's services have naturally been utilised more particularly in this branch of his country's service. In the course of his interview he gave a graphic little description of the character of the mountain fighting experienced by the Italian Army, now, for the first time after many bitter years, entering the unredeemed provinces so long retained by their traditional foes. "The posts that marked the former frontiers between the two countries," said the great Italian, "bore the word *Italia* inscribed on one side and *Austria* on the other. There was tremendous excitement in the ranks one day when an Italian soldier rooted up a post and triumphantly carted it off—between rows of cheering compatriots—for about ten miles further on towards the Austrian lines. I have sometimes seen on other posts the name *Austria* obliterated so as to enable *Italia* to be triumphantly inserted on top."

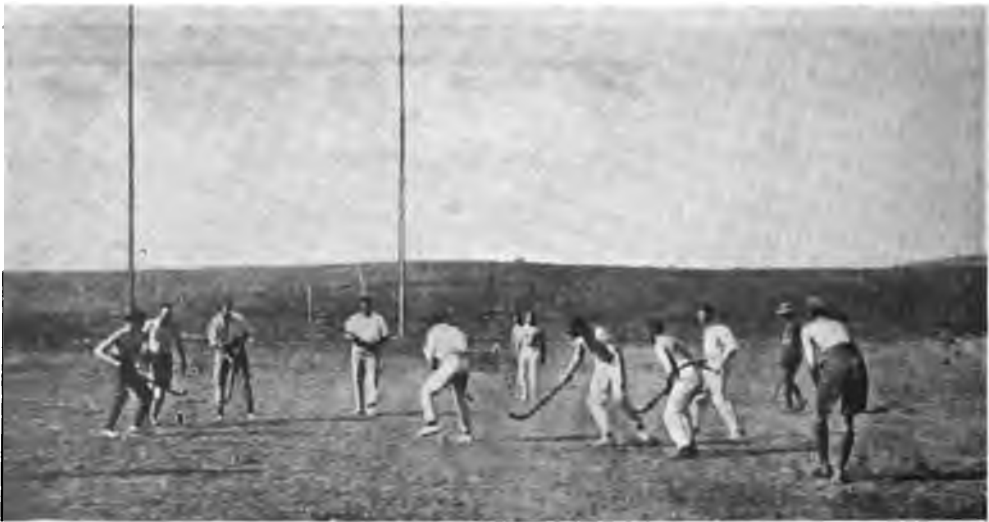

Marconi Posts as Hockey Bases in Gallipoli.

British Association Meeting

Three Papers on Wireless

IN Section G (Engineering) of the British Association on Friday, September 10th, three papers relating to wireless telegraphy were read.

The first was by Dr. W. Eccles, and Mr. A. J. Makower on "Electric Oscillations in Coupled Circuits—a Class of Particular Cases." The paper was of a highly mathematical character, and Dr. Eccles apologised for presenting it to the Engineering Section of the Association. He pointed out, however, that the paper gave several formulæ not to be found in text books, and he felt that these would be of assistance to designers of wireless telegraph installations. The investigations which formed the subject of the paper arose during an examination of the methods of coupling that might give rise to single frequency oscillations.

PROFESSOR GIBBERT KAPP, who was in the Chair, remarked that the author had judged the mentality of his audience rather too highly. He confessed that the subject was beyond him.

PROFESSOR G. W. O. HOWE said he was very interested in the paper, but it was not one that could be discussed very well on account of its very mathematical nature without losing oneself and losing everybody else in the process. He had done some work on similar lines himself and on one or two occasions had written articles criticising adversely the French system of getting a single wave known as "System 'à onde unique' of the Société Française Radio Electrique." When he first heard of this paper, he was not sure whether Dr. Eccles was going to say that he had made a "howler," and he was very relieved to find that it was quite impossible to make a single circuit. Recently also he himself had written a paper on similar lines, of coupling by means of condensers in special cases as well as of inductance, and working out in a simple manner the equivalent couple in the two cases. In the special cases as represented in the paper where the circuits were

joined and coupled by a condenser, there was a simple way of finding out the frequency of oscillation and the equivalent coupling. The method he had adopted in the paper which he had recently written was one which would appeal to the usual elementary student.

PROFESSOR E. W. MARCHANT said it was difficult to discuss a paper of this nature at first sight, but the results in it would be of very great value in connection with it in the design of wireless telegraph stations.

DR. ECCLES briefly replied.

The second paper was by Professor G. W. O. Howe on "The Capacity of Aerials of the Umbrella Type" (see pp. 426-431). In a paper read before the British Association at Sydney last year the author developed a method of calculating the capacity of radiotelegraphic antennæ. In addition to describing the method in general, curves and formulæ were given so that the capacity of aerials of standard types could be determined in a few minutes. The umbrella type, however, was not specially considered, and it has since been suggested to the author that the usefulness of the paper would be considerably increased if curves and formulæ could be given for aerials of this type. The method is briefly as follows: The whole aerial is assumed to have a uniformly distributed charge, and the average potential of the whole aerial under this fictitious condition is then calculated. It is assumed that if the total charge, while remaining unchanged in quantity, be allowed to have its own natural distribution, it will assume a uniform potential approximately equal to this fictitious average potential. The proximity of the earth is taken into account by the method of images. Tables and curves are given for aerials with from two to six ribs and for various angles between the ribs and the vertical. With these curves and those given in the original paper each of the nine component potentials of any given aerial of the umbrella type can be read off and the

resultant average potential determined. The method is then applied to two practical examples, one a simple aerial with six single-wire ribs and the other a more complicated case in which each of the five ribs consists of a four-wire cage, the size of the wire being different from that used for the central vertical wire. Tests on actual aerials have shown that the value of the capacity as calculated by the author's method agrees with the measured values within the errors of observation and of estimation as to the allowance to be made for connecting wires, etc.

In answer to a few questions, Professor Howe said that the thing which had surprised him was the accuracy of the rough assumption in the paper. He had expected to get large discrepancies.

The final paper was by Professor E. W. Marchant, and was entitled "A Note on Earth Resistance." This was a short paper and we give it below.

If an earth plate in the form of a hemisphere is embedded in a homogeneous medium, with a flat bounding surface, the flat face of the hemisphere coinciding with the flat surface, it may easily be shown that the resistance between this surface and a very distant surface also of hemispherical form is $= p/2\pi a^2$, where p is the specific resistance of the material, and a is the radius of the hemispherical earth plate. This may be written $= (p/2\pi a^2) a$. $p/2\pi a^2 =$ specific resistance. / Area of hemispherical earth plate.

a is the length of the uniform bar with area $2\pi a^2$, which could have the same resistance as the earth. " a " may be called the "Equivalent length of the earth resistance," which in this case is equal to the radius of the hemisphere. For other forms of earth than the sphere this equivalent length of earth may be determined. The earth resistance of an earth plate will depend almost entirely on the specific resistance of the material immediately surrounding the earth plate, and, if its value is known, the resistance of the earth at any place may be determined, if the specific resistance of the soil in the neighbourhood of the earth plate is found. In connection with the wireless station at Liverpool some experiments have been made recently on the resistance to earth of three different types of earth plate. The

earth most used was the water pipe system of the building; in addition to this an earth was formed by fourteen 2-in. cast-iron pipes pointed and driven about 1 ft. into the ground, which, in Liverpool, is a good yellow sandstone; a third earth was formed by a copper plate 1 ft. 6 in. wide and 4 ft. 6 in. long, buried vertically at a depth at the lower edge of 6 ft. below ground. To this was riveted two copper strips laid at a depth of 6 ft., each 1 in. wide, and 40 ft. long. In both cases described the earth was made by burying the plates direct in the wet sandstone, without a surrounding volume of coke such as is usually recommended. If good conducting material were used to surround the plate it would, of course, considerably reduce the "effective length" of the earth resistance. The specific resistance of the sandstone, when excavated from the soil and firmly pressed into a wooden box with copper plates at opposite faces, was 375 ohms per foot cube, the percentage of moisture in the sand being 10 per cent. By measuring between these earths in succession and by assuming that the earth resistance of each was some definite quantity, the resistance of each of the three can be estimated. The earth resistance was measured first between A and B with A positive, then with A negative, and so on, and the earth resistances were calculated on the assumption that the earth currents flowed from A to B, from B to C, and from C to A.

Calculating from the measurement so made, the following results were obtained :

	ohms.
Earth resistance of copper plate and strip	6.1
Earth resistance of iron pipes ...	42
" " " water pipes ...	3

Assuming that the current flowed the other way, the earth resistances were :

	ohms.
Earth resistance of copper plate and strip	7.1
Earth resistance of iron pipes ...	40
" " " water pipes ...	2.7

The water pipe earth has very much the lowest resistance as might have been expected from the large area of water pipe embedded in the soil. In comparing the two earths formed by the iron pipes and the

copper plate, it was calculated that the area of surface exposed to the soil was 5.8 sq. ft. in the case of the iron pipes and about 27 sq. ft. in the case of the copper plate. The equivalent length of earth as defined above may be easily calculated from the above data :

For the copper plate earth the mean	ft.
equivalent length is	0.51
For the iron pipes the mean equivalent length is	0.63

It is impossible to estimate the equivalent length of the water-pipe earth, since the area of surface of the water pipes exposed to the ground is unknown, and in any case the calculation of the equivalent length for such a complicated network would have no practicable value. The earth resistance of these plates has not been measured over a very long interval of time, the greatest difference in earth resistance found, so far, is for the copper plate which is buried in ground exposed to rain. After a very dry spell of weather the earth resistance was found to be about 6 per cent. greater than it was after the usual rainy conditions had prevailed for some weeks. The reason for the smaller equivalent length of the copper plate earth is its form, the long copper strip giving contact to a large area of soil, whereas the pointed iron pipes were close together. The determination of the equivalent length of earth for various forms of earth plates provides a simple means of comparing their effectiveness.

PROFESSOR G. W. HOWE said that although Professor Marchant was not aware of it this paper was also an appendix to his own paper in Australia. There was one point which required making a little clearer. The equivalent length in an arrangement of embedded wires in the earth was merely a geometrical thing which could be calculated, depending merely on the dimensions. It did not depend on the specific resistance—*i.e.*, the nature of the earth. It was a geometrical constant depending upon the dimensions which could be calculated approximately quite sufficiently accurately for all practical purposes. With two plates, one positive and one negative, and an insulating medium there were electrostatic lines from one to the other, and, depending upon dimensions, that arrangement had a

certain capacity. If, however, these two plates were embedded in a conducting medium these lines were not electrostatic lines, but lines of flow of current, and depending upon the dimensions for a given specific resistance one obtained certain resistance. The same formulæ that gave capacity gave resistance, and if they calculated the capacity they could say straight away what was the resistance of that arrangement. Given the specific resistance of the medium in which it was embedded, it was possible to calculate the resistance if they could calculate the capacity. The surface of the earth might at first sight appear troublesome, but this could be allowed for by a modification of the method of images. He had applied this method to his formulæ in his Australian paper and the results agreed approximately with those given by Professor Marchant. Professor Marchant's results were absolutely at the mercy of specific resistance. His (Professor Howe's) paper on the subject would shortly be published.

DR. W. H. ECCLES said that in calculations of earth resistance in wireless telegraphy it was necessary to be specially careful to remember that the effective resistance varies with the frequency. It varied up to 300 or 400 per cent.

PROFESSOR HOWE said that he had intended to draw attention to that point, which was mentioned in his forthcoming paper. Low frequency or static measurement of earth resistance had to be used very carefully in wireless telegraphy.

MR. J. FRITH asked how Professor Marchant measured his earth resistance. Continuous current was not a reliable method of measuring earth resistance. A far more reliable method was alternating current using a bridge and telephone.

PROFESSOR KAPP said that one was always under the impression that the earth offered very little resistance—*i.e.*, if it was really a moist earth. Was there not such a thing as contact resistance between the plate and the earth? For instance, the first $\frac{1}{4}$ in. contact between the plate and the earth must have a different resistance to the middle of the plate. Had that fact been observed and how was it accounted for?

PROFESSOR MARCHANT said the main object he had in writing the paper was to attempt to establish some sort of standard

by which the effectiveness of different forms of earth plate could be measured. He agreed with Dr. Eccles that the difference of resistance and difference of wave-length was of very great importance in wireless telegraphy. He understood, however, that the form of the earth plate did not make much difference.

DR. ECCLES, interposing, said that if the earth plate had about one-half or one-third copper in the antennæ it could not be very much improved upon.

PROFESSOR MARCHANT, replying to Mr.

Frith's point, said that he measured with direct-current. Professor Kapp's question as to contact resistance was rather difficult to answer. He did not see how in these tests they could determine whether it was contact resistance or ordinary resistance. On the surface of iron pipes there would be scale or rust which would increase the resistance. He did not think there would be anything much on the copper plates, and thought the results showed that the main factor in the measurement was the resistance of the material.

PATENT RECORD

The following patents have been applied for since our June issue :

(JULY, AUGUST, SEPTEMBER, 1915.)

10272. July 14th. Alban J. Roberts. Amplification of wireless signals. (*Complete.*)

10373. July 16th. Thomas W. Stratford-Andrews. Detector for wireless signalling. (*Provisional.*)

10449. July 19th. Genison & Co., Ltd., F. J. Spencer and W. J. Keily. Machines employed in the manufacture of boots and shoes, and electrical means for obtaining and imparting high-frequency oscillations or vibrations applicable to such machines and for other purposes. (*Provisional.*)

10667. July 22nd. Arthur H. Morse and The Indo-European Telegraph Co., Ltd. Electric alarm or calling devices used in receiving apparatus and more particularly in wireless receiving apparatus. (*Complete.*)

10672. July 22nd. Lewis C. Stewart and J. J. Little. Wireless type-printing and telegraph systems. (*Provisional.*)

10769. July 24th. Sterling Telephone and Electric Co., Ltd., and Thomas D. Ward-Miller. Crystal detector, particularly for wireless signalling. (*Provisional.*)

10963. July 29th. Paul M. Rainey. Isochronising and synchronising systems in multiplex telegraphy. (Convention application August 18th, 1914, United States.) (*Complete.*)

11157. July 31st. Jacob Longman. Wireless telegraph. (*Provisional.*)

11158. July 31st. Jacob Longman. Telephonic receiving apparatus. (*Provisional.*)

11161. August 3rd. Thomas F. Wall. Method of generating high-frequency electric currents. (*Provisional.*)

11443. August 9th. Gaston V. A. G. Mathieu. Spark gaps for wireless telegraphy. (*Complete.*)

11555. August 10th. Fred K. Vreeland. Production of undamped or sustained electric oscillations. (*Complete.*)

11831. August 16th. Marconi's Wireless Telegraph Co., Ltd., and S. O. E. Trost. Transmitters for wireless telephony. (*Provisional.*)

12201. August 24th. Arthur H. Morse and The Indo-European Telegraph Co., Ltd. Electric alarm or calling devices used in telegraph, and more particularly wireless telegraph, receiving apparatus. (*Provisional.*)

12564. September 1st. British Thomson-Houston Co. (*General Electric Company, United States.*) Wireless signalling systems. (*Provisional.*)

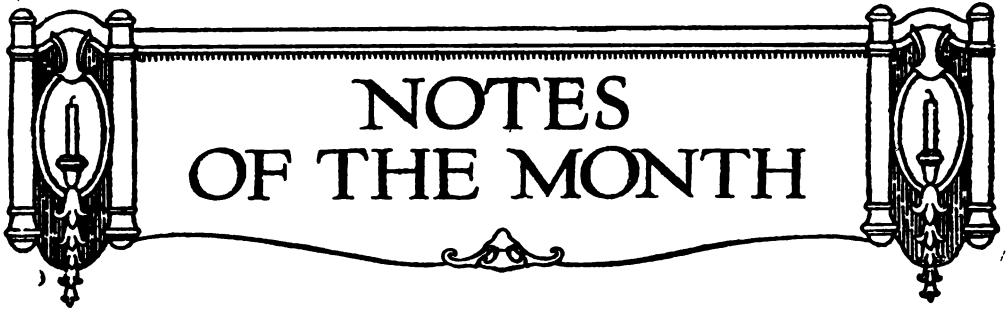

NOTES OF THE MONTH

FROM the Antipodes through the medium of the public press—in this instance the *Sydney Sun*—comes news of an invention which (if only it were true) would revolutionise the face of the earth. Under the heading of “Bullroarers versus “Ultra-Violet Rays” our contemporary contrasts the methods of old time rain-makers with that of the oldest modern exponent of the art: “The rain-maker in “our modern invention does not need to “wear a head-dress of feathers and paint “false ribs on his body with pipeclay; nor “does he need a cannon or a cauldron like “later members of the profession. All he “does is to sit in front of a switchboard, “ascertain by ‘phone or wireless where the “rain is wanted and how much, push in a “few plugs and touch some buttons. Then “it’s time for the populace to rush for “the shops where they sell umbrellas for “2s. 11d.”

Rain in Australia by wireless! If only it were true.

* * *

Under the heading of “Marconi and Commerce,” with the sub-title of “Cheaper than Cables,” the Liverpool Journal of Commerce in its issue of August 16th published the following article, which we reproduce below. It constitutes a really valuable independent testimony to the indebtedness of the commercial world to the system of wireless communication invented and organised by Senatore Marconi.

“The Marconi system of wireless telegraphy is steadily and largely extending its field of operation, and nobody can deny that, apart from its great scientific, strategic, and marine activities, the company “is building up a vast commercial system.

“Had the war not occurred, other new “services would have been at the disposal “of the public, but, on the other hand, let “it be remembered that the important “services rendered to Government, country “and empire have been of so vast and “valuable a nature that a leaning towards “wireless is only to be expected, as evidenced “by the growth of business. Of the Transatlantic service—Canada, the United “States, Honolulu, the West Indies, etc., “can now be reached more cheaply and as “easily and effectively by wireless as by “cable, and when it is taken into consideration that the rates to New York, Montreal, “and, in fact, all places in the 1s. zone of the “cable companies in North America are 8d. “per word, there is the additional substantial attraction of a 33 per cent. saving on “the cable bill of commercial concerns and “private senders, no mean consideration at “the present time. The Marconi Company “has opened an office in the heart of the “City, at No. 1, Fenchurch Street, where “speedy transmission and delivery of all “messages are effected, and it is probable “that when the war is over a considerable “extension of such offices will take place, “and that active competition will be offered “in provincial centres. In the meantime “messages are, of course, accepted at all “postal telegraph offices.

“The American associate of the Marconi “Company is about to open up a commercial “service to Japan, etc., at considerably “reduced charges, and although no doubt “the commercial community is grateful to “any live company prevailing against “powerful interests and reducing rates, it “must be remembered that this cannot “be done without the support of the public, “and, it may be added, it is to their interest

"to do so. Cable companies have already had to bring down their rates to the level of those charged by the wireless, or create special services, but whatever the method the credit therefor is due to wireless."

"Cable telegraphy has, of course, been in existence for about 65 years, and when commercial wireless can look back on this span of years who can say what it will achieve, not only in the direction of saving to the public, but also in consolidation and union of the many countries and people who constitute the British Empire."

* * *

Towards the end of August last the submarine cable between the south-east of Mull and Oban broke. Before it was repaired the only means of communication with the island was by means of wireless telegraphy, the islands of Mull, Coll, and Tiree being otherwise isolated. The usefulness of the wireless system is clearly seen at such a time. Telegraphic messages from Mull on reaching Lochboisdale by wireless are transmitted to Stornoway, and thence by cable to Glasgow and other points. The work, which is especially heavy at present owing to the restricted steamer service on the west coast, is being got through with little or no delay, on account of an increased staff being employed at the two wireless stations.

* * *

Manifold are the uses to which the science of wireless telegraphy is put, but perhaps one of the most curious is that recently exemplified in the case of Galveston, Texas. So severe has been the weather that the town was completely isolated by the seas which swept round it.

Wireless telegraphy was employed to enable the inhabitants to keep in touch with the outside world.

* * *

Referring to Captain W. H. G. Bullard, whose biography we had the pleasure of

publishing last month, it is interesting to know that he is an author, having prepared a handbook for naval electricians, which has undergone three revisions and enlargements, and is now published in two volumes. It is the standing text-book at the United States Naval Academy for the use of midshipmen in their electrical course.

* * *

Perhaps one of the most interesting of the happenings during September was the visit of Mr. Frederick Palmer, a well-known American Press representative, to the British Fleet. The article which he wrote, describing his adventures, made public for the first time a number of facts interesting to those who pay for the upkeep of the Fleet, but who had not been allowed to know anything about it until the American visitor issued his account. Perhaps the most pregnant paragraph from a wireless point of view, occurs in the description of Admiral Jellicoe, the Commander, at the age of 57, of the mightiest battle fleet the world has ever seen. "Stepping into a small room, where telegraph keys clicked and *compact wireless apparatus was hidden behind armour*, we saw one focus of communication which brings Sir John word of any submarine sighted or of any movement in all the seas around the British Isles and carries the Commander-in-Chief's orders far and near."

The immense concentration of power in the Admiral's hands indicated in the passage we have quoted is mainly the work of radiotelegraphy. Without it this great Fleet, whose auxiliaries, outside of the regular service on duty, amount to 2,300 vessels, would be split into a number of separate units keeping in touch as best they could. Thanks to the power of wireless the most distant unit in the Fleet is as completely under Sir John Jellicoe's hand as if he could hail it by megaphone from his quarter-deck.



Maritime Wireless Telegraphy

IN connection with the sinking of the American s.s. *Denver*, an account of which appeared in our May issue, we hear that the United States Secretary of Commerce has sent a letter to the captain of the Atlantic transport steamer *Manhattan* conveying an expression of appreciation to himself, officers, and crew of their courage in rescuing the crew of the sinking steamer. During a terrible storm the *Denver* sent out an urgent wireless call for help, and the *Manhattan* left her course and arrived in time to take off the passengers and crew, numbering altogether fifty-six. The captain of the *Manhattan* will receive from the American State Department material acknowledgment as provided for by the laws of the United States. It is interesting to notice that the White Star Line's *Megantic*, which recently escaped being torpedoed by a German submarine, and the American Line's *St. Louis* also responded to the wireless call.

* * *

There has just been built for the United States Navy a new type of vessel to serve as "mother ship" to the fleet of torpedo-boat destroyers. She is the destroyer tender *Melville*, and is a vessel of 400 feet in length, about 54 feet beam, with a depth of 36½ feet and a draught of 20 feet. She has been designed and equipped to perform the duties of a supply depot, repair ship, and escort to the destroyers. Plenty of provision has been made for the stowage of stores, fuel and ammunition with which to replenish the supply of the vessels of the flotilla. Large machine and general repair shops are fitted with the necessary machinery with which to effect the general repairs to the destroyers, thus keeping them in good order and obviating the necessity of returning to dockyard for minor repairs. She is armed and fitted with two powerful searchlights and has accommodation for a full complement of 357 officers and men. It is inconceivable that such a ship should lack a wireless telegraphic installation, and this evidently was the opinion of the authorities, for she

has been fitted with a standard ship set which will without doubt prove of immense interest in her work.

* * *

We have frequently brought to the notice of our readers instances of the great value of wireless telegraphy in summoning medical and surgical aid, and have shown how life has been saved in this way on more than one occasion. Still another case has now come to our notice. On a recent voyage of the Atlantic transport liner *Minnehaha* the wireless operator received an urgent call for the assistance of a doctor from the s.s. *Georgic*, some sixty or eighty miles off. After the commander of the former vessel had satisfied himself as to the genuineness of the call—for great caution is needed in war-time—the *Minnehaha* had her course altered and made for a rendezvous which had been quickly arranged. So accurately had the two commanders made their calculations that the ships came in sight of one another almost exactly to the time expected. A boat containing the doctor and a stretcher was immediately lowered and dispatched to the *Georgic*, and the chief engineer, who had received serious injury to the stomach, speedily brought back to the *Minnehaha*. With the utmost dispatch an operation was performed and the patient's life saved. Had no assistance been forthcoming it is practically certain that the patient would have died, for the injury was very serious and the *Georgic* was not due to arrive in port for a week.

* * *

The *New York World* declares that the first intimation of illness on board the s.s. *President Lincoln*, which is one of the German liners interned at New York, was picked up from the steamer's wireless, which was supposed to be out of commission. It transpires that there are thirty cases of disease on the boat, which belongs to the Hamburg-America Line. The health authorities are watching the ship, suspecting the possibility of cholera. The majority of those ill came from Kiauchau.

CARTOON OF THE MONTH



Another Wireless Spy in Our Midst.

The Calculation of Inductances

By S. LOWEY.

THE writer has been for some time trying to find some easy method for the calculation of, or comparison of, inductances of solenoids. With this object in view an experimental determination of relative inductances of sections of a solenoid was carried out.

The publication of the *Year-Book of Wireless Telegraphy*, with Dr. Cohen's formula for inductance printed correctly, led him to compare results obtained by using various formulæ and to try to devise some method of calculation applicable either to short or long solenoids or even to coils of only one or two turns.

The results obtained were so closely in keeping with the results obtained experimentally, that he has written this article in the belief (judging by the substance of many queries in the technical press) that he is only one among many who have been earnestly endeavouring to reconcile results from various formulæ with practical experiment. The process may be dry and tedious to many, but the final result—*i.e.*, the two diagrams—should be of interest to any amateur who takes any interest in the mathematical side of the science of wireless telegraphy.

The following formulæ will be made use of, and they are lettered (a), (b) and (c) for convenience of future reference :

$$(a) L=l (\pi.D.N)^2$$

$$\text{when } \begin{cases} D = \text{Diameter in centimetres.} \\ N = \text{Turns per centimetre length.} \\ L = \text{Inductance in C.G.S. units.} \\ l = \text{Length in cms.} \end{cases}$$

DR. COHEN'S FORMULA.

Inductance of a Single Layer Solenoid.

$$(b) L=4\pi^2 N^2 \left(\frac{2a^4 + a^2 l^2}{\sqrt{4a^2 + l^2}} - 8a^3 \right)$$

$$\text{when } \begin{cases} l = \text{Length in cms.} \\ N = \text{Turns per cm.} \\ L = \text{Inductance in cms.} \\ a = \text{Radius in cms.} \end{cases}$$

DR. FLEMING'S FORMULA.

Inductance of Single Ring Coil.

$$(c) L=2l (2.303 \text{ Log}_{10} \frac{4l}{d} - 2.45)$$

$$\text{when } \begin{cases} l = \text{Length of wire.} \\ d = \text{Diameter of wire.} \\ L = \text{Inductance in cms.} \end{cases}$$

Formulæ (b) and (c) are taken from the *Year-Book*.

Formula (a) is obtained by dividing the magnetising force set up by unit current by the magnetic reluctance of the core of solenoid, and multiplying by the number of turns in solenoid.

It does not take into account the magnetic reluctance of the outside path surrounding solenoid, and is correct, therefore, only for a solenoid of infinite length, or one whose core forms a closed magnetic circuit.

The reluctance of the outside path of a solenoid of given diameter increases as the length diminishes.

It is necessary, therefore, in the case of short solenoids, to allow for this reluctance in calculations of inductance.

Formula (b) makes allowance for this, but it is rather a lengthy process to apply it to a number of cases.

If formula (b) is divided by formula (a) a factor is obtained, by which results given by formula (a) may be multiplied to give the same results as if formula (b) had been applied directly.

Formula (a) may be written

$$l (2a.\pi.N)^2 = 4\pi^2 N^2 (a^2 l)$$

if in terms of radius (a) instead of diameter (D).

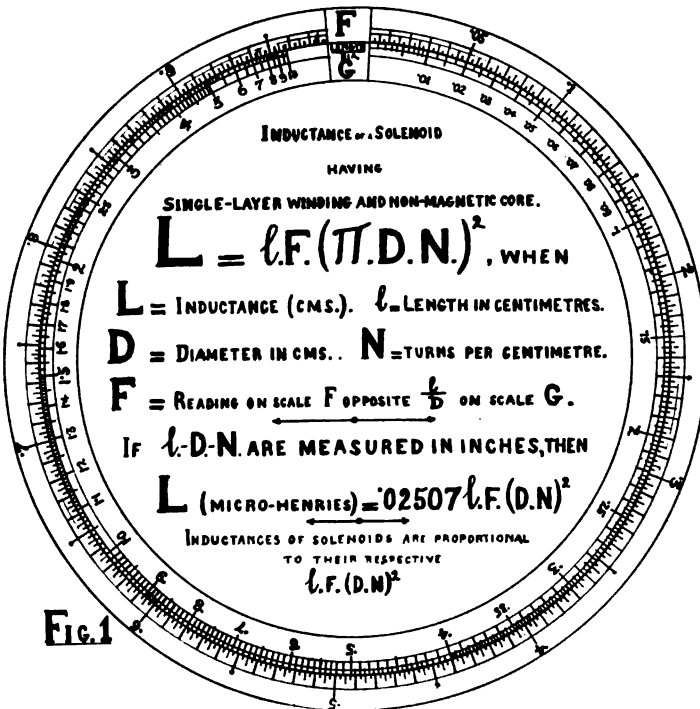

FIG. 1

$$\begin{aligned} \text{Formula (b)} &= \frac{4\pi^2 N^2 (2a^4 + a^2 l^2 - 8a^3)}{4\pi^2 N^2 (a^2 l)} \\ \text{Formula (a)} &= \frac{2a^4 + a^2 l^2}{a^2 l \sqrt{4a^2 + l^2}} - \frac{8a^3}{3a^2 l \pi} \\ &= \frac{2a^2 + l^2}{l \sqrt{4a^2 + l^2}} - \frac{8a}{3l \pi} \end{aligned}$$

If solenoid is one diameter long—i.e., $l=2a$, this expression becomes

$$\begin{aligned} \frac{2a^2 + (2a)^2}{2a \sqrt{4a^2 + (2a)^2}} - \frac{8a}{3 \cdot 2a \cdot \pi} &= \frac{6a^2}{2a^2 \sqrt{8}} - \frac{4}{3\pi} \\ &= \frac{3}{\sqrt{8}} - \frac{4}{3\pi} = 1.06 - .424 = .636. \end{aligned}$$

The inductance of a solenoid 1 diameter long = $.636l (\pi.D.N)^2$.

The result is the same as if formula (b) (Dr. Cohen's) had been used.

If different values of l for different lengths of solenoids are substituted, say, $l=3a$, etc., a table of factors can be made ranging from $F=.9293$ for a solenoid 6 diameters long to $F=.495$ for solenoid half a diameter long.

For lengths less than half a diameter formula (b) does not appear to apply, as the factors begin to increase when the length is less than $\cdot 6$ of radius.

Formula (c) is now made use of. Instead of regarding it as a single turn of wire of length l and diameter d , consider it as a short solenoid of diameter D and length l . The length of wire is then equal to $\pi.D.$ and the diameter of wire = length of solenoid.

Formula (c) then becomes

$$L = 2\pi D (2.303 \log_{10} \frac{4\pi D}{l} - 2.45).$$

But two different solenoids having equal lengths and equal diameters

have inductances proportional to the square of their respective turns. Number of turns = turns per cm. length \times length in cms.

$$\begin{aligned} &= NI \\ (\text{Turns})^2 &= (NI)^2. \end{aligned}$$

The formula may be altered

$$L = 2\pi D (NI)^2 (2.303 \log_{10} \frac{4\pi D}{l} - 2.45).$$

If this is divided by formula (a) the factor for short solenoids is obtained.

$$\begin{aligned} \frac{2\pi D l^2 n^2 (2.303 \log_{10} \frac{4\pi D}{l} - 2.45)}{l (\pi.D.N)^2} \\ &= \frac{2l}{\pi.D.} (2.303 \log_{10} \frac{4\pi D}{l} - 2.45) \\ &= .636 \frac{l}{D} (2.303 \log_{10} \frac{4\pi D}{l} - 2.45). \end{aligned}$$

For a solenoid $\frac{1}{10}$ th diameter long—i.e., $D=10l$., the factor would be

$$\begin{aligned} &.636 \times \frac{1}{10} (2.303 \log_{10} \frac{4\pi \times 10}{1} - 2.45) \\ &= .0636 (2.303 \log_{10} 125.6 - 2.45) \\ &= .1517. \end{aligned}$$

Further factors for solenoids having different ratios $\frac{l}{D}$ may be worked out, and the results combined with those previously obtained to plot out a curve showing how the value of the factor (F) varies with the ratio $\frac{l}{D}$.

Unless curves are on a large scale they are inconvenient for accurate reference. The values of F could be plotted out on one scale opposite to corresponding values of $\frac{l}{D}$ on another scale, when numerical values of F could be read off more easily. These scales could either be straight or circular. Such a circular scale is shown in Fig. 1. Values of F are read off opposite ratio $\frac{l}{D}$ of solenoid whose inductance is being calculated.

$$L \text{ (in cms.)} = lF (\pi.D.N)^2$$

$$L \text{ (in microhenries)} = .001 lF. (\pi.D.N)^2$$

If l , D and N are measured in inches, then

$$L \text{ (in cms.)} = 25.07 lF. (D.N)^2$$

$$L \text{ (in microhenries)} = .02507 lF. (D.N)^2$$

The inductances of any two solenoids are proportional to their respective $l.F.D^2.N^2$, and the wave-lengths to which they will tune with the same capacity are proportional to their respective $D.N \sqrt{l.F}$.

If different length sections of the same uniform solenoid are being dealt with (D and N therefore being equal in each case) the inductances are proportional to the respective $l.F.$, and the wave-lengths are proportional to the respective $\sqrt{l.F}$.

In Fig. 2, Scale B is the ratio $\frac{l}{D}$ for different sections of the same solenoid. Readings on Scale A are proportional to wave-lengths, and on Scale C to the inductances of these sections.

The actual values to which these scales are marked are:—

(A) Scale.—Reading (opposite a given $\frac{l}{D}$ on scale B) = $10 \sqrt{\frac{l.F}{D}}$.

(C) Scale.—Reading (opposite a given $\frac{l}{D}$ on scale B) = $\frac{100 l.F}{D}$.

EXAMPLES OF USE.

If 4 in. length of a tuning inductance 8 in. diameter has an inductance of 4,000 microhenries, what is the inductance of 12 in. length?

The two ratios $\frac{l}{D}$ are $\frac{4}{8} = .5$, and $\frac{12}{8} = 1.5$ respectively.

The two numbers on Scale C opposite to these numbers on Scale B are 24.3 and 110. The required inductance is therefore $\frac{110}{24.3} \times 4,000 = 18,107$ microhenries.

If 7 in. of a coil 5½ in. diameter tunes to 2,000 metres, what length of the same coil will tune to 600 metres? Neglect the induct-

Fig. 2

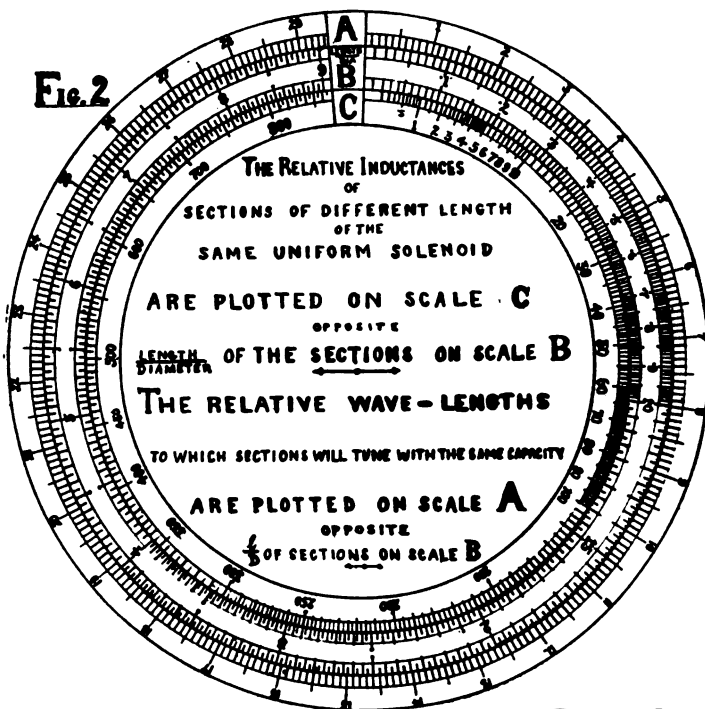

ance of aerial. $\frac{l}{D} = 1.273$. This number on Scale B has opposite to it on Scale A the number 9.35.

$9.35 \times \frac{600 \text{ metres}}{2,000 \text{ metres}} = 2.805$. This number on Scale A is opposite to .245 on Scale B. This number is the $\frac{l}{D}$ required. As $D = 5\frac{1}{2}$ in., $l = .245 \times 5.5 = 1.347$ in.

If it is desired to construct a tuning coil having an inductance of 10,000 microhenries, and the winding space available is 10 in. diameter and 6 in. long, how many turns per inch will be necessary?

Formula given in text $L = .02507 LF (D.N)$.
 $\frac{l}{D} = \frac{6 \text{ in.}}{10 \text{ in.}} = .6$. From scale, value of F for this value $\frac{l}{D}$ is .523.

Then $10,000 = .02507 \times 6 \times .523 \times 10^2 \times N^2$.

$$N^2 = \frac{10,000}{.02507 \times 6 \times .523 \times 10^2}$$

$$N^2 = \frac{10,000}{7.867} = 1,271.1$$

$$N = 35.6 \text{ turns per in.}$$

If on a coil 4 in. diameter having 40 turns per inch, a length of 6 in. tunes a particular station, what length will be required on a coil 6 in. diameter, 30 turns per inch, to tune same station?

Formula in text:—Inductances are proportional to respective.

$$L.F (D.N)^2.$$

For first coil this is $6 \times .733 (4 \times 40)^2$

For second coil it is $L.F (6 \times 30)^2$

These two values of inductance are to be equal, therefore:—

$$L.F = \frac{6 \times .733 \times 160^2}{(6 \times 30)^2} = \frac{20.85}{6} = 3.47$$

$$\frac{100 L.F}{D} \text{ would be } 57.9, \text{ as } D = 6 \text{ in.}$$

This number on Scale C is opposite .935 on Scale B. This is the required $\frac{l}{D}$; but

$$D = 6 \text{ in.,}$$

$$\text{so } l = .935 \times 6 \text{ in.} = 5.61 \text{ in.}$$

It will be at once seen the variety of uses to which these scales can be put. Positions may be marked off on a tuning inductance for different wave-lengths, providing the position for one definite wave-length (prefer-

ably a high one) is known, by using Scales A and B, or the inductance of the whole coil may be calculated by scales in Fig. 1, and then, by applying Scales B and C of Fig. 2, the coil may be marked off in definite values of inductance.

A SOLITARY OUTPOST.

A Visit to a Nantucket Lightship.

THE island of Nantucket forms the easternmost of a group of islands lying off the south-east coast of Massachusetts, and is one of the danger spots of the Atlantic seaboard of the United States of North America. On the north shore is situated Nantucket town, possessing a nearly landlocked harbour and a population of about 3,000 inhabitants. In times past it formed the seat of an important whaling industry, but its claims to fame now rest almost solely on its attractions as a summer resort for the workers of the large cities on the neighbouring main lines. The trend of the coast lends itself admirably to the formation of shoals which constitute a dangerous menace to the mariner. To minimise this danger as far as possible the Commissioners of Navigation of the United States have established a light vessel, of which we are able to reproduce a photograph. We are extremely fortunate in having obtained this as fog surrounds the little ship for the greater part of each year. It possesses an electric lantern containing a light which occults every fifteen seconds, and situated on the foremast. It is a steam lightship, and is anchored in thirty fathoms of water, having been placed there in 1909. The height of the lantern above sea level is 50 feet, and the light is visible for thirteen miles. We are indebted to Mr. W. Condon for the photograph.



Nantucket Lightship.

Doings of Operators

WHILST we were going to press last month the news came through that the British transport *Royal Edward*, bound for the Gallipoli peninsula, had been torpedoed by an enemy submarine with the loss of some hundreds of lives. The *Royal Edward*, a large steamer which prior to the war was well known to travellers to and from Canada, was built in 1908 for the Egyptian Mail Steamship Company, and for a short period traded between Alexandria and Marseilles under the name of the s.s. *Cairo*. The company owning her soon went into liquidation, however, and after a while she was bought by the Canadian Northern Steamship Company and re-christened the *Royal Edward*.

On her last ill-fated trip she had on board two wireless operators, Edward Walter Dyer and John Keir, both of whom were luckily saved. Mr. Dyer, who was born at Stratford, Essex, is twenty-one years old, and served some time as a telephone exchange operator on the Great Eastern Railway. Having a desire to become a wireless operator, he availed himself of the facilities offered by the Marconi Company's evening classes, and after a period of training joined the staff of the Marconi Company in January,



Operator Dyer.

1914. His first appointment was to the s.s. *Corinthian*, and later Mr. Dyer served on board the s.s. *Mount Temple*, *Obuasi*, *Grampian*, *Matina* and *Waipara*. In the middle of this year he was appointed to the s.s. *Royal Edward*.

Mr. Keir, who is twenty years of age, is a native of Blair Atholl, in Perthshire, and has but comparatively recently taken to the profession of wireless operating. After training for wireless telegraphy at an institution in Scotland he joined the Marconi Company's London school in January of this year, and in the following month was appointed to the staff. Prior to joining the *Royal Edward* Mr. Keir served on board the s.s. *Anglo-Mexican*.

Whilst both Mr. Keir and Mr. Dyer were saved, it is to be regretted that neither escaped unscathed. Mr. Dyer is at the time of writing still in hospital at Alexandria,



Operator Keir.



Operator Caldwell.

suffering from severe injuries incurred whilst in the water. Such were the injuries to his legs that one has had to be amputated. We sincerely trust that his recovery may be rapid. Mr. Keir was more fortunate, and has arrived home with no worse hurt than bruised ribs, caused by his being crushed between two collapsible boats which had been washed off the decks. He has at present to avoid much exertion, and is now on leave at his quiet home in Scotland, where we hope he will benefit considerably by the rest.

* * *

Concerning the iniquity of the Germans in sinking the defenceless liner *Arabic* we could write much, but considerations of space forbid us to deal with little save her wireless service and the men who so well performed it. How the great liner bound for New York was torpedoed without warning most of our readers well know, and the story of the magnificent rescue work has already been told.

Two wireless operators were carried on board, Messrs. John Caldwell and James Leonard Batchelor. Caldwell was in charge, and had sailed before on the ship; Batchelor had only just joined. Caldwell, who is a native of Wishaw, is twenty-eight years of age, and prior to taking up wireless had

served in the Post Office as sorting clerk and telegraphist. He has been in the Marconi Company's service for five years and has carried out wireless duties on so many ships that we have no room to catalogue them here. Amongst them we may mention the s.s. *Mantua*, *Grampian*, *Cameronia*, and *Adriatic*. Mr. Batchelor, the junior operator, is twenty-two years old, and makes his home in Kennington. Before he took to wireless as a profession, he held the position of call-boy at the Playhouse Theatre. We have no doubt that when watching the changing scenes upon that stage he had little thought that he himself would come into the spotlight as a star actor on a much larger stage with the world as an audience. It was in his spare time that he studied wireless telegraphy, and after training in the Marconi Company's London school, he joined the operating staff in June, 1914. His first ship was the s.s. *Tunisian*, of the Allan Line, and afterwards he took duty on the s.s. *Lackawanna*, *Indore*, and then the *Arabic*.

On the morning of the disaster both men were in the wireless cabin, having just relieved one another for breakfast, when with a deep dull thud the torpedo exploded and threw up a great mass of water which



Operator Batchelor.

darkened the cabin. In spite of damage to the apparatus, the "SOS" call was sent, and both men, quite cool, made their report to the commander. Receiving their orders to leave the ship, they made their way to the boats and managed to get away in safety. We have before referred to the "long arm of coincidence" in these columns, and here again we find an instance of it. No sooner had Batchelor settled into the boat when he found himself with Mr. Kenneth Douglas, the well-known actor, who has many times appeared at the "Playhouse," the very theatre where Batchelor worked so long.

After drifting about for some time, the boats were found by a steamer which had been sent out from Queenstown to pick them up, and all the survivors were treated with the greatest kindness. At Queenstown, where they arrived before long, further aid was rendered, and both wireless men were able to return home in comfort. They have our congratulations and those of all their colleagues on their fortunate escape.

* * *

About the time that the pirates committed the *Arabic* outrage, a smaller steamer, the s.s. *Baron Erskine*, suffered the same fate. She carried but one operator, Mr. William Clifford Brock, of Manchester. Mr. Brock, who is twenty-six years of age in December next, joined the Marconi school in London at the commencement of the war, and was



Operator Brock.



Operator Robert Jones.

appointed soon after to the s.s. *Adriatic*, on which vessel he made three trips. From the *Adriatic*, he was transferred to the s.s. *Highland Laird*, and thence to the *Baron Erskine*. Mr. Brock sustained no injury whatever in the wreck, and is none the worse for his exciting experiences.

* * *

Amongst the survivors of the *Arabic* was Mr. J. E. Usher, of Nemours Road, Acton, a young wireless operator, who had set out to join his ship on Government Service at San Francisco. Mr. Usher lost everything in the wreck, including his new official uniform, and returned home only with the clothes he was wearing at the time of the disaster.

* * *

On Saturday, September 4th, whilst the United States were still congratulating themselves upon what was described as President Wilson's "victory for diplomacy" in obtaining from Germany a promise not to sink any further liners without warning, the large Allan liner *Hesperian*, outward bound from Liverpool, was torpedoed by a German submarine. As usual, the wireless apparatus was used in calling assistance, and fortunately few lives were lost. The two operators on the *Hesperian* by a strange coincidence were both named Jones and both hailed from Liverpool. Mr. Humphrey



Operator Humphrey Jones

private training institution in Liverpool, and in April, 1913, joined the Marconi Company's London School. After a short finishing course Mr. Jones was appointed to the staff and made his first trip to sea

Jones, the senior operator, is twenty-seven years of age, and after leaving school was employed in clerical work for some time. In 1912 he commenced training for wireless telegraphy at a

on the ss. *Monmouthshire*. He afterwards took duty on the ss. *La Blanca*, *Hydaspes*, *Junin*, and a number of other vessels, and was making his first voyage on the ss. *Hesperian* when that vessel was torpedoed.

Mr. Robert Jones, second operator, is but a year younger than his namesake, and before joining the Marconi Company had served as electrician with the Mersey Docks and Harbour Board. His appointment with the Company dates from June, 1914, and he has already had experience on the ss. *Antillian*, *Michigan*, *City of Madras* and *Cymric*. Previous to the ill-fated trip on which the *Hesperian* was lost he had made two voyages on that ship, and so was well acquainted with the vessel. We are pleased to inform our readers that both men were saved and are none the worse for their experience.

Official Recognition of Wireless Operator's Heroism

On page 297 of our August issue we drew attention to the magnificent bravery of the Captain and officers of the s.s. *Anglo-Californian*, pointing out at the same time how wireless telegraphy was able to summon aid to the bombarded vessel. The Marconi Company have recently received from Messrs. Lawther, Latta and Co., Managers of the Nitrate Producers' Steamship Company, Ltd., the owners of the s.s. *Anglo-Californian*, a letter, from which we extract the following:—

"We have pleasure to advise you that the Lords Commissioners of the Admiralty have had before them a report from the Vice-Admiral, Queenstown, on the subject

"of the attack on the above steamer by a German submarine, and consider the conduct of the officers and crew of the vessel deserving of the highest praise. Further, the Lords Commissioners desire to present a gold watch with a suitable inscription to Mr. J. F. Rea, Chief Marconi Operator, for his devotion to duty in remaining at his post in the wireless telegraphy office during the engagement."

We offer on behalf of our readers our heartiest congratulations to Mr. Rea, whose magnificent conduct will stand out prominently in the records of wireless telegraphy in the present war.



Professor Sparkington Gapp on Munitions

By P. W. HARRIS.

" . . . And you will interview Professor Gapp," said the Editor, "on the subject of Munitions."

"On the subject of what?" I asked, somewhat surprised.

"On the subject of Munitions!" repeated the Editor. "Munitions! pinhead, Munitions! Don't you know what Munitions are? Mu—"

"Oh, yes, I understand!" I exclaimed, anxious to retain my dignity. "But what have munitions to do with wireless?"

"That's for you to find out," replied my chief. "Do you think we pay you thirty-one and sixpence a week to ask idiotic questions?"

I had framed quite a neat reply and

delivered about half of it when I suddenly found myself outside the door. It is useless to argue with people of this type, so I let Jenkins, the office-boy, brush me down—a favour which he much appreciated. Then, finding nothing was torn, I left the building, explained my pedigree and family business to three hundred and forty-nine recruiting sergeants, and finally arrived at Charing Cross. Speaking of Charing Cross reminds me of the Government posters enjoining thrift, which prompted me to say "Season" in the Underground and save threepence. I certainly agree with all this publicity.

Professor Gapp lives in a large mansion at Kensington, a little place near London. The mansion stands by itself and is insulated from the road by a spacious garden, in which many world-famous experiments have been carried out. (See *WIRELESS WORLD*, July, 1915.) As I walked up the drive towards the front door I could not avoid meditating on the immense value to the nation of such a great scientist as Sparkington Gapp.

"Pleased to see you again, young man; pleased to see you," said the great man, as I was ushered into his private room. "I presume you have come on behalf of your excellent magazine? You wish for an interview perhaps?"

Delighted with the famous expert's urbanity, I thanked him and said that his surmise was correct. I explained that the readers of *THE WIRELESS WORLD*, brimming with patriotism and anxious to learn of every new method of defeating the Hunnish foe, were impatiently waiting to hear of the new discoveries which it was rumoured had been made in his laboratory. Would he favour me with a few words on the subject of Munitions?

"With great pleasure," replied the Professor. "My whole time is now devoted to their study and manufacture. I have even roofed in a part of my garden to form



"Those are my ohming pigeons."



"An interruption was caused."

workshops. Will you come through with me?"

With beating heart I accompanied my venerable companion through several luxurious apartments into what had once been the famous wireless garden. Alas! Its erstwhile beauty had vanished and there remained but a small plot of ground surrounded by glazed buildings, from which issued the subdued humming of many machines. In the midst of the plot there rose a tall pole surmounted by what appeared to be a dove-cote. Grey birds winged great circles about the pole and occasionally settled on the ground. I asked the Professor what purpose they served.

"Those are my Ohming pigeons," graciously replied my guide. "I find them very useful as general scavengers for picking up strays, wireworms, atmospherics, and other insects. They are very tame, as you will observe, and subsist on odd bits of carbon and other *pièces de résistance*. I lost one the other day," continued the Professor, with a tear in his eye, "It was trying to pick flies out of a spark-gap and came to an abrupt conclusion."

Touched by this display of human feeling in one so far above it, I changed the conversation by asking whether the birds were British or foreign.

"Well, as a matter of fact, they are Chinese," replied Professor Gapp; "but they are breeding here and rapidly learning Pigeon English."

We had by this time reached the door of the largest building, and the Professor, stepping forward, motioned me to enter, which I did with some trepidation.

"What is taking place here?" I asked.

"These men are all making parts of my new weapon, the 'Wireless Paralyser.' I may mention without divulging too much of Lord Kitchener's future plans, that the Wireless Paralyser is destined to change the whole aspect of trench warfare. It consists," continued my guide, taking in his hand what appeared to be the body of a gigantic aluminium grasshopper, "of a metallic casing with six legs, each of which is worked by a ratchet mechanism. The interior of the case contains the wireless control, a poison-gas generator, and a composite gramophone record. The method of operation is as follows: first the Paralyser is fired from the British lines by a special mortar, and a moment after alights on the parapet of the enemy trench. The gramophone mechanism then automatically comes into operation and shouts with a pronounced Scotch accent, 'Here we are! Here we are! Here we are again!!' By

means of a delicate relay at the words 'are' and at the final word 'again' the whole machine jumps forward six feet, exuding poison gas meanwhile. Thus: 'Here we are!'—six-foot jump; 'Here we are!'—another six-foot jump, 'Here we are again!'—final six-foot jump. A touch on the wireless key in the British trenches changes the tune to Tipperary, whereupon the jumps take place at the words 'Tipperary,' 'Go,' 'Tipperary,' 'Know,' 'Piccadilly,' etc. The object of the poison gas is to prevent the Germans approaching the instrument; but no German is sufficiently brave to come anywhere near it, and hundreds have been found completely paralysed with fright. It is this latter fact which has suggested the name of the invention."

I had barely commenced the expression of my profound admiration of this marvellous engine of warfare when an interruption was caused by a Paralyser getting loose and chasing a workman. A shiver of horror went through my frame as the poor mechanic, white with terror, ran hither and thither endeavouring to avoid the gigantic pounces and monotonous chanting of the glistening mechanical insect. However, after five crowded minutes the Paralyser came into violent contact with a steam-hammer and burst with a blood-curdling shriek. As we crawled from beneath a table the Professor remarked that it was a warm day. I agreed.

We next proceeded to a smaller building, cool and quiet, where a number of men were stirring some dark substances in a large vat. Other workmen were packing the mixture into shell-cases.

"This is the room devoted to the manufacture of my new high explosive 'wirelessite,'" said the great scientist. "It is an explosive of exceptional power. As soon as the shell bursts, all Germans within half a mile are set in a state of violent oscillation. Their arms wave about, their collars rush up and down their necks, and the contents of their pockets shoot out in all directions. Statistics compiled from results so far obtained show that most deaths are caused by the men's boots knocking their heads off."

"How and where do you test this explosive?" I queried in tones of admiration.

"At present we are testing it in this garden on Germans we buy from the nearest

internment camp," was the reply. "We pay sixpence a dozen for ordinary Germans and eightpence for large ones. It is rather a high figure, but we don't use many large ones as they make such a mess."

I commiserated with the Professor and remarked on the red tape which surrounded all official dealings. In Germany they would—at least, not exactly—well, anyway, they would be cheaper.

"I have a number of other inventions in course of manufacture," the scientist continued; "but time will scarcely permit me to deal with them now. I must, however, mention the 'Radio-Irritator.' It has been said that this is a war of artillery, but I maintain that it is a war of nerves, and the side which gets 'jumpy' first is sure to lose. The British so far have refused to get into this condition, but the Germans since Karlsruhe have grown daily more and more so. To hasten the end I have invented the Irritator, which, fired from long-range guns, attaches itself by attraction to enemy wireless aerials and causes the operators to hear nothing but fiendish laughter in the telephones. The details of the invention I must at present keep secret, but I can say that one of the biggest German wireless stations has been shut down because the operators daren't put the 'phones on without disconnecting the aerial. Half of them have been removed to the Potsdam Asylum already.

"Wonderful, wonderful!" I exclaimed, looking at my watch. "A thousand thanks for explaining all these things to me. Our readers will be intensely interested."

"It is nothing," modestly replied the Professor; "I am only too pleased to be of some service to them. But before you go, won't you have a glass of my wireless Whisky?"

"Wireless Whisky!" I exclaimed. "What is that?"

"Oh, it differs from the ordinary kind in sending you into continuous waves," courteously explained the great genius, reaching for a syphon. "Do you like it damped or undamped?"

"Damped, please," I answered. "Thank you, that's enough! Good luck to wireless research!"

"Cheer Oh!" answered Professor Gapp, draining his glass.

QUESTIONS AND ANSWERS

Readers are invited to send questions on technical and general problems that arise in the course of their work or in their study to the Editor, THE WIRELESS WORLD, Marconi House, Strand, London, W.C. Such questions must be accompanied by the name and address of the writer, otherwise they will remain unanswered: and it must be clearly understood that owing to the Defence of the Realm Act we are totally unable to answer any questions on the construction of apparatus during the present emergency.

J. E. (Bergen).—As you are not a British subject, you would stand very little chance of obtaining an appointment such as you mention during the war. What your prospects may be after the war we cannot say; but if you will communicate with us when peace is restored, stating in full the qualifications you possess, we will give you all the advice that we can.

J. K. H. (Plymouth) and a number of other correspondents address queries which the present restrictions will not permit us to deal with.

W. L. C. (Wandsworth Common).—The alternating current district would be much preferable, as there one could use a transformer connected to the mains. We cannot say what restrictions will be in force after the war. In answer to your second question, you do not give us enough details of your accumulator to enable us to give you much help. It would seem that the capacity has been reduced. Are any of the plates covered with sulphate? Is the acid of the right specific gravity? We would suggest that you take the accumulator round to the people who made the repairs and explain your trouble to them.

J. F. I. (Wortley).—We cannot publish details of the nature you desire whilst the present restrictions are in force.

R. H. B. (Whetstone).—Automatic recording apparatus is not used on board ship, as there is at present no great need for it. There is no advantage in first recording signals of ordinary speed and then transcribing them on a form, for it is much quicker to write them down immediately on the form for delivery. On land stations which have to handle a large amount of traffic, such as the large Marconi trans-ocean stations, the position is different, and both transmission and reception are sometimes automatic and at a much higher speed than is possible with hand working. In cases where high speed transmission is used, considerable time is saved by automatic working, as several operators at the same time can be writing up the recorded signals or punching strip for the automatic transmitter, whilst one man supervises the instruments. Thus five men can be punching strip at 20 words per minute and the transmitter operated at a hundred words per minute, and in the same way the receiver may be taking signals at this speed and five men be transcribing at twenty words a minute. The trouble with most recording devices is that they make no distinction between atmospheric noises and the signals it is desired to receive. The Marconi Company has for a long time used phonographs with records running at high speed for reception, and these can be run at a much lower speed for transcription. The experienced transcribing operators can easily distinguish between the pure musical sounds of the signals and the rough sounds of atmospheric. There is a big opening for a recorder of the same order of sensitivity as the telephone receiver and which will record signals but not atmospheric.

W. G. (Klondike, Canada).—We are very glad to hear from friends in such distant and sparsely populated parts of the world. The difficulties of erecting and working wireless in such districts as that in which you live we fully

appreciate. Unfortunately we cannot deal at the present time with the question you ask, as the publication of matter of a constructional nature is not considered advisable. In field stations for military use counterpoises are sometimes made with strips of wire netting covering the ground underneath the aerial. The pieces of netting have, of course, to be well connected electrically, and there is no need for buried plates.

A. H. (Margate) writes to us concerning the use of a parallel condenser in the receiving antenna, and the inefficiency of this arrangement for obtaining long waves compared with the use of inductance only. It is a common practice to make use of a variable condenser in parallel with a part or all of the aerial inductance of an inductively coupled receiver for the purpose of increasing the wavelength to which the aerial is tuned. The method is convenient and obviates the necessity for a large amount of inductance, but, as our correspondent points out, the efficiency is reduced. Dr. Louis W. Austin, in a paper presented before the Institute of Radio Engineers at New York in March of last year, gave tables which showed that with an aerial capacity of 0.0007 microids and a wavelength of 2,000 metres, the substitution of parallel capacity for part of the inductance, in such a way as to keep the wave length the same, gave a regular diminution in efficiency as the value of the shunted capacity increased. As an example, taking the extreme figures of the table, with no capacity in parallel with an aerial inductance of 1,330 mhya., a deflection of 230 units on the galvanometer was given, whereas with a capacity of .002 mf. in shunt with 480 mhya. there was a deflection of only 105 units. Another table of reading with a wave-length of 3,000 metres and a much larger antenna (0.002 mf. capacity) showed the same decrease of efficiency with a parallel capacity, but more capacity could be used in this case without materially decreasing the intensity of received signals. A number of other sets of observations were carried out, and in all cases the results were substantially the same.

C. A. B. (Funchal, Madeira).—We cannot reply to your first question, as the arrangements in all coast stations during war time are secret. In answer to the second question, you would certainly improve matters by taking the step you mention. Question 3, D.C.C. wire is better than enamelled, as although this latter allows many turns to be wound in a small space, it is not used where high efficiency is desired, as there is too much capacity between the turns.

"AMATEUR" (Dundee) writes: (1) "Does the guard lamp in the D.C. side glow brighter if the brushes on the commutator are lifted? (Marconi 1½ kw. set). In Marchant's book of instruction he states, under the heading 'faults': 'If the break (most probably due to the lifting of brushes on commutator) is in the armature circuit, it will be indicated by the guard lamp on the D.C. side of the converter glowing brightly, because the full voltage of the direct current supply is now across the terminals.'" (2) "Does sparking take place, when transmitting, at the micrometer spark gap, as well as at the earth arrester spark gap?"

Answer.—In reply to the first question, the statement is correct that the guard lamp glows brighter if the D.C. brushes are lifted, but it is not wise, particularly in examinations, when the candidate is usually hurried, to attempt to judge by any increased glow whether the brushes are lifted or not. In any case, the increase in brightness is not very pronounced, and it is very easy to examine the brush connections. Question 2 gives us an opportunity of explaining a point which has given trouble to both students and professional operators. Our correspondent asks whether sparking takes place at both the arrester and micromotor gap. The reply to this is that everything depends on the adjustment of these gaps. If our readers will refer to the diagram reproduced here, they will see that the micrometer gap is in *parallel* with the earth arrester gap. This being so, if the two gaps are approximately of the same size, sparking will take place across both, although the inductance of the leads to the tuner will choke some of the current. If the micrometer gap is opened wide, no sparking will take place there, which is not a result to be aimed at, for in that case a great strain is put upon the condensers and windings. The micrometer gap should in all cases be set to have as small

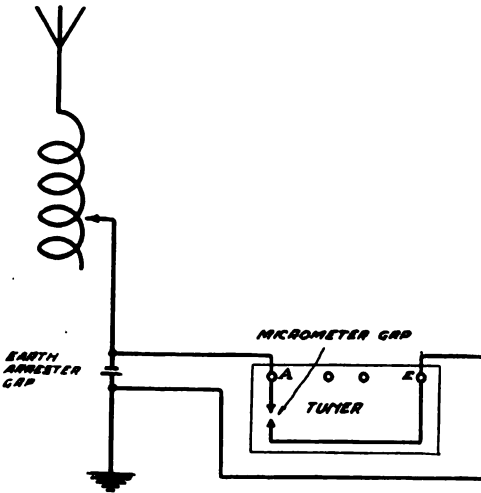

a gap as possible without risk of the points touching. In some installations there will be no sparking even with this minute gap, for the leads will act as a protecting choke, but in most cases there will be a little.

C. L. (Karachi) writes: "(1) Is it as necessary to have low-frequency resonance with an asynchronous as well as with a synchronous rotary gap? If so, in the case of an alternator 200 and an asynchronous rotary gap of 1,000-spark frequency, should 'n' read 200 or 500? (2) In a telephone transformer is it as necessary to have the resistance of the secondary winding equal to the 'phones, as the primary winding equal to the resistance of a detector? My point is this: Phones 120 ohms. If secondary is wound with 500 turns with, say, 22 S.W.G. to a resistance of 120 ohms, and if it is then rewound with 500 turns 13 S.W.G., the ampere turns will be more under the same conditions of magnetic coupling, owing to less total resistance, and it would seem that signals would be stronger! It is understood that 120 ohms of this latter wire might give a stronger magnetic coupling, but the question is: from an efficiency point of view, does the number of turns of a secondary winding (step-down) influence *best effects* as well as the balanced resonances? The point is in reference to one of the Marconi large telephone transformers in a 30 kw. station."

Answers.—In reply to question (1), low frequency

resonance is not so important with an asynchronous as with a synchronous rotary gap, but it is of some value. "N" in the case quoted would be 200. Question 2.—To obtain best results, the telephone transformer and the telephones must be designed to suit both each other and the circuit with which they are to be used. In this connection the inductances are of more importance than the resistances, and the problem is complicated by the fact that it is usual to connect condensers for the purpose of obtaining resonance in the circuits. These also have to be taken into account. The signals obtained by using a higher resistance secondary of the same number of turns would be weaker than with the normal winding, since there would be greater internal loss. If a larger number of turns of wire of lower resistance were used the ratio of transformation would be reduced, but whether this would give better results depends upon the efficiency of the instruments and the relative inductances, etc. The problem could be worked out mathematically if sufficient data were available on these points. Perhaps some of our readers have done work on these lines. We shall be very pleased to open our columns to correspondence on the subject.

G. A. J. (Bushire).—When a transformer is used to charge a circuit which gives one spark per half-cycle of the alternator, the voltage to which the condenser is charged may rise to $\frac{\pi}{2}$ times the value of the maximum voltage given by the transformer when working on a non-inductive load. The maximum volts = $\sqrt{2}$ R.M.S. volts. The above voltage is realised when the spark occurs at the peak of the voltage wave, and the complete low-frequency circuit is tuned to the alternator frequency.

In answer to your second question, choke coils for protecting the transformer need not be calculated. They must have a sufficient number of turns to choke high-frequency currents, and must not in themselves resonate to the frequency of the oscillating circuit. They are usually made by trial and experiment. In the case of the design of low-frequency iron core inductances, we must consider the whole question of low-frequency resonance. The formula for resonance of a single circuit is

$$4\pi^2 n^2 LC=1,$$

where "n" = frequency per second and L and C henrys and farads. The alternator and transformer primary and the condenser and transformer secondary form two circuits interlinked by the mutual inductance of the transformer. In this case the circuit may be treated as a single one by referring to either side of the transformer an equivalent to the resistance inductance and capacity of the complete circuit of the other side of the transformer. If we refer these quantities to the high voltage side of the transformer we must add to the actual resistance, inductance and capacity in the circuit quantities T^2R and T^2L , where R and L are actual resistance and inductance of the low voltage side and T the ratio of transformation of the transformer.

Conversely, we add $\frac{1}{T^2} R'$ and $\frac{1}{T^2} L'$ and T^2C' to the low voltage side if we refer the quantities to this. Thus for a transformer for a value 100/1000 volts, if the primary circuit has a resistance of .01 ohm we must add $.01 \times \left(\frac{1000}{100}\right)^2 = 1$ ohm to the high voltage side, and for inductance of, say, .004 henry we add $.004 \times 100 = .4$ henry to the resistance and inductance of the high voltage side. These values are inserted in the formula.

It will now be seen that the L.F.I.C.I. has to be wound to have an inductance to suit the circuit, and should be made variable to allow of the necessary changes. The best spark is obtained when the low-frequency circuit is slightly off resonance.

* Not $\frac{1}{T^2} C$.

Instructional Article

The following series, of which the article below forms the second part, is designed to provide wireless telegraphists, amateurs, and technical students generally, with clear and precise instruction in technical mathematics, in order that they may be enabled to read and understand the more advanced technical articles which appear from time to time.

5. Division by Logarithms.

TAKING a very simple example, we will divide 1728 by 16, in which case 1728 is called the dividend and 16 the divisor. We can express this operation in the form of a fraction $\frac{1728}{16}$.

Now we know that if we have any fraction $\frac{a}{b}$ we can write it as $a \times \frac{1}{b} = a \times (b^{-1}) = ab^{-1}$.

Similarly $\frac{1728}{16} = 1728 \times (16)^{-1}$.

From log tables we find that

$$\begin{aligned} \log 1728 &= 3.2375 \\ \text{and } \log 16 &= 1.2041 \end{aligned}$$

Therefore

$$\frac{1728}{16} = \frac{10^{3.2375}}{10^{1.2041}} = 10^{3.2375} \times 10^{-1(1.2041)}$$

We have now turned our division into a multiplication, with the important difference that we have *changed the sign of the log of the divisor*. As in the case of any other multiplication, the next operation is to add the logarithms. But changing the sign of one quantity and then adding it to another quantity is the same as subtracting the former from the latter quantity, and so we arrive at the rule for dividing with logarithms:

Subtract the log of the divisor from the log of the dividend, and take the antilog of the remainder.

$$\begin{aligned} \text{In this case } \log 1728 &= 3 + .2375 \\ \log 16 &= 1 + .2041 \end{aligned}$$

$$\text{Subtracting} = 2 + .0334 = 2.0334$$

$$\text{Antilog } 2.0334 = 108.0. \quad \text{Ans.}$$

EXAMPLE.

Divide 0.0297 by 67.84

$$\begin{aligned} \text{From tables } \log 0.0297 &= \bar{2} + .4728 \\ \text{and } \log 67.84 &= 1 + .8315 \end{aligned}$$

In order to be able to subtract the mantissæ, add 1 to the mantissa of log 0.0297, at the same time adding 1 to its characteristic in order to leave the whole logarithm the same as before.

$$\text{Then } \log 0.0297 = \bar{3} + 1.4728$$

$$\log 67.84 = 1 + 0.8315$$

$$\text{Subtracting} = \bar{4} + 0.6413 = \bar{4}.6413$$

$$\text{Antilog } \bar{4}.6413 = 0.0004378. \quad \text{Ans.}$$

6. Powers and Roots by Logarithms.

Logarithms are very useful when dealing with the powers and roots of quantities. Suppose, for example, we wanted to find the value of $(79)^7$, the seventh power of 79.

We can, of course, multiply seven 79's together, but such an operation is obviously long and tedious. If we use logarithms, then, instead of $79 \times 79 \times 79 \times 79 \times 79 \times 79 \times 79$,

$$\begin{aligned} \text{we have } \log 79 + \log 79 + \log 79 + \log 79 \\ + \log 79 + \log 79 + \log 79 = 7 \times \log 79, \end{aligned}$$

the antilog of which product will give us our answer.

$$\begin{aligned} \log 79 &= 1.8976 \\ 7 \times \log 79 &= 7 \times 1.8976 \\ &= 13.2832 \end{aligned}$$

Antilog 13.2832 = 19,200,000,000,000, a result correct to the first four figures. This would generally be written as 1920×10^{10} .

This can be done in any case where we wish to find the power of a number, and so we arrive at the rule—to find the power of any number, multiply the log of the number by the index of the power required, and take the antilog of the product.

This method is applicable to working out roots, for the seventh root of 79, for example, written as $\sqrt[7]{79}$, is the same as the "one-seventh power" of 79, or $(79)^{\frac{1}{7}}$.

Treating it in this way, as before we multiply log 79 by $\frac{1}{7}$ —i.e., divide it by 7, and take the antilog of the quotient.

In this particular case log 79 = 1.8976
 Dividing by 7 = 0.2711 (approx.)
 Antilog 0.2711 = 1.866

Thus, to find the root of any number, divide the log of the number by the index of the root required, and take the antilog of the quotient.

EXAMPLE.

To evaluate $\sqrt[9]{0.06723}$
 Log 0.06723 = 2.8276 = 2 + 0.8276.
 Before dividing this logarithm by 9, we add 7 to the characteristic, and add 7 to the mantissa.
 Then log 0.06723 = $\bar{9} + 7.8276$. This operation has not changed the net value of

$= \left(\frac{213}{1885}\right)^2 \frac{1}{0.00057}$
 Log 213 = 2.3284
 Log 1885 = 3.2754
 Subtracting = $\bar{1}.0530 = \log \left(\frac{213}{1885}\right)$
 Multiplying by 2 = $\bar{2}.1060 = \log \left(\frac{213}{1885}\right)^2$
 $= 3 + 1.1060$
 Log 0.00057 = $\bar{4} + 0.7559$
 Subtracting = $\bar{1} + 0.3501 = 1.3503$
 Antilog 1.3503 = 22.41
 Ans. = 22.41 mhs.

8. Principle of the Slide-rule.

The slide-rule is an instrument which carries out mechanically the operations of

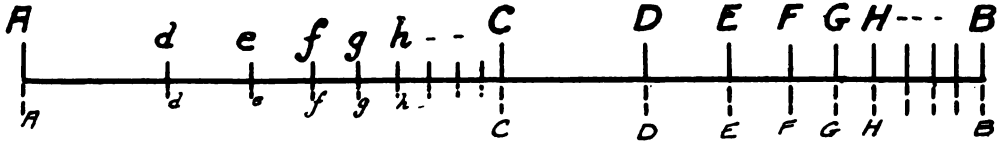

Fig. 1.

the logarithm, but the characteristic is now exactly divisible by 9.

Dividing by 9, we get $\bar{1} + 0.8697$
 $= \bar{1}.8697$

Antilog $\bar{1}.8697 = 0.7408$. Ans.

7. It will sometimes occur that we have to find both the power and the root of a number at the same time; as, for instance, in evaluating such an expression as $\sqrt[6]{9^6}$.

Now, $\sqrt[6]{9^6} = (9^6)^{\frac{1}{6}} = 9^{6 \times \frac{1}{6}} = 9^1$, and so all we do is to find the "six-fifths power" of 9.

Log 9 = 0.9542

$\frac{6}{5} \times 0.9542 = \frac{5.7252}{5} = 1.1450$ (approx.).

Antilog 1.1450 = 13.96. Ans.

EXAMPLE.

Given that an aerial has a capacity of 0.00057 mfd. and oscillates with a wave-length of 213 metres: find its inductance.

From previous instructional articles we know that $\lambda = 1885 \sqrt{LC}$ where

λ = wave-length in metres = 213

C = capacity in mfd. = 0.00057

and L = inductance in mhs.

By squaring $\lambda^2 = (1885)^2 (LC)$

$$L = \frac{\lambda^2}{(1885)^2} \frac{1}{C} = \left(\frac{\lambda}{1885}\right)^2 \frac{1}{C}$$

adding and subtracting logarithms required for multiplication and division respectively.

Let us take a straight line AB, say, 4 inches long (Fig. 1), and agree that its length shall represent the log. of 100—i.e., 2. Thus our scale is

4 inches = 2 logarithm units,

or 2 inches = 1 unit log.

Along AB mark off AC = 2 inches.

= 1 unit log.

= log 10.

Similarly mark the points D, E, F, G, etc., so that AD = 2.6020 inches.

= 1.3010 log units.

= log 20.

AE = log 30.

AF = log 40.

AG = log 50, and so on.

The point A, being at zero distance along AB, represents log 1, which is zero.

In a similar manner we can plot the points d, e, f, g, etc., so that

Ad = log 2,

Ae = log 3,

Af = log 4, and so on.

If also we prepare a similar scale (shown dotted in Fig. 1), so arranged that we can slide it alongside the first scale, we shall be enabled to perform additions and sub-

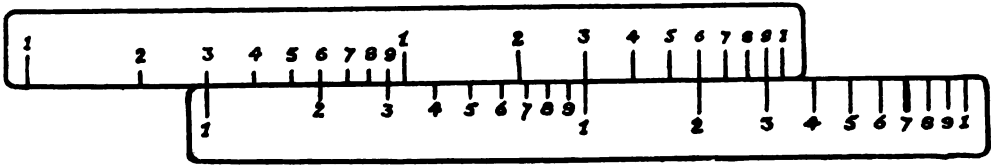

Fig. 2.

tractions of lengths of scale corresponding to any logarithms we wish.

9. In Fig. 2 the scales are shown marked, as in an actual slide-rule, with the numbers the values of whose logarithms have determined the calibration of the scales. The scales have also been displaced so that the 1 of the lower scale comes opposite the 3 of the upper scale.

It will be seen that the distance 1-3 on the top scale added to the distance 1-2 on the bottom scale equals the distance 1-6 on the top scale. This is only to be expected, as 1-3 represents $\log 3$, 1-2 represents $\log 2$ to the same scale, and $\log 3 + \log 2 = \log 6$ (represented by the distance 1-6) because $3 \times 2 = 6$.

With a fully calibrated slide-rule we should read off on the top scale :

- 9 opposite 3 on the bottom scale,
- 12 " 4 " "
- 15 " 5 " "

and so on.

Again, if from the distance 1-6 on the top scale we subtract the distance 1-2 on the bottom scale, we have remaining a distance 1-3 on the top scale. In this case we have $\log 6 - \log 2 = \log 3$ (for $6 \div 2 = 3$).

Thus, to multiply two quantities together, slide the lower scale along until its left-hand end (or right-hand end if more convenient) is opposite the value, on the fixed scale, of one of the quantities ; then, looking along the sliding scale for the value of the second

quantity, read off the result on the fixed scale at this point.

To divide, find the value of the dividend on the fixed scale ; move the slider along until the value of the divisor on the sliding scale coincides with the value of the dividend on the fixed scale ; read off the result on the fixed scale opposite one end of the sliding scale.

10. Fig. 3 shows a simple form of slide-rule as used in practice. The "cursor" is a clip which slides along the rule, and carries a glass window on which is engraved a fine line at right angles to the separating line of the scales. This is used for marking any special value on the rule while the slider is being moved for the purpose of a multiplication or a division.

The lower pair of scales (C and D) consist of the left-hand half of the A and B scales plotted to twice the size. These scales will give rather more accurate results than scales A and B on account of their greater size, and consequently more numerous and more open divisions.

The C and D scales are also very useful for obtaining squares and square roots.

If we put the cursor in any position along the rule, the reading on scale A is the square of that on scale D, and conversely the reading on scale D is the square root of the reading on scale A. The reason for this is easily seen. If we take any distance, say, 1-9, equal to $\log 9$, along scale A and mark

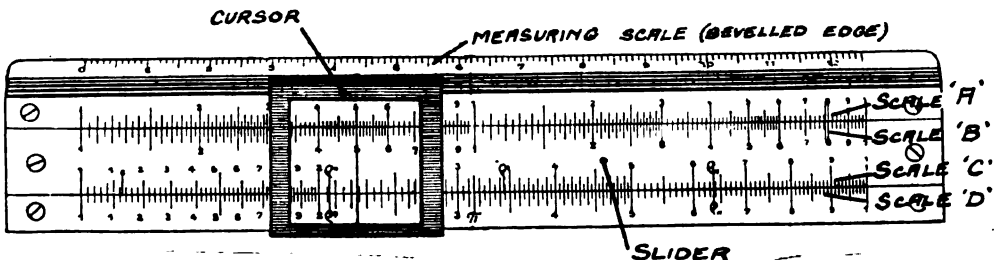

Fig. 3.

off the same distance along scale *D* (from the left-hand end), we get a distance which, on that scale, is only equal to $\frac{1}{2} \log 9$ —i.e., a distance equal to $\log \sqrt{9}$ or $\log 3$.

When taking square roots we must bear in mind the fact that one distance 1-9 on scale *A* equals $\log 9$, and the other distance 1-9 equals $\log 90$, both being measured from the extreme left-hand end. Thus, to find the square root of 9 or 9,00 or 9,00,00 or 0.09, etc., we must put the cursor over the 9 nearer the left-hand end; and for the square root of 90 or 90,00 or 0.90, etc., we must put it over the 9 nearer the right-hand end. Similarly, of course, with any other number. This is because, when taking square roots, the actual figures in the result are unaltered if the original number is multiplied or divided by any *even* power of ten (e.g., by $10^2=100$, or by $10^6=1,000,000$), but the value is quite different if the original number be multiplied by an *odd* power of ten (e.g., by $10^1=10$, or by $10^3=100,000$). Thus

$$\begin{aligned} \sqrt{900} &= 30 \text{ } \left. \begin{array}{l} = 30 \text{ } \left. \begin{array}{l} \text{same} \\ \text{figures,} \end{array} \right\} \\ \text{and } \sqrt{900 \div 10^2} = \sqrt{9} = 3 \end{array} \right\} \\ \text{but } \sqrt{900 \div 10^3} = \sqrt{0.9} = 0.95 \text{ (nearly),} & \\ \text{a quite different value.} & \end{aligned}$$

It is therefore advisable, as in all slide-rule

operations, to work out the result very approximately by ordinary methods as a check on the values obtained from the rule.

Full instructions for the use of a slide-rule will be found in the book of instructions supplied with the instrument.

11. Napierian Logarithms.

This system of logarithms is used in all theoretical and in some practical work, and has for its base the value :

$$1 + \frac{1}{1} + \frac{1}{1 \times 2} + \frac{1}{1 \times 2 \times 3} + \frac{1}{1 \times 2 \times 3 \times 4} + \dots = 2.7183 \dots \text{ (approx.)}$$

This value is sometimes written as *e*, and so we write, for "the Napierian logarithm of 7"— $\log_e 7$.

It is obvious that the Napierian log of any number is greater than its common log, because the smaller base *e* (2.7183) will have to be multiplied up a greater number of times (that is, to a greater power) than will the larger base 10, in order to be equal to the given number.

For the present it is sufficient to know that ordinary logs multiplied by 2.3026 give Napierian logs, and Napierian logs multiplied by 0.4343 give common logs.

AN AMATEUR AND SAYVILLE

Thrilling Story in next month's "Wireless World"

As many of our readers know, it was an amateur wireless experimenter who recorded the signals of the German Wireless Station at Sayville, and proved that the station was being used to transmit unneutral messages to Germany. Mr. C. E. Apgar, the amateur in question, has written a full account of how he trapped the Germans, and this, together with photographs, will be reproduced in the November issue of our magazine.

The LIBRARY TABLE



“MODERN INVENTIONS.” Romance and Reality Series. By V. E. Johnson, M.A. London: T. C. & E. C. Jack. 1915. 3s. 6d.

In his introduction the author strikes a new note by suggesting that had it not been for the research, invention, and discovery of our ancestors we should not now be in possession of many of the things which we accept as commonplace. This is a fresh idea, and the attention of the reader is merited from the new standpoint. The writer takes us successively into the realms of cinematography; he initiates us into the mysteries of the submarine, airship, aeroplane and hydroplane, flying boats, motors, high speed railways, television, electro-culture, radiography, radium, and devotes a whole chapter each to the subjects of wireless telegraphy and wireless telephony. He discourses on various systems of wireless telegraphy, classifying them under the three heads of conduction, induction, and radiation. As the last-named is all-paramount and appears likely to continue so, it is that with which he deals. All our readers will, of course, recognise that it is to this category that the Marconi system belongs. Mr. Johnson gives a brief history of the events which led up to the discovery of wireless, and gives an account and some illustrations of an amateur wireless station. He touches on “directiveness,” that is, being able to send by the ether waves in the direction in

which it is desired to telegraph. He explains the particular apparatus used for this purpose. The author discourses on what might be termed the extravagances of wireless, such as the control of boats, either from another boat or from the shore, the ignition of explosives from a distance, the control of railway trains, and so on. He also deals very fully with the application of wireless telegraphy to aircraft and emphasises the special difficulties in connection with the reception of messages in the case of aeroplanes. These are noise and vibration, and he gives suggestions for the amelioration of the troubles. The chapter on wireless telephony is short but interesting. He explains what is meant by damped and undamped waves, speaks of the apparatus for sending and receiving, and gives a dissertation on the advantages to be gained from the use of wireless telephony. Altogether, the book has been thoughtfully written, and we commend it to the attention of those of our readers who desire more than a passing acquaintance with modern inventions.

* * *

“AEROPLANES AND DIRIGIBLES OF WAR.”

By Frederick A. Talbot. London: William Heinemann. 1915. 3s. 6d. net.

The rapid strides made by aviation during the last ten years has engaged the attention even of the most *blasé*. The science—for

such it is—of aeronautics has made rapid strides, especially in things military. The author is concerned solely with aircraft from this point of view, and traces the history from the first attempts by the use of the captive balloon to the present day, when the skies of the battlefield are speckled with the aircraft of the opposing armies. One of the first instances of the use of aircraft in war time was during the Franco-Prussian War of 1870-1, when certain persons escaped by balloon from Paris whilst that city was being besieged. The author devotes a chapter to the rise of Germany to military airship supremacy, and traces the evolution of the Zeppelin airship. He deals with scouting from the air, bomb-dropping, and the uses of armoured aeroplanes, and contributes a chapter on the management of anti-aircraft guns. Of course, the importance of the application of wireless telegraphy to aircraft has not been overlooked, although he remarks that it is utilised only to a very limited extent. This is due to two causes, one of a technical, and the other of a strategical character. In the first place there is the weight of the necessary installation, and in the second place there is the noise of the motor, which is apt to render difficult the reception of wireless signals, although various means of overcoming this difficulty have been suggested. This argument, of course, does not hold to such an extent in connection with dirigibles. Altogether, the book is very well written, and should certainly find a place on the bookshelves of those who are interested in the application of wireless telegraphy to aircraft.

* * *

“A B C OF ELECTRICITY.” By William H. Meadowcroft. New York and London : Harper & Brothers. 2s. net.

This little book, which is of American origin, claims to fill the need for a text-book “which shall explain, in simple language, to young people of, say, from fourteen years and upward, a general outline of the science of electricity, as well as the groundwork of those electrical inventions which are to-day of such vast commercial importance.” The reader is confronted, on opening the book, with a statement by Thos. A. Edison that he has read the MS. and found the statements

therein correct. With a “guarantee” of this nature the reader might feel perfectly safe in accepting the statements made, but it should be pointed out that the methods referred to are largely American, and should not be taken to apply in all cases to England. For instance, on page 30 we find the following: “We show below the alphabet in these dots, dashes and spaces, and these are the ones now used in sending *all* telegraphic messages” (the italics are ours). The code reproduced is the American Morse, and no mention is made of the Continental code, which is used exclusively in European countries, and in fact practically everywhere but the United States. Further, the code is badly reproduced, and very little difference is shown in the length of dots and dashes: for example, the letter “F,” consisting of a dot, a dash and a dot, might easily be taken for three dots. In the chapter on wireless telegraphy the author has seen fit to make no mention of Senatore Marconi’s name, which is perhaps a little unkind, seeing what the world owes to that inventor; and the information given is not very helpful. After speaking of induction coils with large brass balls, coherers, and Morse registers, the writer says: “In many of the systems the electric pulsations are generated by a dynamo-machine instead of batteries.” This statement is likely to convey the impression that some systems utilise batteries exclusively and others dynamos; in actual practice both are used in most systems. However, these are not very vital points, and altogether the volume can be said to serve its purpose very well.

* * *

“OUR COUNTRY’S INDUSTRIAL HISTORY.” By William J. Claxton. London : George G. Harrap & Co. 1915. 1s. 6d.

To explain the scope of this book we cannot do better than quote a few words from its preface. The author says:—

“In this book I have endeavoured to give “a simple and logical outline of the industrial history of this country, from the days “before the Roman occupation up to the “present day, which has seen the development of such inventions as wireless telegraphy and the aeroplane.”

The book should prove of interest to the

class of reader for whom it is intended, and altogether the writer appears to have spent a good deal of time in getting together the information, particularly the matter from which the blocks were made. A short account of the invention of Senatore Marconi is given, and illustrations of the Glace Bay stations and the wireless apparatus on board the ill-fated *Lusitania* are reproduced. Wireless telegraphy indeed holds first position in the recent inventions of the world, and the author has not failed to realise that it has contributed its quota to our country's industrial history.

* * *

"THE ENGINEER AFLOAT: HIS TRAINING, WORK AND PAY." By Frank Butterworth, A.M.I.Mech.E. London: The Technical Publishing Company, Ltd. 1s. 6d.

The sea-going engineer, whether he be serving amongst the glittering machinery of a first-class liner or in the grimy engine-room of an ocean tramp, lives a life which has a distinct charm and many advantages compared with that of his shore confrère. Prospects of promotion are good, the interests of travel are not to be despised, and, even should he not wish to remain at sea all his life, the marine engineer can have no better training for a position as engineer-in-charge ashore than a few years with steam on the ocean.

For young men who wish seriously to consider the question of taking up this profession the little book under review will furnish as complete and valuable information as could possibly be required. The author, who, by the way, holds an "extra chief's ticket," and therefore is no amateur, possesses the ability—all too rare—of expressing what he knows both clearly and in an interesting manner. Full particulars are given concerning the requirements of the B. O. T. Examinations, and each stage of the engineer's career from workshop to engineer superintendent is considered from every standpoint.

Apart from the technical information given, there is to be found much sound common sense in relation to the outfit, duties of junior engineers, management of firemen, and general care of the engine-room. Many junior engineers who have been through the

"shops" and are just commencing their sea life might well purchase this little book, and would obtain much help therefrom.

* * *

"THE PANAMA CANAL." By Bakenhus, Knapp and Johnson, with maps and illustrations. London: Chapman & Hall, Ltd. 1915. 10s. 6d. net.

We are not generally inclined to appreciate those authors who make apologies for their work. The apology offered for the book under review is that, although a great deal has been published on the Panama Canal, "it is this very wealth of literature which makes another book desirable." The book is well written, and much care and attention appear to have been lavished on its production. There are some excellent illustrations, and a section of the book is devoted to the Panama Canal in International Law. The design and construction of the canal and locks are described, and mention is made of the thousand and one accessories necessitated in attempting so great an undertaking. A brief historical survey is given, and a chapter on sanitation, costs, etc., is appended, whilst a dissertation on the commercial importance of the canal closes the work. Cross-section diagrams of the canal at various points are reproduced, and maps of sections of the canal are attached. Altogether the work forms a fitting monument to the energy and devotion of the authors.

* * *

"CONSTANT VOLTAGE TRANSMISSION." By H. B. Dwight, B.Sc. New York: John Wiley & Sons, Inc. London: Chapman and Hall, Ltd. 5s. 6d.

The author considers the subject of constant voltage transmission from all standpoints, and gives a number of formulæ so that the reader can make his own calculations. Although, of course, the main appeal of this book will be to electrical engineers in countries like America, where numerous power lines are erected, yet there are a sufficient number of such installations in this country to make this volume of interest to many readers on this side of the Atlantic. A number of photographic illustrations and curves help to elucidate the text.

Foreign and Colonial Notes

Argentina.

The following is a translation of an article in the *Revista Telegrafica*, of Buenos Aires, of July 20th, 1915.

“ WIRELESS TELEGRAPHY AND SHIP STATIONS.

“ It being judicially established that any inhabitant of the country can put up an aerial and establish a wireless station at his residence without the authorities being able legally to prohibit him from so doing so long as no law has been passed restricting or abolishing this right, we consider as a logical consequence that the wireless stations installed on board ships of the mercantile marine should work freely without any restriction, especially when it be taken into account that these latter stations are fulfilling a public need, for which reason the law makes their installation obligatory on every ship intended to carry over 30 passengers.

“ We have, in these columns, always supported the view that coercive measures tending to absolutely prohibit all unauthorised private stations should be adopted, as we believed, and we still believe, that they are a danger to the social, commercial and political safety of the country, and besides—as we then stated—their tolerance amounts to the sanctioning the right of violation of the secrecy of traffic.

“ We should approve, with similar enthusiasm, any initiative having for its object the legalisation of such prohibition, but meantime we must respect the law which is contrary to our modes of thinking.

“ And further, if the law allows the right of private parties to have and to use wireless stations, the capacity and range of which are free from all control by the authorities, seeing that no authority has the right to inspect them, why have ship stations to be subject to regulations imposed by the law ?

“ Why should navigators be deprived of the right of communicating during a

“ voyage with their families, their friends, or from attending to their business ? Why should the steamship companies, who have to pay for the upkeep of these stations, be deprived of the receipts which their service brings them in, and which are legally authorised and controlled, and subject to the payment of taxes ? ”

* * *

Australasia.

At the 12th Annual Meeting of the Associated Chambers of Commerce of the Commonwealth of Australia, held at Hobart, Tasmania, on the 15th, 16th and 17th of March of this year, Mr. L. M. Bond, of the Brisbane Chamber of Commerce, moved that the Associated Chambers of Commerce recommend that wireless stations be established at Tulagi (Solomon Islands) and other British Islands in the Pacific. This suggestion was made in view of the fact that the trade between these islands and Australia is increasing and that trade should be encouraged to flow towards Australia. As it is, communication with the Solomon Islands is obtainable by wireless only when the steamer *Kulanbangra* is in the group. The Government has agreed to pay a third of the cost and expense of maintenance. As exemplifying the appreciation of wireless telegraphy by the Colonies it is interesting to note that in response to a request that the town of Cairns should be included in the list of places where wireless apparatus should be established, Mr. Bond said, “ I am agreeable to that because I take it that the more wireless stations we have the better.” Mr. Robison Chapman, of the Hobart Chamber of Commerce, supported the resolution, and said, “ It is most important that wireless stations should be established in the Pacific islands. We have seen,” he said, “ during the war how very necessary they are. They are necessary from a commercial point of view, and also for defence reasons in linking up the Empire.” The resolution was then carried.

Canada.

A debate on navigation in Hudson Bay was recently held in the Canadian House of Commons, and Mr. J. D. Hazen, Minister of Marine, announced that the first wireless station would be erected on Hudson Strait. It will be able to work with the stations at Port Nelson and Le Bas. In answer to a question Mr. Hazen replied that it would be necessary to build and equip more than one wireless station on the Strait in order that the ice conditions might be known.

* * *

Japan.

Some time ago the Department of Communications in Japan established a wireless telephone system between Toba (Shima province) and the island of Ishijima. This communication having rendered great service, it has been decided to establish similar telephones in five other ports, the range in each case being from 40 to 50 miles.

* * *

Oceania.

A Commonwealth scheme of wireless telegraphy includes three high-power stations for long-distance communication, and seventeen low-power stations, at such intervals round the coast as to allow inter-communication from ship to shore. The high-power stations at Sydney and Perth are open for traffic, and preliminary arrangements have been made for the erection of a third power-station at Darwin, capable of communicating with Singapore. The following low-power stations, with the exception of Roebourne and Wyndham, are now in operation: Victoria-Melbourne; Queensland-Brisbane, Rockhampton, Cooktown, Thursday Island, and Townsville; South Australia-Adelaide and Mount Gambier; Western Australia-Geraldton, Roebourne, Broome, Wyndham, and Esperance; Tasmania-Hobart and Flinders' Island; Northern Territory-Darwin; and Papua-Port Moresby. It is intended to increase the number of stations to thirty-two.

* * *

United States.

A despatch has been received from San

Antonio, Texas, that the United States Government wireless station, under the control of the Army at Brownsville, in that State, has been increased to nearly double its former capacity, and is now able to communicate with vessels at sea 800 miles from the station. A large portion of the military messages from the border patrol along the lower Rio Grande to the Army Department at Fort Sam Houston is handled by the station.

* * *

Point Isbell, Texas, on the Rio Grande, is to have a wireless station. The United States collier *Jason* arrived at Galveston recently, and discharged a complete 5 kw. wireless set, including masts, which will be re-shipped to the former point. It is understood that the Navy is going to erect a station to communicate with the battle-ships off Tampico and Vera Cruz.

* * *

The growth of the radio-telegraphic service in the United States has necessitated the appointment of superintendents in the various districts. We learn from the States that Lieut.-Commander E. H. Todd has been appointed Pacific Coast superintendent in so far as wireless telegraphy is concerned. His headquarters will be at the naval training station on Yerba Buena Island. Lieut.-Commander Todd has been in the Navy since 1906, enlisting from Illinois, whilst for the past two years he has commanded the torpedo "Flotilla" of the Pacific fleet.

* * *

The Telegraph Championship Tournament, which was held on August 27th and 28th at the Panama-Pacific International Exposition at San Francisco, comprised nine events in all. The fifth event consisted of a special "wireless" contest, divided into classes "A" and "B." Competitors in Class "A" were required to send twenty ordinary wireless messages, and those in Class "B" to receive twenty ordinary wireless messages. A regulation pair of head telephones was used for receiving, the signals being made on a high-frequency buzzer. We hope to announce the result of the competition shortly.

PERSONAL PARAGRAPHS.

W. A. B. Kirwan Ward commenced his business career in London as an apprentice in the National Telephone Company in August, 1907. During his apprenticeship he studied all branches of telephony, the maintenance and construction of exchanges and the laying and upkeep of overhead and underground lines. He also thoroughly acquainted himself with accountancy. On the completion of his apprenticeship he took up outside construction work in 1910, but resigned in 1912 and joined the Constantinople Telephone Company, where he remained until October, 1913. He joined the Relay Automatic Telephone Company (then called the Betulander Automatic Telephone Company) in November, 1913, and was for some time employed in London and in France in connection with the installation erected in the Bois de Boulogne. On the outbreak of war he was called up to serve with



Sec. Lieut. W. A. B. K. Ward.

his company, in which he held the rank of 2nd Lieutenant, and about six weeks ago was ordered to proceed to Alexandria with a view to joining the Mediterranean Force in the Dardanelles.

The news of his death from wounds came as a great shock to his many friends. He was very popular with the staff with whom he served, and will be remembered by some

of the Marconi staff as the representative of the Relay Company in the competition for the Tennis Challenge Cup.

It is always pleasing to us to hear of heroic deeds and sacrifices rendered to their country by members of the Navy or Army, and we are particularly gratified to learn that wireless telegraphists find their place in the mention of those who deserve it. In this connection we learn that Lieut.-Commander James F. Sommerville, Fleet Wireless Telegraph Officer, is mentioned in Vice-Admiral J. M. de Robeck's despatch on naval matters in the Dardanelles. He "performed good service in organising, with the military, the intercommunication between the allied fleets and armies." We congratulate Lieut.-Commander Sommerville on his receipt of this honourable mention.

In last month's issue we were pleased to make mention of the promotion of Lieut. Hake to commissioned rank. By his courtesy we are enabled to publish a photograph, which will, no doubt, prove of interest to our readers and also to his many friends.



Sec. Lieut. E. G. Hake.

It is with deep regret that we have to record the death from diabetes of Operator Charles Frederick Mackenzie, at the hospital at Wellington, New



Operator Mackenzie.



Operator Pollard.

staff, he served on board the s.s. *Cameronia*, *Saturnia*, *Itapue*, *Nyanza*, *Highland Scot*, and *Tainui*, and whilst serving on this last, was taken ill. We tender the sincerest sympathy to the late gentleman's parents in their sad bereavement.

It is with much regret that we have to record the death of Mr. Frederick George Pollard, of the Marconi Company's operating staff. Mr. Pollard, whose home was at Lewisham, for some time served in the South-Eastern and Chatham Railway Company as telegraphist. In 1913 he joined the Marconi Company's London School, and after a few months' training received his appointment to the staff. Mr. Pollard served at sea on the s.s. *Rexa*, and afterwards on board the *Arlanza*. In August of last year he was taken ill and has since been on sick leave. Although he rallied at times, he never really recovered, and passed away on August 6th.



Operator F. W. Page.

Zealand. Mr. Mackenzie, who was 25 years of age, was born at Leytonstone, Essex, and received his education at the same place. A few years ago he became interested in wireless telegraphy, and after a course in a training college, joined the Marconi Company's school in May, 1912. On appointment to the

We tender to the late gentleman's parents our sincerest sympathy in their sad bereavement.

It is our painful duty to inform our readers of the death from dysentery of Operator Frank William Page, of H.M. Hospital Ship *Sicilia*. Mr. Page, who was 21 years of age, came from Walthamstow, at which place he received his education. Prior to joining the Marconi Company he was employed in a clerical capacity, and during his spare time studied at the Marconi Company's Evening Classes. Just a year ago he was appointed to the staff, and almost immediately joined the Hospital Ship *Sicilia*, on which vessel he remained until the end. His loss was deeply felt by all on board. The funeral took place in the Red Sea on August 24th. We take this opportunity of offering our deepest sympathy to the late gentleman's relatives in their terrible bereavement.

FINAL DIGEST FOR WIRELESS STUDENTS
First Edition, 9d. Second Edition, Enlarged and embracing Handbook: Complete Guide to Government Examination; Useful to Operators, 2/6, post free 2/7½. (Copyright) *Journal of Commerce*: "There is much matter in the book which student will find it impossible to get elsewhere." *Liverpool Daily Post*: "Full directions to candidates for the Government Examinations."—Sole Publisher, J. HENSTOCK, 5 Deeside Parade, West Kirby, Cheshire.

THE YEAR-BOOK OF WIRELESS TELEGRAPHY & TELEPHONY, 1915. Price 3/6 net; post free in United Kingdom 4/-; Abroad 5/-.—THE WIRELESS PRESS, LTD., Marconi House, Strand, W.C.

THE ELEMENTARY PRINCIPLES OF WIRELESS TELEGRAPHY, by R. D. Balfour. Price 1/2 post free. A book eminently suitable for the beginner.—THE WIRELESS PRESS, LTD., Marconi House, Strand, W.C.

BINDING CASES for Volume II. of THE WIRELESS WORLD. Price 1/3 post free.—THE WIRELESS PRESS, LTD., Marconi House, Strand, W.C.

COPIES of Volume II. of THE WIRELESS WORLD, cloth bound, bevelled boards. Price 4/6 net. Postage for United Kingdom, 8d. Abroad at Foreign Parcel Post Rates. As only a limited number are prepared, orders should be placed at once.—THE WIRELESS PRESS, LTD., Marconi House, Strand, W.C.

SPECIMEN COPIES.—We shall be pleased to send sentirely free of charge a few specimen copies of THE WIRELESS WORLD to the friend of any reader likely to be interested in the magazine.—Send a postcard to Sales Manager, THE WIRELESS WORLD, Marconi House, W.C.

MORSE CODE CARD, showing Alphabet, Numerals, Abbreviations, etc., at a glance. Price 2d. post free.—THE WIRELESS PRESS, LTD., Marconi House, Strand, W.C.

ANY BOOKS reviewed in the WIRELESS WORLD or other magazines will be forwarded per return upon receipt of remittance covering cost of book and postage.—THE WIRELESS PRESS, LTD., Marconi House, Strand, W.C.

MAP OF THE WORLD, revised March, 1915. Showing location of over 700 Wireless Stations. Price 1/8 post free.—THE WIRELESS PRESS, LTD., Marconi House, Strand, W.C.

YEAR BOOK OF WIRELESS TELEGRAPHY AND TELEPHONY, 1914. Price 3/- each, post free.—THE WIRELESS PRESS, LTD., Marconi House, Strand, W.C.