

The Wireless World

THE
PRACTICAL RADIO
JOURNAL
24th Year of Publication

No. 809.

FRIDAY, MARCH 1ST, 1935.

VOL. XXXVI. No. 9.

Proprietors: ILIFFE & SONS LTD.

Editor:
HUGH S. POCKOCK.

Editorial,
Advertising and Publishing Offices:
DORSET HOUSE, STAMFORD STREET,
LONDON, S.E.1.

Telephone: Hop. 3333 (50 lines).
Telegrams: "Ethaworld, Wat00, London."

COVENTRY: Hertford Street.
Telegrams: "Autocar, Coventry." Telephone: 5210 Coventry.

BIRMINGHAM:
Guildhall Buildings, Navigation Street, 2.
Telegrams: "Autopress, Birmingham." Telephone: 2971 Midland (4 lines).

MANCHESTER: 260, Deansgate, 3.
Telegrams: "Iliffe, Manchester." Telephone: Blackfriars 1112 (4 lines).

GLASGOW: 26B, Renfield Street, C.2.
Telegrams: "Iliffe, Glasgow." Telephone: Central 4857.

PUBLISHED WEEKLY. ENTERED AS SECOND
CLASS MATTER AT NEW YORK, N.Y.

Subscription Rates:

Home, £1 1s. 8d.; Canada, £1 1s. 8d.; other
countries, £1 3s. 10d. per annum.

*As many of the circuits and apparatus described in these
pages are covered by patents, readers are advised, before
making use of them, to satisfy themselves that they would
not be infringing patents.*

CONTENTS

	Page
Editorial Comment	207
Television Scanning by Cathode Ray	208
Portable 40-metre Transmitter ..	210
An Improved S-W Frequency Changer	213
News of the Week	215
Unbiased	216
Broadcast Brevities	217
New Apparatus Reviewed	218
Plotting Response Curves	219
Listeners' Guide for the Week ..	220
H.M.V. High-Fidelity Auto- radiogram	222
Foundations of Wireless	226
Random Radiations	228
Readers' Problems	230

EDITORIAL COMMENT

Broadcasting and Television Technique

Two Distinct Arts

WHEN broadcasting first began the technique of microphone performances was new and it took many years of development before broadcasting became a distinctive art, where the disability of the audience was overcome and plays could be produced which in many cases actually gained in entertainment value through the absence of the sense of sight. The same thing, of course, happened—though in the reverse order—with the development of the film. Actors in the silent film had to make up for the absence of sound, and effects had often to be produced in quite an elaborate manner to put over ideas which the addition of speech or sound would have made possible with much less effort. A great deal of the silent film technique was thrown overboard as soon as sound accompanied the films.

This leads us to conjecture what the effect upon broadcasting technique may be of the advent of television.

At first, of course, television will play only a very small part in the broadcasting picture. Transmissions will be of short duration and probably films will supply much of the material of the broadcasts. But if, and when, public interest demands a fuller television programme, it might eventually accompany nearly all broadcasting.

If this happens, will the present highly developed technique of broadcasting have to make way for the new order of things, just as happened with the advent of the talkies?

There is, however, this big difference. When the talkies arrived the change-over was fairly sudden and complete. The silent film died so quickly that it

was very soon forgotten. There was no interval of overlapping. From the nature of things television development will be gradual and may very likely never displace normal broadcasting with its special technique. One of the charms of broadcasting to-day lies in the fact that aural concentration only is necessary on the part of listeners. The idea of having to concentrate on a picture at the same time in order to follow a performance will not be welcomed unanimously.

The technique of broadcasting without television should not be neglected, and this suggests that the production of material for sound broadcasts should not be mixed in with television but be run on independent lines, with independent staffs, at the B.B.C. Unless this is done we stand in grave danger that all the work so far done on developing a special microphone art will be lost to us, whilst television still remains in an undeveloped and not really satisfying state, and therefore unfitted to replace it.

Television

A Free Booklet

NEXT week's issue will, we believe, prove of special interest to our readers.

Recognising the fact that there is at the moment a very widespread interest in television and that comparatively little sound information is available to the public on the subject, we have prepared a booklet for free distribution with the issue of March 8th.

Our aim in compiling the booklet has been to explain the principles of television, with particular reference to the cathode ray high-definition system. The booklet also discusses the general aspects of the subject with a view to giving the public a clear idea as to what to expect when the transmissions begin.

Television Scanning by Cathode Ray

Amplification by Electron Multiplication

A DESCRIPTION of the "Image Dissector," which comprises a special type of cathode ray tube, used in conjunction with suitable optical apparatus for direct scanning of scenes to be transmitted by television

A PREVIOUS article on cathode ray television¹ dealt with the general principles of two-dimensional scanning by two saw-tooth voltages and the formation of the picture image on the screen by variation of the instantaneous intensity of the fluorescent spot from point to point. The same article referred to methods of cathode ray scanning at the transmitter, where the advantages of absence of mechanical moving parts and the response to very

the camera. Both effects are already familiar in cinema photography, and the exponents of the cathode ray scanner suggest that these effects in studio or outdoors can easily be obtained by electrical means, at least within fair limits.

So far, two main methods of cathode ray scanning of direct scenes have been proposed. Both have common features in that they both use a photo-electric device and a bundle of electrons, but they differ in the manner of their combination.

One of these devices is the Zworykin Iconoscope, developed in America by the R.C.A. Company, with which the E.M.I. Company in this country is allied. As described in a recent article, this essentially comprises the cathode and beam-producing system of a cathode ray tube, in conjunction with a photo-electric anode. The beam is capable of being moved in two dimensions of deflection—for line scanning

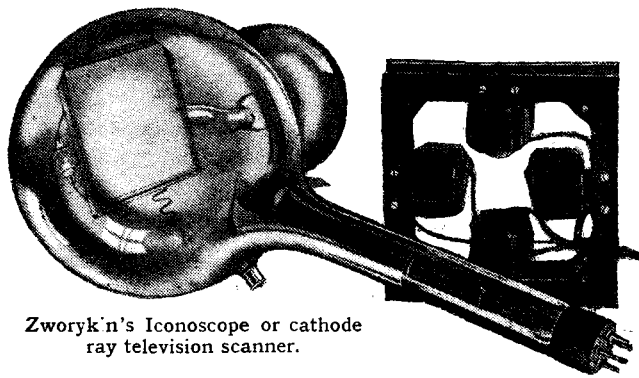

Zworykin's Iconoscope or cathode ray television scanner.

high-speed variations are obviously just as important as at the receiver.

One of the greatest problems awaiting solution in the practical working of television is that of the direct scanning of moving scenes, and there are not a few who pin their faith to the cathode ray tube as the most immediate, and possibly also the most final, solution of this problem. Apart from the fundamental advantages mentioned above, there are further attractive points in the use of the cathode ray tube as a direct scanner. From its size and general shape it can very conveniently be accommodated in a camera structure, where the absence of moving parts is again a practical advantage. In the methods so far proposed the image of the scene is normally focused on a photo-electric surface, and another advantage which arises with the cathode ray tube is the ease with which the size of the picture scanned can be varied to give the impression of the backwards and forwards movement of the camera, while it can also be moved about, giving the impression of rotating

and picture framing—by means of saw-tooth voltages, in the manner also discussed in the previous article. The anode consists of a sheet of fine photo-electric mosaic on which an optical image of the scene is focused. The finely pointed cathode beam, under the influence of the scanning motions, then sets up current impulses proportional to the illumination of the different parts of the anode mosaic

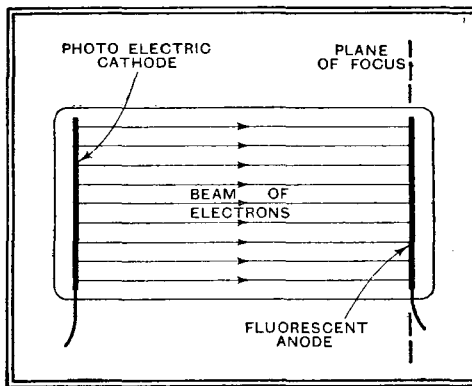

Fig. 1.—Principle of the Farnsworth photo-electric cathode ray tube for television scanning.

over which the beam travels in the course of its scan.

A less-known cathode ray scanner, also of American origin, is the image dissector of P. T. Farnsworth, who has been a consistent exponent of cathode ray methods. So far the device is fairly new in this country, but it is almost an open secret that it will make its public appearance in British practice before long; that is, if Press reports on recent Baird developments are to be logically interpreted.

The Farnsworth scanning unit is also

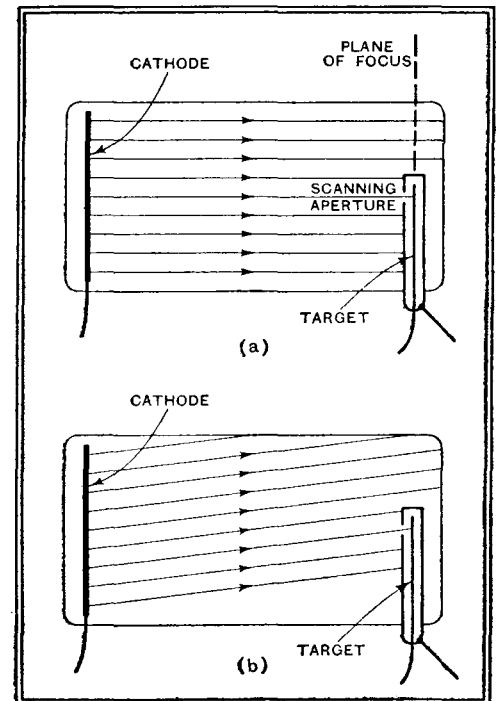

Fig. 2.—Farnsworth photo-electric "image-dissector," illustrating the process of scanning through an aperture in a screen surrounding the anode-target.

essentially a combination of the photo-electric cell and the cathode ray principle, but in this case the photo-electric effect is at the cathode. In this respect it conforms to the conventional photo-cell. It also conforms to the conventional cathode ray tube in that the electron beam given off by the cathode is deflected in the ordinary manner of the cathode ray tube, and different parts of it are caused to give different effects in a "target" anode for purposes of television scanning. The electrons are, of course, generated by photo-electric means instead of thermally, but they are still electrons; they are also in a broad beam instead of the fine pencil of usual cathode ray practice.

The essential features of the Farnsworth image-dissector are illustrated in Fig. 1. The cathode is in the form of a disc

¹ *The Wireless World*, February 22nd, 1935.

Television Scanning by Cathode Ray—

of about ¼ in. diameter, with its surface made photo-electrically active by the normal sensitising methods used for silver-oxide-cæsium cathodes in ordinary photo-cell practice. An image of the picture or scene to be scanned is optically focused on to the photo-electric sensitised surface, when it will be realised that electrons will be emitted from the various points of the surface, in accordance with their respective degrees of illumination. These electrons will be urged in the direction of a positive electrode (anode) at the other end of the tube. They will, however, tend to diverge for a large variety of reasons which need not be considered here, but they can be constrained to form an electron focus of the image in a plane parallel to that of the cathode.

Focusing the Beam

This focusing process is actually done by means of an external magnetic field from a solenoid winding surrounding the tube, the arrangement being one already known as an alternative, or auxiliary, method of focusing the electron beam in the ordinary type of cathode ray tube. Great care is necessary, however, in the case of the image dissector to ensure that an undistorted and focused electron image of the cathode is produced at a plane within the tube, as indicated in Fig. 1. If we have, in this plane, an anode whose surface is coated with a fluorescent material, then an image of the picture optically focused on the cathode is reproduced electrically on the fluorescent anode. This is the condition indicated in Fig. 1; actually the electron beam is not kept parallel all the way (as it is shown in Fig. 1) but is arranged by the outside coil, already mentioned, to be brought to a focus on the anode.

While the electrode system of Fig. 1 is thus suitable for producing an "electron image" in the plane of the anode, it will be seen that it is not suitable for the progressive scanning necessary for television. This scanning is effected by enclosing the anode or target electrode in a screening structure with a very small "scanning aperture" (actually 0.015 inch) as shown in Fig. 2. It will then be seen that only a very small part of the electron beam coming from the cathode can, at any instant, reach the anode through this aperture, giving in the anode circuit an electron-current response proportional to the illumination of that particular part of the cathode.

To obtain scanning it is then only necessary to move the electron beam so that electrons from every point on the cathode are brought successively to

impinge on the target. This is done by additional coils outside the tube which apply a magnetic field giving transverse deflections to the electron beam. This process is, of course, also a well-known method of deflecting the beam of an ordinary cathode ray tube, as was described in recent articles on the cathode ray tube generally. It can be followed by examining the difference between (a) and (b) of Fig. 2, where it will be seen that quite a different part of the photo-electric cathode beam is being allowed to reach the target anode. For scanning of an actual scene two directions of deflection are used, as in general methods of cathode ray scanning, i.e., a low-speed vertical "picture framing" scan and a high-speed horizontal line scan, both being of "saw-tooth" shape and applied by the coils already mentioned. For scanning a cinema film, the framing scan is provided by the continuous motion of the film, and only the line scan is then necessary.

In addition to the image-dissector, Farnsworth uses another interesting device which he calls an "electron multiplier." The action of the device is rather complicated, but it can be stated that it depends on the production of secondary electrons. It is well known that when an electron stream is directed against a metallic surface it tends to cause the emission of secondary electrons. The secondary electrons emitted may actually exceed the primary in number if the latter have sufficient velocity. In practice, in Farnsworth's multiplier, this is used by causing the initial electron stream to be directed against an emissive surface, giving off as many secondaries as possible under the primary impact. These secondaries are then directed against a similar surface, and this process is repeated as many times as desired, and the total electron flow is finally collected. The process is somewhat akin to several stages of valve amplification except that, beginning with small values of electron current, it can be arranged for several stages of the process to occur inside one tube. Farnsworth, indeed, combines the image-dissector and electron multiplier in one tube, which is seen in one of the photographs illustrating this article. The target of the image dissector then becomes effectively the source of primary electrons

used in the multiplier section of the tube. So far the device is new and appears to be relatively little developed. It seems, however, to offer considerable possibilities in the general field of electronic practice. In the application described above its operation is effectively that of ordinary voltage amplification, but it is understood that it can also be arranged for operation as an oscillator, modulator, and also as a

rectifier. Further information on the more general technical development of the device will therefore be awaited with interest.

For practical television working it has the advantage of serving as a very convenient "first amplifier" closely associated with the modulating output immediately at its

point of generation. In scanning a cinema film, where a strong light source is available, it is understood that the simpler type of image dissector (illustrated in principle in Fig. 2) is used. For scanning of a direct scene a tube of the combined type is used, housed in a camera which gives direct focusing of the scene on to the photo-electric cathode. A camera of this type is shown in another of the photographic illustrations accompanying this article, and it is understood that its adherents express great confidence in the combined electronic device as a scanner for direct scenes both in the studio and outdoors.

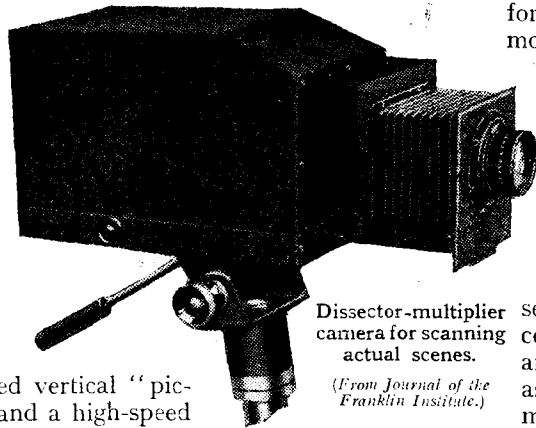

Dissector-multiplier camera for scanning actual scenes.
(From Journal of the Franklin Institute.)

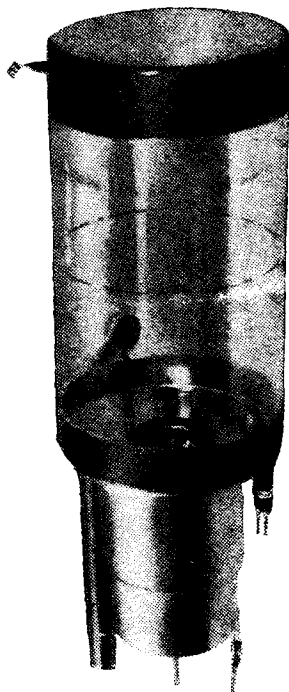

Farnsworth image dissector and electron multiplier tube.
(From Journal of the Franklin Institute.)

**The Wireless World
TELEVISION GUIDE**

**A FREE BOOKLET
— NEXT WEEK —**

Next week's issue will contain a free booklet on Television, prepared with the object of giving the public a clear understanding of the principles of Television, and in particular the cathode ray system which will be employed in the new high-definition transmissions.

The booklet does not assume technical knowledge on the part of the reader, and is, therefore, suited to the requirements of those of the general public who wish to take an intelligent interest in the new subject.

Please tell your friends, so that they may obtain copies of THE WIRELESS WORLD of March 8th, containing the booklet, for themselves. It would be wise to ask newagents, in advance, to reserve copies.

Portable 40-Metre Transmitter

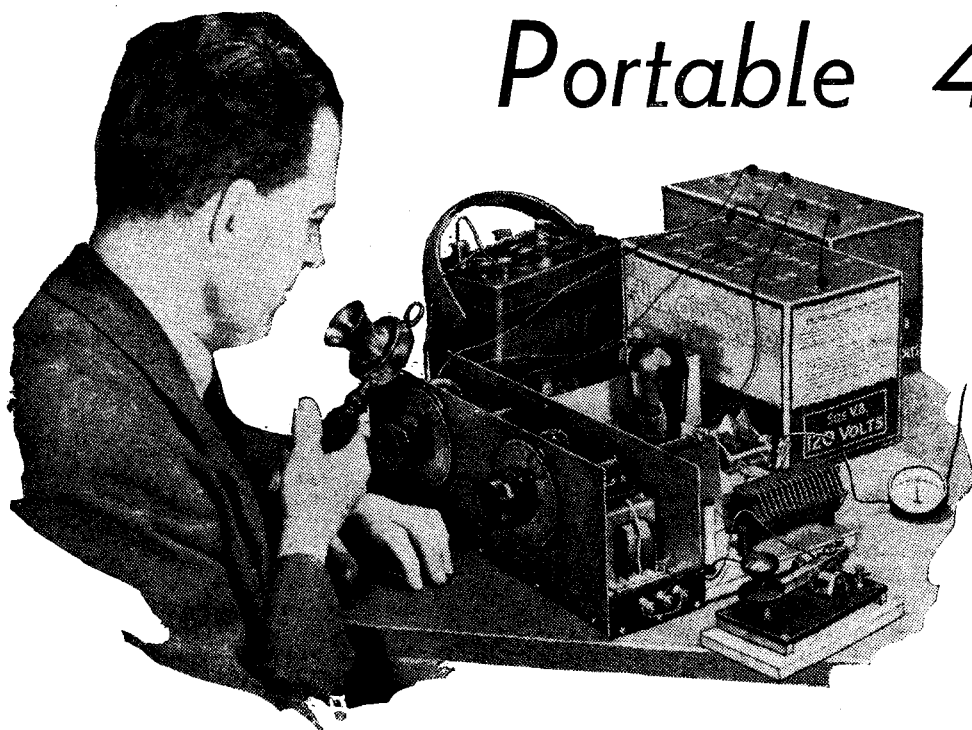

Circuits and
Constructional Details for
Low-power Battery-
operated Telephony and
C.W. Sets

(By courtesy of the General Electric Co., and compiled by the G.E.C. Research Staff, Wembley.)

THIS short-wave transmitter designed for battery operation embodies the minimum number of valves necessary to obtain a satisfactory performance. The refinement of a master oscillator is justified in that it provides a steady signal which is far easier to copy at a distance than one from a more powerful station but varying in strength. For telephony a Class "B" amplifier gives ample output to modulate the oscillator, yet it is economical in its demands from the battery. A licence must be obtained, of course, from the Postmaster-General before experiments are made with transmitting apparatus.

OF the several wavebands allotted to the amateur transmitter the 7.5 mc, or the 40-metre, is perhaps the best for the beginner, since it is sufficiently high up in the radio spectrum to enable useful data to be compiled on the operation and handling of short-wave transmitters. The scope of the amateur lies mainly in investigation in fields not fully explored by commercial interests, yet experience must first be gained, and this is best acquired on a wavelength which is popular, for in those fields where prearranged experiments are

A low-power set equipped for CW and telephony transmission is ideal for this purpose, and if battery-operated has the advantage of portability for use in the open country when weather permits. Either of the transmitting sets mentioned in this article would satisfy these requirements, for they are battery-operated and economy in HT current is effected by using a Class "B" modulator, while provision is made to key the oscillator for CW work.

Short distance communication which would make use of the ground wave and,

by these sets, good reports of telephone signals having been received from several European countries, but so far the extent of the CW range has not been fully explored.

The three-valve set is the simpler of the two as it embodies a self-excited oscillator, while the four-valve model is fitted with a master oscillator driving an HF power amplifier. The modulating circuit is the same for both, and so also is the keying arrangement. Reports reveal that signals from the drive-controlled set are perfectly steady, being comparable to crystal control, and a swaying aerial appears to have no appreciable effect on the received signals.

The complete circuit of the three-valve transmitter is shown in Fig. 1. A PX4 valve serves as the oscillator while a LP2 and a B21 combine the function of a Class "B" modulating stage. The microphone with its associated battery and transformer are external, but if no more than 4 volts are required in the microphone circuit this may be drawn from the common LT battery. The 2-volt LP2 and B21 valves have their filament connected in series, the driver valve being nearer the LT positive so that it derives a slightly greater negative bias on its grid when coupled up to the 6-volt biasing battery which is common to both valves. A switch is included in the positive LT lead, cutting off the entire filament supply, but if telephony transmission is required only occasionally an

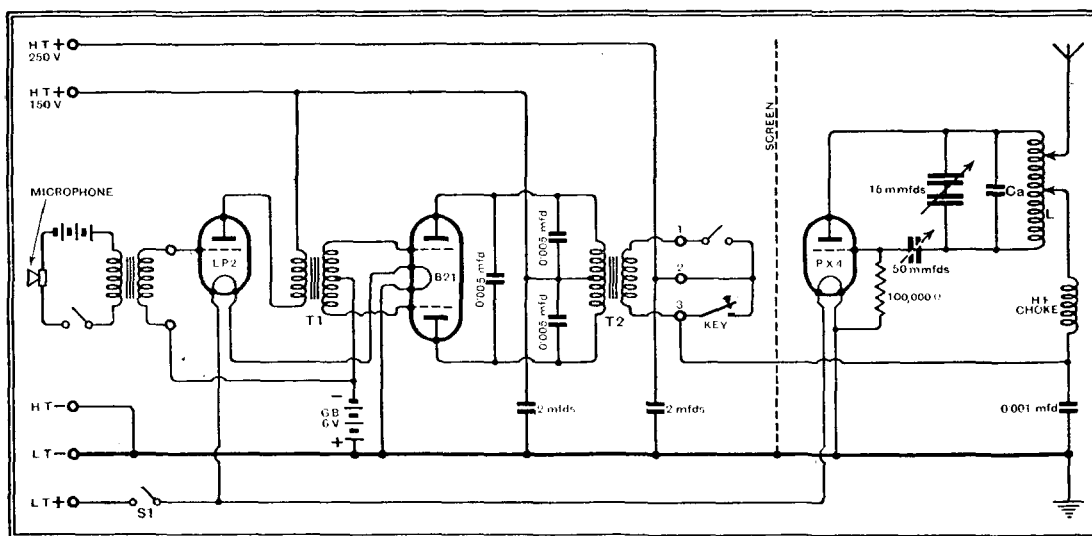

Fig. 1.—The circuit of the three-valve transmitter.

being conducted it may prove difficult to make contacts and obtain reports on the tests the operator has planned.

therefore, not be subject to serious variation, can be taken as about ten miles, but quite long distances have been covered

6-volt biasing battery which is common to both valves. A switch is included in the positive LT lead, cutting off the entire filament supply, but if telephony transmission is required only occasionally an

Portable 40-metre Transmitter—

additional switch could be included to isolate the LP2 and B21 valves.

The LF output from the modulator is fed to the HF power oscillator *via* the

the PX4, which valve is prevented from oscillating of its own accord by a neutralising circuit comprising a portion of the coil L1 and a small neutralising condenser.

The tuning of the drive circuit and of

quired here is 80 micro-microfarads.

A simple baseboard form of construction is adopted, the master oscillator and the power amplifier are assembled at the back with a vertical aluminium partition be-

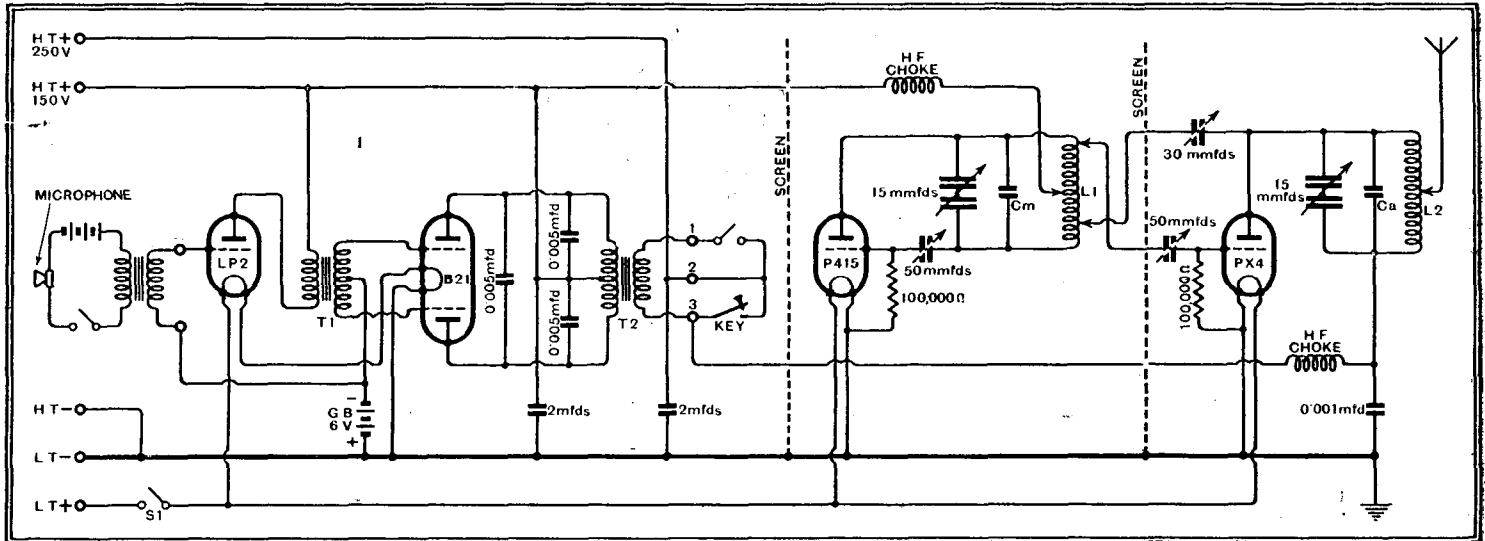

Fig. 2.—The four-valve transmitter embodies a master oscillator, and the complete circuit is shown above.

secondary of the output transformer, which is joined in series with the oscillator valve anode. A switch in the HT feed lead to the oscillator connects either the secondary of the LF output transformer or a signalling key in circuit.

It is not proposed to give very full details of the smaller set, as apart from the modulating equipment the circuit is so straightforward that the theoretical diagram is in itself a sufficiently good guide. The single tuning coil is the same as fitted to the larger set in the power amplifier circuit. Detailed drawings of this coil will be given later. It will suffice to say that the filament consumption is 1.2 amps at 4 volts; the oscillator anode current at 250 volts is 30 to 35 mA., while the modulator requires 150 volts HT and the average current is about 11 mA.

The circuit of the larger set is arranged as in Fig. 2. In this design a low-power oscillator fitted with a P415 valve drives

the amplifier circuit is effected by a fixed condenser, Cm in the one and Ca in the other, with a small variable in parallel. A Cyldon "Bebe" condenser of the series-gap type is used here and connection is made to the fixed plates only. Details of the two fixed capacities are given in the

tween them and the modulation equipment occupies the front part, being separated from the HF oscillator by an aluminium screen extending the full width of the set. The baseboard of this compartment is lined also with aluminium, and a panel of the same material is used.

The tuning condensers are each of 25 m-mfds. maximum capacity, but with

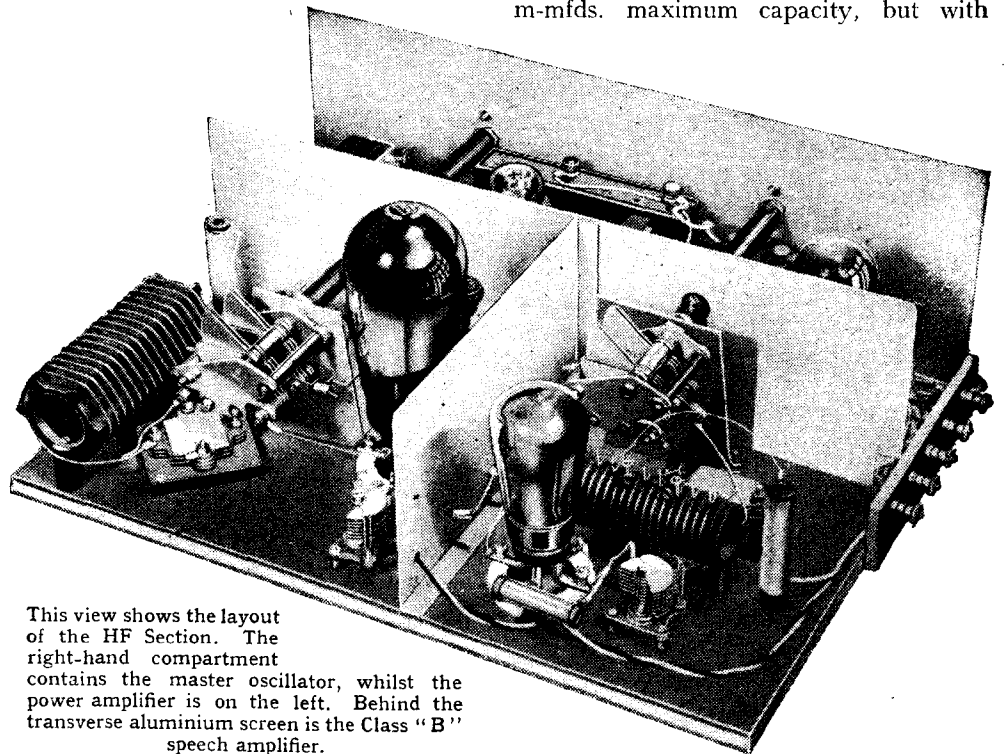

This view shows the layout of the HF Section. The right-hand compartment contains the master oscillator, whilst the power amplifier is on the left. Behind the transverse aluminium screen is the Class "B" speech amplifier.

drawings, but if the constructor finds difficulty in cutting the brass vanes it would be possible to assemble them from the plates used in the Ormond air-dielectric condenser. Although this component is now no longer available, plates and spacing washers can still be obtained from the Ormond Engineering Co., Ltd., and four are needed for Cm, which is 60 micro-mfds., and five for Ca as the capacity re-

the series-gap connections the capacity is reduced to about half this value. They are fitted with long ebonite extension rods passing through clearance holes in the vertical screen and terminate in slow-motion drives attached to the front panel. An on-off switch comprises the only other control on the panel, as the variable grid condensers and the small neutralising condenser in the power amplifier circuit are

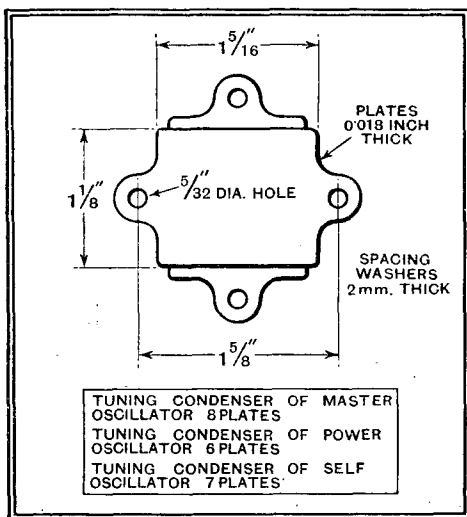

Dimensional drawings of the fixed capacities that are joined in parallel with the variable condensers to tune the master oscillator and amplifier circuits.

Portable 40-metre Transmitter—

mounted on the baseboard. A long insulated screwdriver consisting of an ebonite rod with a small metal tongue inserted into a saw-cut at one end should be employed for making the necessary adjustments.

Standard short-wave HF chokes could be fitted if desired, though those actually used in the set illustrated were constructed by winding a single layer of No. 40 SWG DCC wire on an ebonite tube $\frac{1}{2}$ in. in diameter and $2\frac{3}{4}$ in. long, the winding occupying $2\frac{1}{2}$ in. One end is plugged with wood to take a screw and they are mounted vertically on the baseboard.

As constructional details of the master oscillator and the aerial coils are given in the drawings there is no need for a full description here; it will suffice to say that if facilities are not available for cutting a screw thread on an ebonite tube for the oscillator coil a ribbed former can be used and shallow saw-cuts made in two opposite ribs to give the correct spacing and to position the turns.

Alternate turns of the master oscillator coil have soldered to them short lengths

of No. 16 SWG wire to serve as tapping points. The coils are mounted on ebonite pillars $\frac{1}{2}$ in. in diameter and cut to the length given in the drawings. They are drilled and tapped each end for 4BA screws. An alternative mounting can be found in the small stand-off insulators obtainable from those firms specialising in short-wave components.

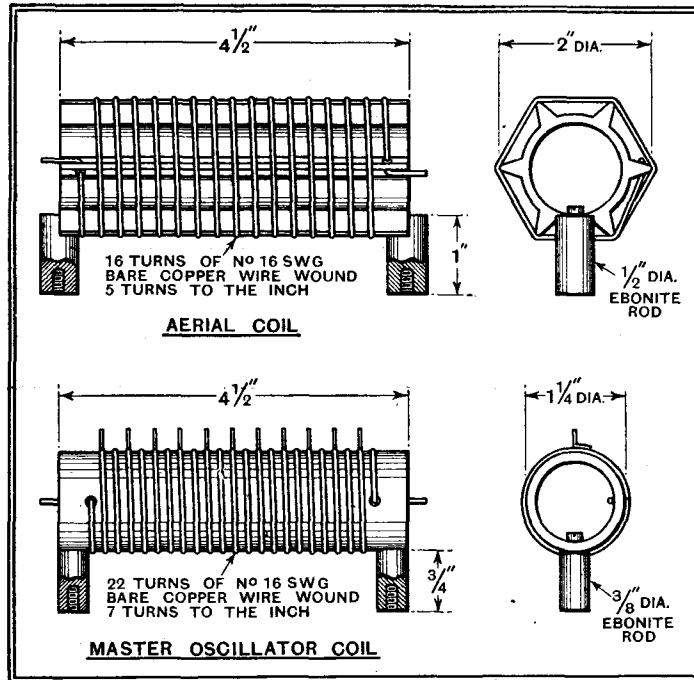

Details of the two coils required for the four-valve set; the aerial coil only is needed for the three-valve model.

LIST OF PARTS

After the particular make of component used in the original model, suitable alternative products are given in some instances.

- 2 Variable Condensers, 25-mmfd., with baseboard brackets **Cydon "Bebe" Series-Gap**
- 2 Slow motion Condenser drives **Utility Micro-dial W181** (Graham Farish, Ormond)
- 2 Air dielectric trimmer condensers, 65-mmfd. **Eddystone 978**
- 2 4-pin Valve holders, short-wave baseboard type **Eddystone 951**
- 1 4-pin Valve holder, baseboard type **W.B. "Rigid"**
- 1 7-pin Valve holder, baseboard type **W.B.** (Benjamin, Bulgin, Eddystone, Goltone, Wearite)
- 2 Resistances, 100,000 ohms, 1 watt **Amplion** (Dubilier, Erie, Ferranti, Claude Lyons, Polar-N.S.F.)
- 2 Fixed condensers, 0.005 mfd. **T.C.C. Type "S"**
- 1 Fixed condenser, 0.005 mfd. **T.C.C. Type "M"**
- 1 Fixed condenser, 0.001 mfd. **T.C.C. Type "M"**
- 1 Fixed condenser, 2 mfd. **T.C.C. 50** (Bulgin, Dubilier, Ferranti, Graham Farish, Polar-N.S.F., T.M.C.Hydra)
- 1 Neutralising condenser **J.B.1050**
- 1 On-off Toggle switch **Bulgin S80** (Claude Lyons)
- 1 Class "B" Transformer } Components to specifications given in text available from **Scientific Supply Stores (Wireless), Ltd.**
- 1 Modulation Transformer }
- 1 Master Oscillator Coil }
- 1 Aerial Coil }
- 1 Ebonite tube, $\frac{1}{2}$ in. outside dia. x $\frac{1}{2}$ in. bore x 18 in. long
- Quantity sheet brass, 0.018 in. thick for fixed condensers, 4BA screwed rod and nuts
- 1 9-volt GB battery
- 2 Wander plugs **Eelex**
- Quantity sheet aluminium, No. 20 SWG for screens, etc.
- 1 Baseboard, $\frac{1}{2}$ in. thick, 16 in. x 11 in.
- 6 Small brass terminals **Eelex**
- 2 Panel bushes, $\frac{1}{2}$ in. bore **Bulgin**
- 2 Ebonite terminal battens
- Valves: 1 each PX4, P415, LP2 and B21 **Osram** (Marconi)

The only other items that call for comment are the Class "B" driver and output transformers. They are similar in construction to the components described in December 15th, 1933, issue of *The Wireless World*, though slight modifications have been made to the windings. Drawings giving all necessary data relating to the transformers required for the transmitter will be included in the next instalment, when particulars of wiring up, adjusting and operating will be fully dealt with.

(To be concluded.)

**DISTANT
RECEPTION NOTES**

BUDAPEST II, which has been working for some time on 834.5 metres, is well heard by those who possess receiving sets that will tune either up to this wavelength on the medium wave range, or down to it on the long. The plant used is, I believe, that of the original Budapest station which was superseded a year or so ago by the 120-kilowatt transmitter now working on 549.5 metres. One cannot help wondering why the No. II station should select such a wavelength as 834.5 metres when there is no particular overcrowding on what is known under the Lucerne Plan as the intermediate band. As it is, Budapest No. II lies in between two Russian stations, one of which, Sverdlovsk, is 15.5 kilocycles away on the one side whilst the second, Rostov-on-Don, is only 4.5 kilocycles away on

the other. Apparently a small wavelength change would ensure that the station was at all times free from heterodyne troubles.

Readers have probably noticed that in the early part of the afternoon Huizen frequently suffers from background interference which takes the form of a loud and unpleasant hum. By the middle of the afternoon this background has usually disappeared and the Dutch station comes in well. The explanation is that up to 3.40 p.m. the old Huizen transmitter, using only 7 kilowatts, is in action. If the Roumanian station Brasov is transmitting at the same time and nominally on the same wavelength, the ratio of wanted to unwanted signal strength is insufficient to drown the interference. When, however, the change is made to the 50-kilowatt Kootwijk plant the interference from Brasov, if heard at all, is too slight to be really troublesome.

Certain alterations have become necessary in the Strasbourg transmitter, which works on 349.2 metres. The station will close down from Monday, March 4th, until the following Sunday. It is expected that considerable improvement in reception will result from the changes that are to be made. Strasbourg already comes in strongly on most evenings, but for some little time now background interference has been noticeable rather often. This comes from the Russian station Simferopol, which shares the Strasbourg wavelength but is apt to wobble a good deal.

Those Spanish Wavelengths

The interference with Leipzig which used to be such a nuisance but seemed to have disappeared has returned on several evenings. It appears to be due to Barcelona EAJ1, which, like so many of the Spanish stations, is not too good at wavelength keeping. Barcelona, with 7 kilowatts, is at present Spain's most powerful station, but within the next year or two the Spanish Regional scheme, which includes a 150-kilowatt long-wave station for Madrid, and a round half dozen medium-wave transmitters ranging from 30 to 60 kilowatts, should be under way.

At the present time the number of stations that can be relied upon for reception at good strength and entirely free from interference evening upon evening is not large. The list includes Luxemburg, Bero-münster, Stuttgart, Vienna, Prague, Rome, Munich, Hamburg, Frankfurt, Bordeaux, Hilversum, and Lyons Doua. On any evening, however, at least a further dozen stations can be well received, though each day's list is slightly different since heterodynes (some very slight) and background interference crop up now here, now there. Berlin, for example, has had a faint accompanying whistle only once during the fortnight preceding the writing of these notes, and Poste Parisien twice and Radio-Paris once.

D. EXER.

The Push-Pull Quality Amplifier

IT may not be generally realised that the use of *The Wireless World* Push-Pull Quality Amplifier, which was redescribed in last week's issue, is not confined to the QA Receiver, but may be employed with many other types of receiver. Details of the necessary connections for typical cases appeared in an article entitled "Push-Pull Input Systems" in *The Wireless World* for September 21st, 1934.

An Improved S-W Frequency Changer

The Heptode with a Separate Oscillator

By E. J. ALWAY

THE design of a frequency changer for a short-wave superheterodyne receiver presents many problems not encountered on the normal broadcast wavelengths. Not the least troublesome is the interdependence of the oscillator section and the signal portion of a heptode when the latter includes a tuned circuit. In this article the author suggests a modification to the orthodox circuit that avoids these difficulties.

NO doubt many readers have in use a heptode frequency changer in either their S-W receiver or in their converter, which is probably wired up in either of the conventional manners shown in Figs. 1 and 2.

Now the great difficulty in successfully operating a heptode frequency changer on the shorter waves, *i.e.*, 10-30 metres, lies in the fact that there is considerable coupling between the two sections of the valve, the oscillator portion and the screen-grid portion, owing to the imperfect electrostatic screening and to the common anode stream.

In practice, two major defects are noticed: first, it becomes impossible to apply AVC bias to the heptode frequency changer because the volts induced on the control grid from the oscillator exceed the grid bias—and cause grid current to flow—which flow of grid current

grid circuit, and if a grid-circuit trimmer is used it will be found to give what is apparently an indication of very sharp

IF frequency, say, 450 kc/s, and as long as 450 kc/s is a fairly high percentage of the oscillator frequency, no volts will be developed across the grid coil, since, so to speak, the oscillator will be "tuned out."

In practice with an MH4 triode oscillator and a VHT4 as a hexode, this grid-current effect was not observed to start until the oscillator frequency was as high as 15,000 kc/s (20 metres), at which point, with 450 kc/s intermediates, the "selectivity" of the input circuit was insufficient to prevent an HF voltage greater than the fixed grid bias to be induced across it from the oscillator section.

Separate Oscillator

In order to shift this critical frequency above 30,000 kc/s (10 metres), the usual limit of the tuning range of S-W sets, it would probably be necessary to use an IF frequency of about 2,000 kc/s.

It is therefore apparent that AVC must not be applied to either a heptode or a triode-hexode arrangement unless the IF frequency is very high—in fact, far higher than is at present used commercially in all-wave or short-wave receivers.

The greatest advantage of the triode-hexode arrangement, however, is that it completely frees the oscillator from the control of the input tuned circuit, at least down to 10 metres, and the grid-circuit trimmer shown in Fig. 3 only changes the

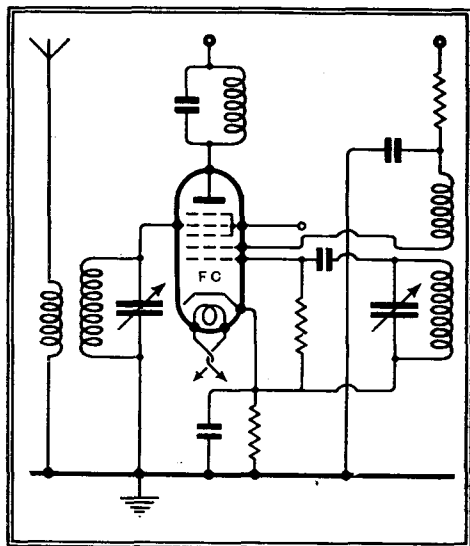

Fig. 1.—Typical short-wave frequency changer with a tuned input circuit in which plug-in coils might be used.

in turn develops high negative potentials across the AVC bias resistances, which are, of course, applied to all of the AVC-controlled valves with a very considerable reduction in sensitivity of the whole system.

The second defect is that the frequency of the oscillations generated in the triode section are controlled by the tuning of the

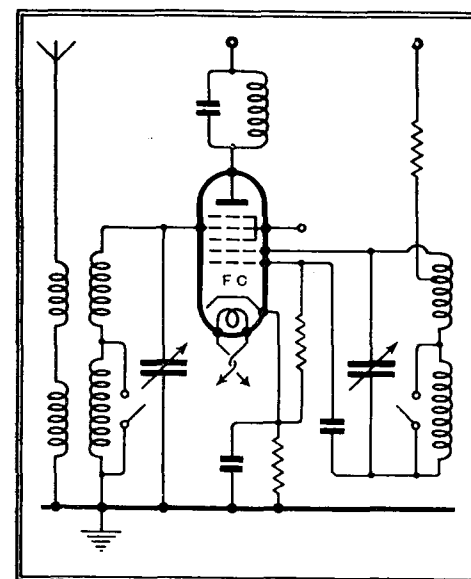

Fig. 2.—This arrangement is an alternative to that of Fig. 1, the main difference being that a Hartley oscillator is employed with dual-range coils.

tuning of this circuit, whereas what is really happening is that the grid-circuit trimmer is in reality tuning in fresh stations or the original one out, because it varies the oscillator frequency. See Fig. 3.

The latter difficulty is almost completely overcome by adopting a triode-hexode combination, and the first difficulty is overcome by also employing a high IF frequency.

Taking the latter point first, if a high IF frequency is employed, the grid input tuning circuit will always be mistuned from the oscillator frequency by an amount equal to the

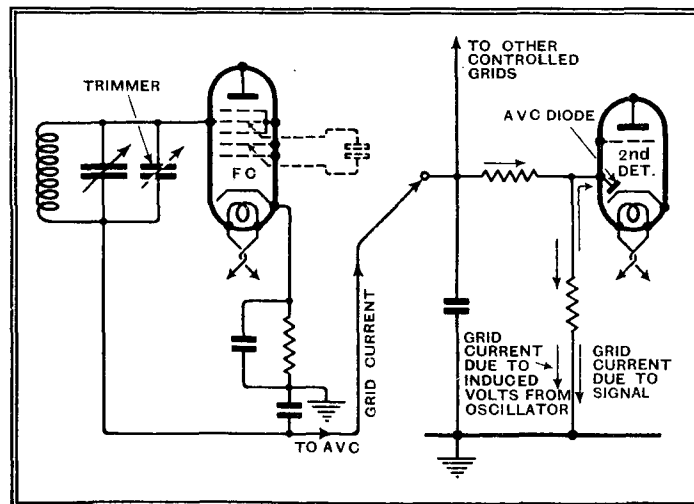

Fig. 3.—When the heptode is included in the AVC chain grid current flowing in the signal-grid circuit is fed back along the AVC line and appears as an additional negative bias on all the valves, thereby lowering the sensitivity.

An Improved S-W Frequency Changer— frequency of the oscillator by a few 100 cycles, for a change in capacity of 0.0001 mfd., whereas in the case of the heptode

is modified by the presence of the 0.01 mfd. Range 1 padding condenser.

On Range 1 the series condenser should have a value of 0.01 mfd., which will

as the case may be—with his own gunpowder, and would throw Caxton into the sea with one of his printing presses round his neck. But who would suspend Hertz by one of the antennæ to which his brilliant investigations have led? A rose without a thorn, ointment without a fly—these are the metaphors which rush to the mind when thinking of Telephony Without Wires, as our French cousins delight to call this great gift of science to mankind."

At this point the mind of the leader-writer is apparently assailed by doubt, for he goes on to express the opinion that these eulogistic metaphors "would not be wholly appropriate, for broadcasting can be made an instrument of diabolical propaganda."

But a consulting engineer, surveying recent advances in design and construction of American broadcast receivers, in *Radio Engineering* (New York), has no such doubts as to the beneficial effect of international broadcasting—which is so often propagandist. He concludes his article by saying:—

"This paper would not be complete if it failed to lay final emphasis upon the profound social significance of the advance into the realm of international broadcasts. The engineers, by making the all-wave receiver a commercial possibility, have made much more than a mere contribution to the prosperity of their industry. It is always an easy matter for the historian to look back upon the scientific advances of former years and see what their effect has been. It is important for us, however, as we review the progress of 1934, to realise that with the increasing use of all-wave receivers there will come an increasing international understanding and goodwill that cannot fail to bear fruit in amity and peace.

"The radio engineer . . . made his great contribution to the safety of life at sea. Then came his entrance into the field of entertainment, with a new cultural influence. . . . But in his gift of international broadcasts, by which the soul of all the world is laid bare, and nations can no longer make a successful secret of their plans and ambitions, the radio engineer may well find his deepest satisfactions."

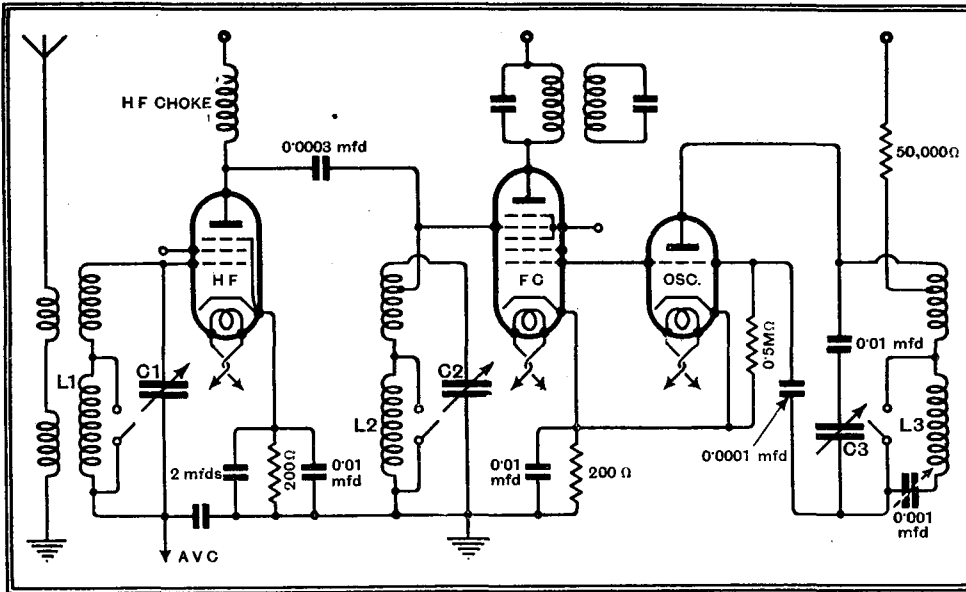

Fig. 4.—Circuit arrangement of a two-valve frequency changer with a stage of signal-frequency amplification, giving good selectivity and embodying ganged circuits and wave-band switching.

(Fig. 3) the corresponding change in the oscillator frequency was 10-20,000 cycles (10-20 kc/s).

The complete circuit for a triode-hexode frequency changer employing two separate valves is shown in Fig. 4, in which details showing the ganging arrangements and an HF stage have been added.

It will be noted that a three-gang condenser is employed, the end section (oscillator) being completely insulated from the first two sections.

The conventional reaction coil system may be employed if desired, when an insulated end-section to the ganged condenser is not necessary, but difficulty may be experienced in making the circuit oscillate below 17 metres, unless separate reaction coils are employed.

It will be noticed that the VHT4 control grid lead is tapped down on its tuning coil, since the incidental capacities due to the HF valve, etc., would otherwise prevent correct ganging on the shorter waves.

Two series padding condensers are used in the oscillator circuit, one fixed, Range 1, and the other variable, Range 2; by this means the oscillator frequency is maintained at approximately 450 kc/s higher than the signal frequency at all points.

On Range 2, for example, the maximum capacity on C2 is 0.00015 mfd., frequency 5,000 kc/s, inductance 6.6 μ H.

Using the same value of inductance in the oscillator circuit, for 5,000 + 450 kc/s, the value of C3 must be 0.000127 mfd.

In order to reduce the value of the variable capacity (0.00015 mfd.) to this figure, a series padding condenser of 0.00083 mfd. would be required, i.e., a pre-set condenser of 0.001 mfd. max.; in practice this figure (0.00083 mfd.)

be sufficiently accurate in most cases, although the correct value may be worked out if desired.

Blessings of Radio Is Broadcasting Always "On the Side of the Angels"?

IN a recent leader *The Times* expresses the opinion that "There are few inventions which have so much to be said for them, so little against, as wireless telephony. Many can to-day be found who would willingly blow up Roger Bacon—or Schwartz,

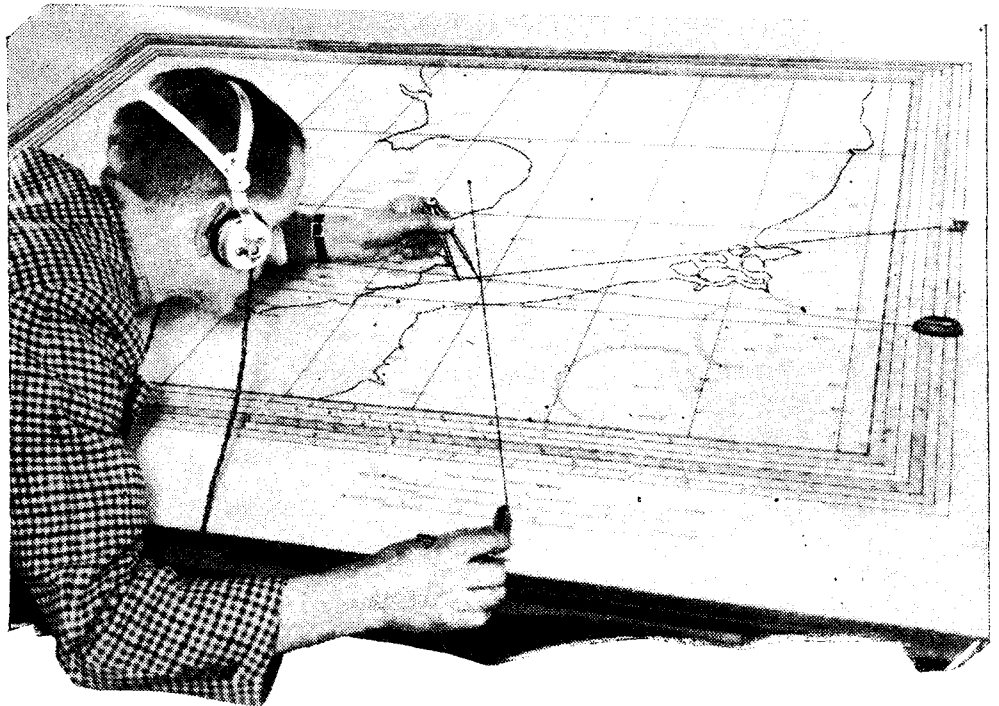

DF FOR AIRCRAFT. The Air Ministry DF station at Pulham, Norfolk, now gives assistance to cross-Channel pilots. Here is a wireless man at Pulham locating a plane's position with the aid of bearings from Croydon and Lympne, as well as from the plane direct.

Current Topics

Events of the Week
in Brief Review

Taxi Radio

PARIS taxi drivers may install wireless provided that the sets are not audible outside the vehicle. No extra charge may be made to passengers.

Television In Hollywood

ONE of the biggest television studios in the world is to be erected in Hollywood, according to Mr. Aylesworth, President of the National Broadcasting Company.

World Talks on Television

THE British Television Report appears to have fluttered scientific doves all over the world. Now comes the news that the Institute of Educational Cinematography has decided to set up an international committee, with European and American representatives, to discuss the problems raised by television. The meeting will probably be held in Rome.

American Radio in India

A CORRESPONDENT'S major impression of the recent radio exhibition in Bombay was of the large proportion of models of non-British manufacture. American sets predominated. These were mostly RCA types.

The preference in India is for all-wave sets, though this tendency may be less widespread when India has an efficient broadcasting system of its own.

Press Radio

AMERICAN newspapers are scrambling to obtain control of the broadcasting stations, and there are now exactly 110 among the 600 broadcasting stations in the United States which are owned or controlled by the Press. According to a correspondent, the most active publisher seeking wavelengths is William Randolph Hearst, whose subsidiary company, Hearst Radio Inc., already owns five important stations.

A Bi-lingual Problem

LISTENERS' strike is threatened in Norway against the tendency to use the literary language rather than the "landsmaalet," or country vernacular, for broadcasting. 25,000 listeners have refused to pay their licence fees when these become due in April.

Manchester Police Radio

MANCHESTER is to have a regional police wireless scheme. Local police wireless points will be under the direction of the central wireless station at the new police headquarters in Jackson's Row, Manchester.

Facing the Music

A LOUD speaker night will be observed by the Croydon Radio Society on Tuesday next, March 5th, when all types will be put through their paces and the audience asked to vote. Readers of *The Wireless World* will be welcomed. The meeting opens at 8 p.m. at St. Peter's Hall, Ledbury Road, South Croydon.

Boys' Wireless League

A BOYS' wireless league is being formed in Portsmouth. Mr. Parsons, of the Portsmouth Municipal College, who is organising the League, states that all boys interested in wireless and television will be welcomed at the monthly meetings, which will aim at guiding the boys in their experiments and acquainting them with current invention.

Tobacco and Bricks

BERLIN firm will probably secure the contract for building Bulgaria's new 100-kilowatt broadcasting station. The firm undertakes the work in return for Bulgarian tobacco to the value of 300,000 Reichsmarks and building materials to the same value. The remainder of the payment will be spread over a number of years.

If barter of this kind continues, says a French contemporary, artists will probably be paid fifty packets of cigarettes per hour. Alternatively, if the artist fails to please, the bricks would have their uses.

The Late Mr. Price

MR. H. D. PRICE, whose tragic death in the Baird Television studios last week was the subject of an inquest, was one of the leading members of the Radio Society of Great Britain, and, operating under the call sign of G6HP, he had many feats of long-distance transmission to his credit; and his death in the cause of the science to which he was devoted is regretted alike by trade and amateur associates.

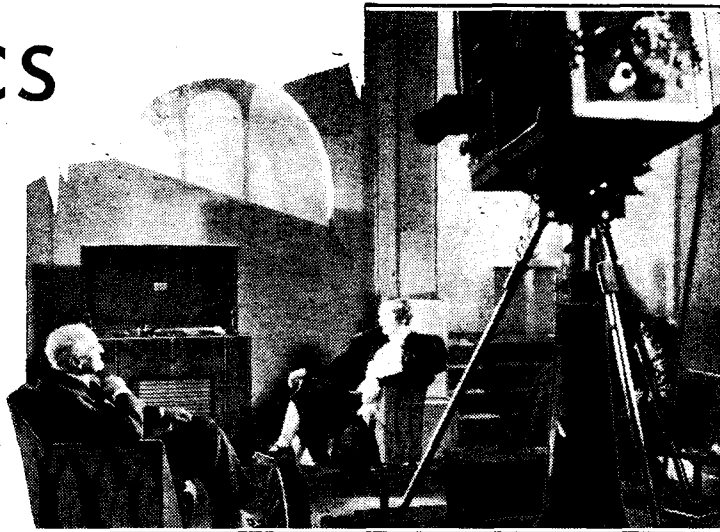

THE JUBILEE FILM. An H.M.V. High Fidelity Radiogram featuring in a scene from "Twenty-five Years a King"—the Pathe film which is being produced with the collaboration of John Drinkwater and Sir Austen Chamberlain. The family are seen listening to a speech broadcast by His Majesty.

Nearly Seven Million

AT the end of January British receiving licences numbered 6,888,730, an increase during twelve months of 764,260.

Pioneers Only

READERS in the Durham and Yorks area who have been interested in short-wave work since 1924 are invited to join a new Chapter of the Society of Wireless Pioneers. Enquiries should be addressed to Mr. R. W. Stewart, 8, East View Terrace, Seaton Carew, West Hartlepool.

Crystal Oscillators

CRYSTAL Oscillators for Radio Transmitters" is the title of a paper by Messrs. C. F. Booth and E. J. C. Dixon, B.Sc., to be read at a meeting of the Wireless Section of the Institution of Electrical Engineers on Wednesday next, March 6th, at 6 p.m. The meeting will be held at the Institution, Savoy Place, London, W.C.2.

Broadcast Organisation in France

LISTENERS have a say in the management of French broadcasting. According to the latest reorganisation plans, each broadcasting region will have its Association of Listeners, the annual meetings of which can be attended by all listeners who hold receipts for set licences. Each association will elect ten representatives to a Managing Council of twenty members which will concern itself with the provision of programmes.

The entire service will be united under a Superior Council comprising eminent persons representing the political, educational, and artistic life of the community, as well as delegates from the listeners' associations.

When Civil Servants Talk

THE New South Wales Government has decided that civil servants who receive fees for broadcast talks given in their spare time must pay one-fourth of such earnings to the Government. If talks are given in departmental time the Government claims three-fourths of the fees.

Scandinavia Calling

SCANDINAVIA is to present a common radio front to the world. At a meeting just held in Stockholm it was decided that the peoples of Norway, Sweden, and Denmark should co-operate in exchanging broadcast programmes during the coming year. A Scandinavian music festival is to be held in the autumn.

Pepping Up U.S. Radio

ARIVAL to the American N.B.C. and C.B.S. broadcasting networks is the American Broadcasting Company, which is setting up studios in the old headquarters of the National Broadcasting Company at 711, Fifth Avenue, New York, which the N.B.C. vacated more than a year ago to move into the ultra-modern Radio City. The company supplies sponsored programmes to about two dozen stations, mostly on the eastern side of the Continent.

With this additional competition American broadcasting promises to grow slicker and more "peppy" than ever.

France Takes Action

THE French struggle against man-made static took a new turn last week, when the Postmaster-General, M. Georges Mandel, nominated a special agent in each Department of France to investigate the cause of all interruptions to radio reception and to seek remedies.



A Censor for Singapore

ALTHOUGH they do contain occasional and inexplicable lapses from the path of moral rectitude, the B.B.C. programmes are usually such as to win the grudging approval of Mr. Stiggins himself. It is, therefore, surprising to learn that, if the B.B.C. programmes are relayed in Malaya, as has been proposed, it would be necessary to censor them. Such, at any rate, is the statement published in a native journal which a reader has been kind enough to send me.

The susceptibilities of the good Malaysians must, indeed, be tender if they can find any cause of offence in a talk on the habits of *cimex lectularius* or suchlike creatures. From a personal experience of places like Singapore, I should have thought that any people who could tolerate in their midst the somewhat broad humour found in certain cafés chantants in Malay Street would have no difficulty in encompassing the breadth of some of the so-called humorous items in the B.B.C. programmes, concerning which apologies have recently been forthcoming.

All About Television

NOW that the television report has been duly hatched out with the customary accompaniment of cacophonous cackles, the Press has busied itself with the usual wild rumours of what we shall see and what we shall not see.

One of the most fatuous announcements is that television will be widely used by candidates in the next general election. One ingenious scribe even goes so far as to describe a television electioneering van which he has been privileged to inspect. According to him the candidate will no longer take up his position on the tail-board of a van and attempt to harangue the mob in the market place. The van will still go down to the market place, but the candidate, instead of appearing in the flesh, will remain safely inside while his features are flashed by television on to a large translucent screen at the back.

This journalist must be particularly gullible, since it is obvious that television

UNBIASED

By FREE GRID

is not involved at all, the whole affair being merely a giant epidiascope. Even so, the thing is absurd, for even the average candidate would have the sense to stay at home and allow a talking film to do the dirty work.

The brightest notion of all, however, comes from a well-known writer in the Sabbath Press who states that, for the sake of poor people who cannot afford £50 for a set, a well-known manufacturer is turning out a "headphones" television receiver which will perform the same office for the impoverished looker of 1935 as the crystal set did for the impecunious listener of 1922.

Getting an "Eyeful"

Briefly, the idea is that the looker-in shall wear a pair of ocular "headphones," these permitting him to get the same effect from a picture about one inch square as from an eight-inch picture projected on to a screen, just as headphones enable a man to get the same mental effect out of a few milliwatts of sound cheaply produced by a crystal set as his more plutocratic neighbour gets out of a few thousand milliwatts produced by an expensive valve set.

The only fly in the ointment so far as I can see is that it requires just as expensive apparatus, in the shape of good valve receiver and other instruments, to produce the "headphone" as to produce the "loud speaker" picture. There is, however, one very big advantage in an "eyephone" set which was demonstrated to me some considerable time ago on the Continent, and I cannot help thinking that it was this which the Sabbatarian scribe has heard of; however, he has entirely missed the boat, since it is not economy which is its great virtue, but something quite different.

Everybody knows how much more realistic and plastic a stereoscopic photograph looks than one of the ordinary type. The apparatus which was demonstrated to me made use of this phenomenon. The looker peeps into an instrument bearing an appearance not greatly dissimilar to that of an ordinary stereoscope and the vivid picture which he sees is actually the product of two small pictures. To produce this stereoscopic effect everything has to be duplicated and two channels of communication used.

The space occupied in the ether is not necessarily doubled however, since, owing to the way the stereoscopic effect deceives the eye with its pleasingly realistic three-dimensionalism, it is possible to transmit a much less detailed picture—half the

number of lines in fact—and still get as good an effect as with a single picture of double the number of lines.

Debunking a Television Tale

WHENEVER a fresh form of popular entertainment is originated the daily Press always dishes up tales of romance which the new medium is alleged to have brought about. In the early days of the cinema several cases were reported of picture-goers suffering from severe heart trouble through gazing at the beauties of the screen; and several of these cases terminated fatally.

Similarly, when broadcasting first began we heard endless tales of Radio Romances. In one case, if I remember rightly, a wretched amateur transmitter in this country got himself entangled with a female ham in New Zealand after exchanging a few affectionate greetings *via* radio. He made unsuccessful endeavours, so the tale goes, to escape under a false name and bogus call sign, but the lady got to work with DF apparatus and soon located her quarry.

It is not surprising, therefore, that an ingenious scribe of the daily Press should use television as an opportunity for further romancing. The tale now goes that television gear was set up in a certain ship and the London station tuned in. On

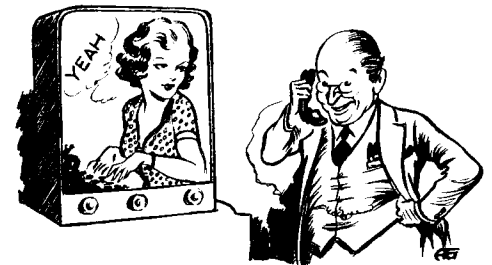

A foregone conclusion.

the screen appeared the features of the customary "pretty typist" (why, by the way, are typists always "pretty"?) A member of the audience whose name and photograph were published, straightaway rose from his seat and rang her up, *via* the ship's radiotelephone service, with a proposal of marriage. The result was, of course, a foregone conclusion.

Now this tale sounds very pretty and romantic, and no doubt thousands believed it. Indeed, I will go so far as to say that I might have believed it myself if the published photograph had not revealed to me the features of a very old acquaintance who had been engaged to the girl in question for some considerable time.



WEATHERPROOF MIKE. Dr. Bernhard Ernst, Cologne's well-known radio reporter, using a microphone protected by umbrella fabric.

Then . . .

BACK in the early days heart-rending cries would have greeted wavelength changes involving half a dozen British broadcasting stations.

"Paterfamilias" would have been busy in the correspondence columns of the daily Press, while "Mother of Eight, Peckham," might have called a dozen doughty pens to her aid in the Sunday papers.

The country would have been in a ferment, and deep down in his heart every Briton would have felt that he had been put upon.

. . . and Now

Yet the changes of last week brought only about thirty letters to Broadcasting House, and the opinions they expressed so nearly coincided with what a baby-in-arms might have predicted, that the Technical Correspondence Department, most long-suffering of all sections at Portland Place, grew quite petulant.

As for the opening of the new medium-wave Droitwich, it is sufficient to say that people living near Daventry reported weaker signals, and people living near Droitwich reported stronger signals.

Still Experimental

The surprisingly low field strength of the new Midland Regional is easily explained. Although the station has taken over the service, it is still experimental; the power is being gradually increased as the weeks go by, and it may not be until April or May that we can assess the station at its true worth.

Incidentally, this is a tactful way of introducing the transmitter to foreign listeners, who have an aversion for sudden

BROADCAST BREVITIES

By Our Special Correspondent

interference, though they will stand any amount on the instalment system.

All About the B.B.C.

FEW Command Papers have the picturesqueness of the B.B.C.'s Annual Report, which, although printed and presented in the by no means "magazine" style of H.M. Stationery Office, achieves a kind of West-End-on-a-Saturday-night effect in spite of itself, and holds the reader from the start to the climax.

Unfortunately, in the 1934 report, just published, it is the climax that disappoints.

Potholes

Skipping merrily along the paths of musical comedy, variety, drama and music, we are unprepared for the financial potholes on the penultimate page. Here it is revealed that "the Corporation has no adequate funds for meeting this future Capital Expenditure," and that "large appropriations of Revenue for this purpose will continue to be necessary." The purpose in question is none other than the provision of low- or medium-powered transmitters in North Wales and in the North, South and East of England.

Disappointing Regional Scheme

This is just one more exposure of the inadequacy of the Regional Scheme. If the B.B.C. had not been obsessed with the "Regional" idea a National distribution system would have been planned from the start. Now the intention appears to be a complex arrangement of patchwork transmitters to fill up the cracks until television requirements demand a national chain of ultra-short-wave stations.

However, let us hope that a typical regional station of the 1935 era will be preserved in the Science Museum.

Progress

In other ways the B.B.C. Report is a monument of inspired endeavour. The most abandoned pessimist could hardly deny that 1934 was a year of real progress, particularly in the conception and presentation of programmes.

Searching for a Name

ALTHOUGH the Guessing Competition has already started, no one, it seems, has got within shouting distance of the actual name of the new

B.B.C. chairman. Let this fact only spur us to greater efforts.

It is a mistake to say there are only a few names from which to choose. Thirty eminent persons attended Broadcasting House last week—members of the new Council of Thirty—and if we exclude the chairman, His Grace the Archbishop of York, there are still twenty-nine names to conjure with, including Mr. Lloyd George and Mr. George Bernard Shaw.

Former P.M.G.

A name very freely mentioned in connection with the chairmanship is that of Lord Selsdon, whose qualifications for the post are so compelling that one wonders where the snag can be, if any. As Sir William Mitchell-Thomson he was the Postmaster-General who opened Daventry 5XX in July, 1925,



LORD SELSDON (then Sir William Mitchell-Thomson, Postmaster-General) at the opening of Daventry 5XX in 1925. Behind him are Sir John Reith and Lord Gainford.

and thus saw the extension of broadcasting to cover nine-tenths of the country.

Masterly Report

Lord Selsdon's handling of the television problem, as chairman of the Postmaster-General's Committee, is testified by the masterly Television Report, and no one was surprised when he became, almost automatically, chairman of the newly formed Television Advisory Committee.

If and when this committee is disbanded, what then? Will Lord Selsdon and broadcasting part company?

Winter Sports and Television

ADMIRAL SIR CHARLES CARPENDALE cut short his annual Swiss holiday to attend last week's first full-dress meeting of the Television Advisory Committee, of which he is a member. The Controller of the B.B.C. forgoes a summer holiday, much preferring winter sports to sun-bathing.

But for the Television "date" both he and Mr. Ashbridge would have been in Geneva for the ordinary meeting of the International Broadcasting Union, at which the B.B.C. was represented this time by Mr. L. W. Hayes, Mr. C. F. Atkinson, and Miss Benzie, foreign director.

The Empire Orchestra

THE B.B.C. Empire Orchestra, which was formed at the beginning of December last, and has since been broadcasting regularly from the Empire Station at Daventry, particularly in the early morning and very late hours at night, will make its debut in home programmes on March 15.

On that date listeners to the Regional programme will hear a concert by the B.B.C. Empire Orchestra, which will simultaneously be broadcast in Transmission 4 of Empire Programmes.

An Unemployed Speaker

MR. ROGER POCOCK, who has organised the "Youth Looks Ahead" series of talks, describes as "brilliant" the script and style of delivery of Mr. William Kenworthy, aged 25, an unemployed man from Coventry, who gives a talk on Tuesday evening, March 5th.

Too Much

I HAVE sometimes suspected that broadcasters go pretty near the line in the medical, domestic and cookery talks. Now action has been taken in the case of the famous Vienna chef, Franz Ruhm, well known for his culinary talks at Radio Vienna. He has been forbidden by the Government to broadcast any more cookery causeries for having given away too many trade secrets.

It seems that the Viennese have now learnt to contract indigestion without professional aid.

New Apparatus Reviewed

Recent Products of the Manufacturers

PIFCO ROTAMETER

THE latest Pifco Rotameter is fitted with a moving-coil instrument, and includes the unique combined switching and scale-changing mechanism that was a feature of the earlier models. It provides eight ranges, four for voltage measurement, three for current and one for valve filament continuity tests and measurement of resistances. This scale is calibrated up to 50,000 ohms.

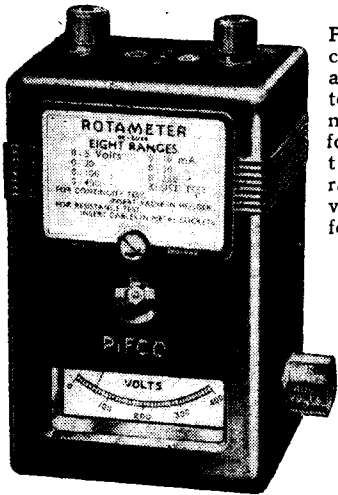

Pifco moving coil Rotameter, a universal DC testing instrument providing four voltage and three current ranges. Provision is made for measuring resistance.

The voltage ranges are 0.5, 0.20, 0.100 and 0.400, all for DC potentials, and the current scales read 0.10, 0.50 and 0.250 mA. The specimen tested exhibited a very high order of accuracy; on the voltage ranges measurements made with the Rotameter agreed very well indeed with those made at the same time with high-grade instruments, the discrepancy being about one per cent. only. It was found possible to measure current to within approximately three per cent. when compared with milliammeters having much more open scales. It is undoubtedly an achievement to obtain such accuracy in the limited space allotted to the scales, for they measure about 1½ in. long only.

This instrument should prove exceedingly useful to experimenters and also to broadcast listeners, as it provides the means for checking the DC voltages, currents and resistances in any type of receiver.

The makers are Pifco, Ltd., Shudehill, Manchester, and 150, Charing Cross Road, London, W.C.2, and the price is 42s.

FRANKS MICROPHONE

THE transverse current carbon microphone supplied by H. Franks, 23, Percy Street, Tottenham Court Road, London, W.1, is assembled in a polished aluminium case measuring 4½ in. × 3½ in. × 1½ in. Chromium-plated front and back plates are fitted, and it is suspended by rubber bands in a telescopic stand which, as a table model, can be extended from 14 to 24 in.

This is finished to match the microphone, so that the whole has a very attractive appearance.

The microphone has an exceedingly good frequency characteristic which, judged aurally, is sensibly flat from about 200 c/s to about 7,000 c/s. Above and below these limits the output falls off, yet there is an appreciable response at 50 c/s, whilst frequencies up to 10,000 c/s are in evidence. This, of course, takes into account the performance of the input transformer, which component accompanied the microphone.

Not only is its performance exemplary as regards reproduction of pure tone notes, but speech and other complex frequency sounds are as well reproduced by the Franks microphone as by any other microphone of similar pattern that we have tested so far. The microphone has a working resistance of 350 ohms, and when supplied with 8 volts passes 21 mA., as the primary resistance of the transformer is 24 ohms.

The microphone costs £2 15s., an extending table-type stand £1 2s. 6d., whilst a floor model costs £2 12s. 6d. and the special transformer 7s. 6d.

WEARITE SHORT WAVE COMPONENTS

MYCALEX, which is a very hard synthetic material having good HF properties, especially at the very high radio frequencies, is used in the majority of

Wearite short-wave HF chokes and valve holder assembled on Mycalex insulating material.

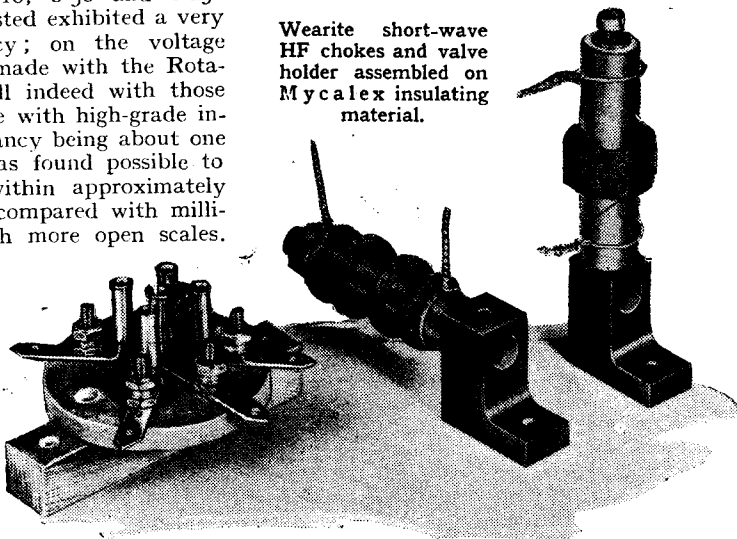

Wearite short-wave components. Their coils wound on formers of this material have already been reviewed in these pages and we have now had an opportunity of examining some short-wave HF chokes and a valve holder in which the same insulating material is employed.

The two chokes submitted are described as the types HF1 and HF2 respectively; the former has a four-section winding of small honeycomb coils, whilst the latter has a single section only. Their inductances are 870 microhenrys and 1,750 microhenrys respectively. The HF1, which costs 1s. 9d., may be said to have a useful range up to 100 metres, whilst the upper limit of the HF2, costing 1s. 6d., is 200 metres.

Franks transverse current microphone mounted in an extending table-type stand.

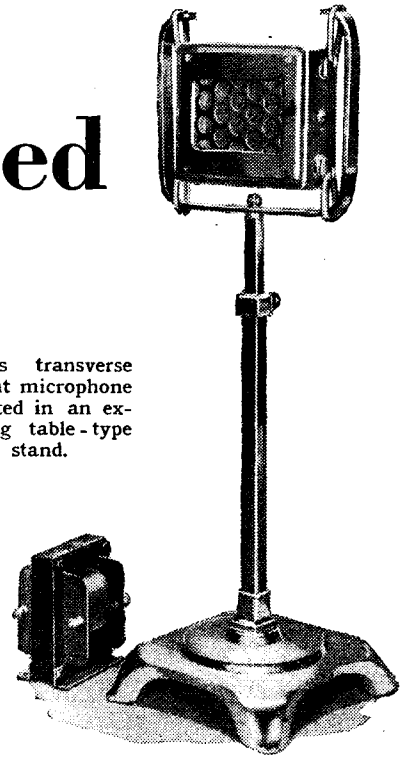

The Mycalex rod is screwed to an ebonite base and this may be fitted to bring the choke former horizontal or vertical as required. For the valve holder longitudinally split sockets are used and a block of Mycalex is attached to the base to raise it ½ in. above the chassis and so avoid undue capacity to earth when it is assembled on metal. The price is 1s. 3d. for a five-pin pattern.

The makers are Wright and Weaire, Ltd., 740, High Road, Tottenham, London, N.17.

AC MOTOR STARTING SWITCHES

SNAP action make-and-break switches designed for use with small Squirrel-Cage and Induction Start Synchronous-Run electric motors have been introduced by Claude Lyons, Ltd., 40, Buckingham Gate, London, S.W.1. These switches embody an interlocking double-lever mechanism which when pressed down to the "On" position makes both starting and running circuits, and on releasing the lever after the motor has gained speed one pair of contacts is returned by spring action automatically to the off position, thereby switching off the starting circuit. The momentary contact element is, of course, connected in the starting winding circuit.

Double- and triple-pole assemblies are made, and in the latter pattern two sets of contacts remain in the "On" position, whilst one pair automatically return to the "Off."

Claude Lyons triple-pole AC motor starting switch rated at 1,250 watts.

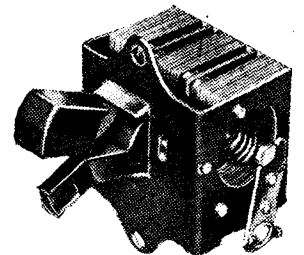

The mechanism is quite simple, but it appears to be perfectly reliable, and should prove trouble-free in use. Both models are rated at 1,250 watts, and the prices are, double-pole 6s. 6d., and triple-pole 8s. 6d.

Plotting Response Curves

Decibels Direct from the Slide Rule

By E. V. WAIT, B.Sc., B.E.

THE plotting of response curves, whether for loud speakers, audio amplifiers or transformers, is usually a laborious process. First, output voltage readings at a large number of frequencies are taken. The next, and perhaps the most tedious step, is to calculate in decibels the gain or loss in response at every frequency compared with the response at a standard frequency. It is with the object of reducing the labour of the calculations that the following slide-rule method of plotting response curves is suggested.

Let us take as an example the following set of readings which have been taken in experiments made in the development of midget speakers.

Frequency.	Microphone Amplifier Voltage.	Voltage Ratio.	Db.
110	10.9	0.58	- 4.6
120	11.3	0.6	- 4.4
140	15.0	0.79	- 2.1
160	23.0	1.22	+ 1.9
180	27.5	1.45	+ 3.3
200	35.7	1.89	+ 5.5
220	35.0	1.85	+ 5.4
240	34.0	1.8	+ 5.1
etc. to 400	18.9	1.0	0
etc. to 3,600	39.5	2.09	+ 6.4
4,000	2.64	0.139	- 17.1
4,500	22.5	1.19	+ 1.6
5,000	46.0	2.43	+ 7.9

frequency considered to the voltage at 400 cycles. Column 4 expresses this ratio of voltages in decibels. With the old method the response curve is plotted from columns 1 and 4. With the new method the calculation of columns 3 and 4 is unnecessary and we proceed as follows:—

Take a piece of logarithmic graph paper of the kind commonly used for plotting response curves. The lines parallel to the horizontal axis are drawn every tenth of an inch. Make a datum line to represent 0 decibels about half-way up the paper. Take a 5in. slide rule, and set the cursor to a reading on the upper fixed scale equal to the microphone amplifier voltage at 400 cycles (in our case 18.9 volts). The cursor should be left in this position throughout.

“ Gain ” and “ Loss ” Ratios

Now let us plot a point at 200 cycles at which frequency the microphone amplifier gave a voltage of 35.7. Move the slide until the hair line falls over a graduation of 35.7 on the upper sliding scale. Place the slide rule along the 200-cycle line of the graph paper with the end of the fixed rule level with the datum line, and mark off the point to be plotted on the 200 line, level with the end of the wood of the slide. (See Fig. 1.)

Fig. 1 also shows the plotting of a point at 4,000 cycles where the voltage ratio is less than 1, and the slide projects from the other end of the rule. If we plot points for all frequencies in this way we will have an accurate response curve to the scale of 8 decibels to the inch. The decibel scale on the graph paper can be numbered accordingly.

A response curve to the scale of 4 decibels to the inch, such as would be useful in describing the characteristics of an audio frequency transformer, can be plotted by using the upper scales of a 10in. slide rule and making the vertical scale on the graph paper read 4 decibels to the inch. A scale of 2 decibels to the inch can be obtained

by using the lower slides of a 10in. rule. The theory on which the method is based is as follows.

If we set the cursor of a 5in. slide rule

It is customary to present frequency response characteristics on a decibel or logarithmic basis, and since the slide rule is itself divided on a logarithmic scale it can be conveniently employed for the direct plotting of curves without intermediate steps of calculation.

to graduation 18.9 on the top fixed scale, the hair line is distant $2.5 \log 18.9$ inches from the zero point on the top fixed scale, and $2.5 \log 18.9 + A$ inches from the end of the wood. (Fig. 2.) If we move the slide until graduation 35.7 on its top scale coincides with the hair line, then the hair line is distant $2.5 \log 35.7$ inches from the zero point on the top sliding scale, and $2.5 \log 35.7 + A$ inches from the end of the wood of the slide. Consequently the end

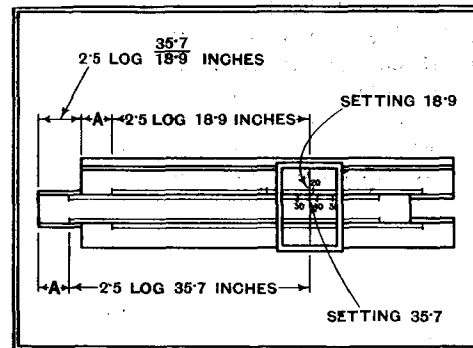

Fig. 2.—Illustrating the principle underlying the use of the slide rule for plotting decibel curves.

of the wood of the slide is distant $(2.5 \log 35.7 + A) - (2.5 \log 18.9 + A)$ inches from the end of the wood of the fixed scale. The length that the slide projects beyond the end of the rule is therefore $(2.5 \log 35.7 + A) - (2.5 \log 18.9 + A)$ inches $= 2.5 (\log 35.7 - \log 18.9)$ inches $= 2.5 \log \frac{35.7}{18.9}$ inches

If the voltage rises from 18.9 to 35.7 the gain in decibels is

$$20 \log \frac{35.7}{18.9}$$

or 8 times the length in inches that the slide projects beyond the end of the rule.

If the settings of the cursor and slide had been made on the upper scales of a 10in. slide rule then the length which the slide projected would have been

$$5 \log \frac{35.7}{18.9}$$

and the gain in decibels would have been four times this length.

It should be noted in conclusion that a slide rule in which the slide is exactly the same length as the body is essential; and those rules in which the slide is foreshortened to accommodate a pointer for auxiliary scales in the middle channel cannot be used.

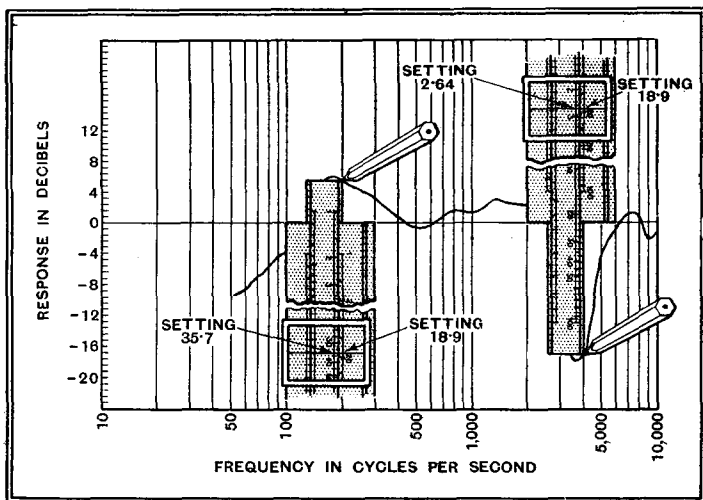

Fig. 1.—Examples of the method of setting the slide rule (left) for points higher in value and (right) lower in value than the output equivalent to zero decibels.

In using the old method of plotting response curves columns 3 and 4 have to be calculated. Column 3 gives the ratio of the microphone amplifier voltage at the

Listeners' Guide for Outstanding Broadcasts at Home



WILHELM BACKHAUS, solo pianist in Schumann's A minor concerto, to be played in the B.B.C. Symphony Concert at the Queen's Hall on Wednesday next. Sir Hamilton Harty conducts. (H.M.V. photo.)

RICHLY VARIED

"COLOURFUL"—the American publicity agent's favourite adjective for Palm Beach, molasses, Beethoven, gasolene and what not—really does describe the coming week's B.B.C. programmes. If the once-mooted loud speaker colour attachment, working in sympathy with programme moods, were now in vogue, the spectrum would be very thoroughly exploited, for in seven short days we shall range from the St. David's Day celebrations to "Pagliacci," from the Peace Ballot to "Ambrose Applejohn's Adventure."

BRITISH MUSIC

WHETHER because of Jubilee Year, or because buying British is fashionable, the B.B.C. is now giving home-produced music a well deserved airing. To-morrow (Saturday) (National, 10) Joseph Lewis conducts Section C of the B.B.C. Orchestra in works by German, Elgar, Haydn-Wood and Geoffrey Shaw; while the Sunday Orchestral Concert (Regional, 9.20), directed by Adrian Boult, will comprise the works of Holst, Delius and Bax. May Harrison (violin) and Lionel Tertis (viola) will play.

30-LINE TELEVISION

Baird Process Transmissions
Vision, 261.1 m.; Sound, 296.2 m.

SATURDAY, MARCH 2nd,
4.30-5.15.

Hermione Gingold (impressions);
Georgie Harris (stage and screen
star); Max Kirby (songs);
Sydney Jerome's Quintet.

WEDNESDAY, MARCH 6th,
11-11.45.

Renée de Vaux (character sketches);
Elinor Shân (mimes and dances);
Navarre (impressions of famous
singers).

SAAR DAY IN GERMANY

TO-DAY (Friday) is unique in German broadcasting, for from 5.30 a.m. onwards all stations in the Fatherland are bonded in a simultaneous transmission celebrating the return of the Saar. Each station is in turn contributing its

Frederick Leister as Pelletier and Frederick Peisley as his son, Jacques. Dino Galvani plays Emile, the valet, and Margarita Scott plays Madeleine.

AMBROSE APPLEJOHN

"CHARLES HAWTRY in 'Ambrose Applejohn's Adventure,'" is one of those rich theatrical memories like "Irving in 'Hamlet,'" or "Phelps in 'Macbeth.'" A broadcast version by Lance Sieveking will be heard on Thursday next (National, 8.15) with Esmé Percy in the name part. This Arabian Nights' entertainment will be "complete with hidden treasure, maidens rescued from desper-

and Abroad

BURLESQUE

BURLESQUE, being founded on ideas rather than slapstick action, rarely fails at the microphone, so "Telling the World," a musical burlesque of Fleet Street, by L. du Garde Peach, on Tuesday (National, 8) and Thursday (Regional, 9), should make a hit. The music is by George Barker. The scene is a newspaper office in which all employees are members of the aristocracy. Nita Nitwit will be played by Miriam Ferris and Lord Ullidge by Alfred Wellesley. Fortunately, the "man-in-the-street" gets a look in in the person of Edgar K. Bruce.

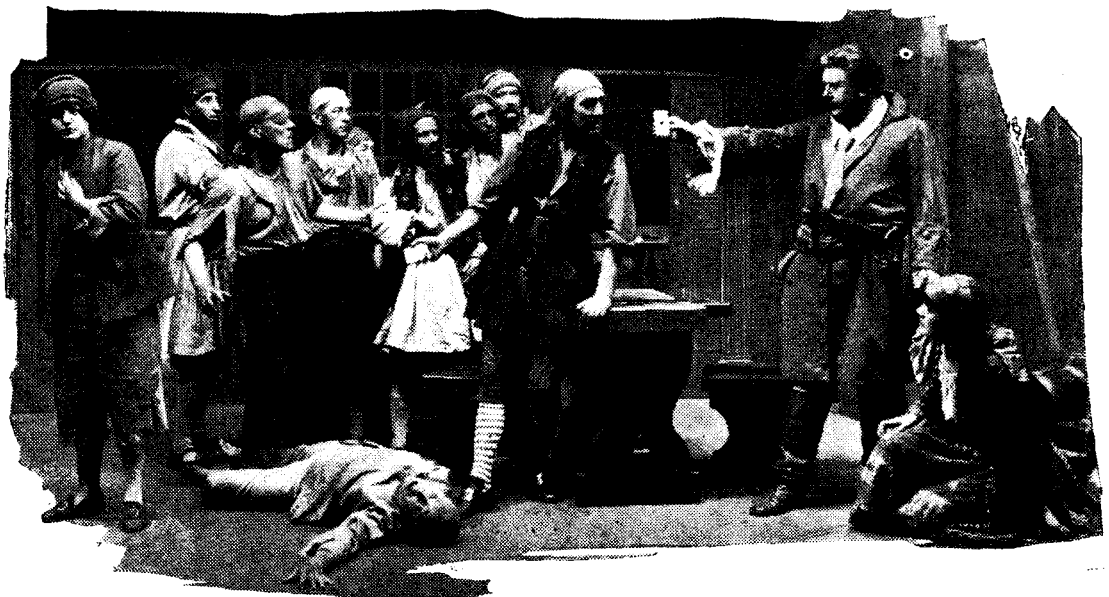

A BREATHTAKING MOMENT in "Ambrose Applejohn's Adventure." The picture shows the late Sir Charles Hawtrey in the name part when the comedy was first produced at the Criterion Theatre some ten years ago. The play is to be broadcast on Thursday next (Nat., 8.15).

quota to the etheric concert, culminating in a relay by Frankfurt of a great demonstration at Saarbrücken at 7 p.m. From 9 until midnight the Deutschlandsender is offering special dance music.

THRILLER

ALL who delight in the closely knit dramatic thriller should tune in Sacha Guitry's "Two for Dinner," which is billed in the National programme for 9 o'clock on Monday next. The characters in this Grand Guignol drama are

ate characters, love at first sight, and midnight alarms."

SMETANA

PRAGUE is remembering the birthday of the great Czechoslovakian composer, Smetana, to-morrow night (Saturday) by relaying his opera, "The Bartered Bride," from the Scala, Milan, from 8 till 11. On the same day, from 6.55 to 7.30, Brussels No. 1 gives a concert of Smetana music on records.

Smetana was born on March 2nd, 1824.

OPERETTA

SACHA GUITRY, the dramatist, appears as opera librettist in "S.A.D.M.P.," the one-act operetta by Beydts, to be broadcast by Paris PTT to-night (Friday) at 8.30. Preceding this operetta will be Thomas' two-act operetta, "Le Caid."

Kalmán's tuneful operetta, "A Kiss in Spring," will be relayed by Budapest to-morrow night from 7.10 to 9.15, and will be followed by an hour of typical gypsy music.

the Week ★ ★ ★

EARLY WAGNER

Wagner's first operatic work, "Das Liebesverbot" ("Forbidden Love"), will be relayed from a Vienna theatre by Radio Paris to-morrow night (Saturday) from 7.45 to 9.30. Vienna relays the same opera the following evening at the same time. First produced at Magdeburg on March 29th, 1836, "Das Liebesverbot" is based on Shakespeare's "Measure for Measure."

CARNIVAL

At this time of year the carnival spirit grips most of Europe.

To-morrow night (Saturday) Leipzig relays a carnival programme from the zoo. We are told to look forward to an augmented choir of 3,000 singers. Munich and Leipzig have a carnival programme on Sunday from 6 to 8.30, and the same stations on the following evening relay a carnival ball in the Frankfurt Broadcasting House between 9.30 and 11 p.m. In Germany the celebrations reach their height on Tuesday, and listeners who want to obtain an excellent idea of the fun should



"THEATRE ROYAL," at the Lyric, is the play from which a scene will be broadcast this evening (Friday) on the Regional wavelengths at 7.30. In this scene are Madge Titheradge, Marie Tempest and Robert Douglas, who come to the studio to-night.

tune in Cologne, Munich and Frankfurt between 7 and 12.

VIENNA, PARIS, ROME

TO-MORROW night (Saturday) Vienna keeps step with the times by giving Johann Strauss' operetta, "The Carnival in Rome." Then on Tuesday all French State stations, except Radio Paris, broadcast a concert epitomising the carnival spirit in Europe.

A FORGOTTEN OPERA

HANDEL probably wrote more forgotten operas than any other composer, living or dead. One of them, "Rodelinda," will be revived, scene by scene, next week in the "Foundations of Music" series. The music of these early operas is always unmistakably Handelian, and although there is a touch of sameness about them, taken singly they are delightfully stimulating.

SYMPHONY CONCERTS

AMONG the more promising symphony concerts is that from Radio Paris at 7 on Thursday, March 7th. In a programme of Belgian music the National Orchestra will play Vieuxtemps' Violin Concerto No. 5, with Béthune as soloist.

During the same period Kalundborg offers its twenty-first Thursday concert. This includes the Bach Cantata No. 67, given by the Radio Symphony Orchestra and the State Radio Choir conducted by Fritz Busch.

PEACEFUL FIGHT

THERE will be no mincing of words when the Rt. Hon. Viscount Cecil of Chelwood, K.C., D.C.L., LL.D., and the Rt. Hon. L. S. Amery, M.P., meet on Monday evening to debate the Peace Ballot (National, 10.5).

THE AUDITOR.

HIGHLIGHTS OF THE WEEK

FRIDAY, MARCH 1st.

Nat., 8, St. David's Day Programme. 8.45, Geraldo and His Sweet Music. 10.20, B.B.C. Orchestra, Section D, conducted by Leslie Heward.

Reg., 7.30, "Theatre Royal." 8.45, B.B.C. Bach - Handel Chamber Concert.

Abroad.

Huizen, 7.45, Oratorio "Belshazzar" (Handel).

SATURDAY, MARCH 2nd.

Nat., 7, "In Town To-night." 7.30, Leicester Brass Band Festival. 8.30, "Music Hall." 10, British Composers' Concert (B.B.C. Orchestra, Section C).

Reg., 8, Conversations in the Train-IX. 8.20, Recital by Bernard Shore (violin) and Angus Morrison (piano). 9.20, "Pagliacci" (Leoncavallo).

Abroad.

Radio-Paris, 9.30, Opera: "La serva padrona" (Pergolesi).

SUNDAY, MARCH 3rd.

Nat., 1, Scottish Studio Orchestra. 4, Organ Recital by G. D. Cunningham. 5.30, The Lener Quartet. 9, Albert Sandler and the Park Lane Hotel Orchestra. 10, The Wireless Military Band.

Reg., 5.30, Band of H.M. Grenadier Guards. 9.20, Sunday Orchestral Concert: B.B.C. Orchestra (Section B).

Abroad.

Kalundborg, 7.15, Danish Romantic Music.

MONDAY, MARCH 4th.

Nat., 8, Leonard Henry's Concert Party. 9, "Two for Dinner," by Sacha Guitry. 10.5, Peace Ballot Discussion: Viscount Cecil and Rt. Hon. L. S. Amery, M.P. Reg., 7.15, Henry Hall and the B.B.C. Dance Band. 8, The B.B.C. String Orchestra. 9, Folk Songs from Many Lands.

Abroad.

Warsaw, 9.15, Polish folk music.

TUESDAY, MARCH 5th.

Nat., 8, "Telling the World." 9.20, Chopin Nocturnes by Cecil Dixon (piano). 10, "News from America."

Reg., 8, Recital by Miriam Licette (soprano) and Shepherd Munn (piano). 9, B.B.C. Theatre Orchestra.

Abroad.

Kalundborg, 7.2, Ballet Music.

WEDNESDAY, MARCH 6th.

Nat., 7.30, B.B.C. Variety Orchestra in Musical Comedy and Film Selections. 8.30, B.B.C. Symphony Orchestra at the Queen's Hall.

Reg., 8, National Dances by the Wireless Military Band. 8.40, Comic opera excerpts.

Abroad.

Toulouse, 9, Opera: "La Basoche" (Messager).

THURSDAY, MARCH 7th.

Nat., 8.15, "Ambrose Applejohn's Adventure."

Reg., 7.15, "Divertissement." 8.15, Reginald King and His Orchestra. 9, "Telling the World."

Abroad.

Brussels II, 9, Gustav Mahler Concert.



CARNIVAL SPIRIT permeates the European ether this week. French stations take part, and Radio Côte d'Azur gives a commentary on the Nice carnival, at which this picture was taken.

H.M.V. High-Fidelity Auto

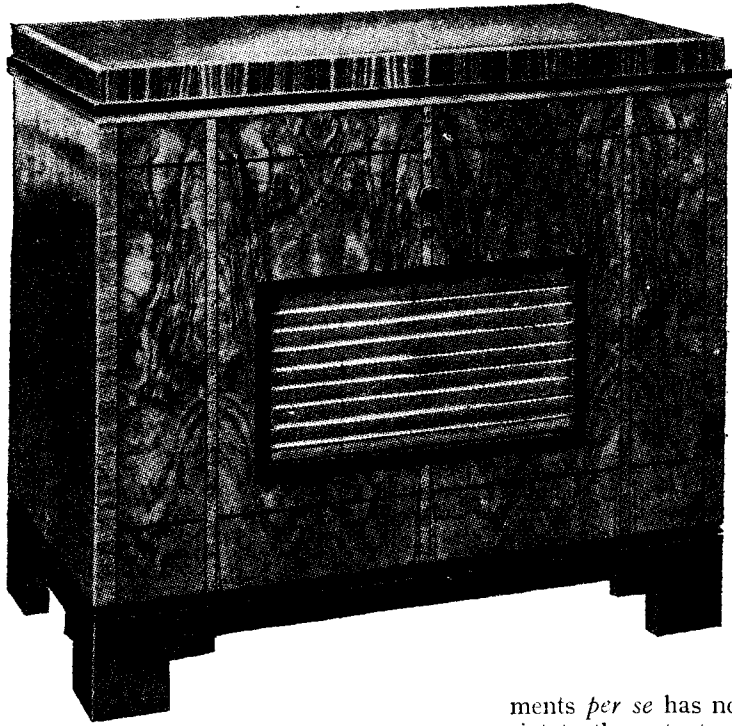

An Instrument of Wide Scope and Exceptional Refinement of Performance

FEATURES.—Type.—Superheterodyne radio gramophone for AC mains. **Circuit.**—HF amplifier—medium- and long-wave oscillator—short-wave oscillator—var.-mu screen grid first det.—1st IF amplifier—IF amplifier for AVC—metal oxide AVC rectifier—double-diode-triode quiet tuning valve—2nd signal IF amplifier—double-diode-triode second detector—LF amplifier—contrast amplifier—push-pull-triode output valves.—Parallel full-wave valve rectifiers. **Controls.**—(1) Tuning, with neon indicator. (2) Waverange switch. (3) Selectivity and contrast control. (4) Volume Control. (5) Tone balance control. (6) Threshold sensitivity control. (7) Record-changer controls, including reject button. **Price.**—110 guineas. **Makers.**—The Gramophone Co., Ltd., 98-108, Clerkenwell Road, London, E.C.1.

ADVANCES, both in superheterodyne circuit design and in the technique of high-quality reproduction, have been both numerous and rapid during recent months, and the H.M.V. model 800 may safely be said to epitomise the present state of our knowledge of the art of electro-acoustic entertainment. It is, however, characteristic of this instrument as an H.M.V. product that enthusiasm for technical improve-

ments *per se* has not been allowed to run riot to the extent of creating any suggestion of fierceness in the performance. The range and sensitivity of the radio receiver is kept well in hand by an elaborate QAVC system, the loud speakers are muted during all changes of circuit by means of the control switches, and the audio-frequency range, while extending high enough to give reproduction which will prove a revelation to most people, has not been made so wide as to introduce or over-emphasise alien noises which are so often

the accompaniment of so-called high-fidelity reproduction.

The maximum frequency response is from 40 to 8,000 cycles, but this, of course, can only be used under favourable circumstances. A switch is provided giving three other alternative frequency ranges up to 7,000, 5,000, and 3,000 cycles respectively. The frequency response is restricted by altering the band width of the HF and IF circuits and is not accomplished wholly by tone-correction in the L.F. stages, as is sometimes the case.

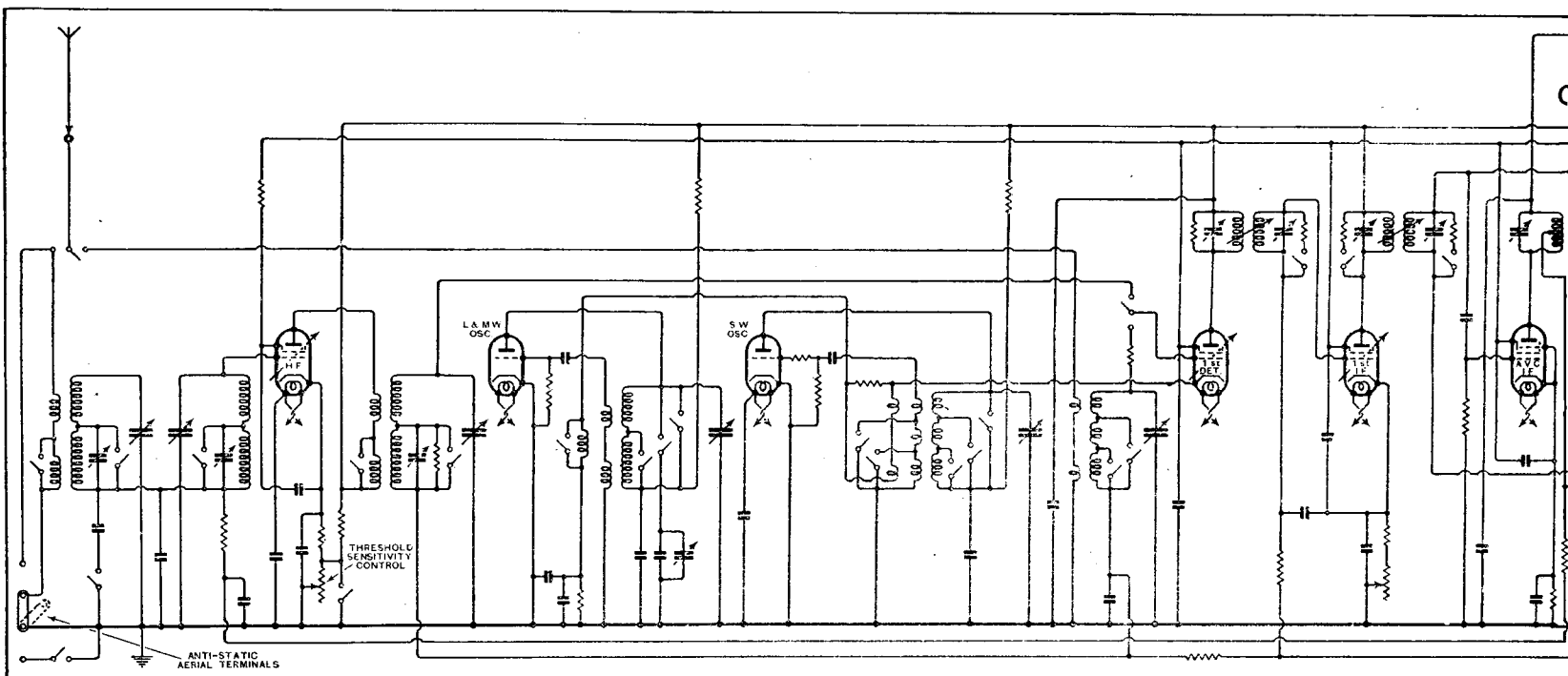

Separate valves are assigned to every function of the circuit, and interesting features are the special IF amplifier feeding the

radiogram

MODEL 800

AVC is in operation on all four ranges, but the Q valve, providing noise suppression between stations, does not operate with the switch in the most selective position. In the two high-fidelity positions (7 kc/s and 8 kc/s) the point at which the noise suppression control comes into operation can be pre-set by means of a graduated knob at the back of the cabinet.

In association with the selectivity control is a switch for bringing into operation the contrast amplifier. This is a device for increasing the volume range between pianissimo and fortissimo passages in orchestral music, and is brought into action by depressing the knob of the selectivity control.

Five Wave Ranges

The waverange switch is mounted immediately above the tuning scale and operates a shutter which uncovers the appropriate scales. A high-ratio slow-motion drive is provided, and the tuning knob carries a small handle for rapid exploration of the tuning range. The neon tuning indicator is mounted in a recess in the tuning scale escutcheon plate. In addition to the normal medium- and long-wave broadcast ranges there are three short-wave ranges covering wavelengths from 13 to 80 metres.

The circuit diagram looks rather complicated, but this is only because separate valves have been assigned to many of the

functions which in cheaper sets are performed by multiple-purpose valves. The aerial input is connected through a band-pass filter to a signal frequency HF stage on the medium- and long-wave ranges, and directly to the input of the first detector on the three short-wave ranges. Separate triode oscillators are used for short waves and for the normal broadcast wave-lengths, and the first detector is a variable-mu screen-grid valve.

Following the first detector is the first IF amplifier, the transformers associated with which are provided with variable coupling, controlled by the selectivity switch. This switch also controls the coupling of the aerial band-pass filter and also the damping of the IF transformers.

The output from the first IF amplifier branches, one path going through a second signal IF amplifier to the double-diode-triode second detector and the other through a separate pentode IF amplifier for operating the AVC and Q circuits.

The pentode valve has a high input impedance, and there is no detrimental loading of the signal amplifier circuits. The AVC rectifier is a Westector fed from the broadly tuned primary of the AVC IF transformer. (A second Westector acts as a limiting device to by-pass surges which might be of too short a duration to operate the AVC system.) The highly selective litz-wound secondary, on the other hand,

is used to operate the Q valve. Consequently, this circuit is not opened until the exact tuning point for any given station is approached. Hence, not only is side-band shriek eliminated but the neon tuning indicator, which derives its voltage from the Q valve, functions with unusual rapidity and precision. The delay voltage for the

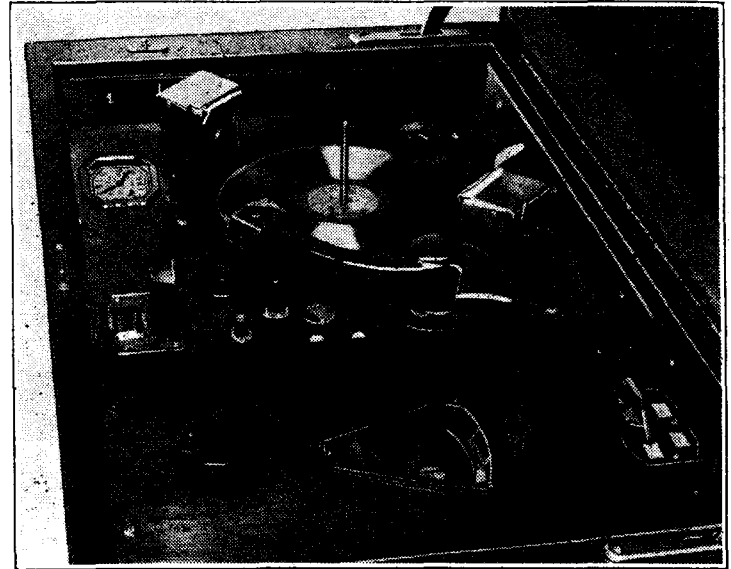

General view of the control panels. The motor board is spring-suspended.

AVC is derived from the main HT potentiometer and is given a different value for short waves. The time constant is also made much shorter than usual, to cope with the rapid fading which is often experienced on short wavelengths.

With regard to the operation of the Q valve, we cannot do better than quote from the handbook issued by the Designs Department of His Master's Voice: "The Q circuit is made to have greater selectivity than the signal so that as a station is tuned in it is not audible until almost the centre of the carrier wave is reached. This means

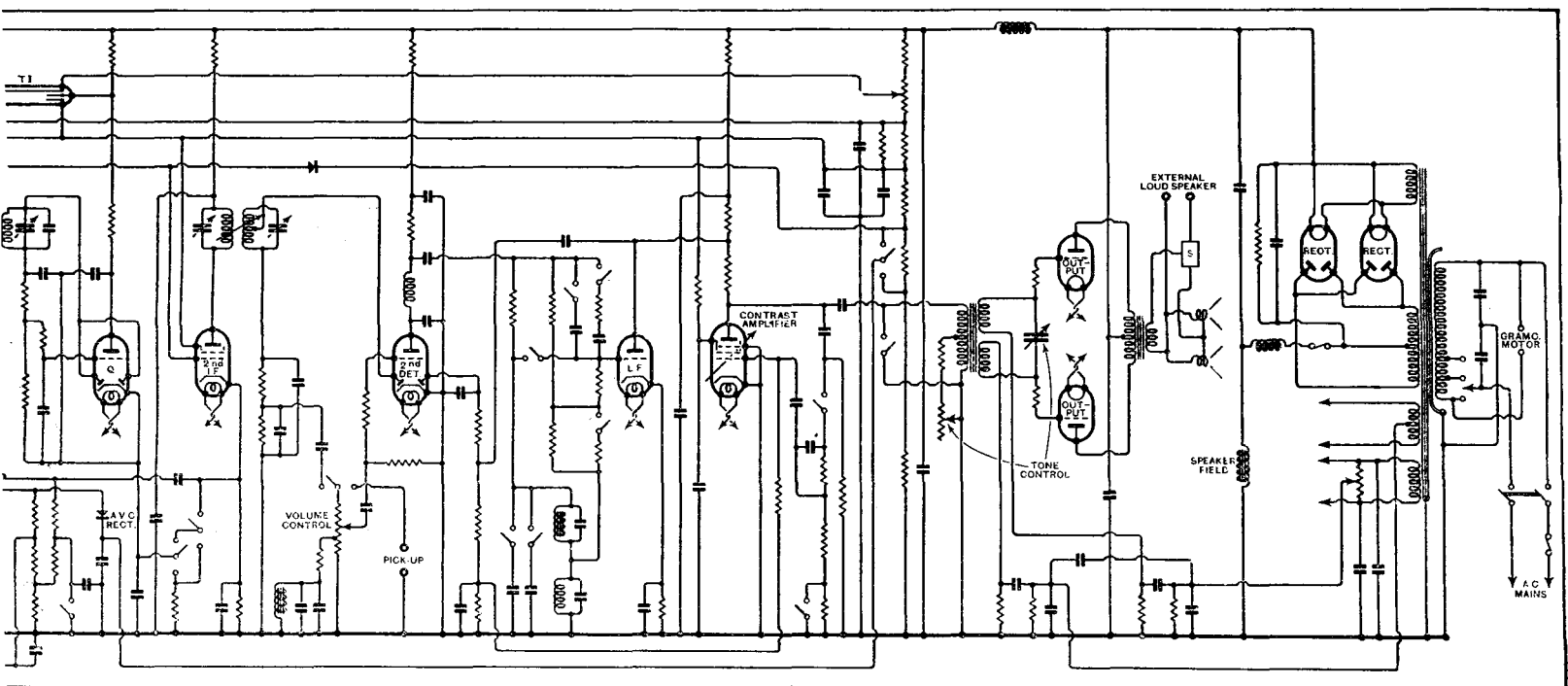

AVC, noise, suppression and tuning indicator circuits, the duplicated oscillator valves, and the volume contrast amplifier.

H.M.V. High-Fidelity Autoradiogram—

that mistuning of a station (resulting in shrill side-band reproduction) is impossible when the Q action is operative. Whilst there is no signal the triode portion of this valve has no negative bias, and an anode current of some 10 milliamperes flows. As this current also flows through the cathode bias resistance of the second signal channel IF amplifier, the latter valve is biased back beyond its cut-off point, and no signal is passed on to the second detector. When, however, a signal is received the sharply tuned secondary of the AVC IF transformer feeds the diodes of the Q valve, which rectify and supply a negative grid voltage to the triode portion of the valve. This cuts the anode current down to a negligible value, and thus re-

the output from the anode circuit of the contrast valve is fed back out of phase to the grid, and the constants of the circuit are arranged so that the effective impedance of this valve decreases as the signal input decreases. As a result the loud passages remain unchanged, but quiet passages are further reduced in volume.

Tone Control

The manual tone control is associated with the push-pull transformer feeding the output valves, and consists of a variable capacity across the secondaries for high-note reduction, ganged to a shunt across one-half of the primary for bass reduction. The control knob is fitted with a notch which enables the user rapidly to

handling capacity, but the distribution of sound extends over a much wider angle in the front of the cabinet. Composite cones with thin metal centres are employed to ensure a sustained response up to 8,000 cycles, while the suspension permits the development of really large amplitudes in the bass without the necessity of resorting to bass resonances.

The general impression of the quality is one of breadth of tone, in which the whole range from 40 to 8,000 cycles is filled out without resonances, but, more important still, without the troughs which often occur in the middle of the frequency range in otherwise quite excellent loud speakers. Much of the credit for the absence of unnatural bass must go to the cabinet designer, who has produced a model which is at the same time acoustically solid and pleasing to the eye.

The radio performance is notable for its versatility, for not only can extreme range and adjacent channel selectivity be obtained with the selectivity control in the 3 kc/s position, but the receiver in other positions of the switch can be left to itself to choose only those stations which are likely to give a satisfactory programme from the quality point of view.

The short-wave ranges are lively, and productive of a very wide choice of interesting transmissions. The scales are calibrated in wavelengths, and those bands which are occupied by regular broadcast transmissions are clearly indicated. Incidentally, the sensitivity of the set in the vicinity of 19

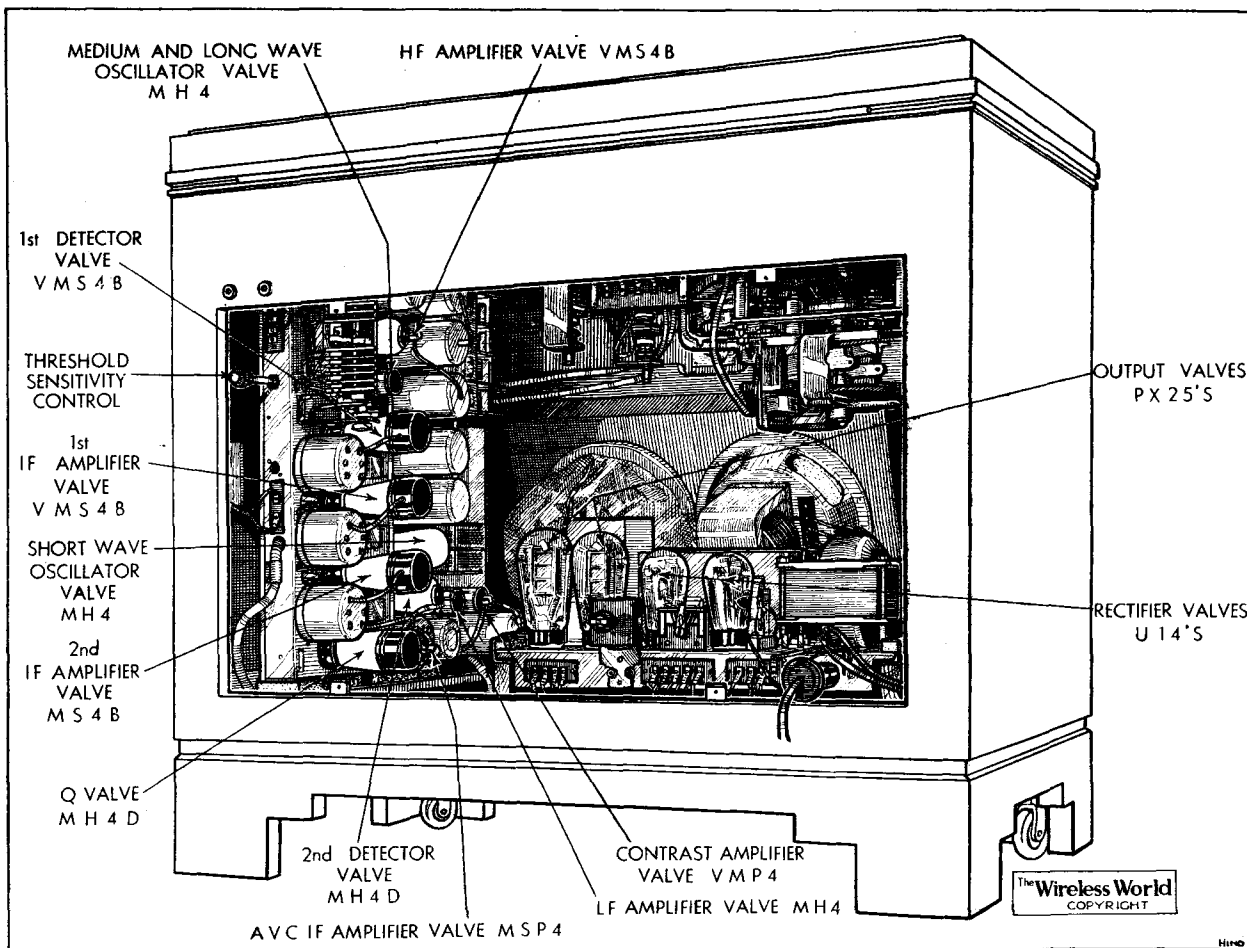

General view of the interior. The parallel loud speakers have identical characteristics, but the right-hand unit is energised and the left-hand has a PM field.

leases the heavy biasing voltage from the second IF signal channel amplifier. The neon fluid-light indicator is associated with the anode circuit of the Q valve and therefore is very selective and gives an exact indication of resonance."

The double-diode-triode second detector, which is quite straightforward, is followed by a triode second LF stage in which there is a certain amount of bass correction and also high-note correction for side-band cutting. The output from this stage is connected through a push-pull transformer to the power valves, and the contrast valve functions as a variable shunt across the primary of this transformer. A portion of

regain the normal level response.

The push-pull PX25 output valves are capable of delivering 10 watts with less than 5 per cent. distortion. Twin loud speakers are provided to handle this output and it is interesting to note that, whereas in most modern designs intended for high-fidelity reproduction one loud speaker is called upon to handle the bass and the other the treble, in the Model 800 the frequency characteristics of the two units are identical. The only difference is in the field magnets, one of which is of the permanent-magnet type and the other mains energised. Not only does the combination of the two units give increased power-

metres and 31 metres, which are used by some of the more important American stations, has been increased. The instruction book also contains a most useful table showing the wavelengths on which distant transmissions are most likely to be found at different times of the day, and also in summer and winter.

Great attention has been given to detail in the design of the gramophone portion, to ensure that the quality of reproduction from modern recordings shall be comparable with the radio performance in this respect. The record changer, which is capable of handling up to eight 10in. or 12in. records has been speeded up in

H.M.V. High-Fidelity Autoradiogram—

operation, and the complete mechanism is spring-suspended to prevent the transmission of the slightest vibration to the cabinet and valves. The heavy cast-iron turntable is belt driven from an induction motor to ensure absolute constancy of speed. The pick-up is of a special high-fidelity type, and a rather larger counter-balance weight than usual is employed, as this pick-up requires a needle pressure of only 2 oz. compared with the standard pressure of 5 oz.

The contrast control valve can be brought into operation on gramophone as well as on radio reproduction. The real pianissimos which every conductor strives to obtain from an orchestra, but which can never be recorded in the normal way on account of surface noise, are obtainable from this instrument with the real atmosphere of the concert hall.

Space does not permit a complete inventory of all the minor refinements of the instrument, but as an instance the synchronous electric clock with interior illuminated dial may be mentioned as an example.

One of the side panels of the cabinet is removable for inspection of the chassis, and a lamp-holder, wired directly to the mains, provides for internal illumination of the cabinet when making adjustments. Incidentally, the services of a specially trained engineer are available to those purchasing one of these sets when the instrument is installed.

A hundred and ten guineas is a high price to pay for a radio-gramophone, but those who must have the best can be sure of a very generous return for this expenditure in the wide scope of entertainment provided by this instrument and the undoubted refinement of its performance.

**AN IMPORTANT
NEW FACTORY**

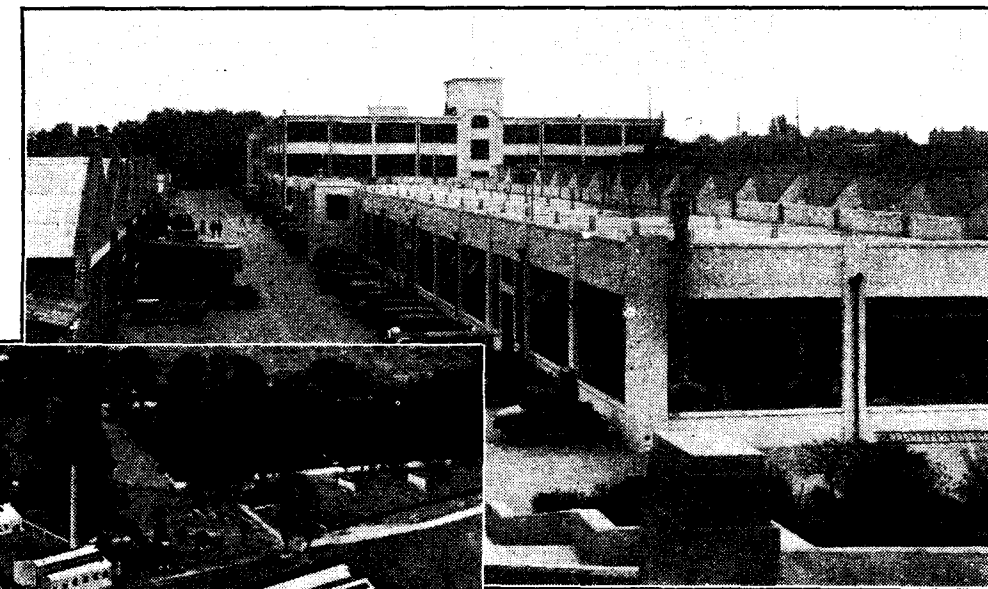
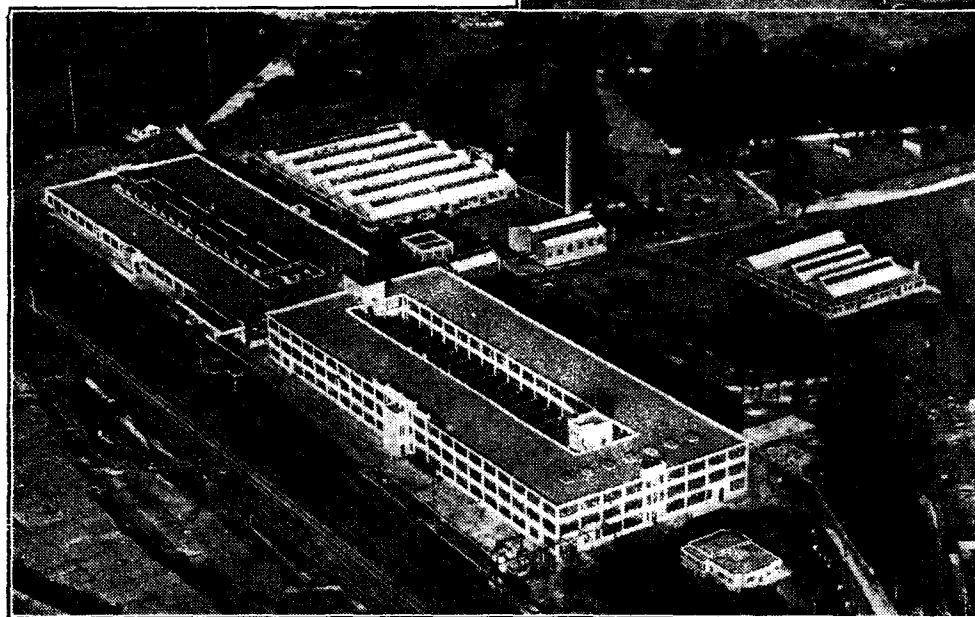

The accompanying photographs show the general site, and a near view of one of the buildings, of the new factory of Standard Telephones & Cables, Ltd., at New Southgate.

The total floor space at present built is 365,000 square feet, and 3,300 are employed. The ultimate plans provide for an area of 1,000,000 square feet.

A smaller factory has been submerged in the new building scheme and nothing has been allowed to stand in the way of most up-to-date and efficient planning.

The activities of the new factory embrace all telephone and radio equipment, the manufacture of transmission equipment, cables and valves being still carried on at Woolwich.

Television Wavelengths and Aircraft

An Authoritative Letter Quoted

AN interesting letter from Mr. R. P. G. Denman, of Heston Airport, on the subject of wavelengths for aircraft communication appeared in a recent number of *The Times*. Now that wavelengths for television are being so much discussed, it is of particular interest to publish in full the text of this letter. Mr. Denman says:—

"In the British Air Number of *The Times* I called attention to the serious shortage of wavelengths for aviation wireless communications. On this matter world agreement cannot be reached until the next Telecommunication Conference meets in Cairo in 1937. Without some earlier improvement, however, our internal air routes cannot expand freely.

"A single television transmission occupies as much of the wavelength spectrum as eighty separate radio telephone conversations. Less than one-tenth of this number, however, is at present available for all communications between ground and air.

"The Postmaster-General (who controls all purely internal wireless services) has already shown that he is alive to the significance of civil aviation development by the grant of air mail contracts. As an essential preliminary to the long-delayed planning of our internal air routes, the reservation of wavelengths for communication, fog landing, and (ultimately) television between ground and air is of at least equal importance."

A point not mentioned in this letter, but to which it may be worth while to draw

attention, is the fact that, although the service range of a seven-metre television transmitter is generally put at about 25 miles, this refers to the ground range of the transmitter only. The "sky" range may be very much greater before attenuation becomes marked. This means that, as far as aircraft communication is concerned, television transmitters would monopolise the ether to a far greater extent than might generally be supposed from a consideration of the ground range alone.

THE RADIO INDUSTRY

IN spite of the fact that it costs only 8s. 6d. in the 120-volt size, the new Oldham "Red Band" battery is of the extra-capacity type. It is claimed to have a 50 per cent. longer life than low-priced standard batteries. Address: Oldham and Sons, Ltd., Denton, Manchester.



All communications for Partridge and Mee, Ltd., should now be addressed to the works at Aylestone Park, Leicester.



We understand that in Philips' Laboratory at Eindhoven new cathode ray tubes have been elaborated for use in television experiments which are being carried on in that laboratory. These experiments have already led to the construction of a new receiving apparatus for television, by means of which reception tests were recently conducted in Berlin.

Foundations of Wireless

Part XIII.—How the Triode Amplifies

By A. L. M. SOWERBY, M.Sc.

PREPARATION and the interpretation of dynamic characteristic curves, from which the behaviour of a valve as an amplifier under working conditions can be estimated, are dealt with in this instalment.

THE "characteristic curves" of a valve, whether the anode current is shown plotted against anode voltage or against grid voltage, do not give complete information as to

initial (negative) grid voltage. The anode current will swing in sympathy with the changes in grid voltage, the points B and C marking the limits of the swing of both. The current, swinging between $7\frac{1}{2}$ and 4

mA., is reduced by $1\frac{3}{4}$ mA. on the negative half-cycle and increased by the same amount on the positive one. The whole is therefore equivalent to the original steady current with an alternating current of $1\frac{3}{4}$ mA. peak superposed on it.

The voltage applied to the grid has therefore produced an alternating component in the anode current, and, since this current is flowing in a circuit of moderately low resistance (namely,

the grid were allowed to run positive it would collect electrons instead of making them all pass through its meshes, and a current would then flow round the grid circuit, absorbing power from the generator. Since this may be, in practice, a tuned circuit of high dynamic resistance, this absorption of power would have markedly ill effects in reducing the voltage across it and in decreasing the effective selectivity.

Provided no current flows in the grid circuit we may for the moment regard the valve as absorbing no power in that circuit. This condition will always be fulfilled if the initial negative voltage, known as *grid bias*, applied by the battery, makes the grid negative enough to prevent the flow of grid current even at the peak of the positive half-cycle of signal voltage. In general, the bias required is equal to, or a volt or so greater than, the peak of the signal that the valve has to accept.

The Load Impedance

The development of an alternating anode current in response to the signal is not, however, enough. The next valve in the chain will require an alternating voltage to operate it. To develop this voltage we have to put an impedance of some kind in the anode circuit of our valve, so that the alternating current through it shall develop the alternating voltage we want.

In principle this is simple (see inset to Fig. 71), but it brings a complication in its

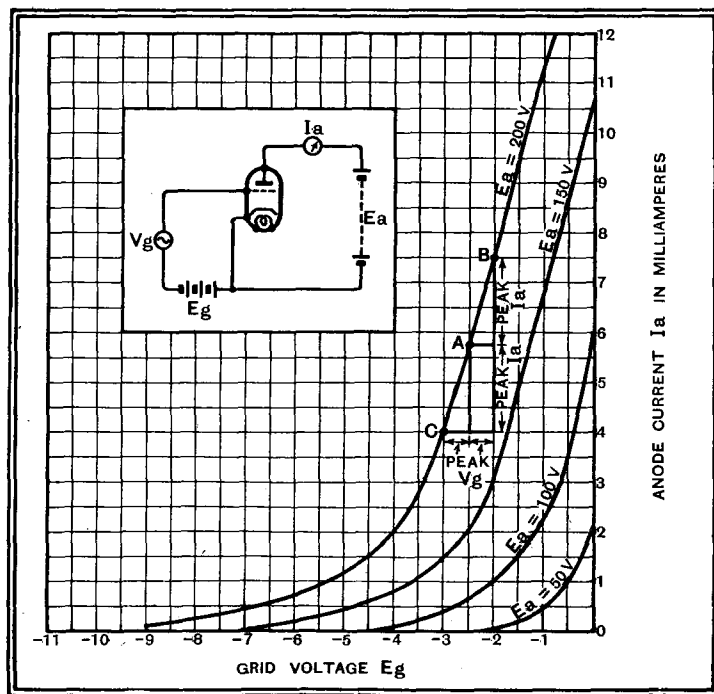

Fig. 70.—Anode current-grid voltage curves of a medium-impedance indirectly heated triode. The alternating anode current evoked in response to an alternating grid-voltage V_g can be read from the curves.

how the valve will behave in the set. They do, however, provide the necessary data from which its performance can be determined.

In Fig. 70 we have a set of E_g-I_a curves for a typical triode of the medium-impedance class. As the slope of the curves shows, its mutual conductance g is about $3\frac{1}{2}$ to 4 mA. per volt for anode currents in excess of about 4 mA., but less for lower currents. Suppose that, as suggested in the inset to that figure, we apply a small alternating voltage V_g to the grid of the valve, what will the anode current do? If the batteries supplying anode and grid give 200 and $2\frac{1}{2}$ volts respectively, the anode current will set itself at about $5\frac{3}{4}$ mA.—point A on the uppermost curve.

If the alternating voltage applied to the grid has a peak value of 0.5 volt, the total voltage on the grid will swing between -3 and -2 volts, alternate half-cycles adding to or subtracting from the

the AC resistance of the valve itself, some $14,000 \Omega$) it represents a very appreciable amount of AC power. Thus, a small or negligible amount of power applied to the grid has released a much larger amount, derived, of course, from the battery, in the anode circuit.

The observant and enquiring reader may have wondered why the grid of the valve has been shown, in these curves, as always negative, and never positive, with respect to the cathode. The reason is bound up with the desire to expend as little power as possible in the grid circuit. If

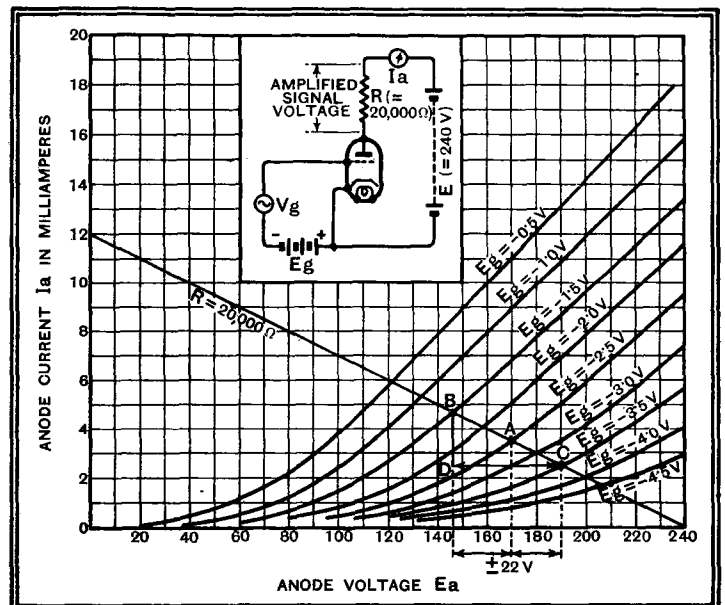

Fig. 71.— E_a-I_a curves of the valve of Fig. 70. The line " $R = 20,000 \Omega$ " drawn across the curves gives, in conjunction with the curves themselves, full data as to the performance of the valve with this value of anode resistance and an HT battery voltage of 240 V.

train. The circuit referred to shows very clearly that the alternating voltage is developed actually on the anode of the valve; we can therefore no longer assume, as in

Foundations of Wireless—

discussing Fig. 70, that the anode voltage is constant. Instead, it rises and falls with the alternations of the signal.

To find out what happens when grid and anode voltages vary together in this way we again have recourse to the valve curves, using this time the E_g-I_a curves of Fig. 71, each of which refers to a definite fixed grid-voltage as indicated against the curves themselves.

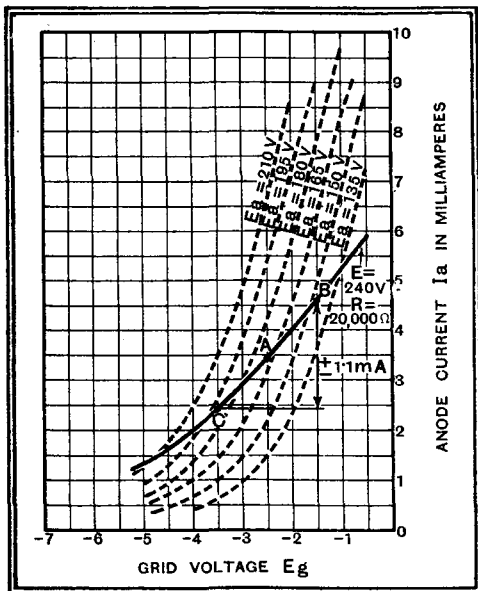

Fig. 72.—Dynamic characteristic of the valve of Figs. 70 and 71 used in the circuit inset on the latter figure. The dotted lines are ordinary E_g-I_a curves, as in Fig. 70. Note the much decreased slope of the dynamic characteristic and that a different dynamic characteristic could be plotted for every combination of anode resistance and battery voltage.

The inset to Fig. 71 indicates that the battery supplies 240 V to the anode circuit as a whole. The steady anode current through the anode resistance R will drop across this resistance some portion of the applied voltage; at the anode itself the voltage will therefore be less than 240 V. For any given value of R we can plot voltage-at-anode against anode-current; if $R = 20,000 \Omega$, there will be lost across it 20 volts for every milliamp. flowing, and the voltage at the anode will be reduced below 240 V by this amount. Thus the anode voltage will be 200 if $I_a = 2 \text{ mA.}$, 160 if $I_a = 4 \text{ mA.}$, and so on. Plotting these points gives us the line " $R = 20,000 \Omega$ " of Fig. 71.

Dynamic Characteristic

From the way in which this line has been derived it is evident that every possible combination of I_a and E_a is expressed by some point along its length. Each of the valve curves across which it falls indicates the combinations of E_a and I_a that are possible for the particular value of grid-bias indicated against that curve. It follows that if we set the bias at $-2\frac{1}{2} \text{ V}$ with the anode resistance in circuit and connected to 240 V as shown, I_a and E_a will be indicated by the point A, since the working point has to fulfil the double conditions of lying on both straight line and curve. For any other value of bias

the anode current and voltage would equally take the values shown by the intersection of the load-line with the corresponding curve.

If the grid-voltage of the valve is slowly increased from $-\frac{1}{2} \text{ V}$ towards $-4\frac{1}{2} \text{ V}$, the anode current will fall, as in Fig. 70, but the fall will be slower than in that figure since the anode voltage will rise as the current drops, as shown by the intersections of the load-line with the curves for successive values of bias.

Picking out and plotting the values of I_a for these intersections we get the heavy-line curve of Fig. 72. This is the dynamic or working characteristic of the valve when used in the particular circuit we are considering. Comparing it with the ordinary or static curves shown in fainter lines in Fig. 72, we see that it has a much lower slope, thus representing a lower mutual conductance, than these. The working value of the slope of the valve-resistance combination is approximately 1 mA/V, as compared with nearly three times this value for the valve alone.

If we remember that $g = \mu/R_o$, the reason for the reduction in slope through the inclusion of the resistance becomes evident; a change in E_g of 1 volt, equivalent to a change in E_a of μ volts, now has to produce its anode-current change through R_o and R in series, instead of through R_o alone.

Hence the working slope of the valve-resistance combination is $\mu/(R + R_o)$.

At the working-point A in Fig. 71 the slope of the curve shows that $R_o = 14,400 \Omega$, while the horizontal spacing between curves shows that $\mu = 39$. This gives, for the valve alone, $g = 39/14,400 = 2.71 \text{ mA/volt}$. By reading directly from the dotted curves of Fig. 72 at an anode current of 3.45 mA. (the current at A) we get the figure 2.65 mA/volt, which is as close an agreement as free-hand curves are likely to give.

For the working slope calculation gives $\mu/(R + R_o) = 39/(14,400 + 20,000) = 39/34,400 = 1.13 \text{ mA/volt}$. Direct check from the heavy curve of Fig. 72 gives 1.10 mA/volt. The theory upon which the calculation was based is thus confirmed.

This study of the effect of a resistance in the anode circuit upon the characteristic curves of a valve has brought us to a point from which the behaviour of the valve as an amplifier is immediately apparent. First, the calculation. Let us start up the AC generator V_g of Fig. 71 and assume it delivers 1 volt to the grid of the valve. This is equivalent, as we know, to introducing μ volts, or in this particular case 39 volts, of AC into the anode circuit. Applied to

R_o and R in series this will produce a current of $39/34,400 = 1.13 \text{ mA.}$ of AC. This, flowing through R ($=20,000 \Omega$) will cause a potential-difference of $1.13 \times 20 = 22.6 \text{ volts}$.

If one volt of signal applied to the grid produces 22.6 volts across R, the amplification of the whole stage (valve plus resistance) is 22.6 times.

Now we will check this directly from the curves. In Fig. 71, the point A lies on the curve $E_g = -2\frac{1}{2} \text{ V}$. If we superpose on this a signal of 1 volt peak the grid will swing between $-3\frac{1}{2}$ and $-1\frac{1}{2} \text{ V}$. Anode current and anode voltage will then swing over the straight line BC, which covers a voltage-swing of $\pm 22 \text{ V}$. Thus a one-volt swing on the grid evokes a 22-volt swing on the anode, as calculated.

The Effect of Load on Amplification

Either on this figure or on Fig. 72 we can see the alternating anode current. C lies at 2.45 mA., B at 4.65 mA., a swing of $\pm 1.1 \text{ mA.}$, as calculated, round the initial steady value at A.

For most purposes, all the information likely to be of use can be read off at once from a set of curves such as those of Fig. 71 in conjunction with the necessary load-line. The working characteristic of Fig. 72, plotted from the intersections on Fig. 71, is chiefly used in connection with the determination of the distortion introduced in the case of output valves, and particularly pentodes. To this point we shall revert later.

The formula for amplification that we have used, $A = \mu R/(R + R_o)$, shows at once that by making R so large that R_o is negligible in comparison with it the amplification given by the stage will rise towards a theoretical maximum equal

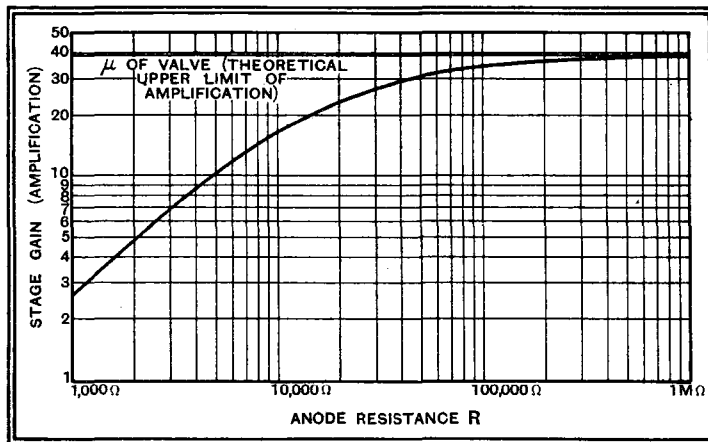

Fig. 73.—Amplification of stage with different values of anode resistance R. The valve, throughout, is supposed to have $\mu = 39$, $R_o = 14,400 \text{ ohms}$.

to μ , which supplies the reason for calling this quantity the "amplification factor" of the valve.

The same result can be had graphically by considering Fig. 71. For a higher value of R than 20,000 Ω , the line would be more nearly horizontal; assuming the working point A retained, it would cut the axis $I_a = 0$ at a higher voltage. Imagining

Foundations of Wireless—

the line pivoted round A till it becomes horizontal (R indefinitely high) we arrive at a diagram in which the anode current remains constant while the anode voltage changes, and so leads to μ as the stage-gain.

Conversely, the effect of a lower load can be studied by tipping the load-line towards the vertical; evidently a lower stage-gain would be produced until, in limit, the line becomes vertical ($R=0$) and there is no change in voltage at the anode in response to the signal.

Fig. 73 shows the values of stage-gain obtained with various anode loads for a valve in which $R_0=14,400 \Omega$ and $\mu=39$. It should be added that such a curve does not take into account the fact that, unless very high anode voltages (external to R) are used, R_0 will not stay constant as assumed, but will rise with the falling anode current. True values can only be obtained by analysis of actual curves on the lines of Fig. 71.

As a summary of this part and the preceding, let us tabulate the most important points about the triode valve.

(1) One volt at the grid controls the anode current to the same extent as μ volts at the anode; μ is the amplification factor of the valve.

(2) Towards AC the valve has a resistance R_0 depending for its exact value upon the steady voltages applied.

(3) The control of anode current by grid voltage is given by the ratio μ/R_0 , known as the mutual conductance or slope, g .

(4) As a corollary to the above, it follows that a valve can be represented as a resistance R_0 in series with a generator the voltage of which is μ times the AC voltage applied to the grid. This representation (Fig. 74) takes no account whatever of steady voltages and currents, except through their influence in determining μ and R_0 .

(5) The amplification given by a valve in conjunction with its anode resistance R is $A = \frac{\mu R}{R + R_0}$, as Fig. 74 clearly shows.

(6) Since R_0 , μ , and g all depend, to a greater or lesser extent, on actual operating voltages, all *detailed* study of a valve's behaviour must be made by drawing load-lines across its actual curves, as in Fig. 71. Deductions such as Fig. 72 can then be made from these.

(7) For the consolation of those who realise that tetrodes, variable- μ tetrodes, pentodes, and screened pentodes are still to come, it is worth remarking that points 1 to 6 cover about 90 per cent. of the philosophy of these more complicated structures.

Random Radiations

By "DIALLIST"

He Who Pays the Piper

FROM France comes the news that listeners in that country are in future to play a considerable part in the control of their local broadcasting. In each area an association of listeners is to be formed, whose annual meeting can be attended by anyone on production of his receiving licence. At this meeting ten representa-

world, signed on as a member of the black gang of a liner bound for New York. Not a few undergraduates have worked their passage in this way, though in my time, when there was a rate war in progress between the various shipping companies, it was more fashionable to travel steerage, as you could for a couple of pounds.

The voice most familiar to listeners is that of Mr. Stuart Hibberd, the Chief Announcer. Like Mr. Marriot he is a Cambridge man. His voice has long been his fortune, for he was a choral scholar at St. John's. He must have come to the microphone very soon after Mr. Arthur Burrows ceased to combine in himself the posts of Chief Announcer, Director of Programmes, Leading Spirit (as "Uncle Arthur") of the Children's Hour, and almost every other (except Chief Engineer) in the infant B.B.C., for his career as an announcer began in 1924.

Wireless to the Rescue Again

THERE can be no possible doubt that the survivors of the disaster which befell the great United States airship *Macon* owe their lives mainly to her wireless installation. She was cruising on a pitch-black night over the sea when, with no warning, she got into difficulties. The S.O.S. message was sent out and naval ships in the neighbourhood rushed to the rescue.

Perhaps the most tragic episode in the history of wireless was the sinking of the *Titanic*. When the huge liner had struck an iceberg and was slowly sinking there was a merchant steamer in sight and only a few miles away. In those days the smaller ships carried only a single wireless operator, and the one in the merchant vessel had gone off duty. Had the *Titanic's* messages been received the greater part of her passengers might have been saved.

The Language of Radio.

NO branch of science, I imagine, has been so unfortunate as electricity in the names that it has selected for its paraphernalia; and wireless, the bud, has been no luckier than its parent branch. Condensers don't condense; batteries don't batter; real grids no more resemble helixes of fine wire than do real plates cylinders of thin metal; wireless sets are far from wire-less, and whether their transformers transform was hotly debated some time ago in the correspondence columns of *The Wireless World*. Many of our terms are the weirdest hybrids of Greek and Latin, and the words culled from both of the languages are used in ways that would sorely puzzle the men of Athens and Rome, could they come back to earth once more.

The Germans have perhaps been wiser in adopting purely German words for electrical and wireless apparatus in everyday use, though their term "Funk" for wireless is now out of date, since it means "spark" and thus enshrines the earliest type of transmitter. When it comes to television—itsself a rather loathely mongrel word—I hope that we shall not coin some horrid

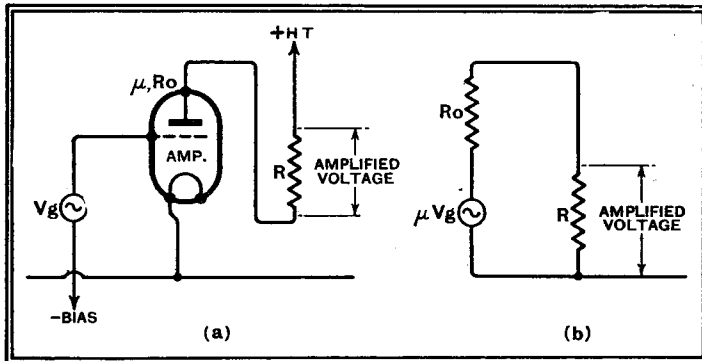

Fig. 74.—A stage of amplification, and (b) a diagrammatic representation of the anode circuit only, the signal voltage V_g on the grid being replaced by its equivalent, μV_g volts, in series with the valve's own anode-cathode resistance R_0 . Only Ohm's Law is needed to show that voltage on R is $\frac{\mu R}{R + R_0}$.

tives will be elected to the local broadcasting council. The council's full membership of twenty will be completed by the nomination of five representatives by the Ministry of P.T.T. and five by literary, artistic trade and technical bodies concerned with broadcasting.

The chief business of the council will be to administer the finances of the local station and to draw up the programmes. The idea is a good one, for it is proverbial that he who pays the piper should call the tune. Myself, though, I can't help feeling that were I a Frenchman there would be one distinction which very definitely I would not court; and that would be election to the local broadcasting council. In every country listeners heave epistolary half-bricks at those who are responsible for the programmes. May the half-bricks not cease to be metaphorical when Monsieur Untel and Monsieur Chose are available in the flesh as inviting targets?

In practice the council will probably prove to be more *façade* than of any practical utility, for I observe that the Minister of P.T.T. has reserved to himself the right to veto any decision that it may make. In this country of ours, as a matter of fact, each Region has not one but several advisory committees; yet I would almost wager a radiogram to a gridleak that you could not give the name of a single member of yours!

The Stoker Announcer

Speaking of advisory committees reminds me of the interesting book on broadcasting by Professor A. Lloyd James, secretary of the Committee on Spoken English. Discussing announcers, he mentions that one of them once made a trip across the Atlantic as a stoker. This is Mr. R. D. A. Marriot, who, when he was a Cambridge undergraduate and thirsted to see the

thing such as "televier" or "televist." "Listener" (or "listener-in") has proved good enough as the description of the user of a wireless receiving set; will not "looker," or "looker-in" if you wish, serve admirably for the devotee of the newest hobby? I am all in favour of the simple words, words that are the shortest cuts to the meanings they convey. A black eye remains a black eye, even though you describe it, as a medical witness once did, as "a supra-orbital contusion!"

■ ■ ■

The Loud Speaker and the Burglar

FEW burglars have ever had such unpleasant surprises as one who was engaged recently in ransacking a country house in the Midlands. Having convinced himself that it was entirely unoccupied, he made his way in and proceeded to the bed-

rooms, where he collected about a hundred pounds' worth of jewellery. Proposing next to turn his attention to the drawing-room, where a much bigger haul was to be expected, he went downstairs, cautiously opened the door and felt for the lighting switches. He found them. The lights went on. But he paused outside the door for a little murmuring sound was coming from within the room. Then suddenly a voice, a loud voice, a he-man voice burst into speech. The burglar fled as fast as his flying feet would carry him.

The house was that of Sir John Brown, ex-chairman of the British Legion, who was away in London celebrating his fifty-fifth birthday. The burglar had clicked on two switches, one of which controlled the wireless set, and though the voice was only that of the announcer giving out the second news bulletin, he stood not upon the order of his going.

deposit on the pipes may give the necessary insulation from earth, and if this is so, the only method of earthing the water, which may be holding the charge, would be to drop a clean metal plate into the tank. A wire from this plate could then be earthed in the usual way.

C. A. CHESTER.

Bucksburn, Aberdeenshire.

Wireless in the Wilds

READING "Wireless in the Wilds" by R. W. Hallows in the February 15th issue of *Wireless World* has reminded me of a method of obtaining LT current from primary cells without variation of voltage. Some years ago I connected a new "dry-charged" slow discharge-type accumulator cell permanently across a battery of three Leclanché cells in series, and it supplied current for a two-valve wireless set for about nine months. (I discontinued the arrangement only because I was then able to change to a mains set.) The set was used for only about six hours a week, but it was evident that that was not the limit of the battery's capacity. If much more were required of the battery it would be necessary to increase the number of Leclanché cells, arranging them in series-parallel; or cells capable of a higher rate of discharge (say, sac-cells) might be substituted. If greater compactness were necessary, dry cells might possibly be used, but it would generally be wasteful to leave them connected to the accumulator when the set was not in use.

W. L. LAWRENCE.

Hornsea, E. Yorks.

NEW MARCONI AND OSRAM PENTODE

A NEW output valve of high mutual conductance, no less than 10 mA/V., is announced by Marconi and Osram. This is the N41, and it is a pentode rated for 250 volts anode and 200 volts screen potentials, and when used with a bias resistance of 90 ohms it passes 32 mA. anode current and 8 mA. screen current, so that the grid bias is 3.6 volts. The optimum load is 7,800 ohms, and the heater consumes 2 amperes at 4 volts.

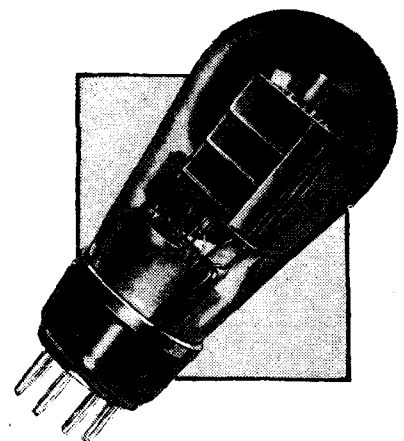

In view of the small input which it requires, the valve is particularly recommended for use with resistance coupling following a diode detector. The total grid to cathode resistance must not exceed 500,000 ohms, including the grid leak, any grid circuit decoupling resistance, and the grid stopper. This last component is advised by the makers in view of the high mutual conductance of the valve. The valve is fitted with a 7-pin base, and is priced at 18s. 6d.

Letters to the Editor

The Editor does not hold himself responsible for the opinions of his correspondents

Television Standardisation

NOW that there has been time to study the Television Committee's Report it would seem that one point of major importance has been overlooked. I refer to the question of the standardisation of picture-frame frequency and scanning frequency.

The values chosen for these two basic constants, common to all present systems of television, will become a radical factor in the design of many thousands of receivers. When the service is established it will obviously be very difficult to make changes, and therefore the initial choice should be made with as much foresight as possible.

I write to suggest that it would be very appropriate to select two frequencies which are respectively an integral submultiple and multiple of the standard 50-cycle frequency in use for the National grid supply system.

Our clocks now run in unison with the frequency of the grid supply, and surely we may hope to have our television receivers synchronised by the same means.

A. E. RIAL.

Mains Interference

WE were interested to read the letter from Mr. W. R. Morton in your Correspondence columns in the issue of February 15th.

We suggest that the interfering noises which he experiences are due to one or more of the following causes:—

(1) The passage of steam or boiling water through the pipe is causing localised air locks resulting in the pipes mechanically vibrating. Turning on a hot-water tap when air locks are not in evidence may lead to the same effect.

(2) The vibration of the pipe is probably transmitted to others, either conduit-carrying electric cables or further water pipes; but in either case crossing or running parallel and in contact with the hot-water pipe.

(3) Vibrations set up in the conduit casing may be leading to intermittent contact between the sections, or even to variations in the contacts of the wires in junction boxes.

(4) An even greater probability is that the mechanical vibration is transmitted to

ceiling lights causing the lamps to make and break contact.

Our suggestion No. 4 would seem the most probable, as your correspondent states that the direct earth to the receiver, and finally to the hot- and cold-water pipes, has no effect.

Since these pipes are in any case substantially earthed (if not directly), it shows that the radiation is of a direct or indirect nature, the interference being picked up in the aerial input to the receiver.

Of course, if the earth lead is a long one, this could also pick up interference, even if it were a direct connection as stated.

We recommend Mr. Morton to examine all his electric light fittings and carry out a systematic search, commencing at the hot-water pipes and tracing their path.

For Ward and Goldstone, Ltd.
Manchester.

G. V. COLLE.
Technical Sales.

YOUR correspondent, W. R. Morton, appears to be troubled by interference caused through lack of continuity in the water supply to the feed, probably due to a poor washer, water-cock, etc., which results in water being fed in a somewhat jerky manner. This certainly was true in regard to a similar trouble which I experienced some little while ago, and I offer it as a possible solution to his.

Plymouth. H. G. CRANE.

I HAVE read with interest the letter from a correspondent who states that he experiences interference from his hot-water supply system.

It seems to me that the most probable explanation is that the steam issuing from the boiler has caused the building up of static electrical charges in some part of the system and that the interference is due to their periodic leakage to earth. This static charge is also met with on steam wagons, which are insulated from earth by their rubber tyres; hence the loose chain which always trails along the ground from these vehicles in order to conduct the charge to earth and prevent the driver receiving a shock as he alights.

It seems just possible that the limestone

THESE columns are reserved for the publication of matter of general interest arising out of problems submitted by our readers. Readers requiring an individual reply to their technical questions by post are referred to "The Wireless World" Information Bureau, of which brief particulars, with the fee charged, are to be found at the foot of this page.

Readers' Problems

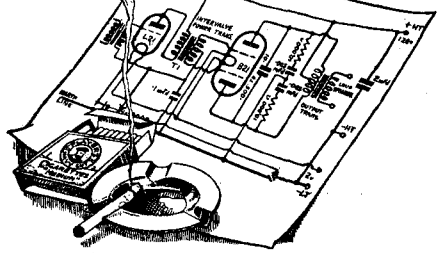

Starting Up

INDIRECTLY heated AC valves usually require half a minute or so after switching on before they warm up properly to their work. So far as straight receivers are concerned, it is quite usual for weak and distorted signals to be audible for a few seconds before full emission has been reached.

A reader who has recently changed over to a superheterodyne is puzzled because his present set, although requiring about the same "warming up" period, gives no preliminary indications, and starts functioning in a normal way without the prelude to which he has become accustomed.

This is by no means unusual. It is often to be ascribed to the fact that the frequency-changing valve does not begin to oscillate until its heating element has almost reached normal operating temperature. By this time the other valves are approaching full emission, and so it is understandable that, as soon as oscillation begins, reproduction should start at sensibly full strength and quality.

HT and LT Voltages

A LETTER dealing with the question of DC mains sets conveys the impression that the writer hardly realises the important difference between the modern DC set, with its special indirectly heated valves, and the

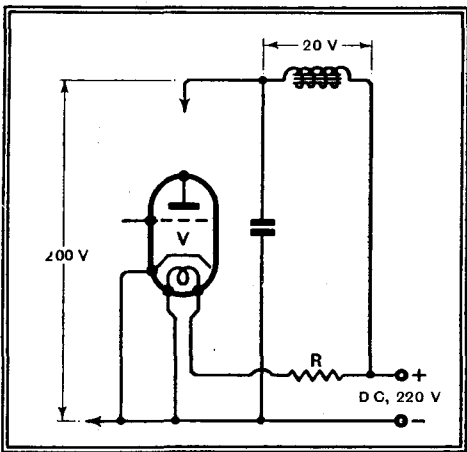

Fig. 1.—Interconnection of HT and LT circuits in a DC mains set; also distribution of HT voltage.

older and much less satisfactory type in which ordinary battery valves with filaments in series were employed. In writing for information on the connections of the valve heaters, this querist states his inability to see how both heater and anode voltages can be obtained from the same source, and goes on to ask whether the actual HT voltage available is reduced in proportion to the number of valves employed.

This is really quite a simple matter, and with modern indirectly heated DC or "Universal" valves, the two circuits in question may be regarded as entirely independent.

The subject will be made clear by reducing it to its simplest possible terms and considering the power supply circuits of an imaginary single valve DC set shown in Fig. 1. The cathode of the valve V is connected to the negative side of the mains, and the full voltage, less an inevitable drop in the smoothing circuit, will be available for feeding the anode. The heater, in series with the voltage-absorbing resistance R, forms a separate circuit in parallel with the supply. No matter how great the number of valves, the same principle holds good, as all their cathodes will be joined to the same point.

Distribution of HT voltage is shown in the diagram. It is assumed that 20 volts will be lost in the smoothing choke; for a single-valve set this is an excessive figure, but in a practical multi-valve receiver it is fairly close to the mark. Finally, there is also a loss of voltage in automatic bias systems of all kinds, but this does not affect the point at issue.

Range of the "QA"

ALTHOUGH the QA Receiver is by no means a long-range set, it is not merely of interest to those who live, figuratively speaking, on the doorstep of a broadcasting station. The considerable number of listeners in various parts of the country who regard Droitwich as their local station may rest assured that this set will have ample sensitivity for the reception of that station except, perhaps, in a few remote localities where conditions are exceptionally bad.

Diodes and Reaction

IT is generally appreciated that reaction effects are unobtainable with ordinary diode detectors; but there are various methods of obtaining such effects with diode-triode multiple valves or when the

The Wireless World

INFORMATION BUREAU

THE service is intended primarily for readers meeting with difficulties in connection with receivers described in *The Wireless World*, or those of commercial design which from time to time are reviewed in the pages of *The Wireless World*. Every endeavour will be made to deal with queries on all wireless matters, provided that they are of such a nature that they can be dealt with satisfactorily in a letter.

Communications should be by letter to *The Wireless World* Information Bureau, Dorset House, Stamford Street, London, S.E.1, and must be accompanied by a remittance of 5s. to cover the cost of the service.

Personal interviews are not given by the technical staff, nor can technical enquiries be dealt with by telephone.

grid of a triode is used as a diode anode.

However, a reader writing on this subject is prepared to add an extra valve to his receiver, which employs a double-diode-triode-detector; it is desired to reduce damping of the tuned circuit preceding this valve for experimental purposes. In response to his request for information, we suggest the arrangement shown in Fig. 2, which will be in essentials applicable either to a superheterodyne or a straight circuit; our correspondent gives no information on this point.

This addition, although simple enough with regard to circuit details, requires at least one precaution in design. It is essential that the reactor valve should be sufficiently biased to avoid the flow of grid

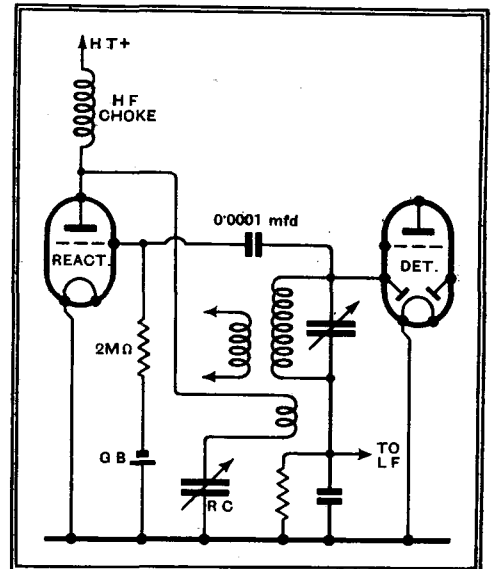

Fig. 2.—Adding reaction to the tuned circuit preceding a diode by means of an extra valve.

current. Its grid has, of course, to accept the same HF input as the diode anode, and in some cases this will be fairly high. As a consequence it may be necessary to use a low-impedance reactor valve.

Pilot Lamps

A CORRESPONDENT, who complains of frequent failure of the pilot lamp in his AC-DC receiver, asks why the bulb burns with abnormal brilliance when the set is first switched on, but quickly becomes so dim that the light is hardly sufficient for illumination of the tuning scale.

In most cases this effect is simply explained by the fact that the pilot lamp is wired across a resistance connected in series with the chain of valve heaters; when the receiver is first switched on the heaters are cold, and so their resistance is low. As a result a high current flows initially in the circuit, and an abnormally high voltage is applied to the lamp. Thus it is not hard to see that if the lamp is to run at normal voltage while the set is working, it will be overloaded excessively during the warming-up period.

The use of a barretter (self-regulating main resistance) in series with the heater circuit largely overcomes this trouble, but so far as the pilot lamp is concerned a still simpler solution lies in the use of a small 5-watt bulb rated at full mains voltage, and wired across the supply leads on the "dead" side of the on-off switch.

The Wireless World

THE
PRACTICAL RADIO
JOURNAL
24th Year of Publication

No. 810.

FRIDAY, MARCH 8TH, 1935.

VOL. XXXVI. No. 10.

Proprietors: ILIFFE & SONS LTD.

Editor:
HUGH S. POCOCK.

Editorial,
Advertising and Publishing Offices:
DORSET HOUSE, STAMFORD STREET,
LONDON, S.E.1.

Telephone: Hop. 3333 (50 lines).
Telegrams: "Ethaworld, Watloo, London."

COVENTRY: Hertford Street.
Telegrams: "Autocar, Coventry." Telephone: 5210 Coventry.

BIRMINGHAM:
Guildhall Buildings, Navigation Street, 2.
Telegrams: "Autopress, Birmingham." Telephone: 2971 Midland (4 lines).

MANCHESTER: 260, Deansgate, 3.
Telegrams: "Iliffe, Manchester." Telephone: Blackfriars 4412 (4 lines).

GLASGOW: 26B, Renfield Street, C.2.
Telegrams: "Iliffe, Glasgow." Telephone: Central 4857.

PUBLISHED WEEKLY. ENTERED AS SECOND
CLASS MATTER AT NEW YORK, N.Y.

Subscription Rates:

Home, £1 1s. 8d.; Canada, £1 1s. 8d.; other
countries, £1 3s. 10d. per annum.

As many of the circuits and apparatus described in these pages are covered by patents, readers are advised, before making use of them, to satisfy themselves that they would not be infringing patents.

CONTENTS

	Page
Editorial Comment	231
Testing without Equipment	232
News of the Week	235
Television Reception and the Super-heterodyne	236
Random Radiations	239
Broadcast Brevities	241
Readers' Problems	242
Components and Accessories for Television Sets	243
Listeners' Guide for the Week ..	246
Foundations of Wireless Part XIV	248
Principal Broadcasting Stations..	251

EDITORIAL COMMENT

Recorded Programmes

A Valuable Tool in the Broadcasting Scheme

IN its annual report the B.B.C. makes no secret of the fact that during the year 1934 there was considerable development in the use of specially recorded material in the transmissions. This, it is stated, was chiefly to increase the topicality and flexibility of the programmes. During the year additional recording equipment was installed at Broadcasting House and the recording organisation was elaborated.

This extended use of recorded material was, of course, all additional to the broadcasting of commercial gramophone records such as are available on sale to the public.

There was a time when the B.B.C. was severely criticised for broadcasting recorded material without disclosing that it was not a direct microphone production. But recorded material has been so cautiously and intelligently employed as a means of enhancing the effect of programmes or supplying items which would have been impossible to obtain direct, that there seems no longer any reason for raising objections to the procedure. Instead, we think the B.B.C. is to be congratulated on having made such wise use of a convenient tool in the broadcasting scheme.

Unique Collection of Records

The B.B.C. meantime is accumulating a wonderful collection of recorded broadcasts of unique historical value; unique also in the sense that they are often of a type which commercial recording companies would never make, because they would not generally be saleable to the public. In time to

come many of these recordings of the B.B.C. will provide material of outstanding interest and the compilation of these alone would seem to justify the expenditure involved in equipping the B.B.C. with an efficient recording organisation.

Television Booklet

Supplement to this Issue

THE booklet which is issued with this week's copy of *The Wireless World* has been prepared in order to give both our readers and their friends a good general idea of television, showing the principles involved, the distinction between low and high definition systems, and a general acquaintance with the subject which should serve to enable them to form a sound opinion as to the possibilities of this new development as well as its limitations.

Whilst taking a sober view, we should not allow ourselves to fall into the error of belittling the technical achievement of television and we should look forward to giving every possible assistance to its development.

The Postmaster-General, on the advice of the Television Committee, has placed television on a foundation on which it can be built up. The importance of this step should be recognised.

When the high definition service is inaugurated a very considerable amount of capital will be involved in it, and as soon as the public purchase receivers the obligation of the B.B.C. to supply acceptable programme material will have started.

In our view, the greatest responsibility in connection with the successful development of television now rests upon those at the B.B.C. who will be entrusted with the task of compiling the television programmes.



With a flashlamp bulb and battery one can test the continuity of heaters and other low-resistance circuits.

Testing without Equipment

Improvised Substitutes for Meters

By M. G. SCROGGIE, B.Sc., A.M.I.E.E.

COMMON SENSE, resourcefulness, and some understanding of the broad principles of receiver design are no less desirable than proper apparatus for the rapid location of faults. Indeed, this article goes to show that in emergencies the apparatus may be dispensed with altogether.

WHEN we were very young we followed the exploits of the Swiss Family Robinson with a growing wonder at the unfailing providence of a Nature that always produced the right thing at the right time. People who have actually tried being marooned on a desert island have found the book rather irritating. A somewhat similar feeling assails those who consult books on how to trace faults in radio receivers. The writers are obviously surrounded by laboratories full of every piece of equipment for analysing the most complex set.

The instructions given are seldom of much use when one is out at a friend's for dinner and the receiver breaks down. It reduces one to the level of a music-hall plumber to say "Hold on a minute until I run round for my Avometer!" The only way of vindicating the personal prestige is to do the trick with the aid of, at the most, ordinary household oddments.

In this game there is positively no substitute for ingenuity and gumption. But this article may provide some suggestions and ideas to work on.

Obscure Faults are Rare

The fundamental principle is system. Poking away hopefully at anything that sticks out (or in) is the refuge of the incompetent. And, of course, the most powerful tool of all is a clear understanding of the working of every part; this is essential for the tracing of the obscure faults that sometimes give the most experienced engineer a bad time. But the majority of common faults are easy ones, for which very moderate technical knowledge, allied to methodical common sense, is enough.

Unless there is good reason to suspect a particular fault, the first step is to narrow the field of enquiry to one department—power unit, loud speaker, output stage, detector, HF amplifier, aerial, etc. It is usually best to take them in that order; for the loud speaker may be the

only indicating device available for the tests.

Let us assume for the time being that we have an AC mains set to tackle. And that the fault is a total cessation of signals. Most sets are now fitted with pilot lights for illuminating the scale. If the lamp is shining, we need look no further for proof that the power is reaching the set and that the transformer is working. A dead short on the HT winding would probably leave the light showing, but at greatly reduced brilliance. And there would soon be a hot smell. Absence of light does not necessarily mean failure of power. It may mean nothing more than a blown lamp, or merely that it is loose in its holder.

A flash-lamp bulb is a thing one may reasonably expect to find somewhere in a house, pocket or garage, and may be very useful if no "live" pilot lamp bulb remains in the set. Wire paper-fasteners or a length of stiff wire can be converted into combined lamp-holder and test prods, and should be used to check the existence of 4 volts across any and every pair of heater sockets. To prevent accidents it is wise to insulate the handleable parts with sticky paper if no insulation tape can be found. (Mental note: Buy insulation tape for car; it may be useful for wireless). If, by ill-luck, the only available lamp is a 2.5-volt specimen, remember that its life on 4 volts AC is not a tremendously large number of seconds, so be snappy.

If no lamp at all is to be had the presence of heater volts can be confirmed by shorting the sockets momentarily. There should be a very obvious spark or flash. Now, after opening out each valve-leg with a knife to ensure contact, see that the heaters are working, by inspection if possible; if not, by feeling whether there is any perceptible warmth after they have been left on for a quarter of an hour upwards.

An independent test of the continuity of a heater is to try and light the flash-lamp bulb through it, using either a flash-

lamp battery that has been checked on the lamp direct or the 4-volt heater source from valve sockets, also checked direct. It may not be possible to do this test, using the 2-volt accumulator, with battery valves of low consumption—0.1 amp.—owing to insufficient current for lighting the lamp. Obviously the lamp test can be applied to tuning coils and other low-resistance circuits.

Having made sure that the heater voltage is "on" and that all the valves are being heated by it, we proceed to check the HT also. The majority of AC receivers have loud speakers with energised field coils which serve also for smoothing, as shown in the typical circuit diagram of Fig. 1. Although a valve rectifier is shown, there is no significance in that—it might be a metal rectifier.

Usually there are terminal strips with four tags or terminals, two of which are X and Z, and the others are strapped

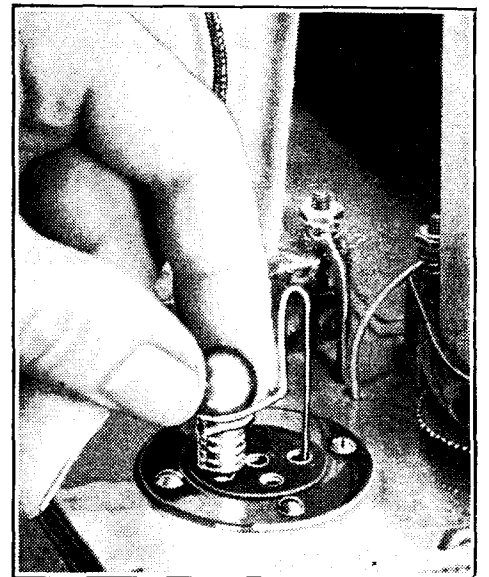

Testing for heater (or filament) supply at the valve socket by means of a flashlamp or pilot light bulb.

Testing Without Equipment—

together and so are easily identifiable as Y. This is a good place to make the first test, and the correct appliance is an ordinary electric lamp of the house voltage; the

it is the X-to-E condenser. But bear in mind that in *normal* operation the rectifier and power valves are usually too hot to hold.

We are not going to go systematically through each type of receiver, because there are too many circuit variations, but the foregoing example shows the sort of procedure for locat-

or decoupling resistors. It is here that it is difficult to find one's way without a circuit diagram. Unfortunately, there are still many manufacturers who omit this, but back numbers of *The Wireless World* may have it.

When there is a resistance of a few thousand ohms or more in circuit it is fairly safe to try the shorting test, even with the forbidden types of receivers because the current is restricted (but remember that in a DC or "universal" set "earth" may be fully live). One might think that in such a case there would not be enough to make a visible spark; but when there is a condenser of 0.01 mfd. upwards it forms a sufficient reservoir to discharge a large current quite safely. In

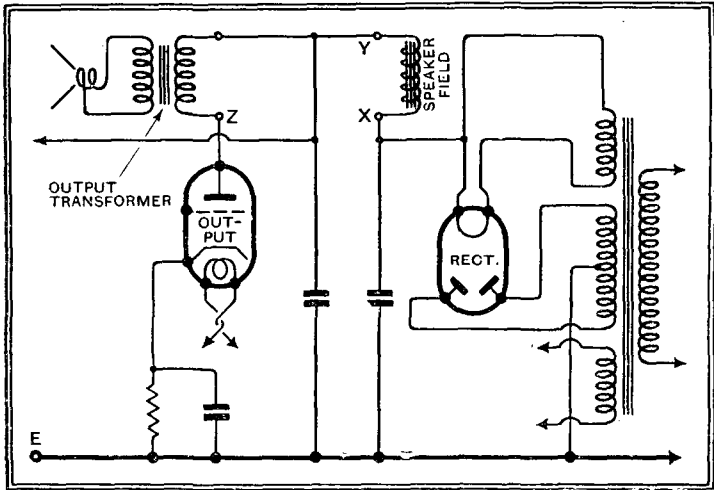

Fig. 1.—Showing the points between which lamp tests are to be made for locating a fault in the power and output circuits.

lowest power you can find. Connect it from "earth" or some handy metal part of the chassis to Y, and it ought to show a certain amount of light. If E to X shows a light and E to Y fails to, it would indicate a break in the field winding. Failure at X means a dead rectifier or a bad contact at its socket (attend to this), or a break in the rectifier wiring or transformer.

Rather Brutal

There is hardly need to emphasise that the lamp overloads the rectifier and must only be held on long enough to get a light, or not, as the case may be. Still more instantaneous must be the action if you are too lazy to go and fetch a lamp, but rely instead on momentarily shorting Y to E and watching for the spark. Any other writer would tell you not to do it at all, but it is very handy all the same. Still, if the rectifier is of the metal type, or the XE test is to be made, it is wise to use the lamp.

Assuming E to Y shows volts, try E to Z. This should cause a loud click in the speaker if the transformer is in order. A simple test for checking the circuit right through, including the power valve itself, is to short X to Y. There should be a good spark and a colossal hum from the loud speaker. If a spark and no hum, suspect the power valve. Remember the possibility of a break in the bias resistor, between cathode and earth. The house-lamp between the cathode pin of the valve and earth will restore signals in such a case. On the other hand, a shorted resistor will cause distortion and overheating of the power valve. Failure of bias may cause other valves to overheat too. It is quite a sound idea to feel the valves in any case, after the power has been on some time. A shorted smoothing condenser causes the rectifier to get very hot, while the other valves remain nearly cold. And if the field is stone cold too,

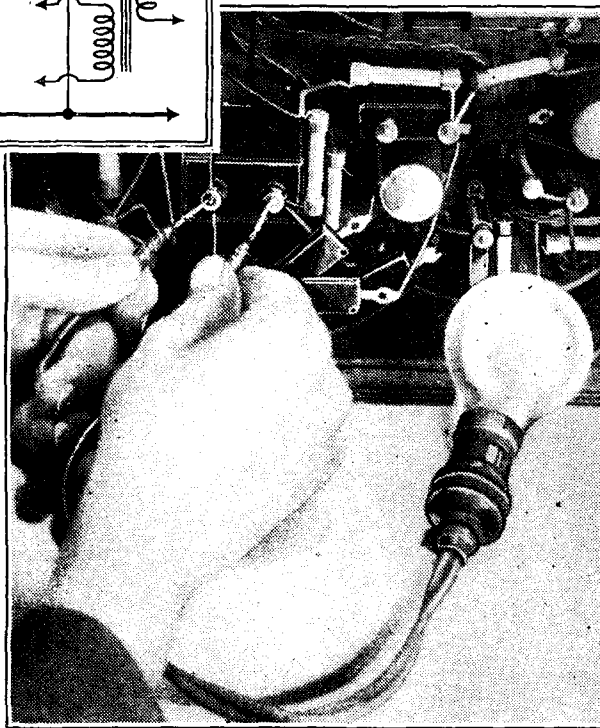

(Below) Applying a low-wattage lamp to check the presence of H.T. voltages.

ing a fault between certain definite points. The object of the present article is rather to suggest how tests can be made without proper apparatus. Some of the methods have already been exemplified—feeling warmth of valves, short-circuiting and lamp lighting. Another is tapping various parts with the finger. If there is not an answering "pong" from the loud speaker when the detector valve is tapped the fault will appear to be somewhere from this valve onwards and not in the HF (or IF) stages. Vigorous shaking and banging of the set may show up loose connections or breaks that are only just separated. Careful pressing here and there with a screwdriver, so as to flex the chassis slightly, may sometimes help to locate such a fault.

The short-circuiting test for checking the presence of power is quite safe when used with discretion on AC receivers incorporating a transformer, but, of course, must not be used on DC, "universal," or battery sets. The house-lamp, carefully used to avoid shorting, serves for the first two, provided that there is no very high resistance (greater than a few thousand ohms) in circuit, such as anode coupling

fig. 2 a short from E to P might be dangerous, but to Q is quite safe and reliable. To R, however, where there is no reservoir, there would be no appreciable spark.

Apart from sparking, the short-circuit test is one of the most useful for locating noises due to irregular contacts or bad valves. Shorting a coupling component, such a resistor or transformer winding, shows whether any noisy fault is before or after that point in the signal chain.

It is no fun to have to unship the whole chassis to get at the inside, so special note should be taken of accessible points for test purposes. There are, of course, aerial and earth terminals or sockets. External loud speaker sockets may come from the secondary of the transformer and thereby serve little purpose for testing, but it is generally quite easy to get at the loud speaker itself, as suggested. Then there are pick-up sockets, but it is difficult to know exactly where they lead without the guidance of a diagram. Valve pins are the most accessible test points, but it requires a good deal of care to make contact without touching others; in battery sets an error here is liable to have fatal results

Fig. 2.—Visual short-circuit tests can be made from E to Q, in spite of the high decoupling resistance.

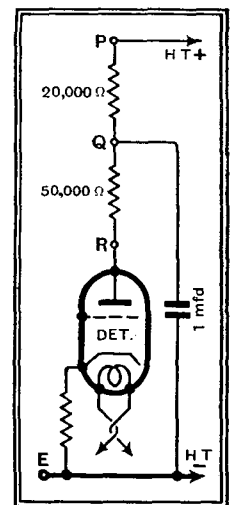

so far as the valves are concerned. Special valve adapters are made for the job—but, of course, we are not supposed to have things like that!

The top terminals of the valves are valuable test points, and more accessible than

Testing Without Equipment—

the pins, but remember that one can no longer assume that they are anode terminals. In battery sets there are all the battery leads to play about with. Failure to get a click when the HT to the output stage is plugged in is a fact heavy with significance to the tester.

Turning again to AC sets, one need never be without an audio-frequency signal of about 2 or 4 volts RMS. There

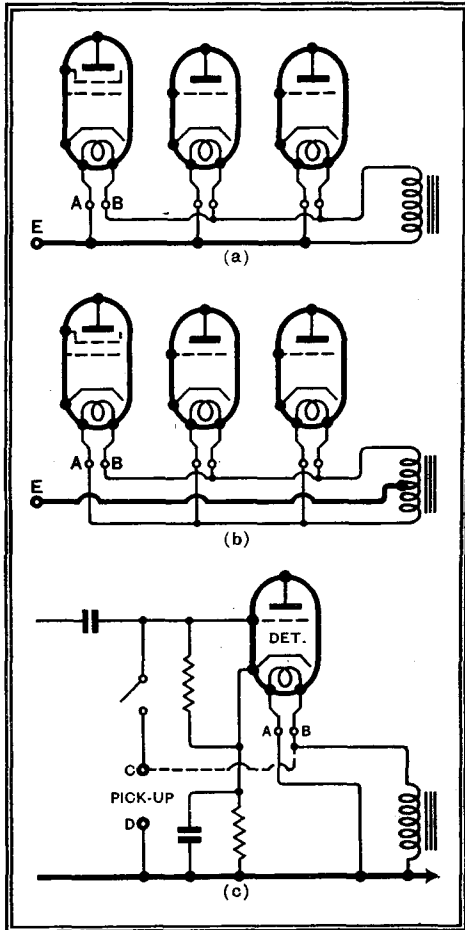

Fig. 3.—If the heaters are wired as in (a), one can get a signal of 4 volts AC from B to earth, but nothing from A to earth. When wired as in (b) either A or B to earth gives 2 volts. Assuming the typical detector circuit with gramophone pick-up sockets as in (c), joining B to C gives the required signal. While A to C or D does nothing, B to D short-circuits the supply (as indicated by a spark).

is the voltage across the heater sockets or from one of them to earth. Fig. 3 shows how in differing circumstances one may get 4 volts, 2 volts, or no volts at all. It also shows how this signal may be used to check the whole LF end of the receiver by applying it to the pick-up terminals; some preliminary trial may be necessary to avoid shorting the heater voltage entirely. But the right connection gives more than full loud speaker volume if all is well. In such a case very weak reception, or no reception, is due to some fault in the HF parts of the receiver (or, as in at least one known case, to someone having walked off with the aerial).

A well-known test for tracing a fault to a first HF stage in superhet or straight receivers is to shift the aerial to the anode of the HF valve, or subsequently to the

grid of the first or only detector. If a certain amount of reception from at least the local station is possible when this is done, and was not possible previously, the fault is immediately localised. It is difficult to pursue this test further with a superhet, because powerful IF signals are not generally available, and we are certainly not going to call for a signal generator or serviceman's oscillator at this stage! Sets that have an intermediate frequency in the region of 470 kc/s may pick up enough to make a test possible with the aerial straight on to the beginning of the IF stage, but some experience is necessary to interpret the results.

Quite a common fault being the failure of wave-change switches, it is very important to take note of whether the complaint is confined to a certain waveband. A bad switch contact may cause medium-wave performance to go right off. And if short waves are provided for, this is the first fault to suspect. Disappearance of signals over a certain range of wavelengths in a superhet is likely to be the result of oscillation stoppage.

Servicemen are disposed to suspect valves, and perhaps rightly so. It saves a lot of brain work to plug new valves in to each socket in turn. That, however, is a method which has been ruled out by our self-denying ordinance. But it may on occasions be useful to know that a spare SG valve can be used as a triode of sorts by joining the anode terminal to the screen pin, or even without doing so. It is not suggested that it should be actually used in this capacity, but merely that it might make an emergency test possible in some circumstances.

Then as regards push-pull stages; failure of one valve has surprisingly little effect apart from increasing hum in a mains-driven set. Therefore if withdrawal of one valve causes the programme to cease, the other valve can be certified a total loss. Finally, if the original complaint is an increase or alteration in the character of the hum, and reduction in undistorted output, consider the possibility of one-half of the rectifier—valve or metal—having withdrawn from active service.

Finding a Home for London's Television Station

THE members of the Television Advisory Committee appointed to recommend a suitable site for the B.B.C.'s first official television transmitter have visited the Alexandra Palace to consider the advantages of that position for the installation of equipment to supply London and the Home Counties with sound and vision programmes.

One of North London's most prominent buildings, the Alexandra Palace has much to recommend its choice. Situated on a hill rising 324ft. above sea-level, the Palace buildings, which date from 1875 and cover nearly eight acres, have a tower at each of four corners rising a further 145ft. By making full use of any of these towers, which also contain ample accommodation for the necessary studio and equipment rooms, an effective height of nearly 470ft. is available for the erection of aerials without any additional structures.

From the expanse of country visible on a clear day the "optical range" of an

ultra-short-wave transmitter should be considerable, the red light at the end of Southend pier, about 36 miles away, being discernible at night.

If the television station does find its home at Alexandra Palace it will not be alone in the supply of public entertainment catered for under this roof, where a theatre, concert and exhibition halls, ball room and skating rink are to be found.

The Grand Central Hall, with its 57,330 sq. ft. and one of the four largest grand organs in Europe, may one day earn the title of the world's largest broadcast studio. The hall has a seating capacity of 8,000.

An ideal subject for a popular type of television broadcast can be found within the boundaries of the grounds. The well-known Alexandra Park racecourse lies at the foot of the southern slopes, a vantage point from which the whole of London stretches before the eye, and the Crystal Palace, the hills of Kent and Surrey appear almost within grasp.

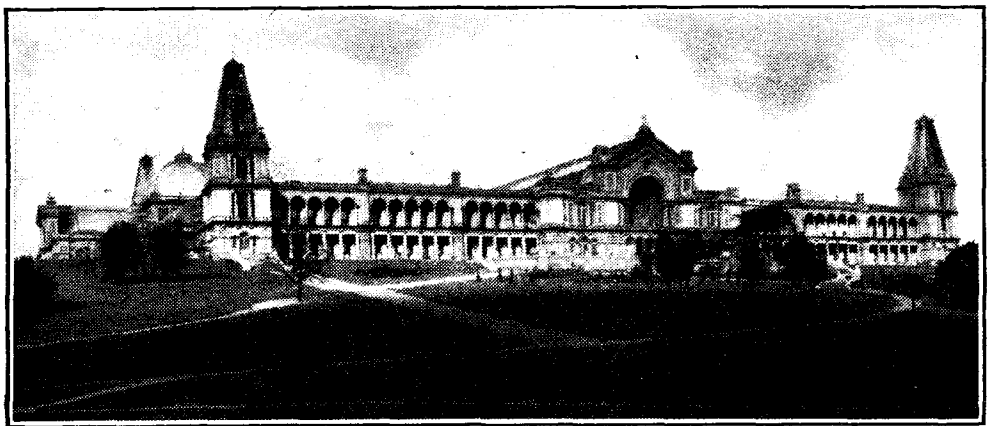

Alexandra Palace at Wood Green in North London may be the B.B.C.'s first official television headquarters.

CURRENT TOPICS

Television-equipped Cinema

A SUPER cinema equipped for television is to be built in Everton Valley, Liverpool.

Afternoon Radio

RADIO-PARIS and the other French State stations, at the request of the radio trade, will soon give transmissions throughout the afternoon from 2 p.m. onwards.

The Woman's Vote

ALTHOUGH women have no political votes in France, the sexes are to vote on an absolutely equal footing at the Regional radio councils, according to the decree by Postmaster-General Mandel.

Listening Costs More

THE cost of Italian receiving licences has been raised because, in the opinion of the authorities, the improved service warrants an increase. A licence now costs 81 lire per annum, if paid in advance, or 7 lire monthly.

Smaller and Smaller

THE latest entrant for the Smallest Wireless Set Stakes is a Mr. Alfred Davis, of Wolverhampton, who has built a crystal set on a piece of ebonite smaller than a three-penny bit. It is stated that he made the set after reading that a London man had constructed one half - an - inch square.

It is rumoured that a South-end resident is at work on a pinhead transmitter.

Released

DR. BREDOW, one of the organisers of the German broadcasting system, and a former Secretary of State, was recently released from custody pending sentence; and on Friday, February 22nd, Dr. Magnus, a former managing director of the broadcasting concern, was also released on the same terms.

The accused, with other officials, have been in custody for some eighteen months, charged with political offences.

Twenty-five Valves

A RECEIVER with twenty-five valves, three loud speakers (including a horn-type "tweeter"), five wave ranges and a switch which, by altering the IF band width, gives "high fidelity" reproduction at will, has just been placed on the American market. It tunes from the top of the medium waveband down to 4.75 metres. It is called the "Stratosphere," and its price is in keeping with its designation—\$750.

German Television Tests

SINCE the publication of the British Television Report, Germany has lost no time in securing a lead. On Thursday next, March 14th, the first public high definition sight and sound television service will be opened in Berlin using ultra-short waves.

New Acoustic Technique

M. ERIC SARNETTE, whose new radio musical instruments were described in *The Wireless World* of March 16th, 1934, has received a favourable report from a special commission which has investigated his "Chamber of Resonance." Tests are shortly to be made at Radio-Paris with this specially designed studio.

"Distances from Greenwich"

A USEFUL little publication for DX listeners, "Distances from Greenwich," has been issued by the International DX'ers Alliance. It gives at a glance the distances of the more important cities and towns of the world and the leading radio centres. Copies can be obtained, price 2d., post free, from Mr. W. W. Warner, 56, East Grove Road, St. Leonards, Exeter, Devon.

Amateurs and the "Ultra Shorts."

SOUTH London seems at present to be the most active area in the matter of ultra-short-wave tests. Every Monday from 10 p.m. onwards several South London stations can be heard on the 56 mc. band, including G6NF, West Norwood (Mr. A. D. Gay), 5JB, Beckenham, and 5OJ, Keston. G6NF opens transmission at 11 p.m. Thursday is also a good night for ultra-short-wave reception in London.

We understand that future plans of the R.S.G.B. include a North London group of ultra-short-wave stations, and, eventually, a complete network of transmitters covering the whole country.

Open Door Policy

AN amusing case in the Paris courts recently concerned two flat tenants, the one an elderly man who objected to climbing five sets of stairs, and a young woman with a wireless set. It appeared that the latter made a practice of leaving the upper lift gate open, compelling the elderly tenant to walk up, her explanation being that the lift caused static in her set. The judge instructed the landlord to equip the lift with an anti-static device.

Events of the Week in Brief Review

The Radio Shows

THE National Radio Exhibition, 1935, will be held at Olympia, London, from August 15th to 24th. The Manchester Radio Exhibition will be held in the City Hall, Manchester, from September 20th to 28th. The B.B.C. will be represented at both exhibitions.

New Television System

A NEW television system evolved by M. Chauviere, a Paris engineer, is reported to have impressed experts who attended a demonstration at Lyons.

Musical Taxis

TWO HUNDRED Peugeot radio-equipped taxis were assembled at the Madeleine, Paris, for public examination last week. The motors are equipped with Philip sets, which work only when the taxi-metre is registering. Reception is controlled by the fare himself.

The Big Three

GREAT BRITAIN, Germany and France figure at the head of the International Broadcasting Union's latest licence figures. At the end of 1934 Great Britain had 6,780,569 licensed listeners, Germany 6,142,921, and France approximately two million.

150 Kilowatts—and the Reason

JAPAN, which celebrates its tenth radio anniversary this month, has twenty-five broadcasting stations, mostly of less than 10 kilowatts output. A 150-kilowatt station is, however, to be erected for reasons of "political prestige," China having a 75-kilowatt plant at Nankin.

British Radio Exports

STATISTICS issued by the Department of Overseas Trade show that the favourable balance of the British radio trade in January amounted to £58,013. This compares with a favourable balance of £66,574 in January, 1934. The main exports during the month were of sets to the Irish Free State, the Netherlands, France and Brazil, and of transmitting apparatus to South Africa, the Argentine, Sweden, Spain and Roumania. Large quantities of valves and components were also exported to the Irish Free State and foreign countries. Over 56,000 valves and 6,000 receiving sets were imported from the United States of America during the month.

150 Kilowatts

BY Easter the new 150-kilowatt Roumanian station at Brasov, constructed by the Marconi Co., is expected to begin tests.



WHY NOT BREAKFAST BROADCASTS? A young camper greets the day with a tune on her H.M.V. portable in one of the new Southern Railway camping coaches. There are no British broadcasts at this hour, but Radio-Paris is a good substitute.

Cable Cutting Again

AN epidemic of cable cutting is threatened. On Friday, February 22nd, when the Swiss Minister, M. Pilet-Golaz, wished to broadcast from Lausanne on the question of new defence laws, it was found that the cable connecting the studio with the Sottens transmitter had been cut at Moudon.

On Sunday, February 24th, when Dr. Ryan, Irish Free State Minister for Agriculture, was broadcasting from Cork via Athlone, the connecting cable was cut.

During a political broadcast from Munich on Saturday, February 23rd, the roof of the transmitter house was blown off in a gale, but it is difficult to lay the blame on any party.

Television Reception

and the Superheterodyne

Ultra Short-wave Frequency-Changers

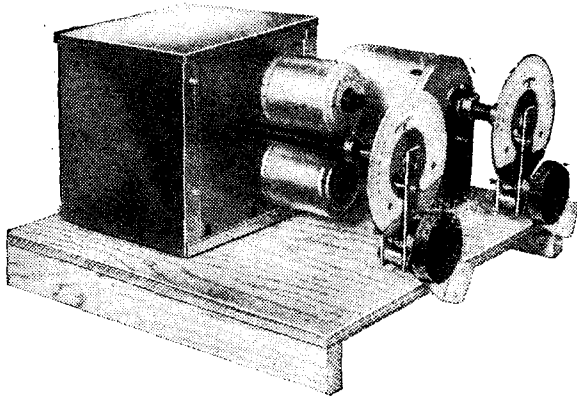

By W. T. COCKING

THE choice of a frequency-changer which is suitable for operating on the extremely high frequencies involved in high-definition television is by no means easy, for most types exhibit serious defects. These defects are discussed in this article, and they are shown to be due chiefly to stray capacity couplings, the effects of which can be eliminated by the use of a new circuit embodying two valves.

THE present experimental, and the future regular, television transmissions of high definition are carried out on wavelengths of some 5 to 9 metres, because longer wavelengths are unsuitable. In the case of sound broadcasting, even the highest standard of quality does not demand the reproduction of a wider range of frequencies than about 30 c/s to 15,000 c/s. High-definition television, however, demands a range of frequencies of at least 25 c/s to 1,000,000 c/s! The lowest frequency required depends upon the number of pictures a second, the highest upon the maximum rate of change of light. The latter is consequently a variable quantity depending on the type of picture, but the figures just given can be taken as approximately right when there are twenty-five pictures a second and 240 scanning lines.

Now it is well known that the carrier frequency must be higher than the highest modulation frequency, so that it would be quite impossible to transmit high-definition television from any station working on a wavelength greater than 300 metres (1,000 kc/s). Even if such a wavelength were chosen, the sideband spread would extend from zero frequency to 2,000 kc/s—it would occupy the whole range of wavelengths above 150 metres. It would cause interference with every station within this range, and, conversely, reception would be marred by any transmission on a longer wavelength than 150 metres!

Ultra-Short Wavelengths

It can thus readily be seen that transmission on the normal broadcasting bands is out of the question. It is possible on the ordinary short wavelengths, of course, but there are two reasons why it is not very practicable. In the first place, these bands are now crowded with broadcasting and commercial transmissions, and, secondly, selective fading is of common occurrence; the effect of this is serious enough on telephony, but it would be much worse in television.

The ultra-short wavelengths are thus

the only ones on which high-definition television can be carried out, and the band used for this purpose will probably be 5 to 9 metres, the first transmitter having a wavelength of some 7.5 metres. This does not seem a very wide band, but it is really enormous, for 5 metres corresponds to a frequency of 60 mc/s (60,000,000 c/s) and 9 metres to 33.3 mc/s. The band width is thus 26.6 mc/s, and even with the large spread of television transmitters, there is room in it for

finned to within a distance perhaps 50 per cent. greater than the optical. It is as yet, however, too early to say what are the limits of reception, and it seems possible that the limiting distance is greater than is often thought.

The properties of these wavelengths, therefore, are rather a matter of speculation at the present time, for although there is a great deal of data on their behaviour, it is by no means complete. It is, consequently more profitable to turn our

attention to receivers, and it will be found that sets for television reception must differ from ordinary broadcast sets in many features because of two fundamental differences—the very high signal frequency and the very wide band of frequencies which must be passed.

In order to clarify our ideas, let us consider the reception of a station on 7.5 metres. The frequency is 40 mc/s, and, allowing for modulation frequencies up to 1,000,000

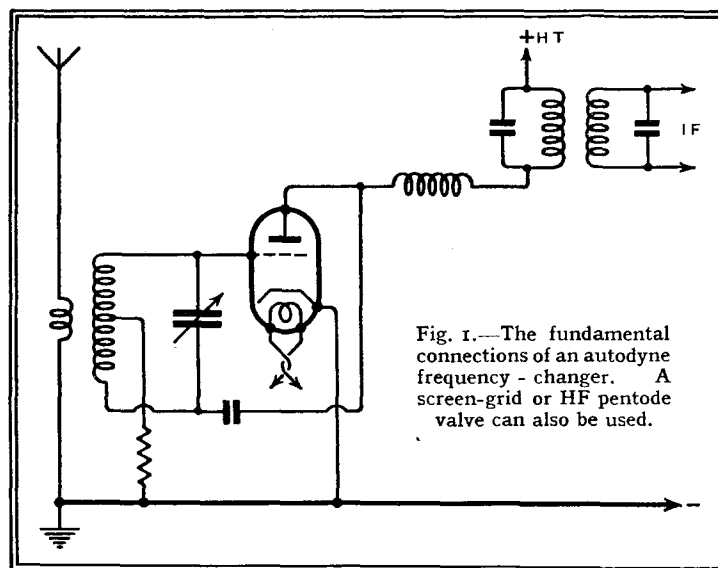

Fig. 1.—The fundamental connections of an autodyne frequency-changer. A screen-grid or HF pentode valve can also be used.

some thirteen stations. A better idea of the enormous width of the band can be gained when it is realised that if it were used for telephony transmissions with the usual station spacing of 9 kc/s, nearly 3,000 stations could be accommodated.

The ultra-short wavelengths differ from longer wavelengths in many ways, and as far as present knowledge goes they are of a quasi-optical nature. They do not appear to be reflected by the Heaviside layer, with the result that, although fading is absent, long-distance reception is impossible. In general, reception is con-

c/s, its total spread is 39-41 mc/s. For distortionless reproduction of the picture, all frequencies in this band must be received and amplified faithfully. The super-regenerative receiver seems unlikely to be of much service on account of the high level of background noise which it introduces and also because of its tendency to distortion, so that the choice of a receiver falls upon the straight set and the superheterodyne. Experience with ordinary short-wave receivers shows it to be difficult to obtain a stage gain of more than 1 or 2 times at 15 to 20 metres, and

Television Reception and the Superheterodyne— unless care be taken the valve may even act as an attenuator. If it be difficult to obtain HF amplification at these wavelengths, how much more so will it be at 7.5 metres. Although it cannot be said that the straight set is an impossibility, the superheterodyne is much simpler at the present time. Such a receiver can be divided into four distinct parts, all of which differ from their counterparts in a medium wave broadcast set. There is first the frequency-changer, secondly the IF amplifier, thirdly the detector, and fourthly the LF amplifier. The IF amplifier must have a band width of 2 mc/s and provide adequate amplification; the frequency used can be anywhere from about 3 mc/s to 12 mc/s, and 4 mc/s is a convenient figure. The LF amplifier must give a minimum of amplitude distortion with an output of some 20 volts, while possessing a flat overall frequency characteristic from 25 to 1,000,000 c/s. The detector requirements are even more difficult to meet, for this piece of apparatus must operate with an input of some 4 mc/s and give an output over practically the whole range of frequencies up to 1 mc/s.

The Frequency-Changer

It is, however, primarily with the frequency-changer that we are concerned in this article, and let us clarify the problem by assuming that we are to receive a station on 40 mc/s, and that the intermediate frequency is 4 mc/s. The oscillator, therefore, must function on either 36 mc/s or 44 mc/s. The simplest form of frequency-changer is undoubtedly the autodyne, the fundamental circuit of which appears in Fig. 1; the valve used may, of course, be a triode as shown, or a tetrode or pentode. In spite of its simplicity, this arrangement is unsatisfactory for many reasons. In the first place, the input circuit must be mistuned from the signal by some 10 per cent., so that there is a decided loss of signal strength. Secondly, the autodyne is not usually an efficient frequency-changer, for it is not easy to control the amplitude of the self-generated local oscillations, with the result that the valve often works in an overloaded condition. Thirdly, and most important, the autodyne is a very good transmitter. With a system such as that of Fig. 1, intense radiation takes place, and were it to become widely used for television re-

ception it is unlikely that there is any district in which interference-free reception would be possible. This point alone should rule out the autodyne frequency-changer.

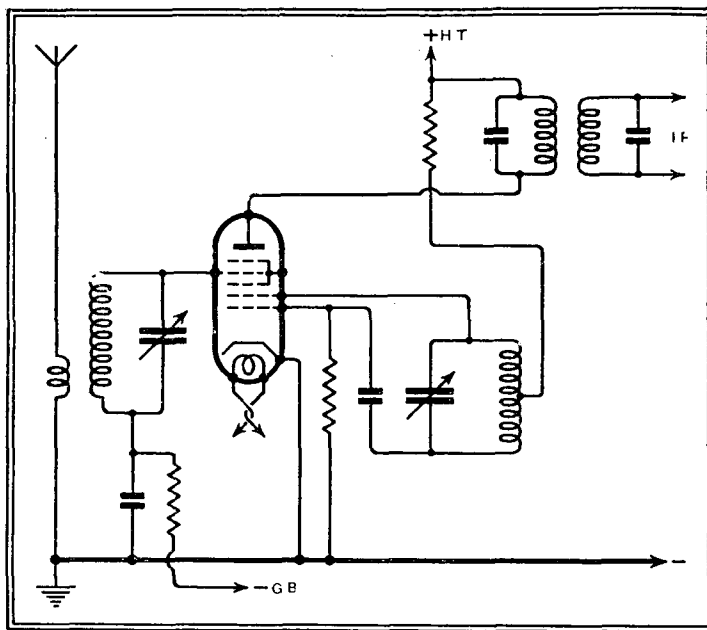
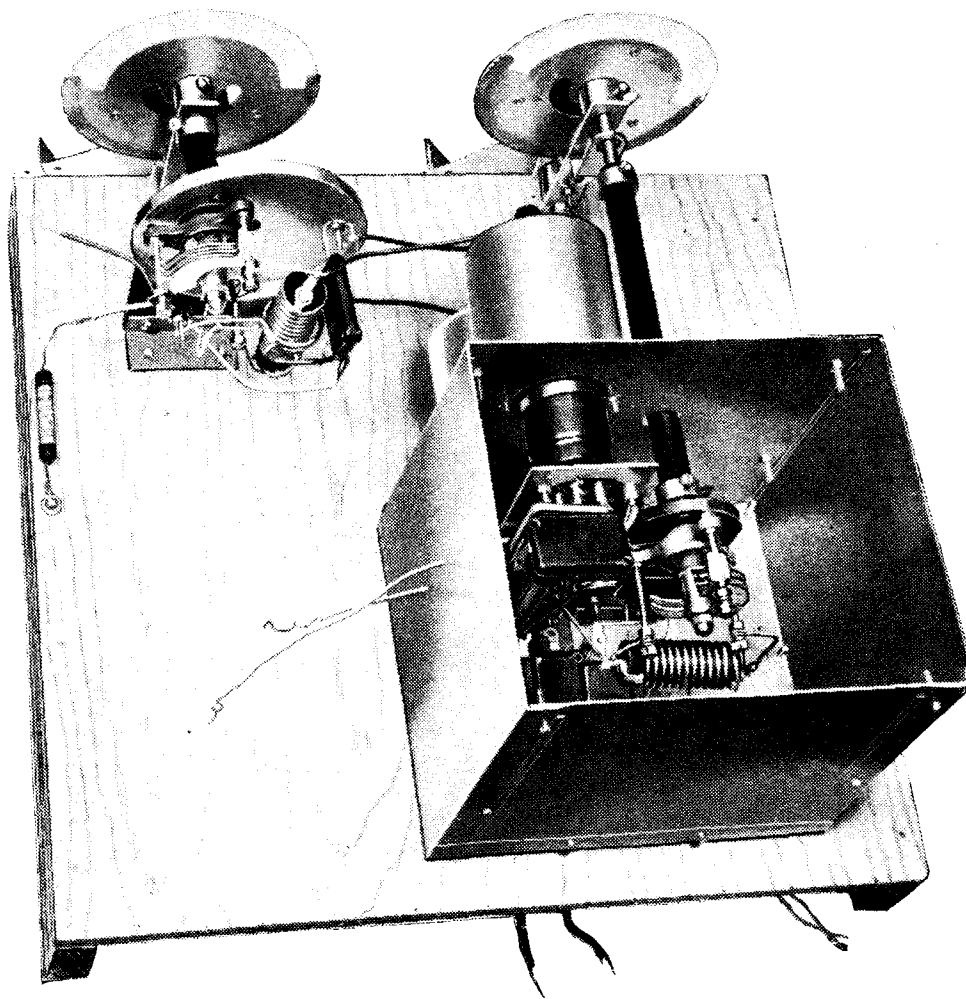

Fig. 2.—The heptode may be employed on ultra-short wavelengths and the Hartley oscillator circuit is most suitable.

The heptode seems the obvious choice for the frequency-changer, therefore, since

one of the greatest advantages claimed for it is the isolation of the signal and oscillator frequency circuits. The arrangement is shown in Fig. 2, and it will be noted that the Hartley circuit is used for the oscillator since it oscillates more readily than the usual system of a tuned circuit with reaction coil. Practical experience shows two difficulties associated with this frequency-changer. The mutual conductance of the triode section of the heptode is fairly low, with the result that difficulty is often experienced in making the valve oscillate at frequencies of the order of 40 mc/s. Even when oscillation can be secured, however, it is found that serious interaction occurs between the signal and oscillator circuits. No screening is perfect, with the result that there are small capacities existing between the various electrodes, so that the true circuit diagram becomes like that of Fig. 3.

The capacities appearing across the oscillator circuit do little harm, but it can readily be seen that C_1 between the control and oscillator grids couples the two tuned circuits together. Its effect is offset to some extent by C_2 between the oscillator anode and the control grid; in fact, if this capacity were given a suitable valve neutralisation of the coupling would result. The coupling upsets the performance of the frequency-changer in several ways: it means that oscillator frequency voltages are applied to the control grid,



This illustration shows an experimental model of the push-pull frequency-changer. The oscillator components are fitted in the large screening box, and the tuned aerial circuit is contained in a smaller can, the cover of which has also been removed.

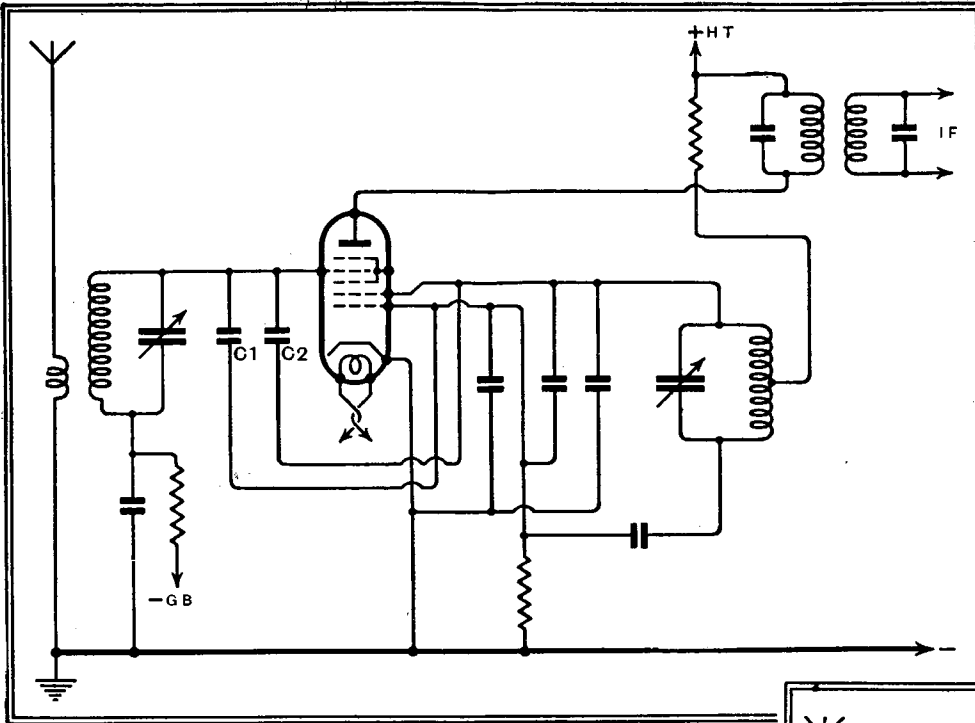

so that the mixing is not entirely electronic; it leads to interaction between the tuning of the two variable condensers so that an adjustment to one necessitates an alteration in the setting of the other, while the oscillator may cease to function altogether at certain settings of the controls; and radiation from the aerial may occur, although it is unlikely to be as severe as with the autodyne. The coupling is not wholly due to the interelectrode valve capacities, for there is a negative mutual conductance between the control grid and the oscillator anode which alone can give rise to serious difficulty.

Two of the faults of the heptode can readily be overcome by using a separate oscillator, as in Fig. 4. No use is then made of the oscillator anode, so that the negative mutual conductance effect ceases

Fig. 3.—The circuit of Fig. 2 is shown here redrawn to include the inevitable valve capacities which are largely responsible for interaction between the tuned circuits.

Fig. 4.—(Right) Pulling can be reduced by using a separate oscillator to feed the heptode, but interaction is not completely avoided unless neutralising be adopted.

Fig. 5.—(Below) A circuit which is inherently free from interaction effects provided that proper screening be used is shown here. Two heptodes are used in push-pull.

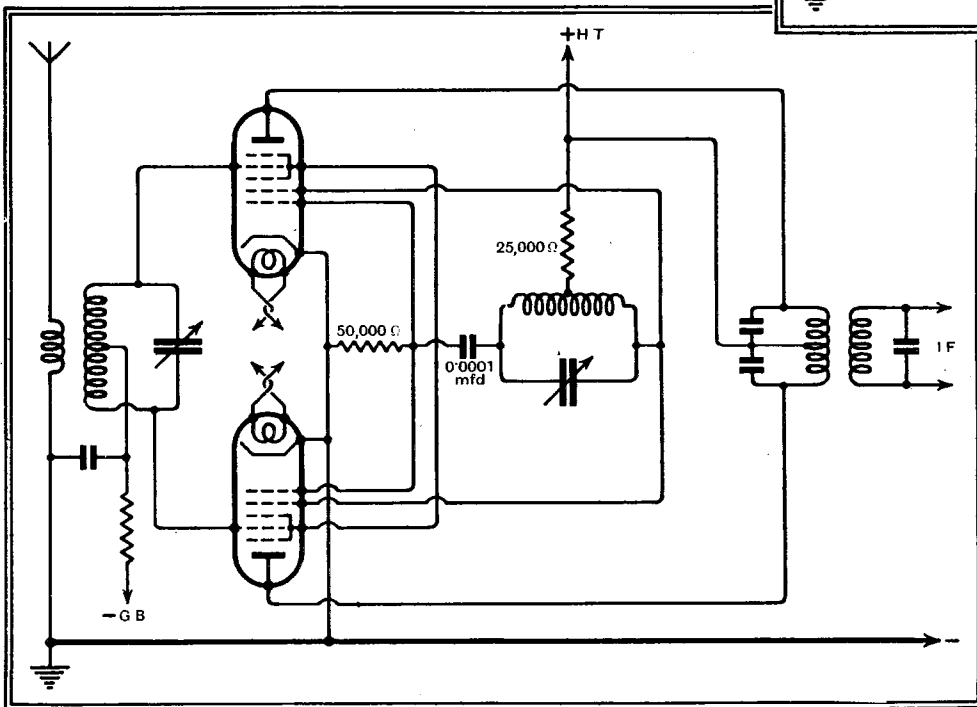
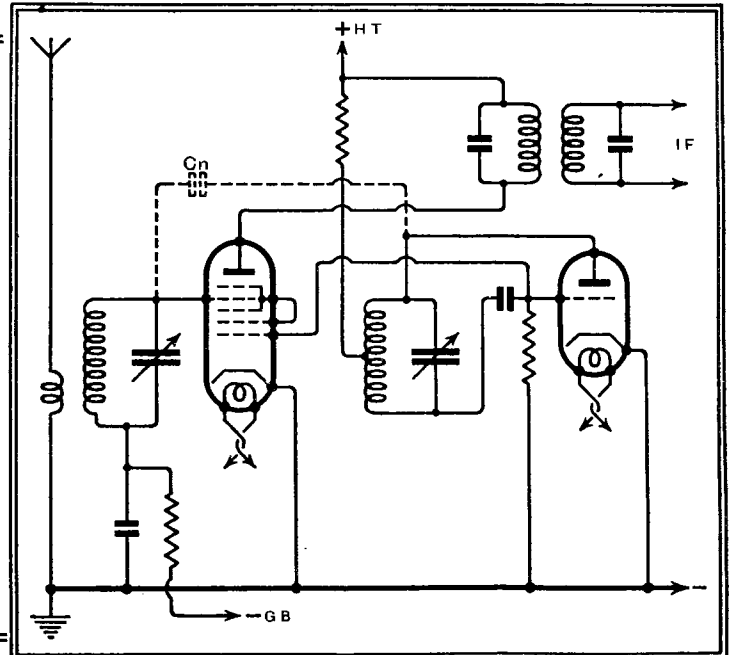

to exist and no difficulty is experienced in maintaining oscillation because of the higher mutual conductance of separate triode valves. The capacity coupling in the valve, however, is still prominent. This could undoubtedly be neutralised by means of a condenser, shown dotted at C_n , connected between the control grid and the oscillator anode. It would, however, be difficult to secure a suitable condenser, for its capacity would be of the order of $0.2 \mu\mu F$ only. Moreover, its adjustment would not be easy.

An alternative arrangement has been developed, therefore, which is inherently self-neutralised. This is shown in Fig. 5, and it will be seen to consist of two heptodes in push-pull as far as the input and output circuits are concerned, but in parallel for the oscillator sections. These oscillator sections may be considered as a single triode having a mutual conductance twice that of one section alone, so that no difficulty is experienced in ob-

taining satisfactory and reliable oscillation over the whole tuning range. A driver valve for the oscillator becomes unnecessary.

Now, in each valve there is a certain coupling to the control grid due to the interelectrode capacities and the negative mutual conductance effect already mentioned. With identical valves the degree and type of coupling is the same in each case; consequently each control grid is coupled to the same point through an identical type of coupling. In the absence of any dissimilarity in the external grid circuits, therefore, each control grid has impressed upon it oscillator frequency potentials which are identical not only in their magnitude but in their phase. If the tuned circuit be connected between the two grids and its centre point earthed, the two ends of the circuit will always be at the same potentials relative to earth, and the potentials will be in the same phase. In consequence, they can drive

Television Reception and the Superheterodyne—no current through the coil and its tuning is entirely independent of that of the oscillator circuit.

The tuned circuit is coupled to the aerial, and signal frequency currents flow in it which set up potentials across its two halves, which are of equal value but of opposite phase. These do not affect the oscillator circuit for the couplings in the valves are to the same point. Mixing takes place in each valve by electronic action, and the intermediate-frequency currents appearing in each anode circuit are combined in the push-pull IF transformer.

In this way it is possible to devise a frequency-changer which will, in theory, allow the tuning of the signal and oscillator circuits to be completely independent and yet give efficient mixing, which will allow ready oscillation over the desired tuning range and yet give no radiation from the aerial. In practice, the achievement of these theoretical expectations depends on many different factors. Obviously, the two valves must be alike, but no difficulty has been experienced in the experimental work when using valves of the same make, but otherwise picked at random. The second point of importance is that external couplings must be reduced as nearly as possible to zero. It is obvious that there is no point whatever in choosing a circuit especially for low coupling between the different circuits if stray couplings are to be allowed to outweigh all its advantages. Very thorough screening of the oscillator circuit is essential, and it is usually necessary to screen the signal-frequency tuning equipment also. Comprehensive decoupling is required and stray capacity couplings must be guarded against like the plague. A stray capacity of $1 \mu\mu\text{F}$ does not sound very large, and at 750 metres on the medium waveband it represents a reactance of 400,000 ohms, so that except in certain cases it may not cause much harm. At 7.5 metres, however, its reactance is only 4,000 ohms, and there are few places where it will not exercise a serious effect.

Practical Notes

The push-pull frequency-changer is by no means a new idea for it is standard practice in commercial stations. Two triodes are normally employed with the signal applied in push-pull to the grids to which a separate oscillator is coupled in parallel. The IF output is taken from the anode circuits in push-pull. The system is employed because of the absence of interaction between the signal and oscillator frequency circuits, but more because it largely eliminates many of the unwanted modulation products found with most ordinary frequency-changers and which give rise to the whistles so common in certain types of superheterodyne. In view of this, it is not improbable that the push-pull system described in this article will find wide application, not only in ultra-short and short wave reception, but also in receivers designed for the medium and long wavebands.

Before concluding, a few practical notes on the circuit of Fig. 5 may be of interest

to experimenters. The signal-frequency coil must be centre-tapped and a cylindrical coil on a $\frac{3}{8}$ in. diameter former is suitable. About 14 turns of No. 16 gauge wire wound 8 turns per inch is suitable when the condenser has a maximum capacity of $15 \mu\mu\text{F}$. A similar coil but with only 12 turns can be used for the oscillator with the same size condenser, but here the tapping can be between the centre and about one-quarter the way from the grid. The best point should be found experimentally. Screening and decoupling must be very thorough. Two

points about the valves are important: the screen voltage must be low if stable operation is to be secured; about 45-60 volts is right, and the valves must *not* be metallised. The valves are best screened, and if they be separately screened it is probably unimportant whether they are metallised or not. If they are not very thoroughly screened, however, it is imperative that they be unmetallised. Apparently the metallising is not a very good conductor, and instead of acting as a screen in the manner intended it functions as a very effective radiator.

Random Radiations

By "DIALLIST"

Linguists All

ONE thing that wireless has done for humanity is vastly to increase the knowledge of foreign languages in civilised countries. There are few lands now in which language lessons do not form part of the broadcast programmes. One of the difficulties about identifying stations is that you can no longer go by the language that is being spoken. You may, for example, find a Czecho-Slovakian station gaily talking anything from Spanish to Dutch—though the odds are that an English lesson will be in progress.

How many of us, too, have found that we have revived languages that we once knew, but thought that we had pretty well forgotten, by means of our wireless trips abroad? I am sure that the number of Britons who have gained or regained at least a smattering of foreign tongues with the help of the wireless set is a pretty big one.

The Spread of English

Some years ago I was rash enough to predict that wireless might eventually lead to the adoption of English as a kind of *lingua franca* for the world. Nowadays it seems almost as if something of the kind were coming to pass. I remember more than once picking up on the short waves conversations—either verbal or in morse—between amateurs in different countries who were using English as the only common medium for communication.

The British and American short-wave stations have a world-wide audience. And

have you noticed how many of the short-wave transmitters in other countries announce their items in English as well as in their own language?

An Accumulator Point

THE mass-plate type of accumulator has become widely used for filament heating purposes in recent years. It owes its popularity, I suppose, largely because it is cheap to make and therefore cheap to buy. Myself I have never been enamoured of the accumulator of this kind except for very light duty. It is not really fit (unless it is of large capacity) to stand up to continuous loads much greater than 0.25-0.4 ampere. Heavier loads mean inevitably an unduly short life. It is rather surprising therefore to find manufacturers supplying the mass-plate accumulator as the filament battery for sets drawing as much as 0.7 ampere of LT current.

I use batteries and battery sets a good deal and my own filament accumulators are always of the multiple-plate type. They will stand heavy loads without distress; and you can always have a new set of positives put in at small cost when the old ones begin to show signs of being the worse for wear.

Wireless as She is Sold

THE other day I came across a really priceless case of interference with wireless reception. A friend who had installed a new superhet of first-rate make told me

TELEVISION REPORTER'S VAN

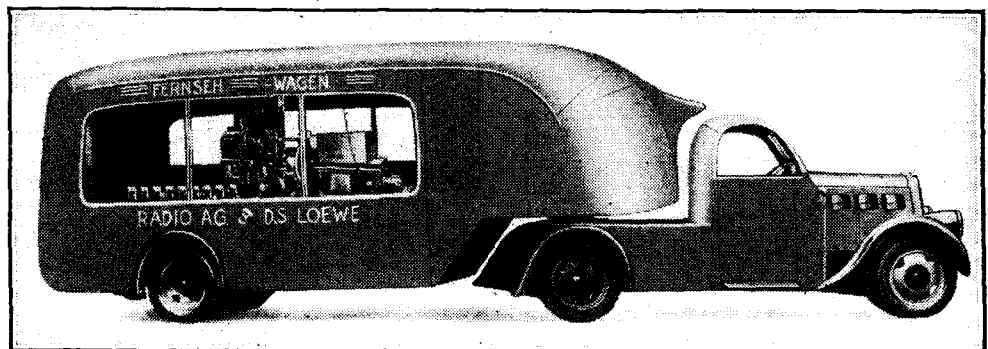

For some eighteen months Berlin has had a television transmitter of high definition in operation on ultra-short waves. Proposals are now on foot to erect a chain of stations in Germany. The illustration shows the Loewe television reporting van intended to be used for filming outside events to be televised later, using the film as an intermediary. Transmission can take place some 30 seconds after a scene has been filmed.

Random Radiations—

over the 'phone a pathetic tale of crashes and bangs from the loud speaker. Reception, even of the local station, was pretty well impossible. Could I possibly help? Round I went to investigate. There was no doubt about the unpleasant noises, and from their regularity (crack—crack, pause, crack—crack—crack, pause, BANG, pause, crack—crack) I diagnosed a flashing sign somewhere not far away. On going out to look round we were not long in finding the source of the trouble. Over a shop front there was an illuminated sign of the kind that lights up in fits and starts, building up a word. The fits and starts corresponded exactly to the cracks emitted by the loud-speaker, and the BANG to the sudden extinguishing of the entire word.

Believe it or not that word was RADIO, and the shop one that had recently extended its activities to selling wireless sets.

Entering we enquired from the "expert" in charge of the radio department whether he was experiencing any interference. Sadly he told us that it had been so bad after dark for the past four days that he could not demonstrate sets to would-be customers in the evening. "Did you have that sign put up four days ago?" we enquired, and learnt that this was so! Suppressors have now done their good work and all is well.

More Robust Valves Wanted

MORE than half the breakdowns that occur nowadays in wireless sets are due, at a conservative estimate, to faults in valves. Why this should be so after all the years of experience that valve-makers have had I don't quite know, but there is no doubt that it is the case. What we want, and want badly, is valves of what the Americans call a more "rugged" type, valves that can stand up to a good thousand hours of service before they qualify for the dustbin. It is of little use to make improvement after improvement in the characteristics of valves and in their "efficiency" if they are prone to die on you after a short life, no matter how gay it may have been.

Robust valves can be built, and it is surely up to our makers to make certain that we get them. We have designers and factories second to none in the world, and the genuinely reliable valve should be their first and foremost aim.

"Impossible" Stations

OFTEN I am moved to wonder why so many of the lay papers publish day by day lists of recommended items from Continental stations that cannot possibly be received, at any rate by the ordinary listener. The day before this note was written I amused myself by taking one paper's morning and afternoon lists and trying for the stations with a pretty efficient 4-valve "straight" set. I found that 75 per cent. of them, if receivable at all, were accompanied by so much interference that they just were not worth listening to. Quite half of the stations produced not so much as a whisper!

What can be the use of selecting for readers such transmissions as Vienna, Madrid or Paris P.T.T. in the morning; or of listing the early afternoon programmes of Barcelona, Turin, Katowice and Copenhagen? It is seldom that the best of sets can receive them at such times with any-

thing approaching entertainment value. The worst of such lists is that they are apt to make listeners expect the impossible from sets that they buy or build. "Surely," they say, "these stations wouldn't be recommended if they weren't receivable; as this set won't bring them in it must be a poor thing." If lists must be published surely it is worth while to compile them intelligently, as a few papers do.

Short-wave Broadcasting

STUDENTS of the theory of short-wave propagation must be considerably worried when they first try to reconcile their theories with practical results. This, by the way, is not the preamble to a lecture, but a reflection on short-wave conditions as they are at the present time.

The behaviour of the Empire Station at Daventry, as received in South London, has been quite extraordinary during the past fortnight. The 16- and 19-metre transmissions have been coming in like locals; the 31-metre programme has been the most consistent, though not so strong; and the 49-metre wave seems to be a law unto itself.

On some nights the last named will spread over 100 kc/s or more, completely swamping most of the other stations in the 49-metre band, while at other times it will be so weak that it has no programme value whatever.

The most extraordinary thing of all is that happenings on the amateur bands do not seem, in any way, to reflect these freakish conditions. Similarly, most of the more

good. Previous to that date they had been definitely bad for some little time.

There now seems to be another change about, and one of its first effects has been to improve reception from Central America once more. Incidentally, the latest list of short-wave stations (published in U.S.A.) shows a tremendous number of broadcast stations in the West Indies, few of which ever seem to be heard on this side of the Atlantic.

The 45-50-metre band alone, for instance, is occupied by the following: Havana, COC, on 49.96; H11A, Dominican Republic, on 47.95; HIX, Santo Domingo, on 50.17; HIZ, same location, 47.5; HIL, same again, 45.94; HI3C, La Romana, 43.48; another Cuban station, call-sign unknown, 48.3 metres.

In addition to these, there are stations with irregular schedules in the Bahamas, Antigua, Barbados, Porto Rico, and Jamaica!

Quite apart from these stations, there are literally scores in Central America, chiefly divided between Honduras, Guatemala, Nicaragua, and Panama. A little lower down (geographically) we have the whole host of Colombians, after which South America becomes fairly quiet.

A really complete list of short-wave stations would probably reveal the fact that the area between Florida and Peru contains more active short-wave broadcasters than any other area of similar size in the world. Conditions for the reception of Asia and the Antipodes are still good. VUB, Bombay, on his wavelength in the 31-metre band, is fairly consistent, though never strong.

A large number of stations in the region of Indo-China, Siam, and the Philippine Islands are also being regularly reported by readers. The most striking piece of reception yet noted is that of a reader who identified VPD, located at Suva, Fiji



HOLY LAND STATION. The three main panels and control desk of the 20 kW transmitter, nearing completion at the Chelmsford works of the Marconi Co. in readiness for final tests prior to shipment to Palestine for the chosen site, seven miles north of Jerusalem.

distant broadcast stations seem to be fairly consistent. The erratic behaviour is more or less confined to the "locals," including Daventry, Zeesen, Pontoise, and Moscow.

The group of sun-spots whose appearance was recently recorded had its immediate effect upon short-wave conditions, which, from February 9th onwards, were really

Islands. This station, operated by the Amalgamated Wireless Co. at Suva, works on 22.7 metres—just above the top limit of the 20-metre amateur band—and has been heard between 5.30 and 7 a.m. Tuesdays and Fridays are believed to be the regular days for transmission.

MEGACYCLE.

Broadcast Brevities

By Our Special Correspondent

Funny Finance

STUDENTS of finance will rub their eyes at the estimate of £200,000 for the proposed extensions to Broadcasting House. The buildings to be taken over cover an area at least the size of that occupied by the existing headquarters, and although there may have been a slight slump in the cost of building materials since Broadcasting House was erected, it is inconceivable that even Colonel Val Myer himself could rear another stately pleasure dome of the same size at a fifth of the figure.

Another Central Tower

Already the minions of Portland Place are stretching their legs in imagination at the prospect of additional space, and are eagerly discussing building plans.

A second central tower seems to be a *sine qua non*, with a set of studios for television and ordinary broadcasting purposes which may white-ephanitise Maida Vale at one sweep and put St. George's Hall on the market.

A Super Cinema?

It is also being whispered that a B.B.C. cinema organ will be constructed, presumably in a second edition of the concert hall. This might provide an opportunity for putting on the screen films that are simultaneously being televised, thus enabling the B.B.C. to run its super cinema.

An Early Morning Test

MANY listeners wondered why both Droitwich and Midland Regional were radiating from midnight to 3 o'clock on Sunday morning, February 24th.

Actually most important tests were being made in Nottingham to prove to the City Passenger Corporation the extent of the interference of trolley buses with radio reception.

Stopper Coils

Six buses were used for the test, all, except one, belonging to the Corporation. The exception was a Notts and Derby Traction Co. vehicle which had been equipped with stopper coils since the inception of the service. This came through the test with flying colours, and so did the Corporation vehicles fitted with the latest Post Office coils of a dual type, covering both long and medium wavebands.

An Interesting Report

The test was arranged by the Post Office, the B.B.C., and the Nottingham Passenger Transport

Department, and was watched by three officials of the Post Office from the Engineer-in-Chief's office, London. A report is to be issued, and it should make interesting reading.

Double Anniversary

"HALLMARKS IV," on March 16th, will be the occasion of a double anniversary. With this Guest Night, Henry Hall and the B.B.C. Dance Orchestra will enter their fourth year of broadcasting and at the same time complete a year of Guest Nights.

Reminiscences

Nearly two hundred guest artists have appeared during the year, many of them coming to the microphone for the first time.

The celebrations will bring a number of previous guests to the microphone for a programme of tunes in reminiscent mood.



WADING COMMENTARY by Announcer Stein and Technician Kelpwood on the Caliente (Cal.) Golf Tournament. The ultra short wave transmitter connected with Station XEBC.

Renewing the Charter

THAT the B.B.C. Charter will be renewed no one at Broadcasting House seems to doubt. The Television Advisory Committee has standing orders covering a period of five years, during which time it will advise the B.B.C. on television procedure. If the B.B.C. Charter were in jeopardy at the end of next year it is hardly likely that this would be the case.

For Blind Listeners

LANGUAGE pamphlets to accompany the new courses of lessons broadcast by Mr. E. M. Stéphan and other B.B.C. teachers can be obtained in Braille by any blind student from the National Institute.

For Western Canada

IF listeners in Western Canada respond to the new B.B.C. move in starting, in the small hours, experimental transmissions specially for their benefit, the service may become a permanency.

The test transmissions began on Friday, March 1st, and are given from 2.30 to 3.30 a.m. (G.M.T.) on Sundays, Mondays, Wednesdays, and Fridays, for reception primarily in Western Canada on the previous evenings, local time.

The transmissions are made on 49.1 metres (GSL) and 31.32 metres (GSC). These may be altered if listeners' reports suggest that a change would improve reception.

Duke of Gloucester's Return

THE speeches at the banquet given by the Royal Empire Society on the return of H.R.H. the Duke of Gloucester, K.G., will be relayed from Grosvenor House, Park Lane, London, at 9.30 p.m. on Wednesday, April 3rd.

Good Empire Shows

ARE the B.B.C. programme builders too proud to partake of the Empire fare? A glance through recent Empire programmes shows that Beresford Clark, the Empire programme builder, is putting across some really fine exclusive stuff with the aid of Cecil Madden.

Thrillers

These programmes include exciting talks and detective thrillers which would be welcomed by listeners at home, who are not so sophisticated as Portland Place is inclined to imagine.

Naturally, the Empire transmitters fill a large percentage of their time with the normal B.B.C. programmes or electrical recordings of these. This is as it should be, for Empire programme expenses must not be allowed to incur a heavy drain on the exchequer.

Return of Empire Director

Cecil Graves, the Empire programme director, has almost recovered from his indisposition, and is expected to return to



CAPTAIN CECIL GRAVES, who may temporarily desert the B.B.C. Empire Department to advise Newfoundland on broadcasting problems.

Broadcasting House towards the end of this month. He will not, however, take full charge again until the end of June, as he contemplates a long recuperative voyage.

A Request from Newfoundland

Although Newfoundland has asked the B.B.C. to send an emissary to advise on the broadcasting system, and although Mr. Graves would be the ideal choice for this purpose, the Governors will give the matter their deep consideration before entrusting the task to Mr. Graves. There is no point in endangering his health at the expense of the B.B.C.

Mr. Graves is a nephew of the late Lord Grey of Falloden, whose Northumberland estate he inherited.

Tenacious Welsh

FOR thirteen years the Welsh have given the world an example in tenacity of purpose. Year after year their deputations have trooped to B.B.C. headquarters to cajole Sir John Reith into providing them with their own broadcasting station.

Sir John continues to win on points, yet the Cambrian patriots come back to the fray.

A Friend at Court

The fact that the B.B.C.'s Annual Report refers nebulously to the erection of a Welsh relay station gives the Welshmen less satisfaction than the knowledge that they have on the B.B.C.'s Advisory Council none other than David Lloyd George.

Mr. Lloyd George's Views

Mr. Lloyd George is, I believe, disinclined to accept the B.B.C.'s view that a high-power Welsh transmitter is unwanted because the number of licences is so small. "Give us a transmitter, and licence figures will go up," say the Welsh; and there is something in this, as the porter said on lifting the trunk.

Readers' Problems

Mixed Valves

WHEN a directly heated output valve is employed in conjunction with indirectly heated AC valves elsewhere, it is generally considered necessary to provide filament current for the first-mentioned valve from a separate winding on the power transformer. At any rate, this course is generally recommended for amateur-built receivers when the output valve is to be automatically self-biased.

Although it is best in most cases to provide this separate winding, it is theoretically possible to avoid doing so, and in reply to a querist who asks for information on the subject, it may be stated that there is no basic reason why a mixed lot of indirectly and directly heated valves should not be heated from the same transformer secondary, provided, of course, that their heater and filament voltages are the same; true self-bias for any valve can still be retained.

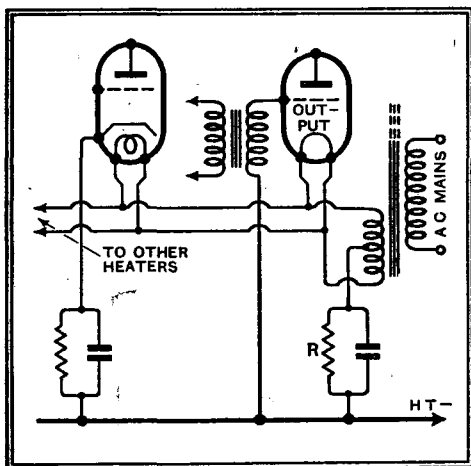

Fig. 1.—Indirectly heated and directly heated valves supplied from the same LT secondary winding.

The usual method of connection is shown in Fig. 1; here the output valve derives bias from the voltage drop across the resistance R, which is shunted by a high-capacity condenser (50 mfd. or so) of the electrolytic type.

Energising a Microphone

A READER who proposes to energise a microphone from a 12-volt accumulator battery asks whether it would be permissible to reduce the applied voltage to the rated value of 6 volts by means of a series resistance.

This arrangement would work, but it should be realised that, as speech-frequency currents must flow through the extra resistance, its presence will tend to reduce the available output from the microphone. As to whether or not this will be harmful depends on circumstances; as the proposed arrangement overcomes the need for a separate microphone battery, it would be worth while to give it a trial.

Hum and Frequency Response

ANYTHING that tends to reduce the low-frequency response of a receiver will probably reduce mains hum as well.

As an example, a querist who is trying to trace the source of a slight but annoying residue of hum in his receiver states that it is removed almost entirely by disconnect-

ing the high-capacity electrolytic by-pass condenser which is wired across the bias resistor of the output valve.

This, we are afraid, does not get us much farther. The purpose of the high-capacity condenser is to maintain bass response, and, in all probability, its removal only reduces hum at the expense of low-frequency reproduction.

THESE columns are reserved for the publication of matter of general interest arising out of problems submitted by our readers. Readers requiring an individual reply to their technical questions by post are referred to "The Wireless World" Information Bureau, of which brief particulars, with the fee charge, are to be found at the foot of this page.

Choke Decoupling

THE idea of using an iron-cored choke for decoupling LF circuits is always attractive when the HT voltage supply is limited. Unfortunately, however, the choke is hardly likely to be as effective as the more usual resistance, for the reason that its reactance falls off very seriously at low frequencies. It is at these low frequencies that the "by-pass" effect of the associated condenser is also at a minimum.

It will therefore be easy to see that choke decoupling cannot safely be recommended for use in an amplifier which gives full proportional amplification of low notes, and a reader who proposes to use it is warned that instability is likely to occur. It is possible, however, that the trouble might be overcome by using by-pass condensers considerably larger than those usually associated with resistance decoupling.

Amplified AVC

IN reply to several correspondents who have asked for information on the subject of fitting amplified AVC to battery-fed receivers, it should be pointed out that the ordinary systems are inapplicable to battery valves. At any rate, the fitting of this system of control would involve the duplication of batteries, which can hardly be considered a practical expedient.

The Wireless World INFORMATION BUREAU

THE service is intended primarily for readers meeting with difficulties in connection with receivers described in *The Wireless World*, or those of commercial design which from time to time are reviewed in the pages of *The Wireless World*. Every endeavour will be made to deal with queries on all wireless matters, provided that they are of such a nature that they can be dealt with satisfactorily in a letter.

Communications should be by letter to *The Wireless World* Information Bureau, Dorset House, Stamford Street, London, S.E.1, and must be accompanied by a remittance of 5s. to cover the cost of the service.

Personal interviews are not given by the technical staff, nor can technical enquiries be dealt with by telephone.

Balanced Reproduction

ALTHOUGH there is no inherent reason why a "tweeter" should not be employed with even the simplest of receivers, we think it should be pointed out to the user of a small battery set, who asks our advice on the subject, that the use of these high-note speakers is generally confined to the more ambitious type of receiver. A small battery set has, of necessity, a limited output and, as a consequence, the lower frequencies are unlikely to be reproduced at their due proportional strength; an abnormal increase in high-note response may be actually harmful, as reproduction will then be less well balanced than before the addition of the extra speaker.

Tuning Out the Whistles

BROADLY speaking, heterodyne notes due to interaction between the carrier waves of stations occupying adjacent channels can be eliminated or minimised in two different ways: by drastic curtailment of the high-note response of the set or by fitting some kind of absorbing circuit, tunable to the frequency of the offending whistle. In moderately skilful hands the second alternative is clearly the better, as a "whistle eliminator" of this type does not affect frequencies above and below that of the interfering heterodyne note.

The question of a tunable suppressor for connection to an existing receiver is raised by a correspondent, who asks us to give him the circuit arrangement of a suitable device for connecting to the LF transformer of his receiver.

In the circumstances, we suggest the arrangement shown diagrammatically in Fig. 2. This consists of a series-tuned acceptor circuit which, as it may be tuned to frequencies of 4,000 c/s upwards, will be capable of dealing with all the usual hetero-

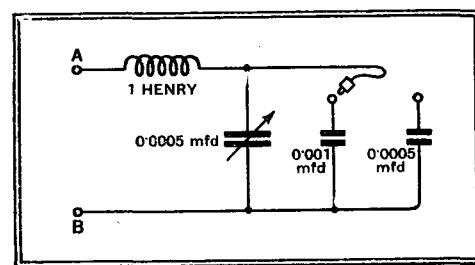

Fig. 2.—Whistle filter for insertion in the LF circuits of an existing receiver.

dyne whistles. To cover the necessary range a tuning condenser of 0.002 mfd. will be required; this is not readily obtainable in suitable form, and so it is suggested that a combination of two fixed and one variable condenser should be used in the manner shown in the diagram. The 1-henry inductance should be of the air-cored type, and of reasonably low resistance; winding data for a suitable coil was given in our issue of October 28th, 1932, in which a good deal of useful and highly practical information regarding this type of filter was published.

The terminals A, B are joined across the primary terminals of the LF transformer, or, for that matter, across any LF coupling device. In some cases they may even be joined to the primary of the output transformer which feeds the loud speaker.

Components and Accessories for Television Sets

Notes on Apparatus at Present Available for Low- and High-Definition Systems

ALTHOUGH plans are being formulated for the establishment of high-definition television broadcasts, some time must elapse before a regular service can be inaugurated. Meanwhile, readers who wish to acquire a little experience in the working and handling of television apparatus have at their disposal the bi-weekly 30-line transmissions now broadcast by the B.B.C.

In compiling this list of firms interesting themselves in the supply of television components and accessories, apparatus applicable to the present system as well as that which will serve for both present and future needs has been included. It is, perhaps inevitable that much of this latter equipment will become obsolete when the high-definition service is inaugurated, but its acquisition at this juncture can be justified on the ground that it enables experience to be gained with the addition of a simple and inexpensive unit to the broadcast receiver. It is very probable, too, that the 30-line transmissions will be continued longer than is generally supposed, whilst the high-definition system will only be available in the London area at the outset.

Ultra-short wave parts are included, as the new system will make use of wavelengths below 10 metres, this being the only portion of the radio spectrum where sufficient ether space is available to comply with the requirements of the high-definition systems.

Very few details are as yet available regarding the television programme of the firms specialising in this branch of wireless, but it is understood that all those mentioned here will, in due time, be marketing high-definition apparatus.

A COMPLETE range of parts necessary for the construction of a television unit is obtainable from Burnett Television Co., Station Road, Redhill. Special AC/DC motors for driving a disc or mirror drum are available at 20s. and 30s. each; a 16-in. scanning disc costs 7s. 6d., a mirror drum 55s., whilst the Burnett Viewing Tunnel, which is totally enclosed and non-reflecting, costs 16s. 6d. complete with matched lenses. This firm supplies, also, cathode ray tubes, time-bases, and ultra-short wave components.

ATENTION is at present being devoted by Burne-Jones & Co., Ltd., Magnum House, 296, Borough High Street, London, S.E.1, to the development of

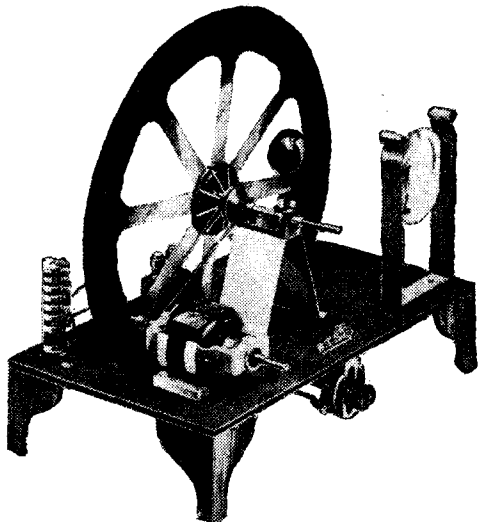

The B.T.S. kit of parts for a television receiver.

short-wave tuning coils, IF transformers mounted on Frequentite, HF chokes and potentiometers, but full details of these components are not yet available.

A CONSTRUCTOR'S kit comprising all the parts required for a disc television receiver is supplied by British Television Supplies, Ltd., Bush House, London, W.C.2, and it includes a Universal motor for mains or battery operation, controlling resistances, 16-in. scanning disc, lenses, neon lamp and holder, and a drilled chassis, the price being 84s. The addition of a synchronising gear can be made if required, and the extra parts unassembled will cost 27s. 6d.

All components are obtainable as separate items. The motor costs 35s., a 16-in. scanning disc 7s. 6d., and a 20-in. model 12s. 6d. There is a special neon lamp, the Telelux, designed to give even illumination of the picture aperture, and its price is 6s. 6d.

ARRANGEMENTS are being made by Henry Ford Radio, Ltd., 56, Howland Street, Tottenham Court Road, London, W.1, to market a range of television components which will include cathode ray tubes suitable for 240-line pictures, amplifiers, time-bases, and special short-wave components employing low-loss insulating materials.

THE exceptionally wide range of components made by A. F. Bulgin & Co., Ltd., Abbey Road, Barking, Essex, includes many that are applicable to television apparatus. There is, for example,

Special hard
cathode ray
tube designed
by Cossor.

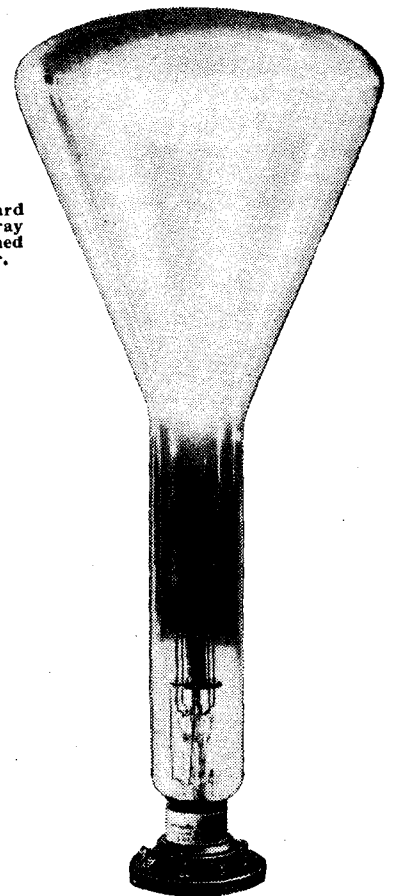

a 60-watt variable resistance made in several values which, used in conjunction with a Bulgin mains resistance, serves admirably for speed control of electric motors driving scanning discs and mirror drums. Their ultra-short wave coils will find application in the special receivers required for the high-definition transmissions.

FOR television reception, A. C. Cossor, Ltd., Highbury Grove, London, N.5, has developed a number of special hard cathode ray tubes for high-definition systems. These are available in several different sizes, one of which has a screen diameter of 12½ in. As voltages of the order of 2,000 or so are needed to excite these tubes, a special low-current half-wave rectifying valve rated at 3,000 volts maximum and for 5 mA. output is available. It is known as the type SU.2130 and costs 20s.

THE cathode ray tubes which have been designed especially for television reception by the Edison Swan Electric

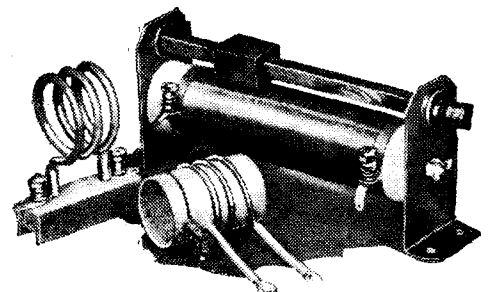

Bulgin 60-watt motor control resistance and ultra-short wave coils.

Components and Accessories for Television Sets— Co., Ltd., 155, Charing Cross Road, London, W.C.2, are of the high-vacuum type. One model, the type BH, has a screen about 4in. in diameter and is 17in. long. The other is a more recent production, and is described as the type AH. Whilst electrically the same as the BH tube, it provides a larger picture area, as the screen measures approximately 6½in. across. Either model is available with a sepia, which is nearly white, or with a green fluorescent screen, the operating voltage is of the order of 2,000, and the price is £8 8s. for the BH type and £10 10s. for the AH model.

High tension for these tubes can be obtained from a mains unit using an Ediswan MU2 half-wave rectifier. It takes 2 volts at 1 amp. for the filament, and is rated for 3,000 volts RMS on the anode. The price is 15s.

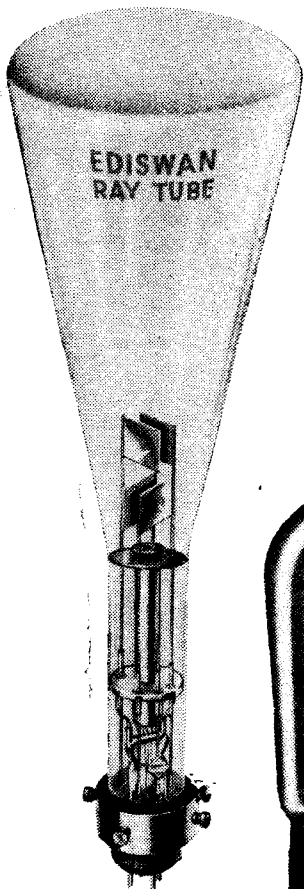

Ediswan new hard cathode ray tube, the type BH, and the Osram gas-filled relay, type GTI.



ALTHOUGH Ferranti, Ltd., Hollinwood, Lancs, has not so far released any special television components, many of their standard parts are suitable for use in the various pieces of apparatus connected with visual reception. Among their LF chokes are several that will find application in smoothing circuits of mains-operated time-base units and similar equipment, whilst their radio meters, particularly ammeters, will be found useful in keeping a check on the heater current of cathode ray tubes, which quickly suffer damage if over-run. A 0-1.5 amp. DC instrument costs £1 15s.

AT present, details are available from General Electric Co., Ltd., Magnet House, Kingsway, London, W.C.2, of two special items only that find application in television apparatus. One is a gas-filled relay, the GTI, priced at 40s., for use in time-base circuits and the other is a new output pentode, the MPT42, which has had its anode connection transferred to the top of the bulb to reduce the capacity, since for high-definition pictures the modulation extends into the radio-band of frequencies.

HAYNES RADIO, Queensway, Enfield Middlesex, has a range of time-base units which has been developed for cathode ray tube reception of television. The standard model is a five-valve unit consisting of an oscillator, trigger, amplitude regulator, synchroniser and HT rectifier covering all scanning frequencies,

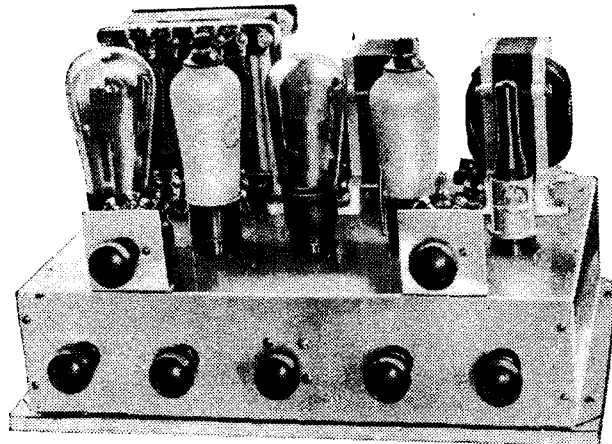

Time-base unit made by Haynes Radio for cathode ray tubes.

and it costs £15 10s., complete. Two such units are needed for television reception. There is, however, a double assembly comprising two of the standard units on one chassis, and whilst this in its present form is intended for the 30-line-12½ pictures per second as at present broadcast, by changing two small fixed condensers the unit is converted for high-definition reception. This model embodies eight valves and costs £28. Haynes Radio also makes exciter units, one model giving a continuously variable output from zero to 3,000 volts, and the price is £6 15s.

THE Pressler photo-electric cells which find application in television transmitters are marketed in this country by Eugen J. Forbat, 28-29, Southampton Street, Strand, London, W.C.2, and the prices range from 8 to 10 guineas according to the sensitivity required; also, the Otto Pressler cathode ray tube, of which two models are available. One, priced at £6, requires a working voltage between 750 and 1,000, whilst the larger model, operating on 1,000 to 2,000 volts, costs £10.

THE design and construction of photo-electric cells is a speciality of the Oxford Instrument Co., Ltd., 7, Keble Road, Oxford. A wide range of models

is available, some *in vacuo* and others gas-filled. They are divided into types A and B. The former has the cathode connection taken to a terminal on the top of the bulb, whilst in the B type it is made

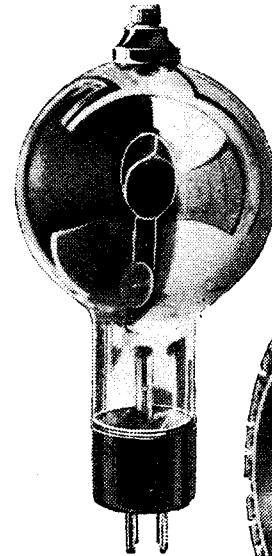

(Left) Oxford photo cell, type X41.

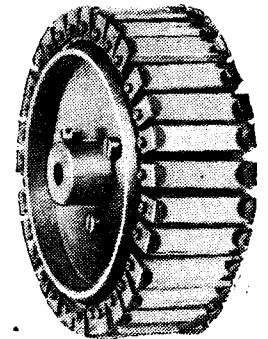

(Below) Mervyn Duo-Sphere Mirror Drum.

to the grid pin of a standard four-pin valve base. Prices range from £4 4s. 4d. to £12 12s.

THE Mervyn Sound & Vision Co., Ltd., 4, Holborn Place, High Holborn, London, W.C.1, has for long specialised in the design of television apparatus, and among the many items marketed is a complete kit of parts for the home construction of a disc-type receiver attachment for the 30-line transmissions. This costs £3. There is a mirror drum priced at £3 10s., and a universal AC/DC motor at 25s.

Cathode ray equipment is supplied, the tube costing £8 8s. and time bases 35s. each. This firm can supply also apparatus for high-definition television.

IN addition to manufacturing every type of transformer needed for the mains operation of television apparatus, Sound Sales, Ltd., Tremlett Grove Works, Junction Road, Highgate, London, N.19, has designed an exciter unit for the new hard cathode ray tube. This unit gives 2,000 volts for the one accelerator elec-

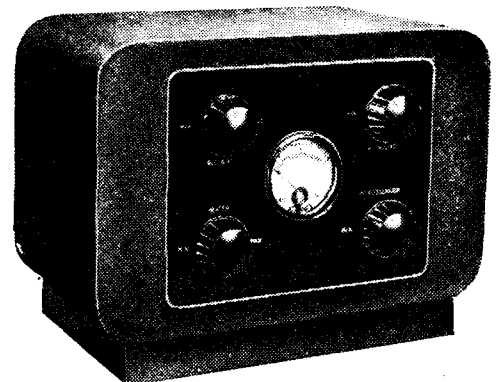

High-voltage cathode ray tube exciter unit made by Sound Sales.

Components and Accessories for Television Sets—trode and an adjustable output for the other, whilst provision is made for AC or battery supply to the tube heater. A filament ammeter is fitted to prevent over-running the heater, and the price is £16 complete.

A mains transformer designed for time-base and exciter units and tapped at 1,000, 1,250 and 1,500 volts with two 4-volt LT windings costs £2 10s., whilst a 100-henry choke to carry 15 mA. is available at 15s.

Transformers for experimental purposes and built to any specification will be supplied.

THE "Ti" lamp, which has been designed especially for television receivers embodying scanning discs or mirror drums, is a product of Television Instruments, Ltd., 323, City Road, London, E.C.1. Its special feature is that a small area only is brightly illuminated, and the design is such that a focusing reflector can be employed behind the tube to concentrate the light on to the scanning apparatus. The lamp costs 25s.

THE voltages required for operating a cathode ray tube will in some cases be as high as 2,000 volts DC, and this is most conveniently obtained from an AC source stepped-up and then rectified. Where DC supply mains only are available, the AC

A special transformer tuned for 375 cycles for the synchronising signal in the 30-line transmissions is available at 12s. 6d.

AS specialists in short-wave receiving equipment Stratton & Co., Ltd., Eddystone Works, Bromsgrove Street, Birmingham, 5, manufacture many components that will be required in the construction of ultra-short wave television receivers. There are variable condensers

Eddystone ultra-short wave coils.

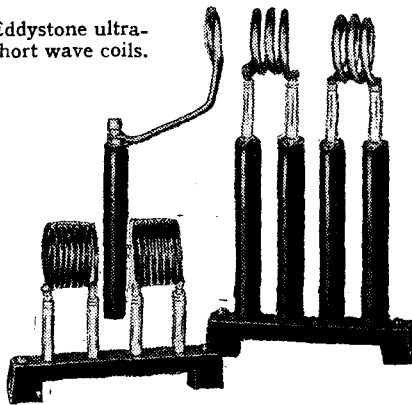

ranging in size from 15 micro-mfds. upwards, special HF chokes, coils and low-capacity valve holders, to mention but a few of the Eddystone products that have been designed especially for use on these very high radio frequencies.

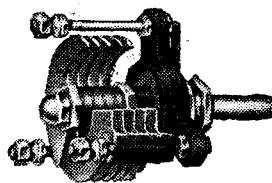

Ultra-short wave tuning condenser, an Eddystone product.

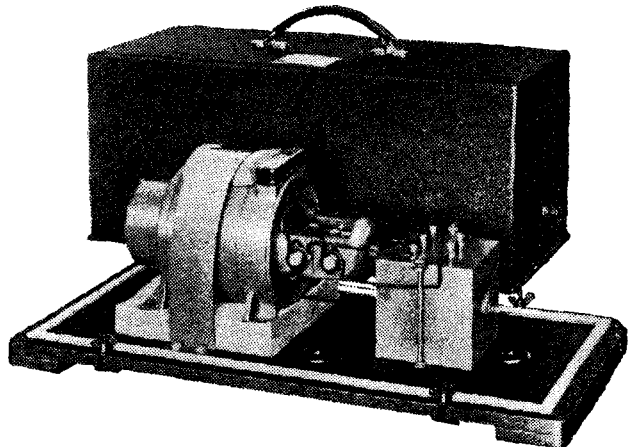

(Left) M-L DC to AC rotary transformer with anti-interference unit and sound-proof cabinet.

input for the exciter unit and other associated apparatus could very well be derived from a DC to AC machine. Rotax, Ltd., Willesden Junction, London, N.W.10, manufacture rotary transformers that would serve admirably for this purpose. They are available in several different sizes and enclosed in silence cabinets fitted with filter units. Similar machines are made also by the Electro-Dynamic Construction Co., Ltd., Devonshire Grove, London, S.W.15.

THE White Line lamp has been developed by Radio Reconstruction Co., Ltd., 33-37, Alfred Place, London, W.C.1, to give an efficient source of illumination for scanning apparatus, especially the mirror screw type. It is made in three types, hard, medium and soft; the former requires a high operating voltage and gives a bright, whitish light, the other two work on lower voltages. The price is 21s. for all types.

THE range of metal rectifiers made by the Westinghouse Brake and Signal Co., Ltd., 82, York Road, King's Cross, London, N.1, includes several models that can be employed in cathode ray tube television receivers. There are some high-voltage low-current rectifiers styled the H type, one model, the H.176, being rated at 750 volts at 5 mA. For higher voltages



Special low-current Westinghouse metal rectifier, the type HI.

two or more may be joined in series for a half-wave rectifying system. The maximum current for this model is 10 mA. Where a DC voltage is required for the tube heater a low-voltage metal rectifier and a smoothing circuit enables the supply to be derived from a winding on the mains transformer.

Condensers

FIXED condensers capable of withstanding high DC potentials are required for cathode ray tube exciter units and for some of the associated apparatus. The new oil-immersed type introduced recently by the Dubilier Condenser Co. (1925), Ltd., Victoria Road, North Acton, London, W.3, are made for 2,000 volts DC working, and are thus suitable for this purpose. The Telegraph Condenser Co., Ltd., Wales Farm Road, North Acton, London, W.3, now include in their range a new series styled the type 131. Petroleum jelly is incorporated in the dielectric, and they are rated for 2,000 volts DC working. Sizes up to 10 mfd. capacity are made.

Mains Equipment

THE design of the necessary equipment used in conjunction with cathode ray tubes for television reception is still very much in the experimental stage, so that it is not possible for those firms interested in the manufacture of mains transformers to anticipate the future demands by producing standardised models. Indeed, even the present demands vary so widely that these components are being made only to order and to customers' specifications.

All the well-known transformer manufacturers are prepared to co-operate with designers and experimenters engaged in television work, and transformers built to any specification will be supplied by the undermentioned firms:—

- All-Power Transformers, Ltd., 8a, Gladstone Road, Wimbledon, S.W.19.
- W. Andrew Bryce & Co., Woodfield Works, Bury, Lancashire.
- Ferranti, Ltd., Hollinwood, Lancashire.
- F. C. Heayberd & Co., 10, Finsbury Street, London, E.C.2.
- Partridge & Mee, Ltd., Aylestone Park, Leicester.
- Partridge, Wilson & Co., Ltd., Davenset Works, Evington Valley Road, Leicester.
- N. Partridge, King's Buildings, Dean Stanley Street, London, S.W.1.
- Rich & Bundy, Ltd., New Road, Ponders End, Middlesex.
- W. Bryan Savage, 56, Clerkenwell Road, London, E.C.1.

NEW G.E.C. RADIO-GRAMOPHONE

The circuit of the latest G.E.C. five-valve AC Superhet consists of a band-pass filter feeding into a heptode frequency-changer. This is followed by a variable-mu pentode IF amplifier operating at 125 kc/s. The second detector is of the double-diode-triode type, and provides amplified and delayed AVC. Resistance-capacity coupling is employed between the detector and the 3-watt pentode output valve. In addition to the "shadow-band" tuning indicator, the controls include a two-position sensitivity control. The gramophone motor is of the induction type.

The instrument is housed in a full-size walnut cabinet, and the price is 23 guineas. The makers are the General Electric Co., Ltd., Magnet House, Kingsway, London, W.C.2.

Portable 40-metre Transmitter

The concluding instalment of this constructional article will be included in next week's issue.

Listeners' Outstanding Bro



(By permission of the Museum and Art Gallery Committee of the Corporation of Birmingham.)

"THE TAMING OF THE SHREW"

STUART ROBERTSON takes the part of Christopher Sly in Shakespeare's "The Taming of the Shrew," to be broadcast in the National programme on Sunday at 5.35 p.m. In this special broadcast version by Peter Cresswell the part of Petruchio will be taken by Godfrey Tearle and that of Katherina, the Shrew, by Mary Hinton.

THE TAMING OF THE SHREW. Sir John Gilbert's fine picture, now in the Birmingham Art Gallery. A broadcast version of the play will be given in the National programme on Sunday next at 5.35 p.m. with Godfrey Tearle as Petruchio and Mary Hinton as Katherina, the Shrew.

LIGHT AND SHADE

MELANCHOLY reflections engendered this week by the farewell performance of the Café Colette Orchestra and by "It Seems Only Yesterday" are offset by the hard practicality of Ice Hockey and "The Taming of the Shrew."

FAREWELL PERFORMANCE

PERHAPS it is "Goodnight, but not Goodbye," in the case of the Café Colette Orchestra, which, under the direction of the indomitable Dimitri Vetter (who looks like a twin brother of Walford Hyden), will waft itself into uncalled-for oblivion on Wednesday next (National, 7.30) with dance music from the Continent and other parts of the world.

A FULL EVENING

WHILE some nights are barren of interest, there are others which offer an embarrassingly wide choice. Such is Thursday next, March 14th. Kalundborg holds its 22nd Thursday concert from 7.10 to 9.15 with the Radio Symphony Orchestra playing Locatelli and Bellini music. Locatelli was a great violin virtuoso in the early eighteenth century.

On the same evening Radio-Paris broadcasts a European Concert at 8.45, the National Orchestra playing "Le Déluge," by Saint-Saëns, and Honegger's "Pacific 231." Also on Thursday Moscow at 7 p.m. offers a Glière Symphonic programme. R. M.

Glière is a living Russian composer who became a gold medallist at the Moscow Conservatoire.

At 10 o'clock on the same evening Konigsberg broadcasts a concert of contemporary music which includes Besch's Hoffmann Overture.

MODERN STAGE LIFE

AN "actuality" peep into the stage life of a young actress of to-day is what John Watt and Henrik Ege conspire to give us in "It Seems Only Yesterday"—a musical tale to be broadcast on Tuesday (Regional, 7.30) and Wednesday (National, 8.30). Joan Carr plays the part of Mary and Ivan Sampson that of Philip. Other artists are Claude Dampier, Leo von Porkoney and John Watt himself.

OPERA

THE biggest operatic event of the week is Verdi's "Otello," to be relayed by Radio-Paris from the Opéra on Wednesday next, March 13th, from 8.15 to the close. Yvonne Gall takes the part of Desdemona.

The Handel anniversary is observed by Hamburg on Sunday next at 7 p.m., when Handel's opera, "Alcina," will be broadcast.

On the same evening at 8.30 two singers, Mme. Balguiere and M. Singher, of the Paris Opéra, will come to the Radio-Paris studio for the broadcast

of Février's opera comique, "Le Roi Aveugle," which was composed in 1906.

B.B.C. IN BRUSSELS

SOME of the sparkle of a great social event should come over to us from Brussels on Tuesday next, when the B.B.C. Orchestra will be heard in its first concert on foreign soil (National, 8.15). Dr. Boulton conducts his 119 players in the Grande Salle de Concert of the Palais des Beaux Arts.

The programme has been offered to all the broadcasting stations of Europe and will figure in many transmissions.

A large cast will include Evelyn Neilson, Richard Golden and Carleton Hobbs.

These Sunday Shakespeare broadcasts are proving beyond doubt that the Bard is the ideal radio dramatist.

RUSSIAN NIGHT

ALL the French State stations, except Radio-Paris, will broadcast a Festival of Russian Music on Tuesday, March 12th, at 8.30. The National Orchestra and Vlassov Choir will be conducted by Inghelbrecht, and the programme includes music by Rimsky-Korsakov, Stravinsky, and Borodin.

B.B.C. ORCHESTRA IN BRUSSELS. The Palais des Beaux Arts, where Dr. Adrian Boulton will conduct the B.B.C. Symphony Orchestra on Tuesday next in a programme of works by Weber, Delius, Beethoven and Ravel. The broadcast will be shared by a number of European Stations.



Guide for the Week

roadcasts at Home and Abroad

NATIONAL HUNT CUP

THE National Hunt Meeting at Cheltenham has been described as the Ascot of the "Jump" season. Between 2.30 and 3 o'clock on Wednesday next, Regional listeners will be able to hear Mr. R. C. Lyle's running commentary on the race, in which the great jumper, "Golden Miller," promises to be the centre of attention. He has won the Cup three years running (or

GOOD MIXERS?

VERDI lovers are not always Wagner lovers, or *vice versa*, but votaries of both will tune in Breslau between 7.10 and 9 to-morrow evening (Saturday) for a Verdi-Wagner concert by the Silesian Philharmonic Choir conducted by Kotz.

BAND AS ORCHESTRA

No one has done more than B. Walton O'Donnell to raise

TCHIEKOV IN THE STUDIO

RUSSIAN drama takes kindly to the microphone, especially under the careful direction of Barbara Burnham, who offers us Tchekov's "The Three Sisters" on Wednesday next, March 13th (Regional, 8) and Thursday (National, 8). An impressive cast includes Carlton Hobbs as Andrej Prozorov, and Cherry Cottrall as Natasha, his fiancée. Other members of the cast are Robert Speaight, Miles Malleson, Philip Wade, and Gladys Young.



"SAVOY MEMORIES" is the title of a special programme to be given from the studio on Thursday next at 9 p.m. by Carroll Gibbons and the Savoy Hotel Orpheans.

jumping), and if he does so again will join "Brown Jack" among the immortals.

TALK IN ENGLISH

Two well-known Polish winter resorts, Zackopane and Krynica, will be described in English by Mr. Thad Ordon in a talk from Warsaw on Monday next, at 10.30 p.m.

30-LINE TELEVISION

Baird Process Transmissions. Vision, 261.1 m.; Sound, 296.2 m.

SATURDAY, MARCH 9th, 4.30-5.15.

Eric Stone and Cléone Stafford (dances); Haig and Haig in high spirits; Margery Wyn (songs); Eric Fawcett (songs); Marita Calvé (dancer from Seville); Sydney Jerome's Quintet.

WEDNESDAY, MARCH 13th, 11.15-11.45.

The Aspidistras in their Front Parlour Entertainment (Elsie French, John Mott, Cornelius Fisher).

the status of the military band. The only question is, does he go too far? In a Grieg programme by the Wireless Military Band on Sunday evening (Regional, 5.30) the band will accompany John Hunt (piano-forte) in the first part of the A Minor Concerto, which was, of course, written for piano-forte and orchestra.

Is this enough to make Grieg turn in his grave?

WEATHER FORECAST

MR. R. WATSON WATT, of the National Physical Laboratory, gives a dramatised talk, "Weather Forecast," to-morrow (Saturday) at 8 o'clock (National). Listeners will have a demonstration of how reports come in to the Meteorological Office from all parts of Europe and from ships crossing the Atlantic. It will then be shown how the daily weather map is prepared and its accompanying forecast compiled.

ICE HOCKEY

MR. BOB BOWMAN will have plenty to talk about when he describes the International Ice Hockey Match between England and Canada at Wembley to-morrow (Saturday) (Regional, 9.30). Mr. Bowman, a well-known Canadian writer on sport, will show how running commentaries are given in the Dominion, where terrific pace and enthusiasm are at a premium. Ice hockey is said to be the fastest game in the world.

ALL-WOMEN CABARET

"You dear, horrid man!" is the title of a radio cabaret to be performed exclusively by women on Wednesday, March 13th, between 7.45 and 9 p.m. Frankfurt, Stuttgart, and Munich are accepting the responsibility of broadcasting this item.

THE AUDITOR.

HIGHLIGHTS OF THE WEEK

FRIDAY, MARCH 8th.

Nat., 7.30, Scenes from Comic Operas. 8.30, Rubinstein's "The Ocean," conducted by Sir Granville Bantock. 10, Song and Dance, by Philip Thornton. Reg., 8, "Ambrose Applejohn's Adventure," 9.15, B.B.C. Dance Orchestra.

Abroad.

Sottens, 7.35, "The Art of Fugue" (Bach).

SATURDAY, MARCH 9th.

Nat., 7.20, Duets for two pianofortes: Edith Gunthorpe and Cecil Baumer. 8, "Weather Forecast." 8.30, "Music Hall." Reg., 8, "New Discs for Old" (John Watt): 9.30, England v. Canada Ice Hockey. 10.10, Ambrose and His Embassy Club Orchestra.

Abroad.

Beromunster, 6.50, Mendelssohn Concert.

SUNDAY, MARCH 10th.

Nat., 1.15, Leslie Bridgewater Quintet. 3.45, Reginald King and His Orchestra. 5.35, "The Taming of the Shrew." 9, Hastings Municipal Orchestra. Reg., 4.30, B.B.C. Orchestra (C) conducted by Joseph Lewis. 9.20, Sunday Orchestral Concert: Schonberg's Gurrelieder.

Abroad.

7, All German Stations: "Alcina" (Handel), from Hamburg.

MONDAY, MARCH 11th.

Nat., 8, Jack Barty's Party. 9.20, Piano recital by Ernest Lush. 10.5, Music from the Scottish Past. Reg., 7.15, B.B.C. Dance Orchestra. 8, B.B.C. Northern Orchestra. 9, Wireless Military Band.

Abroad.

Kalundborg, 7.15, Light Viennese Music by the Radio Orchestra.

TUESDAY, MARCH 12th.

Nat., 8.15, B.B.C. Symphony Concert from Brussels. 10.45, Gershwin Parkington Quintet. Reg., 7.30, "It Seems Only Yesterday." 8.30, Carmen del Rio: Spanish Songs at the Piano. 8.45, Fred Hartley and His Novelty Quintet.

Abroad.

Leipzig, 8.15, Selections from Famous Operas (from Dresden).

WEDNESDAY, MARCH 13th.

Nat., 1, Organ Recital by Sir Walter Alcock. 7.30, Cafe Colette Farewell Programme. 8.30, "It Seems Only Yesterday." 10, Chamber Music.

Reg., 2.30, National Hunt Steeplechase. 8, "The Three Sisters" (Tchekov). 9.30, The New Georgian Trio.

Abroad.

Warsaw, 8, Opera: "The Castle of Czorsztyn," by Kurpinski.

THURSDAY, MARCH 14th.

Nat., 8, "The Three Sisters" (Tchekov). 10.15, B.B.C. Theatre Orchestra.

Reg., 7, Relay from Argyle Theatre, Birkenhead. 8, Mendelssohn Oratorio Programme. (B.B.C. Orchestra, E). 9, "Savoy Memories," by Carroll Gibbons and Savoy Hotel Orpheans.

Abroad.

Radio-Paris, 8.45, Symphony Concert by the National Orchestra. Conductor: Inghelbrecht.

FOUNDATIONS OF WIRELESS

Part XIV.— The Valve as Detector

By A. L. M. SOWERBY, M.Sc.

THE simple diode valve, containing only a cathode and an anode, was the earliest type of thermionic detector. For a good many years it dropped almost entirely out of use, but recent changes in receiver design, especially those bound up with the problems of automatic volume control, have radically altered the requirements that the detector is called upon to meet. As a result there are many modern sets in which the diode provides the best and most convenient method of detection.

We have already seen, in Part XI, how the necessity for detection arises, and we noted that this function can be performed by any device conducting current more

readily in one direction than the other. The diode, in which electrons can flow from cathode to anode but not from anode to cathode, satisfies fully this fundamental requirement.

currents which flow through the telephones. Apart from certain practical disadvantages, the circuit of Fig. 75b, where crystal and telephones, still in series, are interchanged in position, would work as well. Since one side of the crystal is now at earth potential, it could conveniently be replaced by a diode valve without making any alteration in the working of the

circuit, which now becomes as shown at c.

In general, we do not desire to listen in telephones when using a receiver employing valves, but prefer to amplify further and to use a loud speaker. Instead of using the current through the telephones, we should therefore pick up the modulation-frequency voltage at the anode of the diode and pass it to the grid of a succeeding valve. Telephones would hardly be chosen as the impedance across which to allow the current to develop this

A DETAILED explanation of the functioning of the diode detector, including a full and lucid exposition of the working conditions necessary for distortionless rectification.

component required, therefore produces across it a DC voltage which alters the operating conditions of the diode.

The mechanism of the process by which this steady potential is generated can be understood by a study of Figs. 76 and 77. In the former is shown the curve relating anode voltage to anode current in the diode. It is to be noted that at $E_a = 0$ the anode current is *not* zero. In Fig. 75d R is returned, through the tuned circuit, to the cathode (zero voltage); some anode current must flow through it, thus setting up across it a voltage-drop which makes the anode slightly negative. By drawing a load-line on Fig. 76, as shown, the initial voltage on the anode can be determined.

The load-line for a $0.5 \text{ M}\Omega$ resistance is shown at OP; one end at zero volts and zero current, the other at $-1 \text{ v.}, 2 \mu\text{A.}$, at $-2 \text{ v.}, 4 \mu\text{A.}$, or any other point giving the voltage-current relationship across a resistance of this value. The intersection, at A, of the load-line with the curve reveals the initial voltage and current of the anode. (Verification: At A, $E = -0.67 \text{ v.}$; to get this voltage-drop across $0.5 \text{ M}\Omega$ requires $I = 1.34 \mu\text{A.}$ The curve shows this to be the value of I_a at $E_a = -0.67 \text{ v.}$) The line OQ is that for a $2 \text{ M}\Omega$ resistance, leading to the initial no-signal condition at B.

Reverting to the point A ($R = 0.5 \text{ M}\Omega$) let us imagine that there is applied to the anode an unmodulated high-frequency signal, of amplitude 1 V. peak (Fig. 77a). The resulting excursions in E_a will cover the range C to D, leading to an anode current swing from E to F. Owing to the shape of the curve, the rise in current AF is very much larger than the fall AE.

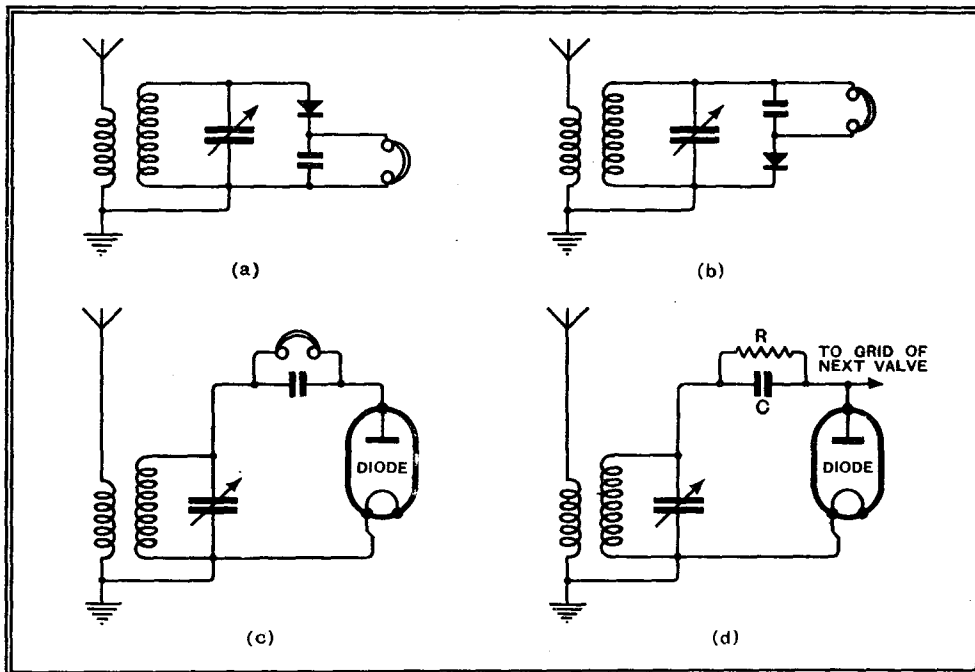

Fig. 75.—Comparing crystal and valve detectors, and leading up to the practical diode circuit of diagram (d).

readily in one direction than the other. The diode, in which electrons can flow from cathode to anode but not from anode to cathode, satisfies fully this fundamental requirement.

The circuit of the crystal detector is reproduced in Fig. 75a, which repeats Fig. 61, already discussed in Part XI. As there described, the rectifying action of the crystal produces modulation-frequency

voltage; a resistance is much smaller and cheaper. We should use, in short, the circuit of Fig. 75d, which is the same as the circuit at c, except for the replacement of the telephones by the resistance R.

The resistance is generally made much higher than that of the telephones that it replaces. The rectified current which, as we saw in Part XI, contains a steady component as well as the audio-frequency

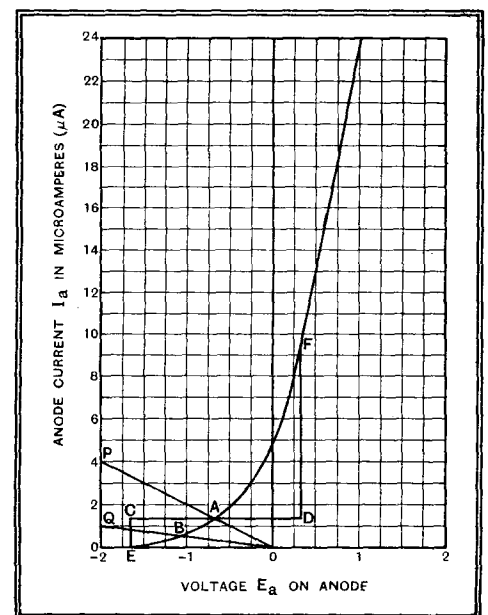

Fig. 76.—Characteristic curve of a diode detector-valve. Load lines OP, OQ are shown for resistances of 0.5 megohm and 2 megohm connected as in Fig. 75d.

Foundations of Wireless—

which takes place on the other half-cycle; the average current, therefore, will rise. Flowing, as it must, through R, this increase in current will lead to an increase in voltage across R, so that the anode will become more negative. The second complete wave will repeat this process, swinging the voltage about the point reached at the end of the first, and driving the anode still more negative. If the signal continues at unchanged amplitude the anode will eventually settle down at a new equilibrium voltage, this being determined by the new value of average anode current flowing through R. In practice, this voltage will be such that the peaks of the received wave just run the anode into momentary current, no current flowing during the rest of the cycle. The change in anode voltage is depicted in Fig. 77b, below the high-frequency voltage that causes it.

Effect of Modulation

If the amplitude of the signal is increased the anode will become more negative, so that it becomes possible to plot a curve such as that of Fig. 78 showing the relationship between the signal-voltage and the steady anode voltage resulting from it. The circuit used for constructing such a curve in the laboratory is shown inset. The derivation of this curve from that of Fig. 76, which obviously determines it, is theoretically possible, but involves rather laborious

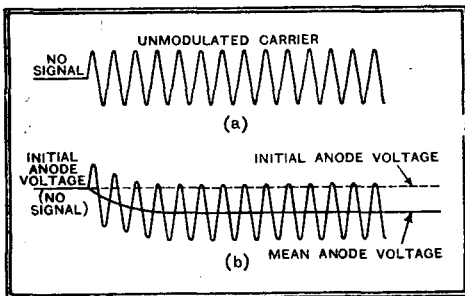

Fig. 77.—Carrier voltage applied to diode, and (dia. b) mean anode-voltage resulting. Note that the peaks of the high-frequency voltage run the anode a little more positive than its initial value, thus providing the current which drives the anode negative.

calculation. With the aid of this new curve, however constructed, the behaviour of the diode when receiving a modulated carrier can be completely elucidated.

The two things that we need to know about the received carrier-voltage are, first, its mean amplitude, and, second, the range over which this amplitude is varied by the modulation. For distortionless transmission the increase and decrease in carrier amplitude that correspond to positive and negative half-cycles of the modulating voltage must be equal. It is evident that the maximum possible decrease in carrier-amplitude is found when the modulation reduces the carrier so far that it just, and only just, ceases at the exact moment of minimum amplitude. At its maximum it will then rise

to double its steady value, as shown in Fig. 79a. Any attempt to make the maximum higher than this will result in the carrier actually ceasing for an appreciable period at each minimum; over this interval the envelope of the carrier-amplitude can no longer represent the envelope of the modulating voltage, and there will be distortion.

When the carrier has its maximum swing, from zero to double its mean value, it is said to be modulated to a depth of 100 per cent. In general, the maximum rise in amplitude, expressed as a percentage of the mean, is taken as the measure of modulation depth. Thus a rise from 1 volt to 1.5 volt corresponds to 50 per cent. modulation, a rise to 1.4 volt to 40 per cent., and so for other values. In transmitting a musical programme, varia-

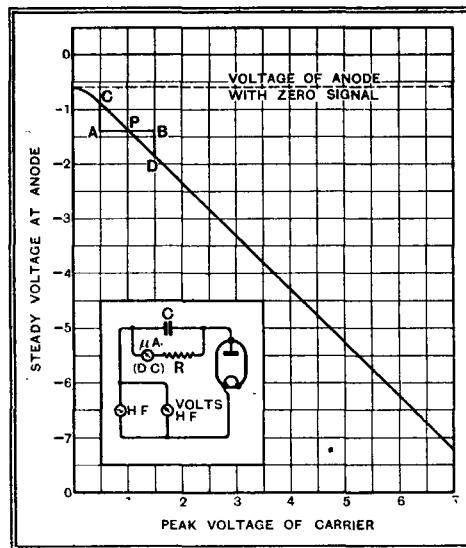

Fig. 78.—Typical rectification curve of diode, showing increasingly negative mean anode potential as the steady (unmodulated) high-frequency voltage rises.

tions in loudness of the received music are produced by variations in modulation-depth, these producing corresponding changes in the audio-frequency output from the detector.

Suppose that to the detector of which the curve is shown in Fig. 78 there is applied a carrier of 1 volt mean amplitude, modulated to 50 per cent. The high-frequency voltage will then swing, at audio-frequency, over the range 0.5 to 1.5 volts, that is, over the range AB. The voltage at the detector anode will then be driven over the range CD, rising by 0.47 V. above and falling by 0.47 V. below its mean value at P. The detector will thus furnish an audio-frequency voltage of this peak amplitude to operate the succeeding valve. Moreover, since the rise above the mean voltage is equal to the fall below it, this audio-voltage will be a faithful replica of the envelope of the carrier, and the process of detection will be distortionless.

But if the modulation of the carrier rises to 90 per cent., distortion will be introduced; the rise will now be 0.76 V. and the fall 0.88 V. This distortion of the received wave-form is equivalent to the

introduction of alien frequencies not present in the original wave, and leads (if sufficiently marked) to an unpleasant falsification of the music ultimately emitted by the loud speaker. It is therefore an effect to be scrupulously avoided if possible.

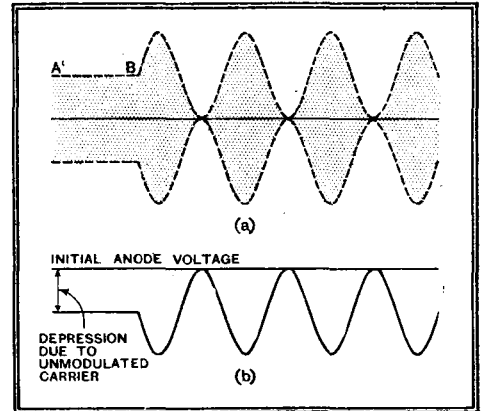

Fig. 79.—Diagram (a) represents a carrier modulated to 100%. Amplitude of HF voltage (individual cycles too fast to show) varies between zero and double the amplitude of the unmodulated carrier shown at AB. Corresponding fluctuations of anode-voltage (of detecting diode) at audio frequency are shown in diagram (b).

This distortion arises, as Fig. 78 makes evident, from the fact that the detector characteristic is curved over the range 0 to 0.4 volt (signal). This curvature, extending over a larger or smaller distance, is characteristic of all thermionic rectifiers and cannot be completely avoided. In the present case, extending to 0.4 V., it permits distortionless rectification of a carrier only so long as the modulation does not swing it below this value. A carrier of 1 V. amplitude can therefore be modulated to 60 per cent. without harm, but detector distortion arises if the modulation is deeper than this.

With a 4-volt carrier the curved part only covers 10 per cent. of the range of variation, so permitting modulation to 90 per cent. before the distortion starts. Modulation of this depth is rarely exceeded, and then only momentarily, on any transmission, so that when supplied with a carrier of this amplitude the distortion introduced by the detector would not

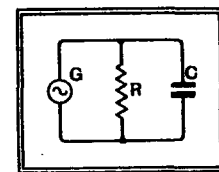

Fig. 80.—Simplified circuit of diode detector. C and R correspond to the capacity and resistance in Fig. 75d, while the generator G must be regarded as supplying a constant current for a given modulation-depth, irrespective of the frequency of modulation.

be serious. The exact modulation-depth at which distortion may be permitted to enter with reasonable safety is clearly not susceptible to precise specification, but most set designers would feel quite content with a detector that was distortionless up to 90 per cent. modulation.

It will be appreciated that the curve of Fig. 78 permits one to read off the audio-frequency voltage obtainable from a car-

Foundations of Wireless—

rier of any amplitude modulated to any depth, but it must be borne in mind that, like the dynamic characteristic of a triode, the curve only applies to one particular combination of diode valve and resistance. Changing the resistance involves constructing a new curve—though the differences are likely to be small so long as R is considerably higher than the AC resistance of the diode itself. After the initial curved portion, the characteristic will in any usual case show the development of little short of 1 volt DC for every volt (peak) of signal applied.

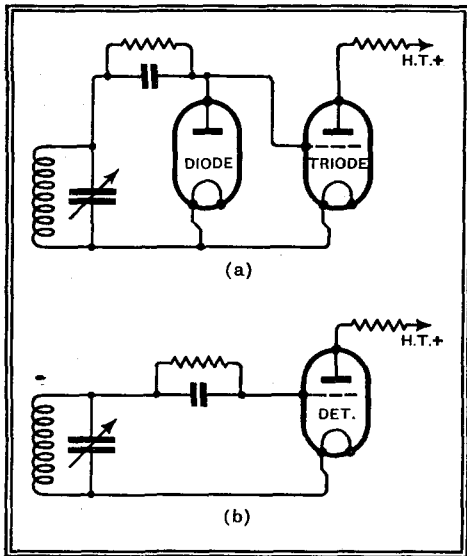

Fig. 81.—Skeleton diagram of diode detector followed by triode as amplifier of the detected signals. Compare this with a "grid detector" (dia. b) in which cathode and grid behave as a diode detector, which acts as combined detector and amplifier.

The main effect of varying the value of R over the usual ranges is to change the damping introduced into the tuned circuit. The rectified current through the valve increases as R diminishes, and since this current is derived from the signal voltages themselves power is abstracted from the tuned circuit. In practice one may reckon, as a close approximation, that the damping effect of a diode detector with a load resistance R is equivalent to connecting a resistance $R/2$ directly across the tuned circuit. The existence of this damping supplies the main reason why R is often allotted a value as high as $0.5\text{ M}\Omega$ or considerably higher.

The capacity chosen for the condenser C is of some importance. It is included to provide a ready path by which the high-frequency signals can reach the anode of the valve. The audio-frequency voltage generated by detection appears across R , with which C is effectively in shunt, since the impedance of the tuned circuit to low-frequency currents is so small that we may neglect it. The circuit thus simplifies down to that of Fig. 80, in which an audio-frequency current, constant irrespective of frequency, passes through R and C in parallel, developing across this combination the voltage which is led to the grid of the succeeding LF amplifier.

The total impedance Z presented by this combination is given by $1/Z^2 = 1/X^2 + 1/R^2$, whence $Z = \frac{RX}{\sqrt{X^2 + R^2}}$. The volt-

age developed is $I \times Z = IR \times \frac{X}{\sqrt{X^2 + R^2}}$.

It is clear that the fraction $X/\sqrt{X^2 + R^2}$ will always be less than unity, but so long as X is much larger than R , only by a trifling amount. At the lower frequencies this condition will be fulfilled for any usual value of C , but at the higher audible frequencies X will drop. If the voltage is not to fall below 90 per cent. of that at lower frequencies, $X/\sqrt{X^2 + R^2}$ must not fall below 0.9, which means that X must not fall below about $2R$. To retain 90 per cent. of 5,000-cycle notes when $R = 0.5\text{ M}\Omega$, C must not exceed the value given by $1/2\pi fC = 1\text{ M}\Omega$, from which we find that the maximum permissible value for C is $31.8\ \mu\text{F}$.

It is more usual, however, to employ a capacity of about three times this value.

The circuit of Fig. 81a shows a diode detector linked through to a triode used as amplifier for the low-frequency voltages

produced by rectification at the diode. With this simple method of connection between the two valves the anode-cathode path of the diode is in parallel with the grid-cathode path of the triode. Since both the anode of the diode and the grid of the triode consist simply of an electrode in the immediate neighbourhood of an emitting cathode, there would seem to be no need to have them both present. Experiment confirms this supposition; there is no change in the performance of the system if the diode is removed from its socket.

The simplified circuit resulting is the well-known *grid-detector* of Fig. 81b, in which the grid and cathode, acting as a diode, rectify in the manner which we have discussed. The audio-frequency voltages appearing on the grid as a result of this then serve to control the electron-stream through the triode, and so produce an amplified LF voltage at the anode in the manner discussed in Part XIII.

The faults in the circuit of Fig. 81b, and the manner in which the diode-triode circuit of Fig. 81a can be modified to overcome them will be considered in the next instalment.

Twenty Years Ago

Extracts from *The Wireless World* of March, 1915

A Variable Condenser

"Mr. N. J. de Waard suggests the following method for making a variable condenser:—

Take two test tubes such as are used by chemists, one fitting easily into the other, and both being filled with water. Spirals of copper wire reaching to the bottoms should be placed in each tube, that in the latter being of such diameter as to allow a smaller tube to slide up and down it. According to Mr. de Waard, mercury does not give better results than water."

From "Wireless Telegraphy in the War"

"A great deal of attention has deservedly been attracted by the public-spirited offer of our esteemed contemporary the *Syren and Shipping*, of £500 to the master and crew of the first non-armed merchant ship which destroys a German submarine. This attention has by no means been confined to the public of this country. The German official wireless news, which comes over daily at all hours of the day and night, was full of it at once, and incidentally showed, by its immediate reference to the offer, how perfect the Teutonic spy system is. Their facilities for obtaining information respecting anything that goes on are little short of marvellous. Here we have yet another instance of the extent to which *wireless is being made use of by all combatants.*"

From a Reader's Description of His Set:—

"One little coil I have is a 'peach'; it cost me sixpence (inductive coupling). I can get the general run of stations on it, but its one outstanding feature is that I can listen to my amateur friends, no other stations getting a look in. This I have never been able to do with any other size. It also gives ship stations more distinct and with greater 'selectiveness' than my larger coils. Here are the details:

"One penny sample jam jar (glass) 2in. by 1½in., wound with 150 turns 32 S.W.G. copper wire as primary; 150 turns same size wire wound on ebonite tubing 1½in. by 1in. as secondary. Primary tapped off every 15

turns, secondary ditto. Size over all is about 2in. by 2in. by 1½in. As a final, short lengths of old celluloid bicycle pumps, with the necessary quantity of tinfoil interleaved with paraffined wax paper, rolled to size and filled in with beeswax, make extremely neat blocking condensers, also plenty of ebonite, and twisted flax in connecting up make for efficiency."

MULLARD TRANSMITTING VALVES

IN view of the interest which is now being taken in ultra-short wavelengths, the introduction of a new transmitting valve suitable for operation on very high frequencies is not without importance. The TZ1-75 is rated for a continuous anode dissipation of 75 watts and has a mutual conductance of 5 mA/V. with an AC resistance of 5,000 ohms. The maximum anode voltage depends on the wavelength at which it is operated, and is 1,500 volts above 45 metres. At 25 metres the voltage must not exceed 1,200 volts, and at 14 metres 1,000 volts.

The valve is fitted with an American-type 4-pin base in which only the filament pins are employed, the grid and anode both being brought out at the top of the bulb in order to reduce inter-electrode capacities to a minimum. As a result of this, it is suitable for use at 5 metres, but at this wavelength the anode potential must not exceed 800 volts. The mean anode current must always be below 120 mA. The valve is priced at £14.

A wide range of other transmitting valves is also listed, including screen-grid types for use in separator stages; the advantages of these, of course, is that they avoid the need for neutralising. Among these the QZ05-15 is worthy of mention in view of its low grid-anode capacity of $0.001\ \mu\text{F}$. It is suitable for use at 5 metres, but the anode voltage must then be restricted. The normal anode dissipation is 15 watts, and the maximum anode supply 500 volts.

PRINCIPAL BROADCASTING STATIONS OF EUROPE

Arranged in Order of Frequency and Wavelength

(Stations with an aerial power of 50 kW. and above in heavy type)

Station.	kc/s.	Tuning Positions.	Metres.	kW.	Station.	kc/s.	Tuning Positions.	Metres.	kW.
Kaunas (Lithuania)	155		1935	7	Poznan (Poland)	868		345.6	16
Brazov (Romania)	160		1875	20	London Regional (Brookmans Park)	877		342.1	50
Huizen (Holland). (<i>Until 3.40 p.m.</i>)	160		1875	7	Graz (Austria). (<i>Relays Vienna</i>)	886		338.6	7
Kootwijk (Holland) (<i>Announced Huizen</i>). (<i>3.40 p.m. onwards</i>)	160		1875	50	Helsinki (Finland)	895		335.2	10
Lahti (Finland)	166		1807	40	Hamburg (Germany)	904		331.9	100
Moscow, No. 1, RW1 (Komintern) (U.S.S.R.)	174		1724	500	Toulouse (Radio Toulouse) (France)	913		328.8	60
Paris (Radio Paris) (France)	182		1648	80	Limoges, P.T.T. (France)	913		328.6	0.5
Istanbul (Turkey)	187.5		1600	5	Brno (Czechoslovakia)	922		325.4	32
Berlin (Deutschlandsender Zeesen) (Germany) (<i>S.w. Stns., 16.89, 19.74, 25.49, 31.38 and 49.83 m.</i>)	191		1571	60	Brussels, No. 2 (Belgium). (<i>Flemish Programme</i>)	932		321.9	15
Droitwich	200		1500	150	Algiers, P.T.T. (Radio Alger) (Algeria)	941		318.8	12
Minsk, RW10 (U.S.S.R.)	208		1442	35	Göteborg (Sweden). (<i>Relays Stockholm</i>)	941		318.8	10
Reykjavik (Iceland)	208		1442	16	Breslau (Germany)	950		315.8	100
Paris (Eiffel Tower) (France)	215		1395	13	Paris (Poste Parisien) (France)	959		312.8	60
Motala (Sweden). (<i>Relays Stockholm</i>)	216		1389	30	Belfast	977		307.1	1
Novosibirsk, RW76 (U.S.S.R.)	217.5		1379	100	Genoa (Italy). (<i>Relays Milan</i>)	986		304.3	10
Warsaw, No. 1 (Raszyn) (Poland)	224		1339	120	Hilversum (Holland). (<i>7 kW. till 6.40 p.m.</i>)	995		301.5	20
Ankara (Turkey)	230		1304	7	Bratislava (Czechoslovakia)	1004		298.8	13.5
Luxembourg	230		1304	150	Midland Regional (Droitwich)	1013		296.2	50
Kharkov, RW20 (U.S.S.R.)	232		1293	20	Barcelona, EAJ15 (Radio Asociación) (Spain)	1022		293.5	3
Kalundborg (Denmark) (<i>S.w. Stn., 49.5 m.</i>)	238		1261	60	Cracow (Poland)	1022		293.5	2
Leningrad, RW53 (Kolpino) (U.S.S.R.)	245		1224	100	Königsberg (Heilsberg Ermland) (Germany)	1031		291	17
Tashkent, RW11 (U.S.S.R.)	256.4		1170	25	Paredo (Radio Club Português) (Portugal)	1031		291	5
Oslo (Norway)	260		1154	60	Leningrad, No. 2, RW70 (U.S.S.R.)	1040		288.5	10
Moscow, No. 2, RW49 (Stechelkovo) (U.S.S.R.)	271		1107	100	Rennes, P.T.T. (France)	1040		288.5	40
Tiflis, RW7 (U.S.S.R.)	280		1071.4	35	Scottish National (Falkirk)	1050		285.7	50
Rostov-on-Don, RW12 (U.S.S.R.)	355		845	20	Bari (Italy)	1059		283.3	20
Sverdlovsk, RW5 (U.S.S.R.)	375		800	50	Tiraspol, RW57 (U.S.S.R.)	1068		280.9	4
Geneva (Switzerland). (<i>Relays Sottens</i>)	401		748	1.3	Bordeaux, P.T.T. (Lafayette) (France)	1077		278.6	12
Moscow, No. 3 (RCZ) (U.S.S.R.)	401		748	100	Zagreb (Yugoslavia)	1086		276.2	0.7
Voroneje, RW25 (U.S.S.R.)	413.5		726	10	Falun (Sweden)	1086		276.2	2
Oulu (Finland)	431		698	1.2	Madrid, EAJ7 (Union Radio) (Spain)	1095		274	7
Ufa, RW22 (U.S.S.R.)	436		688	10	Madona (Latvia)	1104		271.7	50
Hamar (Norway) (<i>Relays Oslo</i>)	519		578	0.7	Naples (Italy). (<i>Relays Rome</i>)	1104		271.7	1.5
Innsbruck (Austria). (<i>Relays Vienna</i>)	519		578	0.5	Moravska-Ostrava (Czechoslovakia)	1113		269.5	11.2
Ljubljana (Yugoslavia)	527		569.3	5	Alexandria (Egypt)	1122		267.4	0.25
Viipuri (Finland)	527		569.3	10	Newcastle	1122		267.4	1
Bolzano (Italy)	536		559.7	1	Nyiregyhaza (Hungary)	1122		267.4	6.2
Wilno (Poland)	536		559.7	16	Hörby (Sweden). (<i>Relays Stockholm</i>)	1131		265.3	10
Budapest, No. 1 (Hungary)	546		549.5	120	Turin, No. 1 (Italy). (<i>Relays Milan</i>)	1140		263.2	7
Beromünster (Switzerland)	556		539.6	100	London National (Brookmans Park)	1149		261.1	50
Athlone (Irish Free State)	565		531	60	North National (Slaithwaite)	1149		261.1	50
Palermo (Italy)	565		531	4	West National (Washford Cross)	1149		261.1	50
Stuttgart (Mühlacker) (Germany)	574		522.6	100	Kosice (Czechoslovakia). (<i>Relays Prague</i>)	1158		259.1	2.6
Grenoble, P.T.T. (France)	583		514.6	15	Monte Ceneri (Switzerland)	1167		257.1	15
Riga (Latvia)	583		514.6	15	Copenhagen (Denmark). (<i>Relays Kalundborg</i>)	1176		255.1	10
Vienna (Bisamberg) (Austria)	592		506.8	100	Kharkov, No. 2, RW4 (U.S.S.R.)	1185		253.2	10
Rabat (Radio Maroc) (Morocco)	601		499.2	25	Frankfurt (Germany)	1195		251	17
Sundsvall (Sweden). (<i>Relays Stockholm</i>)	601		499.2	10	Prague, No. 2 (Czechoslovakia)	1204		249.2	5
Florence (Italy). (<i>Relays Milan</i>)	610		491.8	20	Lille, P.T.T. (France)	1213		247.3	5
Cairo (Abu Zabal) (Egypt)	620		483.9	20	Trieste (Italy)	1222		245.5	10
Brussels, No. 1 (Belgium). (<i>French Programme</i>)	620		483.9	15	Gleiwitz (Germany). (<i>Relays Breslau</i>)	1231		243.7	5
Lisbon (Bacarena) (Portugal)	629		476.9	15	Cork (Irish Free State) (<i>Relays Athlone</i>)	1240		241.9	1
Trøndelag (Norway)	629		476.9	20	Juan-les-Pins (Radio Côte d'Azur) (France)	1249		240.2	2
Prague, No. 1 (Czechoslovakia)	638		470.2	120	Kuldiga (Latvia)	1258		238.5	10
Lyons, P.T.T. (La Doua) (France)	648		463	15	Rome, No. 3 (Italy)	1258		238.5	1
Cologne (Langenberg) (Germany)	658		455.9	100	San Sebastian (Spain)	1258		238.5	3
North Regional (Slaithwaite)	668		449.1	50	Nürnberg and Augsburg (Germany) (<i>Relay Munich</i>)	1267		236.8	2
Sottens (Radio Suisse Romande) (Switzerland)	677		443.1	25	Christiansand and Stavanger (Norway)	1276		235.1	0.5
Belgrade (Yugoslavia)	686		437.3	2.5	Dresden (Germany) (<i>Relays Leipzig</i>)	1285		233.5	1.5
Paris, P.T.T. (Ecole Supérieure) (France)	695		431.7	7	Aberdeen	1285		233.5	1
Stockholm (Sweden)	704		428.1	55	Austrian Relay Stations	1294		231.8	0.5
Rome, No. 1 (Italy) (<i>S.w. stn., 25.4 m.</i>)	713		420.8	50	Danzig. (<i>Relays Königsberg</i>)	1303		230.2	0.5
Kiev, RW9 (U.S.S.R.)	722		415.5	36	Swedish Relay Stations	1312		228.7	1.25
Tallinn (Esthonia)	731		410.4	20	Budapest, No. 2 (Hungary)	1321		227.1	0.8
Madrid, EAJ2 (Radio España) (Spain)	731		410.4	3	German Relay Stations	1330		225.6	1.5
Munich (Germany)	740		405.4	100	Montpellier, P.T.T. (France)	1339		224	5
Marseilles, P.T.T. (France)	749		400.5	5	Lodz (Poland)	1339		224	1.7
Katowice (Poland)	758		395.8	12	Dublin (Irish Free State) (<i>Relays Athlone</i>)	1348		222.6	0.5
Scottish Regional (Falkirk)	767		391.1	50	Milan, No. 2 (Italy) (<i>Relays Rome</i>)	1348		222.6	4
Toulouse, P.T.T. (France)	776		386.6	2	Turin, No. 2 (Italy). (<i>Relays Rome</i>)	1357		221.1	0.2
Leipzig (Germany)	785		382.2	120	Basle and Berne (Switzerland)	1375		218.2	0.5
Barcelona, EAJ1 (Spain)	785		382.2	5	Warsaw, No. 2 (Poland)	1384		218.8	2
Lwow (Poland)	795		377.4	16	Lyons (Radio Lyons) (France)	1393		215.4	5
West Regional (Washford Cross)	804		373.1	50	Tampere (Finland)	1420		211.3	0.7
Milan (Italy)	814		368.6	50	Paris, (Radio LL) (France)	1424		210.7	0.8
Bucharest (Romania)	823		364.5	12	Béziers (France)	1429		209.9	1.5
Moscow, No. 4, RW39 (Stalina) (U.S.S.R.)	832		360.6	100	Miskolc (Hungary)	1438		208.6	1.25
Berlin (Funkstunde Tegel) (Germany)	841		356.7	100	Fécamp (Radio Normandie) (France)	1456		203	10
Bergen (Norway)	850		352.9	1	Pecs (Hungary)	1465		204.8	1.25
Sofia (Bulgaria)	850		352.9	1	Bournemouth	1474		203.5	1
Valencia (Spain)	850		352.9	1.5	Plymouth	1474		203.5	0.3
Simferopol, RW52 (U.S.S.R.)	859		349.2	10	International Common Wave	1492		201.1	0.2
Strasbourg, P.T.T. (France)	859		349.2	25	International Common Wave	1500		200	0.25
					Liepāja (Latvia)	1737		173	0.1

NOTE. Since the publication of the previous list alterations have been made to the particulars of the following station: Cracow (Poland).

SHORT-WAVE STATIONS OF THE WORLD

(N.B.—Times of Transmission given in parentheses are approximate only and represent G.M.T.)

Metres.	kc/s.	Call Sign.	Station.	Tuning Positions.	Metres.	kc/s.	Call Sign.	Station.	Tuning Positions.
75.0	4,000	—	Kuala Lumpur (Malaya). (Relays Empire Broadcasting.)		31.45	9,540	LKJI	Jeløy (Norway). (Relays Oslo.) (Daily 10.00 to 13.00.)	
70.2	4,273	RV15	Kharbarovsk (U.S.S.R.). (Daily 06.00 to 14.00.)		31.45	9,540	DJN	Zeesen (Germany). (Daily 08.45 to 12.15, 13.00 to 16.30, 22.15 to 03.30.)	
58.31	5,145	OKIMPT	Prague (Czechoslovakia). (Experimental)		31.38	9,560	DJA	Zeesen (Germany). (Daily 13.00 to 16.30, 22.15 to 02.15.)	
55.56	5,400	HAT	Budapest (Hungary). (Mon. 01.00 to 02.00.)		31.36	9,565	VUB	Bombay (India). (Sun. 12.30 to 15.30, Wed., Thurs., Sat. 16.30 to 17.30, irregular Mon.)	
52.7	5,692	FIQA	Antananarivo (Madagascar). (Daily ex. Sun. 08.00 to 08.45, 15.00 to 16.00, Sat. 17.30 to 19.00, Sun. 07.30 to 08.00.)		31.35	9,570	W1XAZ	Springfield, Mass. (U.S.A.). (Relays WBZ.) (Daily 12.00 to 06.00.)	
50.26	5,969	HVJ	Vatican City. (Daily 19.00 to 19.15, Sun. 10.00 also.)		31.32	9,580	GSC	Empire Broadcasting	
50.0	6,000	—	Bucharest (Romania)		31.32	9,580	VK3LR	Lindhurst (Australia). (Daily ex. Sun. 08.15 to 12.30.)	
50.0	6,000	RW59	Moscow (U.S.S.R.). (Relays No. 1 Stn.) (Daily 20.00 to 23.00.)		31.28	9,590	W3XAU	Philadelphia, Pa. (U.S.A.). (Relays W.C.U.) (Daily 17.00 to 24.00.)	
49.96	6,005	VE9DN	Montreal (Canada). (Daily 04.30 to 05.00)		31.28	9,590	VK2ME	Sydney (Australia). (Sun. 06.00 to 08.00, 10.00 to 16.00.)	
49.96	6,065	HJ3ABH	Bogotá (Colombia)		31.27	9,595	HBL	Radio Nations, Prangins (Switzerland). (Sat. 22.30 to 23.15.)	
49.85	6,018	ZHI	Singapore (Malaya). (Mon., Wed., Thurs. 23.00 to 01.30, Sun. 03.40 to 05.10.)		31.25	9,600	CT1AA	Lisbon (Portugal). (Tues., Thurs., Sat. 21.30 to 24.00.)	
49.83	6,020	DJC	Zeesen (Germany). (Daily 22.30 to 03.30, 17.00 to 21.30.)		31.0	9,677	CTICT	Lisbon (Portugal). (Thurs. 21.00 to 23.00, Sun. 12.00 to 14.00.)	
49.67	6,040	W1XAL	Boston, Mass. (U.S.A.). (Sun. 22.00 to 24.00, Wed., Fri. 00.30 to 02.00.)		30.67	9,780	2RO	Rome (Italy). (Tues., Thurs., Sat. 00.45 to 02.15.)	
49.67	6,040	YDB	Sourabaya (Java). (Daily 03.30 to 06.30)		30.43	9,860	EAQ	Madrid (Spain). (Daily 22.15 to 00.30, Sat. 18.00 to 20.00 also.)	
49.59	6,050	GSA	Empire Broadcasting		29.04	10,330	ORK	Brussels (Belgium). (Daily 18.30 to 20.30.)	
49.5	6,060	W3XAL	Cincinnati, Ohio (U.S.A.). (Daily 12.00 to 01.00, 04.00 to 06.00.)		28.98	10,350	LSX	Buenos Aires (Argentina). (Daily 20.00 to 21.00.)	
49.5	6,060	W3XAU	Philadelphia, Pa. (U.S.A.). (Relays W.C.U.) (Daily 00.00 to 04.00.)		25.6	11,720	FYA	Paris, Radio Coloniale (France). (Colonial Stn. E.H.) (Daily 00.00 to 03.00, 04.00 to 06.00.)	
49.5	6,060	VQ7LO	Nairobi (Kenya Colony). (Daily 16.00 to 19.00, Sat. to 20.00, Mon., Wed., Fri. 10.45 to 11.15 also, Tues. 08.00 to 09.00 also, Thurs. 13.00 to 14.00 also, Sun. 17.45 to 19.00 also.)		25.6	11,720	CJRX	Winnipeg (Canada). (Daily 00.00 to 05.00, Sat. 24.00 to 06.00 also, Sun. 22.00 to 03.30 also.)	
49.5	6,060	OXY	Skamleback (Denmark). (Relays Kalundborg.) (Daily 18.00 to 24.00, Sun. 16.00 also.)		25.57	11,730	PHI	Eindhoven (Holland). (Daily ex. Tues., Wed. 13.00 to 15.30 (Sat. to 16.30; Sun. to 16.00.)	
49.43	6,069	VE9CS	Vancouver, B.C. (Canada). (Sat. 04.30 to 05.45, Sun. 16.00 to 04.00.)		25.53	11,750	GSD	Empire Broadcasting	
49.4	6,072	ZHJ	Penang (Malaya). (Relays Empire Broadcasting.)		25.49	11,770	DJD	Zeesen (Germany). (Daily 17.00 to 21.30)	
49.4	6,072	OER2	Vienna Experimental. (Daily 14.00 to 22.00.)		25.45	11,790	W1XAL	Boston, Mass. (U.S.A.). (Daily 23.00 to 00.30.)	
49.34	6,080	W9XAA	Chicago, Ill. (U.S.A.). (Relays WCLF.) (Sun. 19.00 to 20.30.)		25.4	11,810	2RO	Rome (Italy)	
49.3	6,085	2RO	Rome (Italy). (Mon., Wed., Fri. 23.00)...		25.36	11,830	W2XE	Wayne, N.J. (U.S.A.). (Relays WABC.) (Daily 20.00 to 22.00.)	
49.26	6,090	VE9BJ	St. John (N.B.). (Daily 00.00 to 01.30)...		25.29	11,860	GSE	Empire Broadcasting	
49.22	6,095	VE9GW	Bowmanville, Ont. (Canada). (Mon., Tues., Wed. 20.00 to 03.00, Thurs., Fri., Sat. 12.00 to 05.00, Sun. 18.00 to 02.00.)		25.27	11,870	W8XK	Pittsburg, Pa. (U.S.A.). (Relays KDKA.) (Daily 21.30 to 03.00.)	
49.2	6,097	ZTJ	Johannesburg (S. Africa). (Daily ex. Sun. 04.30 to 05.30, 08.30 to 12.00, 14.00 to 20.00 (Sat. to 21.45), Sun. 13.00 to 15.15, 17.30 to 20.00.)		25.23	11,880	FYA	Paris, Radio Coloniale (France). (Colonial Stn. N.S.) (Daily 16.15 to 19.15, 20.00 to 23.00.)	
49.18	6,100	W3XAL	Bound Brook, N.Y. (U.S.A.). (Relays WJZ.) (Mon., Wed., Sat. 22.00 to 23.00, Sat. 05.00 to 06.00 also.)		25.0	12,000	RW59	Moscow (U.S.S.R.). (Relays No. 2 Stn.) (Sun. 03.00 to 04.00, 11.00 to 12.00, 15.00 to 16.00.)	
49.18	6,100	W9XF	Chicago, Ill. (U.S.A.). (Daily ex. Mon., Wed., Sun. 21.00 to 07.00.)		24.83	12,082	CTICT	Lisbon (Portugal). (Sun. 14.00 to 16.00, Thurs. 20.00 to 21.00.)	
49.1	6,110	VUC	Calcutta (India). (Daily 07.06 to 08.06 irregular 13.06 to 16.36, Sat. from 12.36, Sun. 04.36 to 07.36, irregular 12.36 to 03.36.)		24.2	12,396	CT1GO	Paredo (Portugal). (Sun. 15.00 to 16.30, Tues., Thurs., Fri. 18.00 to 19.15.)	
49.1	6,110	VE9HX	Halifax N.S. (Daily 14.00 to 16.30, 21.00 to 04.00.)		23.39	12,830	CNR	Rabat (Morocco). (Sun. 12.30 to 14.00)...	
49.02	6,120	YDA	Bandong (Java). (Daily 03.30 to 06.30)		19.84	15,123	HVJ	Vatican City. (Daily 15.30 to 15.45) ...	
49.02	6,120	W2XE	Wayne, N.J. (U.S.A.). (Relays WABC.) (Daily 23.00 to 04.00.)		19.82	15,140	GSE	Empire Broadcasting	
48.86	6,140	W8XK	Pittsburg, Pa. (U.S.A.). (Relays KDKA.) (Daily 21.30 to 06.00.)		19.74	15,200	DJB	Zeesen (Germany). (Daily 08.45 to 12.15)	
48.78	6,150	CJRO	Winnipeg (Canada). (Daily 00.00 to 05.00, Sat. 21.00 to 06.00 also, Sun. 22.00 to 03.30.)		19.72	15,210	W8XK	Pittsburg, Pa. (U.S.A.). (Relays KDKA.) (Daily 15.00 to 21.15.)	
48.4	6,198	CT1GO	Paredo (Portugal). (Daily ex. Sun. and Tues. 00.20 to 01.30, Sun. 16.30 to 18.00.)		19.71	15,220	PCJ	Eindhoven (Holland). (Experimental) ...	
46.69	6,425	W3XL	Bound Brook, N.J. (U.S.A.). (Experimental)		19.68	15,243	FYA	Paris, Radio Coloniale (France). (Colonial Stn. E.H.) (Daily 12.00 to 16.00.)	
45.38	6,610	RW72	Moscow (U.S.S.R.). (Relays Stalin Stn.)...		19.67	15,250	W1XAL	Boston, Mass. (U.S.A.). (Daily 15.50 to 18.30.)	
38.48	7,797	HBP	Radio Nations, Prangins (Switzerland). (Sat. 22.30 to 23.15.)		19.66	15,260	GSI	Empire Broadcasting	
37.33	8,035	CNR	Rabat (Morocco). (Sun. 20.00 to 22.30)...		19.64	15,270	W2XE	Wayne, N.J. (U.S.A.). (Relays WABC.) (Daily 16.00 to 18.00.)	
31.58	9,500	PRF5	Rio de Janeiro (Brazil). (Daily 22.30 to 23.15.)		19.56	15,330	W2XAD	Schenectady, N.Y. (U.S.A.). (Daily 19.30 to 20.30.)	
31.55	9,510	VK3ME	Melbourne (Australia). (Wed. 10.00 to 11.30, Sat. 10.00 to 12.00.)		19.52	15,370	HAS3	Budapest (Hungary). (Sun. 13.00 to 14.00.)	
31.55	9,510	GSB	Empire Broadcasting		17.33	17,310	W3XL	Bound Brook, N.J. (U.S.A.). (Daily 16.00 to 22.00.)	
31.48	9,530	W2XAF	Schenectady, N.Y. (U.S.A.). (Relays W.G.F.) (Daily 23.30 to 04.00, Sat. 19.00 to 22.00 also.)		16.89	17,760	DJE	Zeesen (Germany). (Daily 13.00 to 16.30.)	
					16.87	17,780	W3XAL	Bound Brook, N.J. (U.S.A.). (Relays WJZ.) (Daily except Sun. 11.00 to 13.00, Tues., Thurs., Fri. 20.00 to 21.00 also.)	
					16.86	17,790	GSG	Empire Broadcasting	
					13.97	21,470	GSH	Empire Broadcasting	
					13.93	21,530	GSJ	Empire Broadcasting	
					13.92	21,540	W8XK	Pittsburg, Pa. (U.S.A.). (Daily 12.00 to 19.00.)	

THE results are now announced of the "Avomitor" Competition organised by the Automatic Coil Winder and Electrical Equipment Co., Ltd.

First prize (£1 a week for one year), Mr. Peter Bowers, Pages Hill, Whepstead, Bury St. Edmunds; second prize (10s. a week for one year), Mr. Krikor Ghazaros, University College Hall, Queen's Walk, Ealing, London, W.5.; third prize (£10 cash), Mr. W. H. Stimson, 74a, Miller Road, Bedford.

Consolation prizes have been awarded to twenty-five other entrants.

Among recent important contracts secured by the Alton Battery Co., Ltd., of Alton, Hants, is one for the supply of complete new

THE RADIO INDUSTRY

batteries for the Burnham (Somerset) Radio Station.

New prices are announced for Drydex "Red Triangle" and Drydex "Textet" batteries. As an example, the Red Triangle 120-volt battery now costs 7s. 6d.

The General Electric Co., Ltd., of Magnet House, Kingsway, London, W.C.2, have now made arrangements to supply, at the cost of 2s. 6d. each, revised station registers which take into account the recent wavelength changes of B.B.C. stations. Suitable registers are available for the principal G.E.C. sets.

C. A. Vandervell, Ltd., of Well Street, Birmingham 19, announce new arrangements regarding their dry HT batteries. There are now two ranges: "Standard" and "Cavac," the latter being a low priced series.

A catalogue describing piezo-electric quartz crystals for frequency control, etc., and also transmitting apparatus of various kinds, is issued by the Quartz Crystal Co., Kingston Road, New Malden, Surrey.

Sunbeam Electric, Ltd., of Park Royal Road, London, N.W.10, announce that Sunbeam models 22 and 32 are now withdrawn. The price of model 57 has been increased from 10 guineas to 12 guineas.

The Wireless World

THE
PRACTICAL RADIO
JOURNAL
24th Year of Publication

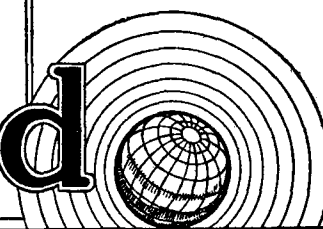
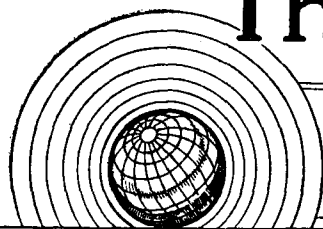

No. 811.

FRIDAY, MARCH 15TH, 1935.

VOL. XXXVI. No. 11.

Proprietors: ILIFFE & SONS LTD.

Editor:
HUGH S. POCOCK.

Editorial,
Advertising and Publishing Offices:
DORSET HOUSE, STAMFORD STREET,
LONDON, S.E.1.

Telephone: Hop. 3333 (50 lines).
Telegrams: "Ethaworld, Watloo, London."

COVENTRY: Hertford Street.
Telegrams: "Autocar, Coventry." Telephone: 5210 Coventry.

BIRMINGHAM:
Guildhall Buildings, Navigation Street, 2.
Telegrams: "Autopress, Birmingham." Telephone: 2971 Midland (4 lines).

MANCHESTER: 260, Deansgate, 3.
Telegrams: "Iliffe, Manchester." Telephone: Blackfriars 4412 (4 lines).

GLASGOW: 26B, Renfield Street, C.2.
Telegrams: "Iliffe, Glasgow." Telephone: Central 4857.

PUBLISHED WEEKLY. ENTERED AS SECOND
CLASS MATTER AT NEW YORK, N.Y.

Subscription Rates:
Home, £1 1s. 8d.; Canada, £1 1s. 8d.; other
countries, £1 3s. 10d. per annum.

*As many of the circuits and apparatus described in these
pages are covered by patents, readers are advised, before
making use of them, to satisfy themselves that they would
not be infringing patents.*

CONTENTS

	Page
Editorial Comment	253
The Image in a Television Re- ceiver	254
High-efficiency Push-Pull Output Stages	256
Current Topics	259
Portable 40-metre Transmitter ..	260
Unbiased	263
Ganging—Is It Worth While? ..	264
Local Conditions	266
Radio Data Charts	267
Listeners' Guide for the Week ..	270
New Apparatus Reviewed ..	272
More About Tone-compensated Volume Control.. ..	273
Random Radiations	274
Letters to the Editor	276
Broadcast Brevities	277
Readers' Problems	278

EDITORIAL COMMENT

Electrical Interference Disappointing Lack of Progress

THE position with regard to electrical interference with broadcast reception is far from satisfactory.

We had hoped that the way would have been paved for legislation after the Committee appointed by the Institution of Electrical Engineers in June, 1933, had deliberated for a matter of a month or two, yet at the present rate of progress we shall be fortunate if any result of value has been achieved in as many years from now.

It is unfortunate that the efforts of the Institution, as the representative body of the electrical industry in this country, in its attempt to arrive at a solution of this difficulty should have proved so disappointing. We know, of course, that the problem is a difficult one, but we venture to think that the Committee has itself added to the difficulties of a solution, first by attempting to arrive at too comprehensive a definition of interference, and secondly by allowing members of the electrical industry who are not entirely disinterested, to influence the Committee unduly in their own individual interests.

An Obstacle

We know that the compulsory suppression of interference cannot be welcomed by producers of electrical apparatus because the cost of rendering apparatus interference-free is not entirely negligible, but in the public interest selfish considerations should not be allowed to delay the solution of a problem which is quite definitely national.

The Television Committee has had a difficult task to carry out, but never-

theless it has been tackled boldly and expeditiously. This Committee had the advantage, of course, that it was composed of members not concerned with the commercial interests involved, and the further superiority that the Postmaster-General had the necessary legal authority not only to appoint the Committee but to act upon its recommendations.

P.M.G.'s Powers

It is unfortunate that the Postmaster-General has not, in the case of interference, the same control. If legislation were passed to give the P.M.G. the right to call for the suppression of interference, then the next step would be for him to appoint an independent Committee to advise him on how to administer his authority, as has been done in the case of television.

The Committee of the Institution of Electrical Engineers having failed to come to agreement and to put forward proposals in a reasonable period of time, it is surely best that the Postmaster-General should now proceed with or without its help, adopting as nearly as the circumstances permit the same procedure as in the case of television.

It may not be out of place to mention here that this problem of electrical interference is one which closely concerns television, because it has already been realised that motor car ignition can cause so much trouble on the short waves which television will occupy that reception near a main road will be far from satisfactory unless the interference is suppressed. The seriousness of this position is emphasised when we remember that the television transmitters, by reason of their very restricted range, will be located in the centre of highly populated districts where motor road traffic may be expected to be at its densest.

The Image in a Television Receiver

EFFECT OF VARIOUS TYPICAL DISTURBANCES AND FAULTS

By MANFRED VON ARDENNE

MANFRED VON ARDENNE is well known as a pioneer in the development of the medium-voltage glass cathode ray tube particularly in its application to television. The photographs accompanying this short article give an impression of the intensity that can be obtained, and illustrate the visible effect of some of the faults that may occur in a cathode ray television receiver.

BY the introduction of new highly efficient screen materials with outputs up to over three candle-power per watt, and by improving the efficiency of the high-vacuum system, the writer has recently succeeded in obtaining received images of such brightness as to enable photographs to be taken of them with exposures of only fractions of a

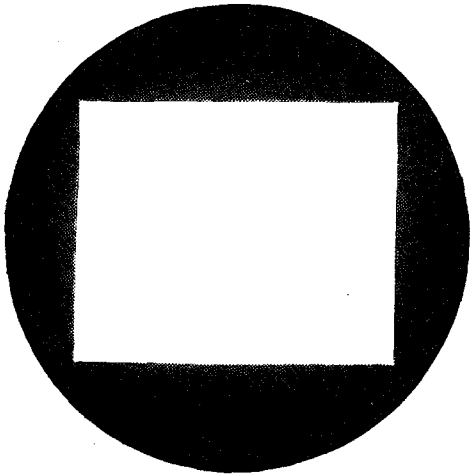

A faultless "raster" surface without picture content. Although the screen is used almost to its edges these are absolutely sharp and the format perfectly rectangular. The space itself is uniformly bright. The picture ratio is correctly adjusted to the prescribed value 5 : 6.

second. In this way it has been possible for the first time to take sharp instantaneous photos of reception from



Blurred effect due to the electron lens being out of focus (wrongly adjusted electron lens potential).

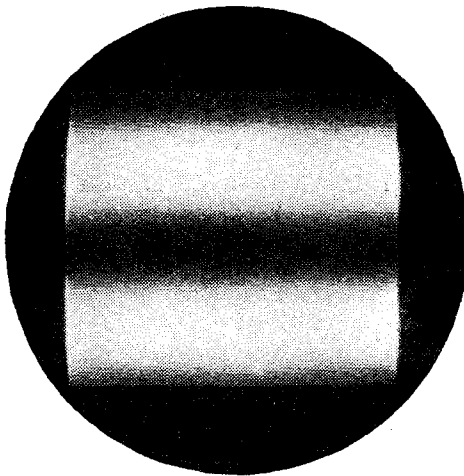

A serious type of "raster" trouble, originating usually in the mains unit; the presence of a 50-cycle potential on the light-modulating electrode, or imperfect smoothing, causes alternate brightening and darkening in the different zones of the "raster." If this fault only appears with the picture itself—i.e., after the light-modulating voltage is switched on—the cause of the disturbing potential must be sought in the receiver unit.

the Berlin ultra-short-wave transmissions of "talkies," sometimes with rapidly moving picture content. Some of the fluorescent-screen snapshots taken in the laboratory at Lichterfeld, near



Image properly focused.

Berlin, are shown in the accompanying photographs. These pictures serve as an objective indication of what can be attained to-day with 180 lines and 25 framing frequency over an all-wireless link.

Such an objective indication can, however, only serve as a help in forming a true opinion of the actual results. For it is very important to realise that the subjective effect on someone watching the moving image on the screen is always far better than would appear from the best photographic reproduction, for various reasons, some of which have often been

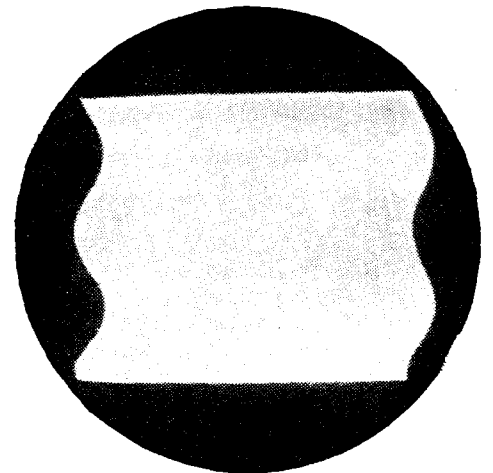

Distortion of the "raster" by a particularly strong 50-cycle magnetic leakage field from a mains transformer wrongly placed close to the ray-generating system. Similar distortion may be produced by mains disturbances in the saw-tooth circuits (producing the scanning movements). Occasionally, if the hum only affects the position of the "release" moment, only one edge of the picture will show the wavy form.

discussed in the literature of television. In the first place, the effect of motion in the image and the consequent continual chang-



Typical distortion of image by erroneous use of 5 : 6.8 picture ratio instead of 5 : 6.

The Image in a Television Receiver—

ing to new picture elements gives an impression of considerably improved sharpness of definition. Added to this is the



Typical result of faulty synchronisation of the line-deflecting saw-tooth. Series of lines are laterally displaced as a result of too weak a synchronising control or wrongly adjusted local saw-tooth frequency. This is one of the disturbances most frequently met with as a result of faulty adjustment or imperfect design of the receiver, and gives a lot of trouble. If the extent of this distortion is found to vary with the nature of the picture content, it may be concluded that the amplitude filter between receiver output and the synchronising terminals of the saw-tooth circuit unit is not working properly, resulting in the strength of the synchronising pulses varying with the picture content.

fact that in a photographic reproduction the movement of the image by as much as the diameter of a single picture element is enough to decrease the sharpness, whereas the eye can follow up such changes in position, provided they do not occur too rapidly. Then again, the photographic process is not free from distortion when it



Typical image appearance due to too low an intermediate frequency—i.e., a wrongly adjusted heterodyning frequency in the superheterodyne vision receiver.

is functioning under the difficult conditions of exposure-times only just sufficient to produce blackening. Further, a luminous picture always makes a greater impression on the eye than a photographic reproduction seen by reflected light. Last, but not least, the fact that the action is accompanied by the sound programme has a very marked effect in augmenting the general impression. Only in one point has the photographic reproduction an advantage over the actual image: it is free from the flicker given by the 25 framing fre-

quency and high luminosity (exceeding some 10 lux).

Taken all in all, therefore, photographs of the screen image must be regarded only



Incorrect positions of the line-synchronising impulses in the received picture. The spaces given by the transmitter for the synchronisation of the line frequency sometimes appear as black streaks, particularly at the right-hand edge of the frame. For high-quality reproduction, however, a phase condition is necessary where this black streak disappears, as it were, behind the picture, since only with this condition is the back-stroke of the line-deflecting oscillation completely darkened, so that the black parts of the image can appear truly black.

as an indication, and not as a measure, of the merit of the images now attainable. But they have a special importance in that they can show—either in technical or popular articles—the results of proposed new methods, improvements newly attained, the action of this or that type of fault in design or bad adjustment, and the effects produced by various kinds of interference. In this field the conditions



The announcement of the Berlin Television Transmitter. The slight appearance of "plastic" (double contours) at the right-hand edge of the letters is the result of a slight over-accentuation of the very high modulation frequencies in the receiver. A small alteration in the tuning of the primary circuit, or in the heterodyning adjustment, will usually make this plastic effect disappear—provided the frequency-characteristic of the whole receiver is correct.

are much more favourable than in the case of sound transmission. In the photographs here given some of the most important ill-effects which may occur as a result of faulty design or bad adjustment of a television receiver are recorded. The explanation of each picture will be found sufficiently descriptive for the reader to

understand its significance. Circuits and important design details of the cathode ray tube receiver with which the faultless images were received, as well as those deliber-



Distorted double picture with half the proper line frequency and correctly adjusted framing frequency. A simple adjustment of the line-frequency regulator would suffice to produce a sudden jump of the image to its proper form.

ately faulty images for the demonstration of the various sources of error, are fully given in the writer's recently published book, "Fernsehempfang" (Verlag Weidmannsche Buchhandlung), 1935).

Photographing Conditions

The photographs were taken with an ordinary wide-aperture camera, a Leybold high-vacuum cathode ray tube, Type Aa 2r8, and the new Standard Screen, giving an output of about 3.15 candles per watt at the outer side of the screen. The anode potential was 4,000 volts; the



Photograph of a received image under strong interference from commutator-sparking, given as an indication of the proofness against interference shown by the writer's receiving equipment. The effect on the character of the received image, due to the action of the interference on the synchronising circuits, is no greater than the direct and unavoidable interference with the light-modulating potentials. The robustness of the synchronising technique with respect to interference is thus shown to be very satisfactory.

change in negative bias of the light-control electrode, for modulation from bright to dark, was less than 15 volts. The recording was greatly facilitated by the high stability of the equipment; everywhere, including the synchronisation, it was so good that faultless reception could be obtained hour after hour.

High-Efficiency Push-Pull Output Stages

A New System for Large Volume

THE push-pull output stage is commonly employed where high quality of reproduction at large volume is required, and it has recently come into use in modified form as a battery economiser system under the names of Class "B" and QPP. In this article a new method of push-pull is described which is applicable in cases where very large output is needed and the output valves are of very low AC resistance.

THE push-pull principle has been extensively applied to power output stages with a view to combining the output of two valves, with the added advantage of great purity of reproduction. The circuit (see Fig. 1) can also lead to a very considerable increase in the output over that obtainable from the same pair of valves connected in parallel, but this aspect of the arrangement appears to have been rather overlooked.

The introduction of a new triode, the PX25A, has directed attention to this feature of the circuit by virtue of the remarkably large power output obtainable from a pair of these valves when used under suitable conditions. Although the PX25A resembles the well-known PX25 as far as anode-dissipation and operating voltages are concerned, the output yielded by a pair of the new type is over 30 watts—no less than six times the output of a single PX25.

The characteristic feature of the PX25A is its extremely low impedance, and it is this feature which enables the striking results just mentioned to be achieved. It is necessary, however, to pay particular attention to the value of the anode-to-anode load-impedance, since it is on the correctness of this figure that the successful operation of the system depends. When the proper impedance has been applied (by adjusting the ratio of the output transformer to suit the impedance of the speaker in use) it will be noticed that the value of the anode supply current to the two output valves varies according to the loudness of the programme matter being reproduced. It does not follow from this that distortion is

being introduced. In fact, if a continuous pure tone of sufficient strength to load the output stage fully were being handled, a 100 per cent. increase in the demand on the HT unit would result, while the proportion of harmonics would only amount to 5 per cent. In practice, however, such a large rise in the anode current is seldom observed because of the transitory nature of very loud sounds in speech and music.

The chief characteristics and operating figures for the PX25A in push-pull circuits are given in the Table, but since the operation of these valves presents some points of novelty, a description of a complete amplifier will now be given, and particular attention paid to the methods of overcoming the difficulties. The amplifier is mains-supplied and has sufficient gain to work successfully from almost any gramophone pick-up. The input voltage required is only 0.1 volt RMS, while the power output (30 watts) is sufficient for a considerable sized hall, or for use in the open air.

It will be realised that perhaps the most unusual feature of the new push-pull condition is the variation in the HT current. This is familiar enough in the domain of battery-fed valves (Class B and QPP stages, for instance), but when it occurs in mains-supplied amplifiers particular attention has to be paid to the design of the mains-unit.

Secondly, as a result of the special value of load impedance employed to give the large output, the maximum or peak anode current which the valve filament has to supply is four or five times as great as the steady current flowing in the absence of any signal. This difficulty, however, is largely a matter for the valve



By
K. A. MACFADYEN,
M.Sc.

(Research Laboratories G.E.C. Ltd.,
Wembley.)

CHARACTERISTICS OF THE PX25A

Filament voltage (A.C.)	4.0	
Filament current	2.0 amperes.	
Anode voltage	400	
Grid bias	about -117 volts	
Maximum anode dissipation (per valve)	25 watts.	
Anode-to-anode load	2,800 ohms.	
Power output (per pair)	32 watts.	
Impedance	580 ohms	} at E _a = 100 V. E _g = 0.
Amplification factor	6.4	

manufacturer, and as long as the user takes care to preserve the full voltage at the filament pins (4.0 volts) he is not likely to meet with any trouble from this cause.

The third point which must be emphasised is that automatic bias cannot be used. The reason for this is very simple. On account of the great increase in the total anode current taken by the two valves, an automatic bias circuit would force down the grid-potential during loud passages of programme matter to such an extent that severe distortion would result. We should have a state of affairs similar to that in an over-biased Class B or QPP valve.

The Amplifier

Another result of the extremely low impedance of the PX25A is that the magnification factor is also low. This means that a rather large signal voltage has to be applied to the grids of the valves in order to elicit the full output. However, the advantage to be gained from the proper use of this new type is so marked that the peculiarities just described cannot be regarded as serious drawbacks.

Let us now consider the actual amplifier more closely. It is entirely mains-supplied and consists of three stages of amplification. Fig. 2 shows the circuit employed. A screened-pentode, resistance coupled, amplifies from the input voltage of about 0.1 volt up to four or five volts. This potential is applied to the grid of an indirectly heated triode, which is choke

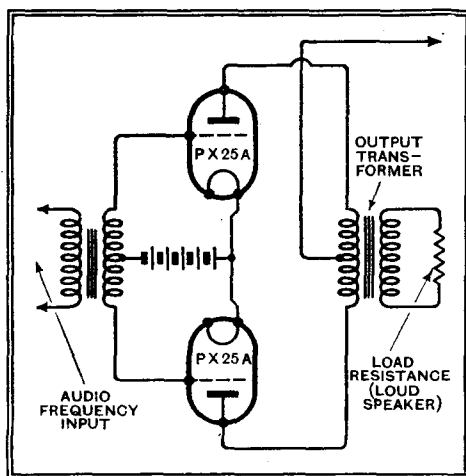

Fig. 1. The fundamental push-pull circuit.

High-Efficiency Push-Pull Output Stages.— coupled to a special type of transformer, to be described later. The transformer supplies the requisite signal voltage to the grids of the PX25A output valves, the energy from which passes into an output transformer designed to suit the impedance of the speaker (or speakers) to be operated.

Grid bias for the first and last valves is derived from a small rectifier unit employing a U10 rectifying valve, while the main HT supply unit embodies two slow-

of a half-megohm volume control, suitable for use with the majority of gramophone pick-ups. Whatever may be the objections to the practice of controlling the volume at this point, there is the overwhelming advantage that it is impossible, with this method, to overload the earlier valves of the amplifier by turning down the volume while maintaining a relatively large input.

The first valve, a resistance-coupled screened-pentode (MSP4), presents no very novel features. It should be noticed,

with the bias-unit enables a suitable bias-voltage to be supplied. The resistance-capacity circuit (R1, C1, Fig. 2) is for eliminating hum from the bias-unit; the two components just specified, together with the volume control, ought to be placed close to the grid terminal of the MSP4. The valve should be mounted in an anti-microphonic holder.

Passing to the next stage by way of the 0.1 mfd. coupling condenser the signals reach the grid of the ML4 triode. This valve is automatically biased, but on

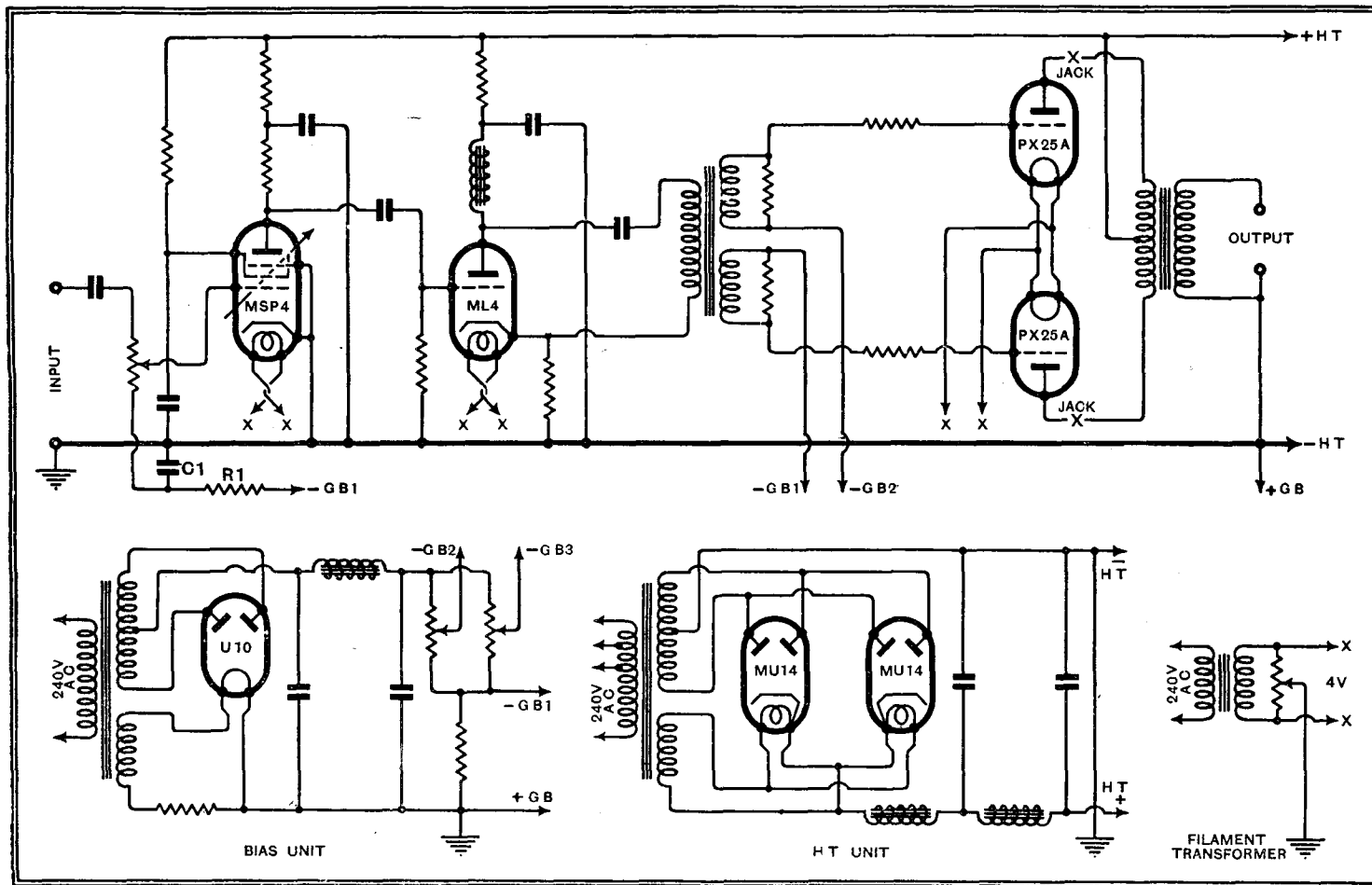

Fig. 2. The complete circuit diagram of an amplifier embodying the new output system. The mains equipment must be of special design owing to the fluctuating anode current of the last valves.

heating MU14 valves in parallel. Since the amplifier filaments and heaters are at earth-potential the entire LT current (excluding that taken by the rectifiers) may conveniently come from a single transformer winding.

If care is taken in the disposition of the various components the hum-level can be reduced to a very low value. The response curve of the entire amplifier is reproduced in Fig. 3. It is sensibly flat from 50 cycles to 10,000 cycles per second. The harmonic content has been measured and found to be 5 per cent. at full output. These characteristics place the amplifier in the "high fidelity" class.

Although it is a sound principle when designing an amplifier to commence at the output terminals and to consider the components in the inverse order, nevertheless, for the sake of clearness, we shall adopt the other method here and commence at the input circuit, which consists

however, that automatic bias is not used here, as it is very difficult, even with modern electrolytic condensers, to by-pass the bias-resistance of a screened-pentode perfectly enough to secure a really satisfactory bass-response. An additional tapping on the potentiometer associated

account of the fact that the alternating component of its anode current is diverted by the anode choke through the primary of the coupling transformer straight back to the cathode, thereby avoiding the bias-resistance altogether, it is not necessary to connect a condenser across this resistance. This precaution is necessary only when the resistance is traversed by alternating current.

In this way one of the advantages of using a choke-coupled transformer instead of allowing the anode current to traverse the transformer primary will be realised. Another point in favour of the practice is that the absence of direct current in the transformer winding enables a far better performance to be secured, especially from the point of view of the response to notes of extremely high frequency.

This transformer is one of the interesting features of the amplifier. It is wound

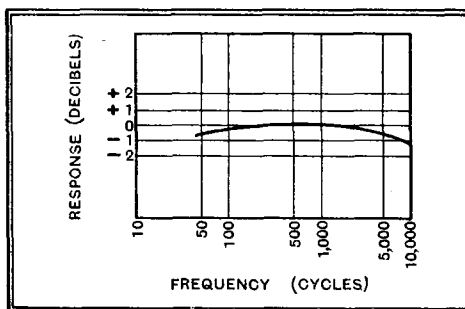

Fig. 3. The overall frequency response curve of the amplifier shown in Fig. 2, taken with an input of 0.1 volt RMS and an output of 28.5 watts.

High-Efficiency Push-Pull Output Stages.—

on a core of high permeability alloy, like many well-known intervalve transformers, but there the resemblance to the conventional intervalve transformer ceases. As a rule, this kind of transformer is provided with a primary winding of extremely high inductance, and is used with its secondary connected to the grid of the next valve in such a way that, apart from the inter-electrode capacities and leakages, this winding may be considered as an "open circuit," i.e., there is no closed path for the passage of current. The object of arranging matters in this way is to gain the greatest possible voltage amplification from the previous valve in the amplifier.

The Push-Pull Transformer

If an intervalve transformer of the ordinary type (especially a high ratio one) is used to operate a pair of large output valves, imperfections in the performance of the arrangement are likely to appear. This is because the transformers are usually designed to work in connection with small- or moderate-sized valves. When large valves with considerable inter-electrode capacity are connected to the secondary the carefully adjusted conditions which normally bring about a fairly uniform frequency-response are upset. The resulting electrical resonances not only give an uneven response-curve, but, in the case of high-efficiency push-pull stages of the kind we are considering here, also cause bad wave-form in certain frequency ranges. This has been found to be associated with inequality in the signal voltages applied to the two valves.

The origin of all these troubles may be traced to the chief aim in the design of the transformer, namely, to secure the greatest voltage amplification from a small preceding valve. In many cases this consideration is a major one, but here, where quality of reproduction is of primary importance, we can afford to use a slightly larger preceding valve and sacrifice a certain amount of sensitivity.

What is done in the present case is to provide a transformer with a comparatively small number of turns and with suitable load-resistances connected to its secondary. The effect of these is to impose a comparatively small AC load (10,000 ohms) on the preceding valve. It is no longer necessary to have an extremely high primary inductance, and, as a result, we rid ourselves of troublesome electrical resonances and obtain a frequency-response curve which is level over an extended range. Moreover, the presence of the secondary load-resistances "swamps" the effects of the inter-electrode capacity of the succeeding valves and causes the output stage to be quite stable and free from self oscillation, even if the input and output terminals are accidentally open-circuited. The resistances should be of the metallised type (for low self-capacity and inductance) and should preferably be chosen to be as nearly equal as possible. If they are unequal it will be apparent that one valve

will be doing more work than the other.

Little need be said of the PX25A output valves themselves, except to remark in passing that they can be mounted horizontally or vertically as desired, but they should not be enclosed in any way likely to restrict free ventilation. The reader is once again reminded of the unsuitability of automatic bias. The bias-unit should consist of a small rectifying and smoothing circuit employing a U10 rectifier. The smoothed output should be fed into a pair of paralleled potentiometers of 50,000 ohms resistance each, so as to enable the bias applied to each output valve to be independently adjusted. This should be done in such a way as to give an anode current of 55 mA. in each anode circuit when no signal is present. If common bias is employed for the two PX25A's it should be adjusted so that the *greater* of the two anode-currents is 55 mA. A pair of current-jacks should be provided in the anode-leads to enable these adjustments to be made from time to time.

The output transformer should be of generous design to be in keeping with the rest of the components. A 1½ in. square section of Stalloy is adequate for the core and the windings should be balanced and interleaved to ensure tight coupling. This is necessary if the response is to be maintained at high frequencies.

Unfortunately it is not possible to give full details of this transformer, since the design depends so much on the type of speaker (or speakers) to be operated. The essential feature is that the anode-to-anode impedance must be 2,800 ohms, hence, if the speaker-impedance is Z ohms the

turns-ratio $\frac{\text{total primary}}{\text{secondary}}$ should be equal

to $\sqrt{\frac{2,800}{Z}}$. About 1,600 turns should

suffice for the primary.

One of the effects attendant upon the increase of anode current when loud pas-

sages of programme matter are being amplified is a decrease in the HT voltage. This "regulation" effect is often a nuisance, but in the present case, provided care is taken to ensure that the full potential of 400 volts is being exerted when the maximum current is being taken, it will be no disadvantage to allow the voltage to rise somewhat when the amplifier is "quiet." This is because the fixed bias ensures that the anode dissipation of 25 watts is not exceeded. If the components for the mains unit be suitably chosen, the dissipation is kept within the 25 watts limit at all times, provided that the bias is adjusted to give an anode current of 50-55 mA. per valve when no signal is being handled. The essential point to observe in any case is that if the mains unit is adjusted to give 400 volts when the output valves are taking their maximum drain (200-210 mA.), it must not have such bad regulation that its voltage rises above about 435 volts when the input signal is removed. If a greater rise than this takes place the valves may suffer damage.

In the design of the mains unit itself it should be noticed that the initial or "reservoir" condenser in the smoothing circuit is omitted and that the chokes have been carefully designed so as to ensure the best possible constancy of voltage consistent with a reasonably small mains transformer.¹

¹ These components were designed on the principles laid down by C. R. Dunham, J.I.E.E. 75, p. 453 (1934).

Television to the Rescue

COMMENTING on the suggestion that American Federal funds should be appropriated for setting up a television service covering the United States (on the lines of the British Service), *Radio Engineering* (New York) says:—

"There is no doubt that such a project would not only provide work for a great number of people, but serve as well to develop an industry . . . that would assist immeasurably in healing our financial wounds."

QA Receiver Coils

COILS for the tone-correction circuit and the whistle suppressor of the *Wireless World* QA Receiver have been received from

Postlethwaite Bros., Church Hill, Kinver, Stourbridge, Worcs.; Scientific Supply Stores, Ltd., 126, Newington Causeway, Elephant and Castle, London, S.E.1; Wilson Radio Electric, Newson Street, Ipswich; Wright & Weaire, 740, High Road, Tottenham, London, N.17. In every case the coils conform to specification and are quite suitable for this receiver. The prices range from 7s. 6d. to 10s. a pair for the tone-corrector chokes, and from 7s. 6d. to 10s. 6d. for the whistle suppressor. In the case of the Kinva coil, the tuning condenser is provided, but with the others only the mounting bracket.

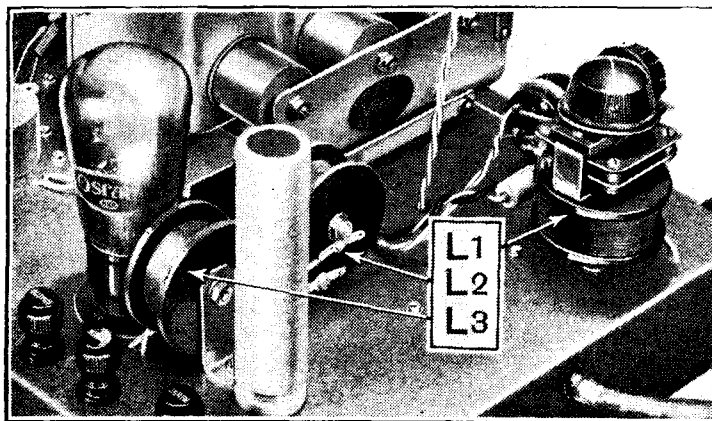

The two tone-corrector coils L2 and L3 and the whistle suppressor L1 are indicated in this illustration which shows part of the QA Receiver.

Current Topics



A NEW VOICE in the ether. Mlle. Mary Lorand, who has just been appointed announcer at Radio Budapest.

Wireless Weddings

THE New Zealand Class "B" station, 1ZR, Auckland, claims to be the first one in the world to broadcast studio baptisms and marriages.

Broadcast Services in Church

THE B.B.C.'s religious service at 10.15 a.m. is re-diffused daily in the parish church of Birmingham (St. Martin's). The north transept is reserved for those who desire to hear the transmission.

New League Transmissions

RADIO NATIONS has inaugurated a new service of daily transmissions at 8.15 a.m. (G.M.T.) on a wavelength of 16.25 metres. These are supplementary to the regular broadcasts on 31.27 and 38.47 metres at 10.30 p.m. (G.M.T.) on Saturdays.

Short Waves in North Ireland

SHORT-WAVE enthusiasts in N. Ireland will be interested in the news of the formation of the Radio Society of N. Ireland with Belfast as headquarters. Enquiries should be addressed to Mr. J. Cowan (G2AFO), 18, London Road, Belfast. Present membership includes about fifteen local R.S.G.B. members.

'Phoning Japan

A DIRECT radio telephone service between Great Britain and Japan was inaugurated on Tuesday last, March 12th, with the exchange of greetings between representatives of the British and Japanese Governments. The hours of working are from 8 a.m. to 12 noon (G.M.T.) daily, except Sundays. Calls cost £2 a minute.

Television for Deaf and Dumb

A DERBYSHIRE listener has lost no time in suggesting free television licences for the deaf and dumb. As a contribution he offers the Governors of the Derbyshire School for the Deaf and Dumb a television installation as soon as a Midland Regional television transmitter is operating.

Eiffel Tower Again

"PARASITE factory" is the epithet hurled at the Eiffel Tower station by a correspondent to the *Temps* newspaper. "Is there," he asks, "any justification for sending out transmissions to navigators and other messages from the heart of Paris, making listening impossible in the vicinity while the Tower is operating?"

A Radio Banquet

A BANQUET behind closed doors was held by the International Broadcasting Union during its last meeting to celebrate the tenth anniversary of its foundation. The hosts were the Swiss Broadcasting Co.

The Conference voted the Lucerne Wavelength Plan a complete success, thus giving the impression that members of the Union do not listen on the long waves.

German Radio Drama

THE new scheme of dramatic studios at Berlin Broadcasting House is almost a replica of those at Broadcasting House, London. Nine small studios are linked by a central dramatic control panel. This arrangement should put an end to the cumbersome practice of erecting studio tents to provide various acoustic effects.

Still Pictures v. Television

AMERICA is still toying with the idea of "still" picture transmission in preference to television. Mr. David Sarnoff, President of the Radio Corporation of America, states in the Corporation's Annual Report that facsimile transmission has reached a stage where a service of pictures, printed matter, and other visual material will be available on the ordinary wavelengths as a supplement to audible broadcasting. He still views television as a laboratory infant, growing stronger almost daily, but "facing technical as well as economic problems that make its introduction in this country on a nation-wide basis virtually impossible in the present state of the art."

Events of the Week in Brief Review

Cheaper Listening

WIREFLESS licences in New Zealand are to be reduced from 30s. to 25s. per annum as from April 1st. The Dominion now has over 100,000 licensed listeners.

How They Listen

VOTING by readers of a Czecho-Slovakian journal reveals that 13 per cent. listen five hours per day; 8 per cent. four hours; 7 per cent. three hours; 6 per cent. six hours; 5 per cent. three to four hours; 4 per cent. four to five hours; 2.5 per cent. six to eight hours; and 2 per cent. two hours.

Paris Television Tests

FRANCE now has its television committee. It has been proposed that television transmissions should use 180-

built some years ago and contains a theatre, has now been chartered for the German short-wave station. There will be two large and two small studios.

British Amateur Activity

A CHECK which has been made during the past year of the amount of amateur transmission taking place in this country reveals that no fewer than sixty per cent. of British amateurs are consistently "on the air," and that the 42-metre band is by far the most popular of the six amateur channels.

It is anticipated that this tangible proof of the large numbers of stations using the amateur frequency allocations will be valuable in pressing for extended wavebands at the Cairo Radiotelegraphic Conference in 1937.



FIRST LADY IN THE LAND. Mrs. Roosevelt, wife of the American President, broadcasting during one of her sponsored programmes, "It's a Woman's World." The entire proceeds—3,000 dollars per week—are devoted to charity. The transmissions can be heard on Saturdays between 1.0 and 1.15 a.m. (G.M.T.) on 49.02 metres (W2XE).

Midnight Talks

THE Rev. Father Charles Coughlin, America's radio priest, whose talks from the Shrine of the Little Flower in Detroit from Station WJR are now famous, has decided in future to speak at midnight. His new Sunday schedule will run from 12 to 12.30 a.m. (Eastern Standard Time).

Father Coughlin's addresses are now heard over a network of twenty-one stations extending from Omaha to Portland, Maine. They are subsidised by voluntary contributions. He first began his broadcasts over the Columbia Broadcasting System six years ago, but now operates an independent network.

line horizontal scanning at 24 frames per second. The French Postal Administration has ordered an experimental television transmitter working on ultra-short-waves. It will be installed in the PTT building, Rue de Grenelle, Paris.

New German Short-Wave Centre

LIKE the B.B.C. building, Berlin's Broadcasting House is proving too small. A few weeks ago (writes our Berlin correspondent) the library was removed to premises several hundreds of yards away to a building formerly occupied by a radio journal. Part of this "Amerika Haus," which was

Portable 40-Metre Transmitter

Constructing, Adjusting and Operating the Set

(Concluded from page 212 of March 1st issue)

THIS concluding instalment contains details of the two special Class "B" components together with notes on the assembly and adjustment of the set

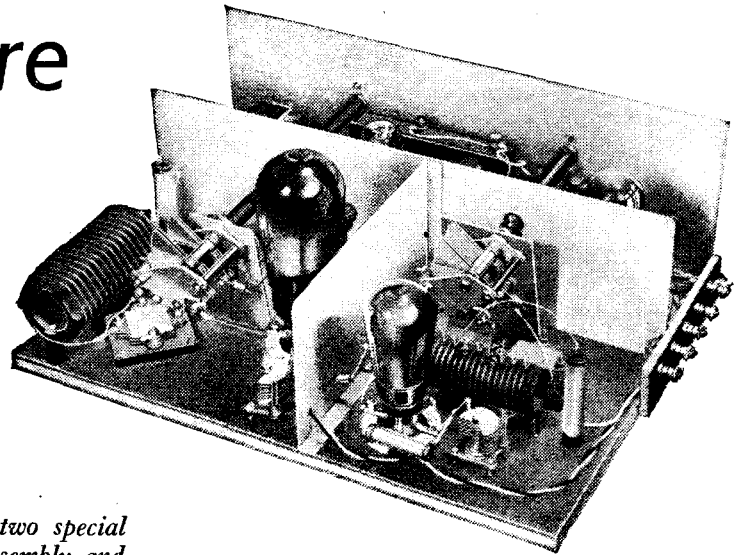

(By courtesy of the General Electric Co., and compiled by the G.E.C. Research Staff, Wembley).

IN the first part of this article constructional details were given of the coils and fixed condensers and mention made of two special Class "B" components for the modulating amplifier.

The reader will probably desire to know why standard components should not be used in the modulator. So far as the intervalve transformer is concerned there is, of course, no valid objection apart from the fact that the quality will not be quite so good. A suitable alternative for the output, or modulation, transformer may be difficult to find, since the secondary winding is required to carry the DC anode current of the HF power oscillator. As this amounts to some 35 to 40 milliamps it will increase the core magnetisation very considerably and quite likely lead to saturation. The inductance of the windings will fall, poor quality and weak

modulation will result. These are, therefore, very good reasons for constructing, or having constructed, the transformers to the specification given here.

The transmitter is assembled on a plywood baseboard about 1/2 in. thick with two vertical aluminium screens erected to partition off the three main units. The master oscillator and the power amplifier are mounted at the back with their respective tuning condensers and long ebonite extension rods carried forward to the panel. This can be made of sheet aluminium of the

serted, and this is supported in a metal panel bush. If the set is used without a cabinet it may be necessary to stiffen the front panel by inserting wooden distance pieces, cut from 1/2 in. doweling between the panel and the transverse screen.

Before setting up the transmitter it would be well first to test the modulator,

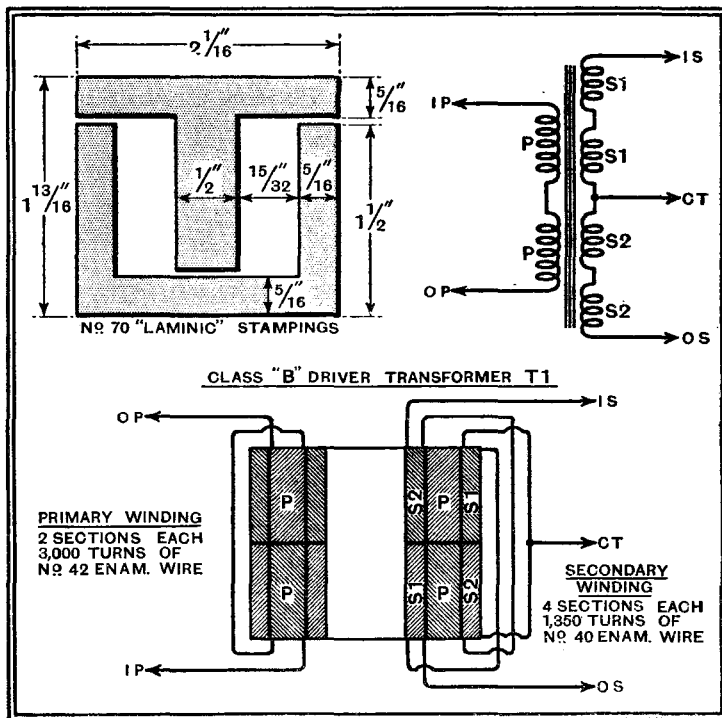

Construction and winding details of the Class "B" driver transformer. The core is of square section and assembled with the laminations interleaved.

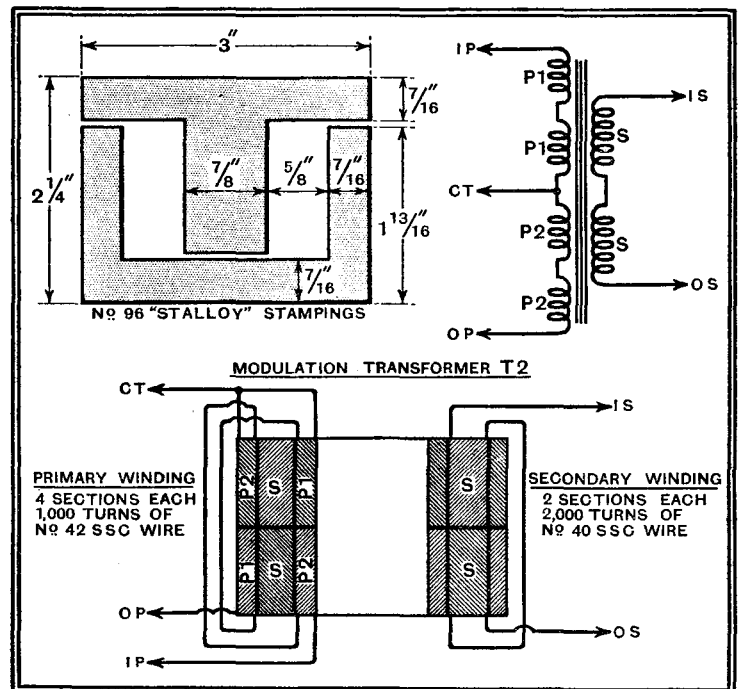

In the modulation transformer of which details are given above, the centre tongue of the core is square and the laminations arranged with all like-shaped pieces on the same side and a small air-gap of 0.1 millimetre left between the ends of the "T" and "U" pieces.

same thickness as for when the oscillator has been adjusted for wavelength and good radiation is obtained, one does not wish to be faced with the bother of looking for a fault in this part of the circuit.

Assuming everything is in order, attention can then be given to the final adjustments.

The amateur 7.5 megacycle waveband includes a narrow band of frequencies from 7005 kc/s to 7295 kc/s, but as some tolerance should be allowed at each end to avoid overlapping adjacent bands it is

for when the oscillator has been adjusted for wavelength and good radiation is obtained, one does not wish to be faced with the bother of looking for a fault in this part of the circuit.

Portable 40-Metre Transmitter—

wisest to regard the two limits as being from 7025 kc/s (42.7 metres) to 7275 kc/s (41.24 metres).

Operation

The first step is to adjust the master oscillator to a frequency within this band, for which purpose a wavemeter of a type approved by the Postmaster-General must be employed. As the circuit diagram shows, the master oscillator tuning coil is joined across the anode and one side of the variable grid condenser of the P415 valve; the centre tap joins to the feed HF choke, while the grid condenser of the power oscillator and the neutralising condenser are connected to tappings on this coil. The former can be the tenth turn from the centre and the latter the sixth turn from the centre on the other side. These are preliminary adjustments and other tapping points might be tried later. The two grid condensers are adjusted to about three-quarters of their total capacity.

Tune the master oscillator to the desired frequency with the PX4 valve in its holder, but without HT on its anode. This adjustment made, complete the anode circuit of the PX4 valve and join a

It should be remembered that before experiments with transmitting apparatus can be made a licence must be obtained from the Postmaster General.

made without the aerial connected or, better still, with an artificial aerial comprising an inductance, a condenser and a resistance joined in series but forming a closed circuit.

If the artificial aerial is an exact replica, so far as its values are concerned, no further adjustments will be needed when it is replaced by the outside aerial, which should consist of 70 feet of wire including the download. A good earth connection is essential and it should go direct to ground, and if in poorly conducting soil several wires may be run out in fan formation on top of the ground and beneath the aerial.

A hot-wire or a thermal-type ammeter

the aerial circuit must be checked whenever any change is made in the position of the aerial tapping, so also should the neutralising.

One 2-mfd condenser only is shown in the wiring diagrams and in the illustrations of the set. This is the by-pass condenser in the 150-volt HT line, and the other, which appears in the theoretical circuit in the 250-volt HT circuit, might be embodied in a small unit consisting of the change-over switch for cw or telephony, which joins to the terminals marked 1, 2 and 3.

When working cw the sudden starting and stopping of the oscillations in the power amplifier circuit, by means of the transmitting key, may produce spurious electrical pulses of no well-defined frequency that could give rise to a localised form of interference commonly described as key clicks or key thumps. Seldom, however, does their effect travel beyond a few hundred yards, but, as it may prove troublesome in the vicinity of the transmitter, it would be well to be conversant with means to suppress it if needs be.

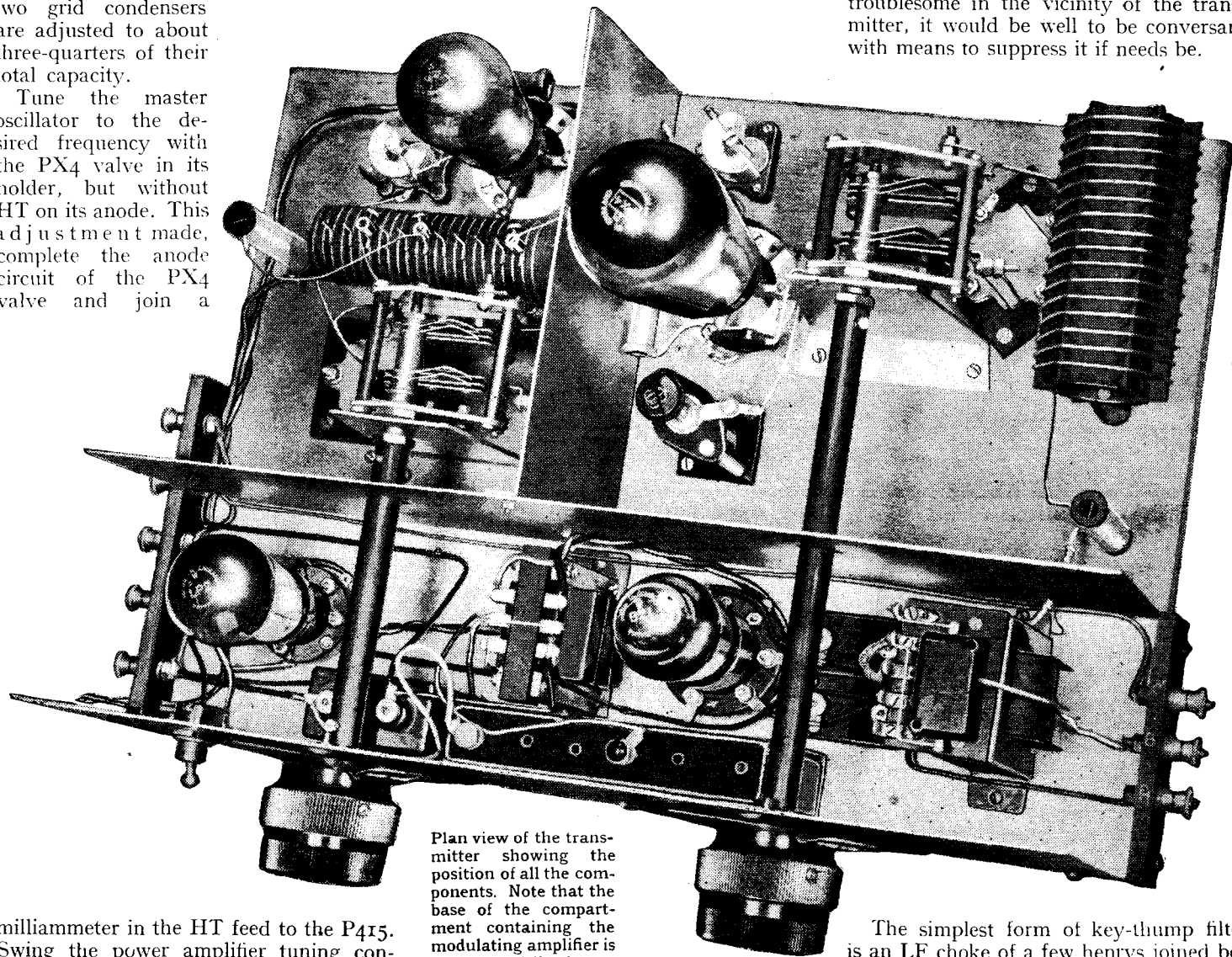

Plan view of the transmitter showing the position of all the components. Note that the base of the compartment containing the modulating amplifier is metal-lined.

milliammeter in the HT feed to the P415. Swing the power amplifier tuning condenser to bring this circuit into resonance with the driver, resonance being indicated by a marked increase in anode current. Note the dial reading of this condenser. Now adjust the neutralising condenser so that when the power amplifier circuit is passing through resonance the ammeter needle remains reasonably steady. All these adjustments should be

connected in the aerial lead, and a milliammeter in the anode circuit of the power amplifier, will be needed to ascertain the best aerial coupling. Adjustments are made to obtain maximum reading on the aerial ammeter with the lowest HT feed current to the PX4 valve. The tuning of

The simplest form of key-thump filter is an LF choke of a few henrys joined between the key contact and the HT supply lead to the valve, but as this may produce sparking at the key points, which would become a further cause of key click, it is usual to connect a condenser and a resistance in series and join them across the key contacts. Suitable values for these components would be 0.1 mfd. and about 100 ohms. The resistance should

WIRING PLAN FOR PORTABLE 40-METRE TRANSMITTER

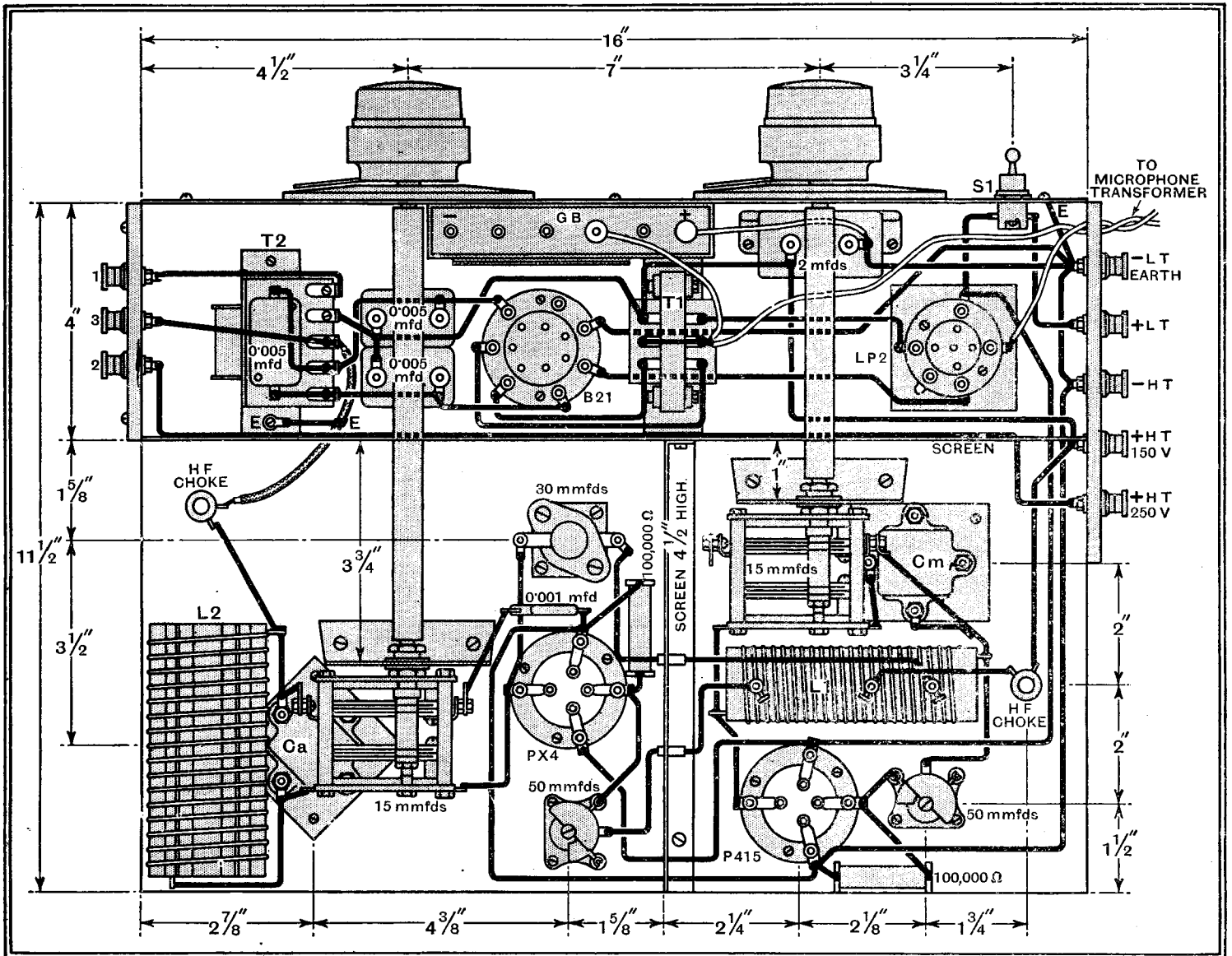

Lay-out of the baseboard and wiring plan.

be variable as a slightly lower value might be needed to damp out the sparking.

Any type of carbon microphone can be used with the set provided it gives a reasonably large output. If the transverse-current type or a moving coil pattern is employed it will generally be necessary to add an additional LF amplifier before the modulating circuit, and, as only a small additional gain is wanted, this stage can quite well be resistance coupled to the LP2 valve.

The total current consumption of the four-valve set is 1.45 amps. at 4 volts for the filaments, about 18 mA. from the 150-volt HT supply, and from 35 to 40 mA. for the power amplifier when its anode potential is 250 volts.

The operator will not need reminding that he should not radiate a carrier wave without giving his licensed station call letters and listening-in from time to time on the wavelength employed to ascertain that his station is not causing interference. The co-operation of another station should be obtained for the preliminary adjustments, as the reports received will prove

very helpful to the beginner and enable the meter's readings to be better interpreted in terms of radiation efficiency.

BOOK REVIEW

"*Grundriss der Kurzwellentherapie*" (Foundations of Short-Wave Therapy: Introduction to the Physical-Technical and Medical Bases of the Application of Short Electric Waves, for Doctors and Biologists), by Doctors W. Holzer and E. Weissenberg. (Verlag W. Maudrich, Vienna IX, Spitalgasse 1B: 189 pp.—vi: RM. 8.)

The radio engineer will find fault with the title of this book, for although what he knows as "short" waves are employed in medicine, the waves dealt with here are chiefly the "ultra-shorts" below ten metres. Thus in the section (p. 123) on what a doctor should demand of his "short-wave" generator, the first requirement is a wave-range from 3.5 to 15 metres, and wherever a wavelength is specifically mentioned throughout the book it is nearly always below ten metres.

Now this adds very considerably to the interest of the book; for whereas the chief

medical application of "short" waves seems to lie in a warming-up of the whole body, in the "artificial fever" treatment of paralysis, for example (originally accomplished by infecting the patient with malaria), the "ultra-shorts" appear to display their usual fascinating and unpredictable qualities, exerting not only a heating effect, but also, apparently, a specific action of their own whose nature is not yet quite clear. As Weissenberg shows in the latter part of the book (the first part, by Holzer, gives an introduction to the physical side of the subject—the nature of the oscillations, their generation, measurement, application, and so on), these waves have been applied, by himself and others in different parts of the world, to the treatment of a singularly varied collection of diseases, from eczema and lupus, arthritis and asthma, to multiple sclerosis and melancholia, hyperacidity and heart troubles. Naturally, in such a huge field there are failures as well as successes, but the writer does not hesitate to quote negative results as well as positive. Each part has a lengthy list of literature references at the end of the book, and the whole forms a valuable introduction to an engrossing and apparently enormously important subject.

D. B.

UNBIASED

Jobs for Designers

IF television does nothing more than make manufacturers exercise common sense in designing receivers so that they are of a reasonable shape, it will not have been in vain.

We have for so long had foisted on us that type of console receiver and radiogramophone in which the loud speaker is practically on the floor that we have almost been hypnotised into believing that it is the proper place for it. I certainly would not put it past certain designers I know to do likewise with the television screen and make us and our piece of Turkish delight squat on the floor, as they did in old Stamboul when I was last there.

By FREE GRID

I have long protested against the foolishness of placing the controls on the front of the receiver itself rather than in a separate remote control unit; as it is, we have either to get up from our armchair every time we want to change the programme or draw the set up to the fireside and have the loud speaker bellowing in our ear all the time. When television comes we cannot very well have the set too near unless we want to press our noses up against the screen, and I think some form of remote control unit is called for.

I do not see that it is impossible for the screen to be hoisted up on the picture rail, from which some of us now suspend our baffles. There would be no need for the whole short-wave receiver to be stuck up there but merely the cathode ray tube, the associated batteries of which could be in a more convenient place; control would, of course, be done from a remote unit. Something similar will, I suppose, have to be done in hospital wards unless they adopt, for each patient, miniature "eyephone" television, such as I was discussing the other week.

I am sorry, by the way, for those lazy people who have thrown their good wireless sets away in favour of a wretched relay service. Television programmes cannot well be distributed from house to house by wire without an enormous expense for special cables. Even then the unfortunate looker would merely get rid of the short-wave receiver and would still need some form of cathode ray tube or other scanning apparatus in his house. So he might just as well have a complete television outfit.

Watts in a Name?

JUDGING by the correspondence in the daily Press, people seem much agitated over what they're going to call their television receivers when they've got them. If these are anything like the ordinary wireless receivers were in the early days of broadcasting I feel sure that names will come quite spontaneously to the tongue when operating the sets.

It is earnestly to be hoped that we shall be delivered from such dreadful uncouth expressions as "the wireless" which seems to have achieved such universal popularity. Years ago, before television got into its stride, I suggested in these pages that an ordinary broadcast receiver might be called a radiophone, while a television set might be termed a radioscope. I suppose, however, that the latter expression merely conveys the idea of vision without its concomitant of hearing, and we shall therefore have to find some combined word like phonoscope or scopophone; of the two I prefer the former, although on second thoughts I think I prefer visaphone.

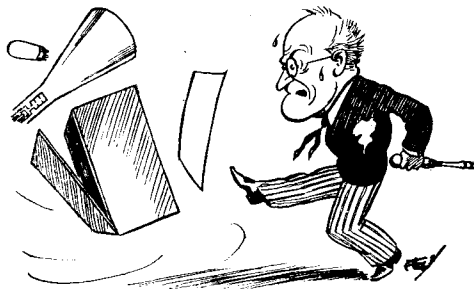

Names will come spontaneously to the tongue.

Of course, the radiogramophone-cum-television receiver is easy, as we shall merely call it a radiogramoscope in order to distinguish it from cinegram or radiocinegram, which is being used to describe that type of radiogramophone which also houses home talkies in its innards.

Down on the Farm

FARMERS are not usually noted for a favourable attitude towards the achievements of modern science, being inclined to regard any invention intended to lighten their labours as being nothing but a new-fangled notion. I am all the more astounded, therefore, at an instance brought to my notice of super-modernity on the part of one of them.

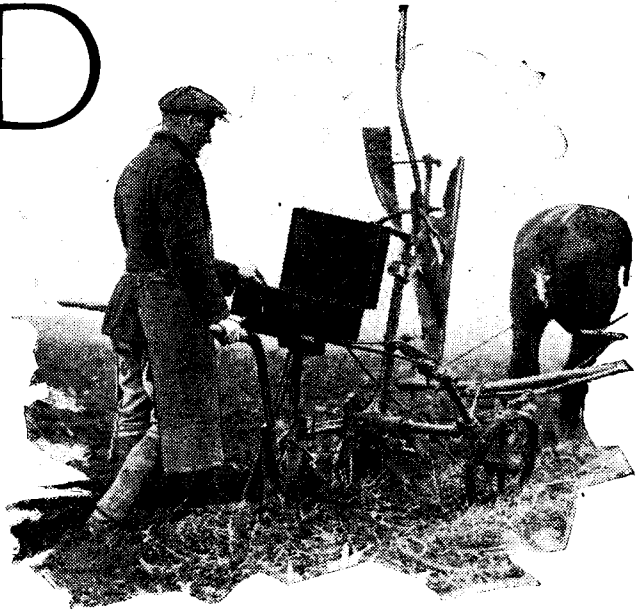

All went well at first, but . . .

This is nothing less than the harnessing of the B.B.C. programmes to the plough, not, however, for the purpose of whiling away the tedium of the weary ploughman's homeward plodding, but to help him to plough a straight furrow.

The farmer being a man of distinctly scientific bent had found out that the nearest B.B.C. station was situated at right angles to the direction in which he intended to plough a large field. Taking advantage of this fact, he rigged up a portable set on the plough in the manner illustrated in the photograph so that when the plough was keeping a straight furrow no sound came from the loud speaker. Immediately the slightest deviation occurred, however, the programme was heard owing to the frame aerial being moved from its "minimum" signal strength position. This plan worked admirably, for the minimum is, as my readers know, very well defined in a properly designed frame aerial receiver. It has even been suggested that advantage should be taken in fine weather to continue ploughing even in darkness through the night!

Propaganda Perverts Ploughman

Alas for the farmer's hopes, however. He had reckoned without human nature, that rock on which so many good inventions have been wrecked. All went well at first and, indeed, all might still have been going well had not the ploughman developed an unnatural taste for uplift and other pernicious propaganda poured out by the B.B.C. The effect on the straightness of the furrows was disastrous, with the result that the farmer has been compelled to have his field ploughed in a direction at right angles to that in which he desired it done. Results are nowhere near so good, however, for naturally the position of "maximum" signal strength is not nearly so well defined as the minimum. Burns, in almost identical circumstances, remarked that the best laid plans of mice and men often miscarry.

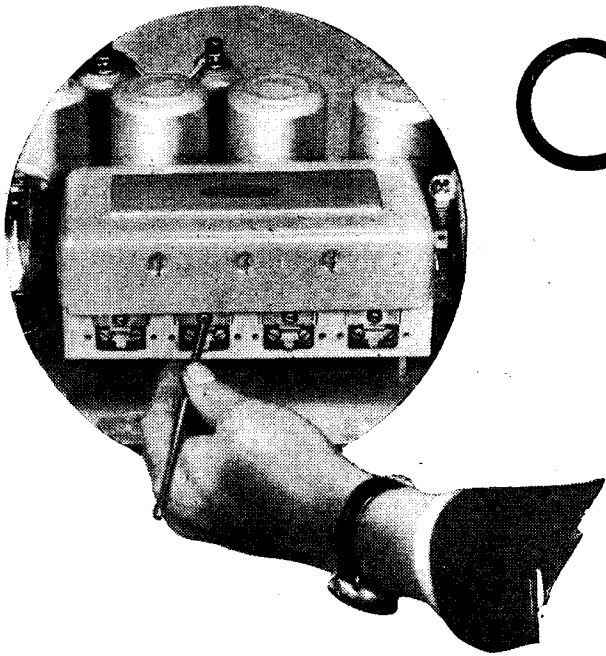

GANGING— Is It Worth While?

Some Facts About Single Control Tuning

It is often forgotten that the attainment of a single tuning control usually means some loss of efficiency. The factors involved are discussed in detail in this article, and the price which must be paid for convenience in tuning is shown to be worth while except in unusual circumstances

GANGING has for so long been customary that the designer of a receiver is apt to take it for granted that a set must only have one tuning control. He may, therefore, in automatically obeying a law which has no technical justification, produce a receiver which is less efficient than its specification would lead one to believe. In general, it may be taken for granted that the average receiver with ganged tuning gives an inferior performance to that obtainable from a similar set having separate tuning controls, *provided that the latter are always correctly tuned.* A set with more than one control naturally requires a more skilful operator than one with ganged tuning, so that we must always bear in mind the possibility of the latter, although inherently the poorer, actually giving the better results in the hands of the average listener.

Even if one arrives at the conclusion that the present practice is the best, taking all points into consideration, it is as well to review the conditions obtaining, for it clarifies one's ideas and may enable one to see cases where a departure from orthodoxy would be beneficial.

The Straight Set

Let us, therefore, consider first the case of the straight set. For maximum sensitivity and selectivity it is necessary that all the tuned circuits should be resonant at the same frequency. If all the circuits are tuned by separate controls there is no difficulty in this, for each is adjusted for maximum signal strength. The only practical difficulty is that the station required may not be audible until the circuits are nearly in tune; although it may be easy to tune in a station when once it is heard, it is sometimes difficult for the

inexperienced to find the station at all.

In a single control receiver the variable condensers are mechanically linked together. The results, however, can only equal those of a set with separate controls if at every dial setting the total capacity in any one circuit is exactly equal to that in every other circuit, and the inductances in all the circuits are identical. In practice this cannot be the case, and it may be taken for granted that in a ganged set no two circuits are exactly in tune with one another except at the particular frequency at which the ganging was adjusted. Both the sensitivity and selectivity, therefore, are below the standard which one would expect from a knowledge of the circuit constants. It is, consequently, important to know how much the performance is affected by the inevitable mistuning.

The best coils are now matched to within plus or minus 0.25 per cent., but gang condensers are rarely matched more accurately than 0.5 per cent. If we accept these as the maximum errors, they will affect the resonant frequency of the circuits by 0.38 per cent., which means that if one circuit be tuned to 1,000 kc/s (300 metres), another may be tuned to 996.2 kc/s; it may be mistuned by 3.8 kc/s.

At different frequencies the number of kilocycles by which the circuits are mistuned varies, but since the selectivity varies also, the effect at any frequency of a given percentage mistuning is very similar. We can, therefore, confine ourselves to 1,000 kc/s. It can be seen that one circuit may be tuned about 3.8 kc/s lower than 1,000 kc/s, while another may be tuned 3.8 kc/s higher, and a third circuit anywhere between the limits. These figures are deviations from the correct frequency, but the difference between any two circuits may be twice as great, or 7.6 kc/s—nearly one channel. Thus, while

one circuit of a ganged set may be tuned to the wanted signal, another may be more nearly tuned to a station on an adjacent channel.

These brief calculations have only taken into account the errors in the coils and condensers and represent the permissible errors with present-day good quality components. When they are connected into a receiver, however, the discrepancies may be greatly increased, for there are many factors which can affect the effective inductance and capacity of a circuit in a manner which is not constant with frequency. Taking 1,000 kc/s as a basis, it may be expected that two or three circuits will tune within about 2 kc/s off this frequency, but that one may be off-tune by as much as a whole channel!

Now the effect of this mistuning depends upon the selectivity of each individual circuit. If the circuits are of high resistance, detuning one by 2 kc/s will have very little effect upon the sensitivity or the selectivity, but if a highly efficient type of coil be used in such a way that its selective properties are retained, this degree of mistuning may easily reduce the sensitivity and selectivity to one-fifth of the maximum possible, or even more.

The Superheterodyne

However carefully a receiver may be designed and constructed, completely accurate ganging is hardly possible to-day. If we are content to suffer the present discrepancies we find that they become of increasing importance as the selectivity of the individual circuits increases, or, to put it in another way, they will prevent us from obtaining much gain from improvements in the individual circuits.

Turning now to the superheterodyne, the IF amplifier, in which nearly all the adjacent channel selectivity is obtained, need not concern us, for it is adjusted once and for all and no questions of ganging enter. As regards the signal-frequency circuits, the problem is identical with that of the straight set, and the ganging of the oscillator is the only fresh matter. If a shaped-plate type of gang condenser be used, ganging can be theoretically perfect over one waveband, but in practice there are the usual discrepancies due to imperfections in components, and these cause errors of the same magnitude as those found in a straight set. If tracking of the oscillator be secured through the use of a padding condenser, and in any case it must be on the long waveband, the errors are increased.

Ganging—Is It Worth While?

In general the ganging in a superheterodyne is not as accurate as that in a straight set, but in spite of this the bad effects are less noticeable. The sensitivity of a superheterodyne is usually so high that the loss of amplification due to ganging errors is negligible, and as the selectivity for the adjacent channels is obtained almost entirely in the IF amplifier, it is hardly affected. Misganging does affect the performance of a superheterodyne very greatly, however, when it is used near a local station. The liability to second-channel interference is greatly increased, and early valves may be overloaded and generate harmonics which can cause whistles in serious proportions.

It will be seen, therefore, that the performance of a receiver is always adversely affected when ganging is used to obtain single control tuning; in the case of a straight set the sensitivity and selectivity are both affected, whereas in a superheterodyne the chief effect is the production of whistles.

It will be clear, therefore, that a ganged receiver has no technical advantage whatever over one with a separate tuning control for each circuit. In fact, the process

If no limit be placed on cost, then it is quite possible to produce a ganged receiver having as good a performance as a simpler set with separate controls, but the price to be paid for the single control is then to be measured in pounds, shillings and pence.

To Gang or Not to Gang?

The question asked by the title of this article is obviously one of some difficulty. Three factors are involved—technique, operation and cost. From the point of view of performance there is no justification for ganging, but from the standpoint of operation it is undoubtedly a great asset. As regards cost, the increase consequent upon the use of ganging will depend very largely upon the degree to which we permit the linking of the controls to affect the performance. If we decide to gang we can compromise between efficiency and cost, and say that we are willing to pay more for a set with only a single control and to put up with a slightly lower standard of selectivity and sensitivity than would be necessary with a set fitted with separate tuning controls. This is probably the best course.

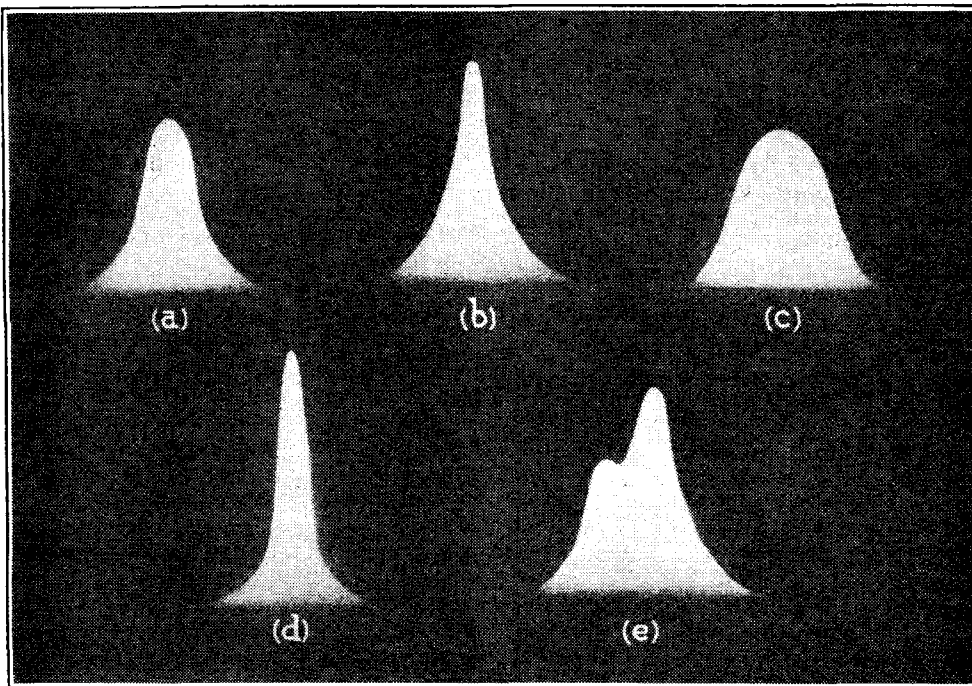

The resonance curves of the individual stages of a receiver may take the form shown by (a), (b), or (c). Where each stage is separately tuned the overall resonance curve is sharp and similar to (d), but where ganged tuning is employed the curve may be less sharp and have a hump in the side as shown at (e). This naturally means not only lower sensitivity but reduced selectivity.

of adjusting the ganging of a set by means of the trimmers is usually the same as that of tuning an unganged receiver. We can thus find no technical justification for ganging, and the reason for its widespread use is solely that of convenience, for it is undoubtedly easier to tune a set which has only a single control than one which has several. The price which must be paid for this simplified operation is a loss of sensitivity and selectivity in a straight set, or a greater tendency to whistle production in a superheterodyne, if the cost of the receivers is to remain comparative.

It may appear to many that the penalties attached to ganging are very severe, and that it is consequently a serious disadvantage, but we have not yet considered the practical question of operating a receiver. The operation of a set with a single control can hardly be simplified, but there is real difficulty in tuning a set with several controls if these are at all critical, and if they are not, ganging would introduce little loss. There is little doubt that if a set has three or more *critical* controls a high degree of skill is necessary for its proper operation. Such a receiver

would be quite unsuitable for general broadcasting reception where it may be desired to listen to half a dozen or more stations in the course of an evening. The question of two controls is rather different, for since most people have two hands it is not difficult to tune such a receiver, even if both controls are critical in their settings.

Confining ourselves to straight sets and superheterodynes, we can see that ganging is an essential, however much loss it may introduce, unless we can keep the controls down to two only. In general, however, modern receivers have more than two variably tuned circuits, so that some form of ganging is always needed; but if some of the circuits must be ganged, we might as well gang them all, for the benefits to be derived from tuning one of them separately are likely to be very small. We can thus conclude that in spite of its technical disadvantages ganging is very necessary.

Single-Span Tuning

It may be remarked that there is a type of receiver which cuts at the root of the trouble by requiring only a single variably tuned circuit, so that single control tuning can be obtained without ganging. This is the modification of the superheterodyne introduced by *The Wireless World*¹ and known as single-span tuning. With this system only the oscillator circuit is varied for tuning, and there are no signal-frequency tuned circuits, so only a single variable condenser is needed.

It will be apparent that whatever type of receiver is used there will normally be only a single tuning control, for the addition of one extra control does not usually give any great advantage, and the use of still more controls would make the set too difficult to operate. It can be seen, however, that if in special cases the addition of a second control would prove beneficial, there is really no objection to it, for the difficulties of operation would not be greatly increased. A case in point is the use of a frame aerial. To be reasonably efficient such an aerial must be tuned, and it is difficult to gang its variable condenser with the others on account of its high self-capacity. The frame aerial, therefore, really demands an extra tuning control. It is not much used at present, but is likely to become increasingly important in the future, since its directional properties provide the only known means of eliminating certain types of interference, such as sideband splash.

¹ *The Wireless World*, March 23rd, and 30th, and April 6th, 1934.

RADIO IN ITALY

ACCORDING to the Italian correspondent of *The Electrician*, imports of wireless receivers and accessories into Italy are at a standstill owing to the high duties and to the recent ban on the import of valves. A seven-valve receiver imported from America now costs 2,250 lire, while a set wired in Italy with Italian components to the same American circuit costs only 990 lire.

Local Conditions

By "CATHODE RAY"

HOW often I am asked what is the *best* wireless set! It is an irritating question. Such a lot depends on the financial resources of the questioner, and the sort of performance he is interested in. The same applies to many other commodities—gramophones, for instance. But whereas a gramophone, fed with a given record and needle, gives identical results whether it is played on a stall in Petticoat Lane or in an African witch-doctor's hut, a wireless receiver may perform very differently at opposite ends of the same street. That is an exceptional example; but experience shows that it is quite difficult to convince many people even that results vary enormously according to situation within the British Isles.

When results are bad, "local conditions" are an excuse so often pleaded by demonstrators that it has reached the low standard of authenticity proverbially ascribed to the cry of "Wolf!" But while there is reason for being sceptical about it, unfortunately it is very often quite true.

It is rather like "Atmospherics." That is an expression the public has got hold of. Every spurious noise—sometimes even shortcomings in the rendering of the programme—is held due to atmospherics. But, of course, occasionally there *are* atmospherics. And when they do appear

they are apt to be present with no uncertain sound.

But to return to local conditions. Their influence is completely mysterious to the lay mind. That is not in the least surprising. Even the local "expert" is generally incapable of giving a convincing explanation of them. He just repeats the same expression in other words. *Obscurum per obscurius*. Which does not help the plain man to believe in the reality of such vague influences.

In Other Fields

Doubtless, when people first made tea at high altitudes they commented on the unsatisfactoriness of the drink; but in the absence of a more logical explanation, put it down to the weather or the strain of climbing the mountain, or perhaps wondered whether it was only imagination. Science dispelled any such doubts by pointing out that the temperature of boiling water bears a definite relationship to barometric pressure, and hence to altitude above sea-level.

The vagaries of wireless reception sometimes seem hopelessly inconsequent; but most of the effects can now be understood, and a good many of them predicted. There are still enough unpredictable ones to make it unsafe to declare that the X.Y.Z. Co.'s Model TQ415P/9OK will

Why Receiver Performance Can Seldom Be Predicted

receive Cologne at good strength free of interference from North Regional at a certain address, without actually trying it there. Neither, of course, does the successful issue of such test guarantee that it can be repeated on another occasion.

Some of the influences that govern reception need no detailed explanation. The story occurs to me of the amateur who claimed to be able to receive every station in the world at full volume on his two-valve set. When challenged to substantiate this sensational claim he admitted that it might be necessary to take the set to the vicinity of the stations! A receiver with only moderate selectivity is not likely to get Cologne clearly in Huddersfield—a few miles from the North Regional aerials. But on the Rhine—or even on the South Coast of England—it stands a much better chance of doing so.

Keen hearing is not of much help in making out a whisper from the other end of the room if somebody is bawling in one's ear. And if a receiver fails to give a good selection of Continental programmes it may not be for any lack of range; it may be due to the listener's address being Brookmans Park. In the North of Scotland, on the other hand, a fair amount of range is essential, because there are hardly any stations within a radius of several hundred miles. Selectivity is much less vital, because there is no one station to swamp reception.

Night Effect

All this is elementary (my dear Watson). There are other, and less obvious, influences. People who buy sets in the winter—and most of them do—are apt to register concern at about the date that Daylight Saving begins. During the dark evenings they have been unconsciously taking advantage of the "whispering gallery" effect produced by the reflecting layers in the upper atmosphere, and have not realised that when the sun is up this reflector softly and silently vanishes away. And those who buy in the summer complain of the scandalous increase in the power of stations that comes with the autumn, whereby they cannot get a single programme unaccompanied by others.

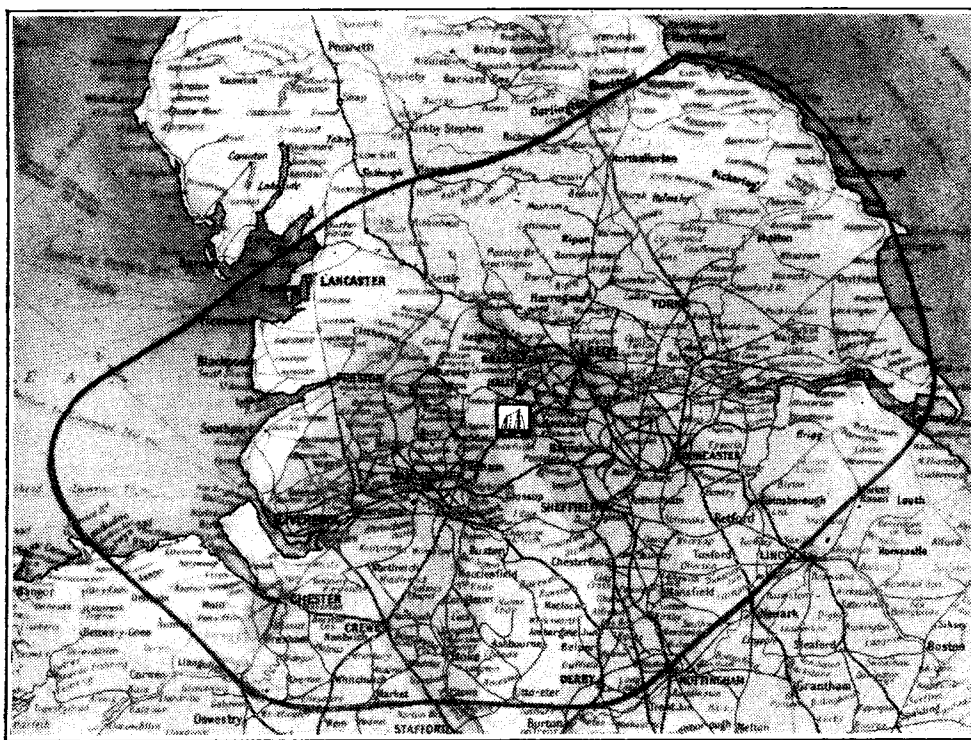

Irregularities of reception around a broadcasting station; the "contour line" passes through points at which signals of equal strength (5 mV. per metre) are receivable from North Regional. How much simpler it would be if intensity were dependent on distance alone!

Local Conditions—

But all that, too, although dependent on recondit scientific phenomena, is becoming common knowledge.

At one time in the history of the London transmitters, so it appeared, reception of the National was satisfactory "on simple types of receiver" (to use the B.B.C. formula) at one end of a certain street and decidedly unsatisfactory on the same type of receiver at the other end. The Regional was good at both ends.

Such effects as this, though not often so pronounced, are quite common. Broadcasting authorities usually make "contour maps" of the areas around their stations, with lines joining up all places getting equal strength. Instead of being perfect circles at increasing radii from the station, these lines are as irregular as geographical contour lines. And they are not wholly unconnected with them, for hills cast radio shadows, and strongest reception is not to be expected at the foot of a deep valley. South Wales suffers badly in this respect. So does Scotland.

But even over a more or less flat city the distribution is irregular. Buildings and large metal structures reflect or

absorb; and the shorter the wavelengths the worse these effects. That is why in South London the National programme is the weaker, although in North London it is, if anything, the stronger. But it is quite impossible to predict the location of "dead spots" with any degree of assurance. Geological characteristics such as metallic deposits may help or hinder.

Town situations suffer in several

respects besides absorption. "Noise" (in the wireless sense) is a town-bred nuisance for the most part. And good aeri- als are generally far less easy to contrive than in the freedom of the country. Most people do not realise how inferior a town indoor aerial is.

All this constitutes one of the strongest reasons why the performance of receivers should be expressed in definite figures, which are entirely independent of local conditions. Technical fellahs already give themselves the benefit of this. Perhaps some day the great general public will also.

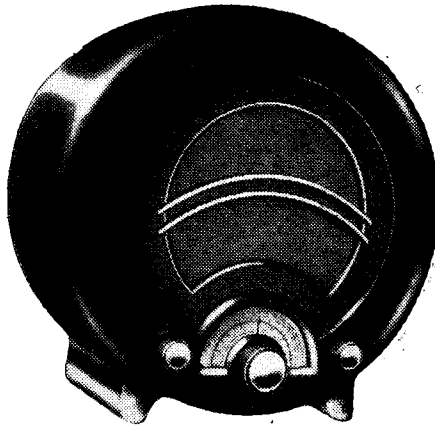

Ekco Model AD36 receiver.

CIRCULAR SET : STRAIGHT CIRCUIT

THE new Ekco model AD36 is similar in external appearance to the well-known universal superheterodyne, and is also interchangeable for AC or DC mains. A "straight" HF-det.-LF circuit is employed with an interesting arrangement which is designed to give constant selectivity and sensitivity at all wavelengths. In a plain walnut-style bakelite case, the price is 8 guineas, while ros. 6d. extra is charged for a black and chromium finish.

Radio Data Charts

THE DECIBEL By R. T. BEATTY, M.A., B.E., D.Sc.

UNDER the title "Radio Data Charts" "The Wireless World" has already published a large number of valuable Abacs designed to facilitate wireless calculations. The series formerly appearing in "The Wireless World" has been produced in book form and has already run into several editions. With "The Decibel" we commence a further series of Data Charts intended to supplement those already published or extend their range.

THE human ear is capable of dealing with sounds over an enormous range of intensity. Thus, if we take as our unit the faintest intensity which is just audible under the best possible conditions for listening—for example, one's own heart beating in a silence chamber so well insulated from the outside world that no whisper of sound penetrates into it—then we find that in a very noisy situation, say the vicinity of an aeroplane engine or an engineering

shop where boiler plates are being hammered, the intensity may be a million million times as great.

Sound.	Intensity Ratio.	Intensity Level in	
		Bels.	Decibels.
Faintest audible sound ..	10 ⁻⁵	5 bels down	50 down
Rustling leaves ..	10 ⁻⁴	4 bels down	40 down
Soft whisper ..	10 ⁻³	3 bels down	30 down
Quiet street ..	10 ⁻²	2 bels down	20 down
Conversational voice ..	1	zero	zero
Lion roaring ..	10 ⁴	4 bels up	40 up
Loud motor horn ..	10 ⁵	5 bels up	50 up
Limit of ear's endurance ..	10 ⁹	9 bels up	90 up

These large numbers are awkward to write down and difficult to comprehend. Moreover, they are quite unsuitable for expressing a scale of sensations produced by a range of intensities. We are well aware that the sensation of loudness is by no means proportional to the intensity of a sound as measured by a physical instrument. Ten typewriters do not sound ten times as loud as one typewriter: they

sound about twice as loud. During a concert the range of intensity may vary over a ratio of a million to one, but our ears do not tell us that the difference between *p.p.* and *f.f.* is anything like so great as that.

In fact, the arithmetic which we inherit from the traders of Sumeria, who lived on the banks of the Tigris 100,000 years ago, and devised a system of bookkeeping to record their buyings and sellings, is not a good notation for expressing power or intensity ratios in radio work.

Bels and Decibels

So a new notation has been devised. In this notation a ratio of 10 to 1 is called 1, a ratio of 10² to 1 is 2, a ratio of 10⁶ to 1 is 6, and so on. The new unit is called the bel and is neither more nor less than the common logarithm of the ratio.

The table will make the matter clear. Since it is only ratios that matter on the new scale, let us take in column 2 the in-

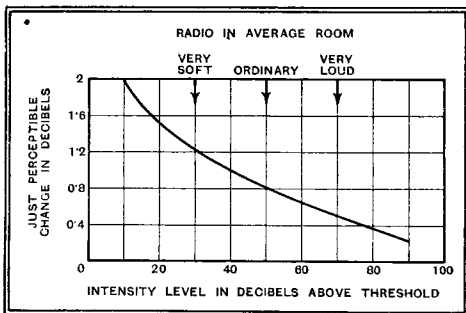

Fig. 1.—This curve illustrates the minimum detectable change in volume for a wide range of sound levels.

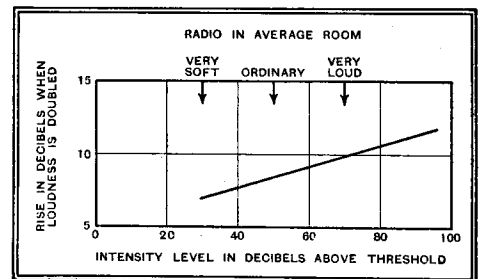
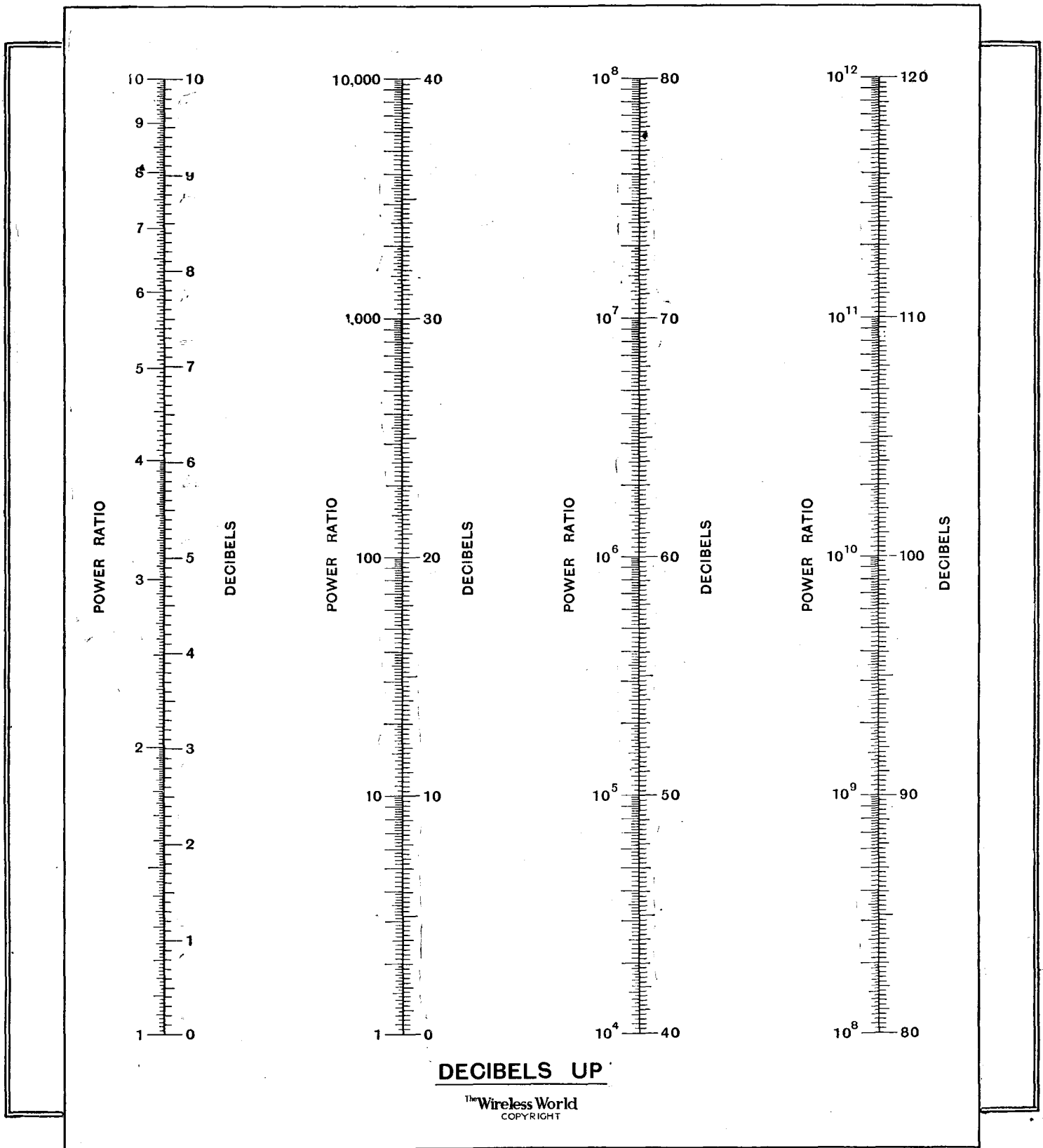

Fig. 2.—The change in intensity necessary to produce an apparent doubling of the volume is shown here.

CONVERSION SCALES FOR RATIOS GREATER THAN UNITY



tensity of the conversational voice as unity and insert the corresponding intensity ratios for the other sounds. Column 3 then shows the corresponding scale in bels: the level rises by one bel every time the intensity becomes ten times as great. By subdividing the scale of bels into tenths we get the scale of decibels, which is convenient for small changes in level such as occur when the output of a good speaker is plotted at various frequencies.

The two abacs allow power or intensity ratios to be translated into changes of level in decibels, and vice versa.

Examples

Fig. 1 shows that at ordinary loud speaker strength a change of 0.8 decibel is just detectable. Reference to the abacs shows that this corresponds to a change in intensity from 1 to 1.2 for a rise, or from 1 to 0.833 for a fall. Again, Fig. 2 shows

that at ordinary strength the loudness sounds twice as great when the level rises by 8.5 decibels, which the abac shows to be equivalent to increasing the intensity 7.08 times.

There are two important facts to be emphasised:—

- (a) *Decibels deal with power or intensity ratios only.*
- (b) *We can put the zero of the decibel scale where we please.*

CONVERSION SCALES FOR RATIOS LESS THAN UNITY

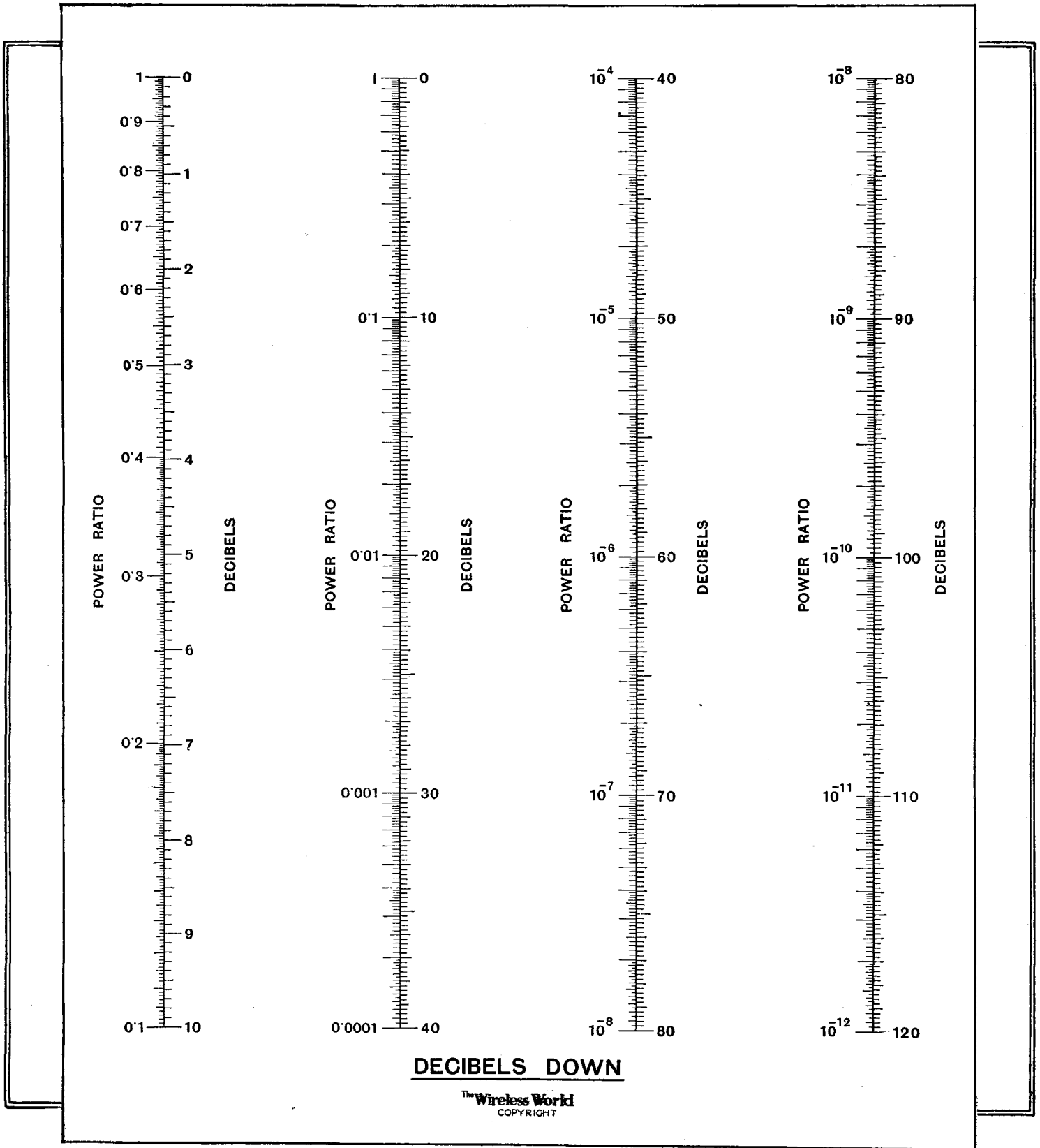

Voltage Ratios

We must be careful not to use decibels to express voltage ratios, but since output power is proportional to square of input voltage there is a relation between signal strength ratio and output power level. Thus, in a perfectly linear set, when the signal strength in millivolts per metre is made tenfold the output power is a

hundredfold, i.e., the power level rises by 20 decibels. Hence the abacs can be used for signal strength ratios by multiplying the corresponding decibel figure by 2, but it must be clearly remembered that the decibels so obtained refer to the level of output power.

By improving the tuned circuit which follows the H.F. valve the voltage signal delivered to the grid of the power valve

becomes nine times as great. What is the rise in power level of the output circuit?

The number on the right-hand scale corresponding to 9 on the left-hand scale is 9.54: this must be multiplied by 2 to give the power level. Hence the power level in the output circuit rises by $2 \times 9.54 = 19.08$ decibels, and the left-hand scale shows that the power is 81 times as great as before.

Listeners' Guide

Outstanding Broadcasts at



AT THE BOAR'S HEAD. George Robey as Falstaff, the rôle he plays before the microphone this evening with Lady Tree (Mistress Quickly) and Patrick Waddington (Prince Hal).

grammes. At 7.15 all German stations will give a Bach programme, and at 8.15 Leipzig and Frankfurt will broadcast a special service at the Bach grave in Leipzig.

At the same time Hamburg will offer Bach's more popular music in a programme also containing folk songs.

In Kalundborg's twenty-third Thursday concert at 7.10 Bach's Concerto in C for three pianofortes and orchestra will be played, the soloists being France Ellegaard, Folmer Jensen and Ove Petters.

GEORGE ROBEY AS FALSTAFF

GEORGE ROBEY as the roistering Sir John Falstaff has been the talk of the town for the last fortnight. This evening (March 15th) in the "From the London Theatre" series, the tavern scene at the Boar's Head from the production of "Henry IV" at His Majesty's Theatre, will be broadcast (Regional, 7.30). Among those who will be heard in the studio are George Robey as Falstaff,

TROISE AND HIS MANDOLIERS, who are now regular broadcasters. Their next appearance at the microphone is on Sunday next (Regional, 6.15) when their programme will include selections from Schubert, Mendelssohn, Delibes and Grieg.

Lady Tree as Mistress Quickly, and Patrick Waddington as Prince Hal.

MOSCOW OPERA WITH ENGLISH COMMENTARY

LISTENERS to Moscow at 4.30 p.m. on Sunday next will hear a broadcast of opera from the Bolshoi Theatre, with a commentary in English. The transmission is on 17.64 and 50 metres simultaneously.

RALEGH'S LAST VOYAGE

How Sir Walter Raleigh was released from the Tower by James I to rediscover gold in South America, how Raleigh failed and, returning to England, was executed by a grateful king, will be told in "The Last Voyage," a radio play by Edward and Theodosia Thompson, to be broadcast on Thursday next, March 21st (Regional, 8). Milton Rosmer will take the part of Sir Walter Raleigh; Nesta Sawyer, Lady Raleigh; Ralph Truman, Lord Chief Justice; and Hubert Leslie, James I.

Howard Rose, the producer, will not use music except as a final curtain. The play will be performed in four studios, and the various episodes will be linked by a "chronicler."

SCOTLAND v. ENGLAND RUGGER

TO-MORROW (Saturday) (National, 3.5) Capt. H. B. T. Wakelam travels up to Murrayfield, Edinburgh, to describe the Scotland v. England Rugby match.

FOR WALTZ LOVERS

It should be difficult not to achieve a hit with Mark Lubbock's "Birth of the Waltz"—a musical feature to be broadcast on Thursday, March 21st (National, 8). This dramatic *pot pourri* has been devised and arranged by G. Walter. The singers will be Nora Gruhn and Michael Cole, and the cast includes Ann Codrington as "an old lady"; Cathleen Cordell as "a young girl"; and Barry Ferguson as "a young man." Henry

30-LINE TELEVISION

Baird Process Transmissions
Vision, 261.1 m.; Sound, 296.2 m.

SATURDAY, MARCH 16th
4.30-5.15.

Derra de Moroda (national dances); Eby Namash (songs); Kenneth Froy (songs and dances); George Lane (songs); Josephine Bradley and Frank Ford (ballroom dances); Sydney Jerome's Quintet.

WEDNESDAY, MARCH 20th
11-11.45.

Lydia Sokolova (ballet); Maria Sandra (soprano); Harold Turner (dances); Gavin Gordon (bass-baritone).

Bronkhurst, who will be at the pianoforte, will be supported by Mantovani and his Tipica Orchestra.

STRONG BEER

A CONVIVIAL programme comes from Munich and Frankfurt at 8 p.m. on Monday in a feature called "Cellar Music." A brass band provides the music, while a number of thirsty souls engage in conversation at a beer table. March 18th happens to be St. Joseph's Day, when Munich starts its strong beer season.

ON THE CONTINENT

THROUGHOUT Germany there will be commemorative pro-



or the Week

Home and Abroad

NELSON KEYS IN THE MARCH REVUE

THE late-night revues seem to have filled an immediate want, for the majority of critics are unstinting in their praise. Nelson Keys will again be the life of the party when the March Revue is broadcast on Tuesday next (National, 10.15). Again Jack Strachey will provide most of the music, though there will be additional numbers by various composers.

HIGH SPIRITS IN VIENNA

VIENNA comes to London on Monday evening, when a special concert will be relayed from the Austrian capital at 8.15 (Regional). This will be an "Entertainment Hour" in the best Viennese tradition,



THE SPIRIT OF VIENNA comes to British listeners in a special relay on Monday (Regional, 8.15). Joseph Holzer and the Vienna Wireless Symphony Orchestra take part in an "Entertainment Hour" which should build up pictures of the most romantic city in Europe.

with Joseph Holzer conducting the Vienna Wireless Symphony Orchestra.

It should be possible to conjure up visions of those little beer gardens under the trees.

ENGLISH IN THE TRAIN

"STANDARD ENGLISH" has been chosen for discussion in to-morrow's "Conversation in the Train" (Regional, 9.10). The cause will be championed by one who is well known to listeners, and other characters in the railway compartment

will be an American visitor to England and an English countryman speaking in dialect. Some listeners may guess the identity of the cast during the journey; there will be no doubt in their minds when the travellers reach Town.

OPERA AND OPERETTA

THIS is a good week for opera and operetta. To-night (Friday) Vienna relays Giordano's five-act opera, "André Chenier," from the State Opera House at 6.25. To-morrow, at 7.15, Lehár's operetta, "Gypsy Love," will be relayed from Geneva by Söttens, and on the same evening Radio-Paris provides an operatic concert with Lecocq's "Gandolfo," followed by



A CONTEMPORARY PORTRAIT of J. S. Bach, whose 250th anniversary on Thursday next is being celebrated in many of the European broadcasting programmes.

National Orchestra will play in a concert from Radio-Paris between 8.45 and 10.30 on Thursday next, March 21st. The same authority states that the music of this symphony "is of such power and audacity that it disconcerted many of the composer's friends, but finally won their applause as a masterpiece." The programme also includes Mozart's Divertissement No. 7 in D.

SCHUBERT IN SPAIN

To pick up Schubert's "Unfinished Symphony" from a Madrid cinema should be a romantic experience. Madrid EAJ7 broadcasts a concert from the Capitol cinema to-morrow evening between 6.30 and 9 p.m., and the programme includes, besides the "Unfinished," three dances from Falla's "The Three-cornered Hat."

The "Unfinished" can be heard again later in the evening at about 10.15, when it will be played by the San Sebastian Symphony Orchestra.

SOUND OF REVELRY BY NIGHT

A GALA programme of folk music comes from Brussels No. 1 to-morrow evening (Saturday) from 8 o'clock to midnight. The ball takes place in the Palais des Beaux Arts, from which the B.B.C. Orchestra recently broadcast.

THE AUDITOR.

HIGHLIGHTS OF THE WEEK

FRIDAY, MARCH 15th.
Nat., 7.30, Violin Recital by Bratza.
8, B.B.C. Orchestra (D). 9.
"I've Got to Have Music."
Reg., 7.30, George Robey as "Falstaff." 7.50, "The Radio Follies."
8.50, "The Barber of Seville," Act 2 (from Sadler's Wells.)

Abroad.

Leipzig, 8, Symphony No. 5 in B flat (Bruckner).

SATURDAY, MARCH 16th.

Nat., 7, "In Town To-night." 8, "Gale Warning"—an everyday drama in sound. 8.30, "Music Hall." 11, Henry Hall's Guest Night.

Reg., 7.30, B.B.C. Theatre Orchestra. 8.30, Organ Recital by Berkeley Mason. 9.30, Piano-forte Recital by Clifford Curzon.

Abroad.

Paris P.T.T., 5, Pasdeloup Symphony Concert.

SUNDAY, MARCH 17th.

Nat., 1, Squire Celeste Octet. 2.45, B.B.C. Orchestra (C). 5.30, The Lyra Quartet. 7.15, Recital by Moiseiwitsch (piano) and John Coates (tenor). 9, Leslie Jeffries and the Grand Hotel Orchestra, Eastbourne.

Reg., 4.30, Belfast Wireless Orchestra. 5.30, Wireless Military Band. 6.15, Troise and his Mandoliers. 9.20, Sunday Orchestral Concert. Conductor: Sir Henry Wood.

Abroad.

Kalundborg, 8.50, Spanish Themes in French Music.

MONDAY, MARCH 18th.

Nat., 8, "Northern Ireland." 9, Student Songs.

Reg., 7.15, The Gershom Parkington Quintet. 8.15, Entertainment Hour relayed from Vienna. 9, B.B.C. Orchestra (E)

Abroad.

Warsaw, 7, Selections from "The Merry Widow" (Lehar).

TUESDAY, MARCH 19th.

Nat., 8, Wireless Military Band. 8.50, Chopin Recital by Henry Sztompka (piano). 10.15, March Revue.

Reg., 7.15, Fol-de-Rols—the Seaside Summer Show. 8.15, Henry Hall and the B.B.C. Dance Orchestra. 9.15, Fred Hartley and His Novelty Quintet.

Abroad.

Radio-Paris, 8.45, Opera: "La Juive" (Halévy).

WEDNESDAY, MARCH 20th.

Nat., 8, B.B.C. Symphony Concert.

Conductor: Adrian Boult. Soloist: Jascha Heifetz (violin). Reg., 7.15, "The Birth of the Waltz." 8.15, Leslie Bridgewater's Quintet. 9, "Meet Mickey Mouse"—a studio party.

Abroad.

Frankfurt and Stuttgart, 11, Opening Symphony Concert of the Season at Baden-Baden.

THURSDAY, MARCH 21st.

Nat., 8, "The Birth of the Waltz." 9.20, Piano Interlude by Sara Stein. 10.15, "Johann Sebastian Bach."

Reg., 8, "The Last Voyage" 9, B.B.C. Orchestra (E).

Abroad.

Radio-Paris, 8.45, Symphony Concert by the National Orchestra.

New Apparatus Reviewed

Recent Products of the Manufacturers

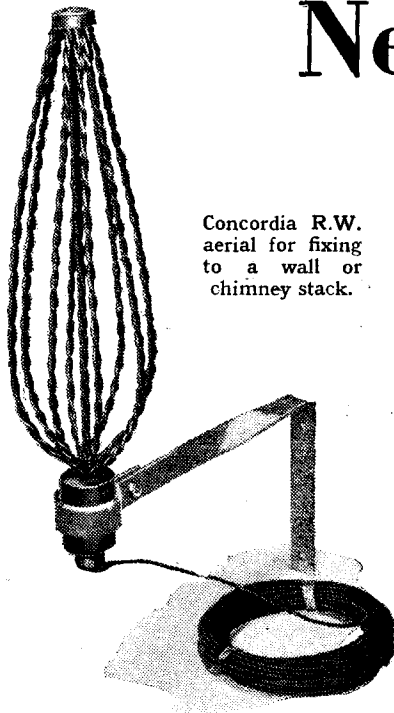

Concordia R.W. aerial for fixing to a wall or chimney stack.

R.W. AERIAL

A NEAT aerial that can be erected with very little trouble in a few minutes has been introduced by the Concordia Electric Wire Co., Ltd., New Sawley, near Nottingham. It consists of a 30ft. length of insulated "Recepticon" lead-in wire attached at the top end to a pear-shaped array of heavy gauge stranded-copper wire. The addition of a top capacity to a vertical aerial has often been advocated as a means of improving the efficiency, so that a slight gain over a plain vertical wire of the same length might reasonably be expected.

The galvanised-iron wall bracket should be fixed to the highest point accessible, such as to a chimney stack, and the down-lead kept as far away from the wall as possible.

This aerial should prove useful to those who wish to dispense with a pole, or possibly have not facilities for erecting a mast, and also to flat dwellers.

Owing to the high sensitivity of modern receivers, all the worth-while broadcast stations can be received on a quite short aerial, and there is less need for the elaborate erections of the past.

The R.W. aerial costs 4s. 9d. complete.

R.C. AND S. STATIC SUPPRESSOR

THE model No. 935 Static Suppressor, made by Richard Cooper and Son (Wolverhampton), Ltd., Atlas Works, Church Lane, Wolverhampton, is a condenser-type filter for use where electrical interference is being caused by domestic apparatus or is



R.C. and S. condenser-type interference filter, model No. 935.

conveyed to the receiver by the supply mains. So far as the first-mentioned is concerned, the unit should be attached to the actual piece of apparatus, whilst for sup-

pressing mains-borne interference the best place to locate it is as near as possible to the point of entry of the electric supply cable.

This suppressor, which is very neat and well made, consists of two 1-mfd. condensers housed in a shallow metal case, measuring 5½ in. x 2½ in. x ¾ in. These are joined to a three-way porcelain connector, the outside sockets being taken to one side of each condenser, and the centre one is common to both. By joining the outer sockets to the mains and the centre to earth, the two capacities are arranged in series across the supply and their junction earthed, which are the usual connections for a filter of this type.

The metal case is isolated from the condensers, and a small terminal is fitted for earthing it. The unit is suitable for either AC or DC supplies, and it will filter out all but the most vicious type of electrical interference; even in very bad cases such a marked improvement can be effected that reception is made tolerable where normally it is well-nigh impossible.

The price is 7s. 6d.

B.T.H. "TRUSPEED-DC" MOTOR

ALTHOUGH designed primarily for use on DC mains, this motor can be run from AC mains with a frequency in the region of 40-50 cycles. It is totally enclosed in a

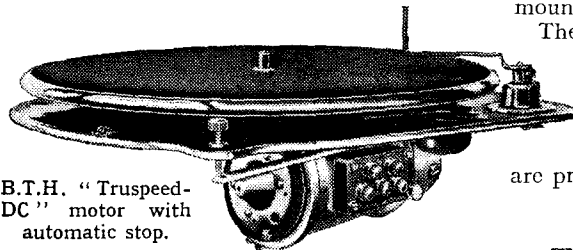

B.T.H. "Truspeed-DC" motor with automatic stop.

die-cast cylindrical body, and is fitted with self-aligning bearings. The speed is adjustable, and the governor is enclosed in the casing to protect it from dust. Pressed-metal end caps protect the commutator and main bearings, and also complete the very effective electrical screening of the unit.

The torque is sufficient to provide an ample reserve of power on loud passages, and the governor is sensitive. Universal motors of this type often develop 50-cycle vibration when used on AC mains, but this was entirely negligible in the case of the "Truspeed-DC," and the silence of running was especially noteworthy. The power consumed is 15 watts, and the motor therefore runs cool over long periods.

The price is £3 7s. 6d., and the makers are the British Thomson-Houston Co., Ltd., Rugby.

BULGIN MAINS RESISTANCE

THE range of mains resistances made by A. F. Bulgin and Co., Ltd., Abbey Road, Barking, Essex, has been extended to include a number of new models for the

Bulgin skeleton mains resistance for 13-volt 0.3 amp. AC/DC valves.

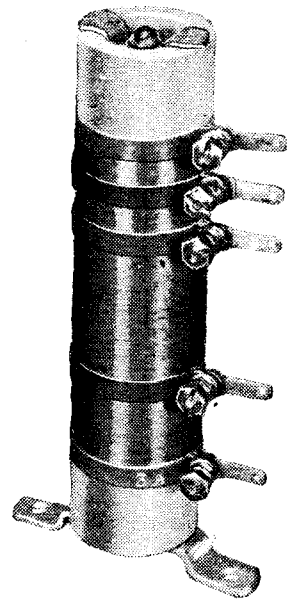

Marconi and Osram 13-volt 0.3 amp. AC/DC valves.

These are made for any number of valves from two to seven, and the resistance of each is adjusted to allow for the inclusion of the rectifier valve which, in this series, requires 26 volts.

The specimen sent in for review is the type MR49 for use with seven valves, one of which would be a mains rectifier, and it has tapings for mains of 100/110, 200/210, 220/230, and 240/250 volts. The asbestos former is fitted with a bracket for mounting in an upright position. The rise in temperature is not excessive, considering the resistance must dissipate about 58 watts, but good ventilation should be provided, as considerable heat is generated.

These new models are made as skeleton types, as illustrated, or assembled in a protecting case of frosted aluminium; the latter style would be used where the resistance is mounted outside the cabinet.

They cost 3s. 6d. each for the skeleton pattern, and 8s. 6d. each enclosed. There is a Universal model that is tapped for any number of valves from three to seven, and the price is 15s. Only the skeleton types are provided with the 100/110-volt tapping.

THE RADIO INDUSTRY

REFERRING to our article "Tone-Compensated Volume Control" (*The Wireless World*, February 15th, 1935), A. F. Bulgin & Co., Ltd., of Abbey Road, Barking, Essex, tell us that they are now supplying the specified 0.05-henry inductances at the price of 2s. each.

The same firm will shortly be producing complete tone-compensated units for use with ordinary volume controls.

◆ ◆ ◆ ◆

Ward & Goldstone, Ltd., of Frederick Road, Pendleton, Salford 6, Lancs, have just issued a leaflet dealing with the various anti-interference devices manufactured by the firm.

Screened aerial downleads, impedance-matching devices, heavy duty HF chokes, condenser combinations, etc., are described; attention is drawn to the fact that a free service of technical information on the use of these appliances is available to readers.

◆ ◆ ◆ ◆

Change of address: London Transformer Products, Ltd., late of 368, High Road, Willesden, London, N.W.10, have now moved into a larger factory: L.T.P. Works, Cobbold Road, Willesden, London, N.W.10. The telephone number remains unchanged: Willesden 3568.

MORE ABOUT

Tone-compensated

Volume Control

By S. O. PEARSON, B.Sc., A.M.I.E.E.

How to Modify Existing Receivers

AN article in "The Wireless World" for February 15th, 1935, explained that the ideal volume control should compensate for deficiencies of the human ear by applying relatively less attenuation to the low and high frequencies than to the middle register. Methods of putting this suggestion into practice are now described.

IN the earlier article on tone-compensated volume control it was suggested that the best position in the receiver for the control is immediately preceding the output valve. The reasons for preferring this position are that, placed here, the control is likely to be more silent during adjustment, and comparatively low values of resistance and inductance can be used, a small, compact inductance coil then being possible.

There are no strong objections, however, to incorporating the compensation in the more usual high-resistance potentiometer type of volume control, and these additional notes are given mainly for those wishing to modify existing receivers. The compensating circuits can easily be added at the "earth" end of the existing volume control resistance at the point marked X in Fig. 1 (a). Now, although it was stated in the original article that the degree of compensation, with the given values of L and C, is approximately the same with other resistance values provided their ratios remain the same, this approximation does not hold when the resistances differ widely from the values given.

For the compensation to be strictly the same with other resistance values the inductance and capacity must be changed also. The necessary condition is that, at any one frequency, the inductive and capacitive reactances must be changed in the same proportion as the resistances. Thus, remembering that the coil reactance is proportional to the inductance and the condenser reactance is inversely proportional to the capacity, if each resistance is increased tenfold, then ten times the inductance will be required and one tenth of the capacity.

Typical Circuit Constants

In the original design the most suitable constants were to be $R_1=30,000\Omega$, $R_2=6,000\Omega$, $R=500\Omega$, $L=0.05\text{H}$ and $C=0.5\text{mfd.}$, for the specified conditions. In a receiver to which compensation is to be added, the existing control resistance is retained and made to play the part of R_1 in the modified receiver, so that the overall shunting resistance is kept to the same order of magnitude, besides saving expense and trouble. Suppose, then, that we wish to add com-

pensation to a receiver with a normal type of volume control, as at (a) in Fig. 1, with a potentiometer resistance of 250,000 ohms. The correct procedure is to break the circuit at X and insert a resistance R_2 equal to $\frac{1}{5}$ of the potentiometer resistance, namely 50,000 ohms. R_1 and R_2 are now 8.33 times as great as in the original design, and so in the present instance we must make $R=500 \times 8.33$

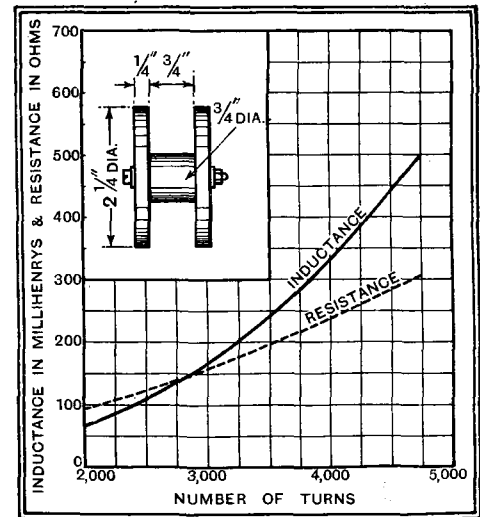

Fig. 2.—Particulars for winding a coil to give any required inductance between 0.066 and 0.5 henry. The curves refer to No. 36 DSC copper wire. The dimensions of the bobbin are given in the inset drawing.

($=4,200\Omega$ approximately), $L=0.05 \times 8.33$ ($=0.42\text{H}$ or 420mH) and $C=0.5 \div 8.33$ ($=0.06\mu\text{F}$, the capacity being varied inversely as the resistances.) The modified circuit is shown at (b).

In the same way the constants can be worked out in simple proportion for any other value of main resistance R_1 . In all cases the product LC must be about 0.025 with L in henrys and C in microfarads.

Winding Data

The new value of L necessitates redesigning the inductance coil, and as this is a matter of some difficulty for those without facilities for measuring inductance, the necessary particulars are given in Fig. 2. The curves give the inductance in millihenrys and resistance in ohms for different numbers of turns of No. 36 DSC copper wire on a $\frac{3}{4}$ in. bobbin, the propor-

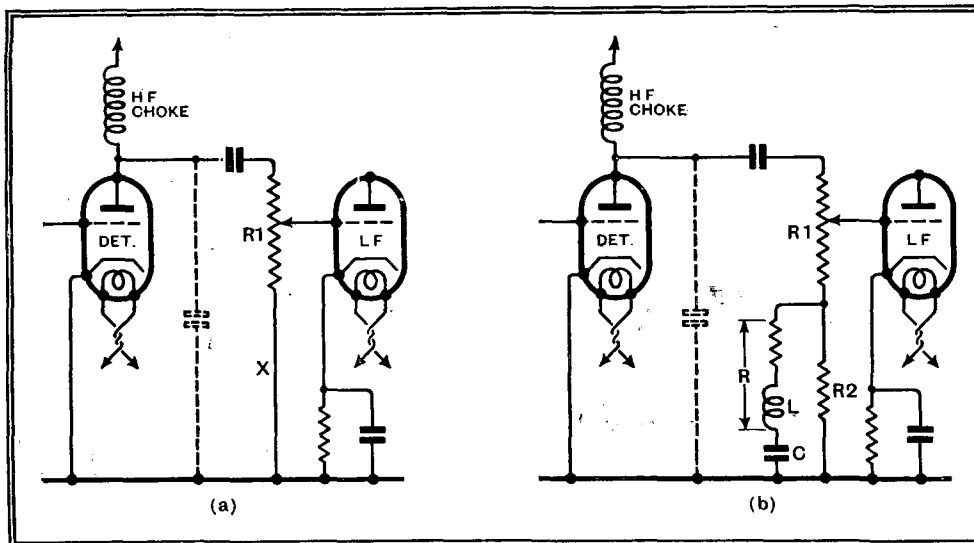

Fig. 1.—Normal type of uncompensated volume control, and (dia. b) the modified circuit. The values of R , R_2 , L and C must be chosen according to the value of R_1 .

More About Tone-compensated Volume Control. tions of which are given in the inset drawing of Fig. 2. For the present example we require 420mH and therefore 4,400 turns of wire are needed, wound evenly but not in layers. This gives a resistance 275 ohms, and to make up the necessary 4,200 we must add 3,925 ohms. (It would be quite satisfactory to add 4,000.)

When transformer coupling is employed the figures given in the original

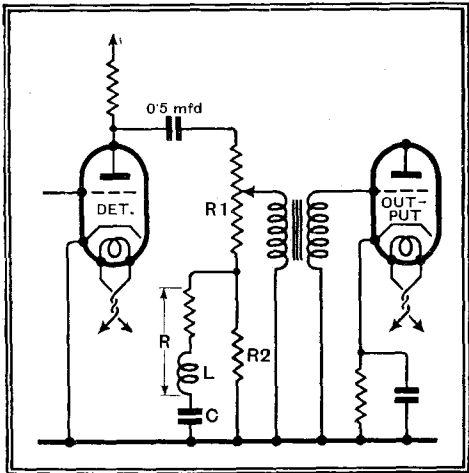

Fig. 3.—Method of connection when LF transformer coupling is used. Parallel feed is essential.

design will, in general, be most suitable. As the actual connections for transformer coupling were not illustrated in the original article they are given here in Fig. 3, in which the anode resistance may be replaced by an LF choke.

In all circumstances, if the compensated control is to be fully effective, it is essential that normal full volume should be obtained when the control is set to maximum, and this condition is met by adjusting the pre-detector volume control as previously explained.

Compensated Gramophone Reproduction

Where the compensated control is to be applied to a gramophone pick-up there is normally nothing to take the part of the pre-detector volume control of the radio receiver. So if the volume is found to be excessive when the compensated control is set to maximum it will be necessary to connect a normal volume control in cascade as in Fig. 4. This is set once and for all to give the necessary maximum volume, and will not interfere with the compensation in any way. On the other hand, the two controls can be operated simultaneously to give ordinary tone correction of deficiencies in the recording, that is, for records in which both treble and bass are weak.

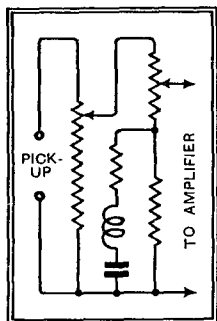

Fig. 4.—Compensated control applied to a gramophone pick-up.

Random Radiations

By "DIALLIST"

Kilowatts and Listeners

THE other day a friend raised a rather interesting point. He had read that in Poland listeners had just touched the 400,000 mark, and this set him thinking. Poland possesses nine broadcasting stations rated at 1 kilowatt or more, and the total power radiated by them is 209.7 kilowatts. This works out at about 1,900 listeners per kilowatt, or roughly half a watt per listener. In Great Britain we have fourteen stations of one kilowatt or more, radiating a total of 604 kilowatts for some 6,800,000 licensed listeners. The proportion in this country is over 11,000 listeners per kilowatt, nearly six times as many as in Poland. My friend argued that, considering the sadly crowded state of the medium and long wavebands, Poland was grossly "over wireless."

At first blush this might seem to be true; but after all it is the area of a country and not the number of its licensed listeners that is the important factor in deciding the number of broadcasting stations required, and the power that must be radiated to ensure an efficient service. Poland's area is over 150,000 square miles; that of our country, under 100,000. So she's certainly not overdoing it in either stations or kilowatts.

Moscow and Paris

If you want to find instances not of countries, but of cities that do seem to be taking more than their fair share of stations you have to turn only to Moscow and Paris. The former has four stations with a total output power of 800 kilowatts; the latter has six with a total of 162.8 kilowatts—and this will shortly be increased by 70 kilowatts when Radio Paris goes up from 80 to 150. Even if we regard the giant Moscow No. 1 and Radio Paris as national rather than local stations, Moscow is still left with three alternative programmes of her very own and Paris with five.

No one can seriously claim that either city really needs such a large variety of broadcast fare. Paris, it is true, has promised to close down the Eiffel Tower, though it is still going strong. Radio LL has long been one of the worst wanderers and the greatest of nuisances on the medium-wave band. Few tears would probably be shed were it to disappear for good and all.

Interference Waning in France

THE French "anti-parasite" law, imposing penalties on all who radiate interference with wireless reception, came into force in October last, and from all accounts it is having good effects. Naturally it has not yet put an end to all unwanted noises, but there is no doubt that interference, particularly in the big cities, is very much less noticeable than it was a year or so ago. I expect that when the listeners' committees that were to be set up in that country get into their stride they will take the strongest possible action to see that the law is enforced.

We still have no legislation, and it is common experience that interference is on the increase in many parts of this country. Our committee appointed to inquire into

the matter has not yet reported, and every day's delay makes things more difficult, for vested interests become more and more firmly established. Had an official warning been issued some time ago pointing out the unwisdom of installing machinery or other apparatus capable of radiating interference, the problem would have been simplified very greatly. As it is, flashing signs, machinery, and domestic appliances of strongly radiating types are being installed here, there and everywhere, and if we wait much longer the business of silencing them may prove too costly to be practicable.

The Post Office Attitude

When they are called in to investigate complaints about interference, the G.P.O.'s officials have to work under serious handicaps. They cannot compel the offender to fit suppressor devices to his apparatus; nor can they fit them free, since there are no funds available. All that they can do is to exercise moral suasion. This comes off in the great majority of cases, but there are many where their attempts to produce a reasonable attitude are just like the proverbial water on a duck's back.

They do their best, and no one could be more obliging or helpful; but they can't work miracles. Many listeners feel aggrieved at the G.P.O.'s attitude towards foreign listening. The position is that the G.P.O. feels that the owner of a set should be satisfied if he can receive the National and Regional programmes reasonably clear of interference; foreign stations, it claims, are altogether outside its purview. Nowadays, when most sets are sensitive and selective enough to bring in a considerable number of foreign stations, the listener's view is that he should be allowed to receive them in peace and quiet. This ideal state of affairs cannot be reached unless and until we have really strong anti-interference legislation.

Newspapers by Radio

AN attempt is to be made in America, I hear, to popularise the reception of still pictures by wireless. It was tried over here some years ago, as readers may recall, but failed to catch on. I was one of the first private owners of a Fultograph, that ingenious apparatus which turned out a very passable picture in about four minutes. The chief reason why it did not achieve popularity was that the pictures sent out were so appallingly dull. Except for one memorable occasion, when pictures of the boat race were radiated within an hour or so of the event, they had usually neither a topical interest nor, so far as one could see, any other!

The American recorder, which is mains operated, works from the extension loud-speaker terminals of any set. It is suggested that those who acquire the new device should leave the set constantly in action, even when they are out of the house. As there is a self-feeding arrangement for the sensitised paper, it will reproduce news pictures, strip cartoons and so on as they are sent out. One remarkable proposal is that there shall be an all night service. You

leave your set at work when you go to bed and in the morning it has waiting for you a "tabloid" newspaper complete with letter-press and illustrations. It could be done right enough, but what would the newspaper people have to say about it? A description of the apparatus appeared in *The Wireless World* some time back.

Non-rustling Paper

THOUGH our announcers are pretty good about turning their pages so carefully that they seldom produce the effect of violent atmospherics from the loud speaker, the same cannot be said of those in some other countries—or, for that matter, of our

own topical talkers. Page-turning before the microphone is something of an art when ordinary paper is used, and talkers who are making their debut in the studio have not always acquired it. I have often wondered why a non-rustling paper has not been produced and made use of, particularly for such things as the news bulletins. What is wanted is something nearly as thick and as soft as a pocket handkerchief. Could not some kind of fine cotton cloth with a specially prepared surface be used? It would, of course, be far more expensive than paper, but probably it could be washed or cleaned and used over and over again. Anyhow, there's the suggestion for what it is worth.

Europe's most reliable stations, is now often hardly worth bothering about.

The French Ministry of Posts and Telegraphs announces that Agen has been officially permitted to change its wavelength from 309.9 to 345.6 metres. Under the Luccrne Plan France is allowed a 20-kilowatt station on the 309.9 wavelength, which is shared with two Russian stations, the 10-kilowatt Odessa and the 2-kilowatt Ukhta. The wavelength of 345.6 metres is allotted to Poznan and to the projected Moroccan station, Marrakesh. Poznan will probably not welcome a wavelength partner geographically so close as Agen, and the B.B.C. may view with mixed feelings the arrival in the channel next to that of the London Regional of a French station. The separation from the London Regional is only 9 kilocycles, so that a small amount of wobbling on the part of Agen may lead to serious heterodyne troubles. Actually, poisonous interference occurred when Agen made its debut on the new wavelength; it must then have been working on a frequency only 2 or 3 kilocycles above that of the London Regional. London Regional has, by the way, another French station as a fairly near neighbour now. Limoges is working on 335.2 metres, 18 kc/s away.

Barcelona EAJR is at present using Lwow's wavelength of 795 kilocycles, and is apparently restraining its wanderings with more success than in the past.

D. EXER.

DISTANT RECEPTION NOTES

BEFORE the end of the year the power of both Brussels No. 1 and Brussels No. II is to be raised to some 75 kilowatts. This is only a temporary measure, for during the next year it will be increased in both cases to 120, or possibly 150 kilowatts. The Brussels stations provide yet another instance of the apparent deterioration of transmitting plants with the passage of time. The falling off is especially marked in the case of Brussels No. 1. With a wavelength of over 500 metres the station was expected to have a large service area when it first came into action some years ago.

broad daylight or after dark. Now Brussels No. 1 is often disappointing even late in the evening. Its signal strength is apt to show remarkable variations, being poor on one evening, fair to moderate on another, and quite first-rate on a third.

In this instance there is no question of the transmissions being drowned by those of powerful neighbours so far as reception in this country is concerned. In daylight so little would be heard of neighbouring stations that there is no need to sacrifice the sensitiveness to selectivity in the receiving set. Brussels No. 1, once one of

Tests showed that the station covered the whole of Belgium (except possibly some of the more hilly parts of the country) in the most satisfactory way. In this country it was splendidly received. One could bring its transmissions at full loud speaker strength at any time when it was working, whether in

"EFFECTS" IN THE MAKING

The B.B.C. Noise Department at Work



These self-explanatory pictures show how real sounds are imitated in radio drama production at Broadcasting House.

Owing to the limitations of broadcasting, manufactured noises often sound more realistic than the genuine article.

Letters to the Editor

The Editor does not hold himself responsible for the opinions of his correspondents

Midland Regional

I NOTICED a letter from a Mr. Nayler in *The Wireless World* of February 22nd referring to the programmes radiated by Midland Regional.

I am wondering whether the change of wavelength and the new transmitter at Droitwich account for the bad quality. For some time now the transmission on 296 metres has been very poor indeed. In daylight the signal is very much weaker than the old transmitter on 391 metres, and after nightfall fading and foreign interference ruin the quality of reception.

I much regret the loss of the Midland Regional transmission, which has always provided such interesting programmes. The B.B.C. might say that London is outside the service area, but why did 391 metres provide such an excellent signal in London?

MARJORIE BROWN.

London, S.W.2.

I NOTE that Mr. Nayler, writing in your issue of February 22nd, queries the quality of the respective "mikes" at the London and Midland studios.

It is probably not so much the "mike" as the input to the transmitter. The superior quality emanating from London upon the occasion of a relay to the Midland transmitter might be attributed to the line output, the characteristics of which are better balanced.

A matter concerning the Midland Regional station which affects listeners in the London area is the deterioration of these transmissions since the wavelength has been altered to 296.2 metres. The fading at night is of the $\frac{4}{2}$ second variety, upon which appears to be superimposed a secondary fading cycle accompanied with severe distortion, of about 15/20 seconds. It is deplorable that a station that has in the past provided such an excellent alternative at times to the London programme should be now rendered *hors de combat*, and it is to be hoped that the B.B.C. will consider a change back to the other end of the medium band.

H. J. HARVEY.

London, N.1.

Frequency Separation

THE main object of my original letter in your issue of January 18th was to indicate just how much was gained by paying the price of increased separation. In your leader of the same issue you say you do not want to go as far as 24 kc/s separation, "because such a range is not practicable." You evidently propose to go from one compromise to another which is nearer perfection. Supposing, then, we chose 13 kc/s as our new separation. This means scrapping one-third of our transmitters, and, if we considered 5,000 cycles as a possible frequency range with 9 kc/s separation and added our gain equally to quality and selectivity, an increase to 7,000 cycles. Less than half an octave added to our musical range, plus slightly improved selectivity!

Now, let us imagine a giant piano with a keyboard of nine octaves, the top octaves being its own harmonic range. The change from 9 to 13 kc/s separation means we gain about three notes in the top half of the

eighth octave! I wonder how many of your readers realise that, although the difference between two adjacent low notes may be only 5 cycles of separation, the difference between two similar high notes in the harmonic range can be more than a kilocycle?

Generally, we rarely find notes used whose fundamental frequency goes above 2,000 cycles. The top note of the piano is 3,500 cycles. The higher frequencies of music are the harmonics of these, so that the loss of the higher harmonic notes does not mean that the fundamental note is lost, but that its character only is changed. An extremely high note played on a violin would sound like a flute, *but* does that matter when very few people can tell the difference between an extremely high note on a violin or wood-wind when these are played within a few feet of them?

No! I am of the opinion that the people who are asking for increased separation do not want it for the improvement of quality, but, unwittingly perhaps, to allow for the deficiencies of their own input filters! Obviously, if the characteristic of this filter is poor, and the "skirts" trail away instead of cutting off sharp, interference will result, and the only apparent alternative is to narrow the band-width of the filter, and, as an unfortunate consequence, attenuate the high notes. This is a point which I urge *The Wireless World* very strongly to guard against, for many manufacturers would welcome wider separation for two reasons—they could use coils of higher decrement, and the heterodyne interference note would be of higher frequency, nearly inaudible, and easier to eliminate. *They would not use wider separation for improvement of quality.* To-day many manufacturers do not make the best use of existing conditions because price does not allow for inclusion of good filters, and high-speed methods of



FIRESIDE WIRELESS. A novel method of mounting a broadcast receiver, seen in the Furniture Section of the South London Exhibition.

production do not allow time for correct tuning and ganging of each individual receiver.

St. Helens, Lancs. A. H. WICKHAM.
(B.I. Research Dept.).

The New Monodial

I HAVE read with interest Mr. Wavell's comments on the New Monodial Super which were published in *The Wireless World* on Friday, February 15th.

I constructed this receiver in September, 1933, and it has functioned magnificently since that date. The entire receiver is undoubtedly a real masterpiece, its best feature being that, now in 1935, it is still absolutely up to date.

I have observed the trouble Mr. Wavell mentions, and have tried the dodge you mention with fairly successful results. As you say, it is impossible to eliminate fading completely, but so rarely has it caused me annoyance that I have left well alone.

Congratulations, however, on the production of a really first-class receiver.

Birmingham. GERALD W. TAYLOR.

LT Current in the Wilds

IN the March 1st issue Mr. W. L. Lawrence suggested the use of an accumulator cell, maintained in a charged condition by a permanently connected primary battery, as a source of LT current in cases where ordinary facilities are lacking. Although at first sight his scheme may seem extravagant, I am inclined to think that the proposal is worthy of careful investigation; as to its practicability, I seem to remember that a basically similar plan was employed long before the War for providing current for the spark transmitter at the Malin Head Station, in the wilds of Northern Ireland.

Dry cells are now so good that they would be well capable of supplying filament current to the simpler type of set were it not that voltage fluctuations under load are so heavy that almost constant readjustment of a regulating rheostat is necessary. A "floating" accumulator connected in parallel with dry cells in the manner suggested would entirely prevent these variations; I imagine that matters can be so arranged that recharging (which is automatically self-regulating) will cope with the usual intermittent discharges. Practical information on the subject would no doubt be appreciated by a number of readers.

London, N.W. "RADIOPHARE."

Sound Reinforcement in Theatres

REGARDING Mr. Sinclair's article on "Sound Reinforcement in Theatres," I was, very recently, at a well-known variety theatre in London, where they have installed three slung microphones along the footlights, and several on stands, and a loud speaker each side of the stage.

I was seated fairly near to the stage, and found it very disconcerting to hear the artistes, partly directly and partly via the loud speakers. If anything, there was too much volume in my position, footsteps sounded like thunder-claps.

Due to some of the artistes being too close to the mikes on floor stands, there was a good deal of "blasting" and overloading on high notes. So one can readily understand people's aversion to this "sound reinforcement" when badly fitted up, with no one really in control of it.

London, W.1. G. L. SIDGREAVES.

BROADCAST BREVITIES

By Our Special

Correspondent

Competition in Portland Place

A CERTAIN tenseness at Broadcasting House is due to the fact that every department is vying with its neighbour to produce the finest programme feature in connection with the Jubilee celebrations.

In this, of course, the "O.B." department has a good start as, in a sense, its "programmes" are ready-made in the shape of public processions, thanksgiving services, naval reviews, etc., but hot on its heels come both the variety and the drama departments.

"Twenty-five Years"

Eric Maschwitz may arrange something in the nature of a Royal Command variety programme. Val Gielgud, the



FOUNDATIONS OF MUSIC. West Australian aborigines being introduced to wireless during an anthropological expedition of the University of Adelaide. The receiver, which travelled by train, motor truck and camel, was described by the natives in their own language as "the man in the box."

drama director, is completing plans for "Twenty-five Years"—a special dramatic programme on the eve of Accession Day, the script of which is being prepared by Professor Harold Temperly, who wrote "Twenty Years Ago" for broadcasting last autumn.

Exploring the Royal Residences

Professor Temperly is enjoying the privilege of inspecting the archives at Buckingham Palace and Windsor in order that the feature may be historically correct in all respects.

Production will be by Laur-

ence Gilliam, who staged the Empire programme on Christmas Day.

Floodlights

If, as seems likely, Broadcasting House is floodlighted during the Jubilee revels, it should present an extraordinarily effective sight.

The building is not notable for its modesty; well plastered with searchlights it should have the appearance of a giant birthday cake. And why not?

Choosing the Site

ALL the labours of the Television Advisory Committee are now directed towards choosing the site for the London ultra-short-wave transmitter. A Post Office official tells me that the Committee recognises that the location of this transmitter

is of major importance, for a mistake at this juncture might easily retard future progress.

North v. South

The search is no armchair business, for ultra-short-wave tests have actually been carried out at the Alexandra Palace, at Hampstead and Highgate, and other eminences North and South of the Thames.

All the old rivalry between North and South London has been aroused, and it requires only a few "frontier incidents" to complete the television sensation for which the Sunday Press must be panting.

WINDY WORK at Lisburn, Co. Down, where the new N. Ireland B.B.C. station is in course of erection.

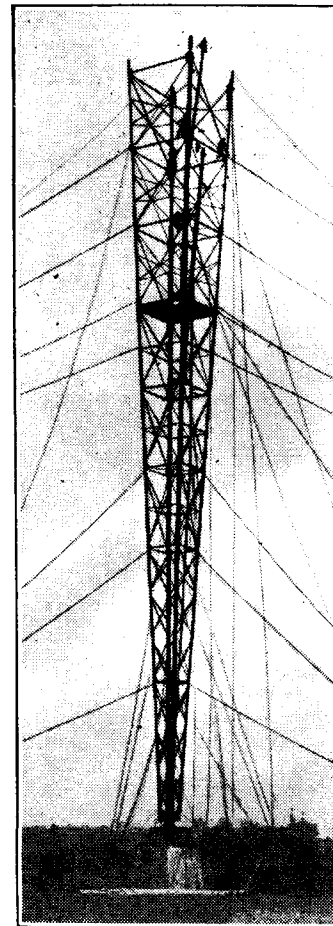

When Manchester Disappointed

A FRIEND whose unaccountable hobby it is to tour from one B.B.C. station to another confesses to me that until now the Manchester studios have always disappointed him more than any others in the B.B.C. collection. In fact, in view of altered circumstances, he now openly admits that "the former studios were hardly in keeping with such a large and important city."

Happier Days

The unhappy stigma has now been removed, for the renovations at Broadcasting House, Piccadilly, are rapidly approaching completion. They include a general modernisation of the equipment, the installation of new control panels and overdue acoustic alterations.

"Down with Multi-studio Drama!"

Heresy is being talked at Manchester, for it seems that Mr. Jan Bussell, the drama producer, believes that microphone actors and actresses "get under the skin" of their subjects very much better if all the company is assembled in one studio. Mr. Bussell, who is well known in Midland repertory circles, contends that the multi-studio idea as conceived by Sieveking, Gielgud and Co. is apt to make artists lose the spirit of the performance, each feeling more like a cog in a wheel.

Nevertheless, Manchester has its dramatic control panel.

A Tricky Job

THE technique involved in producing a Mickey Mouse film calls for general admiration. Almost as ingenious is the method by which John Watt's staff contrives to obtain the book and music of these films for broadcasting in the "Songs from the Films."

Musical Shorthand

There are no complete scores of the Walt Disney films in this country, and so, in co-operation with "Mickey Mouse, Ltd.," an expert sits in the cinema taking down the music in a kind of music shorthand, together with words. The process sometimes entails as many as a dozen

separate viewings. From the shorthand records the music and words are fitted together and orchestrated for the studio performance.

The work is arduous but never boring.

Ipswich Puts in a Plea

TONGUES have been wagging since the B.B.C. mentioned in its Annual Report certain plans for low-power relay stations. I hear that correspondence has been passing between Broadcasting House and the municipal authorities of Ipswich, Suffolk, where it is felt that something is badly needed to boost up signals from Brookmans Park and Droitwich.

The Best Sets

East Anglia has never had a square deal so far as British broadcasting is concerned, and has consequently had to rely largely on the foreign programmes. Which explains why Norfolk and Suffolk possessed good receiving sets when the rest of England had not progressed beyond the woad and sackcloth era.

"Songs My Mother Taught Me"

THE Deutschlandsender has started "singing lessons for mothers," in which the German mothers are instructed how to teach their children to sing the Hitler youth songs.

Readers' Problems

Smooth Reaction

IN reply to a correspondent who asks our advice on improving the smoothness of reaction control of his receiver, we may summarise briefly the requirements for best results in this direction. Smoothness of reaction depends very largely on the operating voltages of the detector valve, and, as a rule, a low anode voltage and a high-resistance grid leak are desirable. It is unfortunate that these requirements are in direct opposition to those for distortionless detection.

The reaction winding and its relationship to the tuned circuit are also factors to be considered. In general, the fewer the number of turns the better, but the coil should be tightly coupled magnetically.

Reducing Voltage

THE obvious way of reducing the voltage derived from a power rectifier is to insert a resistance in one of the leads between the source and the load (see Fig. 1a). But it by no means follows that this method is the best; if, for example, the current to be consumed is very much less than the full rated output there will be a considerable rise in voltage; the extent of this rise is not easily predictable, and so, without a definite basis to work upon, the amateur may find it impossible to estimate the value of series resistance necessary to give the desired working voltage.

The alternative scheme is to connect a resistance in parallel with the rectifier output to act as an artificial load (see Fig. 1b) and thus to bring down the output voltage

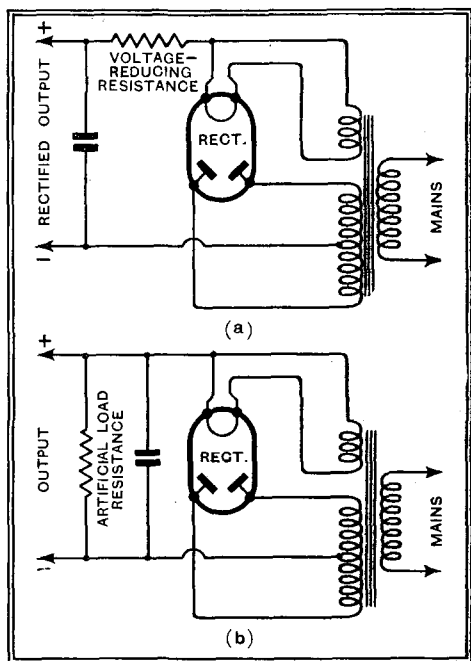

Fig. 1. Alternative methods of reducing the voltage output of a power rectifier; the parallel resistance of diagram (b) provides better voltage regulation on light loads and may be used in conjunction with a series resistance.

to the normal rated figure. This, we think, is the best scheme for a querist who wishes to take comparatively small currents varying between 5 and 30 mA. from a rectifier rated to give 120 mA. The function of the loading resistance may be regarded as that

of absorbing the surplus output—in this case a minimum of 100 mA.—and its value (in ohms) is ascertained by dividing "voltage" by "current to be absorbed," expressed as a fraction of an ampere. "Voltage" will be the normal output voltage of the rectifier under full load.

Constant Aerial Coupling

ALTHOUGH provision for varying aerial coupling is seldom made nowadays, it should not be news to anyone who has carried out experiments on the subject that performance can generally be improved by readjustment of coupling between the aerial and the input tuned circuit when tuning is

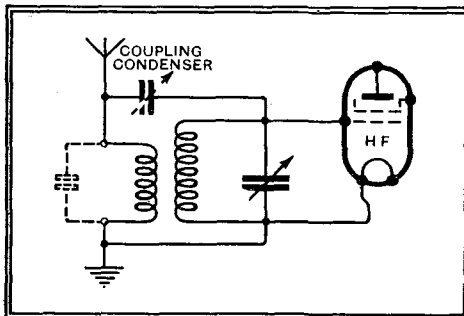

Fig. 2. Combined inductive and capacitive aerial coupling.

changed to any considerable extent. As to whether this complication is really desirable, however, depends on the design of the receiver; if there is ample reserve of sensitivity and selectivity the extra adjustment will hardly be worth while.

Various methods have been suggested for obtaining an aerial coupling that automatically adjusts itself to changes in tuning. A correspondent who asks for a brief outline of a practical system may be referred to Fig. 2, which shows, in essentials, a scheme that gives good results. It will be seen that coupling is effected both magnetically and through a condenser; the aerial coil, which is loosely coupled to the tuned secondary, is of much higher inductance than usual, and matters are arranged so that the aerial circuit as a whole is tuned (by virtue of its own capacity or an additional condenser, shown in dotted lines) to a wavelength slightly higher than the longest wavelength covered by the tuned circuit. This ensures an adequate transference of energy at the upper end of the tuning range, while the coupling condenser comes into action at shorter wavelengths. In practice this latter condenser, which has a very small capacity, may be adjusted by trial and error to suit prevailing working conditions. When the best setting has once been found, subsequent adjustment will not be necessary.

Field Winding Leakage

A CORRESPONDENT is naturally perturbed to find that the metal framework of his energised moving-coil loud speaker is "live" with respect to earth. He rightly assumes that this state of affairs indicates a fault, and asks our advice as to tracing it.

There are two positions at which the short circuit which is undoubtedly causing this trouble may occur: in the field-magnet primary and its casing or core. With regard

THESE columns are reserved for the publication of matter of general interest arising out of problems submitted by our readers. Readers requiring an individual reply to their technical questions by post are referred to "The Wireless World" Information Bureau, of which brief particulars, with the fee charged, are to be found at the foot of this page.

to the latter possibility, we are assuming that the output transformer forms part of the loud speaker, and is mounted in such a way that it is in metallic contact with the framework.

To find out which of these windings is at fault, a simple continuity test must be made between the frame and the windings themselves after having disconnected all external leads. Finally, our correspondent may be warned that the defect may only show up when the field winding is warm, and so the test should be carried out as quickly as possible after switching off the set.

Calculated and Measured Amplification

IT is a fact that the stage gain of an amplifier is generally rather less than the value anticipated as a result of the usually rather rough calculation. For one thing, AC resistance of the valve under working conditions is bound to be appreciably higher than the figure given by the manufacturer, which is always that relating to zero grid voltage and not with negative bias as under ordinary amplifying conditions.

Another discrepancy—which applies to the case of the querist who raises this matter—is that there are always losses in an LF transformer, and so the voltage step-up actually obtained seldom equals the rated turns ratio.

Good Value

A READER who wishes to make a simple short-wave set for headphone reception asks our opinion as to the relative advantages of single-valve and two-valve circuits.

It is assumed that our correspondent has in mind a plain detector set and a detector-LF combination. There can be no doubt that the amplification afforded by the added low-frequency amplifier is highly beneficial. As the cost of the extra stage is comparatively small, and as it adds little to the complexity of the receiver, it must be regarded as good value.

The Wireless World INFORMATION BUREAU

THE service is intended primarily for readers meeting with difficulties in connection with receivers described in *The Wireless World*, or those of commercial design which from time to time are reviewed in the pages of *The Wireless World*. Every endeavour will be made to deal with queries on all wireless matters, provided that they are of such a nature that they can be dealt with satisfactorily in a letter.

Communications should be by letter to *The Wireless World* Information Bureau, Dorset House, Stamford Street, London, S.E.1, and must be accompanied by a remittance of 5s. to cover the cost of the service.

Personal interviews are not given by the technical staff, nor can technical enquiries be dealt with by telephone.



No. 812.

FRIDAY, MARCH 22ND, 1935.

VOL. XXXVI. No. 12.

Proprietors: ILIFFE & SONS LTD.

Editor:
HUGH S. POCOCK.

Editorial,
Advertising and Publishing Offices:
DORSET HOUSE, STAMFORD STREET,
LONDON, S.E.1.

Telephone: Hop. 3333 (50 lines).
Telegrams: "Ethaworld, Watloo, London."

COVENTRY: Hertford Street.
Telegrams: "Autocar, Coventry." Telephone: 5210 Coventry.

BIRMINGHAM:
Guildhall Buildings, Navigation Street, 2.
Telegrams: "Autopress, Birmingham." Telephone: 2971 Midland (4 lines).

MANCHESTER: 260, Deansgate, 3.
Telegrams: "Iliffe, Manchester." Telephone: Blackfriars 4112 (4 lines).

GLASGOW: 26B, Renfield Street, C.2.
Telegrams: "Iliffe, Glasgow." Telephone: Central 4857.

PUBLISHED WEEKLY. ENTERED AS SECOND CLASS MATTER AT NEW YORK, N.Y.

Subscription Rates:
Home, £1 1s. 8d.; Canada, £1 1s. 8d.; other countries, £1 3s. 10d. per annum.

As many of the circuits and apparatus described in these pages are covered by patents, readers are advised, before making use of them, to satisfy themselves that they would not be infringing patents.

CONTENTS

	Page
Editorial Comments	279
Class B Transformers	280
A Home-made Oscillograph ..	283
Wave-traps and Selectors ..	285
News of the Week	287
High-Definition Television in Germany	288
New Types of Short-wave Tuned Circuits	290
Broadcast Brevities	293
Unbiased	294
New Apparatus Reviewed ..	295
Listeners' Guide for the Week ..	296
Harmonics	298
Random Radiations	300
Foundations of Wireless, XV ..	302

EDITORIAL COMMENT

Television Receivers

What Will the Public Be Offered?

THERE is no doubt that the wide publicity television has received, which is likely to be very much more intense when the official transmissions are about to begin, will loosen the purse strings of the public, and sets for television reception will be bought in considerable numbers.

Statements have already been appearing in the Press to the effect that low-priced receivers for the reception of the present 30-line transmissions will be available very shortly and that these sets will be capable of being converted later on for the high-definition transmissions at a very small cost.

30-line v. High Definition

The construction of television receivers for the 30-line transmissions is a comparatively easy matter, but lack of public demand on account of the temporary and experimental nature of these transmissions and their poor entertainment value has limited the sale. The manufacture of high-definition receivers is a much more difficult task; we know that the estimated cost to the public of such sets is above, rather than below, £50.

It is quite a simple matter to modify a high-definition receiver to make it suitable for the reception of the present 30-line transmissions, but it is a very different problem to attempt to reverse the process.

The basic idea of producing sets for the present transmissions which can later be made equally suitable for high-definition reception is a very good one if it can be successfully carried out.

But the public must not expect that by this method it will be possible to get a satisfactory high-definition receiver at a lower cost than if the receiver had been designed in the first place for high-definition reception. The public, before buying sets of this nature, should be confident that converting the receivers can be done satisfactorily at an agreed cost, and that the concerns which sell the sets now will all be there to make the conversion when the time comes.

Loud Speaker Curves

Definite Facts at Last

OF all the component parts of a wireless receiver the loud speaker still remains the most important, the least efficient and the most interesting in design.

The lack of efficiency of speakers does not much matter in these days when means of amplification are so readily available, but the response of the speaker to the range of frequencies of the audio spectrum cannot be compromised with, since serious variations of sensitivity at any particular frequencies must distort the reproduction.

The Wireless World has recognised for a long time the value of response curves of loud speakers and for some months apparatus has been in the process of development in our laboratory which, now that it is ready for use, enables direct photographic records of the acoustic output of loud speakers to be made.

In next week's issue an account will be given of the nature of the equipment evolved and representative curves taken of well-known speakers will be published. This issue will prove one of the most interesting and informative numbers in the history of *The Wireless World*.

Class B Transformers

Obtaining High Quality Reproduction with Class B

QUIESCENT output systems are now widely used in battery-operated receivers in which economy in current consumption is of great importance. They are also often used with a mains drive in cases where very large output is required. If satisfactory results are to be secured with a Class B stage very careful design of the components is necessary, and in this article the requirements are discussed in some detail

By N. PARTRIDGE, B.Sc., A.M.I.E.E.

THE economy of battery Class B is well known, but the extension of this principle to mains-operated amplifiers has received little publicity. The scheme results in a substantial saving in the initial cost of valves, mains equipment, etc., with a considerable reduction in running cost and overall weight of the apparatus, an important feature for P.A. work. Owing to the poor design of components in the early days, Class B became regarded as incapable of good quality reproduction. This, however, is not true, and the purpose of this article is to outline the important points of design with special reference to the transformer technique concerning which several very erroneous notions are widespread.

A skeleton circuit is illustrated in Fig. 1. Two similar power valves form the output stage, and these are biased back to the bottom bend of their characteristics. For small signals it is clear that these valves will function in QPP, an arrangement that has been fully described in past issues of *The Wireless World*. However, in QPP the grids of the output pair are never allowed to become positive, whereas in the application described the grids are made to swing over such a wide range that they do become positive and therefore grid current flows. Hence, for small signals, the output can be regarded as QPP, but for large signals part of the cycle is handled as in QPP, while the peaks are handled as in Class B. A study of Fig. 2 will clarify the foregoing.

Valve Rating

Since the power valves are overbiased, very little current will flow in their anode circuits with no signal; it is therefore permissible for the peak currents to be larger than would be allowable in Class A so long as the average anode dissipation does not exceed the manufacturer's rating for the valves in question. A suitably chosen pair of output valves operated as described can be made to give a speech output several times greater than the output obtainable using the same valves in straight push-pull.

At this juncture it is interesting to note that variations of the circuit illustrated are at present widely used for Wireless Relay and P.A. work. A good commer-

cial example is the "Sareco" amplifier illustrated in Fig. 3. This amplifier gives a speech output of 90 watts with 5 per cent. distortion, and the frequency response is within plus or minus 2 db. from 30 to 10,000 cycles.

The general theory about to be examined applies equally to the present circuit and to all forms of Class B whether mains or battery operated. Returning to Fig. 1, it will be noted that the driver valve has a varying impedance in its anode circuit. While no current is flowing in the grid circuits of the output pair (with small signals) the impedance across the secondary of the driver transformer will be very high. As soon as grid current flows (with large signals) the effective impedance will drop and will become a minimum when the signal voltage reaches

undistorted voltage wave form exactly similar to that applied across XY. If this is to be successfully achieved with a varying anode impedance, the regulation of the whole driver stage must be of a high order. In other words, the signal voltage lost across R_T and R_V must always be small compared with the signal voltage produced across R_L , even when R_L is at its minimum value. It at once follows that a satisfactory state will exist as long as the minimum value of R_L is large compared with the sum of R_T and R_V . Reverting to the practical circuit, this means that the minimum value of the effective impedance of the output grids multiplied by the square of the transformer ratio must be high compared with the AC resistance of the driver valve plus the total resistance of the driver transformer referred to the primary.

The Driver Transformer

The required circuit conditions being established, the design of the driver transformer can be considered in greater detail. A large step-down ratio from primary to secondary will ensure a high impedance in the driver anode circuit, but a limit is soon reached in this direction, since the transformer secondary must provide sufficient voltage to load the output stage. It is apparent that the best ratio is that which will cause the output stage to be fully loaded just before the driver valve becomes fully loaded. This con-

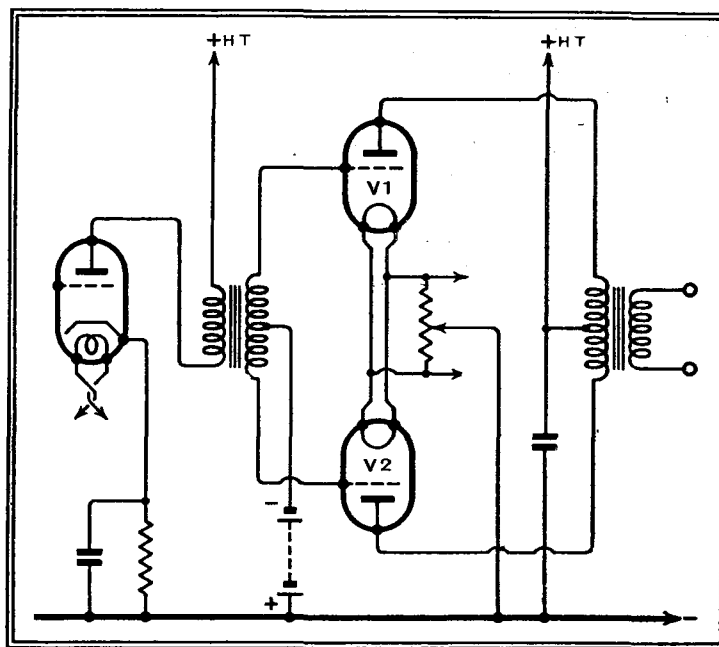

Fig. 1.—The fundamental circuit of a mains-driven Class B stage.

dition gives the greatest possible step-down ratio and therefore the highest workable anode impedance. Having calculated this optimum ratio, it does not follow that it will prove satisfactory in every case. Great care has to be exercised in the selection of the driver valve or it will be found that the ratio as determined above will still not provide a sufficiently high primary impedance. The remedy is to resort to the use of two driver valves in push-pull.

It is obviously the purpose of the driver stage to produce across AB (Fig. 4) an

Class B Transformers—

To obtain a good frequency response the primary inductance must be such that the reactance at the lowest important frequency is at least twice the load resistance of the driver valve. The leakage inductance must be minimised to avoid attenuation of the extreme upper frequencies and also to reduce the tendency which this inductance has to resonate with the input grid capacity of the output stage and so produce parasitic oscillation.

Good regulation is obtained by keeping the total copper losses of the driver transformer as low as possible. It can be shown theoretically that for a normal transformer this condition is attained when the primary copper losses are equal to the secondary copper losses.

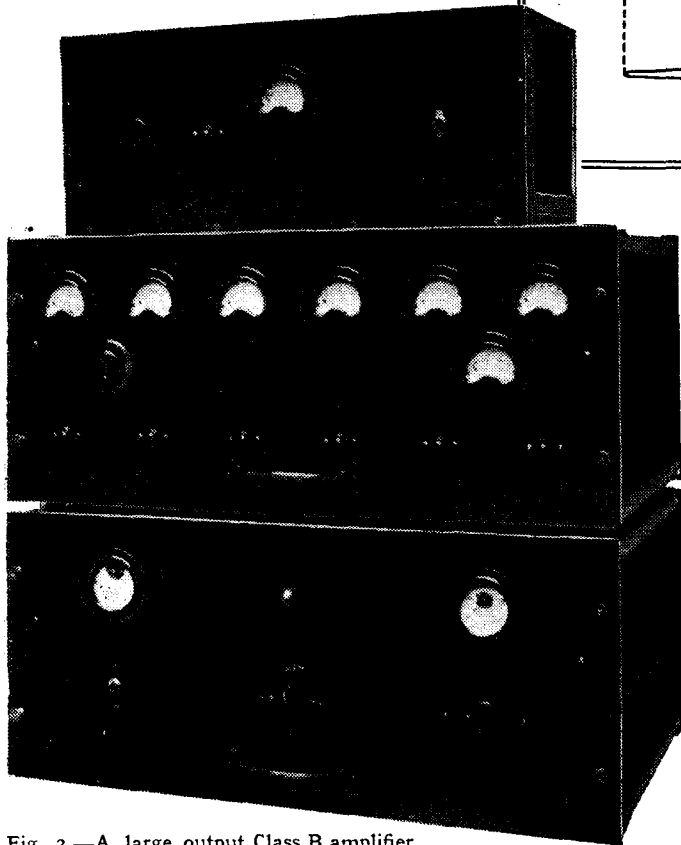

Fig. 3.—A large output Class B amplifier.

However, a driver transformer has virtually two secondaries that are used alternately, since only one-half of the total secondary carries current at any instant. Hence, to obtain maximum efficiency, the total secondary must occupy twice the space that would be required if the transformer had only one secondary.

The Transformer Windings

The practical result is that in a well-designed driver transformer approximately one-third of the winding space is filled by the primary, while the total secondary occupies the remaining two-thirds. This has given rise to the idea that the value of the secondary resistance is more important than that of the primary, a supposition that is quite without foundation, it being the correct proportioning of the resistances that is important.

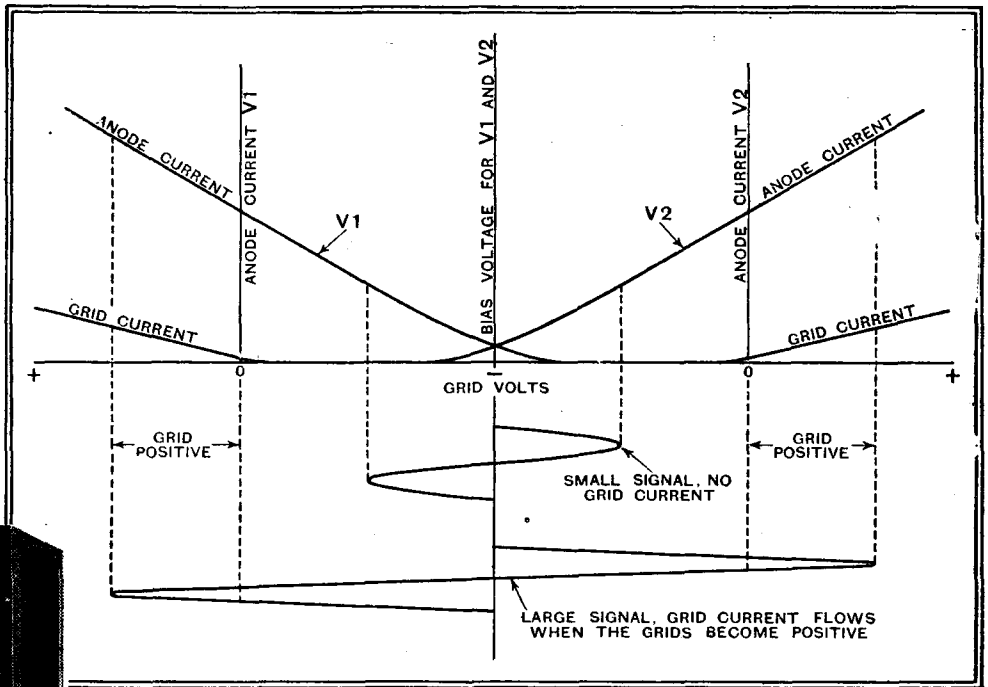

Fig. 2.—As shown in this diagram, grid current only flows when the signal input exceeds the grid bias, so that with small voltages the operation is more like QPP than Class B.

The final problem is to wind a low resistance primary that shall occupy only one-third of the available winding space and yet possess a sufficiently high inductance. The polarising current from the plate of the driver valve complicates matters and necessitates an air gap in the core. The solution is to employ a much larger section of iron than is usually associated with an intervalve transformer. Further, the writer has found a substantial

advantage from the use of a comparatively new magnetic alloy known as "Vicor," produced by Messrs. Magnetic and Electrical Alloys, Ltd., of Wembley. This material combines low losses with a very high permeability that is less affected by a polarising field than the better known transformer materials. A smaller air gap can be used with this alloy than would otherwise be necessary; thus not only is the inductance improved but the magnetic leakage is reduced, with beneficial results to the frequency response.

The Output Transformer

Before leaving the driver stage, it may be noted that Fig. 1 shows the bias voltage applied to the output valves as being derived from batteries. This has been done to simplify the main issue. In practice this voltage is

obtained from the power supply, but the stringent conditions set by the circuit demand a technique that cannot be described in this article.

Having examined the driver transformer in some detail, the output transformer will present less difficulty. The essential feature of the output stage is that only one of the output valves is in operation at a time, since they alternately handle each half cycle (see

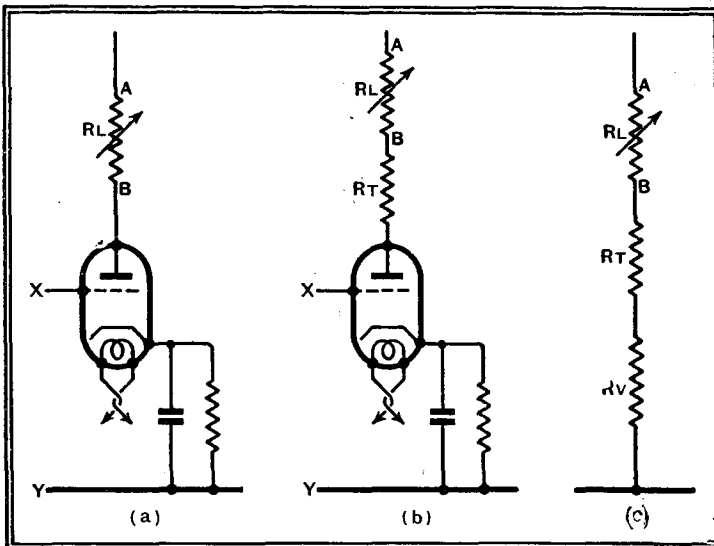

Fig. 4.—The operation of the driver stage is illustrated here: at (a) only the load resistance R_L appears, but (b) includes the transformer resistance R_T . In (c) the valve is replaced by its internal resistance R_v .

Class B Transformers—

Fig. 2). It follows that the necessary output ratio must be calculated with reference only to one-half of the primary, and also, since the two half-primaries are really alternative whole-primaries, they will together occupy approximately twice the

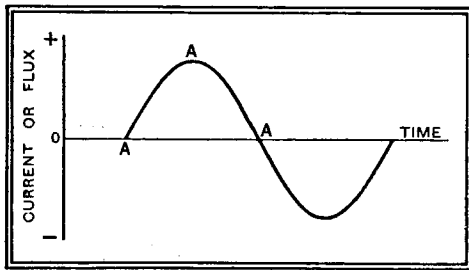

Fig. 5.—A single cycle of alternating current is represented by the familiar sine curve.

winding space taken by the secondary for a condition of maximum efficiency.

Since plate current flows alternately first in one valve and then in the other, the two valves do not provide equal and opposite DC in the two halves of transformer primary, as is the case with normal push-pull. Does this mean that the core will be liable to saturation and that it should be provided with an appropriate air gap? It seems to be generally accepted that the core is polarised by the plate current, which is unfortunate since, truth to tell, *the core of a Class B output transformer is no more polarised by the plate current than that of a normal push-pull transformer.* This statement is directly opposed to the public writings of more than one technician and must, therefore, be supported by further reasoning.

For the primary of a transformer to lose inductance owing to the polarisation of the core it is necessary for the mean magnetisation throughout one complete cycle to be some value other than zero. Consider Fig. 5, which represents one cycle of alternating current passing round the windings of a choke or transformer primary. The flux in the core will follow the same curve (approximately) and since there is no suggestion of DC nobody will

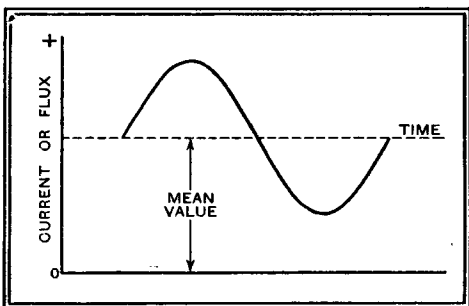

Fig. 6.—When DC passes through a transformer winding, the sine curve is displaced as shown.

hint at a state of polarisation. However, throughout the half-cycle marked AAA the current is unidirectional; further, at any single instant the winding is traversed by pure DC. Nevertheless, the core is not polarised because the average current (or flux) for the complete cycle is zero.

Fig. 6 shows a similar curve for an interval transformer carrying the full

anode current of its associated valve. Here the core is polarised because the mean current (or flux) is not zero for the complete cycle.

Returning now to the Class B output transformer, it will be seen that one valve provides a half-cycle of current (or flux) in one direction while the other valve completes the cycle by providing an identical half-cycle in the reverse direction. Hence the average primary current (or flux) is zero for the complete cycle and the core is therefore not polarised.

These conditions are almost exactly reproduced in the circuit of a full wave rectifier as illustrated in Fig. 7. The rectifier anodes pass current alternately, as do the output valves in Class B. Hence the mains transformer has a DC flowing

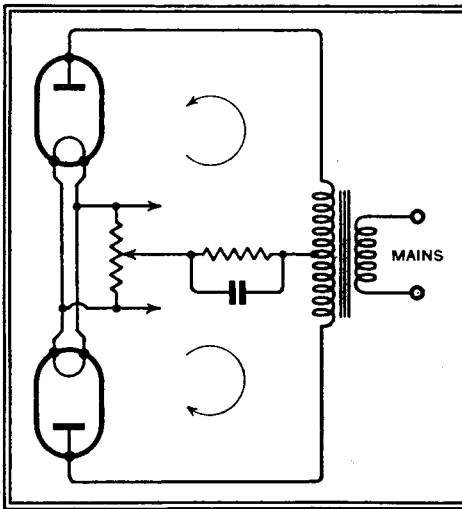

Fig. 7.—The connections of a typical full-wave rectifier circuit, illustrating how the DC is balanced and leaves the core unaffected.

in only one-half of its HT winding at any instant, exactly similar to the primary of the Class B output transformer. The electro-magnetic conditions existing in the two cases are strictly comparable. It has always been recognised as one of the advantages of full wave rectification that the mains transformer is not polarised. Why not so with Class B?

To conclude, a word about the HT supply to the output stage is essential. With no signal the HT current flowing is small, but it increases in proportion to the grid input voltage. If the HT supply be taken from the mains the usual rectifier and smoothing circuits have far too poor a regulation to work satisfactorily under these circumstances. A special technique has to be employed. The mer-

cury vapour rectifier, in conjunction with a rather unusual choke, the inductance of which must be an inverse function of the DC passing through it, forms the basis of the HT supply circuit, but the design of such equipment is really a separate subject in itself.

Reception in Europe

By a Correspondent.

DOES most of Europe enjoy the same sort of radio reception? That it does is the opinion I have formed after two recent tours which have taken me from the South of Italy to Scandinavia via Italy, France, Switzerland, Belgium, Holland, Germany and Denmark. At Rome I tuned in the Hamburg transmission at excellent strength; when I tuned in the same station at Geneva and Brussels the results were practically the same. Similarly, Rome came in at equal strength at Geneva, Hamburg and Copenhagen. The conclusion forced upon me is that, just as each country is more or less saturated by its own broadcast programmes, so that the populace thinks the same thoughts and enjoys the same music, so all Europe is bound by similar bonds of a common radio interest.

Owing to the technical improvements of the last few years the standard of reception is uniformly good. Hence the list of stations that can, as a rule, be received well in almost all parts of Europe includes nearly all transmitters with a power of more than 20 kilowatts. The exceptions are the two 15-kW Brussels transmitters and the Swedish stations Göteborg and Hörby, with a power of 10 and 7 kilowatts respectively, both of which I heard well all over Europe.

The poorest reception on the Continent was, in my experience, in certain parts of German Switzerland. Geological conditions may account for this, and, indeed, Swiss research workers contend that the mountains are an effective screen, particularly with regard to short waves.

Certainly it would appear that the long-distance DXer must roam farther than Europe for the excitement of picking up elusive transmitters. It is the short waves that now offer the fascination which ten years ago could be found in pursuing transmitters only a few hundred miles distant.

GERMAN 180 LINE SET.—Assembling one of the Telefunken high-definition receivers. The units are assembled in a metal frame chassis.

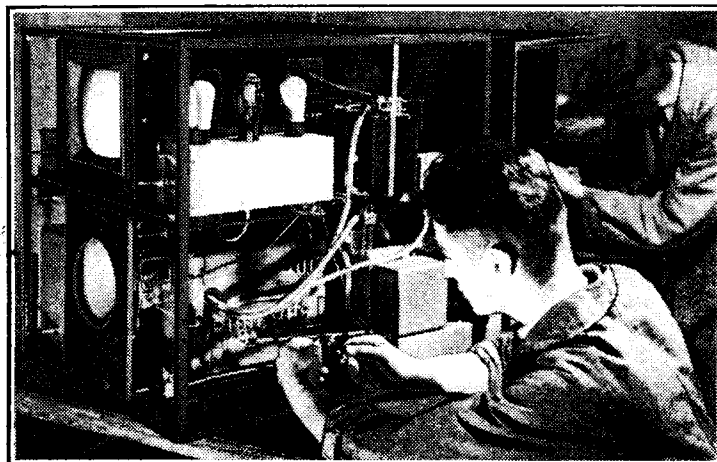

A Home-made Oscillograph

Cathode Ray Experiments at Low Costs

By C. C. INGLIS, A.M.I.E.E.

THIS article shows how the amateur may obtain an insight into practical cathode ray working at small expense and with the simplest apparatus.

IN its usual form, the cathode ray oscillograph is a rather expensive and somewhat complicated piece of apparatus, almost beyond the reach of the average experimenter. But worth-while results can be obtained (and much useful knowledge can be acquired) with something much less elaborate than the usual "professional" oscillograph; on the principle that half a loaf is better than no

and this line obviously corresponds to movement (a) mentioned above.

Now as the Tunograph lacks a second pair of deflecting plates, the obvious problem is to devise means of deflecting the beam (and consequently the spot) at right angles to movement (a), and the only way of successfully obtaining the time base movement (b) is by magnetic control carried out by means of an external coil.

It has already been pointed out that a cathode stream is capable of being deflected by a magnetic field, and that the beam is deflected at right angles to the field. Various methods of applying this principle suggest themselves, but the most useful in practice is the application of the field produced

making the time base comprise two movements at right angles in space and at 90 deg. in time, one being much larger than the other in amplitude. By way of explanation, if these two movements are equal to one another, the result is a circle; if one is larger than the other an ellipse results. How these two movements of the spot are caused will be explained later.

Assuming that the time base traces out an ellipse as shown in Fig. 1 (a), then if the voltage to be examined is applied to the axis XOX, the effect will be as illustrated in Fig. 1 (b). The appearance



Showing the light spot on the "Tunograph" screen.

of the figures so obtained will be as if the waves had been wrapped round a transparent drum which will appear to be revolving if the frequency of the time base and that of the "work voltage," as it is called, are not exactly multiples of one another. In the present case the screen of the Tunograph is not large enough to permit of the whole of the ellipse being registered, and only a short portion of it (represented by the dotted rectangle in

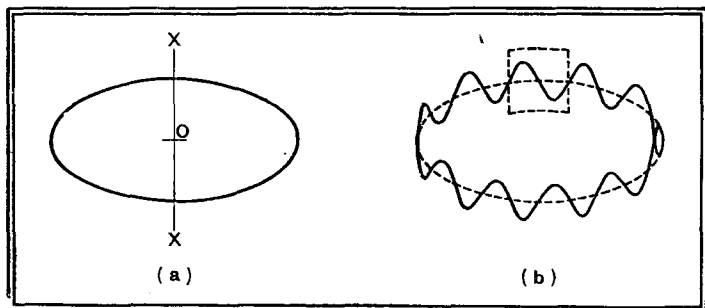

Fig. 1.—The principle of the elliptical time base.

bread, the writer believes that a description of more or less improvised apparatus will be of interest to many readers. With the advent of television, the cathode ray tube becomes almost as important as the valve, and practical knowledge of its technique is of the greatest value.

Miniature Cathode Ray Tube

The oscillograph to be described may be set up for an outlay of about thirty shillings. The principal item in its construction is the Micromesh Tunograph,¹ which is a miniature cathode ray device designed for use as a tuning indicator in receivers. It was described in *The Wireless World* for October 13th, 1933, and in recent issues of the journal the basic principles of the cathode ray tube have been treated at length.

Readers of this article are assumed to be more or less conversant with these principles, and will realise that in order to make visible a wave-form we need two principal movements of the cathode beam, due to (a) the voltage to be examined and (b) the time base. When the Tunograph is used for its original purpose, as described in the article referred to, an AC voltage, when applied to the deflecting plate, causes a luminous line to appear,

by a coil fed with AC at 50 cycles in such a way as to produce an elliptical time base. It is necessary at this point to digress for a moment to explain what is meant by this.

If the beam is periodically deflected in such a way that the spot makes a return journey over the same line as it took on the outward journey, then (as waves of the voltage to be examined will be produced by both excursions) confusion of the images will result for two reasons. First, the waves will not necessarily be found at the same place on the two excursions; and secondly, the waves will have been traced in different directions. It is therefore desirable to cause the spot to follow a different path on the two journeys.

This is done by

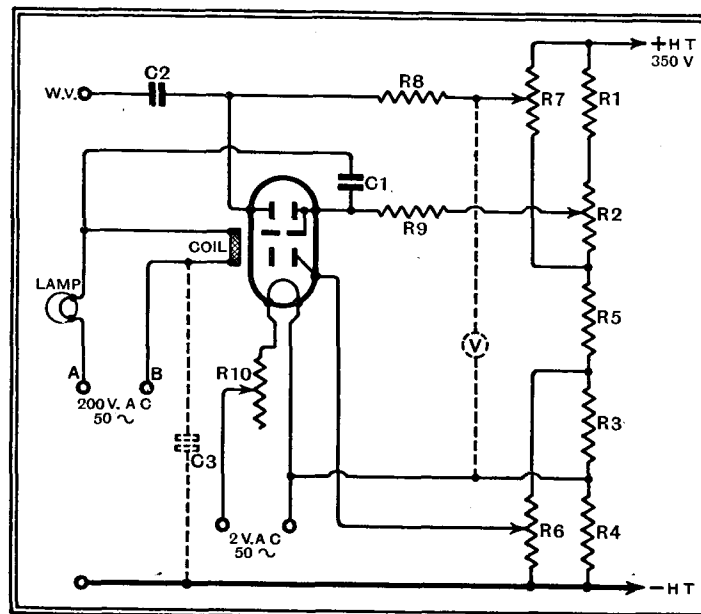

Fig. 2.—Complete circuit diagram of the home-made oscillograph. Terminals A and B are mains connections; B should be earthed. Values: R1, 10,000 ohms; R2, 25,000 ohms; R3, R4, 5,000 ohms; R5, 20,000 ohms; R6, R7, 250,000 ohms; R8, R9, 0.5 megohm; R10, filament rheostat, 4 ohms; C1, C2, 0.001 mfd.; C3 (if necessary), 0.001 mfd. or over.

¹ Made by Standard Telephones and Cables, Ltd.

A Home-made Oscillograph—

Fig. 1 (b) is allowed to fall on the screen. This figure shows (approximately to scale) the actual conditions. It must be realised that this time base is not truly linear, but as the screen registers only a small central portion of the ellipse the departure from linearity of this portion is not sufficient to distort the wave-form to any great extent.

Magnetic Time Base Control

The elliptical movement of the spot is obtained by deflecting the beam magnetically in one direction and electrostatically in a direction at right angles (but to a lesser extent), the movements being in quadrature with one another. A coil of wire is thus placed close to the Tunograph so that its axis is at right angles to the cathode stream and parallel to one of the long sides of the screen. If AC is fed to the coil the spot turns into a line across the screen and parallel to its short side. Now the magnetic field is in phase with the current and the current is approximately 90 deg. out of phase with the voltage feeding the coil, so if a portion of this voltage is fed to one of the deflecting plates the spot will have its two movements at right angles.

The coil actually used by the writer is similar to a super-regenerative quenching coil, and its construction is shown in Fig. 4. The number of turns of wire is not critical, but, of course, the sense of both sections must be the same. It is necessary to connect in series with the coil a 60- or 100-watt lamp to limit the flow of current.

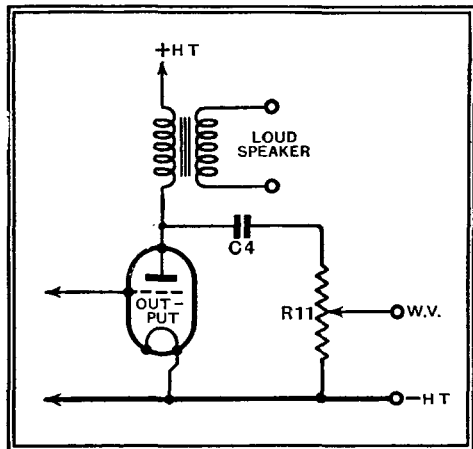

Fig. 3.—Examining the output wave-form. Values: R11, 250,000 ohms; C4, 0.01 mfd. (mica).

A complete circuit diagram of the apparatus appears in Fig. 2, from which it will be seen that the resistances R1, R2, R3, and R4 constitute a potentiometer across the DC high-tension supply (in the case of the writer's apparatus, 350 volts). Provided that a minimum of 200 volts is available, the values given will be found suitable, though for supplies under 250 volts R1 and R2 may, with advantage, be replaced by a potentiometer of 30,000 ohms.

By way of explanation, it should be added that the potentiometer R2 is used to vary the anode voltage of the Tunograph; R1, R3, R4, and R5 are fixed

1-watt resistors, while R6 is a 250,000-ohm potentiometer which allows the voltages on the shield to be varied between 25V. positive and 25V. negative with respect to the filament.

With regard to focusing of the spot, the minimum diameter under any working conditions is adjusted by means of R6; the AC potential of the deflecting plate is controlled by R7. Two $\frac{1}{2}$ -megohm resistances R8 and R9 serve to isolate the deflecting plates from the circuits supplying their polarising voltage. Out-of-phase voltage for the time base is fed to one of the deflecting plates through C1, and the "work voltage" is fed to the other plates through C2.

The procedure in operating is to switch on the DC supply and the filament of the Tunograph. A spot about $\frac{1}{8}$ in. in diameter should appear on the screen when R7 is adjusted, R6 having been set to its maximum. If no spot appears it can be made to do so by holding a permanent magnet near the glass or stroking the glass with it from the base to the top. An alternative method is to disconnect the lead from the shield and apply full DC voltage to it for a few seconds. This produces a kind of haze on the screen, which, on reconnecting the shield lead to its proper terminal, can be brought to a focus by R6. The time base circuit is next switched on, and in all probability the spot will disappear, due to the fact that none of the ellipse appears on the screen, but manipulation of the potentiometer R7 will make visible a line across the screen. It will be found that there are two positions of R7 which will produce lines, these being due to the two sides of the ellipse. Finally, the "work

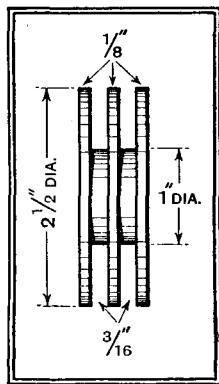

Fig. 4.—Dimensions of deflecting coil former. Each slot may be wound full of No. 32 S.W.G. enamelled wire.

voltage" to be examined is applied to the terminal W.V. and the wave-form will appear on the screen.

Uses of the Oscillograph

The particular application to which the writer put his apparatus was an examination of the voltages occurring on the plate of the detector in a super-regenerative receiver. The frequency which was examined was of the order of 10,000 c/s, and many interesting features have been noticed.

No doubt readers will think of other applications, and one which is well worth trying is the examination of the wave-form of the voltages on the plate of an output valve; the circuit for this experiment is shown in Fig. 3. By means of the voltmeter V (in Fig. 2), and by adjusting R7 so as to shift the wave produced across the screen a measurement of the peak voltage can be made.

QA Receiver Chassis

CHASSIS for the QA Receiver and the Push-Pull Quality Amplifier have been received from the Peto-Scott Co., Ltd., of 77, City Road, London, E.C.2. They are of matt-finished aluminium, and are stoutly constructed, with riveted corners. They are supplied ready fitted with valve holders and all holes are made, the punching being particularly clean.

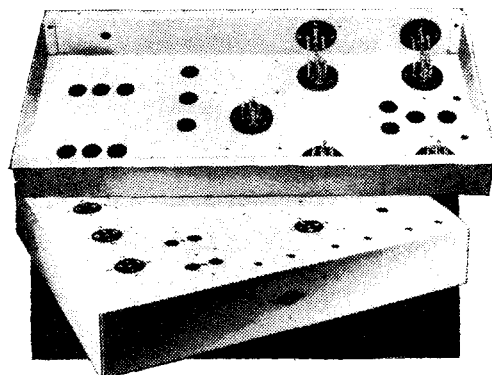

The chassis are available separately, if desired, and they are priced at 10s. 6d. each; they can confidently be recommended for this receiver and amplifier.

The Radio Industry

INFORMATION regarding aeroplane departures and arrivals, baggage arrangements, etc., is now passed to passengers waiting in the main booking hall and buffet at Croydon Airport through a recently installed Tannoy public address equipment. Announcements can be made through this system from the Croydon offices of each of the operating air lines.

A special Drydex battery, known as Type H1116, is now available for the Bush SB4 receiver. It has a voltage of 144, with appropriate tappings.

London Radio Development Service, Ltd., of 56, Hazel Road, Kensal Rise, London, N.W.10, announce the formation of a subsidiary company, known as British Radiovision Corporation, which is marketing short-wave and television apparatus. A short-wave battery receiver for tropical conditions, an AC-DC short-wave converter, and a short-wave AC-DC superhet are already in production.

Prices of Grosvenor "Red Line" batteries have been reduced, and a new series of low-priced batteries, to be known as Grosvenor Radio, has been introduced.

Ward and Goldstone, Ltd., Frederick Road, Salford 6, Lancs. have just introduced a special form of twin short-wave cable to be used as aerial downleads with dipole and similar aeriels. This cable, known as "Telestat," costs 6d. per yard, and its use is clearly shown in a blue print just issued by the makers. Ward and Goldstone have also issued a leaflet in which constructional details of the Whistle Filter, described in *The Wireless World* for November 10th, 1933, are repeated, with circuit diagrams, etc. Ready-made Goltone inductance coils, wound to the published specification, are described in this leaflet.

A new AC superheterodyne with the interesting feature of variable selectivity is announced by Orr Radio, Ltd., of Parkhurst Road, London, N.7.

Wave-traps and Selectors

Unusual Applications of Reaction

By F. G. MEE, M.A., B.Sc.

IN this article the author describes interesting methods of improving the selectivity of existing receivers by means of valve-assisted wave-traps and additional tuned aerial circuits

IN order to understand the devices with which this article deals it will be necessary to describe the arrangements from which they are developed. The first of these is known as a *wave-trap*, which seeks to cut out a single interfering station, and the second may be termed a *wave selector*, because it seeks to strengthen one particular wanted station. A wave-trap consists of a tuned circuit, which is interposed in—or more usually coupled to—the aerial circuit, as in Fig. 1 (a). Oscillations of the frequency to which the circuit L,C is tuned can only pass from aerial to set with difficulty, whilst other frequencies can pass with relative ease. The extent of absorption of unwanted signals depends upon the damping in the eliminating circuit and the closeness of its coupling to the aerial circuit. Unfortunately, if this coupling is made close, it automatically increases the damping in the tuned circuit. This reduces its effect, and, what is much more important, broadens the tuning of C. As a result, such an arrangement reduces the intensity of the wanted station as well as that of the unwanted unless they are widely separated in frequency.

But if the damping in the eliminating circuit could be artificially reduced its sharpness and efficiency could be increased. There is quite a simple way of doing this, which consists in supplying this circuit

oscillations of this frequency passing to the set, whilst leaving others unaffected. A suitable circuit for the purpose is shown in Fig. 1 (b).

In the particular arrangement shown, ordinary inductive reaction is employed, and a "fine adjustment" is obtained by means of a grid potentiometer. No doubt capacity reaction would do equally well if sufficiently finely controlled. The tuning condenser must be of a high-quality slow-motion type, as the tuning is exceedingly sharp. The LT and HT batteries shown are the same ones as are used to supply the set itself. For the ordinary medium wave-band, coil L1 may consist of about 50 turns wound on a 3in. diameter former, assuming the condenser C1 is of 0.0005 mfd. capacity. The reaction coil L3 may be of about 10 turns of the same diameter. For C2 any capacity from about 0.001 mfd. upwards will be satisfactory (this also applies to Fig. 2 (b) to be discussed later). Using an ordinary "general purpose" valve, a grid bias control from 0 to -3 volts has been found to give a satisfactory control of reaction when 90 volts was used on the anode of the valve. The set will usually already incorporate a condenser across the HT battery; if not, it is desirable to add one of 1 or 2

there are too many turns on L2 or if it is too closely coupled with L1 the tuning on C1 will still be rather broad, and the device will tend to weaken wanted as well as unwanted stations. If, on the other hand, the turns are too few or the coupling too weak, the tuning on C1 is so exceedingly sharp that the device eliminates the carrier wave of the unwanted station without removing its sidebands. In this case, too, the tuning and reaction adjustments are naturally extremely critical. The author has found that about three turns of wire on a 3in. former are adequate for L2, and that 9-kilocycle selectivity in the trap could be obtained if this coil was set up coaxially with L1 and with its turns about half an inch from it. The beauty of the arrangement lies in the

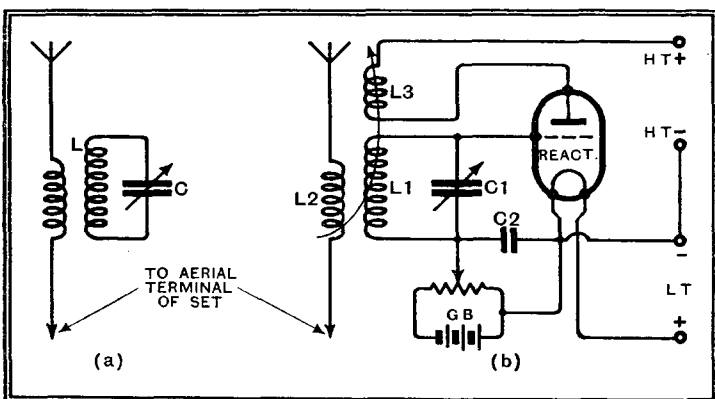

Fig. 1.—An ordinary wave-trap, shown in diagram (a), compared with a more effective type (b) in which damping is reduced by a reactor valve.

with a valve and reaction coil. If the valve is near its oscillation point, the damping in the circuit is very low indeed at the particular frequency to which it is tuned, so that it will effectively prevent

mfd. capacity; the value is not critical. The extent of the coupling with the coil L2, which is in the aerial circuit, depends a great deal upon the set, the aerial, and upon the signal to be eliminated. If

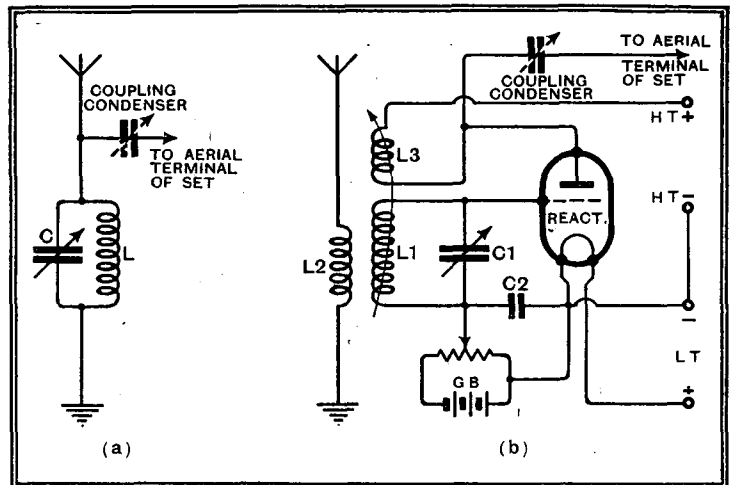

Fig. 2.—A separate aerial tuner for adding to an existing receiver is shown in diagram (a). Its valve-assisted counterpart (diagram [b]) provides stronger signals and greatly increased selectivity.

fact that the damping of the set to the wanted station is not reduced by excessive reaction, so that the elimination is carried out without affecting the quality of reception.

Two-circuit Aerial Tuning

For the general reception of distant stations a device based upon the *wave selector* is likely to be more serviceable, as there may be several interfering stations and a slight loss of quality can usually be tolerated. Fig. 2 (a) shows a typical circuit widely used for increasing the selectivity of a set. Its effectiveness depends chiefly on the sharpness of the tuning of the circuit L,C which is determined by its inherent resistance and upon the damping imposed by the aerial itself and by the set through the small coupling condenser. If this condenser is made very small, damping from this source will be reduced, but only a small fraction of the available energy will be communicated to the set, and the signal strength will suffer in consequence. Again, damping due to the aerial can be reduced

Wave-traps and Selectors—

by coupling loosely to it instead of connecting directly to it, but this will involve loss of signal strength if carried too far. Consequently, the circuit of Fig. 2 (a) is only suitable for much about the same purpose as the original wave-trap—that of helping to separate stations with a considerable frequency difference.

Such a circuit can, however, be subjected to the same modification as the simple wave-trap to increase the sharpness of its tuning. By incorporating a valve with reaction the damping can be brought to a very low figure for the particular frequency to which the circuit is tuned. A circuit suitable for this is shown in Fig. 2 (b). The sizes of coils and condensers, and the grid and anode voltages, may be the same as those in the “undamped wave-trap” described earlier.

Short Waves and the Amateur

A Day's DX on 20 Metres

By G2TD and G5KU

THE conditions during the last few weeks have been steadily improving on 20 metres. This is possibly due to an abnormal condition brought about by the recent solar activities in the form of a large sunspot, or it may be one of those little understood cyclic periods which are favourable for DX work. The conditions have been very favourable for communication with Africa, Asia and Oceania, although most of the North American districts are accessible in the afternoon.

Let us take you on a DX trip to all the continents of the earth and endeavour to recapture some of the thrills which seem unavoidable, even to the “Old Timer” when a distant country or island is held in two-way communication for the first time.

It is Sunday morning in G2TD's shack, with the sun peeping shyly over the Thames and a brisk snap in the air.

There is the receiver—a five-valve single signal superhet. which is home constructed, and while departing a little from the aesthetic in appearance, is fully capable of counterbalancing this deficit by a very creditable performance. The twenty-metre band, which is about 0.75 metre in width, is encompassed by the full one hundred and eighty degrees slow motion condenser dial, so that little is missed when carefully searching for weak signals. The transmitter housed in the well-known domestic Easiwork kitchen cupboard is an example of careful layout and design rather than an imposing array of meters and knobs. It consists of a master crystal oscillator, working at a frequency of 7,069 kc/s, followed by a frequency doubler and neutralised power amplifier. The high tension feed is at 400 volts from carefully smoothed rectified A.C. derived from full wave thermionic rectifiers. Considerable care has been taken to ensure a pure, steady note, as it is fully realised that such practice produces less neighbouring interference, and can be more easily copied at poor signal to noise ratios which are inevitable when listening for real DX.

We clock on at 08.15 G.M.T. for a short spell before breakfast and through the quiet background hiss we hear the first DX of

The small coupling condenser through which the energy is finally communicated to the set may, with advantage, be variable. A small trimmer or reaction condenser of some 20 micro-microfarads maximum capacity and with a very low minimum is satisfactory for the purpose. The coupling between L₂ and L₁ should be kept as loose as is consistent with adequate signal strength. In using the arrangement it is best first to remove almost all reaction from the set itself, and then adjust the potentiometer until the selector valve is near the oscillation point, but not so near as to cause distortion. The volume can then be brought up by means of the controls provided on the set. If surplus volume is then available the coupling capacity can be somewhat reduced, and C₁ and the selector reaction adjusted to suit.

the morning; New Zealand and a summer evening are brought to us by the CQ call from ZL2MR. Apart from the rather indescribable “shimmering” effect associated with long-distance signals, there is little fading and his excellent signals are worthy of a call. The valve filaments of the transmitter are already alight and we click the power on and change over the aerial, and so our signals flash across the seas, deserts and tropical jungles as we call the Antipodes.

Thus our first DX contact of the day is established and we exchange salutations and reports. Our distant colleague tells us of heat waves and drought, and we draw the electric fire a little closer as a token of gratefulness.

Our next contact is Australia, and we chat with VK4BB in Queensland for a short while. The band is very lively with ZL and VK calls and it is an easy matter to establish contact on less than ten watts average plate power to the final stage of the transmitter. The winter morning conditions appear preferable to summer evening conditions for ZL and VK.

QRT for Breakfast

Our old friend PYIAW in Rio de Janeiro is active and we are pleased to call him as representing a possible South American contact. We miss him first call and find him answering another English station, but we stand by, and a certain amount of patience is rewarded by a very cheery QSO with this very enthusiastic Brazilian amateur. By this time, with two continents logged and worked, we are QRT for breakfast and renew our activities in great comfort an hour later. There appears to be considerable B.E.R.U. activity as the low power contest is in operation. By dint of wading carefully through the ethereal morass we hear the well-known Porto Rico station K4SA working morse with the Argentine. K4SA is best remembered for his excellent telephony transmissions which were so consistently received during the evenings of last summer. In reply to his QRZ? call we switch on the transmitter and obtain a very encouraging R6 report from the West

Indies. K4SA's strength warrants a request from us for his 'phone and his cheery Americanisms come back to us across the Atlantic. For a few minutes we exchange brief reports concerning condition and close with the usual 73's.

Two Jamaican stations are heard calling Australia, their calls VP5AB and VP5PZ are duly logged and the dial setting noted in case we wish to listen again for the chance of a contact. By this time, with the arrival of noon, several Canadian and American “hams” are calling and working and we reply to the faint CQ calls from W4AGP, who returns with a good report on our signals and some interesting remarks with regard to general conditions.

The communications so far have been carefully checked up for latitude and longitude with the aid of an atlas, since we are endeavouring, by averaging a number of reports from different districts, to obtain the effective ray distribution from the aerial which is a little unconventional in the matter of dimensions and method of feed.

Three continents have been worked before lunch and we adjourn to feast and take a short rest from wearing headphones, which, however light, become somewhat painful after a few hours' continuous use.

At 14.00 G.M.T. we resume activities and search awhile amongst the general buzz of activity in which atmospherics, now transmitted from Equatorial zones, are playing a part. This indicates the possibility of communication with India and Africa, and it is not long before we hear VU2JT in Karachi. His signals are very weak, but he appears to be in contact with a British amateur station, and he is duly logged—the first VU of the year. Then the rare stations really commence to reach audibility. Out of the receiver mush, similar in manner to the sudden focusing of a lens upon a picture, we hear stations in Mauritius, Tanganyika, Madagascar, Kenya and the Belgian Congo. It is indeed a thrill and fully repays many blank hours of futile listening.

Two-way communication is established with V8AC (Mauritius), VQ3BAL (Tanganyika), VQ4CRP (Kenya) and FB8C (Madagascar), and by this time we are wondering what the next turn of the dial will bring us from the far-flung places of the earth. It is with the greatest satisfaction that we follow up with a fine contact with VS8AB at Singapore Harbour.

It requires one European contact to achieve W.A.C. in one day without any particularly undue effort. ES5C (Esthonia) obliges us in this respect.

All the results obtained have to be carefully checked against the theoretical charts to see what figures may be obtained; this is a task for some later evening.

It is now 17.00 G.M.T. and the widespread activity has slightly subsided. South African amateurs are calling us and we succumb to the temptation of ZT6M, with whom we have a brief conversation.

Finally, in the gathering twilight with the gradual dwindling of distant stations into inaudibility, we hear faint signals from a W5 and then silence as the skip distance rises rapidly with nightfall. This ends a remarkably good day, during which time consistent communication with every continent has been possible without resort to freak effects. With the approaching sunspot maximum a repetition of these results should be a simplified matter with, apart from summer periods, an extended nighttime activity and we therefore predict an excellent spell of DX conditions.

Current Topics

EVENTS OF THE WEEK IN BRIEF REVIEW

News by Television

A TELEVISION news theatre is to be included in an entertainment centre to be constructed in Tottenham Court Road at a cost of £500,000.

Jewish Broadcasting Station?

ACCORDING to the Norwegian journal, *Haugesunds Avis*, a London banking firm has undertaken to raise £300,000 for the erection of an international Jewish broadcasting station.

Radio Pavilion

ONE of the attractions in the "Albertum" Pavilion at the Brussels International Exhibition this year will be a glass-walled broadcasting studio. There will also be radio and electrical exhibits, not omitting television.

Open to All

MR. A. HALL will open a discussion on "The Servicing of Broadcast Receivers" at an informal meeting of the Wireless Section of the Institution of Electrical Engineers on Tuesday next, March 26th. The meeting will be held at 6 p.m. at the Institution, Savoy Place, Victoria Embankment, London, W.C.2, and will be open to non-members. Tickets of admission will not be required.

Another Public Enemy

ELECTRICAL interference is now described in America as "Radio's Public Enemy No. 1." A campaign to round up this ubiquitous culprit is being organised by the Radio Manufacturers' Association, which is forming a Joint Committee on Radio Interference Abatement. At least one half of the noises that mar home reception, it is maintained, can be traced to electrical circuits and appliances within a few hundred feet of the listener's set. The popularity of all-wave reception with highly sensitive receivers during the last few years has intensified the problem of man-made static.

Listening in the United States

THE total number of radio homes in the United States on January 1st last is placed at 21,455,799 in a census report issued by the Columbia Broadcasting System. To this number the report adds 1,800,000 radio-equipped cars and 2,295,770 homes having two or more radio sets, making a grand total of 25,551,569.

A B.B.C. for U.S.?

PRESIDENT ROOSEVELT, when he leaves the White House, may, according to the *Morning Post*, be the managing director of a Federally owned and operated broadcasting system on the lines of the B.B.C.

Parasite Control

ANTI-INTERFERENCE officers in France go under the official title of "Controllers of Parasites"—a picturesque description which has not failed to impress the comic writers. It is suggested that the officers should take a turn in the French Chamber of Deputies.

Scrapbook of 1934

THE Viennese have a flair for picturesque statistics. Thus the Ravag broadcasting organisation states that the number of gramophone records broadcast during last year would cover a surface area greater than that of

Short Waves for China

THE Chinese Ministry of Communications has placed a contract with the Marconi Company for seven short-wave stations to form part of a network of new wireless communications services linking up the principal cities and commercial centres of China.

Finding a Name

WHILE no British expression has been coined to replace "looker-in," it is interesting to study attempts to discover an equivalent in France. According to the Paris correspondent of the *Sunday Times*, suggested names include "téléviste," "télévisiste," "télévidiste," "télévoyante," "visiophile," "téléviseur," "Téléspecteur"

German Listeners

ALTHOUGH British licence figures outstripped the German over a year ago, the latter are still following hard on our heels, and the total is now 6,599,721. The total number of listeners has increased by nearly half a million in the first two months of this year. The 40,000 listeners in the Saar territory are not included in the above figures.

Short-wave Rally

UNDER the auspices of the International Short-Wave Club, a short-wave rally is to be held at the "Accaris Café," Clock Tower, Leicester, on Sunday, March 31st, at 3.30 p.m., when there will be talks and demonstrations of short-wave reception. Members will attend from districts as widely separated as London and Manchester. After tea a tour will be made of the amateur stations in the Leicester district. Full particulars can be obtained from the European representative, Mr. Arthur E. Bear, 10, St. Mary's Place, Rotherhithe, S.E.16.

Silent Royalty

A GOOD story concerns a recent effort to broadcast the voice of the Swedish Crown Prince on his return from a voyage to the Far East. Delegates from various associations were grouped on the railway platform, and Mr. Sven Jerring, the announcer, hid himself with his microphone behind a group which expected to be greeted by His Royal Highness. Sure enough the Prince came along, but to the dismay of Mr. Jerring, no word proceeded from the royal lips. Only after the royal visitor had passed on did the announcer catch sight of a small banner held by the leader of the group bearing the device: "The Society of the Stone Deaf."

Radio Vacancies in R.A.F.

NEARLY 500 vacancies will occur in August next for well-educated boys, aged 15-17, to be trained as aircraft apprentices in the Royal Air Force trades of fitter, wireless operator, mechanic, and instrument maker. Full particulars regarding enrolment and conditions of service may be obtained from the Secretary, Air Ministry, Gwydyr House, Whitehall, London, S.W.1.



COPENHAGEN CALLING. Miss Grethe Otho, the only permanent lady announcer in Scandinavia, is daily on duty at Copenhagen-Kalundborg from dawn till 2 p.m.

the Austrian capital. Talks approximated to forty-eight volumes of 500 pages each, while the musical scores played through during the twelve months under review would, piled on top of each other, make a tower 750 feet high. Running commentaries would fill 3,500 newspaper pages. The price for Wagner relays was a tram ticket per listener.

The Anti-Interference War

SWEDEN recently tackled the interference problem with a three-day conference in Stockholm attended by more than a hundred delegates, including representatives from Germany.

and "longemireur" are among other suggestions not likely to be entertained.

N.E.R.A.

MEETINGS of the National Radio Engineers' Association during next week will be as follows:—

March 25th.—(W. London) Bush Hotel, Shepherd's Bush.
March 27th.—(S.W. London) Alexandra Hotel, 14, South Side, Clapham Common.
March 28th.—(N. London) Alpha Cafe, 306, Seven Sisters Road, Finsbury Park.
March 29th.—(W. Middlesex) Holy Trinity Church Hall, Southall.

At each meeting, which will be held at 8.15 p.m., service technique will be demonstrated. Meetings are open to all whose occupation requires a knowledge of radio principles.

High-Definition Television

in Germany

Public Tests Begin
at Berlin "Funkturn"

By Our Berlin Correspondent

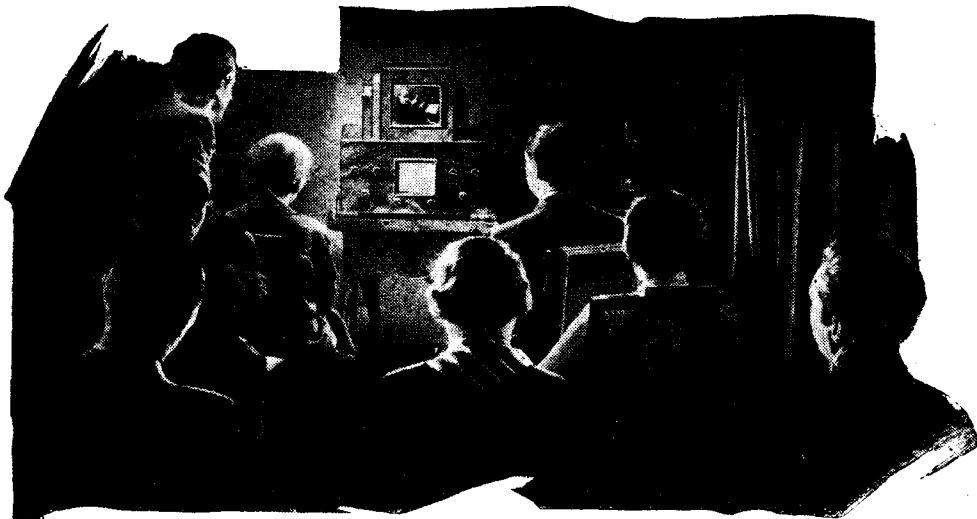

HITHERTO high-definition television tests in Germany have been confined to scientific laboratories and a few expert amateurs. To-day (Friday) a regular sight and sound service begins from the Broadcasting Tower in Berlin and all members of the public can participate.

THE ultimate aim of those responsible for broadcasting in National-Socialist Germany is to make it technically possible for every German not only to listen to the speeches of the Führer but also to see him speaking. The present development of broadcasting has made the first aim possible, and now work is being speeded up to provide a suitable television service so as to realise the second.

The German Post Office laboratories started high-definition test transmissions in August, 1933. At that time 90-line pictures were broadcast. A few months later, in 1934, a second ultra-short-wave transmitter was provided and this was used for 180-line pictures, the accompanying sound being broadcast by the older transmitter. These stations operate with a power of 16 kW, but the long feeder line up the Witzleben radio tower which supports the two dipole aerials, 430ft. above ground level, consumes a portion of this. Taking this into account and making use of the usual Copenhagen formula for calculating power of broadcasting stations, the power in the aerial can be said to be approximately 1.5 to 2 kW, a very large amount for ultra-short waves.

Thirty-Mile Range

Up to the present the reception of these test transmissions, which have taken place for several hours every day, has been limited to scientific laboratories and to those television amateurs capable of building their own ultra-short-wave receivers and of handling the high voltages required for successfully operating cathode ray tubes. The Post Office engineers broadcast strips of film, and although these were

often interesting there was no definite programme, and one could therefore not talk of entertainment value. The German Broadcasting Company's decision to start supplying regular programmes will be welcomed by all concerned in Germany, as now the question of supply of receivers will come nearer solution. One German firm, Loewe, claim to be able to supply all-mains-operated sight and sound television receivers for RM. 600. These receivers are comparatively simple to operate and have already been demonstrated in London to the Television Committee as well as in Berlin. Another German firm,

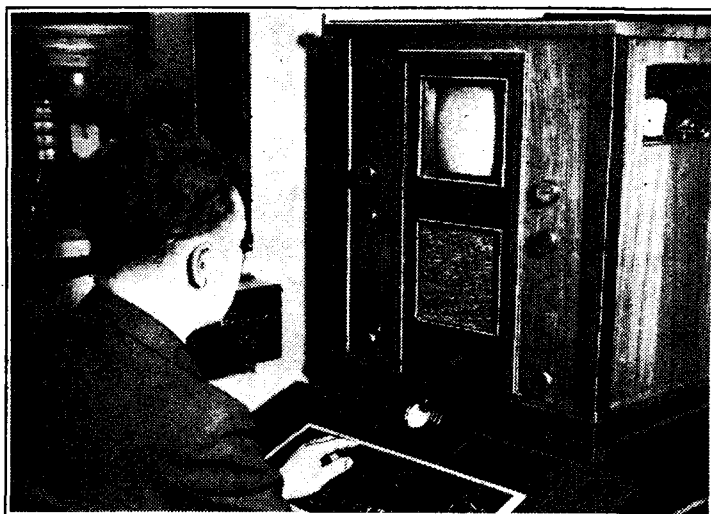

The check receiver and modulation control panel at Broadcasting House, Berlin. The apparatus was constructed by the Telefunken Company.

Telefunken, supply a much larger type of apparatus, although the actual picture is not very much bigger. At the present moment it is not to be expected that a

large number of the German public will buy television receivers. The broadcasters, however, have ordered a certain number from both companies, and these receivers will be suitably distributed in the service area of the short-wave transmitters. Tests have proved this to be within a radius of some thirty miles from the radio tower. The persons entrusted with looking-in will then be asked to provide constructive criticism both as to the nature of the programmes and of the actual practical working of the receivers and the entertainment value achieved. Meanwhile the German Post Office laboratories and Telefunken are hard at work perfecting a system of electrical scanning, and are also working on the problem of suitable amplifiers and cables to provide for an even higher degree of definition than the present 180 lines. In Germany it is generally accepted that 180 lines is the minimum for a television service with entertainment value. On the other hand,

the difficulties of practical high-power ultra-short-wave broadcasting with even higher definition are at present considered to be too great to warrant the further retarding of the public television service. It will be remembered that in Germany 30-line transmissions never took place on any large scale, and therefore, as far as the German general public is concerned, they are still strangers to television except for what they have

seen at the various radio exhibitions. One hundred and eighty lines and twenty-five frames per second means a frequency band of 500,000 cycles for transmission,

High-Definition Television in Germany— and 240 lines would mean one million cycles. Most people realise that this is too big a jump, especially when a practical system of 180 lines actually exists and suitable receivers are available.

Television News Reels

The opening of the television service, which was first scheduled for the second week in March, has now been definitely fixed for to-day (March 22nd). Programmes will be broadcast three times a week from 8.30 p.m. to 10 p.m. CET, and will consist of excerpts from news reels and of a full entertainment film. Programmes will be changed once a week as at a cinema. Within a short while after the opening of the service the German Broadcasting Company will start providing its own news reel. A suitable sound-recording car with the necessary lighting van has already been ordered. These news reels will be taken and processed in the usual manner, and broadcast each evening under the title: "Mirror of the Day." Apart from these ordinary news reels use will be made of the daylight television van operating on the intermediate film system to provide red-hot actuality broadcasts of important events. These will be



Television reporting van with which events will be filmed for subsequent transmission in the high-definition test programmes.

broadcast at the time of happening, and will then be repeated in the evening again.

The transportable twin ultra-short-wave transmitters which were ordered some months ago are now nearing completion, and it is hoped to start tests with the second set of high-power transmitters in the late spring. These transmitters are first to be tried out on the Brocken mountain, and modulation will be received from Berlin by wireless link. The transmitters themselves will all be mounted on suitable trucks for transport by road.

The opening of a public high-definition television in Germany at the present moment can be considered as a preliminary run to gather practical data on the actual service requirements, and programmes will gradually be developed

from week to week. On the other hand, the laboratories will be at it full speed ahead to produce a "Volks-Fernseher" (a people's television set). The quality of the pictures at present transmitted from the Berlin Broadcasting House and received on a Telefunken receiver is exceptionally good, and it was possible to look in for a full half an hour at a film and really enjoy it. Naturally 240 lines would be better, but the Germans think quite rightly that for the small circle who will be able to afford relatively expensive receivers 180 lines has sufficient entertainment value. To-day the Press will be generally invited to the opening, and important pronouncements may be expected, especially as a technical German research engineer has only just returned from

to frequency monitors, transmitters and aerials. The handbook contains a full list of all the recognised abbreviations used in CW transmission together with those com-

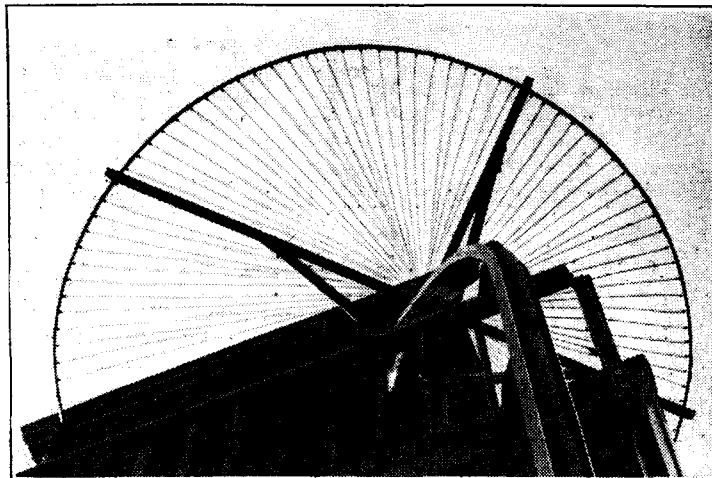

A close-up of one of the ultra-short-wave transmitting aerials and counterpoises at the top of the Berlin broadcasting tower. To-day (Friday) two transmitters open a regular service of sight and sound programmes for all members of the German public who care to buy television receivers.

monly employed by amateurs the world over.

It is a work that will appeal to the beginner as well as to the experienced amateur, and copies can be obtained from F. L. Postlethwaite, 41, Kinfauns Road, Goodmayes, Essex, and the price is 4s. 6d. post free at the present rate of exchange.

H. B. D.

Hivac Midget Valves

A SERIES of three miniature valves is now being produced by the High Vacuum Valve Co., Ltd., of 113-117, Farringdon Road, London, E.C.1. Two of the valves are triodes of the high- and medium-impedance type, while the third is a screen-grid valve—the first, we believe, of its kind to be available commercially.

Although the valves are so small, they appear to be robust. Their characteristics are comparable with those of normal valves, but naturally the mutual conductance is slightly lower. The filament current is given as 0.06 amp. at 2 volts, so it would be practicable to use dry-cell LT batteries.

The introduction of these new valves opens up interesting possibilities in the way of truly portable sets or even "pocket sets," and for police use, etc. The price of the triode valves has been fixed at 10s. 6d., while the screen grid type costs 15s. 6d.

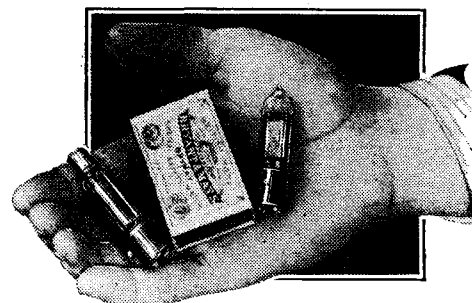

The new miniature valves; the screen grid type is seen on the left.

America where he is said to have investigated systems of electrical scanning.

Amateurs' Short-Wave Handbook

A COMPREHENSIVE reference book under the title of "Radio Amateurs' Handbook," published by the American Radio Relay League, West Hartford, Connecticut, U.S.A., is now in its twelfth edition and covers every aspect of amateur activity on the short waves. It is very fully illustrated throughout, and sections are devoted to the fundamentals of electricity and wireless which are explained in a lucid and easily understandable manner.

Modern short-wave receiving technique is dealt with, and there are chapters devoted

New Types of Short-wave Tuned Circuits

HF Amplification on the Ultra-short Wavelengths

STRAIGHT HF amplification on the ultra-short waves may not be worth while with the orthodox tuned circuit, but the somewhat novel designs discussed in this article, though developed primarily for frequency stabilization, have interesting possibilities in this field.

IN recent years there have been two major developments in broadcast radio-communication which have brought into prominence the problems of short-wave radio technique. The first of these was the institution of the Empire broadcasts on 13.50 metres, and the second, more recent, is the prospect of high definition television on waves possibly as short as 3 metres.

In the long- and medium-wave bands there is almost an *embarras de richesses* of efficient receiving circuits, but in the ultra-short and short-wave bands the position is quite different. Supersonic

resonance. Consider, for example, a circuit intended to tune to, say, 20 metres with a capacity of 100 $\mu\mu\text{F}$. The inductive reactance ($2\pi \times \text{frequency} \times \text{inductance}$) will be only about 100 ohms. The "goodness," "voltage magnification," "Q," or whatever other name is used for inductive reactance divided by resistance ($\omega L/R$) is therefore 100 divided by the total effective resistance of the circuit. At these high frequencies, the so-called "skin-effect" gives the coil a resistance very much greater than its continuous current value, and the total effective resistance might be as much as three or four ohms—giving a

"Q" of only 25 for the higher value, with correspondingly poor selectivity and voltage magnification by resonance. The amplification given by such a coil in the anode circuit of a valve will depend on its so-called "dynamic resistance" (R_d)—i.e., the square of the inductive reactance divided by the total resistance. At long and medium wave-lengths this quantity

sistance of between two and three thousand ohms only, and, with a valve having a mutual conductance of, say, 2 m.a. per volt, could not be expected to give an amplification of more than four or five at best, and would certainly give less than this in practice.

There is comparatively little exact information available as to the practically realisable values of Q and R_d in coil circuits intended to tune to wave-lengths of, say, 20 metres and less—the measurements are not easy to make—but the well-known difficulty of maintaining oscillation at such short waves by means of the dynatron circuit is additional confirmation of the low R_d values indicated above.

It appears, then, that coils of normal design are not likely to prove adequate for really efficient short-wave reception, and any available alternatives should be explored. Two such alternatives have recently been described in American and Russian publications.

The first of these, due to F. A. Kolster (Proceedings of the Institute of Radio Engineers, Dec., 1934), is not so much an innovation as a logical development of the ordinary tuned circuit. It is, in fact, a tuned circuit constructed in such a way as to give the maximum conducting surface for a given inductance and, moreover, to embody the capacitance in a manner that dispenses with solid insulation and its associated dielectric losses. The

type of construction is illustrated diagrammatically in Fig. 1. The inductance consists of the central copper tube and the two copper hemispheres—it is, in effect, a single toroidal turn, the effective inductive area of which is shown shaded in Fig. 1b. The capacitance is mainly the mutual capacitance of the

two ring flanges, but there will be in addition the self-capacitance of the sphere as a whole.

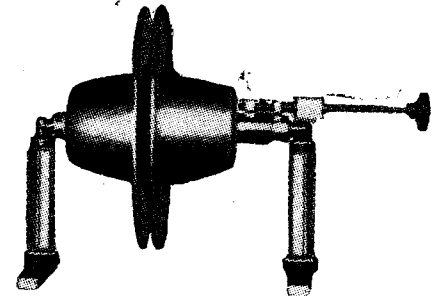

General appearance of the circuit constructed in accordance with design data given by F. A. Kolster in Proceedings of the I.R.E., December, 1934.

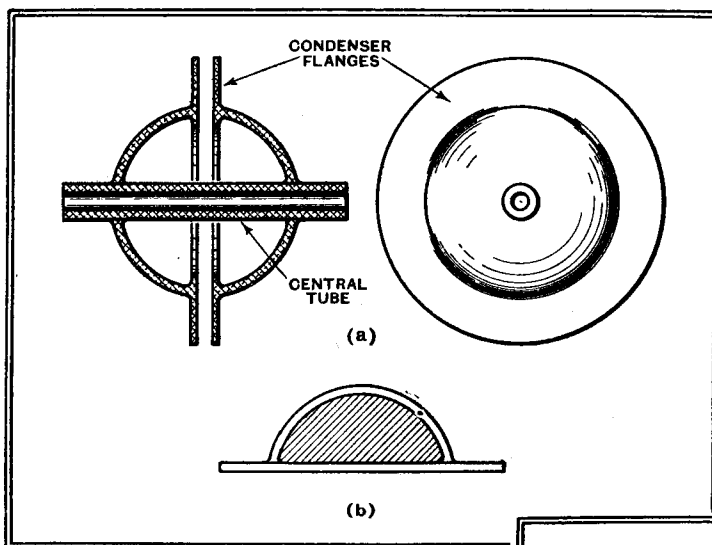

Fig. 1.—Novel design of the tuned circuit. The two hemispheres provide the inductance (shaded in b) and the flanges the capacity.

heterodyne reception can be, and is, used at very short wavelengths, but the requirements in respect of oscillator stability are severe, and are not easily fulfilled. Signal-frequency amplification can be used, with screen-grid valves, but the amplification per stage, if any, is measured in units, rather than the tens and hundreds obtainable at longer wavelengths.

In all cases the principal difficulty is that of obtaining, with reasonable economy of space and material, selective tunable circuits giving, at very short wavelengths, a useful degree of voltage magnification by

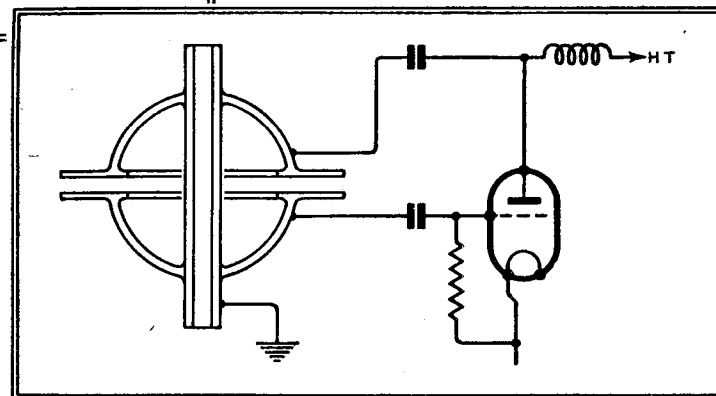

Fig. 2.—Spherical tuned circuit connected as an oscillator.

may be anything up to a megohm for a really good coil, but the short-wave coil specified above would have a dynamic re-

New Types of Short-wave Tuned Circuits—

These circuits have been developed primarily as oscillators or transmitters with connections such as are shown in Fig. 2. The great area of copper conducting surface makes the arrangement almost ideal for these purposes, since the current carrying capacity will be very large, and the temperature rise under load (with its consequential drift of frequency) will be kept to a very low value by the large radiating surfaces. Equally important in this connection is the low power factor of the circuit, i.e., the high values of Q and of the dynamic resistance R_d . The values of Q obtainable by this construction are, in fact, enormous—from 600 to 2,000! In this respect such circuits compare well even with quartz crystals. Indeed, it is stated in the article that the circuit is superior to the quartz crystal as far as frequency stability is concerned, and has, of course, a very great superiority in volt-ampere capacity. It is also a simple constructional matter to make the flange separation a variable for tuning purposes.

Parallel-wire Resonators

The disadvantage, as far as any application other than to transmitters is concerned, is the relatively large size of the circuits for all except the lowest wavelength. Thus, for a wavelength range of 10-15 metres, the diameter of the condenser flanges is about four feet, and the centre tube about two feet. At very short wavelengths, however, the size is not impracticably large. Thus, at 5 metres, a Q of about 1,000 can be realised with a sphere diameter of five inches, and a flange diameter of thirteen inches. This brings it into the region of practical politics for use in receivers for short-wave television, for example.

For most of the applications in which readers of this journal are likely to be interested, however, there would seem to be more promise in another method of realising low power-factor at short wavelengths described in some detail by F. E. Terman in an article published in the American journal *Electrical Engineer-*

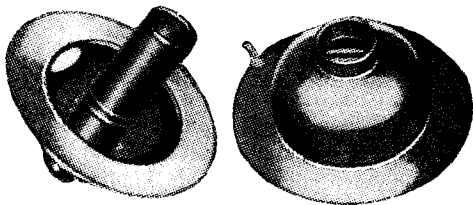

Component parts of the spherical type of circuit.

ing (July, 1934). Here again the basic principle involved is not new, but new and interesting applications are developed. Briefly, it consists of utilising parallel lines or concentric tubular conductors as resonant systems. In other words, the distributed inductance and capacitance of such lines are used in place of the lumped or localised inductances and capacitances of ordinary tuned circuits. It is claimed that, by suitable design, impedances (equivalent to the dynamic resistances of tuned

circuits) of the order of 100,000 ohms, and Q factors of from 500 to 5,000 can be obtained at wave-lengths of 10 metres or less, in systems of practicable size.

This idea had already been exploited with great success in the design of short-wave transmitters, which application appears to have been originated by Messrs. Conklin, Finch & Hansell (*Proc. Inst. Rad. Eng.*, Nov., 1931), and the further applications to all the other functions of tunable resonant circuits is a logical development from this initial success.

For the majority of such applications, the most useful basic system is a pair of wires, or two concentric tubular conductors, one-quarter of a wavelength long, and short-circuited at one end, as shown in Fig. 3. In the same diagram are shown the current and potential distributions for such a line, excited at the open end.

For the full realisation of the potentialities of such systems it is essential that there should be suitable ratios between the diameters and spacings of the tubes or lines, and it is in this field that Terman's

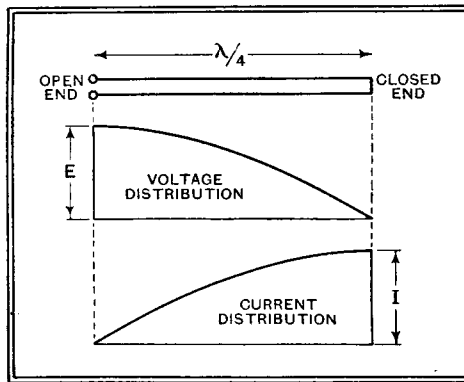

Fig. 3.—A quarter-wave transmission line can be utilised as a resonant system and the voltage and current distribution are shown in the curves.

paper is of special value, for it gives all the relevant design formulæ and curves. Thus, for a quarter-wave transmission line, the open-end impedance (which, for uniformity with the description of the tuned-sphere circuits, will be called R_d) is given by

$$R_d = 23.95 G b \sqrt{f} \text{ ohms,}$$

where f = frequency in cycles/sec.,

a = conductor radius in cms.,

b = spacing between wire centres in cms.,

and G is a factor depending on the ratio of b to a , as shown in Fig. 4.

For values of b/a from about 7 to 15, G can be taken as unity, and the formula simplified to

$$R_d = 23.95 b \sqrt{f}.$$

Suppose, for example, the frequency is 30 megacycles per second (wavelength 10 metres), then

$$R_d = 131,000 \times b \text{ ohms,}$$

giving 131,000 ohms for a pair of lines of radius 1 mm. and spacing 1 cm. and 2.5 metres in length.

The length may seem to be an objectionable feature, but this difficulty can be overcome by coiling up the pair of lines on a convenient diameter. In this case it

will probably be desirable that the pitch of the pair shall be at least equal to the spacing between centres, and preferably greater than this. The quarter-wave line for a 10-metre wavelength could thus be accommodated on a cylindrical former of about 10 cms. diameter and 20 cms. length, and it is quite certain that a normal

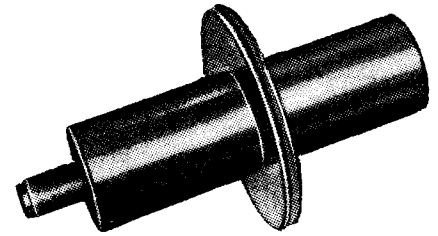

Replacing the hemispheres in the tuned circuit by copper cylinders gives a larger inductance component. Design suggested by F. A. Kolster in December, 1934, issue of Proceedings of the I.R.E.

tuned circuit giving this dynamic resistance could not be constructed in so small a space.

It is possible that coiling the pair will result in some little decrease of the resonant impedance. Terman gives no exact information on this point, but it may be mentioned that some Russian workers have been experimenting with parallel-wire systems as oscillating circuits (*Russian Journal of Technical Physics*, No. 2, Vol. 4, 1934), and report that about the same stability of oscillation was realised with straight and with coiled pairs of wires, suggesting that there was no significant increase of power-factor as a consequence of coiling.

One rather curious feature of the resonant line is that the selectivity factor Q (determined, in this case, as the variation of impedance with frequency, in the neighbourhood of resonance) reaches its highest value for a spacing ratio different from that giving the highest resonant impedance. The formula for Q is

$$Q = 0.0887 J b \sqrt{f},$$

where J has the values shown in Fig. 5, and reaches its optimum value of unity,

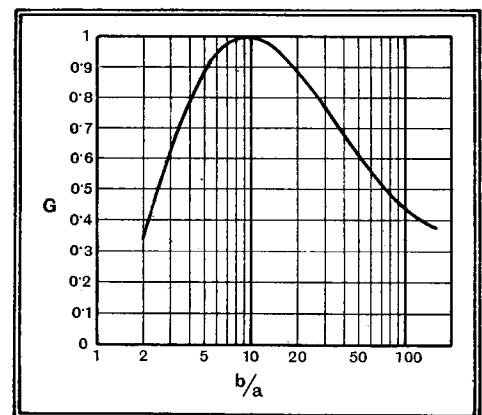

Fig. 4.—Curve relating spacing between wires in transmission line (b) with radius of conductor (a) and giving a factor G for calculating open-end impedance of line.

when b/a is about 2.7. This factor is not critical, however, and a spacing ratio of from 6 to 8 is a useful compromise in respect of both features. In certain applications, however, the Q factor will be the

New Types of Short-wave Tuned Circuits— objective and the smaller spacing ratio will be appropriate.

For the line already considered and a frequency of 30 megacycles/sec., the above formula gives a Q of about 485—an enormous value compared with those for normal tuned circuits at such short wavelengths.

Terman gives a number of examples of

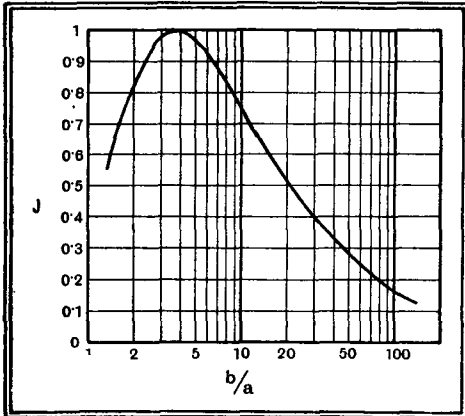

Fig. 5.—The selectivity factor Q for the resonant transmission line discussed in the text takes into account a factor J which is related by the above curve to the spacing and radius of the wires (b/a).

applications of resonant lines to receiving and oscillating circuits. Fig. 6, for example, illustrates an oscillating circuit which is clearly the same in type as a well-known quartz-crystal oscillator circuit, but with a resonant line substituted

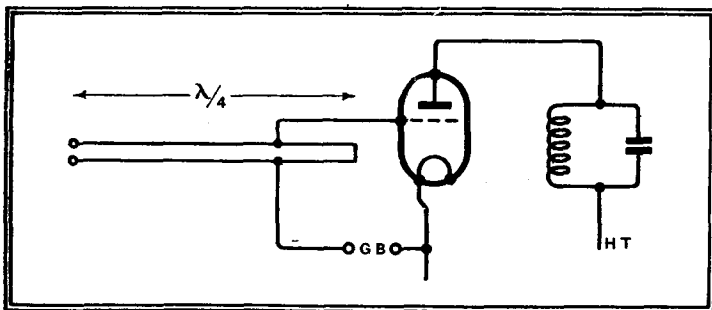

Fig. 6.—Method of connecting a quarter-wave transmission line for stabilising an oscillator.

for the crystal. It will be observed, moreover, that the input terminals (grid-filament) are tapped on the line near to the short-circuited end. This has the effect of giving a loose coupling between the line and valve, minimising what would otherwise be an excessive damping effect of the valve on the line. It is found that oscillators can be stabilised in this way to a degree that compares well with, or is even superior to, that given by quartz crystals. The system lends itself, moreover, to temperature stabilisation by using a line construction such that the effective length of the line is very little

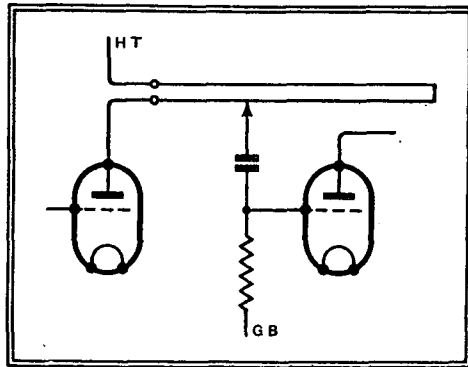

Fig. 8.—A modification of Fig. 7 to reduce circuit damping.

affected by temperature. The relatively very large volt-ampere capacity of the line as compared with a crystal is also a valuable feature in this respect.

Fig. 7 shows a resonant line used as an anode-circuit load for radio-frequency amplification. In such connections it must be remembered that the input capacity of the valve will affect the resonance conditions. The length of line giving maximum input voltage will probably be found to be somewhat less than a quarter of a wavelength, giving an inductive line reactance which balances the capacitive reactance of the valve input circuit. Also, the damping effect of the losses in the valve input-circuit may need to be minimised by some connection such as that shown in Fig. 8. Terman gives very little detailed information with regard to the effect of association with valve circuits on

the performance of the resonant lines—probably because comparatively little is yet known with any exactness as to the nature of valve input-circuit impedances at very short wavelengths. The best means of utilising the valuable properties of resonant lines in valve circuits is a

matter for experiment and trial, and appears to open up a new and interesting field. It is probable that in most cases optimum coupling conditions can be found empirically by adjustment of the points

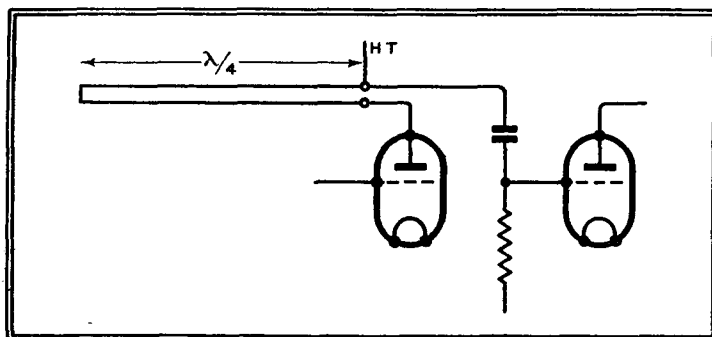

Fig. 7.—Transmission line used as an inter-valve HF coupling.

of connection of the load or input circuit to the line.

One particularly interesting suggested

application illustrated by Terman is that shown in Fig. 9, in which three pairs of open-ended lines are assembled in such a way as to constitute a band-pass filter. Another useful possibility arises from the fact that a short-circuited pair of lines of length greater than a quarter-wave and less than a half-wave (Fig. 10) has a capacitive reactance, and thus constitutes, in effect, a condenser capable of passing direct current.

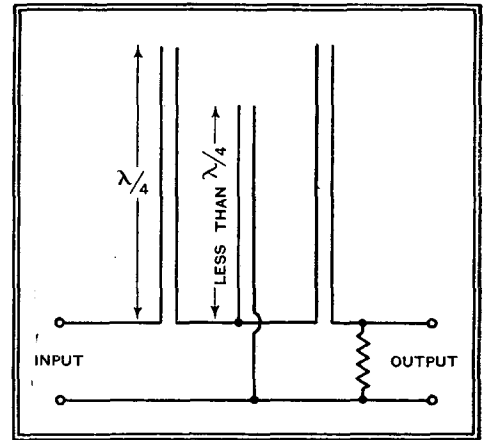

Fig. 9.—Connection of transmission lines to give band-pass characteristics.

As already intimated, the possibilities of suitably designed pairs of lines—or, of course, of concentric tubular conductors—are by no means fully explored as yet, and

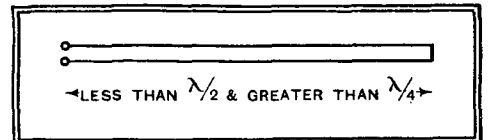

Fig. 10.—A transmission line of length suitably related to the wavelength has a capacitive reactance and in effect constitutes a condenser but capable of passing DC.

the main purpose of the present note is to give publicity to the idea and to stimulate experiment in this new field.

BLUE PRINTS

For the convenience of constructors full-sized blue prints are available of the following popular *Wireless World* sets that have been fully described for home construction, price 1s. 6d., post free.

Olympic 8-8 Six. (Six-valve Single-span AC Superheterodyne in two units.) **Aug. 10th, 17th and 24th, 1934.**

Universal Single-Span Receiver for AC or DC mains. (Six-valve Superheterodyne.) **July 6th and 13th, 1934.**

New Single-Span Battery Four. (Four-valve Superheterodyne.) **Dec. 7th and 14th, 1934.**

1935 AC Short-Wave Receiver, 12-70 metres. (HF-det-Pen with valve rectifier, in two units.) **Aug. 31st and Sept. 7th, 1934.**

Standard Battery Two. (Detector and QPP Output Stage.) **Sept. 28th, 1934.**

Standard AC Two. (Detector and LF giving over 2 watts output.) **Nov. 9th, 1934.**

Standard AC Three. (Straight HF-det-Pen circuit with valve rectifier.) **Oct. 19th and 26th, 1934.**

QA Receiver. (AC Four-valve HF and detector unit designed to work with Push-pull Quality Amplifier.) **Feb. 8th and 15th, 1935.**

Push-Pull Quality Amplifier. (AC resistance-coupled double push-pull.) **Feb. 22nd, 1935.**

These can be obtained from the Publishers, Hiffe and Sons Ltd., Dorset House, Stamford Street, London, S.E.1.

Broadcast Brevities

By Our
Special
Correspondent

Little by Little

"THE Little Nationals" has always seemed to me a peculiar designation for transmitters agitating the ether to the tune of 50 kilowatts. (In America such stations are outsize.) Now, however, it appears that the epithet is no longer applicable, for the power of the London, North and West Nationals has, I believe, been surreptitiously reduced in the last few days.

Blaming the Receiver

It seems a pity that such changes cannot be officially communicated to the public, for they must inevitably affect reception, and the long-suffering listener naturally blames his set before suspecting the great and good B.B.C.

"Wave Squatting"

So long as the Little Nationals operate, no matter on what power, they monopolise the 261.1-metre wavelength, preventing it from being appropriated by foreigners. But to use three Regional stations simply for this purpose is more spectacular than economical.

Trailing Clouds of Glory

MR. GERALD COCK will leave the "O.B." department at the psychological moment—just when his star in this direction shines brightest, for the Jubilee celebrations will mark the biggest series of outside broadcasts, or *reportages*, in the history of the B.B.C.

Twenty-seven Circuits

Take the case of the Royal Procession to St. Paul's Cathedral for the Thanksgiving Service on May 6th. No fewer than twenty-seven microphone circuits will be involved.

The chain of microphones will begin at Aldwych, extending past St. Clement Dane's, Temple Bar, down Fleet Street, across Ludgate Circus, and up the hill. Listeners will hear the cheers of the crowd, the peal of bells in the towers of St. Mary-le-Strand, St. Clement Dane's, St. Dunstan's-in-the-West, St. Bride's, Fleet Street, and St. Martin's, Ludgate, the latter melting into the strains of the organ in the Cathedral.

Where Experience Tells

At strategic points commentators will paint word pictures of the glittering procession and the cheering crowds, what time Mr. Cock and his staff are operating, with the easy skill of long ex-

perience, an immense cluster of gain controls and microphone switches to obtain a faultless broadcast.

An Evening to Remember

The evening of Accession Day will be singularly rich in special broadcasts. Rudyard Kipling himself will be heard at the microphone, following the dinner of the Royal Society of St. George in the Connaught Rooms. There will be an all-star variety programme from one of the larger provincial theatres, with Jack Payne taking a leading part; but the main event of the evening will, of course, be the Empire-wide speech of the King from Buckingham Palace. This will be given in a small room looking on to the Inner Courtyard, where His Majesty will be able to speak undisturbed by the cheers of the waiting crowds.

July 18th, 1934.—Opening of the Mersey Tunnel.

September 26th, 1934.—Launching of the "Queen Mary" (King and Queen).

December 25th, 1934.—Christmas Day, Sandringham.

The King's Microphone

No special microphone is reserved by the B.B.C. for the King's use. A thoroughly tested instrument is taken from stock and mounted in a case of Australian wood 10in. high with a gauze facing which completely conceals the instrument.

On each side are placed two similar cases, with oak finish, 8in. high, which contain the red lights for signalling from control.

Address of Loyalty

The King will again be heard on May 9th, when the Lords and Commons will present an Address of Loyalty to the Crown in Westminster Hall.

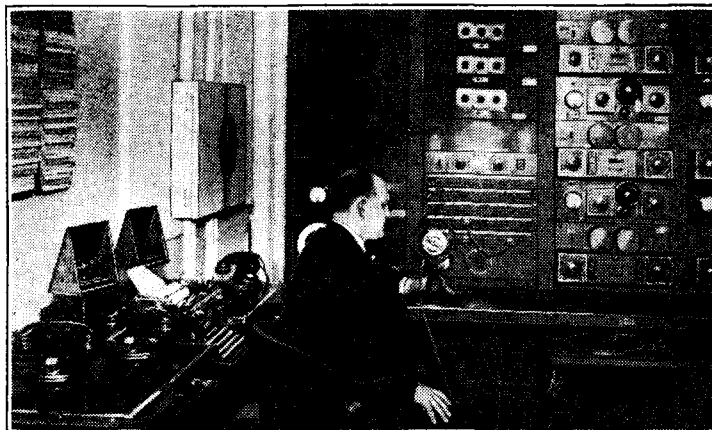

COMBING THE WORLD FOR TALENT. The control board at Radio City, New York, where British and Continental broadcasts are switched through to the various American networks. U.S. listeners hear a number of broadcasts from B.B.C. studios which go unheard in this country.

A Long Record

This will be the King's sixteenth broadcast, the first having been given as long ago as April, 1924, at the opening of the Wembley Exhibition. The complete list is as follows:—

April 23rd, 1924.—Opening of Wembley Exhibition.

April 21st, 1927.—Opening of National Museum of Wales, Cardiff.

June 21st, 1930.—Opening of London Naval Conference, House of Lords.

July 8th, 1930.—Opening of India House.

November 12th, 1930.—India Round Table Conference, House of Lords.

July 10th, 1931.—Opening of New Dock at Shieldhall, Govan, Glasgow.

July 18th, 1931.—Opening of King George Hospital, Ilford.

December 25th, 1932.—Christmas Day, Sandringham.

June 12th, 1933.—Opening of World Economic Conference, Geological Museum.

June 22nd, 1933.—Opening of South Africa House (Empire programme).

July 26th, 1933.—Opening of New Graving Dock, Southampton.

December 25th, 1933.—Christmas Day, Sandringham.

This Freedom

FAMOUS statesmen, a physician, members of the High Courts of Justice, authors and M.P.s will take part in a series of broadcasts during next quarter. The speakers will be asked by the B.B.C. to state their ideas of freedom and to say what they personally are prepared to sacrifice or concede in order to achieve it. They are not being selected on any political basis, although the increasing restrictions on mankind's liberty with which they will deal are mainly of a legislative character.

The series is expected to provide some of the most eminent leaders of thought with the opportunity for considerable outspokenness, supported *a fortiori* by freedom of the microphone.

Broadcast Feature on Gramophone Record

FILMS and gramophones are now coming to broadcasting for their material. Two interesting instances of this came to my notice last week.

The Columbia Graphophone Company has turned out a complete broadcast feature programme on two sides of record No. DX670, "Scrapbook for 1910"—the year King George came to the throne. This Jubilee record is a miracle of compression, for without any suggestion of haste Leslie Baily and Charles Brewer have included excerpts from "The Dollar Princess," "The Quaker Girl" (with Joseph Coyne in person), Mr. Claude Grahame-White in the first £10,000 Air Race, Pelissier's Follies (with Muriel George in person), Commander H. G. Kendall's account of the arrest of Crippen on the liner "Montrose," and several other highlights of the year.

"Charing Cross Road"

Then the British Lion Film Corporation is working on "Charing Cross Road," an adaptation of the radio play broadcast a few months ago. The production includes such stars as June Clyde, John Mills, Derek Oldham and Jean Colin and is being directed by Albert de Courville.

Any Complaints?

POSSIBLY the Post Office questionnaire form is responsible for the fact that the B.B.C. has received far fewer complaints of electrical interference in recent months. They are not accustomed to such public restraint at Portland Place, and the absence of complaints invariably produce a feeling of uneasiness.

Aerial Query

There has been less oscillation, too. The listening public is much more independent to-day than it was ten years ago, when the B.B.C. could be forgiven for a grandmotherly attitude towards a public which had not really mastered the most elementary facts of radio.

Even now curious letters are received. Here is an extract from last week's postbag:—

"My aerial appears to be exactly to your instructions, 102ft. high, but a neighbour two miles away is getting better reception from his wife's washing line, which is annoying."

And if a P.O. inspector observes that aerial, 102ft. high, it will be still more annoying.

UNBIASED

Very Odd

I HAVE heard extraordinary explanations of natural phenomena, such as the preference of gentlemen for blondes, but I really think that the reason I heard given last week for an elderly lady's preference for a gramophone instead of a wireless set just about beats the lot.

The good dame in question has for many years been addicted to chamber music and other noxious noises. One would have thought, therefore, that the average B.B.C. programme would just about fit her idea of perfect bliss and that a good wireless set would be one of her proudest possessions. In actual fact, she is known to possess only a gramophone, which is, however, in fairly regular use. She was eventually tackled on the matter by the local wireless dealer, who heard of her passion for Bach and thought he saw the opportunity of catering for it. She explained, however, that much as she would like a wireless set she preferred to keep her gramophone, as "you could always turn it off when you wanted to."

Under cross-examination she admitted that years ago, when living in a former locality, she did possess a set, but found it a great nuisance having to sit up till 12 nearly every night until the dance music from the local station had finished, as she found it quite impossible to sleep through the noise of the loud speaker. Furthermore, she added, the effects of the loud speaker made conversation with friends very difficult. Finally, she had given the set away to her sister, whose temperament was such that she did not mind that sort of thing. Apparently the set in question was one of the earliest all-

mutual satisfaction, but got in touch with the sister and succeeded in persuading her that there are times when silence is golden even on the part of a loud speaker.

I have been told by a well-known set manufacturer to whom I related this incident that it is by no means an isolated one and that to his certain knowledge there are many people with other and equally foolish ideas concerning the limitations or otherwise of a wireless set. Apparently they fall into the same category as those people who are fearful that the coming of television will mean that they will be seen in the privacy of their baths by unprincipled Peeping Toms.

By

FREE GRID

I, myself, have been wondering whether this idea that the wireless set cannot be "turned off when you feel like it" can possibly account for the existence of the daily drooler who allows his loud speaker to go on continuously churning out its stuff from morning to midnight every day as a sort of background to the normal activities of the household.

Teaser Models

I HAVE not infrequently discussed in these columns the policy of certain wireless manufacturers who adopt what is known as the carton policy, refraining from letting their customers have the real working model of the set purchased until the age-old ritual has been gone through of sending and receiving back from the customer at least three dummy models which are, I believe, technically known among wireless dealers as "teasers" or "teaser models."

It appears, however, that in the case of one particular set-maker this policy has been carried to extreme limits. An irascible sister-in-law of mine recently purchased a new receiver of the make in question. The instrument, in its customary carton, had been dumped in the hall of her house and had been allowed to remain there a few hours while certain furniture rearranging, so beloved of most women, was carried out.

In the hall were several other packages, one of which was awaiting collection by

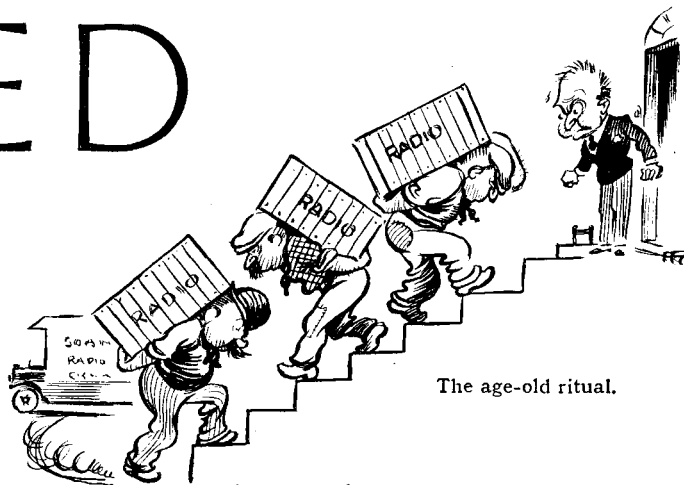

the van of a certain well-known firm of carriers. In due course the van arrived at a time when my sister-in-law was in the back garden. She had apparently forgotten to leave any definite instructions with the old family butler concerning which package was the one intended for the carrier, and was only just in time to stop the vanman from taking away the wireless set.

Cross-examination of the man elicited the fact that seeing the wireless set there he had naturally assumed that it was the package for which he had been summoned, since he explained that "fully ninety per cent. of the firm's business nowadays consisted in humping wireless sets to and fro between customers and manufacturer."—*Verb sap.*

Sold as New

A LONG overdue reform is sorely needed in the wireless trade, judging by what I have recently seen. Myself, I am always extremely careful where I get my valves, as certain unscrupulous dealers are not above using their stock valves for test purposes and then sticking them back in their cartons and selling them as new.

The other evening I happened to be in a strange district and had gone into a wireless dealer's to get a DO75 valve for use by an aunt who is somewhat hard of hearing. While waiting to be served I noticed that a radiogramophone was being demonstrated, or perhaps I should say that a girl-assistant was endeavouring to while away the weariness of the waiting customers by giving an impromptu gramophone recital. While I was there she played through quite a number of expensive records and not once did she change the needle. Close examination revealed to me the fact that the needle was not one of the semi-permanent type, but just an ordinary one. After playing, the records were stuck back on the shelves ready for selling "as new" to some luckless purchaser.

Not only were they not new, but they were badly chewed up by the old needle. They were still further damaged by the fact that the radiogramophone in use was a cheap instrument with a perfectly barbarous form of pick-up which had obviously not been mounted to get even an approximation of proper tracking.

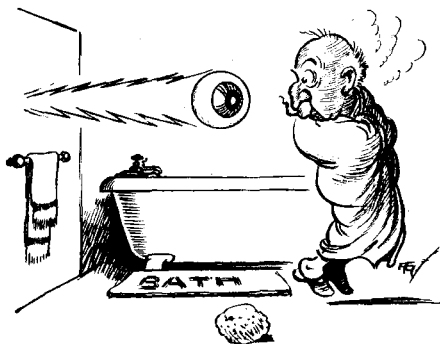

The coming of television.

mains type, some of which, as many of my readers may remember, were not provided with a switch, the makers evidently intending either that the ordinary household switch should be used for controlling them, or that the adaptor should be withdrawn from the socket in order to switch off.

Needless to say, the enterprising dealer not only sold her a modern set to their

New Apparatus Reviewed

Recent Products of the Manufacturers

RADIOLAB TEST APPARATUS

THE Radiolab Universal Oscillator, made by Everett, Edgcombe, and Co., Ltd., Colindale Works, London, N.W.9, is a signal generator giving a modulated HF output for testing all types of broadcast sets, and it has been designed to meet the special requirements of the service engineer. It is, therefore, made as compact as possible, and all batteries are contained in a screened case, measuring $9\frac{1}{2}$ in. \times $9\frac{1}{2}$ in. \times $9\frac{1}{2}$ in.

A single, low-consumption valve provides both HF and LF modulation, but a switch interrupts the internal modulation circuit, thereby giving an HF signal, which may be modulated by external apparatus if required, and two terminals are provided for this purpose.

The HF output is taken from an attenuator with an arbitrary scale, and thence through an artificial aerial network to a screened lead for connection to the receiver. The modulation frequency is 220 c/s approximately.

Each instrument is provided with a hand-drawn graph and an abridged calibration chart, the latter being fixed to the outside of the case below the wave-change switch. Compared with a laboratory standard wavemeter, the HF calibration was found to be accurate to within one per cent.

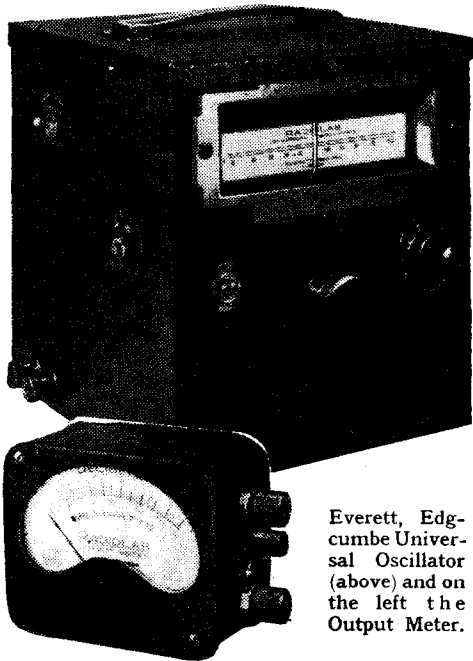

Everett, Edgcombe Universal Oscillator (above) and on the left the Output Meter.

The three-way switch covers medium, long, and IF wavebands, the full range being 1,400 kc/s to 110 kc/s (214 to 2,727 metres) with a small gap between the medium and the long wavebands; the fundamental frequency of the oscillator is employed throughout.

The application of the oscillator may be stated briefly as for fault-finding, aligning straight and superheterodyne receivers, checking wavelength calibration, comparing sensitivity of receivers, measurement of stage gain and power output (for which purpose an output meter is required), and for

sundry other purposes apart from its special application in servicing receivers.

The price complete is £7 7s.

An output meter is available also for use with the test oscillator, and this covers a range of 0-4,000 milliwatts in three steps. A scale calibrated in decibels is embodied also. It has an impedance of 4,000 ohms, and this provides a satisfactory load for most triode power valves. Connection is made by joining one terminal to the anode of the output valve, and the other to the chassis of the set. The price is £3 15s.

WEARITE WAVE-TRAP COIL

THIS is a very compact dual-range coil unit designed especially for use in a wave trap, which simple device is very effective in reducing the spreading of a powerful local station, and also in eliminating spurious whistles in superheterodynes.

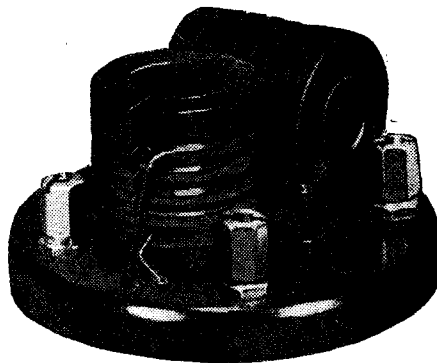

Wearite dual range iron-cored wave-trap coil.

The coils are of high efficiency, being wound on sectionalised formers fitted with iron cores and assembled with their axes at right angles. Litz wire is used for the medium-wave section, which has an inductance of 156 μ H, but a single-strand conductor suffices for the long-wave loading coil, as at the lower frequencies a coil of adequate efficiency is obtained without using stranded wire. The inductance of the two coils in series is 1900 μ H.

The unit is not screened, as in most cases it will be located outside the receiver, as the customary position for a rejector is in the aerial lead. Furthermore, when screening is found necessary the tuning condenser should be included, also the wavechange switch for which a single pole on-off pattern is required.

The makers are Wright & Weaire, Ltd., 740, High Road, Tottenham, London, N.17, and the price is 7s. 6d.

GOLTONE NODALIZER

THE Nodalizer is a small 30-ohm potentiometer for joining across the filament or heater pins of AC valves to provide an artificial centre tap for earthing the circuit. It could be used in place of the usual centre tapping on the filament winding of mains transformers should it be suspected that the physical centre of the winding is not, in any particular case, the actual electrical centre of the system. The adjustable contact has a limited travel only, but this is more than adequate for all purposes.

When fitted on a metal chassis the moving contact is automatically joined to the earth

line *via* the fixing bush, and two wires only need be taken to the valve holder.

The makers are Ward and Goldstone, Ltd., Frederick Road (Pendleton), Salford, 6, Lancashire, and the price is 2s. 6d.

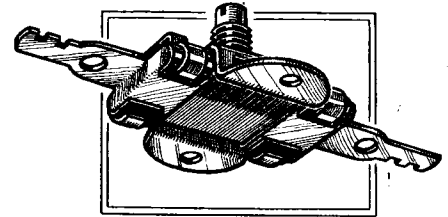

Goltone Nodalizer provides an artificial centre tap for AC valve filaments.

FERRANTI SELF-STARTING SYNCHRONOUS TIME MOTOR

SMALL synchronous motors operated from time-controlled 50 c/s AC supply mains find many applications in the laboratory, in commerce, and in everyday domestic life, the now widespread use of synchronous electric clocks being but one example. Many of the small motors developed for these purposes are of the hand-starting type, and whilst these are quite satisfactory for clocks there are several types of time switches and similar mechanism in use that require a self-starting synchronous motor.

Such a unit is now obtainable from Ferranti, Ltd., Hollinwood, Lancashire, the motor in question being designed to run at 200 r.p.m. when connected to time-controlled 50 c/s AC mains. The motor is of the impulse start type, and as the direction of rotation cannot be predetermined by the design of the rotor, which is a six-wing spider, a pivoted spring-controlled pawl is fitted to prevent rotation in an anti-clockwise direction.

The model illustrated measures $1\frac{1}{8}$ in. in diameter and about 1 in. deep, and the rotor

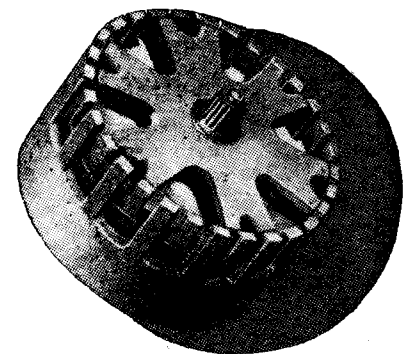

Ferranti small self-starting synchronous motor for use in clocks, time switches and similar apparatus

is provided with a small pinion. It is designed for 200/250-volt mains, and the consumption is rated at 1.4 watts. The price is 12s. 6d.

TELEVISION COMPONENTS

IN the compendium of television apparatus published in our issue of March 8th last, the Bennett specialties were inadvertently referred to as Burnett products. It should be noted that the manufacturers are the Bennett Television Co., Redhill, Surrey.

★ ★ ★ Listeners' Guide

Outstanding B



king of the island and becoming a dictator.

The broadcasting version of this fantastic comedy includes special music and songs written by Walter Leigh, which will provide a form of scene

WHAT DO WE DO NOW? Charlemagne, the ship's stoker, explaining to his millionaire master and guests that they have been wrecked on a desert island. A radio adaptation of the Pathé-Natan film "Charlemagne" will be broadcast on Monday, March 25th, (Regional) and Tuesday (National).

painting and help to establish the atmosphere. A strong cast includes Bruce Winston, Matthew Boulton, John Cheatle, Philip Wade and Yvette Darnac.

All next week the original film, with English captions, will be running at the Academy Cinema, Oxford Street.

LADY TREE TO BROADCAST

MARK LUBBOCK comes to the fore again in a romantic operetta, "For a Twelve-month and a Day," which is to be broadcast Regionally on Wednesday, March 27th, and Nationally on Thursday. The book is by Denis Freeman, Lubbock providing the music.

The story concerns the adventures of a touring theatrical company in the South of England, and the cast includes Lady Tree as Magdalen Burnley, tragedienne, and Tessa Deane as Mary.



Photo: British Lion Film Corporation.

TESSA DEANE, who plays the part of Mary in "For a Twelve-month and a Day," Denis Freeman's romantic operetta in the Regional programme (Wednesday) and National (Thursday).

PLEASING OURSELVES

ONE crowded week—if ever there was one. Prelates, sportsmen, musicians, comedians cluster round the microphone, all at the disposal of the omnipotent man-at-the-dial. Shall we listen or shall we not?

"ONE CROWDED HOUR"

If high speed is a recommendation, "One Crowded Hour," devised and compéred by John Watt, which is the main item in the National programme on Monday next, should have an immense appeal. The irresistible Mr. Watt squeezes twelve turns into sixty minutes, together with those between-turn pleasantries which warm the cockles of our hearts.

BEETHOVEN

BEETHOVEN died on Monday March 26th, 1827, and to commemorate the 108th anniversary Berlin (Funkstunde) is broadcasting a Beethoven programme on Tuesday next, at 9.30, the station choir and orchestra taking part. On the same night all French State stations, except Radio-Paris, relay a Beethoven Festival from the Paris Conservatoire. The now famous National Orchestra will be conducted by

Inghelbrecht. Included in the programme are the Pianoforte Concerto in G and the Romance in C for violin.

To-night (Friday) Brussels No. 2 gives a Beethoven concert.

RAISING BOY BAN

WHY are boy sopranos banned from the B.B.C. studios? Personally, I often

30-LINE TELEVISION

Baird Process Transmissions
Vision, 261.1 m.; Sound, 296.2 m.

SATURDAY, MARCH 23rd.

"Here's Looking at You"—Effie Atherton and Ronald Hill; Laurie Devine (Ballerina); Tom Rees (dances); Sydney Jerome's Quintet.

WEDNESDAY, MARCH 27th

Charles Heslop (burlesques); Roy Royston and Marie Dayne (musical comedy stars).

prefer the pure notes of a youthful chorister to those of a sophisticated and over-trained prima donna. One boy who has got through the barrage is Jimmy Phelan (soprano), who contributes to the "Victorian Melodies" programme (Regional) on Tuesday evening with the B.B.C. Theatre Orchestra and the Wireless Male

Voice Chorus, directed by Stanford Robinson. Bravo, Jimmy!

Denmark places no embargo on boy's voices. To-night (Friday) at 7.15 we can hear the Copenhagen Boys' Choir in a Bach and Handel programme relayed by Kalundborg from the Church in the Parliament Building, Christiansborg. The organist, Mr. Bernard Christensen, must be extremely versatile, for he alternates between classical organ recitals and jazz compositions, for which he is famous.

ON A DESERT ISLAND

"CHARLEMAGNE," to be broadcast on the Regional wavelengths on March 25th and Nationally on March 26th, is the first example of a radio play adapted direct from a film. Laurence Gilliam saw the film at the Academy Cinema a year ago, and at once realised its possibilities for broadcasting.

The story concerns a group of modern Parisians. Charlemagne is a stoker on a luxury yacht which is wrecked, and becomes the "Admirable Crichton" of the party. However, after a period of faithful service he turns on his exploiters, proclaiming himself

or the Week

roadcasts at Home and Abroad

VARSITY SPORTS

TO-MORROW afternoon H. M. Abrahams, the famous Oxford 100-yards sprinter, visits the White City to broadcast a running commentary on the last two events of the Varsity sports, the "Mile" and the "Quarter Mile."

A LUTE ON THE ETHER

A POET turned loose by his father and wandering about the world with his lute provides the theme for "Poet, Take thy

Monday next (National), when Mr. Young will start a second series with a talk on "My First Solo."

ONE WAY TO GET THERE

AT about 9.50 p.m. (National) on Thursday next (March 28th) S. C. H. Davis hopes to give an eye-witness description of the R.A.C. 1,000-mile Car Rally at Eastbourne. Mr. Davis, who will be speaking from the Grand Hotel, takes part in the Reli-



VICTORIAN MELODIES will be offered by the B.B.C. Theatre Orchestra on Tuesday (Regional). Here is a photograph taken in a Victorian drawing-room in the early 'Sixties.

Lute" to be broadcast in the Regional programme on Thursday. The story is from a poem of the same name by Richard le Gallienne. The part of the poet is taken by Leslie French, while Robert Speaight is the narrator. Special music has been composed by Robert Chignell, with lute accompaniment by Diana Poulton.

FLYING ALONE

FILSON YOUNG's flying lessons, which provided material for the talks series, "Growing Wings," last summer, will be drawn upon again on

ability Trial himself, driving a Triumph from London to Eastbourne via such places as Truro, Leamington, Llandudno, and King's Lynn. Other competitors will adopt similarly circuitous routes, the proviso being that they must cover at least 1,000 miles.

WEINGARTNER AND LAMOND

BEETHOVEN'S Pianoforte Concerto No. 3 in C minor is to be played by Lamond at the 2nd B.B.C. Symphony Concert at the Queen's Hall, which forms the staple item in the National programme on Wednesday next, March 27th.



H.M.V. Photo.

LAMOND is soloist in Beethoven's C minor Concerto, No. 3, with the B.B.C. Symphony Orchestra at the Queen's Hall on Wednesday next. Herr Felix Weingartner conducts.

Felix Weingartner will conduct. The second part of the concert concludes with Liszt's Symphony to Dante's "Divina Comedia."

COMPETITION ON THE ETHER

A BAND competition will be heard by listeners to Denmark to-morrow night (Saturday) between 7.15 and 9. A special invitation to listen is extended to grandparents, who are promised the tunes of their youth.

OPERA

THIS is a good week for relays of opera from the theatre. To-night (Friday) Richard Strauss' "Salome" will be relayed from the Paris Opéra at 7.15 by Paris P.T.T.; and to-morrow evening (Saturday) between 8 and 10.50 Brussels No. 2 will relay Giordano's "Madame Sans Gêne" from the Royal Flemish Opera House, Antwerp.

Wagner's "Twilight of the Gods" comes from the Grand Theatre, Bordeaux, at 8.30 on Wednesday, March 27th.

On the same evening we have an alternative choice in Albert Dupuis' Lyric Tragedy, "La Victoire," from the Verviers Conservatoire, relayed by Brussels No. 1.

VOCAL PUNCH

FOUR Danish crooners are to engage in a "vocal boxing match" in the Kalundborg-Copenhagen transmission to-morrow night (Saturday) between 9 and 11.15.

DON'T SWITCH OFF

WHILE preparing the midday meal on Monday next, March 25th, housewives should tune in the mid-morning National talk by F. Laing and G. M. Boumphrey on "Common Household Insects."

THE AUDITOR.

HIGHLIGHTS OF THE WEEK

FRIDAY, MARCH 22nd.

Nat., Music of George Posford. "Last Voyage of Sir Walter Raleigh."

Reg., Variety, with Mr. Flotsam and Mr. Jetsam, Don Sesta and His Band, etc.

Abroad.

Prague, 7.35, Beethoven Concert by the Czech Philharmonic Orchestra. Conductor: Weingartner (from the Smetana Hall).

SATURDAY, MARCH 23rd.

Nat., In Town To-night. "Music Hall." B.B.C. Theatre Orchestra.

Reg., Ipswich Male Voice Choir. Recital by Sophie Wyss (soprano) and Steff Geyer (violin). B.B.C. Orchestra (D).

Abroad.

Frankfurt, 7.5, Opera, "Carmen" (Bizet).

SUNDAY, MARCH 24th.

Nat., London Zigeuner Orchestra. Bolsover Colliery Band. Albert Sandler and Park Lane Hotel Orchestra. The Gershom Parkington Quintet.

Reg., B.B.C. Orchestra (E), conducted by Joseph Lewis. Wireless Military Band, conducted by B. Walton O'Donnell. Sunday Orchestral Concert: "The Song of Songs" (Bantock).

Abroad.

Deutschlandsender, 7.20, "The Cold Heart"—a fairy tale opera.

MONDAY, MARCH 25th.

Nat., Variety: "One Crowded Hour" compered by John Watt. "Flying" by Filson Young. B.B.C. Orchestra (D), conducted by Sir Landon Ronald.

Reg., Recital by David Wise (violin) and John Pauer (piano-forte). "Charlemagne."

Abroad.

Strasbourg, P.T.T., 8, Viennese Boys' Choir.

TUESDAY, MARCH 26th.

Nat., "Charlemagne." Recital by Maria-Sandra (soprano) and Frank Laffitte (piano).

Reg., Victorian Melodies (III) by the B.B.C. Theatre Orchestra.

Abroad.

Athlone, 7.31, Concert by the Augmented Station Orchestra.

WEDNESDAY, MARCH 27th.

Nat., B.B.C. Symphony Orchestra in the Queen's Hall.

Reg., Part Songs by Contemporary British Composers (The Wireless Singers). The Wireless Military Band, conducted by B. Walton O'Donnell. Romantic Operetta: "For a Twelvemonth and a Day."

Abroad.

Radio-Paris, 8, "The Merchant of Venice" (Hahn), relayed from the Opera.

THURSDAY, MARCH 28th.

Nat., Romantic Operetta: "For a Twelvemonth and a Day." Organ Recital by O. S. Peasgood.

Reg., Halle Fund Pension Concert by the Sheffield Choral Union, from the Free Trade Hall, Manchester. Conductor: Sir Thomas Beecham. Radio Play: "Poet, Take thy Lute."

Abroad.

Copenhagen, 7.10, Russian Concert by the Radio Symphony Orchestra. Conductor: Malko.

HARMONICS

The Meaning of a Much-used but Seldom Explained Term

By "CATHODE RAY"

THE Briton is notoriously at sea when he gets abroad, owing to his inability or unwillingness to learn foreign languages. The wireless enthusiast may be at an even greater disadvantage when he roams through the pages of a technical journal; for he finds that a writer, unlike the foreigner, seldom takes the trouble to speak English. For sheer confusedness the expression *harmonic* must take a high place among this radio jargon.

Dealing with distortion, for example, a writer probably explains that there are two chief sorts; one is due to the absence of harmonics; the other is due to the presence of harmonics. The reader is cheerfully left to imagine how this can be so; and it does not make it any easier for him when he is further expected to understand that harmonics can blow hot and cold in this way at one and the same time. He is also liable to be told that some of the whistles he hears in a bad superhet are

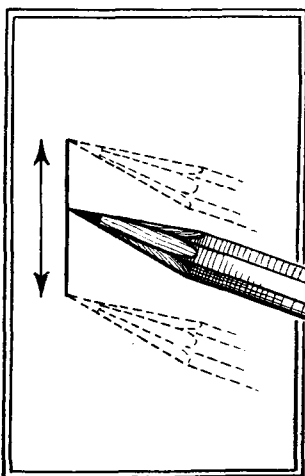

Fig. 1.—An unsuccessful attempt to represent an oscillation by means of to-and-fro pencil strokes; the time factor is lacking.

Fig. 2.—(Right) A pure sine wave oscillation; amplitude represented vertically and time horizontally.

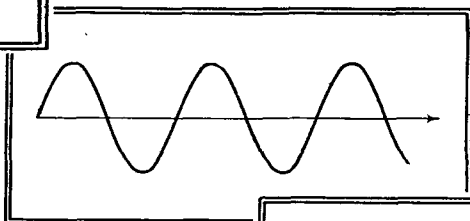
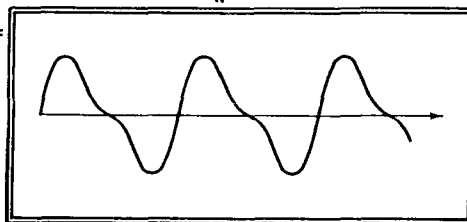

Fig. 3.—(Below) An impure or non-sinusoidal wave-form.



due to harmonics. When, too, he goes down to short waves and unexpectedly hears a medium-wave programme, that also is a harmonic.

In order to learn that there is no inconsistency about all this, one must usually be prepared to face a stiffish bit of mathematics. The following explanation is intended to be an alternative route. Even so, one is assumed to know that sustained sound, such as can readily be obtained by pressing a key or pedal of an organ, or blowing a trumpet, is the result of back-and-forward movements, or oscillations, or cycles, or periods, or vibrations, or waves. (All these mean much the same thing.) However they are set up, they are usually conveyed to the

ear by the surrounding air, which is in turn set into vibratory motion. Air is by no means necessary, however; sounds can be heard a good deal better under water, and better still along a steel rod or pipe, as miners know when they are trapped underground and employ this means for signalling. The more vibrations there are per second, the higher in pitch is the sound; and if there are more than about 15,000 per second the pitch becomes too high for the ear to detect, and one is in the realm of *radio* vibrations. They are then more often referred to as oscillations; this is one of the several available words which the radio engineer prefers for all sorts of vibrations, audible or otherwise.

If one tries to draw an oscillation on a piece of paper the result is merely a rather uninteresting straight line, as shown in Fig. 1. The point of the pencil moves backwards and forwards over this track, and all one can learn about it is the extent, or *amplitude*, of its motion; which is equal to the length of the line. A much more useful diagram is produced if the hand that holds the pencil moves steadily and continuously along at right angles to the direction of the oscillation. It may now look like Fig. 2 or Fig. 3, or any one

of an infinite variety of shapes. In any case, it is now easy to see why it is sometimes called a *wave*.

The most important shape is that of Fig. 2 (known technically as the sine wave), because it corresponds to a perfectly regular motion, or pure musical tone. One would get a very satisfactory sine wave by tying a paint-brush to the bob of a very long heavy pendulum, and pulling a strip of paper steadily along

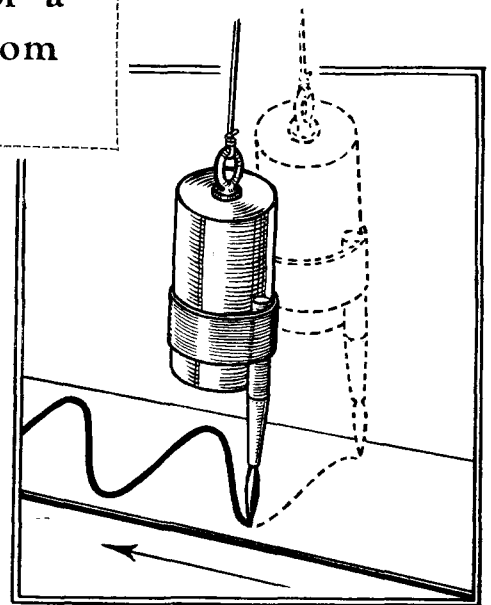

Fig. 4.—A working model to demonstrate the pictorial representation of oscillations.

below it with the brush just touching it and marking out the curve (Fig. 4). With a little ingenuity it is possible to get similar traces of the vibration of a piano string. Really clever people have devised ways of getting pictures of radio oscillations happening many millions of times per second.

It should be fairly obvious that if the strip of paper is moved at the rate of a foot per second, and there are twelve complete back-and-forward waves per foot, the frequency of vibration is 12 per second, and the wave length is one inch. If the vibrator is tightened up it will vibrate more rapidly and give more vibrations per second. Suppose it gives just twice as many. The frequency is double what it was, and the wavelength is a half (try it on paper if you do not agree). It is a *harmonic*. The choice of name is not very obvious when one is playing about with only a few vibrations (or cycles) per second, but if the frequency is high enough to sound musical, yet too low for you to join in and whistle with comfort, then without knowing anything about the mathematics of the thing you instinctively pitch your whistle an octave higher, which simply means that you make the air around you vibrate twice as many times per second as the music. It *harmonises* so naturally that sometimes it is quite difficult to tell whether you are whistling in unison or on a harmonic.

The Fundamental Frequency

Another octave higher gives *three* times the frequency, so it is called the third harmonic (the first harmonic is no harmonic at all, being just the original frequency; usually called the fundamental), and so on. Just to make sure of it, Fig. 5

Harmonics—

shows one complete cycle of the fundamental and the corresponding 2nd, 3rd and 4th harmonics. Harmonics are usually relatively small in the up-and-down direction, or amplitude, but not necessarily so.

What happens when a note is played on a violin? The bow is sticky with rosin, and when it is drawn over the string it drags it to one side. As the string is tightly stretched it soon exerts a strong resistance to any further dragging, and suddenly flies back. It is then slacker again and is caught up by the moving bow and goes through the same process again and again. So it sets up a vibration. But it is fairly obvious that it is not a smooth sine wave, but a very jerky affair. None of the curves of Fig. 5 represents it at all accurately.

Now it is a very interesting thing that if the motions of two wave-pictures are added together to form one curve, the result is a true picture of the wave that is produced by emitting the two sounds simultaneously. If you are whistling the 2nd harmonic to the fundamental played by an organ pipe, it makes no difference whether you think of them as two separate sounds having pictures like the top line in Fig. 5, or as a

Fig. 6.—Illustrating the combination of fundamental and harmonic.

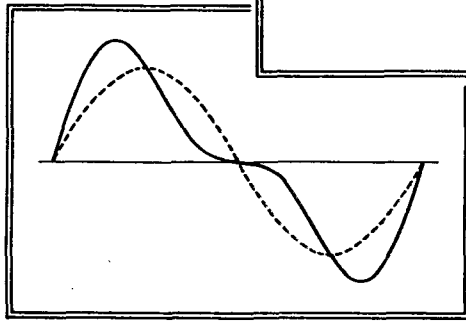

single sound having a picture built up by combining the two, as in the full line in Fig. 6. This is made by adding (or subtracting, as the case may be) the up-and-down movements. The result is a more complicated curve than either of them separately.

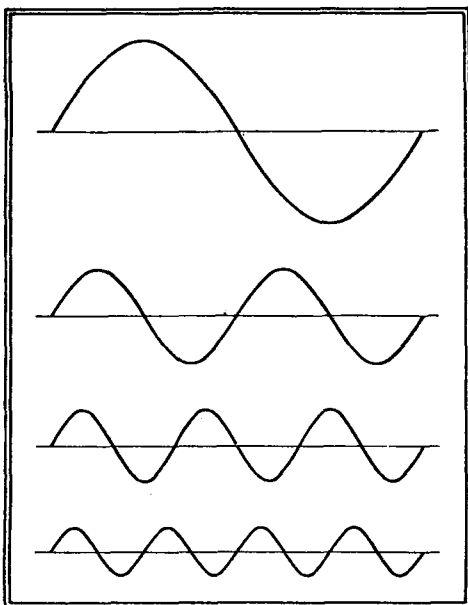

Fig. 5.—A complete cycle of an oscillation, with its 2nd, 3rd, and 4th harmonics.

If a number of harmonics of assorted sizes are added together, one can get a very knobby wave, such as Fig. 7.

Experimental Proof

Remembering that the violin is responsible for a rough product of this sort, it requires no great effort to jump to the conclusion that a violin note is equivalent to a fundamental and harmonics played simultaneously. The soundness of such a conclusion has been very delightfully proved by certain painstaking experts who, by making a selected group of tiny pipes and whistles each giving a pure sound, have reproduced a violin note when they are all blown at once. They have even copied the still more compli-

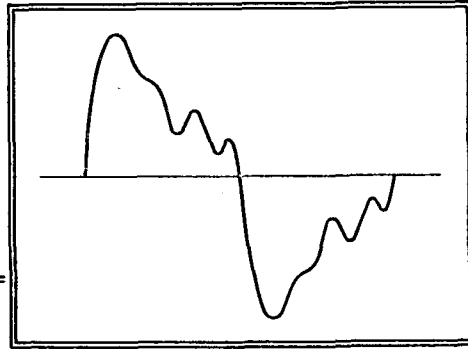

Fig. 7.—Combination of a number of harmonics.

cated waveforms of the human voice, and made a system of simple organ pipes speak; in rather baby fashion, it is true; but quite convincingly human.

An instrument emitting a pure, smooth sine wave gives a pure, smooth note, which by itself very soon bores one to tears. The timbre or characteristic quality of a sound depends on the number and proportions of harmonics. Sounds that are exceptionally rich in harmonics are capable of great beauty and expressiveness, as in the violin and French horn; or of great harshness and stridency, as in numerous examples that readily come to mind.

Now the fundamental frequency of a vibration may be very high—several thousands per second. If, then, the lowest harmonic is double this, and the others are higher still, it is obvious that if any of the many links in the chain of apparatus between the broadcasting studio and the listener's ear fails to reproduce very high audible frequencies, the reproduction is not really characteristic of the violin, and is therefore distorted. The same is more or less true of all other sounds. This is the sin of the omission of harmonics.

There may also be the sin of commission. It is easier to understand how ingredients of the original sounds can drop

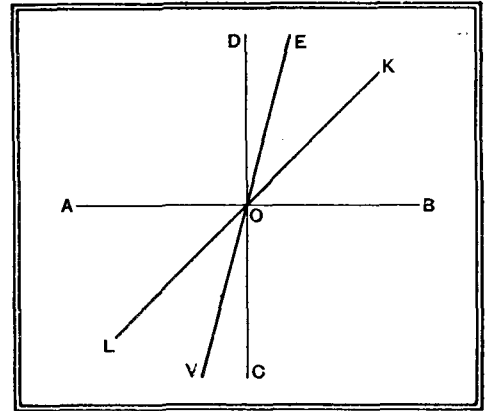

Fig. 8.—Illustrating the production of spurious frequencies.

out in transmission, than how it can introduce others that formed no part in the original. We now bend to this more difficult task.

Suppose you have a speaking tube connecting you up with Broadcasting House. Sounds go in at the far end of the tube and sounds come out at your end. It is very unlikely that the two lots of sounds would be identical. If they were it would be impossible for a blind man at your end to tell that he was not sitting in the studio. If the wave motion of the ingoing sound is represented by a horizontal distance and the outgoing sound by vertical distance, the relation between the two in our distortionless speaking tube is represented by a diagonal line (Fig. 8). This is the only part of the argument that verges on the mathematical. The diagonal LK shows that when a point moves an inch along AB, a corresponding point moves an inch up CD. If LK lay flat along AB instead, movement along AB would have no counterpart along CD at all—LK would then represent a complete stoppage. But if the linking line were inclined more steeply than LK, the movement up CD would be greater than that along AB; VE represents a magnifying link or amplifier.

Spurious Frequencies Introduced

A speaking tube is not likely to be a magnifying link; on the contrary, a tube of a hundred miles or so would reduce the strength of the sound so considerably as to be more nearly represented by a complete stoppage. So for this and other reasons it is customary to distribute the

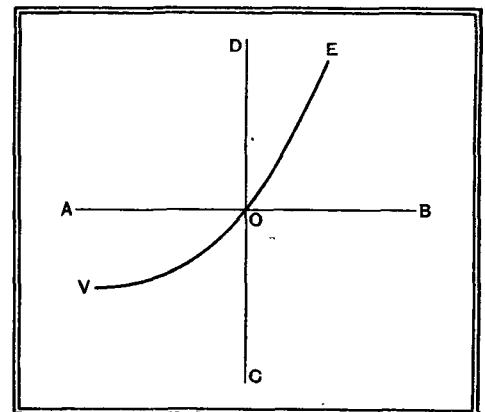

Fig. 9.—The characteristic curve of a valve is by no means straight.

Harmonics—

programmes in electrical form, using magnifying links, known popularly as valves, wherever needed. The ideal valve would have a characteristic "curve" like VE in Fig. 8; that is to say, a straight line. But real valves that can be bought are much more likely to have curves something like VE in Fig. 9.

If the wave movement along AB is quite small, and confined to the neighbourhood of O, then the corresponding motion along CD, which represents the output, is a nearly faithful copy of it. But if the

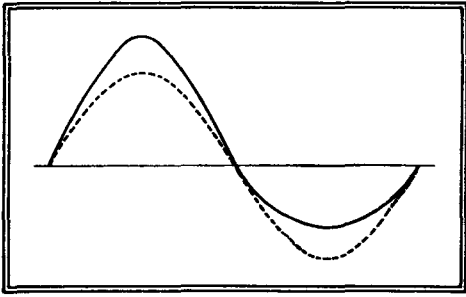

Fig. 10.—Distortion of wave-form.

former extends the full length of AB shown, the copy along CD goes up much higher along CD than downward along OC. When a perfect sine wave is put in, a distorted version comes out, having a tall peak at the top and a stunted underpart. See Fig. 10, where the original is shown dotted for comparison.

The person who knows all about harmonics, on being confronted with this wave picture, has no hesitation in declaring that he can build up something very much like this from a fundamental and 2nd harmonic. In Fig. 11 he does this. Actually he would probably have to add a dash of other harmonics to produce a faultless replica to the pattern supplied; but the example is good enough to show how, when valve operating conditions are unsuitable, an oscillation frequency comes into existence that was not there before.

Almost every part of a receiver, not

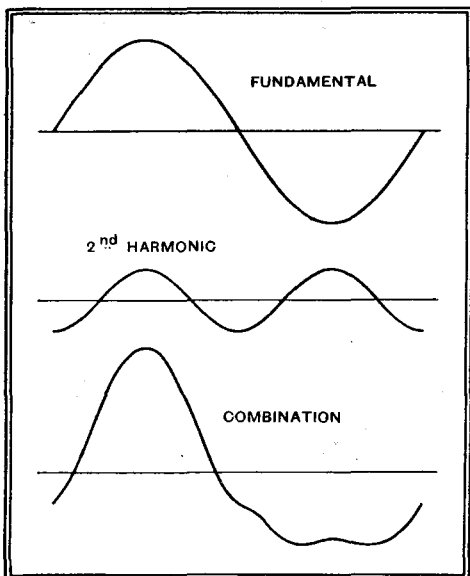

Fig. 11.—Result of combining a fundamental oscillation and its second harmonic.

omitting the loud speaker, introduces harmonics in this way. The object of the designer is to arrange things so that these harmonics are too slight to be noticeable. Authorities differ as to what is noticeable. But when a receiver is badly designed or improperly used—such as by tuning to the local station with the volume control at MAX.—the loud speaker emits hosts of harmonics that had no part in the original programme, and the result is harshness. As the harmonics are always relatively *high* in frequency, it is easy to understand why this sort of distortion has a shrill effect.

All this has been about audible oscillations. When the fundamental frequency is too high to be audible, the same applies to the harmonic *a fortiori*. For instance, Fécamp transmits on 1,456 kilocycles per

second, or 1,456,000 cycles per second. That is a wavelength of about 206 metres. If you tune to double the frequency, or 103 metres, with a sufficiently sensitive receiver, you may hear the Fécamp programme. That is because it is impossible to transmit a perfectly pure sine wave oscillation; there are always harmonics. By taking suitable precautions the engineers reduce the radiation of harmonics to what is usually a negligible amount, but they can be heard at close range or with a very sensitive receiver.

In a superhet receiver there is an oscillator right in the set itself, and if it is not working under the right conditions the harmonics may be excessive and interfere with some of the incoming signals. Thus harmonics are the cause of some at least of the superhet whistles.

Random Radiations

By "DIALLIST"

Berlin's Television Service

SO Berlin is, after all, to be the first city in the world to have a regular high-definition television service. Experimental transmissions have been going on for some time now, and these have proved so successful that they are to give way to regular programmes of a simple but interesting kind. A start will be made with less good definition than is recommended by our own Television Committee, for the 180-line system will be used. It will be remembered that our committee laid down 240 lines as the minimum, but I think it more than likely that 360-line transmitters will be ready by the time that the London Station is completed.

The Way of the Announcer

THE broadcast announcer, as Mr. Hilbert, the B.B.C.'s head man, told an audience the other night, has a hard life. When he is taking part in a simultaneous broadcast by all the B.B.C. stations he may be speaking to 25,000,000 people, and in the case of Empire or other world-wide relays the figures become almost astronomical. Naturally, such a multitude of listeners contains not a few critics, who are ever ready to pounce if he makes the smallest error in his delivery or in the pronunciation of some outlandish word. It must be rather an ordeal at times for an English announcer who finds himself confronted with Welsh, Scottish, or Irish place-names of the more complicated kinds. English names, too, can be pretty trying. I wonder how many readers would score full marks on Towcester, Pytchley, Cirencester, Bicester, Braughing, Ardingly, Welwyn, Grantham, Chenies and Fowey?

English as She is Spoke

The B.B.C.'s Committee on Spoken English is doing noble work on behalf of this queer language of ours by laying down the accepted pronunciation of words in cases where it has long been regarded as doubtful. They are, in fact, carrying out much the same task as the French Academy, which is the final authority in the language of France. We may not agree with all of its recommendations, but we must admit that a com-

mittee of this kind is very much needed to deal with a language like ours, which contains probably more anomalies and more instances of doubtful pronunciation than any other in the world.

I have often wondered why Mr. George Bernard Shaw should have been chosen as Chairman of the Committee. Charming and delightful as his diction is, his profoundest admirers can scarcely claim that it is without a marked Irish accent. But G.B.S. would, no doubt, stoutly maintain that Irish is the best English!

The Moon and Wireless

THE recent discovery by Professor Sydney Chapman, of the Royal College of Science, South Kensington, that the moon causes regular tides to occur in the atmosphere is of great interest to those who indulge in long-distance wireless reception, particularly that of the short-wave variety. Minute as they are—at the Equator the atmosphere is pulled back and forth only some 150 yards in the course of a complete lunar cycle, and the corresponding barometric variation is but one-sixteenth of a millimetre—these tides have a marked effect on the condition of the reflecting layers that play such an important part in wireless transmission and reception. This is due to the fact that the tidal movements of the air give rise to electrical changes high up in the atmosphere.

Most short-wave enthusiasts will have noticed how very different reception conditions can be at new moon and full moon. Professor Chapman's work may be most valuable in assisting in the discovery of optimum wavelengths at different phases of the moon.

Olympia this Year

JUST when the first Wireless Exhibition was held I can't recall, though I have very clear recollections of the first in London and of the quaint apparatus displayed. It was held in the Horticultural Hall at Westminster at the end of 1922, and I remember meeting there both Capt. S. R. Mullard, who had not long before given the world his epoch-making "Ora" valve, and Mr.

A. F. Bulgin, of components fame. I think I am right in saying that the first Exhibition at Olympia took place in 1926. Wherever it was held, there were but seventy exhibitors at that year's show and the attendance totalled 46,000.

The next Olympia Exhibition opens on Wednesday, August 14th, and continues till Saturday, the 24th. In this year of celebrations it is going to be a particularly good show, and it will, no doubt, attract many visitors from abroad who will be in this country during the Jubilee summer.

Myself, I don't feel that the middle of August is an ideal time for the Exhibition. It is the holiday month, and it is also, as a rule, one of the hottest times of the year. The show used to be held in the second half of September, but that was really too late. Schoolboys and schoolgirls, whose interest in radio is of the keenest, had their noses to the grindstone again after the summer holidays. Manufacturers, who gauge the demand for their new models by the interest shown in them at Olympia, had not time enough to get them into full production before the autumn rush came on. I cannot help feeling that we should strike the happy mean and meet the convenience of all concerned if the Exhibition were held in future years in the first fortnight of September.

Canada and Empire Programmes

YOU scarcely realise the vastness of Canada until you examine a map showing the differences in the time in the various parts of that country. In the whole of Europe local time differs by only three hours between the easternmost and westernmost countries; but in Canada noon in the longitude of Nova Scotia corresponds to 7 a.m. in the Yukon and 8 a.m. in British Columbia. On this account the times of the Empire short-wave relays intended for Canada have not hitherto proved satisfactory. Those living in the Western Provinces have had to rely on the No. 5 transmission from Daventry, which reaches them between 3 and 5 p.m. by local time.

The ideal of those responsible for the Empire transmissions is to make reception possible in every part during the early evening, that is to say between about 6 and 9 p.m., by local time, for it is then that the largest number of people are able to listen. For Western Canada a new service is now in operation experimentally. The transmission, lasting at present only one hour, is made between 2.30 and 3.30 a.m. Greenwich time. It is received in Western Canada between 6.30 and 7.30 on the evening before.

How It's Done in America

AMERICAN designers have never seen eye to eye with our own, at any rate so far as the number of valves in mains sets are concerned. Sixteen valves are quite common in their sets, and few of those of the better class contain less than ten or eleven. Nor are these big sets particularly expensive. One that covers all wavelengths from 9 to 2,000 metres sells at a price equivalent at the present rate of exchange to about £11. This does not include valves, and it is for the chassis only. But with valves and cabinet such a set costs little more than £18-£20. Don't, please, imagine that I am advocating the purchase of American sets. Far from it. Reception conditions are entirely different in the two countries and the set that is a good performer over there may give a poor account

of itself here. But I do feel that it would be well worth the while of some of our manufacturers to market bigger sets containing larger numbers of valves. At the present time it is difficult to find a set

costing £25 or £20, though there are plenty of people ready and willing to spend this amount on a receiver containing refinements of all kinds and capable of really first-rate performance.

Short-wave Broadcasting

Activity on Many Wavebands

CONDITIONS, at the time of writing, are extremely good, but, in a way, unusual. The European stations are coming in at much greater strength than one usually expects at this time of year, and the distant stations, although strong, suffer from severe fading.

W8XK and W2XAD on the 19-metre band have had a pronounced "echo," their carrier-waves exhibiting the well-known effect of someone "whistling in a tunnel." This has also been observed on the modulation, and has, at times, been sufficiently severe to reduce the intelligibility almost to zero.

On the 20-metre amateur band the same effect has been logged, certain American stations being completely unreadable on account of this ringing or echo.

Rome appears to be working regularly on both 49.2 and 30.67 metres, in addition to his 25-metre wavelength. Other Italian stations, however, may often be heard relaying his programme, and this leads to a certain amount of confusion.

IRM, in the 30-metre band, has been heard relaying VUB, Bombay, and JOAK, Tokio, doubtless to the delight of short-wave listeners who did not catch the initial announcement!

Another new European is ORK, Brussels, working on 29 metres approximately.

The "Seth Parker," which was in the news recently, is listed under the call-sign KNRA, using 33.94 metres. KNRA is reported as being "somewhere in Oceania," and has been heard working with Manila (Philippine Islands) and with an amateur station in Hawaii.

The other notable station, KFZ, of the

Byrd Expedition, does not seem to be heard at all in this country, although the previous expedition used to put over some very strong transmissions. Probably the fact that some twenty-four different wavelengths are used is responsible. It must be very difficult to find the right one at the right time!

ZTJ, Johannesburg, is being heard once more on 49.2 metres. The best time appears to be between 5 and 7.30 p.m., but interference from Zeesen and Daventry is sometimes pretty bad at this time of the evening, and a selective receiver is necessary if anything much is to be made of ZTJ.

VQ7LO, higher in wavelength, is still closer to GSA's setting, but often comes in well when the latter station is not on the air.

A tremendous number of Canadian commercial stations seem to put out broadcast matter at various times. CJRX on 25.6 metres seems to be logged more often than any other. VE9GW (49.22 metres) and VE9CS (49.4 metres) are, of course, "genuine" broadcast stations. The latter, however, is in Vancouver, and is reported as using a power of 2 watts, so that anyone who has received it may safely conclude that he has been dreaming.

Conditions during April and May are usually extremely favourable for the Americans, particularly during the hours of daylight and on the shorter waves. W8XK is already logged regularly as "R9," and it seems that a readjustment of the audibility scale will be necessary. This station has quite wrested the laurels from W2XAD, who used to be easily the best of the North Americans. MEGACYCLE.

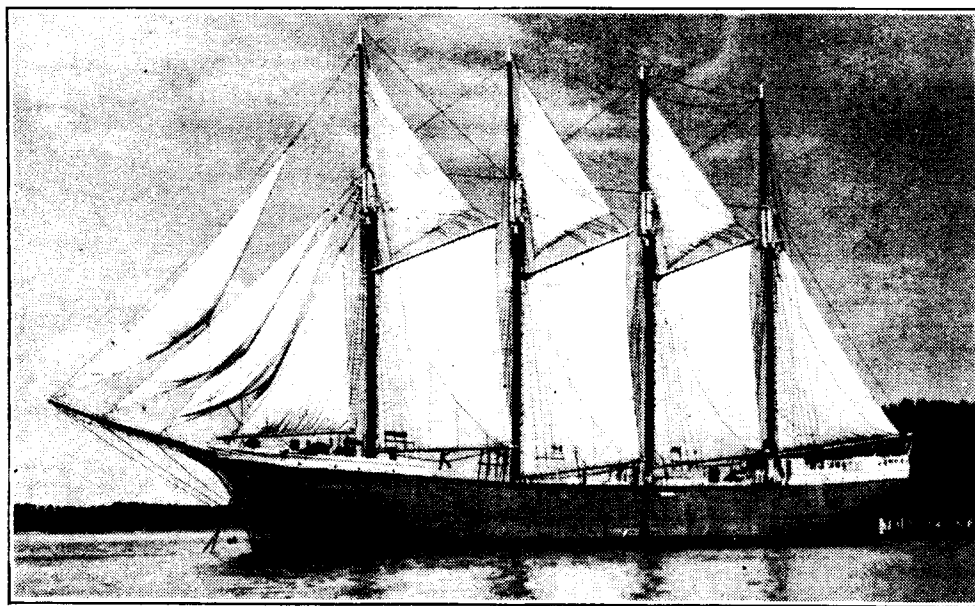

The "Seth Parker," described as a floating broadcasting station, which recently brought the cruiser "Australia" to its aid while the Duke of Gloucester was returning to England on the latter vessel. The ship used the call sign KNRA and has recently been heard in this country on 33.94 metres.

FOUNDATIONS OF WIRELESS

XV.— More About Detectors

THIS instalment deals at length with anode-bend detection—from which, in spite of its obsolescence, many useful lessons may be learned—and also with the more practical question of the best operating conditions for grid detectors.

By A. L. M. SOWERBY, M.Sc.

WE have seen that the triode can act simultaneously as detector and amplifier of incoming signals. In this use of the valve detection takes place entirely between grid and cathode, these two electrodes behaving exactly like the diode detector discussed in the last instalment. The modulation-frequency voltages produced on the grid in this manner then serve to control the anode current of the valve, producing across the anode-circuit load an amplified copy of themselves. The grid of the detector serves, in this simple view of the process, both as anode of a diode detector and as grid of a low-frequency amplifier.

In the diode, as in the crystal, we saw that detection arose out of the *non-linearity of the characteristic*, resulting in unequal changes of current in response to the two equal half-cycles of voltage applied. In these particular cases the current was actually driven by the signal-voltage, but

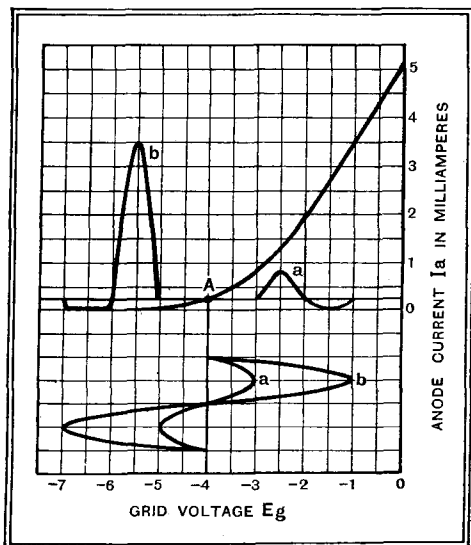

Fig. 82.—Illustrating rectification of both weak and strong signals by an anode-bend detector.

the same principle would apply if the signal only *controlled* the current, provided that the current did not vary linearly with the controlling voltage.

If we examine the valve curve of Fig. 82, in which anode current is plotted against grid-voltage (of a triode), we see

again a non-linear characteristic. At currents over about $1\frac{1}{2}$ mA. the curve is nearly straight, so that rectification will not occur, but at lower currents it is very definitely curved. If, at the anode voltage to which the curve relates, we bias the valve to -4 volts, we shall have an anode current of 0.25 mA. On applying an alternating voltage to the grid, as in Fig. 83, we shall swing the grid voltage rapidly to and fro about the point A as centre. On the positive half-cycle the anode current will rise largely, while on the negative half-cycle it can do no more than drop to zero.

The lower curves *a* and *b* in Fig. 82 show two sine-wave voltages centred on -4 V.; by tracing out the corresponding currents and plotting them we get two upper curves *a* and *b*. These represent the anode current, instant by instant, produced by the alternating voltages shown. In the current-curve *b*, corresponding to 3 V. peak on the grid, rectification is very evident indeed; the upper half-cycle is tall, indicating a large increase in current, while the lower half-cycle is very small. Rectification is thus very nearly perfect, since one half-wave is almost completely suppressed. It is evident that the mean anode current will rise some way above the initial 0.25 mA. and will remain at this increased value as long as the alternating voltage is applied.

Partial Rectification

The current-curve *a*, corresponding to the application of a smaller alternating voltage (1 V. peak) to the grid, shows much less perfect rectification, as is indicated by the nearer approach to equality between the two half-cycles. The rise in anode current resulting from this smaller voltage will in consequence be very much less than one-third of that due to the larger voltage. But it is quite clear that in either case rectification takes place, and that if a modulated high-frequency voltage were applied to the grid instead of the simple carrier-voltage of which one cycle is shown, telephones in the anode circuit of the valve would reproduce as sound the programme modulating the carrier.

Rectification taking place, as here, by virtue of the bend in the anode-current curve is known as *anode-bend*, or, more

colloquially, as *bottom-bend* rectification.

As in other cases of detection, we could plot change in anode current against amplitude of carrier applied to the valve. Since, however, we shall probably use a detector to supply the audio-frequency signal-voltage to a succeeding valve, it would be more profitable to plot, instead of change in anode current, the change in voltage produced across a coupling resistance in the anode circuit. In the curve A of Fig. 84 this is done for a typical battery-heated triode with an anode resistance of 0.1 M Ω .

Unlike the corresponding curve for the diode rectifier, which, after a short initial curvature, was a straight line, this curve continues to grow steeper and steeper throughout its entire length. The relation

between carrier voltage V_g and change in anode voltage V_a is, in fact, such that $V_a \propto V_g^2$ —for which reason the detector is known as a *square-law* detector. The diode, on the other hand, is a *linear* detector. In connection with the latter we saw that straightness in this curve was an essential for distortionless rectification; here the point is clearly illustrated.

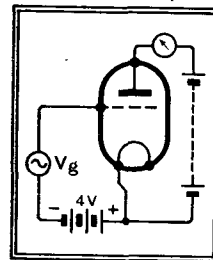

Fig. 83.—Circuit of anode-bend detector to which the curves of Fig. 82 are related; V_g represents the HF voltages shown in the voltage (lower) curves *a* and *b* of that figure.

Below the curve at B are drawn two modulated carrier waves; both of mean amplitude 1.5 volt. One (shaded) is modulated to a depth of 100 per cent. and is designated *a*; the other, *b*, is unshaded and is modulated to 33 per cent. only. The curves of anode voltage corresponding to these, deduced by picking out from the curve the individual voltages corresponding to a number of the different carrier-amplitudes indicated by the envelope of the modulated wave, are drawn at C on the diagram.

Output curve *a*, derived from the deeply modulated carrier, is a most unfaithful reproduction of the wave-form of the original carrier-envelope. Since the carrier-amplitude, centred round 1.5 V., is swinging with the modulation between zero and 3 V., and the curve shows that the corresponding changes in V_a are from an initial 5 V. down to zero and up to 20 V., the source of the inequality is not far to

Foundations of Wireless—

seek. It is simply due to the non-linearity of the V_a - V_g characteristic. This results in a kind of double rectification, the audio-frequency output produced by rectification of the carrier being itself partially rectified.

As a comparison, Fig. 85 shows, to the same scales as Fig. 84, the curve of a purely

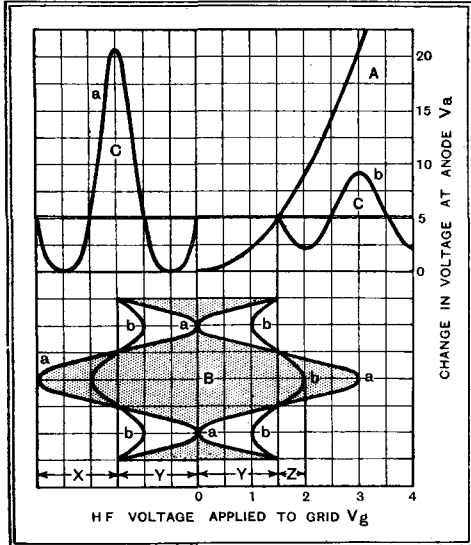

Fig. 84.—Summarising the process of anode-bend detection. A, rectification characteristic of anode-bend detector. B, modulated HF voltages applied to grid. C, anode-voltage swings corresponding to B; deduced directly from A. X, modulation rise 1.5V, 100% modulation. Y, mean carrier amplitude, 1.5V. Z, modulation rise, 0.5V, 33-1/3% modulation.

imaginary detector of absolutely linear characteristic, together with the audio-frequency output it would give if supplied with a carrier of mean amplitude 1.5V., modulated to a depth of 100 per cent. Here the final output is an exact facsimile of the envelope of the received carrier; the detector is thus completely distortionless.

From the practical point of view the conclusion to be drawn from these curves is that considerable distortion, far more than enough to be audible in the loud speaker as a falsification of the music, results when a square-law detector is used to detect a deeply modulated carrier.

Effect of Modulation

With less deep modulation, as in the voltage and current curves *b* of Fig. 84, this distortion of the audio-frequency output from the detector is much less marked. It is still present, but at 33 per cent. modulation the range over which the carrier-voltage is swung by the modulation is so much shortened that the corresponding section of the curve A approaches more nearly to a straight line. At low values of modulation, round about 15 per cent., the distortion becomes unnoticeably small.

In spite of this very serious failing, anode-bend detectors are quite often used in receiving sets, apparently with reasonable success from the point of view of quality of reproduction. This is understandable when one remembers that the

transmitter sends out the bulk of its music at quite moderate modulation (probably round about 15 per cent.), reserving deep modulation, approaching 100 per cent., for an occasional crashing *fortissimo*. Nevertheless, the inherent tendency to distortion of the anode-bend rectifier is leading to its disappearance from receivers of modern design, in spite of the advantage it offers in that, not taking current at its grid, it imposes no grid-current damping upon the tuned circuit from which it derives its signal.

The process of anode-bend detection has been discussed at some length in spite of its obsolescence, partly because it illustrates several interesting points in connection with detector action and detector distortion, and partly because the possibility of detection of this type limits rather seriously the performance of a valve used as a grid detector.

In the circuit of Fig. 86 we see a triode arranged as a grid detector. On receipt of an unmodulated carrier the grid, initially

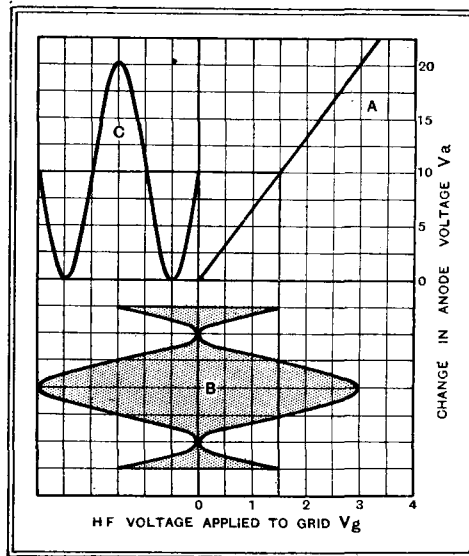

Fig. 85.—The curves of Fig. 84, now drawn for a purely fictitious linear detector. Note complete absence of distortion shown by output curve C.

at or near zero potential, will run negative to an extent approximately equal to the peak voltage of the signal applied, duplicating exactly the behaviour of the anode of the diode discussed in Part XIII. This change is shown accomplished at *a* in Fig. 87, where the carrier is shown as having a peak amplitude of 1 volt. In sympathy with this shift of mean grid voltage, the anode current of the valve will suffer a reduction; on the curve $E_a=60$ at the top of Fig. 87 we see that I_a drops from 4.9 to 3.1 mA.

If now the high-frequency voltage is modulated to a depth of 100 per cent., which means that the carrier-amplitude is alternately doubled and reduced to zero by successive half-cycles of the (LF) modulating voltage, the grid will swing between its original no-signal voltage and -2 volts, as shown by the full-line curve at *b* in Fig. 87. This swing will take place at modulation frequency, and represents the result of the process of detection by the grid acting as diode.

From the anode-current curve corresponding to $E_a=60V$. we see that this audio-frequency voltage developed on the grid will cause an audio-frequency current swing from 1.25 to 4.9 volts. Since the valve-curve is a straight line over this range, the wave-form of the current might be expected to be a strict duplicate of the audio - frequency grid - voltage. Unfortunately it is not, on account of the presence on the grid of the high-frequency carrier-voltage, which is shown on Fig. 87 as a shaded area enclosed by a dotted line. The high - frequency voltage swings the grid to -4 V., thereby running the anode current as read from the curve $E_a=60$ over the curved part of the characteristic and

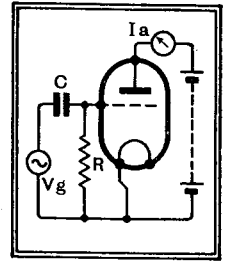

Fig. 86.—Conventional arrangement of triode as grid detector. Note that since R has to carry steady and audio-frequency currents only, it is immaterial whether it is connected as shown here or in parallel with C.

down to zero. Over this region, as we have already seen, anode-bend rectification will take place, raising the anode current above the value it would have had in the absence of the HF voltage. Since this rise takes place at the moment when the detected LF voltage on the grid is trying to send the anode current *down*, the result is a flattening of the peak of this part of the audio-cycle. Again we have met our old enemy *distortion*.

The cure for this trouble is quite simple,

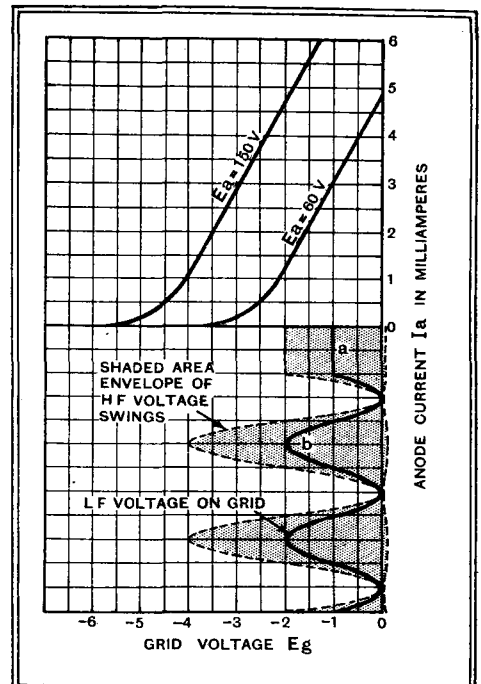

Fig. 87.—Curves showing reason for overload of grid detector. Even though the rectified voltage *b* on the grid may not overrun the straight part of the characteristic, the HF voltage accompanying it may cause anode-bend detection.

and consists in keeping down the voltage of the applied signal to so low a value that the high-frequency ripple on the grid never

Foundations of Wireless—

drives the anode current down, even momentarily, to so low a value that the non-linear part of the valve characteristic is entered upon. This means that the low-frequency output voltage from the anode must be kept down to a maximum of one-half of that which could be obtained if the HF voltage were absent and the valve were acting purely as low-frequency amplifier.

This is the condition in which an ordinary grid-detector is made to work, and its performance when used in this way is very reasonably satisfactory. But owing to the low voltages being handled at the grid, the initial curvature of the rectification curve (see Fig. 78, Part XIV) will introduce some distortion on deeply modulated signals. This can only be minimised, as we have seen, by supplying a larger voltage for detection.

This can be done if we increase the anode voltage of the grid detector to perhaps 150 V., when the anode current at all grid voltages will be raised, so that the

use implies, the diode detector is generally preferred.

From what has been said, it will be evident that the propensity to overload characteristic of the grid detector is due entirely to the need to accommodate large high-frequency current swings in the anode circuit. Since detection takes place on the grid of the valve, we have no use for high-frequency current at the anode; we are really trying, rather ineffectively, to use the valve as an amplifier of the rectified audio-frequency voltages only.

By using a diode for the actual detection, and so connecting it to a succeeding triode that the audio-frequency voltages only are passed to its grid, we can at one blow remove the need for making the triode amplify these troublesome HF voltages, and so free it completely from any danger of overloading other than that due to a possible excess of low-frequency signals. Two circuits for this purpose are shown in Fig. 88; at *a* the separation of

the two currents is performed by interposing a *filter*, consisting of a *high-frequency* choke L and a condenser C, these components being so dimensioned that L has a much higher, and C a much lower, reactance to high-frequency currents than to those of low frequency. Alternatively, we can adopt the circuit shown at *b*, where the condenser and resistance associated with detection are placed at the lower end of the tuned circuit. In this case, as the diagram suggests, the grid of the triode is connected to a point where there exists the full audio-frequency voltage developed across R, while the high-frequency voltage is only that across C, and is negligible compared with that across the tuned circuit.

Either of these circuits provides a detector-amplifier system free from all the disadvantages attendant upon making a single triode, whether as anode-bend or as grid detector, perform both functions simultaneously.

Letters to the Editor

The Editor does not hold himself responsible for the opinions of his correspondents

Volume and AVC

I HAVE observed the effect mentioned by your correspondent, Mr. C. W. Wavell, on two different commercial receivers by very well-known makers. In both cases the AVC system had been carefully tested by means of an oscillator fitted with an attenuator and an AC output meter.

With a view to discovering at what period of the fade the distortion and volume increase occurred, I included a sensitive milliammeter in the anode circuit of one of the controlled valves, so as to be able to watch the functioning of the AVC system, and I discovered that the distortion does not always occur during periods of bad fading, but frequently when the signal strength is well above that which would bring the delay voltage into action.

Further, I noticed some obvious increase in volume on several occasions during the periods in which the milliammeter was practically steady.

Is it possible that either the time constant of the AVC system is too slow, thus allowing the signal to overtake it, as it were, or that the carrier wave occasionally fades, out of phase with the side bands?

Possibly some of your correspondents who are in a position to experiment with the phenomenon of fading more extensively might be able to enlighten me on the subject.
COLWYN L. WOLSEY.
Great Yarmouth.

The National "Ghost"

I WAS interested in the letter of W. E. M. Crook in your issue of February 22nd, as I experienced a similar phenomenon on Friday evening (February 22nd) whilst listening to West Regional between 9.15 and 9.45. The programme was variety from Torquay, and in the intervals of quietness one could follow quite distinctly the play transmitted on the National, i.e., "The Mystery of the Temple."

This is the first time I have had the "effect" at such strength—if "effect" it is—and I suspect that my previous experi-

ences have been due to contacts somewhere on the lines. Whether this one was I do not know, but the stormy conditions of the last few days may have had something to do with the trouble.
C. W. TOWNSIN.
Newcastle-on-Tyne, 3.

Television

IN March 1st issue of *Wireless World* A. E. Rial suggests using the standard 50-cycle frequency of the grid supply for synchronising our television receivers.

It must be mentioned, however, that though the grid system is advocated to cure problems of synchronisation in television, it is very doubtful if it will be suitable for high-definition service.

Television must take a lead now, and it depends upon the grid system, which may be twenty years before completed.

N. M. BUTTON.

Breaston, nr. Derby.

Good and Bad Mikes?

I NOTICE with interest that Mr. Nayler has realised that the B.B.C. transmissions are not always as perfect in quality as those of us who are "quality lovers" would like them to be. The question of good and bad microphones is the standing complaint whenever quality lovers meet.

I think Mr. Nayler may derive considerable comfort from the fact that only a proportion of the transmissions from Broadcasting House are as perfect from a quality point of view as one would expect. London listeners are not therefore particularly favoured. It is gratifying to note that the B.B.C. engineers are conscious of the fact that many of their microphones are very inferior, both from the point of view of frequency response and amplitude distortion. This is proved by the fact that the radiation of really first-class quality is becoming more and more frequent, and it is to be hoped that the good work of replacing the dud "mikes" by superior "mikes" will soon be accelerated.
P. G. A. H.

London, S.E.19.

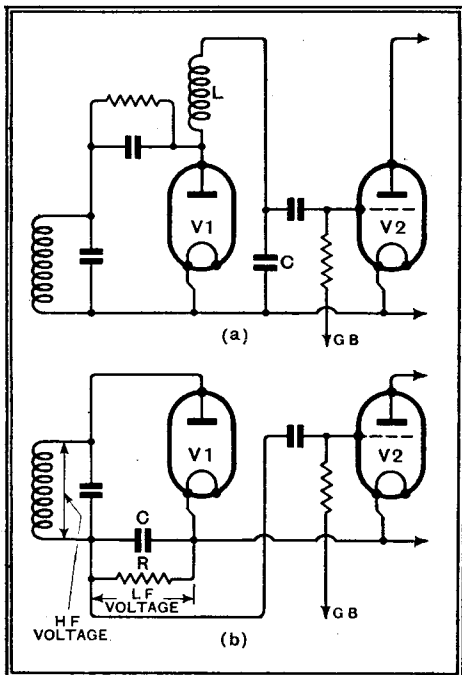

Fig. 88.—Detection by diode V1 followed by pure LF amplification by the triode V2. Two methods of keeping HF voltages from the grid of V2 and so stopping overload: (a) By interposing the filter composed of L and C. (b) By picking up the audio-frequency for V2 from a point X where HF voltages are practically non-existent.

grid must be made more negative before the curved portion of the characteristic is reached. This is shown by the curve $E_a = 150$ of Fig. 87, and comparison of this with the grid-voltage curve below it will show that even at the moments when the high-frequency voltage is at its maximum the straight part of the curve is not departed from. So handled, the detector is known as the "power grid detector"; it has the disadvantage of a high anode current, but is otherwise admirable. It has had a considerable vogue in the past, but is now falling to some extent into disuse, for the reason that when there are available such large signal-voltages as its

The Wireless World

THE PRACTICAL RADIO JOURNAL
24th Year of Publication

No. 813.

FRIDAY, MARCH 29TH, 1935.

VOL. XXXVI. No. 13.

Proprietors: ILIFFE & SONS LTD.

Editor:
HUGH S. POCOCK.

Editorial,
Advertising and Publishing Offices:
DORSET HOUSE, STAMFORD STREET,
LONDON, S.E.1.

Telephone: Hop. 3333 (50 lines).
Telegrams: "Ethaworld, Watloo, London."

COVENTRY: Hertford Street.

Telegrams: "Autocar, Coventry."
Telephone: 5210 Coventry.

BIRMINGHAM:

Guildhall Buildings, Navigation Street, 2.
Telegrams: "Autopress, Birmingham."
Telephone: 2971 Midland (4 lines).

MANCHESTER: 260, Deansgate, 3.

Telegrams: "Iliffe, Manchester."
Blackfriars 4412 (4 lines).

GLASGOW: 26B, Renfield Street, C.2.

Telegrams: "Iliffe, Glasgow." Telephone: Central 4837.

PUBLISHED WEEKLY. ENTERED AS SECOND
CLASS MATTER AT NEW YORK, N.Y.

Subscription Rates:

Home, £1 1s. 8d.; Canada, £1 1s. 8d.; other
countries, £1 3s. 10d. per annum.

*As many of the circuits and apparatus described in these
pages are covered by patents, readers are advised, before
making use of them, to satisfy themselves that they would
not be infringing patents.*

CONTENTS

	Page
Editorial Comment	305
Loud Speaker Response Curves ..	306
News of the Week	311
The Permanent Magnet Industry	312
Volume Control at the Loud Speaker	315
Some Representative Loud Speakers and Their Axial Response Curves	316
The Cathode Ray	320
Unbiased	321
Listeners' Guide for the Week ..	322
Valve Diagrams for Loud Speaker Loads	324
Broadcast Brevities	327
Foundations of Wireless, XVI ..	328

EDITORIAL COMMENT

Television Research

The Need for Equality of Opportunity

WE have always contended in these pages that when television reached the stage of becoming a public service all manufacturers of wireless equipment should be in a position to participate in it on an equal footing, subject to licences from owners of patents, but, although this view was strongly supported in the Television Committee's Report, in practice this ideal is not being carried out.

Nearly all British manufacturers are interesting themselves in the possibilities of television and are at least considering the advisability of producing sets for the public. But equal facilities are not available to them. In London the E.M.I.-Marconi Company and the Baird Company are carrying out test transmissions for their own benefit, to enable them to perfect their receivers, but the rest of the industry and research workers on the problem are not only unaware of the times of these transmissions, which are irregular, but they do not know the precise nature of them.

It is exceedingly difficult for those working on the design of receivers to carry on unless they have transmissions to receive and test with. It does not seem to us to be a fair arrangement for the two companies mentioned above to be alone in having facilities of this kind. It may be said that the Postmaster-General would readily grant experimental transmitting licences for television to any other firms which cared to apply for them, but this would not really meet the case, as the transmissions will ultimately be by the Baird and E.M.I.-Marconi systems and unless the de-

signer knows exactly what is the nature of these transmissions he cannot hope to make headway in the production of receivers.

If the E.M.I.-Marconi Company and the Baird Company were not themselves interested in the production of television receivers in competition with other manufacturers, there would, of course, be no unfairness, but this is not the case.

We cannot imagine that it was the intention of the Television Committee or of the Postmaster-General to make these two companies a present of all the business in the sale of sets which may accrue when television transmissions start, but this is, in fact, what is being done, and it is time some action was taken to put an end to a very one-sided state of affairs.

The Loud Speaker

Accurate Measurement of Performance

ALTHOUGH the loud speaker is probably the most important link in the chain of apparatus between the listener and his aerial, accurate measurement has played very little part in arriving at an opinion as to its performance.

In this issue we describe apparatus which has been evolved for taking photographic records of the audio-frequency response curves of loud speakers, and the results obtained are published with an explanation as to how they should be interpreted.

In the process of taking a large number of these curves of different makes of speaker, the most interesting general conclusion to arrive at is the high standard of reproduction of the majority of modern speakers, the average performance being a good deal better than we believe is generally supposed.

Loud Speaker Response Curves

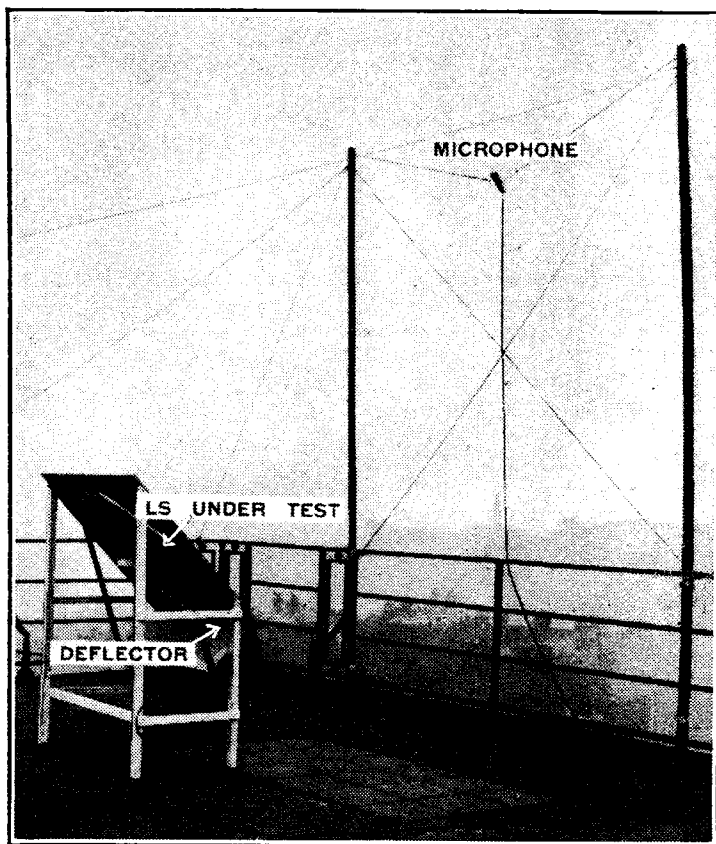

General view of apparatus on the roof of Dorset House.

Curves

Full Details of "The Wireless World" Method of Measurement

WE are already familiar with the characteristics of pick-ups, intervalve transformers and other component parts of the apparatus used at the receiving end of the broadcast chain, but with one or two notable exceptions we have up till now been kept in the dark as far as the final link—the loud speaker—is concerned.

lessly below the microphone. There is still the possibility, however, of a reflection from the back of the diaphragm as shown by the dotted line in Fig. 1. This is eliminated by a deflector which reflects and disperses the ray without causing any appreciable reaction on the loud speaker diaphragm.

Unless otherwise stated, all the tests have been carried out on a standard baffle, the dimensions of which have been fixed at 3ft. square. A larger size would

NO one will seriously dispute the statement that "the ear is the final criterion of loud speaker performance." It is easy, without any scientific or musical training, to appreciate natural reproduction when one hears it or to criticise a loud speaker in general terms on the score of "woolliness," "harshness," "lack of body," etc. If one wishes to go further, however, and to be in a position to say just *why* a particular type of diaphragm should pro-

duce a "woolly" tone or whether harshness is due to irregularities in the frequency response or to the production of spurious harmonics, then one must be prepared to make precise measurements, to back subjective opinion with objective facts.

To begin with, very few people realise, when they have passed an opinion about quality of reproduction, that their criticism does not apply to the loud speaker they have been listening to, but to a much more complex acoustic system which includes the room and its absorption and reverberation coefficients, resonances and re-radiation in windows, cavity resonances in furniture, etc. It is evident that all these factors must be taken into account in the final reckoning, but equally so that they must be eliminated from measurements intended to give information concerning the properties of the loud speaker unit itself.

Free Air Conditions

To be quite sure that no disturbing factors will creep in, the loud speaker and microphone must be mounted in the open air. We are fortunate in having access to a flat roof sufficiently far above the street level to be outside the range of traffic noises. Even so there is still one potential source of error, namely, reflection from the roof. To overcome this the axis of the loud speaker has been tilted upwards so that all reflections arising from the front of the diaphragm pass harm-

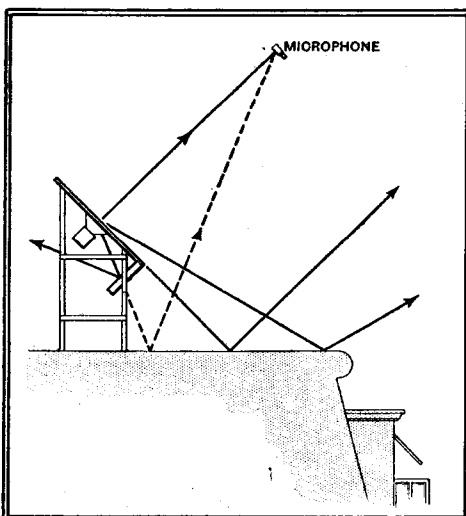

Fig. 1.—The loud speaker axis is tilted upwards at an angle of 45 deg. to eliminate ground reflection. Radiation from the back of the diaphragm is deflected by an extension of the baffle at right angles to the base.

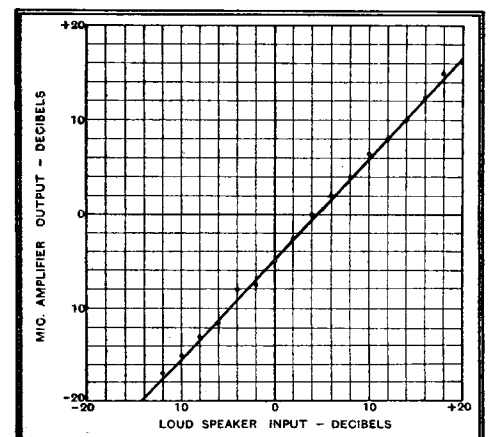

Fig. 2.—The microphone is free from amplitude distortion over a range of 40 db. in the region of the sound pressures used in the tests.

probably have shown an all-round improvement in bass response in the units tested, but it was thought better to settle on an average size in order to approximate more closely to the conditions under which the loud speakers will be used in practice. Some considerable trouble was at first experienced with absorptions arising from baffle vibration, but this trouble was almost entirely eliminated by lining the back of the board with Celotex and stiffening with diagonal battens.

While dealing with the outside gear,

Loud Speaker Response Curves—

reference should be made to the microphone. This is a Rothermel-Brush type G2S2P piezo-electric unit in which a number of "sound cells" having natural resonances above 10,000 cycles are connected in series-parallel. By this means interference due to mechanical vibration and wind noise is reduced, and a lower impedance is obtained, so that a fairly long screened cable may be used without serious loss of sensitivity. Incidentally, the capacity of the leads does not affect the frequency characteristic, but only reduces sensitivity, since the microphone itself is, from the electrical point of view, a capacity.

The actual microphone used we have ourselves calibrated by means of the Rayleigh disc, which is generally accepted as one of the best methods of measuring absolute sound intensity. Since the Rayleigh disc is a velocity-operated device and the

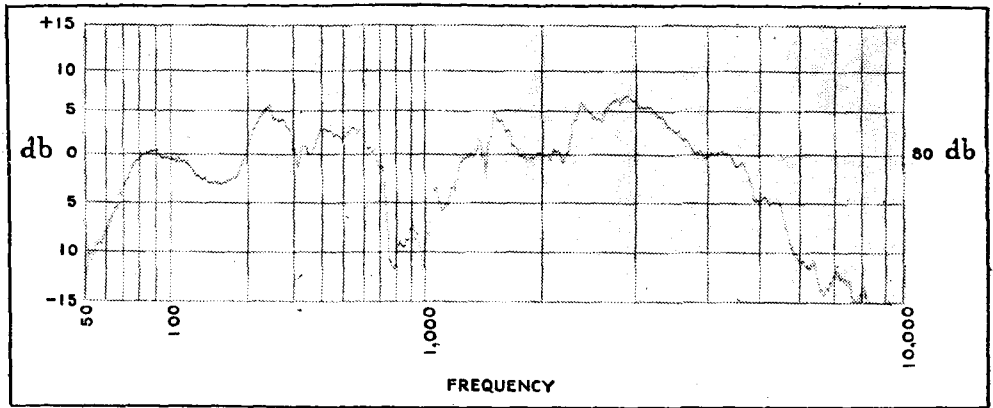

Actual response curves of the same loud speaker measured (above) in the open air and (below) indoors in "The Wireless World" laboratory. Distance of microphone from loud speaker, 3ft.; power input, the same in both cases. It will be noticed that the general level of the indoor curve is approximately 5 db. above the outdoor curve.

All we propose to say about this piece of apparatus at the moment is that it gives a DC output proportional to the logarithm of the AC input voltage (R.M.S.). It is a special form of AVC-controlled rectifier, and plots a vertical scale on the recorder paper directly in decibels, without the necessity for calculation. There is no possibility of arithmetical error, and as this part of the apparatus is battery operated each curve is individually calibrated to ensure freedom from errors due to voltage drift in the batteries.

Scale Calibration

The calibrator consists of a potential divider in which the resistances of the sections have been adjusted to give 5 db. steps. It is fed with 10 volts R.M.S. at 50 cycles and metered by a Weston sub-standard instrument. Before and after each curve is taken the input leads to the level indicator are connected to the calibrator, and a number of points are marked along each edge of the paper and subsequently joined.

The direct current from the level indicator is connected to a photographic recorder which incorporates a dead-beat reflecting microammeter. A sheet of ordinary bromide paper is wrapped round a

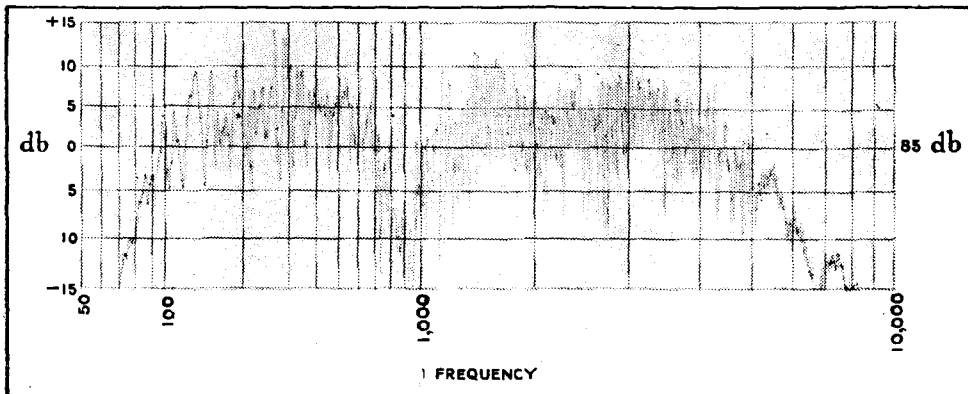

microphone is pressure operated, the curves have been corrected in the bass to indicate the pressure under plane wave conditions. Actually the working distance from the microphone has been fixed at 6ft., and all curves have been taken at this distance unless otherwise stated. It is necessary to work at some distance from the loud speaker, otherwise there is a false increase in the bass response, and also standing wave patterns in the region where the sound from different parts of the diaphragm is combining. On the other hand, at greater distance than 6ft. the sound pressure falls to a level which is comparable with the prevailing noise level. It will be seen that the response is flat within \pm or $-2\frac{1}{2}$ db. from 50 to 9,000 cycles, and there is a sharp upper tendency between 9,000 and 10,000 as the natural frequency of the sound cells is approached.

As a rough check for amplitude distortion in the microphone over the range of pressures used in the tests, the microphone output was plotted against the power input into a loud speaker which could be assumed to be free from amplitude distortion at the frequency used—about 500 cycles. It will be seen from the graph in Fig. 2 that the results from this point of view are entirely satisfactory. The microphone amplifier used is the R.G.D. Model CMA4. This amplifier is entirely mains operated and has a very low hum level. Normally it is fitted with

a microphone correction circuit, but for our purpose this was removed, thus giving a curve flat within 1 db. from 50 to 10,000 cycles. The curve in Fig. 3 is actually the combined curve for the microphone and amplifier as calibrated by the Rayleigh disc.

The AC output from the microphone amplifier is passed to a level indicator.

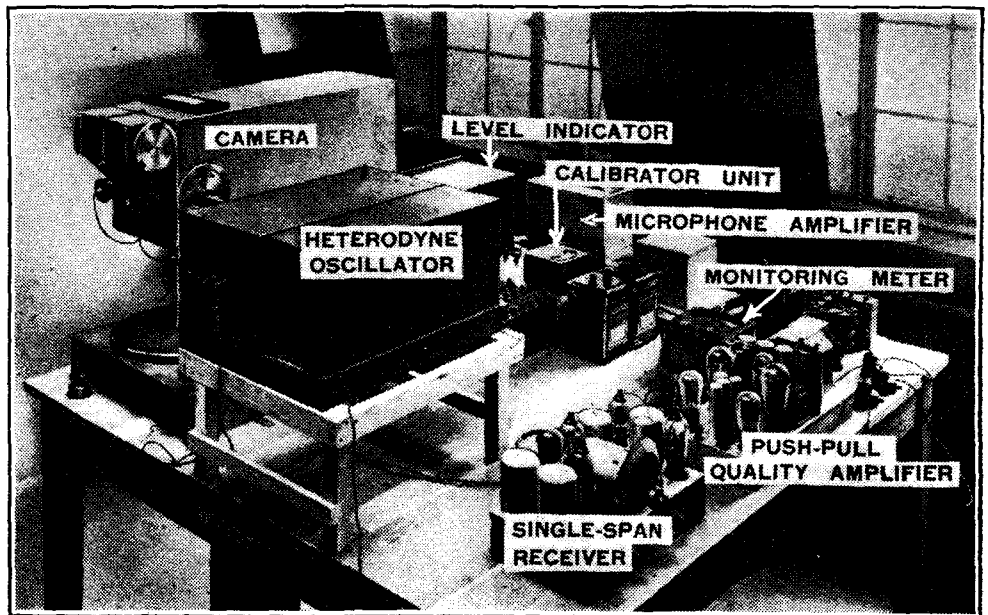

General view of indoor apparatus associated with the loud speaker and microphone on the roof.

Loud Speaker Response Curves—

drum which is housed in a detachable box at the end of the camera. A narrow slit in the box runs parallel to the axis of the drum, and the light from the galvanometer lamp is focused in a vertical slit which intersects the horizontal slit at right angles. This gives a dot on the paper about 0.5 mm. square.

The calibration of the horizontal frequency scale is also made directly on the

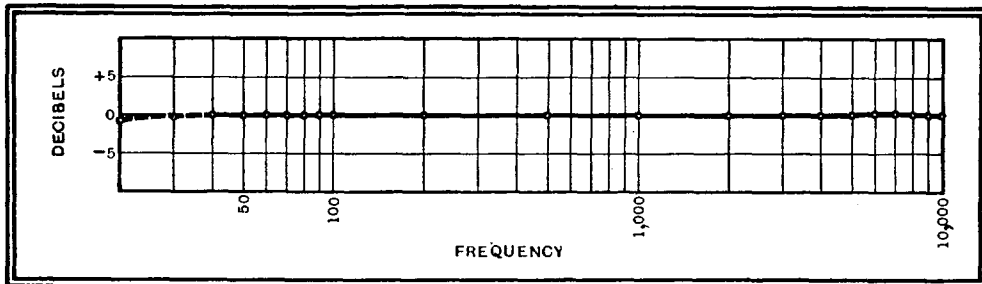

Fig. 6.—The output of the heterodyne oscillator is flat within 1 db. from 50 to 10,000 cycles.

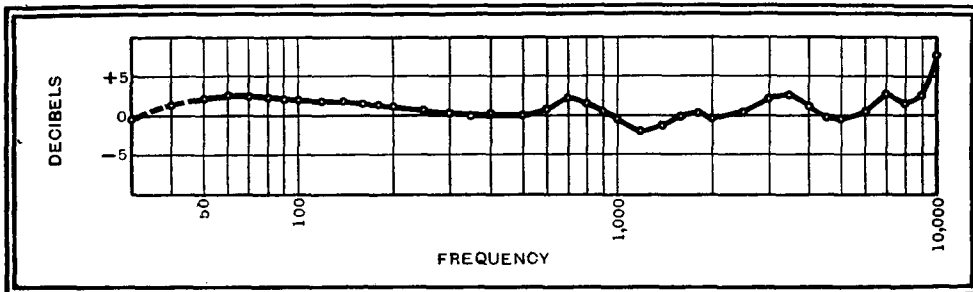

Fig. 3.—Microphone amplifier voltage output for constant sound pressure at the microphone under plane wave conditions.

paper by illuminating the whole of the interior of the camera with a small pilot lamp every time the pointer on the heterodyne oscillator passes one of the principal frequencies. This fogs the paper along the entire length of the slit and provides the vertical lines on the graph. The camera and the condenser of the heterodyne oscillator are coupled by a shaft provided with universal joints, and the whole mechanism is driven from a gramophone turntable which will be used subsequently for taking automatic curves of gramophone pick-ups.

The time taken to cover the frequency range from 50 to 10,000 cycles is approximately four minutes, and as the meter is very rapid in action and practically dead beat there is no possibility of overlooking minor irregularities in the frequency response of the loud speaker.

The heterodyne oscillator makes use of

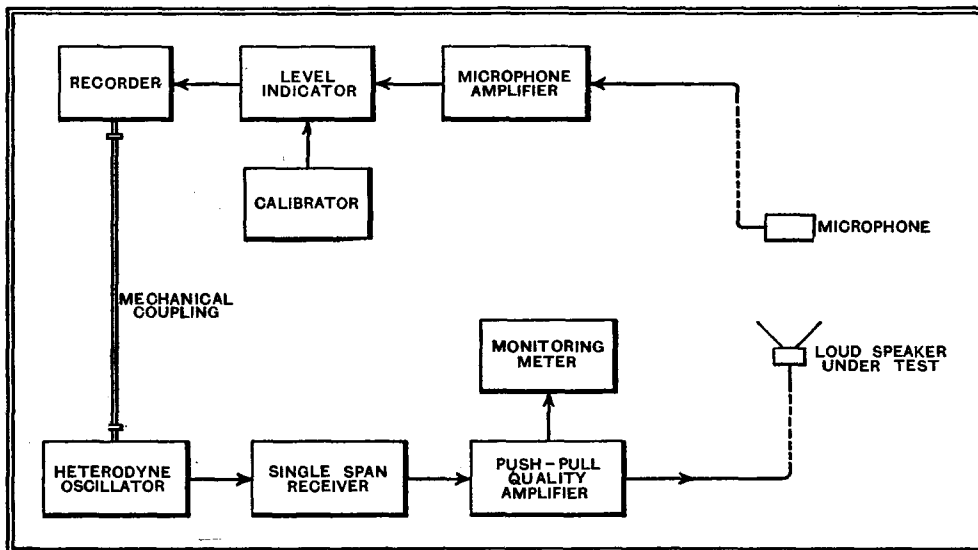

Fig. 4.—Schematic arrangement of component parts of the measuring apparatus.

radio quality for judging the performance of the loud speakers aurally. The output is metered by measuring the voltage across

includes the characteristics of this component, as it should do.

Interpretation of the Curves

Before turning to a detailed consideration of the performance of some representative loud speakers we want to make it quite clear to readers that, important as is the information to be gleaned from the axial response curve, it must not be taken as giving a complete picture of the performance. Until such time as methods are devised for measuring the other factors involved the evidence of the ear must be relied upon to provide information regard-

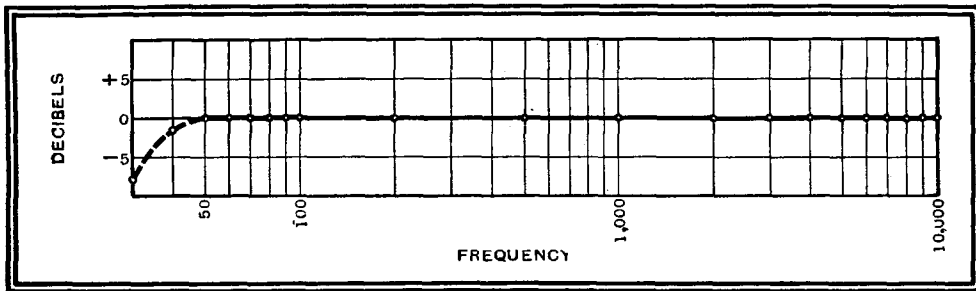

Fig. 5.—Frequency characteristic of decibel level indicator.

dynatrons, and the zero does not drift more than two or three cycles throughout the course of the day. Nevertheless, the zero is checked before each curve is taken.

The output from the heterodyne oscillator is passed to a *Wireless World* Push-Pull Quality Amplifier with PX4's in push-pull in the output stage. A "Single Span" receiver provides the necessary pre-amplifier and also a source of good

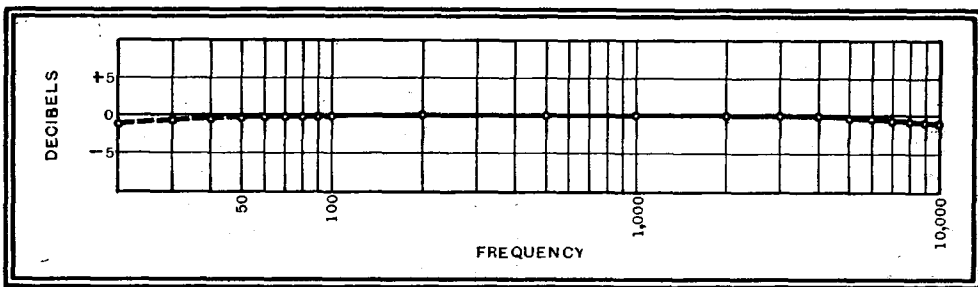

Fig. 7.—Frequency characteristic of the Push Pull Quality Amplifier on the same scale as the response curves.

Loud Speaker Response Curves—

ing such points as transient reproduction which may quite spoil the performance of a loud speaker showing a perfectly straight frequency response characteristic.

Then there is the question of amplitude distortion which will give rise to doubling of the frequencies at the lower end of the scale and will not show on the curve; the reading at 50 cycles may actually be for a 100-cycle note! Again, a sharp peak in

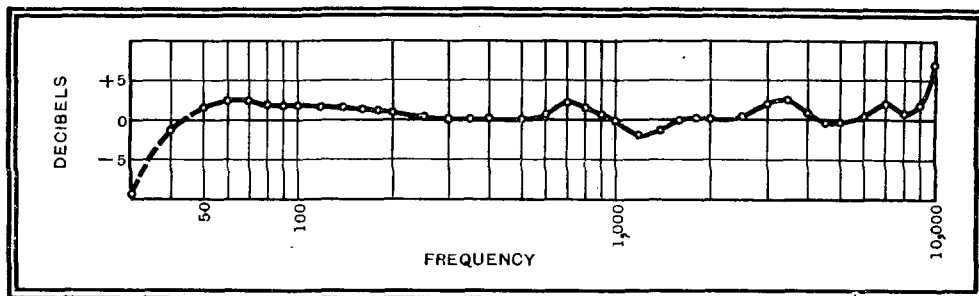
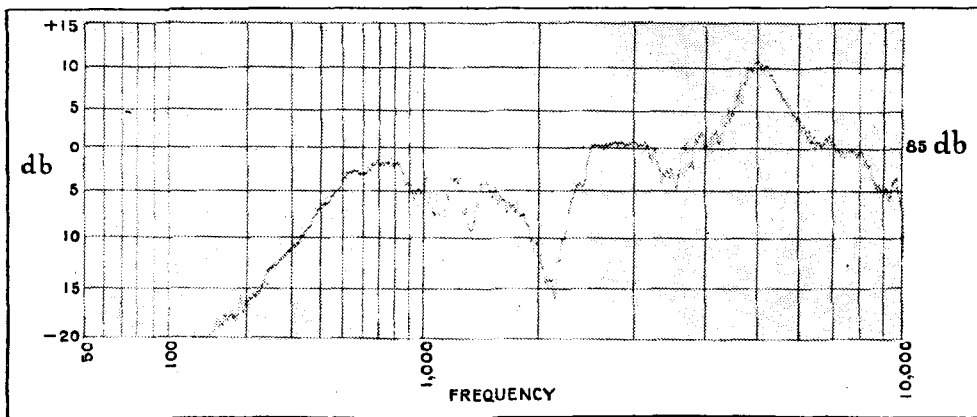

Fig. 8.—Overall response curve of the whole apparatus drawn approximately on the same scale as the loud speaker response curves.



The response curves of the Hartley-Turner Standard loud speaker taken (above) without baffle and (right) on the standard baffle, indicate that the absorption at 500 cycles has its origin in the baffle itself.

the upper register may cause irritation only on the axis of the loud speaker, since the whole of the energy at that frequency may be concentrated into a narrow beam. This will be scattered by reflection in a room, with the result that if the listener were prepared to avoid sitting in a direct line with the loud speaker the general reproduction might be excellent.

All these and many other aspects of the performance will be dealt with in the text

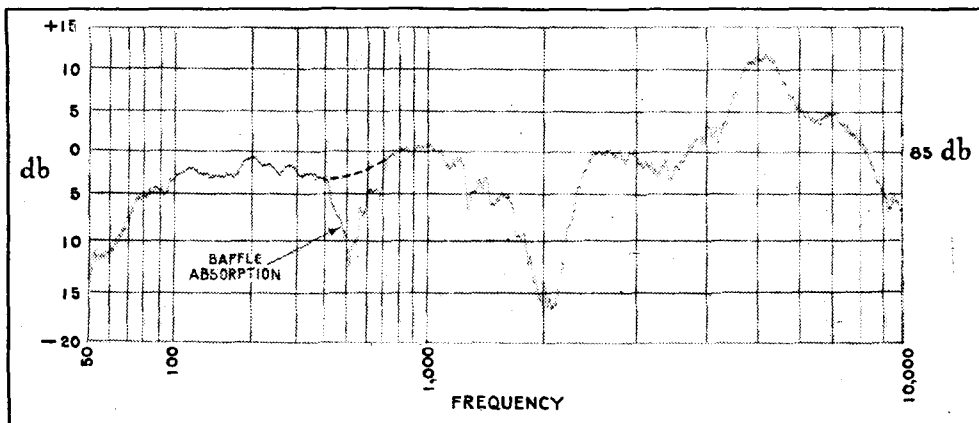

as they will rarely be detectable when listening to broadcasting. Resonances which have a definite approach extending over a considerable frequency band will, however, affect the general result. One of these will be observed to be common to the majority of the curves. This is the dip at 500 cycles, and is due to an absorption in the baffle which was used in these preliminary tests. The accompanying curves of the Hartley-Turner Standard loud speaker, taken on the standard baffle and without any baffle at all, clearly indicate the origin of this irregularity. It varies in depth from curve to curve, depending on the degree of coupling between the loud speaker and the baffle, since more energy is transmitted through the chassis supports in some loud speakers than in others. Attention is now being given to rearrangement of the baffle damping in order that this dip may be eliminated from future tests.

In many cases a series of irregularities will be noticed in the region of 1,000 to 2,000 cycles, which were proved to be due to vibration of the chassis at the fairly high level at which the loud speakers were tested. These can be safely ignored as they will only build up on continuous

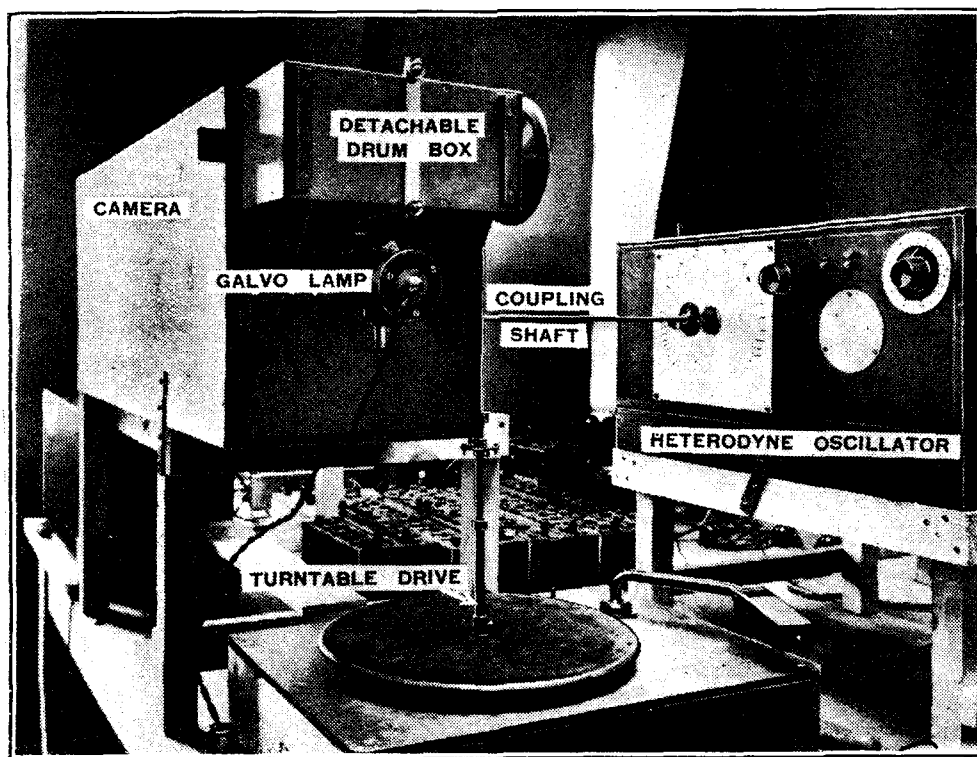

Close-up of recording camera and heterodyne oscillator. The oscillator condenser spindle is geared to the camera drum and the mechanism is driven by a synchronous gramophone turntable.

Loud Speaker Response Curves—

frequency tests and will not be excited to the same extent by the rapidly changing input under normal conditions of use.

To ensure that extraneous noises have not been included in the response curves at least two records have been taken of each loud speaker. Comparison of these two curves at once indicates any irregularity which may be due to external causes. Few cases of discrepancy have been detected, and in every case the irregularity is quite local and does not amount to more than 2 or 3 db.

This point serves to illustrate the importance of a continuous method of recording. The older method of taking readings at a number of frequencies and joining them up to give a continuous curve is not only laborious, but is liable to give misleading results. With the continuous recorder the time taken in photographing a group of curves is often less than the time occupied in fitting the loud speaker to the baffle. In the near future we hope to be in a position to give some interesting facts relating to general problems of loud speaker design, such as the influence of baffle design, etc.

BOOK REVIEWS

Problems in Radio Engineering, by E. A. T. Rapson, A.C.G.I., D.I.C., A.M.I.E.E., Assoc.I.R.E., F.P.S. Pp. 91. Sir Isaac Pitman and Sons, Ltd., Parker Street, Kingsway, London, W.C.2. Price 3s. 6d.

This small volume consists essentially of a classified collection of questions taken from past examination papers in electrical and radio communication of the City and Guilds of London Institute, the Institution of Electrical Engineers, and the University of London. Answers to numerical questions are given at the end of the book.

The fundamental laws and formulæ relating to each class of question are given briefly but very clearly at the head of each group. This makes the book particularly useful to all making a study of radio communication, whether they intend taking an examination or not. O. P.

Modern Radio Communication, Volume I, 5th Edition, by J. H. Reyner, B.Sc. (Hons.), A.C.G.I., D.I.C., A.M.I.E.E., M.Inst.R.E. Pp. 330 + xiii and 157 illustrations. Sir Isaac Pitman and Sons, Ltd., Parker Street, Kingsway, London, W.C.2. Price 5s.

This is an elementary text-book intended primarily for those studying radio communication with a view to taking examina-

tions such as the City and Guilds Institute Preliminary and Intermediate Grades, the P.M.G. Certificate, etc. The text is divided into thirty-two chapters, each giving in a descriptive but concise manner the fundamentals of the various aspects of the subject, which is treated in a non-mathematical way throughout.

The first seven chapters are devoted to general AC theory, and its application to modern methods only is given in the remaining chapters. Examples for the student to work out for himself are appended at the conclusion of most chapters, the answers being given at the end of the book, where specimen examination papers are also included.

There appear to be notably few errors, although one or two slight inaccuracies were observed. For instance, on page 317, the expression $10 \log_{10} \frac{P_1}{P_2}$ is called a power ratio instead of the number of decibels "gain" or "loss." Also, the subject of coupled circuits is not very amenable to simplified explanation, and one or two liberties seem to have been taken here.

The feature of the book is that it fulfils its purpose admirably by adhering to fundamental principles only, and can be recommended to the serious-minded student of radio communication. O. P.

Music from Paper Tape**New Selenophone Machine Used for Broadcasting**

By a Correspondent

CERTAIN of the Italian stations, as well as Radio-Toulouse, are now using an interesting development of the Selenophone paper tape recording machine as described in *The Wireless World* of February 4th, 1931.

No one could pretend at that time that this device for the recording and reproducing of sound by means of a paper strip had passed the experimental stage. To-day the Selenophon G.m.b.H., Vienna, is offering the much-improved Type U7 illustrated on this page.

In sound films, as is well known, the sound track is recorded on a light sensitive film by means of sound-modulated light waves. Modulation can involve either the variable density or the variable area systems, and it is the latter that is used by the Selenophone. The new instrument combines not only the production and reproduction of films, but operates on paper strips, 6 mm. wide, copied from film sound tracks. The light is modulated by a string oscillograph, i.e., a metallic wire or thread vibrating in accordance with sound-actuated

electrical impulses and more or less obscuring a beam of light directed on to a photo-cell.

As reproduction from a paper strip involves reflected light in contrast to reproduction from film, which is transparent,



A paper sound track (twice actual size).

two lamps are directed on the paper strip from different angles in order to avoid "grain" shadows. The film or paper ribbon is moved at constant speed by friction wheels instead of progressing in a series of jerks as is the case with film in a cinematograph

A side view of the new Selenophone.

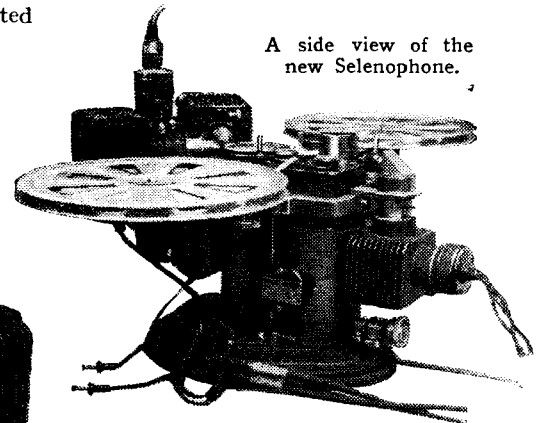

projector. thus there is little likelihood of either film or paper being torn in the Selenophone.

Besides this advantage, the manufacturers claim that paper strip recording is remarkably cheap, and point out that, because of the ease of joining, long continuous programmes can be made up simply by gumming various lengths of paper strip.

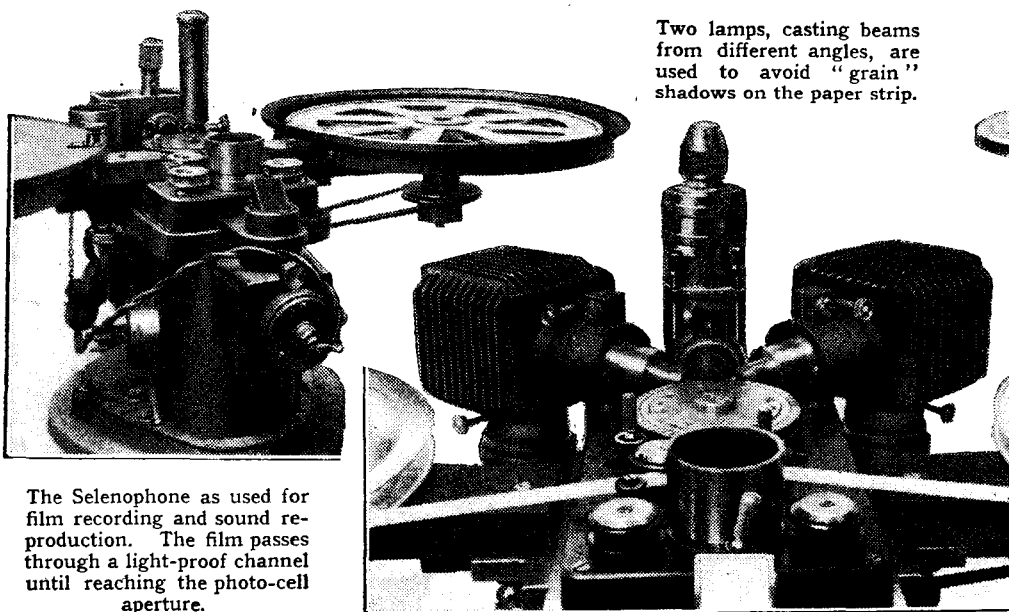

The Selenophone as used for film recording and sound reproduction. The film passes through a light-proof channel until reaching the photo-cell aperture.

Two lamps, casting beams from different angles, are used to avoid "grain" shadows on the paper strip.

CURRENT TOPICS

Events of the Week in Brief

Eiffel Tower : Latest

WITHIN the next day or two the Eiffel Tower station is expected to leave the long-wave band and operate on 206 metres.

Moscow to Tell the World

A NEW Russian radio combine known as Comintern will shortly begin construction of a Moscow short-wave station of 120 kilowatts, designed to be heard in any part of the world.

Springtime Warning

WITH the approach of Spring and the open-window season the Paris Prefect of Police has issued instructions that police chiefs in the various City districts are to see that the anti-loud speaker noise regulations are strictly enforced. Paris does not encourage loud speakers which can be heard on the public highways.

Invitation to Listen

BERLIN (Funkstunde) adopted an interesting precedent on March 16th by issuing printed invitations to a number of listeners to switch on between 10.15 and 11 p.m. The occasion was a special radio play, "Argonnerwald um Mitternacht," describing how the song of this name was composed in the trenches in December, 1914.

Radio at Olympia

MUCH of Marchese Marconi's early experimental equipment is on view in the "25 Years of Progress" section of the Ideal Home Exhibition, which opened at Olympia on Tuesday last, March 26th. The exhibits show the amazing progress of invention during the King's reign, a noteworthy example being the development of the gramophone from the early types with external horns to the high fidelity auto-radiograms of to-day. Advances in sound recording are shown by the Gramophone Company.

"Mike" to the Rescue

AN unexpected *contretemps* occurred recently in the Belgian Parliament, which is equipped with microphones and loud speakers. According to a correspondent, one of the microphones must have been insecurely fixed, for when a certain speaker made a sudden gesticulation it turned completely on its tripod just in time to catch a question put by a senator to one of his neighbours. To the surprise of the House the loud speakers boomed: "How long will this bore keep going?"

France's Radio Map

A BROADCASTING map of France has been prepared by the Post Office, dividing the country into twelve radio divisions, each with its main State station. The Paris region covers the largest area, with Lyons and Rennes next. Corsica is included in the Nice region for technical and administrative purposes.

receiving system operating simultaneously on both wavelengths with the object of maintaining nearly uniform signal strength.

Slow Morse Transmissions

LISTENERS who wish to improve their knowledge of the Morse code are now well catered for, as a number of stations operate regular schedules of slow

"World Radio"

WITH the issue of Friday last, March 22nd, our contemporary, *World Radio*, increased its appeal to the ordinary listener by adopting a more popular style and appearing in an attractive coloured cover, with a price reduction to twopence.

Besides providing full foreign programmes, *World Radio* has extended its illustrated features dealing with programme topics.

Leicester Radio Show

THE Leicester Amateur Radio Society is holding an Exhibition of Apparatus to-day (Friday) and to-morrow at the Turkey Café, Granby Street, Leicester. The Exhibition is chiefly of members' apparatus, and includes 40-metre and 5-metre transmitters and receivers. There are also broadcast sets, including *The Wireless World* Single Span receiver.

A £20,000 Radio Contract

PORTUGAL is to have a new "Empire" short-wave station of 20 kilowatts at Barcarena, near Lisbon, to maintain a link between her colonies, Brazil and Portuguese compatriots in the U.S. The £20,000 radio order for the construction of this station has been secured by Standard Telephones and Cables, Ltd. The transmitter will employ the latest type of directive antennae.

N.R.E.A.

MEETINGS of the National Radio Engineers' Association during next week will be as follows:—

Monday, April 1st.—"Red Lion," Vicarage Road, Watford.
Wednesday, April 3rd.—Castle Hotel, High Street, Ebbwam.
Thursday, April 4th.—Pigeons Hotel, 122, Rounford Road, Stratford.
All meetings open at 8.15 p.m.

Listening in the Professions

PHYSICIANS and chemists make greater use of wireless than the members of any other profession in Poland. In an interesting list issued by the International Broadcasting Union, it is shown that 62.5 per cent. of the doctors, chemists and veterinary surgeons in the country have wireless sets. Other percentages are as follows:—Lawyers, 55.9; land owners, 47.6; clergymen, 27.5; teachers, 27.4; military, 25.4; private employees, 22.6; police officers, 19.4; civil servants, 14.4; merchants, 8.8; mechanics and workmen, 2.6; farm labourers, 1.1; and small farmers, 0.3.



JAPANESE FLYING SQUAD. A strange blend of East and West is shown in this Tokyo photograph of the latest police radio cars in regular commission in the Japanese capital.

Set Servicing in U.S.

HOW set servicing is carried out in America will be described by Mr. J. S. Haliday, lecturing under the auspices of the Institute of Wireless Technology (Home Counties Section) at 7.30 p.m. on Thursday next, April 4th, at the Bedford Hotel, Southampton Row, London, W.C.2.

Twin Transmission on "Ultra Shorts"

ULTRA-SHORT-WAVE research by the American Radio Relay League in their hill-top experimental laboratory at West Hartford, Conn., has confirmed suggestions that conditions on the $2\frac{1}{2}$ -metre waveband are in direct contradiction to those existing on the now familiar 5-metre band. In other words, when conditions are good on 5 metres they are often at their worst on $2\frac{1}{2}$ metres.

Tests are now being carried out with a dual transmitting and

Morse practices on Sundays. They include G2JL, Newport, Mon. (10.30 a.m., 1,911 kc/s); G2DQ, Wickford, Essex (10 a.m., 1,850 kc/s); G2UV, Wembley, Middx. (11 a.m., 1.7 m.c.); G5BK, Cheltenham (9.30 a.m., 1,785 kc/s); and G2WO, Swansea (12.1 a.m. and 9.30 p.m., 1,761 kc/s).

Reports on any of these transmissions should be sent to Mr. T. A. St. Johnston, 28, Douglas Road, London, E.4.

Man Power Broadcasting

MAN power operates the new Peshawar broadcasting station on the North-West Frontier of India. The accumulators are charged by a 12-volt car generator, belt-driven from the rear wheels of specially mounted bicycles. Natives pedal for two hours daily, the energy being converted into news bulletins, talks on hygiene, agriculture, music, native songs, and readings from the Koran.

The PERMANENT MAGNET Industry

Sheffield's Decade of Research and Progress

PROBABLY few people who use the efficient permanent magnet speaker of to-day realise that the demand for a permanent magnet to replace the mains-energised type presented a very real problem to the magnet manufacturer, accustomed though he was to producing magnets to all sorts of varying specifications for the electrical industry. In this article the story of the gradual development of the magnet is told, and further articles will shortly appear dealing with characteristics of magnet alloys and the relative advantages of permanent and energised loud speakers.

TO all who follow the technical growth of our modern world the story of any great or new industry, in its interest, is little short of a romance. The history of the evolution of the permanent magnet is no exception to this rule. On the metallurgical side the family of available magnetic materials has constantly expanded from carbon and tungsten steels through the range comprising chrome, molybdenum and cobalt to the comparatively recent and novel nickel-aluminium alloy. On the design side there have been constantly changing features and a pertinacious seeking for greater and still greater efficiency consistent with economic production. Today, the manufacture of permanent magnets has grown into an important industry which serves in its turn loud-speaker makers and radio manufacturers, whose activities are on an even greater scale.

The City of Sheffield is the home of world-famous cutlery and steel reminiscent of "Excalibur," but it can also claim to be the birthplace of the modern moving-coil loud speaker permanent magnet as we know it to-day. Possibly few have stopped to think that the component which is absolutely essential to the modern battery set has only resulted after concerted

reed or balanced-armature vibration motor, both of which were magnetically polarised by a suitable form of horse-shoe magnet made from either tungsten or chrome steel. For this purpose a few million magnet steel forgings were produced and a huge market existed at that time for an inexpensive product. However, with increased demands for a better standard of acoustical reproduction it was evident that the electro-magnetic type of loud speaker would have to give way sooner or later to the then comparatively new and successful Rice-Kellogg moving-coil loud speaker, which enabled a vastly

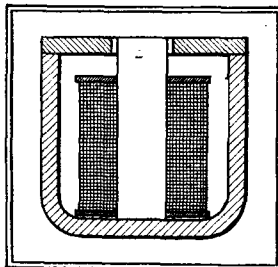

Fig. 1(a).—Simple electro-magnetic "pot" magnet, showing field winding.

improved reproduction in the lower musical register to be achieved.

It was late in 1926 or early in 1927 that radio engineers were dreaming of an equivalent to a Rice-Kellogg moving-coil loud speaker, but without a separate source of field-magnet excitation, and enquiries were made regarding the possibility of exploiting the mysterious and ever-fascinating permanent magnet for this purpose. It is interesting to visualise the situation. Fine steel makers at that time were mostly employed in producing tungsten tool steels and similar alloys, and because of the similarity in technique, were also the pioneers of Lord Kelvin's tungsten compass-needle magnet steel, later studied so exhaustively by Evershed. Simple forged magnets were then demanded by the electrical industry, and the principal line was undoubtedly a large horse-shoe-type tungsten steel magnet for magnetos. Other contemporaneous magnets were mostly of simple form, such as rectangular bars or rods. The idea, therefore, of setting up a strong radial magnetic field in an annular

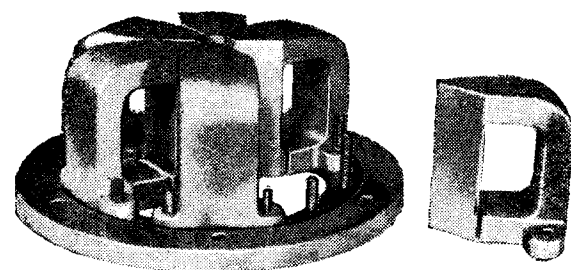

Fig. 3.—Showing construction of magnet in Fig. 2 from individual components.

gap, using magnet steel for the purpose, was an entirely fresh problem, and special methods, of necessity, had to be developed to cope with the new demand.

Perhaps it would be as well to say that at this time the well-known electro-magnetic "pot" magnet was commonly made in the form of a heavy cast-iron casting, often weighing as much as 10 lb. It was usually fitted with an annular gap about 2 in. diameter, and sometimes had a radial gap length of almost $\frac{1}{2}$ in. This design owed a great deal to the very thorough early development work carried out by Rice and Kellogg in America, but in the essentials of its design was the same as the now historically famous "pot" magnet designed twenty-five years before, by Sir Oliver Lodge (Fig. 1). A sketch of this general type of electro-magnet is shown in Fig. 1 (a).

As so frequently happens when a new problem arises, the less straightforward method was first adopted, and it is of real interest to trace some of the steps in the evolution of the modern moving-coil loud

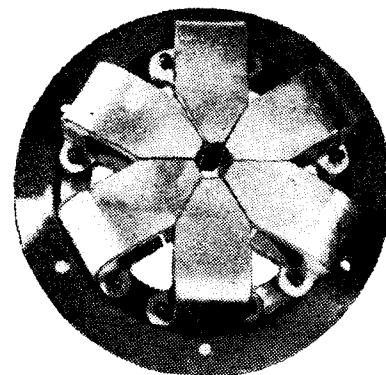

Fig. 2.—Early built-up permanent magnet with hexagonal gap.

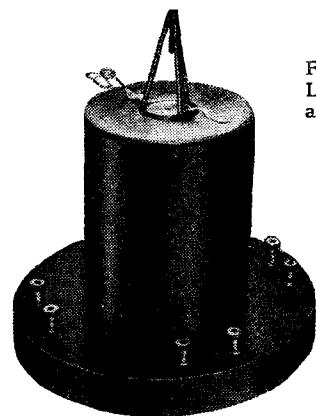

Fig. 1.—Sir Oliver Lodge's famous annular gap electro-magnet.

(From an exhibit in the Science Museum, South Kensington.)

joint effort on the part of inventors, metallurgists, physicists and engineers.

Perhaps it would be as well to explain that the battery set first appeared with a cone-type loud speaker driven by a small

speaker permanent magnet. A photograph of one of the very early magnets which were successful enough to be put on the market is seen in Fig. 2. It is composed of six slightly modified separate magnets, such as at that time were used for damping the rotating discs in alternating

The Permanent Magnet Industry—

current electricity meters, and a photograph showing the way in which these magnets were arranged is seen in Fig. 3.

One of the most striking features of this first Magnet is that the gap is hexagonal in shape, necessitating the use of a special hexagonal moving-coil, which was actually made and exhibited at the Radio Exhibition in 1927, and later sold in its finished form as the "Cubist" Loud Speaker. A few hundred of these loud speakers were sold shortly afterwards. The reason why the gap was hexagonal is simply that the gap in each of the six original component Magnets was straight, and methods of producing curved gaps in the very hard magnet steel were unknown at that time.

Simplification

The next development of considerable interest is seen in Fig. 4, where the number of separate limbs possessed by the completed magnet had been cut down from

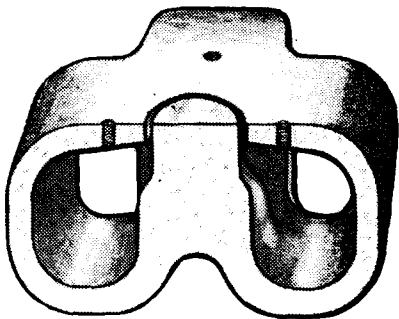

Fig. 4.—First magnet with integrally cast limbs.

six to four, and all four limbs produced together as an integral casting. The gap was then cut directly into this complicated casting, and the special trepanning tool necessary for the purpose is seen in Fig. 5. In effect, it is like a multi-pair of compasses in which a small cutting blade is inserted in place of the pen or pencil. It is located by means of a small central spindle which rotated in a pilot hole drilled in the centre of the magnet itself.

This tool was quite successful in cutting the magnet steel, still very hard, even when in the annealed condition, but its principal limitation was that the gaps having a radial length of less than 0.070in. could not be cut, due to the fact that the

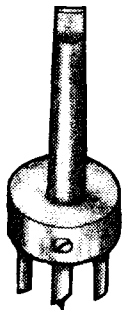

Fig. 5.—Special trepanning tool to cut circular gap in magnet steel.

blades in the trepanning tool had to be so small that they readily broke, and the job ceased to become practical.

A further development of this original cross-type magnet is seen in Fig. 6, in which a further real advance had been made. The gap was now formed in mild steel, and this feature of magnet technique is still retained in present standard practice. The magnet was formed originally as an open casting, and the portion shown at "A" was turned or ground to a pre-

cise diameter. Into this circular cavity was pressed a mild steel ring, in itself bored to the correct outer pole diameter, and the

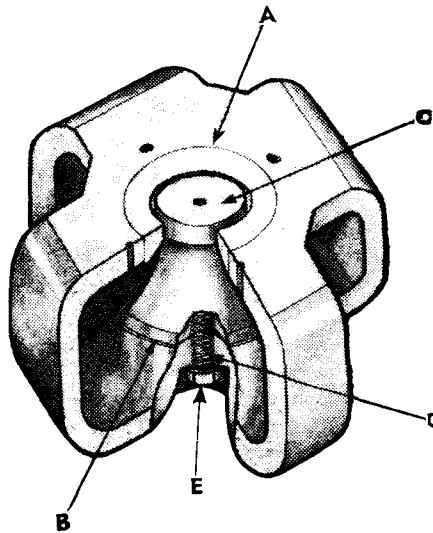

Fig. 6.—Completely developed "four-claw" or "cross-type" permanent magnet.

central portion of the casting which originally came right up into the gap was now foreshortened to a position such as "B," and a mild steel tip "C" secured in position by means of a central bolt "D," finally locked by a lead seal "E." This magnet, although developed as early as 1928, still has a number of very important advantages, including great robustness and rigidity in its several parts, and while largely superseded by more modern types in certain directions, it is still manufactured in the form shown, and still holds a

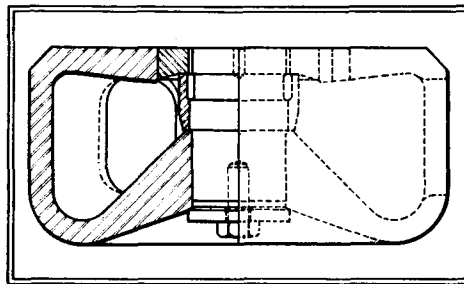

Fig. 7.—An early pot-shaped permanent magnet with windows to permit of temporary winding for magnetising.

place in the market, which it rightly won for itself at its inception.

Another type of re-entrant pot-shaped magnet produced at about the same time is seen in Fig. 7, which has some excellent features of design. The shape of the outside wall is such as to give low magnetic leakage external to the gap, and the collection of the flux by the mild steel centre-pole is efficient because of the large area of contact at the joint. These magnets were mostly cast in 9 per cent. Cobalt steel, but the matter of the choice of the most suitable steel will be dealt with later.

The next important development was really a simplification, and two of the limbs were eliminated. Also, in certain alloys and in particular chrome, it was found that if the magnet steel was brought right up to the limit of the outer pole and machined on that face as well as on the seating for the central pole tip, that a thoroughly satisfactory magnet could be

made, and besides being straightforward in manufacture was also quite efficient magnetically. These have been termed the "integral top-plate type," the two-claw type," and the "O" type, and they have been produced in quantities running into hundreds of thousands. Fig. 8 shows an example in this class.

Production

It might be of interest to describe briefly how such a magnet is made. The rough casting, as taken from the sand mould, has the shape shown in Fig. 9, in which the head of the casting is seen at "H." The procedure, briefly, is to remove the adherent sand, to anneal the casting so that it can be machined, of which the first preliminary operation is the removal of the head by means of a special saw. Once the head is removed the casting can then be mounted on the face plate of a suitable lathe, and, at one operation, the outer pole bored and the seating for

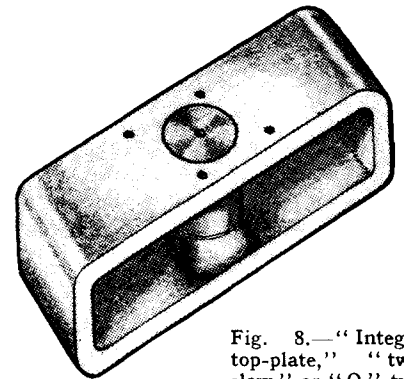

Fig. 8.—"Integral top-plate," "two-claw" or "O" type permanent magnet.

the central pole tip turned. This seating is further drilled to enable the centre pole fixing screw to pass through the casting from the back. Any roughness on the external surfaces of the magnet is removed by holding the magnet against a suitable kind of grinding wheel, after which the steel is finally hardened by heating to the correct temperature and quenching in oil. To prevent corrosion and to give a finish the magnet is cadmium plated. Small precision mild steel centre poles already cadmium plated, are then bolted in position, exact centrality being ensured by inserting a hardened ring gauge into the gap

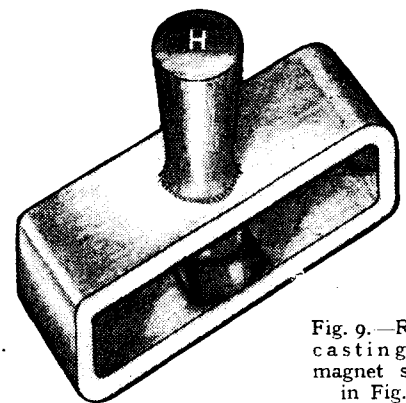

Fig. 9.—Rough casting for magnet shown in Fig. 8.

during this operation. The bolt head is finally locked by a lead or rosin-solder seal. The completed magnet is then

The Permanent Magnet Industry—

cleaned, gauged, magnetised and tested, and all those failing to give a certain pre-determined performance are rejected. After magnetisation scrupulous care is taken to prevent the ingress of dirt and magnetic particles, and a compressed air blast is employed to blow out the gap before packing in tissue paper prior to final packing and despatch. If the magnets are to be delivered unmagnetised, then they are demagnetised after testing by the application of a strong alternating current field.

Another type which was conspicuously successful during its career, but which has now been largely superseded by the more modern nickel-aluminium alloy magnets, is seen in Fig. 10. Here different materials were employed for the various parts, and it was therefore known as the "Composite" magnet. The centre pole was made of a somewhat stronger magnetic material than the longer limbed yoke, screwed or welded to the top plate. A typical design in this class would have a 9 per cent. cobalt centre pole, a Tungsten steel yoke and a mild steel top plate. No parts were cast, and the yoke was forged hot to the required shape. The magnetic efficiency

was high because the magnet steel was taken right up into the gap. For a given economic performance the mass of the magnet was low, because mild steel parts were reduced to a minimum.

The advent of nickel-aluminium alloy has necessitated radical changes in design, and it is proposed to deal with these in

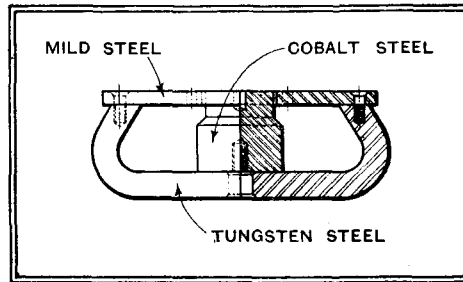

Fig. 10. — A "composite" permanent magnet made from different varieties of steel.

further articles as well as to explain the desirable characteristics which should be possessed by the magnetic alloys which have come into everyday use. Consideration will also be given to the relative advantages of permanent and energised loud speaker magnets and the factors which influence the choice between them.

DISTANT RECEPTION NOTES

READERS may have noticed that the 4.2 kilowatt Klagenfurt station, working on 231.8 metres, is often to be heard at very good strength after dark. This station works with three others, Linz (0.5 kW.), Dornbirn (0.5 kW.), and Vorarlberg (2 kW.) on the Austrian Common Wave; either the stations are particularly well synchronised or Klagenfurt's power is sufficient for it to over-ride the others, for there is usually little or no sign of common-wave "jumbling." On the other hand, a slight heterodyne is sometimes noticeable which appears to come from Danzig.

Another common-wave station which often gives good reception is the 17-kilowatt Frankfurt on 251 metres. In this case the common wave belongs to Germany, a country whose authorities are particularly good in preventing erring and straying. Here again, though mutual interference between the wave-length partners is rare, a heterodyne is sometimes found. This seems to be due to Kharkov.

It is a great pity that there should be so much wave-length wandering in the lower part of the medium wave band, for it contains many interesting stations which would be well heard were it not for the heterodynes and the jamming caused by other transmitters which either cannot or will not keep to their proper wavelengths. Trieste is a case in point. This station was strongly and well received some time ago in Great Britain, and still would be but for the unwelcome attentions of Lille. We cannot, though, completely absolve the Italian authorities: Milan II, whose proper wavelength is the International Common Wave of 222.6 metres, has been working of late on a wavelength just a little shorter. As the power of Milan II is 4 kilowatts this small change has given rise to a good deal of interference with other stations. In an attempt to avoid it Turin II has also re-

duced its wavelength by something under a metre—and so it goes on. If one station in the very crowded lower portion of the medium band begins to make unauthorised changes in its wavelength, its neighbours are forced to follow suit, and then their neighbours must do likewise. The result is rather like what happens when a goods train pulls up, each truck cannoning into the one in front of it for the whole length of the train.

New Dutch Transmitter

Though I have not myself been using a receiving set in the small hours during the past fortnight, many readers have doubtless been doing so in search of America. From some of these I have reports that they picked up a new and much more powerful Hilversum transmitter working experimentally on 301.5 metres. I should be glad to have confirmation by post card from any others who have picked up the transmissions. Will those who are kind enough to write please say whether they heard any announcement about the output power that is being used?

Now that Radio Toulouse is permitted to use 60 good kilowatts excellent reception of its programmes is obtainable in this country. The station comes through clearly and well, and full loud-speaker volume is assured whenever one turns to 328.6 metres. Luckily no interference is now noticeable from the Russian station which now shares the same wavelength, and Limoges has been moved for the time being to 335.2 metres.

Here is a list of a dozen star performers amongst European stations at the present time: Stuttgart, Prague I, Rome, Munich, Leipzig, Berlin, Hamburg, Toulouse, Brussels II, Breslau, the Poste Parisien, and Bordeaux.

D. EXER.

Wind-Driven Generators

IT is rather surprising that so few serious attempts are made by those without mains supplies to harness the power of the wind to the generation of electrical energy for feeding broadcast receivers. For fairly obvious reasons it would seldom or never be practicable to generate a steady supply for an ordinary mains set (at any rate for an AC mains set), but the feeding of a battery model is relatively simple.

The fact that both low- and high-tension current is needed has hitherto been an obstacle, but nowadays there are many ways of overcoming this difficulty.

We cannot expect to obtain a supply of electrical energy directly from the wind, which proverbially bloweth where it listeth—and more important still, when it listeth. What is clearly needed is some form of reservoir (e.g., an accumulator) in which energy can be stored during a good breeze against periods of calm weather.

The plan, then, is to have an accumulator battery (say, of 6 or 12 volts), charged whenever conditions permit from a wind-driven dynamo, and to take the LT supply direct from the battery. There remains the HT problem. Three practical methods of "stepping up" the low voltage of the accumulator battery suggest themselves; a rotary DC generator; a bank of HT accumulators arranged like the Milnes units for charging in parallel and discharging in series; lastly, a vibratory HT generator.

This subject has lately been brought into the limelight by the introduction of the Dutch Mill battery charger, a wind-driven device of American origin for which R. A. Rothermel, Ltd., of Canterbury Road, Lon-

A wind-driven dynamo, charging a 6-volt accumulator at rates varying between 3 and 15 amps., depending on wind velocity. A distribution board completes the equipment.

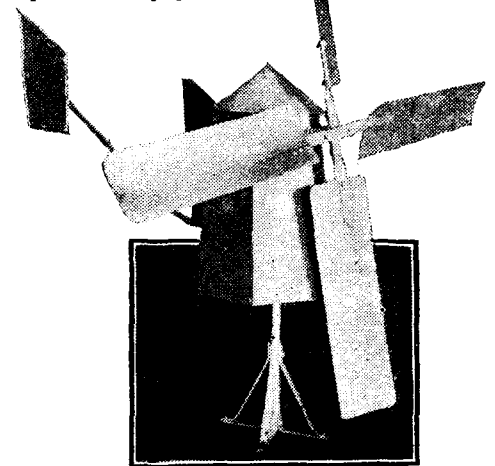

don, N.W.6, are the British agents. The mill, which stands about 4ft. high, is mounted in some elevated position on a roof or pole. A 6-volt generator, contained in a weatherproof housing, is driven by a V-belt from sails 6ft. in diameter. Lubrication of the shaft bearing is done with a grease gun, motor car fashion, and, broadly speaking, automobile practice is also followed on the electrical side; the generator is designed to give a more or less constant voltage output after a certain critical speed of rotation is reached, and a cut-out is, of course, fitted so that the accumulator does not discharge through the dynamo windings during calms.

Volume Control at the Loud Speaker

ONE feature that makes an extension loud speaker less beneficial than it might be is the dash into the other room to subdue it when the telephone bell rings. And if someone else happens to be listening there a minor conflict may ensue. Meanwhile the 'phone is steadily ringing. Or perhaps you have been enjoying the Symphony or Theatre or Dance Orchestra—according to your taste—at a good rousing volume; and Mlle. Oklosia Iaz is announced for a group of songs. The strain of selecting the lesser evil—to have to hear her at unabated volume, or to go into the room where the switch is situated for the purpose of closing her down—may be very severe. When people are listening off the same receiver in different rooms there may well be different ideas as to how loudly the programme should be reproduced.

All these little problems are greatly eased when the loud speaker itself is fitted with a volume control. It is bad in principle, of course. There is the risk that the output valve may be overloaded in being called upon to turn out much more than the loud speaker is actually using; which is a state of affairs that causes the worst form of distortion. But there is no need to worry about that, so long as care is taken to limit the output by means of the ordinary volume control to such an extent that nothing disastrous in the form of distortion takes place when the loud speaker volume control is pushed over to maximum. The purpose of the latter is solely to *reduce* volume when there are any special reasons, such as those I have just suggested, for doing so.

Impedance Variations

Now, about the method. There is one important thing to be known, the impedance of the loud speaker. In an earlier article, "The Extension Loud Speaker" (December 7th, 1934), I explained how the impedance at the extension speaker sockets may be anything from 1 to 10,000 ohms in modern receivers. If the connection is made without the interposition of a step-down transformer, it comes in the category of "High Impedance," and ranges from about 1,000 to 10,000 ohms, according to the optimum working load of the valve; triodes take the lower figures and pentodes the higher. Sockets connected to the secondary terminals of the output transformer, ready to go directly to the moving coil of a loud speaker, are generally designed for an impedance of not more than 12 ohms; most often about 2 ohms at the present time.

The circuit of the volume control is simple, and unaffected by all this—see Fig. 1—but the resistance of the potentiometer is bound up with the impedance of the speaker. If it is excessive there are two bad results: the control is too drastic

Choosing the Correct Resistance

and causes most of the volume to be dropped in the first few degrees; and there is likely to be distortion. The distortion is more particularly bad if the speaker is of the moving-iron type.

On the other hand, if it is too low it wastes a serious proportion of the output itself, and mismatches the whole

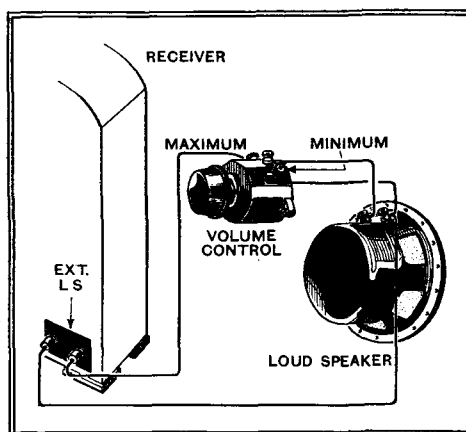

Connections of a volume control in a loud speaker extension line.

arrangement. It is generally satisfactory to choose a resistance not less than two or three times, and not more than ten times, the impedance of the loud speaker.

If the speaker is a low-impedance moving coil it is allowable to go considerably above ten times; in fact, it is rather beneficial to do so, because it is difficult to get really good volume controls of only a few ohms, and even more care than usual is necessary to keep the resistance of the wiring and connections generally to a low enough figure.

Here are some recommendations:—

Output.	Resistance of Potentiometer : ohms.	
	Moving Coil Speaker.	Moving Iron Speaker.
Direct from Battery Pentode or Class B.	100,000	50,000
Direct from Mains Pentode.	50,000	50,000 or 25,000
Direct from Small Triode	50,000	25,000
Direct from Large Mains Triode.	25,000	10,000
Transformer - coupled for 12 ohms.	100	—
Transformer - coupled for 5 ohms.	50	—
Transformer - coupled for 2½ ohms.	25-50	—

But they are only a rough guide. So there is no need to take the trouble to write in and tell me you are getting results with double or half as many ohms.

A "tapered" or "logarithmic" type of control is an advantage, provided that it is connected in such a way that the resistance change is gradual at first, moving from the loudest position, and steepest at the "minimum" end.

Quite a good scheme is to mount the volume control on the end of a length of flex, so that it can be located on the arm of the chair, or other lazy position.

When working with an impedance of single-figure ohms it is obviously very important to keep all wiring resistances down by using thick wire and making really good joints. And do not forget that it is unhealthy for a pentode to work into a load much greater (in number of ohms) than it is rated for. Such a condition would arise if (a) no loud speaker is directly connected, and (b) a speaker is connected through a volume control having a resistance much greater than the optimum load, and (c) the volume control is set some distance from maximum. *Verb. sap.*

M. G. S.

Push-Pull Quality Amplifier

A MODEL of *The Wireless World* Push-Pull Quality Amplifier has been received from Chas. F. Ward, of 46, Farringdon Street, London, E.C.4. The apparatus is assembled on a metal chassis and is solidly constructed, high-quality components being used throughout. On test the amplifier functioned in an entirely satisfactory manner, and proved in every way the equal of the original model. It is priced at £14, but it can be supplied in modified form for use with PX25 type output valves at £16. This firm is also marketing the QA Receiver for use with this amplifier.

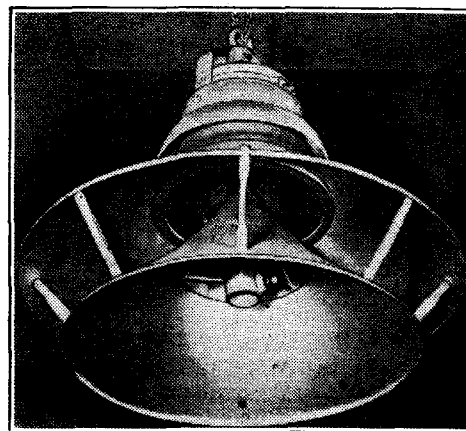

NON-DIRECTIONAL loud speaker now used extensively for public address purposes in Germany. It is a product of the Körting firm.

Some Representative Loud Speakers and their Curves

Correlating Measurements with Performance as Judged by Ear

THE following response curves which represent the first fruits of the apparatus designed in *The Wireless World* laboratory for obtaining concrete data regarding loud speaker performance should be carefully studied in conjunction with the remarks on the performance as judged by the ear.

All the curves were taken at a level of 4 watts with the microphone at a distance of 6ft. The figure at the right-hand side of each curve represents the sound level above the threshold of hearing, and as a first approximation may serve as an indication of relative efficiency. The power of 4 watts under steady frequency conditions was found to produce resonances in the chassis of some of the smaller units, and in future tests a lower level may have to be standardised.

In every case the depression at 500 c/s, which has been bridged by a dotted line, may be ignored as it is introduced by the baffle on which the majority of the tests have been made, and will be eliminated in all future curves.

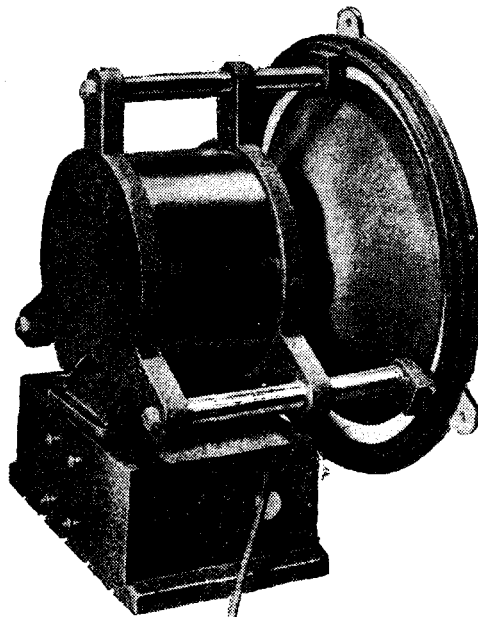

Epoch Type 101 1/2 J.

pectation this does not appear to have resulted in any serious amplitude distortion, and 1 1/2 watts can be accepted at 50 c/s without frequency doubling. Apart from the smoothness of the response up to 6,000 c/s the most noteworthy aspect of the performance is the transient reproduction which is distinctly above the average. An input of 4 watts has not the slightest effect on the exceptionally solidly constructed chassis.

The model tested was equipped with a rectifier for energising the field from AC mains. DC models are available at lower prices.

Ferranti Type M1+. Price £7

AS with the majority of high-grade moving-coil loud speakers, this unit will accept considerable powers in the region

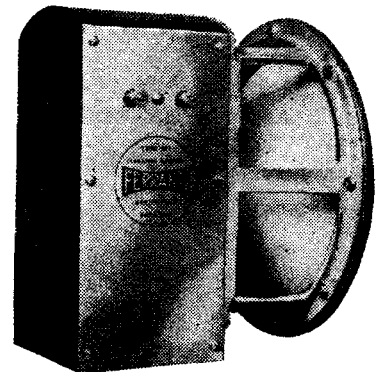

Ferranti M1+.

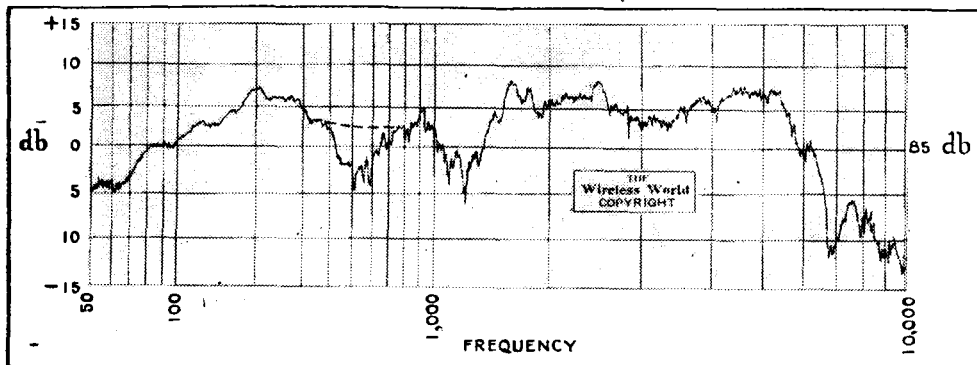

(Above) Curve of the Epoch Type 101 1/2 J, and (below) of the Ferranti M1+.

below 100 c/s without introducing amplitude distortion or provoking modulation of the high frequencies. Tests showed that the power which may be applied at 50 c/s before frequency doubling can be detected by the ear is slightly more than 1 watt. This corresponds to a much higher level at other parts of the frequency range and allows an ample margin for all normal requirements.

In conclusion we should like to acknowledge the confidence implied both in their own products and in this journal by the ready acceptance of the following firms of our invitation to submit units for the purpose of these preliminary tests.

Epoch Type 101 1/2. Price £9 5s.

THE performance of this loud speaker bears out in every respect the promise of its excellent response curve. There is no coloration by resonances, neither is there any lack of fullness of tone caused by depressions in the response curve. The diaphragm surround is of soft leather and is under slight tension. Contrary to ex-

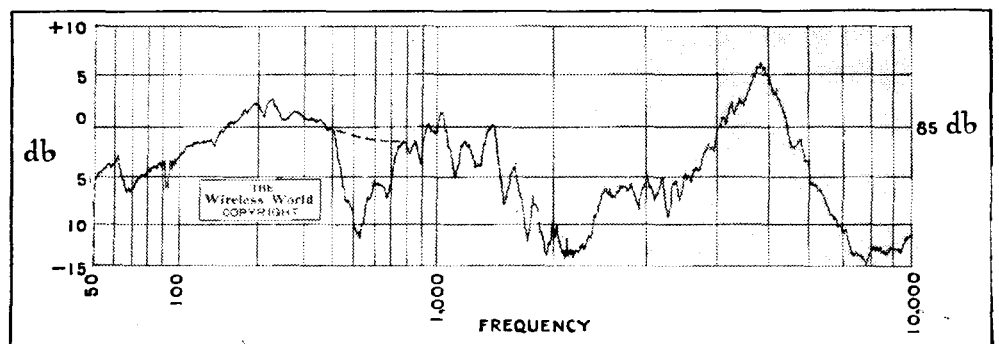

Some Representative Loud Speakers and Their Curves—

The general depression in the curve between 1,500 and 4,000 c/s is noticeable on combinations like string quartets where the body of tone already shows a tendency to thinness, but curiously enough it does not appear to be so serious in the reproduction of the full orchestra.

The peak at 5,000 c/s produces coloration of the upper register when listening on the axis of the loud speaker, but this becomes progressively less as the observer moves away from the axis. The angle of 45 degrees appears to be about the best position for listening to this reproducer, although in this position there is some reduction of the useful output between 7,000 and 10,000 c/s which is indicated in the curve.

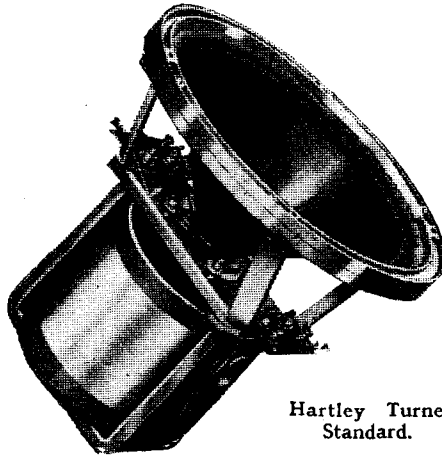

Hartley Turner Standard.

70 c/s is largely accounted for by the limitations of the baffle. It is extremely unlikely that amplitude distortion is present even with 4 watts input—certainly there is no trace that can be detected by ear—for the woollen surround is of U section, and offers a negligible restoring force to the excursions of the cone, while the rear centring device is also very flexible. Neither do the large bass amplitudes produce modulation of high frequencies, as was proved by listening to an organ broadcast in which the pedal notes gave rise to excursions of fully $\frac{3}{8}$ in. without causing the slightest waver in a sustained note on the flute stop.

The trough at 2,000 c/s could not be definitely identified on this organ transmission, though it is probable that it would be detected by a quick ear in a scale or arpeggio passage.

The whole of the top register is lifted by a well-rounded hum at 5,000 c/s, with the result that the output at 10,000 cycles does not fall below the general level of the curve. Owing to the angle of the cone the energy at the 5,000 c/s is concentrated in a beam, and although some coloration is evident in a direct line with the loud speaker, this diminishes as the observer moves away from the axis.

The reproduction of noises rich in high harmonics such as cymbals and hand clapping is excellent.

Haynes Radio. Price £7 15s.

THE bass response from 1,000 down to 50 c/s is remarkably uniform in this instrument, and is exceptionally free from amplitude distortion even at 50 c/s. The speaker will accept 2 watts at this frequency

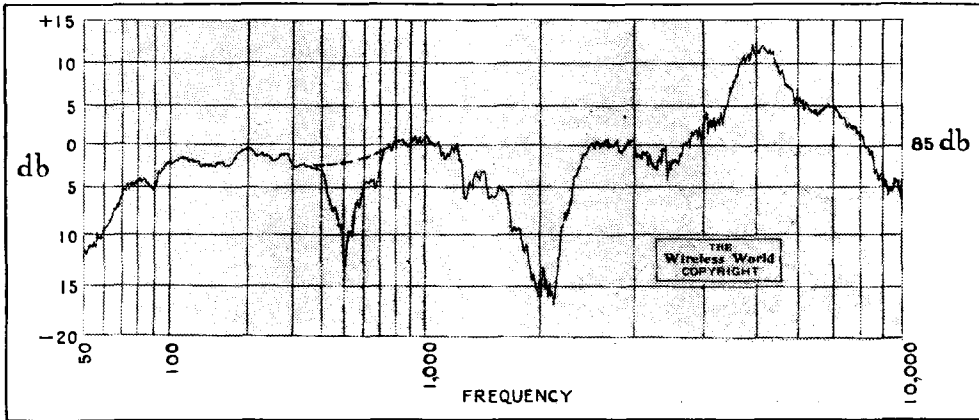

Hartley Turner Standard loud speaker curve.

Goodmans "Grille." Price 45s.

APART from some effects of frequency doubling below 150 c/s, the reproduction from this unit was in every respect satisfactory, the quality of strings and pianoforte music being exceptionally good. As with most loud speakers of this type the maximum power which could be accepted at 50 c/s under steady conditions without amplitude distortion was of the order of $\frac{1}{4}$ watt.

The reproduction is entirely free of coloration of any resonances, and the tail off from 5,000 towards 10,000 c/s is gradual, giving brightness to the quality without harshness.

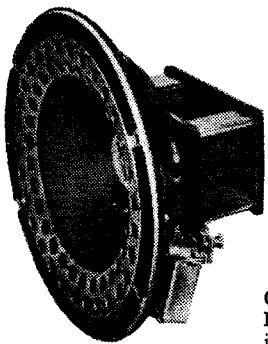

Goodman's "Grille" Loud Speaker and its response curve.

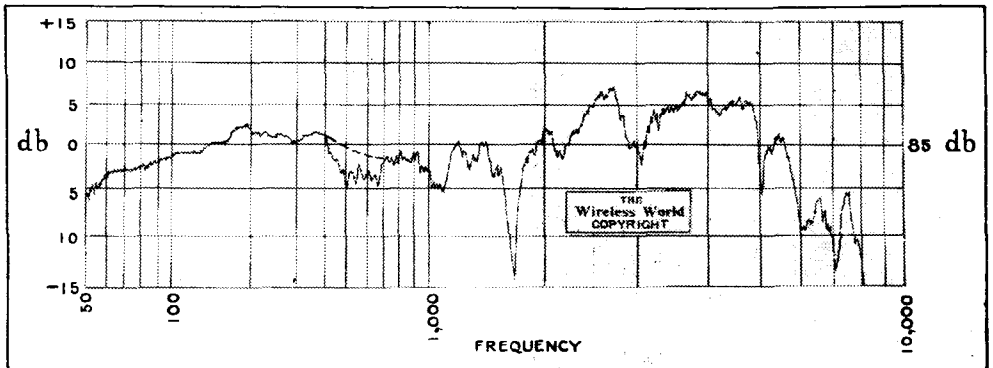

Hartley Turner "Standard." Price £7 7s.

THE outstanding feature of the performance of this unit is the level bass response. The free suspension of the diaphragm permits the development of very considerable amplitudes below 100 c/s, and the drop in sound output below

Haynes Radio Loud Speaker (D.C. model) and (above) its axial response curve.

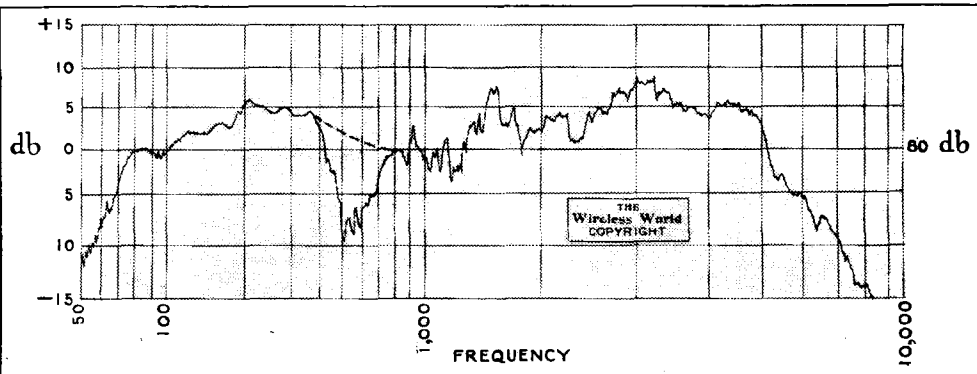
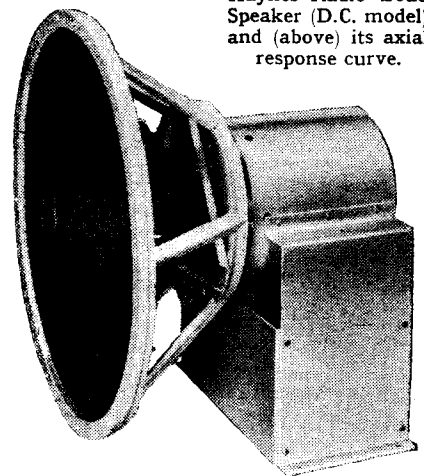

before harmonic distortion commences. The rising level over the region of 2,000 to 5,000 c/s gives more brilliance to the general effect than might at first be expected. As a result the tone of strings is perhaps a little

Some Representative Loud Speakers and their Curves—

brighter than the original, but the brass section of the orchestra undoubtedly benefits by this slight hardening of tone. There is a very useful output in the region from 6,000 to 8,000 c/s, but this is mostly concentrated at the axis.

The crevasse at 1,750 c/s is too narrow to produce any appreciable effect. Incidentally there was no trace of vibration in any part of the chassis with power inputs up to 4 watts.

R. & A. "Alpha." Price 55s.

THIS unit is notable for the full body of tone which is attributable to the uniformity of the response in the region from

The raised portion of the curve, between 50 and 60 c/s, was due to rattling of the cone at the level of 4 watts at which the curve was taken. The irregularities in the re-

R. & A. "Alpha" chassis and response curve.

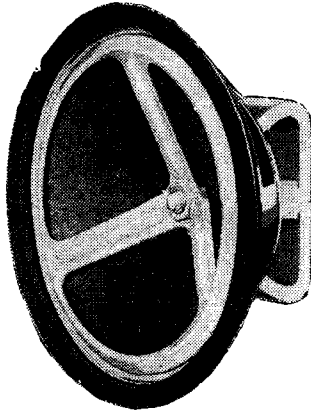

shows a continuous decline below 100 c/s, the *apparent* cut-off of the horn is much lower, and the observer will estimate it at 70 c/s.

Between 100 and 6,000 cycles the output remains constant for all intents and purposes between + or - 5db. Above 6,000 c/s the sound energy does not fall rapidly away as in the majority of loud speakers, but is maintained up to at least 10,000 c/s, although at a level of about 10db below the main part of the curve.

Excellent as is the frequency response, however, the two features for which this loud speaker is especially notable are the extremely high electro-acoustic efficiency and the excellence of the transient response. Both these features are attributable to the better air loading of the diaphragm and the high damping of the field in which the flux density is of the order of 17,000 lines.

W.B. Stentorian Senior. Price £2 2s.

IGNORING for the moment the peaks at 190 and 2,600 c/s, the general run of this curve is remarkably level from 60 up to 5,000 c/s, and it is noteworthy that the output above this frequency does not cut-

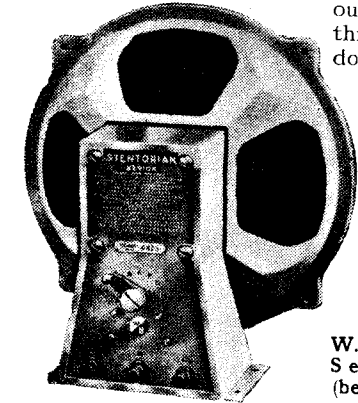

W.B. Stentorian Senior and (below) its response curve.

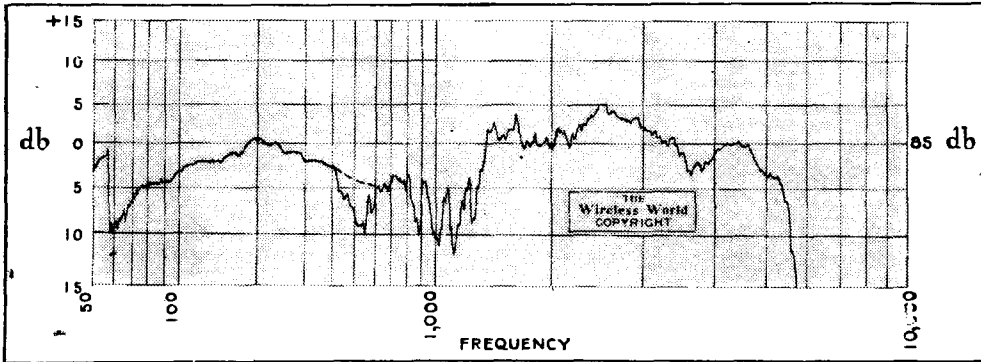

100 to 500 c/s with a slight rise at 200 c/s. There is a fairly sharp cut-off above 5,500 c/s, but any suggestion of lack of brilliance due to the absence of extreme top has been avoided by just the right degree of over-emphasis of the region 2,000 to 5,000 c/s.

Frequency doubling is less noticeable than in many units of this class, and the diaphragm will accept 1/2 watt at 60 c/s before the lack of linearity becomes apparent to the ear.

gion of 1,000 c/s would also disappear at the lower volume level, since they arise from chassis vibration.

Voigt Twin Diaphragm. Price £23

THIS unit was tested on one of the original 4ft. "Tractrix" horns in which the sides were constructed of rather thin ply-wood. As a result of vibration of

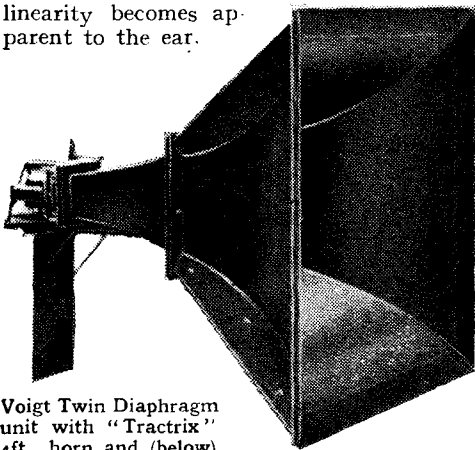

Voigt Twin Diaphragm unit with "Tractrix" 4ft. horn and (below) its axial response curve.

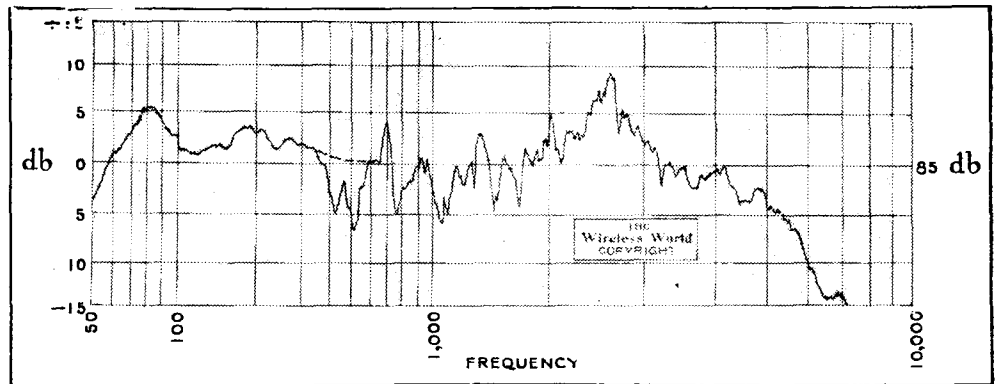

the sides of the horn a depression appears in the curve between 100 and 200 c/s. This would not show in current models of the horn in which a greater thickness of wood has been employed. Although the output

off sharply, but contributes usefully to the general result up to 8,000 c/s. The irregularity in the region of 1,000-2,000 c/s was due to vibration of the chassis: this does not commence until the power input is fully 1 1/2 watts, and even then would not be noticed under normal reception conditions.

Coloration due to the peak at 2,600 c/s does not obtrude unless the volume is turned up to a fairly high level.

The bass resonance is not as bad as it looks, as most of the output at this point was due to vibration against the dust cover with 4 watts input. There was some frequency doubling below 100 c/s, and the level at which this commenced at 50 c/s was approximately 1/4 watt.

Wharfedale "Golden." Price 58s. 6d.

THE first thing to be noticed in the quality from this loud speaker is the exceptionally good "attack" and the

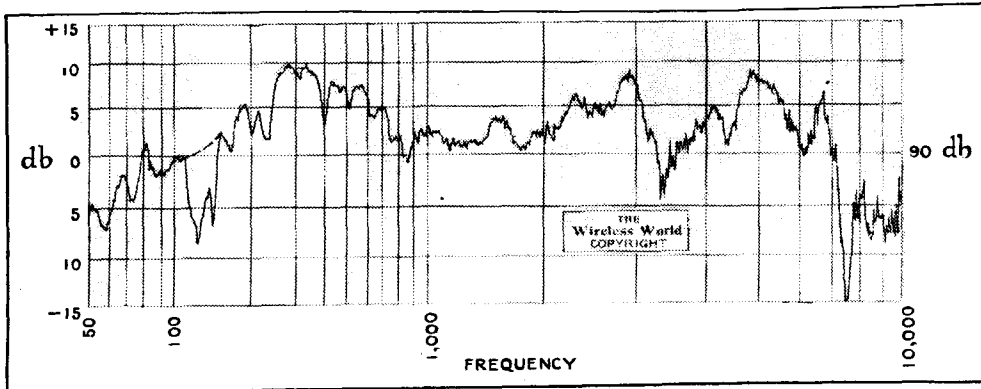

**Some Representative Loud Speakers
and their Curves—**

general clarity of the reproduction. The instruments of the orchestra stand apart, and there is no suggestion of woolliness of any type of transmission. The diaphragm is of fairly hard material, and there is a system of corrugations concentrated near the middle.

The true bass below 100 c/s, however, is less than might be anticipated from the curve, and the high output at the resonant frequency of 80 c/s was due to rattling at the rather high level (4 watts) at which the curve was taken. At 50 c/s frequency doubling commences, somewhere between $\frac{1}{4}$ and $\frac{1}{2}$ watt.

Wharfedale "Golden" chassis and its response curve.

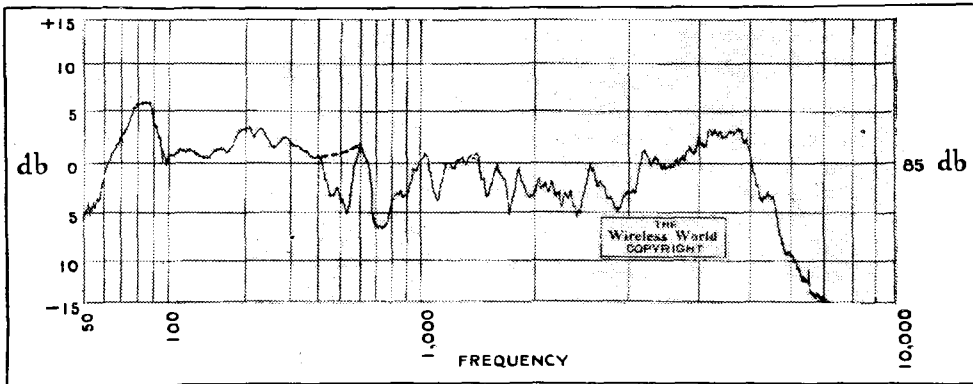
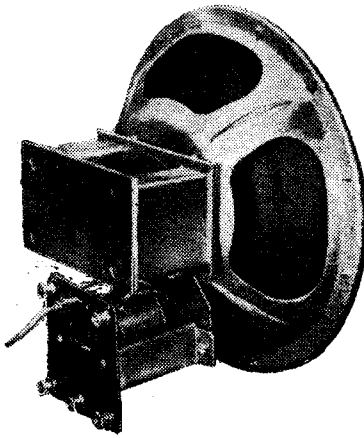

Brown Multi-wave Tuner

A New Method of Signal-frequency Tuning

A NEW system of tuning for which outstanding advantages are claimed has been developed by Mr. S. G. Brown, F.R.S., of headphone fame, and receivers incorporating it will shortly be manufactured. It is understood that these will be marketed by National Radio Service, of 14-16, Alfred Place, Tottenham Court Road, London, who are showing a model on their stand at the *Daily Mail* Ideal Home Exhibition. The receiver itself follows standard practice apart from its tuning circuits, and consists of three valves arranged as an HF amplifier, detector, and LF stage. It is battery-operated, with self-contained batteries and loud speaker, and is designed to operate from an indoor aerial only 8ft. in length.

Current Nodes

The tuning unit is the heart of the receiver, and this differs radically from standard practice, for the inductance and capacity is not lumped as usual, but distributed. It is well known that such a circuit behaves very differently from an ordinary resonant circuit, and the most familiar example of it is the aerial. Among the peculiarities of such a circuit is the fact that the current is not uniform throughout its length, but may drop to zero at one or more points, depending upon its dimensions. At these nodal points the voltage is a maximum, so that the greatest voltage is obtained for the operation of a valve by tapping off at a current node. In general, this phenomenon is noticeable under ordinary

receiving conditions only on the short wavelengths, and particularly the ultra-short wavelengths, for only then do the dimen-

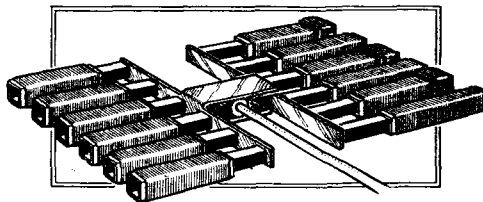

In this sketch the chief points in the mechanical assembly of the tuner are shown.

sions of the aerial become equal to or greater than the wavelength.

It is not essential, however, for the physical dimensions to be greater than the wavelength, for a small circuit can exhibit similar properties if its inductance and capacity are properly distributed along its length. One example of this nature is a coil having a length very much greater than its diameter, and it is this type of circuit which is employed in the Brown Multi-Wave Tuner. Four series-connected coils are used for the medium waveband and two for the long, the tapping point for feeding the valve being taken at the fourth node on the medium waveband and at the second on the long, since higher selectivity is considered necessary on the former waveband.

The nodes, of course, occur only at the tapping points for certain definite wavelengths, so that the system is selective and tuning can be carried out by changing either the inductance or the capacity. In practice, however, it is hardly practicable to change the capacity, since this must necessarily be distributed, and, in consequence, the inductance is varied by means of movable iron cores.

The Tuner

The assembly consists of six long coils mounted side by side with six cores rigidly fixed to a cross-strap and movable for tuning by means of a rack and pinion. Two similar assemblies, one for the aerial circuit and the other for the intervalve, are mounted on a single moulding, and the two sets of cores are linked together and operated by one panel control. Reaction is applied to the intervalve circuit.

It is claimed that the system is both highly efficient and very selective, and that the selectivity increases according to the degree of the node at which the tapping point is taken. Thus, if the system is designed to possess many nodes the selectivity is higher at the tenth node than at the ninth, and so on. In the examples now being marketed the fourth node is employed as this is considered to give sufficiently high selectivity.

Full details of the method of operation are not yet available and will be awaited with interest. If the claims for this system are fully substantiated in practice, however, it would appear to open up a new field for development. It is understood that the tuning units, as distinct from the complete receiver, will be available as components for inclusion in existing receivers.

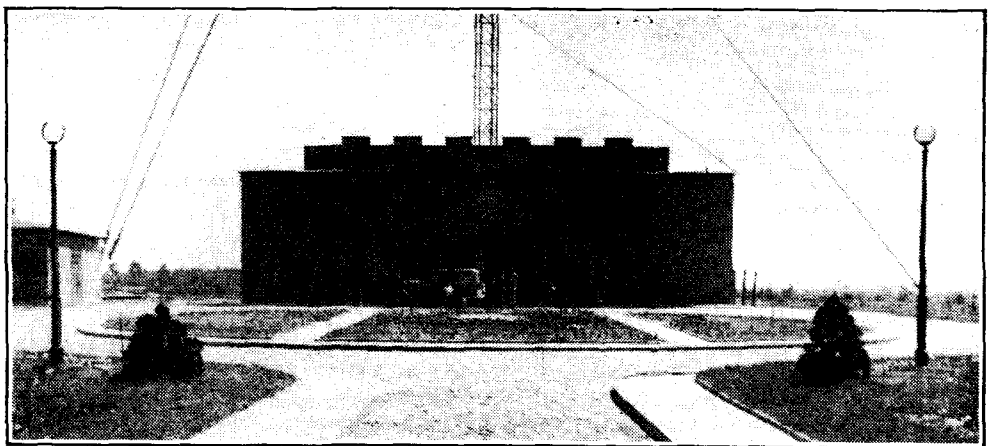

WARSAW No. 1. The transmitter house of Poland's 120 kW station at Raszyn, near the city. Warsaw operates on a wavelength of 1339 metres.

The Cathode Ray

A Simplified Explanation

By "CATHODE RAY"

AN elementary description of the cathode ray tube, in which its working is explained by a simple analogy. The behaviour of the electron stream under external influences is compared with that of a jet of water.



One of the latest Cossor tubes, with a fluorescent screen of large diameter.

NO, this is not an autobiography. But, since you are asking, perhaps there is no harm in pointing out that your "Cathode Ray" is so named because of his exceptional powers of clearly delineating the abstruse and invisible submanifestations of radio. (Ironical cheers, as the Parliamentary reports say.)

The cathode ray (small letters now) is one of the many amusing laboratory novelties that afterwards turn out to be invaluable everyday tools and articles of commerce. The radio valve is the example that everybody thinks of; and the cathode ray tube is at least a first cousin, and one that is quite likely to step forward at any moment on to hoardings and advertisement pages, just like the valve.

Even now it hardly needs introduction to readers of *The Wireless World*, but we who are constantly working with these things (more cheers) are prone to forget that the why and the how of them are not self-evident. Forgive me if I descend to puerilities, but I always think that a first-class model of a cathode ray tube (usually called, but not always justifiably, an oscillograph) can be got—in imagination, of course—by playing a garden hose vertically against the flattened glass dome of a large conservatory. To a bird or aviator above the dome, the effect is a splashy sort of spot on the glass. For the moment we are assuming that the jet of water is shooting up vertically like a fountain. But unlike a fountain the nozzle is not fixed in this position, but is held by the uncertain hands of four children sitting around it at the four cardinal points of the compass (mariners please excuse if there are more than four cardinal points).

If, as is highly probable, the children look on this situation as a heaven-sent opportunity, the nozzle will not remain in a truly vertical position of rest, but will be jerked about in all directions. The aviator (or bird), although too far away to see directly anything of the activities of the children in the depths of the conservatory, is able to deduce the nature of these activities by watching the movements of the spot of water on the dome.

We might carry the illustration a stage farther by supposing the children to be too far gone in a state of coma to manifest

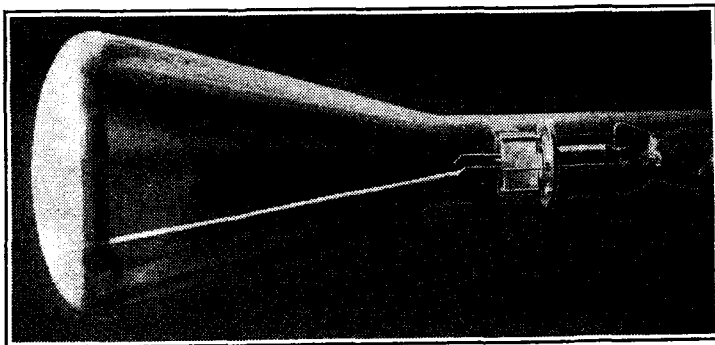

Deflection of the electron beam in a cathode ray tube.

any activities, but that an attempt is made to revive them by connecting electric wires to each opposite pair. The effect of the current would probably be to jerk the nozzle to a degree which would bear some relation to the strength of current. Thus the flyer would (if he understood the nature of the arrangement) be able to tell quite a lot about the electric currents without descending to make a personal investigation.

A Working Model.

The conservatory represents the well-known funnel-shaped cathode-ray tube. Instead of water a jet of electrons is used. This does not carry us any farther out of our depth, because it is of the same nature as the stream of electrons shot off from the filament (or cathode) of every valve; but, instead of being projected more or less in all directions, it is concentrated into a narrow beam. The de-

tails of how this is achieved vary according to the make and type of tube.

In a valve the stream of electrons ends up on the anode, after having been hindered or encouraged by the grid, because the high positive voltage on the anode is an irresistible attraction. In the cathode ray tube the attraction is made still more powerful by putting on many hundreds or even thousands of volts; but, owing to the skilful placing and shaping of the parts, the electrons are travelling so fast by the time they reach the neighbourhood of the anode that they cannot stop, and go shooting through a hole specially provided for the purpose. It is really amazing how the people who specialise in this sort of thing can make the poor electrons do exactly what we comparatively ignorant users of valves and tubes want them to do. They are made to "see red" in the shape of the positive electrode, and rush towards it at—believe it or not—a hundred thousand times the speed of sound, and then find themselves thrust into outer darkness, heading for a chemical screen at the far end of the tube (the dome of the conservatory).

If the jet of water were travelling as fast as the electrons it would lift itself and bits of the dome sky-high in considerably less time than a brace of shakes of the children's hands. So it is easy to understand why the electrons, although incredibly small, make a visible splash

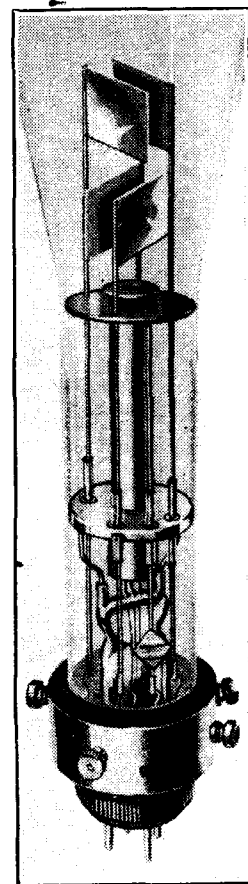

The "electron gun" and method of mounting the deflecting plates.

The Cathode Ray—

when they hit the sensitive chemical coating of the screen. Furthermore, the parents of the children would have something to say afterwards about the effects of the fountain, but the electrons are so negligible in size that one does not see cascades of them falling back to earth.

Another flaw in the illustration is that children introduce what modern scientists call the "random element," and the external observer would not be justified in drawing exact quantitative conclusions from the data furnished. But in the cathode ray tube the deflections of the ray

are caused by the electrical attractions of four simple metal plates near the "nozzle." If you connect one pair of them to 20 volts the spot moves, say, one inch; and, if the tube has been properly designed, 40 volts will shift it two inches. And if the voltage is applied between the other pair of plates, the direction of motion is at right angles.

The Editor does not like my contributions to be made into a heart-gripping serial, but perhaps, in view of the importance of the subject, he will allow room next week to explain why cathode rays are used.

expected from the average man after years of listening to cheap and nasty receivers with carpet-beater type loud speakers. Possibly this sort of mental attitude accounts for the comparatively slow headway which is being made by first-class "quality" receivers in this country. Would-be purchasers, even though they could afford it, simply won't buy one because they don't like good quality when they hear it.

A somewhat similar state of affairs exists in the photographic world. I remember some time ago showing to a friend a landscape photograph I had taken with one of the new infra-red plates. My friend didn't like it a bit; he was so used to the relatively indifferent reproduction of ordinary photography that he described my effort as unnatural.

UNBIASED

By
FREE GRID

Photo-cells and the Car

BBROADCASTING has brought many blessings in its train, some of a very doubtful nature. Among the blessings upon the merits of which opinion seems to be divided is that of car radio. Its growing popularity has, however, served to turn the attention of radio inventors to the car, with the result that the heart of radio's most important by-product, Television, has been turned to use in what I regard as a very ingenious manner. I refer, of course, to the adoption of photo-cells to safeguard from the clutches of the law those unfortunates who park their cars by the roadside while it is still daylight and forget to come out after darkness has fallen in order to switch on their navigation lights.

The invention, like all great ones, is quite simple. The photo-cell is merely connected up to the lighting system in such a manner that it switches on the lights after darkness has fallen. It might, of course, be argued by carping critics that this could be done just as well by a clock fitted with suitable contacts. Such a suggestion only goes to show up their muddled thinking, for if a car owner had a sufficiently good memory to recollect to wind up the clock and alter the contacts each day to keep pace with the lengthening or shortening daylight hours, then he would be quite capable of remembering to come out of the house and switch on the car lights himself, and so would have no need for any automatic device at all.

The beauty of the photo-cell idea is, of course, that it does not merely switch the lights on and off with the blind unreason of a time-switch but serves to put them on at any time of the day when the light becomes very bad, and so safeguards the car from damage by collision in the event of a thick fog coming on during the day.

Not Up To Standard

THE constant and monotonous repetition of moral uplift by the loud speaker is bound, in the long run, to have the same psychological effect as a constantly repeated patent medicine advertisement; in time you begin to believe in it, and as an instance of this I could, if the Editor would permit me, quote the case of a well-known Harley Street specialist of my acquaintance who is a swallower of the products not only of the advertising department but also of the factory of a well-known patent pill maker.

However, the point I want to make is that any benefits which the B.B.C. fondly imagines it has conferred on the masses in the shape of a musical education is entirely illusory. Only the other day I persuaded a typical man-in-the-street, who is also an avid listener, to accompany me to the Queen's Hall. Before the concert was ended he confessed that he was very disappointed, the performance being, in his opinion, not nearly up to the radio standard. Pressed

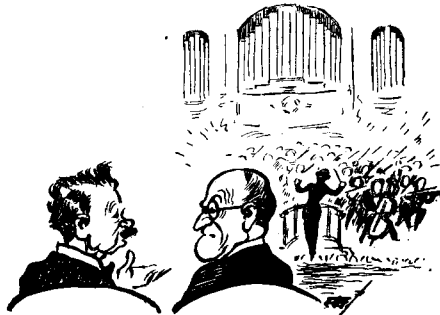

Not nearly up to radio standard.

for further explanations, he pointed out that there was far too much of this "high note business" and an almost complete absence of bass. "Why," he added, indignantly, "there wasn't hardly a good hearty thump all the evening!"

I suppose this sort of thing is only to be

Telling the Tale

TELEVISION has provided a heaven-sent opportunity for some of the bright young scribes of the lay Press to let themselves go. When I was first launched upon the stormy sea of life to paddle my own canoe the maxim was impressed on me most earnestly never to tell a lie when the truth would serve as well; but modern writers seem to have no moral principles whatever.

Not content with the truth, which, in

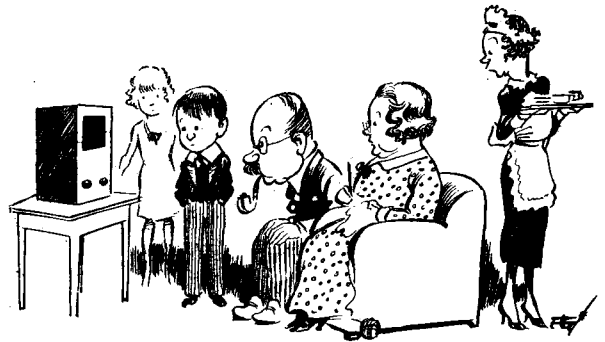

Velvet darkness of the tropical night.

this case, is interesting and exciting enough, certain of these despoilers of good paper have launched into an orgy of exaggeration and fanciful imaginings concerning what we are to see next autumn when the new television service starts.

According to them "we shall be able to have television plug-points in each room in the house, just as some of us have loud speaker points; those in hospitals will be able to plug-in their little screens together with their headphones—while mighty arc-lights will be transported to the desert to televise the velvet darkness of the tropical night."

With regard to the latter item of news, I can only suppose that the compère will be the same man who, some years ago, took the microphone to the Sahara to broadcast the shrieking silence of the desert.

In my opinion this sort of thing does more harm than good to television, as people are led to expect too much of it, and thus there will be unnecessary and quite unjustifiable disappointment when it does start.

Listeners' Guide

Outstanding Broadcasts at H

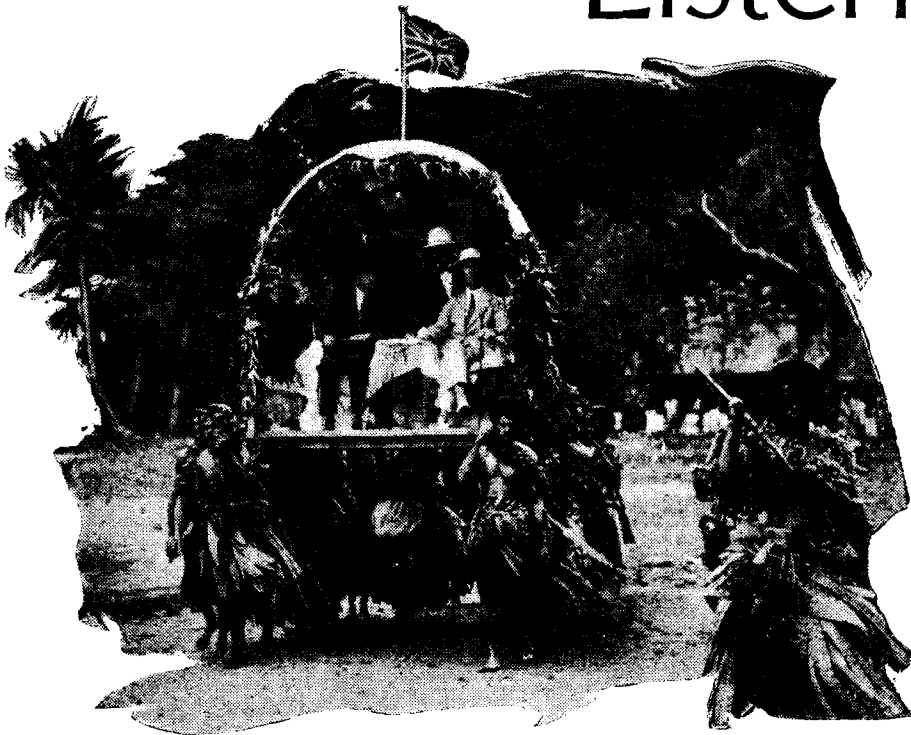

THE DUKE'S ADVENTURES

THE Duke of Gloucester's own account of his experiences during his Australasian tour will be heard by Regional listeners on Wednesday night, April 3rd, when welcome home greetings will be offered to His Royal Highness at the Empire Societies' Dinner at Grosvenor House, London. After-dinner broadcasts have an appeal of their own, for there is nothing else quite so spontaneous in the material that comes to us over the ether. Wednesday's broadcast should be exceptionally interesting, for the Duke's tour has been packed with incident and adventure.

LAUNCHING THE "STRATHMORE"

ANOTHER Royal broadcast takes place on Thursday morning, April 4th, when the Duchess of York will christen the "Strathmore" in her father's name, when this 24,000-ton liner is launched at Barrow-in-Furness. Microphones installed along the slipway will pick up the sounds as the vessel takes the water, and there will be a running commentary on the proceedings by Commander D. A. Stride.

GAIETY IN THE CLASSICS

THE rapidly diminishing number of people who imagine that classical music can never be jolly should tune in Berlin

(Funkstunde) between 6 and 6.40 to-morrow night (Saturday) for a programme entitled "Gay Moments in Classical Music," which will include Handel's "Roderigo" in the form of a dance suite, and Schubert's Symphony No. 5 in B, which is full of youthful gaiety.

NEW TECHNIQUE IN RADIO PLAY

HENRY AINLEY takes the part of First Narrator in "Roland," a drama derived from "Turol's Song" by E. A. Harding, now B.B.C. programme director at Manchester. "Roland" is essentially a radio play, and the effect of the story, which is one of chivalry, honour, friendship and untimely death, is achieved purely by words. I understand that the producers, Felix Felton and Val Gielgud, are to adopt a new technique when the play is broadcast on Wednesday next, April 3rd.

The cast includes John Cheatle, Robert Speaight, Felix Aylmer and Francis de Wolff.

SYMPHONY CONCERTS

THE new French National Symphony Orchestra is rapidly making a name for itself. To-morrow night (Saturday) it can be heard from Paris P.T.T. (8.30 to 10.30) in a programme of music by Glück, Couperin,

continues its cycle of Brückner's music with a performance of the 8th Symphony in C Minor.

French and Spanish post-war composers are to be represented in a concert from all the French stations at 8.30 on Tuesday next, April 2nd, the most notable item, perhaps, being the Viola Concerto by Honegger, played by Alice Merkel. Jascha Heifetz, the celebrated violinist, appears in the Kalundborg programme on Thursday, when he will play



EXOTIC MUSIC is a feature of the programmes of Mantovani and his Tipica Orchestra, who make another welcome microphone appearance on Monday next (Regional).

Glazounov's Violin Concerto with the Radio Symphony Orchestra conducted by Malko (7.10).

GRAND NATIONAL

THAT perfect pair of commentators, Messrs. R. C. Lyle and W. Hobbiss, will tell us this afternoon (Friday), minute by minute, all that is worth knowing about the Grand National at Aintree.

Mr. Lyle's running commentary will cover the parts of the course leading up to Becher's Brook and after Valentine's Brook, including the start and finish, while Mr. Hobbiss will describe the canal turn and the remainder of the course. The broadcast will be on all wavelengths.

Becher's Brook is named after Captain Becher, who, in 1839, riding "Conrad," took a "purler" over the fence into the brook and lay in the water while half a dozen horses cleared the obstacle. Then he emerged, collected his horse, and went on, leaving his name for ever to the brook in which he had been immersed.

PROGRAMME BUILDING AT HOME

THE listener can make his own operatic *pot-pourri* to-morrow evening, March 30th, ringing the changes on Richard Strauss' "The Egyptian Helen" (Berlin, Funkstunde, 7 p.m.); Millöcker's "Gasparone" (Königsberg, 7.15);

Verdi's "Ernani" (Monte Ceneri, 7), or Offenbach's "Tales of Hoffmann" (Radio-Paris, 8.25).

or the Week

ome and Abroad

LOOKING BACKWARDS

Is the cult of modernity on the wane? If the B.B.C. programmes are a criterion, it would seem that the youth of to-day are obsessed with the



BARBARA COUPER, who takes the part of Sarah in "Episode Past"—Thursday's radio play on the National wavelengths.

contemplation of the past. Scarcely a day passes in which memories of some kind or another are not evoked, and fully in keeping with this retrospective trend is next Thursday's radio play, "Episode Past," which will go out on National wavelengths.

The authoress is Valentine Dunn, and the story is about three generations of a family centring round the chief character, Sarah, played by Barbara Couper. The play opens with a present-day scene when Sarah, nearly eighty years of age, lies dying, and her mind, reverting to her girlhood days, unfolds the pages of her life.

30-LINE TELEVISION

Baird Process Transmissions. Vision, 261.1 m.; Sound, 296.2 m.

SATURDAY, MARCH 30th.
More Televiety: Margaret Banerman (the West-End star); Hermione Gingold (impressions); Max Kirby (songs and dances); Mathea Merryfield (dances), with Sydney Jerome's Sextet.

WEDNESDAY, APRIL 3rd.
Maxim Turganoff (the Russian tenor); Katherine Arkandy (soprano), with Sydney Jerome's Sextet.

The cast includes Patrick Curwen, Stafford Hilliard, Gladys Young, George Hagen, Queenie Russell, Philip Wade, Valentine Dunn and John Cheatle.

CHILDREN'S REQUEST WEEK

APRIL 1ST is the start of "Request Week" in the Children's Hour, based on the votes of 6,000 eager young listeners. First on the "Most Popular Feature" list is "Toy Town," with 4,000 out of 6,000 votes. The "Zoo Man" (David Seth-Smith) is second, and Stephen King-Hall third.

THE WANDERING MICROPHONE

SHROPSHIRE dialect will modulate the Regional transmitters on Tuesday evening (April 2nd) when "The Microphone at Large" visits the old market town of Much Wenlock. The programme will include an act representing the reconsecration of Wenlock Priory, originally founded in the seventh century by St. Milburga, then destroyed by the Danes and restored by Lady Godiva.

We are also promised some actuality

GUILDHALL AND CHURCH in the quaint old town of Much Wenlock, which the "Microphone at Large" will visit on Tuesday (Regional). Shropshire dialect will be heard.

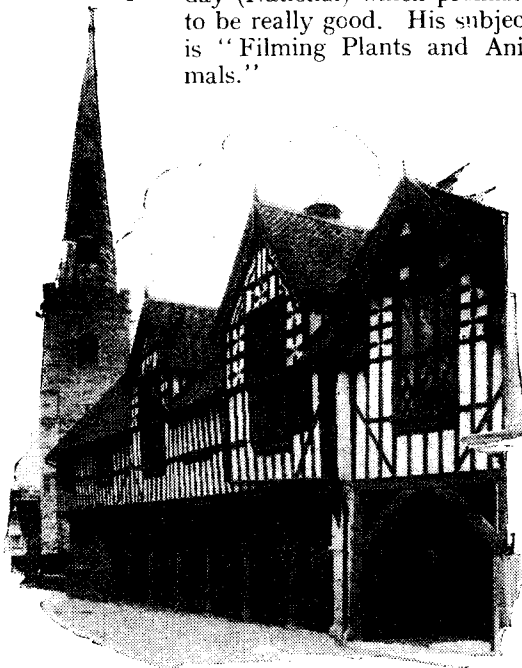

moments with the inhabitants, which should re-create some of the happier episodes in A. E. Housman's "Shropshire Lad."

IN BONNY DUNDEE

CONTINUING their wanderings, the B.B.C. Symphony Orchestra arrive at the Caird Hall, Dundee, on Wednesday next, April 3rd, for a concert to be broadcast on the National

wavelengths. Dr. Adrian Boult will conduct the orchestra in Wagner's "Flying Dutchman" Overture; "Coronach" by David Stephen; and Brahms' Symphony No. 3 in F.

"Coronach" was composed when David Stephen was Principal of the Dunfermline School of Music, and was intended as a memorial to his students who fell in the Great War.

WILD WAVES CALLING

GOOD work is being done by the Fol-de-Rols Concert in these uncertain March days to whet our appetites for the delights of summer by the sea. On Monday evening in the National programme George Royle and Greatrex Newman offer a genuine "seaside summer hour" in which the Fol-de-Rols will be represented by Marriott Edge, Will King, Madeleine Rossiter, Kathleen Sothcott, and Peggy Desmond.

If the "effects" people do their share, the temptation to go down to the sea again should be almost irresistible.

FILMING ANIMALS

JULIAN HUXLEY will give an early evening talk on Monday (National) which promises to be really good. His subject is "Filming Plants and Animals."

HIGHLIGHTS OF THE WEEK

FRIDAY, MARCH 29th.
Nat., Musical Comedy: "Hearts and Harmony," by Max Kester. ♪Fred Hartley and His Novelty Quintet.
Reg., B.B.C. Orchestra (D) conducted by Adrian Boult.
Abroad.
Paris P.T.T. 9.15, Opera: "Le caid" (Thomas).

SATURDAY, MARCH 30th.
Nat., In Town To-night. ♪"Music Hall," with Harry Brunning, The Cole Brothers, etc.
Reg., Walford Hyden Magyar Orchestra. ♪Recital by Miriam Licette (soprano) and Tibor de Machula (cello).
Abroad.
Beromunster, 7, Bach's St. Matthew Passion, by the Berne Cecilia Choir, Municipal Orchestra and Soloists.

SUNDAY, MARCH 31st.
Nat., Reginald King and His Orchestra. ♪Gypsy Smith on "Lessons of a Long Life." ♪Recital on Two Pianos by Ethel Bartlett and Rae Robertson. ♪Fred Hartley and His Novelty Quintet.
Reg., London Palladium Orchestra. ♪"News from Yesterday." ♪Sunday Orchestral Concert, conductor Nicolai Malko.
Abroad.
Deutschlandsender, 7, "A Thousand Happy Notes"—dance music and a piano quartet.

MONDAY, APRIL 1st.
Nat., Foundations of Muic: Bach Celebrations (throughout week). ♪Fol-de-Rols Concert Party.
Reg., B.B.C. Dance Orchestra. ♪Pianoforte Recital by Mark Hambourg. ♪Mantovani and His Tipica Orchestra.
Abroad.
Kalundborg, 7, Scandinavian light music by the Radio Orchestra.

TUESDAY, APRIL 2nd.
Nat., Dotty Ditties. ♪"Best Sellers" with Marius B. Winter and His Band. ♪"Freedom" by Sir Ernest Benn, Bt.
Reg., Maidstone Choral Society: Palestrina's Missa Papæ Marcelli. ♪"Microphone at Large" in Much Wenlock.
Abroad.
All French P.T.T. Stations, 7.45, Choral Concert of early Italian music from Rome.

WEDNESDAY, APRIL 3rd.
Nat., B.B.C. Symphony Orchestra in Dundee. ♪Henry Ainley in "Roland."
Reg., Band of 1st Battrn. Royal Scots. ♪"One Crowded Hour," compered by John Watt. ♪Speech by H.R.H. The Duke of Gloucester at Empire Societies' Banquet.
Abroad.
Brussels No. 1, 7.15, Mozart Concert from the Conservatoire.

THURSDAY, APRIL 4th.
Nat., "Episode Past." ♪Anona Winn and her Four Winners. "Flying" by Filson Young.
Reg., Verdi's Requiem: Royal Philharmonic Society's Orchestra conducted by Sir Thomas Beecham.
Abroad.
Berlin (Funkstunde), 7.15, Popular tunes of old Berlin.

Valve Diagrams for Loud Speaker Loads

Working Characteristics of the Output Stage

THIS instalment explains the preparation of output valve load diagrams in various cases where purely resistive or purely inductive loads are involved.

THOSE experimenters who use milliammeters to read the anode feed current to the power valve know that things begin to happen when the needle of the instrument indicates violent fluctuations therein. Small fluctuations are of little account from an aural aspect, but appreciable movement of the needle is accompanied by unpleasant reproduction. As the reader is doubtless well aware, these variations in DC are due to the valve being operated on the non-linear part of its characteristics, chiefly the bottom-bend portion. To investigate the matter technically, we use the well-known anode current/anode voltage curves, which are illustrated in Fig. 1. It is also necessary to know the impedance of the speaker. This depends upon two factors: (a), the type of speaker; (b) the frequency.

Before plunging into the loud-speaker part of the programme, it may be well to consider the principles underlying the subject of valve load diagrams. Suppose we have a power valve whose characteristics are those illustrated in Fig. 2. The voltage at the terminals of the smoothing equipment is 500 and the grid bias -135 volts. If a resistance of 3,000 ohms is connected in the anode circuit, at which point on its characteristic does the valve operate?

To arrive at a decision on this question, we can conveniently replace the valve by a variable resistance $R=AF$, as shown in Fig. 3 (a). The change in resistance is accomplished by varying the grid bias. The voltage across the valve, that is between its anode and filament (A to F) is the product RI , where I is the steady feed current. Perhaps it will avoid misunderstanding if we remark that R is not the usual alternating current impedance of the valve as given by manufacturers; it is merely the voltage across AF (measured

by an electrostatic voltmeter or a valve voltmeter) divided by the direct current in the circuit. If it were possible to reduce R to zero by making the grid sufficiently positive, the voltage drop would be entirely on the 3,000-ohm resistance, because that across AF vanishes. The current is then $500/3,000=167$ mA. Since the anode voltage is now zero, the corresponding point is at A on the vertical axis (Fig. 2).

Having gone to one extreme by assuming that it is possible to make R zero, we now go to the other and assume it to be infinite by making the grid bias sufficiently negative. In practice it is easier to approach this state than the zero resistance one. Under the above condition, where R in Fig. 3 (a) is infinite, the whole of the voltage drop is across the valve AF .

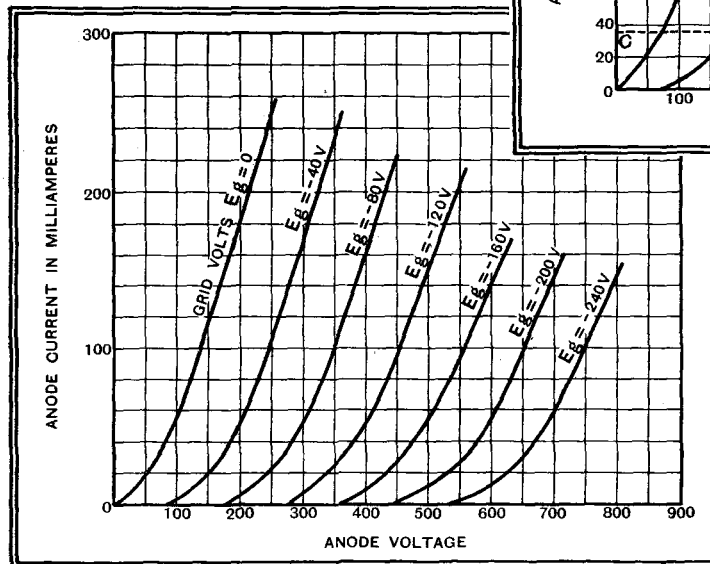

Fig. 1.—Anode volts/anode current curves for different values of grid bias.

Hence the point we now seek is that where the anode voltage drop $E_a=500$ but $I_a=0$, and it is obviously along the horizontal axis at B. Thus we have got two extreme points on the load diagram. Now

join AB by a straight line, choose any convenient point G on OB , and project a line vertically upwards to meet AB in P . The point P lies on the curve corresponding to a grid bias -135 volts. The anode voltage at P is $CP=OG$, so that the amount dropped on the 3,000-ohm resistance is $GB=PD$. Also the current through both valve and resistance is $BD=PG$. Thus $PD/BD=E/I=3,000$ ohms. From elementary geometrical principles it is seen that wherever P is situated on the line AB , the ratio $PD/BD=OB/OA=3,000$ ohms, as it should be if our construction is correct.

Thus we have proved that the working point for the valve with a 3,000-ohm resistance in its anode circuit lies somewhere on the straight line AB . If an alternating

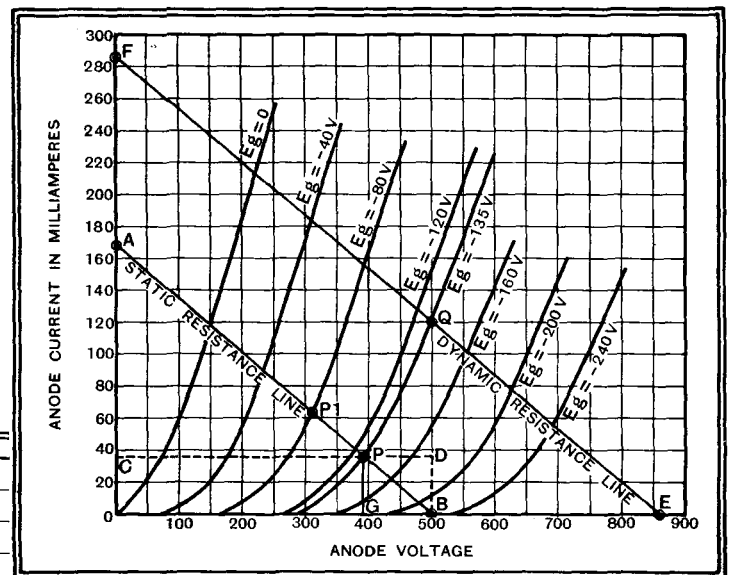

Fig. 2—Characteristics for two different types of resistive load.

voltage is applied to the valve grid, the working point moves to and fro along the line. When E_g is -80 volts the static working point is P_1 .

The preceding case is one which occurs in practice with resistance-capacity coupling (provided the influence of the condenser and grid leak for connecting on to the next stage is negligible). Thus, to obtain the working line, it is only necessary to proceed likewise with the appropriate valve characteristics. Where loud speakers are concerned, we do not put 3,000-ohm resistances in circuit to drop valuable volts. Here, either a choke-condenser filter or a transformer is used, so that the DC voltage drop is relatively small. Although the speaker has an impedance, it only shows up on the valve characteristic during operation when an

Valve Diagrams for Loud-Speaker Loads— alternating voltage is applied to the valve grid.

We shall now treat the case of a dynamic resistance, i.e., one which drops no volts with DC, but plenty with AC. Referring

in the usual way at about the centre of the straight portion of the characteristic, this being Q in Fig. 2. We have already discovered that a static resistance load is represented by a straight line as at AB. Consequently to get the dynamic resist-

steady DC supply from the rectifier (this being 500 volts), as shown in Fig. 4 (b). It will be seen from Figs. 4 (a) and (b) that the PD on the inductance is equal but opposite to that at the valve anode. This follows from the fact that the applied voltage is 500 and the sum of the internal voltages must be equal to it.

From Fig. 4 (a) we observe that the current is a maximum or a minimum when the PD on the inductance is zero. If the value of inductance is 13.8 henrys and the frequency 50 c/s, the maximum current is $I = 200/2\pi \times 50 \times 13.8 = 46$ milliamperes. Thus we obtain the two points H and K, where $HQ = 48$ mA. and $KQ = 48$ mA., the first being the maximum and the second the minimum value of the current. These are, of course, superimposed on the feed current of 120 mA. Thus we have found four points HFKG on the load curve, and the problem is now to obtain additional points to enable the complete curve to be drawn in. This can be done in two ways, both of which are given below.

In Fig. 5 the point H corresponds to H in Fig. 4 (c), G to G, and so on, each to each. Divide the line X₄ into any four parts and erect perpendiculars $p_1r_1, p_2r_2,$ etc., to meet the voltage and current

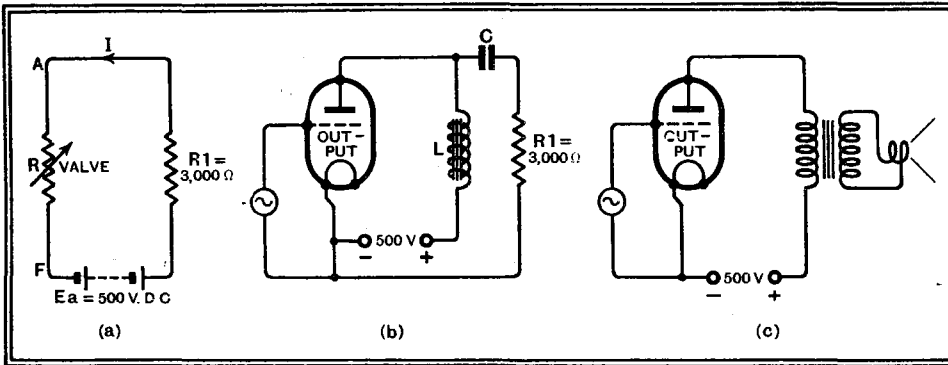

Fig. 3.—Illustrating output circuit connections.

to Fig. 3 (b), we have a conventional choke-condenser output circuit and a resistance load $R_1 = 3,000$ ohms, this being dynamically equivalent to Fig. 3 (c) when L and C are large enough.¹ Assuming that the DC voltage drop in the choke is negligible, it is easy to find the working point on the curve. The valve is biased

once load line through Q, we draw FQE parallel to APB. Then we still find that $OB/OA = EO/OF = 3,000$ ohms, as in the preceding case. It will be seen that not only are we well away from the bottom-bend portion of the characteristics, but that the permissible variation in anode voltage is much greater than before.

The next step is to consider the case of an inductive load.

No loud-speaker load is wholly inductive, but first of all we shall contemplate the case of a pure inductance and then modify the construction to include a resistance. By simple argument we showed that the load diagram for a pure resistance is a straight line. The diagram for an inductance is, however, not so readily deduced owing to the fact that the voltage across the inductance is 90 degrees out of phase with the current through it, as illustrated in Fig. 4 (a). The reader is, of course, well aware that voltage and current in a resistance are in phase, which avoids complications. We now take Fig. 3 (a) and assume that R_1 is replaced by an inductance whose resistance is small enough to be neglected. In the absence of any signals the grid has its normal bias, so the working point is Q in Fig. 5. From Fig. 4 (a) we see that if a sine-wave voltage is applied between the valve grid and filament, the alternating current in its anode circuit is zero when the alternating PD on the inductance is a maximum, as at G, or a minimum as at F. If the maximum and minimum values are ± 200 volts we get the two corresponding points G and F in Fig 5, where $QG = 200$ and $QF = -200$ volts. The variation in PD on the valve anode is superimposed upon the

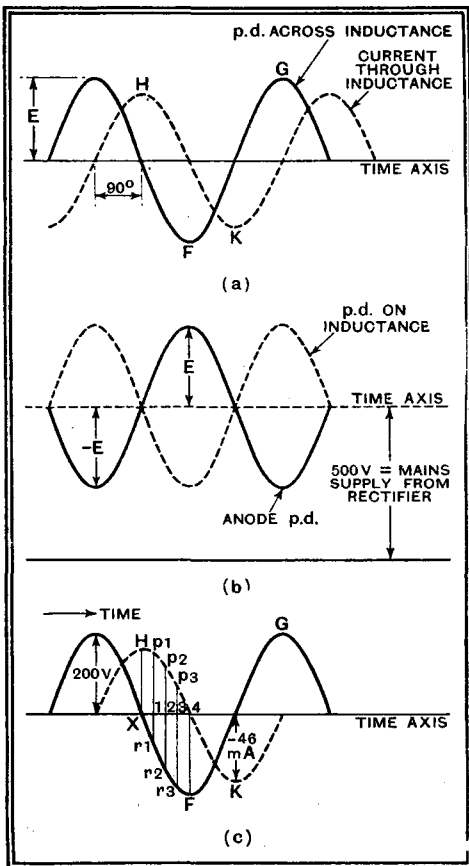

Fig. 4.—Distribution of current and voltage.

¹ The data and diagrams are based upon the load thrown into the anode circuit by the transformer. The actual coil data can be obtained on division by the square of the transformation ratio. For example, if the transformer ratio in the above case is 15 : 1, the coil resistance is $3,000/225 = 13.3$ ohms. Or conversely if the coil resistance is 13.3 ohms, and the optimum load for the valve 3,000 ohms, the transformer ratio is $\sqrt{3,000/13.3} = 15 : 1$.

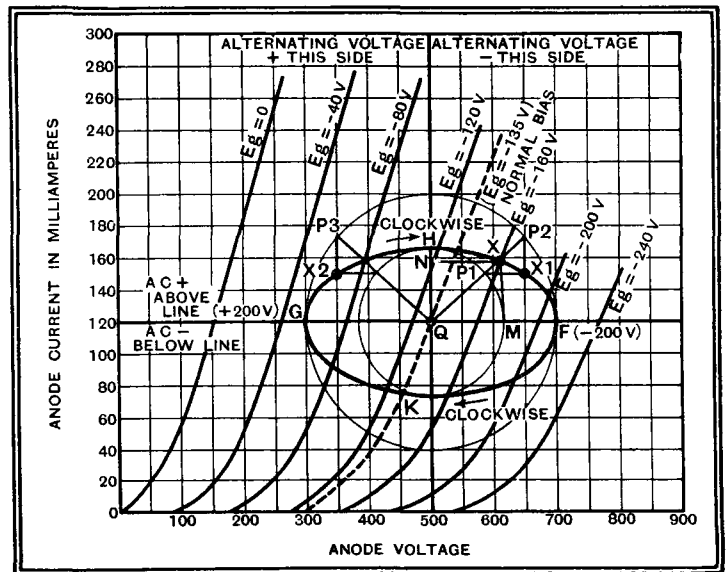

Fig. 5.—Load diagram for a purely inductive load.

curves. Each pair of points on these curves corresponds to a point on the valve load diagram to be plotted in Fig. 5. Since $HX = HQ$ and $4F = QF$, we set off $QN = 1p$ and $QM = 1r$, thereby obtaining the point X by horizontal and vertical projection. Next set off $2p_2, 2r_2,$ etc., and proceed in like manner. By drawing a curve through the points we get the quadrant shown between H and F in Fig. 5. This construction, although more tedious than the next one, is more instructive, since it shows how the corresponding values of current and voltage are obtained from the actual wave forms. If the wave forms are complicated by the presence of harmonics the construction is still the same but the resulting curve in Fig. 5 will be quite different.

Valve Diagrams for Loud Speaker Loads—

The second construction depends upon the fact that in the case under consideration the current and voltage waves are sine curves 90 degrees out of phase. Draw circles with Q as centre and HQ, FQ respectively, as radii. Draw any radius QP₂ which cuts the inner circle in P₁. Project horizontally outwards from P₁ and vertically downwards from P₂ to intersect in X₁, which is a point on the load curve. Remaining points can be obtained by

taking other radii and repeating the procedure in all four quadrants. In this way the symmetrical oval which the mathematician calls an ellipse is constructed. During a cycle of the grid voltage the working point on the valve characteristics traverses the ellipse HFKG in a clockwise direction as indicated by the arrow. This direction can readily be deduced from Fig. 4 (b), bearing in mind that time increases as we travel from left to right.

(To be concluded.)

Short Waves and the Amateur That 10-Metre Band

By G2TD and G5KU

THE various frequency bands allotted to the transmitting amateur are in direct harmonic sequence, and for this reason are well defined in their transmission characteristics, since such factors as attenuation, ionised layer reflection, and radiation efficiency vary as the square of the frequency.

The ten-metre band has been somewhat neglected during the last few years, mainly because of the absence of interesting long-distance contacts. Most amateurs agree that this waveband is only giving very occasional DX and European communication, with only ground wave contacts of a few miles to any degree of certainty. Although a few will remember the excellent DX contacts of 1928, during sunspot maximum, there appears to be little enthusiasm left to continue these investigations, in spite of occasional reports of contacts with the Antipodes and with other countries at shorter distances.

The eleven-year sunspot cycle is now approaching a maximum, and during the next two or three years there should be a very rapid improvement in transmitting and receiving conditions as a whole; but particularly on the 10-metre band.

The characteristic required for efficient transmission on 10 metres is, primarily, an intense F layer ionisation, and this limits transmission to times when the whole route is in bright daylight. Much of the F layer ionisation is produced by solar ultra-violet light emission, and this is probably enhanced at the period of sunspot maximum, hence its great influence, particularly upon 10 metres, when the F layer ionisation must be intense for efficient sky-wave propagation.

The density of the attenuating E layer is not so important as on 20 or 40 metres, and many observers who have tried to correlate 20- and 10-metre conditions should realise that, providing the appropriate F layer ionic density exists, the transmissions on 20 metres will be mainly controlled by the E layer attenuation.

On the other hand, for successful 10-metre communication an appropriate F layer density is the major requirement.

On account of the difficulty experienced in obtaining this characteristic, especially on routes parallel to the Equator, the large signal strengths obtained on 20 and 40 metres must not be expected for a given radiated power, and the daily periods of usefulness will also be restricted, as pointed out, be-

cause of the need for a route lying in intense daylight.

Another important feature, concerned with the limited reflection properties of the F layer on 10 metres, is the need for carefully designed aerial systems, capable of maximum radiation at low zenithal angles.

This is most successfully achieved with vertical aerials which possess the added advantage of omni-directional transmission properties. A voltage- or current-fed half wave vertical aerial will be fairly suitable, although a full-wave vertical aerial is to be recommended an account of improved low-angle radiation. In this case two current antinodes will appear, and must be suitably phased to prevent wave cancellations. This

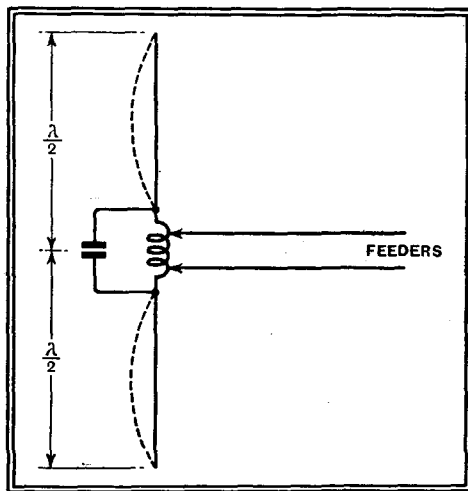

Half-wave vertical aerial for 10 metres; the dotted line shows influence of tuned circuit on the current distribution.

may be achieved by an aerial arranged as shown in the diagram, in which the tuned circuit effects the necessary phase shift to produce the current characteristics shown by the dotted line. This system permits of simple feeding, providing the circuit is tuned to resonance and the vertical components of the aerial are of correct length. If it is desirable to use the aerial on 20 metres, it is a simple matter to short the tuned circuit and supply a voltage feed at the base. The aerial thus behaves as a half-wave radiator on 20 metres.

The writers are looking forward to an interesting summer for 10-metre activity, and would be glad to co-operate with any overseas enthusiasts. For those who wish to arrange schedules, we would recommend

WIDZE and CXICG as likely to be active representatives of North and South America respectively. Although it may still require the elapse of a year or two before the good results of 1928 are repeatable, it is evident that more suitable equipment, both in knowledge of wave propagation and transmitting apparatus is available with which to explore this uncharted band.

DX Notes

An interesting feature of the passing winter is the repetition of certain of the conditions found during the autumn, while additional new features are encountered, particularly along routes roughly parallel to the Equator.

Among the repeated conditions one may cite the good level on South American stations for a few hours around midnight. It appears that the ionisation of the layer averages just a sufficient density to make communication possible at this time between the dark Northern hemisphere and the light Southern hemisphere.

An improvement, due to the coming of spring, will occur along the routes on the Northern hemisphere of India. Malay and Japan are now beginning to reach good audibility in the afternoon, together with a prolonged period—now from 0800 to 1500 G.M.T., during which contact with ZL and VK is easily possible. The late afternoon is now very interesting for the DX enthusiast.

THE RADIO INDUSTRY

A KOLSTER-BRANDES car radio receiver has now been produced. The new set is of the two-unit type, remotely controlled. The receiver proper and the loud speaker are housed in a container shaped to permit the easiest possible installation on the average car, while the second unit comprises the power supply equipment, including a rotary HT generator. A technical specification of the set is given in a pamphlet available from the makers at Cray Works, Sidcup, Kent.

The H.M.V. exhibit at the Ideal Home Exhibition at Olympia illustrates the progress of the gramophone and radio-gramophone during the twenty-five years of H.M. the King's reign.

His Master's Voice, as the only Royal Warrant holders for the supply of radio apparatus to His Majesty, are to install a Model 800 Auto-radiogram in the King's House at Burgh Heath.

Halcyon Radio, Ltd., have just moved from Acton into a larger factory. The firm's address in future will be Sterling Works, Dagenham, Essex.

British Television Supplies, Ltd., of Bush House, London, W.C.2, have published prints giving practical wiring plans of two short-wave kit sets (for battery or universal mains), and also of a universal AC-DC short-wave converter.

A folder describing the new Climax "534" all-wave AC receiver is now available from Climax Radio Electric, Ltd., Haverstock Works, Parkhill Road, Hampstead, London, N.W.3. The set covers wavelengths between 10 and 2,000 metres in four steps.

We have received from Burne-Jones and Co., Ltd., Magnum House, 296, Borough High Street, London, S.E.1, a leaflet describing the Magnum Yacht Radio Receiver. The set is designed specifically for use afloat, and covers wavelengths between 150 and 2,000 metres. It thus permits yachtsmen to take advantage of the G.P.O. service whereby telegrams may be broadcast to yachts not fitted with transmitting apparatus. A directional aerial attachment is available.

Broadcast Brevities

By Our Special Correspondent

Wireless

IT has seemingly taken the B.B.C. programme chiefs a dozen years to realise that wireless uses wires, and that it is accordingly inexact to refer to the "Wireless Military Band." This, by the way, confounds the views of an old lady friend of mine who has always imagined that the Wireless Military Band is so called because it contains no stringed instruments.

B.B.C. on the March

Now B. Walton O'Donnell will wield his jocund baton over the "B.B.C. Military Band"—does this title square up with the Corporation's peace-loving propensities?—and only the Scottish and Western Studio Orchestras are allowed to dispense with the ubiquitous initials.

Egyptians Had a Word for It

Talking of wireless reminds me of the alleged discovery of cables underneath the ancient Colosseum. This proved, it was said, that the Romans made use of telegraphy. An Egyptologist, on hearing the news, related his experiences in excavating at Thebes, where, he said, he had found no wires, thus proving that the Egyptians made use of wireless.

expenditure was under consideration at Broadcasting House, with the possibility of staff reductions.

The modicum of truth lay in the fact that the programme mandarins had indeed been discussing shorter transmission periods; but this was simply in the direction of cutting down alternative programmes, just as was done last summer.

Animated Conference

Last week an animated conference between programme heads revealed quite an exciting cleavage of opinion, the parties being fairly evenly divided for and against any reduction in programme hours. There the matter rests at present.

I am able to say, however, that those who know—and such people do exist at Broadcasting House—consider that summer programmes this year will be on a more ambitious scale than in 1934.

A Plea to the Treasury?

What is certain is that the B.B.C. has not lost its head over television, as some critics suggest. Money must certainly be found for television development, but it has become an article of faith with the Governors and Sir John Reith that sound broadcasting must not suffer on that account.

Into the Wilderness

MEMBERS of the B.B.C. Productions Department sometimes go into retreat in order to meditate upon a forthcoming radio drama.

Val Gielgud has just bestowed "this freedom" on Peter Cresswell so that he may construct from authoritative sources an actuality drama based on Drake's circumnavigation of the globe. To those listeners who heard Cresswell's "Gordon of Khartoum" the form that this Drake programme will take will be obvious.

The drama will be based on authentic incidents brought to life so vividly that listeners will become, in effect, the companions of the deathless Admiral.

You Might Meet Him

When he constructed the "Gordon" programme, Peter Cresswell had access to many official papers, but Drake presents a problem much farther in the background. To get the spirit of the times he is reading Hakluyt's "Voyages," Cavendish's "Lives," Raleigh's "History of the World," and Fletcher's "The Globe and Compass."

Readers who are interested may possibly find Mr. Cresswell in the British Museum, so to assist identification I append his portrait.

Maximum Power at Droitwich

LISTENERS to the new Midland Regional who took heart of grace from the recent paragraph in these columns to the effect that the Droitwich medium-wave station was not using its full power must now resign themselves to the fact that the maximum has now been reached.

Midland Regional is now working at 50 kilowatts, and unless the summer months improve reception conditions, which seems most unlikely, listeners in the Midlands must resign themselves to reception as it is to-day.

Easter Day in Jerusalem

ON Easter Day the bells of Christ Church, Old City, Jerusalem, will be broadcast by the B.B.C. in co-operation with the Post Office. The bells of Bethlehem have already rung round the world, and it is now felt that the bells of the Holy City will provide an appropriate



PETER CRESSWELL has gone into retreat to prepare an actuality drama on the life and adventures of Admiral Drake.

background to the sacred ceremonies of Easter Day.

Talk by the Vicar

Christ Church is a familiar landmark to pilgrims. It is near the Jaffa Gate and opposite the Citadel.

A descriptive talk on how Jerusalem is spending Easter will be given by the Rev. M. L. Maxwell, Vicar of Christ Church, during the relay, which, incidentally, will be sent out on the Empire wavelengths as well as in the ordinary B.B.C. programme on the Sunday afternoon.

Microphone as Debunker

MR. GLADSTONE MURRAY, the B.B.C. Public Relations Officer, was in fine fettle when he spoke on "Broadcasting and Empire Developments" last week at the Empire Crusade Club in London. Here are some of his winged words:—"There is no debunker in the world like the microphone"; "The United States may get better 'peak' broadcasts than the B.B.C., but I doubt it. Is Bing Crosby better than the King?"; "There are more listeners in the States to our Empire transmissions than anywhere else. Last year we received 50,000 letters from America"; and, quoting from the B.B.C. mail bag: "You give me a pain in the pants. Thank God, I am 100 per cent. American."

Better than Six Camels

He also referred to a striking tribute paid to Colonel Alan Dawnay B.B.C. Programme Controller, by Lawrence of Arabia, with whom Colonel Dawnay was associated during the War. "Had I the choice of six camels or Colonel Dawnay," said Lawrence, "I would take Dawnay."



"TO THINE OWN SELF BE TRUE." Val Gielgud taking the rôle of himself as Director of Radio Drama in the new film, "Death at Broadcasting House," shown recently in London and soon to be generally released. He is seen making an unpleasant discovery.

Rumour Rampant

WHEN wild rumours anent the future of broadcasting agitate our great national newspapers, not to mention their readers, a modicum of truth is probably lurking around somewhere. It was so last week when a story "broke" to the effect that ruthless reduction in

It would be an unpleasant task for the B.B.C. to have to stand on the Treasury doorstep and beg for a greater allocation from the licence fees, but more than once in its history the Corporation has not hesitated to put the interests of listeners first, and will doubtless do so again.

Foundations of Wireless

Part XVI.—The Single-Valve Set

THIS instalment, which deals step by step with the details of the simplest receiver—a classical single-valve detector set—serves as a useful introduction to the subject of practical receiver design.

IN the last four parts of this series we have discussed detection by diodes and triodes, and amplification by the latter, dealing with each subject in a fairly detailed manner from the point of view of the valves themselves. Taking these processes now for granted, we can consider some of the less obvious points that arise in studying the design and behaviour of a simple receiver. We now begin to get away from the fairway of simple theory, and find ourselves making acquaintance with some of the incidental complications that arise when we have to deal with real circuits in place of circuits idealised to bring out their fundamental properties.

The set we shall discuss is the single-valve receiver, in which a triode is used as grid detector. In this Part we shall confine ourselves to the receiver whose circuit is shown in Fig. 89; a simple detector, receiving its signal voltage from an aerial through a transformer of which the secondary only is tuned, and delivering the detected and amplified signals into a pair of telephones T.

In setting up a receiver of this type, we have to be careful that all the various inductances, condensers, and resistances incorporated are allotted values suited to the work they have to do. If, as is usual, the tuning condenser C1 has a maximum

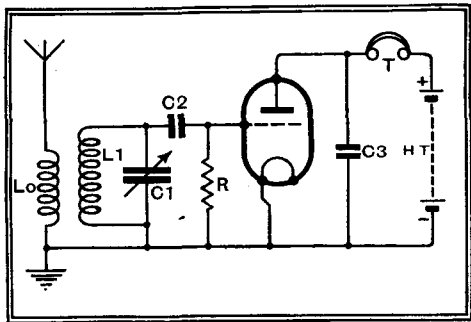

Fig. 89.—Circuit of single-valve set in which a triode valve is used as grid detector and amplifier of the detected signals.

capacity of 500 μF ., and it is desired to receive signals of wavelength up to 550 metres, we find from the usual formula ($\lambda = 1,885 \sqrt{LC}$) that the inductance of L1 must not be less than 170 μH . But we must not overlook that the total capacity across L1 is not that of C1 alone, but is increased by the capacities due to the valve and its holder, the wiring, the terminals or tags to which the ends of L1

are brought, and by a certain amount of capacity transferred from the aerial through the primary L0. We shall, in consequence, have rather more tuning capacity than the scheduled 500 μF .; with coils and components of modern type the "strays" enumerated will add some 45 to 60 μF ., allowing L1 to drop to about 155 μH .

The lowest wavelength to which the circuit will tune is almost entirely a function of the stray capacities, in an average case 200 metres can just about be reached with the values given.

Having settled the inductance of L1, we next need to consider the primary L0. In the case shown in the diagram, this is not tuned to the frequency of the desired signal, but only serves as a means by which the high-frequency current flowing from aerial to earth can be made to set up a voltage in the tuned circuit L1C1. The two coils form a *high-frequency transformer* in which the magnetic field set up by the passage of current through the primary L0 passes, also through the secondary L1, thereby injecting a voltage into the tuned circuit.

Aerial Transformer Design

In Fig. 90 is given a simplified version of the circuit, in which all the relevant quantities are explicitly shown. The voltage V_0 is that picked up by the aerial from the electromagnetic field due to the transmitter we wish to receive; if the field-strength at the aerial is F microvolts per metre ($\mu\text{V}/\text{m}$), and the effective height of the aerial is h metres, $V_0 = Fh$ microvolts. C , L , and r , represent respectively the equivalent capacity, inductance, and resistance of the aerial; the values of these, in conjunction with the inductance of L_0 , and the mutual inductance between this coil and L1, will determine the current driven round the aerial circuit by the voltage V_0 picked up.

In the notes on transformers, at the end of Part x, it was pointed out that each of the two circuits affects the other through the interlocking of their magnetic fields. In the present case a very large primary (many turns on L_0) will transfer much of the resistance and of the untuned characteristics of the aerial circuit into the tuned secondary, making it tune flatly and reducing its magnification. The voltage V developed across it will therefore not be

very large in spite of the large injected voltage produced by the many turns on L_0 . Conversely, the high dynamic resistance of the tuned circuit will be in large part transferred to the aerial circuit, thereby limiting the current that can be driven through it by V_0 .

A small primary, on the other hand, will transfer very little of the primary characteristics into the secondary, leaving it sharply tuned and responsive. Nor will much of the dynamic resistance of the secondary find its way into the aerial cir-

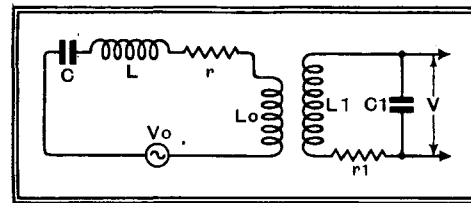

Fig. 90.—Equivalent aerial-to-grid circuit, forming a basis for calculating the transformer ratio.

cuit, so that the primary current will be large. But it is clear that neither of these desirable features will be of much avail in increasing V if L_0 has not turns enough to inject, through its field, a reasonable voltage into L1. It would, therefore, appear that there is some medium winding for L_0 that will give a maximum ratio of V to V_0 ; in other words, which will give the greatest signal strength.

In the simple case where L1 and L_0 are so closely inter-wound that all the field set up by the passage of current through one passes also through the other, the turns ratio required to produce the maximum voltage across the tuned circuit can be derived from a very simple formula.¹ This is $n^2 = R/Zp$, where n is the number by which the turns in L1 are divided to find the requisite turns for L_0 , R is the dynamic resistance L/Cr of the tuned circuit, and Zp is the total impedance $\sqrt{r^2 + (X_L - X_C)^2}$ of the aerial.

Reference to the notes on transformers shows that this ratio corresponds to making the impedance transferred into the secondary from the aerial circuit equal to the dynamic resistance of the tuned circuit by itself.² This latter conclusion will remain true whatever may be the construction of the transformer; if the

¹ The proof of this formula involves both vector algebra and calculus; it is therefore left out.

² There are some further complications not discussed here; the interested reader is referred to "The Detector as Radio-frequency Load." *The Wireless World*, Feb. 22nd, 1935, p. 193.

Foundations of Wireless—

coupling between the coils were less perfect than we have assumed, L_0 would require to have more turns than the formula prescribes in order to make up for its greater distance from L_1 .

It is important to note that coupling tighter than the optimum decreases both signal strength and selectivity. Weaker coupling, though again it reduces signal strength, at least offers some compensation in the form of an improvement in selectivity by removing more of the aerial-circuit damping from the secondary, and allowing its selectivity to approach more closely that of the unloaded circuit.

It will be noticed that the correct coupling or turns ratio depends on the characteristics of the individual aerial in use. Further, since R and Z_p both have different values for different wavelengths, turns ought to be wound on or off L_0 as we tune up or down the waveband; for an average tuned circuit and aerial, L_0 should have three or four times as many turns at 550 metres as at 200. The formula is, therefore, not of much practical use except as a rough guide; it is usual to allot to L_0 one quarter or one third of the turns used for L_1 , which is generally an acceptable compromise.

Detector Action

Reverting to the circuit of Fig. 89, we see that the voltage developed across the tuned circuit is applied, through the grid-condenser C_2 , across grid and cathode of the valve. Since the grid is returned, through the grid-leak R , directly to cathode, rectification will take place on the grid. As we have seen, usual values for C_2 and R are 0.0001 mfd. and 0.5 MΩ. The rectified signals on the grid control the anode current in the usual way, and provide a modulation-frequency current that is heard in the telephones as audible sound.

The effect of the grid circuit of the valve in damping the tuned circuit has already been mentioned; it is approximately equal to putting across C_1 a resistance $\frac{1}{2}R$, or, in this case, 0.25 MΩ. If the dynamic resistance of the tuned circuit alone is 125,000 ohms it will be reduced by this damping to two-thirds of its original value. Alternatively expressed, the valve will increase the equivalent series resistance of the circuit by 50 per cent.

In addition to this effect, which is solely due to the grid current taken by the valve, there is another which depends for its existence upon the voltages developed in the anode circuit, and upon the small capacity between the anode and the grid of the valve. In Fig. 91 (a) there is shown the conventional diagram of the valve used as high-frequency amplifier, the impedance in the anode circuit being represented by Z_a . This may be a resistance, a capacity, or an inductance. C_{ga} represents the total capacity between grid and anode, which is partly in the valve-electrodes themselves and the glass pinch supporting them, and partly in the valve-

base, the valve-holder, and the wiring.

Since the amplifying action of the valve produces a high-frequency voltage at the anode, a small high-frequency current will flow through C_{ga} and the tuned circuit to the cathode of the valve. In flowing

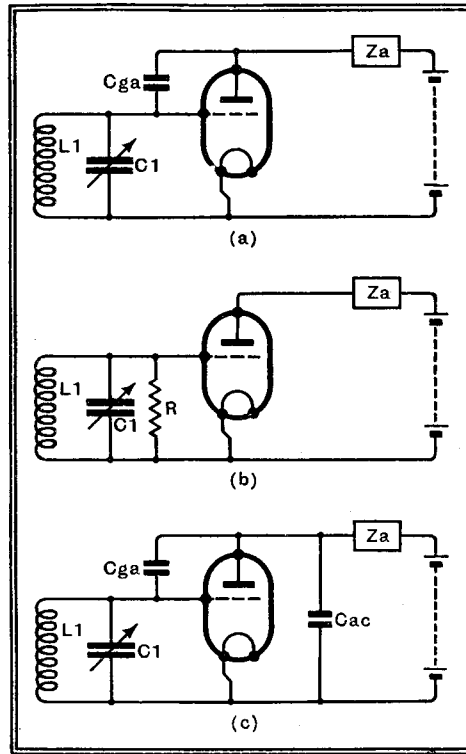

Fig. 91.—Illustrating the Miller Effect. (a)—A voltage at the anode of a valve can pass, by way of C_{ga} , back into the grid circuit. (b)—If Z_a is a capacity, the anode-grid feed is equivalent to connecting a damping resistance R across the grid circuit. (c)—Owing to the stray capacities from anode to cathode, any anode-circuit impedance Z_a is necessarily shunted by C_{ac} .

through the components in the grid circuit, this current will develop across them a voltage, and it will be clear that this voltage might have any one of three possible phase-relationships with the voltage already present due to the signal. If it were in phase with the signal voltage the two would simply add, and the original voltage would be artificially increased. If it were 180° out of phase, on the other hand, this new voltage would be in opposition to that already there, and the energy fed through C_{ga} would tend to damp out and reduce the signal voltage. In the third case, which is of less interest, the voltage fed back from the anode is 90° out of phase with that already present, and would therefore neither help nor hinder it.

Since the alternating anode current of the valve is produced in response to the alternating voltage at its grid, the phase of the current is fixed with respect to the original signal voltage. The phase of the alternating voltage developed on the anode depends on the nature of the impedance Z_a , through which the current is made to flow. It can be shown that if Z_a is a pure resistance, the phase of the current fed back through C_{ga} is such as to produce no effect on the initial signal voltage at the grid. If Z_a is a capacity,

the energy fed back tends to damp out the voltage already present, while if it is an inductance, the energy fed back reinforces and increases the signal voltage on the grid.

In the case where Z_a is a capacity, the damping effect on the grid circuit can be exactly reproduced by connecting a resistance R of suitably chosen value across grid and cathode of the valve in the manner shown in Fig. 91 (b). But a little thought will make it clear that since the whole effect depends on the alternating voltage at the anode, changes in magnitude of this will alter the value of the equivalent damping resistance R . The higher the impedance of Z_a (or since we are considering the case where this is a capacity, the lower the value of this capacity) the higher will be the voltage developed, and hence the greater will be the damping effect in the grid circuit. Thus a high value of Z_a corresponds to a low value of R , reducing very markedly the voltage across the tuned circuit of Fig. 89, and flattening its tuning to a considerable extent. The magnitude of the damping depends also upon the frequency, becoming worse as the frequency is raised owing to the falling reactance of C_{ga} .

If the capacitive reactance of Z_a is made high (corresponding to a small value for C_3 in Fig. 89) the damping can be very serious indeed; with C_3 omitted altogether, so that the anode-circuit impedance for high-frequency currents consists only of the stray capacities across valve, valve-holder, and telephones, the energy fed back from anode to grid may be equivalent, for a signal at 1,000 kc/s, to connecting a resistance of as low a value as 5,000Ω between grid and cathode. Since the dynamic resistance of the tuned circuit L_1C_1 will probably be twenty times as great as this, the effect of the damping in dropping signal strength and flattening tuning is positively catastrophic.

The Anode By-pass

This explains the presence of C_3 in Fig. 89; it is inserted as a low impedance to the high-frequency currents so that the voltage developed at the anode may be as low as possible.

It might seem advisable so to design the receiver that the energy fed back either had no effect on the grid circuit or was in phase with the grid voltage and so helped to increase it. On paper, either might seem easy enough to arrange by making the anode circuit either resistive or capacitive, but we have to remember the stray capacities from anode to earth (about 20 μμF.) which are inevitably in parallel with any component we may insert in the anode circuit, as Fig. 91 (c) shows. A purely resistive circuit therefore cannot be built up; the nearest approach to it would be to connect, directly from HT+ to anode, a resistance low in comparison with the reactance (about 8,000 ohms at 1,000 kc/s.) of the stray capacities. Some 500 ohms would probably be effective, but since this

Foundations of Wireless—

would practically short-circuit the telephones, we should not be much better off.

To make the anode circuit inductive is an even more hopeless task. It requires that the bulk of the anode current should flow through an inductance, so that the coil would require to have a low reactance, again of the order of 500 ohms, to the high-frequency currents we are trying to render harmless. Its reactance to speech-frequency currents would be about one-thousandth of this; it would, therefore, short-circuit the telephones even more effectively than the resistance previously suggested.

Evidently there is no help for it; we must accept a capacitive circuit and try, by making the capacity as large as we dare, to reduce the high-frequency voltage at the anode so that the damping on

the tuned circuit becomes reasonably small. If we make C_3 , in Fig. 89, about 0.001 mfd., its reactance at 1,000 kc/s. will be little more than 150 ohms, while at the higher audio-frequencies (5,000 cycles) it will rise to 30,000 ohms, which will not be a very serious shunt to the telephones, and so will not cause too great a diversion of high notes from their windings. Like almost every other point in a wireless set, the choice of a capacity for C_3 is a compromise that tries to make the best of both worlds.

We can now rest satisfied that the circuit of Fig. 89, with the component values we have suggested, will perform its dual task of rectification and amplification as perfectly as its inherent limitations permit; in the next Part we shall go on to see what useful additions could be made to the basic circuit itself.

Random Radiations

By "DIALLIST"

Possible and Impossible Stations

MY recent note on the futility of publishing, as some of the lay papers are wont to do, lists of programme selections from unreceivable stations has brought me quite a few enquiries from readers. What I had chiefly in mind when I wrote was the choice of morning and early afternoon items from stations which are seldom well heard until after sunset. From this hour onwards there are comparatively few European stations that are not receivable from time to time in some kind of way. I was thinking also of the uselessness of choosing stations that are chronic sufferers from heterodyne interference. Those who have written want first of all to know which stations I regard as definitely unreceivable with any entertainment value.

To begin with the question of the locality of the receiving station is rather important. For instance, those who live on or near the North-East Coast may have fairly good daylight reception of stations that would be completely inaudible to dwellers in the Midlands or the West Country. Or, if you are using a good aerial on the South Coast you may receive French, Italian, and other stations that do not reach the more northerly parts. It is difficult, therefore, to say that certain transmissions are or are not receivable *everywhere* at particular times. All that one can do is to discover which stations come in and which do not in a locality where reception conditions are normally pretty good.

Proving the Pudding

The surest proof of all puddings lies in the eating. Hence I have spent two mornings and two afternoons in running over the medium and long wavebands with a set which, though not super-sensitive, is a pretty good all-round performer. Had more HF or IF amplification been used the list of stations might have been greater; but if you care anything about the signal-to-noise ratio there is a limit to the amount of such amplification that can usefully be employed.

Of the long-wave stations Radio Paris, the Eiffel Tower, Huizen, Luxembourg,

Zeesen, and Kalundborg were all reasonably good; but nothing else was really fit to listen to, save that on one afternoon I heard Warsaw fairly well.

On the Medium Waves

Amongst the stations selected by my daily paper at times between 9 a.m. and 5 p.m. were Beromünster, Budapest, Königsberg, Milan I, Prague, Sottens, Stockholm, Vienna, Katowice, Lyons and Zagreb. None of these could be heard at all, and I should class them as normally unreceivable between these hours at this time of year. Another paper's list included Bucharest, Trieste, Nürnberg and Toulouse. Of these, Nürnberg alone was audible, and it was so badly heterodyned as to be completely useless.

Here are the medium-wave stations that were heard: Breslau (generally pretty good), Brussels I (varying, but often worth while), Brussels II (generally good), Cologne (generally good), Frankfurt (mostly heterodyned), Nürnberg (always heterodyned), Stuttgart (good at times), Gleiwitz (weak), Fécamp (always good), Rennes (fair to moderate), Hilversum (good), Lille (very fair), the Poste Parisien (always good), Paris PTT (weak).

After Sunset

Sunset in this country was at a minute or two before six o'clock on the days when these tests were made. It would, of course, occur an hour earlier in countries such as Germany, Italy, Scandinavia, Hungary, and others which use Mid-European time. The way in which transmissions from these countries strengthened from about 5.30 onwards was very noticeable. Budapest, for example was to be heard a little before 6 p.m.; Leipzig, Munich, Prague, Rome, Stuttgart, Toulouse, Oslo and Bucharest also appeared at about the same time. From six o'clock onwards newcomers cropped up everywhere, and an hour later one could take one's pick of a score or more of good transmissions.

The behaviour of Frankfurt in daylight is rather interesting. As I have mentioned, it was invariably heterodyned; but as dark-

ness drew on the interference became less and less noticeable. Apparently the increase in Frankfurt's field-strength was not offset by a similar increase in that of the station which had been causing the whistle; hence after dusk Frankfurt was coming strongly enough to drown the interference.

**Television Censorship**

IT has been suggested seriously that, when the high-definition television service comes into being in this country, one of the most urgent needs will be for an efficient censorship. Myself, I feel that we can very safely leave it to the B.B.C. to put forth no images likely to offend even the most tender susceptibilities. If the still pictures with which they sought to regale us in Fultograph days are anything to go by, I think it possible that something like an uncensorship may prove more desirable.

Still, supervision, even stricter than that exercised over "sound" broadcasting, will no doubt be necessary. We have had in recent months one or two samples of the way in which alleged comedians can be devastatingly coarse by slipping in unrehearsed gags. A televised turn offers far greater opportunities for a performer to be vulgar without being funny.

**Is Droitwich a Poor Site ?**

THERE is no getting away from the fact that both the long-wave national and the medium-wave regional stations erected at Droitwich have so far produced rather disappointing results. The 150-kilowatt national has proved to have a service area a good deal smaller than was anticipated, and I have had several reports that the medium-waver fades badly in places where the old Daventry station used to be well received. All this rather makes one wonder whether Droitwich is really a good site for a transmitting station. Before it was finally selected extensive tests were made, and the results of these appeared to be entirely convincing. There seems, though, to be a nigger in the wood pile somewhere, and the process of tracking him down is a nice problem for the B.B.C. engineers.

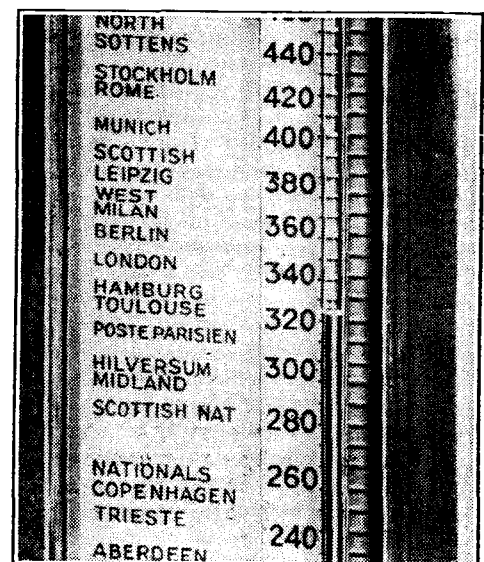

THERMOMETER TUNING. The scale of the new Cossor AC Superheterodyne Model 364 is exceptionally clear and easy to read. A moving metal rod, linked mechanically to the condenser spindle, simulates the column of the familiar thermometer. A corresponding long-wave scale is provided.